



CHAPTER

3

Signals

SECTION 3.1

USING FLASHING MODE AT SIGNALIZED INTERSECTIONS AND DEPLOYING FLASHING BEACONS

3.1.1 DEFINITIONS

Flashing Beacon: A highway traffic signal with one or more signal sections that light up intermittently. It can be used at an intersection to control traffic or elsewhere as a warning beacon.

Signal Face: An assembly of one or more signal sections that controls traffic movements on a single approach.

Signal Indication: The illumination of a signal lens.

Operating Traffic Control Signals in Flashing Mode

- **Non-Programmed Flashing Mode Operation:** The automatic shift from an intersection signal's normal operating mode (stop and go, steady red-yellow-green) to flashing mode (stop or caution, flashing red-yellow, or red) because of signal controller malfunction, a conflict in signal displays, or maintenance personnel or police manually selecting the flashing mode.
- **Programmed Flashing Mode Operation:** The automatic shift from an intersection signal's normal operating mode (stop and go, steady red-yellow-green) to flashing mode (stop or caution, flashing red-yellow or red) at set times during the day.

3.1.2 RECOMMENDATIONS FOR SIGNALIZED INTERSECTIONS

3.1.2.1 Programmed Flashing Mode Operation

Flashing mode is energy efficient and can save effort, money, and time. Consider the following before using this mode at a signalized intersection:

- Flashing yellow-red may be used when two-way traffic volumes on the main street are below 200 vehicles per hour.
- Flashing yellow-red may be used at any hour of the day or night when [Manual on Uniform Traffic Control Devices \(MUTCD\) Warrants 1 and 2](#) are not met and two-way main street volume is greater than 200 vehicles per hour, provided the ratio of main street to side street volume is greater than 4:1.
- If crashes or conflicts at an intersection increase after changing to flashing mode or crash severity increases, return the signal to normal operation.

- Signals set to normal operating mode (cycling through steady red, green, and yellow phases at intervals that maintain signal progression at an appropriate speed) can help prevent a "speedway effect."
- Use flashing mode only at intersections where side street drivers can easily see approaching main street traffic. Avoid using it at intersections with more than four legs, skewed intersections (greater than 15 degrees), or railroad-preempted signals.
- Limit flashing signal mode to a maximum of three non-consecutive periods within 24 hours.

3.1.2.2 Non-Programmed Flashing Mode

When a signal at an intersection malfunctions during normal operation, it will immediately switch to flashing mode without a clearance interval.

3.1.3 FLASHING MODE APPLICATIONS

Use the following signal flashing mode and start-up sequences:

3.1.3.1 Yellow-Red Flashing Mode

Main Street: Flashing yellow during flashing mode, then steady green on start-up sequence.

Arrow Turn signals: Flashing red signal arrows during yellow-red flashing mode, then steady red arrow on start-up sequence.

Side Street: Flashing red during flashing mode, then steady red on the start-up sequence.

3.1.3.2 Red-Red Flashing Mode

Main Street: Flashing red during flashing mode, then steady green on the start-up sequence.

Arrow Turn signals: Flashing red signal arrows during red-red flashing mode, then steady red arrow on start-up sequence.

Side Street: Flashing red during flashing mode, then steady red on the start-up sequence.

3.1.4 SIGNAL FACES IN FLASHING MODE

[MUTCD Section 4G.03](#) requires all signal faces on an approach (including yellow or red turn signal indications) to be flashed when the signal is in flashing mode.

Do not illuminate pedestrian signal indications (*WALK* and *DON'T WALK*) at a signalized intersection when flashing mode is on.

3.1.5 FLASHING INDICATION COLORS

Consider the following when determining whether to flash red or yellow circular or arrow:

- Set flashing display for each signal-controlled approach, including separately-controlled turn movements.
- Flash the same color on all signal faces at an approach. Separate signal faces for separately-controlled turn movements may be flashed as described in [MUTCD Section 4G.03](#).
- There is no need to shield or position flashing yellow indications for through traffic from drivers in separately-controlled turn lanes but do shield separate protected turn movement signals from through traffic. See [MUTCD Section 4F.10](#), [Section 4F.11](#), [Section 4F.12](#), [Section 4F.13](#), [Section 4F.14](#), and [Section 4F.15](#) for additional guidance.
- When programming a signal with only arrow indications to flashing mode, flash the appropriate red or yellow arrow indication.
- When a signal face includes both circular and arrow indications of the desired color, flash only the circular indication of that color. When a five-section head is used, flash the same color as for the approach through lanes. When the traffic signal is in flashing mode, only circular red or circular yellow indications will flash.
- Do not immediately follow a steady green or flashing yellow indication with a steady or flashing red indication without displaying the steady yellow indication. Transitioning from a steady green to a flashing yellow indication is acceptable without displaying the steady yellow indication. This applies to both the circular and arrow indications. A transition from stop-and-go to flashing mode, whether initiated by a signal conflict monitor or a manual switch, may be made at any time.

Main Street, Through Traffic: From flashing yellow to steady green.

Main Street, Separate Left Turn: From flashing red to steady red.

Side Street, Through Traffic: From flashing red to steady red.

Keep green arrow indications that are continuously illuminated during normal operations continuously illuminated during flashing mode.

3.1.6 INTERSECTION CONTROL BEACONS INSTALLATION AND OPERATION REQUIREMENTS

When replacing or installing new intersection control beacons (ICB), design the traffic control devices with a minimum of two 12-inch signal indications for all approaches. Place the indications facing each intersection approach and center the indications within the approach lanes as much as possible. Separate the approach indications laterally by a minimum of 8 feet. Flash the horizontally-aligned indications simultaneously to avoid confusion with grade crossing signals.

Treat each intersection approach independently. For instance, on a divided highway, use a single dual-indication beacon assembly for each approach.

Two vertically-aligned signal faces for each ICB signal indication may be used and flashed alternately to improve driver awareness of the intersection control.

Figure 3.1-1. Intersection Control Beacon



3.1.7 OTHER FLASHING BEACON APPLICATIONS

Flashing beacons may be used to make warning, posted speed limit, and stop signs more conspicuous as detailed in [MUTCD Section 4S.03](#), [Section 4S.04](#), and [Section 4S.05](#), respectively. These beacons may have one or more signal sections of a standard traffic signal control face and flash accordingly.

SECTION 3.2

GUIDELINES FOR LEFT TURN TREATMENTS

3.2.1 PURPOSE

This section provides guidelines on selecting the type of left turn treatment, as defined in [MUTCD Section 4F.02](#).

3.2.2 LEFT-TURN SIGNAL PHASING

When selecting the type of left-turn phasing at an intersection approach with an established need for this type of control, apply the guidelines below and exercise sound traffic engineering judgment. The types of left-turn treatments include:

Permissive-Only Mode: Drivers can turn after yielding to opposing traffic and pedestrians. When a circular green indication is displayed, both directional turns are permitted unless otherwise prohibited by another traffic control device. A flashing yellow arrow may be displayed to indicate a permissive turning movement in either protected/permissive mode or permissive-only mode. When a flashing yellow or red arrow is displayed, the turn indicated by the arrow is permitted.

Protected-Only Mode: Drivers can turn when a green arrow indication is displayed.

Protected/Permissive Mode: A combination of protected and permissive modes can occur during the same cycle. Turning vehicles have the right of way during the protected phase and can complete the turn "permissively" when the adjacent through movement receives its circular green indication.

Split Phasing: Assigns right of way to all movements on a particular approach, followed by all the movements on the opposing approach.

Variable Left-Turn Mode: The operating mode changes among protected-only, protected/permissive, or permissive-only modes during different periods of the day or as traffic conditions change.

Use the protected/permissive mode for all intersection approaches requiring a left-turn phase unless there is a compelling reason to use another mode. If it is not obvious whether protected/permissive or protected-only mode is best, use protected/permissive mode on a trial basis. If operations are satisfactory, retain it. If they are not, convert to protected-only mode.

Engineers may vary the left-turn mode on an approach throughout the day between the permissive-only, protected/permissive, or protected-only left-turn modes, where an engineering study shows this type of operation can improve safety and operations.

Apply protected-only mode at an intersection approach if any of the following conditions are present:

- There are two or more left-turn-only lanes.
- Geometric conditions requirements cannot be met (e.g., horizontal and vertical curve, intersection skew angle, cone of vision) and resulting sight distance makes protected-only mode necessary.
- The approach is the lead portion of a lead/lag intersection phasing sequence.
- There is an offset left-turn lane. These do not meet the [MUTCD Section 4D.07](#) cone of vision requirements for a shared signal display.

Consider a protected-only mode under any of the following conditions:

- The opposing traffic speed limit is higher than 45 mph.
- Left-turning traffic must cross three or more lanes of opposing through traffic.
- A protected/permissive mode is in use and there are more than six left-turn angle crashes caused by left-turning drivers on the approach within a 12-month period.
- Unusual intersection geometry, such as restricted sight distance, makes permissive left turning confusing or hazardous.

A permissive/protected mode can be used for some intersection approaches if the traffic engineer determines that better progression, as demonstrated in a traffic signal analysis, justifies violating driver expectations. However, limit the use of this type of left-turn phasing and restrict it to the following situations, which will not create a left-turn trap:

- T-intersections where U-turns are prohibited.
- Four-way intersections where the opposing approach prohibits left turns or has protected left-turn phasing.
- Four-way intersections where left-turn volumes from opposing approaches do not change substantially throughout a normal day, so overlap phasing is not beneficial or required.

Split phasing can be used effectively if any of the following conditions apply:

- Opposing approaches are offset so far from each other that simultaneous left turns from opposing directions are not viable or are hazardous.
- Left-turn volumes are extremely heavy on opposing approaches, and both are nearly equal to the adjacent through movement critical lane volume.
- Left-turn volume is extremely heavy on an approach that does not have a separate left-turn lane.
- Drivers can turn left from more than one lane and may also use the rightmost left-turn lane to travel through.

3.2.3 LEFT-TURN SIGNAL DISPLAYS

The signal displays to be used with the various types of left-turn phasing are listed below. See [MUTCD Section 4F.02](#) for additional guidance.

Protected/Permissive Mode: Use a five-section signal head centered over the lane line between the left-turn lane and the leftmost through lane. The five-section signal head can serve as one of the two required through traffic signal heads. Do not provide supplemental signing for a five-section signal head. A four-section signal head with flashing yellow arrow (FYA) can also be used for protected/permissive mode. Use arrows with the red, yellow, and green signal faces with the four-section signal head. See **TEM Section 3.10** for additional guidance on FYA display.

Protected-Only Mode with a Single Left-Turn Lane: Center a three-section vertical or horizontal signal head over the left-turn lane. From top to bottom—or left to right on a horizontal signal head—display the left-turn arrows in the following order: red, yellow, and green.

Protected-Only Mode with Two or More Left-Turn Lanes: Use at least two three-section vertical or horizontal signal heads, as described above, centering one signal head over each left-turn lane.

Split Phasing: Center a five-section signal head over the lane line between the left-turn lane and the leftmost through lane. The five-section signal head can serve as one of the two required through traffic signal heads. Do not provide supplemental signing.

Variable Left-Turn Mode: Follow the display guidance above dependent on the programmed left-turn modes (permissive-only, protected/permissive, or protected-only).

3.2.4 SIGNAL DISPLAY FOR EXCLUSIVE LEFT-TURN LANE

Do not place a three-section (red, yellow, and green) signal head over an exclusive left-turn lane unless the signal phasing sequence allows a protected left-turn movement during the cycle.

3.2.5 LEFT-TURN PHASES FOR SEPARATED LEFT AND THROUGH LANES

Left-turn lanes at signalized intersections separated from through lanes by raised islands or painted gores may operate in several modes: protected-only, protected/permissive, or permissive-only. When choosing protected/permissive mode, use a five-section signal or a four-section FYA signal. Make it clear the signal is shared by placing it overhead on the lane line between the through lane and the island. In all cases, follow the cone of vision requirements in [MUTCD Section 4D.07](#).

Figure 3.2-1 uses standard lane widths for a four-lane divided highway. **Table 3.2-1** shows the maximum island or gore width allowed for the indicated signal head distance from the stop line without shifting the signal head.

Figure 3.2-1. Signal Head/Left-Turn Treatment

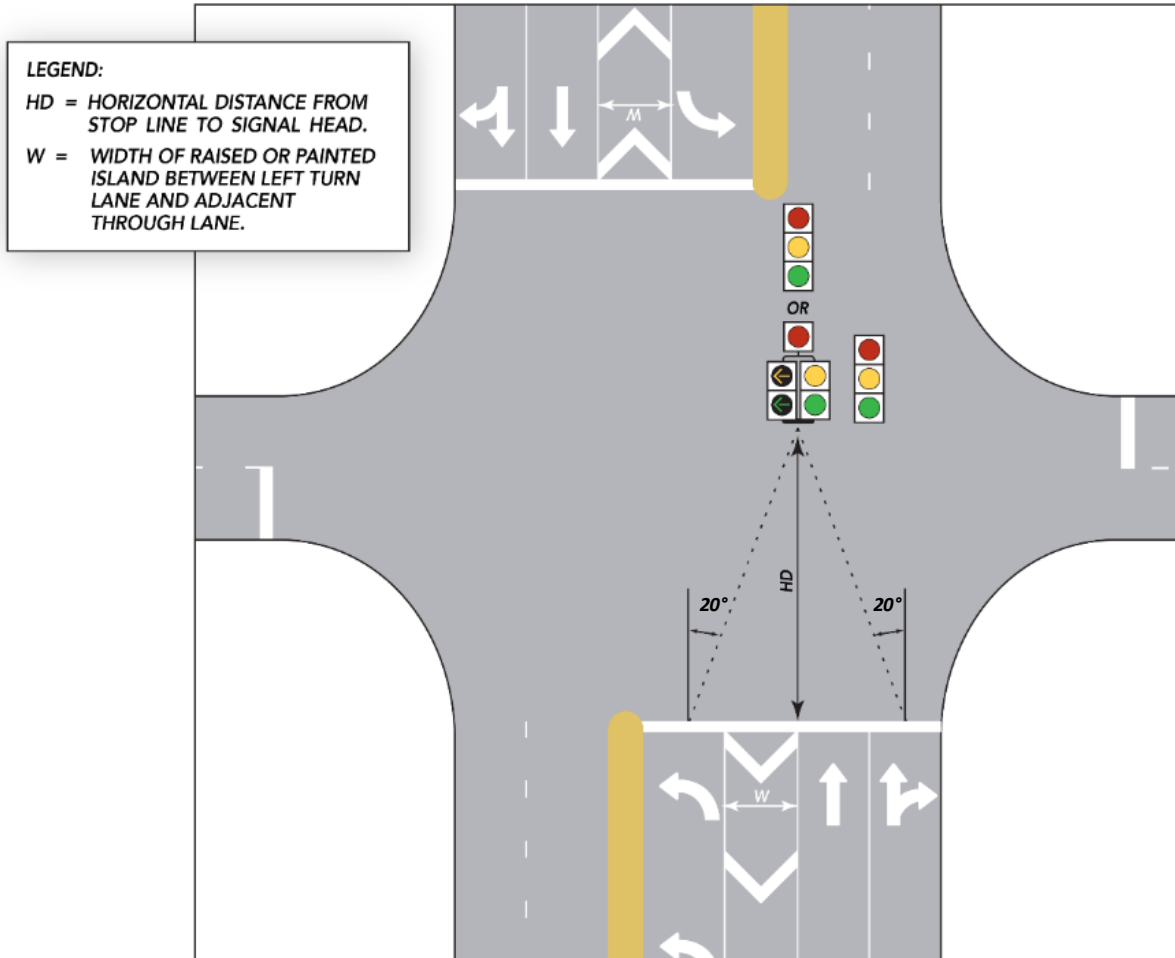

Table 3.2-1. Maximum Width of Island or Gore Without Shifting Signal Head

Horizontal Distance (feet)	Width (feet)
40	8
50	12
60	15
70	19
80	23
90	26
100	30
110	34
120	37
130	41
140	44
150	48

Do not use signals with circular green indications above an exclusive left-turn lane or the extension of the lane for a permissive-only left turn. Do not post-mount the signals on the far side median in front of the left-turn lane.

If positioning a shared signal head on the lane line adjacent to the nearest through lane does not meet cone of vision requirements due to an offset left-turn lane's separation or geometric conditions, the shared signal face may be offset to the left from the adjacent through lane line. This will ensure cone of vision requirements are met for the rightmost through lane and the left-turn lane. See **Figure 3.2-2** for a schematic representation of this offset.

Use this lateral offset spacing only after other options, such as increasing the horizontal distance to the signal heads, have been considered. Place the signal so it is obvious to drivers that it is shared. Generally, keep the lateral offset spacing of the shared signal head from the adjacent through lane no greater than one-half the island's width ($\frac{1}{2}W$).

If the lateral shift is too great, the cone of vision may not be adequate for the driver in the rightmost through lane. This may be due to a large parallel offset left-turn lane or a tapered or curved offset left-turn lane. When the cone of vision requirements cannot be met, a protected-only mode must be used.

Figure 3.2-2 Left-Turn Lane Signal Head Shift

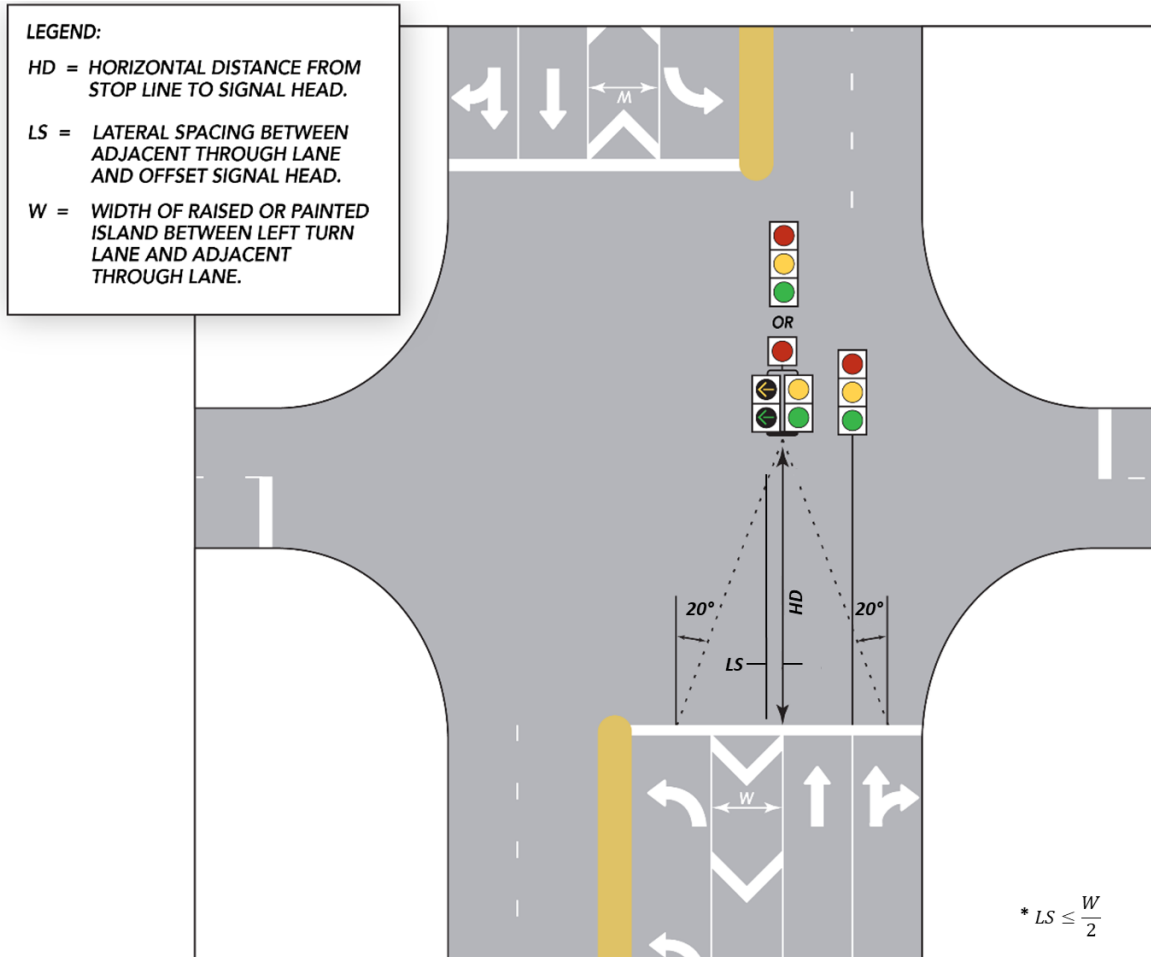

3.2.6 PERMISSIVE-ONLY MODE IN MULTI-LEFT-TURN-LANE APPROACHES

Do not use a permissive green interval for two or more left-turn lane approaches.

SECTION 3.3

SCHEDULING INTERSECTION CONTROL EVALUATIONS AND SECURING FUNDING

3.3.1 PURPOSE

This section establishes criteria for responding to requests to install traffic signals; conducting related studies, such as intersection control evaluations (ICE), to determine need and appropriate intersection control strategy; and securing funding and arranging implementation for warranted signals.

3.3.2 GENERAL

FDOT is responsible for developing statewide guidelines and maintaining uniform traffic control devices to regulate, manage, guide, and protect all State Highway System users. FDOT must respond uniformly to all signal requests and schedule and conduct traffic studies accordingly. If an intersection meets signal warrants, follow the procedure described in FDOT's [Manual on Intersection Control Evaluation](#) to determine the appropriate intersection control strategy.

3.3.3 RESPONSE TO SIGNAL REQUESTS AND SCHEDULING TRAFFIC SIGNAL STUDIES

Before committing resources for a signal warrant study, the [District Traffic Operations Office](#) reviews all traffic signal installation requests received by FDOT. This initial screening includes reviewing existing information and local knowledge of the intersection and may require a brief site visit to confirm field conditions. All data collected during the initial screening is kept on file in writing. Reviewers will attempt to relate all data and analysis to [MUTCD](#) standards.

If the initial screening prompts FDOT to conduct a signal warrant study, the appropriate District Traffic Operations Office will contact the local maintaining agency, advise them of FDOT's decision, and obtain their views and input. The District Traffic Operations Office will also advise the local maintaining agency that if signal warrants are met, an ICE analysis will be required to determine the appropriate intersection control strategy.

If FDOT decides not to further consider a signal warrant study based on the initial screening results, the District Traffic Operations Office will document the reasons and share a copy of the findings with the requestor and local maintaining agency.

Though local government support is ideal, FDOT may commit resources to a signal warrant study and subsequent ICE analysis without it if a signal is warranted.

The District Traffic Operations Office normally conducts signal warrant studies for intersections on the State Highway System, but a local maintaining agency may conduct a signal warrant study and submit it to the District Traffic Operations Office for review. All studies must follow the procedure and standards in this document and be signed and sealed by a Florida-licensed professional engineer.

If the signal warrant study shows installing a new traffic signal is warranted, the District Traffic Operations Office or local maintaining agency will conduct an ICE analysis to determine the appropriate intersection control strategy.

Formal legal resolutions from local agencies may form the basis of their concurrence in the need for a signal warrant study. However, such documents are required by FDOT as a prerequisite to scheduling the study. Implementation funds do not need to be available before assessing traffic signalization needs (conducting a study).

The District Traffic Operations Office keeps a log of requests for signal warrant studies and their outcomes. To the extent practical, they will prioritize signal warrant study scheduling based on request date, traffic volumes, crashes (frequency, type, injury levels), and the degree of local government interest.

3.3.4 TRAFFIC SIGNAL STUDIES

Traffic signal studies, ICE analyses, and other required planning and engineering services for traffic signals or alternative intersections on the State Highway System can be undertaken by FDOT staff, local agency engineers, or qualified consulting engineers. FDOT, however, is responsible for requiring and overseeing all such work.

Complete all traffic signal studies as described in FDOT's [*Manual on Uniform Traffic Studies \(MUTS\), Chapter 2*](#). Comply with FDOT's [*Manual on Intersection Control Evaluation*](#) for any ICE analyses. Plans and specifications, if required, need to comply with established FDOT procedures.

The developer must cover the cost of traffic signal studies, ICE analyses, or engineering analyses for new private access points to major traffic generators or proposals to significantly revise access points. Qualified traffic engineers must conduct all studies.

These studies are typically part of the Driveway Permit Application, as laid out in the requirements of [*Rule 14-96*](#). A Driveway Permit Application for Categories E, F, and G standard connection categories is required to conduct ICE analysis and have the analysis approved by both the District Design Engineer and the [*District Traffic Operations Engineer \(DTOE\)*](#), in accordance with FDOT's *Manual on Intersection Control Evaluation, Section 2.3(1)(d)*.

In addition to evaluating the need for signal control at unsignalized intersections and alternative intersection forms from the ICE analyses, these studies must also consider enhanced features at upstream and downstream signalized intersections as needed. All

studies and reports must be signed and sealed by a Florida-licensed professional engineer.

The developer is also normally responsible for engineering costs associated with preparing implementation plans and specifications. In some cases, specific critical design needs may require FDOT staff to perform engineering work. In these cases, the District Secretary may direct FDOT staff to complete the engineering work at no cost to the developer.

Engineering studies at existing private access points due to normal traffic growth are usually made by qualified traffic engineers hired and paid by the requestor. In extraordinary situations FDOT may elect to do this work.

3.3.5 FUNDING ARRANGEMENTS FOR WARRANTED NEW SIGNAL INSTALLATIONS

Funding for new traffic signals or alternative intersections recommended by an ICE analysis on the State Highway System may come from any combination of private, local, state, or federal sources.

If the improvements are required by a new or revised Driveway Permit or local government Development Order, the developer must fully fund them. This includes planning, engineering, and construction for any new traffic signal, alternative intersection, or enhancements to existing traffic signals specified in the Permit or Order.

If the developer's proposals to install signals or alternative intersections or to modify existing signalization exceed the minimum required by the Permit or Order and improve the State Highway System substantially beyond mitigating development impacts, FDOT may consider assuming some of the cost. In that event, district secretaries will determine an appropriate financial participation formula and assign a percentage to the developer related to the specific conditions at each site.

FDOT is responsible for installing traffic signals and constructing alternative intersections on the State Highway System, but local maintaining agencies can voluntarily cover some or all of the costs based on their cooperative agreements with FDOT's District Offices. Local funds are most often used to advance the implementation schedule. When local funds are accepted by FDOT, both parties must execute a formal joint project agreement.

Most local governments in Florida's urban areas have qualified traffic engineering units with experienced traffic signal field crews. Local agency crews have installed new signals on the State Highway System with control hardware supplied by FDOT. The Department encourages this approach when the local maintaining agency is agreeable. Since most of these agencies maintain and operate these sites themselves, this partnership is encouraged. No formal agreement is needed since no money is changing hands, but FDOT needs to request a letter from the local maintaining agency agreeing to install FDOT-supplied hardware.

3.3.6 OTHER CONSIDERATIONS

Follow the study guidelines provided in the [*Manual on Intersection Control Evaluation*](#) before finalizing an intersection improvement recommendation.

Follow the [*Approved Product List Submittal Process*](#) provisions before purchasing, using, or installing traffic signals.

If a local agency agrees to maintain the signal, add the signal to **Exhibit A** of the [*Traffic Signal Maintenance and Compensation Agreement*](#) with that agency.

SECTION 3.4

EMERGENCY TRAFFIC CONTROL SIGNALS

3.4.1 PURPOSE

This section gives guidance for warranting, designing, and operating emergency traffic control signals at locations where emergency vehicles—most commonly fire trucks—enter the street system.

3.4.2 BACKGROUND

FDOT's district offices often receive local agency requests for traffic signal control for departing emergency vehicles. This section offers comprehensive guidance to determine if an emergency signal is warranted.

3.4.3 PROCEDURE

An emergency traffic control signal shall be considered necessary if an engineering study finds that one of the following warrants is met:

- When minimum traffic volumes are met for the peak hour or for 24 hours (both travel directions based on Signal Warrant 2), as shown in **Table 3.4-1**.

Table 3.4-1. Minimum Traffic Volumes

Roadway	Peak Hour (VPH)	24 Hours (ADT)
Two lanes	750	7,500
Four lanes	900*	9,000*
Six lanes or more	1,200*	12,000*

*Increase values by one-third when the arterial has traffic signal system coordination with signals located within 1,000 feet in both directions of the emergency signal location.

- When the emergency vehicle facility requires returning emergency vehicles to back in, blocking the roadway, and emergency vehicle lights and flaggers are inadequate to control traffic volume or speeds.
- When the emergency vehicle driveway is consistently blocked by traffic queues from adjacent signalized intersections. Consider using a *DO NOT BLOCK INTERSECTION* sign (**R10-7**) in conjunction with installing the emergency signal.

- On all approaches when vertical or horizontal curvature or other obstructions do not provide adequate stopping sight distance for traffic approaching an emergency vehicle driveway.

3.4.4 EMERGENCY SIGNAL CONFIGURATION AND OPERATION

[MUTCD Section 4M.03](#) defines the operational requirements for locating an emergency signal mid-block. The **MUTCD** allows either a steady green or flashing yellow signal when emergency vehicles are not entering the roadway.

For new or reconstructed emergency signal installations, follow the criteria below:

- Provide dual signal faces for each roadway approach. Install two signal faces for the emergency vehicle driveway, the minimum required is one signal face.
- If the emergency service is off the main roadway and emergency vehicles access it by the minor street, emergency signals may be installed at the intersection of these roadways. Use dual signal faces on the minor street, with the signals resting on the flashing red mode.
- Operate mid-block emergency signals in flashing yellow mode when emergency vehicles are not entering the roadway. Use a three-section roadway signal head operated as shown in **Figure 3.4-1**. The engineer may use LEDs or solar-powered signals when permitted by the local maintaining agency.
- At signalized intersections pre-empted by emergency vehicles, determine signal operations on an individual basis.

During the evaluation of an emergency signal, consider site-specific factors for its implementation. These may include the route distance between the intersection and emergency vehicle driveway, intersection geometrics, number of lanes, normal queue length, and traffic volumes.

3.4.5 EMERGENCY SIGNAL SIGN (R10-13)

As emergency signals are installed along major arterials where emergency vehicles enter the roadway, place **EMERGENCY SIGNAL** signs (**R10-13**) on the span wire or mast arm to alert drivers to the signal's purpose.

Mount the **EMERGENCY SIGNAL** sign (**R10-13**) between the dual signal faces on each roadway approach.

No sign is required for the emergency vehicle driveway approach.

3.4.6 OTHER REQUIREMENTS

Include a controller timing chart in the contract plans.

FDOT requires a Traffic Signal Maintenance and Compensation Agreement for all emergency signals on the State Highway System.

FDOT requires a signal timing study to determine proper clearance intervals.

Figure 3.4-1. Mid-Block Emergency Signal Operation

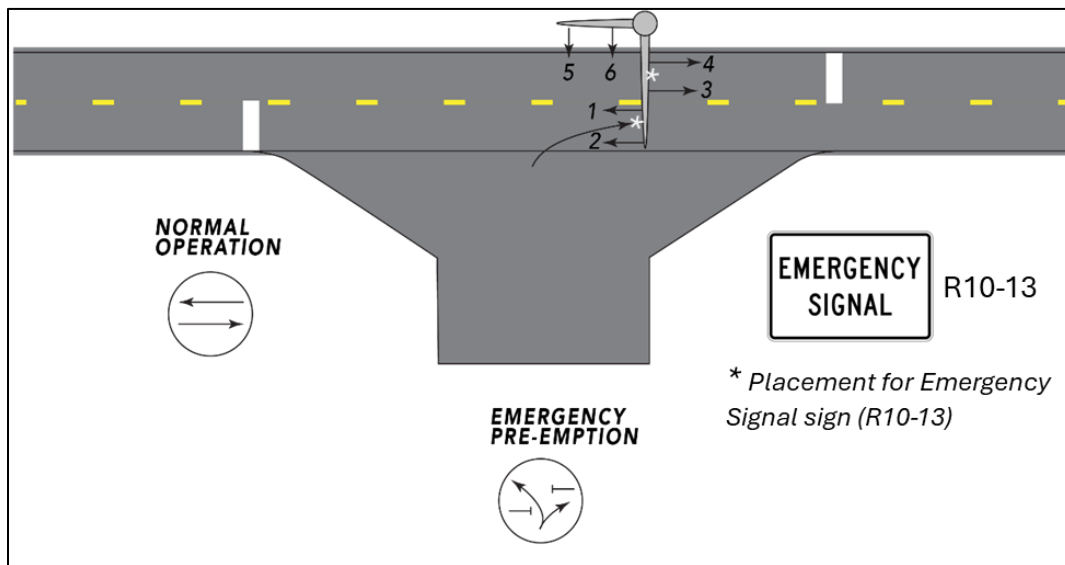

NORMAL OPERATION	CHANGE TO EMERGENCY PREEMPTION	EMERGENCY PREEMPTION	CHANGE FROM EMERGENCY PREEMPTION	RELEASE
<u>Signal 1, 2, 3, 4</u> 	<u>Signal 1, 2, 3, 4</u> 	<u>Signal 1, 2, 3, 4</u> 	<u>Signal 1, 2, 3, 4</u> 	<u>Signal 1, 2, 3, 4</u>
<u>Signal 5, 6,</u> 	<u>Signal 5, 6,</u> 	<u>Signal 5, 6,</u> 	<u>Signal 5, 6,</u> 	<u>Signal 5, 6,</u>

SECTION 3.5

TRAFFIC SIGNAL MAST ARM SUPPORT BOUNDARIES

3.5.1 GENERAL

Comply with the Mast Arm Structures Boundary Maps when selecting the appropriate support for traffic signal installations on the State Highway System. See [FDM 232.8.1](#) for more information.

3.5.2 IMPLEMENTATION

3.5.2.1 Mast Arm Structures Boundary Maps

The Mast Arm Structures Boundary Map follows an alignment of state roads to the coastline. Official mapping of district-specific boundaries is available at this location: <https://www.fdot.gov/traffic/trafficservices/pdfs/districts>.

SECTION 3.6

YELLOW CHANGE AND RED CLEARANCE INTERVAL STANDARDS FOR SIGNALIZED INTERSECTIONS

3.6.1 PURPOSE

This section outlines standards for timing yellow change and red clearance intervals at signalized intersections. These intervals provide a consistent transition between conflicting traffic signal phases. A yellow change interval warns drivers they will soon need to stop and allow conflicting traffic the right of way. A red clearance interval allows time for drivers to clear the intersection before conflicting traffic is given a green indication.

Program a yellow change interval to last 3 seconds at a minimum but no more than 6 seconds, as described in [MUTCD Section 4F.17](#). Program a red clearance interval not to exceed 6 seconds. These standards apply to the following conditions on the State Highway System:

- New traffic signal installations
- All traffic infraction detector installations
- Signal phasing changes
- Geometric changes affecting timing or phasing
- Corridor retiming projects

3.6.2 STANDARD

[Section 316.075\(3\)\(a\), F.S.](#) prohibits the use of any traffic control signal that does not display a yellow or "caution" indication between the green or *GO* indication and the red or *STOP* indication. The statute is silent on how long the yellow indication should last and does not mention or mandate the use of a red clearance interval.

3.6.2.1 Yellow Change Interval

To calculate the yellow change interval, use the formula from the Institute of Transportation Engineers (ITE) publication *Determining Vehicle Signal Change and Clearance Interval* (1994), shown below as **Formula 3.6-1**.

Formula 3.6-1 was used to calculate the Florida yellow change intervals shown in **Table 3.6-1**. These intervals are the required standard minimum values. The calculations use a perception reaction time of 1.4 seconds and a grade of 0%. Do not use a perception

reaction time shorter than 1.4 seconds per [Traffic Engineering and Operations Bulletin 02-13](#).

The approach speed in **Table 3.6-1** and **Formula 3.6-1** is the posted speed limit for the approach being analyzed.

If **Formula 3.6-1** produces a value lower than the one in **Table 3.6-1** for a given posted speed limit, use the corresponding value in **Table 3.6-1**. Do not program yellow change intervals shorter than the standard values in **Table 3.6-1**.

Yellow change intervals longer than the standards for posted speed limits in **Table 3.6-1** are allowed, but base them on [MUTCD Section 4F.17](#), engineering practice, and **Formula 3.6-1**. Do not program a yellow interval longer than 6 seconds.

Do not use the extended kinematic model included in ITE's **Guidelines for Determining Traffic Signal Change and Clearance Intervals** (2020) to calculate the minimum yellow change interval.

Round up yellow change and red clearance interval times to the nearest 0.1 second.

Table 3.6-1. Florida Yellow Change Interval (0.0% Grade) Standard *

Approach Speed (mph)	Yellow Interval (seconds)
25	3.4
30	3.7
35	4.0
40	4.4
45	4.8
50	5.1
55	5.5
60	5.9
65	6.0

* For approach grades other than 0%, use **Formula 3.6-1**.

Formula 3.6-1

$$Y = t + \frac{1.47v}{2(a + Gg)}$$

Where:

- Y = Length of yellow interval, in seconds
- t = Perception-reaction time (use 1.4 seconds)
- v = Speed of approaching vehicles, in mph
- a = Deceleration rate in response to the onset of a yellow indication (use 10 ft/sec²)
- g = Acceleration due to gravity (use 32.2 ft/sec²)
- G = Grade, with uphill positive and downhill negative (percent grade/100)

3.6.2.2 Red Clearance Interval

Always include a red clearance interval at a signalized intersection. Allowing enough time for drivers to clear the intersection after their signal phase turns red can reduce the number of angle crashes, even if some drivers run the red indication.

Compute the red clearance intervals using the appropriate formula from ITE's *Determining Vehicle Signal Change and Clearance Interval* (1994), which is shown below as **Formula 3.6-2**.

Formula 3.6-2

$$R = \frac{W + L}{1.47v}$$

Where:

- R = Length of red interval, in seconds
- W = Width of the intersection, in feet, measured from the near-side stop line to the far edge of the conflicting traffic lane along the actual vehicle path
- L = Length of vehicle (use 20 feet)
- v = Speed of approaching vehicles, in mph

The red clearance interval must be between 2 and 6 seconds long. Engineers may program red clearance intervals longer than the values calculated using **Formula 3.6-2** at their discretion. A longer red clearance interval may be appropriate for wide or complex intersections or those with a crash history or limited sight distance. Any interval extension must meet the minimum/maximum guidance for red clearance intervals.

National Cooperative Highway Research Partnership (NCHRP) [Report 731: Guidelines for Timing Yellow and All-Red Intervals at Signalized Intersections](#) recommends using a modified ITE formula that allows for a 1.0-second reduction in the red clearance interval values computed using **Formula 3.6-2**. This accounts for reaction time delay from conflicting traffic. Use engineering judgment when exercising this option, but do not program a red clearance interval shorter than 2.0 seconds.

SECTION 3.7

ACCESSIBLE PEDESTRIAN SIGNALS

3.7.1 PURPOSE

This section establishes criteria for installing and operating accessible pedestrian signals (APS) on the State Highway System. These traffic control devices provide information non-visually, using audible tones, speech messages, or vibrating surfaces.

3.7.2 GENERAL

The standards for APS on public roadways are set in [MUTCD Sections 4K.01 to 4K.05](#). Additional guidance for their installation is available in [MUTCD Section 4I.06](#). Review these **MUTCD** sections when addressing requests to install APS.

3.7.3 PROCEDURE

Obtain [DTOE](#) approval to install APS at signalized intersections and signalized midblock crossings on the State Highway System.

The DTOE reviews requests from the public, maintaining agencies, public agencies, and support groups for people with visual impairments to install APS. The DTOE may request input from public agencies and organizations that support people with visual impairments to determine if a given APS installation would be effective and safe for users.

An engineering study will follow if the DTOE's preliminary review supports installing APS. When conducting the engineering study, consider the needs of all pedestrians, not just those with visual impairments.

Consider the following features when reviewing requests to install APS:

- Potential demand for APS
- Right-on-red movements
- Free-flow right-turn movements
- Signal phasing complexity
- Intersection geometry complexity
- Traffic volumes during times when pedestrians might be present
- Audible tones or sounds that may cause confusion
- Verbal messages instead of tones or sounds

- Vibrotactile pedestrian devices
- Pushbutton versus passive pedestrian detectors
- APS automatic volume adjustment, not to exceed 100 dBA (decibels), in response to ambient traffic sound level
- Additional geometrics, operations, and pedestrian safety considerations at locations with more than four lanes or posted speed limits greater than 35 mph

3.7.4 APS REQUEST REVIEW PROCESS

DTOEs review all requests for APS installations on the State Highway System, either directly or through engineering studies. The ***DTOEs*** consider the needs of all pedestrians in the review, not just those with visual impairments.

The initial review may require site visits to verify field conditions. FDOT records and maintains all data gathered during the initial screening. Reconcile all data and analysis with **MUTCD Sections 4K.01 to 4K.05** standards. Although local government concurrence is desirable, it is not a prerequisite for committing FDOT resources for an APS installation.

If the ***DTOE*** denies an APS installation after the initial review, document the reasons, advise the requestor of the review findings, and provide the local government with a copy.

SECTION 3.8

CALCULATING RAILROAD TRAFFIC SIGNAL PREEMPTION TIME

3.8.1 PURPOSE

This section describes how to determine the required preemption time for a traffic signal adjacent to a highway at-grade rail crossing with an active warning system.

3.8.2 GENERAL

This comprehensive guidance on calculating signal preemption time adheres to [Rule 14-57.013\(5\), F.A.C.](#)

A preemption phase is required at any signalized intersection within 200 feet of a grade crossing. Set this as part of the active grade crossing traffic control device design.

For signalized intersections within 200 to 500 feet from a grade crossing, complete an engineering study to determine if preemption is needed.

Consider preemption for signalized intersections more than 500 feet from a grade crossing if traffic queues past the grade crossing or there is potential for that condition to develop.

Consult and coordinate with the appropriate railroad agency, the [District Rail Office](#), and the [DTOE](#) before implementation.

3.8.3 DEFINITIONS

Advance Preemption (AP): The length of time before activation of railroad warning devices that a highway traffic signal controller unit or assembly is notified of an approaching train.

Clear Storage Distance (CSD): The distance available for vehicle storage measured between 6 feet from the rail nearest the intersection to the intersection stop line or the normal stopping point on the highway.

Controller's Equipment Response Time to Preempt (CERTP): The time that elapses while the controller electronically registers the preempt call.

Design Vehicle (DV): The longest vehicle permitted by statute of the road authority (State or other) on a given roadway.

Design Vehicle Clearance Distance (DVCD): How far, in feet, the design vehicle must travel to enter and completely pass through the railroad crossing's minimum track clearance distance. This is the sum of the minimum track clearance distance and the total design vehicle's length. Design vehicle length can be found in [FDM 201](#).

Design Vehicle Clearance Time (DVCT): How long it takes for the design vehicle to accelerate from a stop and travel through and clear of the minimum track clearance distance.

Desired Minimum Separation Time (DMST): A time buffer between the departure of the last vehicle (the design vehicle) from the railroad crossing and the arrival of the train.

Maximum Highway Traffic Signal Preemption Time (MHTSPT): The maximum time a highway traffic signal needs after initiating the preemption sequence to finish timing the right of way transfer time, queue clearance time, and separation time.

Minimum Green Time During Right of Way Transfer (MGTRT): The minimum number of seconds any existing phase will display a green indication before the controller unit terminates the phase through its yellow change and red clearance intervals and transitions to the track clearance green interval. A 5-second interval is recommended to make the transition to the track clearance green interval as rapid as possible.

Minimum Track Clearance Distance (MTCD): The length along the highway at one or more railroad tracks, measured from the portion of the railroad crossing automatic gate arm farthest from the near rail to 6 feet beyond the tracks measured perpendicular to the far rail.

Minimum Walk Time During Right of Way Transfer (MWTRT): The minimum pedestrian *WALK* indication time before the preemption sequence begins. FDOT recommends a 5-second interval to make the transition to the track clearance green interval as rapid as possible.

Other Green Time During Right of Way Transfer (OGTRT): Any additional green time beyond the preempt minimum green time for the worst-case vehicle phase.

Pedestrian Clearance Time During Right of Way Transfer (PCTRT): The pedestrian clearance (i.e., flashing *DON'T WALK* indication) time for the worst-case pedestrian phase. A zero value is allowed for the most rapid transition to the track clearance green interval.

Preemption: The transfer of normal traffic control signal operation to a special control operation mode.

Preempt Delay Time (PDT): The number of seconds the traffic signal controller is programmed to wait from the initial receipt of a preempt call until the call is verified and considered a viable request for transfer into preemption mode.

Preempt Trap: A potential hazard condition that happens when the gates do not block vehicle access to the crossing before the expiration of the track clearance green. Vehicles can continue to cross the tracks and possibly stop on the tracks. In a preempt trap, the track clearance green interval has already expired, so there will be no further opportunity to clear the tracks.

Preempt Verification and Response Time (PVRT): The number of seconds between when the controller unit receives a preempt call from the railroad's grade crossing warning equipment and the controller software begins to respond to the preempt call.

Queue Clearance Time (QCT): The time it takes the design vehicle to start up, move through, and clear the entire minimum track clearance distance when it is stopped just inside.

Queue Start-up Time (QST): Time from the beginning of the track clearance green until the design vehicle can start moving.

Red Clearance Time (RCT): The required red clearance interval time during right of way transfer before transitioning to track clearance.

Required Preemption Time (RPT): The time provided by the engineer of record to the railroad signal designer.

Right of Way Transfer Time (RTT): The maximum amount of time needed for the worst-case condition, prior to display of the track clearance green interval. This includes any railroad or light rail transit or highway traffic signal control equipment time to react to a preemption call, and any traffic control signal green, pedestrian walk and clearance, yellow change, and red clearance intervals for conflicting traffic.

Separation Time (ST): The portion of maximum highway traffic signal preemption time when the minimum track clearance distance is clear of vehicles before the arrival of a train.

Track Clearance Distance (TCD): The length along a highway at one or more railroad tracks, measured from the highway stop line, warning device, or 12 feet perpendicular to the track center line, to 6 feet beyond the track(s) measured perpendicular to the far rail, along the center line or edge line of the highway, as appropriate, to obtain the longer distance.

Track Clearance Time (TCT): Time needed to travel through the track clearance distance plus a 4-second separation time.

Vehicle-Gate Interaction: When the automatic gate descends on a stationary or slow-moving vehicle as it moves through the minimum track clearance distance.

Yellow Change Time (YCT): The required yellow change interval time during right of way transfer prior to the track clearance.

3.8.4 PROCEDURE

Engineers may calculate the maximum preemption time for highway-rail grade crossings as follows.

Calculate the Right of Way Transfer Time.

The components of right-of-way transfer time include the *preempt verification and response time* and the *worst-case conflicting vehicle or pedestrian time*. Calculate these through the following steps:

Step 1: Calculate *preempt verification and response time* (seconds).

Collect the preempt delay time (seconds) and the controller response time to preempt (seconds). Calculate the preempt verification and response time by adding the preempt delay time and the controller response time.

Step 2: Calculate the *worst-case conflicting vehicle time* (seconds).

Add the minimum green time during right-of-way transfer (seconds), other green time during right-of-way transfer (seconds), yellow change time (seconds), and red clearance time (seconds). The worst-case conflicting vehicle time is the total.

Step 3: Calculate the *worst-case conflicting pedestrian time* (seconds).

Add the minimum *WALK* time during right-of-way transfer, pedestrian clearance time during right-of-way transfer, vehicle yellow change time, and vehicle red clearance time. The worst-case conflicting pedestrian time is the total.

Step 4: Determine the worst-case conflicting vehicle or pedestrian time.

The worst-case conflicting vehicle or pedestrian time is whichever is longer between the worst-case conflicting vehicle time (**Step 2**) and the worst-case conflicting pedestrian time (**Step 3**).

Step 5: Calculate the right-of-way transfer time.

The right-of-way transfer time is the sum of the *preempt verification and response time* (**Step 1**) and the worst-case conflicting vehicle or pedestrian time (**Step 4**).

Calculate the queue clearance time.

The queue clearance time includes the time it takes the design vehicle to start moving and to accelerate through the clearance distance. Calculate this through the following steps:

Step 1: Determine the queue start-up distance.

Measure the clear storage distance and minimum track clearance distance for the highway-rail grade crossing. Calculate the queue start-up distance, L (feet), by adding the clear storage distance with the minimum track clearance distance.

Step 2: Calculate the time the design vehicle needs to start moving.

Calculate the time the design vehicle needs to start moving, in seconds, as 2 plus the queue start-up distance, L , divided by the speed of 20 feet per second.

Step 3: Determine the design vehicle clearance distance.

Combine the minimum track clearance distance and the total design vehicle's length, as shown in **Figure 3.8-1**.

Figure 3.8-1. Geometric Data at the Highway-Rail Grade Crossing

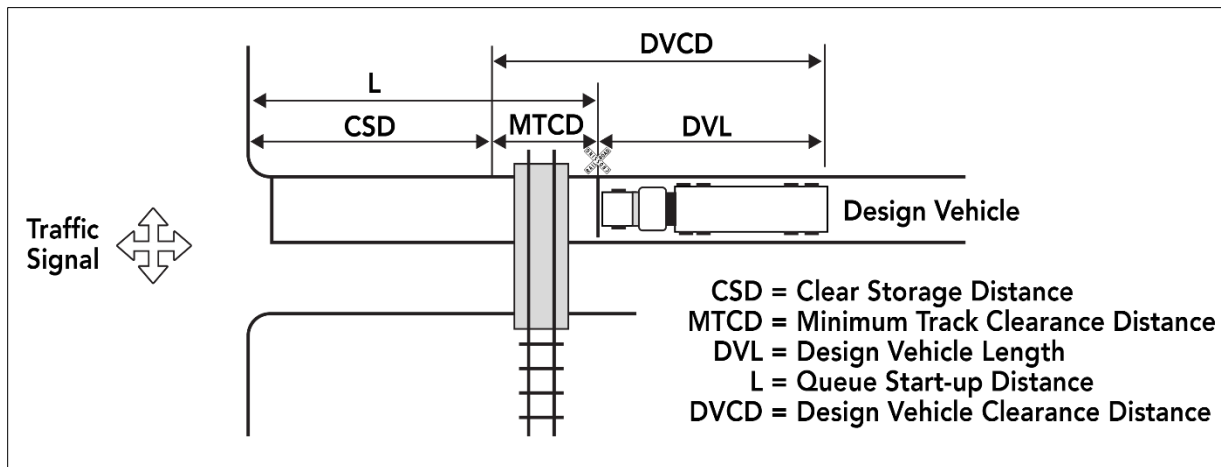

Step 4: Calculate the time the design vehicle needs to accelerate through the design vehicle clearance distance on level terrain.

Select the design vehicle for the analysis. Use **Figure 3.8-2** to determine the time the design vehicle needs to accelerate through the design vehicle clearance distance on level terrain.

Figure 3.8-2. Acceleration Time Over a Fixed Distance on a Level Surface

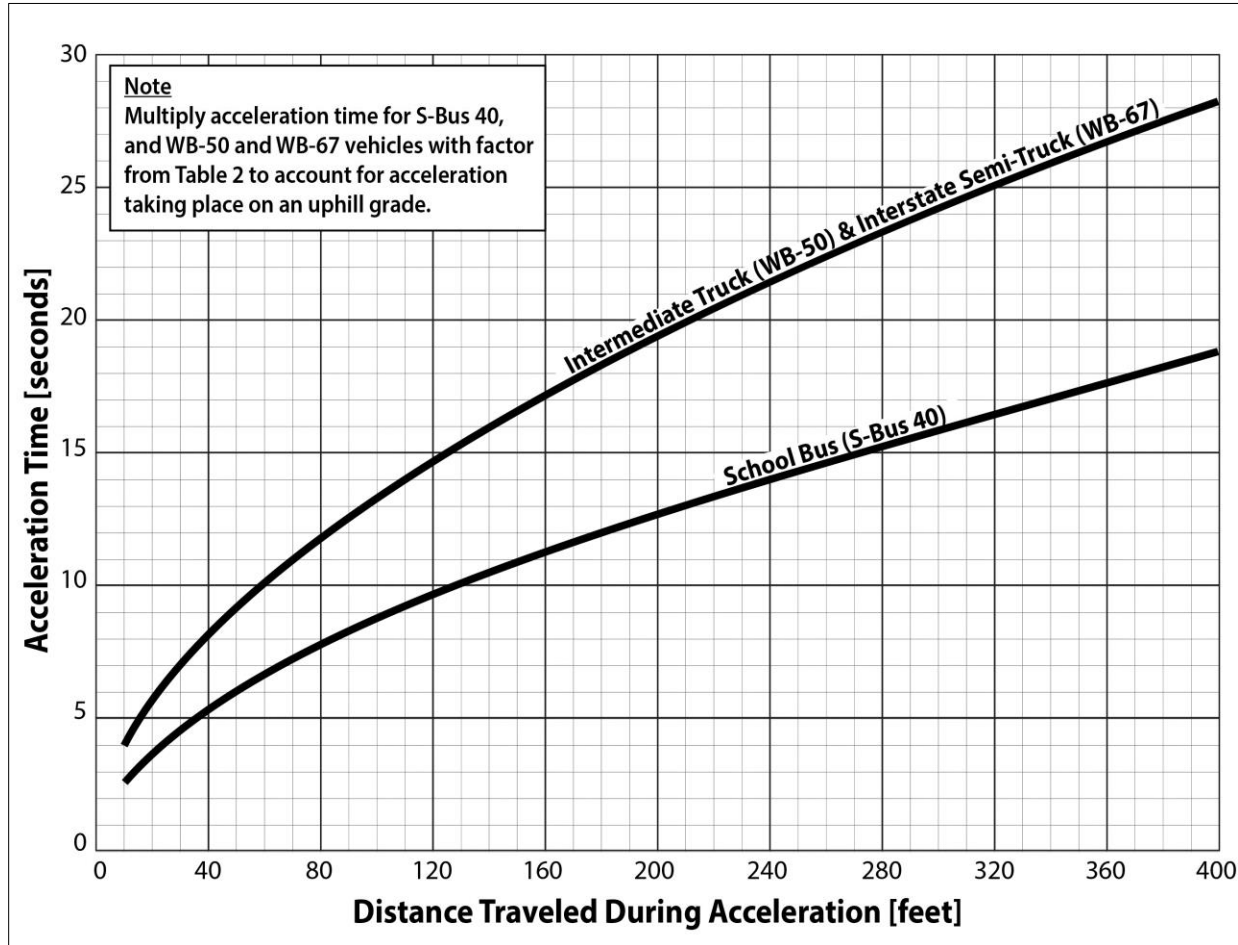

Step 5: Calculate the time the design vehicle needs to accelerate through the design vehicle clearance distance on an uphill grade.

If the design vehicle clearance distance is on an uphill grade, calculate the approach grade factor to account for slower acceleration. Determine the approach grade factor, shown in **Table 3.8-1**, based on design vehicle clearance distance, design vehicle, and slope grade.

To calculate the time needed for the design vehicle to accelerate through the design vehicle clearance distance on an uphill grade, multiply the time it needs to accelerate through the design vehicle clearance distance on level terrain by the approach grade factor.

Table 3.8-1. Factors to Account for Slower Acceleration on Uphill Grades

Acceleration Distance (feet)	Design Vehicle and Percentage Uphill Grade									
	School Bus (S-BUS 40)					Intermediate Truck (WB-50) and Interstate Semi-Truck (WB-67)				
	≤1%	2%	4%	6%	8%	0%	2%	4%	6%	8%
25	1.00	1.01	1.10	1.19	1.28	1.00	1.09	1.27	1.42	1.55
50	1.00	1.01	1.12	1.21	1.30	1.00	1.10	1.28	1.44	1.58
75	1.00	1.02	1.13	1.23	1.33	1.00	1.11	1.30	1.47	1.61
100	1.00	1.02	1.14	1.25	1.35	1.00	1.11	1.31	1.48	1.64
125	1.00	1.03	1.15	1.26	1.37	1.00	1.12	1.32	1.50	1.66
150	1.00	1.03	1.16	1.28	1.40	1.00	1.12	1.33	1.52	1.68
175	1.00	1.03	1.17	1.29	1.42	1.00	1.12	1.34	1.53	1.70
200	1.00	1.04	1.17	1.30	1.43	1.00	1.13	1.35	1.54	1.72
225	1.00	1.04	1.18	1.32	1.45	1.00	1.13	1.35	1.56	1.74
250	1.00	1.04	1.19	1.33	1.47	1.00	1.13	1.36	1.57	1.76
275	1.00	1.05	1.20	1.34	1.49	1.00	1.14	1.37	1.58	1.77
300	1.00	1.05	1.20	1.35	1.50	1.00	1.14	1.37	1.59	1.79
325	1.00	1.05	1.21	1.36	1.52	1.00	1.14	1.38	1.60	1.81
350	1.00	1.05	1.22	1.37	1.54	1.00	1.15	1.39	1.61	1.82
375	1.00	1.06	1.22	1.38	1.55	1.00	1.15	1.39	1.62	1.84
400	1.00	1.06	1.23	1.40	1.57	1.00	1.15	1.40	1.63	1.85

Step 6: Calculate the queue clearance time.

The queue clearance time is the sum of the time the design vehicle needs to start moving and the time it needs to accelerate through the design vehicle clearance distance.

Select the desired minimum separation time (seconds).

The separation time is added for safety reasons and to avoid driver discomfort. ITE (in an article by Marshall and Berg in February 1997) recommends a minimum separation time of 4 seconds. This value may be reduced to as low as 0 seconds if the necessary warning time is not available.

Calculate the maximum preemption time.

To get the required preemption time, add the right of way transfer time, queue start-up time, and desired minimum separation time. If using advance preemption, check using the worst-case scenario that the preemption phase does not end before the activation of the grade crossing warning devices. Consider variability in train arrival times. Submit the calculated maximum preemption time to the [DTOE](#) and [District Rail Office](#) for approval.

Coordinate with the appropriate railroad agency and the railroad signal designer.

After approval by the *DTOE* and *District Rail Office*, provide the required preemption time to the railroad signal designer so they can determine the required rail warning system and timings.

3.8.5 PREEMPT TRAP CHECK

A preempt trap happens when the track clearance phase ends before the active railroad grade crossing warning lights start to flash or the gates start to descend. Vehicles may cross or stop in the crossing after the end of the track clearance phase without the opportunity to clear before a train arrives. Variable actual warning time or an insufficient track clearance green interval cause preempt traps.

A preempt trap can be checked using the following procedures.

Request the advance preemption time from the railroad.

Use the actual value provided by the railroad. If no advance preemption time is provided, you can use a value of 0 seconds.

Determine a multiplier for maximum advance preemption time due to train handling.

Use field measurements. Divide the longest advance preemption time observed by the advance preemption time provided by the railroad.

If no field observations are available or the advance preemption time is not provided, the multiplier for maximum advance preemption time can be estimated as 1.60 if warning time variability is high or 1.25 if warning time variability is low. High warning time variability is typical in the vicinity of switching yards, branch lines, or anywhere low-speed switching maneuvers take place.

Calculate maximum advance preemption time.

Multiply advance preemption time by the multiplier for maximum advance preemption time.

Calculate the minimum duration for the track clearance green interval.

Subtract the minimum time for a flashing-light signal before the arrival of any train from the minimum time between the gate arm reaching its horizontal position and the arrival of a train.

Calculate the time for gates down after start of preemption.

Add the maximum advance preemption time to the minimum duration for the track clearance green interval.

Calculate the minimum right of way transfer time.

Add preempt verification and response time with best-case conflicting vehicle or pedestrian time. The best-case conflicting vehicle or pedestrian time is usually 0 seconds.

Calculate the minimum track clearance green interval.

Subtract the minimum right-of-way transfer time from the time for gates down after preemption begins. The minimum track clearance green interval has to be as long as it takes for a car to clear the tracks after the gates are lowered to avoid a preempt trap.

If the actual track clearance green interval is shorter than the minimum track clearance green interval, a preempt trap will occur.

3.8.6 VEHICLE-GATE INTERACTION CHECK

Even if there is sufficient warning time and the preempt trap has been addressed, the automatic gates may still descend on slow-moving or stationary vehicles, causing panic, confusion, or other unsafe actions from drivers.

Long, high vehicles that accelerate slowly, such as tractor-trailers, are most exposed. The gates may “clip” the rear of the trailer as the vehicle crosses the track during the clear track phase. **Figure 3.8-3** shows the passing vehicle-descending gate relationship. The vehicle-gate interaction can be checked as follows:

Figure 3.8-3. Relationship between Descending Gate and Passing Vehicle

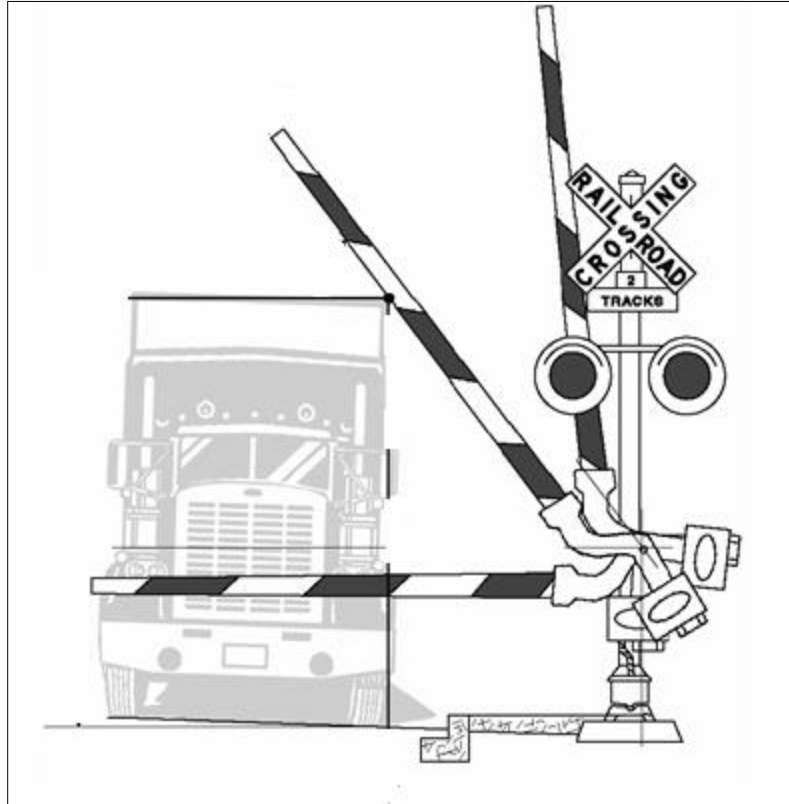

Calculate the time the design vehicle needs to clear the descending gate.

Collect the right of way transfer time and the time the design vehicle needs to start moving from previous steps. Calculate the time the design vehicle needs to accelerate through the design vehicle length using **Figure 3.8-2** and **Table 3.8-1**.

Add the right of way transfer time, time the design vehicle needs to start moving, and time the design vehicle needs to accelerate through the minimum track clearance distance.

Collect the flashing light duration before the gate starts to descend.

This value typically ranges from 3 to 5 seconds and must be obtained from the railroad. The railroad's value may be verified through field observations.

Calculate non-interaction gate descent time.

Step 1: Collect the full gate descent time from the railroad.

The value obtained from the railroad may be verified through field observations. In the case where multiple gates descend at different speeds, use the descent time of the gate that reaches the horizontal position first.

Step 2: Determine the proportion of non-interaction gate descent time.

Select the distance from the center of the gate mechanism to the nearest side of the design vehicle, d , on the vertical axis of **Figure 3.8-4**, draw a horizontal line until you reach the curve that represents the design vehicle (h is the vehicle height). Next, draw a vertical line down to the horizontal axis and read off the value of the proportion of non-interaction gate descent time.

Figure 3.8-4. Proportion of Gate Descent Time Available

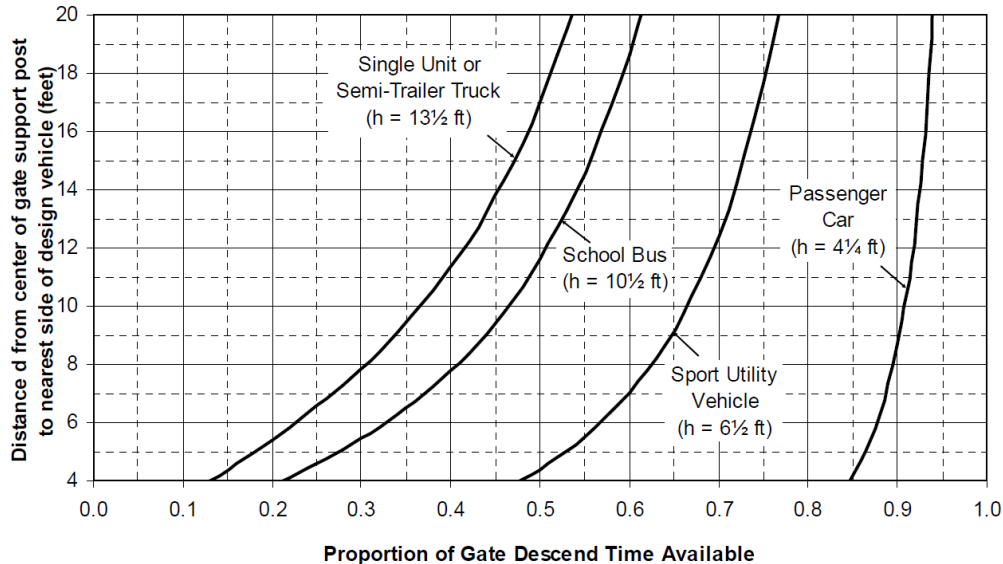

Step 3: Calculate the non-interaction gate descent time.

Multiply the full gate descent time with the proportion of non-interaction gate descent time.

Calculate time available for the design vehicle to clear the descending gate.

Add the duration of flashing lights before gate descent starts with the non-interaction gate descent time.

Vehicle-gate interaction check.

Compare the time the design vehicle needs to clear the descending gate with the time available.

If the time available is greater than or equal to the time needed, there will be no vehicle-gate interaction.

If the time available is less than the time needed, provide advance preemption time to avoid vehicle-gate interaction.

3.8.7 EXAMPLE

This example illustrates the step-by-step procedure for calculating the preemption time for a highway-rail grade crossing. The crossing shown in **Figure 3.8-5** is within 200 feet of an existing signalized intersection and requires a preemption phase.

Figure 3.8-5. Intersection for Preemption Time Calculation

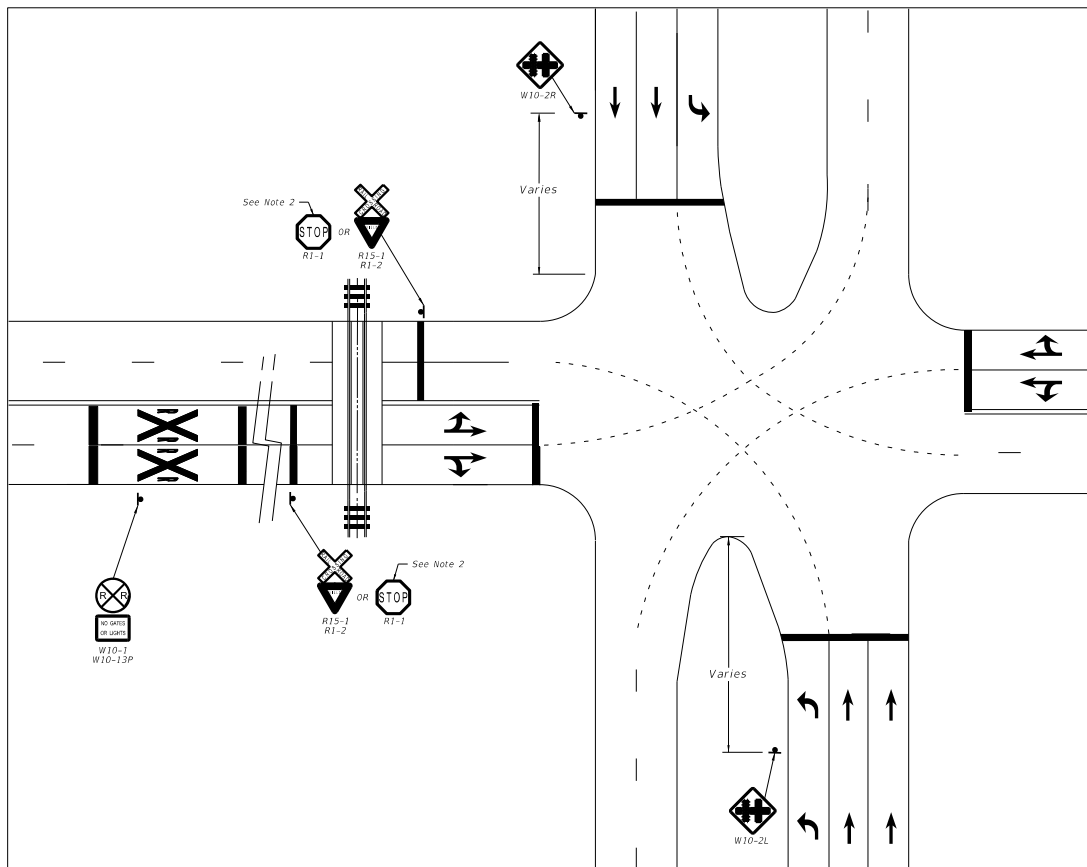

Calculate the Right-of-Way Transfer Time

Step 1: Calculate the preempt verification and response time.

The preempt delay time is 0 seconds. The controller response time to preempt provided by the controller manufacturer is 0 seconds. The preempt verification and response time is 0 seconds, which is calculated by adding the preempt delay time and controller response time.

Step 2: Calculate the worst-case conflicting vehicle time.

The worst-case conflicting vehicle phase number is *Phase 8* for this intersection. The minimum green time during right-of-way transfer is 5 seconds. The other green

time during right-of-way transfer is 1 second. The yellow change time for *Phase 8* is 4 seconds, and the red clearance time for *Phase 8* is 1 second. The worst-case conflicting vehicle time is 11 seconds.

Step 3: Calculate the worst-case conflicting pedestrian time.

The worst-case conflicting pedestrian phase number is *Phase 8* for this intersection. The minimum walk time during right-of-way transfer is 5 seconds. The pedestrian clearance time during right-of-way transfer is 0 seconds. The vehicle yellow change time is 4 seconds, and the vehicle red clearance time is 1 second. The worst-case conflicting pedestrian time is 10 seconds.

Step 4: Determine the worst-case conflicting vehicle or pedestrian time.

The worst-case conflicting vehicle or pedestrian time is 11 seconds based on results from **Steps 2** and **3**.

Step 5: Calculate the right-of-way transfer time.

The right-of-way transfer time is 11 seconds based on results from **Steps 1** and **4**.

Calculate the queue clearance time.

Step 1: Determine the queue start-up distance.

The measured clearance storage distance is 54 feet. The measured minimum track clearance distance is 55 feet. The queue start-up distance is 109 feet.

Step 2: Calculate the time the design vehicle needs to start moving.

$$2 + 109 \div 20 = 8 \text{ seconds}$$

Step 3: Determine the design vehicle clearance distance.

The minimum track clearance distance is 55 feet, and the design vehicle length is 48 feet. The design vehicle clearance distance is 103 feet based on the minimum track clearance distance and design vehicle length.

Step 4: Calculate the time the design vehicle needs to accelerate through the design vehicle clearance distance on level terrain.

The design vehicle is WB 50 & WB-67. The time the design vehicle needs to accelerate through the design vehicle clearance distance on level terrain is 14 seconds based on **Figure 3.8-6**.

Figure 3.8-6. Calculation of Time for Design Vehicle to Accelerate through the Design Vehicle Clearance Distance on Level Terrain

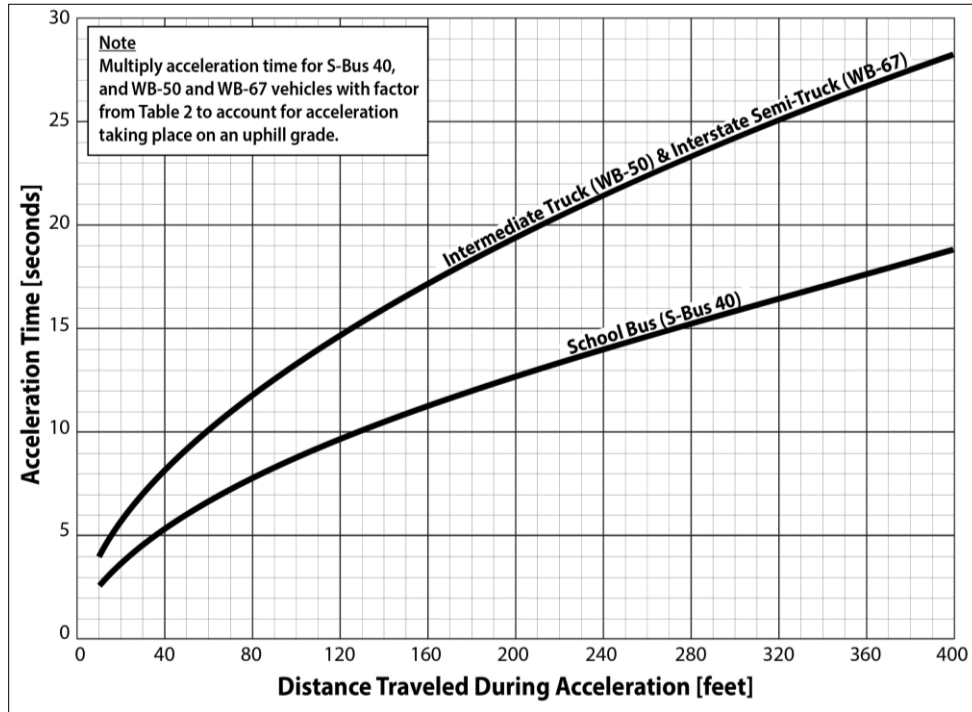

Step 5: Calculate the time the design vehicle needs to accelerate through the design vehicle clearance distance on an uphill grade.

The terrain for the selected intersection is level, so there is no need to calculate acceleration time for an uphill grade.

Step 6: Calculate the queue clearance time.

The time the design vehicle needs to start moving (**Step 2**) is 8 seconds, and the time it needs to accelerate through the design vehicle clearance distance on level terrain (**Step 4**) is 14 seconds. The queue clearance time is 22 seconds based on results in **Steps 2** and **4**.

Select the desired minimum separation time.

The minimum separation time is 4 seconds, based on ITE's recommendation.

Calculate the maximum preemption time.

The right-of-way transfer time is 11 seconds. The queue clearance time is 22 seconds. The desired minimum separation time is 4 seconds. The maximum preemption time is 37 seconds.

The final calculated maximum preemption time is 37 seconds for this intersection.

SECTION 3.9

INSTALLING RETROREFLECTIVE SIGNAL BACKPLATES ON EXISTING STRUCTURES

3.9.1 PURPOSE

This section describes how to retrofit existing signal structures on the State Highway System with retroreflective signal backplates. Follow the guidelines in this section for installing flexible retroreflective backplates (FRBs) on existing mast arm and span wire structures at signalized intersections without backplates.

3.9.2 BACKGROUND

Retroreflective signal backplates improve the contrast between the traffic signal indications and their surroundings, making them easier to see during both day and night conditions and during power outages.

Installing retroreflective signal backplates can enhance safety at intersections. This countermeasure has a crash modification factor in FHWA's [*Crash Modification Factor \(CMF\) Clearinghouse*](#).

Include rigid retroreflective backplates on all new or reconstructed traffic signal structures.

Some existing signal support structures have unknown structural capacity limits, and retrofitting their signal heads with rigid retroreflective backplates would require structural analysis. Research and structural evaluations using FRBs have shown negligible wind-loading impacts to mast arm and span wire support structures, making them suitable for signal retrofits.

3.9.3 DEFINITIONS

Flexible Retroreflective Backplate (FRB): A signal backplate that allows portions of the panels to fold back when subjected to high winds and return to their original position when the wind subsides.

Mast Arm: A structure that is rigidly attached to a vertical pole and used to provide overhead support for highway traffic signal faces or grade crossing signal units.

Rigid Retroreflective Backplate: A signal backplate that remains fixed in one position when subjected to wind loading.

Signal Face: An assembly of one or more signal sections that controls traffic movements on a single approach.

Signal Head: An assembly of one or more signal faces that controls traffic movements on one or more approaches.

3.9.4 PROCEDURE

For existing mast arm and span wire structures, the use of FRBs listed on FDOT's [Approved Product List \(APL\)](#) is exempt from the [FDM 261](#) structural capacity analysis requirements. This exemption applies only when the elements to be added to an existing signal structure are FRBs.

The [District Traffic Operations Offices](#) track and document locations and implementation dates within the signalized assets by district found in [eTraffic](#).

All other signal hardware, features, and attachments proposed for retrofitting existing traffic signal structures must undergo structural analysis in accordance with [FDM 261](#) to determine if structural capacity is adequate. These include, but are not limited to:

- Rigid retroreflective backplates
- Signal heads
- Overhead street name signs
- Static signs
- Blank-out signs

Perform any required structural analysis of existing traffic signal structures in accordance with [FDM 261](#). Refer to FDOT's [Structures Manual, Volume 3, Section 18](#) for additional information regarding the analysis of existing structures.

SECTION 3.10

FLASHING YELLOW AND RED ARROW SIGNAL APPLICATION

3.10.1 PURPOSE

This section provides criteria, guidelines, and best practices for installing and operating flashing yellow arrow (FYA) and flashing red arrow (FRA) signals as directed by [MUTCD Section 4F.04](#) and [Section 4F.08](#).

3.10.2 BACKGROUND

For many years, engineers have been concerned that drivers turning left on a permissive circular green signal will mistakenly believe they have right of way over opposing traffic. Geometric conditions can contribute to this impression.

FYA and FRA indications have been used to mitigate the “yellow trap” condition, where a left-turning driver completes their turn on a yellow indication assuming oncoming traffic also has a yellow.

Based on the intuitive understanding of FYA for permissive turning movements and to ensure uniformity across the state, FDOT encourages the use of FYA over FRA. Per [MUTCD Section 4F.04](#), FRA may be used during the permissive left-turn movement for unusual geometric conditions, such as wide medians with offset left-turn lanes, but only when an engineering study determines that each and every vehicle must successively come to a full stop before making a permissive left turn.

To date, research studies have been conducted and guidelines developed only for left-turning FYA treatments. However, right-turn FYA treatments may be used, per the **MUTCD** and this section of the **TEM**. Further guidance for right-turn FYA treatments may be included in this manual in response to research findings, implementation, and case studies.

In 2003, **NCHRP** published [Report 493: Evaluation of Traffic Signal Displays for Protected/Permissive Left Turn Control](#). Its key findings are as follows:

- The FYA is a good overall alternative to the circular green as the permissive signal display for a left-turn movement.
- Left-turn drivers are highly likely to understand and correctly respond to the FYA. The FYA has a lower fail-critical rate than the circular green.
- Making the FYA display a separate signal face for the left-turn movement allows more versatility in field application. It can be operated in any of the various modes

of left-turn operation by time of day and is easily programmed to avoid the yellow trap associated with some permissive turns at the end of the circular green display.

FHWA's [Crash Modification Factor \(CMF\) Clearinghouse](#) reports a CMF for installation of left-turn FYA signals and supplemental traffic signs.

3.10.3 OPERATIONAL REQUIREMENTS

The following design and operational requirements apply, according to [MUTCD Section 4F.07](#), when a separate left-turn signal phase operates in a protected/permissive left-turn mode and a flashing left-turn yellow arrow signal is provided.

Left-Turn Operation Mode(s):

The FYA signal may be displayed to indicate a permissive left-turn movement in either protected/permissive or permissive-only modes.

Engineers may vary the left-turn operation mode (i.e., permissive-only, protected-only, or protected/permissive) during different periods of the day when the following conditions apply:

- The calculated critical gap is a minimum of 7 seconds during non-peak hours. FDOT's [Manual on Uniform Traffic Studies \(MUTS\)](#) provides additional guidance on conducting vehicular critical gap studies.
- Fewer than 240 vehicles turn left per hour, or the product of left-turning vehicles and opposing through vehicles is fewer than 50,000 (one opposing through lane) or 100,000 (two or three opposing through lanes). Product being defined as the multiplication of one hour of left-turning volume times the corresponding opposing through hourly volume.
- There are no fatalities and two or fewer left-turn crashes per year attributed to permissive left-turning movements.

Signal Head Arrangement: Provide at least one separate four-section signal head for the left-turn movement in addition to the minimum of two signal heads for other traffic on the approach. The signal face must be able to display, from top to bottom (or left to right), a steady left-turn red arrow, steady left-turn yellow arrow, flashing left-turn yellow arrow, and steady left-turn green arrow.

Signal Head Location: In an exclusive left-turn lane, center the signal head over the lane or its extension. If centering the signal head is not practical, do not position it any further to the right than the lane line (or the extension of the lane line) between the left-turn lane and the adjacent through lane or any further to the left than the left edge of the left-turn lane (or extension of the lane line).

Signal Displays: Signal head displays must meet the following requirements:

- Display the following signal heads: Steady left-turn red arrow, steady left-turn yellow arrow, flashing left-turn yellow arrow, and left-turn green arrow. Display only one of the four indications at any given time.
- During the protected left-turn movement, display a left-turn green arrow signal.
- Display a steady left-turn yellow arrow signal following the left-turn green arrow signal.
- During the permissive left-turn movement, display a flashing left-turn yellow arrow signal.
- Display a steady left-turn yellow arrow signal after the flashing left-turn yellow arrow signal if the permissive left-turn movement is ending, and the separate left-turn signal head will subsequently display a steady left-turn red arrow indication. At locations where a history of drivers failing to yield to pedestrians during permissive left-turn phases has been documented, the following countermeasures may be implemented:
 - Omit the FYA when the pedestrian phase is actuated.
 - Implement leading pedestrian interval (LPI) in accordance with [TEM 3.11](#).
- The engineer may choose to display a flashing left-turn yellow arrow signal for a permissive left-turn movement while the signal heads for the adjacent through movement display steady circular red indications and the opposing left-turn signal heads display left-turn green arrow signals for a protected left-turn movement.
- Before the FYA begins, provide a start-up delay (2 seconds) for all opposing through movements to establish position in the intersection.
- When changing phase from a permissive left-turn movement to a protected left-turn movement, display a left-turn green arrow signal immediately after the flashing left-turn yellow arrow indication. Do not display a steady left-turn yellow arrow signal between the display of the flashing left-turn yellow and the display of the steady left-turn green arrow indications. See [TEM 3.10.4](#) for further guidance.
- Use a four-section signal head unless constrained by height limitations (or lateral positioning limitations for a horizontally mounted signal head). In constrained conditions, the engineer may use a three-section signal head with a dual-arrow signal section. The dual-arrow signal section, where used, must display a green arrow for the protected left-turn movement and a flashing yellow arrow for the permissive left-turn movement. The **DTOE** must concur and approve the installation of any three-section FYA signal head.
- During steady mode (stop-and-go), the signal section that displays the steady left-turn yellow arrow signal during change intervals must not be used to display the flashing left-turn yellow arrow signal for permissive left turns.

- During flashing mode, display a flashing left-turn yellow arrow signal only from the signal section that displays a steady left-turn yellow arrow signal during steady mode (stop-and-go) (see [MUTCD Section 4G.03](#)).

Yellow Trap: FYA can be used to reduce the risk of a left-turn yellow trap. The signal timing sequence may allow the permissive left-turn phase (FYA) to continue until the opposing traffic's through phase ends, even if the adjacent through phase has already ended.

When implementing FYA, review all potential sequencing combinations to determine if a yellow trap could occur. Include those that skip phases due to lack of demand and special patterns such as preemption. If a yellow trap appears possible, modify the sequencing and controller programming parameters as necessary to eliminate it. The design engineer has primary responsibility for including adequate information in design plans for others who may establish sequences and program controllers.

The four-section signal protected/permissive left-turn mode (**Figure 3.10-1**), is illustrated in [MUTCD Figure 4F-7](#).

Figure 3.10-1. Four-Section Signal Protected/Permissive Left-Turn Mode

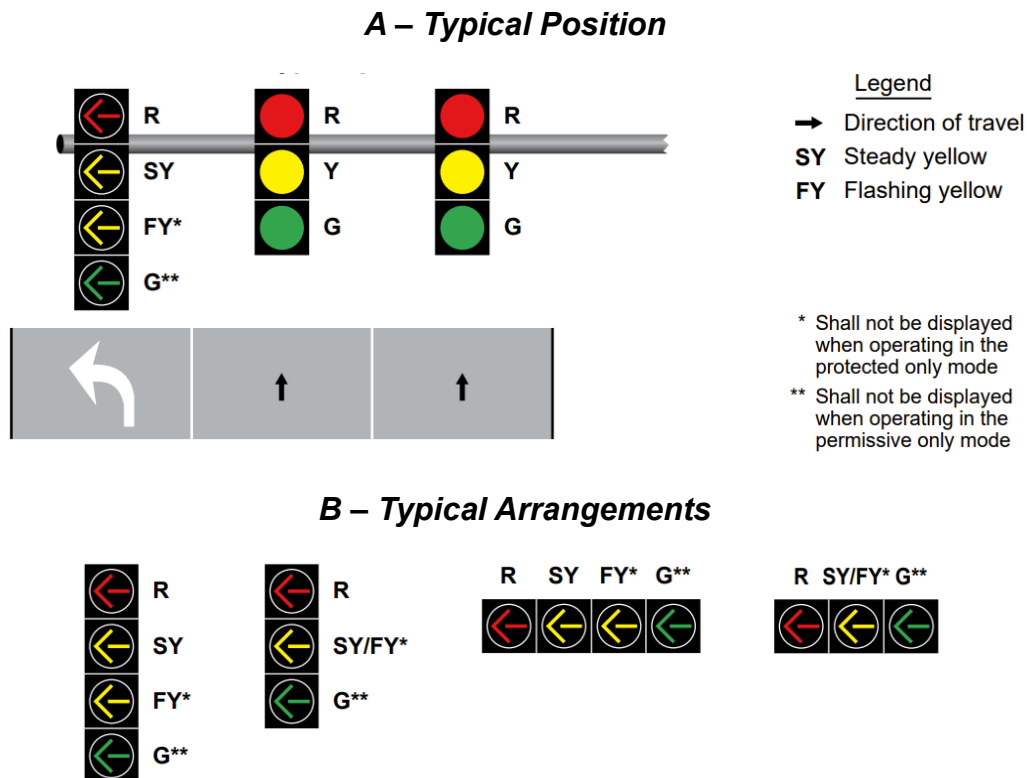

Installation Guide:

The FYA is an option for permissive/protected left-turn phasing. However, as with protected/permissive operations in general, careful consideration is needed when deciding where to install the FYA.

It is recommended that districts obtain local maintaining agencies' agreement before recommending and installing FYA at a signalized intersection.

To ensure statewide consistency for FYA installation:

- Consider and prioritize four-section FYA signal displays for new signal installations and candidate retrofit locations that meet the criteria below:
 - Corridors where changing to lead/lag from lead/lead left-turn phasing would improve progression.
 - Locations where left-turn demand is low during off-peak periods and variable modes of left-turn phasing will improve safety and operations.
- Center the signal display for the left-turn movement over the corresponding exclusive left-turn lane for new and retrofitted FYA installations.
- For locations with high populations of people 65 years or older or intersections in a [Safe Mobility for Life Coalition Priority County](#), conduct an intersection operations and crash history evaluation before implementing FYA.
- The supplemental *LEFT-TURN YIELD ON FLASHING YELLOW ARROW* sign (**FTP-85-13**) may be used to educate motorists about FYA operations.
- If the structural loading capacity meets the minimum requirements to withstand the wind loading under FDOT's established design criteria, engineers may install the supplemental *LEFT TURN YIELD ON FLASHING YELLOW ARROW* sign (**FTP-85-13**). Please see [TEM 3.10.4](#) for further guidance on loading.
- If using FYA for permissive-only, protected/permissive, or permissive/prohibited phasing, consider time-of-day applications.
- When recommending replacing a five-section signal head with a four-section FYA signal head for the left-turn lane and a three-section signal head for the inside through lane, the engineer must confirm FDOT's structural loading capacity requirements are met.
- Avoid FYA installation under the following conditions:
 - Crash patterns involve left-turning vehicles and could be attributed to driver misunderstanding of shared signal indications.
 - Frequent railroad or emergency vehicle preemption activations happen, resulting in a higher risk of a left-turn trap condition.

3.10.4 INSTALLATION CRITERIA

Engineers may consider installing FYA at signalized intersections with the following characteristics:

- FYA installation is facilitated by intersection geometry and traffic operations characteristics, including:
 - Opposing left-turn paths that do not conflict.
 - Available sight distance greater than the required sight distance based on approach speeds and left-turn lane offset conditions.
 - The approach has only one left-turn bay.
 - There are one or two opposing through lanes. Engineers may consider intersections with three opposing through lanes on a case-by-case basis supported by an engineering study.
- The intersection has a protected/permissive mode, and less than three left-turn-related crashes per year have been recorded over a three-year period, which may have been avoided with protected-only phasing.
- Fewer than 240 vehicles turn left per hour, or the product of left-turning vehicles and opposing through vehicles is fewer than 50,000 (one opposing through lane) or 100,000 (two or three opposing through lanes). The product is defined as the multiplication of one hour of left-turning volume times the corresponding opposing through hourly volume.
- Signal coordination plans indicate operations improved with the installation of FYA permissive-protected operation based on volume criteria and crash patterns during peak periods.

Using a consistent left-turn treatment along a corridor makes it easier for drivers to navigate, but it may not be practical due to the potential associated costs for its implementation. FYA left-turn protected/permissive mode often requires installing an additional left-turn signal head and could require a mast arm replacement (e.g., wind loading requirements are not met, longer mast arms are needed). The cost of replacing signal poles to accommodate FYA can be prohibitive.

Some FYA implementations have resulted in a mix of FYA and five-section circular green display protected/permissive operation. In these cases, FDOT recommends installing FYA at any new signalized intersection on the corridor that meets the criteria for protected/permissive left-turn mode operation without immediately modifying the other intersections along the corridor. Avoid installing FYA at intersections that are within view of other intersections with the five-section circular green display.

At locations with a protected-only mode, consider using FYA protected/permissive mode only after conducting an intersection engineering study. Do not remove protected-only left-turn phasing if opposing sight distance is inadequate for permissive left turns, high

operating speeds are reported, roadway geometry is complicated, or there are too many opposing through lanes. For more information on sight distance, refer to the [FDM 212](#).

3.10.5 VARIABLE MODE

Variable mode operation—changing between protected-only and protected/permissive mode or between protected/permissive and permissive-only mode by time of day—is possible with the four-section FYA signal head. It can be applied where an engineering study shows this type of operation can improve safety and operations. It is important to ensure the traffic signal controller can switch between modes so the flashing yellow arrow indication and the opposing through movement indication terminate together.

When switching between protected/permissive and permissive-only, ensure that the controller can reassign the left-turn detectors to call the associated through phases by time of day.

3.10.6 PUBLIC NOTIFICATION

Coordinate installation of an FYA left-turn operation with the [District Public Information Office](#). Consider issuing press releases letting the public know when they can expect to see the new indications. Send out press releases at least two weeks before implementation.

3.10.7 EDUCATION

The [Safe Mobility for Life Program](#) developed an FYA tip card (**Figure 3.10-2**) to inform and educate the public about this traffic control device. The tip card was developed using human factors studies and uses plain language to help the public understand what to do when encountering an FYA on the roadway system. This tip card is part of the Roadway Safety Series, designed to be used by district staff for public outreach. To obtain digital or print versions of the FYA educational materials, visit [SafeMobilityFL.com](#).

Conduct location-specific education using portable changeable message signs. Display the following alternating messages both before implementation (minimum one week) and after (maximum six weeks):

- Phase 1: *NEW SIGNAL DISPLAY*
- Phase 2: *YIELD ON FLASHING ARROW*

Figure 3.10-2. Flashing Yellow Arrow Tip Card

What is a flashing yellow arrow?

A new traffic signal that means you can turn left if there is a safe gap in traffic

SEE THIS DO THIS

	Stop.
	Prepare to stop or complete your left turn.
	Turn left provided there is a safe gap in vehicle and pedestrian traffic.
	Turn left.

What you need to know!

SafeMobilityFL.com

3.10.8 SIGNAL RETROFIT CHECKLIST

Use the following checklist to examine hardware conditions at an intersection before programming an FYA signal in the field. Knowing the hardware conditions makes a smooth FYA implementation more likely.

Signal Retrofit Checklist:

- Check that the mast arm is long enough to center the FYA signal head over the exclusive left-turn lane.
- Check replacement head size/mounting. Raising wire spans to install vertical four-section signal heads may be necessary to replace five-section signal heads.
- Ensure signal equipment is in working order. A malfunctioning load switch or bad load switch socket may lead to problems during FYA implementation.

- Make sure the available cables are sufficient to install FYA signals. Protected/permissive left-turn phasing often uses a circular green display for the permissive interval, which is illuminated by the same means as the green through phase. Additional cabling may be needed for the flashing yellow display to be controlled by its own circuit.
- Verify with the signal equipment manufacturer that the controller and management malfunction unit are applicable and confirm the programming method. Leading signal equipment manufacturers have developed new controller models and management malfunction units that support FYA signal operations. Controllers must have the correct firmware to enable FYA operations.
- Check if the controller cabinet needs modification. The industry has not standardized FYA controllers. Contact the manufacturer representative for information. The controller make and model will determine whether the cabinet needs to be modified. Make sure the management malfunction unit you select is capable of FYA operation. Install a management malfunction unit recommended by the controller manufacturer. The cabinet flash programming must be modified.
- The **MUTCD** does not include a standard explanatory sign for FYA installation since the signal's meaning is intended to be intuitive to drivers. However, FDOT has designed a 30 x 36-inch *LEFT TURN YIELD ON FLASHING YELLOW ARROW* sign (**FTP-85-13**) with a white background and black lettering, as shown in **Figure 3.10-3**. The sign details are shown in [Standard Plans, Index 700-102](#) and can be installed adjacent to the new FYA signal head for additional clarification. If the FYA signal module is to be installed at a location with a five-section head, verify the sign can be installed and ensure any conflicting signs, such as the *LEFT TURN YIELD ON GREEN* sign (R10-12), are removed.

Do NOT use other FYA signs as an alternative to **FTP-85-13**, including sign variations that replace the text with symbols.

Figure 3.10-3. Flashing Yellow Arrow Sign (FTP-85-13)



SECTION 3.11

SIGNAL TIMING APPLICATIONS FOR PEDESTRIAN MOVEMENTS

3.11.1 PURPOSE

This section defines signal timing applications to improve safety and enhance pedestrian mobility. It covers considerations for implementing a leading pedestrian interval (LPI), a flashing yellow arrow (FYA) omit by ped, and delayed turn applications at signalized intersections.

3.11.2 BACKGROUND

Signal timing features are used to make traffic easier to see and enhance pedestrian safety. [*NCHRP Report 812: Signal Timing Manual*](#) and [*Report 969: Traffic Signal Control Strategies for Pedestrians and Bicyclists*](#) highlight signal timing applications for pedestrian movements. Signal timing and signal timing adjustments are evaluated, determined, and documented by a traffic engineer.

3.11.3 DEFINITIONS

Concurrent Yet Protected: A variation on the *Delayed Turn* timing treatment, where left and right-turning movements are not permitted during the conflicting *WALK* and *flashing DON'T WALK* intervals. This treatment requires exclusive turn lanes, signal heads, and *NO TURN ON RED* signage.

Flashing DON'T WALK: A warning to pedestrians that the *WALK* indication has ended and the *DON'T WALK* indication is active.

Flashing Yellow Arrow Omit by Ped (FYA Omit by Ped): A signal controller option that omits a permissive left-turn movement during the conflicting *WALK* and *flashing DON'T WALK* intervals.

Delayed Turn: A signal controller option that releases through vehicles and pedestrians concurrently while holding turning movements with a red indication and *NO TURN ON RED* signage. This treatment requires exclusive turn lanes, signal heads, and *NO TURN ON RED* signage.

Lagging Pedestrian Interval: The pedestrian *WALK* interval starts several seconds after the adjacent through movement phase. This option allows a waiting right-turn queue to clear before the *WALK* indication is presented and reduces conflicts with right-turning

vehicles. It is applicable at intersections where there is either an exclusive right-turn lane (or lanes) or the two intersecting roads have one-way traffic.

Leading Pedestrian Interval (LPI): A pedestrian interval option, also known as “pedestrian head start” or “delayed vehicle green,” which gives pedestrians an advance *WALK* indication before a green signal, is provided to vehicles. This allows pedestrians to establish a presence in the crosswalk, reducing conflicts with turning vehicles. LPI is a proven safety countermeasure to reduce vehicle-pedestrian crashes at signalized intersections.

Pedestrian Detector Call: An input into the associated phase of the controller when a pedestrian is detected that actuates service of the pedestrian *WALK* indication.

Pedestrian Omit: A command that ignores pedestrian calls for service and prevents a pedestrian phase. This feature is a consideration at intersections with rail preemption. Activation does not affect a pedestrian movement in the process of timing.

Pedestrian Recall: This mode eliminates the need for a push button or passive detection and ensures that pedestrian *WALK* and clearance intervals are provided in each cycle.

Pedestrian Recycle: A signal controller option that allows a pedestrian phase to be served multiple times within the same vehicle phase when pedestrian demand exists and the split time remaining is greater than or equal to the time needed to serve the pedestrian phase.

- In the actuated mode, if a serviceable pedestrian call exists on the subject and the *Hold* input is active, the pedestrian movement is recycled when the *Pedestrian Recycle* input is active, regardless of whether a serviceable conflicting call exists.
- In the non-actuated mode, if the subject phase has reached the *Green Dwell/Select* state, the *Pedestrian Omit* is not active on the phase, and a serviceable conflicting call does not exist, the pedestrian movement is recycled when the *Pedestrian Recycle* input is active.

Pedestrian Scramble/Barnes Dance: An exclusive pedestrian phase with no concurring vehicular movement in any direction. Pedestrians may cross all intersection legs or cross diagonally. Walking time is extended for diagonal movement. Ped heads, accessible pedestrian signals, and pavement markings indicate pedestrians may cross diagonally.

Pedestrian Walk Interval: A signal providing initial right of way to pedestrians during a pedestrian phase and prior to the pedestrian clearance interval.

Rest in Walk: The pedestrian phase is set to rest in the *WALK* interval to maximize the *WALK* display during a vehicle green. This pertains to whether the *WALK* signal is initially activated by the pedestrian push button, passive pedestrian detection, or automatic pedestrian recall. The flashing *DON'T WALK* interval times prior to the yield point.

Walk Rest Modifier: When activated, modifies non-actuated operation only. Upon activation, the non-actuated phase(s) remain in the timed-out *WALK* state (*Rest In Walk*) in the absence of a serviceable conflicting call without regard to the *Hold* input status. With the input inactive, non-actuated phase(s) do not remain in the timed-out *WALK* state unless the *Hold* input is active. The controller recycles the pedestrian movement when reaching the *Green Dwell/Select* state in the absence of a serviceable conflicting call.

3.11.4 GENERAL CONSIDERATIONS

To reduce wait times and increase compliance with pedestrian signals, avoid lengthy traffic signal cycles. The *INRIX Smart Signal Dashboard* can be used to identify efficiencies in cycle lengths. Consider automatic pedestrian recall that allows vehicles at least the same amount of time as the sum of the *WALK* and flashing *DON'T WALK* intervals.

3.11.5 LPI CONSIDERATIONS

Comply with [MUTCD Section 4I.06](#) when considering LPI signal applications.

Review all new signalized intersections and existing intersections as timing changes are made for LPI implementation. See *TEM 3.11.5.1* for considerations that indicate an LPI may be appropriate.

LPI implementation is at the discretion of the [DTOE](#). Document the decision process for LPI implementation in the project file as an email or technical memorandum.

3.11.5.1 LPI LOCATION SCREENING CONSIDERATIONS

LPIs are generally used for pedestrian phases timed concurrently with a conflicting right turn. Research has demonstrated that LPIs can be beneficial at intersections with pedestrian activity.

The following conditions indicate an LPI may improve conditions for pedestrians. LPI may be considered for implementation under the following conditions:

- Field observations, citizen complaints, crash history, near misses, or risk analysis indicate conflicts between turning vehicles on green and pedestrians.
- Marked school crossings.
- Drivers' view of pedestrians is blocked due to obstructions or poor sight distance. At a minimum, consider the following:
 - Intersection geometry that obscures pedestrians from motorists or vice versa.
 - Lighting problems that cannot be adequately addressed through standard lighting requirements.

- Sun angle that blocks drivers' view at certain times of day or times of the year.
- Approaches where the time needed to serve vehicular demand is less than the associated *WALK* and flashing *DON'T WALK* intervals.

Consider the following points at intersections with low to medium pedestrian volumes:

- LPIs can increase visibility in areas where pedestrian volume is low, and drivers may not expect to see them.
- Where the pedestrian phase is actuated, LPIs can benefit pedestrians when they are present without timing every cycle.
- Combining LPI with automatic pedestrian recall for low pedestrian volume phases may increase vehicular impacts of the LPI with limited added benefit for pedestrians.
- With medium pedestrian volume (particularly on corridors with more signals), actuated LPIs delay vehicular traffic as progression is lost. Implementing automatic pedestrian recall in these cases can generally recover the vehicle delay as it is often not caused by capacity constraints but by lack of progression.

Consider the following points at high pedestrian volume intersections:

- Vehicular impacts of LPIs may be lower where a high volume of crossing pedestrians may inhibit right-turn movements.
- LPIs may not provide the desired level of protection at very high-volume pedestrian crossing locations. A pedestrian scramble may be more appropriate where any of the following conditions exist:
 - Very high volume of pedestrian crossings.
 - High volume of right turns.
 - High demand for diagonal pedestrian crossings.

3.11.5.2 LPI IMPLEMENTATION CONSIDERATIONS

Most modern controllers support LPI natively. At intersections where the controller does not support LPI programming, consider replacing the controller. For information on how to program an LPI, refer to FDOT's [*Leading Pedestrian Interval Programming Primer*](#).

Set LPI timing to allow pedestrians to clear at least the width of one lane in the direction of moving traffic, including the width of a parking and bicycle lane, to increase the visibility of pedestrians to turning traffic. A minimum 3-second LPI duration is required by the **MUTCD**.

A maximum LPI duration limits drivers' tendency to disobey the signal.

- With an actuated pedestrian phase, the optimal maximum LPI duration is 10 seconds. If more time is needed, either based on **Formula 3.11.5.2-1** or due to sight distance concerns, consider geometry updates such as curb bulb-outs to shorten the distance pedestrians need to cross to get through one through lane. Alternatively, consider using an exclusive pedestrian phase or concurrent yet protected signal timing if site conditions allow.
- With a pedestrian phase on automatic recall, the maximum LPI time is 7 seconds.

Consider a 3-second LPI duration when an intersection operates close to capacity.

Use **Formula 3.11.5.2-1** to calculate the LPI duration for each crosswalk:

Formula 3.11.5.2-1

$$LPI = \frac{ML + B}{W} + PS$$

Where:

LPI = Number of seconds rounded up to the nearest interval allowed by the controller between the onset of the *WALK* signal for pedestrians and the green indication for vehicles.

ML = Distance on the crosswalk to clear the width of one through lane from the edge of the curb, in feet. Consider large corner radii as per [MUTCD Section 4I.06 \(22\)](#).

B = Distance from the pedestrian detector location to the edge of curb, in feet. Use 6 feet if no pedestrian detector is present. This measures the distance a pedestrian travels to arrive at the curb.

W = Walking speed (3.5 ft/s for pedestrian clearance interval calculation suggested by the *MUTCD*). The [Manual on Uniform Traffic Studies \(MUTS\)](#) provides additional guidance on conducting individual pedestrian walking speed studies.

PS = Pedestrian start-up lost time (FDOT recommends using 1.6 seconds). This term can be omitted if an accessible pedestrian signal is provided.

Consider using an accessible pedestrian signal ([MUTCD Sections 4K.01 to 4K.05](#)) with LPI applications, as vision-impaired pedestrians use the sound of moving traffic to decide when to start crossing. Accessible pedestrian signals alert pedestrians that the *WALK* indication has initiated. Refer to **TEM Section 3.7** for accessible pedestrian signal applicability and implementation.

When an LPI is used, consider concurrent turning movements across the crosswalk.

Right Turn

Use either of the following options:

- A static or dynamic *NO TURN ON RED* sign (**R10-11**) to prohibit turns on red. If using a dynamic sign, display the message during the LPI interval and the preceding yellow and red intervals.
- A shared lane with through vehicles totaling more than two-thirds of the traffic within the lane.

Protected Left Turn

Do not time LPIs concurrent with the opposing protected left-turn interval. Protected left turns may be leading or lagging, but lagging the opposing left-turn movement is preferred to reduce pedestrian conflicts with late-turning vehicles.

For opposing leading left-turn movement, time the LPIs after the opposing protected left-turn movement and before the green through vehicle interval. For opposing lagging left-turn movement, time the LPIs before the green interval for through-vehicle movements.

Protected/Permissive Left Turn

Do not time LPIs concurrent with the opposing protected left-turn interval. Protected/permissive left turns may be leading or lagging. Lagging the opposing left-turn movement is preferred to reduce pedestrian conflicts with late-turning vehicles.

Time the pedestrian phases with LPIs concurrently unless FYA signal heads are used for the conflicting left-turn movements. This prohibits permissive left-turning movements during the LPI.

Permissive Left Turn

LPIs may be implemented with permissive left turns. Time the pedestrian phases with LPIs concurrently unless FYA signal heads are used for the conflicting left-turn movements. This prohibits permissive left-turning movements during the LPI. See **Figure 3.11-1** for examples.

Figure 3.11-1. Schematic Diagram for Signal Timing with LPI

A - Lead/Lead Left Turn

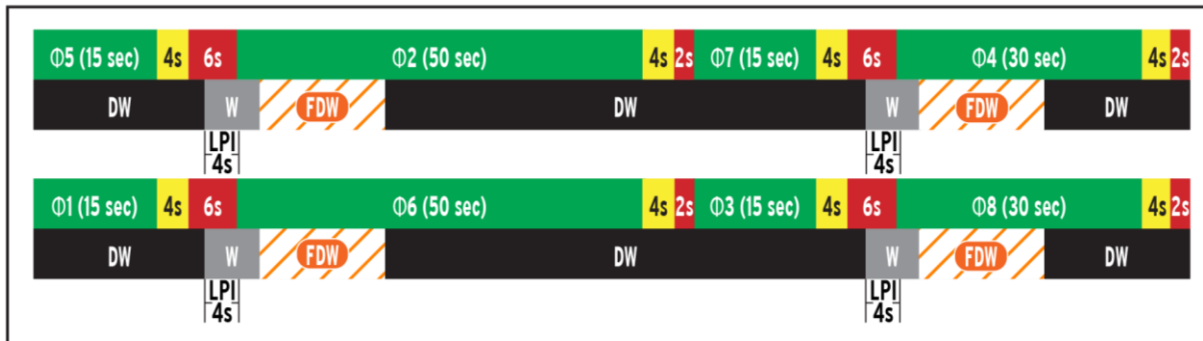

B - Lead/Lag Left Turn

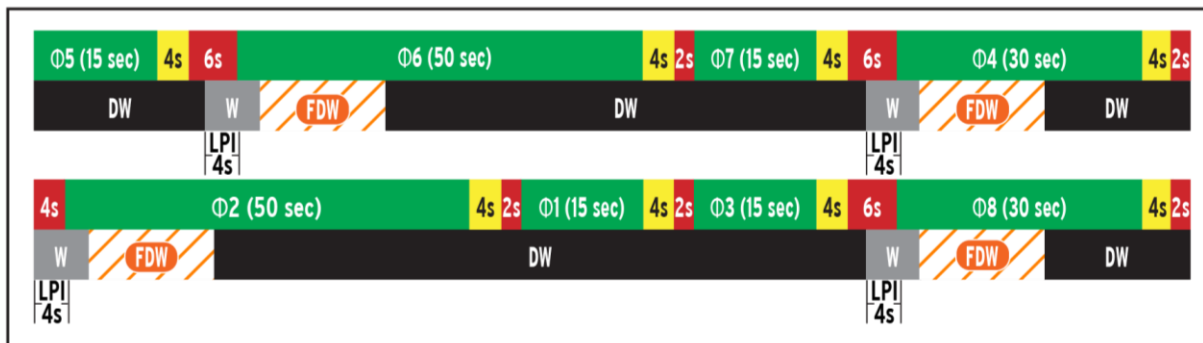

LEGEND	Green Interval	Red Interval	Walk Interval
	Yellow Interval	Don't Walk Interval	Flashing Don't Walk Interval

For corridors with LPIs at multiple intersections, consider using automatic pedestrian recall in conjunction with LPIs to maintain progression along the corridor.

FDOT recommends conducting field observations to evaluate improvements to safety and overall intersection operations after implementing LPI. Engineers may adjust signal timing further based on safety needs and engineering judgment.

3.11.6 FYA OMIT BY PED

Consider implementing *FYA Omit by Ped* at locations with protected/permissive signal phasing and four-section signal heads.

Engineers may program *FYA Omit by Ped* for times of day with higher pedestrian volumes that can inhibit permissive left turns. This may be useful in the following cases:

- Intersections with high permissive left-turning conflicts with pedestrians
- School arrival and dismissal periods
- Arrival and dismissal periods at event venues

Use of *Rest in Walk* is not recommended with *FYA Omit by Ped* as it results in a protected-only left-turn phase.

3.11.7 DELAYED TURN

Consider implementing *Delayed Turn* on approaches with dedicated lanes and signal heads for turning movements. This treatment also requires *NO TURN ON RED* signage. Left- and right-turn movements may be held for the duration of the *WALK* and flashing *DON'T WALK* intervals to achieve concurrent yet protected phasing. Use **Formula 3.11.5.2-1** and engineering judgment to calculate turning movement duration.

SECTION 3.12

TRAFFIC SIGNAL RETIMING

3.12.1 PURPOSE

This section provides guidance on how frequently to retime a traffic signal to reduce travel delays, crash frequency, and pollution from fuel consumption and emissions.

3.12.2 GENERAL

Signal retiming is a low-cost approach to keeping traffic moving safely and smoothly while also helping:

- Reduce traffic congestion.
- Reduce aggressive driving behavior/red light running.
- Reduce the number of fatalities and serious injury crashes.
- Reduce fuel consumption and emissions.
- Reduce the need to increase road capacity through construction.
- Reduce speeding along a corridor through context-sensitive considerations.

Retiming traffic signals every three to five years has become standard practice. Signal timing may need to be reexamined due to:

- Increased capacity or turning movements.
- Increased traffic congestion.
- More trucks as a percentage of traffic.
- Construction activities (road or development).
- New traffic signals along the corridor.

3.12.3 PROCEDURE

Urban signals are retimed every three years, and rural signals are retimed every five years. Retiming runs in cycles, so 33 percent of urban and 20 percent of rural signals are retimed each year. This approach follows a regularly scheduled system for retiming signals on the State Highway System.

Alternate approaches districts can take include:

- Traffic study based on observation of performance loss (queues not fully discharged, spillback, and unused green time).
- Analyze the existing timing against optimized timing performance developed through signal timing software.

These alternate approaches have been adopted for areas where traffic flows have matured and stabilized. Analyze traffic signals every three to five years to determine whether or not the signal is being retimed.