



Manual of Uniform Minimum
Standards for Design,
Construction and Maintenance
for Streets and Highways

Commonly known as the
Florida Greenbook

FDOT Office of Design
Topic # 625-000-015

Date of Publication
2023 Edition

A grayscale photograph of a city street scene. In the foreground, there are several palm trees and a road with a guardrail. In the background, there are several multi-story buildings under a cloudy sky. A large, teal-colored diagonal banner is overlaid on the right side of the image, containing the text "Florida Greenbook" in white, bold, sans-serif font.

Florida Greenbook

USER REGISTRATION

Manual of Uniform Minimum Standards for Design, Construction and Maintenance for Streets and Highways

(Commonly known as the ***Florida Greenbook***)

202318 Edition

To: Florida Greenbook Users

The Florida Department of Transportation (FDOT) utilizes a contact database that enables ~~the Department~~ the FDOT to e-mail important information to registered users on topics selected by each user. The database allows a user to update their physical address, e-mail address, topics of interest, and any other information in their profile at any time.

All Florida Greenbook users must register their e-mail addresses in this contact database in order to receive updates, notices, design memos, or other important information concerning ~~the Department's~~ the FDOT's design manuals. Users must register at the following link:

<http://www.fdot.gov/designsupport/ContactDatabase.shtm>

New subscribers will need to create a new account. Once the information is registered, new subscribers will need to “Edit Interests.” The Florida Greenbook may be found under: Publications → Design → Roadway Design → Florida Greenbook”

TABLE OF CONTENTS

User Registration

Florida Greenbook Committee Members and Chapter Subcommittees
Purpose, Policies and and and Objectives, and Definitions of Terms

Chapter 1	Planning <u>and Land Development</u>
Chapter 2	Land Development <u>Chapter Removed – See Chapter 1</u>
Chapter 3	Geometric Design
Chapter 4	Roadside Design
Chapter 5	Pavement Design and Construction
Chapter 6	Lighting
Chapter 7	Rail-Highway Crossings
Chapter 8	Pedestrian Facilities
Chapter 9	Bicycle Facilities
Chapter 10	Maintenance and Resurfacing
Chapter 11	Work Zone Safety <u>and Mobility</u>
Chapter 12	Construction
Chapter 13	Public Transit
Chapter 14	Design Exceptions and Variations
Chapter 15	Traffic Calming
Chapter 16	Residential Street Design
Chapter 17	Bridges and Other Structures
Chapter 18	Signing and Marking
Chapter 19	Traditional Neighborhood Development
Chapter 20	Drainage

THIS PAGE INTENTIONALLY LEFT BLANK

FLORIDA GREENBOOK COMMITTEE MEMBERS

202318

The Florida Greenbook Advisory Committee is composed of four professional engineers within each of the Department of Transportation's seven district boundaries as described in Section 336.045(2), Florida Statutes (F.S.).

Section 336.045, Florida Statutes. Uniform minimum standards for design, construction, and maintenance; advisory committees.

(2) An advisory committee of professional engineers employed by any city or any county in each transportation district to aid in the development of such standards shall be appointed by the head of the department. Such committee shall be composed of: one member representing an urban center within each district; one member representing a rural area within each district; one member within each district who is a professional engineer and who is not employed by any governmental agency; and one member employed by the department for each district.

~~Contact information for the Florida Greenbook Advisory Committee members can be found on the Florida Greenbook web page:~~

~~<http://www.fdot.gov/roadway/FloridaGreenbook/FGB.shtm>~~

DEDICATION

The 2023 Florida Greenbook is dedicated to Jeremy W. Fletcher (b.1970 – d.2022), who joined the Department in December 2006 in the Roadway Design Office (Tallahassee, Florida). His contributions and dedication to improve this vital document are recognized by the Department and the Florida Greenbook Advisory Committee.

The Florida Greenbook Advisory Committee Members at the time of publication are as follows:

DISTRICT 1

Kevin Ingle, P.E.
District Design Engineer
FDOT - District 1

Shane Parker, P.E.
Public Works Director
Hendry County

Ryan Bell, P.E., PTOE
Director of Transportation
Johnson Engineering, Inc.

Nikesh Patel, P.E.
City Engineer
City of Sarasota

DISTRICT 2

Kathryn D. Thomas, P.E.
District Design Engineer
FDOT - District 2

Gene Howerton, P.E.
Vice President
Arcadis U.S., Inc.

Kenneth Dudley, P.E.
County Engineer
Taylor County

Ramon D. Gavarrete, P.E.
County Engineer
Alachua County

DISTRICT 3

Adam Scurlock, P.E.
District Design Engineer
FDOT - District 3

Keith Bryant, P.E., P.T.O.E.
Public Works Director
Bay County

Rick Hall, P.E.
Principal
Hall Planning and Engineering, Inc.

[Chance Powell, P.E.](#)
[Traffic Operations Engineer](#)
[Walton County](#)

DISTRICT 4

John Olson, P.E.
District Design Engineer
FDOT - District 4

Richard B. Szpyrka, P.E.
Director of Public Works
Indian River County

Robert Behar, P.E.
President
R. J. Behar and Company, Inc.

Richard Tornese, P.E.
County Engineer
Broward County

DISTRICT 5

Ed Kestory P.E.
District Design Engineer
FDOT - District 5

Gail Woods, P.E.
Assistant Vice-President
TranSystems

Ghulam Qadir, P.E.
Chief Engineer
Orange County Public Works

Deborah I. Snyder, P.E., P.T.O.E.
Public Works Director
Sumter County

DISTRICT 6

Karina Fuentes, P.E.
District Design Engineer
FDOT - District 6

Andres Garganta, P.E.
Vice President
WGI

Miguel Soria, P.E.
Assistant Director, Highway Engineering
Miami-Dade County

Juvenal Santana, P.E.
Director
City of Miami Public Works Department

DISTRICT 7

Allan Urbonas, P.E.
District Design Engineer
FDOT - District 7

[D. Todd Crosby, P.E.](#)
[Assistant County Engineer](#)
[Hernando County](#)

Richard Diaz, Jr., P.E.
President
Diaz Pearson & Associates, Inc.

[Calvin Hardie, P.E.](#)
[Chief Design Engineer](#)
[City of Tampa](#)

ASSOCIATE MEMBERS (Non-Voting)

Billy Hattaway, P.E.
Transportation Department Director
England-Thims & Miller, Inc

Charles Ramdatt, P.E., P.T.O.E., AICP
[Public Works Director](#)
City of Winter Park

Allen W. Schruppf, P.E.
Senior Associate
DRMP, Inc.

Kenneth J. Leeming, P.E.
Highway Construction Manager
Orange County Public Works

FACERS LIAISON

Travis Terpstra, P.E. LEED GA
Senior Project Manager
Volusia County

COMMITTEE STAFF

[Derwood Sheppard, P.E.](#)
[State Roadway Design Engineer](#)
[FDOT - Central Office](#)

Rhonda Taylor, P.E.
Roadway Design Criteria Administrator
FDOT - Central Office

DeWayne Carver, CNUa
Criteria Publications Manager
FDOT – Central Office

[Jacqui Morris, CPM, CNUa](#)
[Criteria Publications Coordinator](#)
[FDOT – Central Office](#)

CHAPTER TECHNICAL ADVISORS

Gabrielle (Gabe) Matthews
Transit Planning Administrator
FDOT – Central Office

[David Cerlanek, P.E., P.T.O.E., CPM](#)
[District Program Administration Engineer](#)
[FDOT – District 2](#)

Chris Wigglesworth
Transit Planner
FDOT – Central Office

[Aurybell Rivero, Rivero, EI, MEVE](#)
[Senior Transportation Planner](#)
[Pasco County](#)

Dana Knox
Traffic Operations
FDOT – Central Office

[May Cheng, P.E.](#)
[Traffic Signals/Street Lighting](#)
[Palm Beach County Traffic Engineering](#)
[Division](#)

Richard Stepp, P.E.
Standard Plans Engineer
FDOT - Central Office

[Alina Sardinias, MSCE](#)
[Civil Engineer, Special Projects](#)
[Palm Beach County Traffic Engineering](#)
[Division](#)

Benjamin J. Gerrell, P.E.
Quality Assurance Engineer
FDOT - Central Office

[Jerald Marks](#)
[Orange County Public Works](#)

Andre Pavlov, P.E.
Assistant State Structures Design
Engineer
FDOT – Central Office

[Lauren Torres](#)
[Project Manager, Traffic Engineering](#)
[Orange County Public Works](#)

Mary Jane Hayden, P.E.
Roadway Quality Assurance Administrator
FDOT - Central Office

[Barry Westmark, P.E.](#)
[Senior Engineer, Engineering Services](#)
[Department,](#)
[City of Largo](#)

[Rick Jenkins, P.E.](#)
[State Standards Plans Engineer](#)
[FDOT – Central Office](#)

[Rob Phelan, P.E.](#)
[Lee County Department of Transportation](#)

[James Poole, P.E.](#)
[District Drainage Design Engineer](#)
[FDOT – District 4](#)

[William Corbett, P.E., P.T.O.E.](#)
[City Traffic Engineer](#)
[City of Cape Coral](#)

Alissa Torres, Ph.D., AICP, P.L.S.
Chief Planner, Orange County
Transportation Planning Division

Luis A. Alván, Esq., P.E.
Senior Engineer
Orange County Public Works

Frank C. Yokiell, AICP
Orange County Public Works
Engineering Division

Daryl Hildoer, P.E., ENV SP
Stormwater Drainage Design Section
Miami-Dade Department of Transportation
and Public Works

Joanne Keller, P.E.
Director of Land Development
Engineering Department, Palm Beach
County

Maria Molina, P.E.
Chief, Right of Way Division
Miami-Dade Department of Transportation
and Public Works

Naomi Tillett, P.E.
Engineer II, Public Works Department
City of Lakeland

Liza Herrera, P.E., ENV SP
Stormwater Drainage Design Section
Miami-Dade Department of Transportation
and Public Works

Juan Vasquez, P.E.
Vice President
R.J. Behar & Company

~~20196, 2020 and 202117~~

In addition to the members noted previously, the following served on the Florida Greenbook Committee or as Technical Advisors from 2019 through 2022~~in 2014 and 2015~~.

DISTRICT 1

Alexandrea Davis-Shaw, P.E.
City Engineer
City of Sarasota
Highlands County

Steven Neff, P.E.
Public Works Director
City of Cape Coral

Andy Tilton, P.E.
Public Works Director
Volusia County

DISTRICT 2

John Veilleux, P.E.
Supervising Engineer
City of Gainesville

DISTRICT 3

Thomas C. Phillips (Chris), P.E.
County Engineer
Santa Rosa County

Rodney Chamberlain, P.E.
District Design Engineer
FDOT - District 3

DISTRICT 4

Steve Braun, P.E.
District Design Engineer
FDOT - District 4

DISTRICT 5

Marrio Bizzio, P.E.
District Design Engineer
FDOT - District 5

Jeffrey Cicerello, P.E.
District Design Engineer
FDOT - District 5

DISTRICT 6

Daniel Iglesias, P.E.
District Design Engineer
FDOT - District 6

Gaspar Miranda, P.E.
Assistant Director, Highway Engineering
Public Works Department
Miami-Dade County

DISTRICT 7

Milton J. Martinez, P.E.
Chief Transportation Engineer
Transportation and Stormwater Services
Department
City of Tampa

[Margaret W. Smith, P.E.](#)
[Engineering Services Director/
County Engineer](#)
[Pasco County](#)

CENTRAL OFFICE

Catherine (Katey) Earp, P.E.
Drainage Design Engineer
FDOT - Central Office

[Gevin McDaniel, P.E., P.S.M.](#)
[Roadway Design Criteria Administrator](#)
[FDOT - Central Office](#)

[Mary Anne Koos, CPM](#)
[Special Projects Coordinator](#)
[FDOT – Central Office](#)

[Jeremy Fletcher, P.E., P.S.M.](#)
[Roadway Quality Assurance Administrator](#)
[FDOT – Central Office](#)

[Tim Lattner, P.E.](#)
[Director, Office of Design](#)
[FDOT - Central Office](#)

[Patrick Overton, P.E.](#)
[State Utility Engineer](#)
[FDOT - Central Office](#)

Michael Shepherd, P.E.
Director, Office of Design
FDOT - Central Office

FACERS LIAISON

Benjamin Bartlett, P.E.
Public Works Director
Volusia County

CHAPTER SUBCOMMITTEES

The Chapter Chairs at the time of publication are as follows:

<u>Chapter</u>	<u>Chair</u>
1. Planning <u>and Land Development</u>	Richard Tornese and Rick Hall
2. Land Development	Sunset Ricard Tornese
3. Geometric Design	Andy Garganta
4. Roadside Design	Robert Behar
5. Pavement Design and Construction	Margaret Smith Kevin Ingle
6. Lighting	Vacant Keith Bryant Bernie Masing
7. Rail-Highway Crossings	Karina Fuentes Daniel Iglesias
8. Pedestrian Facilities	Ed Kestory Mario Bizzio
9. Bicycle Facilities	Ed Kestory Mario Bizzio
10. Maintenance and Resurfacing	Allan Urbonas
11. Work Zone Safety <u>and Mobility</u>	Karina Fuentes Daniel Iglesias
12. Construction	Vacant John Veilleux Richard Szpyrka
13. Public Transit	Vacant Juvenal Santana Milton Martinez
14. Design Exceptions and Variations	Miguel Soria Howard Webb
15. Traffic Calming	Juvenal Santana Billy Hattaway
16. Residential Street Design	Margaret Smith Richard Tornese
17. Bridges and Other Structures	Keith Bryant
18. Signing and Marking	Gail Woods
19. Traditional Neighborhood Development	Rick Hall Nikesh Patel
20. Drainage	Ryan Bell

THIS PAGE INTENTIONALLY LEFT BLANK

PURPOSE, POLICIES AND OBJECTIVES, AND DEFINITIONS

PURPOSE

The purpose of this Manual is to provide uniform minimum standards and criteria for the design, construction, and maintenance of all transportation facilities off the State Highway System (SHS), roads, highways, bridges, sidewalks, curbs and curb ramps, crosswalks, bicycle facilities, underpasses, and overpasses used by the public for vehicular and pedestrian traffic as directed by **Sections 20.23(3)(a), 316.0745, 334.044(10)(a), and 336.045, F.S.**

The Florida Greenbook encourages context-based transportation planning and design. Context-based planning and design offers a diverse approach using existing tools in creative ways to improve the transportation system and meet the needs of users of all ages and abilities. This includes pedestrians, bicyclists, transit riders, motorists, and freight handlers. Planning and design of streets and highways must be based on the surrounding development patterns for existing and planned land development patterns. The approach also considers community needs, trade-offs between those needs, and alternatives to achieve multiple objectives. Context-based design principles help to promote safety, quality of life, and economic development.

In the following statutory excerpts, the term "Department" refers to the Florida Department of Transportation.

Section 20.23, F.S. Department of Transportation. There is created a Department of Transportation which shall be a decentralized agency.

(3)(a) The central office shall establish departmental policies, rules, procedures, and standards and shall monitor the implementation of such policies, rules, procedures, and standards in order to ensure uniform compliance and quality performance by the districts and central office units that implement transportation programs. Major transportation policy initiatives or revisions shall be submitted to the commission for review.

Section 316.0745, F.S. Uniform signals and devices.

(1) The Department of Transportation shall adopt a uniform system of traffic control devices for use on the streets and highways of the state. The uniform system shall, insofar as is practicable, conform to the system adopted by the American

Association of State Highway Transportation Officials and shall be revised from time to time to include changes necessary to conform to a uniform national system or to meet local and state needs. The Department of Transportation may call upon representatives of local authorities to assist in the preparation or revision of the uniform system of traffic control devices.

Section 334.044, F.S. Department; powers and duties. The department shall have the following general powers and duties:

(10)(a) To develop and adopt uniform minimum standards and criteria for the design, construction, maintenance, and operation of public roads pursuant to the provisions of **Section, 336.045, F.S.**

Section 336.045, F.S. Uniform minimum standards for design, construction, and maintenance; advisory committees.

(1) The department shall develop and adopt uniform minimum standards and criteria for the design, construction, and maintenance of all public streets, roads, highways, bridges, sidewalks, curbs and curb ramps, crosswalks, where feasible, bicycle ways, underpasses, and overpasses used by the public for vehicular and pedestrian traffic. In developing such standards and criteria, the department shall consider design approaches which provide for the compatibility of such facilities with the surrounding natural or manmade environment; the safety and security of public spaces; and the appropriate aesthetics based upon scale, color, architectural style, materials used to construct the facilities, and the landscape design and landscape materials around the facilities.

(2) An advisory committee of professional engineers employed by any city or any county in each transportation district to aid in the development of such standards shall be appointed by the head of the department. Such committee shall be composed of one member representing an urban center within each district; one member representing a rural area within each district; one member within each district who is a professional engineer and who is not employed by any governmental agency; and one member employed by the department for each district.

(4) All design and construction plans for projects that are to become part of the county road system and are required to conform with the design and construction standards established pursuant to subsection (1) must be certified to be in substantial conformance with the standards established pursuant to subsection (1) that are then in effect by a professional engineer who is registered in this state.

These standards are intended to provide basic guidance for developing and maintaining a highway system with reasonable operating characteristics and a minimum number of hazards.

Standards established by this Manual are intended for use on all transportation facilities off the State Highway System (SHS). Certain projects off the SHS but on the National Highway System (NHS) utilizing federal funds may be required to follow additional design criteria. Please see [Chapter 19](#) of the FDOT's [Local Agency Program Manual](#) for further information. Information on roadways included in the NHS is found at the FDOT's website: [National Highway System Maps](#).

Standards are provided for the design of new construction and reconstruction projects as well as maintenance and resurfacing projects. It is understood that existing streets and highways may not conform to all minimum standards applicable to the design of new and reconstruction projects. For existing roads not being replaced or reconstructed, it is intended the requirements provided in **Chapter 10 – Maintenance and Resurfacing** are applied. For all projects, there may be practical reasons a certain standard is not met. A process is provided in **Chapter 14 – Design Exceptions and Variations** to address those situations.

The Federal Highway Administration's [Manual on Uniform Traffic Control Devices, 2009 Edition \(MUTCD\)](#), has been adopted by [Rule 14 – 15.010, F.A.C.](#), and establishes a uniform system of traffic control devices. The [Manual on Uniform Traffic Control Devices \(2009 Edition with Revision Numbers 1 and 2, May 2012, MUTCD\)](#) includes additional requirements.

When this Manual refers to guidelines and design standards given by current American Association of State Highway and Transportation Officials (AASHTO) publications, these guidelines and standards shall generally be considered as minimum criteria. The FDOT may have standards and criteria that differ from the minimum presented in this Manual or by AASHTO for streets and highways under its jurisdiction. A county or municipality may substitute standards and criteria adopted by the FDOT for some or all portions of design, construction, and maintenance of their facilities. The ~~Department~~ [FDOT](#) standards, criteria, and manuals must be used when preparing projects on the state highway system or the national highway system.

Criteria and standards set forth in other manuals, which have been incorporated by reference, shall be considered as requirements within the authority of this Manual.

This Manual is intended for use by qualified engineering practitioners for the communication of standards and criteria (including various numerical design values and use conditions). The design, construction, and maintenance references for the infrastructure features contained in this Manual recognize many variable and often complex process considerations. The engineering design process, and associated use of this Manual, incorporates aspects of engineering judgment, design principles, science, and recognized standards towards matters involving roadway infrastructure.

Users of this Manual are cautioned that the strict application of exact numerical values, conditions or use information taken from portions of the text may not be appropriate for all circumstances. Individual references to design values or concepts should not be used out of context or without supporting engineering judgment.

The contents of this Manual are reviewed annually by the Florida "Greenbook" Advisory Committee. Membership of this committee is established by the above referenced **Section 336.045(2), F.S.** Comments, suggestions, or questions may be directed to any committee member.

POLICIES AND OBJECTIVES

Specific policies governing the activities of planning, design, construction, reconstruction, maintenance, or operation of streets and highways are listed throughout this Manual. This manual uses a context-based design approach that considers the mobility, convenience, accessibility, and safety of all road users; and places an emphasis on the most vulnerable users of a given transportation facility. Decisions ~~shall~~~~should~~ be predicated upon meeting the following objectives:

- A. Specifies all users - Provide streets and highways with operating characteristics that support users of all ages and abilities.
 - ✓ Incorporate appropriate context based design elements when planning and designing the transportation network.
 - ✓ Draw on all sources of transportation funding to implement context based design.
 - ✓ Seek input from a variety of local stakeholders when designing or revising transportation projects to promote equity and meet the diverse needs of system users.
- B. Applies to all projects - Each transportation agency should establish and maintain a program to promote context based design in all activities on streets and highways under its jurisdiction.
 - ✓ Planning, design, construction, and maintenance activities are all essential activities for implementing context-based design.
- C. Procedure for exceptions and variations – When proposed design elements do not meet the criteria contained in this Manual, sufficient detail and justification of such deviations must be documented.
 - ✓ Sufficient detail and explanation must be given to justify approval to those reviewing the request.
 - ✓ Consider potential mitigation strategies that may reduce the adverse impacts to highway safety and traffic operations.

- D. Creates a network - Design, operate, and maintain a transportation system that provides a highly connected and diverse network of streets that accommodate all intended modes of travel.
- ✓ Place a priority on connecting communities with economic and employment centers and visitor destinations.
 - ✓ Prioritize non-motorized connectivity improvements to services, schools, parks, civic uses, regional connections, and commercial uses.
 - ✓ Identify routes for freight traffic that provide access to industrial centers, warehouses, distribution centers (rail, freight, intermodal), and ports (airports, seaports, and space ports).
 - ✓ Consider the “last mile” needs of freight handlers and transit riders.
 - ✓ Seek opportunities to repurpose or add new rights of way to enhance connectivity for pedestrians, bicyclists, and transit or shift freight traffic to more appropriate corridors.
- E. Adoptable by all agencies - A well-connected, diverse transportation system supports Florida’s existing and future economic development.
- ✓ Increase productivity by improving the accessibility of people and businesses to reach jobs, services, goods, and activities.
 - ✓ Increase level of accountability for metropolitan, regional, and local agencies to demonstrate the need, economic impact, and return of transportation investments.
 - ✓ Strengthen local policies, ordinances requiring new development or redevelopment to provide interconnected street networks with small blocks that connect with existing or planned streets on the perimeter.
 - ✓ Support regional land use, economic development goals, and regional vision.
- F. Latest and best design criteria - Provide uniformity and consistency in the design and operation of streets and highways.
- ✓ Strive to design and maintain facilities that are consistent with the local context, through single projects or incremental improvements over time.

- ✓ Document conditions that may preclude achieving full multi-modal design, such as environmental, historical or cultural constraints, limited right of way, or disproportionate cost.
 - ✓ Anticipate needs of connected and autonomous vehicles and other emerging technologies.
- G. Context-sensitive - Transportation investments should align with land use, and support a community's quality of life. A context-based approach helps communities and regions make sound decisions which support their long-term vision.
- ✓ Harmonize the transportation system with adjacent existing or proposed context such as neighborhoods, business districts, commercial areas, and public services (schools, parks, health, and entertainment centers).
 - ✓ Design streets with a strong sense of place; use architecture, landscaping, streetscaping, public art, and signage to reflect the community, neighborhood, history, and natural setting.
 - ✓ Highlight natural features such as waterways, trees, scenic views, slopes, and preserved lands and minimize impacts.
- H. Establishes performance measures - Develop and maintain a transportation system that provides a safe environment.
- ✓ Understand that children, elderly adults, and persons with disabilities may require appropriate accommodations.
 - ✓ Establish and maintain procedures for construction, maintenance, utility, and emergency operations that provide for safe operating conditions during these activities.
 - ✓ Use existing street pavement widths as efficiently as possible to accommodate all modes of transportation, recognizing that allocating designated space by mode is preferred, but shared facilities may be the most practical solution in some cases.
- I. Includes specific next steps for implementation.
- ✓ Understand the priorities and concerns by reaching out to stakeholders, collect data, synthesize issues and opportunities, and define context classifications.

- ✓ Define the project's purpose, needs and evaluation measures (i.e., person throughput, network completeness, street connectivity, access to jobs, housing, retail, public facilities).
- ✓ Define and evaluate alternatives.

Additional general and specific objectives related to various topics and activities are listed throughout this Manual. Where specific standards or recommendations are not available or applicable, the related objectives shall be utilized as general guidelines.

DEFINITIONS OF TERMS

The following terms shall, for the purpose of this Manual, have the meanings respectively ascribed to them, except instances where the context clearly indicates a different meaning. The [Manual on Uniform Traffic Control Devices \(2009 Edition with Revision Numbers 1 and 2, May 2012, MUTCD\)](#) includes additional information on terms used in conjunction with the application of the **MUTCD**.

Alley	A narrow right of way to provide access to the side or rear of individual land parcels.
Annual Average Daily Traffic (AADT)	The total volume of traffic on a highway segment for one year, divided by the number of days in the year. This volume is usually estimated by adjusting a short-term traffic count with weekly and monthly factors.
Average Daily Traffic (ADT)	The total traffic volume during a given time period (more than a day, less than a year) divided by the number of days in that time period.
Auxiliary Lane	A designated width of roadway pavement marked to separate speed change, turning, passing, and climbing maneuvers from through traffic.
Average Running Speed	For all traffic, or component thereof, the summation of distances divided by the summation of running times.
Bicycle Lane (Bike Lane)	A portion of a roadway that has been designated for preferential use by bicyclists by pavement markings, and if used, signs. They are one-way facilities that typically carry traffic in the same direction as adjacent motor vehicle traffic.

Boarding And Alighting (B&A) Area

A firm, stable, slip resistant surface that accommodates passenger movement on or off a transit vehicle.

Border Area

The border area provides space for roadside design components (e.g., signing, drainage features, sidewalks, and traffic control devices), a buffer between vehicles and pedestrians, and permitted public utilities. It also provides space for construction and maintenance of the facility.

Bridge

A structure, including supports, erected over a depression or an obstruction, such as water, a highway, or a railway, having a track or passageway for carrying traffic or other moving loads, and having a total span of more than 20 feet between undercopings of abutments.

Clear Zone

The unobstructed, traversable area beyond the edge of the traveled way for the recovery of errant vehicles. The clear zone includes shoulders and bicycle lanes.

Context Classification System

Broadly identifies the built environments in Florida, based upon existing and future land use characteristics, development patterns, network scale, and roadway connectivity of an area.

Corridor

A strip of land between two termini within which traffic, topography, environment, population, access management, and other characteristics are evaluated for transportation purposes.

Cross Slope

The transverse slope and/or superelevation described by the roadway section geometry.

Crosswalk

Portion of the roadway at an intersection included within the connections of lateral lines of the sidewalks on opposite sides of the highway, measured from the curbs or in the absence of curbs from the traversable roadway. Crosswalks may also occur at an intersection or elsewhere distinctly indicated for pedestrian crossing.

Design Hour Volume (DHV)

Traffic volume expected to use a highway segment during the design hour of the design year. The DHV is related to the AADT by the “K” factor. It includes total traffic in both directions of travel.

Design Year

Both current and future traffic volumes are considered in design. Future traffic volumes expected to use a particular facility are projected for the design year, which is usually 10 to 20 years in the future.

Directional Design Hour Volume (DDHV)

Traffic volume expected to use a highway segment during the design hour of the design year in the peak direction.

Design Speed

A selected speed used to determine the various geometric design features of the roadway. The selected design speed should be a logical one with respect to the topography, anticipated operating speed, adjacent land use, and functional classification of the highway.

Design User

Anticipated users of a roadway (including pedestrians, bicyclists, transit riders, motorists, and freight handlers) that form the basis for each roadway’s design.

Design Vehicle	A vehicle, with representative weight, dimensions, and operating characteristics, used to establish highway design controls for accommodating vehicles of designated classes.
Driveway	An access from a public way to adjacent property.
Expressway	A divided arterial highway for through traffic with full or partial control of access and generally with grade separations at major intersections.
Federal Aid Highway	A highway eligible for assistance under the United States Code Title 23 other than a highway classified as a local road or rural minor collector.
Freeway or Limited Access Highway	<u>A controlled access, divided arterial highway with grade separation at intersections.</u> An expressway with full control of access.
Frontage Road or Street	A street or highway constructed adjacent to a higher classification street or other roadway network serving adjacent property or control access.
Grade Separation	A crossing of two roadways or a roadway and a railroad or pedestrian pathway at different levels.
High Speed	Speeds of 50 mph or greater.
High-Speed Rail	Intercity passenger rail service that is reasonably expected to reach speeds of at least 110 miles per hour.
Highway	<u>A high-speed roadway (divided or undivided) intended for travel between destinations like cities and towns.</u>

Highway, Street, or Road

General terms, denoting a public way for purposes of traffic, both vehicular and pedestrian, including the entire area within the right of way. The term street is generally used for urban or suburban areas.

Intersection

The general area where two or more streets or highways join or cross.

Lateral Offset

The lateral distance from the edge of the traveled way or when applicable, face of curb, to a roadside object or feature.

Low Speed

Speeds less than or equal to 45 mph.

May

A permissive condition. Where "may" is used, it is considered to denote permissive usage.

Maintenance

A strategy of treatments to an existing roadway system that preserves it, retards future deterioration, and maintains or improves the functional condition.

New Construction

The construction of any public way (paved or unpaved) where none previously existed, or the act of paving any previously unpaved road, except as provided in Chapter 3, Section A of these standards.

Operating Speed

The rate of travel at which vehicles are observed traveling during free-flow conditions.

Paratransit

Comparable transportation service required by the ADA for individuals with disabilities who are unable to use fixed route transportation systems.

Pedestrian Access Route

A continuous and unobstructed path of travel provided for pedestrians with disabilities within or coinciding with a pedestrian circulation path.

Pedestrian Circulation Path

A prepared exterior or interior surface provided for pedestrian travel in the public right of way.

Preferential Lane

A street or highway lane reserved for the exclusive use of one or more specific types of vehicles or vehicles with at least a specific number of occupants.

Public Way

All public streets, roads, highways, bridges, sidewalks, curbs and curb ramps, crosswalks (where feasible), bicycle facilities, underpasses, and overpasses used by the public for vehicular and pedestrian traffic.

Ramp

1) Includes all types, arrangements, and sizes of turning roadways that connect two or more legs at an interchange. 2) A combined ramp and landing to accomplish a change in level at a curb (curb ramp).

Reconstruction

Streets and highways that are rebuilt primarily along existing alignment. Reconstruction normally involves full-depth pavement replacement. Other work that would fall into the category of reconstruction would be adding lanes adjacent to an existing alignment, changing the fundamental character of the roadway (e.g., converting a two-lane highway to a multi-lane divided arterial) or reconfiguring intersections and interchanges.

Recovery Area

A clear zone that includes the total roadside border area, starting at the edge of the traveled way, available for safe use by errant vehicles.

Residential Streets

Streets primarily serving residential access to the commercial, social, and recreational needs of the community. These are generally lower volume and lower speed facilities than the primary arterial and collector routes of the local system "or as adopted by local government ordinance".

Resurfacing

Work to place additional layers of surfacing on highway pavement, shoulders, bridge decks and necessary incidental work to extend the structural integrity of these features for a substantial time period.

Right of Way

A general term denoting land, property or interest therein, usually in a strip, acquired or donated for transportation purposes. More specifically, land in which the State, the FDOT, a county, a transit authority, municipality, or special district owns the fee or has an easement devoted to or required for use as a public road.

Roadway

A prepared surface (asphalt, concrete, brick, or other materials) for use primarily by vehicles, including shoulders and adjacent bicycle lanes. A divided roadway provides a separation between opposing traffic lanes.~~The portion of a street or highway, including shoulders, for vehicular use. A divided highway has two or more roadways~~

Rural Areas

Those areas outside of urban boundaries. Urban area boundary maps based upon the 2010 Census are located on the [the FDOT's Urban Area 1-Mile Buffer Maps.](#)

Shall or Must

A mandatory condition. (When certain requirements are described with the "shall" or "must" stipulation, it is mandatory these requirements be met.)

Shared Lane

Roadways where no bicycle lanes or adjacent shoulders usable by bicyclists are present and where travel lanes are too narrow for bicyclists and motor vehicles to operate side by side.

Shared Roadway

A roadway that is open to pedestrian, bicycle, motor vehicle, street cars, and rail travel. This may be an existing roadway, street with wide curb lanes, or road with paved shoulders.

Shared Street

Street that includes a shared zone where pedestrians, bicyclists, and motor vehicles mix in the same space. The design supports slower vehicle speeds and lower motor vehicle volumes. It lacks design elements that suggest motor vehicle priority or segregate modes; and includes elements that suggest a pedestrian priority (e.g., gathering areas, seating, lighting, art, special plantings).

Shared Use Path or Multi - Use Trail

A facility with a firm, stable, slip-resistant surface physically separated from motorized vehicular traffic by an open space or barrier with minimal cross flow by motor vehicles. Users may include pedestrians, bicyclists, skaters, and others. Special design and approval is needed when travelers use vehicles such as golf carts or other motorized devices.

Should

An advisory condition. Where the word "should" is used, it is considered to denote advisable usage, recommended but not mandatory.

Slope	The relative steepness of the terrain, expressed as a ratio or percentage. Slopes may be categorized as positive (backslopes) or negative (foreslopes) and as parallel or cross slopes in relation to the direction of traffic. In this manual slope is expressed as a ratio of vertical to horizontal (V:H).
Surface Transportation System	Network of highways, streets, and/or roads. Term can be applied to local system or expanded to desired limits of influence.
Traditional Neighborhood Development (TND)	TND refers to the development or redevelopment of a neighborhood or town using traditional town planning principles. Projects should include a range of housing types and commercial establishments, a network of well-connected streets and blocks, civic buildings and public spaces, and include other uses such as stores, schools, and places of worship within walking distances of residences.
Traffic	Pedestrians, bicyclists, motor vehicles, streetcars and other conveyances either singularly or together while using for purposes of travel any highway or private road open to public travel.
Traffic Lane	Includes travel lanes, auxiliary lanes, turn lanes, weaving, passing, and climbing lanes.
Travel Lane	A designated width of roadway pavement marked to carry through traffic and to separate it from opposing traffic or traffic occupying other traffic lanes. Generally, travel lanes equate to the basic number of lanes for a facility.
Traveled Way	The portion of the roadway for the movement of vehicles, exclusive of shoulders and bicycle lanes.

Turning Roadway

A connecting roadway for traffic turning between two intersection legs.

Urban Area

A geographic region comprising, as a minimum, the area inside the United States Bureau of the Census boundary of an urban place with a population of 5,000 or more persons, expanded to include adjacent developed areas as provided for by Federal Highway Administration (FHWA) regulations. Urban area boundary maps based upon the 2010 Census are located on the [the FDOT's Urban Area 1-Mile Buffer Maps](#).

Urbanized Area

A geographic region comprising, as a minimum, the area inside an urban place of 50,000 or more persons, as designated by the United States Bureau of the Census, expanded to include adjacent developed areas as provided for by Federal Highway Administration (FHWA) regulations. Urban areas with a population of fewer than 50,000 persons which are located within the expanded boundary of an urbanized area are not separately recognized.

Vehicle

Every device upon, or by which any person or property is or may be transported or drawn upon a traveled way, excepting devices used exclusively upon stationary rails or tracks. Bicycles are defined as vehicles per Section 316.003, [Florida Statutes F.S.](#)

Vertical Clearance

Minimum unobstructed vertical passage space.

Very Low-Volume Road

A road that is functionally classified as a local road and has a design average daily traffic volume of 400 vehicles per day or less.

Wide Outside Lane

Through lanes that provide a minimum of 14 feet in width. This lane should always be the through lane closest to the curb or shoulder of the road when a curb is not provided.

CHAPTER 1

PLANNING AND LAND DEVELOPMENT

A	CONTEXT-BASED PLANNING AND DESIGN	1-1
B	CLASSIFICATION	1-2
B.1	Functional Classification	1-2
B.2	Context Classification	1-4
B.3	Design Speed	1-7
C	CONSIDERATIONS FOR DESIGN	1-7
C.1	Safety	1-7
C.2	Economic Constraints	1-7
C.3	Access Requirements	1-8
C.4	Measures of Level of Service	1-8
C.5	Maintenance Capabilities	1-8
C.6	Utility and Transit Operations	1-8
C.7	Emergency Response	1-9
C.8	Environmental Impact	1-9
C.9	Community and Social Impact	1-9
D	LANE REPURPOSING	1-10
D.1	Data Needs	1-11
D.1.a	Multidisciplinary Review Team	1-12
D.1.b	Concept Reports	1-12
D.1.c	Project Description	1-13
D.1.d	Proposed Modifications	1-13
D.1.e	Traffic Analysis	1-14
D.1.f	Safety Analysis	1-15
D.1.g	Public Involvement	1-15
E	LAND DEVELOPMENT	1-15
E.1	Development Types and Guidelines	1-16
E.1.a	Conventional Suburban Design	1-17
E.1.b	Traditional Neighborhood Design (TND)	1-17

	E.1.c	Transit–Oriented Design (TOD)	1-17
E.2		Space Allocation.....	1-17
E.3		Access Control	1-18
E.4		Control Techniques	1-19
	E.4.a	Right of Way Acquisition	1-19
	E.4.b	Regulatory Authority	1-19
		E.4.b.1.....General Regulatory Requirements	1-19
		E.4.b.2.....Specific Control.....	1-20
E.5		Contracts and Agreements	1-20
E.6		Education.....	1-20
F.		OPERATION	1-22
	F.1	Policy	1-22
	F.2	Objectives.....	1-22
	F.3	Activities.....	1-22
		F.3.a Maintenance and Reconstruction	1-23
		F.3.b Work Zone Safety	1-23
		F.3.c Traffic Control	1-23
		F.3.d Emergency Response	1-24
		F.3.e Coordination and Supervision	1-24
		F.3.f Inspection and Evaluation	1-24
G		REFERENCES FOR INFORMATIONAL PURPOSES	1-25

TABLES

Table 1 – 1	Functional Classification Types	1-3
-------------	---------------------------------------	-----

FIGURES

Figure 1 – 1	Context Classifications.....	1-5
--------------	------------------------------	-----

CHAPTER 1

PLANNING AND LAND DEVELOPMENT

A CONTEXT-BASED PLANNING AND DESIGN

In 1996, the Federal Highway Administration (FHWA) released guidance encouraging context-based transportation planning and design. Since then, many regional and local transportation agencies in Florida and throughout the U.S. have adopted context-based planning and design policies and practices. Context-based planning and design offers a flexible approach using existing tools in creative ways to address multimodal needs in different contexts. The approach also considers community needs, trade-offs between those needs, and alternatives to achieve multiple objectives.

The Florida Greenbook's Context-Based Design policy captures three core concepts:

- Serve the needs of transportation system users of all ages and abilities, including pedestrians, bicyclists, transit riders, motorists, and freight handlers.
- Design streets and highways based on local and regional land development patterns that reflect existing and future context.
- Promote safety, quality of life, and economic development.

This Context-Based approach builds on flexibility and innovation to ensure that all streets and highways are developed based on their context classification, as determined by the local jurisdiction to the maximum extent feasible. With a Context-Based approach, every non-limited access transportation project, including those on the Strategic Intermodal System (SIS) or part of a residential, commercial, industrial development is uniquely planned and designed to serve the context of that roadway and the safety, comfort, and mobility of all users.

In a high-speed rural context, where higher truck traffic is anticipated, and walking and bicycling are infrequent, wider travel lanes with paved shoulders are appropriate. Shared use paths as part of a regional trail system or for access to schools or parks may also be needed. In urban contexts, where high volumes of pedestrians, bicyclists, and transit users are expected or desired, a roadway should include features such as wide sidewalks, bicycle facilities, transit stops, and frequent, pedestrian crossing opportunities.

Limited-access highways may incorporate elements of context-based design where they connect to the non-limited-access system.

Planning for communities occurs at several levels, including the region, city/town, community, block, and, finally, street and building. Planning should be holistic, looking carefully at the relationship between land use, buildings, and transportation in an integrated fashion. This approach, and the use of form-based codes, can create development patterns and transportation networks that balance walking, bicycling, and transit with motor vehicle transportation.

B CLASSIFICATION

Designs for transportation projects are based on established design controls for the various elements of the project such as width, side slopes, horizontal and vertical alignment, drainage, accessibility, and intersection considerations.

The design criteria presented in this manual are based on:

- Functional Classification
- Context Classification
- Design Speed

A determination of the functional and context-based design and operational requirements, and a clear definition of the classification of each new facility isare determined by the local government with jurisdiction over the street or highway. There should be consultation among local governments in determining the classification. The determination is required prior to the actual design.

B.1 Functional Classification

Functional classification is the grouping of highways by the character of service and connectivity they provide in relation to the total road network. Table 1 – 1 Functional Classification Types summarizes the primary characteristics of each functional classification.

Functional road classifications for Florida are defined in [Section 334.03 F.S.](#) The **AASHTO** publication ***A Policy on Geometric Design of Highways and Streets (2011)*** presents an excellent discussion on highway functional classifications.

e.1

Table 1 – 1 Functional Classification Types

Functional -Classification	Primary Characteristics
Limited Access Facilities	<ul style="list-style-type: none"> • Limited access • Through traffic movements • Primary freight routes • Guided by FHWA Design Standards for Highways (NHS)
Principal Arterial	<ul style="list-style-type: none"> • Through traffic movements • Longer distance traffic movements • Primary freight routes • Access to public transit • Pedestrian and bicycle travel
Minor Arterial	<ul style="list-style-type: none"> • Connections between local areas and network principal arterials • Connections for through traffic between arterial streets or highways • Access to public transit and through movements • Pedestrian and bicycle travel
Collector	<ul style="list-style-type: none"> • Carry traffic with trips ending in a specific area • Access to commercial and residential centers • Access to public transit • Pedestrian and bicycle travel
Local Roads	<ul style="list-style-type: none"> • Direct property access—residential and commercial • Pedestrian and bicycle travel

B.2 Context Classification

Following context-based design, projects are uniquely planned and designed to be in harmony with the surrounding land use characteristics and the intended uses of the street or highway. To this end, a context-based classification system comprising eight context classifications has been adopted. Figure 1 – 1 Context Classifications describes the context classifications that will determine key design criteria elements. Criteria for limited access facilities are independent of the adjacent land uses; therefore, context classifications shown in Figure 1 – 1 do not apply to these facilities.

For state and federal facilities and planning activities, urban and rural are based on population density gathered from the most recent census and mapped as urban area boundaries. Urban areas are considered to have *dense* development patterns, while rural areas are considered to have *sparse* development patterns. The Department FDOT's's Urban Area 1-Mile Buffer Maps identify urban and rural areas based on the census data and regional travel patterns.

Florida cities and counties may use the state and federal urban and rural definitions as guidance. Local comprehensive plans and other studies provide more precise context designations for urban, suburban, and rural areas.

Additional information on context classifications and guidance on the determination of the context classification is provided in the FDOT [Context Classification Document](#). Local governments are encouraged to apply these same definitions to local land areas off the state roadway system. They may also be based upon local context and analysis.

To meet local needs and travel demands, deviations in design criteria may be appropriate for urban streets. ***Chapter 3 – Geometric Design, Chapter 8 – Pedestrian Facilities, Chapter 9 – Bicycle Facilities, Chapter 13 – Transit, Chapter 15 – Traffic Calming, Chapter 16 – Residential Street Design, and Chapter 19 – Traditional Neighborhood Development*** provide additional information for the design of urban streets.

Figure 1 – 1 Context Classifications



C1 – Natural

Lands preserved in a natural or wilderness condition, including lands unsuitable for settlement due to natural conditions.

C2 – Rural

Sparsely settled lands; may include agricultural land, grassland, woodland, and wetlands.

C2T – Rural Town

Small concentrations of developed areas immediately surrounded by rural and natural areas; includes many historic towns.

C3R – Suburban Residential

Mostly residential uses within large blocks and a disconnected or sparse roadway network.

Figure 1 – 1 Context Classifications (continued)



C3C – Suburban Commercial

Mostly non-residential uses with large building footprints and large parking lots. Buildings are within large blocks and a disconnected or sparse roadway network.

C4 – Urban General

Mix of uses set within small blocks with a well-connected roadway network. May extend long distances. The roadway network usually connects to residential neighborhoods immediately along the corridor or behind the uses fronting the roadway.

C5 – Urban Center

Mix of uses set within small blocks with a well-connected roadway network. Typically concentrated around a few blocks and identified as part of the community, town, or city of a civic or economic center.

C6 – Urban Core

Areas with the highest densities and with building heights typically greater than four floors. Many are regional centers and destinations. Buildings have mixed uses, are built up to the roadway, and are within a well-connected transportation network.

B.3 Design Speed

See **Chapter 3, Section C.1 Design Speed** for information on establishing appropriate design speeds.

C CONSIDERATIONS FOR DESIGN

The following criteria ~~shall~~^{should} be considered and resolved in the initial planning and design of streets and highways. The criteria are not listed in order of priority, and the weighting of each criterion should be based on the context of a project, the available resources, and the users.

C.1 Safety

Functional and context classification play an important role in setting expectations and measuring outcomes for safety. Since agencies consider the type of street or highway in evaluating the significance of crash rates, classification can be used as part of evaluating relative safety and the implementation of safety improvements and programs.

C.2 Economic Constraints

In determining the benefit/cost ratio for any proposed facility, the economic evaluation should go beyond the actual expenditure of highway funds and the capacity and efficiency of the facility. Overall costs and benefits of various alternatives should include an evaluation of all known environmental, community, and social impacts and the quality and cost of the project.

Allocation of sufficient funds for obtaining the proper corridor and adequate right of way and alignment should receive the initial priority. Future acquisition of additional right of way and major changes in alignment are often economically prohibitive. This can result in substandard streets and highways that don't support the community's vision. Reconstruction or modification under traffic may be expensive, inconvenient, or hazardous to the user. This increase in costs, hazards, and inconvenience can be limited by initial development of quality facilities.

C.3 Access Requirements

Degree and type of access permitted on a given facility is dependent upon its intended function and context and should conform to the guidelines in **Chapter 3 – Geometric Design**. Reasonable access control must be exercised to allow a street or highway to fulfill its function. The proper layout of the highway network and the utilization of effective land use controls (~~Chapter 2 – Land Development~~) can provide the basis for regulating access.

C.4 Measures of Level of Service

Level of service (LOS) is essentially a measure of the quality of the operating characteristics of a street or highway for each travel mode. Factors involved in determining the level of service include speed and safety, as well as travel time; traffic conflicts and interruptions; freedom to maneuver; convenience and comfort; and operating costs. Level of service is also dependent upon actual traffic volume and composition of traffic (motor vehicles, trucks, transit, bicyclists, and pedestrians).

The [Highway Capacity Manual, 6th Edition](#) provides further information on assessing the traffic and environmental effects of highway projects.

C.54 Maintenance Capabilities

Planning and design of streets and highways should include provisions for the performance of required maintenance. The planning of the expected maintenance program should be coordinated with the initial highway design to ensure maintenance activities may be conducted without excessive traffic conflicts or hazards.

C.65 Utility and Transit Operations

Utility accommodation within rights of way is generally considered to be in the public's best interest, since rights of way frequently offer the most practical engineering, construction, and maintenance solutions for utility service to businesses and residences. Utility and transit facility locations should be carefully chosen to optimize operations and safety of the transportation facility. Additional information on the design of transit facilities can be found in **Chapter 13 – Transit**.

C.76 Emergency Response

Development of an effective emergency response program is dependent upon the nature of the highway network and the effectiveness of the operation of the system. Provisions for emergency access and communication should be considered in the initial planning and design of all streets and highways. Local emergency response personnel should be included in primary activities.

C.87 Environmental Impact

Construction and operation of streets and highways frequently produces an adverse effect upon the environment. Early consideration and resolution of environmental issues can avoid costly delays and modifications that may compromise the quality and efficiency of operation. Specific topics often encountered include the following:

- Air Quality
- Coastal Zone Resources
- Farmland
- Floodplains
- Hazardous Waste and Brownfields
- Noise
- Roadside vegetation
- Safe Drinking Water Act
- Water Quality
- Watersheds Management
- Wetlands
- Wild and Scenic Rivers and Wilderness Areas
- Wildlife and Threatened and Endangered Species
- Wildlife, Habitat and Ecosystems

C.98 Community and Social Impact

Quality and value of a community is directly influenced by the layout and design of

streets and highways. Quality of the network determines the freedom and efficiency of movement. Inadequate design of the network and poor land use practices can lead to undesirable community separation and deterioration. Specific design of streets and highways has a large effect upon the overall aesthetic value which is important to the motorist and resident. When using federal funds for transportation projects, the following considerations should be addressed:

- Corridor Preservation
- Historical and Archaeological Preservation
- Scenic Byways
- [Section 4 \(f\)](#) (parks, refuges, and historic sites)
- [Section 6 \(f\)](#) properties
- Visual Impacts

D LANE REPURPOSING

A lane repurposing project is a way to reassign/reallocates roadway space/travel lane(s) to achieve other purposes such as safety, economic development, and mobility for all users. This section serves as a resource for local transportation agency planners and engineers to analyze potential lane repurposing projects and includes the potential factors to be considered prior to design and implementation.

A typical goal for lane repurposing is better managing motor vehicular traffic in-order to make the area more amenable to people who walk/bicycle or at-risk populations, such as children and older adults. A local government may want to create an exclusive lane for transit service. For lane repurposing projects that involve facilities for transit-related services, additional discussion and coordination with their respective transit agencies should take place as early as possible.

All lane repurposing projects must comply with **Section 334.61 F.S.**

Lane repurposing on the Strategic Intermodal System (SIS) will not be considered.

The FDOT [Lane Repurposing Guidebook](#) provides additional information and tools on how to implement lane repurposing projects on the State Highway System, along with several detailed case studies. This document also provides useful information to locals for additional guidance.

D.1 Data Needs

Evaluating the potential success of a lane repurposing application process may require significant amounts of data, depending on the nature of the project. A lane repurposing project that has future or existing low Annual Average Daily Traffic (AADT) and simply requires restriping to implement will be less data intensive than a project which requires construction of curbs, gutters, and medians. Examples of data needed include:

- Existing and long-range future AADT (the latter based on historical growth and the regional travel demand model).
- Consistency with the local government's comprehensive plan and capital improvements program, MPO's Long-Range Transportation Plan (LRTP), Transportation Improvement Program (TIP), Transit Development Plan (TDP), master plans, visions, and context-based design initiatives.
- Status of the roadway as an Evacuation Route or freight route, ~~and part of the Strategic Intermodal System (SIS).~~
- Status of the roadway as a major transit corridor per the LRTP or TDP.
- Proposed use(s) for the right-of-way after lanes are eliminated (e.g., widened sidewalks, bicycle lanes, landscaping, on-street parking, transit lanes).
- Impact on bicycle/pedestrian infrastructure and connectivity.
- Impact on parking.
- Impact on transit routes, stop locations (including appropriateness of turn radii and lane widths), include total number of stops and routes in the area.
- Existing right-of-way width and any proposed changes to the right-of-way width.
- Anticipated changes in jurisdictional responsibility for ownership or maintenance of the roadway.
- Anticipated changes in functional classification, context classification, and/or access management classification.
- Public involvement, agency outreach and endorsement.
- Existing design and posted speeds.
- Existing and future typical section.
- Target speed with anticipated changes in posted speed limits and design speeds.

- Need for design variations or design exceptions.
- Plan for obtaining input and review from businesses, residents, and other stakeholders.
- Plan for receiving endorsement from elected officials.
- Funding source and cost estimates.
- Size of impact area: parallel and cross streets.
- Potential implementation strategy and partner commitments.
- Impact on school crossing locations and midblock crossing.
- Need to add, remove, or modify traffic signals.
- Existing and proposed near and long-range multimodal level of service (LOS) and queuing analysis for intersections and segments in the impact area.
- Mitigation to address the potential significant adverse impact on other local and state roads and regional transportation system.
- Crash data summary and analysis for the segment and intersections in the project limit.
- Case-specific special considerations to be determined (e.g., railroad crossing improvements).

D.1.a Multidisciplinary Review Team

The evaluation of potential lane repurposing projects benefits from a multidisciplinary review team. The team may include expertise from planning, environmental management, modal development, roadway design, traffic operations, construction, and maintenance.

D.1.b Concept Reports

Lane repurposing projects involve changes to the roadway cross section and restriping of existing travel lanes for either a roadway segment or an entire corridor. The changes may include design modifications such as reduced lane widths, median changes, pedestrian refuge islands, access management modifications, bicycle lanes, new or wider sidewalks, shared-use paths, landscaping, on-street parking, transit-only lanes, or curb zones and loading/transportation network company (TNC) zones.

Traffic operation improvements and design enhancements such as turn lanes and improved turning radii must be evaluated for all lane repurposing projects. Additionally, these projects should consider the incorporation of additional features to improve the mobility or aesthetics of an area, as well as address community needs such as transit accommodations, pedestrian enhancements, on-street parking (including accessible parking), and landscaping. Concept reports should include a project description, proposed modifications, traffic, and safety analysis.

D.1.c Project Description

A project description is critical in ~~informing on~~ detailing the current conditions of the roadway and the proposed changes to be made. A project description also includes information as to why a roadway should undergo lane repurposing.

- Project purpose, which clearly state the purpose and goals of the proposed lane repurposing project.
- Project location, including a map series showing the location of the project and nearby roads, land uses and other relevant information to aid reviewers in understanding the context of the proposed project.
- Area of influence and information on how the project may impact surrounding roadways and features during and after its construction.
- Existing conditions, including roadway typical section, functional classification, context classification (if available), evacuation route, ~~SIS designation~~, posted speed limits and average speeds, traffic data, crash history, signalized intersections, utilities, levels of service (LOS), access management, transit, and parking circulation plans.

D.1.d Proposed Modifications

As part of the concept report, a detailed review of the proposed modifications to the roadway that is being studied should be provided. This conceptual design should include:

- Typical section and intersection designs.
- Proposed changes to the design speed or posted speed limits.
- Consistency with local plans.

- Potential design variations or exceptions.

D.1.e Traffic Analysis

Lane repurposing projects will affect traffic by altering the capacity of the roadway via removal of one or more lanes. This effect may impact the study corridor only or it may ripple to adjacent roadways. The purpose of the project will influence how traffic impacts are prioritized when evaluating performance. Since traffic analysis can require a substantial amount of time and resources, it is important to develop an analysis approach. This section describes attributes of traffic analysis for lane repurposing projects to help streamline the analysis. Components to consider include:

- Existing and future traffic patterns and potential growth of traffic in the study area which allows for a comparison between the Build and No-Build scenarios for existing and future conditions.
- Establishment of a “de minimis” (minimal impacts) level. A level of 3% of existing and projected roadway segment vehicle capacity is suggested.
- Size of the area under study and the level of accuracy needed. These two elements will determine the intensity of the data collection and processing. A minimum radius of ±1 mile in all directions per 1-mile segment proposed for lane repurposing is recommended.
- Corridor and intersection Level of Service (LOS) Analysis of Build versus No-Build Alternatives that provide the user experience as a metric for how well a roadway is performing. It should include an analysis for pedestrians and bicyclists, as well as motor vehicles.
- For projects that serve a transit corridor, person throughput should be studied.
- Existing and proposed truck routes, ingress, and egress to port facilities and intermodal centers, and delivery zones and loading areas.
- Effects upon adjacent neighborhoods, communities, and other jurisdictions.

D.1.f Safety Analysis

Lane repurposing projects, in general, have been demonstrated to reduce crashes, including fatalities by all users, while slowing average speeds and reducing traffic exposure. A 5-year crash analysis of the corridor should be conducted. Projects are typically proposed on corridors which demonstrate some of the following characteristics related to safety:

- High crash numbers and rates.
- High crash locations by type.
- Rear-end crashes from left-turning vehicles.
- Left-turning vehicles stopped in the inside travel lane.
- Sideswipe and angle crashes due to lane changes.
- Pedestrian and bicycle crashes.
- Wide crossing distances for pedestrians and bicyclists.
- High differential in speeds in travel lanes.

D.1.g Public Involvement

Support by the local community is crucial to the long-term success of a lane repurposing project. The process to build consensus for the reconfiguration of a roadway in a community can involve some misperceptions. For example, lane repurposing projects can initially be perceived as increasing motor vehicle delay, but at the same time, they can improve safety, ~~and~~ accessibility and mobility for multiple users. Therefore, community engagement requires a commitment to a strong partnership and public involvement process throughout the process. Public involvement tools may include social media, webpages, workshops, and implementation of small demonstration projects, with polling before and after.

For public involvement requirements including meetings and public notice, ~~See Section 334.61 F.S.~~ for time-frames for public notice requirements.

E LAND DEVELOPMENT

Development controls are needed to aid in the establishment of safe streets and highways

that will retain their efficiency and economic worth. There may be legal, social, and economic challenges in land use controls. Proper coordination among the public, various governmental bodies, and public transit and highway agencies can provide solutions to many of these challenges. Implementation of responsible land use and development regulations along with intergovernmental respect for the goals and objectives of each, will promote a high-quality long-term transportation network.

Land development practices should promote high quality street networks that provide interconnectivity and access control. The street network shall be designed for the safety of all road users – pedestrians, bicyclists, transit, and motor vehicle operators and passengers.

The design of the street network and features shall be consistent with the desired context and meet the criteria in this Manual. Context based street design incorporates the following elements:

- Streets are sized and detailed to equitably serve the needs of the intended road users and support target speed.
- Flow patterns are designed to interconnect neighborhoods while discouraging through motorized traffic on local street networks.
- Sufficient right of way is provided, including space allocations for stormwater, utilities, signing and lighting.
- Public transit is supported through a high level of connectivity and attractive facilities (stops, shelters, hubs).
- Energy, infrastructure, and automobile use is reduced through a compact form.
- Provides for aesthetic and environmental compatibility.
- Building size and character spatially define streets and squares.

E.1 Development Types and Guidelines

There are many variables involved in land development. The following principles and guidelines should be utilized in the design of the road network, in the control of access, and in the land-use controls and space allocation that would affect vehicular and pedestrian use.

E.1.a Conventional Suburban Design

This development type was common practice through the 20th century. It is characterized by automobile-dominant design and segregated land uses. The street patterns channel local traffic onto collector and arterial streets to reach most destinations. Although destinations are oftentimes adjacent to one another, this conventional suburban design does not typically connect to them directly. This makes walking an inefficient form of transportation in this development type.

E.1.b Traditional Neighborhood Design (TND)

This refers to the development or redevelopment of a neighborhood or town using traditional town planning principles. Projects should include a range of housing types and commercial establishments, a network of well-connected streets and blocks, civic buildings, and public spaces, and include other uses such as stores, schools, and worship within walking distances of residences. TND communities rely on a strong integration of land use and transportation.

E.1.c Transit-Oriented Design (TOD)

This development type is a compact, mixed use area within one half mile of a transit stop or station that is characterized by streetscapes and an urban form oriented to pedestrians to promote walking trips to stations and varied other uses within station areas. Transit-supportive development enables citizens to use a variety of transportation modes for at least one or more of their daily trips between home, work, shopping, school, or services. These concepts are often called “new urbanism”.

For more information on Conventional Suburban, TND and TOD, refer to the [21st Century Land Development Code](#) and FDOT's ~~[FDOT's Traditional Neighborhood Development Handbook \(2011\)](#)~~ [Traditional Neighborhood Development Handbook \(2011\)](#).

E.2 Space Allocation

The provisions for adequate space and proper location of various activities is essential to promote safety and efficiency. The following guidelines should be utilized in land use:

- Adequate corridors and space should be considered for utilities. Utility locations should be carefully chosen to minimize interference with the operation of the streets, highways, and bicycle and pedestrian facilities.
- Adequate space for drainage facilities should be provided. Open drainage facilities should be located well clear of the traveled way.
- Right of way and setback requirements should be adequate to provide ample sight distance at all intersections.
- Space allocation for street lighting (existing or planned) should be incorporated into the initial plan. Supports for this lighting should be located outside of the required clear zone unless they are clearly of a breakaway type, or are guarded by adequate protective devices.
- Sufficient right of way should be provided for future widening, modification, or expansion of the street and highway network.
- Adequate space for desired or required landscaping, shade trees, and greenways should be provided.
- Adequate space for appropriate public transit facilities should be provided.

E.3 Access Control

The utilization of proper control over access is one of the most effective and economical means for maintaining the safety and utility of streets and highways. The following principles should be utilized in the formation of land use controls for managing access:

- The standards presented in **Chapter 3 – Geometric Design, C.8 Access Control**, should provide the basis for establishing land development criteria for control of access.
- The use of an arterial or major collector as an integral part of the internal circulation pattern on private property should be prohibited.
- Access to sites which generate major traffic (motor vehicular, pedestrian, and bicycle), should be located to provide minimum conflict with other traffic. These generators include schools, shopping centers, business establishments, industrial areas, entertainment facilities, etc.
- Commercial strip development, with the associated proliferation of driveways, should be eliminated. Vehicular and pedestrian interconnections should be encouraged.

- The spacing and location of access points should be predicated upon reducing conflicts between and among motor vehicles, pedestrians, and bicyclists. Crossing and left turn maneuvers may be controlled by continuous median separation.
- Pedestrian access should be provided, with frequent opportunities for crossings.

E.4 Control Techniques

The implementation of a sound highway transportation plan requires certain controls. A logical network design, adequate access controls, and proper land use controls are dependent upon and foster proper land development practices. Techniques that may be utilized to establish these necessary controls include the following:

E.4.a Right of Way Acquisition

The acquisition of sufficient right of way is essential to allow for the construction of streets and highways as specified in this manual. The provision of sufficient space for travel lanes, intersections, bicycle, pedestrian and transit facilities, landscaping, shade trees, buffer zones, drainage facilities, and future expansion is necessary to develop and maintain safe streets and highways.

E.4.b Regulatory Authority

The regulatory authority of local highway agencies (and other related agencies) should be sufficient to implement the necessary land use controls. The following general regulatory requirements and specific areas of control should be considered as minimum:

E.4.b.1 General Regulatory Requirements

The necessary elements for achieving the following transportation goals should be incorporated into all land use and zoning ordinances:

- General highway transportation plans should be created and implemented.

- Determination and acquisition of transportation corridors for future expansions is essential.
- Development plans clearly showing all street and highway layouts, transit facilities, pedestrian and bicycle facilities, and utility corridors should be required. The execution of these plans should be enforceable.
- Development plans, building permits, and zoning should be reviewed by the appropriate agency.

E.4.b.2 Specific Control

Specific areas of control necessary to develop adequate and efficient roadways include the following:

- Land use control and development regulations
- Control of access
- Driveway design
- Street and highway layouts
- Location of vehicular and pedestrian generators
- Location of transit, pedestrian, and bicycle facilities
- Right of way and setback requirements for sight distances and clear zone
- Provisions for drainage

E.5 Contracts and Agreements

Where land purchase or regulatory authority is not available or appropriate, the use of contractual arrangements or agreements with individuals can be beneficial. Negotiations with developers, builders, and private individuals should be used, where appropriate, to aid in the implementation of the necessary controls.

E.6 Education

Education of the public, developers, and governmental bodies can be beneficial in promoting proper land development controls. The need for future planning, access control, and design standards should be clearly and continuously emphasized.

Successful solidification of the cooperation of the public and other governmental bodies depends upon clear presentation of the necessity for reasonable land development controls.

FD OPERATION

The concept of operating the existing street and highway network as a system is essential to promote safety, efficiency, mobility, and economy. This requires comprehensive planning and coordination of all activities on each street and highway. These activities would include maintenance, construction, utility operations, public transit operations, traffic control, and emergency response operations. The behavior of travelers should be considered as an integral part of the operation of streets and highways. Coordination of the planning and supervision of each activity on each facility is necessary to achieve safety and efficient operation of the total system.

FD.1 Policy

Each transportation agency with general responsibility for existing streets and highways should establish and maintain an operations department. Each existing street or highway should be assigned to the jurisdiction of the operations department. The operations department shall be responsible for planning, supervising, and coordinating all activities affecting the operating characteristics of the system under its jurisdiction.

FD.2 Objectives

The primary objective of an operations department shall be to maintain or improve the operating characteristics of the system under its jurisdiction. These characteristics include safety, capacity, and level of service. The preservation of the function of each facility, which would include access control, is necessary to maintain these characteristics and the overall general value of a street or highway.

FD.3 Activities

The achievement of these objectives requires the performance of a variety of coordinated activities by the operations department. The following activities should be considered as minimal for promoting the safe and efficient operation of a system.

DE.3.a Maintenance and Reconstruction

Maintaining or upgrading the quality of existing facilities is an essential factor in preserving desirable operating characteristics. The planning and execution of maintenance and reconstruction activity on existing facilities must be closely coordinated with all other operational activities and, therefore, should be under the general supervision of the operations department.

All maintenance work should be conducted in accordance with the requirements of **Chapter 10 – Maintenance and Resurfacing**. The priorities and procedures utilized should be directed toward improvement of the existing system. The standards set forth in this Manual should be used as guidelines for establishing maintenance and reconstruction objectives. All maintenance and reconstruction projects should be planned to minimize traffic control conflicts and hazards.

FD.3.b Work Zone Safety

An important responsibility of the operations department is the promotion of work zone safety on the existing system. The planning and execution of maintenance, construction, and other activities shall include provisions for the safety of motorists, bicyclists, pedestrians, and workers. All work shall be conducted in accordance with the requirements presented in **Chapter 11 – Work Zone Safety and Mobility**.

FD.3.c Traffic Control

Traffic engineering is a vital component of highway operations. The planning and design of traffic control devices should be carried out in conjunction with the overall design of the street or highway and highway user. The devices and procedures utilized for traffic control should be predicated upon developing uniformity throughout the system and compatibility with adjacent jurisdictions.

A primary objective to be followed in establishing traffic control procedures is the promotion of safe, orderly traffic flow. The cooperation of police agencies and coordination with local transit providers is essential for the achievement of this objective. Traffic control during maintenance, construction, utility, or emergency response operations should receive special consideration.

FD.3.d Emergency Response

The emergency response activities (i.e., emergency maintenance and traffic control) of the operations department should be closely coordinated with the work of police, fire, ambulance, medical, and other emergency response agencies. The provisions for emergency access and communications should be included in the initial planning for these activities.

FD.3.e Coordination and Supervision

Coordination and supervision of activities on the system should include the following:

- Supervision and/or coordination of all activities of the operations department and other agencies to promote safe and efficient operation
- Coordination of all activities to provide consistency within a given jurisdiction
- Coordination with adjacent jurisdictions to develop compatible highway systems
- Coordination with other transportation modes to promote overall transportation efficiency

FD.3.f Inspection and Evaluation

The actual operation of streets and highways provides valuable experience and information regarding the effectiveness of various activities. Each operations department should maintain a complete inventory of its system and continuously inspect and evaluate the priorities, procedures, and techniques utilized in all activities on the existing system under its jurisdiction. Activities by other agencies, as well as any agency, should be subjected to this supervision.

Promotion of transportation safety should be aided by including a safety office (or officer) as an integral part of the operations department. Functions of this office would include the identification and inventory of hazardous locations and procedures for improving the safety characteristics of highway operations.

Results of this inspection and evaluation program should be utilized to make the modification necessary to promote safe and efficient operation. Feedback for modifying design criteria should be generated by this program. Experience and data obtained from operating the system should be utilized as a basis for recommending regulatory changes. Cooperation of legislative, law enforcement, and regulatory agencies is essential to develop the regulation of vehicles, driver behavior, utility, emergency response activities, and the access land use practices necessary for the safe and efficient operation of the highway system.

GE REFERENCES FOR INFORMATIONAL PURPOSES

- [Florida Transportation Plan](http://floridatransportationplan.com/)
<http://floridatransportationplan.com/>
- [Florida Growth Management and Comprehensive Planning Laws \(DEO~~OE~~\)](http://www.floridajobs.org/community-planning-and-development)
<http://www.floridajobs.org/community-planning-and-development>
- [1000 Friends of Florida](http://www.1000fof.org/)
<http://www.1000fof.org/>
- [Florida Metropolitan Planning Organization Advisory Council \(MPOAC\)](http://www.mpoac.org/)
<http://www.mpoac.org/>
- [Understanding Sprawl, A Citizen's Guide](https://www.osti.gov/etdeweb/biblio/20414909)
<https://www.osti.gov/etdeweb/biblio/20414909>
- [Traditional Neighborhood Development Handbook](http://www.fdot.gov/roadway/FloridaGreenbook/TND-Handbook.pdf)
<http://www.fdot.gov/roadway/FloridaGreenbook/TND-Handbook.pdf>

~~Design criteria are established for transportation projects to ensure that they provide safe, economical, and fully functional multimodal transportation facilities. Various Department FDOT publications contain information on procedures, criteria, and standards for guiding and controlling design and construction activities. There are many local, state, and federal laws and rules that may impact the design of a project. These laws and rules are referenced in the publications when the Department is aware of them.~~

~~For situations where specific design standards or criteria cannot be found in the Department FDOT publications, current approved technical publications such as [*AASHTO's Policy on Geometric Design of Highways and Streets \(2011\)*](#) should be used as design guidelines. Local agencies must ensure that project designs meet or~~

~~exceed the referenced design criteria and that the standards developed from acceptable guidelines are appropriate for the proposed facility.~~

~~The following publications provide further information and guidance for Roadway and Bridge/Structure designs:~~

~~— FDOT Design Plans Preparation Manual, Volume I (Topic No. 625-000-0027) and Volume II (Topic No. 625-000-008)
<http://www.fdot.gov/roadway/FDM/>~~

~~•~~

~~— Design Standard Plans for Road and Bridge Constructions (Standard Indexes) (Topic No. 625-010-003)
<http://www.fdot.gov/design/standardplans/>~~

~~• FDOT Standard Specifications for Road and Bridge Construction~~

~~Project Development and Environment Manual Part 1 and Part 2 (Topic No. 650-000-001)
<http://www.fdot.gov/environment/pubs/pdeman/pdeman1.shtm>~~

~~• <http://www.dot.state.fl.us/rddesign/DesignStandards/Standards.shtm>~~

~~• Manual of Uniform Minimum Standards for Design, Construction and Maintenance for Streets and Highways (Florida Greenbook) (Topic No. 625-000-015)
<http://www.dot.state.fl.us/rddesign/FloridaGreenbook/FGB.shtm>~~

~~• A Policy on Geometric Design of Highways and Streets, 6th Edition (AASHTO Green Book) (AASHTO Bookstore GDHS-6)
https://bookstore.transportation.org/collection_detail.aspx?ID=110~~

~~• FDOT Standard Specifications for Road and Bridge Construction
<http://www.dot.state.fl.us/specificationsoffice/Implemented/SpecBooks/default.shtm>~~

~~• AASHTO LRFD Bridge Design Specifications, Customary U.S. Units, 6th Edition (AASHTO Bookstore LRFDUS-6-M)
https://bookstore.transportation.org/item_details.aspx?id=1924~~

~~• FDOT Structures Manual (Topic No. 625-020-018)
<http://www.dot.state.fl.us/structures/StructuresManual/CurrentRelease/StructuresManual.shtm>~~

- ~~FDOT Facilities Design Manual (Topic No. 625-020-016)
<http://www.dot.state.fl.us/projectmanagementoffice/Publications/default.shtm>~~
- ~~Florida Intersection Design Guide
<http://www.dot.state.fl.us/rddesign/FIDG-Manual/FIDG.shtm>~~
- ~~NCHRP Report 672—Roundabouts: An Informational Guide, 2nd Edition
http://onlinepubs.trb.org/onlinepubs/nchrp/nchrp_rpt_672.pdf~~
- ~~AASHTO Highway Safety Manual, 1st Edition (AASHTO Bookstore HSM-1)
<https://bookstore.transportation.org/>~~
- ~~https://bookstore.transportation.org/collection_detail.aspx?ID=33~~
- ~~Local Agency Program Manual (Topic No. 525-010-300)
http://www.dot.state.fl.us/projectmanagementoffice/lap/LAP_TOC.shtm~~
- ~~Project Development and Environmental Manual Part 1 and Part 2 (Topic No. 650-000-001)
<http://www.dot.state.fl.us/emo/pubs/pdeman/pdeman1.shtm>~~
- ~~Rigid Pavement Design Manual (Topic No. 625-010-006)
<http://www.dot.state.fl.us/rddesign/PM/Publications.shtm>~~
- ~~Flexible Pavement Design Manual (Topic No. 625-010-002)
<http://www.dot.state.fl.us/rddesign/PM/publicationS.shtm>~~
- ~~FDOT Drainage Manual (Topic No. 625-040-002)
<http://www.dot.state.fl.us/rddesign/Hydraulics/ManualsandHandbooks.shtm>~~
- ~~Soils and Foundations Handbook
<http://www.dot.state.fl.us/structures/DocsandPubs.shtm>~~
- ~~Standard Highway Signs (FHWA)
<http://mutcd.fhwa.dot.gov/ser-shs-millennium.htm>~~
- ~~Manual on Uniform Traffic Control Devices for Streets and Highways, 2009 Edition
http://mutcd.fhwa.dot.gov/kno_2009r1r2.htm~~
- ~~Roadway Lighting Design Guide (AASHTO Bookstore GL-6)
https://bookstore.transportation.org/item_details.aspx?id=320~~
- ~~AASHTO Standard Specifications for Structural Supports for Highway Signs, Luminaires, and Traffic Signals, 6th Edition (AASHTO Bookstore LTS-6)
https://bookstore.transportation.org/collection_detail.aspx?ID=126~~
- Highway Functional Classification: Concepts, Criteria and Procedures, 2013 Edition (FHWA)
http://www.fhwa.dot.gov/planning/processes/statewide/related/highway_functi

[onal classifications/section00.cfm](#)

- ~~Highway Capacity Manual 2010 (Transportation Research Board) (TRB Bookstore HCM10)~~
~~<http://books.trbbookstore.org/hcm10.aspx>~~
- ~~Quality/Level of Service Handbook (FDOT, 2020~~13~~)~~
~~<https://www.fdot.gov/planning/systems/documents/sm/default.shtm>~~~~<http://www.fdot.gov/planning/systems/programs/sm/los/default.shtm>~~
- ~~<http://www.dot.state.fl.us/planning/systems/programs/sm/los/default.shtm>~~
- Manual on Uniform Traffic Studies (Topic No. 750-020-007)
~~<https://www.fdot.gov/docs/default-source/traffic/TrafficServices/Studies/MUTS/MUTS-Final-01.2016.pdf>~~~~https://fdotwww.blob.core.windows.net/sitefinity/docs/default-source/traffic/trafficservices/studies/muts/new-muts-2021-and-forms/2021-muts-compiled-20220420.pdf?sfvrsn=141a4970_0~~
- ~~Surveying Procedure (Topic No. 550-030-101)~~
~~<https://pdl.fdot.gov/api/procedures/downloadProcedure/550-030-101>~~
- ~~Right of Way Mapping Procedure (Topic No. 550-030-015)~~
~~http://www.dot.state.fl.us/surveyingandmapping/doc_pubs.shtm~~

CHAPTER 2

LAND DEVELOPMENT

A	INTRODUCTION	2-1
B	OBJECTIVES	2-3
C	PRINCIPLES AND GUIDELINES	2-4
C.1	Development Types and Area Types	2-4
C.1.a	Conventional Suburban Design	2-4
C.1.b	Traditional Neighborhood Design (TND)	2-4
C.1.c	Transit-Oriented Design (TOD)	2-5
C.2	Network Design	2-6
C.3	Access Control	2-8
C.4	Land Use Controls and Space Allocation	2-9
D	COORDINATION	2-11
E	CONTROL TECHNIQUES	2-12
E.1	Right of Way Acquisition	2-12
E.2	Regulatory Authority	2-12
E.2.a	General Regulatory Requirements	2-12
E.2.b	Specific Control	2-13
E.3	Contracts and Agreements	2-14
E.4	Education	2-14
F	REFERENCES FOR INFORMATIONAL PURPOSES	2-16

**THE CONTENTS OF THIS CHAPTER HAVE BEEN REVISED
AND MOVED TO CHAPTER 1 - PLANNING AND LAND
DEVELOPMENT**

~~THIS PAGE INTENTIONALLY LEFT BLANK~~

CHAPTER 2

LAND DEVELOPMENT

A INTRODUCTION

A major portion of street and highway construction and reconstruction is a result of land development for residential, commercial, industrial, and public uses. The general land use layout influences, and is controlled by, connections to adjacent road networks with different transportation modes. Techniques, principles, and general layout used for any development also dictate the resulting internal road network. The arrangement and space allocations for this network may determine whether safe, efficient, and economical streets and highways are constructed or reconstructed.

Land development practices should promote high quality street networks that provide interconnectivity and access control. The street network shall be designed for the safety of all road users — pedestrians, bicyclists, transit, and motor vehicle operators and passengers.

The design of the street network and features should be consistent with the desired context and meet the criteria in this Manual. Context based street design incorporates the following elements:

- Streets are sized and detailed to equitably serve the needs of the intended road users.
- Building size and character spatially define streets and squares.
- Compact form reduces requirements for energy, infrastructure, and automobile use.
- Public transit is supported through a high level of connectivity and attractive facilities (stops, shelters, hubs).

~~Some development patterns, such as conventional suburban, do not promote the creation of a high quality, accessible street network. To promote the creation of context sensitive high quality interconnected streets:~~

- ~~• Design for desired/target speeds.~~
- ~~• Design desirable geometry to achieve sufficient sight distance and appropriate cross section (not too wide or too narrow for the context).~~
- ~~• Provide sufficient right of way and space allocations for stormwater, utilities, pedestrian features, and lighting, etc.~~
- ~~• Provide reasonable control of access.~~

~~Two of the more recent alternatives to the conventional suburban development patterns include Traditional Neighborhood Development (TND) and Transit Oriented Development (TOD). For more information, refer to [21st Century Land Development Code](#).~~

~~Development controls are needed to aid in the establishment of safe streets and highways that will retain their efficiency and economic worth. Provisions for adequate alignment, right of way, setbacks, expansion, and access control are essential.~~

~~There may be legal, social, and economic challenges in land use controls. Proper coordination among the public, various governmental bodies, and public transit and highway agencies can provide solutions to many of these challenges. Implementation of responsible land use and development regulations along with intergovernmental respect for the goals and objectives of each, will promote a high quality long term transportation network.~~

B OBJECTIVES

~~Provisions for vehicular and pedestrian safety are important objectives to be considered in land development. Other land development objectives, related to surface transportation, should include the promotion of smooth traffic flow, efficiency, economy, aesthetics, and environmental compatibility of the transportation network.~~

~~General objectives for land development that should be followed to promote good highway design include the following:~~

- ~~• Ensure the function of each street and highway meets its intended purpose and context~~
- ~~• Provide for logical and energy efficient interconnected street network and flow patterns~~
- ~~• Reduce trip lengths~~
- ~~• Encourage the appropriate vehicular speed~~
- ~~• Reduce traffic conflicts to a minimum and eliminate confusion~~
- ~~• Apply safe geometric design principles~~
- ~~• Promote bicycle and pedestrian use through connectivity and access~~
- ~~• Provide for future modifications and expansion~~
- ~~• Provide for aesthetic and environmental compatibility~~
- ~~• Develop economic design, construction, and maintenance strategies~~
- ~~• Provide for public transit facilities~~
- ~~• Provide accessibility for persons with disabilities~~

C PRINCIPLES AND GUIDELINES

There are many variables involved in land development; therefore, specific standards and requirements for land use and road network layouts cannot always be applied. Use of sound principles and guidelines can, however, aid in meeting the objectives of a better road network. Proper planning and design of the development layout are necessary to provide a satisfactory road network and to allow for the construction of safe roadways. The following principles and guidelines should be utilized in the design of the road network, in the control of access, and in the land use controls and space allocation that would affect vehicular and pedestrian use.

C.1 Development Types and Area Types

C.1.a Conventional Suburban Design

This development type was common practice through the 20th century. It is characterized by automobile-dominant design, segregated land uses, and roadways that are often designed primarily for the use of the automobile. The street patterns channel local traffic onto collector streets and roads to reach most destinations. Although destinations are oftentimes adjacent to one another, this conventional suburban design does not typically connect to them directly. This makes walking an inefficient form of transportation in this development type.

C.1.b Traditional Neighborhood Design (TND)

This development type is a development alternative that promotes a strong integration of land use and transportation. For further

~~information on TND, refer to Chapter 19 of this Manual.~~

~~C.1.c Transit-Oriented Design (TOD)~~

~~This development type is defined as a compact, mixed use area within one half mile of a transit stop or station that is designed to maximize walking trips and access to transit. They also are characterized by streetscapes and an urban form oriented to pedestrians to promote walking trips to stations and varied other uses within station areas. Further information on TOD can be found on the Department's website: <http://www.fltod.com/>.~~

~~Transit-supportive planning and development rethinks land-use and development patterns so that communities may be effectively served by a balanced transportation system. Transit-supportive development enables citizens to use a variety of transportation modes for at least one or more of their daily trips between home, work, shopping, school, or services. These concepts are often called new urbanism to distinguish that form of urban design practice.~~

~~For more information on Conventional Suburban, TND and TOD, refer to the 21st Century Land Development Code and Traditional Neighborhood Development Handbook.~~

~~C.2 Network Design~~

~~The general layout of the road network establishes the traffic flow patterns and conflicts, thereby determining the basic safety and efficiency criteria. The design of the road network should be based on the following principles:~~

~~The layout of street and highway systems should be logical and easily understood by the user.~~

~~The design and layout of all streets and highways should clearly indicate their function.~~

~~Local circulation patterns should be compatible with adjacent areas.~~

~~Flow patterns should be designed to interconnect neighborhoods while discouraging through motorized traffic on local street networks.~~

~~Elements in the local circulation should be adequate to avoid the need for extensive traffic controls.~~

~~Typically, some streets are designed to accommodate a higher speed~~

~~than the posted speed, which may cause enforcement problems and can have a negative safety impact on the circulation within an urban or residential network. In other situations, controlling speed levels is important in areas of concentrated pedestrian activities, areas with narrow right of way, areas with numerous access points, and on-street parking. Local authorities may elect to use traffic calming design features which are presented in *Chapter 15 – Traffic Calming*.~~

~~The internal circulation should be sufficient to provide reasonable travel distance for local trips.~~

~~The road network should be compatible with other transportation modes such as mass transit and pedestrian and bicycle facilities. Conflicts between different modes (particularly with pedestrian and bicycle traffic) should be kept to a minimum.~~

~~The road network layout should be designed to reduce conflicts with pedestrians, eliminate substantial speed differentials and hazardous turning and crossing maneuvers.~~

~~Generally the number of intersections should meet user needs, support development patterns, and traffic flow and connectivity requirements.~~

~~Roundabouts should be evaluated for installation at new intersections. Consideration should be given to redesigning existing intersections as roundabouts. For further information on roundabouts, refer to the *National Cooperative Highway Research Project (NCHRP) 672* and *674*.~~

~~One-way streets are an option to consider where feasible.~~

~~Streets should be designed to limit vehicle speeds (length, width,~~

~~alignment, and intersections).~~

~~The network should be designed to reduce the number of crossings and left turn maneuvers that are required.~~

~~C.3 Access Control~~

~~The standards and requirements presented in *Chapter 3 – Geometric Design*, are necessary to maintain safe and efficient streets and highways. Failure to provide adequate control of access has seriously damaged many existing roadways. Unrestricted access to major collectors and arterials has dramatically reduced their capacity and general economic value. The safety characteristics of these facilities have similarly been diminished by significantly increasing the number of vehicular, pedestrian, and bicycle traffic conflicts.~~

~~The utilization of proper control over access is one of the most effective and economical means for maintaining the safety and utility of streets and highways. The procedures and controls used for land development significantly affect access control. The following principles should be utilized in the formation of land use controls for limiting access:~~

~~The standards presented in *Chapter 3 – Geometric Design, C.8 Access Control*, should provide the basis for establishing land development criteria for control of access.~~

~~The use of an arterial or major collector as an integral part of the internal circulation pattern on private property should be prohibited.~~

~~The intersection of private roads and driveways with arterials or major collectors should be strictly controlled.~~

~~Access to sites which generate major traffic (vehicular, pedestrian, and~~

~~bicycle), should be located to provide the minimum conflict with other traffic. These generators include schools, shopping centers, business establishments, industrial areas, entertainment facilities, etc.~~

~~Commercial strip development, with the associated proliferation of driveways, should be eliminated. Vehicular and pedestrian interconnections should be encouraged.~~

~~The function of all streets and highways should be preserved by the application of the appropriate access controls.~~

~~The spacing and location of access points should be predicated upon reducing the total traffic and pedestrian conflict.~~

~~Hazardous maneuvers should be restricted by access controls. For example, crossing and left turn maneuvers may be controlled by continuous median separation. Pedestrian access should be allowed at appropriate intervals. Medians with waiting space for pedestrians crossing the street are often necessary.~~

~~C.4 Land Use Controls and Space Allocation~~

~~The provisions for adequate space and proper location of various activities is essential to promote safety and efficiency. The following guidelines should be utilized in land use:~~

~~Adequate corridors and space should be considered for utilities. Utility locations should be carefully chosen to minimize interference with the operation of the streets, highways, and sidewalks.~~

~~Adequate space for drainage facilities should be provided. Open drainage facilities should be located well clear of the traveled way.~~

~~Design for pedestrian and bicycle facilities should comply with *Chapter*~~

~~8—Pedestrian Facilities and Chapter 9—Bicycle Facilities.~~

~~Adequate space should be provided for off-street and side-street parking. This is essential in commercial and industrial areas.~~

~~Right of way and setback requirements should be adequate to provide ample sight distance at all intersections.~~

~~Sufficient space should be allocated for the development of adequate intersections, including accessibility for disabled individuals.~~

~~Space allocation for street lighting (existing or planned) should be incorporated into the initial plan. Supports for this lighting should be located outside of the required clear zone unless they are clearly of breakaway type, or are guarded by adequate protective devices. Lighting plans should provide for well-lit, safe waiting and walking areas and shall conform with the provisions of Chapter 6—Lighting.~~

~~Sufficient right of way should be provided for future widening, modification, or expansion of the highway network.~~

~~Adequate corridors for future freeways, High Occupancy Vehicle (HOV) lanes, arterials, or major collectors should be provided.~~

~~Adequate space for desired or required greenways should be provided.~~

~~Adequate space for appropriate public transit facilities should be provided.~~

D — COORDINATION

~~There are many demands that can conflict with the development of safe and efficient streets and highways. Meeting the demand for access can negatively impact the capacity of a roadway. Pressure to limit the amount of land dedicated for streets and highways inhibits the construction of an adequate road system. Coordination between highway agencies and other governmental bodies can assist in improving the procedures used in land development. Proper coordination should be solicited from legislative bodies, courts, planning and zoning departments, and transit and other governmental agencies to aid in developing a well-designed highway network. Coordination with transit planners, developers, engineers, architects, contractors, and other private individuals should be a continuous process.~~

~~The *Florida Metropolitan Planning Organization Advisory Council (MPOAC)* is a statewide transportation planning and policy organization created by the Florida Legislature pursuant to *Section 339.175(11), Florida Statutes*, to augment the role of individual MPOs in the cooperative transportation planning process. The MPOAC assists MPOs in carrying out the urbanized area transportation planning process by serving as the principal forum for collective policy discussion. Further information on the MPOAC, including links to MPOs, can be found at <http://www.mpoac.org/>.~~

~~E~~ ~~CONTROL TECHNIQUES~~

~~The implementation of a sound highway transportation plan requires certain controls. A logical network design, adequate access controls, and proper land use controls are dependent upon and foster proper land development practices. Techniques that may be utilized to establish these necessary controls include the following:~~

~~E.1~~ ~~Right of Way Acquisition~~

~~The acquisition of sufficient right of way is essential to allow for the construction of adequate streets and highways as specified in Chapter 3—Geometric Design and Chapter 4—Roadside Design. The provision of adequate space for clear roadside, sight distance, drainage facilities, buffer zones, intersections, transit, sidewalks, frontage roads, and future expansion is also necessary to develop and maintain safe streets and highways.~~

~~E.2~~ ~~Regulatory Authority~~

~~The regulatory authority of state and local highway agencies (and other related agencies) should be sufficient to implement the necessary land use controls. The following general regulatory requirements and specific areas of control should be considered as minimum:~~

~~E.2.a~~ ~~General Regulatory Requirements~~

~~The necessary elements for achieving the following transportation goals should be incorporated into all land use and zoning ordinances:~~

~~General highway transportation plans should be created and implemented.~~

~~Determination and acquisition of transportation corridors for future~~

~~expansions is essential.~~

~~Development plans clearly showing all street and highway layouts, transit facilities, pedestrian and bicycle facilities, and utility corridors should be required. The execution of these plans should be enforceable.~~

~~Development plans, building permits, and zoning should be reviewed by the appropriate agency.~~

~~A safety check of proposed streets and highways should be a required step in the review and acceptance of all development plans.~~

~~E.2.b Specific Control~~

~~Specific areas of control necessary to develop adequate and efficient~~

~~roadways include the following:~~

~~Land use control and development regulations~~

~~Control of access~~

~~Driveway design~~

~~Street and highway layouts~~

~~Location of vehicular and pedestrian generators~~

~~Location of transit, pedestrian, and bicycle facilities~~

~~Right of way and setback requirements for sight distances and clear zone~~

~~Provisions for drainage~~

~~E.3 Contracts and Agreements~~

~~Where land purchase or regulatory authority is not available or appropriate, the use of contractual arrangements or agreements with individuals can be beneficial. Negotiations with developers, builders, and private individuals should be used, where appropriate, to aid in the implementation of the necessary controls.~~

~~E.4 Education~~

~~Education of the public, developers, and governmental bodies can be beneficial in promoting proper land development controls. The need for future planning, access control, and design standards should be clearly and continuously emphasized. Successful solidification of the cooperation of the public and other governmental bodies depends upon clear presentation of the necessity for reasonable land~~

development controls.

F — REFERENCES FOR INFORMATIONAL PURPOSES

~~21st Century Land Development Code~~

~~<https://www.planning.org/publications/book/9026709/>~~

~~Florida Transportation Plan~~

~~<http://floridatransportationplan.com/>~~

~~Florida Growth Management and Comprehensive Planning Laws (DOE)~~

~~<http://www.floridajobs.org/community-planning-and-development>~~

~~1000 Friends of Florida~~

~~<http://www.1000fof.org/>~~

~~Florida Metropolitan Planning Organization Advisory Council (MPOAC)~~

~~<http://www.mpeac.org/>~~

~~Understanding Sprawl, A Citizen's Guide~~

~~<http://www.davidsuzuki.org/publications/resources/2003/understanding-sprawl-a-citizens-guide/>~~

Traditional — Neighborhood — Development — Handbook

<http://www.fdot.gov/roadway/FloridaGreenbook/TND-Handbook.pdf>

CHAPTER 3

GEOMETRIC DESIGN

A	INTRODUCTION	3-1
B	OBJECTIVES	3-3
C	DESIGN ELEMENTS	3-3
C.1	Design Speed	3-3
C.2	Design Vehicles	3-6
C.3	Sight Distance.....	3-10
C.3.a	Stopping Sight Distance.....	3-10
C.3.b	Decision Sight Distance	3-12
C.3.c	Passing Sight Distance	3-14
C.3.d	Intersection Sight Distance	3-15
C.4	Horizontal Alignment.....	3-15
C.4.a	General Criteria.....	3-15
C.4.b	Maximum Deflections in Alignment without Curves	3-16
C.4.c	Superelevation	3-19
C.4.c.1	Rural Highways, Urban Freeways and High Speed Urban Highways	3-19
C.4.c.2	Low Speed Urban Roadways.....	3-20
C.4.d	Maximum Curvature/Minimum Radius	3-24
C.4.e	Superelevation Transition (superelevation runoffs plus tangent runoff)	3-24
C.4.f	Sight Distance on Horizontal Curves	3-26
C.4.g	Lane Widening on Curves.....	3-31
C.5	Vertical Alignment	3-34
C.5.a	General Criteria.....	3-34
C.5.b	Grades	3-34
C.5.c	Vertical Curves.....	3-36
C.6	Alignment Coordination.....	3-42
C.7	Cross Section Elements.....	3-43
C.7.a	Number of Lanes	3-43
C.7.b	Pavement.....	3-43

	C.7.b.1	Pavement Width	3-43
	C.7.b.2	Traveled Way Cross Slope (not in superelevation)	3-45
	C.7.c	Shoulders.....	3-46
	C.7.c.1	Shoulder Width.....	3-46
	C.7.c.2	Shoulder Cross Slope	3-48 3-47
	C.7.d	Sidewalks and Shared Use Paths.....	3-48
	C.7.e	Medians	3-49
	C.7.e.1	Type of Median.....	3-50
	C.7.e.2	Median Width	3-51 3-50
	C.7.e.3	Median Slopes.....	3-53 3-52
	C.7.e.4	Median Barriers	3-53 3-52
	C.7.f	Islands	3-53 3-52
	C.7.f.1	Channelizing Islands	3-56 3-55
	C.7.f.2	Divisional Islands.....	3-61 3-60
	C.7.f.3	Refuge Islands	3-62 3-61
	C.7.g	Curbs	3-68 3-66
	C.7.h	Parking.....	3-69 3-67
	C.7.h.1	Parallel Parking Lanes	3-69 3-67
	C.7.h.2	Angle Parking.....	3-71 3-68
	C.7.h.3	Cross Slope.....	3-73 3-70
	C.7.h.4	ADA Requirements.....	3-73 3-70
	C.7.h.5	Parking Restrictions	3-74 3-71
	C.7.h.6	Signing and Marking.....	3-76 3-73
	C.7.i	Right of Way	3-76 3-73
	C.7.j	Changes in Typical Section.....	3-77 3-74
	C.7.j.1	General Criteria	3-77 3-74
	C.7.j.2	Lane Deletions and Additions.....	3-77 3-74
	C.7.j.3	Preferential Lanes	3-77 3-74
	C.7.j.4	Structures	3-78 3-75
	C.7.j.4.(a)	Lateral Offset.....	3-78 3-75
	C.7.j.4.(b)	Vertical Clearance	3-79 3-76
	C.7.j.4.(c)	End Treatment.....	3-79 3-76
C.8	Access Control.....		3-79 3-76
	C.8.a	Justification	3-80 3-77

C.8.b	General Criteria.....	3-80 3-77
C.8.b.1	Location of Access Points	3-80 3-77
C.8.b.2	Spacing of Access Points	3-80 3-77
C.8.b.3	Restrictions of Maneuvers	3-80 3-77
C.8.b.4	Auxiliary Lanes	3-81 3-78
C.8.b.5	Grade Separation	3-81 3-78
C.8.b.6	Roundabouts	3-82 3-79
C.8.c	Control for All Limited Access Highways.....	3-82 3-79
C.8.d	Control of Urban and Rural Streets and Highways	3-83 3-80
C.8.e	Land Development.....	3-84 3-81
C.9	Intersection Design	3-84 3-81
C.9.a	General Criteria.....	3-85 3-82
C.9.b	Sight Distance.....	3-86 3-83
C.9.b.1	General Criteria	3-86 3-83
C.9.b.2	Obstructions to Sight Distance	3-87 3-84
C.9.b.3	Stopping Sight Distance	3-88 3-85
C.9.b.3.(a)	Approach to Stops.....	3-88 3-85
C.9.b.3.(b)	On Turning Roads.....	3-89 3-86
C.9.b.4	Sight Distance for Intersection Maneuvers... 88	3-91 3- 88
C.9.b.4.(a)	Driver’s Eye Position and Vehicle Stopping Position	3-95 3-92
C.9.b.4.(b)	Design Vehicle	3-95 3-92
C.9.b.4.(c)	Case B1 - Left Turns from the Minor Road	3-96 3-93
C.9.b.4.(d)	Case B2 - Right Turns From the Minor Road and Case B3 – Crossing Maneuver From the Minor Road	3-96 3-93
C.9.b.4.(e)	Intersections with Traffic Signal Control (AASHTO Case D) ..	3-97 3- 94
C.9.b.4.(f)	Intersections with All-Way Stop Control (AASHTO Case E)...	3-98 3- 95
C.9.b.4.(g)	Left Turns from the Major Road (AASHTO Case F)	3-98 3-95
C.9.b.4.(h)	Intersection Sight Distance	

	References.....	3-98 3-95
C.9.c	Auxiliary Lanes.....	3-100 3-97
	C.9.c.1 Merging Maneuvers.....	3-100 3-97
	C.9.c.2 Acceleration Lanes.....	3-102 3-99
	C.9.c.3 Exit Lanes	3-106 3-103
	C.9.c.4 Auxiliary Lanes at Intersections.....	3-109 3-106
	C.9.c.4.(a) Widths of Auxiliary Lanes ...	3-109 3-106
	C.9.c.4.(b) Lengths of Auxiliary Lanes for Deceleration.....	3-109 3-106
	C.9.c.4.(c) Lengths of Auxiliary Lanes for Acceleration	3-113 3-110
C.9.d	Turning Roadways at Intersections.....	3-114 3-111
	C.9.d.1 Design Speed.....	3-114 3-111
	C.9.d.2 Horizontal Alignment	3-114 3-111
	C.9.d.3 Vertical Alignment	3-115 3-112
	C.9.d.4 Cross Section Elements	3-116 3-113
C.9.e	At Grade Intersections	3-119 3-116
	C.9.e.1 Turning Radii.....	3-119 3-116
	C.9.e.2 Cross Section Correlation	3-119 3-116
	C.9.e.3 Median Openings	3-120 3-117
	C.9.e.4 Channelization.....	3-120 3-117
C.9.f	Driveways	3-120 3-117
C.9.g	Interchanges	3-121 3-118
C.9.h	Clear Zone	3-122 3-119
C.10	Other Design Factors.....	3-123 3-120
	C.10.a Pedestrian Facilities.....	3-123 3-120
	C.10.a.1 Policy and Objectives - New Facilities..	3-123 3-120
	C.10.a.2 Accessibility Requirements	3-123 3-120
	C.10.a.3 Sidewalks and Shared Use Paths	3-123 3-120
	C.10.b Bicycle Facilities.....	3-125 3-121
	C.10.c Bridge Design Loadings.....	3-126 3-121
	C.10.d Dead End Streets and Cul-de-Sacs.....	3-126 3-122
	C.10.e Bus Benches and Transit Shelters.....	3-126 3-122
	C.10.f Traffic Calming.....	3-126 3-122
C.11	Reconstruction	3-127 3-123

C.11.a	Introduction	3-127 3-123
C.11.b	Evaluation of Streets and Highways	3-127 3-123
C.11.c	Priorities	3-128 3-123
C.12	Design Exceptions	3-130 3-125
C.13	Very Low-Volume Local Roads (ADT ≤ 400)	3-130 3-125
C.13.a	Bridge Width	3-130 3-126
C.13.b	Roadside Design.....	3-130 3-126

TABLES

Table 3 – 1	Minimum and Maximum Design Speed (mph)	3-5 <u>3-6</u>
Table 3 – 2	Design Vehicles	3-7 <u>3-8</u>
Table 3 – 3	Minimum Turning Radii of Design Vehicles.....	3-9 <u>3-10</u>
Table 3 – 4	Minimum Stopping Sight Distance	3-11 <u>3-13</u>
Table 3 – 5	Decision Sight Distance	3-13 <u>3-15</u>
Table 3 – 6	Minimum Passing Sight Distance.....	3-15 <u>3-17</u>
Table 3 – 7	Maximum Deflection Angle Through Intersection.....	3-18 <u>3-21</u>
Table 3 – 9	Length of Compound Curves on Turning Roadways	3-19 <u>3-22</u>
Table 3 – 10	Superelevation Rates for Rural Highways, Urban Freeways and High Speed Urban Highways ($e_{max} = 0.10$)	3-21 <u>3-23</u>
Table 3 – 11	Superelevation Rates for Low Speed Arterials and Collectors ($e_{max} = 0.05$)	3- 22 <u>3-24</u>
Table 3 – 12	Minimum Radii (feet) for Design Superelevation Rates Low Speed Local Roads ($e_{max} = 0.05$).....	3-23 <u>3-25</u>
Table 3 – 13	Superelevation Transition Slope Rates	3-26 <u>3-29</u>
Table 3 – 14	Horizontal Curvature	3-30 <u>3-33</u>
Table 3 – 15A	Calculated and Design Values for Traveled Way Widening on Open Highway Curves (Two-Lane Highways, One-Way or Two-Way).....	3-32 <u>3-35</u>
Table 3 – 15B	Adjustments for Traveled Way Widening Values on Open Highway Curves (Two-Lane Highways, One-Way or Two-Way).....	3-33 <u>3-36</u>
Table 3 – 16	Maximum Grades (in Percent)	3-35 <u>3-38</u>
Table 3 – 17	Maximum Change in Grade Without Using Vertical Curve.....	3-37 <u>3-40</u>
Table 3 – 18	Rounded K Values for Minimum Lengths Vertical Curves (Stopping Sight Distance)	3- 38 <u>3-41</u>
Table 3 - 19	Design Controls for Crest Vertical Curves (Passing Sight Distance)	3- 40 <u>3-43</u>
Table 3 – 20	Minimum Lane Widths.....	3-44 <u>3-47</u>
Table 3 – 21	Minimum Shoulder Widths for Flush Shoulder Highways.....	3-47 <u>3-50</u>

Table 3 – 22	Shoulder Cross Slope	3-48 3-51
Table 3 – 23	Minimum Median Width.....	3-52 3-55
Table 3 – 24	Minimum Parallel Parking Lane Width	Error! Bookmark not defined. 3-72
Table 3 – 25	Parking Restrictions for Driveways, Intersections and Mid-Block Crosswalks.....	3-75 3-78
Table 3 – 26	Access Control for All Limited Access Highways	3-83 3-88
Table 3 – 27	Minimum Stopping Sight Distance (Rounded Values)	3-89 3-95
Table 3 – 28	Length of Taper for Use in Conditions with Full Width Speed Change Lanes	3-100 3-106
Table 3 – 29	Design Lengths of Speed Change Lanes Flat Grades - 2 Percent or Less	3-103 3-109
Table 3 – 30	Ratio of Length of Speed Change Lane on Grade to Length on Level	3-104 3-110
Table 3 – 31	Minimum Acceleration Lengths for Entrance Terminals.....	3-105 3-111
Table 3 – 32	Minimum Deceleration Lengths for Exit Terminals.....	3-107 3-113
Table 3 – 33	Turn Lanes – Curbed and Uncurbed Medians	3-113 3-119
Table 3 – 34	Superelevation Rates for Curves at Intersections	3-114 3-121
Table 3 – 35	Maximum Rate of Change in Pavement Edge Elevation for Curves at Intersections.....	3-115 3-121
Table 3 – 36	Maximum Algebraic Difference in Pavement Cross Slope at Turning Roadway Terminals	3-115 3-121
Table 3 – 37	Derived Pavement Widths for Turning Roadways for Different Design Vehicles	3-117 3-124

FIGURES

Figure 3 – 1A	Horizontal Sight Line Offset Distances for Stopping Sight Distance on Horizontal Curves.....	3-28
Figure 3 – 1B	Diagram Illustrating Components for Determining Horizontal Sight Distance	3-29
Figure 3 – 2	Critical Length Versus Upgrade	3-36 3-39
Figure 3 – 3	Length of Crest Vertical Curve (Stopping Sight Distance).....	3-39 3-42
Figure 3 – 4	Length of Sag Vertical Curve (Open Road Conditions).....	3-41 3-44
Figure 3 – 5	General Types and Shapes of Islands and Medians.....	3-54 3-57
Figure 3 – 6	Channelization Island for Pedestrian Crossings (Curbed).....	3-58 3-61
Figure 3 – 7	Details of Corner Island for Turning Roadways (Curbed).....	3-59 3-62
Figure 3 – 8	Details of Corner Island for Turning Roadways (Flush Shoulder)	3-60 3-63
Figure 3 – 9	Alignment for Divisional Islands at Intersections	3-62 3-65
Figure 3 – 10	Pedestrian Refuge Island.....	3-63 3-66
Figure 3 – 11	Pedestrian Crossing with Refuge Island (Yield Condition)	3-64 3-67
Figure 3 – 12	Pedestrian Crossing with Refuge Island (Stop Condition).....	3-65 3-67
Figure 3 – 13	Pedestrian Crossing in Refuge Island	3-67 3-70
Figure 3 – 14	Standard Detail for FDOT Type F and E Curbs.....	3-68 3-71
Figure 3 – 15	Signing and Marking of Parallel Parking Spaces.....	3-70 3-73
Figure 3 – 16	Signing and Marking for 45 degree Forward-In Angle Parking....	3-71 3-74
Figure 3 – 17	Signing and Marking for 45 degree Reverse-In Angle Parking ...	3-73 3-76
Figure 3 – 18	Sight Distances for Approach to Stop on Grades.....	3-90 3-93
Figure 3 – 19	Departure Sight Triangle (Traffic Approaching from Left or Right) ..	3-93 96
Figure 3 – 20	Intersection Sight Distance	3-94 3-97
Figure 3 – 21	Sight Distance for Vehicle Turning Left from Major Road	3-99 3-102
Figure 3 – 22	Termination of Merging Lanes.....	3-101 3-104
Figure 3 – 23	Entrance for Deceleration Lane.....	3-108 3-111
Figure 3 – 24	Auxiliary Lanes for Deceleration at Intersections (Turn Lanes).....	3-112 3- 115

CHAPTER 3

GEOMETRIC DESIGN

A INTRODUCTION

Geometric design is defined as the design or proportioning of the visible elements of the street or highway. The geometry of the street or highway is of central importance since it provides the framework for the design of other highway elements. In addition, the geometric design establishes the basic nature and quality of the vehicle path, which has a primary effect upon the overall safety characteristics of the street or highway.

The design of roadway geometry must be conducted in close coordination with other design elements of the street or highway. These other elements include pavement design, roadway lighting, traffic control devices, transit, drainage, and structural design. The design should consider safe roadside clear zones, pedestrian safety, emergency response, and maintenance capabilities.

The safety characteristics of the design should be given primary consideration. The initial establishment of sufficient right of way and adequate horizontal and vertical alignment is not only essential from a safety standpoint, but also necessary to allow future upgrading and expansion without exorbitant expenditure of highway funds.

The design elements selected should be reasonably uniform but should not be inflexible.

The minimum standards presented in this chapter should not automatically become the standards for geometric design. The designer should consider use of a higher level, when practical, and consider cost-benefits as well as consistency with adjacent facilities. Reconstruction and maintenance of facilities should, where practical, include upgrading to these minimum standards.

In restricted or unusual conditions, it may not be possible to meet the minimum standards. In such cases, the designer shall obtain an exception in accordance with ***Chapter 14 – Design Exceptions and Variations*** from the reviewing or permitting organization. However, every effort should be made to obtain the best possible alignment, grade, sight distance, and proper drainage consistent with the terrain, the development, safety, and fund availability. The concept of road users has expanded in recent years creating additional considerations for the designer.

In making decisions on the standards to be applied to a particular project, the designer must also address the needs of pedestrians, bicyclists, elder road and transit users, people with disabilities, freight movement and other users and uses. This is true for both urban and rural facilities.

The design features of urban local streets are governed by practical limitations to a greater extent than those of similar roads in rural areas. The two dominant design controls are: (1) the type and extent of urban development and its limitations on rights of way and (2) zoning or regulatory restrictions. Some streets primarily are land service streets in residential areas. In such cases, the overriding consideration is to foster a safe and pleasing environment. Other streets are land service only in part, and features of traffic and public transit service may be predominant.

The selection of the type and exact design details of a particular street or highway requires considerable study and thought. When specific criteria are not provided in this Manual and reference is made to guidelines and design details given by current American Association of State Highway and Transportation Officials (AASHTO) publications, these guidelines and standards should generally be considered as minimum criteria. For the design of recreational roads, local service roads, and alleys, see [*A Policy on Geometric Design of Highways and Streets \(AASHTO, 2011\)*](#), also known as the [*AASHTO Greenbook \(2011\)*](#) and other publications.

Right of way and pavement width requirements for new construction may be reduced for the paving of certain existing unpaved streets and very low volume rural roads provided all of the conditions listed below are satisfied:

- The road is functionally classified as a local road.
- The 20-year projected ADT is less than or equal to 400 vehicles per day and the design year projected peak hourly volume is 100 vehicles per hour or less. Note: The design year may be any time within a range of the present to 20 years in the future, depending on the nature of the improvement.
- The road has no foreseeable probability of changing to a higher functional classification through changes in land use, extensions to serve new developing land areas, or any other use which would generate daily or hourly traffic volumes greater than those listed above.
- There is no reasonable possibility of acquiring additional right of way without.
- Incurring expenditures of public funds in an amount which would be excessive compared to the public benefits achieved.

- Causing substantial damage or disruption to abutting property improvements to a degree that is unacceptable considering the local environment

B OBJECTIVES

The major objective in geometric design is to establish a vehicle path and environment providing a reasonable margin of safety for the motorist, transit, bicyclist, and pedestrian under the expected operating conditions and speed. It is recognized that Florida's design driver is aging, and tourism is our major industry. This gives even more emphasis on simplicity and easily understood geometry. The design of street or highway features should consider the following:

- Provide the most simple geometry attainable, consistent with the physical constraints
- Provide a design that has a reasonable and consistent margin of safety at the expected operating speed
- Provide a design that is safe at night and under adverse weather conditions
- Provide a facility that is adequate for the expected traffic conditions and transit needs
- Allow for reasonable deficiencies in the driver, such as:
 - Periodic inattention
 - Reduced skill and judgment
 - Slow reaction and response
- Provide an environment that minimizes hazards, is as hazard free as practical, and is "forgiving" to a vehicle that has deviated from the travel path or is out of control.

C DESIGN ELEMENTS

C.1 Design Speed

Design speed is a selected speed used to determine the various geometric design features of the street or highway. Selection of an appropriate design speed must consider the anticipated operating speed, topography, existing and future adjacent land use, and functional classification. Consideration must also be given to pedestrian and bicycle usage.

Many critical design features such as sight distance and curvature are directly related to, and vary appreciably with, design speed. For this reason, the selected design speed should be consistent with the speeds that drivers are likely to expect

on a given street or highway facility. The design speed shall not be less than the expected posted or legal speed limit. Once the design speed is selected, all pertinent highway features should be related to it to obtain a balanced design.

Above minimum design criteria for specific design elements such as flatter curves and longer sight distances should be used where practical, particularly on high speed facilities. On lower speed facilities, use of above minimum values may encourage travel at speeds higher than the design speed.

The design speed utilized should be consistent over a given section of street or highway. Required changes in design speed should be effected in a gradual fashion. When isolated reductions in design speed cannot reasonably be avoided, appropriate speed signs should be posted.

Minimum and maximum values for design speed are given in Table 3 – 1 Minimum and Maximum Design Speed.

High speed facilities are defined as those facilities with design speeds 50 mph and greater. Low speed facilities are defined as those facilities with design speeds 45 mph and less. The posted speed shall be less than or equal to the design speed.

The [AASHTO Greenbook \(2011\)](#) provides additional information on design speed.

Table 3 – 1 Minimum and Maximum Design Speed (mph)

Facility ¹		AADT (vpd)	Terrain	Design Speed (mph)
Freeways	Rural	All	Level and Rolling	70
	Urban	All	Level and Rolling	50 – 70 ²
Arterials	Rural	All	Level	60 – 70
			Rolling	50 – 70
	Urban	All	All	30 – 60 ³
Collectors	Rural	≥ 400	Level	60 – 65 (50 mph min for AADT 400 to 2000)
			Rolling	50 – 65 (40 mph min for AADT 400 to 2000)
	< 400	Level	40 – 60	
		Rolling	30 – 60	
	Urban	All	All	30 – 50 ³
Local	Rural	≥ 400	Level	50 – 60
			Rolling	40 – 60
	< 400	Level	30 – 50	
		Rolling	20 – 40	
	Urban	All	All	20 – 30 ⁴

Footnotes:

1. Urban design speeds are applicable to streets and highways located within designated urban boundaries as well as those streets and highways outside designated urban boundaries yet within small communities or urban like developed areas. Rural design speeds are applicable to all other rural areas.
2. A design speed of 70 mph should be used for urban freeways when practical. Lower design speeds should only be used in highly developed areas with closely spaced interchanges. For these areas a minimum design speed of 60 mph is recommended unless it can be shown lower speeds will be consistent with driver expectancy.
3. Lower speeds apply to central business districts and in more developed areas while higher speeds are more applicable to outlying and developing areas.
4. Since the function of urban local streets is to provide access to adjacent property, all design elements should be consistent with the character of activity on and adjacent to the street, and should encourage speeds generally not exceeding 30 mph.

C.2 Design Vehicles

A "design vehicle" is a vehicle with representative weight, dimensions, and operating characteristics, used to establish street and highway design controls for accommodating vehicles of designated classes. For the purpose of geometric design, the design vehicle should be one with dimensions and minimum turning radii larger than those of almost all vehicles in its class. Design vehicles are listed in Table 3 – 2 Design Vehicles. One or more of these vehicles should be used as a control in the selection of geometric design elements. In certain industrial (or other) areas, special service vehicles may have to be considered in the design. Fire equipment and emergency vehicles should have reasonable access to all areas. Additional information on the maximum width, height and length of vehicles in Florida can be found in [Section 316.515, F.S. Motor Vehicles; Maximum width, height, length.](#)

If a significant number or percentage (5 percent of all the total traffic) of vehicles of those classes larger than passenger vehicles are likely to use a particular street or highway, that class should be used as a design control. The design of arterial streets and highways should normally be adequate to accommodate all design vehicles. The decision as to which of the design vehicles (or other special vehicles) should be used as a control is complex and requires careful study. Each situation must be evaluated individually to arrive at a reasonable estimate of the type and volume of expected traffic.

- Design criteria significantly affected by the type of vehicle include:
- Horizontal and vertical clearances
- Alignment
- Lane widening on curves
- Shoulder width requirements
- Turning roadway and intersection radii
- Intersection sight distance
- Acceleration criteria

Particular care should be taken in establishing the radii at intersections, so vehicles may enter the street or highway without encroaching on adjacent travel lanes or leaving the pavement. It is acceptable for occasional trucks or buses to make use of both receiving lanes, especially on side streets.

Table 3 – 2 Design Vehicles

Design Vehicle		Dimensions (feet)					
Type	Symbol	Wheelbase	Overhang		Overall Length	Overall Width	Height
			Front	Rear			
Passenger Car	P	11	3	5	19	7	4.3
Single Unit Truck	SU-30	20	4	6	30	8	11-13.5
Single Unit Truck – 3 Axle	SU-40	25	4	10.5	39.5	8	11-13.5
City Transit Bus	CITY-BUS	25	7	8	40	8.5	10.5
Conventional School Bus (65 passenger)	S-BUS 36	21.3	2.5	12.0	35.8	8.0	10.5
Articulated Bus	A-BUS	22+19.4=41.4	8.6	10	60	8.5	11
Motor Home	MH	20	4	6	30	8	12
Car & Camper Trailer	P/T	11+5+17.7=33.7**	3	12	48.7	8	10
Car & Boat Trailer	P/B	11+5+15=31**	3	8	42	8	---
Intermediate Semitrailer ^{***}	WB-40	12.5+25.5=38	3	4.5	45.5	8	13.5
Intermediate Semitrailer	WB-50	14.6+35.4=50	3	2	55	8.5	13.5
Interstate Semitrailer ^{***}	WB-62	19.5+41=60.5	4	4.5	69	8.5	13.5
Florida Interstate Semitrailer ^{***}	WB-62FL	19.5+41=60.5	4	9	73.5	8.5	13.5
Interstate Semitrailer ^{***}	WB-67	21.6+45.4=67	4	2.5	73.5	8.5	13.5
"Double-Bottom"-Semitrailer/Trailer Combination	WB-67D	11+23+10*+22.5=66.5	2.3	3.0	72.3	8.5	13.5

Source: 2011 AASHTO Greenbook, Design Controls and Criteria, Table 2-1b.

* Distance between rear wheels of front trailer and front wheels of rear trailer

** Distance between rear wheels of trailer and front wheels of car

*** The term "Interstate" does not imply the vehicle is restricted to interstate and limited access highways only.

The minimum turning radii of design vehicles is presented in Table 3 – 3 Minimum Turning Radii of Design Vehicles. The principal dimensions affecting design are the minimum centerline turning radius, the out-to-out track width, the wheelbase, and the path of the inner rear tire. The speed of the turning vehicle is assumed to be less than 10 mph.

The boundaries of the turning path of each design vehicle for its sharpest turns are established by the outer trace of the front overhang and path of the inner rear wheel. This sharpest turn assumes that the outer front wheel follows the circular arc defining the minimum centerline turning radius as determined by the vehicle steering mechanism.

Figures illustrating the minimum turning radii for a variety of vehicles along with additional information can be found in the [**AASHTO Greenbook \(2011\), Chapter 2 – Design Controls and Geometrics.**](#)

Table 3 – 3 Minimum Turning Radii of Design Vehicles

Design Vehicle Type	Symbol	Dimensions In Feet		
		Minimum Design Turning Radius	Centerline Turning* Radius	Minimum Inside Radius
Passenger Car	P	23.8	21.0	14.4
Single Unit Truck	SU-30	41.8	38.0	28.4
Single Unit Truck – 3 Axle	SU-40	51.2	47.4	36.4
City Transit Bus	CITY-BUS	41.6	37.8	24.5
Conventional School Bus (65 passenger)	S-BUS 36	38.6	34.9	23.8
Articulated Bus	A-BUS	39.4	35.5	21.3
Motor Home	MH	39.7	36.0	26.0
Car & Camper Trailer	P/T	32.9	30.0	18.3
Car & Boat Trailer	P/B	23.8	21.0	8.0
Intermediate Semitrailer	WB-40	39.9	36.0	19.3
Intermediate Semitrailer	WB-50	45	41	17.0
Interstate Semitrailer	WB-62	44.8	41.0	7.4
Florida Interstate Semitrailer***	WB-62FL	44.8	41.0	7.4
"Double-Bottom"- Semitrailer/Trailer Combination	WB-67D	44.8	40.9	19.1

Source: 2011 AASHTO Greenbook, Design Controls and Criteria, Table 2-2b.

* The turning radius assumed by a designer when investigating possible turning paths and is set at the centerline of the front axle of a vehicle. If the minimum turning path is assumed, the CTR approximately equals the minimum design turning radius minus one-half the front width of the vehicle.

C.3 Sight Distance

The provision for adequate horizontal and vertical sight distance is an essential factor in the development of a safe street or highway. An unobstructed view of the upcoming roadway is necessary to allow time and space for the safe execution of passing, stopping, intersection movements, and other normal and emergency maneuvers. It is also important to provide as great a sight distance as possible to allow the driver time to plan for future actions. The driver is continuously required to execute normal slowing, turning, and acceleration maneuvers. If he can plan in advance for these actions, traffic flow will be smoother and less hazardous. Unexpected emergency maneuvers will also be less hazardous if they are not combined with uncertainty regarding the required normal maneuvers. The appropriate use of lighting (**Chapter 6 – Lighting**) may be required to provide adequate sight distances for night driving.

Future obstruction to sight distance that may develop (e.g., vegetation) or be constructed should be taken into consideration in the initial design. Areas outside of the road right of way that are not under the highway agency's jurisdiction should be considered as points of obstruction. Planned future construction of median barriers, guardrails, grade separations, or other structures should also be considered as possible sight obstructions.

C.3.a Stopping Sight Distance

Safe stopping sight distances shall be provided continuously on all streets and highways. The factors, which determine the minimum distance required to stop, include:

- Vehicle speed
- Driver's total reaction time
- Characteristics and conditions of the vehicle
- Friction capabilities between the tires and the roadway surface
- Vertical and horizontal alignment of the roadway

It is desirable that the driver be given sufficient sight distance to avoid an object or slow-moving vehicle with a natural, smooth maneuver rather than an extreme or panic reaction.

The determination of available stopping sight distance shall be based on a height of the driver's eye equal to 3.50 feet and a height of obstruction to be

avoided equal to 2.0 feet. It would, of course, be desirable to use a height of obstruction equal to zero (coincident with the roadway surface) to provide the driver with a more positive sight condition. Where horizontal sight distance may be obstructed on curves, the driver's eye and the obstruction shall be assumed to be located at the centerline of the traffic lane on the inside of the curve.

The stopping sight distance shall be no less than the values given in Table 3 – 4 Minimum Stopping Sight Distance for level and rolling roadways.

Table 3 – 4 Minimum Stopping Sight Distance

Design Speed (mph)	Stopping Sight Distance (feet)						
	Level (≤ 2%)						
		Downgrades			Upgrades		
		3%	6%	9%	3%	6%	9%
20	115	116	120	126	109	107	104
25	155	158	165	173	147	143	140
30	200	205	215	227	200	184	179
35	250	257	271	287	237	229	222
40	305	315	333	354	289	278	269
45	360	378	400	427	344	331	320
50	425	446	474	507	405	388	375
55	495	520	553	593	469	450	433
60	570	598	638	686	538	515	495
65	645	682	728	785	612	584	561
70	730	771	825	891	690	658	631

Source: 2011 AASHTO Greenbook, Table 3-1 Stopping Sight Distance on Level Roadways and Table 3-2 Stopping Sight Distance on Grades.

C.3.b Decision Sight Distance

Decision sight distance is the distance needed for a driver to detect an unexpected or otherwise difficult to perceive information source or condition in a roadway environment that may be visually cluttered. It allows the driver to recognize the condition or its potential threat, select an appropriate speed and path, and initiate and complete complex maneuvers. Minimum stopping distance does not provide sufficient space or time for the driver to make decisions regarding complex situations requiring more than simple perception-reaction process.

Examples of critical locations where additional sight distance is needed include interchange and intersection locations, where unusual or unexpected maneuvers are needed, changes in typical sections such as toll plazas or lane drops, and areas of concentrated demand where there is visual noise from competing sources of information, such as roadway elements, traffic, traffic control devices and advertising signs.

The decision sight distances in Table 3 – 5 Decision Sight Distance may be used (1) to provide values for sight distances that may be appropriate at critical locations, and (2) to serve as criteria for evaluating the suitability of the available sight distances at these locations. If it is not practical to provide decision sight distance because of horizontal or vertical curvature or if relocation of decision points is not practical, special attention should be given to using appropriate traffic control devices providing advance warning of the conditions that are likely to be encountered.

Table 3 – 5 Decision Sight Distance

Design Speed (mph)	Decision Sight Distance (feet)				
	Level Avoidance Maneuver				
	A	B	C	D	E
20	130	305	300	355	410
25	170	395	375	445	515
30	220	490	450	535	620
35	275	590	525	625	720
40	330	690	600	715	825
45	395	800	675	800	930
50	465	910	750	890	1030
55	535	1030	865	980	1135
60	610	1150	990	1125	1280
65	695	1275	1050	1220	1365
70	780	1410	1105	1275	1445

Source: 2011 AASHTO Greenbook, Table 3 - 3 Decision Sight Distance

- Notes:
1. Avoidance Maneuver A: Stop on rural road – t = 3.0 s
 2. Avoidance Maneuver B: Stop on urban road – t = 9.1 s
 3. Avoidance Maneuver C: Speed/path/direction change on rural road – t varies between 10.2 and 11.2 s
 4. Avoidance Maneuver D: Speed/path/direction change on suburban road – t varies between 12.1 and 12.9 s
 5. Avoidance Maneuver E: Speed/path/direction change on urban road – t varies between 14.0 and 14.5 s

The sight distance on a freeway preceding the approach nose of an exit ramp should exceed the minimum by 25 percent or more. A minimum sight distance of 1000 feet, measured from the driver's eye to the road surface is a desirable goal. There should be a clear view of the exit terminal including the exit nose.

C.3.c Passing Sight Distance

The passing maneuver, which requires occupation of the opposing travel lane, is inherently dangerous. The driver is required to make simultaneous estimates of time, distance, relative speeds, and vehicle capabilities. Errors in these estimates result in frequent and serious crashes.

Streets or highways with two or more travel lanes in a given direction are not subject to requirements for safe passing sight distance. Two-lane, two-way highways should be provided with safe passing sight distance for as much of the highway as feasible. The driver demand for passing opportunity is high and serious limitations on the opportunity for passing reduces the capacity and safe characteristics of the highway.

The distance traveled after the driver's final decision to pass (while encroaching into the opposite travel path) is that which is required to pass and return to the original travel lane in front of the overtaken vehicle. In addition to this distance, the safe passing sight distance must include the distance traveled by an opposing vehicle during this time period, as well as a reasonable margin of safety. Due to the many variables in vehicle characteristics and driver behavior, the passing sight distance should be as long as is practicable.

The determination of passing sight distance shall be based on a height of eye equal to 3.50 feet and a height of object passing equal to 3.50 feet. Where passing is permitted, the passing sight distance shall be no less than the values given in Table 3 – 6 Minimum Passing Sight Distances.

Table 3 – 6 Minimum Passing Sight Distance

(For application of passing sight distance, use an eye height of 3.50 feet and an object height of 3.50 feet above the road surface)											
Design Speed (mph)	20	25	30	35	40	45	50	55	60	65	70
Minimum Passing Sight Distance (feet)	400	450	500	550	600	700	800	900	1000	1100	1200

Source: 2011 AASHTO Greenbook, Table 3-4 Passing Sight Distance for Design of Two-Lane Highways.

C.3.d Intersection Sight Distance

Sight distances for intersection movements are given in the general intersection requirements (C.9 Intersection Design, this chapter).

C.4 Horizontal Alignment

C.4.a General Criteria

The standard of alignment selected for a particular section of street or highway should extend throughout the section with no sudden changes from easy to sharp curvature. Where sharper curvature is unavoidable, a sequence of curves of increasing degree should be utilized.

Winding alignment consisting of sharp curves is hazardous, reduces capacity, and should be avoided. The use of as flat a curve as possible is recommended. Flatter curves are not only less hazardous, but also frequently less costly due to the shortened roadway.

Maximum curvature should not be used in the following locations:

- High fills or elevated structures. The lack of surrounding objects reduces the driver's perception of the roadway alignment.
- At or near a crest in grade.
- At or near a low point in a sag or grade.
- At the end of long tangents.
- At or near intersections, transit stops, or points of ingress or egress.

- At or near other decision points.

The "broken back" arrangement of curves (short tangent between two curves in the same direction) should be avoided. This is acceptable only at design speeds of 30 mph or less. This arrangement produces unexpected and hazardous situations.

When reversals in alignment are used and superelevation is required, a sufficient length of tangent between the reverse curves is required for adequate superelevation transition.

Compound curves should be avoided, especially when curves are sharp. They tend to produce erratic and dangerous vehicle operations. When compound curves are necessary, the radius of the flatter curve should not be more than 50 percent greater than the sharper curve.

The transition between tangents and curves should normally be accomplished by the use of appropriate straight-line transitions or spirals. This is essential to assist the driver in maintaining his vehicle in the proper travel path.

C.4.b Maximum Deflections in Alignment without Curves

The point where tangents intersect is known as the point of intersection (PI). Although the use of a PI with no horizontal curve is discouraged, there may be conditions where it is necessary. The maximum deflection criteria without a horizontal curve are as follows:

- Flush shoulder and curbed roadways with design speed 40 mph and less is 2° 00' 00".
- Flush shoulder roadways with design speed 45 mph and greater is 0° 45' 00".
- Curbed roadways with design speed 45 mph and greater is 1° 00' 00".
- High speed curbed roadways with design speed 50 mph and greater is 0° 45' 00".

Although deflections through intersections are discouraged, there may be conditions where it is necessary. The maximum deflection angles at

intersections to be used in establishing the horizontal alignment are given in Table 3 – 7 Maximum Deflection Angle Through Intersection.

Table 3 – 7 Maximum Deflection Angle Through Intersection

Design Speed (mph)					
≤ 20	25	30	35	40	45
16° 00'	11° 00'	8° 00'	6° 00'	5° 00'	3° 00'

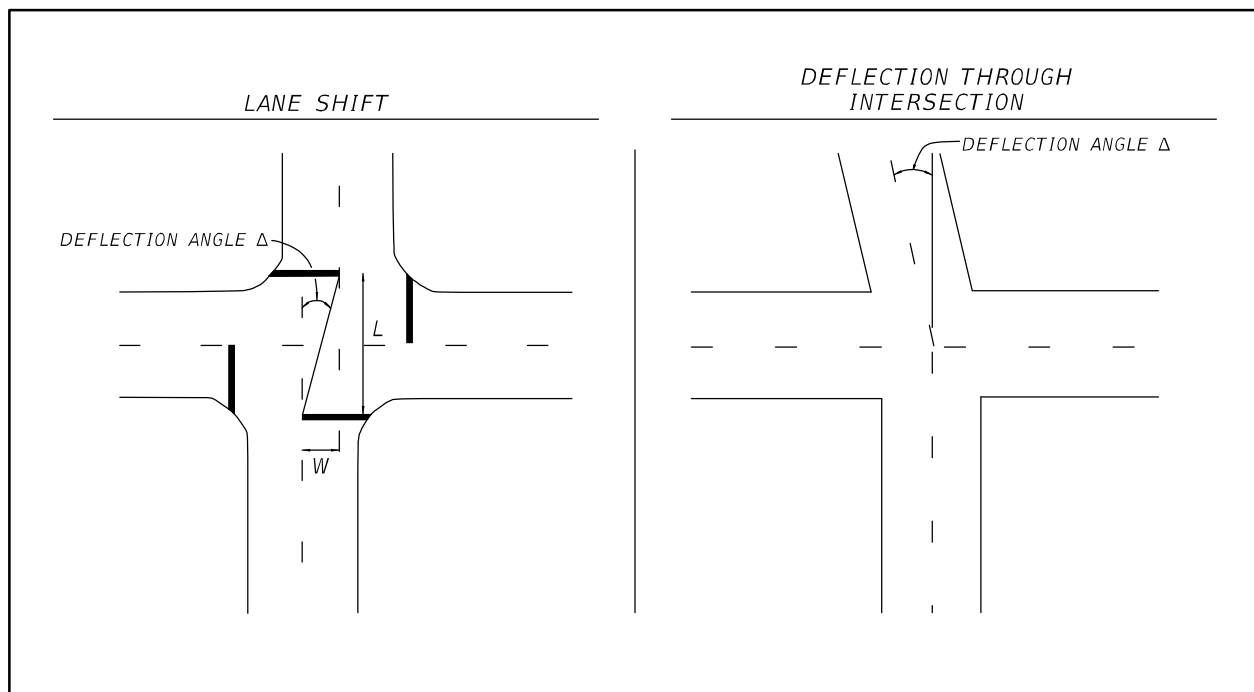

Notes 1. The deflection angle used is not to cause a lane shift (W) of more than 6 feet from stop bar to stop bar.

Curves on main roadways should be sufficiently long to avoid the appearance of a kink. Gently flowing alignment is generally more pleasing in appearance, as well as, superior from a safety standpoint. Flatter curvature with shorter tangents is preferable to sharp curves connected by long tangents, i.e., avoid using minimum horizontal curve lengths. Table 3-8 Minimum Lengths of Horizontal Curves provides minimum horizontal curve lengths that should be used in establishing the horizontal alignment.

Table 3 – 8 Minimum Lengths of Horizontal Curves

Curve Length Based on Design Speed										
Design Speed (mph)	25	30	35	40	45	50	55	60	65	70
Arterials, Collectors (Length in feet = 15 x Design Speed, but not less than 400 feet)	400	450	525	600	675	750	825	900	975	1050
Freeways - Mainline (Length in feet = 30 x Design Speed)	--	--	--	--	--	1500	1650	1800	1950	2100
Curve Length Based on Deflection Angle										
Deflection Angle (degrees)	5°		4°		3°		2°		1°	
Curve Length (feet)	500		600		700		800		900	
Notes:										
<ol style="list-style-type: none"> Horizontal curve length should be the greater of the lengths based on design speed and length based on deflection angle. If the curve lengths for arterials and collectors cannot be attained, provide the greatest attainable length possible, but not less than 400 feet. If the curve lengths for mainline freeways cannot be attained, provide the greatest attainable length possible, but not less than the lengths used for arterials and collectors. Curve length shall provide for full superelevation within the curve of not less than 200 ft. (Rural) or 100 ft. (Urban). 										

Compound curves are sometimes used for turning roadways at intersections. For turning roadways and intersections a ratio of 2:1 (where the flatter radius precedes the sharper radius in the direction of travel) is acceptable. The arc lengths of compound curves for turning roadways when followed by a curve of one half radius or preceded by a curve of double radius should be as shown in Table 3 – 9 Length of Compound Curves on Turning Roadways.

Table 3 – 9 Length of Compound Curves on Turning Roadways

Radius (feet)	100	150	200	250	300	400	≥ 500
Desirable Arc Length (feet)	65	70	100	120	150	180	200
Minimum Arc Length (feet)	40	50	65	85	100	120	150

C.4.c Superelevation

In the design of street and highway curves, it is necessary to establish a proper relationship between curvature of the roadway and design speed. The use of superelevation (rotation of the roadway about its axis) is employed to counteract centrifugal force and allow drivers to comfortably and safely travel through curves at the design speed.

The terms Rural and Urban used in this section reflect the location of the project. In addition to the criteria provided below, additional information regarding superelevation given in the [Department's FDOT Design Manual](#), and [A Policy on Geometric Design of Highways and Streets \(AASHTO, 2011\)](#), may be considered.

C.4.c.1 Rural Highways, Urban Freeways and High Speed Urban Highways

The superelevation rates for high speed (50 mph or greater) roadways are provided in Table 3 – 10 Superelevation Rates for Rural Highways, Urban Freeways and High-Speed Urban Highways (e max =0.10). These rates are based on Method 5 from the [2011 AASHTO Greenbook](#) using a maximum rate of 0.10 foot per foot of

roadway width. Table 3 – 10 also provides the minimum radius required for normal crown without superelevation.

C.4.c.2 Low Speed Urban Roadways

For low speed (45 mph and less) roadways in urban areas, various factors combine to make superelevation difficult, if not impractical, in many built-up areas. Such factors include:

- Wide pavement areas
- Need to meet grade of adjacent property
- Surface drainage considerations
- Frequency of cross streets, alleys, and driveways

Superelevation rates for low speed urban roadways therefore rely more heavily on side friction than rates used for high speed roadways and the maximum superelevation rate is set at 0.05 foot per foot. Separate criteria are provided for low speed Local Roads vs. low speed Arterials and Collectors as follows:

Low Speed Urban Arterials and Collectors: Superelevation rates for low speed urban arterials and collectors are provided in Table 3 – 11 Superelevation Rates for Low Speed Arterials and Collectors ($e_{max} = 0.05$). These rates are based on the [FDOT's the Department's](#) superelevation criteria for low speed arterials and collectors. Table 3 – 11 also provides the minimum radius required for normal crown without superelevation.

Low Speed Local Roads: Minimum radii for design superelevation rates for low speed local roads are provided in Table 3 – 12 Minimum Radii (feet) for Design Superelevation Rates, Low Speed Local Roads ($e_{max} = 0.05$). These rates are based on Method 2 from the 2011 AASHTO Greenbook. Table 3 – 12 also provides the minimum radius required for normal crown (-0.02 ft/ft) without superelevation.

Table 3 – 10 Superelevation Rates for Rural Highways, Urban Freeways and High Speed Urban Highways (e max = 0.10)

Tabulated Values										
Degree of Curve <i>D</i>	Radius <i>R</i> (ft.)	Design Speed (mph)								
		30	35	40	45	50	55	60	65	70
0° 15'	22,918	NC	NC	NC	NC	NC	NC	NC	NC	NC
0° 30'	11,459	NC	NC	NC	NC	NC	NC	RC	RC	RC
0° 45'	7,639	NC	NC	NC	NC	RC	RC	0.023	0.025	0.028
1° 00'	5,730	NC	NC	NC	RC	0.021	0.025	0.030	0.033	0.037
1° 15'	4,584	NC	NC	RC	0.022	0.026	0.031	0.036	0.041	0.046
1° 30'	3,820	NC	RC	0.021	0.026	0.031	0.037	0.043	0.048	0.054
	* <i>R</i> _{NC}									
2° 00'	2,865	RC	0.022	0.028	0.034	0.040	0.048	0.055	0.062	0.070
	* <i>R</i> _{RC}									
2° 30'	2,292	0.021	0.028	0.034	0.041	0.049	0.058	0.067	0.075	0.085
3° 00'	1,910	0.025	0.032	0.040	0.049	0.057	0.067	0.077	0.087	0.096
3° 30'	1,637	0.029	0.037	0.046	0.055	0.065	0.075	0.086	0.095	0.100
4° 00'	1,432	0.033	0.042	0.051	0.061	0.072	0.083	0.093	0.099	Dmax = 3° 30'
5° 00'	1,146	0.040	0.050	0.061	0.072	0.083	0.094	0.098	Dmax = 4° 15'	
6° 00'	955	0.046	0.058	0.070	0.082	0.092	0.099	Dmax = 5° 15'		
7° 00'	819	0.053	0.065	0.078	0.089	0.098	Dmax = 6° 30'			
8° 00'	716	0.058	0.071	0.084	0.095	0.100	Dmax = 8° 15'			
9° 00'	637	0.063	0.077	0.089	0.098	Dmax = 10° 15'				
10° 00'	573	0.068	0.082	0.094	0.100	Dmax = 13° 15'				
11° 00'	521	0.072	0.086	0.097	Dmax = 17° 45'					
12° 00'	477	0.076	0.090	0.099	Dmax = 24° 45'					
13° 00'	441	0.080	0.093	0.100						
14° 00'	409	0.083	0.096							
15° 00'	382	0.086	0.098							
16° 00'	358	0.089	0.099							
18° 00'	318	0.093								
20° 00'	286	0.097								
22° 00'	260	0.099								
24° 00'	239	0.100								
		Dmax = 24° 45'								
* NC/RC and RC/e Break Points (Radius in feet)										
Break Points	Design Speed (mph)									
	30	35	40	45	50	55	60	65	70	
<i>R</i> _{NC}	3349	4384	5560	6878	8337	9949	11709	13164	14714	
<i>R</i> _{RC}	2471	3238	4110	5087	6171	7372	8686	9783	10955	
e = NC if R ≥ <i>R</i> _{NC} e = RC if R < <i>R</i> _{NC} and R ≥ <i>R</i> _{RC}										

NC = Normal Crown (-0.02) RC = Reverse Crown (+0.02)

*R*_{NC} = Minimum Radius for NC *R*_{RC} = Minimum Radius for RC

Rates for intermediate D and R's are to be interpolated.

**Table 3 – 11 Superelevation Rates for Low Speed Arterials and Collectors
 ($e_{max} = 0.05$)**

Tabulated Values					
Degree of Curve <i>D</i>	Radius <i>R</i> (ft.)	Design Speed (mph)			
		30	35	40	45
2° 00'	2,865	NC	NC	NC	NC
2° 15'	2,546				
2° 45'	2,083				NC
3° 00'	1,910				RC
3° 45'	1,528			NC	
4° 00'	1,432			RC	
4° 45'	1,206				
5° 00'	1,146		NC		
5° 15'	1,091		RC		
5° 30'	1,042				
5° 45'	996				
6° 00'	955				RC
6° 15'	917				0.022
6° 30'	881				0.024
6° 45'	849				0.027
7° 00'	819	NC			0.030
7° 15'	790	RC			0.033
7° 30'	764				0.037
7° 45'	739				0.041
8° 00'	716			RC	0.045
8° 15'	694			0.022	0.050
8° 30'	674			0.025	Dmax = 8° 15'
8° 45'	655			0.027	
9° 00'	637			0.030	Dmax = 10° 45'
9° 30'	603			0.034	
10° 00'	573			0.040	
10° 30'	546		RC	0.047	
11° 00'	521		0.023	Dmax = 10° 45'	
11° 30'	498		0.026		
12° 00'	477		0.030		
13° 00'	441		0.036		
14° 00'	409	RC	0.045		
15° 00'	382	0.023	Dmax = 14° 15'		
16° 00'	358	0.027			
17° 00'	337	0.032			
18° 00'	318	0.038			
19° 00'	302	0.043			
20° 00'	286	0.050			
		Dmax = 20° 00'			

NC = Normal Crown (-0.02) RC = Reverse Crown (+0.02)
 Rates for intermediate D and R's are to be interpolated.

**Table 3 – 12 Minimum Radii (feet) for Design Superelevation Rates
 Low Speed Local Roads ($e_{\max} = 0.05$)**

e - ft/ft	Design Speed (mph)							
	10	15	20	25	30	35	40	45
0.05	16	41	83	149	240	355	508	675
0.045	16	41	85	152	245	363	520	692
0.04	16	42	86	154	250	371	533	711
0.035	16	42	87	157	255	380	547	730
0.03	16	43	89	160	261	389	561	750
0.025	16	43	90	163	267	398	577	771
0.02	17	44	92	167	273	408	593	794
0.015	17	45	94	170	279	419	610	818
0.01	17	45	95	174	286	430	627	844
0.005	17	46	97	177	293	441	646	871
0	18	47	99	181	300	454	667	900
-0.01	18	48	103	189	316	480	711	964
-0.02	19	50	107	198	333	510	762	1038
-0.03 ¹	19	52	111	208	353	544	821	1125
-0.04 ¹	20	54	116	219	375	583	889	1227
-0.05 ¹	20	56	121	231	400	628	970	1350

1. Negative superelevation values beyond -0.02 feet per foot should be used only for unpaved surfaces such as gravel, crushed stone, and earth.

C.4.d Maximum Curvature/Minimum Radius

Where a directional change in alignment is required, every effort should be made to utilize the smallest degree (largest radius) curvature possible. The use of the maximum degree of curvature should be avoided when possible. Design speed maximum degree of curvature or minimum radius for the maximum superelevation rates are provided in Tables 3 – 10 Superelevation Rates for Rural Highways, Urban Freeways and High-Speed Urban Highways, 3 – 11 Superelevation Rates for Low Speed Arterials and Collectors, and 3 – 12 Minimum Radii (feet) for Design Superelevation Rates Low Speed Local Roads. The use of sharper curvature would call for superelevation beyond the limit considered practical or for operation with tire friction beyond safe or comfortable limits or both. The maximum degree of curvature or minimum radius is a significant value in alignment design.

C.4.e Superelevation Transition (superelevation runoffs plus tangent runoff)

Superelevation runoff is the general term denoting the length of street or highway needed to transition the change in cross slope from a section with the adverse crown removed (level) to the fully superelevated section, or vice versa. Tangent runoff is the general term denoting the length of street or highway needed to accomplish the change in cross slope from a normal cross section to a section with the adverse crown removed, or vice versa.

The standard superelevation transition places 80% of the transition on the tangent and 20% on the curve. In transition sections where the travel lane(s) cross slope is less than 1.5 %, one of the following grade criteria should be applied:

- Maintain a minimum profile grade of 0.5%, or
- Maintain a minimum edge of pavement grade of 0.2% (0.5% for curbed roadways).

When superelevation is required for curves in opposite directions on a common tangent (reverse curves), a suitable distance is required between the curves. This suitable tangent length should be determined as follows:

- 80% of the transition for each curve should be located on the tangent.

- The suitable tangent length is the sum of the two 80% distances, or greater.
- Where alignment constraints dictate a less than desirable tangent length between curves, an adjustment of the 80/20 superelevation transition treatment is allowed (where up to 50% of the transition may be placed on the curve).

Superelevation transition slope rates used to compute transition lengths are provided in Table 3 –13 Superelevation Transition Slope Rates. The 2011 AASHTO Greenbook provides additional information on superelevation transition design.

~~The~~The [FDOT Department's](#) [Standard Plans for Road and Bridge Construction](#) provide additional information on superelevation transitions for various sections and methods for determining length of transition.

Table 3 – 13 Superelevation Transition Slope Rates

Number of Lanes in One Direction	High Speed Roadways				Low Speed Roadways		
	Design Speed (mph)				Design Speed (mph)		
	25-40	45-50	55-60	65-70	25-35	40	45
1-Lane & 2-Lane	1:175	1:200	1:225	1:250	1:100	1:125	1:150
3-Lane	---	1:160	1:180	1:200			
4-Lane or more	---	1:150	1:170	1:190			

High Speed Roadways:

1. The length of superelevation transition is to be determined by the relative slope rate between the travel way edge of pavement and the profile grade, except that the minimum length of transition is 100 feet.
2. For additional information on transitions, see the [Standard Plans, Index 000-510](#).

Low Speed Roadways:

1. The length of superelevation transition is to be determined by the relative slope rate between the travel way edge of pavement and the profile grade, except that the minimum length of transition is 50 feet for design speeds 25-35 mph and 75 ft. for design speeds 40-45.
2. A slope rate of 1:125 may be used for 45 mph under restricted conditions.
3. For additional information on transitions, see the [Standard Plans, Index 000-511](#).

Spiral curves may be used to transition from the tangent to the curve. Where the spiral curve is employed, its length is used to make the entire superelevation transition. For additional information on the use of spiral curves, see the [2011 AASHTO Greenbook](#).

C.4.f Sight Distance on Horizontal Curves

Where there are sight obstructions (such as walls, cut slopes, buildings, and longitudinal barriers) on the inside of curves or the inside of the median lane

on divided highways and their removal to increase sight distance is impractical, a design may need adjustment in the normal highway cross section or alignment. With sight distance for the design speed as a control, make the appropriate adjustments to provide adequate stopping sight distance. Figure 3 – 1A Horizontal Sight Line Offset Distances for Stopping Sight Distance on Horizontal Curves and Figure 3 – 1B Diagram Illustrating Components for Determining Horizontal Sight Distance show the horizontal sight line offsets needed for clear sight areas that satisfy stopping sight distance criteria presented in Table 3 – 3 Minimum Stopping Sight Distances for horizontal curves of radii on flat grades.

Figure 3 – 1A Horizontal Sight Line Offset Distances for Stopping Sight Distance on Horizontal Curves

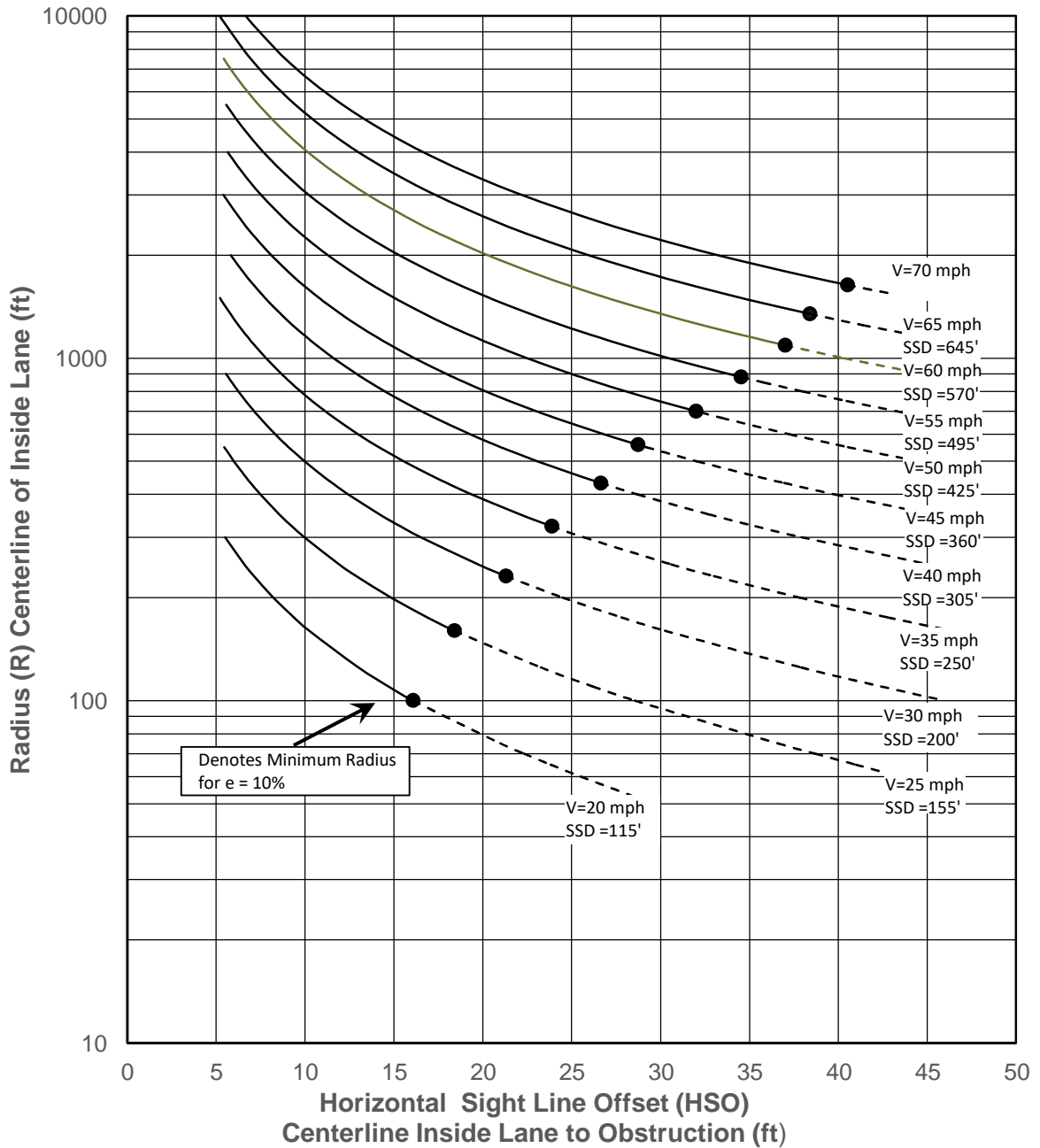
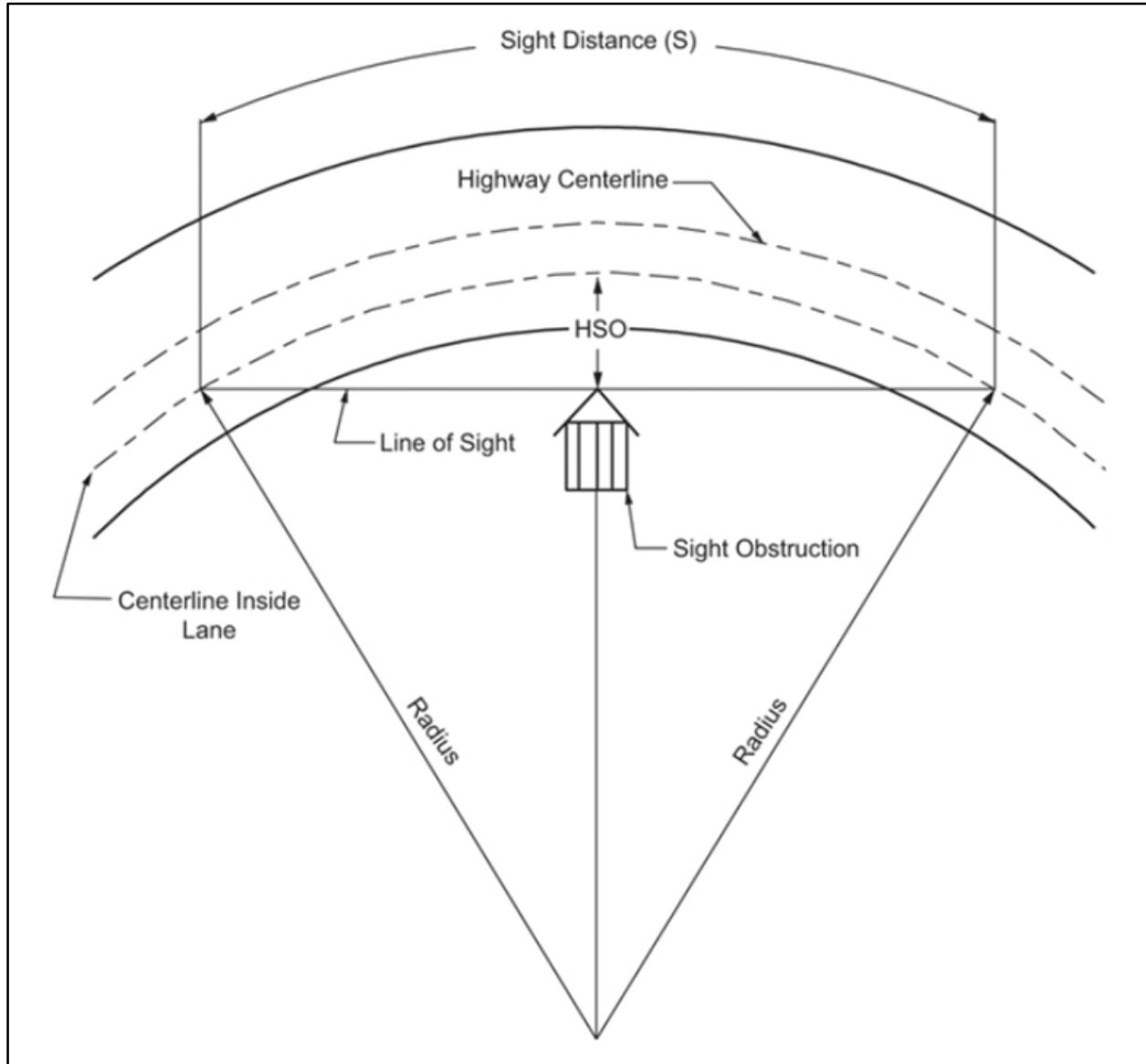

Figure 3 – 1B Diagram Illustrating Components for Determining Horizontal Sight Distance



HSO – Horizontal Sight Distance

Source: 2011 AASHTO Greenbook, Figure 3 – 23. Diagram Illustrating Components for Determining Horizontal Sight Distance

Table 3 – 14 Horizontal Curvature

Lateral Clearance from Edge of Traveled Way to Obstruction For Maximum Curvature (Degrees), Based on Line of Sight On Inside Lane (Lateral Clearance = $M_{\text{Inside Lane}} - 6'$) Based on $e_{\text{MAX}} = 0.10$		
Design Speed (mph)	Maximum Curvature	Clearance (feet)
20	57° 45'	11
25	36° 15'	13
30	24° 45'	16
35	17° 45'	19
40	13° 30'	21
45	10° 15'	23
50	8° 15'	27
55	6° 30'	29
60	5° 15'	31
65	4° 15'	33
70	3° 30'	35

C.4.g Lane Widening on Curves

The traveled way should be widened on sharp curves due to the increased difficulty for the driver to follow the proper path. Trucks and transit vehicles experience additional difficulty due to the fact that the rear wheels may track considerably inside the front wheels thus requiring additional width. Adjustments to traveled way widths for mainline and turning roadways are given in Tables 3 – 15A Calculated and Design Values for Traveled Way Widening on Open Highway Curves (Two-Lane Highways, One-Way or Two-Way and 3 – 15B Adjustments or Traveled Way Widening Values on Open Highway Curves (Two-Lane Highways, One-Way or Two-Way. A transition length shall be introduced in changing to an increased/decreased lane width. This transition length shall be proportional to the increase/decrease in traveled way width in a ratio of not less than 50 feet of transition length for each foot of change in lane width.

**Table 3 – 15A Calculated and Design Values for Traveled Way Widening on Open Highway Curves
 (Two-Lane Highways, One-Way or Two-Way)**

Radius of Curve (feet)	Roadway width = 24 feet.						Roadway width = 22 feet.						Roadway width = 20 feet.										
	Design Speed (mph)						Design Speed (mph)						Design Speed (mph)										
	30	35	40	45	50	55	60	30	35	40	45	50	55	60	30	35	40	45	50	55	60		
7000	0.0	0.0	0.0	0.0	0.0	0.0	0.0	0.7	0.7	0.8	0.8	0.9	1.0	1.0	1.0	1.7	1.7	1.8	1.8	1.9	2.0	2.0	2.1
6500	0.0	0.0	0.0	0.0	0.0	0.1	0.1	0.7	0.8	0.8	0.9	1.0	1.0	1.1	1.1	1.7	1.8	1.8	1.9	1.9	2.0	2.0	2.1
6000	0.0	0.0	0.0	0.0	0.1	0.1	0.1	0.7	0.8	0.9	0.9	1.0	1.1	1.1	1.1	1.7	1.8	1.9	1.9	2.0	2.1	2.1	2.2
5500	0.0	0.0	0.0	0.1	0.1	0.2	0.3	0.8	0.9	0.9	1.0	1.1	1.1	1.2	1.2	1.8	1.9	1.9	2.0	2.1	2.1	2.2	2.3
5000	0.0	0.0	0.1	0.1	0.2	0.3	0.4	0.9	0.9	1.0	1.1	1.1	1.2	1.3	1.3	1.9	2.0	2.1	2.1	2.2	2.2	2.3	2.4
4500	0.0	0.0	0.1	0.1	0.2	0.3	0.4	0.9	1.0	1.1	1.1	1.2	1.3	1.4	1.4	1.9	2.0	2.1	2.1	2.2	2.2	2.3	2.4
4000	0.0	0.1	0.2	0.2	0.3	0.4	0.5	1.0	1.1	1.2	1.2	1.3	1.4	1.5	1.5	2.0	2.1	2.2	2.2	2.3	2.3	2.4	2.5
3500	0.1	0.2	0.3	0.4	0.5	0.6	0.6	1.1	1.2	1.3	1.4	1.5	1.5	1.6	1.6	2.1	2.2	2.3	2.4	2.5	2.5	2.6	2.6
3000	0.3	0.4	0.4	0.5	0.6	0.7	0.8	1.3	1.4	1.4	1.5	1.6	1.7	1.8	1.8	2.3	2.4	2.4	2.5	2.6	2.6	2.7	2.8
2500	0.5	0.6	0.7	0.8	0.9	1.0	1.1	1.5	1.6	1.7	1.8	1.9	2.0	2.1	2.1	2.5	2.6	2.7	2.8	2.9	3.0	3.0	3.1
2000	0.7	0.9	1.0	1.1	1.2	1.3	1.4	1.7	1.9	2.0	2.1	2.2	2.3	2.4	2.4	2.7	2.9	3.0	3.1	3.2	3.3	3.3	3.4
1800	0.9	1.0	1.1	1.3	1.4	1.5	1.6	1.9	2.0	2.1	2.3	2.4	2.5	2.6	2.6	2.9	3.0	3.1	3.3	3.4	3.5	3.5	3.6
1600	1.1	1.2	1.3	1.5	1.6	1.7	1.8	2.1	2.2	2.3	2.5	2.6	2.7	2.8	2.8	3.1	3.2	3.3	3.5	3.6	3.6	3.7	3.8
1400	1.3	1.5	1.6	1.7	1.9	2.0	2.1	2.3	2.5	2.6	2.7	2.9	3.0	3.1	3.1	3.3	3.5	3.6	3.7	3.9	4.0	4.0	4.1
1200	1.7	1.8	1.9	2.1	2.2	2.4	2.5	2.7	2.8	2.9	3.1	3.2	3.4	3.5	3.5	3.7	3.8	3.9	4.1	4.2	4.4	4.4	4.5
1000	2.1	2.3	2.4	2.6	2.7	2.9	3.0	3.1	3.3	3.4	3.6	3.7	3.9	4.0	4.0	4.1	4.3	4.4	4.6	4.7	4.9	4.9	5.0
900	2.4	2.6	2.7	2.9	3.1	3.2		3.4	3.6	3.7	3.9	4.1	4.2		4.4	4.6	4.7	4.9	5.1	5.2			
800	2.7	2.9	3.1	3.3	3.5	3.6		3.7	3.9	4.1	4.3	4.5	4.6		4.7	4.9	5.1	5.3	5.5	5.6			
700	3.2	3.4	3.6	3.8	4.0			4.2	4.4	4.6	4.8	5.0			5.2	5.4	5.6	5.8	6.0				
600	3.8	4.0	4.2	4.4	4.6			4.8	5.0	5.2	5.4	5.6			5.8	6.0	6.2	6.4	6.6				
500	4.6	4.9	5.1	5.3				5.6	5.9	6.1	6.3				6.6	6.9	7.1	7.3					
450	5.2	5.4	5.7					6.2	6.4	6.7					7.2	7.4	7.7						
400	5.9	6.1	6.4					6.9	7.1	7.4					7.9	8.1	8.4						
350	6.8	7.0	7.3					7.8	8.0	8.3					8.8	9.0	9.3						
300	7.9	8.2						8.9	9.2						9.9	10.2							
250	9.6							10.6							11.6								
200	12.0							13.0							14.0								

Source: 2011 AASHTO Greenbook, Table 3 – 26b Calculated and Design values for Traveled Way Widening on Open Highway Curves.

Notes: 1. Values shown are for WB-62 design vehicle and represent widening in feet. For other design vehicles, use adjustments in Table 3-15B.

2. Values less than 2.0 feet may be disregarded, For 3-lane roadways For 3-lane roadways, multiply above values by 1.5.

**Table 3 – 15B Adjustments for Traveled Way Widening Values on Open Highway Curves
 (Two-Lane Highways, One-Way or Two-Way)**

Radius of Curve (FEET)	Design Vehicle						
	SU-30	WB-40				WB-67	WB-67D
7000	-1.2	-1.2				0.1	-0.1
6500	-1.3	-1.2				0.1	-0.1
6000	-1.3	-1.2				0.1	-0.2
5500	-1.3	-1.2				0.1	-0.2
5000	-1.3	-1.3				0.1	-0.2
4500	-1.4	-1.3				0.1	-0.2
4000	-1.4	-1.3				0.1	-0.2
3500	-1.5	-1.4				0.1	-0.3
3000	-1.6	-1.4				0.1	-0.3
2500	-1.7	-1.5				0.2	-0.4
2000	-1.8	-1.6				0.2	-0.5
1800	-1.9	-1.7				0.2	-0.5
1600	-2.0	-1.8				0.2	-0.6
1400	-2.2	-1.9				0.3	-0.6
1200	-2.4	-2.1				0.3	-0.8
1000	-2.7	-2.3				0.4	-0.9
900	-2.8	-2.4				0.4	-1.0
800	-3.1	-2.6				0.5	-1.1
700	-3.4	-2.9				0.6	-1.3
600	-3.8	-3.2				0.7	-1.5
500	-4.3	-3.6				0.8	-1.8
450	-4.7	-3.9				0.9	-2.0
400	-5.2	-4.3				1.0	-2.3
350	-5.8	-4.7				1.1	-2.6
300	-6.6	-5.4				1.3	-3.0
250	-7.7	-6.3				1.6	-3.6
200	-9.4	-7.6				2.0	-4.6

Source: 2011 AASHTO Greenbook, Table 3 - 27 Adjustments for Traveled Way Widening Values on Open Highway Curves.

- Notes:
1. Adjustments are applied by adding to or subtracting from the values in Table 3-15A.
 2. Adjustments depend only on radius and design vehicle; they are independent of traveled way width and design speed.
 3. For 3-lane roadways, multiply above values by 1.5.
 4. For 4-lane roadways, multiply above values by 2.0.

C.5 Vertical Alignment

C.5.a General Criteria

The selection of vertical alignment should be predicated to a large extent upon the following criteria:

- Obtaining maximum sight distances
- Limiting speed differences (particularly for trucks and buses) by reducing magnitude and length of grades
- A "hidden dip" which would not be apparent to the driver must be avoided.
- Steep grades and sharp crest vertical curves should be avoided at or near intersections.
- Flat grades and long gentle vertical curves should be used whenever possible.

C.5.b Grades

The grades selected for vertical alignment should be as flat as practical, and should not be greater than the value given in Table 3 – 16 Maximum Grades in Percent.

For streets and highways requiring long upgrades, the maximum grade should be reduced so the speed reduction of slow-moving vehicles (e.g., trucks and buses) is not greater than 10 mph. The critical lengths of grade for these speed reductions are shown in Figure 3 – 2 Critical Length Versus Upgrade. Where reduction of grade is not practical, climbing lanes should be provided to meet these speed reduction limitations.

The criteria for a climbing lane and the adjacent shoulder are the same as for any travel lane except that the climbing lane should be clearly designated by the appropriate pavement markings. Entrance to and exit from the climbing lane shall follow the same criteria as other merging traffic lanes; however, the climbing lane should not be terminated until well beyond the crest of the vertical curve. Differences in superelevation should not be sufficient to produce a change in pavement cross slope between the climbing lane and through lane in excess of 0.04 feet per foot.

Recommended minimum gutter grades:

Rolling terrain - 0.5% Flat terrain - 0.3%

Table 3 – 16 Maximum Grades (in Percent)

Type of Roadway	Level Terrain											Rolling Terrain											
	Design Speed (mph)											Design Speed (mph)											
	20	25	30	35	40	45	50	55	60	65	70	20	25	30	35	40	45	50	55	60	65	70	
Freeway ¹	---	---	---	---	---	---	4	4	3	3	3	---	---	---	---	---	---	5	5	4	4	4	
Arterial	Rural	---	---	---	---	5	5	4	4	3	3	3	---	---	---	---	6	6	5	5	4	4	4
	Urban	---	---	8	7	7	6	6	5	5	---	---	---	---	9	8	8	7	7	6	6	---	---
Collector ²	Rural	7	7	7	7	7	7	6	6	5	---	---	10	10	9	9	8	8	7	7	6	---	---
	Urban	9	9	9	9	9	8	7	7	6	---	---	12	12	11	10	10	9	8	8	7	---	---
Local ³	Rural	8	7	7	7	7	7	6	6	5	---	---	11	11	10	10	10	9	8	7	6	---	---

Source: 2011 AASHTO Greenbook, Tables 5–2, 6–2, 6–8, 7–2, 7–4, 8–1.

Notes: 1. Grades 1% steeper than the value shown may be provided in urban areas with right of way constraints.

2. Short lengths of grade (≤ 500 feet in length), one-way downgrades, and grades on low volume collectors may be up to 2% steeper than the grades shown above.

3. Residential street grade should be as level as practical, consistent with surrounding terrain, and less than 15%. Streets in commercial or industrial areas should have grades less than 8%, and flatter grades should be encouraged.

Figure 3 – 2 Critical Length Versus Upgrade

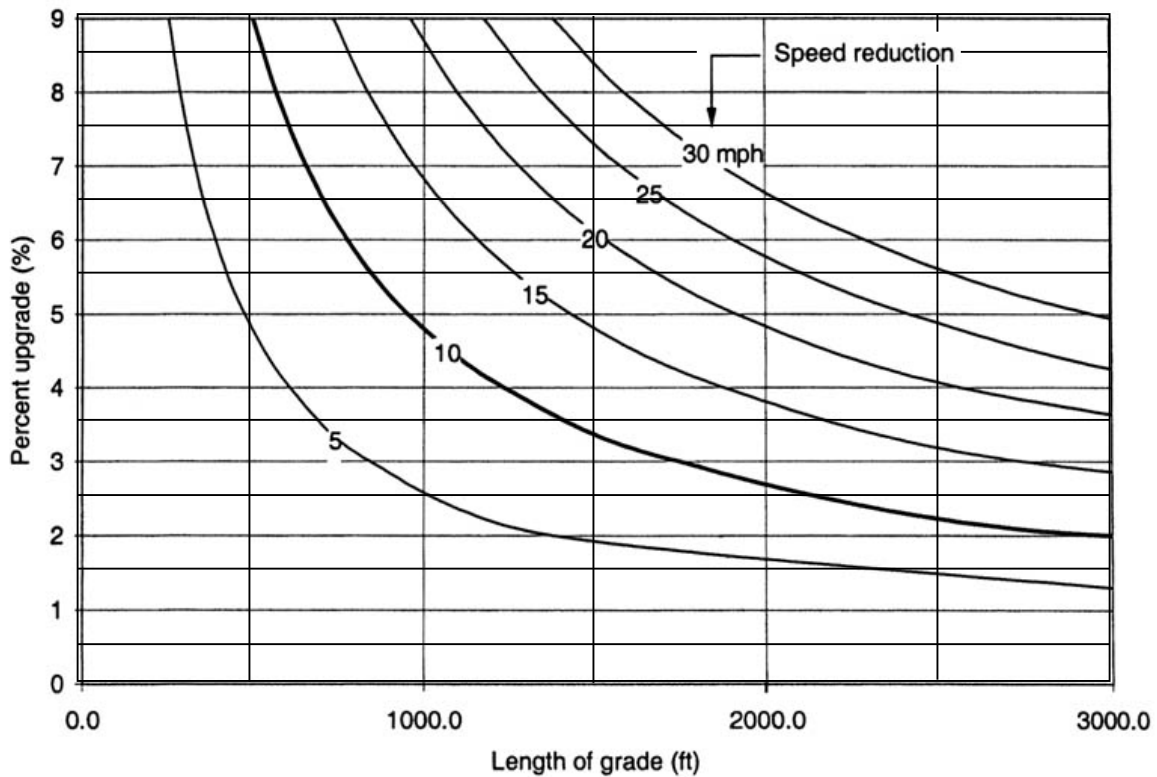

**Critical Lengths of Grade for Design, Assumed Typical Heavy Truck
of 200 lb/hp, Entering Speed = 70 mph**

Source: 2011 AASHTO Greenbook, Figure 3-28.

C.5.c Vertical Curves

Changes in grade should be connected by a parabolic curve (the vertical offset being proportional to the square of the horizontal distance). Vertical curves are required when the algebraic difference of intersecting grades exceeds the values given in Table 3 – 17 Maximum Change in Grade Without Using Vertical Curve. Table 3 – 18 Rounded K Values for Minimum Lengths Vertical Curves provides additional information.

The length of vertical curves on a crest, as governed by stopping sight distance, is obtained from Figure 3 – 3 Length of Crest Vertical Curve (Stopping Sight Distance). The minimum length for passing sight distance on crest vertical curves shall be based on the K-values as shown in Table

3 – 19 Design Controls for Crest Vertical Curves (Passing Sight Distance).
The minimum length of a sag vertical curve on open road conditions, as governed by vehicle headlight capabilities, is obtained from Figure 3 - 4 Length of Sag Vertical Curve (Headlight Sight Distance).

Wherever feasible, curves longer than the minimum should be considered to improve both aesthetic and safety characteristics.

Table 3 – 17 Maximum Change in Grade Without Using Vertical Curve

Design Speed (mph)	20	25	30	35	40	45	50	55	60	65	70
Maximum Change in Grade in Percent	1.20	1.10	1.00	0.90	0.80	0.70	0.60	0.50	0.40	0.30	0.20

**Table 3 – 18Rounded K Values for Minimum Lengths Vertical Curves
 (Stopping Sight Distance)**

(Based upon an eye height of 3.50 feet and an object height of 2 feet above the road surface)											
$L = KA$ L = Length of Vertical Curve, A = Algebraic Difference of Grades in Percent											
Design Speed (mph)	20	25	30	35	40	45	50	55	60	65	70
K Values for Crest Vertical Curves	7	12	19	29	44	61	84	114	151	193	247
K Values for Sag Vertical Curves	17	26	37	49	64	79	96	115	136	157	181
<ul style="list-style-type: none"> • The length of vertical curve must never be less than three times the design speed of the highway. • Curve lengths computed from the formula $L = KA$ should be rounded upward when feasible. • The minimum lengths of vertical curves to be used on collectors, arterials and freeways are shown in the table below: 											
Minimum Lengths for Vertical Curves on Collectors, Arterials, and Freeways (feet)											
Design Speed (mph)							50	60	70		
Crest Vertical Curves (feet)							300	400	500		
Sag Vertical Curves (feet)							200	300	400		

Figure 3 – 3 Length of Crest Vertical Curve (Stopping Sight Distance)

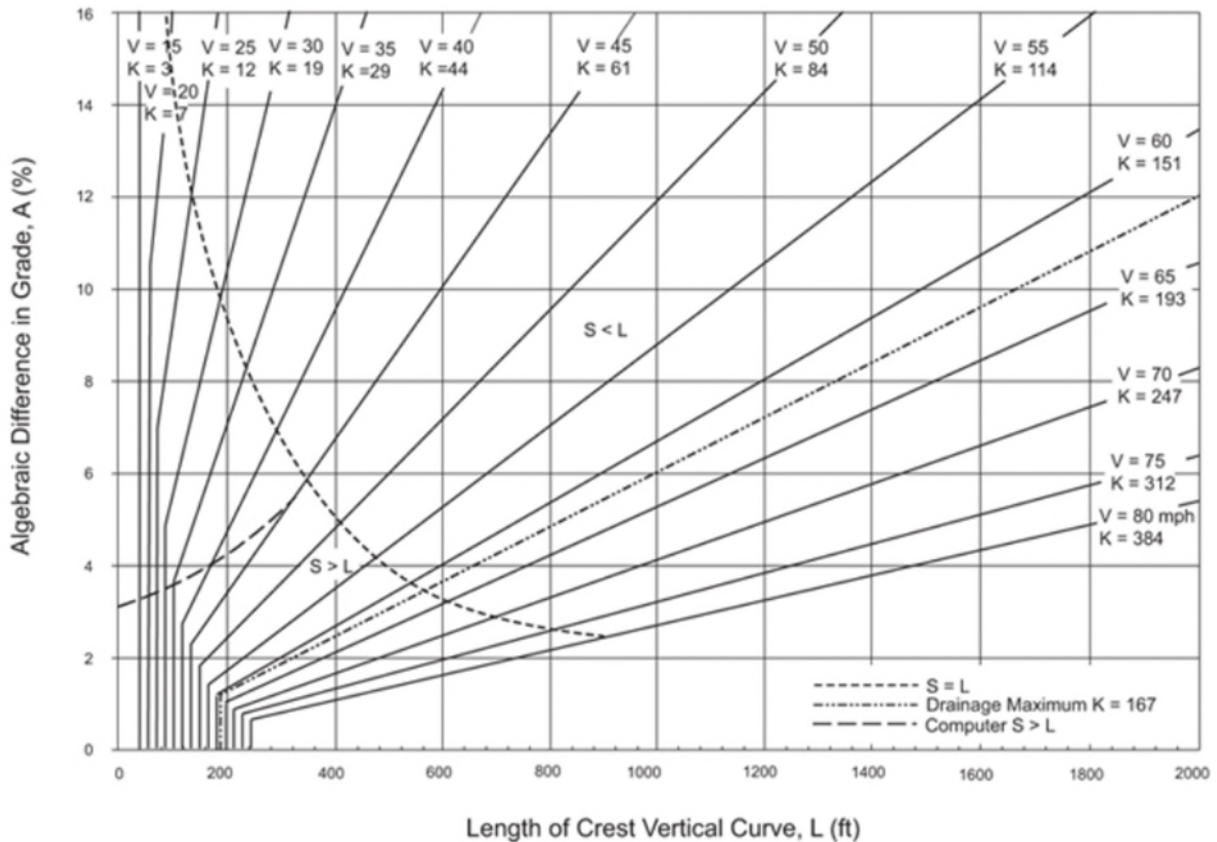

Source: Figure 3-43 Design Controls for Crest Vertical Curves – Open Road Conditions, 2011 AASHTO Greenbook

Lengths of crest vertical curves are computed from the formulas:

When S is less than L, $L=AS^2/2158$

When S is greater than L, $L=2S - (2158/A)$

- A = Algebraic Difference In Grades In Percent
- S = Sight Distance
- L = Minimum Length of Vertical Curve In Feet

**Table 3 – 19 Design Controls for Crest Vertical Curves
 (Passing Sight Distance)**

Based upon an eye height of 3.50 feet and an object height of 3.5 feet above the road surface.)		
$L = KA$ L = Length of Vertical Curve, A = Algebraic Difference of Grades in Percent		
Design Speed (mph)	Passing Sight Distance (feet)	Rate of Vertical Curvature, K ^a
20	400	57
25	450	72
30	500	89
35	550	108
40	600	129
45	700	175
50	800	229
55	900	289
60	1000	357
65	1100	432
70	1200	514
^a Rate of vertical curvature, K, is the length of curve per percent algebraic difference in intersecting grades (A), $K = L/A$.		

Source: Table 3-35 Design Controls for Crest Vertical Curves Based on Passing Sight Distance, 2011 AASHTO Greenbook.

For further information on both crest and sag vertical curves, see Section 3.4.6 Vertical Curves of the [AASHTO Greenbook \(2011\)](#).

Figure 3 – 4 Length of Sag Vertical Curve (Open Road Conditions)

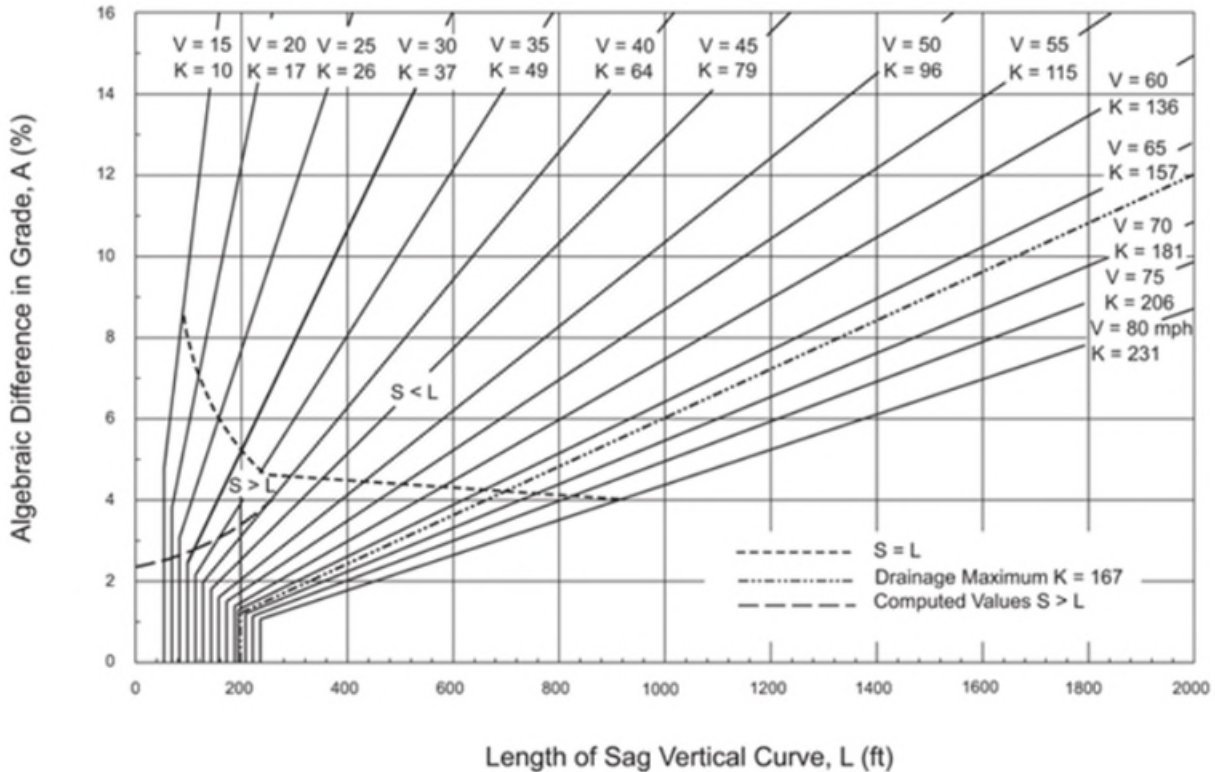

Source: Figure 3-44 Design Controls for Sag Vertical Curves – Open Road Conditions, 2011 AASHTO Greenbook.

Lengths of sag vertical curves are computed from the formulas:

When S is less than L, $L = AS^2 / (400 + 3.5S)$

When S is greater than L, $L = 2S - ((400 + 3.5S) / A)$

- L = Length of Sag Vertical Curve, feet
- A = Algebraic Difference in Grades, percent
- S = Light Beam Distance, feet

C.6 Alignment Coordination

Horizontal and vertical alignment should not be designed independently. Poor combinations can spoil the good points of a design. Properly coordinated horizontal and vertical alignment can improve appearance, enhance community values, increase safety, and encourage uniform speed. Coordination of horizontal and vertical alignment should begin with preliminary design, during which stage adjustments can be readily made.

Proper combinations of horizontal alignment and profile can be obtained by engineering study and consideration of the following general controls:

- Curvature and grades should be in proper balance. Tangent alignment or flat curvature with steep grades and excessive curvature with flat grades are both poor design. A logical design is a compromise between the two conditions. Wherever feasible the roadway should "roll with" rather than "buck" the terrain.
- Vertical curvature superimposed on horizontal curvature, or vice versa, generally results in a more pleasing facility, but it should be analyzed for effect on driver's view and operation. Changes in profile not in combination with horizontal alignment may result in a series of disconnected humps to the driver for some distance.
- Sharp horizontal curvature should not be introduced at or near the top of a pronounced crest vertical curve. Drivers cannot perceive the horizontal change in alignment, especially at night. This condition can be avoided by setting the horizontal curve so it leads the vertical curve or by making the horizontal curve longer. Suitable design can be made by using design values well above the minimums.
- Sharp horizontal curvature should not be introduced at or near the low point of a pronounced sag vertical curve to prevent an undesirable distorted appearance. Vehicle speeds are often high at the bottom of grades and erratic operation may result, especially at night.
- On divided highways, variation of the median width and the use of independent vertical and horizontal alignment should be considered. Where right of way is available, a superior design without significant additional costs can result from the use of independent alignment.
- Horizontal alignment and profile should be made as flat as possible at interchanges and intersections where sight distance along both highways is important. Sight distances above the minimum are desirable at these locations.

- Alignment should be designed to enhance scenic views for the motorists.
- In residential areas, the alignment should be designed to minimize nuisance to the neighborhood.

C.7 Cross Section Elements

The design of the street or highway cross section should be predicated upon the design speed, terrain, adjacent land use, classification, and the type and volume of traffic expected. The cross section selected should be uniform throughout a given length of street or highway without frequent or abrupt changes. See **Chapter 4 – Roadside Design** for design criteria for roadside design, clear zone, lateral offset, and roadside ditches located within the clear zone.

C.7.a Number of Lanes

The number of travel lanes is determined by several interrelated factors such as capacity, level of service, and service volume. Further information on determining the optimum number of travel lanes can be found in [A Policy on Geometric Design of Highways and Streets \(AASHTO, 2011\)](#), and the [Highway Capacity Manual \(TRB, 2010\)](#).

C.7.b Pavement

The paved surface of roadways shall be designed and constructed in accordance with the requirements set forth in **Chapter 5 - Pavement Design and Construction**.

C.7.b.1 Pavement Width

Minimum lane widths for travel lanes, speed change lanes, turn lanes and passing lanes are provided in Table 3 – 20 Minimum Lane Widths. The table applies to both divided and undivided facilities. For Information on parking lanes, see Section C.7.h Parking of this Chapter.

On existing multilane curbed streets where there is insufficient space for a separate bicycle lane, consideration should be given to using unequal-width lanes. In such cases, the wider lane is located on the outside (right). This provides more space for large vehicles that usually occupy that lane, provides more space for bicycles, and allows drivers to keep their vehicles at a greater distance from the right edge. See **Chapter 9 – Bicycle Facilities**.

Table 3 – 20 Minimum Lane Widths

Facility		ADT (vpd)	Design Speed (mph)	Lane Width – (feet)		
				Travel Lanes ¹	Turn Lanes ⁶ (LT/RT/MD)	Passing Lanes
Freeway	Rural	All	All	12	--	--
	Urban	All	All	12	--	--
Arterial	Rural	All	All	12 ⁹	12 ⁹	12 ⁹
	Urban	All	≥ 50	12	12	12
		All	≤ 45	11 ^{3, 4}	11 ^{3, 4, 7}	11 ^{3, 4}
Collector	Rural	> 1500	All	12 ⁹	12 ⁹	12 ⁹
		401 to 1500	All	11 ^{3, 4}	11 ^{3, 4}	--
		≤ 400	≥ 50	11	11 ⁷	--
	≤ 45		10	10	--	
	Urban	All	All	11 ^{2, 3, 4}	11 ^{2, 7}	--
Local	Rural	> 1500	All	12 ⁹	12 ⁹	12 ⁹
		401 to 1500	All	11 ^{3, 4}	11 ^{3, 4}	--
		≤ 400	≥ 55	11 ³	11 ^{3, 4}	--
			45 to 50	10	10	--
			≤ 40	9	9	--
	Urban	All	All	10 ^{2, 5}	10 ⁸	--
See Footnotes on next page						

Footnotes

1. A minimum traveled way width equal to the width of two adjacent travel lanes (one way or two way) shall be provided on all rural facilities.
2. In industrial areas and where truck volumes are significant, 12' lanes should be provided, but may be reduced to 11' where right of way is constrained.
3. In constrained areas where truck volumes are low and design speeds are \leq 35 mph, 10' lanes may be used.
4. On roadways with a transit route, a minimum of 11' outside lane width is required.
5. In residential areas where right of way is severely limited, 9' may be used.
6. Turn lane width in raised or grass medians shall not exceed 14'. Two-way left turn lanes should be 11 – 14' wide and may only be used on 3- and 5-lane typical sections with design speeds \leq 40 mph. On projects with right of way constraints, the minimum width may be reduced to 10'. Two-way left turn lanes shall include sections of raised or restrictive median for pedestrian refuge.
7. Turn Lane width should be same as Travel Lane width. May be reduced to 10' where right of way is constrained.
8. Turn Lane width should be same as Travel Lane width. May be reduced to 9' where truck volumes are low.
9. For design speeds below 50 mph, lane widths of 11 feet are acceptable.

C.7.b.2 Traveled Way Cross Slope (not in superelevation)

The selection of traveled way cross slope should be a compromise between meeting the drainage requirements and providing for smooth vehicle operation. The recommended traveled way cross slope is 0.02 feet per foot. When three lanes in each direction are necessary, the outside lane should have a cross slope of 0.03 feet per foot. The cross slope shall not be less than 0.015 feet per foot or greater than 0.04 feet per foot. The change in cross slope between adjacent through travel lanes should not exceed 0.04 feet per foot.

C.7.c Shoulders

The primary functions of a shoulder are to provide emergency parking for disabled vehicles and an alternate path for vehicles during avoidance or other emergency maneuvers. In order to fulfill these functions satisfactorily, the shoulder should have adequate stability and surface characteristics. The design and construction of shoulders shall be in accordance with the requirements given in **Chapter 5 - Pavement Design and Construction**.

Shoulders should be provided on all streets and highways incorporating open drainage. The absence of a contiguous emergency travel or storage lane is not only undesirable from a safety standpoint, but also is disadvantageous from an operations viewpoint. Disabled vehicles that must stop in a through lane impose a severe safety hazard and produce a dramatic reduction in traffic flow. Shoulders should be free of abrupt changes in slope, discontinuities, soft ground, or other hazards that would prevent the driver from retaining or regaining vehicle control.

Paved outside shoulders are required for rural high speed multilane highways and freeways. They provide added safety to the motorist, public transit and pedestrians, for accommodation of bicyclists, reduced shoulder maintenance costs, and improved drainage.

C.7.c.1 Shoulder Width

A shoulder is the portion of the roadway contiguous with the traveled way that accommodates stopped vehicles, emergency use, and provides lateral support of subbase, base and surface courses. In some cases, the shoulder may also accommodate pedestrians or bicyclists. Shoulders may be surfaced either full or partial width and include turf, gravel, shell, and asphalt or concrete pavements.

The minimum width of outside and median shoulders is provided in Table 3 – 21 Minimum Shoulder Widths for Flush Shoulder Highways. Shoulders for two-lane, two-way highways are based upon traffic volumes. Shoulder widths for multi-lane highways are based upon the number of travel lanes in each direction. Where bicyclists or pedestrians are to be accommodated on the shoulder, a minimum usable width of 4 feet is required (5 feet if adjacent to a barrier). On approaches to narrow bridges where the paved shoulder is reduced, the [FDOT's ~~the Department's Standard Plans Index 700-106~~](#) provide information on signing and marking the approaching

shoulder.

Table 3 – 21 Minimum Shoulder Widths for Flush Shoulder Highways

Two Lane Undivided

Design Speed (mph)	Average Daily Traffic (2 – Way)		
	0 - ≤400	401 - 750	>750 -
All	2 feet	6 feet	8 feet

Multilane Divided

Number of Lanes Each Direction	Shoulder Width (feet)			
	Outside		Median	
	Roadway	Bridge	Roadway	Bridge
2	8 (min.)	8	4 (min.)	4
3 or more	10 (min.)	10	6 (min.)	6

C.7.c.2 Shoulder Cross Slope

The shoulder serves as a continuation of the drainage system; therefore, the shoulder cross slope should be somewhat greater than the adjacent traffic lane. The cross slope of shoulders should be within the range given in Table 3 – 22 Shoulder Cross Slope.

Table 3 – 22 Shoulder Cross Slope

	Shoulder Type		
	Paved	Gravel or Crushed Rock	Turf
Shoulder Cross Slope (Percent)	2 to 6%	4 to 6%	6 to 8%

Notes: 1. Existing shoulder cross slope (paved and unpaved) \leq 12% may remain.

Source – 2011 AASHTO Greenbook, Section 4.4.3 Shoulder Cross Sections.

Whenever possible, shoulders should be sloped away from the traveled way to aid in their drainage. The combination of shoulder cross slope and texture should be sufficient to promote rapid drainage and to avoid retention of surface water. The maximum algebraic difference between the traveled way and adjacent shoulder should not be greater than 0.07 feet per foot. Shoulders on the outside of superelevated curves should be rounded (vertical curve) to avoid an excessive break in cross slope and to divert a portion of the drainage away from the adjacent traveled way.

C.7.d Sidewalks and Shared Use Paths

The design of sidewalks is affected by many factors, including traffic characteristics, pedestrian volume, roadway type, and other design elements. **Chapter 8 - Pedestrian Facilities** and Chapter 9 – Bicycle Facilities of this Manual and A Policy on Geometric Design of Highways and Streets (AASHTO, 2011), present the various factors that influence the design of sidewalks and other pedestrian facilities.

Sidewalks and/or shared use paths should be constructed in conjunction with new construction and major reconstruction in or within one mile of an urban area. As a general rule, sidewalks should be constructed on both sides of the roadway. Exceptions may be made where physical barriers (e.g., a canal paralleling one side of the roadway) would substantially reduce the expectation of pedestrian use of one side of the roadway. Also, if only one side is possible, sidewalks should be available on the same side of the road as transit stops or other pedestrian generators.

The decision to construct a sidewalk or shared use path in a rural area should be based on engineering judgment, after observation of existing pedestrian traffic or ~~and~~ expectation of additional demand. ~~should a sidewalk be made available.~~

Sidewalks and shared use paths shall be constructed as defined in this Manual. **Chapter 8 – Pedestrian Facilities, Chapter 10 – Maintenance and Resurfacing** and **Section C.10.a.3 – Sidewalks and Curb Ramps** of this chapter provide additional detailed information. **AASHTO’s Guide for the Planning, Design and Operation of Pedestrian Facilities (2004)**, and **Section 4.17.1 Sidewalks of AASHTO’s Policy on Geometric Design of Highways and Streets (2011)** provide additional information.

The [Highway Capacity Manual, Volume 3, Chapter 23, Off-Street Pedestrian and Bicycle Facilities \(2010\)](#) includes further information on how optimal widths can be determined.

~~Curb ramps shall be provided at all intersections with curb (**Section 336.045 (3), Florida Statutes**). In addition to the design criteria provided in this chapter, the **2006 Americans with Disabilities Act Standards for Transportation Facilities** as required by 49 C.F.R. 37.41 or 37.43 and the **2012 Florida Accessibility Code for Building Construction** as required by 61G20-4.002 impose additional requirements for the design and construction of pedestrian facilities.~~

C.7.e Medians

Median separation of opposing traffic lanes provides a beneficial safety feature and should be used wherever feasible. Separation of the opposing traffic also reduces the problem of headlight glare, thus improving safety and comfort for night driving. When sufficient width of medians is available, some landscaping is also possible.

The use of medians often aids in the provision of drainage for the roadway surface, particularly for highways with six or more traffic lanes. The median also provides a vehicle refuge area, improves the safety of pedestrian crossings, provides a logical location for left turn auxiliary lanes, and provides the means for future addition of traffic lanes and mass transit. In many situations, the median strip aids in roadway delineation and the overall highway aesthetics.

Median separation is required on the following streets and highways:

- Freeways
- All streets and highways, rural and urban, with 4 or more travel lanes and with a design speed of 40 mph or greater

Median separation is desirable on all other multi-lane roadways to enhance pedestrian crossings.

The nature and degree of median separation required is dependent upon the design speed, traffic volume, adjacent land use, and the frequency of access. There are basically two approaches to median separation. The first is the use of horizontal separation of opposing lanes to reduce the probability of vehicles crossing the median into incoming traffic. The second method is to attempt to limit crossovers by introducing a positive median barrier structure.

In rural areas, the use of wide medians is not only aesthetically pleasing, but is often more economical than barriers. In urban areas where space and/or economic constraints are severe, the use of barriers is permitted to fulfill the requirements for median separation.

Uncurbed medians should be free of abrupt changes in slope, discontinuities, soft ground, or other hazards that would prevent the driver from retaining or regaining control of the vehicle. Consideration should be given to increasing the width and decreasing the slope of medians on horizontal curves. The requirements for a hazard free median environment are given in **Chapter 4 - Roadside Design**, and shall be followed in the design and construction of medians.

C.7.e.1 Type of Median

A wide, gently depressed median is the preferred design. This type

allows a reasonable vehicle recovery area and aids in the drainage of the adjacent shoulders and travel lanes. Where space and drainage limitations are severe, narrower medians, flush with the roadway, or raised medians, are permitted. Raised medians should be used to support pedestrian crossings of multi-laned streets and highways.

C.7.e.2 Median Width

The median width is defined as the horizontal distance between the inside (median) edge of travel lanes of the opposing roadways. The selection of the median width for a given type of street or highway is primarily dependent on design speed and traffic volume. Since the probability of crossover crashes is decreased by increasing the separation, medians should be as wide as practicable. Median widths in excess of 30 feet to 35 feet reduce the problem of disabling headlight glare from opposing traffic.

The minimum permitted widths of freeway medians are given in Table 3 – 23 Minimum Median Width. Where the expected traffic volume is heavy, the widths should be increased over these minimum values. Median barriers shall be used on freeways when these minimum values are not attainable.

The minimum permitted median widths for multi-lane rural highways are also given in Table 3 – 23 Minimum Median Width. On urban streets, the median widths shall not be less than the values given in Table 3 – 23. Where median openings or access points are frequent, the median width should be increased.

The minimum median widths given in these Tables may have to be increased to meet the requirements for cross slopes, drainage, and turning movements (C.9 Intersection Design, this chapter). The median area should also include adequate additional width to allow for expected additions of through lanes and left turn lanes. Where the median width is sufficient to produce essentially two separate, independent roadways, the left side of each roadway shall meet the requirements for roadside clear zone. Changes in the median width should be accomplished by gently flowing horizontal alignment of one or both of the separate roadways.

Table 3 – 23 Minimum Median Width

Type of Facility	Width (feet)
Freeways	
Freeways, Without Barrier	---
Design Speed \geq 60 mph	60
Design Speed $<$ 60 mph	40
All, With Barrier, All Design Speeds	26 ¹
Arterial and Collectors	
Design Speed \geq 50 mph	40
Design Speed \leq 45 mph	22 ²
Paved and Painted for Left Turns	See Table 3 – 20 Minimum Lane Widths
<p>Median width is the distance between the inside (median) edge of the travel lane of each roadway.</p> <p>Footnotes:</p> <ol style="list-style-type: none"> 1. Based on 2 ft. wide, concrete median barrier and 12 ft. shoulder. 2. On projects where right of way is constrained, the minimum width may be reduced to 19.5 ft. for design speeds = 45 mph, and to 15.5 ft. for design speeds \leq 40 mph. 	

C.7.e.3 Median Slopes

A vehicle should be able to transverse a median without turning over and with sufficient smoothness to allow the driver a reasonable chance to control the vehicle. The transition between the median slope and the shoulder (or pavement) slope should be smooth, gently rounded, and free from discontinuities.

The median cross slope should not be steeper than 1:6 (preferably not steeper than 1:10). The depth of depressed medians may be controlled by drainage requirements. Increasing the width of the median, rather than increasing the cross slope, is the proper method for developing the required median depth.

Longitudinal slopes (median profile parallel to the roadway) should be shallow and gently rounded at intersections of grade. The longitudinal slope, relative to the roadway slope, shall not exceed a ratio of 1:10 and preferably 1:20. The change in longitudinal slope shall not exceed 1:8 (change in grade of 12.5 %).

C.7.e.4 Median Barriers

See **Chapter 4 – Roadside Design** for criteria on median barriers. The **AASHTO Roadside Design Guide** provides additional information and guidelines on the use of median barriers.

C.7.f Islands

An island is a defined area between traffic lanes used for control of vehicle movements. Most islands combine two or more of these primary functions:

1. Channelization — To control and direct traffic movement, usually turning.
2. Division — To divide opposing or same direction traffic streams, usually through movements; and
3. Refuge — To provide refuge for pedestrians.

Islands generally are either elongated or triangular in shape and situated in areas unused for vehicle paths. Islands should be located and designed to offer little obstruction to vehicles and be commanding enough that motorists

will not drive over them. The placement of mast arms in channelizing islands is discouraged. Mast arms are not permitted in median islands.

The dimensions and details depend on the intersection design as illustrated in Figure 3 – 5 General Types and Shapes of Islands and Medians. They should conform to the general principles that follow.

Figure 3 – 5 General Types and Shapes of Islands and Medians

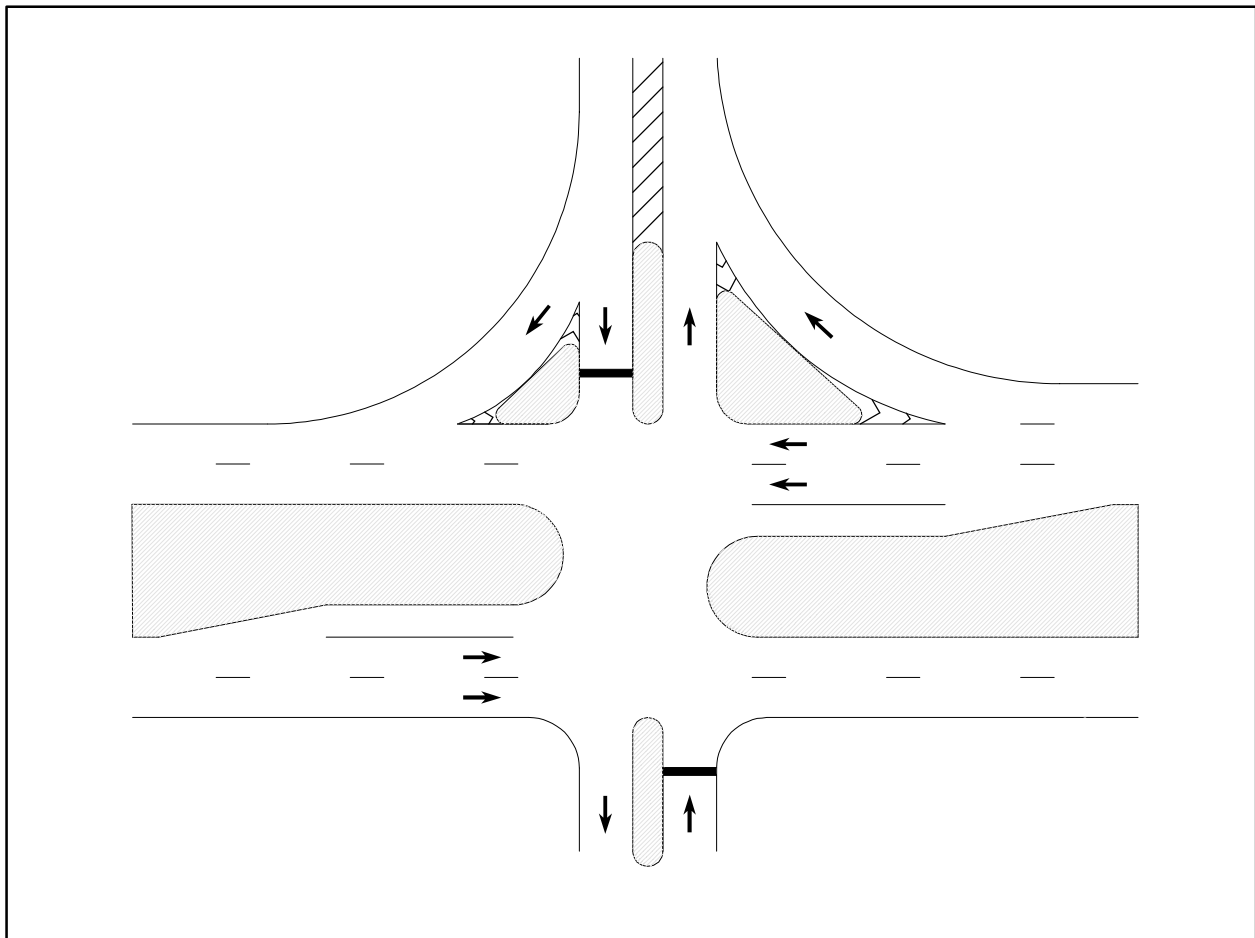

Curbed islands are sometimes difficult to see at night. Where curbed islands are used, the intersection should have fixed-source lighting or appropriate delineation. Under certain conditions, painted, flush medians and islands or traversable type medians may be preferable to the raised curb type islands. These conditions include the following:

- Lightly developed areas that will not be considered for access management.
- Intersections where approach speeds are relatively high.
- Areas where there is little pedestrian traffic.
- Areas where fixed-source lighting is not provided.
- Median or corner islands where signals, signs, or luminaire supports are not needed; and
- Areas where extensive development exists and may demand left-turn lanes into many entrances.

Painted islands may be used at the traveled way edge. At some intersections, both curbed and painted islands may be desirable. All pavement markings should be reflectorized. The use of thermoplastic striping, raised dots, spaced and raised retroreflective markers, and other forms of long-life markings also may be desirable. See **Section 9.6.3** of the [2011 AASHTO Greenbook](#) and the [MUTCD, Part 3](#) for additional information on the design and marking of islands.

The central area of large channelizing islands in most cases has a turf or other vegetative cover. As space and the overall character of the highway determine, low plant material may be included, but it should not obstruct sight distance. Ground cover or plant growth, such as turf, vines, and shrubs, can be used for channelizing islands and provides excellent contrast with the paved areas, assuming ~~that~~ the ground cover is cost-effective and can be properly maintained. The [Index 546 of The Department FDOT Design Manual, Chapter 212 Intersections Design Standards](#) provides additional information on designing landscaping in medians or at intersections.

Small, curbed islands may be mounded, but where pavement cross slopes are outward, large islands should be depressed to avoid draining water across the pavement. For small, curbed islands and in areas where growing conditions are not favorable, some type of paved surface may be used on the island.

Careful consideration should be given to the location and type of plantings. Plantings, particularly in narrow islands, may create problems for maintenance activities. Plantings and other landscaping features in channelization areas may constitute roadside obstacles and should be consistent with the requirements in Section C.9.b Sight Distance. The [AASHTO Roadside Design Guide \(2011\)](#) provides additional information on landscaping of islands.

C.7.f.1 Channelizing Islands

Channelizing islands may be of many shapes and sizes, depending on the conditions and dimensions of the intersection. A common form is the corner triangular shape that separates right-turning traffic from through traffic. Central islands may serve as a guide around which turning vehicles operate.

Channelizing islands should be placed so that the proper course of travel is immediately obvious, easy to follow, and of unquestionable continuity. Where islands separate turning traffic from through traffic, the radii of curved portions should equal or exceed the minimum for the turning speeds expected. Curbed islands generally should not be used in rural areas and at isolated locations unless the intersection is lighted and curbs are delineated.

Islands should be sufficiently large to command attention, with 100 ft² preferred. The smallest curbed corner island should have an area of at least 50 ft² for urban and 75 ft² for rural intersections. A corner triangular island should be at least 15 feet on a side (12 ft. minimum) after the rounding of corners.

While mast arms are discouraged in channelizing islands, when they are used the minimum lateral offset as shown in Chapter 4, Roadside Design Table 4 – 2 Lateral Offset shall be provided. Mast arm foundation diameters vary from 3.5 feet to 5.0 feet. The minimum

lateral offset for 45 mph and less should be based on minimum offset to a hazard from curb face – 4 feet standard, 1.5 feet absolute minimum.

Details of curbed corner island designs used in conjunction with turning roadways are shown in Figures 3 – 6 Channelization Island for Pedestrian Crossings (Curbed), 3 – 7 Details of Corner Island for Turning Roadways (Curbed) and 3 – 8 Details of Corner Island for Turning Roadways (Flush Shoulder). The approach corner of each curbed island is designed with an approach nose treatment.

Further information on the pavement markings that can be used with islands can be found in ~~of the Department~~ the [FDOT's *Standard Plans, Index 711-001*](#).

Figure 3 – 6 Channelization Island for Pedestrian Crossings (Curbed)

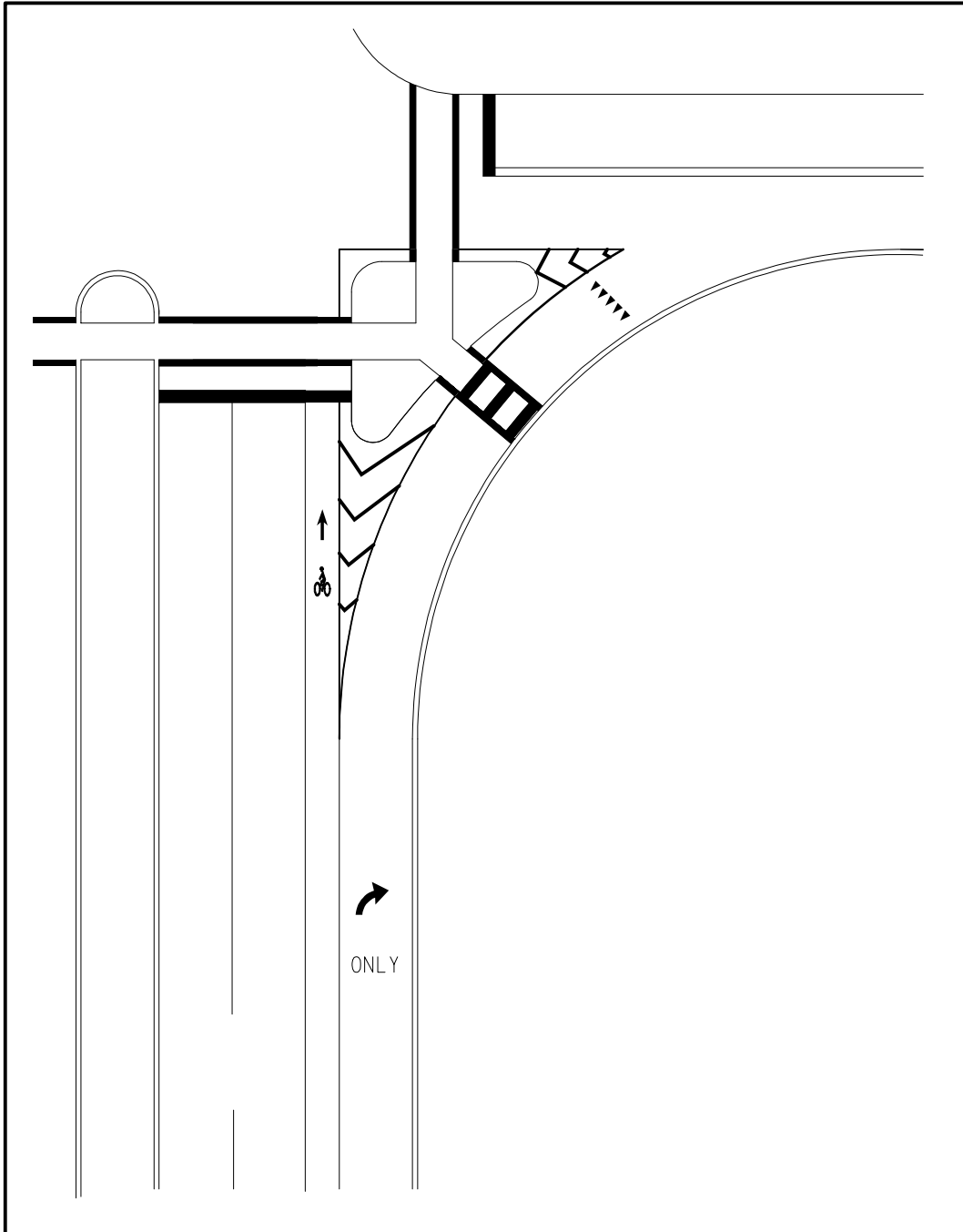

Figure 3 – 7 Details of Corner Island for Turning Roadways (Curbed)

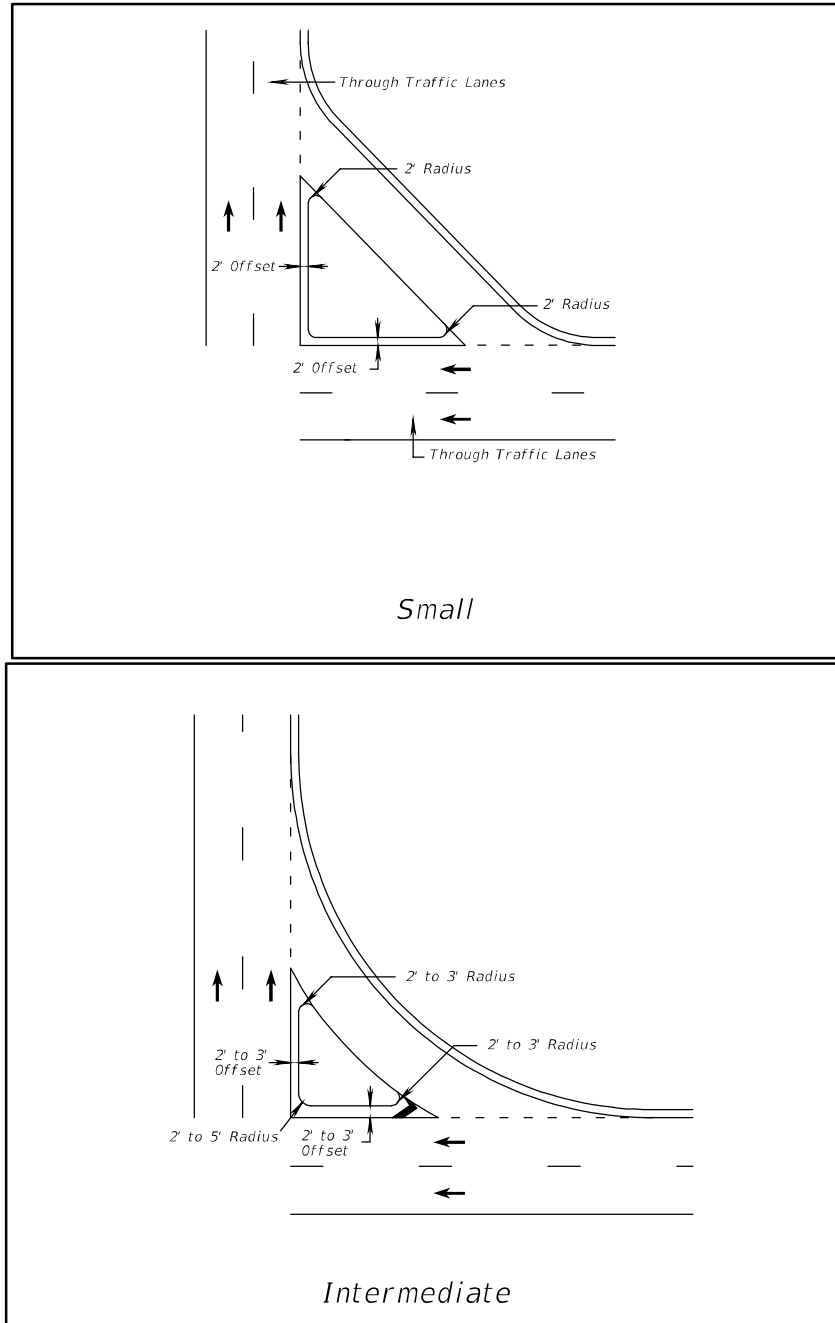
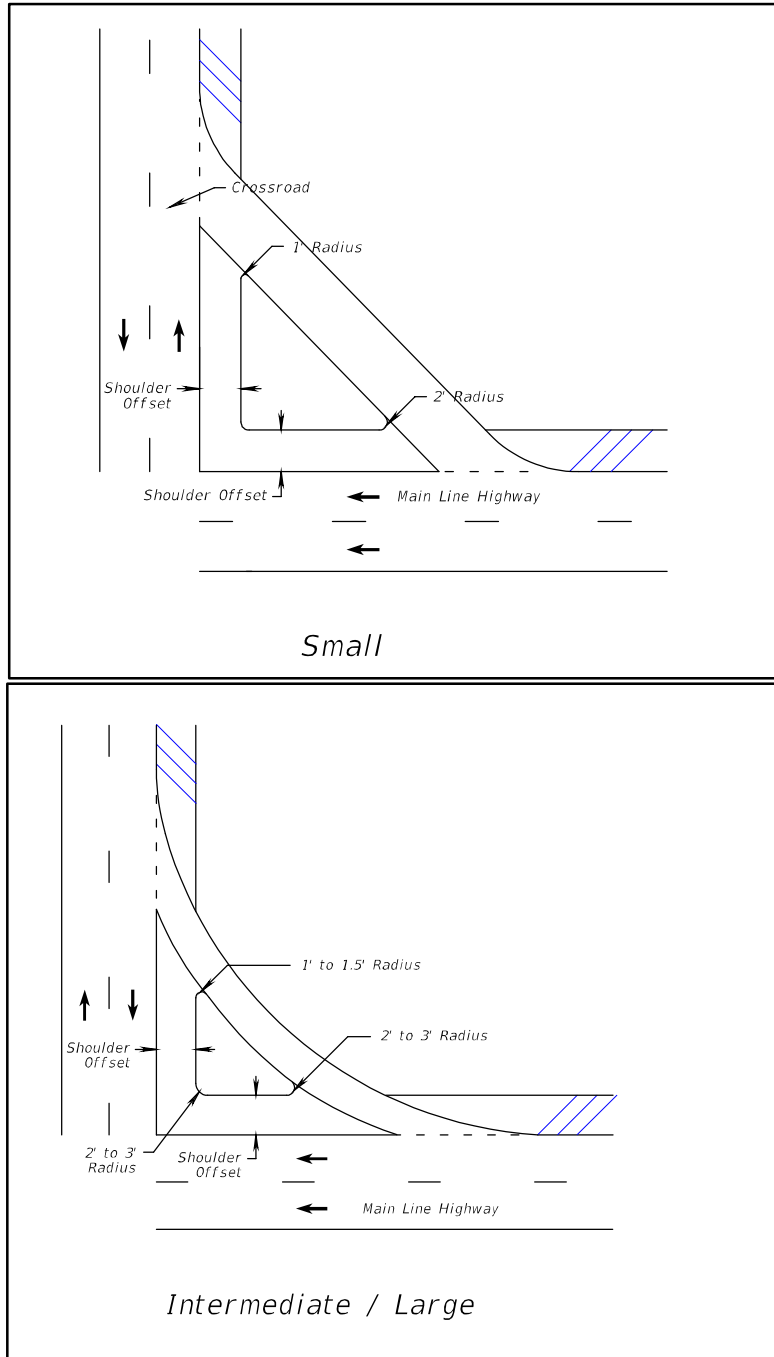

Figure 3 – 8 Details of Corner Island for Turning Roadways (Flush Shoulder)



C.7.f.2 Divisional Islands

Divisional islands often are introduced on undivided highways at intersections. They alert drivers to the crossroad ahead and regulate traffic through the intersection. These islands are particularly advantageous in controlling left turns at skewed intersections and at locations where separate roadways are provided for right-turning traffic.

Widening a roadway to include a divisional island should be done in such a manner that the proper paths to follow are unmistakably evident to drivers. The alignment should require no appreciable conscious effort in vehicle steering.

Elongated or divisional islands should be not less than 4 feet wide and 20 to 25 feet long. In general, introducing curbed divisional islands at isolated intersections on high-speed highways is undesirable unless special attention is directed to providing high visibility for the islands. Curbed divisional islands introduced at isolated intersections on high-speed highways should be 100 feet or more in length. When situated in the vicinity of a high point in the roadway profile or at or near the beginning of a horizontal curve, the approach end of the curbed island should be extended to be clearly visible to approaching drivers.

Where an island is introduced at an intersection to separate opposing traffic on a four-lane road or on a major two-lane highway carrying high volumes, two full lanes should be provided on each side of the dividing island (particularly where future conversion to a wider highway is likely). In other instances, narrower roadways may be used. For moderate volumes, roadway widths shown under Case II (one-lane, one-way operation with provision for passing a stalled vehicle) in Table 3 – 34 Derived Pavement Widths for Turning Roadways for Different Design Vehicles are appropriate. For light volumes and where small islands are needed, widths on each side of the island corresponding to Case I in Table 3 – 34 may be used.

Figure 3 – 9 Alignment for Divisional Islands at Intersections

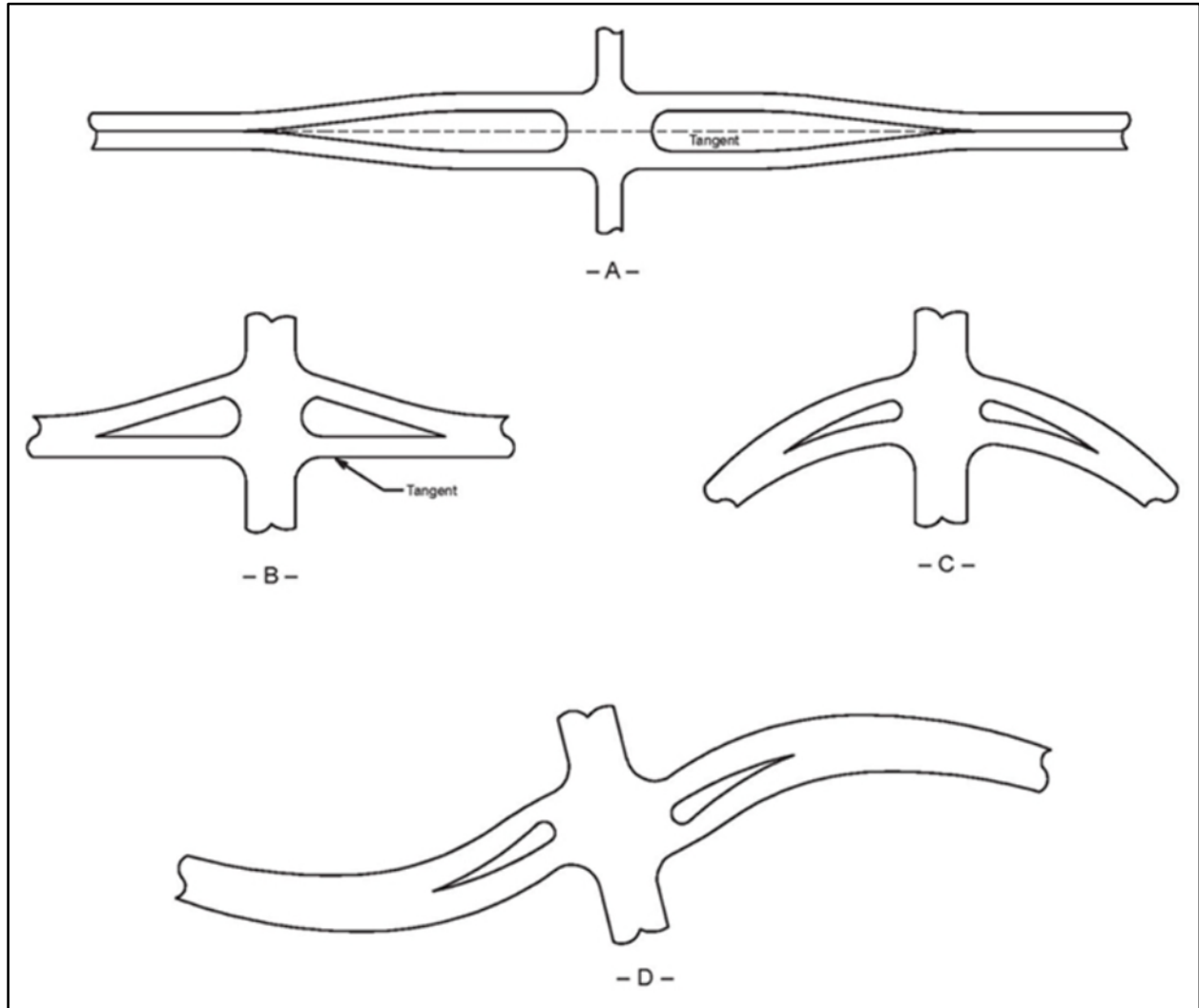

C.7.f.3 Refuge Islands

A refuge island for pedestrians at or near a crosswalk or shared use path crossing aids pedestrians and bicyclists who cross the roadway. Raised-curb corner islands and center channelizing or divisional islands can be used as refuge areas. Refuge islands for pedestrians and bicyclists crossing a wide street, for loading or unloading transit riders, or for wheelchair ramps are used primarily in urban areas. Figure 3 – 10 Pedestrian Refuge Island, Figure 3 – 11 Pedestrian Crossing with Refuge Island (Yield Condition), and Figure 3 – 12

Pedestrian Crossing with Refuge Island (Stop Condition) show divisional islands that support a midblock crosswalk with stop and yield conditions. The distance A shown in the figures is based upon the [MUTCD](#), and shown following the figures.

The location and width of crosswalks, the location and size of transit loading zones, and the provision of curb ramps influence the size and location of refuge islands. Refuge islands should be a minimum of 6 feet wide. Pedestrians and bicyclists should have a clear path through the island and should not be obstructed by poles, sign posts, utility boxes, etc. Sidewalk and shared use path curb ramps in islands shall meet the requirements found in **Section C.10.a.3** of this chapter and **Chapter 8 – Pedestrian Facilities**. Curb ramps that are part of a shared use path shall also meet the requirements of **Chapter 9 – Bicycle Facilities**.

Figure 3 – 10 Pedestrian Refuge Island



Figure

3—10—Pedestrian Refuge Island

North Main Street, Gainesville, FL

Figure 3 – 11 Pedestrian Crossing with Refuge Island (Yield Condition)

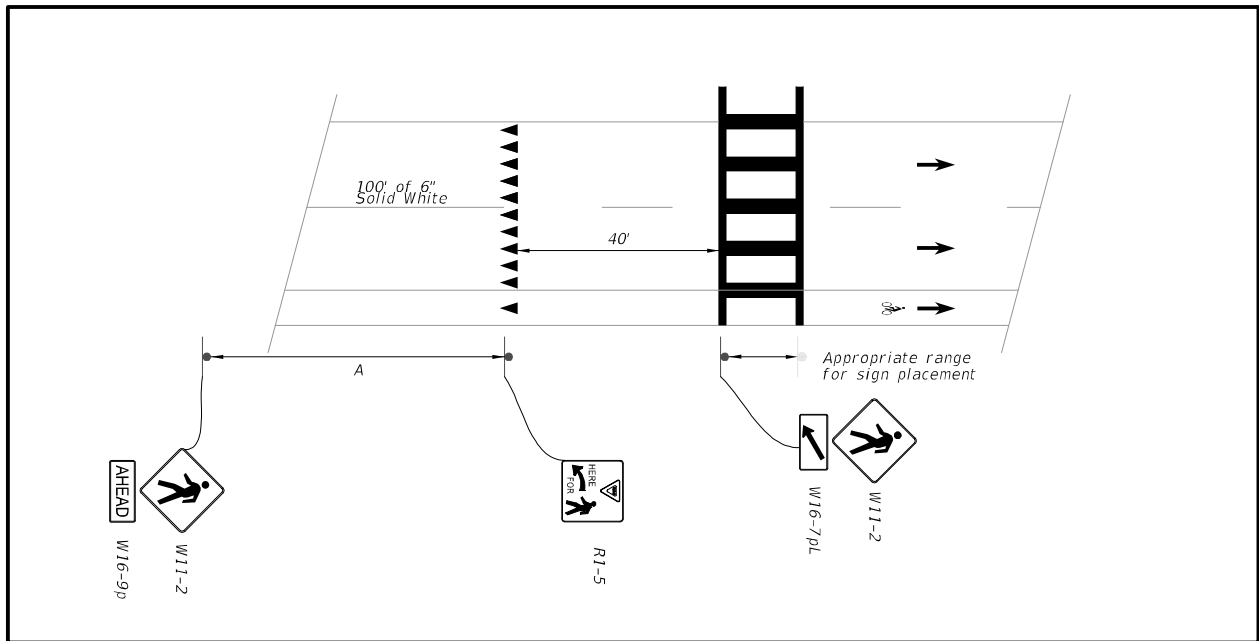
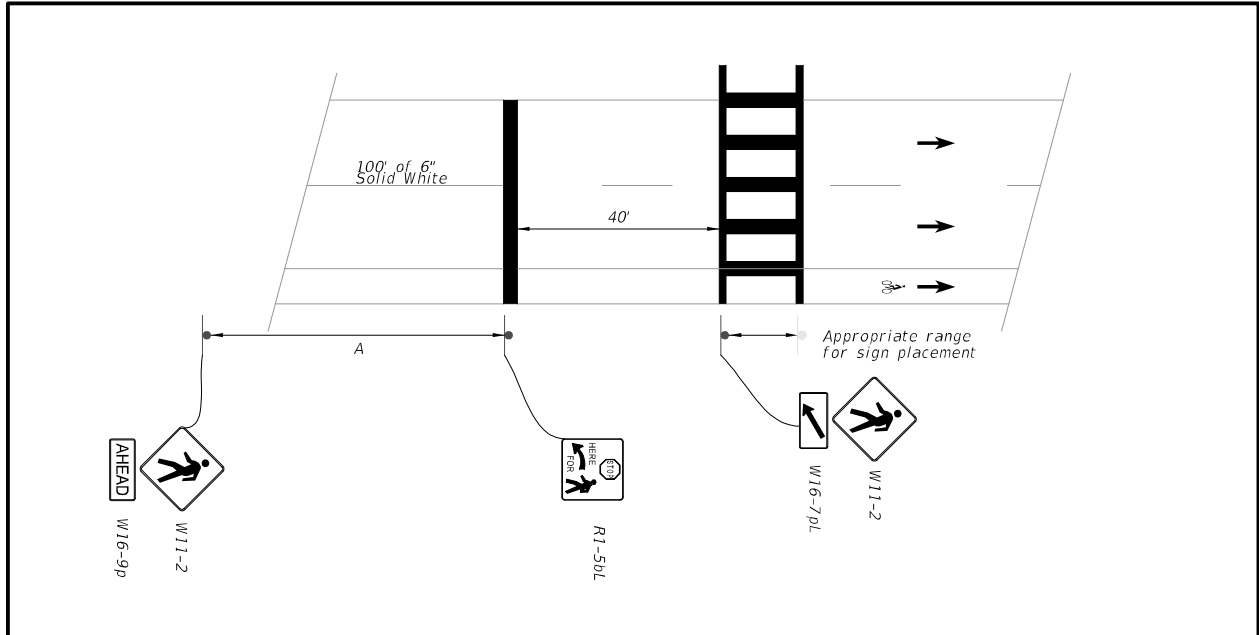

Figure 3 – 12 Pedestrian Crossing with Refuge Island (Stop Condition)



Note: 1. See following page for distance A.

The distance A shown in **Figures 3 – 11** and **3 – 12** for the advance warning sign should be:

Posted Speed (mph)	Advance Placement Distance (feet)
25 or Less	100
26 to 35	100
36 to 45	175

Source: 2009 MUTCD, with 2012 Revisions, Table 2C-4. Guidelines for Advance Placement of Warning Signs. Typical condition is the warning of a potential stop condition.

An example of a pedestrian crossing through a refuge island is shown in Figure 3 – 13 Pedestrian Crossing in Refuge Island. Other options are shown in ~~the Department~~ [the FDOT's Standard Plans 522-002 Detectable Warnings and Sidewalk Curb Ramps.](#)

C.7.g Curbs

Curbs may be used to provide drainage control and to improve delineation of the roadway. Curbs are generally designed with a gutter to form a combination curb and gutter section. In Florida, the standard curb of this type is 6 inches in height. See Figure 3 – 14 Standard Detail for FDOT Type F and E Curbs for examples of sloping curbs. These curbs are not to be used on facilities with design speeds greater than 45 mph. See **Chapter 4 – Roadside Design** for additional design criteria on the use of curbs.

Figure 3 – 14 Standard Detail for FDOT Type F and E Curbs

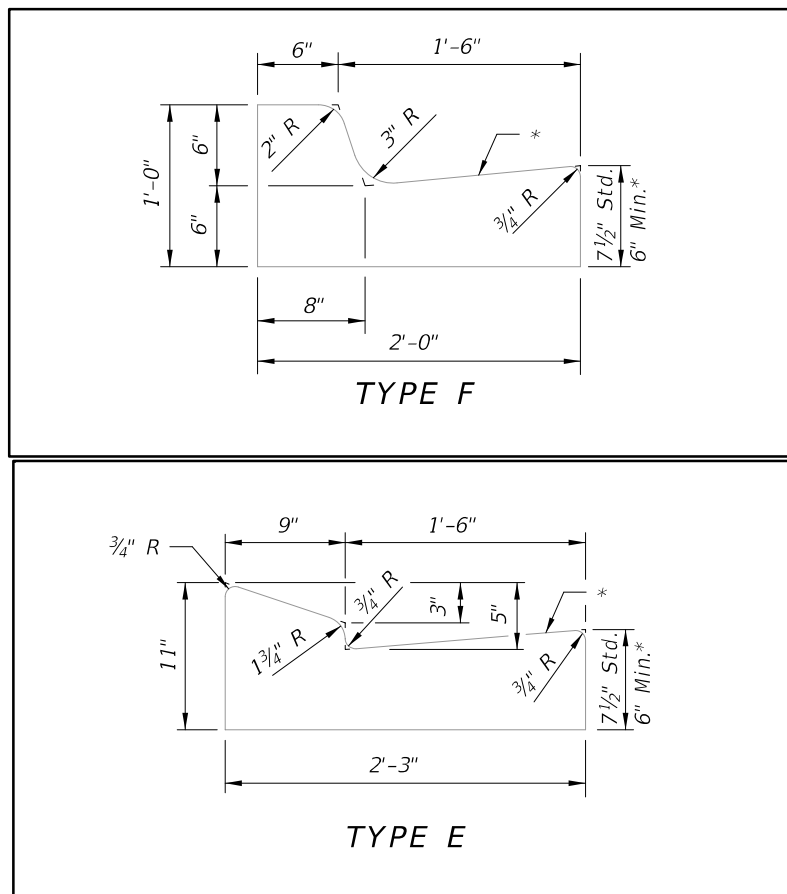

C.7.h Parking

Where parking is needed, and adequate off-street parking facilities are not available or feasible, on-street parking may be necessary. On-street parking is allowed on facilities with posted speeds of 35 mph or less. It is typically located at the outside edge of the roadway between the traveled way and the sidewalk. On streets with a posted speed of 25 mph or less, parking may be located within the median in downtown urban centers. On-street parking may be either parallel or angle (traditional or reverse).

On-street parking may help manage traffic speeds, and provides separation between the sidewalk and travel lanes. It may also decrease through capacity, reduce traffic flow, and increase crash potential.

~~When on-street parking is to be an element of design, parallel parking should be considered. Under certain circumstances, angle parking is an allowable form of street parking. The type of on-street parking selected should depend on the specific function and width of the street, the adjacent land use, traffic volume, as well as existing and anticipated traffic operations. On-street parking is allowed on facilities with posted speeds of 35 mph or less.~~

~~It can generally be stated that on-street parking decreases through capacity, impedes traffic flow, and increases crash potential. However, where parking is needed, and adequate off-street parking facilities are not available or feasible, on-street parking may be necessary.~~

C.7.h.1 Parallel Parking Lanes

Minimum parking lane widths for parallel parking are provided in Table 3 – 24 Minimum Parallel Parking Lane Width.

If on-street parking is provided adjacent to a bike lane, a buffer zone should be provided to reduce the potential for a car door opening into the bike lane (door zone). The buffer zone between the bike lane and on-street parking should be at least 3' wide, however 4' is preferred. See Figure 9 – 18 Buffered Bicycle Lane Markings with On-Street Parking for more information.

Table 3 – 24 Minimum Parallel Parking Lane Width

Facility	Posted Speed (mph)	Parallel Parking Lane Width¹ (feet)
<u>Arterial</u>	<u>≤ 35 mph</u>	<u>8²</u>
<u>Collector</u>	<u>≤ 35 mph</u>	<u>8^{2,3}</u>
<u>Local</u>	<u>≤ 35 mph</u>	<u>8^{2,3}</u>

1. Width measured to face of curb.
 2. A parking lane width of 10 to 12 feet is desirable where delivery trucks need to be accommodated.
 3. May be reduced to 7 feet minimum in residential areas or with posted speeds 25 mph or less, where only passenger vehicles need to be accommodated.

See **Figure 3 – 15** for example details for the signing and marking of parallel parking spaces. The **MUTCD** provides additional examples of how on-street parking may be marked.

Figure 3 – 15 Signing and Marking of Parallel Parking Spaces

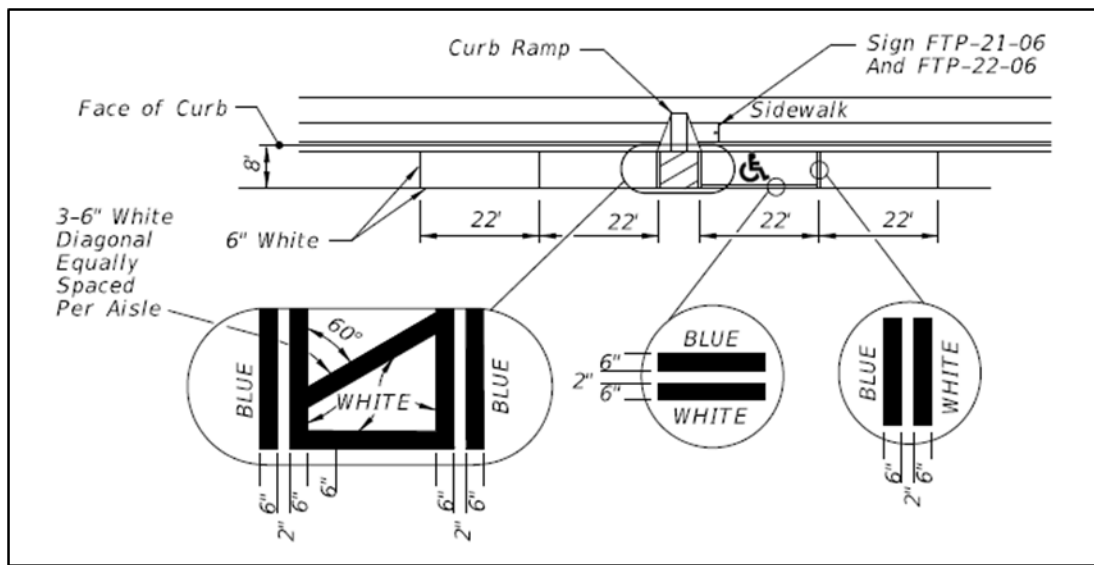

C.7.h.2 Angle Parking

Under certain circumstances, angle parking is an allowable form of street parking. Consideration must be given to the specific function and width of the street, the adjacent land use, traffic volume, and posted speed, as well as existing and anticipated traffic operations. Angle parking presents special problems because of the varying lengths of vehicles and the sight distance problems associated with vans and recreational vehicles. The extra length of such vehicles may interfere with the traveled way. When reverse angle parking is proposed for on-street parking, a raised median may be used to discourage front in parking and access from the opposite direction of travel.

Angle parking typically requires a minimum of 17 to 18 feet between the curb face or edge of pavement and traveled way.

See **Figure 3 – 16** Signing and Marking of 45 degree Forward-In Angle Parking and Figure 3 – 17 Signing and Marking of 45 degree Reverse-In Angle Parking, for examples of angle parking.

Figure 3 – 16 Signing and Marking for 45 degree Forward-In Angle Parking

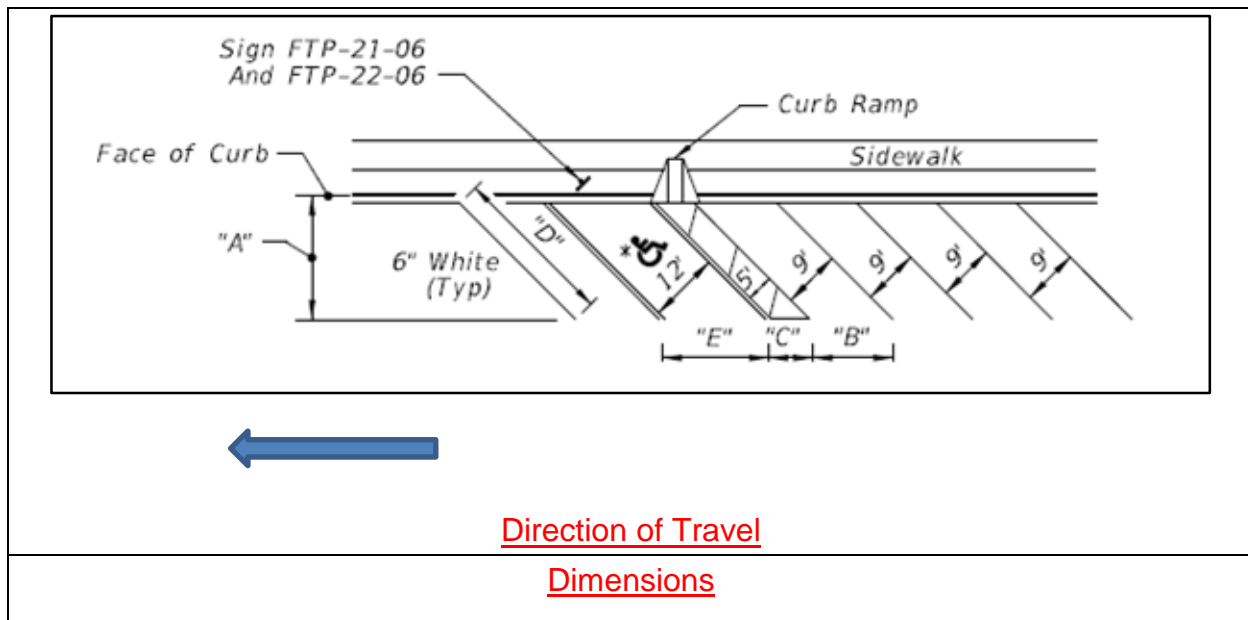

<u>"A"</u>	<u>"B"</u>	<u>"C"</u>	<u>"D"</u>	<u>"E"</u>
<u>17' 0"</u>	<u>12' 9"</u>	<u>7' 0"</u>	<u>24' 0"</u>	<u>17' 0"</u>

Figure 3 – 17 Signing and Marking for 45 degree Reverse-In Angle Parking

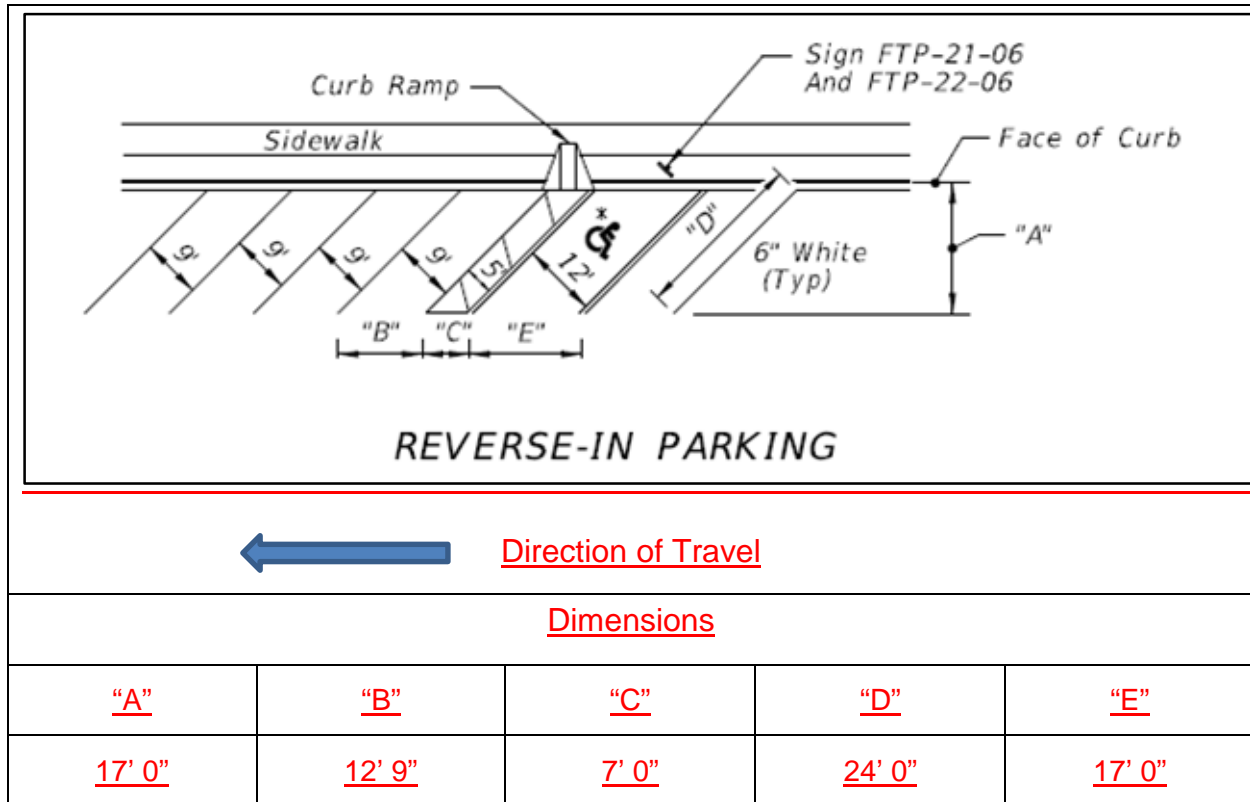

C.7.h.3 Cross Slope

Cross slopes on parking lanes may be 0.015 to 0.05. Portions of parking lanes that are reserved for parking and access isles for people with disabilities are to have cross slopes not exceeding 2%. See Section C.7.h.4 for further information on accessibility requirements.

The height of the curb, pavement cross slope, utilities, street furniture, and landscaping can all affect the functionality of on-street parking. A bilevel sidewalk can help mitigate the differences in diverse elevations between the roadway, on-street parking, and access to buildings.

C.7.h.4 ADA Requirements

In addition to the criteria provided in this section, accessible parking

spaces shall be included with on-street parking in accordance with the requirements of the **2006 Americans with Disabilities Act Standards for Transportation Facilities** as required by 49 C.F.R 37.41 or 37.43 and the **2020 Florida Building Code, Accessibility (7th Edition)** as required by 61G20-4.002. Additionally, the **U.S. Access Board's (Proposed Public Rights-of-Way Accessibility Guidelines, Section R309 On-Street Parking)** provides the latest direction on accessible design requirements that should be followed.

Figure 3 – 16 Signing and Marking for 45 degree Forward-In Angle Parking and Figure 3 – 17 Signing and Marking for 45 degree Reverse-In Angle Parking provide examples of dimensions, signing and marking of on-street parking including accessible parking spaces. The FDOT's **Standard Plans** provide further information on the Universal Symbol of Accessibility (Accessible Parking Pavement Marking) and the required signage designating accessible parking spaces.

C.7.h.5 Parking Restrictions

On-street parking space boundaries shall be established in accordance with the restrictions identified in **F.S. 316.1945**, which restricts parking near driveways, intersections, crosswalks, railroad crossings, fire hydrants and fire stations.

On-street parking shall be located no closer to driveways and intersections than the distances provided in Table 3 – 25 Parking Restrictions for Driveways, Intersections, and Mid-Block Crosswalks. This includes mid-block crossings and roundabout approaches. Midblock crossings on streets with parking should include curb extensions or bulb-outs to improve a driver's and pedestrian's ability to see each other. See Chapter 15 – Traffic Calming for more information.

Table 3 – 25 Parking Restrictions for Driveways, Intersections and Mid-Block Crosswalks

<u>Control Type</u>	<u>Posted Speed (mph)</u>	<u>A Up Stream (feet)</u>	<u>B Down Stream (feet)</u>	
			<u>2- Lane</u>	<u>4-Lane or More</u>
<u>Unsignalized</u>	<u>< 35</u>	<u>90</u>	<u>60</u>	<u>45</u>
	<u>35</u>	<u>105</u>	<u>70</u>	<u>50</u>
<u>Signalized and 4-Way Stop Controlled</u>	<u>< 35</u>	<u>30</u>	<u>30</u>	<u>30</u>
	<u>35</u>	<u>50</u>	<u>50</u>	<u>50</u>

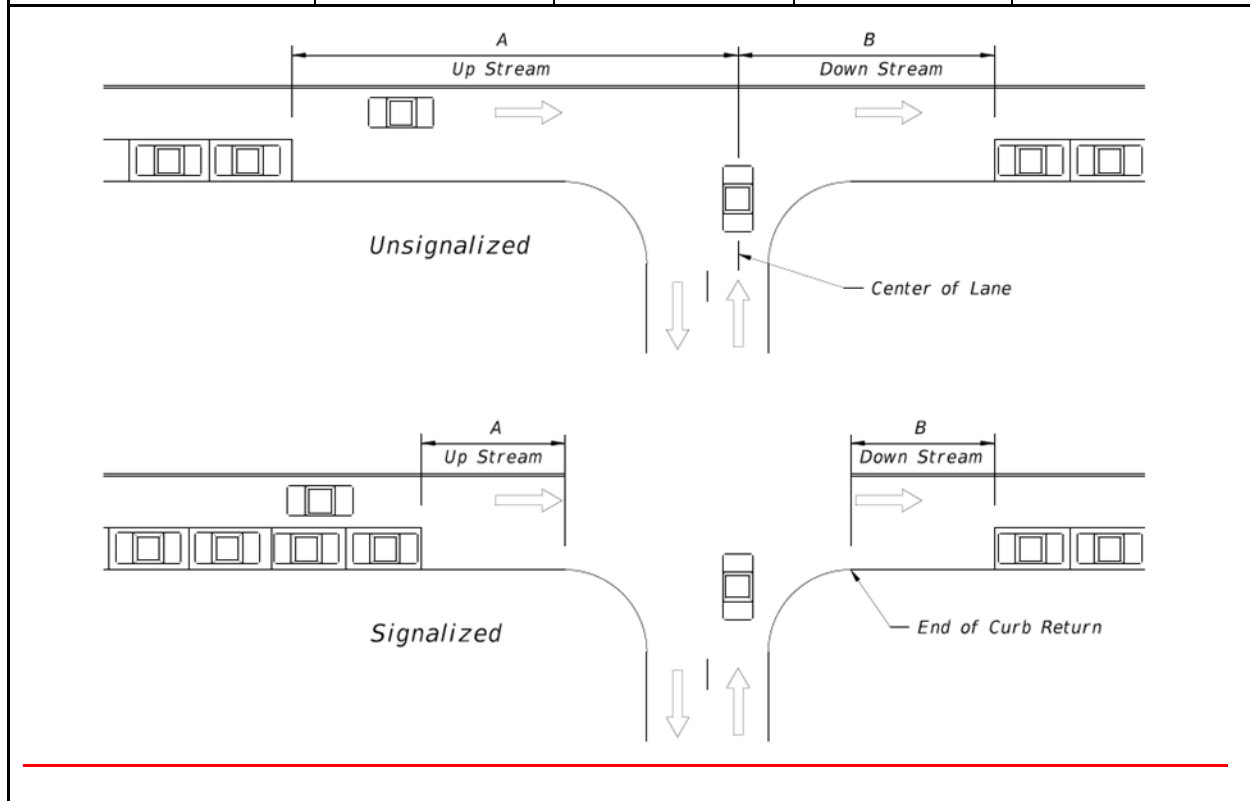

Notes:

- 1. For entrances to one-way streets, the downstream restriction (B) may be reduced to 20 feet.**
- 2. Do not place parking within 20 feet of the nearest edge of a marked crosswalk.**

C.7.h.6 Signing and Marking

Signing and marking of on-street parking shall conform to MUTCD as well as ADA requirements identified in Section C.7.h.4.

C.7.i Right of Way

The acquisition of sufficient right of way is necessary in order to provide space for a safe street or highway. The width of the right of way required depends on the design of the roadway, the arrangement of bridges, underpasses and other structures, and the need for cuts or fills. The right of way acquired should be sufficient to:

- Allow development of the full cross section, including adequate medians and roadside clear zones. Determination of the necessary width requires that adequate consideration also be given to the accommodation of utility poles beyond the clear zone.
- Allow the layout of safe intersections, interchanges, and other access points.
- Allow adequate sight distance at all points, particularly on horizontal curves, at an intersection, and other access points.
- Allow, where appropriate, additional buffer zones to improve roadside safety, noise attenuation, and the overall aesthetics of the street or highway.
- Allow adequate space for placement of pedestrian and bicycle facilities, including curb ramps, bus bays, and transit shelters, where applicable.
- Allow for future lane additions, increases in cross section, or other improvement. Frontage roads should also be considered in the ultimate development of many high volume facilities.
- Allow treatment of stormwater runoff.
- Allow for construction of future intersection improvements, such as turn lanes, bicycle and pedestrian facilities or over and underpasses.
- Allow corner cuts for upstream corner crossing drainage systems and placement of poles, boxes, and other visual screens out of the critical sight triangle.
- Allow landscaping and irrigation as required for the project.

The acquisition of wide rights of way is costly, but it may be necessary to allow the construction and future improvement of safe streets and highways. The minimum right of way should be at least 50 feet for all two-lane roads. For pre-existing conditions, when the existing right of way is less than 50 feet, efforts should be made to acquire the necessary right of way.

Local cul-de-sac and dead end streets having an ADT of less than or equal to 400 and a length of 600 feet or less, may utilize a right of way of less than 50 feet, if all elements of the typical section meet the standards included in this Manual.

The right of way for frontage roads may be reduced depending on the typical section requirements and the ability to share right of way with the adjacent street or highway facility.

C.7.j Changes in Typical Section

C.7.j.1 General Criteria

Changes in cross section should be avoided. When changes in widths, slopes, or other elements are necessary, they should be affected in a smooth, gradual fashion.

C.7.j.2 Lane Deletions and Additions

The addition or deletion of traffic or bicycle lanes should be undertaken on tangent sections of roadways. The approach to lane deletions and additions should have ample advance warning and sight distance.

The termination of lanes (including auxiliary lanes) shall meet the general requirements for merging lanes. See Section C.9.c.1 for additional information.

Where additional lanes are intermittently provided on two-lane, two-way highways, median separation should be considered.

C.7.j.3 Preferential Lanes

To increase the efficiency and separation of different vehicle

movements, preferential use lanes, such as bike lanes and bus lanes, should be considered. These lanes are often an enhancement to corridor safety and increase the horizontal clearance to roadside aboveground fixed objects. The [MUTCD, Chapter 3D](#) provides further information on preferential lane markings. See **Chapter 9 – Bicycle Facilities** for information on marking bicycle lanes.

C.7.j.4 Structures

The pavement, median, and shoulder width, and sidewalks should be carried across structures such as bridges and box culverts. Shoulder widths for multi-lane rural divided highway bridges may be reduced as shown in Table 3 – 20 Minimum Shoulder Widths for Flush Shoulder Rural Highways. The designer should evaluate the economic practicality of utilizing dual versus single bridges for roadway sections incorporating wide medians.

The minimum roadway width for bridges on urban streets with curb and gutter shall be the same as the curb-to-curb width of the approach roadway. Sidewalks on the approaches should be carried across all structures. Curbed sidewalks should not be used adjacent to traffic lanes when design speeds exceed 45 mph. When the bridge rail (barrier wall) is placed between the traffic and sidewalk, it should be offset a minimum distance of 2½ feet from the edge of the travel lane, wide curb lane or bicycle lane. For long (500 feet or greater), and/or high level bridges, it is desirable to provide an offset distance that will accommodate a disabled vehicle. The transition from the bridge to the adjacent roadway section may be made by dropping the curb at the first intersection or well in advance of the traffic barrier, or reducing the curb in front of the barrier to a low sloping curb with a gently sloped traffic face. See **Chapter 17 – Bridges and Other Structures** for additional requirements.

C.7.j.4.(a) Lateral Offset

Supports for bridges, barriers, or other structures should be placed at or beyond the required shoulder. Where possible, these structures should be located outside of the required clear zone. See **Chapter 4 – Roadside Design** for additional information on lateral offsets for structures.

C.7.j.4.(b) Vertical Clearance

Vertical clearance should be adequate for the type of expected traffic. Freeways and arterials shall have a vertical clearance of at least 16 feet-6 inches (includes 6 inch allowance for future resurfacing). Other streets and highways should have a clearance of 16 feet unless the provision of a reduced clearance is fully justified by a specific analysis of the situation (14 feet minimum). The minimum vertical clearance for a pedestrian or shared use bridge over a roadway is 17 feet. The minimum vertical clearance for a bridge over a railroad is 23 feet; however additional clearance may be required by the rail owner.

C.7.j.4.(c) End Treatment

The termini of guardrails, bridge railings, abutments, and other structures should be constructed to protect vehicles and their occupants from serious impact. Requirements for end treatment of structures are given in ***Chapter 4 - Roadside Design***.

C.8 Access Control

All new facilities (and existing when possible) should have some degree of access control since each point of access produces a traffic conflict. The control of access is one of the most effective, efficient, and economical methods for improving the capacity and safety characteristics of streets and highways. The reduction of the frequency of access points and the restriction of turning and crossing maneuvers, which should be primary objectives, is accomplished more effectively by the design of the roadway geometry than by the use of traffic control devices. Design criteria for access points are presented under the general requirements for intersection design.

Additional information on access management can be found in [**Rule Chapter 14-97 State Highway System Access Control Classification System, Florida Administrative Code**](#). The ~~The Department~~[**FDOT's Access Management Guidebook \(2019\) Driveway Information Guide \(2008\)**](#) and provides further information on designing roadways and connections to support access management.

C.8.a Justification

The justification for control of access should be based on several factors, including safety, capacity, economics, and aesthetics.

C.8.b General Criteria

C.8.b.1 Location of Access Points

All access locations should have adequate sight distance available for the safe execution of entrance, exit, and crossing maneuvers.

Locations of access points near structures, decision points, or the termination of street or highway lighting should be avoided.

Driveways should not be placed within the influence zone of intersections or other points that would tend to produce traffic conflict.

C.8.b.2 Spacing of Access Points

The spacing of access points should be adequate to prevent conflict or mutual interference of traffic flow.

Separation of entrance and exit ramps should be sufficient to provide adequate distance for required weaving maneuvers.

Adequate spacing between access and decision points is necessary to avoid burdening the driver with the need for rapid decisions or maneuvers.

Frequent median openings should be avoided.

The use of a frontage road or other auxiliary roadways is recommended on arterials and higher classifications where the need for direct driveway or minor road access is frequent.

C.8.b.3 Restrictions of Maneuvers

Where feasible, the number and type of permitted maneuvers

(crossing, turning slowing, etc.) should be restricted.

The restriction of crossing maneuvers may be accomplished by the use of grade separations and continuous raised medians.

The restriction of left turns is achieved most effectively by continuous medians.

Channelization should be considered for the purposes of guiding traffic flow and reducing vehicle conflicts.

C.8.b.4 Auxiliary Lanes

Deceleration lanes for right turn exits (and left turns, where permitted) should be provided on all high-speed facilities. These turn lanes should not be excessive or continuous since they complicate pedestrian crossings and bicycle/motor vehicle movements.

Storage (or deceleration lanes) to protect turning vehicles should be provided, particularly where turning volumes are significant.

Special consideration should be given to the provisions for deceleration, acceleration, and storage lanes in commercial or industrial areas with significant truck/bus traffic.

C.8.b.5 Grade Separation

Grade separation interchange design should be considered for junctions of high-volume arterial streets and highways.

Grade separation (or an interchange) should be utilized when the expected traffic volume exceeds the intersection capacity.

Grade separation should be considered to eliminate conflict or long waiting periods at potentially hazardous intersections.

C.8.b.6 Roundabouts

Roundabouts have proven safety and operational characteristics and should be evaluated as an alternative to conventional intersections whenever practical. Modern roundabouts, when correctly designed, are a proven safety countermeasure to conventional intersections, both stop controlled and signalized. In addition, when constructed in appropriate locations, drivers will experience less delay with modern roundabouts. [NCHRP Report 672 Roundabouts: An Informational Guide](#), is adopted by FHWA and establishes criteria and procedures for the justification, operational and safety analysis of modern roundabouts in the United States. The modern roundabout is characterized by the following:

- A central island of sufficient diameter to accommodate vehicle tracking and to provide sufficient deflection to promote lower speeds
- Entry is by gap acceptance through a yield condition at all legs
- Speeds through the intersection of 20 - 25 mph.
- Single or multilane configurations.

Roundabouts should be considered under the following conditions:

1. New construction
2. Reconstruction
3. Traffic Operations improvements
4. Resurfacing (3R) with Right of Way acquisition
5. Need to reduce frequency and severity of crashes

C.8.c Control for All Limited Access Highways

Entrances and exits on the right side only are highly desirable for all limited access highways. Acceleration and deceleration lanes are mandatory. Intersections shall be accomplished by grade separation (interchange) and should be restricted to connect with arterials or collector roads.

The control of access on freeways should conform to the requirements given in Table 3 – [264](#) Access Control for All Limited Access Highways.

The spacing of exits and entrances should be increased wherever possible to reduce conflicts. Safety and capacity characteristics are improved by restricting the number and increasing the spacing of access points.

Table 3 – 264 Access Control for All Limited Access Highways

	Urban	Rural
Minimum Spacing		
Interchanges	1 to 3 miles	3 to 25 miles
Maneuver Restrictions		
Crossing Maneuvers	Via Grade Separation Only	
Exit and Entrance	From Right Side Only	
Turn Lane Required	Acceleration Lane at all Entrances Deceleration Lane at all Exits	

C.8.d Control of Urban and Rural Streets and Highways

The design and construction of urban, as well as rural, highways should be governed by the general criteria for access control previously outlined. In addition, the design of urban streets should be in accordance with the criteria listed below:

- The general layout of local and collector streets should follow a branching network, rather than a highly interconnected grid pattern.
- The street network should be designed to reduce, consistent with origin/destination requirements, the number of crossing and left turn maneuvers.
- The design of the street layout should be predicated upon reducing the need for traffic signals.
- The use of a public street or highway as an integral part of the internal circulation pattern for commercial property should be discouraged.

- The number of driveway access points should be restricted as much as possible through areas of strip development.
- Special consideration should be given to providing turn lanes (auxiliary lane for turning maneuvers) where the total volume or truck/bus volume is high.
- Major traffic generators may be exempt from the restrictions on driveway access if the access point is designed as a normal intersection adequate to handle the expected traffic volume.

These are minimum requirements only; it is generally desirable to use more stringent criteria for control of access.

The design of rural highways should be in accordance with the general criteria for access control for urban streets. The use of acceleration and deceleration lanes on all high-speed highways, particularly if truck and bus traffic is significant, is strongly recommended.

C.8.e Land Development

It should be the policy of each agency with responsibility for street and highway design, construction, or maintenance to promote close liaison with utility, lawmaking, zoning, building, and planning agencies. Cooperation should be solicited in the formulation of laws, regulations, and master plans for land use, zoning, and road construction. Further requirements and criteria for access control and land use relationships are given in **Chapter 12 – Planning and Land Development**.

C.9 Intersection Design

Intersections increase traffic conflicts and the demands on the driver, and are inherently hazardous locations. The design of an intersection should be predicated on reducing motor vehicle, bicycle, and pedestrian conflicts, minimizing the confusion and demands on the driver for rapid and/or complex decisions, and providing for smooth traffic flow. The location and spacing of intersections should follow the requirements presented in Section C.8 Access Control, this chapter. Intersections should be designed to minimize time and distance of all who pass through or turn at an intersection.

The additional effort and expense required to provide a high quality intersection is justified by the corresponding safety benefits. The overall reduction in crash

potential derived from a given expenditure for intersection improvements is generally much greater than the same expenditure for improvements along an open roadway. Properly designed intersections increase capacity, reduce delays, and improve safety.

One of the most common deficiencies that may be easy to correct is lack of adequate left turn storage.

The requirements and design criteria contained in this section are applicable to all driveways, intersections, and interchanges. All entrances to, exits from, or interconnections between streets and highways are subject to these design standards.

C.9.a General Criteria

The layout of a given intersection may be influenced by constraints unique to a particular location or situation. The design shall conform to sound principles and criteria for safe intersections. The general criteria include the following:

- The layout of the intersection should be as simple as is practicable. Complex intersections, which tend to confuse and distract the driver, produce inefficient and hazardous operations.
- The intersection arrangement should not require the driver to make rapid or complex decisions.
- The layout of the intersection should be clear and understandable so a proliferation of signs, signals, or markings is not required to adequately inform and direct the driver.
- The design of intersections, particularly along a given street or highway, should be as consistent as possible.
- The approach roadways should be free from steep grades and sharp horizontal or vertical curves.
- Intersections with driveways or other roadways should be as close to right angle as possible.
- Adequate sight distance should be provided to present the driver a clear view of the intersection and to allow for safe execution of crossing and turning maneuvers.

- The design of all intersection elements should be consistent with the design speeds of the approach roadways.
- The intersection layout and channelization should encourage smooth flow and discourage wrong way movements.
- Special attention should be directed toward the provision of safe roadside clear zones.
- The provision of auxiliary lanes should be in conformance with the criteria set forth in Section C.8 Access Control, this chapter.
- The requirements for bicycle and pedestrian movements should receive special consideration.

C.9.b Sight Distance

Inadequate sight distance is a contributing factor in the cause of a large percentage of intersection crashes. The provision of adequate sight distance at intersections is absolutely essential and should receive a high priority in the design process.

C.9.b.1 General Criteria

General criteria to be followed in the provision of sight distance include the following:

- Sight distance exceeding the minimum stopping sight distance should be provided on the approach to all intersections (entrances, exits, stop signs, traffic signals, and intersecting roadways). The use of proper approach geometry free from sharp horizontal and vertical curvature will normally allow for adequate sight distance.
- The approaches to exits or intersections (including turn, storage, and deceleration lanes) should have adequate sight distance for the design speed and also to accommodate any allowed lane change maneuvers.
- Adequate sight distance should be provided on the through roadway approach to entrances (from acceleration or merge lanes, stop or yield signs, driveways, or traffic signals) to provide capabilities for defensive driving. This lateral sight distance should include as much length of the entering lane or intersecting roadway as is feasible. A clear view of entering

vehicles is necessary to allow through traffic to aid merging maneuvers and to avoid vehicles that have "run" or appear to have the intention of running stop signs or traffic signals.

- Approaches to school or pedestrian crossings and crosswalks should have sight distances exceeding the minimum values. This should also include a clear view of the adjacent pedestrian pathways or shared use paths.
- Sight distance in both directions should be provided for all entering roadways (intersecting roadways and driveways) to allow entering vehicles to avoid through traffic. See Section C.9.B.4 for further information.
- Safe stopping sight distances shall be provided throughout all intersections, including turn lanes, speed change lanes, and turning roadways.
- The use of lighting (**Chapter 6 – Lighting**) should be considered to improve intersection sight distance for night driving.

C.9.b.2 Obstructions to Sight Distance

The provisions for sight distance are limited by the street or highway geometry and the nature and development of the area adjacent to the roadway. Where line of sight is limited by vertical curvature or obstructions, stopping sight distance shall be based on the eye height of 3.50 feet and an object height of 2.0 feet. At exits or other locations where the driver may be uncertain as to the roadway alignment, a clear view of the pavement surface should be provided. At locations requiring a clear view of other vehicles or pedestrians for the safe execution of crossing or entrance maneuvers, the sight distance should be based on a driver's eye height of 3.50 feet and an object height of 3.00 feet (preferably 1.50 feet). The height of eye for truck traffic may be increased for determination of line of sight obstructions for intersection maneuvers. Obstructions to sight distance at intersections include the following:

- Any property not under the highway agency's jurisdiction, through direct ownership or other regulations, should be considered as an area of potential sight distance obstruction.

Based on the degree of obstruction, the property should be considered for acquisition by deed or easement.

- Areas which contain vegetation (trees, shrubbery, grass, etc.) that cannot easily be trimmed or removed by regular maintenance activity should be considered as sight obstructions.
- Parking lanes shall be considered as obstructions to line of sight. Parking shall be prohibited within clear areas required for sight distance at intersections.
- Large (or numerous) poles or support structures for lighting, signs, signals, or other purposes that significantly reduce the field of vision within the limits of clear sight shown in **Figure 3 – 196** Departure Sight Triangle in Section C.9.b.4. may constitute sight obstructions. Potential sight obstructions created by poles, supports, and signs near intersections should be carefully investigated.

In order to ensure the provision for adequate intersection sight distance, on-site inspections should be conducted before and after construction, including placement of signs, lighting, guardrails, or other objects and how they impact intersection sight distance.

C.9.b.3 Stopping Sight Distance

The provision for safe stopping sight distance at intersections and on turning roadways is even more critical than on open roadways. Vehicles are more likely to be traveling in excess of the design or posted speed and drivers are frequently distracted from maintaining a continuous view of the upcoming roadway.

C.9.b.3.(a) Approach to Stops

The approach to stop signs, yield signs, or traffic signals should be provided with a sight distance no less than values given in Table 3 – 25 Minimum Stopping Sight Distance (Rounded Values). These values are applicable for any street, highway, or turning roadway. The driver should, at this required distance, have a clear view of the intersecting roadway, as well as the sign or traffic signal.

Where the approach roadway is on a grade or vertical curve, the sight distance should be no less than the values shown in [Figure 3 – 185](#) Sight Distances for Approach to Stop on Grades. In any situation where it is feasible, sight distances exceeding those should be provided. This is desirable to allow for more gradual stopping maneuvers and to reduce the likelihood of vehicles running through stop signs or signals. Advance warnings for stop signs are desirable.

Table 3 – 27 Minimum Stopping Sight Distance (Rounded Values)

Design Speed (mph)	20	25	30	35	40	45	50	55	60	65	70
Stopping Sight Distance (feet)	115	155	200	250	305	360	425	495	570	645	730

C.9.b.3.(b) On Turning Roads

The required stopping sight distance at any location on a turning roadway (loop, exit, etc.) shall be based on the design speed at that point. Ample sight distance should be provided since the driver is burdened with negotiating a curved travel path and the available friction factor for stopping has been reduced by the roadway curvature. The minimum sight distance values are given in [Table 3 – 275](#) Minimum Stopping Sight Distance (Rounded Values) or [Figure 3 – 185](#) Sight Distances for Approach to Stop on Grades. Due to the inability of vehicle headlights to adequately illuminate a sharply curved travel path, roadway lighting should be considered for turning roadways.

Figure 3 – 185 Sight Distances for Approach to Stop on Grades

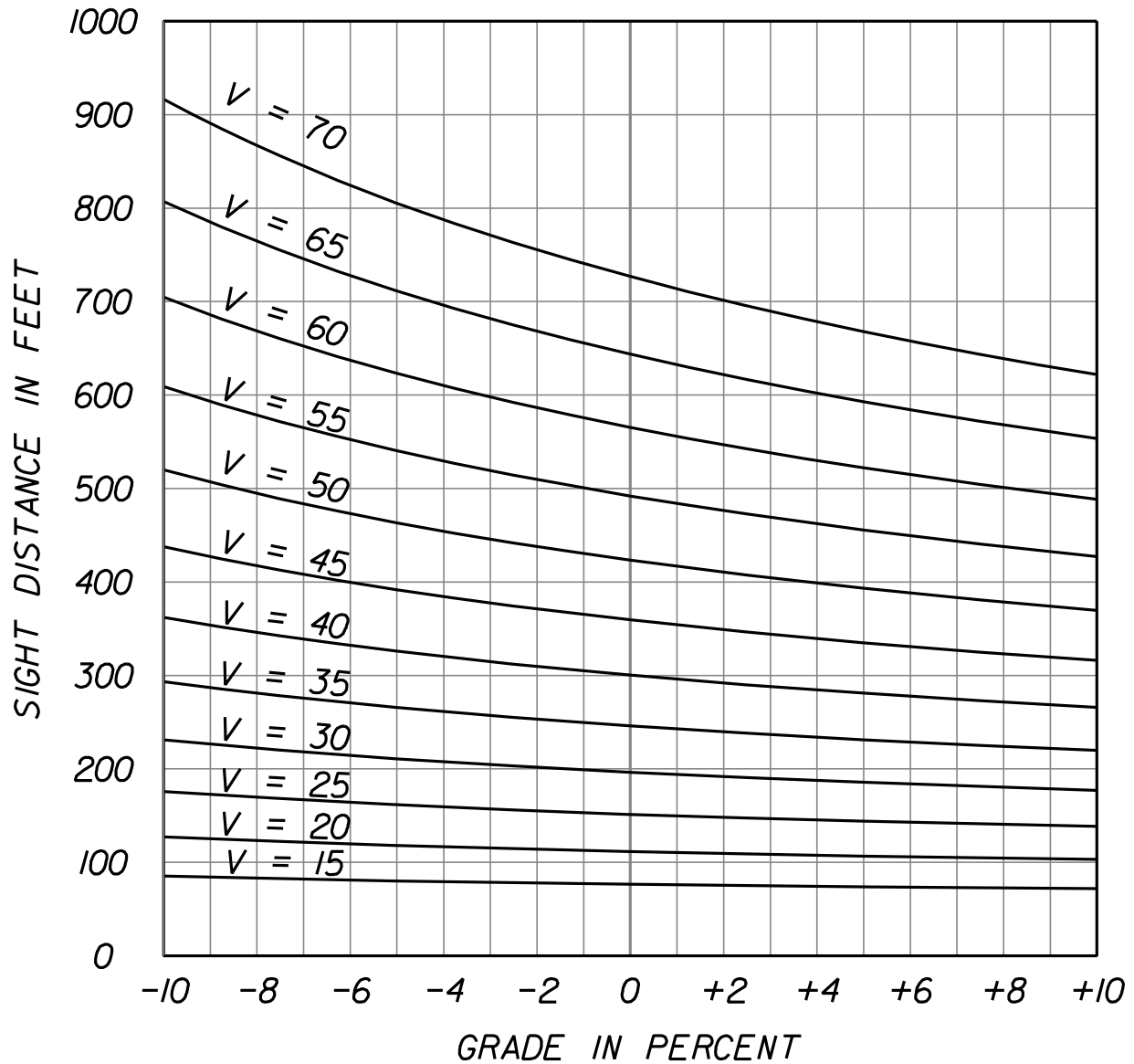

$$S = 3.675V + \frac{V^2}{30(0.3478 \pm G)}$$

S = Sight Distance
 V = Design Speed
 G = Grade

C.9.b.4 Sight Distance for Intersection Maneuvers

Sight distance is also provided at intersections to allow the drivers of stopped vehicles a sufficient view of the intersecting street or highway to decide when to enter or cross the intersecting street or highway. Sight triangles, which are specified areas along intersection approach legs and across their included corners, shall, where practical, be clear of obstructions that would prohibit a driver's view of potentially conflicting vehicles. Departure sight triangles shall be provided in each quadrant of each intersection approach controlled by stop signs.

Figures [3 – 196](#) Departure Sight Triangle (Traffic Approaching from Left or Right) and [3 – 2017](#) Intersection Sight Distance show typical departure sight triangles to the left and to the right of the location of a stopped vehicle on a minor road (stop controlled) and the intersection sight distances for the various movements.

Distance “a” is the length of leg of the sight triangle along the minor road. This distance is measured from the driver's eye in the stopped vehicle to the center of the nearest lane on the major road (through road) for vehicles approaching from the left, and to the center of the nearest lane for vehicles approaching from the right.

Distance “b” is the length of the leg of the sight triangle along the major road measured from the center of the minor road entrance lane. This distance is a function of the design speed and the time gap in major road traffic needed for minor road drivers turning onto or crossing the major road. This distance is calculated as follows:

$$ISD = 1.47V_{major}t_g$$

Where:

ISD=Intersection Sight Distance (ft.) – length of leg of sight triangle along the major road.

V_{major} = Design Speed (mph) of the Major Road

t_g = Time gap (sec.) for minor road vehicle to enter the major road.

Time gap values, t_g , to be used in determination of ISD are based on

studies and observations of the time gaps in major road traffic actually accepted by drivers turning onto or across the major road. Design time gaps will vary and depend on the design vehicle, the type of the maneuver, the crossing distance involved in the maneuver, and the minor road approach grade.

For intersections with stop control on the minor road, there are three maneuvers or cases that must be considered. ISD is calculated for each maneuver case that may occur at the intersection. The case requiring the greatest ISD will control. Cases that must be considered are as follows (Case numbers correspond to cases identified in the AASHTO – "A Policy on Geometric Design of Highways and Streets" - 2011):

Case B1 – Left Turns from the Minor (stop controlled) Road

Case B2 – Right Turns from the Minor (stop controlled) Road

Case B3 – Crossing the Major Road from the Minor (stop controlled) Road

See Sections C.9.b.4.(c) and (d) for design time gaps for Case B.

For Intersections with Traffic Signal Control see Section C.9.b.4.(e) (AASHTO Case D).

For intersections with all way stop control see Section C.9.b.4.(f) (AASHTO Case E).

For left turns from the major road see Section C.9.b.4.(g) (AASHTO Case F).

Figure 3 – ~~1916~~ Departure Sight Triangle
(Traffic Approaching from Left or Right)

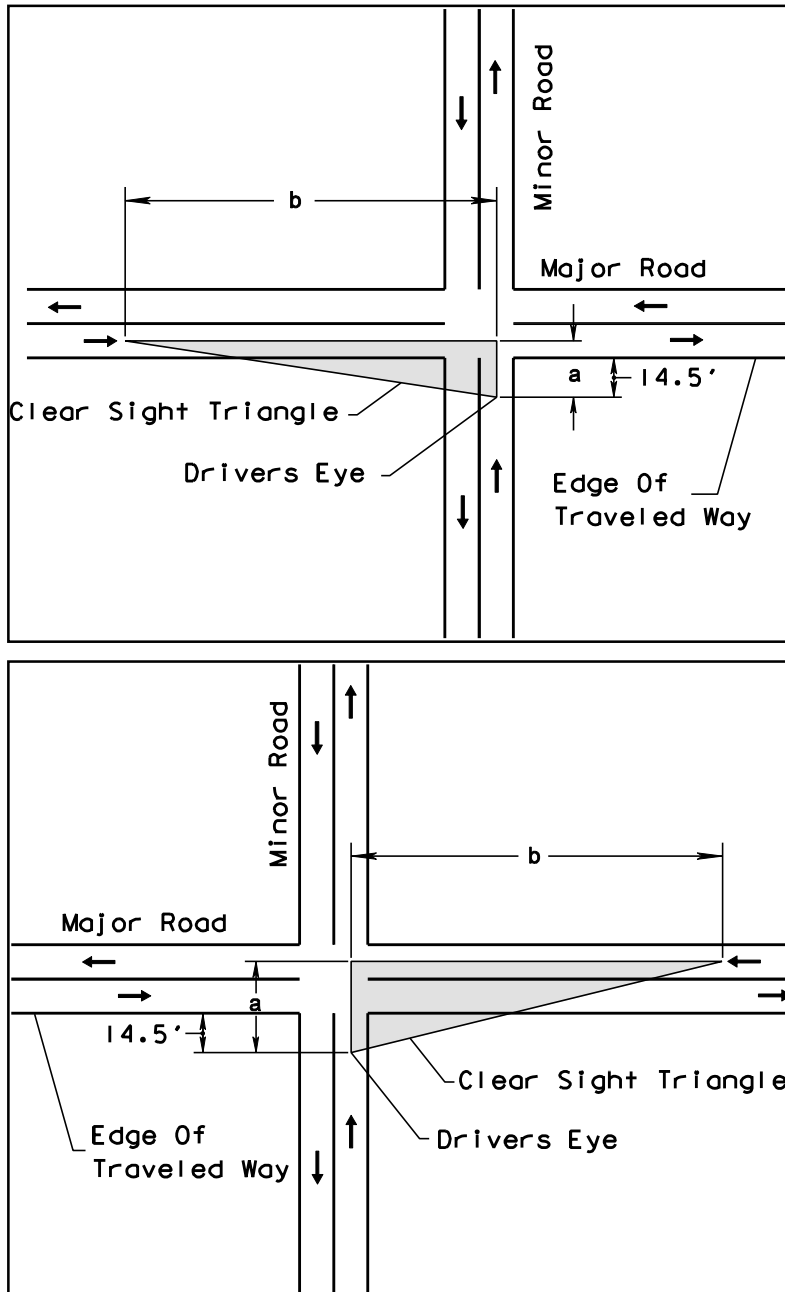
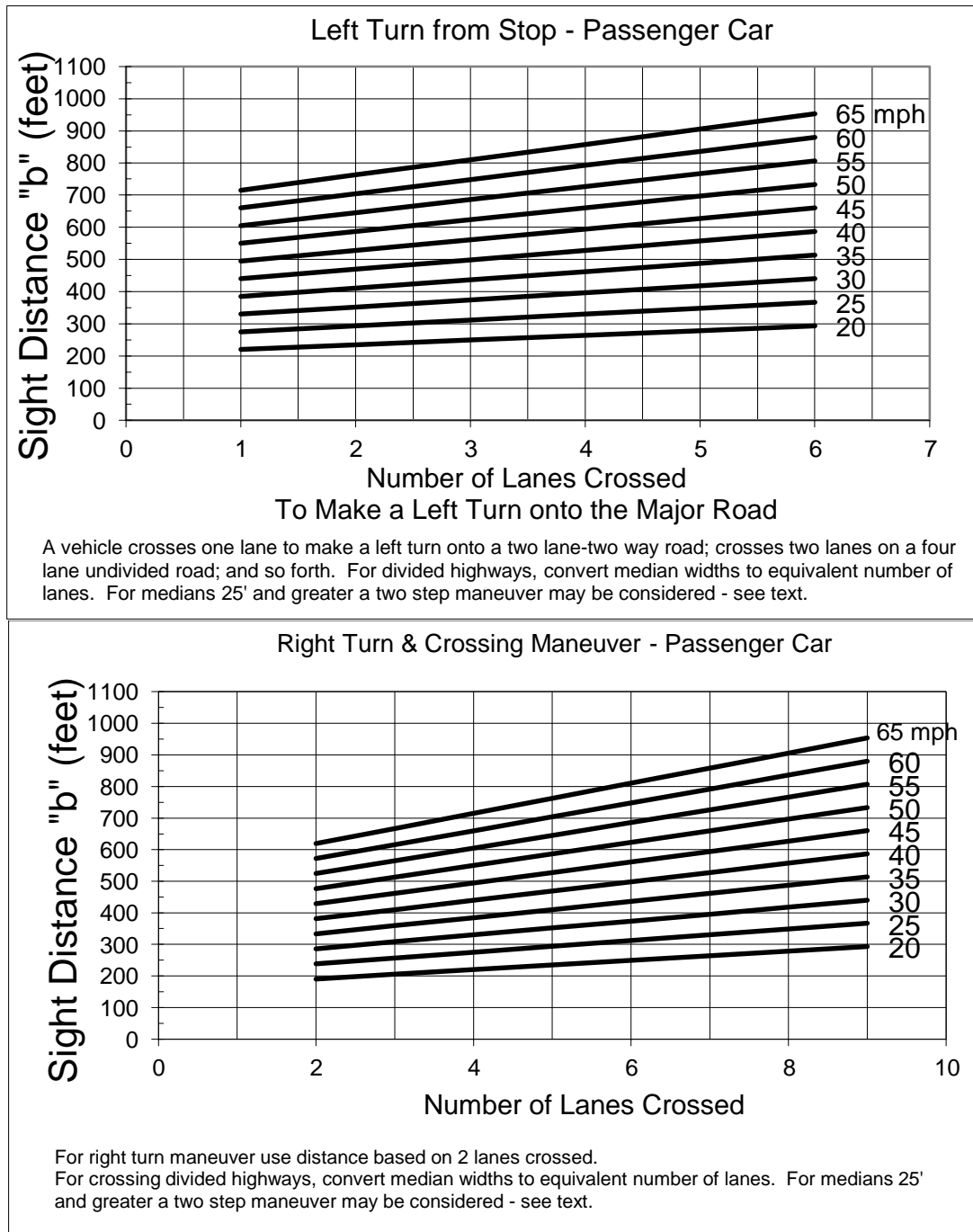

Figure 3 – 2017 Intersection Sight Distance



C.9.b.4.(a) Driver's Eye Position and Vehicle Stopping Position

The vertex (decision point or driver's eye position) of the departure sight triangle on the minor road shall be a minimum of 14.5 feet from the edge of the major road traveled way. This is based on observed measurements of vehicle stopping position and the distance from the front of the vehicle to the driver's eye. Field observations of vehicle stopping positions found that, where necessary, drivers will stop with the front of their vehicle 6.5 feet or less from the edge of the major road traveled way. Measurements of passenger cars indicate that the distance from the front of the vehicle to driver's eye for the current U.S. passenger car fleet is almost always 8 feet or less.

When executing a crossing or turning maneuver after stopping at a stop sign, stop bar, or crosswalk as required in **Section 316.123, Florida Statutes**, it is assumed that the vehicle will move slowly forward to obtain sight distance (without intruding into the crossing travel lane) stopping a second time as necessary.

C.9.b.4.(b) Design Vehicle

Dimensions of clear sight triangles are provided for passenger cars, single unit trucks, and combination trucks stopped on the minor road. It can usually be assumed that the minor road vehicle is a passenger car. However, where substantial volumes of heavy vehicles enter the major road, such as from a ramp terminal, the use of tabulated values for single unit or combination trucks should be considered.

C.9.b.4.(c) Case B1 - Left Turns from the Minor Road

Design time gap values for left turns from the minor road onto two lane two way major highway are as follows:

Design Vehicle	Time Gap (t_g) in Seconds
Passenger Car	7.5
Single Unit Truck	9.5
Combination Truck	11.5

If the minor road approach grade is an upgrade that exceeds 3 percent, add 0.2 seconds for each percent grade for left turns.

For multilane streets and highways without medians wide enough to store the design vehicle with a clearance of 3 feet on both ends of the vehicle, add 0.5 seconds for passenger cars or 0.7 seconds for trucks for each additional lane from the left, in excess of one, to be crossed by the turning vehicle. The median width should be included in the width of additional lanes. This is done by converting the median width to an equivalent number of 12 foot lanes.

For multilane streets and highways with medians wide enough to store the design vehicle with a clearance of 3 feet on both ends of the vehicle a two-step maneuver may be assumed. Use case B2 for crossing to the median.

C.9.b.4.(d) Case B2 - Right Turns From the Minor Road and Case B3 – Crossing Maneuver From the Minor Road

Design time gap values for a stopped vehicle on a minor road to turn right onto or cross a two lane highway are as follows:

Design Vehicle	Time Gap (t_g) in Seconds
Passenger Car	6.5
Single Unit Truck	8.5
Combination Truck	10.5

If the approach grade is an upgrade that exceeds 3 percent, add 0.1 seconds for each percent grade.

For crossing streets and highways with more than 2 lanes, add 0.5 seconds for passenger cars or 0.7 seconds for trucks for each additional lane to be crossed. Medians not wide enough to store the design vehicle with a clearance of 3 feet on both ends of the vehicle should be included in the width of additional lanes. This is done by converting the median width to an equivalent number of 12 foot lanes.

For crossing divided streets and highways with medians wide enough to store the design vehicle with a clearance of 3 feet on both ends of the vehicle, a two-step maneuver may be assumed. Only the number of lanes to be crossed in each step are considered.

C.9.b.4.(e) Intersections with Traffic Signal Control (AASHTO Case D)

At signalized intersections, the first vehicle stopped on one approach should be visible to the driver of the first vehicle stopped on each of the other approaches. Left turning vehicles should have sufficient sight distance to select gaps in oncoming traffic and complete left turns. Apart from these sight conditions, no other sight triangles are needed for signalized intersections. However, if the traffic signal is to be placed on two-way flashing operation in off peak or nighttime conditions, then the appropriate departure sight triangles for Cases B1, B2, or B3, both to the left and to the right, should be provided. In addition, if right turns on red are to be permitted, then the appropriate departure sight triangle to the left for Case B2 should be provided to accommodate right turns.

C.9.b.4.(f) Intersections with All-Way Stop Control (AASHTO Case E)

At intersections with all-way stop control, the first stopped vehicle on one approach should be visible to the drivers of the first stopped vehicles on each of the other approaches. There are no other sight distance criteria applicable to intersections with all-way stop control.

C.9.b.4.(g) Left Turns from the Major Road (AASHTO Case F)

All locations along a major road from which vehicles are permitted to turn left across opposing traffic shall have sufficient sight distance to accommodate the left turn maneuver. In this case, the ISD is measured from the stopped position of the left turning vehicle (see Figure 3 – ~~2148~~ Sight Distance for Vehicle Turning Left from Major Road).

Design time gap values for left turns from the major road are as follows:

Design Vehicle	Time Gap (t_g) in Seconds
Passenger Car	5.5
Single Unit Truck	6.5
Combination Truck	7.5

For left turning vehicles that cross more than one opposing lane, add 0.5 seconds for passenger cars and 0.7 seconds for trucks for each additional lane to be crossed.

C.9.b.4.(h) Intersection Sight Distance References

The ~~The Department~~ [FDOT Design Manual, Chapter 212 Intersections Standards, Index 546](#), provides ISD values for several basic intersection configurations based on Cases B1, B2, B3, and D, and may be used when applicable. For additional guidance on Intersection Sight Distance, see the [AASHTO Green Book \(2011\)](#).

Figure 3 – 2118 Sight Distance for Vehicle Turning Left from Major Road

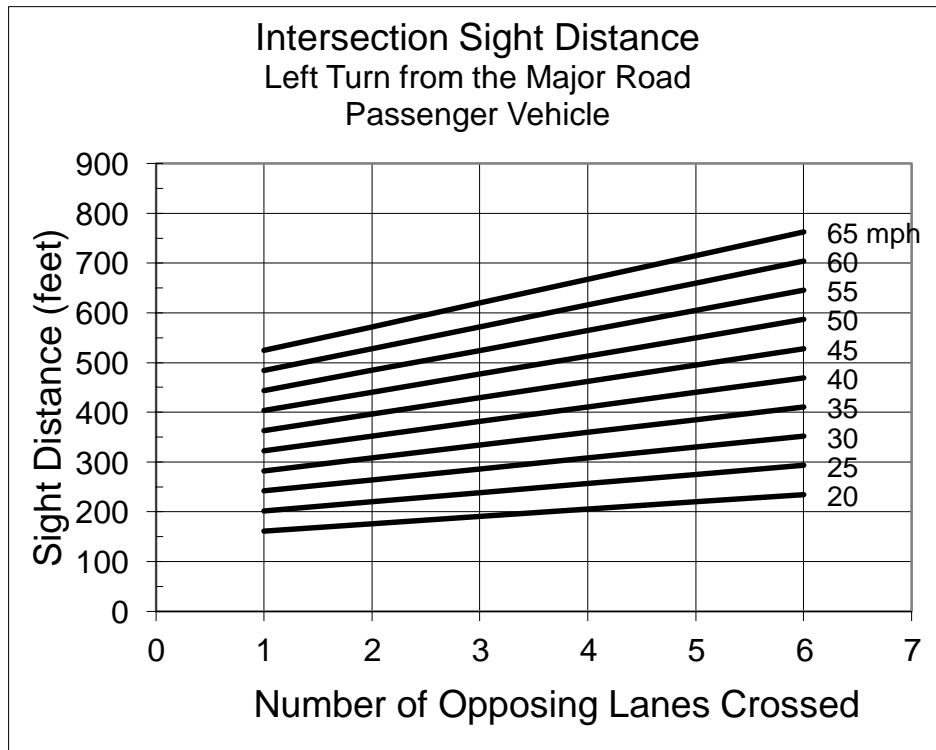
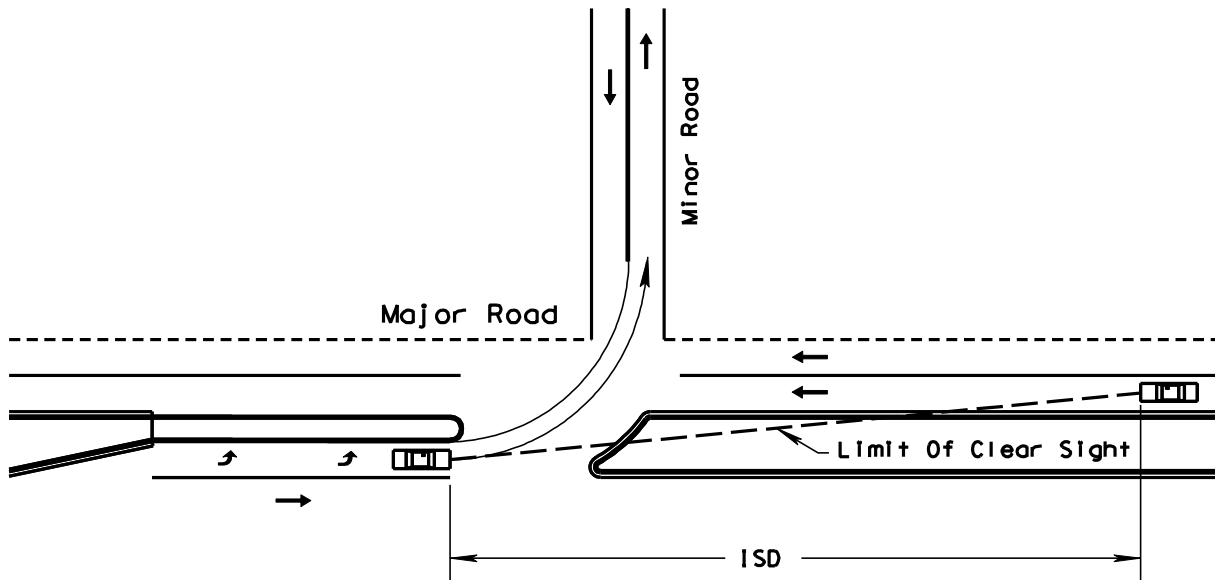

C.9.c Auxiliary Lanes

Auxiliary lanes are desirable for the safe execution of speed change maneuvers (acceleration and deceleration) and for the storage and protection of turning vehicles. Auxiliary lanes for exit or entrance turning maneuvers shall be provided in accordance with the requirements set forth in C.8 Access Control, this chapter. The pavement width and cross slopes of auxiliary lanes should meet the minimum requirements shown in Table 3 – 20 Minimum Lane Widths.

C.9.c.1 Merging Maneuvers

Merging maneuvers occur at the termination of climbing lanes, lane drops, entrance acceleration, and turning lanes. The location provided for this merging maneuver should, where possible, be on a tangent section of the roadway and should be of sufficient length to allow for a smooth, safe transition. The provision of ample distance for merging is essential to allow the driver time to find an acceptable gap in the through traffic and then execute a safe merging maneuver. It is recommended that a merging taper be on a 1:50 transition, but in no case, shall the length be less than set forth in Table 3 – ~~286~~ Length of Taper for Use in Conditions with Full Width Speed Change Lanes. The termination of this lane should be clearly visible from both the merging and through lane and should correspond to the general configuration shown in Figure 3 – ~~2219~~ Termination of Merging Lanes. Advance warning of the merging lane termination should be provided. Lane drops shall be marked in accordance with **Section 14-15.010, F.A.C. Manual on Uniform Traffic Control Devices (MUTCD)**.

Table 3 – ~~286~~ Length of Taper for Use in Conditions with Full Width Speed Change Lanes

Design Speed (mph)	20	25	30	35	40	45	50	55	60	65	70
Length of Deceleration Taper (feet)	110	130	150	170	190	210	230	250	270	290	300
Length of Acceleration Taper (feet)	80	100	120	140	160	180	210	230	250	260	280

Figure 3 – ~~2219~~ Termination of Merging Lanes

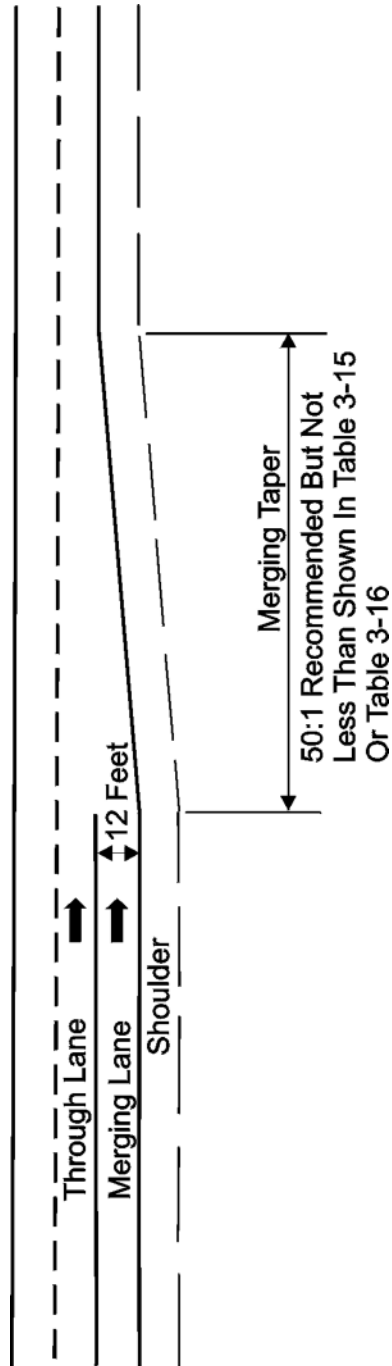

C.9.c.2 Acceleration Lanes

Acceleration lanes are required for all entrances to expressway and freeway ramps. Acceleration lanes may be desirable at access points to any street or highway with a large percentage of entering truck traffic.

The distance required for an acceleration maneuver is dependent on the vehicle acceleration capabilities, the grade, the initial entrance speed, and the final speed at the termination of the maneuver. The distances required for acceleration on level roadways for passenger cars are given in Table 3 – ~~297~~ Design Lengths of Speed Change Lanes Flat Grades. Where acceleration occurs on a grade, the required distance is obtained by using Tables 3 – ~~3028~~ Ratio of Length of Speed Change Lane on Grade to Length on Level and ~~Table 3 – 3129~~ Minimum Acceleration Lengths for Entrance Terminals.

The final speed at the end of the acceleration lane, should, desirably, be assumed as the design speed of the through roadway. The length of acceleration lane provided should be at least as long as the distance required for acceleration between the initial and final speeds. Due to the uncertainties regarding vehicle capabilities and driver behavior, additional length is desirable. The acceleration lane should be followed by a merging taper (similar to Figure 3 – ~~2319~~ Termination of Merging Lanes), not less than that length set forth in Table 3 – 28 Length of Taper for Use in Conditions with Full Width Speed Change Lanes. The termination of acceleration lanes should conform to the general configuration shown for merging lanes in Figure 3 – ~~2219~~ Termination of Merging Lanes. Recommended acceleration lanes for freeway entrance terminals are given in Table 3 – 29 Minimum Acceleration Lengths for Entrance Terminals.

**Table 3 – 297 Design Lengths of Speed Change Lanes
 Flat Grades - 2 Percent or Less**

Design Speed of turning roadway curve (mph)	Stop Condition	15	20	25	30	35	40	45	50	
Minimum curve radius (feet)	---	55	100	160	230	320	430	555	695	
Design Speed of Highway (mph)	Length of Taper (feet)*	Total length of DECELERATION LANE, including taper, (feet)								
30	150	385	350	320	290	---	---	---	---	
35	170	450	420	380	355	320	---	---	---	
40	190	510	485	455	425	375	345	---	---	
45	210	595	560	535	505	460	430	---	---	
50	230	665	635	615	585	545	515	455	405	
55	250	730	705	690	660	630	600	535	485	
60	270	800	770	750	730	700	675	620	570	
65	290	860	830	810	790	760	730	680	630	
70	300	915	890	870	850	820	790	740	690	
Design Speed of Highway (mph)	Length of Taper (feet)*	Total length of ACCELERATION LANE, including taper (feet)								
30	120	300	260	---	---	---	---	---	---	
35	140	420	360	300	---	---	---	---	---	
40	160	520	460	430	370	280	---	---	---	
45	180	740	670	620	560	460	340	---	---	
50	210	930	870	820	760	660	560	340	---	
55	230	1190	1130	1040	1010	900	780	550	380	
60	250	1450	1390	1350	1270	1160	1050	800	670	
65	260	1670	1610	1570	1480	1380	1260	1030	860	
70	280	1900	1840	1800	1700	1630	1510	1280	1100	

* For urban street auxiliary lanes, shorter tapers may be used due to lower operating speeds. Refer to Figure 3-16 for allowable taper rates.

Table 3 – ~~3028~~ Ratio of Length of Speed Change Lane on Grade to Length on Level

Deceleration Lane			Acceleration Lane					
	Design Speed of Turning Roadway (mph)			Design Speed of Turning Roadway (mph)				
Design Speed of Highway (mph)	All Speeds 3% -4% Upgrade	All Speeds 3%-4% Downgrade	Design Speed of Highway (mph)	20	30	40	50	All Speeds
				3% - 4% Upgrade				3% - 4% Downgrade
All Speeds	0.9	1.2	40	1.3	1.3	---	---	0.7
			45	1.3	1.35	---	---	0.675
			50	1.3	1.4	1.4	---	0.65
			55	1.35	1.45	1.45	---	0.625
			60	1.4	1.5	1.5	1.6	0.6
			65	1.45	1.55	1.6	1.7	0.6
			70	1.5	1.6	1.7	1.8	0.6
	5% - 6% Upgrade	5% - 6% Downgrade		5% - 6% Upgrade				5% - 6% Downgrade
All Speeds	0.8	1.35	40	1.5	1.5	---	---	0.6
			45	1.5	1.6	---	---	0.575
			50	1.5	1.7	1.9	---	0.55
			55	1.6	1.8	2.05	---	0.525
			60	1.7	1.9	2.2	2.5	0.5
			65	1.85	2.05	2.4	2.75	0.5
			70	2.0	2.2	2.6	3.0	0.5
Ratios in this table multiplied by the values in Table 3 – 26 give the length of speed change lane for the respective grade.								

Table 3 – 3129 Minimum Acceleration Lengths for Entrance Terminals

Highway Design Speed (mph)	L = Acceleration Length (feet)								
	For Entrance Curve Design Speed (mph)								
	Stop Condition	15	20	25	30	35	40	45	50
30	180	140	---	---	---	---	---	---	---
35	280	220	160	---	---	---	---	---	---
40	360	300	270	210	120	---	---	---	---
45	560	490	440	380	280	160	---	---	---
50	720	660	610	550	450	350	130	---	---
55	960	900	810	780	670	550	320	150	---
60	1200	1140	1100	1020	910	800	550	420	180
65	1410	1350	1310	1220	1120	1000	770	600	370
70	1620	1560	1520	1420	1350	1,230	1000	820	580

Expressway and Freeway Entrance Terminals

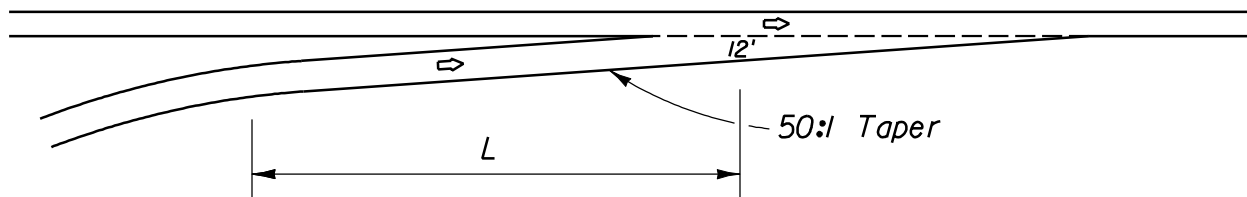

TAPER TYPE

Recommended when design speed at entrance curve is 50 mph or greater.

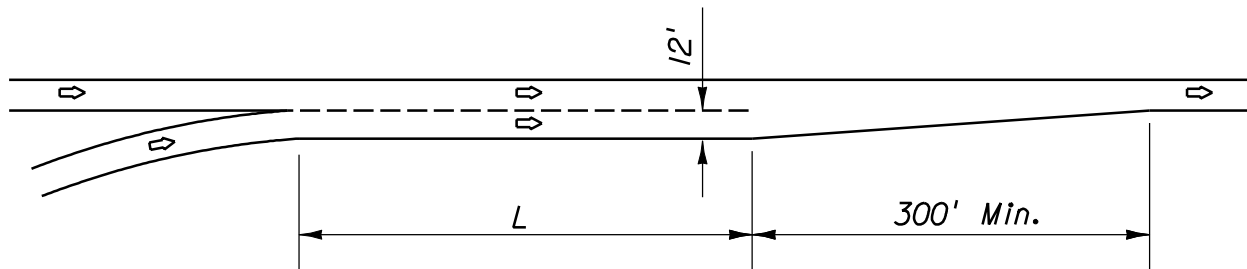

PARALLEL TYPE

Recommended when design speed at entrance curve is less than 50 mph.

C.9.c.3 Exit Lanes

Auxiliary lanes for exiting maneuvers provide space outside the through lanes for protection and storage of decelerating vehicles exiting the facility.

- Deceleration Lanes - The primary function of deceleration lanes is to provide a safe travel path for vehicles decelerating from the operating speed on the through lanes. Deceleration lanes are required for all freeway exits and are desirable on high-speed (design speed greater than 50 mph) streets and highways.

The distance required for deceleration of passenger cars is given in Table 3 – ~~32~~ Minimum Deceleration Lengths for Exit Terminals.

The required distance for deceleration on grades is given in Tables 3 – ~~297~~ Design Lengths of Speed Change Lanes Flat Grades - 2 Percent or Less and 3 – ~~3028~~ Ratio of Length of Speed Change Lane on Grade to Length on Level.

The length of deceleration lanes shall be no less than the values obtained from Tables 3 – ~~297~~ and 3 – ~~3028~~ and should be increased wherever feasible. The initial speed should, desirably, be taken as the design speed of the highway. The final speed should be the design speed at the exit (e.g., a turning roadway) or zero, if the deceleration lane terminates at a stop or traffic signal. A reduction in the final speed to be used is particularly important if the exit traffic volume is high since the speed of these vehicles may be significantly reduced.

The entrance to deceleration (and climbing) lanes should conform to the general configuration shown in Figure ~~3 – 239~~ Entrance for Deceleration Lane. The initial length of straight taper, shown in Table ~~3 – 3129~~ Minimum Acceleration Lengths for Entrance Terminals, may be utilized as a portion of the total required deceleration distance. The pavement surface of the deceleration lane should be clearly visible to approaching traffic, so drivers are aware of the maneuvers required. Recommended deceleration lanes for exit terminals are given in Table ~~3 – 329~~ Minimum Deceleration Lengths for Exit Terminals.

Table 3 – 329 Minimum Deceleration Lengths for Exit Terminals

Highway Design Speed (mph)	L = Deceleration Length (feet)								
	For Design Speed of Exit Curve (mph)								
	Stop Condition	15	20	25	30	35	40	45	50
30	235	200	170	140	---	---	---	---	---
35	280	250	210	185	150	---	---	---	---
40	320	295	265	235	185	155	---	---	---
45	385	350	325	295	250	220	---	---	---
50	435	405	385	355	315	285	225	175	---
55	480	455	440	410	380	350	285	235	---
60	530	500	480	460	430	405	350	300	240
65	570	540	520	500	470	440	390	340	280
70	615	590	570	550	520	490	440	390	340

Expressway and Freeway Exit Terminals

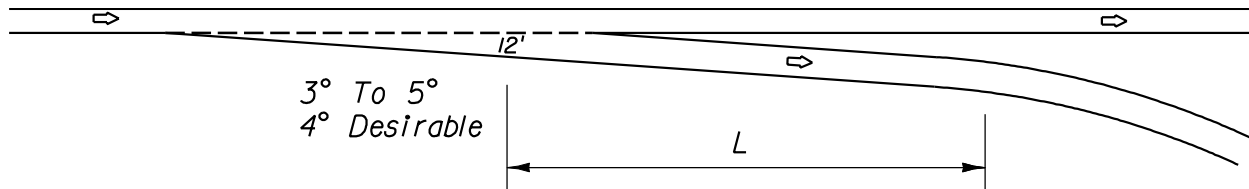

TAPER TYPE

Recommended when design speed at exit curve is 50 mph or greater and when approach visibility is good.

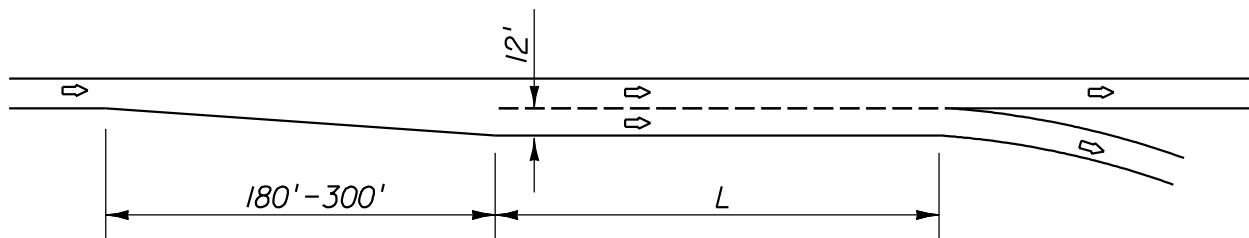

PARALLEL TYPE

Recommended when design speed at exit curve is less than 50 mph or when approach visibility is not good.

Figure 3 – ~~230~~ Entrance for Deceleration Lane

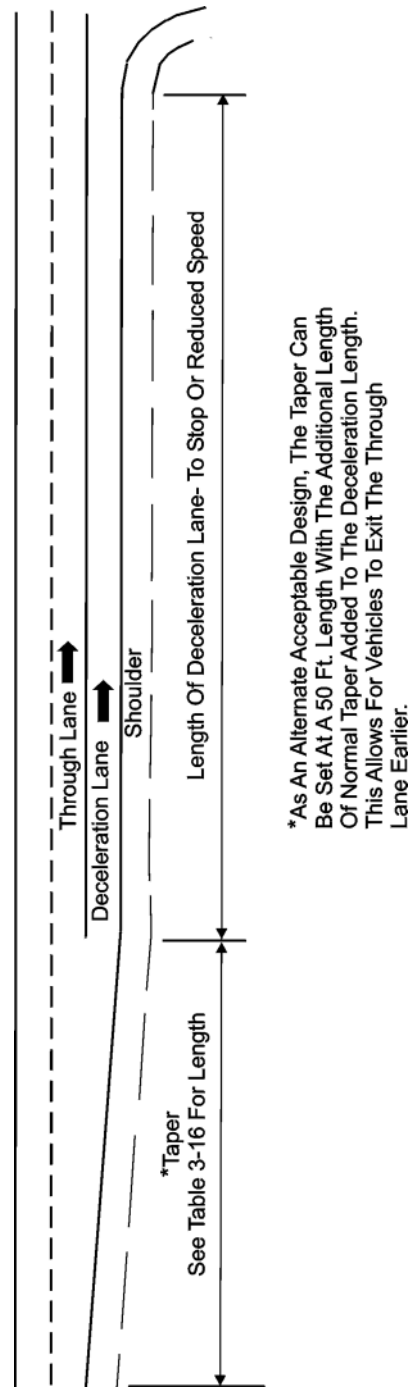

C.9.c.4 Auxiliary Lanes at Intersections

The primary function of auxiliary lanes at intersections is to accommodate speed changes and maneuvering of turning traffic. They are typically added to increase capacity and/or reduce crashes at an intersection. Auxiliary lanes for deceleration and storage of queuing vehicles are used preceding intersections and median openings for left-turning and right-turning movements. In some cases, auxiliary lanes for acceleration are used following right-turning movements.

C.9.c.4.(a) Widths of Auxiliary Lanes

The minimum widths for auxiliary lanes are given in Table 3 – 20 Minimum Lane Widths.

C.9.c.4.(b) Lengths of Auxiliary Lanes for Deceleration

Recommended lengths for auxiliary lanes for deceleration (turn lanes) at intersections are provided in Figure 3 – 24 Auxiliary Lanes for Deceleration at Intersections (Turn Lanes) and Table 3 – 33 Turn Lanes – Curbed and Uncurbed Medians. These lengths are based on ~~the Department~~ [FDOT](#) criteria. As shown in Figure ~~3 – 24~~ [3 – 24](#), the total length of turn lanes consists of three components, (1) Deceleration Length, (2) Storage or Queue Length and (3) Entering Taper. It is common practice to accept a moderate amount of deceleration within the through lanes and to consider the taper as part of the deceleration length. The length criteria for each of the auxiliary lane components are explained as follows:

Deceleration Length

The required total deceleration length is that needed for a safe and comfortable stop from the design speed of the highway. Minimum deceleration lengths (including taper) for auxiliary lanes are provided in Figure 3 – 24 and are based on minimum stopping sight distance.

Storage (Queue) Length

The auxiliary lane should be sufficiently long to store the number of vehicles likely to accumulate during a critical period. The storage length should be sufficient to avoid the possibilities of turning vehicles stopping in the through lanes or the entrance to the auxiliary lane being blocked by vehicles queuing in the through lanes.

At unsignalized intersections the storage length, exclusive of taper, may be based on the number of turning vehicles likely to arrive in an average two-minute period within the peak hour. For low volume intersections where a traffic study is not justified, a minimum 50-foot queue length (2 vehicles) should be provided on rural highways. A minimum 100-foot queue length (4 vehicles) should be provided in urban areas. Locations with over 10% truck traffic should accommodate at least one car and one truck.

At signalized intersections, the required storage length is determined by traffic study and depends on the signal cycle length, the signal phasing arrangement and the rate of arrivals and departures of turning vehicles. The storage length is a function of the probability of occurrence of events and should be based on 1.5 to 2 times the average number of vehicles that would store per cycle that is predicted in the design volume.

Where dual turning lanes are used, the required storage length is reduced to approximately one-half of that required for single-lane operation.

Approach End Taper

[The Departments](#) The FDOT's criteria for approach end taper lengths for turn lanes are 50 feet for a single turn lane and 100 feet for a double turn lane, as shown in Figure 3 - [2421](#) Auxiliary Lanes for Deceleration at Intersections (Turn Lanes) and Table 3 – 33 Turn Lanes – Curbed and Uncurbed Medians. These taper lengths apply to all design speeds and

are recommended for use on turn lanes on all roads. Short taper lengths are intended to provide approaching road users with positive identification of an added auxiliary lane and results in a longer full width auxiliary lane than use of longer taper lengths based on the path that road users actually follow. The clearance distances L_1 and L_3 account for the full transition lengths a road user will use to enter the auxiliary lane for various speed conditions assumed for design.

It is acceptable to lengthen the taper up to L_1 for single left turns and L_3 for double left turns where traffic study can establish that left turn queue vehicles are adequately provided for within the design queue length and through vehicle queues will not block access to the left turn lane(s).

Figure 3 – 241 Auxiliary Lanes for Deceleration at Intersections (Turn Lanes)

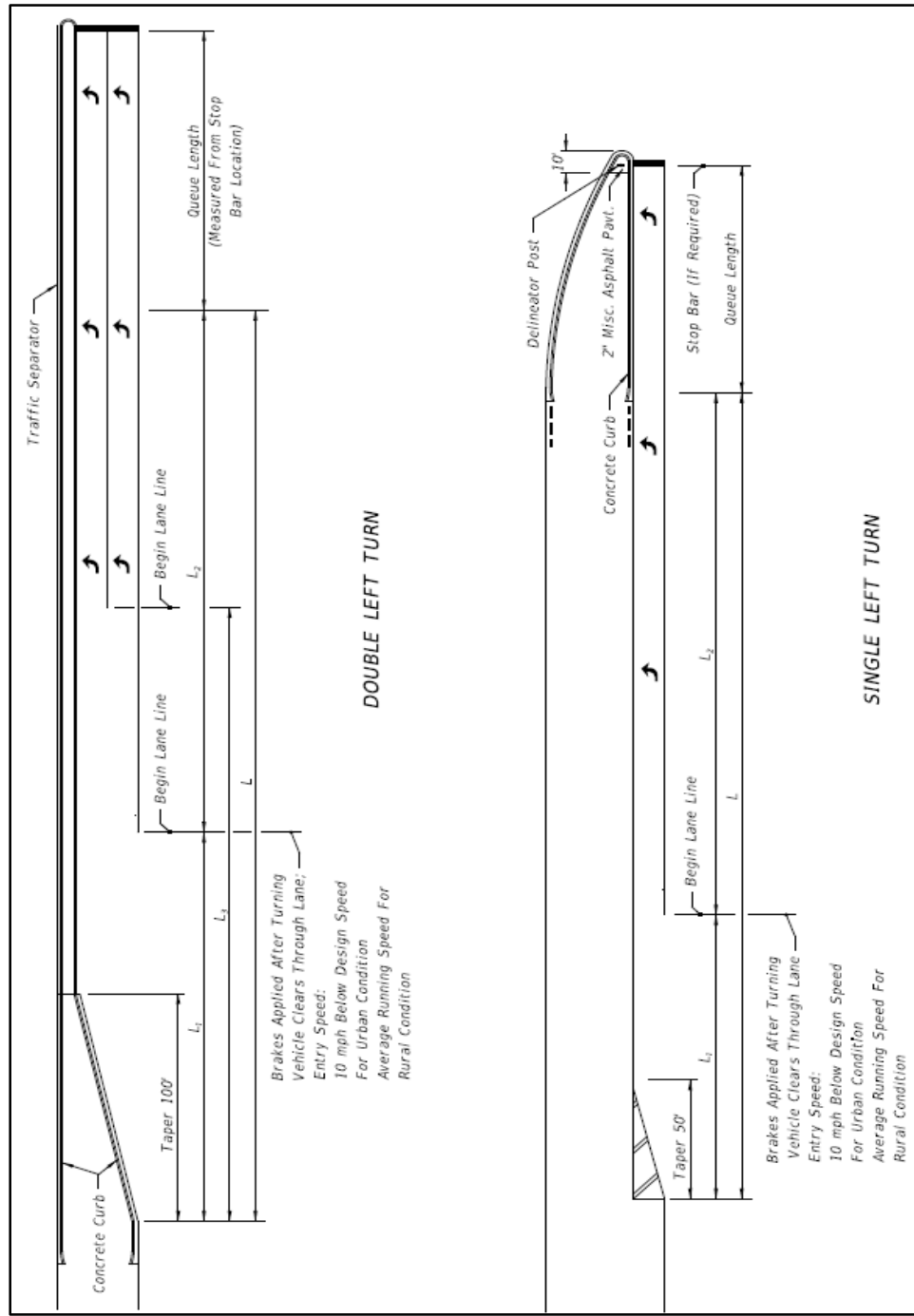

Table 3 – 331 Turn Lanes – Curbed and Uncurbed Medians

Design Speed (mph)	Entry Speed (mph)	Clearance Distance L ₁ (feet)	Urban Conditions			Rural Conditions		
			Brake to Stop Distance L ₂ (feet)	Total Decel. Distance L (feet)	Clearance Distance L ₃ (feet)	Brake to Stop Distance L ₂ (feet)	Total Decel. Distance L (feet)	Clearance Distance L ₃ (feet)
≤ 30	≤ 25	60	75	135	100			
35	25	70	75	145	110	----	----	----
40	30	80	75	155	120	----	----	----
45	35	85	100	185	135	----	----	----
50	40/44	105	135	240	160	185	290	160
55	48	125	----	----	----	225	350	195
60	52	145	----	----	----	260	405	230
65	55	170	----	----	----	290	460	270

Note: Right turn lane tapers and distances are identical to left turn lanes under stop control conditions. For free flow or yield control conditions, taper lengths and distances are site specific.

C.9.c.4.(c) Lengths of Auxiliary Lanes for Acceleration

Acceleration lanes similar to those used for freeways and expressways are sometimes used at intersections. They are not always desirable at stop-controlled intersections where entering drivers can wait for an opportunity to merge without disrupting through traffic. Acceleration lanes are advantageous on roads without stop control and on all high-volume roads even with stop control where openings between vehicles in the peak-hour traffic streams are infrequent and short. When used, acceleration lanes at intersections should be designed using the criteria provided in Section C.9.c.2 Acceleration Lanes.

C.9.d Turning Roadways at Intersections

The design and construction of turning roadways shall meet the same general requirements for through roadways, except for the specific requirements given in the subsequent sections.

C.9.d.1 Design Speed

Lanes for turning movements at grade intersections may, where justified, be based on a design speed as low as 10 mph. Turning roadways with design speeds in excess of 40 mph shall be designed in accordance with the requirements for through roadways.

A variable design speed may be used to establish cross section and alignment criteria for turning roadways that will experience acceleration and deceleration maneuvers.

C.9.d.2 Horizontal Alignment

- Curvature - The minimum permitted radii (maximum degree) of curvature for various values of superelevation are given in Table 3 – [342](#) Superelevation Rates for Curves at Intersections. These should be considered as minimum values only and the radius of curvature should be increased wherever feasible. Further information contained in **AASHTO – "A Policy on Geometric Design of Highways and Streets" - 2011**, should also be considered.

Table 3 – [342](#) Superelevation Rates for Curves at Intersections

	Design Speed (mph)					
	20	25	30	35	40	45
Minimum Superelevation Rate	0.02	0.04	0.06	0.08	0.09	0.10
Minimum Radius (feet)	90	150	230	310	430	540

The rate of 0.02 is considered the practical minimum for effective drainage across the surface.

Note: Preferably use superelevation rates greater than these minimum values.

- Superelevation Transition - Minimum superelevation transition (runoff) rates (maximum relative gradients) are

given in Tables 3 – [353](#) Maximum Rate of Change in Pavement Edge Elevation for Curves at Intersections and 3 – [364](#) Maximum Algebraic Difference in Pavement Cross Slope at Turning Roadway Terminals. Other information given in *AASHTO – "A Policy on Geometric Design of Highways and Streets" - 2011*, should also be considered.

Table 3 – [354](#) Maximum Rate of Change in Pavement Edge Elevation for Curves at Intersections

Design Speed (mph)	20	25	30	35	40	45	50	55	60	65	70
Maximum relative gradients for profiles between the edge of two lane pavement and the centerline (percent)	0.74	0.70	0.66	0.62	0.58	0.54	0.50	0.47	0.45	0.43	0.40

Table 3 – [364](#) Maximum Algebraic Difference in Pavement Cross Slope at Turning Roadway Terminals

Design Speed of Exit or Entrance Curve (mph)	Maximum Algebraic Difference in Cross Slope at Crossover Line (percent)
20 and under	5.0 to 8.0
25 and 30	5.0 to 6.0
35 and over	4.0 to 5.0

C.9.d.3 Vertical Alignment

Grades on turning roadways should be as flat as practical and long vertical curves should be used wherever feasible. The length of vertical curves shall be no less than necessary to provide minimum stopping sight distance. Minimum stopping sight distance values are given in Table 3 – 4 Minimum Stopping Sight Distances. For additional guidance on vertical alignment for turning roadways, see *AASHTO – "A Policy on Geometric Design of Highways and Streets" - 2011*.

C.9.d.4 Cross Section Elements

- Number of Lanes - One-way turning roadways are often limited to a single traffic lane. In this case, the total width of the roadway shall be sufficient to allow traffic to pass a disabled vehicle. Two-way, undivided turning roadways should be avoided. Medians or barriers should be utilized to separate opposing traffic on turning roadways.
- Lane Width - The width of all traffic lanes should be sufficient to accommodate (with adequate clearances) the turning movements of the expected types of vehicles. The minimum required lane widths for turning roadways are given in Table 3 - ~~375~~ Derived Pavement Widths for Turning Roadways for Different Design Vehicles. Changes in lane widths should be gradual and should be accomplished in coordination with adequate transitions in horizontal curvature.
- Shoulders - On one-lane turning roadways, serving expressways and other arterials (e.g., loops, ramps), the right hand shoulder should be at least 6 feet wide. The left hand shoulder should be at least 6 feet wide in all cases. On two-lane, one-way roadways, both shoulders should be at least 6 feet wide. Where guardrails or other barriers are used, they should be placed at least 8 feet from edge of travel lane. Guardrails should be placed 2 feet outside the normal shoulder width.
- Clear Zones - Turning roadways should, as a minimum, meet all open highway criteria for clear zones on both sides of the roadway. The areas on the outside of curves should be wider and more gently sloped than the minimum values for open highways. Guardrails or similar barriers shall be used if the minimum width and slope requirements cannot be obtained.

Further criteria and requirements for roadway design are given in **Chapter 4 - Roadside Design**.

Table 3 – 375 Derived Pavement Widths for Turning Roadways for Different Design Vehicles

Radius on Inner Edge of Pavement, R (feet)	Case 1, One-Lane Operation, No Provision for Passing a Stalled Vehicle												
	P	SU-30	Su-40	City Bus	S-Bus-36	A-Bus	WB-40	WB-62	WB-67	WB-67D	MH	P/T	P/B
50	13	18	21	21	18	22	23	44	57	29	18	19	18
75	13	17	18	19	17	19	20	30	33	23	17	17	17
100	13	16	17	18	16	18	18	25	28	21	16	16	16
150	12	15	16	17	16	17	17	22	23	19	15	16	15
200	12	15	16	16	15	16	16	20	21	18	15	15	15
300	12	15	15	16	15	16	15	18	19	17	15	15	15
400	12	15	15	15	15	15	15	17	18	16	15	15	14
500	12	14	15	15	14	15	15	17	17	16	14	14	14
Target	12	14	14	15	14	15	14	15	15	15	14	14	14

Table 3 – 375 Derived Pavement Widths for Turning Roadways for Different Design Vehicles (Con't)

Radius on Inner Edge of Pavement, R (feet)	Case II, One-Lane, One-Way Operation, with Provision for Passing a Stalled Vehicle by Another of the Same Type												
	P	SU-30	SU-40	City Bus	S-Bus-36	A-Bus	WB-40	WB-62	WB-67	WB-67D	MH	P/T	P/B
50	20	30	36	38	31	40	39	81	109	50	30	30	28
75	19	27	30	32	27	34	32	53	59	39	27	27	26
100	18	25	27	30	25	30	29	44	48	34	25	25	24
150	18	23	25	27	23	27	26	36	38	29	23	23	23
200	17	22	24	25	23	26	24	32	34	27	22	22	22
300	17	22	22	24	22	24	23	28	30	25	22	22	21
400	17	21	22	23	21	23	22	26	27	24	21	21	21
500	17	21	21	23	21	23	22	25	26	23	21	21	21
Target	17	20	20	21	20	21	20	21	21	21	20	20	20

Radius on Inner Edge of Pavement, R (feet)	Case III, Two-Lane Operation, Either One- or Two-Way (Same Type Vehicle in Both Lanes)												
	P	SU-30	SU-40	City Bus	S-Bus-36	A-Bus	WB-40	WB-62	WB-67	WB-67D	MH	P/T	P/B
50	26	36	42	44	37	46	45	87	115	56	36	36	34
75	25	33	36	38	33	40	38	59	65	45	33	33	32
100	24	31	33	35	31	36	35	50	54	40	31	31	30
150	24	29	31	33	29	33	32	42	44	35	29	29	29
200	23	28	30	31	29	32	30	38	40	33	28	28	28
300	23	28	28	30	28	30	29	34	36	31	28	28	27
400	23	27	28	29	27	29	28	32	33	30	27	27	27
500	23	27	27	29	27	29	28	31	32	29	27	27	27
Target	23	26	26	27	26	27	28	27	27	27	26	26	26

Source – 2011 AASHTO Greenbook, Table 3-28b Derived Pavement Widths for Turning Roadways for Different Design Vehicle

C.9.e At Grade Intersections

C.9.e.1 Turning Radii

Where right turns from through or turn lanes will be negotiated at low speeds (less than 10 mph), the minimum turning capabilities of the vehicle may govern the design. It is desirable that the turning radius and the required lane width be provided in accordance with the criteria for turning roadways. The radius of the inside edge of traveled way should be sufficient to allow the expected vehicles to negotiate the turn without encroaching the shoulder or adjacent traffic lanes.

Where turning roadway criteria are not used, the radius of the inside edge of traveled way should be no less than 25 feet. The use of three-centered compound curves is also a reasonable practice to allow for transition into and out of the curve. The recommended radii and arrangement of compound curves instead of a single simple curve is given in *AASHTO – "A Policy on Geometric Design of Highways and Streets" - 2011*.

C.9.e.2 Cross Section Correlation

The correlation of the cross section of two intersecting roadways is frequently difficult. A careful analysis should be conducted to ensure changes in slope are not excessive and adequate drainage is provided. At stop-controlled intersections, the through roadway cross section should be carried through the intersection without interruption. Minor roadways should approach the intersection at a slightly reduced elevation so the through roadway cross section is not disturbed. At signalized intersections, it is sometimes necessary to remove part of the crown in order to avoid an undesirable hump in one roadway.

Intersections of grade or cross slope should be gently rounded to improve vehicle operation. Pavement generally should be sloped toward the intersection corners to provide superelevation for turning maneuvers and to promote proper drainage.

Where islands are used for channelization, the width of traffic lanes for turning movements shall be no less than the widths recommended by AASHTO.

C.9.e.3 Median Openings

Median openings should be restricted in accordance with the requirements presented in C.8 Access Control, this chapter. Where a median opening is required, the length of the opening shall be no less than 40 feet. Median curbs should be terminated gradually without the exposure of abrupt curb ends. The termination requirements are given in ***Chapter 4 - Roadside Design***.

C.9.e.4 Channelization

Channelization of at grade intersections is the regulation or separation of conflicting movements into definite travel paths by islands, markings, or other means, to promote safe, orderly traffic flow. The major objective of channelization is to clearly define the appropriate paths of travel and thus assist in the prevention of vehicles deviating excessively or making wrong maneuvers. Channelization may be used effectively to define the proper path for exits, entrances, and intersection turning movements. The methods used for channelization should be as simple as possible and consistent in nature. The channelized intersection should appear open and natural to the approaching driver. Channelization should be informative rather than restrictive in nature.

The use of low sloping curbs and flush medians and islands can provide adequate delineation in most cases. Islands should be clearly visible and, in general, should not be smaller than 100 square feet in area. The use of small and/or numerous islands should be avoided.

Pavement markings are a useful and effective tool for providing delineation and channelization in an informative rather than restrictive fashion. The layout of all traffic control devices should be closely coordinated with the design of all channelization.

C.9.f Driveways

Direct driveway access within the area of influence of the intersection should be discouraged.

Driveways from major traffic generators (greater than 400 vpd), or those with significant truck/bus traffic, should be designed as normal intersections.

C.9.g Interchanges

The design of interchanges for the intersection of a freeway with a major street or highway, collector/distributor road, or other freeway is a complex problem. The location and spacing of intersections should follow the requirements presented in C.8 Access Control, this chapter. The design of interchanges shall follow the general intersection requirements for deceleration, acceleration, merging maneuvers, turning roadways, and sight distance.

Interchanges, particularly along a given freeway, should be reasonably consistent in their design. A basic principle in the design should be to develop simple open interchanges that are easily traversed and understandable to the driver. Complex interchanges with a profusion of possible travel paths are confusing and hazardous to the motorist and are generally inefficient.

Intersections with minor streets or highways or collector/distributor roads may be accomplished by simple diamond interchanges. The intersection of exit and entrance ramps with the crossroad shall meet all intersection requirements.

The design of freeway exits should conform to the general configurations given in Table 3 – ~~320~~ Minimum Deceleration Lengths for Exit Terminals. Exits should be on the right and should be placed on horizontal curves. Where deceleration on an exit loop is required, the deceleration alignment should be designed so the driver receives adequate warning of the approaching increase in curvature. This is best accomplished by gradually increasing the curvature and the resulting centrifugal force. This increasing centrifugal force provides warning to the driver that he must slow down. A clear view of the exit loop should also be provided. The length of deceleration shall be no less than the values shown in Table – ~~29~~.

Entrances to freeways should be designed in accordance with the general configurations shown below Table 3 – ~~3120~~ Minimum Acceleration Lengths for Entrance Terminals. Special care should be taken to ensure vehicles entering from loops are not directed across through travel lanes. The entering roadway should be brought parallel (or nearly so) to the through

lanes before entry is permitted. Where acceleration is required, the distances shown in Table 3 – ~~3129~~ shall, as a minimum, be provided. Exits and entrances to all high-speed facilities (design speed greater than 50 mph), should, where feasible, be designed in accordance with Tables 3 – ~~320~~ and 3 – ~~3129~~. The lengths obtained from Tables 3 – ~~320~~ and 3 – ~~3129~~ should be adjusted for grade by using the ratios in Table 3 – ~~3028~~.

The selection of the type and exact design details of a particular interchange requires considerable study and thought. The guidelines and design details given in **AASHTO "A Policy on Geometric Design of Highways and Streets" - 2011**, should generally be considered as minimum criteria.

C.9.h Clear Zone

The provisions of ample clear zone or proper redirection of energy absorbing devices is particularly important at intersections. Every effort should be made to open up the area around the intersection to provide adequate clear zone for vehicles that have left the traveled way. Drivers frequently leave the proper travel path due to unsuccessful turning maneuvers or due to the necessity for emergency avoidance maneuvers. Vehicles also leave the roadway after intersection collisions and roadside objects should be removed to reduce the probability of second impacts. The roadside areas at all intersections and interchanges should be contoured to provide shallow slopes and gentle changes in grade.

The roadside clear zone of intersecting roadways should be carried throughout intersections with no discontinuities or interruptions. Poles and support structures for lights, signs, and signals should not be placed in medians or within the roadside clear zone.

The design of guardrails or other barriers should receive particular attention at intersections. Impact attenuators should be used in all gore and other areas where structures cannot be removed.

Particular attention should be given to the protection of pedestrians in intersection areas - **Chapter 8 - Pedestrian Facilities**. Further criteria and requirements for clear zone and protection devices at intersections are given in **Chapter 4 - Roadside Design**.

C.10 Other Design Factors

C.10.a Pedestrian Facilities

The layout and design of the street and highway network should include provisions for pedestrian traffic in urban areas. All pedestrian crossings and pathways within the road right of way should be considered and designed as in integral part of any street or urban highway.

C.10.a.1 Policy and Objectives - New Facilities

The planning and design of new streets and highways shall include provisions for the safe, orderly movement of pedestrian traffic.

The overall objective is to provide a safe, continuous, convenient, and comfortable trip for pedestrian traffic.

C.10.a.2 Accessibility Requirements

Pedestrian facilities, such as sidewalks, shared use paths, underpasses, overpasses, and transit boarding and alighting areas shall be designed to accommodate people with disabilities. In addition to the design criteria provided in this Manual, the [United States Department of Transportation ADA Standards for Transportation Facilities \(2006\)](#) and [Department of Justice ADA Standards \(2010\)](#) as required by 49 C.F.R 37.41 or 37.43; and the [2020 Florida Building Code – Accessibility, 7th Edition](#) as required by [Rule Chapter 61G20-4.002, Florida Administrative Code](#) impose additional requirements for the design and construction of pedestrian facilities. [The Proposed Public Rights-of-Way Accessibility Guidelines \(PROWAG\) provides additional information on the design of accessible pedestrian facilities.](#)

C.10.a.3 Sidewalks [and Shared Use Paths](#)

Sidewalks should provide a safe, comfortable space for pedestrians. The width of sidewalks is dependent upon the roadside environment, volume of pedestrians, and the presence of businesses, schools, parks, and other pedestrian attractors. The minimum [and recommended widths](#) for sidewalks [and shared use paths](#) is covered in [**Chapter 8 – Pedestrian Facilities**](#) and [**Chapter 9 –**](#)

Bicycle Facilities. ~~Section C.7.d of this chapter.~~ To ensure compliance with federal and state accessibility requirements for sidewalks:

- Sidewalks less than 60 inches wide must have passing spaces of at least 60 inches by 60 inches, at intervals not to exceed 200 feet.
- The minimum clear width may be reduced to 32 inches for a short distance. This distance must be less than 24 inches long, and separated by 5-foot long sections with 48 inches of clear width.
- Sidewalks not constrained within the roadway right of way with slopes greater than 1:20 are considered ramps and must be designed as such.

~~Sidewalks 5 feet wide or wider will provide for two adults to walk comfortably side by side.~~

C.10.a.4 — Curb Ramps

~~In areas with sidewalks, curb ramps must be incorporated at locations where crosswalks adjoin the sidewalks. The basic curb ramp type and design application depends on the geometric characteristics of the intersection or other crossing location.~~

~~Typical curb ramp width shall be a minimum of 4 feet with 1:10 curb transitions on each side when pedestrians must walk across the ramp. Ramp slopes shall not exceed 1:120 and shall have a firm, stable, slip resistant surface texture. Ramp widths equal to crosswalk widths are encouraged.~~

~~Curb ramps at marked crossings shall be wholly contained within the crosswalk markings excluding any flared sides.~~

~~If diagonal ramps must be used, any returned curbs or other well-defined edges shall be parallel to the pedestrian flow. The bottom of diagonal curb ramps shall have 48-inch minimum clear space within the crosswalk. Curb ramps whose sides have returned curbs provide useful directional cues where they are aligned with the pedestrian~~

~~street crossing and are protected from cross travel by landscaping or street, street furniture, or railings.~~

~~It is important for persons using the sidewalk that the location of the ramps be as uniform as possible. Detectable warnings are required at all curb ramps and flush transitions where sidewalks or shared use paths meet a roadway.~~

~~The Department's Standard Plans, Index 522-002, provides additional information on the design of accessible sidewalks and shared use paths. Designers should keep in mind there are many variables involved, possibly requiring each street intersection to have a unique design.~~

~~Two ramps per corner are preferred to minimize the problems with entry angle and to decrease the delay to pedestrians entering and exiting the roadway.~~

C.10.a.5 — Additional Considerations

~~For additional information on pedestrian facilities design, including physical separation from the roadway, over and underpasses, pedestrian crossings, traffic control, sight distance and lighting, refer to **Chapter 8 — Pedestrian Facilities**.~~

C.10.b Bicycle Facilities

Provisions for bicycle traffic should be incorporated into the street or highway design. All new roadways and major corridor improvements, except limited access highways, should be designed and constructed under the assumption they will be used by bicyclists. Roadway conditions should be favorable for bicycling. This includes appropriate drainage grates, pavement markings, and railroad crossings, smooth pavements, and signals responsive to bicycles. In addition, facilities such as bicycle lanes, shared use paths, and paved shoulders, should be included to the fullest extent feasible. All flush shoulder arterial and collector roadway sections should be given consideration for the construction of 4-foot or 5-foot paved shoulders. In addition, all curbed arterial and collector sections should be given consideration for bicycle lanes.

For additional information on bicycle facilities design and the design of shared use paths, refer to **Chapter 9 – Bicycle Facilities**.

C.10.c Bridge Design Loadings

The minimum design loading for all new and reconstructed bridges shall be in accordance with **Chapter 17 – Bridges and Other Structures**.

C.10.d Dead End Streets and Cul-de-Sacs

The end of a dead-end street should permit travel return with a turnaround area, considering backing movements, which will accommodate single truck or transit vehicles without encroachment upon private property. Recommended treatment for dead end streets and cul-de-sacs is given in Figure 5-1 Types of Cul-de-Sacs and Dead-End Streets of **AASHTO – "A Policy on Geometric Design of Highways and Streets" - 2011**.

C.10.e Bus Benches and Transit Shelters

Bus benches should be set back at least 10 feet from the travel lane in curbed sections with a design speed of 45 mph or less, and outside the clear zone in flush shoulder sections. See **Chapter 4 – Roadside Design**, Table 4 – 2 Lateral Offset for further information.

Any bus bench or transit shelter adjacent to a sidewalk within the right of way of any street or highway shall be located so as to leave at least 48 inches of clearance for pedestrians and persons in wheelchairs. An additional one foot of clearance is required when any side of the sidewalk is adjacent to a curb or barrier. Such clearance shall be measured in a direction perpendicular to the centerline of the road. A separate bench pad or sidewalk flare out that provides a 30-inch-wide by 48-inch-deep wheelchair space adjacent to the bench shall be provided. Transit shelters should be set back, rather than eliminated during roadway widening.

Additional information on the design of transit facilities is found in **Chapter 13 – Public Transit**.

C.10.f Traffic Calming

Often there are community concerns with controlling travel speeds

impacting the safety of a street or highway such as in areas of concentrated pedestrian activities, those with narrow right of way, areas with numerous access points, on street parking, and other similar concerns. Local authorities may elect to use traffic calming design features that could include, but not be limited to, the installation of speed humps, speed tables, chicanes, or other pavement undulations. Roundabouts are also another method of dealing with this issue at intersections. For additional details and traffic calming treatments, refer to **Chapter 15 – Traffic Calming**.

C.11 Reconstruction

C.11.a Introduction

The reconstruction (improvement or upgrading) of existing facilities may generate equal or greater safety benefits than similar expenditures for the construction of new streets and highways. Modifications to increase capacity should be evaluated for the potential effect on the highway safety characteristics. The long-range objectives should be to bring the existing network into compliance with current standards.

C.11.b Evaluation of Streets and Highways

The evaluation of the safety characteristics of streets and highways should be directed towards the identification of undesirable features on the existing system. Particular effort should be exerted to identify the location and nature of features with a high crash potential. Methods for identifying and evaluating hazards include the following:

- Identification of any geometric design feature not in compliance with minimum or desirable standards. This could be accomplished through a systematic survey and evaluation of existing facilities.
- Review of conflict points along a corridor.
- Information from maintenance or other personnel.
- Review of crash reports and traffic counts to identify locations with a large number of crashes or a high crash rate.
- Review for expected pedestrian and bicycle needs.

C.11.c Priorities

A large percentage of street and highway reconstruction and improvements is directed toward increasing efficiency and capacity. The program of reconstruction should be based, to a large extent, upon priorities for the improvement of safety characteristics.

The priorities for safety improvements should be based on the objective of obtaining the maximum reduction in crash potential for a given expenditure of funds. Elimination of conditions that may result in serious or fatal crashes should receive the highest priority in the schedule for reconstruction.

Specific high priority problem areas that should be corrected by reconstruction include the following:

- Obstructions to sight distance which can be economically corrected. The removal of buildings, parked vehicles, vegetation, large poles or groups of poles that significantly reduce the field of vision, and signs to improve sight distance on curves and particularly at intersections, can be of immense benefit in reducing crashes. The purchase of required line of sight easements is often a wise expenditure of highway funds. The establishment of sight distance setback lines is encouraged.
- Roadside and median hazards which can often be removed or relocated farther from the traveled way. Where removal is not feasible, objects should be shielded by redirection or energy absorbing devices. The reduction of the roadside hazard problem generally provides a good return on the safety dollar. Details and priorities for roadside hazard reduction, which are presented in **Chapter 4 – Roadside Design**, should be incorporated into the overall priorities of the reconstruction program.
- Poor pavement surfaces which have become hazardous should be maintained or reconstructed in accordance with the design criteria set forth in **Chapter 5 – Pavement Design And Construction**, and **Chapter 10 – Maintenance And Resurfacing**.
- Specific design features which could be applied during reconstruction to enhance the operations and safety characteristics of a roadway include the following:
- Addition of lighting.

- Frontage roads may be utilized to improve the efficiency and safety of streets and highways with poor control of access.
- Widening of pavements and shoulders. This is often an economically feasible method of increasing capacity and reducing traffic hazards. Provision of median barriers (**Chapter 4 - Roadside Design**) can also produce significant safety benefits.
- The removal, streamlining, or modification of drainage structures.
- Alignment modifications are usually extensive and require extensive reconstruction of the roadway. Removal of isolated sharp curves is a reasonable and logical step in alignment modification. If major realignment is to be undertaken, every effort should be made to bring the entire facility into compliance with the requirements for new construction.
- The use of traffic control devices. This is generally an inexpensive method of alleviating certain highway defects.
- Median opening modifications.
- Addition of median, channelized islands, and mid-block pedestrian crossings.
- Auxiliary lanes.
- Existing bridges that fail to meet current design standards which are available to bicycle traffic, should be retrofitted on an interim basis as follows: As a general practice, bridges 125 feet in length or longer, bridges with unusual sight problem, steep gradients (which require the cyclist longer time to clear the span) or other unusual conditions should display the standard W11-1 caution sign with an added sign "On Bridge" at either end of the structure. Special care should be given to the right most portion of the roadway, where bicyclists are expected to travel, assuring smoothness, pavement uniformity, and freedom from longitudinal joints, and to ensure cleanliness. Failure to do so forces bicyclists farther into the center portion of the bridge, reducing traffic flow and safety.
- Addition of bicycle facilities.
- Addition of transit facilities, sidewalks, crosswalks, and other pedestrian features.

C.12 Design Exceptions

See **Chapter 14 - Design Exceptions and Variations** for the process to use when the standard criteria found in this Manual cannot be met.

C.13 Very Low-Volume Local Roads (ADT \leq 400)

Where criteria is not specifically provided in this section, the design guidelines presented in Chapter 4 of the [AASHTO Guidelines for Geometric Design of Very Low-Volume Local Roads \(ADT \$\leq\$ 400\), 1st Edition \(2001\)](#) may be used in lieu of the policies in Chapter 5 of the AASHTO Policy on Geometric Design of Highways and Streets. See Table 3 – 20 Minimum Lane Widths for lane widths for very low volume roads.

C.13.a Bridge Width

Bridges are considered functionally obsolete when the combination of ADT and bridge width is used in the National Bridge Inventory Item 68 for Deck Geometry to give a rating of 3 or less. To accommodate future traffic and prevent new bridges from being classified as functionally obsolete, the minimum roadway width for new two lane bridges on very low-volume roads with 20 year ADT between 100 and 400 vehicles/day shall be a minimum of 22 feet. If the entire roadway width (traveled way plus shoulders) is paved to a width greater than 22 feet, the bridge width should be equal to the total roadway width. If significant ADT increases are projected beyond twenty years, a bridge width of 28 feet should be considered. One-lane bridges may be provided on single-lane roads and on two-lane roads with ADT less than 100 vehicles/day where a one-lane bridge can operate effectively. The roadway width of a one-lane bridge shall be 15 ft. One-lane bridges should have pull-offs visible from opposite ends of the bridge where drivers can wait for traffic on the bridge to clear.

C.13.b Roadside Design

Bridge traffic barriers on very low-volume roads must have been successfully crash tested to a Test Level 2 (minimum) in accordance with NCHRP Report 350 or Manual for Assessing Safety Hardware (MASH).

THIS PAGE INTENTIONALLY LEFT BLANK

CHAPTER 4

ROADSIDE DESIGN

A	INTRODUCTION	4-1
B	ROADSIDE TOPOGRAPHY AND DRAINAGE FEATURES	4-4
	B.1 Roadside Slopes, Clear Zone and Lateral Offset.....	4-4
	B.1.a Roadside Slopes and Clear Zone	4-4
	B.1.b Lateral Offset	4-12
	B.2 Drainage Features	4-16
	B.2.a Roadside Ditches.....	4-16
	B.2.b Drainage Structures	4-16
	B.2.c Canals and Water Bodies	4-17
	B.2.d Curb.....	4-20
C	ROADSIDE SAFETY FEATURES AND CRASH TEST CRITERIA.....	4-22
	C.1 Crash Test Criteria.....	4-22
	C.2 Safety Hardware Upgrades.....	4-26
D	SIGNS, SIGNALS, LIGHTING SUPPORTS, UTILITY POLES, TREES AND SIMILAR ROADSIDE FEATURES	4-27
	D.1 General	4-27
	D.2 Performance Requirements for Breakaway Devices.....	4-27
	D.3 Sign Supports	4-27
	D.4 Traffic Signal Supports.....	4-28
	D.5 Lighting Supports	4-28
	D.5.a Conventional Lighting	4-28
	D.5.b High Mast Lighting	4-29
	D.6 Utility Poles	4-29
	D.7 Trees.....	4-30
	D.8 Miscellaneous	4-30
	D.8.a Fire Hydrants	4-30
	D.8.b Railroad Crossing Warning Devices	4-30
	D.8.c Mailbox Supports	4-30

	D.8.d	Bus Benches and Shelters.....	4-33
E		BARRIERS, APPROACH TREATMENTS AND CRASH CUSHIONS	4-34
	E.1	Roadside Barriers	4-34
	E.2	End Treatments	4-34
	E.3	Crash Cushions	4-35
	E.4	Performance Requirements	4-35
	E.5	Warrants	4-35
	E.5.a	Above Ground Hazards	4-36
	E.5.b	Drop-Off Hazards.....	4-36
	E.5.c	Canals and Water Bodies	4-36
	E.6	Warrants for Median Barriers	4-36
	E.7	Temporary Barriers in Work Zones	4-37
	E.8	Barrier Types	4-39
	E.8.a	Guardrail	4-39
	E.8.b	Concrete Barrier.....	4-40
	E.8.c	High Tension Cable Barrier.....	4-41
	E.8.d	Temporary Barrier.....	4-42
	E.8.e	Selection Guidelines	4-43
	E.8.f	Placement.....	4-43
	E.8.f.1	Barrier Offsets	4-43
	E.8.f.2	Deflection Space and Zone of Intrusion	4-46
	E.8.f.3	Grading	4-46
	E.8.f.4	Curbs.....	4-46
	E.8.f.5	Flare Rate	4-46
	E.8.f.6	Length of Need.....	4-47
	E.8.g	Barrier Transitions.....	4-48
	E.8.h	Attachments to Barriers	4-48
E.9		End Treatments and Crash Cushions	4-48
	E.9.a	End Treatments for Guardrail.....	4-48
	E.9.b	End Treatments for Rigid Barrier	4-50
	E.9.c	End Treatments for High Tension Cable Barrier (HTCB) ...	4-50
	E.9.d	End Treatments for Temporary Barrier	4-50
	E.9.e	Crash Cushions	4-51

F	BRIDGE RAILS	4-52
G	ROADSIDE DESIGN IN WORK ZONES	4-52
G.1	Clear Zone Width in Work Zones	4-52
G.2	Above ground Hazards in Work Zones	4-53
G.3	Non-Traversable Edge Drop-Offs, Critical Slopes and Roadside Excavations.....	4-54
G.4	Temporary Barriers in Work Zones	4-56
H	REFERENCES FOR INFORMATIONAL PURPOSES	4-57

TABLES

<u>Table 4 – 1</u>	<u>Minimum Width of Clear Zone (feet)¹ (Curbed and Flush Shoulder Roadways)</u>	<u>4-6</u>
<u>Table 4 – 2</u>	<u>Lateral Offset (feet).....</u>	<u>4-15</u>
<u>Table 4 – 3</u>	<u>Test Levels for Barriers, End Terminals, Crash Cushions</u>	<u>4-24</u>
<u>Table 4 – 4</u>	<u>Test Levels for Breakaway Devices, Work Zone Traffic Control Devices.....</u>	<u>4-25</u>
<u>Table 4 – 5</u>	<u>Clear Zone Width Requirements for Work Zones</u>	<u>4-53</u>
<u>Table 4 – 6</u>	<u>Device Requirements for Edge Drop-Offs</u>	<u>4-55</u>

FIGURES

Figure 4 – 1	Clear Zone Plan View	4-7
Figure 4 – 2	Basic Clear Zone Concept	4-8
Figure 4 – 3	Adjusted Clear Zone Concept.....	4-8
Figure 4 – 4	Roadside Ditches – Bottom Width 0 to < 4 Feet	4-10
Figure 4 – 5	Roadside Ditches – Bottom Width ≥ 4 Feet	4-11
Figure 4 – 6	Minimum Offsets for Canal Hazards (Flush Shoulders)	4-19

Figure 4 – 7 Minimum Offsets for Canal Hazards (Curbed) 4-20

Figure 4 – 8 Location of Guardrail..... 4-44

Figure 4 – 9A End Treatment Usage When End of Guardrail is Within Clear Zone of Approaching Near Lane 4-49

Figure 4 – 9B Approach Terminal Usage When End of Guardrail is Within Clear Zone of Approaching Far Lane (2-Lane, 2-Way Road Shown)..... 4-50

Figure 4 – 10 Drop-Off Condition Detail 4-54

Topic # 625-000-015

2023

~~2018~~

Manual of Uniform Minimum Standards
for Design, Construction and Maintenance
for Streets and Highways

THIS PAGE INTENTIONALLY LEFT BLANK

CHAPTER 4

ROADSIDE DESIGN

A INTRODUCTION

This chapter presents guidelines and standards for roadside designs intended to reduce the likelihood and/or consequences of roadside crashes. Due to the variety of causative factors, the designer should review crash reports for vehicles leaving the traveled way at any location. On average, lane departure crashes in Florida represent approximately 1/3 of all crashes and almost 50% of all highway fatalities. Construction and maintenance of safe medians and roadsides are of vital importance in the development of safe streets and highways. More information on lane departure crashes in Florida can be found in [the ~~the~~ ~~FDOT's~~ ~~Department's~~ Florida Strategic Highway Safety Plan](#).

Many of the standards presented in **Chapter 3 – Geometric Design** are predicated to a large extent upon reducing the probability of vehicles leaving the proper travel path. The intent of this chapter is to reduce the consequences of crashes by vehicles leaving the roadway. The design of the roadside beyond the shoulder should be considered and conducted as an integral part of the total highway design.

The general objective of roadside design is to provide an environment that will reduce the likelihood and/or consequences of crashes by vehicles that have left the traveled way. The achievement of this general objective will be aided by the following:

- Roadside areas adequate to allow reasonable space and time for a driver to regain or retain control of the vehicle and stop or return to the traveled way safely.
- Shoulders, medians, and roadsides that may be traversed safely without vehicle vaulting or overturning.
- Location of roadside fixed objects and hazards as far from the travel lane as is economically feasible.
- Roadsides that accommodate necessary maintenance vehicles, emergency maneuvers and emergency parking.
- Providing adequate shielding of hazards where appropriate and compatible with vehicle speeds and other design variables.

Topic # 625-000-015

2023

~~2018~~

Manual of Uniform Minimum Standards
for Design, Construction and Maintenance
for Streets and Highways

Prior to any other consideration, the designer should, in order of preference, attempt to:

1. Eliminate the hazard
 - a. Remove the hazard
 - b. Redesign the hazard so it can be safely traversed
 - c. Relocate the hazard outside the clear zone
2. Make the hazard crashworthy
3. Shield the hazard with a longitudinal barrier or crash cushion.
4. Delineate the hazard and leave the hazard unshielded. This treatment is taken only when the barrier or crash cushion is more hazardous than the hazard. See Section E.5 for information on making this determination.

This chapter contains standards and general guidelines for situations encountered in roadside design due to the variety and complexity of possible situations encountered. In addressing roadside hazards, the designer should utilize the following as basic guidelines to develop a safe roadside design.

B ROADSIDE TOPOGRAPHY AND DRAINAGE FEATURES

B.1 Roadside Slopes, Clear Zone, and Lateral Offset

Providing a sufficient amount of recoverable slope or clear zone adjacent to the roadway, free of obstacles and hazards provides an opportunity for an errant vehicle to safely recover. Minimum standards for roadside slopes, clear zone and lateral offsets to hazards are provided as follows.

B.1.a Roadside Slopes and Clear Zone

The slopes of all roadsides should be as flat as possible to allow for safe traversal by out of control vehicles. A slope of 1:4 or flatter should be used, desirably 1:6 or flatter. The transition between the shoulder and adjacent side slope should be rounded and free from discontinuities. A slope as steep as 1:3 may be used within the clear zone if the clear zone width is adjusted to provide a clear runout area as described below. If sufficient right of way exists, use flatter side slopes on the outside of horizontal curves.

Clear zone is the unobstructed, traversable area beyond the edge of the traveled way for the recovery of errant vehicles. The clear zone includes shoulders and bicycle lanes. The clear zone shall follow the requirements for clear zone and lateral offset shown in this manual.~~must be free of aboveground fixed objects, water bodies and non-traversable or critical slopes.~~ Clear zone width requirements are dependent on AADT, design speed, and roadside slope conditions. With regard to the ability of an errant vehicle to traverse a roadside slope, slopes are classified as follows:

1. Recoverable Slope – Traversable Slope 1:4 or flatter. Motorists who encroach on recoverable foreslopes generally can stop their vehicles or slow them enough to return to the roadway safely.
2. Non-Recoverable Slope – Traversable Slope steeper than 1:4 and flatter than 1:3. Non-recoverable foreslopes are traversable but most vehicles will not be able to stop or return to the roadway easily. Vehicles on such slopes typically can be expected to reach the bottom.
3. Critical Slope – Non-Traversable Slope steeper than 1:3. A critical foreslope is one on which an errant vehicle has a higher propensity to overturn.

Clear zone widths for recoverable foreslopes 1V:4H and flatter are provided in Table 4 – 1 Minimum Width of Clear Zone. Clear zone is applied as shown in Figures 4 – 1 Clear Zone Plan View and 4 – 2 Basic Clear Zone Concept. Clear zone is measured from the edge of the traveled way.

On non-recoverable slopes steeper than 1:4 and flatter than 1:3, a high percentage of encroaching vehicles will reach the toe of these slopes. Therefore, the clear zone distance cannot logically end at the toe of a non-recoverable slope. When such non-recoverable slopes are present within the clear zone width provided in Table 4 – 1, additional clear zone width is required. The minimum amount of additional width provided must equal the width of the non-recoverable slope with no less than 10 feet of recoverable slope provided at the toe of the non-recoverable slope. See Figure 4 – 3 Adjusted Clear Zone Concept.

When clear zone requirements cannot be met, see **Sections C, D** and **E** for requirements for roadside barriers and other treatments for safe roadside design. In addition, the [AASHTO Roadside Design Guide \(2011\)](#), and [AASHTO Guidelines for Geometric Design of Very Low Volume Local Roads \(ADT ≤ 400\) \(2001\)](#) may be referenced for a more thorough discussion of roadside design.

2018

Table 4 – 1 Minimum Width of Clear Zone (feet)¹
(Curbed and Flush Shoulder Roadways)

Design Speed mph	AADT ≥ 1500			AADT < 1500 ^{1,2}		
	Travel Lanes & Multilane Ramps		Aux Lanes and Single Lane Ramps	Travel Lanes & Multilane Ramps		Aux Lanes and Single Lane Ramps
	1V:6H or flatter	1V:5H to 1V:4H	1V:4H or flatter	1V:6H or flatter	1V:5H to 1V:4H	1V:4H or flatter
≤ 40	14	16	10	10 ²	12 ²	10 ²
45 – 50	20	24	14	14	16	14
55	22	26	18	16	20	14
60	30	30 ³	24	20	26	18
65 – 70	30	30 ³	24	24	28	18

1. Clear Zone for roads functionally classified as Local Roads with a design AADT ≤ 400 vehicles per day:
 - a. A clear zone of 6 feet or more in width must be provided if it can be done so with minimum social/environmental impacts.
 - b. Where constraints of cost, terrain, right of way, or potential social/environmental impacts make the provision of a 6 feet clear zone impractical, clear zones less than 6 feet in width may be used, including designs with 0 feet clear zone.
 - c. In all cases, clear zone must be tailored to site-specific conditions, considering cost-effectiveness and safety tradeoffs. The use of adjustable clear zone widths, such as wider clear zone dimensions at sharp horizontal curves where there is a history of run-off-road crashes, or where there is evidence of vehicle encroachments such as scarring of trees or utility poles, may be appropriate. Lesser values of clear zone width may be appropriate on tangent sections of the same roadway.
 - d. Other factors for consideration in analyzing the need for providing clear zones include the crash history, the expectation for future traffic volume growth on the facility, and the presence of vehicles wider than 8.5 feet and vehicles with wide loads, such as farm equipment.
2. May be reduced to 7 feet for a design AADT < 750 vehicles per day.
3. Greater clear zone widths provide additional safety for higher speed and volume roads. See Section 3.1 of the [AASHTO Roadside Design Guide \(2011\)](#) for further information.

Source: Table 3 – 1, Suggested Clear Zone Distances in Feet from the Edge of the Travel Lane, 2011 AASHTO Roadside Design Guide.

Figure 4 – 1 Clear Zone Plan View

Two Lane, Two -Way Roadway

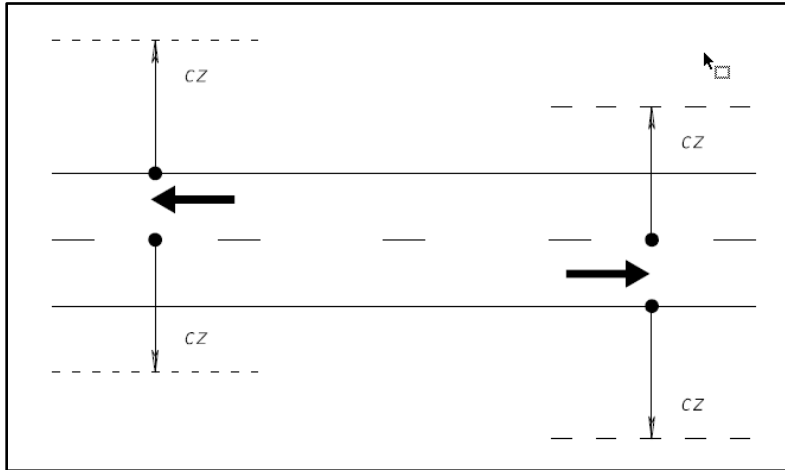

Multi-Lane Two-Way Roadway

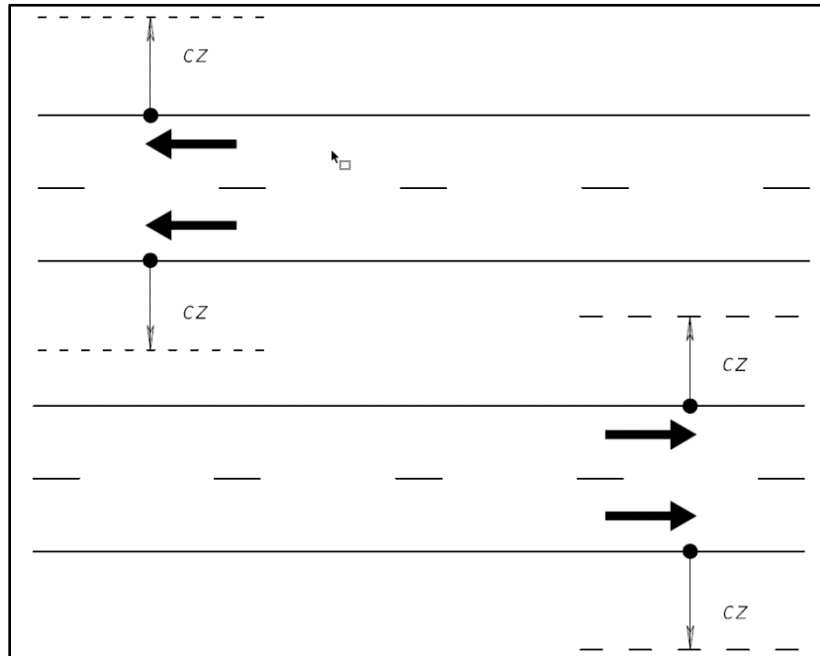

Note: 1. Lateral offset is measured out from the centerline of roadway and edge of traveled way or face of curb to a roadside object or feature.

Figure 4 – 2 Basic Clear Zone Concept

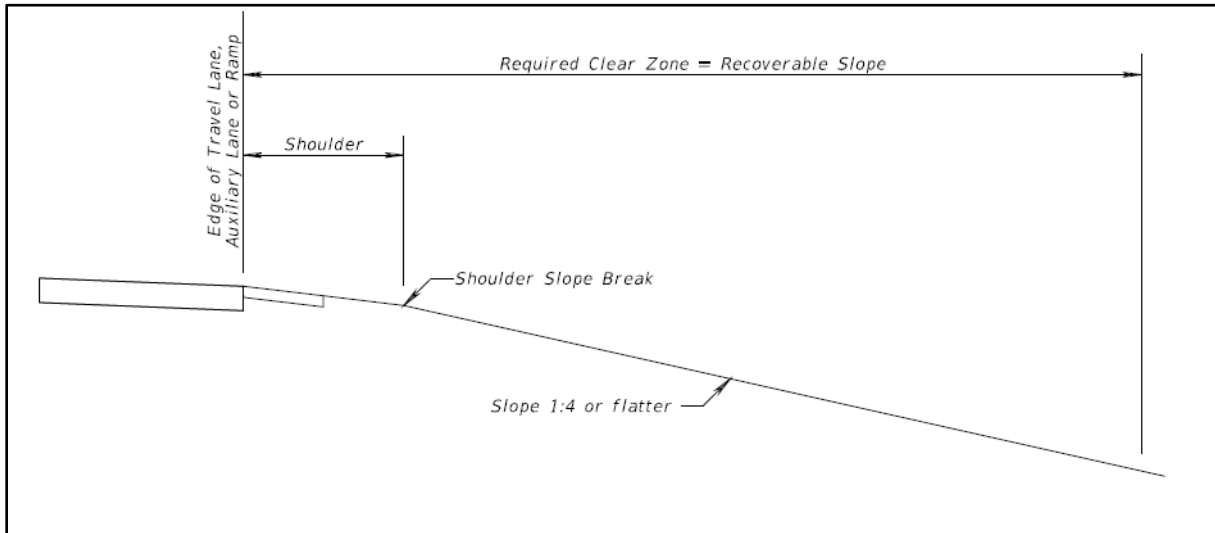
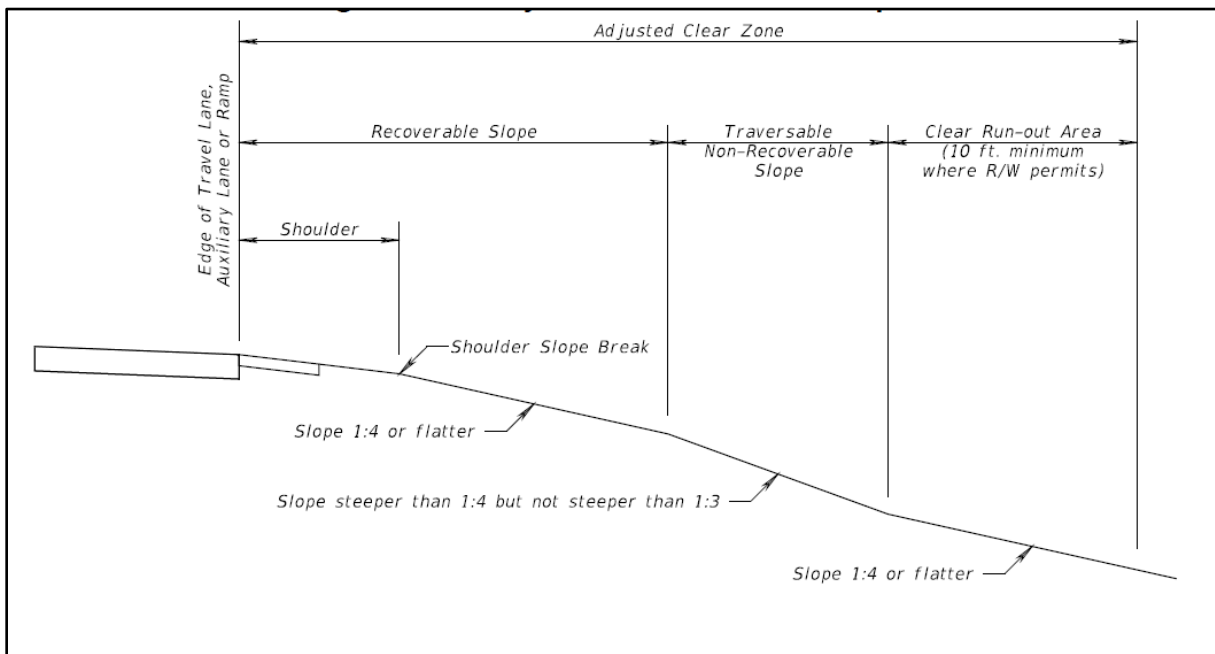
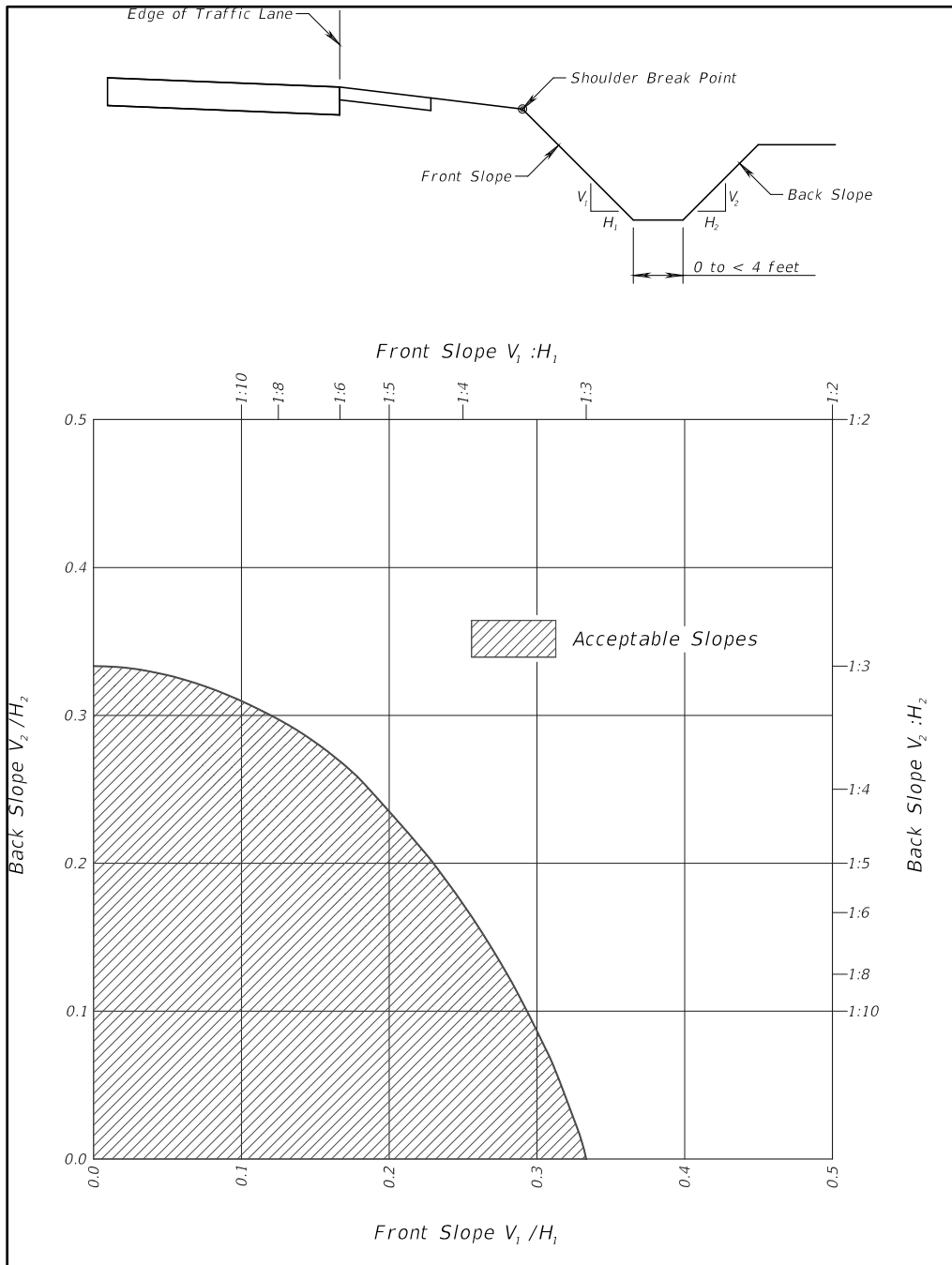

Figure 4 – 3 Adjusted Clear Zone Concept



Roadside ditches may be included within the clear zone if properly designed to be traversable. Acceptable cross section slope criteria for roadside ditches within the clear zone is provided in Figure 4 – 4 Roadside Ditches – Bottom Width 0 to < 4 Feet and Figure 4 – 5 Roadside Ditches – Bottom Width \geq 4 Feet. These roadside ditch configurations are considered traversable.

Figure 4 – 4 Roadside Ditches – Bottom Width 0 to < 4 Feet



Source: Figure 3 – 6, 2011 AASHTO Roadside Design Guide.

Figure 4 – 5 Roadside Ditches – Bottom Width \geq 4 Feet

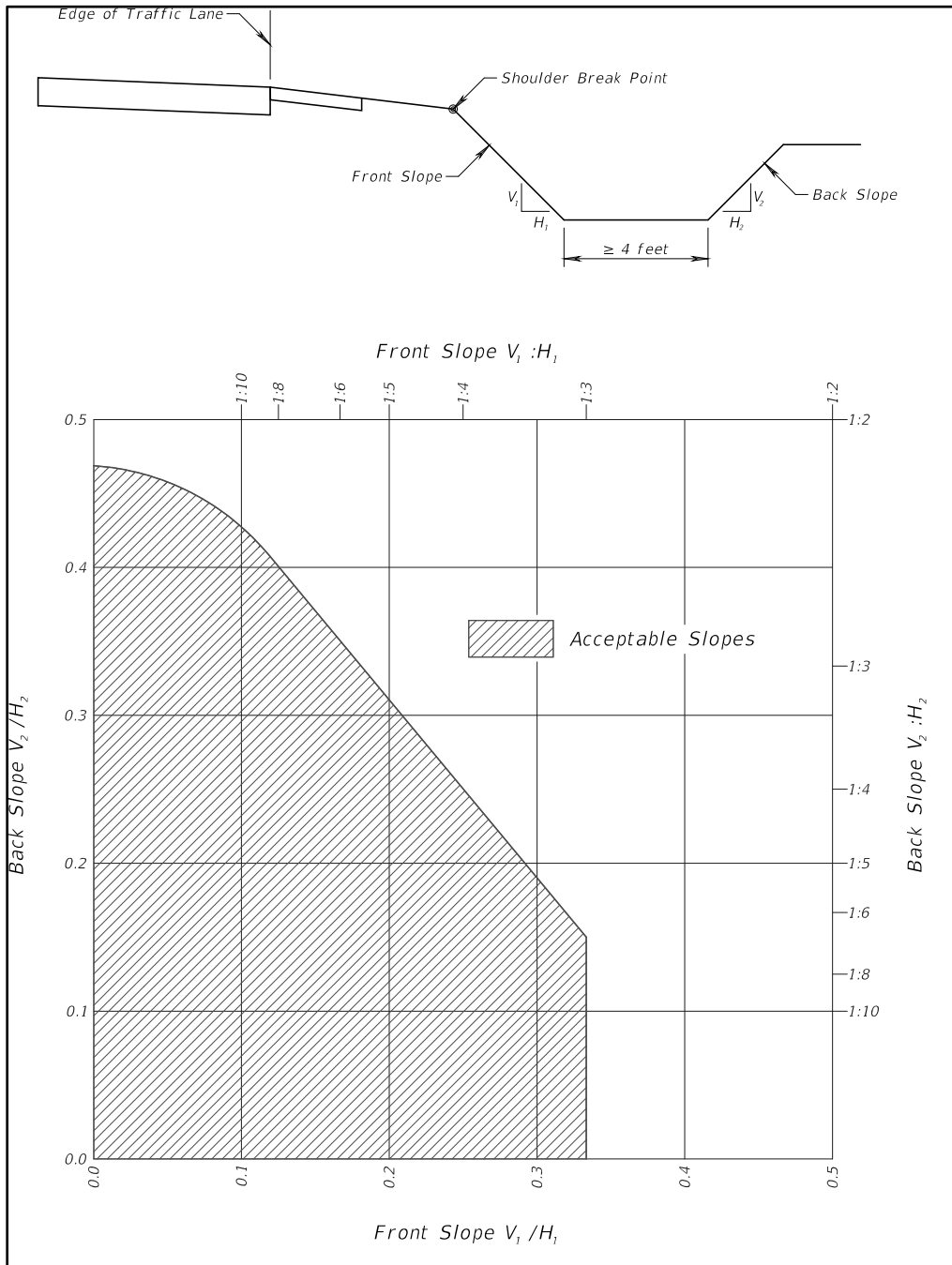

Source: Figure 3 – 6, 2011 AASHTO Roadside Design Guide.

B.1.b Lateral Offset

Lateral offset is the distance from a specified point on the roadway to a roadside hazard. Lateral offset to the roadside hazard is measured as follows:

- Curbed roadways - from face of curb.
- Flush shoulder and high-speed curbed roadways - from outside edge of traveled way.

Lateral offsets apply to all roadways and are determined based on the following:

- Type of facility, i.e., flush shoulder or curbed roadway.
- Design speed.
- Design element.
- Project type, i.e., New Construction, Resurfacing (RRR).

Flush shoulder roadways typically have sufficient right of way to provide the required clear zone widths. Therefore, minimum lateral offset for these roadways is based on maintaining a clear roadside for errant vehicles to recover (i.e., maintaining clear zone width provided in Table 4 – 1 Minimum Width of Clear Zone).

Lateral offsets for curbed roadways should be based on clear zone criteria; however, curbed roadways typically do not have sufficient right of way to provide the required clear zone widths. Therefore, minimum lateral offset on these roadways is based on offset needed for normal operation of the roadway.

At times, it may be necessary to place poles (e.g., signal, light, sign) within the sidewalk. Refer to Chapter 8 – Pedestrian Facilities for minimum unobstructed sidewalk width requirements. Table 4 – 2 Lateral Offset provides minimum lateral offset criteria for roadside features and roadside hazards typically encountered and considered functionally necessary for normal operation of the roadway, e.g., signing, lighting, landscaping, and utilities.

For crashworthy objects, meet or exceed the minimum lateral offset criteria provided in Table 4 – 2 Lateral Offset. Locate objects that are not crashworthy as close to the right of way line as practical and no closer than the minimum lateral offset criteria provided. When a roadside hazard is placed behind a barrier that is justified for other reasons, the minimum lateral offset to the object equals the setback requirements (deflection distance) of the barrier. Additional information on barrier placement and permissible attachments can be found in the *FDOT Design Manual, Chapter 215.*

~~Lateral offset is the lateral distance from a specified point on the roadway such as the edge of traveled way or face of curb, to a roadside feature or above ground object that is more than 4 inches above grade. Lateral offset requirements apply to all roadways. The requirements for various objects or features are based on:~~

- ~~• Design speed,~~
- ~~• Location, i.e., rural areas or within urban boundary,~~
- ~~• Flush shoulder or with curb,~~
- ~~• Traffic volumes, and~~
- ~~• Lane type, e.g., travel lanes, auxiliary lanes, and ramps.~~

~~Lateral Offset requirements are provided in Table 4 – 2 Lateral Offset.~~

~~Flush shoulder roadways typically have sufficient right of way to provide the required clear zone widths. Therefore, lateral offset requirements for these type roadways are based on providing the clear zone widths provided in Table 4 – 1. Minimum Width of Clear Zone.~~

~~On urban curbed roadways with design speeds \leq 45 mph, lateral offsets based on Table 4 – 1 clear zone requirements should be provided where practical. However, these urban low speed roads are typically located in areas where right of way is restricted (characterized by more dense abutting development, presence of parking, closer spaced intersections and accesses to property, and more bicyclists and pedestrians). The available right of way is typically insufficient to provide the required clear zone widths. Therefore, lateral offset requirements for above ground objects on these roadways are based on offsets needed for normal operation and not on maintaining a clear roadside for errant vehicles.~~

Topic # 625-000-015

2023

~~2018~~

Manual of Uniform Minimum Standards
for Design, Construction and Maintenance
for Streets and Highways

Table 4 – 2 Lateral Offset (feet)

Roadside Feature	Urban Curbed Roadways Design Speed ≤ 25 (mph)	Urban Curbed Roadways Design Speed ≤ 45 (mph)	All Other
Above Ground Objects ¹	<u>1.5 ft. from Face of Curb^{3,4}</u>	4 ft. from Face of Curb ^{2,4}	Clear Zone Width
Drop Off Hazards ^{5,3}	<u>Clear Zone Width</u>	Clear Zone Width	Clear Zone Width
Water Bodies	<u>Clear Zone Width</u>	Clear Zone Width	Clear Zone Width
Canal Hazards	<u>See Section B.2.c</u>	See Section B.2.c	See Section B.2.c

1. Above ground objects are anything greater than 4 inches in height and are firm and unyielding or do not meet crashworthy or breakaway criteria. For urban curbed areas ≤ 45 mph this also includes crashworthy or breakaway objects except those necessary for the safe operation of the roadway.

2. May be reduced to 1.5 ft. from Face of Curb on roads functionally classified as Local Streets and, on all roads, where the 4 ft. minimum offset cannot be reasonably obtained and other alternatives are deemed impractical. For very low-volume roads, ≤ 400 vpd, a minimum of 1.5 feet of clearance is desirable but may be reduced to 6" from the face of curb where the corridor is constrained. [AASHTO's Guidelines for Geometric Design of Very Low-Volume Local Roads \(ADT ≤ 400\), 2001](#) provides additional information.

3. May only be used in areas where development patterns and land use would qualify as an Urban Center or Urban Core Context Classification.

a. Urban Center - Mix of uses set within small blocks with a well-connected roadway network. Typically concentrated around a few blocks and identified as part of the community, town, or city of a civic or economic center.

b. Urban Core - Areas with the highest densities and with building heights typically greater than four floors. Many are regional centers and destinations. Buildings have mixed uses, are built up to the roadway, and are within a well-connected transportation network.

2.4. A design variation for failure to meet clear zone criteria is not required for existing, low speed, curbed roadways if the requirements for the placement of above ground fixed objects are met.

3.5. Drop off hazards are:

a. Any vertical faced structure with a drop off (e.g., retaining wall, wing-wall, etc.) located within the Clear Zone.

b. Slopes steeper than 1:3 located within the Clear Zone.

c. Drop-offs with significant crash history.

B.2 Drainage Features

Drainage design is an important aspect of the long-term performance of a roadway, and to achieve an effective design, drainage features are necessary in close proximity to travel lanes. These features include ditches, curbs, and drainage structures (e.g., transverse/parallel pipes, culverts, endwalls, wingwalls, and inlets). The placement of these features is to be evaluated as part of roadside safety design. Refer to **Chapter 20 – Drainage** for information regarding proper hydraulic design.

When evaluating the design of roadside topography and drainage features, consider the future maintenance implications of the facility. Routine maintenance or repairs needed to ensure the continued function of the roadway slopes or drainage may lead to long-term expenses and activities, which disrupts traffic flow and exposes maintenance personnel to traffic conditions.

B.2.a Roadside Ditches

Minimum standards for side slopes and bottom widths of roadside ditches and channels within the clear zone are provided in Section B.1.a.

B.2.b Drainage Structures

Drainage structures and their associated end treatments located along the roadside should be implemented using either a traversable design or located outside the required clear zone. The various drainage inlets and pipe end treatments needed for an efficient drainage design typically contain curb inlets, ditch bottom inlets, endwalls, wingwalls, headwalls, flared end sections and/or mitered end sections. If not adequately designed or properly located, these features can create hazardous conditions (e.g., abrupt deceleration or rollovers) for vehicles. For detailed background information concerning traversable designs, refer to the [AASHTO Roadside Design Guide](#).

Standard details for drainage structures and end treatments commonly used in Florida are provided in the FDOT's [Standards Plans](#). Drainage features shown in the FDOT's [Standard Plans](#) have the potential for conflict with a [motor vehicle](#) [or bicyclist](#) either departing the roadway or within a commonly traversed section of a roadway. [The](#) FDOT's [The](#)

[Department's Drainage Manual](#) identifies those standard drainage structures which are acceptable for use within the clear zone.

B.2.c Canals and Water Bodies

Roadside canals and other bodies of water close to the roadway should be eliminated wherever feasible. When not feasible, they should be located outside of the clear zone as shown in Table 4 – 1 Minimum Width of Clear Zone. If the body of water meets the definition of a canal hazard, additional lateral offset is required for arterial and collector roadways.

A canal hazard is defined as an open ditch parallel to the roadway for a minimum distance of 1,000 feet and with seasonal water depth more than 3 feet for extended periods of time (24 hours or more). Other conditions shall be evaluated using clear zone conditions.

Canal hazard lateral offset is the distance from the edge of travel lane, auxiliary lane, or ramp to the top of the canal side slope nearest the road. Minimum required lateral offset distances are as follows:

- Not less than 60 feet for flush shoulder and curbed roadways with design speeds of 50 mph or greater.
- Not less than 50 feet for flush shoulder roadways with design speeds of 45 mph or less.
- Not less than 40 feet for curbed roadways with design speeds of 45 mph or less.

See also Figure 4 – 6 Minimum Offsets for Canal Hazards (Flush Shoulders) and Figure 4 – 7 Minimum Offsets for Canal Hazards (Curb and Curb and Gutter). On new alignments and/or for new canals, greater distances should be provided to accommodate future widening of the roadway.

On fill sections, a flat berm (maximum 1:10 slope) no less than 20 feet in width between the toe of the roadway front slope and the top of the canal side slope nearest the roadway should be provided.

When the slope between the roadway and the "extended period of time" water surface is 1:6 or flatter, the minimum distance can be measured from

the edge of the travel lane, auxiliary lane, or ramp to the "extended period of time" water surface. A berm is not required.

On sections with ditch cuts, a minimum of 20 feet between the toe of the front slope and the top of the canal side slope nearest the roadway should be provided.

When the required minimum lateral offset cannot be met, the canal hazard shall be shielded with a crashworthy roadside barrier. Barriers shall be located as far from the traveled way as practical. When shielding canal hazards the barrier shall be located outside the clear zone where possible. Guardrail shall be located no closer than 6 feet from the canal front slope and high tension cable barrier shall be no closer than 15 feet from the canal front slope.

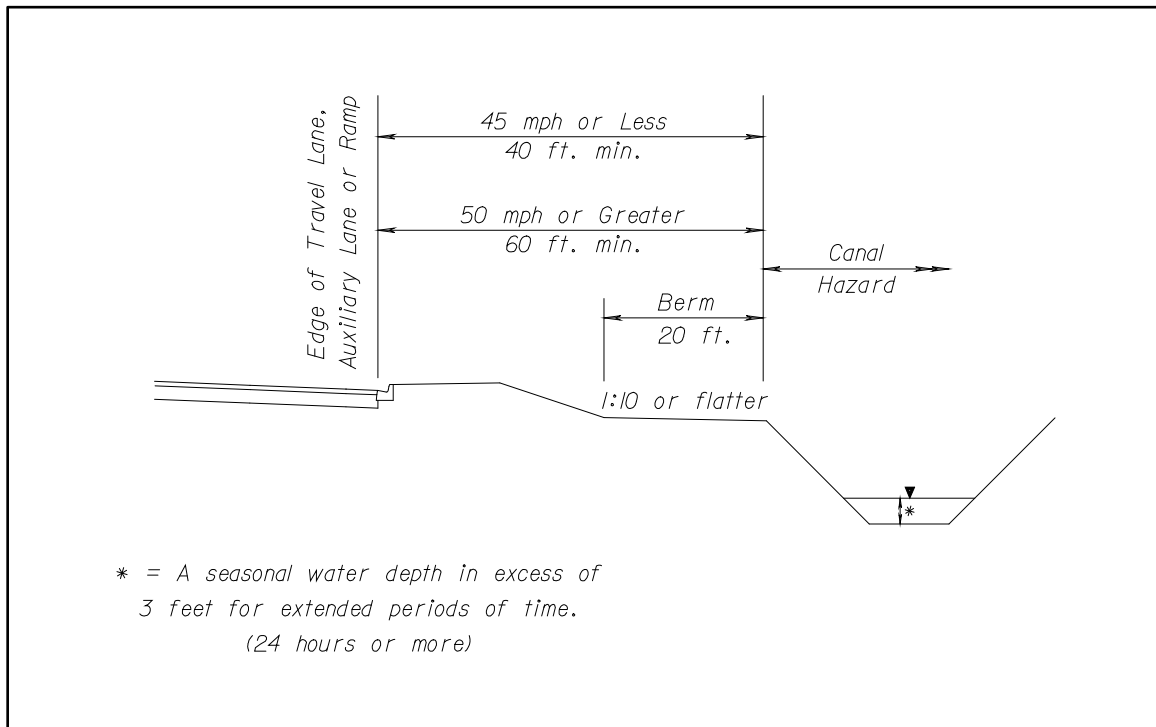
Figure 4 – 7 Minimum Offsets for Canal Hazards (Curbed)**B.2.d Curb**

Curbs with closed drainage systems are typically used in urban areas to minimize the amount of right of way needed. Curbs also provide a tangible definition of the roadway limits and delineation of access points. These functions are important in urban areas because of the following typical characteristics:

- Low design speed (Design Speed \leq 45 mph).
- Dense abutting development.
- Closely spaced intersections and accesses to property.
- Higher number of motorized vehicles, bicyclists, and pedestrian volumes.
- Restricted right of way.

Chapter 3 – Geometric Design provides criteria on the use of curbs. It should be noted that curbs have no redirection capabilities except at very low speeds; less than the lowest design speeds typically used for urban streets. Therefore, curbs are not considered to be effective in shielding a hazard and are not to be used to reduce lateral offset requirements.

The FDOT's [Standard Plans](#) provide ~~standard~~ details for curb shapes commonly used in Florida. Typical applications for urban roadways include Type E and Type F curbs. Both curb types have a sloped face; however, the Type E has a flatter face to allow vehicles to traverse it more easily. Shoulder gutter is also frequently used along roadway fill sections and bridge approaches to prevent excessive runoff down embankment slopes. The FDOT's [The Department's Drainage Manual](#) may be referenced for direction on the use of shoulder gutter.

Curb types such as Type E (height 5" or less with a sloping face equal to or flatter than the Type ~~E~~) may be used in the following cases on high speed roadways. The face of the curb shall be placed no closer to the edge of the traveled way than the required shoulder width.

- High speed multilane divided highways with design speeds of 55 mph and less. For examples see the [FDOT Department's Design Manual, Chapter 210 Arterials and Collectors](#).
- Directional Median Openings. For examples see the [FDOT Department's Design Manual, Chapter 212 Intersections](#).
- Transit Stops (harmonize with flush shoulder accessible transit stops).

C ROADSIDE SAFETY FEATURES AND CRASH TEST CRITERIA

While a traversable and unobstructed roadside is highly desirable from a safety standpoint, some appurtenances near the traveled way are necessary. Man-made fixed objects that frequently occupy road rights-of-way include traffic signs, traffic signals, roadway lighting, railroad warning devices, intelligent transportation systems (ITS), utility poles, and mailboxes. Other features include safety hardware such as barriers, end treatments and crash cushions which are often necessary to shield errant motorists from a variety of roadside hazards.

These features are in addition to trees and other vegetation often present, either naturally occurring or as part of landscaping. Applicable criteria for each of these features is presented in the following sections. Certain features are required to meet specific crash test criteria involving full scale crash testing.

C.1 Crash Test Criteria

Crash test criteria for roadside safety features has been in existence since 1962. [**NCHRP Report 350, Recommended Procedures for the Safety Performance Evaluation of Highway Features**](#), published in 1993, has been the accepted criteria for safety hardware device testing for many years. Changes have occurred in vehicle design, hardware performance, and testing methodologies, which have led to improvements in crash barrier and roadside design.

More recently, the [**AASHTO Manual for Assessing Safety Hardware \(MASH\)**](#) was published and has superseded [**NCHRP Report 350**](#) as the most current criteria. To allow adequate time for the testing and development of features under MASH criteria, safety hardware installed on new and reconstruction projects shall meet [**NCHRP Report 350**](#) crash test criteria as a minimum. For projects on the National Highway System, a schedule has been established for implementing requirements for devices meeting MASH criteria. For more information see FHWA's web site for [**Roadway Departure Safety**](#). New and reconstruction projects not on the National Highway System are not required to conform to this implementation schedule, but should comply to the extent practical.

[**The FDOT**](#)~~The Department~~ maintains standard details, specifications, and approved products for all types of roadside devices commonly used in Florida that meet the required crash test criteria, and are acceptable for use on all public

roadways. Non-proprietary, standardized devices are detailed in the [FDOT's ~~'Departments Standard Plans~~](#). Proprietary products are included on [the FDOT's ~~the Department's~~ Approved Product List \(APL\)](#). These devices address the majority of roadside needs for all roads in Florida. The most current version of the [Design Standard Plans](#) and [APL](#) should be used as the [FDOT Department](#) maintains and updates these publications as necessary to comply with required implementation dates for changes in crash test criteria.

For cases where a device may be needed that is not covered by the [FDOT's ~~Department's~~](#) standards and approved products, the Federal Highway Administration (FHWA) maintains lists of eligible crashworthy devices, which can be found on their website for [Roadway Departure Safety](#). In addition, the AASHTO-Associated General Contractors of America (AGC)-American Road and Transportation Builders Association (ARTBA), [Task Force 13 Guide to Standardized Roadside Safety Hardware](#) provides engineering drawings for a multitude of barrier components and systems.

The criteria for crash testing specified in [NCHRP Report 350](#) and [AASHTO MASH](#) provides six Test Levels (TL-1 thru TL-6) for the evaluation of roadside hardware suitability. A test level is defined by impact speed and angle of approach, and the type of test vehicle. Test vehicles range in size from a small car to a loaded tractor trailer truck. Each Test Level provides an increasing level of service in ascending numerical order.

Tables 4 – 3 Test Levels for Barriers, [Approach](#)~~End~~ Terminals, Crash Cushions and 4 – 4 Test Levels for Breakaway Devices, Work Zone Traffic Control Devices summarize the vehicle types, vehicle mass, test speeds and impact angles used in testing for each test level. Tables 4 – 3 and 4 – 4 also show the differences in vehicle mass between MASH and [NCHRP Report 350](#) criteria for the small car, pickup, and single unit truck test vehicles.

In addition to differences in vehicle mass, MASH test criteria incorporated several other changes that differ from [NCHRP Report 350](#). For additional information on crash test criteria, refer to the [AASHTO MASH, NCHRP Report 350](#), the [AASHTO Roadside Design Guide](#), and the FHWA web site for [Roadway Departure Safety](#).

Table 4 – 3 Test Levels for Barriers, End-Approach Terminals, Crash Cushions

Test Level	Test Vehicle Type	Vehicle Designation and Mass		Test Conditions MASH	
		NCHRP 350 (lbs.)	MASH (lbs.)	Impact Speed (mph)	Impact Angle (for Barriers) (degrees)
1	Passenger Car Pickup Truck	820C 1800	1100C 2420	31	25
		2000P 4400	2270P 5000	31	25
2	Passenger Car Pickup Truck	820C 1800	1100C 2420	44	25
		2000P 4400	2270P 5000	44	25
3	Passenger Car Pickup Truck	820C 1800	1100C 2420	62	25
		2000P 4400	2270P 5000	62	25
4	Passenger Car Pickup Truck Single-Unit Truck	820C 1800	1100C 2420	62	25
		2000P 4400	2270P 5000	62	25
		8000S 17640	10000S 22000	56	15
5	Passenger Car Pickup Truck Tractor-Van Trailer	820C 1800	1100C 2420	62	25
		2000P 4400	2270P 5000	62	25
		36000V 79300	36000V 79300	50	15
6	Passenger Car Pickup Truck Tractor-Tank Trailer	820C 1800	1100C 2420	62	25
		2000P 4400	2270P 5000	62	25
		36000V 79300	36000V 79300	50	15

Note: Test Levels 1, 2, and 3 apply to end terminals and crash cushions, while all 6 Test Levels apply to barriers.

Table 4 – 4 Test Levels for Breakaway Devices, Work Zone Traffic Control Devices

Test Level	Feature	Test Vehicle Type	Vehicle Designation and Mass		Impact Speeds		Impact Angle (degrees)
			NCHRP 350 (lbs.)	MASH (lbs.)	Low Speed (mph)	High Speed (mph)	
2	Support Structures and Work Zone Traffic Control Devices	Passenger Car Pickup Truck	820C 1800 Not Required	1100C 2420 2270P 5000	19 19	44 44	0 – 20 0 – 20
	Breakaway Utility Poles	Passenger Car Pickup Truck	820C 1800 Not Required	1100C 2420 2270P 5000	31 31	44 44	0 – 20 0 – 20
3	Support Structures and Work Zone Traffic Control Devices	Passenger Car Pickup Truck	820C 1800 Not Required	1100C 2420 2270P 5000	19 19	62 62	0 – 20 0 – 20
	Breakaway Utility Poles	Passenger Car Pickup Truck	820C 1800 Not Required	1100C 2420 2270P 5000	31 31	62 62	0 – 20 0 – 20

Note: Criteria for Test Levels 2 and 3 are provided for support structures, work zone traffic control devices and breakaway utility poles. Test Level 3 is the basic test level used for most devices.

As noted in Tables 4 – 3 and 4 – 4, Test Levels 1 through 3 are limited to passenger vehicles while Test Levels 4 through 6 incorporate heavy trucks. The test speeds and impact angles used for testing represent approximately 92.5% of real word crashes. As implied by the information in Tables 4 – 3 and 4 – 4:

1. Test Level 1 devices should be used only on facilities with design speeds 30 mph and less.
2. Test Level 2 devices should be used only on facilities with design speeds 45 mph and less.

3. Test Level 3 through Test Level 6 devices are considered acceptable for all design speeds.
4. Test Level 3 devices are generally considered acceptable for facilities of all types and most roadside conditions.
5. Test Levels 4 through 6 should be considered on facilities with high volumes of heavy trucks and/or where penetration beyond the barrier would result in high risk to the public or surrounding facilities.

For additional information regarding appropriate application of Test Levels refer to the [AASHTO Roadside Design Guide](#).

C.2 Safety Hardware Upgrades

On new construction and reconstruction projects existing obsolete safety hardware shall be upgraded or replaced with hardware meeting crash test criteria as described above.

For existing roadways, highway agencies should upgrade existing highway safety hardware to comply with current crash test criteria either when it becomes damaged beyond repair, or when an individual agency's maintenance policies require an upgrade to the safety hardware.

~~The FDOT~~[The Department's Design Manual, Chapter 215 Roadside Safety](#) provides a list of considerations when investigating the need for upgrading barriers and other hardware. [The FDOT's Standard Plans](#) provide standard details for transitioning new barriers to existing barriers. The [AASHTO Roadside Design Guide](#) also provides guidelines for upgrading hardware.

D SIGNS, SIGNALS, LIGHTING SUPPORTS, UTILITY POLES, TREES, AND SIMILAR ROADSIDE FEATURES

D.1 General

This section provides criteria for traffic sign supports, signal supports, lighting supports, utility poles, trees, and similar roadside features.

Generally, those roadside appurtenances and features that cannot be removed or located outside the clear zone must meet breakaway criteria to reduce impact severity. For those features located within the clear zone where it is not practical to meet breakaway criteria, shielding may be warranted and shall be considered.

D.2 Performance Requirements for Breakaway Devices

The term breakaway support refers to traffic sign, highway lighting, and other supports that are designed to yield, fracture, or separate when impacted by a vehicle. The release mechanism may be a slip plane, plastic hinge, fracture element, or combination thereof. Crash test criteria applicable to breakaway devices are presented in Section C. Additional requirements for breakaway supports are provided in the [AASHTO Standard Specifications for Structural Supports for Highway Signs, Luminaries, and Traffic Signals](#). For a more detailed discussion on breakaway supports, refer to the [AASHTO Roadside Design Guide](#).

See Section C for references that provide additional information and details on crash tested breakaway supports.

D.3 Sign Supports

Traffic signs and sign supports shall meet the requirements provided in the [Manual on Uniform Traffic Control Devices \(MUTCD\)](#) as stated in **Chapter 18 – Signing and Marking**. The **MUTCD** requires all sign supports within the clear zone to be shielded or breakaway. See Section B for clear zone requirements. Only when the use of breakaway supports is not practicable should a traffic barrier or crash cushion be used exclusively to shield sign supports. In addition, sign supports should be located where they are least likely to be hit. Where possible, signs should be placed behind existing roadside barriers beyond the design deflection distance or on existing structures.

~~The FDOT's~~ [The Standard Plans](#) provides details for breakaway supports for single and multi-post ground mounted signs that are acceptable for use within the clear zone. The most current version of these [Standard Plans](#) details should be used as ~~the~~ FDOT maintains and updates these details as necessary to comply with required implementation dates for changes in crash test criteria.

Overhead signs and cantilever signs require relatively large size support systems. The potential safety consequences of these systems falling necessitate a fixed-base design that cannot be made breakaway. Overhead sign and cantilever sign supports therefore are required to be located outside the clear zone (Section B) or be shielded with a crashworthy barrier (Section E). Where possible, these supports should be located behind traffic barriers shielding nearby overpasses or other existing structures, or the signs should be mounted on the nearby structure. ~~The FDOT's The Department's~~ [Standard Plans](#) ~~and~~ provide details and instructions for the design of these systems.

D.4 Traffic Signal Supports

Traffic signal supports commonly used in Florida are fixed base and shall meet the required lateral offset and clear zone criteria provided in Section B. Traffic signal supports should not be located within medians. ~~The~~ FDOT's [Standard Plans](#) provide details and instructions for the design of traffic signal supports.

D.5 Lighting Supports

Lateral offset criteria for lighting supports depend on whether the support is breakaway or fixed base as discussed below. See **Chapter 6 - Lighting** for additional design criteria for lighting.

D.5.a Conventional Lighting

Supports for conventional lighting (heights up to 60 feet) shall be breakaway which are typically frangible bases (cast aluminum transformer bases), slip bases, or frangible couplings (couplers). ~~The FDOT's~~ [Standard Plans](#) provide further information for breakaway lighting supports which are acceptable for use. ~~As a general rule~~ **Generally**, a breakaway lighting support will fall near the line of the path of an impacting vehicle. The mast arm usually rotates and points away from the roadway when resting on the ground. For poles located on the outside of the roadway (not in medians),

this action generally results in the pole not falling into other traffic lanes. However, the designer should remain aware that these falling poles may endanger other motorists or bystanders such as pedestrians and bicyclists. The [AASHTO Roadside Design Guide](#) may be referenced for additional discussion on breakaway lighting supports.

On curbed roadways with design speeds 45 mph or less, breakaway lighting supports shall be located to meet lateral offset requirements provided in Section B, Table 4 – 2.

On flush shoulder roadways, breakaway lighting supports shall be located a minimum of 20 feet from the nearest travel lane, 14 feet from the nearest auxiliary lane or outside the clear zone provided in Section B, Table 4 – 1, whichever is less. The foreslope shall be 1:6 or flatter in cases where supports are located within the clear zone.

Lighting should not be located in medians, except in conjunction with barriers that are justified for other reasons.

D.5.b High Mast Lighting

High mast or high-level lighting supports are fixed-base support systems that do not yield or break away on impact. High mast lighting supports shall be located outside the clear zone provided in Section B, Table 4 – 1. High mast lighting shall not be located in medians except in conjunction with barriers that are justified for other reasons. [The FDOT's ~~The~~ Department's Standard Plans](#) provides additional information.

D.6 Utility Poles

Utility poles shall be located to meet lateral offset and clear zone requirements provided in Section B and be located as close as practical to the right of way line. They should be installed per the permitting agency's requirements. The [AASHTO Roadside Design Guide](#) provides additional discussion and guidance on utility poles.

In accordance with Section 337.403, F.S., existing utility poles must be relocated when unreasonably interfering with the "convenient, safe, or continuous use, or the maintenance, improvement, extension, or expansion" of public roads. Utility

poles adjacent to road improvement projects, but not directly interfering with construction, should be considered for relocation, to the extent they can be relocated, to achieve the [lateral offset](#)~~clear zone~~ requirements of Table 4 – 42 Lateral Offset. Utility poles that cannot be relocated and will remain within the clear zone, should be approved through the exception process prescribed in **Chapter 14 - Design Exceptions and Variations**.

D.7 Trees

Trees with a diameter greater than 4 inches measured 6 inches above grade shall be located to meet lateral offset and clear zone requirements in Section B, Tables 4 – 1 and 4 – 2. The [AASHTO Roadside Design Guide](#) provides additional discussion and guidance on trees.

D.8 Miscellaneous

D.8.a Fire Hydrants

Most fire hydrants are made of cast iron and are expected to fracture upon impact, however, crash testing meeting current criteria has not been done to verify that designs meet breakaway criteria. For this reason, fire hydrants should be located as far from the traveled way as practical and preferably outside lateral offset/clear zone requirements in Section B, yet where they are still readily accessible to and usable by emergency personnel. Any portion of the hydrant not designed to break away should be within 4 inches of the ground.

D.8.b Railroad Crossing Warning Devices

See **Chapter 7 – Rail-Highway Crossings** for location requirements for railroad crossing warning devices.

D.8.c Mailbox Supports

Mailboxes and their location are subject to US Postal Service requirements. They are often located within the clear zone and pose a potential hazard. However, with proper design and placement, the severity of impacts with mailboxes can be reduced. To achieve consistency, it is recommended each highway agency adopt regulations for the design and placement of

mail boxes within the right of way of public highways. The [AASHTO Roadside Design Guide](#) provides a model regulation that is compatible with US Postal Service requirements.

The following requirements apply to mailbox installations on public roadways:

No mailbox will be permitted where access is obtained from a freeway or where access is otherwise prohibited by law or regulation. Mailboxes shall be located as follows:

- On the right-hand side of the roadway in the carrier's direction of travel except on one-way streets, where they may be placed on the left-hand side.
- Where a mailbox is located at a driveway entrance, it shall be placed on the far side of the driveway in the carrier's direction of travel.
- Where a mailbox is located at an intersecting road, it shall be located a minimum of 200 feet beyond the center of the intersecting road in the carrier's direction of travel. This distance may be decreased to 100 feet on very low volume roads.
- When a mailbox is installed in the vicinity of an existing guardrail, it should, when practical, be placed behind the guardrail.

The bottom of the box shall be set at a height established by the U. S. Postal Service, usually from 41 to 45 inches above the roadway surface.

On flush shoulder roadways, the roadside face of the box should be offset from the edge of the traveled way a distance no less than the greater of the following:

- 8 feet (where no paved shoulder exists and shoulder cross slope is 10 percent or flatter), or
- width of the shoulder present plus 6 to 8 inches, or
- width of a turnout specified by the jurisdiction plus 6 to 8 inches.

On very low volume flush shoulder roads with low operating speeds the offset may be reduced to 6 feet from the traveled way.

On curbed streets, the roadside face of the mailbox should be set back from the face of the curb 6 to 8 inches. On residential streets without curbs or all-weather shoulders that carry low traffic volumes operating at low speeds, the roadside face of the mailbox should be offset between 8 inches and 12 inches behind the edge of the pavement.

Design criteria for the mailbox support structure when located within the clear zone should consist of the following:

- Mailboxes shall be of light sheet metal or plastic construction conforming to the requirements of the U. S. Postal Service. Newspaper delivery boxes shall be of light metal or plastic construction of minimum dimensions suitable for holding a newspaper.
- No more than two mailboxes may be mounted on a support structure unless crash tests have shown the support structure and mailbox arrangement to be safe. However, light-weight newspaper boxes may be mounted below the mailbox on the side of the mailbox support.
- A single 4 inch by 4 inch square or 4 inch diameter wooden post; or metal post, Schedule 40, 2 inch (normal size IPS (external diameter 2-3/8 inch) (wall thickness 0.154 inches) or smaller), embedded no more than 24 inches into the ground, shall be acceptable as a mailbox support. A metal post shall not be fitted with an anchor plate, but it may have an anti-twist device that extends no more than 10 inches below the ground surface.
- Unyielding supports such as heavy metal pipes, concrete posts, brick, stone or other rigid foundation structure or encasement should be avoided.
- The post-to-box attachment details should be of sufficient strength to prevent the box from separating from the post top if the installation is struck by a vehicle. The exact support hardware dimension and design may vary, such as having a two-piece platform bracket or alternative slot-and-hole locations. The product must result in a satisfactory attachment of the mailbox to the post, and all components must fit together properly.
- The minimum spacing between the centers of support posts should be the height of the posts above the ground line. Mailbox support designs not described in this regulation are acceptable if approved by the jurisdiction.

The FDOT's ~~The Department's Standard Plans~~ and the [AASHTO Roadside Design Guide](#) provide details on hardware, supports and attachment details acceptable for mailboxes located within the clear zone which conform to the above requirements.

[Additional information on the design and construction of residential and commercial mailboxes, including outdoor cluster boxes can be found on the United States Postal Service's Delivery Growth Management web page.](#)

D.8.d Bus Benches and Shelters

See **Chapter 3 – Geometric Design** for location criteria for bus benches and shelters. Additional criteria are provided in **Chapter 13 – Public Transit**.

E BARRIERS, APPROACH END—TREATMENTS, AND CRASH CUSHIONS

E.1 Roadside Barriers

Roadside barriers are used to shield motorists from roadside hazards and in some cases are used to protect bystanders, pedestrians, cyclists and/or workers from vehicular traffic. In still other cases, roadside barriers are used to protect bridge piers from vehicle impacts. Median barriers are similar to roadside barriers but are designed for vehicles striking either side and are primarily used to separate opposing traffic on a divided highway. Median barriers also may be used on heavily traveled roadways to separate through traffic from local traffic or to separate high occupancy vehicle (HOV) and managed lanes from general-purpose lanes. Barriers are further classified as rigid, semi-rigid and flexible which are discussed in more detail below.

Barrier transition sections are used between adjoining barriers that have significantly different deflection characteristics. For example, a transition section is needed where a semi-rigid guardrail attaches to the approach end of a rigid concrete bridge rail, or when a barrier must be stiffened to shield fixed objects.

Requirements for bridge railings are provided in **Chapter 17 – Bridges and Other Structures**.

E.2 End Treatments

End treatments include trailingend anchorages, approachend terminals, and crash cushions. TrailingTrailingEnd anchorages are used to anchor a flexible or semi-rigid barrier to the ground to develop its tensile strength during an impact. TrailingEnd anchorages are not designed to be crashworthy for headend on impacts. They are typically used on the trailing end of a roadside barrier on one-way roadways, or on the approach or trailing end of a flexible or semi-rigid barrier that is located outside the clear zone or that is shielded by another barrier system. TrailingEnd anchorages are discussed in more detail below.

ApproachEnd terminals are basically crashworthy anchorages. Approach terminals are used to anchor a flexible or semi-rigid barrier to the ground at the end of a barrier that is within the minimum clear zone and exposed to approaching traffic. Most approachend terminals are designed for vehicular impacts from only

one side of the barrier, however some are designed for median applications where there is potential for impact from either side. ApproachEnd terminals are discussed in more detail below.

E.3 Crash Cushions

Crash cushions, sometimes referred to as impact attenuators, are crashworthy end treatments typically attached at the approach end of median barriers, roadside barriers, bridge railings or other rigid fixed objects, such as bridge piers. Crash cushions may be used in a median, a ramp terminal gore, or other roadside application. Crash cushions are discussed in more detail below.

E.4 Performance Requirements

Roadside barriers, transitions, approachend terminals, and crash cushions must be crashworthy as determined by full scale crash testing in accordance with specific crash test criteria discussed in Section C. Descriptions of commonly used devices in Florida are described below. Section C also provides references where more information can be found on crashworthy devices.

E.5 Warrants

The determination as to when shielding is warranted for given hazardous roadside feature must be made on a case-by-case basis, and generally requires engineering judgment. It should be noted that the installation of roadside barriers presents a hazard in and of itself, and as such, the designer must analyze whether the installation of a barrier presents a greater risk than the feature it is intended to shield. The analysis should be completed using the [Roadside Safety Analysis Program \(RSAP\)](#) or in accordance with the [AASHTO Highway Safety Manual \(HSM\)](#).

Please see Section A for the considerations to be included when determining when to shield a roadside hazard.

The following hazards located within the clear zone are normally considered more hazardous than a roadside barrier:

E.5.a Above Ground Hazards

Above ground hazards are defined in Section B, Table 4 – 2 Lateral Offset. They include but are not limited to:

1. Bridge piers, abutments, and railing ends
2. Parallel retaining walls with protrusions or other potential snagging features
3. Non-breakaway sign and lighting supports
4. Utility Poles
5. Trees greater than 4" in diameter measured 6" above ground.

E.5.b Drop-Off Hazards

Drop-off hazards are defined in Section B, Table 4 – 2 Lateral Offset.

E.5.c Canals and Water Bodies

Criteria for addressing canal and water body hazards is provided in Section B.2.c.

E.6 Warrants for Median Barriers

Median barriers shall be used on high speed, limited access facilities where the median width is less than the minimum values given in Chapter 3, Geometric Design, Table 3 – [2316](#) Minimum Median Widths. For locations where median widths are equal to or greater than the minimum, median barriers are not normally considered except in special circumstances, such as a location with significant history of cross median crashes. Any determination to use a median barrier on limited access facilities must consider the need for barrier openings for median crossovers that are appropriately spaced to avoid excessive travel distances by emergency vehicles, law enforcement vehicles, and maintenance vehicles. The FDOT Design Manual may be referenced for additional criteria and guidelines for locating and designing median crossovers on limited access facilities.

On high speed divided arterials and collectors, median barriers are not normally used due to [a number of several](#) factors that are very difficult, if not impractical, to

address. Such factors include right-of-way constraints, property access needs, presence of at-grade intersections and driveways, adjacent commercial development, intersection sight distance and barrier end termination. However, provided these factors can be properly addressed, median barriers for these type facilities may be considered where median widths are less than minimum or where justified ~~on the basis of~~ **based on** significant crossover crash history.

See Section E for median barrier types and proper end treatment requirements. The [AASHTO Roadside Design Guide](#) and [the FDOT Department's Design Manual, Chapter 215 Roadside Safety](#) and [Standards Plans](#) provide additional information and guidelines on the use of median barriers

E.7 Temporary Barriers in Work Zones

See Section G Roadside Design in Work Zones for criteria on the use of temporary barriers in work zones.

Clear zone widths for work zones, as a minimum, shall be the lessor of clear zone requirements provided in Table 4—1 Minimum Width of Clear Zone, Table 4—5 Clear Zone Width Requirements for Work Zones, or existing clear zone width.—Clear zone widths in work zones are measured from the edge of Traveled Way defined by the Temporary Traffic Control (TTC) Plan.

Table 4—5 Clear Zone Width Requirements for Work Zones

2018

Manual of Uniform Minimum Standards
for Design, Construction and Maintenance
for Streets and Highways

<u>Work Zone Posted Speed (mph)</u>	<u>Travel Lanes & Multilane Ramps (feet)</u>	<u>Auxiliary Lanes & Single Lane Ramps (feet)</u>
<u>Curbed</u>		
<u>45 mph or less All Speeds w/Curb & Gutter</u>	<u>4' Behind Face of Curb</u>	<u>4' Behind Face of Curb</u>
<u>Flush Shoulder</u>		
<u>30—40</u>	<u>14</u>	<u>10</u>
<u>45—50</u>	<u>18</u>	<u>10</u>
<u>55</u>	<u>24</u>	<u>14</u>
<u>60—70</u>	<u>30</u>	<u>18</u>

When clear zone widths cannot be met, the use of temporary barriers shall be considered. Temporary barriers in work zones can serve several functions:

- Shield edge drop-offs, excavation, roadside structures, falsework for bridges, material storage sites and/or other exposed objects.
- Provide protection for workers.
- Separate two-way traffic.
- Separate pedestrians from vehicular traffic.

The decision to use temporary barriers in a work zone should be based on engineering judgement and analysis. There are many factors, including traffic volume, traffic operating speed, offset, and duration, that affect barrier needs within work zones. The Department's **Design Standard Plans**, Index 102-600 Series, **MUTCD** and the **AASHTO Roadside Design Guide** provide additional information and guidance on the use of temporary barriers in work zones.

E.8 Barrier Types

Roadside barriers are classified as flexible, semi-rigid and rigid depending on their deflection characteristics when impacted. Flexible systems have the greatest deflection characteristics. Given much of the impact energy is dissipated by the deflection of the barrier and lower impact forces are imposed on the vehicle, flexible systems are generally more forgiving than rigid and semi-rigid systems. Rigid barriers, on the other hand, are assumed to exhibit no deflection under impact conditions so crash severity will likely be the highest of the three classifications.

In the following sections are basic descriptions of the barrier types commonly used in Florida for each these classifications. These commonly used barriers are those that are addressed in the [FDOT's Department's Standard Plans](#) and [FDOT Design Manual](#). Those documents should be referenced for additional details and discussion on the proper use of these systems.

The basis for the [FDOT Department's](#) systems and devices, as well as many other generic and proprietary guardrail systems meeting **NCHRP Report 350** and/or MASH criteria, can be found in the following documents:

- [AASHTO Roadside Design Guide](#)
- [Federal Highway Administration \(FHWA\) Countermeasures that Reduce Crash Severity](#)
- **AASHTO-Associated General Contractors of America (AGC)-American Road and Transportation Builders Association (ARTBA) Joint Committee Task Force 13** report, [A Guide to Standardized Highway Barrier Hardware](#) available at

E.8.a Guardrail

The most commonly used barrier on new construction projects in Florida is the w-beam guardrail system detailed in [the FDOT's ~~the Department's~~ Design Standard Plans, Index 536-001400](#) referenced as "General TL-3 Guardrail". This w-beam guardrail system, sometimes referred to as a strong post guardrail system, is a semi-rigid system, uses posts at 6'-3" spacing, 8" offset blocks, and mid-span splices with a rail height of 2'-1" to center of the panel. This system was developed based on the 31" Midwest Guardrail System (MGS) and meets MASH Test Level 3 criteria.

Compatible proprietary components may be referenced by the 31" height. This system can be used as a roadside barrier or in a double face configuration as a median barrier. Deflection space requirements for this system are provided in the [FDOT Department's Design Manual, Chapter 215 Roadside Safety](#).

The current 31" height system replaces the 27" height system (1'-9" to center of panel) that had been used for many years and still present on roadways throughout Florida. Section C.3 addresses requirements for upgrading existing 27" height systems.

The [FDOT's Department's Standard Plans](#) also provides details for a similar w-beam guardrail system referenced as "Low Speed, TL-2 Guardrail", with posts at 12'-6" spacing which meets MASH Test Level 2 criteria. While this TL 2 system may be used on low speed roadways 45 mph or less, it preferably should be used only on roadways with design speeds 35 mph and less to account for the potential for changes in posted speed limits and/or vehicles exceeding the design speed.

To achieve a minimum level of crash performance, guardrail installations shall have a minimum length of 75 feet with design speeds greater than 45 mph.

E.8.b Concrete Barrier

The most commonly used concrete barriers in Florida are detailed in the [FDOT's Department's Standard Plans, Index 521-001410](#). Details are provided for median application, shoulder application and pier protection. Additional information on these barriers is provided in the [FDOT's Department's Design Manual, Chapter 215 Roadside Safety](#).

The [FDOT's Department's](#) 32" height F-Shape concrete barrier wall system that has been in use for many years meets [NCHRP Report 350](#) Test Level 4 criteria and MASH Test Level 3 criteria. The [FDOT Department](#) is replacing this 32" F-Shape system with a 38" height single slope concrete barrier system which meets MASH Test Level 4 criteria. In addition to improved crash test performance, the single slope face provides for simpler construction.

While shielding bridge piers to protect motorists from a hazard within the clear zone is often necessary, some bridge piers may need shielding for protection from damage due to design limitations (i.e., piers not designed for vehicular collision forces). Coordination with the Structural Engineer of Record is required to determine if pier protection is warranted. [The FDOT's ~~The Department's Design Standard Plans, Index 521-002411~~](#) provides details for crashworthy Pier Protection barriers and the [FDOT Design Manual, Chapter 215 Roadside Safety](#) provides a process for determining the appropriate level of pier protection. As with median and shoulder concrete barrier walls, [the](#) FDOT is replacing the F-Shape pier protection barriers that have been in use for several years with single slope face systems.

E.8.c High Tension Cable Barrier

There are a variety of crash tested flexible barrier systems using w-beam and cable, but they historically have not been in common use in Florida. In recent years several proprietary high-tension cable barrier (HTCB) systems have been developed that meet [NCHRP Report 350](#) and MASH criteria. These systems are installed with a significantly greater tension in the cables than the generic low-tension systems that have been used in some states for many years. High tension cable barrier systems may be used for both median and roadside application. Deflection space requirements are dependent on the system, system length and post spacing, and are significantly greater than semi-rigid systems.

High tension cable barrier has shown to have several advantages over other types of flexible barrier systems. One advantage is they tend to result in less damage when impacted. Another is that certain systems have been tested for use on slopes as steep as 1:4. Still another advantage is that in many cases, the cables remain at the proper height after an impact that damages several posts. While no manufacturer claims their barrier remains functional in this condition, there is the potential that this offers a residual safety value under certain crash conditions. Posts are typically lightweight and can be installed in cast or driven sockets in the ground to facilitate removal and replacement. One disadvantage is that each vendor uses a different post design and cable arrangement, and therefore posts are not interchangeable between systems manufactured by different vendors.

~~The FDOT~~~~The Department~~ has used High Tension Cable Barrier (HTCB) in selected locations and continues to install these systems using ~~the FDOT's~~~~the Department's~~ **Developmental Design Standards and Developmental Specifications (DDS)** process. Detailed information on the usage requirements and design criteria of HTCB can be found on ~~the FDOT's~~~~the~~ **DDS** website.

It includes the following:

- ***Developmental Standard Plans Instructions D 540-001***
- ***Developmental Standard Plans Index D 540-001***
- ***Developmental Specification, Dev540***

E.8.d Temporary Barrier

As stated in Section E.5.e, temporary barriers are used primarily in work zones for several purposes. The ~~most commonly used~~**most used** temporary barriers in Florida are those adopted for use by ~~the~~ FDOT. ~~The FDOT's~~~~The department's~~ temporary barriers include:

Low Profile Barrier – Standard Plans, Index 102-120 (TL-2, NCHRP 350)

Type K Barrier – Standard Plans, Index 102-110 (TL-3, NCHRP 350)

Proprietary Temporary Barrier – Standards Plans, Index 102-100 and the **Approved Products List (APL)** (TL-2 & TL-3, NCHRP 350)

Additional information on the proper use of these barriers is provided in ~~the~~ the **FDOT Department's Design Manual** and the Vendor drawings on the **FDOT's Approved Products List**.

Additional information on temporary barrier systems meeting **NCHRP Report 350** and/or MASH criteria can be found in the **Manual for Assessing Safety Hardware** and the **AASHTO Roadside Design Guide**.

E.8.e Selection Guidelines

The evaluation of numerous factors is required to ensure that the appropriate barrier type is selected for a given application. Consideration should be given to the following factors when evaluating each site:

- Barrier placement requirements (see Section E.6.f)
- Traffic characteristics (e.g., vehicle types/percentages, volume, and growth)
- Site characteristics (e.g., terrain, alignment, geometry, access facility type, access locations, design speed, etc.)
- Expected frequency of impacts
- Initial and replacement/repair costs
- Ease of maintenance
- Exposure of workers when conducting repairs/maintenance
- Aesthetics

For additional information about considerations for barrier selections refer to the [AASHTO Roadside Design Guide](#). Barrier type selection decisions and warrants should be documented.

E.8.f Placement

E.8.f.1 Barrier Offsets

Roadside barriers should be offset as far from the travel lanes as practical with consideration for maintaining the proper performance of the barrier. For the barriers described above see the [FDOT Department's Design Manual, Chapter 215 Roadside Safety](#) and [Standard Plans](#) for proper barrier placement. Figure 4 – 8 Location of Guardrail provides information on the offset of guardrail on curbed and flush shoulder roadways.

Figure 4 – 8 Location of Guardrail

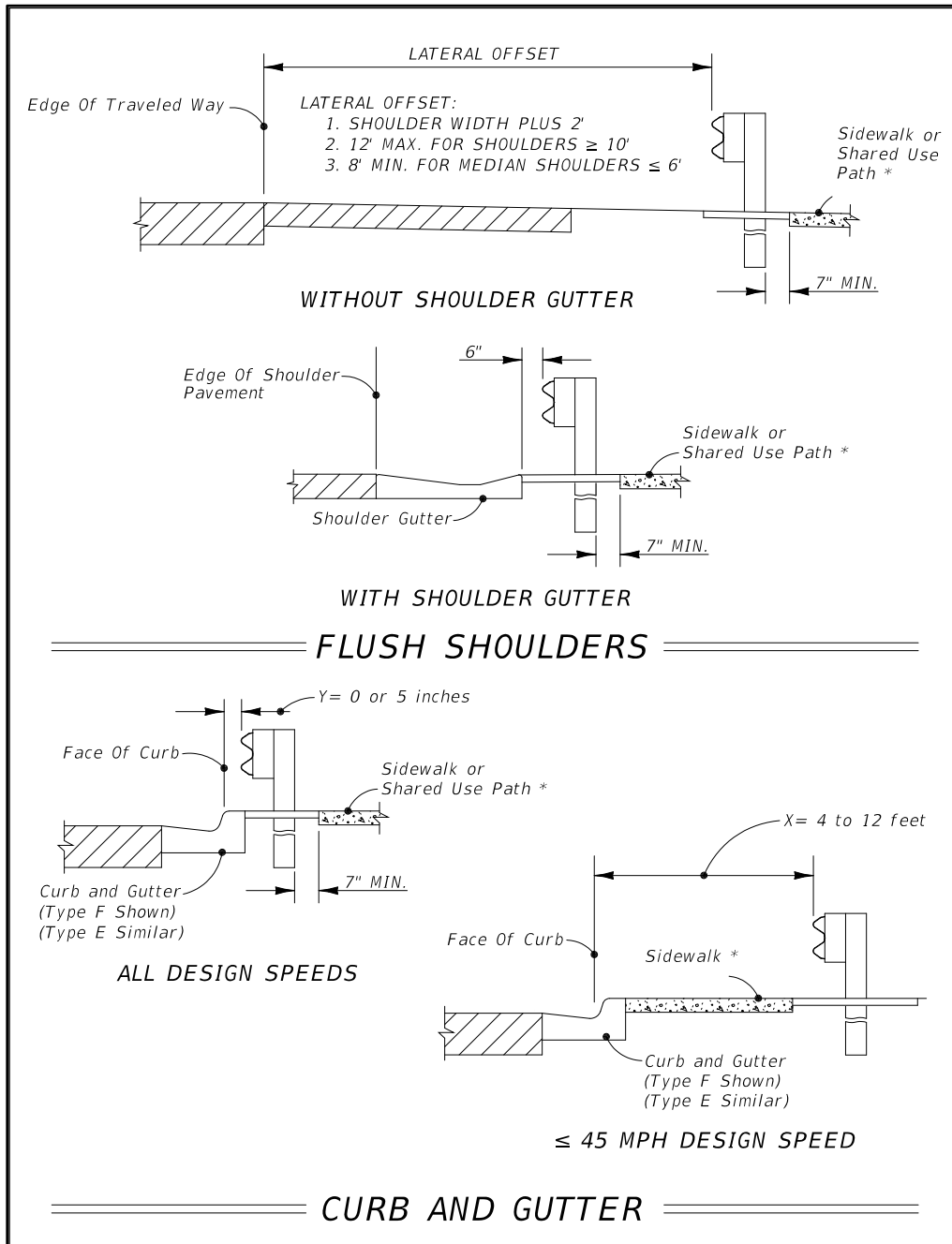

Topic # 625-000-015

2023

~~2018~~

Manual of Uniform Minimum Standards
for Design, Construction and Maintenance
for Streets and Highways

* When a sidewalk is present or planned. See Chapter 8 – Pedestrian Facilities and Chapter 9 – Bicycle Facilities for criteria for sidewalks and shared use paths (~~e.g.~~e.g., width of facility plus clear, graded areas adjacent to the path or sidewalk).

E.8.f.2 Deflection Space and Zone of Intrusion

In addition to travel lane lateral offset considerations, an adequate setback must be provided behind the barrier to ensure proper function. For flexible and semi-rigid barriers, the setback is based on deflection tolerances and is required to prevent the barrier from contacting aboveground objects.

For rigid barriers, the setback is required to keep the area above and behind the barrier face free of obstructions that could penetrate or damage the vehicle compartment. This requirement is based on the Zone of Intrusion (ZOI) concept as described in the [AASHTO Roadside Design Guide](#).

These requirements do not apply to devices located within the setback distances detailed in [the FDOT's the Department's Standard Plans](#) (e.g., pedestrian/bicycle railing, fencing, noise walls, etc.).

E.8.f.3 Grading

The terrain effects between the traveled way and a barrier can have a significant impact on whether a barrier will perform as intended. Proper grading around a barrier will ensure that as a vehicle approaches a barrier its suspension is not dramatically affected, causing the vehicle to underide or override a barrier.

E.8.f.4 Curbs

As with grading, the presence of curb in combination with barriers deserves special attention. A vehicle which traverses a curb prior to impact may override the barrier if it is partially airborne at the moment of impact. Conversely, the vehicle may "submarine" under the rail element of a guardrail system and snag on the support posts if it strikes the barrier too low.

E.8.f.5 Flare Rate

A flared roadside barrier is when it is not parallel to the edge of the traveled way. A flared barrier may be necessary for several reasons:

- To locate the barrier terminal farther from the roadway
- To minimize a driver's reaction to an obstacle near the road by gradually introducing a parallel barrier installation
- To transition a roadside barrier to an obstacle nearer the roadway such as a bridge parapet or railing
- To reduce the total length barrier needed.
- To reduce the potential for barrier and terminal impacts and provide additional roadside space for an errant motorist to recover.

A concern with flaring a section of roadside barrier is that the greater the flare rate, the higher the angle at which the barrier can be hit. As the angle of impact increases, the crash severity increases, particularly for rigid and semi-rigid barrier systems. Another disadvantage to flaring a barrier installation is the increased likelihood that a vehicle will be redirected back into or across the roadway following an impact.

For the barriers described above, see the [FDOT Department's Design Manual, Chapter 215 Roadside Safety](#) for acceptable flare rates. Additional information on flare rates are provided in the [AASHTO Roadside Design Guide](#).

E.8.f.6 Length of Need

The length of need for a particular barrier type is calculated based on several factors including the length of the hazard, the lateral area of concern, run out length and other factors. Length of need must consider traffic from both directions.

A spreadsheet tool for calculating length of need is provided on the [FDOT's Department's Standard Plans](#) web page, adjacent to [Index 536-001](#) in the **Design Tools** column. Additional information on length of need is provided in the [AASHTO Roadside Design Guide](#).

E.8.g Barrier Transitions

Guardrail transitions are necessary whenever standard W-Beam guardrail converges with rigid barriers. The purpose of the transition is to provide a gradual stiffening of the overall approach to a rigid barrier so that vehicular pocketing, snagging, or penetration is reduced or avoided at any position along the transition. Guardrail transitions must include sound structural connections, nested ~~panels~~panels, and additional posts for increased stiffness. ~~The FDOT's~~The Department's **Standard Plans** provide details for several transitions for both permanent and rigid barriers that meet MASH criteria. Additional information on transitions is provided in the **FDOT's Department's Design Manual, Chapter 215 Roadside Safety** and the **AASHTO Roadside Design Guide**.

E.8.h Attachments to Barriers

Attachments to barriers such as signs, light poles, and other objects will affect crash performance and should be avoided where practical. Attachments not meeting the requirements discussed in Section E.6.f Placement, should meet crash test criteria. See the **FDOT**~~Department's~~ **Design Manual, Chapter 215 Roadside Safety** for additional information on attachments to barriers.

E.9 End Treatments and Crash Cushions

As previously discussed, end treatments include ~~trailing~~end anchorages, ~~approach~~end terminals, and crash cushions. Details for end treatments for each barrier type described above are detailed in the **FDOT's**~~Department's~~ **Standard Plans** and the **Approved Products List (APL)**.

E.9.a End Treatments for Guardrail

End treatments for guardrail are categorized as follows:

1. Approach ~~end~~end terminals – required for guardrail ends within the clear zone of approaching traffic. ~~The Department's~~Guardrail approach end terminals are proprietary devices listed on the **APL**. **MASH compliant** ~~a~~Approach terminals are classified by Test Level (TL-2 for Design

2018

Manual of Uniform Minimum Standards
for Design, Construction and Maintenance
for Streets and Highways

Speeds \leq 45 mph or TL-3, which is acceptable for all Design Speeds) and as follows:

- a. Flared – preferred terminal for locations where sufficient space is available to offset barrier end from approaching traffic.
 - b. Parallel – use only when sufficient space is not available for a flared terminal.
 - c. Double Face – preferred end treatment for double faced guardrail installations.
2. Crash Cushions – See Section E.7.e.
 3. Trailing End Anchorages (Type II) – required for anchoring of the trailing ends of guardrail. Trailing End Anchorages are considered non-crashworthy as an approach end treatment, and are not permitted as an approach guardrail end treatment, on the approach end within the Clear Zone, unless shielded by another run of barrier. The FDOT's The Department's Type II Trailing End Anchorage, is detailed in the Standard Plans. Index 536-001.

Figures 4-9A and 4-9B below illustrate how to determine when an approach terminal, trailing anchorage or crash cushion should be selected when using guardrail to provide protection for a hazard.

Figure 4 – 9A End Treatment Usage When End of Guardrail is Within Clear Zone of Approaching Near Lane

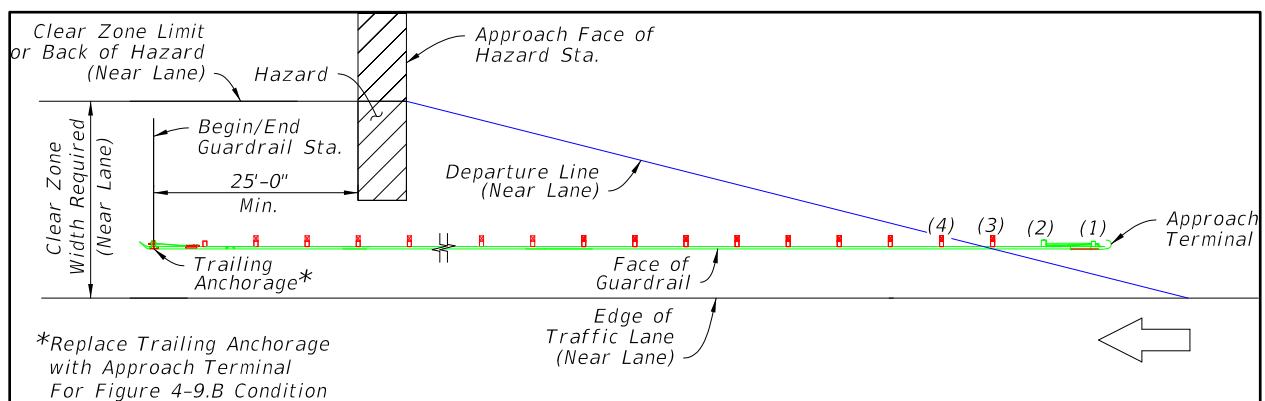

2018

Manual of Uniform Minimum Standards
for Design, Construction and Maintenance
for Streets and Highways

Figure 4 – 9B Approach Terminal Usage When End of Guardrail is Within Clear Zone of Approaching Far Lane (2-Lane, 2-Way Road Shown)

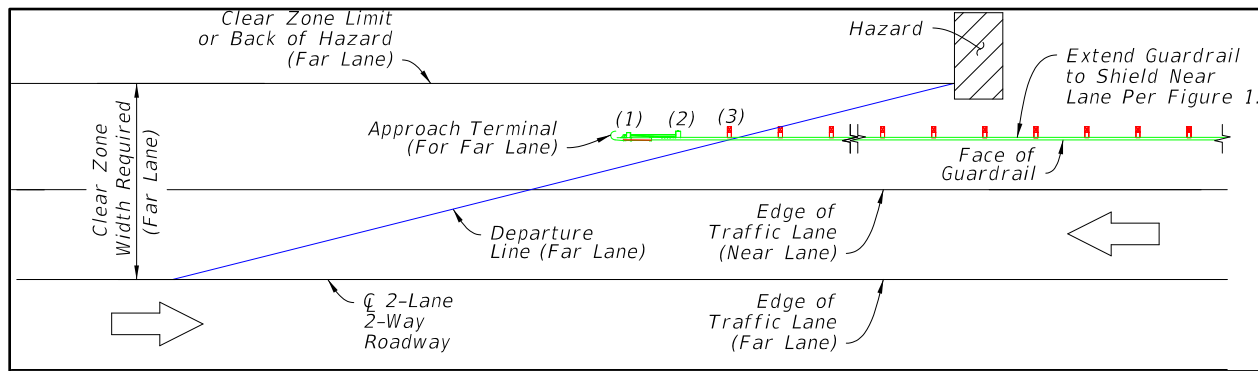

Additional information on guardrail end treatments is provided in the [FDOT Department's Design Manual, Chapter 215 Roadside Safety](#).

E.9.b End Treatments for Rigid Barrier

Rigid Barrier ends must be terminated by either transitioning into another barrier system (e.g., guardrail), or by shielding with a Crash Cushion. Details are provided in the [FDOT's Department's Standard Plans](#). Treatment of the trailing end of rigid barriers is not required unless additional hazards exist beyond the rigid barrier or the barrier is within the clear zone of opposing traffic.

E.9.c End Treatments for High Tension Cable Barrier (HTCB)

End treatments for high tension cable barrier are vendor specific. For additional information regarding the end treatment of HTCB, refer to [the FDOT's the Department's](#) developmental design standards discussed above.

E.9.d End Treatments for Temporary Barrier

Details for end treatments for the [FDOT's Department's](#) Temporary Barrier are provided in the [FDOT's Department's Standard Plans](#) and include:

1. Connecting to an existing barrier. Smooth, structural connections are required. Information on connections can be found in the [FDOT's ~~Department's~~ Standard Plans](#) and [APL](#).
2. Shield end with a crash cushion as detailed in the [FDOT's Standard Plans ~~Index 102 Series~~](#) or [APL](#) for the specific type of Temporary Barrier (i.e., portable concrete barrier, steel, or water filled).
3. Attaching or Transitioning to a crashworthy end treatment as described above.
4. Flaring outside of the Work Zone Clear Zone.

E.9.e Crash Cushions

Crash cushions are classified based on Test Level and Design Speed which is shown for each system on each vendor's respective drawings posted on [the FDOT's APL](#).

The design of a crash cushion system must not create a hazard to opposing traffic. The APL drawings provide details for transitions for optional barrier types with and without bi-directional traffic.

An impacting vehicle should strike the systems at normal height, with the vehicle's suspension system neither collapsed nor extended. Therefore, the terrain surrounding crash cushions must be relatively flat (i.e., 1:10 or flatter) in advance of and along the entire design length of the system. Curbs should not be located within the approach area of a crash cushion.

The [FDOT ~~Department's~~ Design Manual, Chapter 215 Roadside Safety](#) provides additional information on permanent and temporary crash cushions.

F BRIDGE RAILS

See **Chapter 17 - Bridges and Other Structures** for requirements for bridge rails. The **FDOT Department's Design Manual, Chapter 215 Roadside Safety** may be referenced for additional information and typical applications.

G ROADSIDE DESIGN IN WORK ZONES

The roadside design concepts presented in the previous sections shall be applied to work zones as appropriate for the type of work being done and to the extent existing roadside conditions allow. This includes providing clear zone and using traffic control devices and safety appurtenances that are crashworthy or properly shielded with crashworthy devices. However, because work zones are temporary and often involve restricted or limited space, modified criteria for clear zones, drop-off conditions and above ground hazards are provided as follows.

G.1 Clear Zone Width in Work Zones

Clear zone is defined in Section B Roadside Topography and Drainage Features. Clear zone widths for work zones, as a minimum, shall be the lessor of clear zone requirements provided in Table 4 – 1 Minimum Width of Clear Zone, Table 4 – 5 Clear Zone Width Requirements for Work Zones, or existing clear zone width. Clear zone widths in work zones are measured from the edge of Traveled Way.

Table 4 – 5 Clear Zone Width Requirements for Work Zones

<u>Work Zone Posted Speed (mph)</u>	<u>Travel Lanes & Multilane Ramps (feet)</u>	<u>Auxiliary Lanes & Single Lane Ramps (feet)</u>
<u>Curbed</u>		
<u>≤ 45 mph</u>	<u>4' Behind Face of Curb</u>	<u>4' Behind Face of Curb</u>
<u>> 45 mph</u>	<u>Same as Flush Shoulder</u>	<u>Same as Flush Shoulder</u>
<u>Flush Shoulder</u>		
<u>≤ 40</u>	<u>14</u>	<u>10</u>
<u>45 – 50</u>	<u>18</u>	<u>10</u>
<u>55</u>	<u>24</u>	<u>14</u>
<u>60 – 70</u>	<u>30</u>	<u>18</u>
<p><u>Note: The above clear zone widths apply to medians and roadside conditions other than for roadside canals. Where roadside canals are present, clear zone widths are to conform with the lateral offset distances to canals described in this Chapter.</u></p>		

The clear zone must be free of above ground fixed objects, water bodies and non-traversable edge drop-offs or critical slopes.

G.2 Above Ground Hazards in Work Zones

An above ground hazard in work zones is any object, material, or equipment other than temporary traffic control devices that is greater than 4 inches in height, firm and unyielding, and encroaches upon the clear zone. During working hours, above

ground hazards in the work zone should be treated with appropriate precautions. During nonworking hours, all objects, materials, and equipment that constitute an above ground hazard must be stored/placed outside of the clear zone or be shielded by a barrier or crash cushion.

G.3 Non-Traversable Edge Drop-Offs, Critical Slopes and Roadside Excavations

Non-traversable edge drop-offs, critical slopes and roadside excavations located within the clear zone are to be addressed as follows:

A drop-off is defined as a drop in elevation, parallel to the adjacent travel lanes, greater than 3" with slope (A:B) steeper than 1:4. In superelevated sections, the algebraic difference in slopes should not exceed 0.25 (See Figure 4 – 10 Drop-off Condition Detail.

Figure 4 – 10 Drop-Off Condition Detail

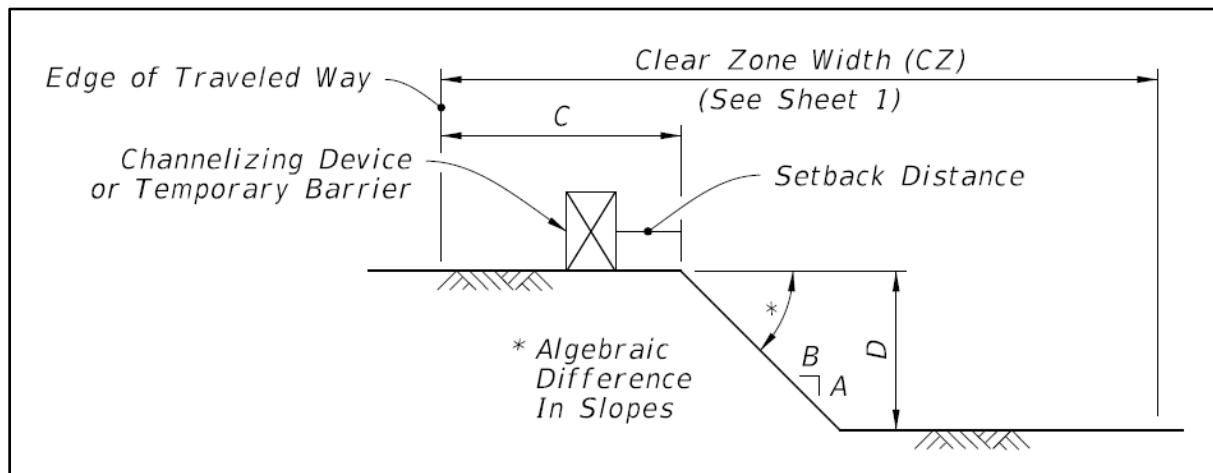

When an edge drop-off condition occurs within the clear zone, channelizing devices or temporary barriers shall be provided in accordance with Table 4 – 6 Device Requirements for Edge Drop-Offs.

Drop-offs may be mitigated by placing slopes of optional base material. See the [the FDOT's Standard Specifications, Section 285](#) for further information.

Slopes shallower than 1:4 may be required to avoid an algebraic difference in slopes greater than 0.25.

Table 4 – -6 Device Requirements for Edge Drop-Offs

<u>Condition</u>	<u>D (inches)</u>	<u>C (feet)</u>	<u>Device Required</u>
<u>1</u>	<u>>3</u>	<u>2 - 12</u>	<u>Temporary Barrier</u>
<u>2</u>	<u>>3 to ≤5</u>	<u>12 - CZ</u>	<u>Channelizing Device</u>
<u>3</u>	<u>>5</u>	<u>2 - 12</u>	<u>Temporary Barrier</u>
<u>4</u>	<u>Removal of Bridge or Retaining Wall Barrier</u>		<u>Temporary Barrier</u>
<u>5</u>	<u>Removal of portions of Bridge Deck</u>		<u>Temporary Barrier</u>

Footnotes:

1. Do not allow any drop-off conditions greater than 3 inches within two feet of traveled way.
2. For Conditions 1 and 3, channelizing devices and placement of slopes 1:4 or flatter constructed of base material per the **FDOT Specifications Section 285** may be used in lieu of temporary barriers. Slopes shallower than 1:4 may be required to avoid algebraic difference in slopes greater than 0.25.
3. For Conditions 1 and 3 any drop-off condition that is created and restored within the same work period will not be subject to the use of temporary barriers. However, channelizing devices will be required.
4. When permanent curb heights are ≥ 6", no channelizing device will be required.

A setback distance appropriate for the type of barrier selected shall be provided. For further information on setback requirements for various types of barriers, see the FDOT's **Standard Plans**.

Drop-offs adjacent to pedestrian facilities shall be provided with pedestrian longitudinal channelizing devices, temporary barrier wall, or approved handrail. Adjacent to pedestrian facilities, a drop-off is defined as:

- a) a drop in elevation greater than 10" that is closer than 2 feet from the edge of the sidewalk or shared use path, or

b) a slope steeper than 1:2 that begins closer than 2 feet from the edge of the sidewalk or shared use path when the total drop-off is greater than 60".

G.4 Temporary Barriers in Work Zones

When clear zone widths cannot be met, the use of temporary barriers shall be considered. Temporary barriers in work zones can serve several functions:

- Shield edge drop-offs and roadside excavations – see Section G.1.
- Shield above ground hazards, including roadside structures, falsework for bridges, material storage sites and/or other exposed objects.
- Provide positive protection for workers.
- Separate two-way traffic.
- Separate pedestrians from vehicular traffic.

The decision to use temporary barriers for conditions not specifically addressed in Section G.1 should be based on engineering judgement and analysis. There are many factors, including traffic volume, traffic operating speed, offset, and duration, that affect barrier needs within work zones. The FDOT's **Standard Plans, MUTCD** and the **AASHTO Roadside Design Guide** provide additional information and guidance on the use of temporary barriers in work zones.

HG REFERENCES FOR INFORMATIONAL PURPOSES

The following is a list of publications that may be referenced for further guidance:

- AASHTO Roadside Design Guide
<https://store.transportation.org/Item/CollectionDetail?ID=105/>
- Task Force 13 Guide to Standardized Roadside Safety Hardware
<http://www.tf13.org/Guides/>
- FHWA Web Site
http://safety.fhwa.dot.gov/roadway_dept/
- FDOT Design Manual
<http://www.fdot.gov/roadway/FDM/>
- FDOT Standard Plans for Road and Bridge Construction (Standard Plans)
<http://www.fdot.gov/design/standardplans/>
- *FDOT Structures Design Guidelines*
<http://www.fdot.gov/structures/StructuresManual/CurrentRelease/StructuresManual.shtm>
- FDOT Drainage Manual,
<http://www.fdot.gov/roadway/Drainage/ManualsandHandbooks.shtm>
- *Florida Strategic Highway Safety Plan 2016*
<https://www.fdot.gov/safety/shsp/shsp.shtm>

<http://www.fdot.gov/safety/SHSP2016/SHSP-2012.shtm>
<http://www.fdot.gov/safety/SHSP2012/SHSP-2012.shtm>

CHAPTER 5

PAVEMENT DESIGN AND CONSTRUCTION

A	INTRODUCTION	5-1
B	PAVEMENT DESIGN	5-2
	B.1 Pavement Type Selection	5-2
	B.1.a Unpaved Roadway Material Selection	5-2
	B.2 Structural Design	5-2
	B.3 Skid Resistance	5-3
	B.4 Drainage	5-4
	B.4.a Unpaved Roadway Drainage	5-4
	B.5 Shoulder Treatment	5-4
C	PAVEMENT CONSTRUCTION	5-7

THIS PAGE INTENTIONALLY LEFT BLANK

CHAPTER 5

PAVEMENT DESIGN AND CONSTRUCTION

A INTRODUCTION

The function of the pavement or roadway surface is to provide a safe and efficient travel path for vehicles using the street or highway. The pavement should provide a good riding surface with a minimum amount of distraction to the driver. The pavement friction characteristics should be such that adequate longitudinal and lateral forces between the vehicle tires and the pavement can be developed to allow a margin of safety for required vehicle maneuvers. These characteristics should be provided at the highest reasonable level for the expected pavement surface, weather conditions, and the anticipated operational characteristics of the facility. Resurfacing of the existing pavement is discussed and included under **Chapter 10 – Maintenance and Resurfacing** of this manual.

In order for the pavement to perform its function properly, the following objectives shall be considered in the design and construction of the pavement:

- Provide sufficient pavement structure and the proper pavement material strength to prevent pavement distress prior to the end of the design period.
- Develop and maintain adequate skid resistance qualities to allow for safe execution of braking, cornering, accelerating, and other vehicle maneuvers.
- Provide drainage to promote quick drying and to reduce the likelihood of hydroplaning and splashing.
- ~~Provide a Safety Edge treatment adjacent to the travel lane on roadways without curb or paved shoulders and with posted speed 45 mph or greater.~~

B PAVEMENT DESIGN

B.1 Pavement Type Selection

For new construction and major reconstruction projects, the designer should determine the type of pavement to be constructed utilizing formal analysis of existing and anticipated conditions. High volume roadways where a significant amount of truck traffic (>10%) exists may warrant consideration for special asphalt pavement designs and for rigid pavement designs. The [FDOT Department](#) has a documented procedure patterned after the [1993 AASHTO Guide for Design of Pavement Structures, Appendix B](#). This procedure may be found in [the FDOT's Department's Pavement Type Selection Manual \(20193\)](#).

B.1.a Unpaved Roadway Material Selection

The material chosen should be locally available when possible. Frequency of grading and replacement of material from loss due to erosion should be evaluated. A life cycle economic analysis should be performed to determine suitable material type. For example: Reclaimed asphalt pavements (RAP) from milling operations provide for a suitable all weather material and can be considered for unpaved roads.

The material chosen should exhibit low potential for losses due to wind, traffic and water erosion. EPA's publication AP-42 contains methodology for estimating the dust generation potential for unpaved road surfaces. Proper gradation of the chosen material is critical for its success. Designers should consider flexible or rigid pavements where runoff from unpaved roads may impact surface waters.

Designers may consult with AASHTO's [Guidelines for Geometric Design of Very Low-Volume Local Roads \(ADT ≤ 400\), 2001](#) and [FHWA's Gravel Roads Construction and Maintenance Guide, August 2015](#) for further guidance regarding material selection.

B.2 Structural Design

The pavement shall be designed and constructed so the required surface texture is maintained and its structure retains an adequate level of serviceability for the design period. The strength of the pavement materials shall be sufficient to maintain the desired roadway cross section without the formation of ruts or other

depressions which would impede drainage. Subgrade strength and subgrade drainage are major factors to be considered in pavement design. Where high ground water conditions are present, adequate clearance to the bottom of the pavement base is necessary for good pavement performance and to achieve the required compaction and stability during construction operations.

The FDOT's pavement design manuals, including the [Flexible Pavement Design Manual, 2021](#) and [Rigid Pavement Design Manual, -2021](#), are recommended as a guide for both flexible and rigid pavement design. Other design procedures are available including the [AASHTO Guide for Design of Pavement Structures, 1993](#), and procedures which have been developed by the Portland Cement Association, the American Concrete Pavement Association, and the Asphalt Institute. The selection of the design procedure and the development of the design data must be managed by professional personnel competent to make these evaluations.

B.3 Skid Resistance

Pavements shall be designed and constructed to maintain adequate skid resistance for as long a period as the available materials, technology, and economic restraints will permit, thus eliminating cost and hazardous maintenance operations.

The results of relevant experience and testing (i.e., tests conducted by ~~the~~ [the FDOT Department's](#) Materials Office) should be used in the selection of aggregate and other materials, the pavement mix design, the method of placement, and the techniques used for finishing the pavement surface. The design mixes should be monitored by continuous field testing during construction. Changes to the design mix or construction procedures must be made by qualified pavement designers and laboratory personnel ONLY.

The use of transverse grooving in concrete pavements frequently improves the wet weather skid resistance and decreases the likelihood of hydroplaning. This technique should be considered for locations requiring frequent vehicle maneuvers (curves, intersections, etc.) or where heavy traffic volumes or high speeds will be encountered. The depth, width, and spacing of the grooves should be such that control of the vehicle is not hindered.

B.4 Drainage

Adequate drainage of the roadway and shoulder surfaces should be provided. Factors involved in the general pavement drainage pattern include –pavement longitudinal and cross slopes, shoulder slopes and surface texture, curb placement, and the location and design of collection structures. The selection of pavement cross slopes should receive particular attention to achieve the proper balance between drainage requirements and vehicle operating requirements. The use of curbs or other drainage controls adjacent to the roadway surface should be avoided, particularly on high-speed facilities. Specific requirements for cross slopes and curb placement are given in **Chapter 3 – Geometric Design**.

B.4.a Unpaved Roadway Drainage

Properly graded unpaved roadways require less maintenance and suffer less material loss. Designers should strive to provide adequate cross slope, shoulder and swale profiles wherever possible. Typical cross slopes should be 2% with 1.5% minimum. During maintenance grading, the operator should ensure that the final shoulder does not become higher than the travel lane edge to prevent ponding of water on the roadway.

Designers may consult with AASHTO's publication [Guidelines for Geometric Design of Very Low-Volume Roads \(ADT < 400\), 2001](#) and FHWA's [Gravel Roads Construction & Maintenance Guide, August 2015](#) for further guidance regarding proper cross slope profiles for unpaved roads.

B.5 Shoulder Treatment

The primary function of the shoulder is to provide an alternate travel path for vehicles in an emergency situation. Shoulders should be capable of providing a safe path for vehicles traveling at roadway speed, and should be designed and constructed to provide a firm and uniform surface capable of supporting vehicles in distress. Particular attention shall be given to provide a smooth transition from pavement to shoulder. Shoulder pavement may be provided to improve drainage of the roadway, provide lateral support of roadway pavement, to serve bicyclists**bicycles**, pedestrians, –and transit users, and to minimize shoulder maintenance. See **Chapter 3 – Geometric Design** for additional information and criteria for shoulders.

Safety Edge is a technology that mitigates vertical drop offs. The Safety Edge

provides a higher probability of a vehicle returning safely to the travel lane when it drifts off the pavement. ~~The wedge shape eliminates tire scrubbing and improves vehicle stability as it crosses a drop-off.~~ Details of the Safety Edge are included in ~~Figures 5—1 Two Lane road with Safety Edge and 5—2 Safety Edge detail (no Paved Shoulders).~~ For further information on Safety Edge, See **Chapter 10 – Maintenance and Resurfacing, Section C.3.a Pavement Safety Edge** for additional information and requirements for Safety Edge.

Figure 5—1—
Two Lane Road with Safety Edge

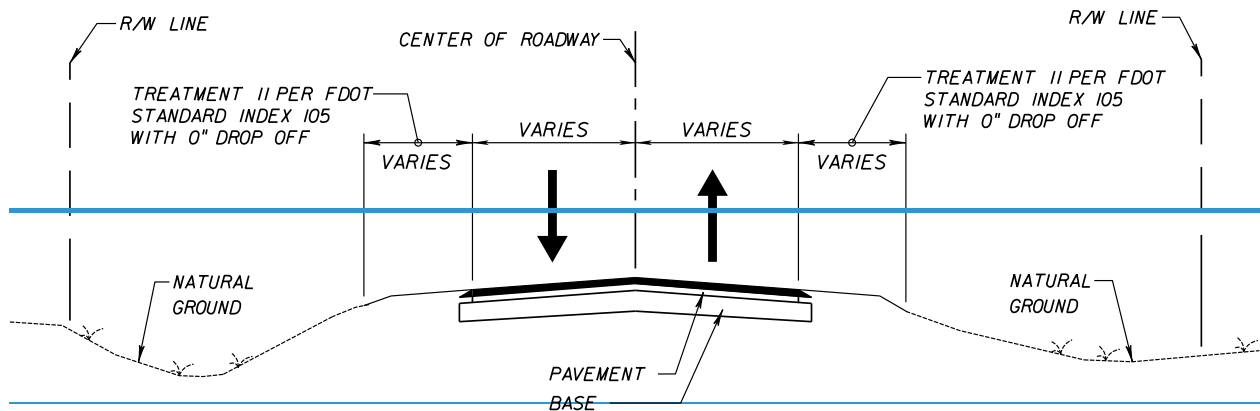
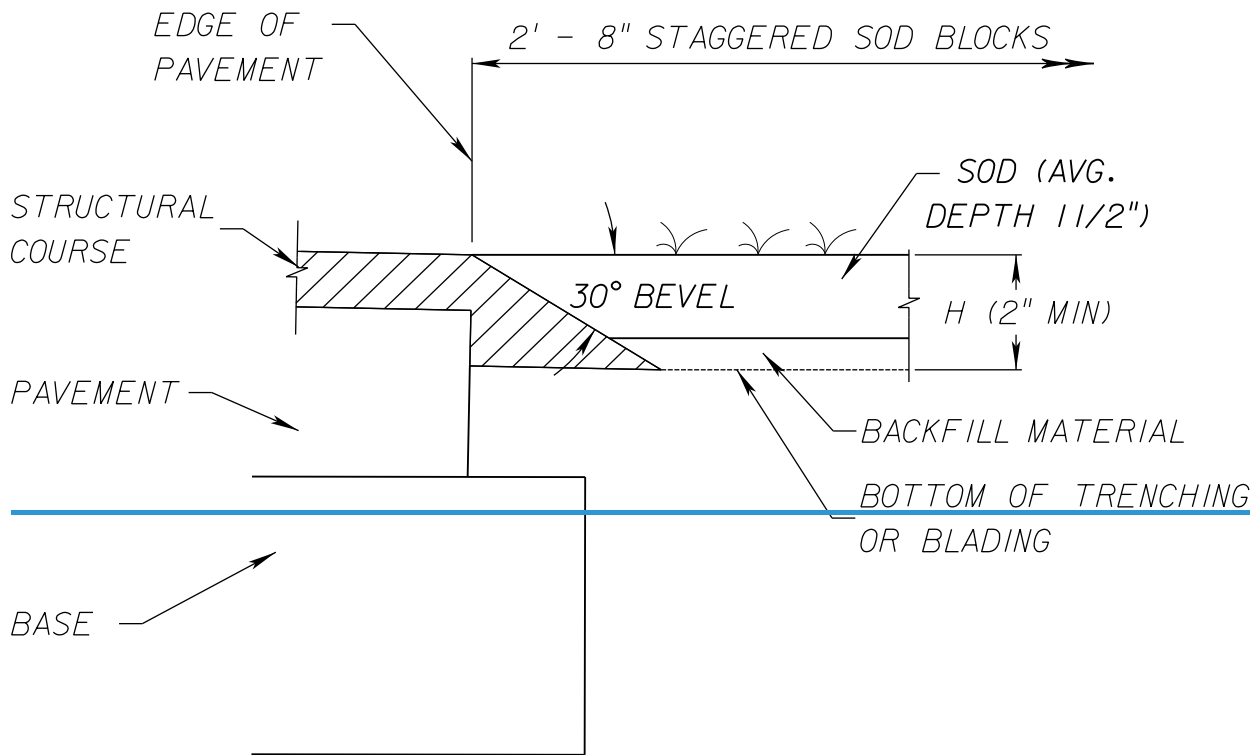

Figure 5—2—
Safety Edge Detail (No Paved Shoulders)



FOR $2" \leq H \leq 5"$

SINGLE LIFT

SAFETY EDGE DETAIL

Shoulder pavement may be provided to improve drainage of the roadway, to serve bicycles, pedestrians and transit users, and to minimize shoulder maintenance.

C PAVEMENT CONSTRUCTION

A regular program of inspection and evaluation should be conducted to ensure the pavement criteria are satisfied during the construction process. Any regular inspection program should include the following:

- The use of standard test procedures, such as AASHTO and the American Society for Testing and Materials (ASTM).
- The use of qualified personnel to perform testing and inspection.
- The use of an independent assurance procedure to validate the program.

~~After construction, the pavement surface shall be inspected to determine the required surface texture was achieved and the surface has the specified slopes. Spot checking skid resistance by approved methods should be considered. Periodic reinspection should be undertaken in conformance with the guidelines described in Chapter 10 – Maintenance and Resurfacing.~~

After construction, the pavement surface shall be inspected to determine the required surface texture was achieved and the surface has the specified slopes. Spot checking skid resistance by approved methods should be considered. Periodic reinspection should be undertaken in conformance with the guidelines described in **Chapter 10 – Maintenance and Resurfacing.**

THIS PAGE INTENTIONALLY LEFT BLANK

CHAPTER 6

LIGHTING

A	INTRODUCTION	6-1
B	OBJECTIVES	6-2
C	WARRANTING CONDITIONS.....	6-3
C.1	Criteria Based Upon Crash History	6-3
C.2	Criteria Based Upon Analysis and Investigation	6-3
C.3	General Criteria.....	6-4
D	TYPES OF LUMINAIRES	6-5
E	LIGHTING DESIGN TECHNIQUES	6-5
E.1	Illuminance.....	6-7
E.2	Luminance	6-7
E.3	Lighting Design Levels.....	6-8
F	UNIFORMITY OF ILLUMINATION	6-11
G	UNDERPASSES AND OVERPASSES	6-12
G.1	Daytime Lighting	6-12
G.2	Night Lighting.....	6-12
H	DECORATIVE ROADWAY LIGHTING.....	6-13
I	ADAPTIVE LIGHTING.....	6-13
J	WILDLIFE-SENSITIVE LIGHTING	6-13
-J.1	Work Zones in Wildlife Sensitive Areas.....	6-14
K	OVERHEAD SIGN LIGHTING.....	6-16
L	ROUNDBABOUTS.....	6-16
M	MIDBLOCK CROSSWALKS.....	6-17
N	MAINTENANCE	6-18

O LIGHT POLES 6-19
P REFERENCES FOR INFORMATIONAL PURPOSES 6-20

TABLES

Table 6 – 1 Road Surface Classifications 6-8
Table 6 – 2 Illuminance and Luminance Design Values 6-9
Table 6 – 3 Illuminance and Luminance Levels for Sign Lighting 6-16

FIGURES

Figure 6 – 1 Illuminance and Luminance 6-6
Figure 6 – 2 Horizontal and Vertical Illuminance for Mid-Block Crosswalk 6-17

CHAPTER 6

LIGHTING

A INTRODUCTION

The major reason for lighting streets and highways is to improve safety for vehicular and pedestrian traffic. Improvements in sight distance and reduction of confusion and distraction for nighttime driving can reduce the hazard potential on streets and highways. There is evidence indicating that highway lighting will produce an increase in highway capacity as well as improve the economic, safety, and aesthetic characteristics of highways.

Experience and technical improvements have resulted in improved design of lighting for streets and highways. Photometric data provide a basis for calculation of the illumination at any point for various combinations of selected luminaire types, heights, and locations. Lighting engineers can develop lighting systems that will comply with the requirements for level and uniformity of illumination; however, some uncertainties preclude the adoption of rigid design standards. Among these uncertainties is the lack of understanding of driver response and behavior under various lighting conditions. The design of lighting for new streets and highways, as well as improvements on existing facilities, should be accompanied by careful consideration of the variables involved in driver behavior and problems peculiar to particular locations.

Rights of way with pedestrian sidewalks and/or bikeways adjacent to the roadway should first address lighting requirements for the roadway to assure it is continuously illuminated. Additional lighting for a sidewalk or shared use path may be necessary if it is substantially set back from the roadway, at the discretion of the responsible/maintaining agency. Pedestrian sidewalks and/or bikeways should not be illuminated in lieu of lighting the adjacent roadway to avoid glare or potential lighting distractions to drivers.

See **Chapter 17 – Bridges and Other Structures, Section C.6** for structural requirements for lighting.

B OBJECTIVES

The objective for providing lighting is to improve the safety of roadways, sidewalks, and shared use paths and visibility of signs for road users (drivers, pedestrians, and bicyclists). The achievement of this objective will be aided by meeting these specific goals:

- Provide an improved view of the general highway geometry and the adjacent environment.
- Increase the sight distance to improve response to hazards and decision points.
- Eliminate "blind" spots unique to travel at night or in low light conditions.
- Provide a clearer view of the general situation during police, emergency, maintenance, and construction operations.
- Provide assistance in roadway, sidewalk or path delineation, particularly in the presence of confusing background lighting (i.e., surrounding street and other area lighting confuses the driver on an unlighted street or highway).
- Minimize glare that is discomforting or disabling.
- Reduce abrupt changes in light intensity.
- Avoid the introduction of roadside hazards resulting from improper placement of light poles, pull boxes, etc. (as covered under **Chapter 3 – Geometric Design** and **Chapter 4 – Roadside Design**).

C WARRANTING CONDITIONS

Although precise warrants for the provision of roadway lighting are difficult to determine, criteria for lighting is established and should be followed for new and reconstruction projects and for improvement of existing facilities. The following locations should be considered as a basis for warranting roadway lighting:

C.1 Criteria Based Upon Crash History

- Locations that, by a crash investigation program, have been shown to be hazardous due to inadequate lighting.
- Locations where the night/day ratio of serious crashes is higher than the average of similar locations.
- Specific locations that have a significant number of night time crashes and where a large percentage of these night time crashes result in injuries or fatalities.

C.2 Criteria Based Upon Analysis and Investigation

- Locations requiring a rapid sequence of decisions by the road user.
- Locations where night sight distance problems exist, with consideration to headlight limitations (i.e., where vertical and horizontal curvature adversely affect illumination by headlamps).
- Locations having discomforting or disabling glare.
- Locations where background lighting exists, particularly if this could be distracting or confusing to the road user.
- Locations where improved delineation of the highway alignment is needed.

C.3 General Criteria

- Roundabouts and signalized intersections.
- Urban streets, particularly with high speed, high volumes, or frequent turning movements.
- Urban streets of any category experiencing high night time volumes or speeds or that have frequent signalization or turning movements.
- Areas frequently congested with vehicular and/or pedestrian traffic.
- Pedestrian and bicyclist crossings (intersections or mid-block locations)
- Transit stops and hubs, passenger rail stations.
- Areas such as entertainment districts, sporting arenas, shopping centers, beach access points, parks, and other locations that generate higher volumes of pedestrian activity.
- Schools, places of assembly, or other pedestrian or bicyclist generators.
- High density land use areas.
- Central business districts.
- Junctions of major highways in rural areas.
- Rest areas/picnic shelters/trail heads/recreational facilities.

D TYPES OF LUMINAIRES

Examples of common types of lighting are identified and discussed below. Other types of lighting may be desired and currently in use for specific applications.

- Light Emitting Diode (LED) – is the preferred light source for street lighting. Light produced by LED lamps have a CCT of 4000°K to 6000°K which is a white to bluish color. The average rated life for LED can vary from 50,000 to 100,000 hours. To provide sufficient lumen levels for roadway applications, most LED fixtures have an initial luminous efficiency of around 75 lumens per watt.
- High Pressure Sodium (HPS) Lamps – Light produced by HPS lamps has a correlated color temperature (CCT) around 2100°K which is a warm yellow color. The average rated life for an HPS lamp is from 24,000 to 30,000 hours. HPS lamps have a very high initial luminous efficiency of over 100 lumens per watt.
- Metal Halide (MH) Lamps – is used for overhead lighting of commercial parking lots, sports facilities, retail stores and street lighting. Light produced by MH lamps has a CCT of 3800°K to 4000°K which is a white color. The average rated life of a MH lamp can vary from 9,000 to 20,000 hours. MH lamps have a high initial luminous efficiency of around 75 - 100 lumens per watt.

E LIGHTING DESIGN TECHNIQUES

The accepted methods for achieving a given lighting condition are known as either level of illuminance or level of luminance. Both methods of calculation are dependent upon light being reflected toward the observer's eye. Horizontal illuminance is used for intersections and interchanges and includes a variable for surface type. Horizontal and vertical illuminance is the preferred method for pedestrian areas. The luminance method can be used for straight roadways and streets, based upon the appropriate choice of surface type.

Figure 6 – 1 Illuminance and Luminance illustrates how illuminance and luminance are measured. Illuminance is the measure of the amount of light flux falling on a surface and is measured in foot candles. Luminance is a measure of the amount of light flux leaving a surface and is measured in candelas per meter squared.

Figure 6 – 1 Illuminance and Luminance

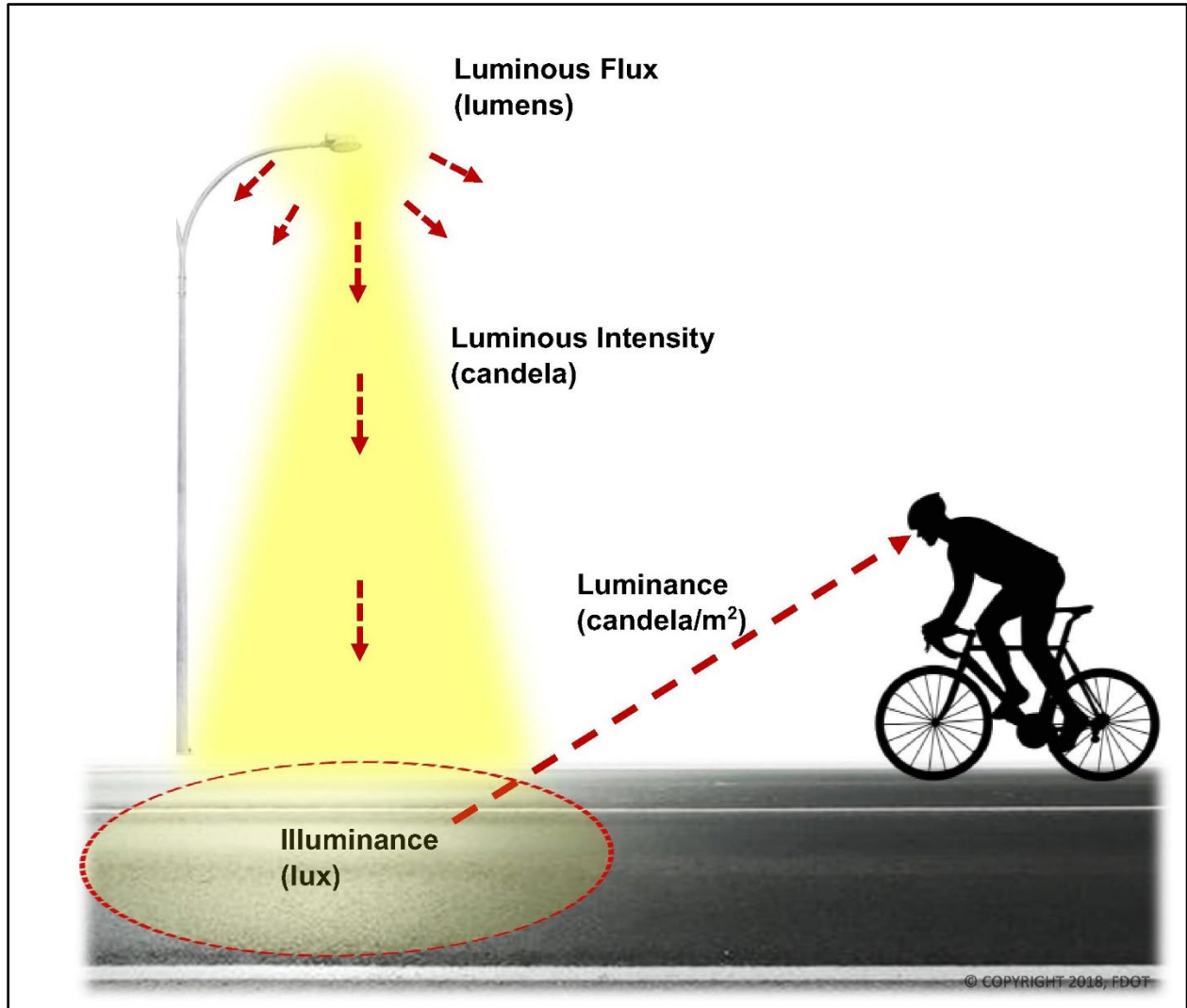

E.1 Illuminance

The illuminance method determines the amount of light falling on the roadway surface or on vertical surfaces from the roadway lighting system. Because the amount of light seen by the driver is the portion that reflects from the pavement towards the driver, and because different pavements exhibit varied reflectance characteristics, different illuminance levels are needed for each type of standard roadway surface. Illuminance is easily calculated and measurable and is not observer or pavement dependent.

E.2 Luminance

The luminance method determines how “bright” the road is by determining the amount of light reflected from the pavement in the direction of the driver. It uses the reflective characteristics (R-classification) noted in Table 6 – 1 Road Surface Classifications for the standard roadway surface types and a specific observer position.

The R-classification system is a measure of the lightness (white to black) and specularity (shininess) of roadway surfaces. A system of pavement reflectance values divides the pavement characteristics into four categories: R1, R2, R3 and R4. These categories are based upon the [American National Standard Practice for Roadway Lighting](#) and have been adopted by **AASHTO** in their [Roadway Lighting Design Guide](#).

Table 6 – 1 Road Surface Classifications

Class	Q0*	Description	Mode of Reflectance
R1	0.10	Portland cement concrete road surface. Asphalt road surface with a minimum of 12% of the aggregates composed of artificial brightener or aggregates.	Mostly diffuse
R2	0.07	Asphalt road surface with an aggregate composed of minimum 60% gravel (size greater than 0.4 in.). Asphalt road surface with 10 to 15% artificial brightener in aggregate mix. (Not normally used in North America).	Mixed (diffuse and specular)
R3	0.07	Asphalt road surface (regular and carpet seal) with dark aggregates (e.g., trap rock, blast furnace slag); rough texture after some months of use typical highways).	Slightly specular.
R4	0.08	Asphalt road surface with very smooth texture.	Mostly specular.

* Q₀ = representative mean luminance coefficient.

E.3 Lighting Design Levels

The level of illumination for streets and highways should not be less than those shown in Table 6 – 2 Illuminance and Luminance Design Values. When adding supplemental lighting for pedestrian activity, ensure lighting is compatible with any existing lighting in the corridor and minimizes glare.

These levels are for the purpose of highway safety and do not apply to lighting levels required for crime reduction. Further information may be found in the [**AASHTO Roadway Lighting Design Guide \(2005\).**](#)

Table 6 – 2 Illuminance and Luminance Design Values

Roadway and Walkway Classification	Off-Roadway Light Sources	Illuminance Method					Luminance Method			Additional Values (both Methods)
		Average Maintained Illuminance (Horizontal)				Illuminance Uniformity Ratio	Average Maintained Luminance			Veiling Luminance Ratio
		R1	R2	R3	R4		Lavg	Uniformity		
	General Land Use	(foot-candles) (min)	(foot-candles) (min)	(foot-candles) (min)	(foot-candles) (min)	avg/min (max) (6)	cd/m2 (min)	Lavg/Lmin (max)	Lmax/Lmin (max)	Lv(max)/Lavg (max) ⁽³⁾
Principal Arterials (partial or no control of access)	Commercial	1.1	1.6	1.6	1.4	3:1	1.2	3:1	5:1	0.3:1
	Intermediate	0.8	1.2	1.2	1.0	3:1	0.9	3:1	5:1	0.3:1
	Residential	0.6	0.8	0.8	0.8	3:1	0.6	3.5:1	6:1	0.3:1
Minor Arterials	Commercial	0.9	1.4	1.4	1.0	4:1	1.2	3:1	5:1	0.3:1
	Intermediate	0.8	1.0	1.0	0.9	4:1	0.9	3:1	5:1	0.3:1
	Residential	0.5	0.7	0.7	0.7	4:1	0.6	3.5:1	6:1	0.3:1
Collectors	Commercial	0.8	1.1	1.1	0.9	4:1	0.8	3:1	5:1	0.4:1
	Intermediate	0.6	0.8	0.8	0.8	4:1	0.6	3.5:1	6:1	0.4:1
	Residential	0.4	0.6	0.6	0.5	4:1	0.4	4:1	8:1	0.4:1
Local	Commercial	0.6	0.8	0.8	0.8	6:1	0.6	6:1	10:1	0.4:1
	Intermediate	0.5	0.7	0.7	0.6	6:1	0.5	6:1	10:1	0.4:1
	Residential	0.3	0.4	0.4	0.4	6:1	0.3	6:1	10:1	0.4:1
Alleys	Commercial	0.4	0.6	0.6	0.5	6:1	0.4	6:1	10:1	0.4:1
	Intermediate	0.3	0.4	0.4	0.4	6:1	0.3	6:1	10:1	0.4:1
	Residential	0.2	0.3	0.3	0.3	6:1	0.2	6:1	10:1	0.4:1

Continued next page

Table 6 – 2
Illuminance and Luminance Design Values
 (Continued)

Sidewalks	Commercial	0.9	1.3	1.3	1.2	3:1	Use illuminance requirements
	Intermediate	0.6	0.8	0.8	0.8	4:1	
	Residential	0.3	0.4	0.4	0.4	6:1	
Pedestrian Ways and Bicycle Ways ⁽²⁾	All	1.4	2.0	2.0	1.8	3.1	
Notes	<ol style="list-style-type: none"> 1. Meet either the Illuminance design method requirements or the Luminance design method requirements and meet veiling luminance requirements for both illuminance and Luminance design methods. 2. Assumes a separate facility. For Pedestrian Ways and Bicycle Ways adjacent to roadway, use roadway design values. Use R3 requirements for walkway/bikeway surface materials other than the pavement types shown. 3. Lv (max) refers to the maximum point along the pavement, not the maximum in lamp life. The Maintenance factor applies to both the Lv term and the Lavg term. 4. There may be situations when a higher level of illuminance is justified. The higher values for freeways may be justified when deemed advantageous by the agency to mitigate off-roadway sources. 5. Physical roadway conditions may require adjustment of spacing determined from the base levels of illuminance indicated above. 6. Higher uniformity ratios are acceptable for elevated ramps near high-mast poles. 7. See AASHTO publication entitled, "A Policy on Geometric Design of Highways and Streets" for roadway and walkway classifications. 8. R1, R2, R3 and R4 are Road Surface Classifications, defined in the AASHTO Roadway Lighting Design Guide and further described in Table 6.2. 						

F UNIFORMITY OF ILLUMINATION

To avoid vision problems due to varying illumination, it is important to maintain illumination uniformity over the roadway. It is recommended the ratio of the average to the minimum initial illumination on the roadway be between 3:1 to 4:1.

A maximum to minimum uniformity ratio of 10:1 should not be exceeded. It is important to allow time for the driver's eye to adjust to lower light levels. The first light poles should be located on the side of the incoming traffic approaching the illuminated area. The eye can adjust to increased or increasing light level more quickly. In transition from a lighted to an unlighted portion of the highways, the level should be gradually reduced from the level maintained on the lighted section. This may be accomplished by having the last light pole occur on the opposite roadway. The roadway section following lighting termination should be free of hazards or decision points. Lighting should not be terminated before changes in background lighting or roadway geometry, or at the location of traffic control devices.

It is also important to ensure color consistency when lighting a highway/pedestrian corridor. Mixing of different types of lighting may reduce the lighting uniformity. As we transition to LED, it is acceptable to have mixed lighting segments along the same corridor.

The use of spot lighting at unlit intersections with a history of nighttime crashes is an option.

Close coordination between the Engineer of Record and the responsible local governmental agency is essential.

G UNDERPASSES AND OVERPASSES

One of the criteria to be followed to determine requirements for underpass lighting is the relative level between illumination on the roadway inside and outside of the underpass. The height, width, and length of the underpass determines the amount of light penetration from the exterior.

The need for lighting of independent sidewalks or shared use paths should be evaluated on a project specific basis. Considerations include the likelihood of night time use, the role of the facility in the community's bicycle and pedestrian network, and whether alternatives are available for night time travel.

When lighting an underpass, use a wall-mounted luminaire that is attached to a pier, pier cap, or the wall copings underneath the bridge.

G.1 Daytime Lighting

A gradual decrease in the illumination level from daytime level on the roadway, sidewalk or path to the underpass should be provided. Consider daytime lighting for vehicles in underpasses greater than 80 feet in length.

Supplemental lighting of sidewalks or shared use paths in roadway underpasses less than 80 feet in length should be considered. Sidewalks and shared use paths on independent alignments with little natural light should be illuminated, especially if the exit is not visible upon entry.

G.2 Night Lighting

The nighttime illumination level in the underpass of the roadway should be maintained near the nighttime level of the approach roadway. Lighting of sidewalks or shared use paths adjacent to roadways in underpasses should be considered. Sidewalks and shared use paths on independent alignments open to travel during darkness should be illuminated. Due to relatively low luminaire mounting heights in underpasses, care should be exercised to avoid glare.

H DECORATIVE ROADWAY LIGHTING

Decorative or architectural roadway lighting is acceptable provided it meets the minimum design criteria and the objectives contained in this Manual. Examples include architectural lighting posts, cross arms, wall brackets, bollards, and light fixtures.

I ADAPTIVE LIGHTING

Some locations such as coastal roadways where sea turtles may be affected, may require lower lighting levels and different colors than what might normally be provided. FHWA's publication [*The Guidelines for the Implementation of Reduced Lighting on Roadways*](#) describes a process by which an agency or a lighting designer can select the required lighting level for a road or street and implement adaptive lighting for a lighting installation or lighting retrofit. This document supplements existing lighting guidelines.

J WILDLIFE-SENSITIVE LIGHTING

The lighting on some coastal roadways may affect wildlife, including sea turtles, and may require lower lighting levels, adjusting direction of luminaires, –and different types and colors of lighting installations than what might normally be provided. Sea turtles and their habitat (nesting beaches) are afforded protection in accordance with *Florida's Marine Turtle Protection Act (379.2431, F.S.)* which restricts the take, possession, disturbance, mutilation, destruction, selling, transference, molestation, and harassment of marine turtles, nests or eggs.

The state of Florida developed the *Model Lighting Ordinance for Marine Turtle Protection Rule (62B-55, F.A.C.)* to guide local governments in creating lighting ordinances. Counties and municipalities in Florida that have passed ordinances prohibiting light from reaching the beach can be found on the Municipal Code Corporation web site. Coordinate with the local agencies in proximity to the project for additional requirements and guidance on providing permanent lighting or lighting in work zones.

Wildlife areas of concern can be determined by contacting the Florida Fish and Wildlife Conservation Commission (FWC) at [*MarineTurtle@MyFWC.com*](mailto:MarineTurtle@MyFWC.com). KMZ layers and Shape files illustrating areas where wildlife sensitive areas occur can be found on the *FDOT's Office of Environmental Management "OEM Resources"* web page, under Turtle Lighting.

An interactive map of wildlife sensitive areas can also be found in the *Florida Geographic Data Library (FGDL)*, and will show areas of the state where wildlife sensitive lighting

measures should be implemented. Use the key word “turtle” in the search function. Direct links for download from the **FGDL** layers are:

- https://download.fgdl.org/pub/state/trtl_sen_light_jul20.zip
- https://download.fgdl.org/pub/state/trtl_drksky_light_jul20.zip

Additional information can be found on **FWC’s Sea Turtle Lighting Guidelines** website.

For conventional lighting near a wildlife area of concern, incorporate the following design requirements:

1. Where feasible, orient luminaires away from the wildlife area of concern.
2. Design lighting system using luminaires that meet the following requirements:
 - a. The light source for the luminaires must be true red, orange, or amber light-emitting diodes (LEDs) with no more than 1.75% of the spectral power distribution below 560 nm.
 - b. The optics must have an IP 66 rating.
 - c. The luminaire mounting assembly must be a slip fitter type designed to accommodate a nominal 2 inch pipe size (2-3/8 inch O.D.) arm or a pole top mounting assembly designed to accommodate a 2-3/8 inch pole top tenon.
 - d. Luminaires must have a IESNA light distribution curve (IES LM-79) designated by an EPA-recognized laboratory.
 - e. Luminaires must meet a minimum pole spacing of 50 feet.

Further information on luminaires which meet the criteria for wildlife sensitive lighting may be found on the FDOT’s **Approved Product List (APL)** in the Wildlife-Sensitive Conventional Lighting category or FWC’s **Certified Wildlife Lighting Guidelines**. The AGi32 lighting optimization tool, used in accordance with the settings shown in the FDOT **Standard Specifications for Road and Bridge Construction, 992-2.4 Luminaires for Wildlife Sensitive Lighting**, may be used to design appropriately spaced lighting.

Section J.-1 Work Zones in Wildlife Sensitive Areas

For night work along coastal roadways where sea turtles may be affected, incorporate the following for temporary lighting of work zone operations:

1. Direct all work zone lighting away from the beach to avoid illumination of or direct visibility from the beach.
2. Shield luminaires to avoid lighting areas outside of the immediate construction area.

K OVERHEAD SIGN LIGHTING

If the visibility of the sign due to roadway geometry or retro reflectivity of the sign sheeting is inadequate, overhead sign lighting should be provided. It is recommended that the level of illumination for overhead signs not be less than guidelines found in Table 6 – 3 Illuminance and Luminance Levels for Sign Lighting. See **Chapter 18 – Signing and Marking** for signage retroreflectivity requirements.

Table 6 – 3 Illuminance and Luminance Levels for Sign Lighting

Ambient Luminance	Sign Illuminance		Sign Luminance*	
	Footcandles	Lux	Candelas per Square Meter	Candelas per Square Foot
Low	10 - 20	100 - 200	22 - 44	2.2 – 4.4
Medium	20 - 40	200 - 400	44 - 89	4.4 – 8.9
High	40 - 80	400 - 800	89 - 178	89 – 178

Source: AASHTO Roadway Lighting Design Guide (October 2005), Table 10 – 1 Illuminance and Luminance Levels for Sign Lighting.

*Based upon a maintained reflectance of 70 percent for white sign letters.

L ROUNDABOUTS

Roundabouts should be supplemented with roadway lighting. Where pedestrians are expected, provide additional lighting of 2.0-foot candles of maintained vertical illumination, measured at 5 feet from the road surface. Calculate the vertical illuminance for the crosswalk on each near side approach entering and exiting the roundabout.

M MIDBLOCK CROSSWALKS

At midblock pedestrian crossings, provide 2.0-foot candles of maintained vertical illumination, measured at 5 feet from the road surface. Calculate the vertical illuminance for the crosswalk on each near side approach.

Figure 6 – 2 Horizontal and Vertical Illuminance for Mid-Block Crosswalk

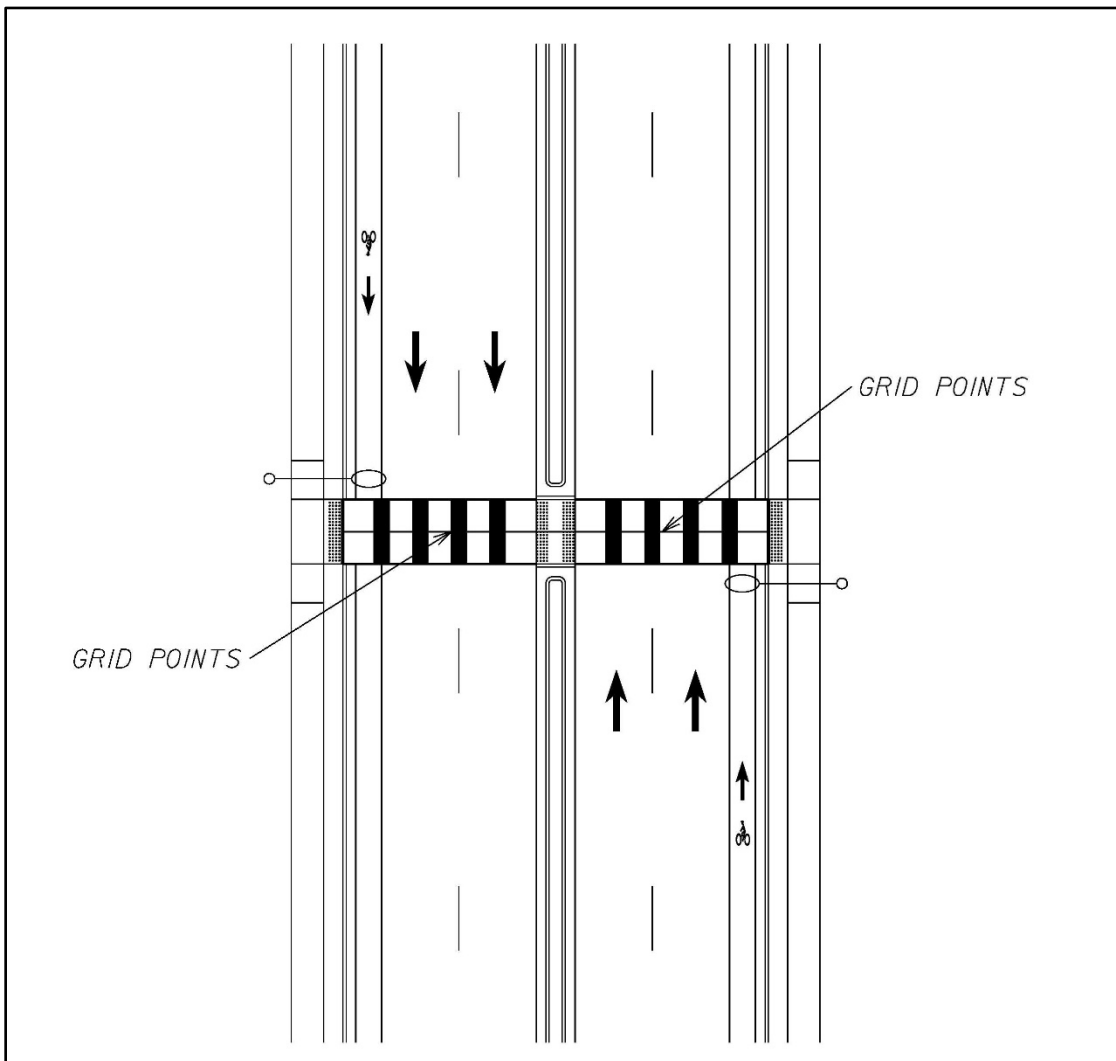

N MAINTENANCE

A program of regular preventive maintenance should be established to ensure levels of illumination do not go below required values. The program should be coordinated with lighting design to determine the maintenance period. Factors for consideration include a decrease in lamp output, luminaire components becoming dirty, and the physical deterioration of the reflector or refractor. The maintenance of roadway lighting should be incorporated in the overall maintenance program specified in **Chapter 10 – Maintenance and Resurfacing**.

O LIGHT POLES

Light poles should not be placed in the sidewalk when adequate right of way is available beyond the sidewalk. Placement of lighting structures and achieved illumination may be limited by existing conditions such as driveways, overhead and underground utilities, drainage structures, and availability of right of way.

Light poles should not be placed so as to provide a hazard to errant vehicles. Non-frangible light poles should be placed outside of the clear zone. They should be as far removed from the travel lane as possible or behind adequate guardrail or other barriers. Light poles should be placed on the inside of the curves when feasible. Foundations or light poles and rigid auxiliary lighting components that are not behind suitable barriers should be constructed flush with or below the ground level.

The use of high mast lighting should be considered, particularly for lighting interchanges and other large plaza areas. This use tends to produce a more uniform illumination level, reduces glare, and allows placement of the light poles farther from the roadway. Additional emphasis lighting should be considered to illuminate specific and desired pedestrian crossings.

The placement of light poles should not interfere with the driver's sight distance or visibility of signs, signals, or other traffic control devices. In addition, the [National Electrical Code \(NEC\)](#) requires a working area for safety purposes around the poles. Further criteria regarding the placement of roadside structures, including light poles, is specified in **Chapter 4 – Roadside Design**.

P REFERENCES FOR INFORMATIONAL PURPOSES

The publications referenced in this chapter can be obtained at the following web sites.

- Roadway Lighting, ANSI/RP-8-21
<https://blog.ansi.org/ansi-ies-rp-8-21-design-roadway-lighting/#gref>
- Design Guide for Residential Street Lighting (2015), Illuminating Engineering Society
<https://www.ies.org/store/design-guides/design-guide-for-residential-street-lighting/>
- AASHTO - Roadway Lighting Design Guide (October 2005)
<https://bookstore.transportation.org> <https://highways.dot.gov/safety/other/visibility/roadway-lighting-resources>
- Guidelines for the Implementation of Reduced Lighting on Roadways
PUBLICATION NO. FHWA-HRT-14-050 JUNE 2014
<http://www.fhwa.dot.gov/publications/research/safety/14050/14050.pdf>
- The Lighting Handbook, 10th Edition, Illuminating Engineering Society (IESA)
<https://www.ies.org/store/lighting-handbooks/lighting-handbook-10th-edition/>
- National Electric Code
<https://www.nfpa.org/NEC/About-the-NEC/Free-online-access-to-the-NEC-and-other-electrical-standards>

CHAPTER 7

RAIL-HIGHWAY CROSSINGS

A	INTRODUCTION	7-1
B	OBJECTIVE AND PRIORITIES	7-1
B.1	Conflict Elimination.....	7-1
B.2	Hazard Reduction	7-1
C	RAIL-HIGHWAY GRADE CROSSING NEAR OR WITHIN PROJECT LIMITS	7-2
D	DESIGN OF RAIL-HIGHWAY CROSSINGS	7-3
D.1	Sight Distance.....	7-3
D.1.a	Stopping Sight Distance.....	7-3
D.1.b	Sight Triangle.....	7-3
D.1.c	Crossing Maneuvers	7-4
D.2	Approach Alignment.....	7-7
D.2.a	Horizontal Alignment.....	7-7
D.2.b	Vertical Alignment.....	7-7
D.3	Highway Cross Section	7-8
D.3.a	Pavement.....	7-8
D.3.b	Shoulders.....	7-8
D.3.c	Medians	7-9
D.3.d	Sidewalks and Shared Use Paths.....	7-10
D.3.e	Roadside Clear Zone	7-13
D.3.f	Auxiliary Lanes.....	7-13
D.4	Roadside Design.....	7-13
D.5	Vertical Clearance.....	7-13
D.6	Horizontal Clearance.....	7-14
D.6.a	Adjustments for Track Geometry	7-16
D.6.b	Adjustments for Physical Obstructions.....	7-16
D.7	Access Control.....	7-17
D.8	Parking.....	7-17
D.9	Traffic Control Devices.....	7-17

D.10	Rail-Highway Grade Crossing Surface.....	7-19
D.11	Roadway Lighting	7-19
D.12	Crossing Configuration.....	7-19
D.13	Railroad Dynamic Envelope Pavement Marking and Signage	7-22
E	QUIET ZONES	7-27
F	HIGH SPEED RAIL	7-29
G	MAINTENANCE AND RECONSTRUCTION	7-30
H	REFERENCES FOR INFORMATIONAL PURPOSES	7-31

TABLES

Table 7 – 1	Sight Distance at Rail-Highway Grade Crossings	7-6
Table 7 – 2	Minimum Vertical Clearances for New Bridges	7-14
Table 7 – 3	Horizontal Clearances for Railroads	7-16
Table 7 – 4	Location of “Do Not Stop on Tracks” Signage for Railroad Crossings Using the Rail Dynamic Envelope	7-26

FIGURES

Figure 7 – 1	Visibility Triangle at Rail-Highway Grade Crossings	7-5
Figure 7 – 2	Flush Median Channelization Devices	7-9
Figure 7 – 3	Pedestrian Crossings	7-11
Figure 7 – 4	Flangeways and Flangeway Gaps	7-12
Figure 7 – 5	Track Section	7-15
Figure 7 – 6	Median Signal Gates for Multilane Curbed Sections.....	7-18
Figure 7 – 7	Passive Rail-Highway Grade Crossing Configuration	7-20
Figure 7 – 8	Active Rail-Highway Grade Crossing Configuration.....	7-21
Figure 7 – 9	Railroad Dynamic Envelope Pavement Marking Detail	7-22

Figure 7 – 10 Railroad Crossing at 2-Lane Roadway
7-23

Figure 7 – 11 Railroad Crossing at Multilane Roadway 7-24

Figure 7 – 12 Railroad Crossing at Multilane Roadway with Right Turn Lane..... 7-25

Figure 7 – 13 Gate Configuration for Quiet Zones 7-28

CHAPTER 7

RAIL-HIGHWAY CROSSINGS

A INTRODUCTION

The basic design for grade crossings should be similar to that given for highway intersections in **Chapter 3 – Geometric Design**. Rail-highway grade crossings should be limited in number and should, where feasible, be accomplished by grade separations. Where at-grade crossings are necessary, adequate traffic control devices and proper crossing design are required to limit the probability of crashes.

B OBJECTIVE AND PRIORITIES

The primary objective in the design, construction, maintenance, and reconstruction of rail-highway crossings is to provide safety for both rail and roadway vehicles in a feasible and efficient manner. The achievement of this objective may be realized by utilizing the following techniques in the listed sequence of priority.

B.1 Conflict Elimination

The elimination of at grade rail-highway conflicts is the most desirable procedure for promoting safe and efficient traffic operations. This may be accomplished by the closing of a crossing or by utilizing a grade separation structure.

B.2 Hazard Reduction

The design of new at-grade crossings should consider the objective of hazard reduction. In addition, an effective program of reconstruction should be directed towards reducing crash potential at existing crossings.

The regulation of intersections between railroads and all public streets and highways in Florida is vested in the [Florida Administrative Code, \(Rule Chapter 14-57: Railroad Safety and Clearance Standards, and Public Railroad-Highway Grade Crossings\)](#). This rule contains minimum requirements for all new grade crossings.

The [FDOT Department](#)'s rail office has other documents available that contain additional guidance for the design, reconstruction, and upgrading of existing rail-highway grade crossings, and may be contacted for further information.

C RAIL-HIGHWAY GRADE CROSSING NEAR OR WITHIN PROJECT LIMITS

Federal-aid projects must be reviewed to determine if a rail-highway grade crossing is within the limits of or near the terminus of the project. If such rail-highway grade crossing exists, the project must be upgraded to meet the requirements of the [Manual on Uniform Traffic Control Devices \(2009 Edition with Revision Numbers 1 and 2, May 2012\) \(MUTCD\)](#) in accordance with *Title 23, United States Code (U.S.C.), Chapter 1, Section 109(e) and 23 C.F.R. 646.214(b)*.

These requirements are located in **Chapter 8** of the *MUTCD*. “Near the terminus” is defined as being either of the following:

- If the project begins or ends between the crossing and the MUTCD-mandated advanced placement distance for the advanced (railroad) warning sign. See *MUTCD, Table 2C-4 (Condition B, Column “0” mph)* for this distance.
- An intersection traffic signal within the project is linked to the crossing's flashing light signal and gate.

D DESIGN OF RAIL-HIGHWAY CROSSINGS

The primary requirement for the geometric design of a grade crossing is that it provides adequate sight distance for the motorist to make an appropriate decision as to stop or proceed at the crossing.

D.1 Sight Distance

The minimum sight distance requirements for streets and highways at rail-highway grade crossings are ~~similar to~~like those required for highway intersections (*Chapter 3 – Geometric Design*).

D.1.a Stopping Sight Distance

The approach roadways at all rail-highway grade crossings should consider stopping sight distance no less than the values given in *Chapter 3*, Table 3 – 3 Minimum Stopping Sight Distances for the approach to stop signs. This distance shall be measured to a stopping point prior to gates or stop bars at the crossing, but not less than 15 feet from the nearest track. All traffic control devices shall be visible from the driver eye height of 3.50 feet.

D.1.b Sight Triangle

At grade crossings without train activated signal devices, a sight triangle should be provided.

The provision of the capability for defensive driving is an important aspect of the design of rail-highway grade crossings. An early view of an approaching train is necessary to allow the driver time to decide to stop or to proceed through the crossing.

The size of this sight triangle, which is shown in Figure 7 – 1 Visibility Triangle at Rail-Highway Grade Crossings, is dependent upon the train speed limit, the highway design speed, and the highway approach grade. The minimum distance along the highway (d_H), includes the requirements for stopping sight distance, the offset distance (D) from the edge of track to the stopped position (15 feet), and the eye offset (d_e) from the front of vehicles (8 feet); (Figure 7 – 1, Case A). The required distance (d_T) along the track, given in Table 7 – 1 Sight Distance at Rail-Highway Grade Crossings, is necessary to allow a vehicle to stop or proceed across the

track safely. Where the roadway is on a grade, the lateral sight distance (d_T) along the track should be increased as noted (Table 7 – 1). This lateral sight distance is desirable at all crossings. In other than flat terrain it may be necessary to rely on speed control signs and devices and to predicate sight distance on a reduced speed of operation. This reduced speed should never be less than 15 mph and preferably 20 mph.

D.1.c Crossing Maneuvers

The sight distance required for a vehicle to cross a railroad from a stop is essentially the same as that required to cross a highway intersection as given in **Chapter 3 – Geometric Design**.

An adequate clear distance along the track in both directions should be provided at all crossings. This distance, when used, shall be no less than the values obtained from Figure 7 – 1 Visibility Triangle at Rail-Highway Grade Crossings and Table 7 – 1 (Case B), Sight Distance at Rail-Highway Grade Crossings. Due to the greater stopping distance required for trains, this distance should be increased wherever possible.

The crossing distance to be used shall include the total width of the tracks, the length of the vehicle, and an initial vehicle offset. This offset shall be at least 10 feet back from any gates or flashing lights, but not less than 15 feet from the nearest track. The train speed used shall be equal to or greater than the established train speed limit.

The setback for determining the required clear area for sight distance should be at least 10 feet more than the vehicle offset. Care should be exercised to ensure signal supports and other structures at the crossing do not block the view of drivers preparing to cross the tracks.

Figure 7 – 1 Visibility Triangle at Rail-Highway Grade Crossings

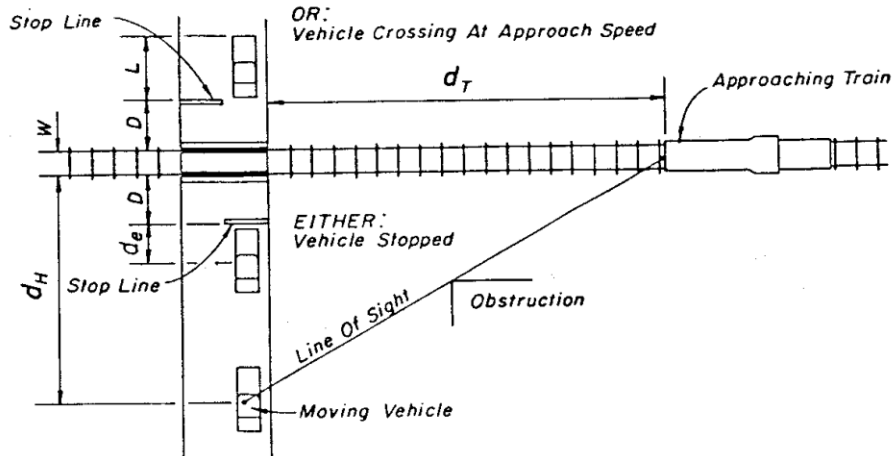

CASE A

APPROACHING VEHICLE TO SAFELY CROSS OR STOP AT RAILROAD CROSSING

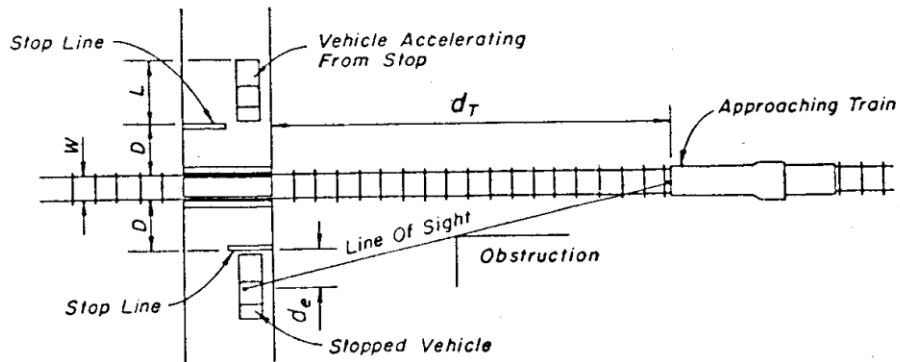

CASE B

VEHICLE DEPARTING FROM STOPPED POSITION TO SAFELY CROSS RAILROAD TRACK

For d_H and d_T values and crossing conditions see Table 7-1.

Table 7 – 1 Sight Distance at Rail-Highway Grade Crossings

Design Sight Distances for Combinations of Train and Highway Vehicle Speeds Conditions:								
Single Track 90° Crossing Design Vehicle WB-62FL and WB-67 (L=73.5' d _e =8') Flat Highway Grades				Track Width (W) = 5' Vehicle Stop Position (D) = 15' No Train Activated Warning Devices				
Train Speed (mph)	Case B Vehicle Departure From Stop	Case A Moving Vehicle						
	Vehicle Speed (mph)							
	0	10	20	30	40	50	60	70
	d _t (feet) Sight Distance Along Railroad Track							
10	255	155	110	102	102	106	112	119
20	509	310	220	203	205	213	225	239
30	764	465	331	305	307	319	337	358
40	1019	619	441	407	409	426	450	478
50	1274	774	551	509	511	532	562	597
60	1528	929	661	610	614	639	675	717
70	1783	1084	771	712	716	745	787	836
80	2038	1239	882	814	818	852	899	956
90	2292	1394	992	915	920	958	1012	1075
100	2547	1548	1102	1017	1023	1064	1124	1194
110	2802	1703	1212	1119	1125	1171	1237	1314
120	3057	1858	1322	1221	1227	1277	1349	1433
130	3311	2013	1433	1322	1329	1384	1461	1553
(Continued on Next Page)								

Table 7 – 1 Sight Distance at Rail-Highway Grade Crossings (Cont')

d _H (feet) Sight Distance Along Highway							
	69	135	220	324	447	589	751
<p>Notes: 1. Sight distances are required in all quadrants of the crossing.</p> <p>2. Corrections must be made for conditions other than shown in the table, such as, multiple rails, skewed angle crossings, ascending and descending grades, and curvature of highways and rails. For condition adjustments and additional information refer to Railroad-Highway Grade Crossings under Chapter 9 of "A Policy on Geometric Design of Highways and Streets", AASHTO (2011). Additional information is available on FHWA's website for Highway-Rail Grade Crossing Surfaces and NCHRP Synthesis 250 Highway – Rail Grade Crossing Surfaces, TRB, (1998)."</p>							

Source: Developed from **Table 9 – 32, A Policy on Geometric Design of Highway and Streets, AASHTO (2011)**.

D.2 Approach Alignment

The alignment of the approach roadways is a critical factor in developing a safe grade crossing. The horizontal and vertical alignment, and particularly any combination thereof, should be as gentle as possible.

D.2.a Horizontal Alignment

The intersection of a highway and railroad should be made as near to the right angle (90 degrees) as possible. Intersection angles less than 70 degrees should be avoided. The highway approach should, if feasible, be on a tangent, because the use of a horizontal curve tends to distract the driver from a careful observation of the crossing. The use of superelevation at a crossing is normally not possible since this would prevent the proper grade intersection with the railroad.

D.2.b Vertical Alignment

The vertical alignment of the roadway on a crossing is an important factor in safe vehicle operation. The intersection of the tracks and the roadway

should constitute an even plane. All tracks should, preferably, be at the same elevation, thus allowing a smooth roadway through the crossing. Where the railroad is on a curve with superelevation, the vertical alignment of the roadway shall coincide with the grade established by the tracks.

Vertical curvature on the crossing should be avoided. This is necessary to limit vertical motion of the vehicle.

The vertical alignment of the approach roadway should be adjusted when rail elevations are raised to prevent abrupt changes in grade and entrapment of low clearance vehicles.

The roadway approach to crossing should also coincide with the grade established by the tracks. This profile grade, preferably zero, should be extended a reasonable distance (at least two times the design speed in feet) on each side of the crossing. Where vertical curves are required to approach this section, they should be as gentle as possible. The length of these vertical curves shall be of sufficient length to provide the required sight distance.

D.3 Highway Cross Section

Preserving the continuity of the highway cross section through a grade crossing is important to prevent distractions and to avoid hazards at an already dangerous location.

D.3.a Pavement

The full width of all travel lanes shall be continued through grade crossings. The crown of the pavement shall be transitioned gradually to meet the cross-sectional grade of the tracks. This pavement cross slope transition shall be in conformance with the requirements for superelevation runoff. The lateral and longitudinal pavement slopes should be designed to direct drainage away from the tracks.

D.3.b Shoulders

All shoulders shall be carried through rail-highway grade crossings without interruption.

The use of full-width paved shoulders is required at all new crossings to maintain a stable surface for emergency maneuvers. The shoulders should

be paved a minimum distance of 50 feet on each side of the crossing, measured from the outside rail. It is desirable to pave 100 feet on either side to permit bicycles to exit the travel lane, slow for their crossing, and then make an adequate search before selecting a gap for a return to the travel lane. See **Chapter 3, Table 3 – 11 Shoulder Widths for Rural Highways** for further information on shoulder width.

D.3.c Medians

It is recommended that the full median width on divided highways should be continued through the crossing. The median should be contoured to provide a smooth transition on the tracks.

A raised median is the ideal deterrent to discourage motorists from driving around the gates to cross the tracks or making a U-turn prior to the tracks. Flush medians should have channelization devices as a deterrent. Railroad signals and gate assemblies should be installed in the median only when gate arms of 36 feet will not adequately span the approach roadway.

Figure 7 – 2 Flush Median Channelization Devices



Alexander Street, SR 39A, Plant City, FL 1

D.3.d Sidewalks and Shared Use Paths

To provide an accessible route for pedestrians at grade rail-highway crossings, new or existing sidewalks and shared use paths shall be continued across the rail crossing. The surface of the crossing shall be:

- firm, stable and slip resistant,
- level and flush with the top of rail at the outer edges of the rails, and
- area between the rails align with the top of rail.

Detectable warnings shall be placed on each side of the rail-highway crossing, extend 2.0 feet in the direction of pedestrian travel and the full width across the sidewalk or shared use path, as shown in Figure 7 – 3 Pedestrian Crossings.

The edge of the detectable warning nearest the rail crossing shall be 6.0 to 15.0 feet from the centerline of the nearest rail. Where pedestrian gates are provided, detectable warnings shall be placed a minimum of 4.0 feet from the side of the gates opposite the rail, and within 15.0 feet of the centerline of the nearest rail.

If traffic control signals are in operation at a crossing that is used by pedestrians or bicyclists, an audible device such as a bell shall also be provided and operated in conjunction with the traffic control signals. See [MUTCD, Chapters 8B and 8C](#) for further information and to determine if additional signals, signs, or pedestrian gates should be included. See [MUTCD, Chapter 8D](#) for additional information on designing crossings for shared use paths.

Figure 7 – 3 Pedestrian Crossings

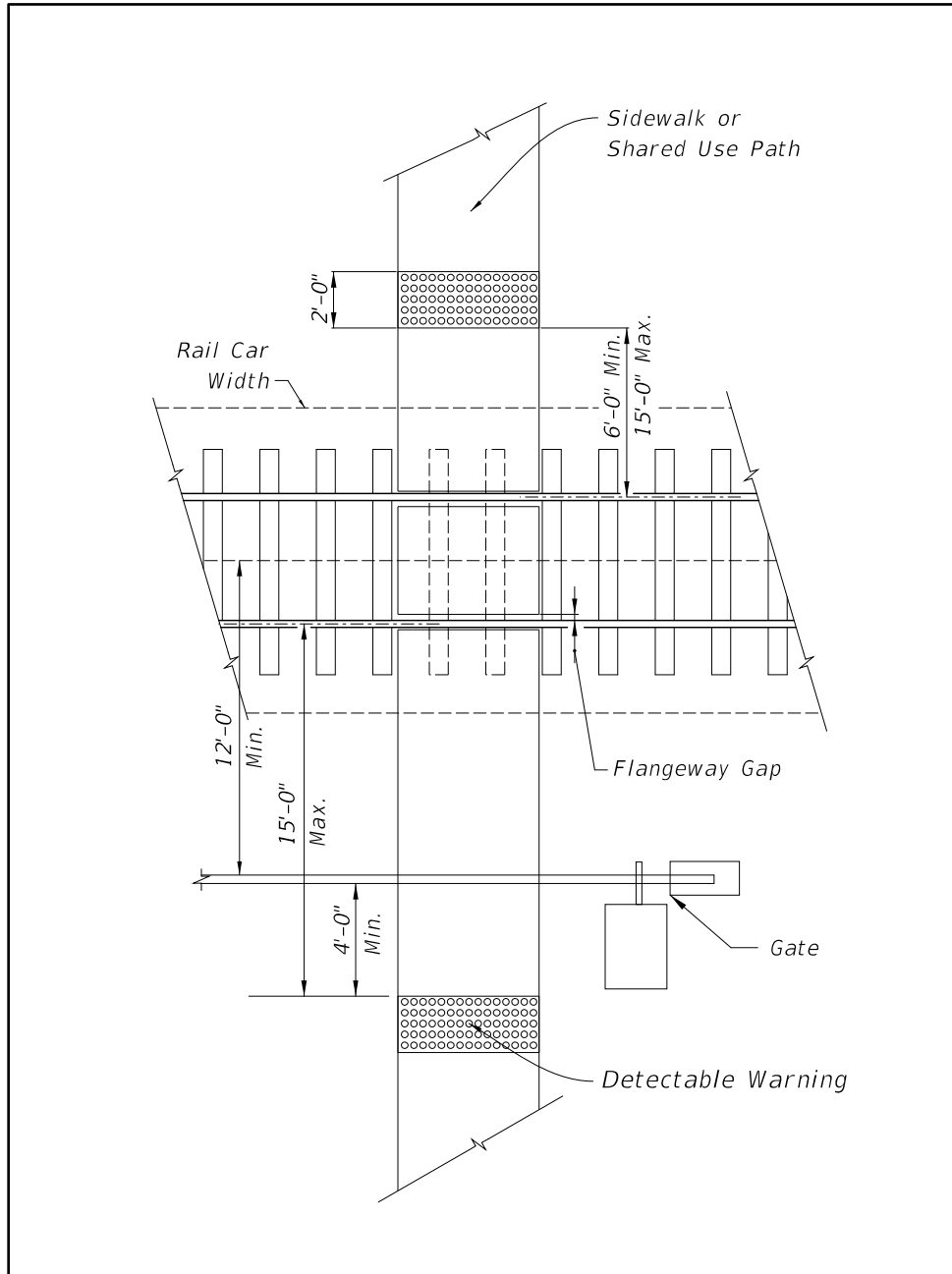

Note: Pedestrian gates may be installed on the outside of the sidewalk/shared use path or in the utility strip.

Flangeway gaps are necessary to allow the passage of train wheel flanges; however, they pose a potential hazard to pedestrians who use wheelchairs because the gaps can entrap the wheelchair casters. Flangeway gaps at pedestrian at-grade rail crossings shall be 2 ½" maximum on non-freight rail track and 3" maximum on freight rail track.

Figure 7 – 4 Flangeways and Flangeway Gaps illustrates where the flanges are located on the wheel, how they interact with the rails, and the maximum gap allowed.

Figure 7 – 4 Flangeways and Flangeway Gaps

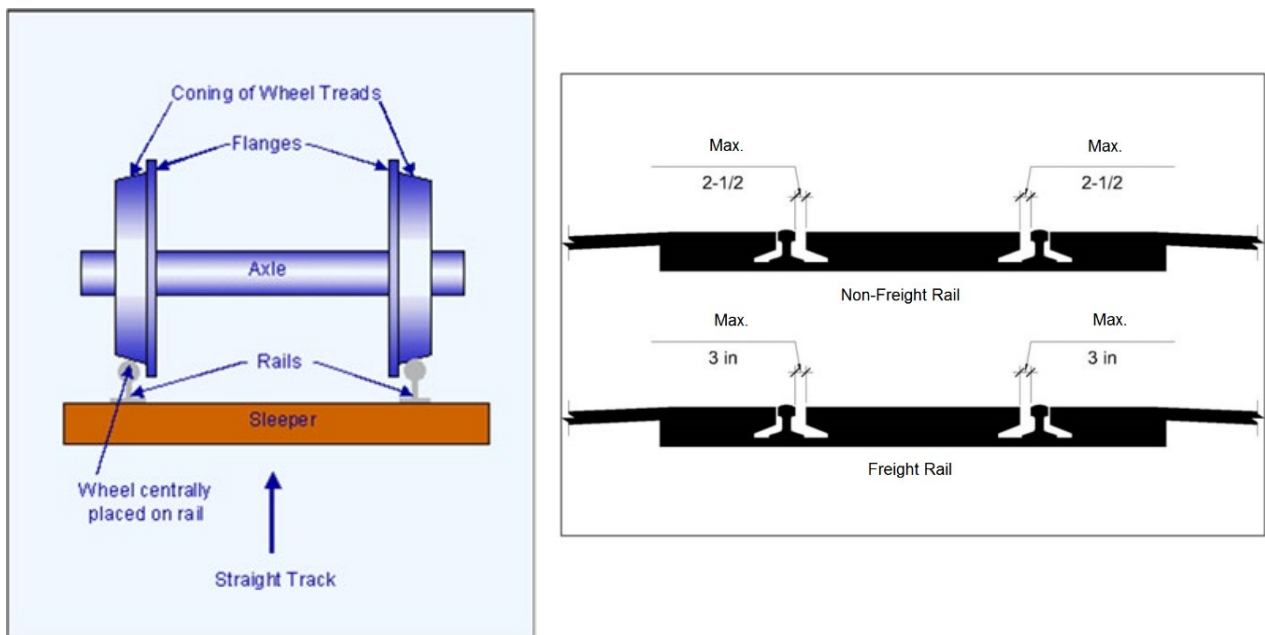

See **Chapter 8 – Pedestrian Facilities** and **Chapter 9 – Bicycle Facilities** for further information on designing sidewalks and shared use paths. The [2006 Americans with Disabilities Act – Standards for Transportation Facilities](#) and the [2020~~17~~ Florida Building Code, Accessibility 7th Edition—Code](#) impose additional requirements for the design and construction of pedestrian facilities.

D.3.e Roadside Clear Zone

Although it is often not practical to maintain the full width of the roadside clear zone, the maximum clear area feasible should be provided. This clear zone shall conform to the requirements for slope and change in grade for roadside clear zones.

D.3.f Auxiliary Lanes

Auxiliary lanes are permitted but not encouraged at signalized rail-highway grade crossings that have a large volume of bus or truck traffic required to ~~stop at all times~~ **always stop**. These additional lanes should be restricted for the use of these stopping vehicles. The approaches to these auxiliary lanes shall be designed as storage for deceleration lanes. The exits shall be designed as acceleration lanes.

D.4 Roadside Design

The general requirements for roadside design given in **Chapter 3 – Geometric Design** and **Chapter 4 – Roadside Design**, should be followed at rail-highway grade crossings. Supports for traffic control devices may be required within the roadside recovery area. Due to the structural requirements and the necessity for continuous operation, the use of a breakaway design is not recommended. The use of a guardrail or other longitudinal barrier is also not recommended, because an out of control vehicle would tend to be directed into the crossing.

~~In order to~~ **To** reduce the hazard to errant vehicles, all support structures should be placed as far from the traveled way as practicable.

D.5 Vertical Clearance

Minimum vertical clearances for grade separated rail-highway crossings are shown in Table 7 – 2 Minimum Vertical Clearances for New Bridges. Minimum vertical clearance is the least distance between the bottom of the superstructure and the top of the highest rail utilized anywhere within the horizontal clearance zone.

Table 7 – 2 Minimum Vertical Clearances for New Bridges

Facility Type	Clearance
Railroad over Roadway	16'-6"
Roadway over Railroad ¹	23'-6"
Pedestrian over Railroad ¹	23'-6"

1. Over High Speed Rail Systems, see the latest version of [American Railway Engineering and Maintenance-of-Way Association \(AREMA\)](#) guidelines, or the design office of the high-speed rail line of interest for specific guidelines and specifications. Over Electrified Railroad, the minimum vertical clearance shall be 24 feet 3 inches. (See [Department Topic No. 000-725-003: South Florida Rail Corridor Clearance.](#))

For any construction affecting existing bridge clearances (e.g., bridge widenings or resurfacing) vertical clearances less than 16' - 0" shall be maintained or increased. If reducing the design vertical bridge clearance to a value between 16' - 0" and 16' - 2", the design vertical clearance dimension in the plans shall be stated as a minimum.

D.6 Horizontal Clearance

Horizontal clearances shall be measured in accordance with Figure 7 – 5 Track Section. The governing railroad company occasionally may accept a waiver from normal clearance requirements if justified, i.e., for designs involving widening or replacement of existing overpasses. The [FDOT District Rail Coordinator](#) should be consulted if such action is being considered for FDOT owned rail corridors. For other rail crossings, coordinate with the owner of the rail corridor.

Figure 7 – 5 Track Section

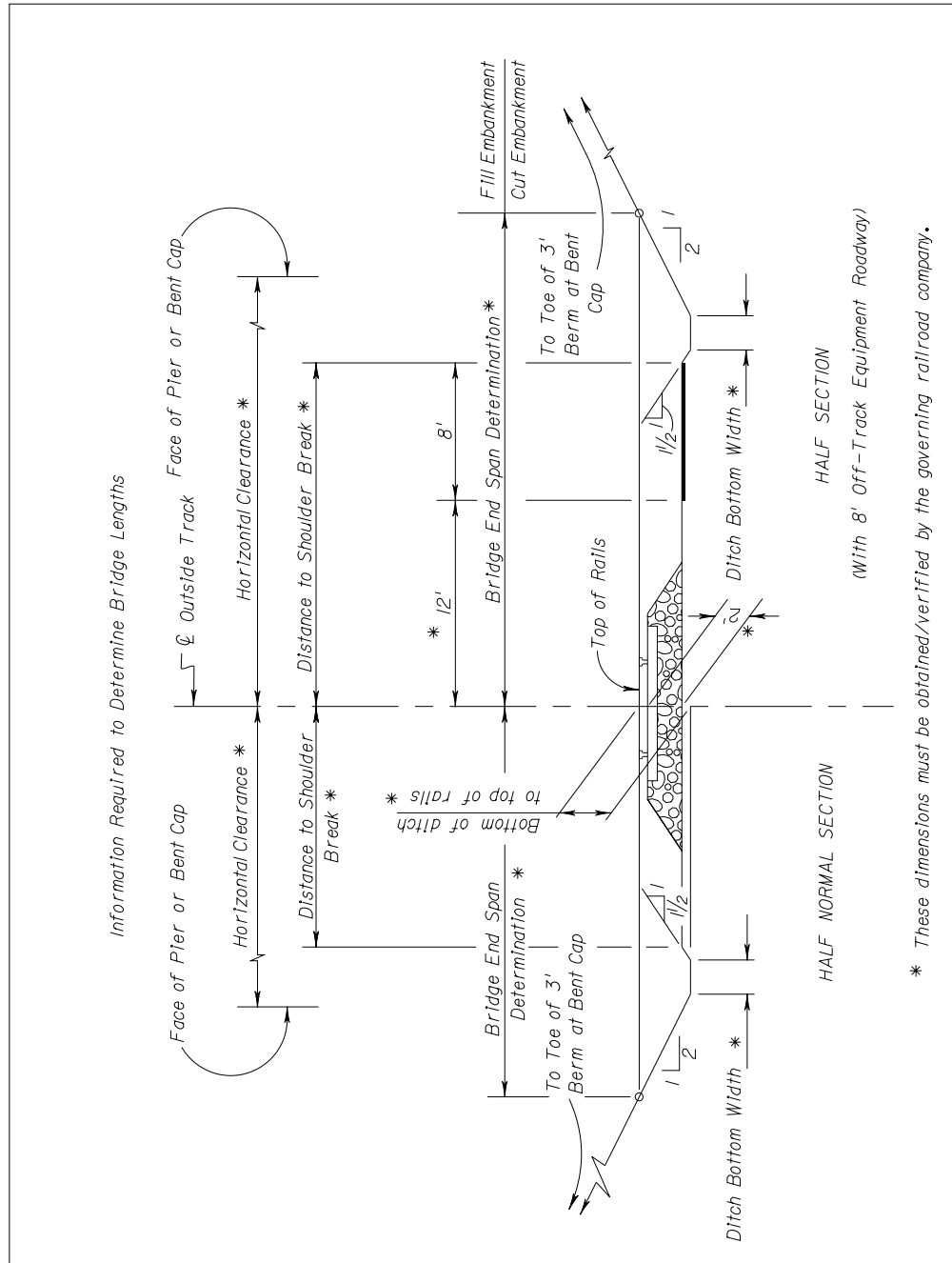

The minimum horizontal clearances measured from the centerline of outermost existing or proposed tracks to the face of pier cap, bent cap, or any other adjacent structure are shown in Table 7 – 3 Horizontal Clearances for Railroads but must be adjusted for certain physical features and obstructions such as track geometry and physical obstructions.

Table 7 – 3 Horizontal Clearances for Railroads

Minimum Clearance Requirements	Normal Section ¹	With 8' Required Clearance for Off-Track ²	Temporary Falsework Opening
With Crash Walls	18 ft.	22 ft.	10 ft.
Without Crash Walls	25 ft.	25 ft.	N/A

¹ Any proposed structure over the South Florida Rail Corridor shall be designed and constructed to provide a horizontal clear span of a minimum of 100 feet but not less than 25 feet from the center line of the outermost existing or proposed tracks. (See [Department Topic No. 000-725-003: South Florida Rail Corridor Clearance.](#))

² The additional 8 ft. horizontal clearance for off-track equipment shall be provided only when specifically requested in writing by the railroad.

D.6.a Adjustments for Track Geometry

When the track is on a curve, the minimum horizontal clearance shall be increased at a rate of 1.5 inches for each degree of curvature. When the track is superelevated, clearances on the inside of the curve will be increased by 3.5 inches horizontally per inch of superelevation. For extremely short radius curves, the [AREMA](#) requirements shall be consulted to assure proper clearance.

D.6.b Adjustments for Physical Obstructions

Columns or piles should be kept out of the ditch to prevent obstruction of drainage. Horizontal clearance should be provided to avoid the need for crash walls unless extenuating circumstances dictate otherwise.

Figure 7 – 5 Track Sections shows horizontal dimensions from the centerline of track to the points of intersection of a horizontal plane at the

rail elevation with the embankment slope. These criteria may be used to establish the preliminary bridge length, which normally is also the length of bridge eligible for FHWA participation; however, surrounding topography, hydraulic conditions, and economic or structural considerations may warrant a decrease or an increase of these dimensions. These dimensions must be coordinated with the governing railroad company.

The FDOT [Structures Design Guidelines, Section 2.6.7](#) provide additional information on the design of structures over or adjacent to railroad and light rail tracks.

D.7 Access Control

The general criteria for access control in **Chapter 3 – Geometric Design** for streets and highways should be maintained in the vicinity of rail-highway grade crossings. Private driveways should not be permitted within 150 feet, nor intersections within 300 feet, of any grade crossing.

D.8 Parking

No parking shall be permitted within the required clear area for the sight distance visibility triangle.

D.9 Traffic Control Devices

The proper use of adequate advance warning and traffic control devices is essential for all grade crossings. Advance warning should include pavement markings and two or more signs on each approach. Each new crossing should be equipped with train-activated flashing signals.

Automatic gates, when used, should ideally extend across all lanes, but shall at least block one-half of the inside travel lane. It is desirable to include crossing arms across sidewalks and shared use paths.

Traffic control devices shall meet the requirements of the [MUTCD](#). See Section E of this chapter for additional requirements for traffic control devices in Quiet Zones. Figure 7 – 6 Median Signal Gates for Multilane Curbed Sections provides an example of gate installation when a median is present.

Figure 7 – 6 Median Signal Gates for Multilane Curbed Sections

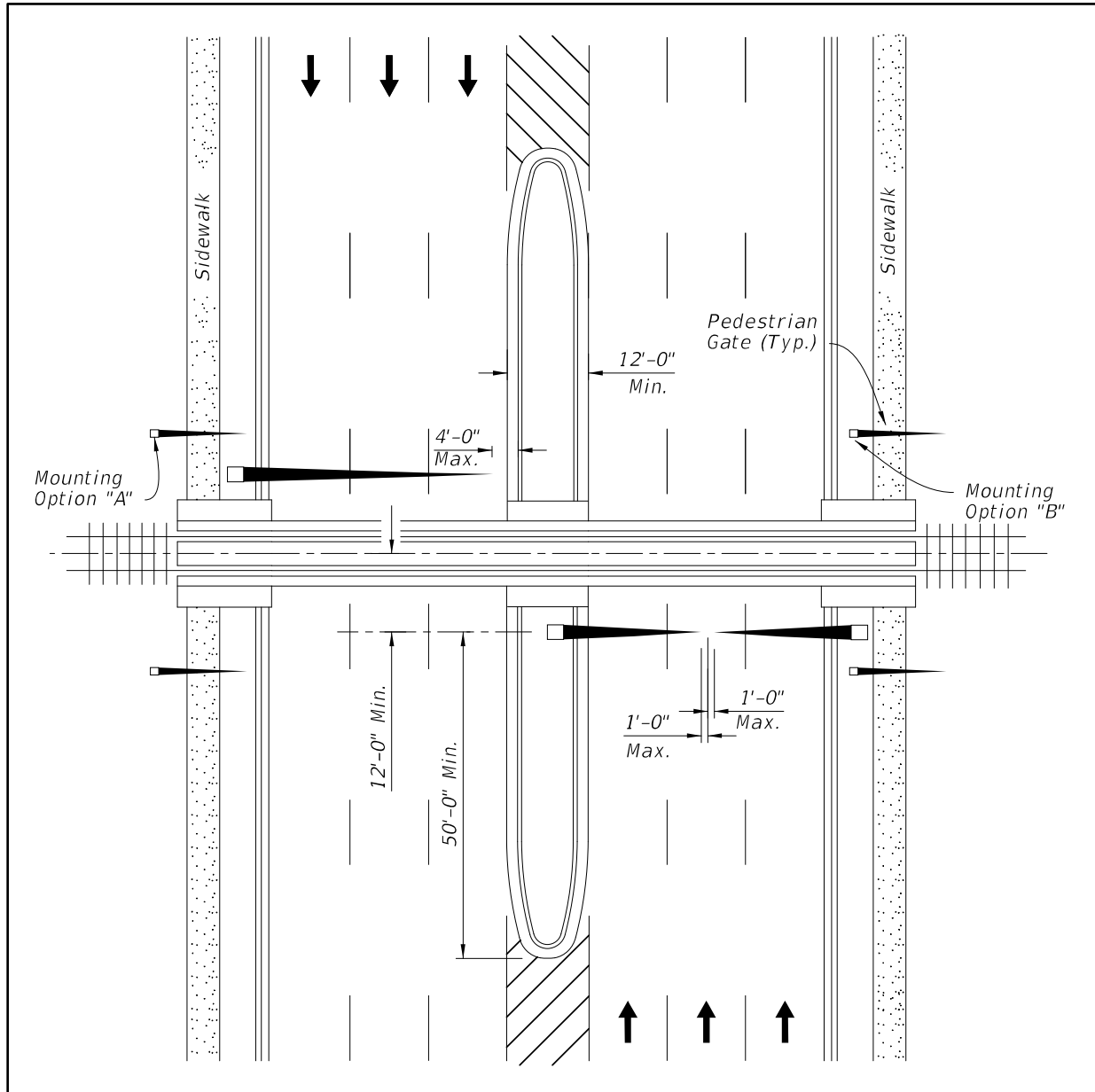

D.10 Rail-Highway Grade Crossing Surface

Each crossing surface should be compatible with highway user requirements and railroad operations at the site. When installing a new rail-highway crossing or reworking an existing at-grade crossing, welded rail should be placed the entire width from shoulder point to shoulder point. Surfaces should be selected to be as maintenance free as possible.

D.11 Roadway Lighting

The use of roadway lighting at grade crossings should be considered to provide additional awareness to the driver. Illumination of the tracks can also be a beneficial safety aid.

D.12 Crossing Configuration

Recommended layouts for grade crossings are shown in Figures 7 – 7 Passive Rail-Highway Grade Crossing Configuration and 7 – 8 Active Rail-Highway Grade Crossing Configuration. The distance “A” in the Figures is determined by speed and shown in the [MUTCD, Table 2C – 4. Guidelines for the Advance Placement of Warning Signs](#). Although the design of each grade crossing must be “tailored” to fit the existing situation, the principles given in this section should be followed in the design of all crossings. Additional information on the design of rail-highway crossings can be found in the [FDOT’s](#) Standard Plans.

Passive rail-highway grade crossings include traffic control devices that provide static messages of warning, guidance, and, in some instances, mandatory action for the driver. (Source: [FHWA Railroad-Highway Grade Crossing Handbook](#))

Active rail-highway grade crossings include traffic control devices that give advance notice of the approach of a train. (Source: [FHWA Railroad-Highway Grade Crossing Handbook](#)).

Figure 7 – 7 Passive Rail-Highway Grade Crossing Configuration

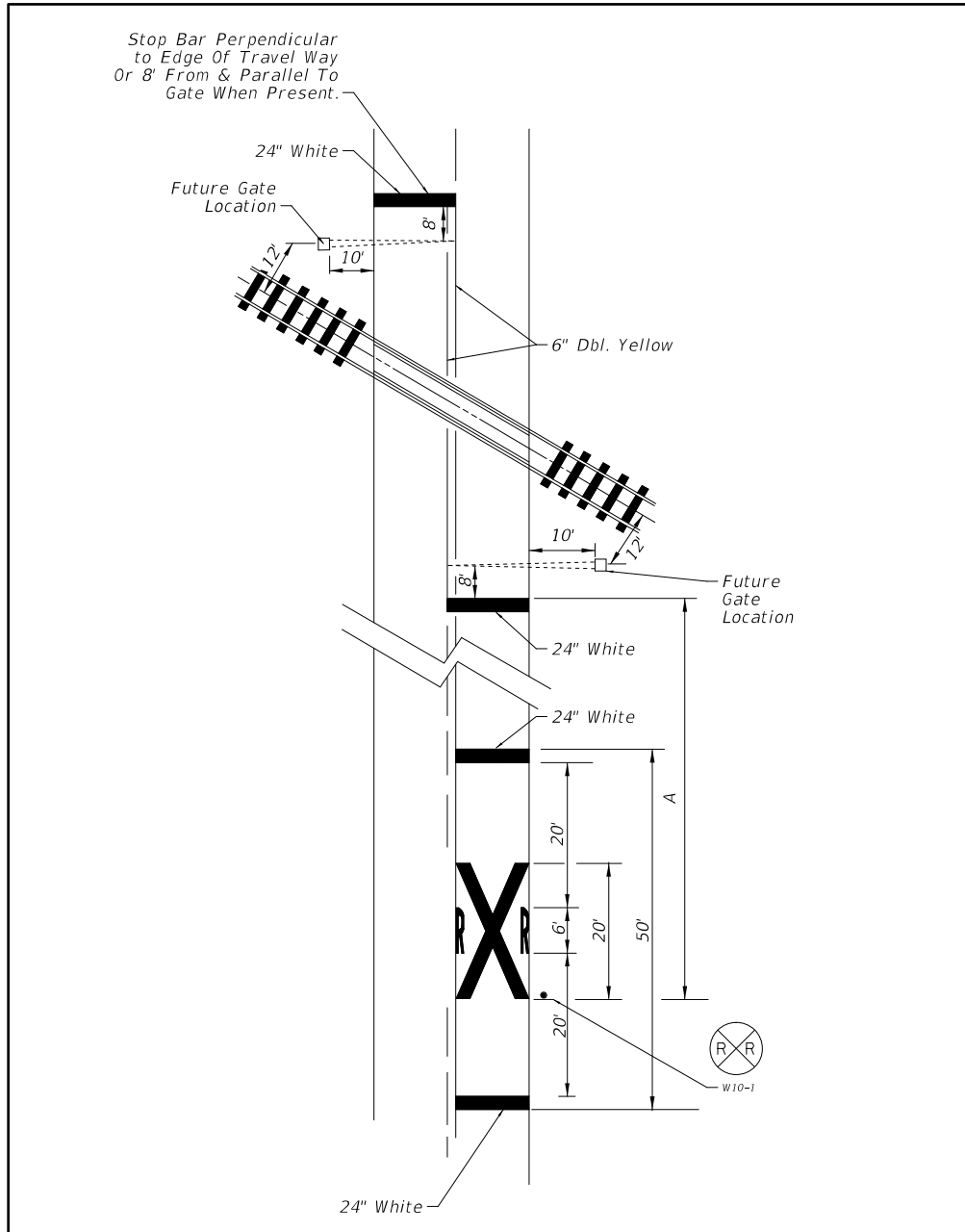

Note: The distance "A" is determined by speed and shown in the [MUTCD, Table 2C – 4. Guidelines for the Advance Placement of Warning Signs.](#)

Figure 7 – 8 Active Rail-Highway Grade Crossing Configuration

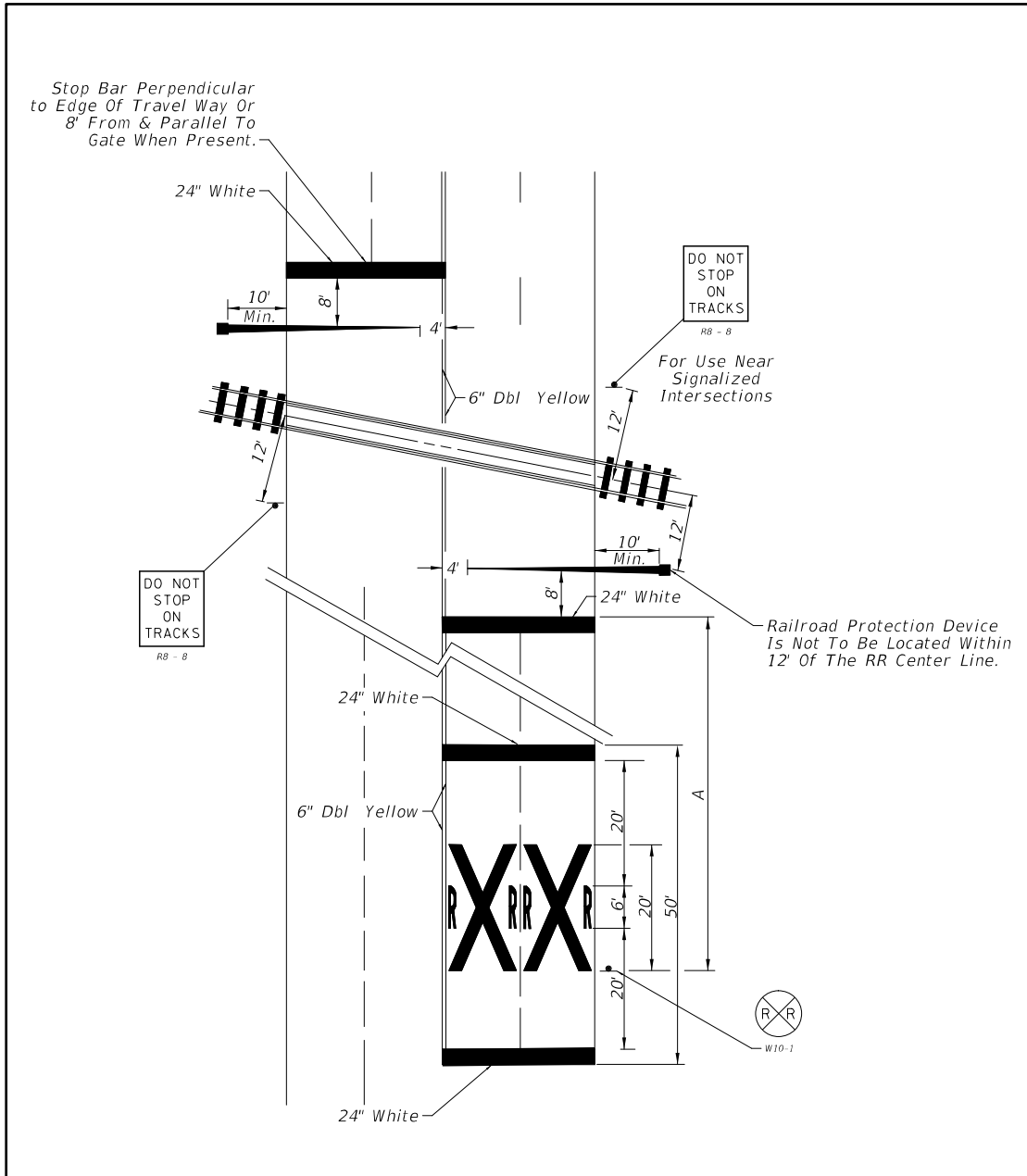

Note: The distance "A" is determined by speed and shown in the [MUTCD, Table 2C – 4. Guidelines for the Advance Placement of Warning Signs.](#)

D.13 Railroad Dynamic Envelope Pavement Marking and Signage

Railroad Dynamic Envelope pavement markings should be used to delineate the area around at-grade railroad crossings where vehicles should not stop. The U. S. Department of Transportation's (U.S. DOT) Volpe Center found that the addition of the dynamic envelope pavement markings and modified signage reduced the number of vehicles that stopped within the dynamic envelope zone and increased the number of vehicles that stopped behind the stop line. The research was published as a presentation and called Evaluation of Pavement Markings within the Dynamic Envelope. Coordination with the railroad is necessary. See Part 8 of the MUTCD for additional requirements for signage.

Where local roads cross state owned rail corridors, the railroad dynamic envelope pavement marking is required.

Figures 7 – 9 Railroad Dynamic Envelope Pavement Marking Detail, Figure 7 – 10 Railroad Crossing at 2-Lane Roadway, Figure 7 – 11 Railroad Crossing at Multilane Roadway, and Figure 7 – 12 Railroad Crossing at Multilane Roadway with Right Turn Lane provide examples of how rail dynamic envelopes can be signed and marked for at-grade rail crossings. Table 7 – 4 Location of "Do Not Stop on Tracks" Signage for Railroad Crossings Using the Rail Dynamic Envelope shows the distance between the RR Warning Sign (W10-1) and the Do Not Stop on Tracks (R8-8) sign. For additional information see the FDOT's FDOT's Standard Plans.

Figure 7 – 9 Railroad Dynamic Envelope Pavement Marking Detail

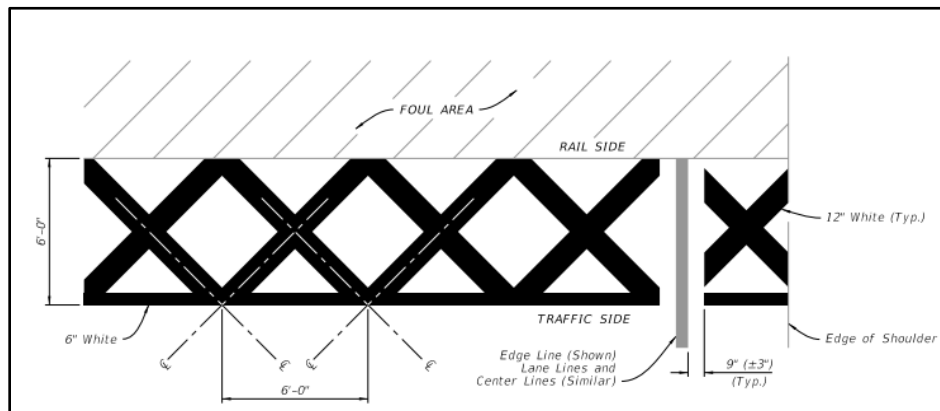

Notes: 1. The pavement markings shall begin a minimum of 4' from the edge of the nearest rail or outside the foul area, as determined by the railroad owner.

Figure 7 – 11 Railroad Crossing at Multilane Roadway

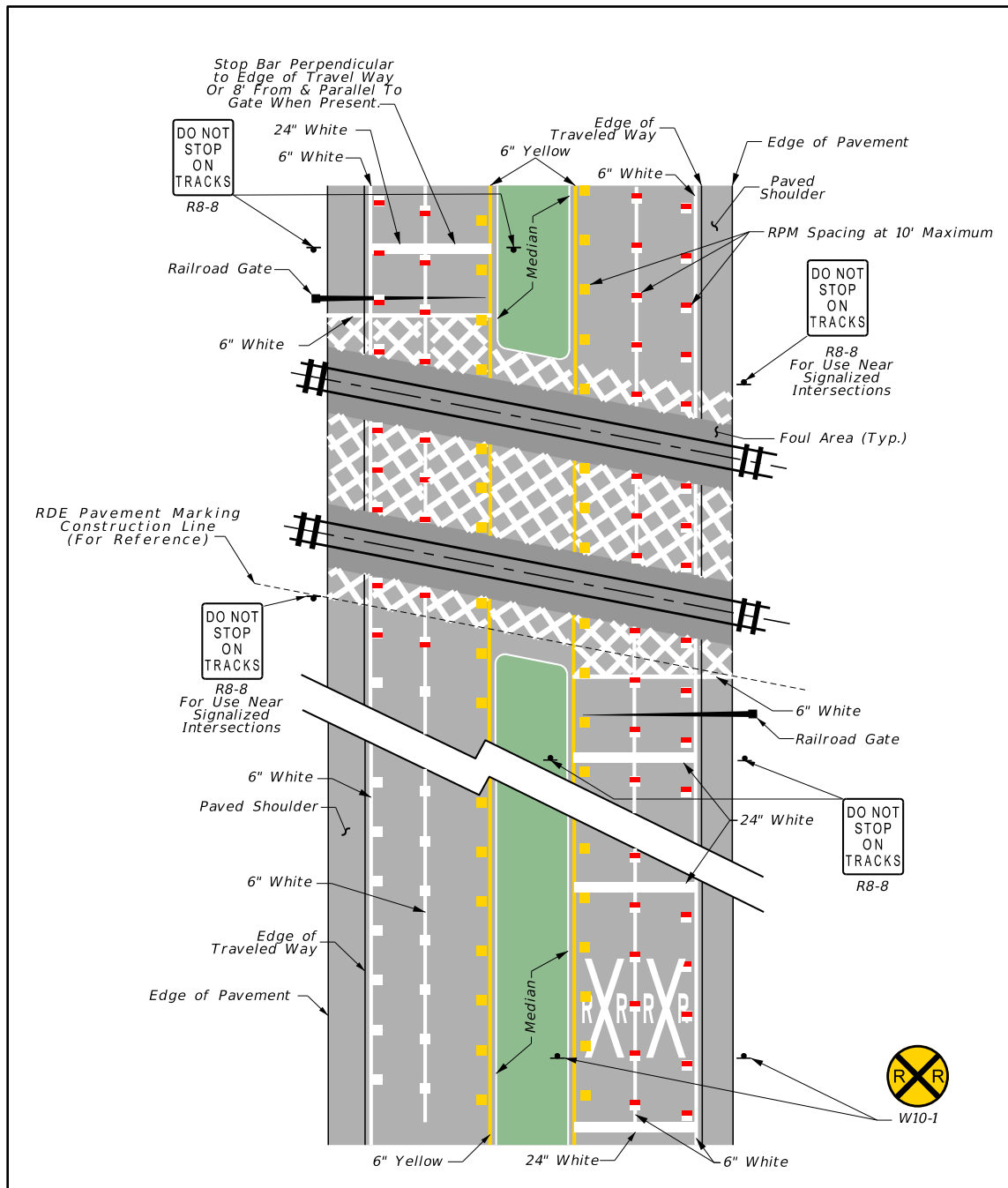

Note: 1. Dimensions not shown for clarity, see Figure 7 – 10 Railroad Crossing at 2 Lane Roadway.

Table 7 – 4 Location of “Do Not Stop on Tracks” Signage for Railroad Crossings Using the Rail Dynamic Envelope

<u>Design Speed (mph)</u>	<u>Distance “A (feet)”</u>
<u>60</u>	<u>400</u>
<u>55</u>	<u>325</u>
<u>50</u>	<u>250</u>
<u>45</u>	<u>175</u>
<u>40</u>	<u>125</u>
<u>35</u>	<u>100</u>
<u>Curbed</u>	<u>85 Min.</u>

.

E QUIET ZONES

Quiet Zone means a segment of a rail line that includes public rail-highway crossings at which locomotive horns are not routinely sounded. The Federal Railroad Administration (FRA) has established guidelines the applying jurisdiction must follow for approval of quiet zones. Applying entities can go to the [FRA's website](#) and the [Code of Federal Regulations \(CFR\), Title 49, Subtitle B, Chapter II, Part 222](#) for further information on the process for approval of Quiet Zones.

Coordinate with the FDOT's District Rail Coordinator to determine if crossings are located within designated Quiet Zones for State owned rail corridors or crossings of state highways. State owned rail corridors include the Central Florida Rail Corridor and the South Florida Rail Corridor. For other rail crossings, coordinate with the local government who maintains the crossing roadway, sidewalk, or shared use path to determine if the location has been approved by the FRA for a Quiet Zone.

For a crossing within a Quiet Zone that requires supplemental safety measures, approved supplemental safety measures include:

- Temporary closure of a public railroad-highway-rail grade crossing.
- Four-quadrant gate systems.
- Gates with medians or channelization devices.
- One way street with gate(s); and
- Permanent closure of a public highway-rail grade crossing.

The [CFR, Title 49, Chapter II, Part 222, Appendix A, Approved Supplemental Safety Measures](#) provides additional information on the design of Quiet Zones to meet federal approval. The **CFR** also requires that any traffic control device and its application where used as part of a Quiet Zone shall comply with all applicable provisions of the **MUTCD**. See [MUTCD, Part 8, Traffic Control for Railroad and Light Rail Transit Grade Crossings](#) for further information. Pedestrian gates, audible device, and detectable warnings are required when a sidewalk or shared use path is present or proposed.

For Quiet Zones that cross state owned rail corridors, the [FDOT Design Manual, Chapter 220 Railroads](#) provides additional information.

Figure 7 – 139 Gate Configurations for Quiet Zones illustrates the maximum gap allowed for gates at rail-highway crossings within Quiet Zones, based upon **CFR, Title 49, Chapter II, Part 222**.

Figure 7 – 139 Gate Configuration for Quiet Zones

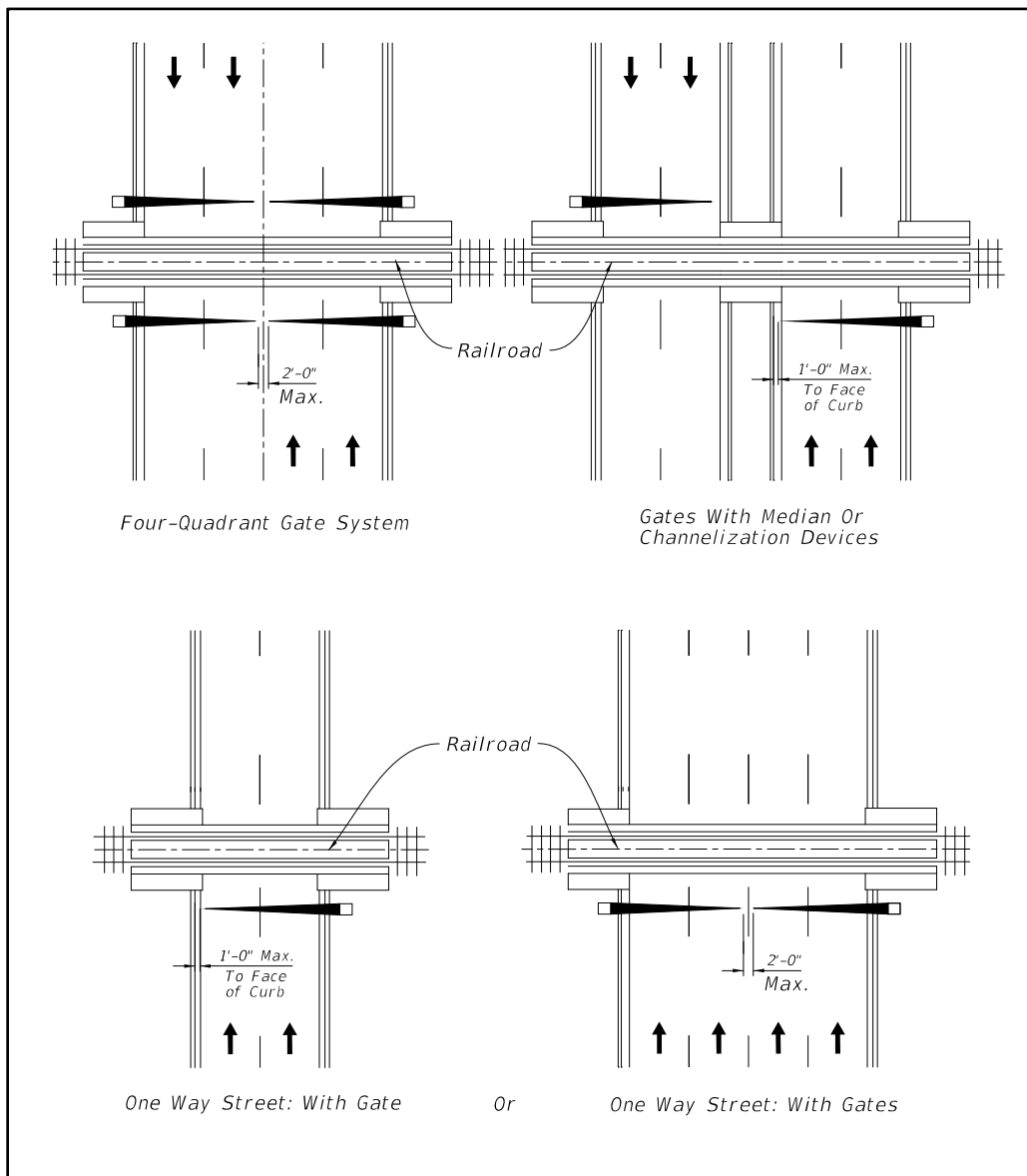

F HIGH SPEED RAIL

The establishment of high-speed rail service is governed by **49 U.S. Code 26106 – High-Speed Rail Corridor Development**.

The [High-Speed Rail \(HSR\) Strategic Plan](#) divides potential operations into four categories or generic descriptions:

- HSR – Express. Frequent express service between major population centers 200 - 600 miles apart, with few intermediate stops. Top speeds of at least 150 mph on completely grade-separated, dedicated rights-of-way (with the possible exception of some shared track in terminal areas). Intended to relieve air and highway capacity constraints.
- HSR – Regional. Relatively frequent service between major and moderate population centers 100 - 500 miles apart, with some intermediate stops. Top speeds of 110 - 150 mph, grade-separated, with some dedicated and some shared track (using positive train control (PTC) technology). Intended to relieve highway and, to some extent, air capacity constraints.
- Emerging HSR. Developing corridors of 100 - 500 miles, with strong potential for future HSR Regional and/or Express service. Top speeds of up to 80 - 110 mph on primarily shared track (eventually using PTC technology), with advanced grade crossing protection or separation. Intended to develop the passenger rail market and provide some relief to other modes.
- Conventional Rail. Traditional intercity passenger rail services of more than 100 miles with as little as 1 to as many as 7 - 12 daily frequencies; may or may not have strong potential for future high-speed rail service. Top speeds of up to 79 mph generally on shared track. Intended to provide travel options and to develop the passenger rail market for further development in the future.

Further information on the implementation of high-speed rail service can be found on the Federal Railroad Administration's website [High Speed Rail Overview](#).

G MAINTENANCE AND RECONSTRUCTION

The inspection and maintenance of all features of rail-highway grade crossings shall be an integral part of each highway agency's and railroad company's regular maintenance program (**Chapter 10 – Maintenance ~~a~~ And Resurfacing**). Items that should be given a high priority in this program include pavement stability and skid resistance, clear sight distance, and all traffic control and protective devices.

The improvement of all substandard or hazardous conditions at existing grade crossings is extremely important and should be incorporated into the regular highway reconstruction program. The objective of this reconstruction program should be to upgrade each crossing to meet these standards. The priorities for reconstruction should be based upon the guidelines set forth by the [FDOT Department](#).

H REFERENCES FOR INFORMATIONAL PURPOSES

The following is a list of publications that for further guidance:

- Federal Highway Administration Railroad-Highway Grade Crossing Handbook, Revised Second Edition, August 2007
<https://rosap.ntlhttps://rosap.ntl.bts.gov/view/dot>
- http://safety.fhwa.dot.gov/xings/com_roaduser/07010/
- Code of Federal Regulations (CFR), Title 49 Transportation, Part 222, Use of Locomotive Horns at Public Highway-Rail Grade Crossings
http://www.ecfr.gov/cgi-bin/text-idx?tpl=/ecfrbrowse/Title49/49cfr222_main_02.tpl
- The Train Horn Rule and Quiet Zones
<https://www.fra.dot.gov/Page/P0104>
- MUTCD, Part 8, Traffic Control for Railroad and Light Rail Transit Grade Crossings
<http://mutcd.fhwa.dot.gov/pdfs/2009r1r2/part8.pdf>
- The American Railway Engineering and Maintenance-of-Way Association (AREMA)
<https://www.arema.org/>
- Florida Administrative Code, (Rule 14-57: Railroad Safety and Clearance Standards, and Public Railroad-Highway Grade Crossings)
[https://www.flrules.org/gateway/RuleNo.asp?title=RAILROAD SAFETY AND CLEARANCE STANDARDS, AND PUBLIC RAILROAD-HIGHWAY GRADE CROSSINGS&ID=14-57.011](https://www.flrules.org/gateway/RuleNo.asp?title=RAILROAD%20SAFETY%20AND%20CLEARANCE%20STANDARDS,%20AND%20PUBLIC%20RAILROAD-HIGHWAY%20GRADE%20CROSSINGS&ID=14-57.011)
- Florida Department of Transportation Rail Contacts
<https://www.fdot.gov/rail/contacts/staff.shtm>

THIS PAGE INTENTIONALLY LEFT BLANK

CHAPTER 8

PEDESTRIAN FACILITIES

A	INTRODUCTION	8-1
B	TYPES OF PEDESTRIAN FACILITIES	8-2
	B.1 Sidewalks	8-2
	B.2 Shared Use Paths	8-4
	B.3 Shared Streets	8-4
	B.4 Shoulders	8-4
C	MINIMIZING CONFLICTS	8-5
	C.1 General Needs	8-5
	C.2 Horizontal Separation	8-5
	C.2.a General Criteria	8-6
	C.2.b Buffer Widths	8-7
	C.3 Other Considerations	8-7
D	BARRIER SEPARATION	8-8
	D.1 Longitudinal Barriers	8-8
	D.2 Fencing, Pedestrian Channelization Devices or Landscaping	8-9
E	GRADE SEPARATION	8-10
	E.1 Overpasses	8-11
	E.2 Underpasses	8-11
F	DROP-OFF HAZARDS FOR PEDESTRIANS	8-12
G	PEDESTRIAN CROSSINGS	8-14
	G.1 Crosswalks	8-14
	G.1.a Marked Crosswalks	8-14
	G.1.b Midblock Crosswalks	8-16
	G.2 Curb Ramps and Blended Transitions	8-18
	G.3 Detectable Warnings	8-20
	G.4 Curb Extensions	8-21
	G.5 Pedestrian Signals	8-21

G.6	Sight Distance.....	8-21
G.7	Rail Crossings.....	8-22
H	LIGHTING.....	8-23
I	REFERENCES FOR INFORMATIONAL PURPOSES	8-25

FIGURES

Figure 8 – 1	Shoulder Point with Sidewalk.....	8-6
Figure 8 – 2	Guardrail with Pipe Rail Detail	8-9
Figure 8 – 3	Pedestrian Bridge Typical Section	8-10
Figure 8 – 4	Drop-Off Hazards for Pedestrians and Bicyclists	8-13
Figure 8 – 5	Pedestrian Median Refuge with Curb Extension.....	8-15
Figure 8 – 6	Raised Midblock Crosswalk	8-16
Figure 8 – 7	Pedestrian Hybrid Beacon (PHB).....	8-17
Figure 8 – 8	Pedestrian Median Refuge with Rectangular Rapid Flashing Beacons	8-18

CHAPTER 8

PEDESTRIAN FACILITIES

A INTRODUCTION

Pedestrian facilities shall be given full consideration in the planning and development of transportation facilities, including the incorporation of such facilities into state, regional, and local transportation plans and programs under the assumption that transportation facilities will be used by pedestrians. Pedestrian facilities should be considered in conjunction with the construction, reconstruction, or other significant improvement of any transportation facility. Special emphasis should be given to projects in or within 1 mile of an urban area. Examples of pedestrian facilities include sidewalks, shared use paths, over and under passes, curb ramps, median refuges, and crosswalks.

In addition to the design criteria provided in this ~~manual~~chapter, the following documents provide criteria and guidance in the design of pedestrian facilities in the public right of way:

- United States Department of Transportation ADA ~~Americans with Disabilities Act~~ Standards for Transportation Facilities (2006) and as required by 49 C.F.R 37.41 or 37.43.
- United States Department of Justice ADA Standards (2010) as required by 28 C.F.R 35 (title II) and 36 (title III).
- Public Rights-of-Way Accessibility Guidelines (PROWAG) provides additional information for the design of pedestrian facilities.

~~The~~ and the 202017 Florida Accessibility Code for Building Code, Accessibility, 7th Edition Construction as required by 61G20-4.002 contains ADA requirements for accessibility to sites, facilities, buildings, and elements by people with disabilities ~~impose additional requirements for the design and construction of pedestrian facilities.~~

~~Examples of pedestrian facilities include sidewalks, shared use paths, over and under passes, curb ramps, median refuges, and crosswalks.~~

Each ~~transportation~~highway agency responsible for a system of streets and highways should establish and maintain a program for implementing pedestrian facilities, and for maintaining existing pedestrian facilities.

B TYPES OF PEDESTRIAN FACILITIES

There are several ways in which pedestrians can be accommodated in the public right of way.

B.1 Sidewalks

Sidewalks are walkways parallel to the roadway and designed for use by pedestrians. Sidewalks should be provided along both sides of roadways that are in or within one mile of an urban area. If sidewalks are constructed on the approaches to bridges, they should be continued across the structure. If continuous sidewalks are constructed on only one side of the street, pedestrians should be provided access to facilities and services located on the opposite side of the street. Newly constructed, reconstructed, or altered sidewalks shall be accessible to and usable by persons with disabilities.

The minimum width of a sidewalk shall be 5 feet on both curb and gutter and flush shoulder roadways. The minimum separation for a 5-foot sidewalk from the back of curb is 2 feet. If the sidewalk is located adjacent to the curb, the minimum width of sidewalk is 6 feet. Provide a minimum 1-foot wide level graded area with a maximum slope of 1:6 along both sides of the sidewalk. This would not apply to the side of the sidewalk located immediately adjacent to a curb, structure or the right of way line. ~~For sidewalks, not adjacent to the curb, at least a 1-foot wide graded area should be provided on both sides, flush with the sidewalk and having a maximum 1:6 slope.~~ Wider sidewalks should be considered in Central Business Districts and in areas where heavy two-way pedestrian traffic is expected.

A 5-foot wide (minimum) sidewalk that connects a transit stop or facility with an existing sidewalk or shared use path shall be included to comply with ADA accessibility standards. **Chapter 13 – Transit** provides illustrations of the connection between the sidewalk and transit facility.

Particular attention shall be given to pedestrian accommodations at the termini of each project. If full accommodations cannot be provided due to the limited scope or phasing of a roadway project or an existing sidewalk is not present at the termini, an extension of the sidewalk to the next appropriate pedestrian crossing or access

point should be considered. If pedestrian facilities are provided, they shall be connected with facilities (e.g., sidewalks, shared use path, and crosswalks on the adjoining projects).

For new construction and reconstructed roadways, grades on sidewalks or shared use paths shall not exceed 5%, unless accessible ramps and landings are provided. However, in a roadway right of way, the grade of sidewalks or shared use paths is permitted to equal the general grade established for the adjacent street or highway. There should be enough sidewalk or path cross slope to allow for adequate drainage, however the maximum shall be no more than 2% to comply with ADA requirements.

Where existing physical constraints make it impracticable for altered elements, spaces, or facilities to fully comply with the requirements for new construction, compliance is required to the extent practicable within the scope of the project. Existing physical constraints include, but are not limited to, underlying terrain, right-of-way availability, underground structures, adjacent developed facilities, drainage, or the presence of a notable natural or historic feature.

The location of new poles or relocated poles shall provide at least 48" minimum unobstructed sidewalk width.

Evaluate existing driveways and turnouts for compliance to ADA requirements. Nonconforming driveways are not required to be upgraded if it is not feasible within the scope of the project.

~~Additional information on designing accessible pedestrian facilities is provided by the United States Access Board at the following web site:~~

~~[**Proposed Guidelines for Pedestrian Facilities in the Public Right-of-Way**](#)~~

Edge drop-offs should be avoided. When drop-offs cannot be avoided, they should be shielded as discussed in Section F, Drop-Off Hazards for Pedestrians.

For additional information concerning the design of sidewalks, refer to **Section C.7.d** of **Chapter 3 – Geometric Design**.

B.2 Shared Use Paths

Paths are usually set back from the roadway and separated by a green area, ditch, swales, or trees. Shared use paths are intended for the use by both pedestrians and bicyclists and shall be accessible. For additional information concerning the design of shared-use paths, refer to **Chapter 9 – Bicycle Facilities**.

B.3 Shared Streets

Shared uses of a street for people walking, bicycling, and driving are referred to as shared streets. These are usually specially designed spaces such as pedestrian streets which are local urban streets with extremely low vehicle speed.

B.4 Shoulders

Highway shoulders are not intended for frequent use by pedestrians, but do accommodate occasional pedestrian traffic. Highway shoulders often have cross slopes which exceed 2%; consequently, they are not considered or expected to fully meet ADA criteria.

C MINIMIZING CONFLICTS

The planning and design of new streets and highways shall include provisions that support pedestrian travel and minimize vehicle-pedestrian conflicts. These may include:

- Sidewalks and/or shared use paths parallel to the roadway
- Marked pedestrian crossings
- Raised median or refuge islands
- Pedestrian signal features such as pedestrian signal heads and detectors
- Transit stops and shelters

In some situations, it may be possible to eliminate a vehicle-pedestrian conflict through close coordination with the planning of pedestrian facilities and activity outside of the highway right of way. Care should be exercised to ensure the elimination of a given conflict point does not transfer the problem to a different location. Any effort to minimize or eliminate conflict points must consider the mobility needs of the pedestrian. The desired travel path should not be severed and the number of required crossing points and/or walking distances should not be significantly increased. Some crossings should be redesigned rather than eliminated or relocated.

C.1 General Needs

Minimizing vehicle-pedestrian conflicts can be accomplished by providing adequate horizontal, physical, or vertical (primarily for crossings) separation between the roadway and the pedestrian facility.

C.2 Horizontal Separation

The development of independent systems for pedestrian and motor vehicular traffic is the preferred method for providing adequate horizontal separation.

C.2.a General Criteria

New sidewalks should be placed as far from the roadway as practical in the following sequence of desirability:

1. As near the right of way line as possible. (ideally, 3 feet of width should be provided behind the sidewalk for above ground utilities)
2. Outside of the clear zone.
3. Sufficiently off-set from the curb to allow for the placement of street trees, signs, utilities, parking meters, benches, or other street furniture outside of the sidewalk in urban locations (e.g., town center, business, or entertainment district).
4. Five feet from the shoulder point on flush shoulder roadways.
5. At the grass shoulder point of flush shoulder roadways.

Figure 8 – 1 Shoulder Point with Sidewalk provides an illustration of the location of the shoulder point.

On arterial or collector roadways, sidewalks shall not be constructed contiguous to the roadway pavement, unless a curb or other barrier is provided. Nearing intersections, the sidewalk should be transitioned as necessary to provide a more functional crossing location that also meets driver expectation. Further guidance on the placement of stop or yield lines and crosswalks is provided in the [MUTCD, Part 3](#).

Figure 8 – 1 Shoulder Point with Sidewalk

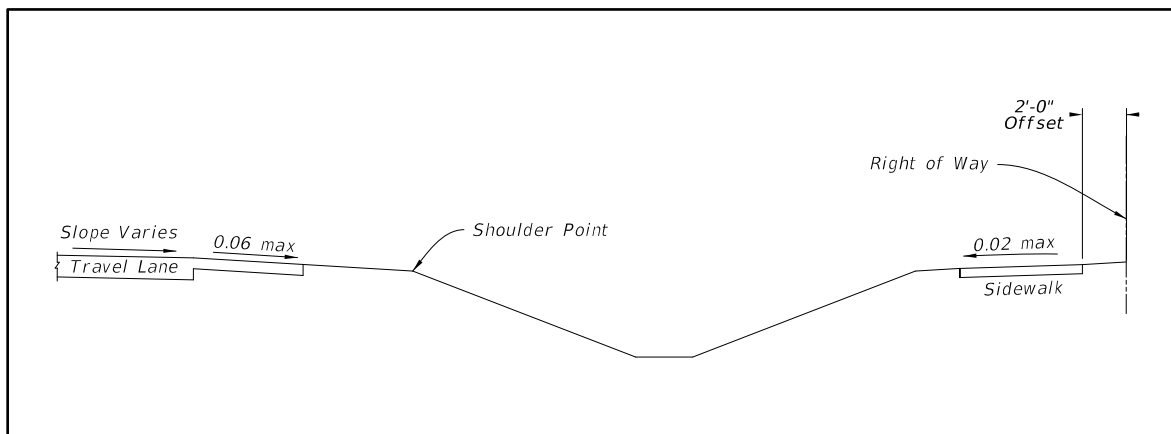

C.2.b Buffer Widths

Providing a buffer can improve pedestrian safety and enhance the overall walking experience. Buffer width is defined as the space between the sidewalk and the edge of traveled way. On-street parking or bike lanes can also act as an additional buffer. The planting strip or buffer strip should be 6 feet where practical to eliminate the need to narrow or reroute sidewalks around driveways. With this wider buffer strip, the sidewalk is placed far enough back so that the driveway slope does not have to encroach into the sidewalk.

C.3 Other Considerations

When designing urban highways, the following measures may be considered to help increase the safe and efficient operation of the highway for pedestrians:

- Use narrower lanes and introduce raised medians to provide pedestrian refuge areas
- Provide pedestrian signal features and detectors
- Prohibit right turn on red
- Control, reduce, or eliminate left and/or right turns
- Prohibit free flow right turn movements
- Reduce the number of lanes

D BARRIER SEPARATION

Barriers may be used to assist in the separation of motor vehicular and pedestrian traffic.

D.1 Longitudinal Barriers

Longitudinal barriers such as guardrails, rigid barriers, and bridge railings are designed primarily to redirect errant vehicles away from roadside hazards. These barriers can also be used to provide valuable protection of pedestrian facilities from out-of-control vehicles.

Where adequate horizontal separation is not feasible, or where there is a significant hazard from out-of-control vehicles, longitudinal barriers may be utilized. If electing to use barriers, special consideration should be made to ensure proper sight distance near driveways and intersections is maintained. See Chapter 4, Figure 4 – 8 Location of Guardrail for information on the correct placement of a sidewalk in conjunction with a guardrail.

When a new sidewalk or shared use path is within 4 feet of the back of a guardrail with steel posts, a pipe rail ~~shall~~ould be installed on the back of the post. For a guardrail with timber posts, the bolt ends ~~shall~~ould be trimmed flush with the post or recessed. See Figure 8 – 2 Guardrail with Pipe Rail Detail for an illustration of when a pipe rail is needed. Additional information on the design of guardrails adjacent to a sidewalk or shared use path can be found in the FDOT ~~Department~~Standard Plans. ~~Index 536-001~~FDOT Design Standards, Index 400.

Figure 8 – 2 Guardrail with Pipe Rail Detail

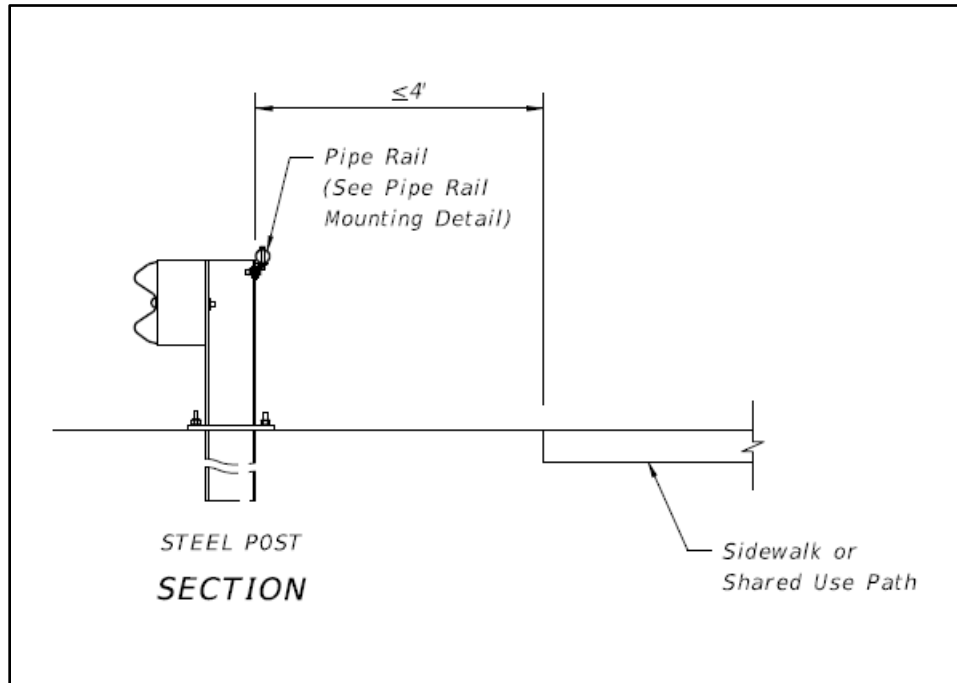

D.2 Fencing, Pedestrian Channelization Devices or Landscaping

Fencing, pedestrian channelization devices or landscaping may be used to discourage pedestrian access to the roadway and aid in channeling pedestrian traffic to the proper crossing points. These should not be considered a substitute for longitudinal barriers, but may be used in conjunction with redirection devices.

E GRADE SEPARATION

Grade separation may be selectively utilized to support the crossing of large pedestrian volumes across highways where the traffic volume on the roadway is at or near capacity or where speeds are high. Overpasses or underpasses may be justified at major pedestrian generators such as schools, shopping centers, sports and amusement facilities, transit centers, commercial buildings, parks and playgrounds, hospitals, and parking facilities.

The minimum clear width of any stand-alone pedestrian overpass or underpass on a pedestrian accessible route is 8 feet. However, if the contiguous sidewalk or path is greater than 8 feet wide, the clear width of the overpass or underpass should match that width. The minimum clear height of a pedestrian overpass or underpass is 8 feet. See Figure 8 – 3 Pedestrian Bridge Typical Section for an example of a pedestrian bridge typical section.

The FDOT [Structures Manual - Volume 1 - Structures Design Guidelines \(SDG\), Section 10](#) provide additional guidance on engineered steel and concrete pedestrian bridges.

Figure 8 – 3 Pedestrian Bridge Typical Section

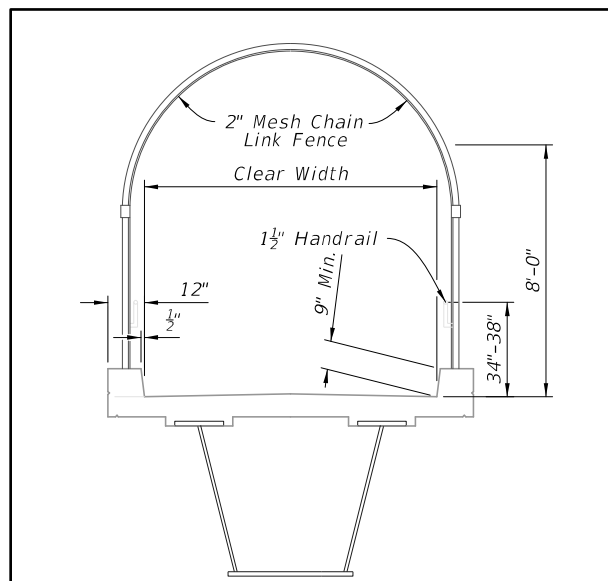

- Notes: 1. Pedestrian handrails may be required. See the [2006 Americans with Disabilities Act Standards for Transportation Facilities](#).
2. Other superstructure configurations may be used provided an 8 ft. minimum headroom is maintained.

E.1 Overpasses

Pedestrian overpasses are typically bridge structures over major roadways or railroads. Overpasses should provide elevator access if they are not designed to provide accessible ramps with compliant slopes, level landings, and handrails on both sides. Bridges over roadways should be covered or screened to reduce the likelihood of objects being dropped or thrown below. The area adjacent to overpasses may be fenced to prevent unsafe crossings and to channel pedestrians to the overpass structure.

E.2 Underpasses

Pedestrian underpasses or tunnels perform the same function as overpasses. Their use is convenient when the roadway is elevated above the surrounding terrain.

Underpasses should be adequately maintained to reduce potential problems in lighting, cleaning, policing, and flooding and to maximize safety. The area adjacent to underpasses may be fenced to prevent unsafe crossings and to channel pedestrians to the underpass structure.

F DROP-OFF HAZARDS FOR PEDESTRIANS

Drop-off hazards are defined as steep or abrupt downward slopes that can be perilous to pedestrians and bicyclists. Consider shielding any drop-off determined to be a hazard. Care should be taken when using Pedestrian/Bicycle Railings or fencing near intersections or driveways as they could obstruct the driver's line of sight. To reduce the need for railings as a sidewalk or shared use path approaches an intersection, consider extending cross drains and side drains to minimize drop-offs.

There are two cases that require shielding as shown in Figure 8 – 4 Drop-Off Hazards for Pedestrians and Bicyclists. Depending on the depth of the drop-off and severity of the conditions below, shielding may be necessary for cases other than described above.

Railings or fences should be provided for vertical drop-off hazards or where shielding is required. The standard height for a pedestrian/bicycle railing is 42 inches. A 48 inch tall pedestrian/bicycle railing should be used when sidewalk grades are steeper than 5% and bicycle travel is expected. A standard railing is generally intended for urbanized areas, locations attaching to bridge rail or along concrete walkways. Fencing is generally intended for use in rural areas along paths and trails.

Figure 8 – 4 Drop-Off Hazards for Pedestrians and Bicyclists

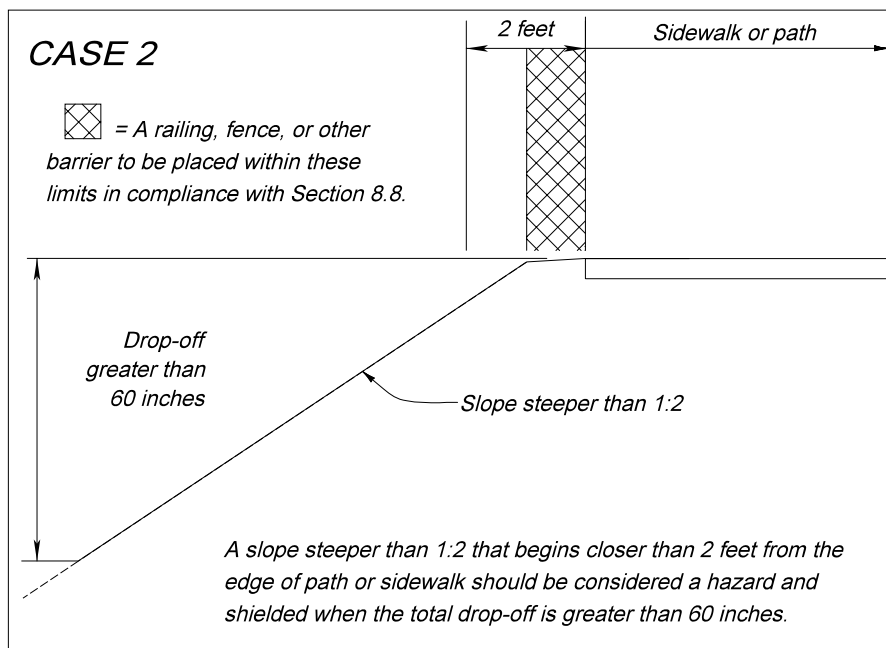
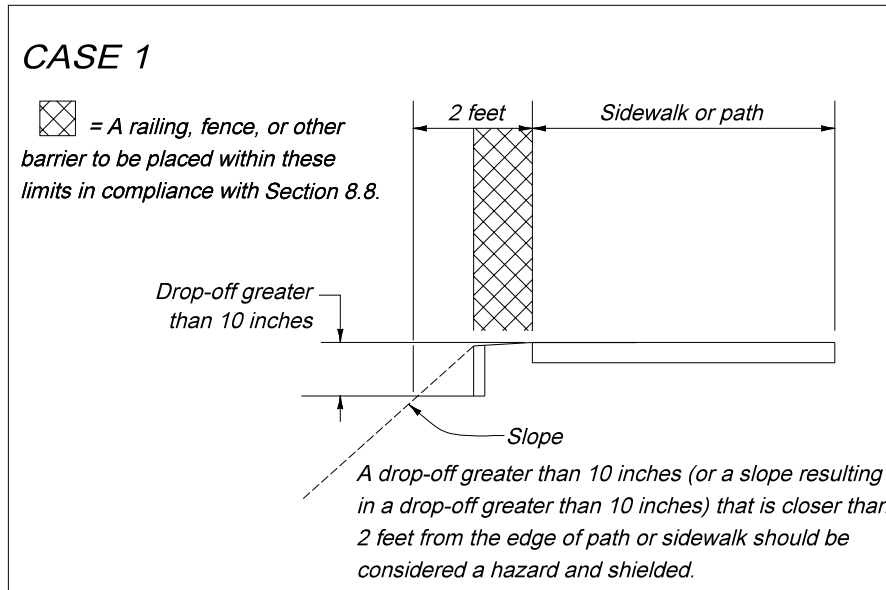

G PEDESTRIAN CROSSINGS

The design of pedestrian crossings and parallel pathways within the right of way shall be considered an integral part of the overall design of a street or highway.

The development of protection at any remaining crossings or conflict points must be adequate to achieve a total pedestrian transportation mode that is reasonably safe.

G.1 Crosswalks

The design of pedestrian crosswalks ~~shall~~~~should~~ be based on the following requirements:

- Crosswalks should be placed at locations with sufficient sight distances
- At crossings, the roadway should be free from changes in alignment or cross section
- The entire length of crosswalk shall be visible to drivers at a sufficient distance to allow a stopping maneuver
- Stop bars or yield markings, in conjunction with the appropriate signing, shall be provided at all marked crosswalks
- Crosswalks shall be easily identified and clearly delineated, in accordance with the [Manual on Uniform Traffic Control Devices \(MUTCD\)](#) and [Rule 14-15.010, F.A.C.](#)

G.1.a Marked Crosswalks

Marked crosswalks are one tool to allow pedestrians to cross the roadway safely. They are often used in combination with other treatments (signs, flashing beacons, curb extensions, pedestrian signals, raised median or refuge islands, and enhanced overhead lighting). Marked crosswalks serve two purposes: 1) to inform motorists of the location of a pedestrian crossing so that they have time to lawfully yield to or stop for a crossing pedestrian; and 2) to assure the pedestrian that a legal crosswalk exists at a particular location. See Figure 8 – 5 Pedestrian Median Refuge with Curb Extensions for an example of a pedestrian median refuge with a curb extension.

Figure 8 – 5 Pedestrian Median Refuge with Curb Extension



Urban Street Design Guide,
National Association of City Transportation Officials (NACTO)

Marked crosswalks on an uncontrolled leg of an intersection or a mid-block location shall be supplemented with other treatments (such as signing, beacons, curb extensions, raised medians, raised traffic islands, or enhanced overhead lighting) when any of the following conditions exist:

1. Where posted speeds are greater than 40 mph.
2. On a roadway with 4 or more lanes without a raised median or raised traffic island that has an ADT of 12,000 or greater.
3. On a roadway with 4 or more lanes with a raised median or raised traffic island that has or is projected to have (within 5 years) an ADT of 15,000 or greater.

See **Chapter 6 – Lighting** for information on illuminating crosswalks and pedestrian facilities.

Additional guidance on marked crosswalks can be found in the [AASHTO Guide for the Planning, Design, and Operation of Pedestrian Facilities](#) and [FHWA's Safety Effects of Marked vs. Unmarked Crosswalks at Uncontrolled Locations: Executive Summary and Recommended Guidelines](#).

Marked crosswalks can also be used to create midblock crossings.

G.1.b Midblock Crosswalks

Midblock crosswalks facilitate crossings to places that people want to go but that are not well served by the existing sidewalk or path network. These pedestrian crossings commonly occur at schools, parks, museums, waterfronts, and other destinations. Designers should study both existing and projected pedestrian volumes in assessing warrants for midblock crossings to account for latent demand.

Midblock crossings are located according to a number of factors including pedestrian volume, traffic volume, roadway width, traffic speed and type, desired paths for pedestrians, land use, and to accommodate transit connectivity. Midblock crossings should not be installed where sight distance or sight lines are limited for either the motorist or pedestrian.

Midblock crossings should be marked and signed in accordance with the [MUTCD](#). See Figure 8 – 6 Raised Midblock Crosswalks for an example of a midblock crosswalk.

Figure 8 – 6 Raised Midblock Crosswalk



Suwannee Street, Tallahassee, Florida

Crosswalks may be supplemented with Pedestrian Hybrid Beacons (PHB) or Rectangular Rapid Flashing Beacons (RRFBs). Illumination should be evaluated if night-time pedestrian activity is expected. See **Chapter 6 – Lighting** for further information.

A PHB is a special type of beacon used to warn and control traffic at an unsignalized location to assist pedestrians in crossing a street or highway at a marked crosswalk. [Chapter 4F. Pedestrian Hybrid Beacons, MUTCD](#) provides additional information regarding their installation. See Figure 8 – 7 Pedestrian Hybrid Beacon for an example of a pedestrian hybrid beacon.

Figure 8 – 7 Pedestrian Hybrid Beacon (PHB)



16th Street South, St. Petersburg, Florida

The RRFB uses rectangular-shaped high-intensity LED-based indications, flashes rapidly in a wig-wag "flickering" flash pattern, and is mounted immediately between the crossing sign and the sign's supplemental arrow plaque. Use of PHBs should be limited to locations with the most critical safety concerns, such as pedestrian and school crosswalks across uncontrolled approaches.

The use of RRFBs requires interim approval from FHWA. The [MUTCD](#) provides further information on obtaining [interim approval](#) for the use of [RRFBs](#). See Figure 8 – 8 Pedestrian Median Refuge with Rectangular Rapid Flashing Beacon for an example of a Rectangular Rapid Flashing Beacon (RRFB).

Figure 8 – 8 Pedestrian Median Refuge with Rectangular Rapid Flashing Beacons (RRFB)



4th Street North, St. Petersburg, Florida

G.2 Curb Ramps and Blended Transitions

A continuous accessible pedestrian route, including curb ramps and blended transitions is needed along pedestrian networks. Blended transitions are raised pedestrian street crossings, depressed corners, or similar connections between pedestrian access routes at the level of the sidewalk or shared use path and level of the pedestrian street crossing that have a grade of 5% or less. Blended transitions can be used when geometrics and allocated space doesn't allow for separated curb ramps.

Curb ramps shall be provided at all intersections with curb (**Section 336.045 (3), Florida Statutes**). Each crossing should have separate curb ramps, perpendicular with the curb, and landing within the crosswalk. Include sidewalk curb ramps at the following locations:

- At curbed returns for intersections and turnouts. ~~Include a landing at the top of each ramp.~~
- On curbed roadways between intersections where a crosswalk has been established, such as midblock crossings and side streets.

Relocate or adjust pull boxes, manholes and other types of existing surface features to meet the ADA requirements for nonslip top surfaces, ¼ inch height protrusion, and slopes flush with the surrounding surface.

On sidewalks, the curb ramp width shall be a minimum of 4 feet; curb ramp widths equal to crosswalk widths are encouraged. For shared use paths, the curb ramp shall be at least as wide as the approaching width of the path. Curb ramp slopes shall not exceed 1:12 and shall have a firm, stable, slip resistant surface texture.

Curb ramps should be in line with the crossing. At intersections where more than one road is crossed, provide separate curb ramps at both ends of each crossing. Two ramps per corner are preferred to minimize the problems with entry angle and to decrease the delay to pedestrians entering and exiting the roadway.

Crossings are required to meet the same grade and cross slope requirements as sidewalks. Where criteria for maximum cross slope of the crossing cannot be met, provide the minimum attainable cross slope. When following the profile grade of the roadway, curb ramps ~~slopes are not required to exceed~~ ~~should not~~ 15 feet in length.

Curb ramps whose sides have returned curbs on the outside edges provide useful directional cues when they are aligned with the pedestrian street crossing and are protected from cross travel by a buffer area or landscaping.

Provide transition slopes (flared sides) where a pedestrian circulation path crosses the curb ramp. The maximum slope of transition slopes is 1:10, measured parallel with and adjacent to the curb line.

A turning space at least 4 feet by 4 feet wide shall be provided at the top of the curb ramp and shall be permitted to overlap other turning spaces and clear spaces. Where the turning space is constrained at the back-of-sidewalk, the turning space shall be at least 4 feet by 5 feet. The 5-foot dimension shall be provided in the direction of the ramp run.

When altering an existing pedestrian facility and conditions preclude the accommodation of a curb ramp slope of 1:12, provide a slope from 1:12 to 1:10 with a maximum rise of 6 inches.

Further information on curb ramps, landings and blended transitions is provided in the FDOT [Department's Standard Plans, Index 522-002.](#)

G.3 Detectable Warnings

Install detectable warnings to cover the full width of the walking surface and 2 feet in length. They are required on sidewalks and shared use paths at the following locations:

- Curb ramps and blended transitions at street crossings
- Cut-through pedestrian refuge islands or medians six feet wide or greater
- Pedestrian at-grade rail crossings
- Commercial driveways with a stop sign, yield sign or traffic signal
- Boarding and alighting areas adjacent to the roadway at bus stops where there is an at-grade connection to the roadway
- Edges of rail boarding platforms not protected by screens or guards

Detectable warnings are not required where sidewalk intersects urban flared turnouts or sidewalks that run continuously through driveways. Do not place detectable warnings on transition slopes or over grade breaks.

The detectable warning systems on the Department's **Approved Product List (APL)** are designed to work with concrete surfaces. In areas where the pedestrian facility has an asphalt surface, such as a shared use path, specify an appropriate detectable warning system. In these cases, consider including a short section of concrete that will accommodate any system.

Further information on detectable warnings are provided in the [FDOT Department's *Standard Plans*, *Index 522-002*](#).

G.4 Curb Extensions

Curb extensions (a.k.a., bulb-outs) may be used in conjunction with on-street parking at intersections or midblock locations where there is a crosswalk, provided there is adequate width for existing traffic movements. Curb extensions shorten the crossing distance, and provide additional space at intersections, allowing pedestrians to see and be seen before entering a crosswalk. The design of curb extensions must take into consideration the needs of transit vehicles, drainage, and bicyclists.

G.54 Pedestrian Signals Controls

Signs, signals, and markings should be utilized to provide the necessary information and direction for pedestrians. All directions and regulations should be clear, consistent, and logical, and should, at a minimum, conform to the requirements given in the [MUTCD](#). The [installation use](#) of accessible pedestrian signals that include audible and/or vibro-tactile, and visual signals should be considered ~~for pedestrian traffic control and regulation~~.

Where pedestrian facilities are provided or planned, include provisions (e.g., conduit, conductors, signal cables, push button pedestals, curb ramps) needed for future installation of Accessible Pedestrian Signal (APS) devices on all new and reconstructed signalized intersections and signalized crossing locations.

Provide a level landing at the base of all pedestrian pushbutton locations. The landing must provide a clear area of 30 inches by 48 inches (in either direction) directly in front of and centered on, the pedestrian pushbutton to allow persons using a wheeled mobility device to actuate the button while remaining stationary.

G.65 Sight Distance

The general requirements for sight distances for the driver are given in **Chapter 3 - Geometric Design**.

Stopping sight distances greater than the minimum should be provided at all pedestrian crossings. These sight distances should include a clear view of the pedestrian approach pathway. Where parallel pedestrian pathways are within the

roadside recovery area, or where casual pedestrian crossings are likely, the normal required stopping sight distance should also include a clear view of the entire roadside recovery area.

Sight distances shall be based upon a driver's eye and object height as discussed in **Chapter 3 – Geometric Design**. Due to the small size of some pedestrians (particularly children), they are generally easy to confuse with other background objects.

Parking shall be prohibited where it would interfere with the required sight distance. Particular care should be exercised to ensure ample mutual sight distances are provided at all intersections and driveways.

G.76 Rail Crossings

Roadways, sidewalks, and shared use paths at grade may cross light rail, street car rail, passenger rail, and freight railroads. Special design considerations are needed for these pedestrian intersections so that pedestrians are warned of the crossing and potential presence of a train. In addition, these crossings have specific accessibility requirements relating to surface continuity which must be met. See **Chapter 7 – Rail-Highway Crossings** for further information. The [Federal Railroad Administration](#) may impose additional requirements for the design and construction of rail crossings.

H LIGHTING

Lighting of the roadway itself is not only important for the safety of vehicular traffic, but also valuable for the protection of pedestrians. Vehicle headlamps often do not provide sufficient lighting to achieve the required stopping sight distance. Since this requirement is of vital importance at any potential pedestrian crossing point, lighting of the crossing should be considered. Lighting a street or highway is also valuable in improving the pedestrian's view of oncoming vehicles. At intersections or other locations with vehicle turning maneuvers, vehicle headlights may not be readily visible to the pedestrian.

Lighting shall be provided in pedestrian underpasses and should be considered on pedestrian overpasses. All pedestrian lighting shall be vandal resistant. The installation of daytime lighting is warranted when underpass user visibility requirements are not met with sunlight. Pedestrian underpass and overpass lighting should conform to the general lighting requirements given in the American Association of State Highway and Transportation Officials (AASHTO) Roadway Lighting Design Guide.

The general requirements for lighting on streets and highways are given in **Chapter 6 – Lighting**. Pathways adjacent to a street or highway should not be illuminated to a level more than twice that of the roadway itself.

In general, lighting should be considered as warranted when it is necessary, at night, to provide the mutual sight distance capabilities described in the preceding **Chapter 3 – Geometric Design**. Locations with significant night time pedestrian traffic that should be considered for lighting of the roadway and adjacent pedestrian facilities include the following:

- Any street or highway that meets the warranting criteria given in **Chapter 6 – Lighting**
- Streets and highways with speed limits ~~in excess of~~ more than 40 mph that do not have adequate pedestrian conflict elimination
- Sections of highway with minimal separation of parallel pedestrian pathways
- Intersections, access and decision points, and areas adjacent to changes in alignment or cross sections
- Areas adjacent to pedestrian generators
- Transit stops and other mass transit transfer locations
- Parking facilities

- Entertainment districts, sports/recreation complexes, schools, and other activity centers generating night travel
- Pedestrian crossings
- Any location where improvement of night time sight distance will reduce the hazard of vehicle-pedestrian conflicts

See **Chapter 6 – Lighting** for further information on lighting of pedestrian facilities and shared use paths.

I REFERENCES FOR INFORMATIONAL PURPOSES

- Florida Department of Transportation Transit Facility Design
<http://www.dot.state.fl.us/transit/Pages/NewTransitFacilitiesDesign.shtm>
<https://www.fdot.gov/fdottransit/transitofficehome/transitplanning.shtm/newtransitfacilitiesdesign.shtm>
- USDOT/FHWA ADA Standards for Accessible Design (ADAAG)
<http://www.access-board.gov/guidelines-and-standards/buildings-and-sites/about-the-ada-standards/ada-standards>
- 2006 Americans with Disabilities Act Standards for Transportation Facilities
<https://www.access-board.gov/files/ada/ADAdotstandards.pdf>
- 2012 Florida Accessibility Code for Building Construction
<https://www.flrules.org/gateway/ruleno.asp?id=61G20-4.002>
[http://floridabuilding.org/fbc/committees/accessibility/aac/Changes to Law/Florida Accessibility Code 2012 ICC FINAL.pdf](http://floridabuilding.org/fbc/committees/accessibility/aac/Changes%20to%20Law/Florida%20Accessibility%20Code%202012%20ICC%20FINAL.pdf)
- [AASHTO – Guide for the Planning, Design, and Operation of Pedestrian Facilities](https://store.transportation.org/)
<https://store.transportation.org/>
- AASHTO – Roadway Lighting Design Guide †
<https://store.transportation.org/>
- NACTO Urban Streets Design Guide
<https://nacto.org/publication/urban-street-design-guide/>
- [Designing Walkable Urban Thoroughfares \(CNU and ITE\)](https://www.cnu.org/our-projects/cnu-ite-manual)
<https://www.cnu.org/our-projects/cnu-ite-manual>
- FHWA Policy Memo for Flexibility in Pedestrian and Bicycle Facility Design
https://nacto.org/wp-content/uploads/2013/09/design_flexibility_memorandum_092013.pdf
- AASHTO Load and Resistance Factor Design (LRFD) Bridge Design Specifications, 6th Edition, (2012) with 2013 Interim Revisions
<https://store.transportation.org/>
- Federal Railroad Administration General Manual - Policies, Procedures, and General Technical Bulletins (July 2014)
<https://railroads.dot.gov/about-fra/about-fra>

CHAPTER 9

BICYCLE FACILITIES

A	INTRODUCTION	9-1
B	ON-STREET FACILITIES.....	9-2
	B.1 Bicycle Lanes.....	9-2
	B.2 Buffered Bicycle Lanes	9-19
	B.3 Bicycle Lane with Bus Bay	9-22
	B.4 Separated Bicycle Lanes	9-23
	B.5 Green Colored Bicycle Lanes	9-24
	B.6 Paved Shoulders.....	9-30
	B.7 Wide Outside Lanes.....	9-30
	B.8 Shared Lane Markings.....	9-31
	B.9 Bicycles May Use Full Lane Sign	9-34
C	SHARED USE PATHS	9-35
	C.1 Width and Clearance.....	9-36
	C.2 Separation Between Shared Use Paths and Roadways	9-37
	C.3 Design Speed	9-38
	C.4 Horizontal Alignment.....	9-38
	C.5 Accessibility	9-38
	C.6 Shared Use Path – Roadway Intersections.....	9-39
	C.6.a Grade Separated Crossings.....	9-40
	C.6.b Sidepath Crossings.....	9-41
	C.6.c Midblock Shared Use Path Crossings.....	9-42
	C.6.c.1 Intersections with Yield Control	9-42
	C.6.c.2 Intersections with Signal Control or Stop Control.....	9-45
	C.7 Structures.....	9-45
	C.8 Pavement Markings and Signage	9-45

D RAILROAD CROSSINGS..... 9-46
E STRUCTURES 9-48
F REFERENCES FOR INFORMATIONAL PURPOSES 9-49

TABLES

Table 9 – 1 Lane Widths Urban Multilane or Two-Lane with Curb and Gutter 9-8
Table 9 – 2 Formulas for Lengths of Roadway and Path Legs – Yield Condition . 9-43
Table 9 – 3 Intersection Sight Distance Calculated Lengths of Roadway
and Path Lengths..... 9-44

FIGURES

Figure 9 – 1	Minimum Widths for Bicycle Lanes	9-3
Figure 9 – 2	Detail of Bicycle Lane Markings	9-4
Figure 9 – 3	Bicycle Lanes.....	9-5
Figure 9 – 4	Left Side Bicycle Lanes.....	9-6
Figure 9 – 5	Example of Obstruction Pavement Markings	9-7
Figure 9 – 6	Bicycle Lane Markings	9-9
Figure 9 – 7	Bicycle Lanes with Separate Right Turn Lane (Curb and Gutter)	9-10
Figure 9 – 8	Bicycle Lanes with On Street Parking, No Right Turn Lane (Curb and Gutter).....	9-11
Figure 9 – 9	Bicycle Lane with Right Turn Drop Lane (Curb and Gutter).....	9-12
Figure 9 – 10	"Tee" Intersection with Bicycle Lane, Separate Right and Left Turn Lanes (Curb and Gutter).....	9-13
Figure 9 – 11	"Tee" Intersection with Bicycle Lanes, Left Turn Lane and Right Turn Drop Lane (Curb and Gutter).....	9-14
Figure 9 – 12	Bicycle Lanes with No Right Turn Lane (Flush Shoulder).....	9-15
Figure 9 – 13	Bicycle Lane with Separate Right Turn Lane (Flush Shoulder).....	9-16
Figure 9 – 14	Bicycle Lanes with Bus Bay, No Right Turn Lane (Curb and Gutter).....	9-17
Figure 9 – 15	Bicycle Lanes on Interchange Ramps (Flush Shoulder)	9-18
Figure 9 – 16	Buffered Bicycle Lane Adjacent to On-Street Parking.....	9-19
Figure 9 – 17	Buffered Bicycle Lane Markings.....	9-20
Figure 9 – 18	Buffered Bicycle Lane Markings with On-Street Parking.....	9-21
Figure 9 – 19	Buffered Bicycle Lane with Bus Bay Marking (Curb and Gutter).....	9-22
Figure 9 – 20	Green Bicycle Lane with Separate Right Turn Lane	9-26

Figure 9 – 21 Green Bicycle Lane with Right Turn Drop Lane 9-27

Figure 9 – 22 Green Bicycle Lane with Channelized Right Turn Lane 9-28

Figure 9 – 23 Green Bicycle Lane with Bus Bay 9-29

Figure 9 – 24 Shared Lane Marking 9-31

Figure 9 – 25 Shared Lane Marking Placement (No Designated Parking, Lane Width ≤ 14 Feet).....9-32

Figure 9 – 26 Shared Lane Marking Placement (With On-Street Parking)..... 9-33

Figure 9 – 27 Mid-Block and Sidepath Crossings Relative to Intersection Functional Area.....9-40

Figure 9 – 28 Yield Sight Triangles 9-42

Figure 9 – 29 Sign Placement on Shared Use Paths 9-46

CHAPTER 9

BICYCLE FACILITIES

A INTRODUCTION

Bicycle facilities ~~shall~~^{should} be given full consideration in the planning and development of transportation facilities, including the incorporation of such facilities into state, regional, and local transportation plans, and programs under the assumption that transportation facilities will be used by cyclists. Bicycle facilities should be established in conjunction with the construction, reconstruction, or other change of any transportation facility and special emphasis should be given to projects in or within 1 mile of an urban area. The provision for bicycle facilities ~~is~~^{is} also desirable for resurfacing, restoration & rehabilitation (RRR) projects.

Bicycle and pedestrian facilities are not required to be established:

1. Where their establishment would be contrary to public safety.
2. When the cost would be excessively disproportionate to the need or probable use;
or
3. Where other available means or factors indicate an absence of need.

Appropriately designed and located bicycle facilities play an important role in supporting bicycle travel. Bicyclists ~~shall~~^{should} be considered in all phases of transportation planning, design, construction, and maintenance activities. ~~Particular~~^{Particular} ~~E~~^{Emphasis} should be given to new construction, reconstruction, intersection improvement, and transit projects. Bicycle facilities can include bicycle lanes, paved shoulders, wide curb lanes, shared lanes, shared use paths, and bicycle parking facilities.

In addition to the design criteria provided in this chapter, shared use paths and structures that include provisions for pedestrians shall be designed to be accessible to persons with disabilities. For more information on accessible design requirements, see Chapter 8 – Pedestrian Facilities. ~~the 2006 Americans with Disabilities Act Standards for Transportation Facilities as required by 49 C.F.R 37.41 or 37.43 and the 2017 Florida Accessibility Code for Building Construction as required by 61G20-4.002 impose additional requirements for the design and construction of facilities such as shared use paths and structures that include provisions for pedestrians.~~

B ON-STREET FACILITIES

Provisions for bicycle traffic should be incorporated in the original roadway design. All roadways, except where bicycle use is prohibited by law, should be designed, constructed, and maintained under the assumption they will be used by bicyclists. Roadway conditions should be favorable for bicycling, with smooth pavement and limited changes in elevation along edge lines. Drainage inlets and utility covers that cannot be moved out of the travel way ~~shall~~~~should~~ be designed flush with grade, well seated, and make use of bicycle-compatible grates and covers.

Railroad grade crossings on a diagonal can cause steering difficulties for bicyclists. Crossings for bicycle facilities should be perpendicular to the rail. This can be accomplished with a widened shoulder or bicycle lane, or separate path. Consideration ~~shall~~~~should~~ be given to improving the smoothness of the crossing and reducing the width and depth of the flangeway opening. Flangeway fillers can be used on heavy rail lines to minimize the size of the opening adjacent to the rail.

Bicycle lanes, paved shoulders, wide curb lanes, or shared lanes should be included to the fullest extent feasible. The appropriate selection of a bicycle facility depends on many factors, including motor vehicle and bicycle traffic characteristics, adjacent land use and expected growth patterns. All new or reconstructed arterial and collector roadways, in and within one mile of an urban area, should include bicycle lanes.

Rumble strips used in a traffic lane to alert operators to conditions ahead (e.g., stop signs, traffic signals or curves) should provide clear space (free of rumble strips) for bicyclists. This clear space may be a paved shoulder or if no paved shoulder is present, a minimum of 1.5 feet of clear space at the outermost portion of the lane.

B.1 Bicycle Lanes

Bicycle lanes delineate available roadway space for preferential use by bicyclists, providing more predictable movements by motorists and bicyclists. Bicycle lanes also help increase the total capacity of highways carrying mixed bicycle and motor vehicle traffic. Bicycle lanes shall have a minimum functional width of 4 feet. At least 1-foot additional width is needed when the bicycle lane is adjacent to a curb or other barrier, on-street parking is present, there is substantial truck traffic (>10%), or posted speeds exceed 50 mph. Minimum bicycle lane widths are illustrated in Figure 9 – 1 Minimum Widths for Bicycle Lanes. The 4-foot bicycle lane shown in the flush shoulder typical section assumes the grass portion of the shoulder provides emergency maneuvering room.

Figure 9 – 1 Minimum Widths for Bicycle Lanes

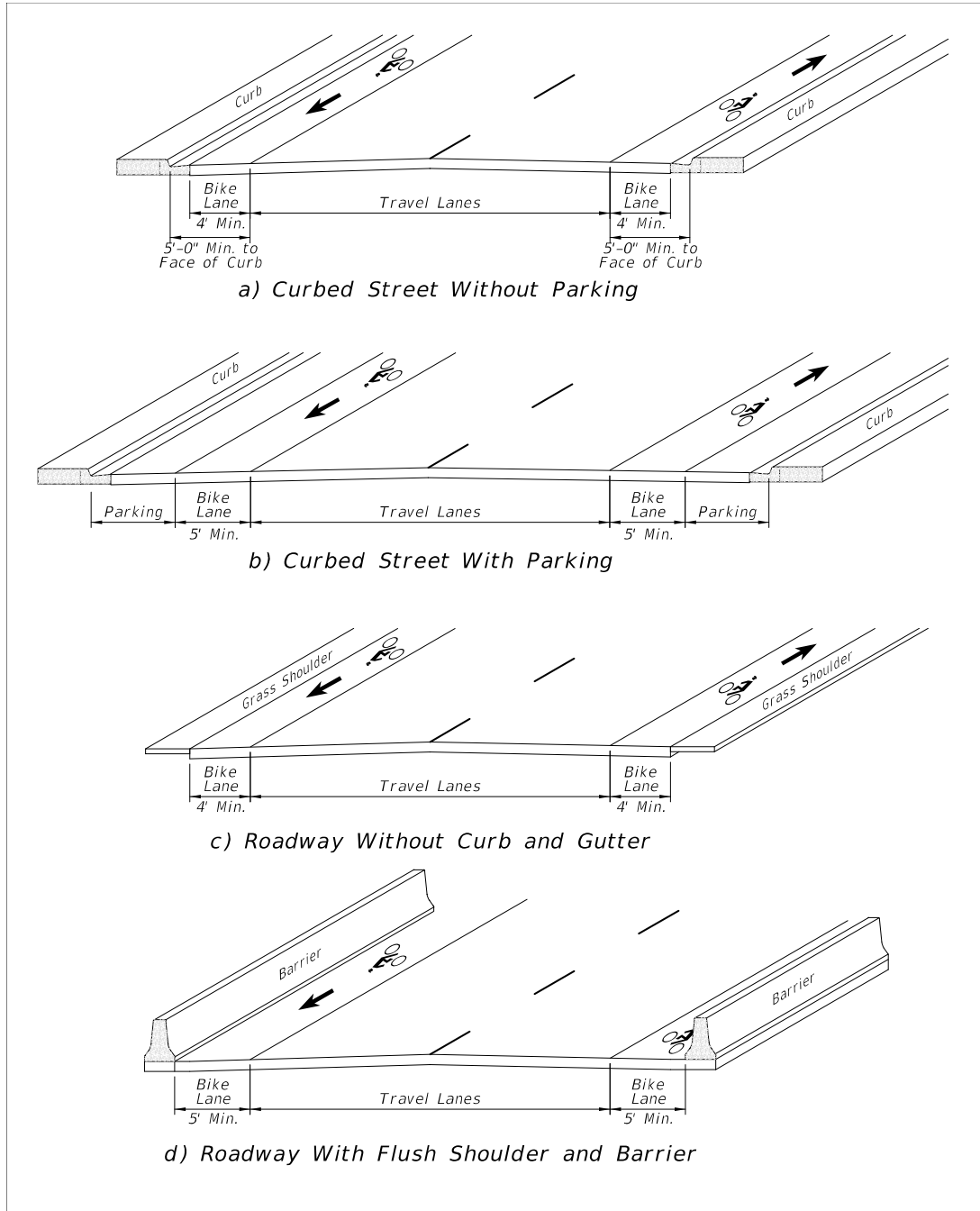

Bicycle lanes are one-way facilities and carry bicycle traffic in the same direction as the adjacent motor vehicle traffic. A bicycle lane should be delineated from the travel lanes with a solid white line and be marked with the bicycle symbol and arrow as shown in Figure 9 – 2 Detail of Bicycle Lane Markings. The dimensions for each pavement marking is 72" long, separated by 72".

The recommended placement of bicycle lane markings is:

- a) At the beginning of a bicycle lane, on the far side of major intersections, and prior to and within the bicycle lane between a through lane and turn lane.
- b) Along the roadway as needed to provide a maximum spacing of 1,320 for posted speeds less than or equal to 45 mph, 2,640 feet for a posted speed of 50 mph or greater.

Figure 9 – 2 Detail of Bicycle Lane Markings

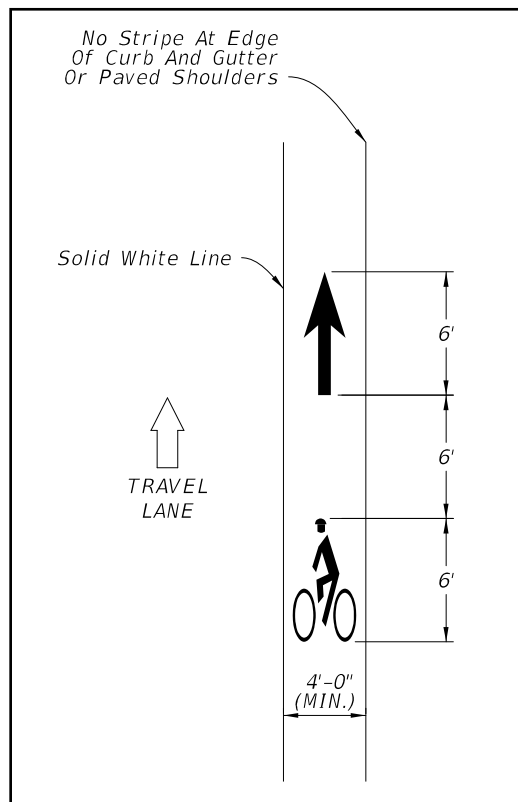

If used, bike lane signs and plaques should be placed in advance of the upstream end of the bicycle lane, at the downstream end of the bicycle lane, and at periodic intervals based upon prevailing speed of bicycle and other traffic, block length, and distances from adjacent intersections, and other considerations. They should only be used in conjunction with marked bicycle lanes. Bike lane signs are not required.

Figure 9 – 3 Bicycle Lanes



NACTO Urban Bikeway Design Guide, National Association of City Transportation Officials

A through bicycle lane shall not be positioned to the right of a right turn only lane or to the left of a left turn only lane. For new construction, reconstruction, and traffic operations projects, where bicycle lanes are provided between the through lane and right turn lane, bus bay or parking lane they shall be a minimum of 5 feet wide. For bicycle lanes adjacent to parking lanes, if the parking volume is substantial or the turnover is high a width of 6-7 feet is desirable to avoid opening vehicle doors.

On one-way streets, bicycle lanes should generally be placed on the right side of the street. A bicycle lane on the left side of the street can be considered when a bicycle lane on the left will substantially decrease the number of conflicts, such as those caused by frequent bus traffic, heavy right turning movements, high-turnover parking lanes, or if there are a significant number of left turning bicyclists. See Figure 9 – 4 Left Side Bicycle Lanes for an illustration.

Figure 9 – 4 Left Side Bicycle Lanes

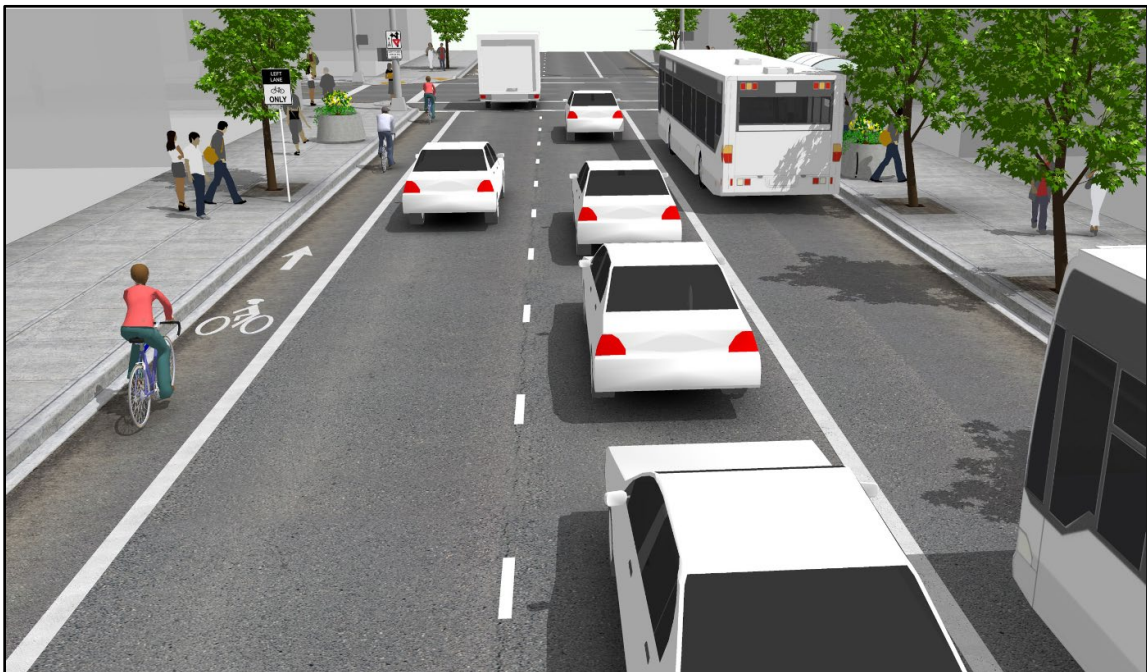

NACTO Urban Bikeway Design Guide, National Association of City Transportation Officials

Bicycle lanes shall not be provided on the circular roadway of a roundabout, and shall be transitioned prior to the roundabout in accordance with the MUTCD.

Existing drainage inlets, grates and utility covers shall be evaluated as to whether they present an obstruction to bicyclists, and should be relocated out of the cyclist's path of travel. Drainage inlets, grates and utility covers to remain should be adjusted to be flush with the adjacent pavement surface, utilize a grate recommended for bicycle travel, and may be marked as an obstruction.

Advance warning of an inlet or other obstruction may be provided as shown in the [MUTCD, Part 9](#). Additional information on appropriate drainage inlets in or near pedestrian and bicycle facilities can be found in [the FDOT's ~~the Department's~~ Florida Dept. of Transportation's Drainage Manual, Section 3.7.4 Inlet Placement, \(2022\) January 2018 Edition.](#)

Figure 9 – 5 Example of Obstruction Pavement Markings

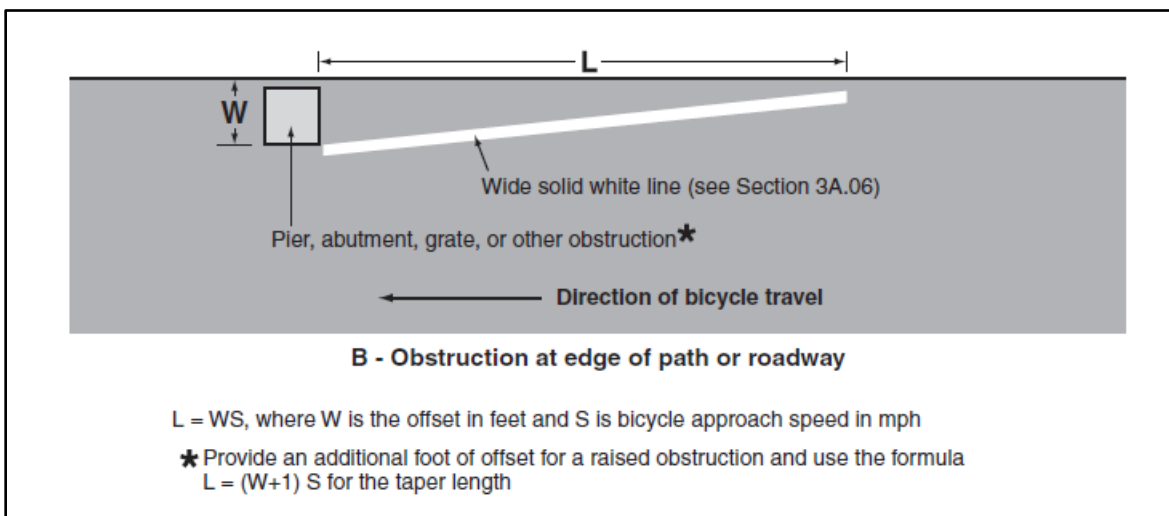

Traffic signals should be responsive to bicyclists. Regular maintenance of bicycle lanes should be a priority, since bicyclists are unable to use a lane with potholes, debris, or broken glass.

In conjunction with resurfacing projects, the roadway width shall be redistributed when practical to provide for bicycle facilities. The types of bicycle facilities considered for implementation include buffered bicycle lanes, bicycle lanes, wide outside lanes, and shared lanes. Lane widths on urban multilane roadways and two-lane curb and gutter roadways may be reduced as shown in Table 9 – 1 Lane Widths to provide for bicycle facilities.

**Table 9 – 1 Lane Widths Urban Multilane or
Two-Lane with Curb and Gutter**

Design Year AADT	Design Speed (mph)	Minimum Thru Lane (ft.)	Minimum Turn Lane (ft.)	Minimum Parking Lane (ft.)
ALL	ALL	10 ₁	9 ₂	7 ₃

1. 11 ft. where either of the following conditions exist:
 - a) Trucks are >10% of Design Year Traffic.
 - b) Design Speed is 40 mph or greater.
2. 10 ft. for 2 Way Left Turn Lanes.
3. A minimum width of 7 ft. measured from face of curb may be left in place. Otherwise provide 8 ft. minimum, measured from face of curb.

Various configurations of bicycle lanes on curb and gutter and flush shoulder typical sections are illustrated in Figures 9 – 6 to 9 – 23.

Figure 9 – 6 Bicycle Lane Markings

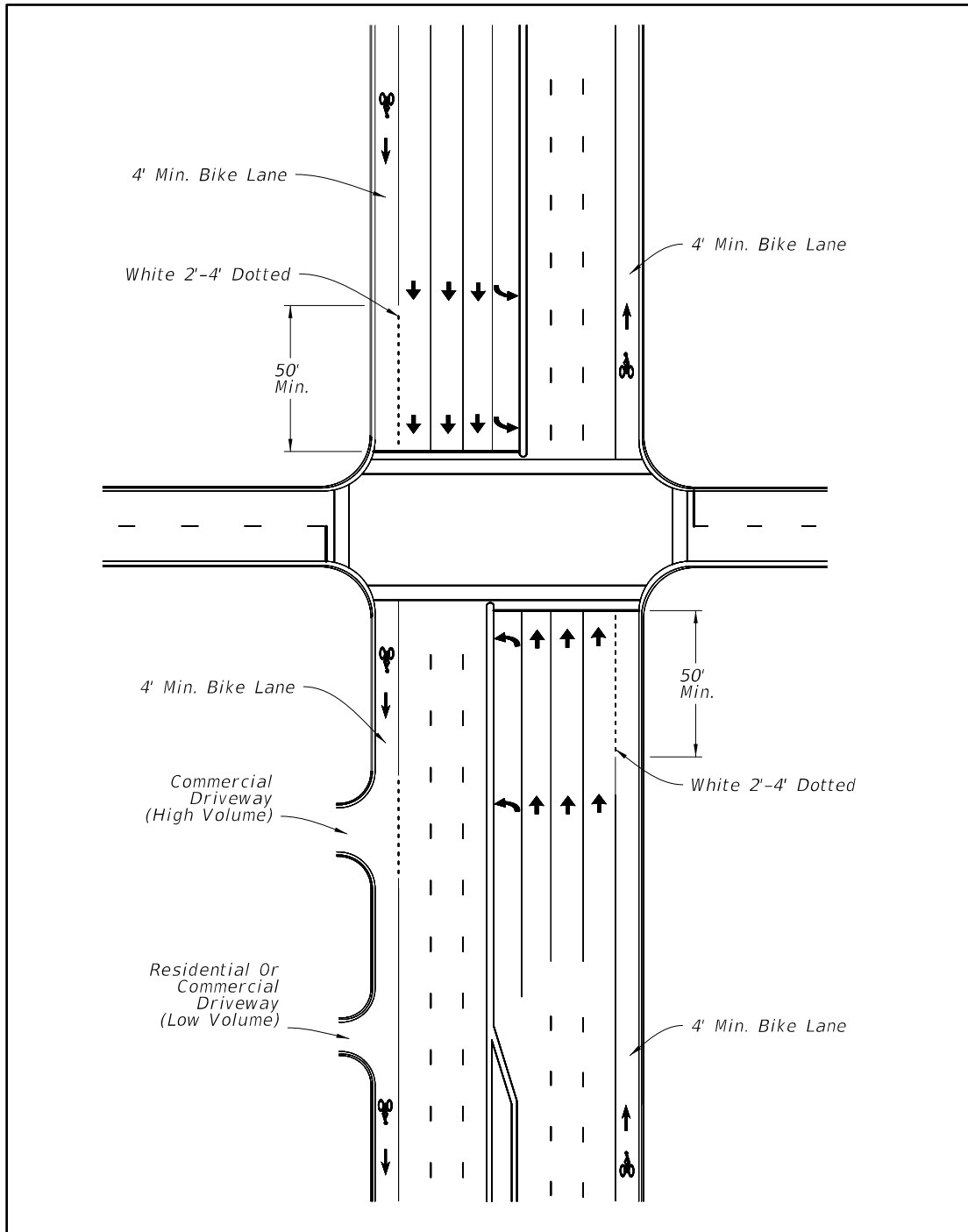

**Figure 9 – 7 Bicycle Lanes with Separate Right Turn Lane
(Curb and Gutter)**

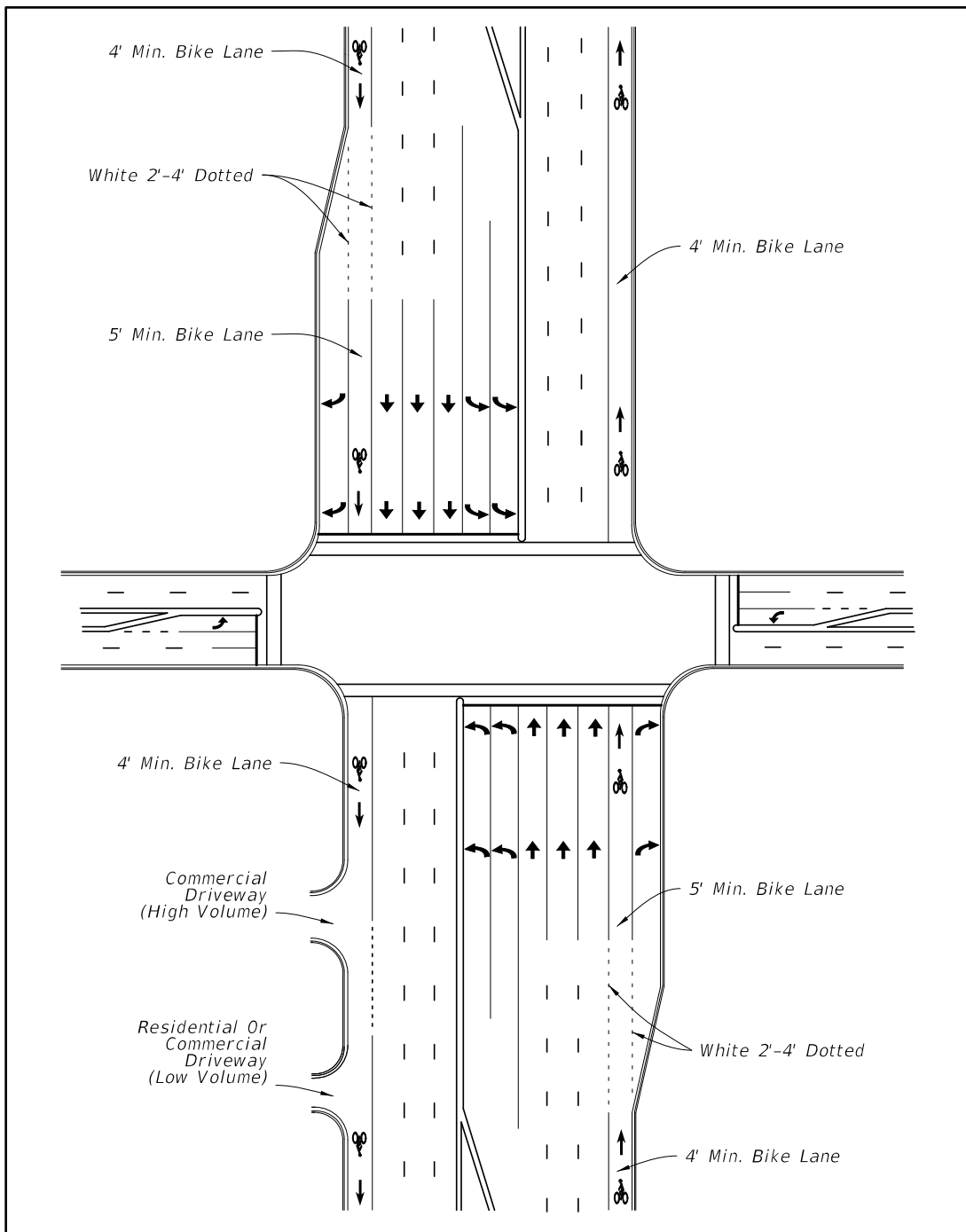

**Figure 9 – 8 Bicycle Lanes with On Street Parking, No Right Turn Lane
(Curb and Gutter)**

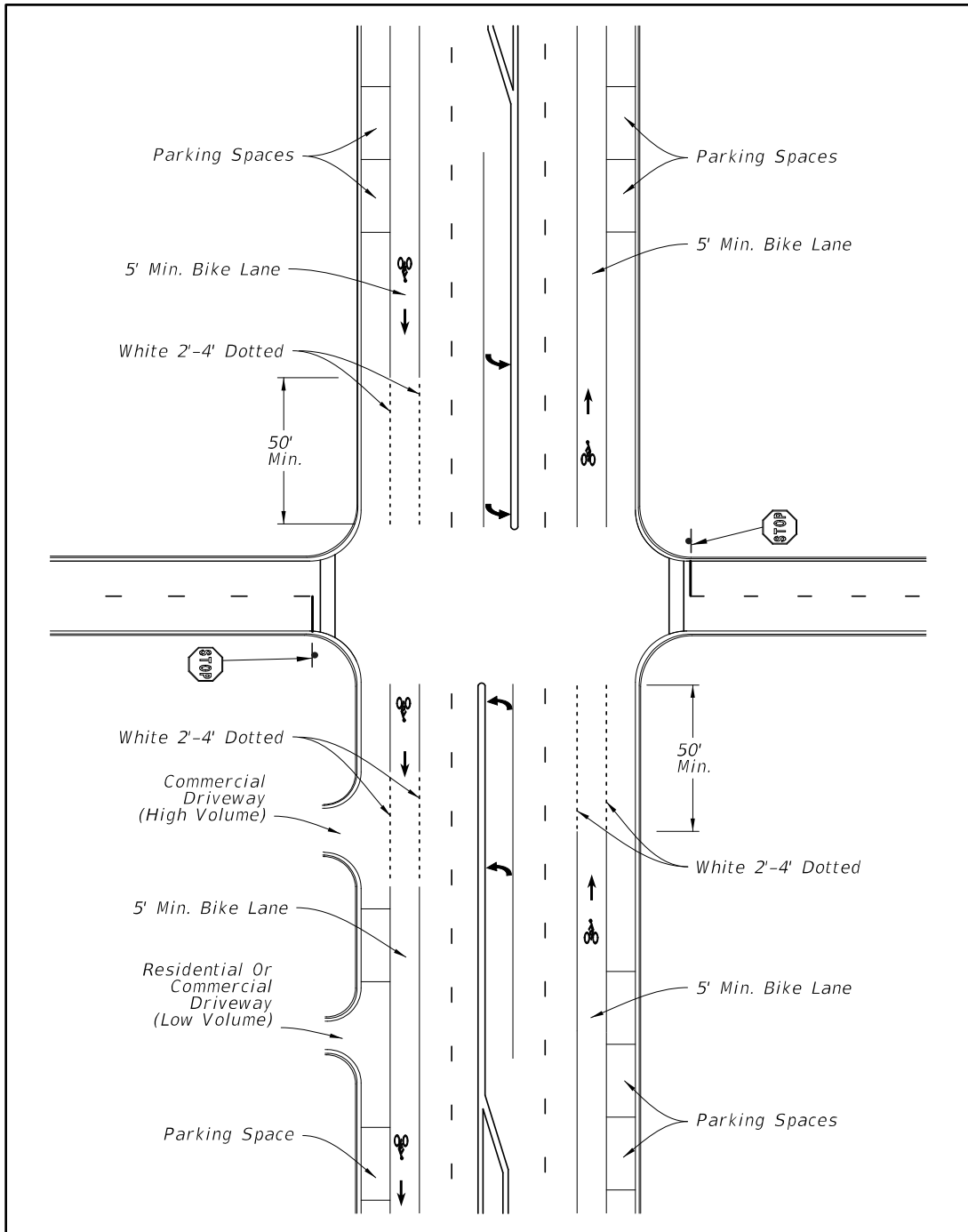

**Figure 9 – 9 Bicycle Lane with Right Turn Drop Lane
(Curb and Gutter)**

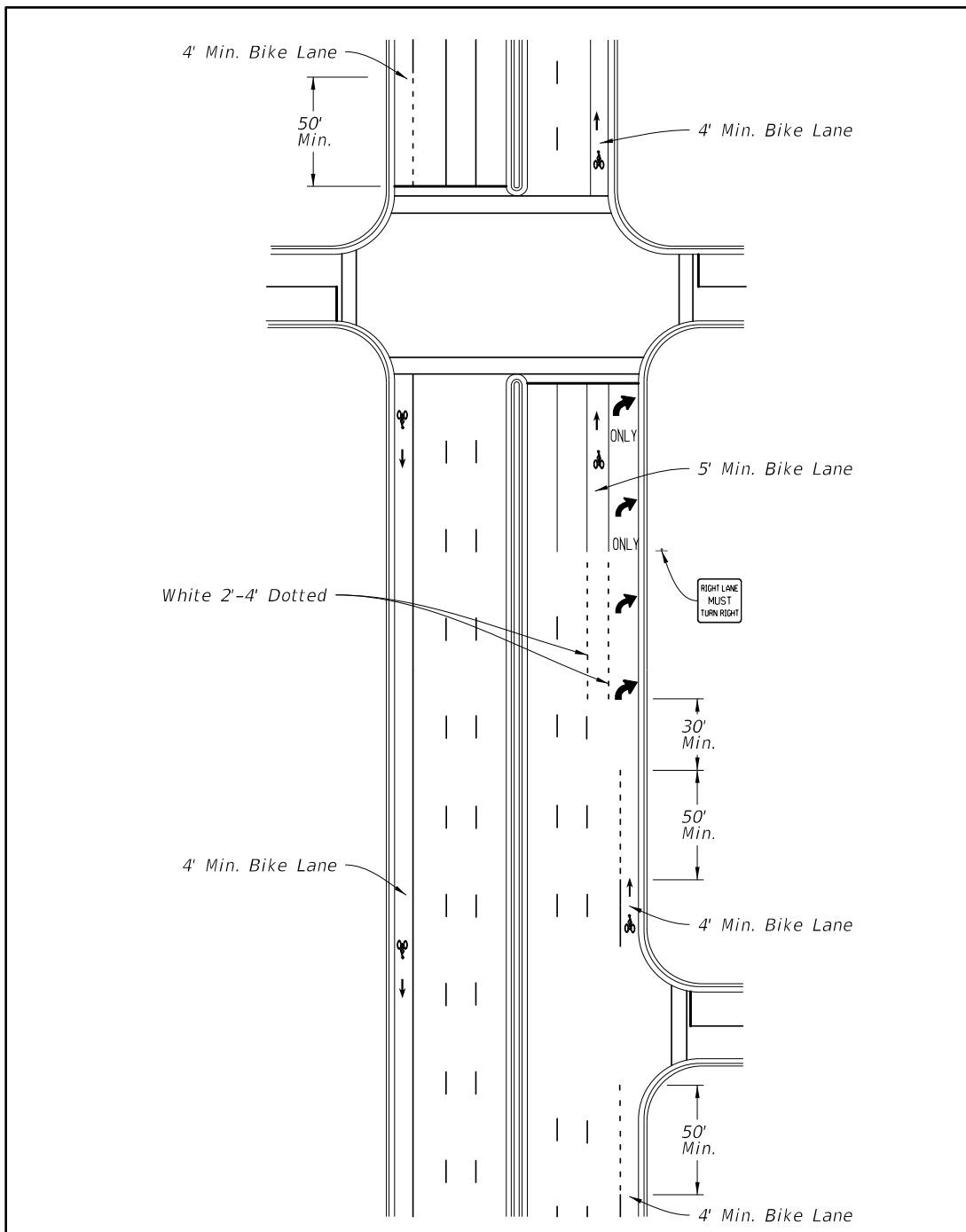

Figure 9 – 10 "Tee" Intersection with Bicycle Lane, Separate Right and Left Turn Lanes (Curb and Gutter)

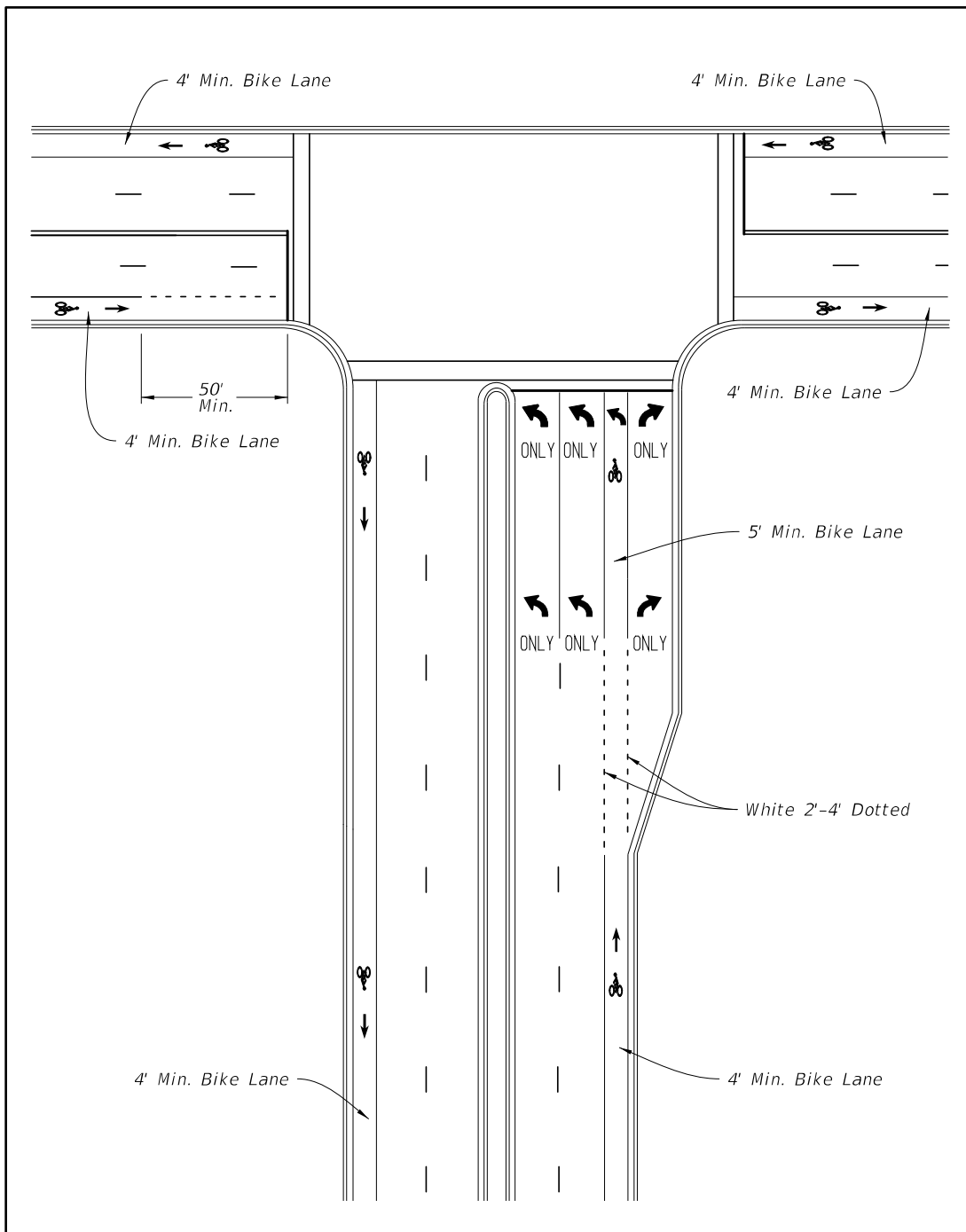
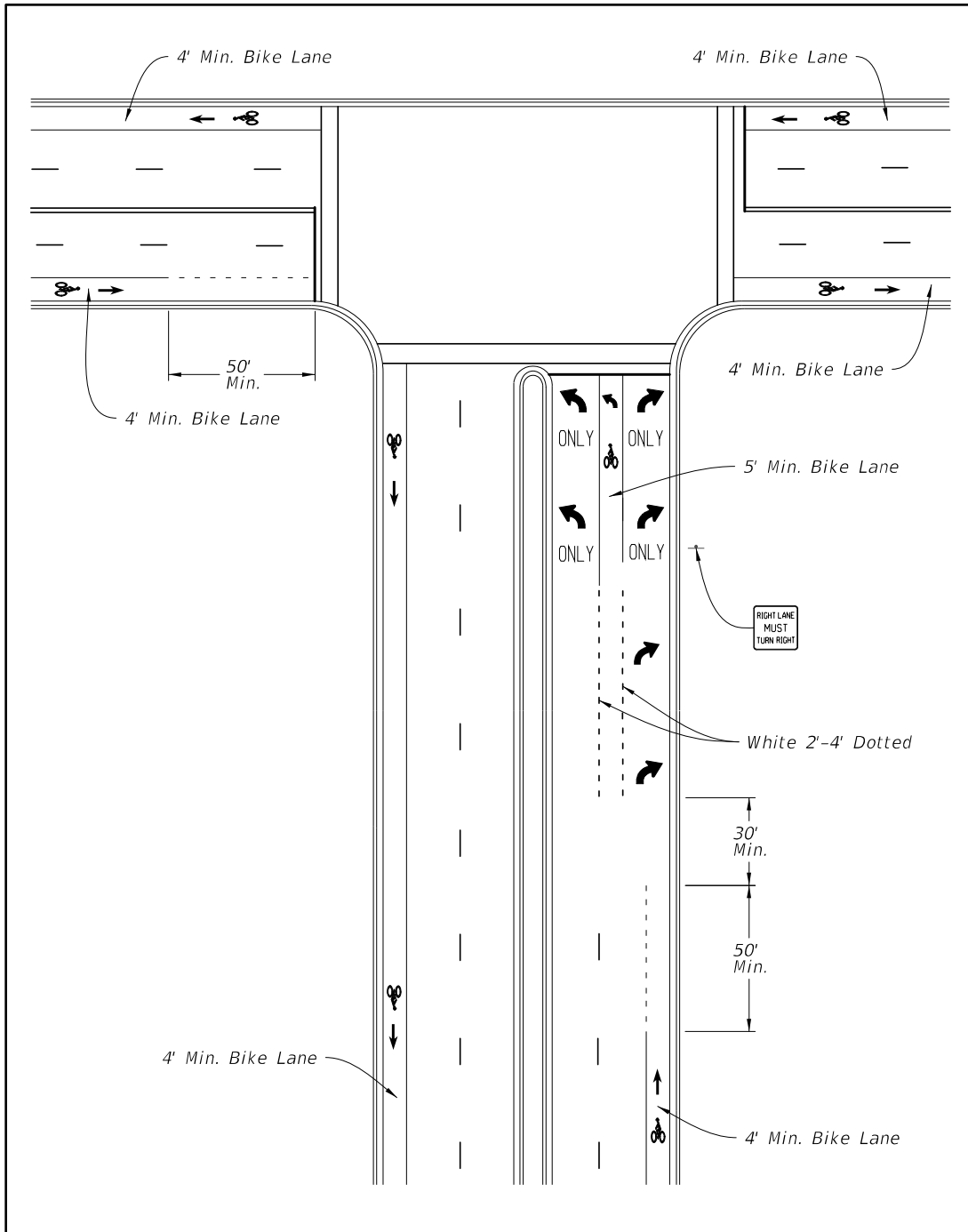
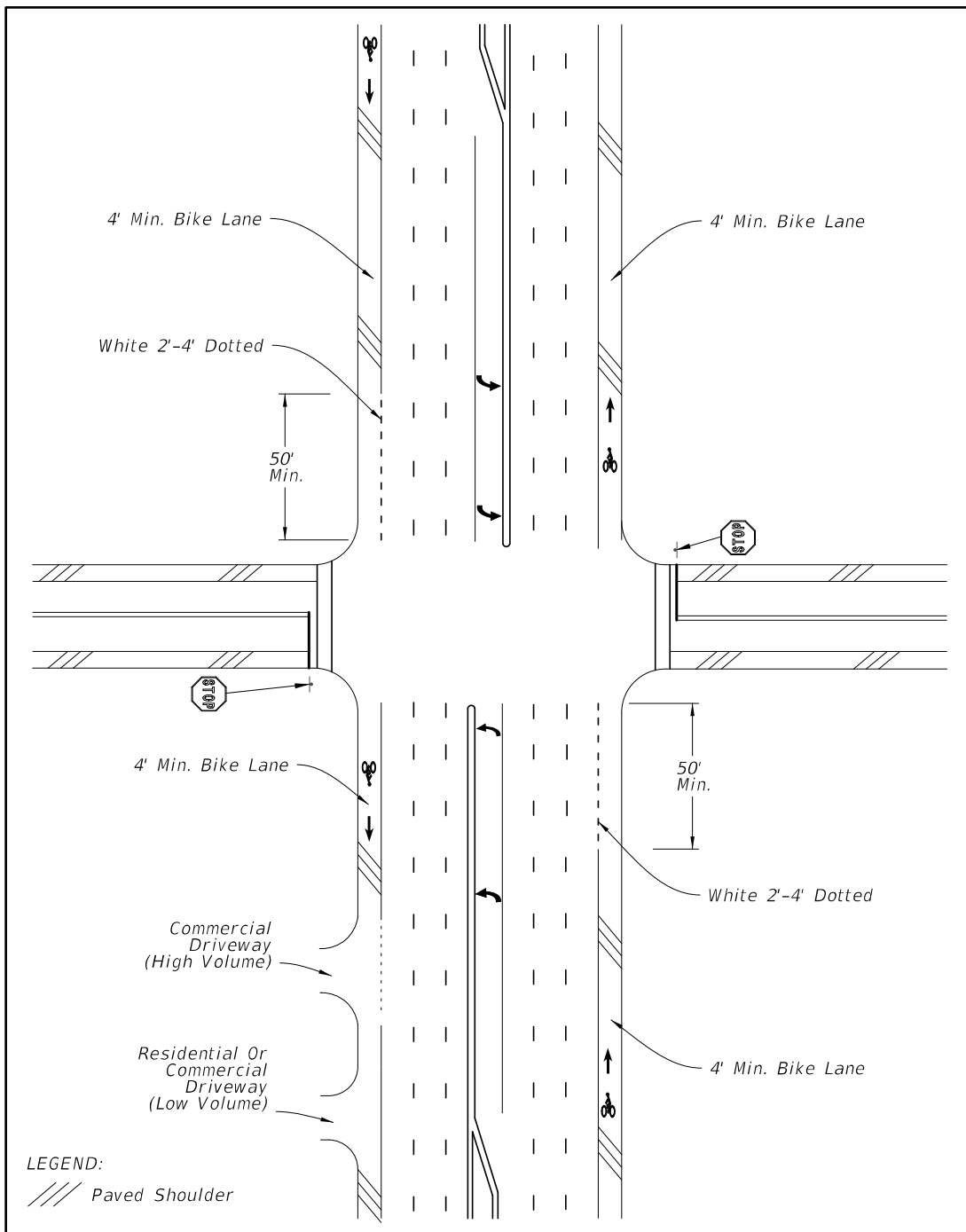

Figure 9 – 11 "Tee" Intersection with Bicycle Lanes, Left Turn Lane and Right Turn Drop Lane (Curb and Gutter)



**Figure 9 – 12 Bicycle Lanes with No Right Turn Lane
(Flush Shoulder)**



**Figure 9 – 13 Bicycle Lane with Separate Right Turn Lane
(Flush Shoulder)**

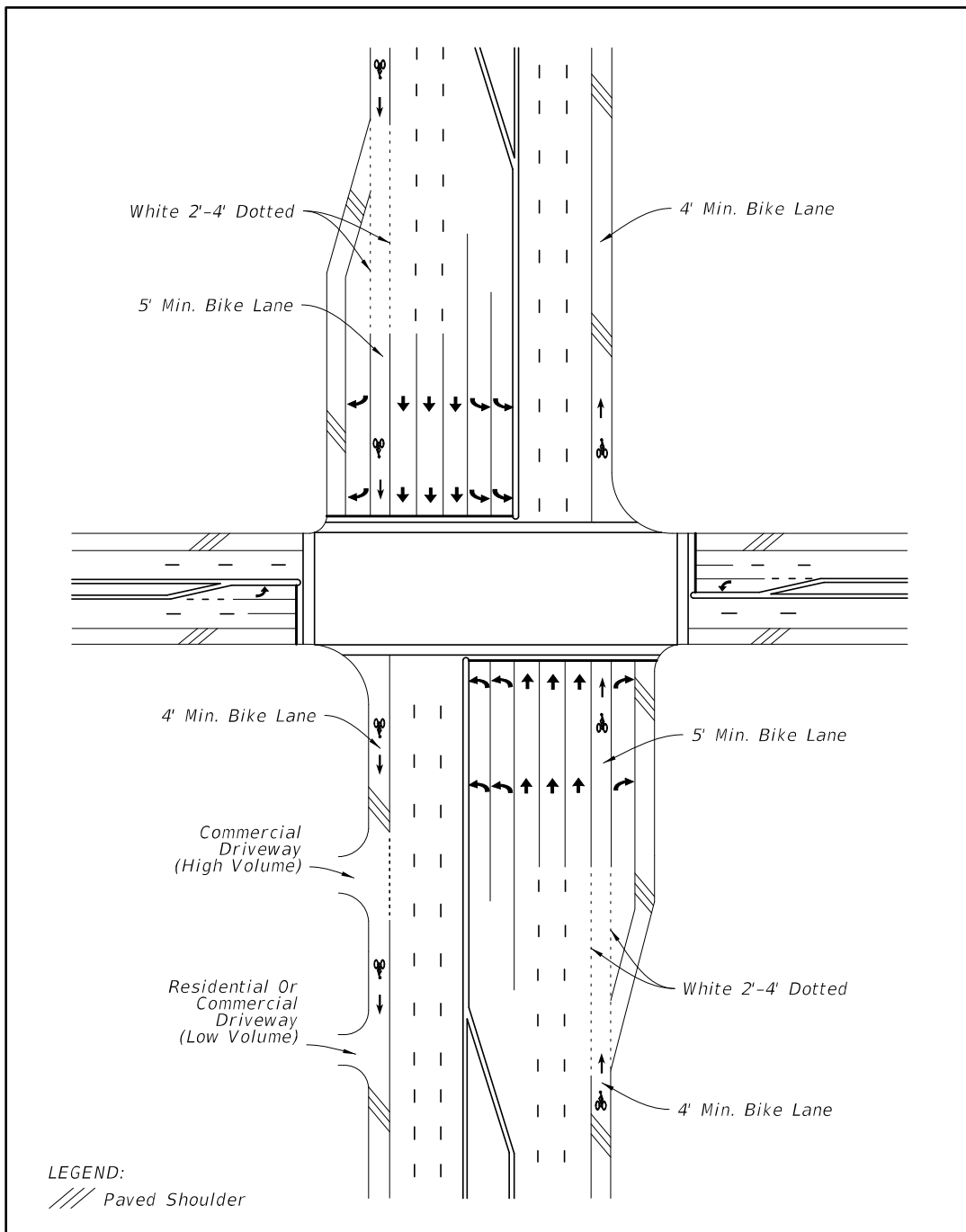

**Figure 9 – 14 Bicycle Lanes with Bus Bay, No Right Turn Lane
(Curb and Gutter)**

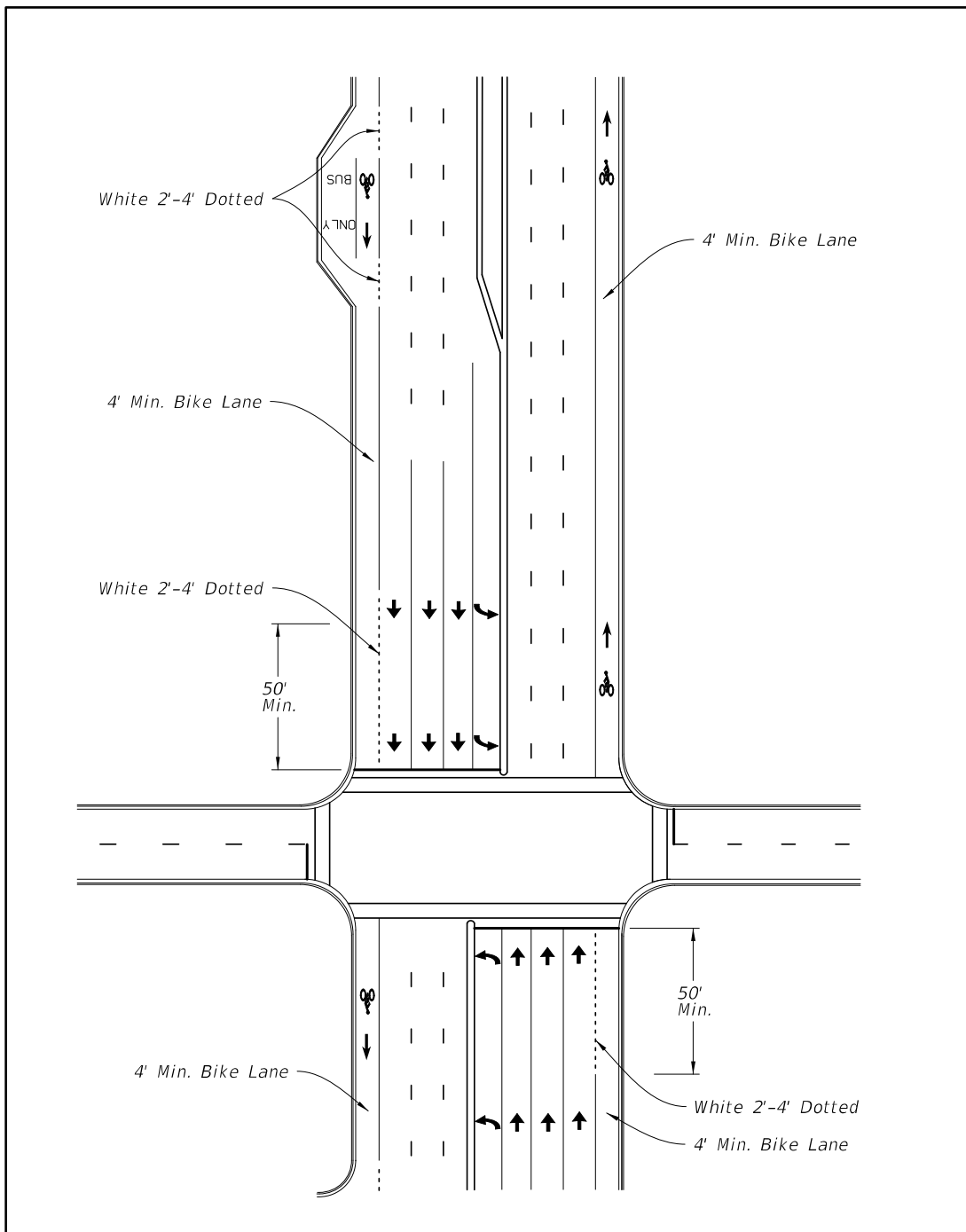

**Figure 9 – 15 Bicycle Lanes on Interchange Ramps
(Flush Shoulder)**

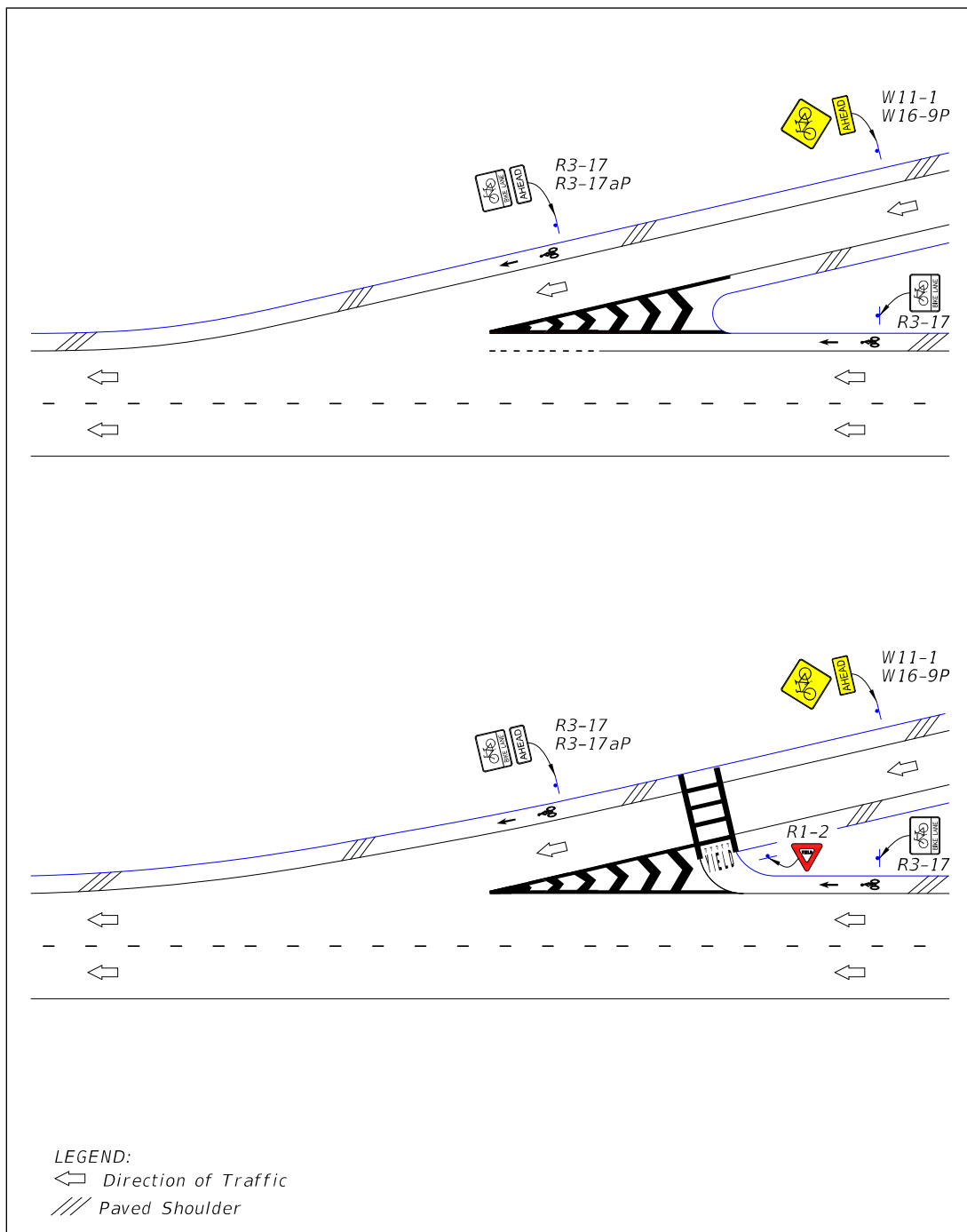

B.2 Buffered Bicycle Lanes

Buffered bicycle lanes are bicycle lanes separated from either the adjacent travel lane or parking lane with a marked buffer area. They provide greater shy distance between motor vehicles and bicyclists and encourage bicyclists to ride outside of the “door zone” of parked cars. Typical applications include streets with high travel speeds, high traffic volumes, high amounts of truck or transit traffic, or where there are underutilized travel lanes or extra pavement width.

The bicycle lane symbol and arrow markings shall be used, along with longitudinal lines to create the buffer. There are several options for marking the buffer area, including a wide solid double line (crossing prohibited), wide solid single line (crossing discouraged) or wide dotted single line (crossing permitted to make right hand turn). Where the buffer space is wider than 4 feet and crossing the buffer is prohibited, chevron markings should be placed in the buffer area.

At an intersection approach, the buffer striping should transition to a wide dotted stripe using a 2/4 skip pattern. The transition should begin 150 feet in advance of an intersection to provide sufficient distance for an automobile or truck to merge into the bicycle lane before turning right. Figures 9 – 16, 17 and 18 provide examples of buffered bicycle lanes. [Chapter 3D. Markings for Preferential Lanes of the MUTCD](#) provides additional information on the striping of buffered bicycle lanes.

Figure 9 – 16 Buffered Bicycle Lane Adjacent to On-Street Parking

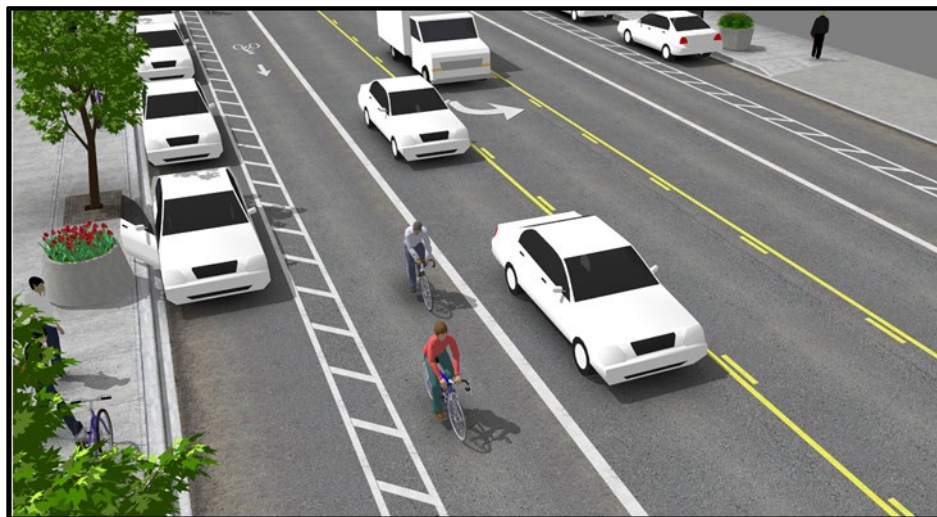

NACTO Urban Bikeway Design Guide, National Association of City Transportation Officials

Figure 9 – 17 Buffered Bicycle Lane Markings

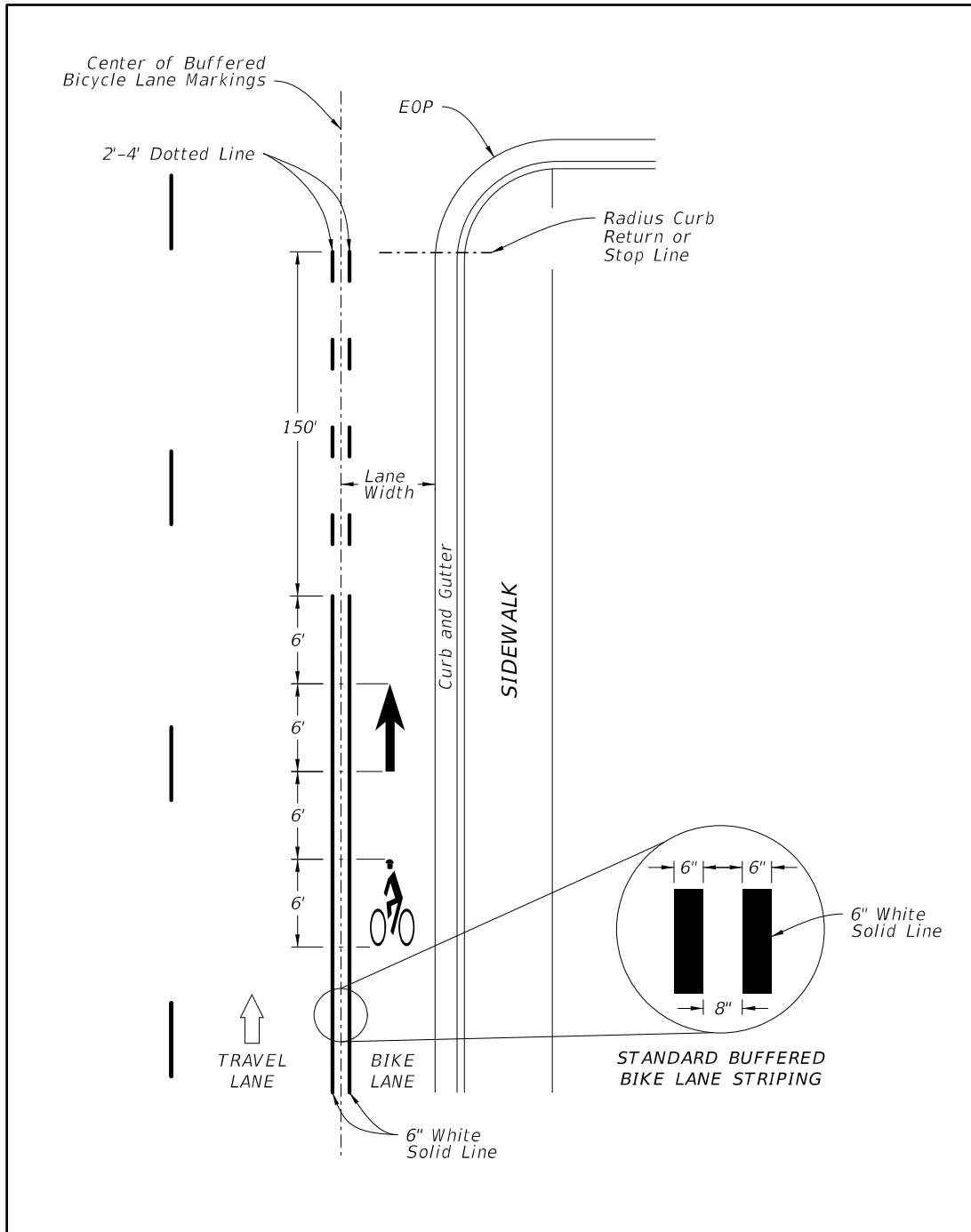
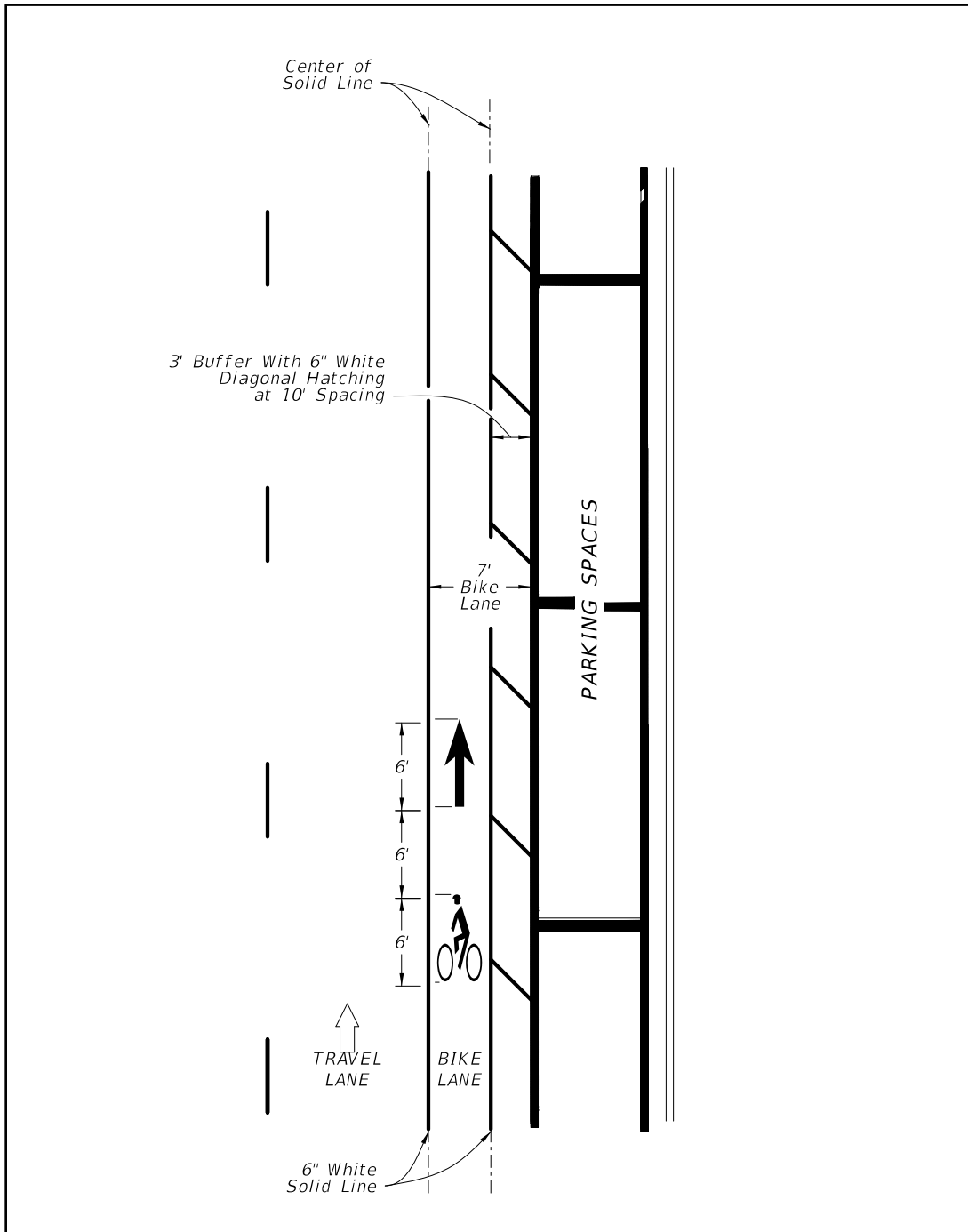

Figure 9 – 18 Buffered Bicycle Lane Markings with On-Street Parking



B.3 Bicycle Lane with Bus Bay

When a bus bay is provided on roadways with bicycle lanes, the bicycle lane shall be continued adjacent to the bus bay. Figure 9 – 19 Buffered Bicycle Lane with Bus Bay Marking provides an example of a buffered bicycle lane with a bus bay.

**Figure 9 – 19 Buffered Bicycle Lane with Bus Bay Marking
(Curb and Gutter)**

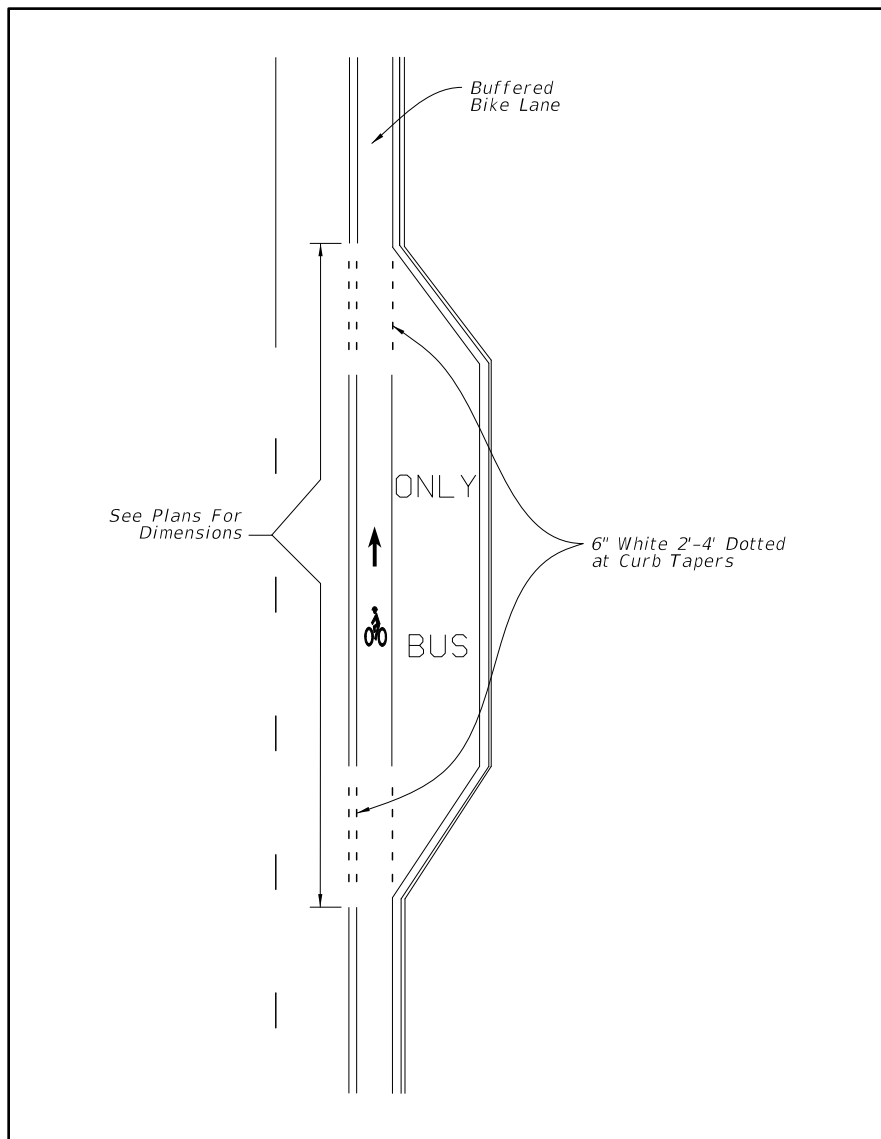

B.4 Separated Bicycle Lanes

Separated bicycle lanes use a combination of horizontal separation (buffer distance) and vertical separation (e.g., flex posts, parked cars, medians, traffic separators, or curbs) to separate people bicycling from motor vehicle traffic. The combination of lateral separation distance and vertical separation elements (such as flexible delineators, curbs or height differences, or vehicle parking) can improve the comfort level of bicycling. They may be designed to support either one-way or two-way traffic. The amount of separation tends to increase as adjacent motor vehicle traffic volumes and speed increase.

Required features of a separated bicycle lane include:

- Is a preferential use lane, signed and marked as required by the **MUTCD**. Include the bicycle lane symbol and arrow markings at the beginning of the lane and at periodic intervals.
- A horizontal separation is required, vertical elements may be added when required or desired.
- Types of vertical elements include changes in elevation, tubular markers, or similar type of lane delineator, raised medians, traffic separators, on-street parking, and rigid barriers (with appropriate end treatments). For posted speeds of 40 to 45 mph, raised medians, traffic separators or rigid barriers are required.
- The widths of separation are:
 1. A minimum of 3 feet separation is required if adjacent to on-street parking.
 2. If adjacent to travel lanes:
 - Posted speeds of 35 mph or less – a 6 feet minimum separation is preferred, 3 feet minimum (unless using tubular markers or similar type of lane delineator or raised median; then 2 feet minimum).
 - Posted speeds of 40 to 45 mph – an 8 feet minimum separation is preferred, 3 feet minimum.
- For one-way separated bicycle lanes, 7 feet is the preferred width, 6 feet is the minimum allowed. For two-way separated bicycle lanes, 12 feet is the preferred width, 10 feet is the minimum allowed.
- Separation is maintained between bicycle and motorized vehicle traffic through intersections.
- Conflict points are minimal and mitigated through pavement markings, color or

other treatment.

For additional information on planning and designing separated bike lanes, please see [FHWA's Separated Bike Lane Planning and Design Guide](#).

B.54 Green Colored Bicycle Lanes

The Federal Highway Administration (FHWA) has issued an [Interim Approval](#) for the use of green colored pavement in bicycle lanes and in extensions of bicycle lanes through intersections and other traffic conflict areas. Colored pavements shall not replace or be used in lieu of required markings for bike lanes as defined in the **MUTCD**, but shall only supplement such markings. Traffic conflict areas include where the:

- bicycle lane crosses a right turn lane,
- traffic in a right turn lane crosses a bike lane, or
- bicycle lane is adjacent to a dedicated bus bay.

The Interim Approval may be found at the following website and provides further information on how to submit a written request to use green colored pavement:

http://mutcd.fhwa.dot.gov/res-interim_approvals.htm

The effectiveness of green colored pavement ~~is~~~~may be~~ maximized if the treatment is used only where the path of bicyclists and other road users cross and yielding must occur. Because colored pavements are addressed in the 2009 MUTCD, they are ~~by definition~~ a traffic control device whose need should be demonstrated before they are used. A need for this treatment can be demonstrated by either of the following:

1. A history of 3 or more motor vehicle-bicycle crashes exists at or adjacent to the traffic conflict area over the most recent three-year period, or
2. A government agency has observed and documented conflicts (failure of the motor vehicle to yield to the bicyclist) between cyclists and motor vehicles at an average rate of two per peak hour. The documentation for conflicts shall include observations from a minimum of two separate data collection periods, conducted on different days in a one month period, and include at least one weekday and one weekend count period during peak bicycle travel times. Each period should be at least 2 hours in duration. Peak times vary by region and surrounding land use, but are typically:

- Weekday, 11:00 AM to 1:00 PM
- Weekday, 5:00 PM to 7:00 PM
- Saturday, 8:00 AM to 2:00 PM

When used in conjunction with white skip lines, such as when extending a bike lane across a right turn lane or access to a bus bay, the transverse colored marking shall match the 2'-4' white skip line pattern of the bike lane extension. The green colored pavement should begin as a solid pattern 50 feet in advance of the skip striping, match the 2' 4' skip through the conflict area, and then resume the solid color for 50' after the conflict area, unless such an extent is interrupted by a stop bar or an intersection curb radius. Details of each installation and associated pavement markings shall be shown in the plans. Figures 9 – 20, 21, 22 and 23 illustrate how the green portion of the bicycle lane may be marked.

Materials permitted to color the bike lane green shall be non-reflective and fall within the color parameters defined by FHWA in their interim approval. Materials which have been tested to meet these requirements can be found in the FDOT's [FDOT's Product Application and Tracking System \(PATH\)](#) which includes products on both the FDOT's [FDOT's Approved Product List \(APL\), Specification 523, Patterned Pavement](#) or the FDOT's [FDOT's Innovative Products List \(IPL\), Dev-714 Green-Colored Pavement Markings](#).

Figure 9 – 20 Green Bicycle Lane with Separate Right Turn Lane

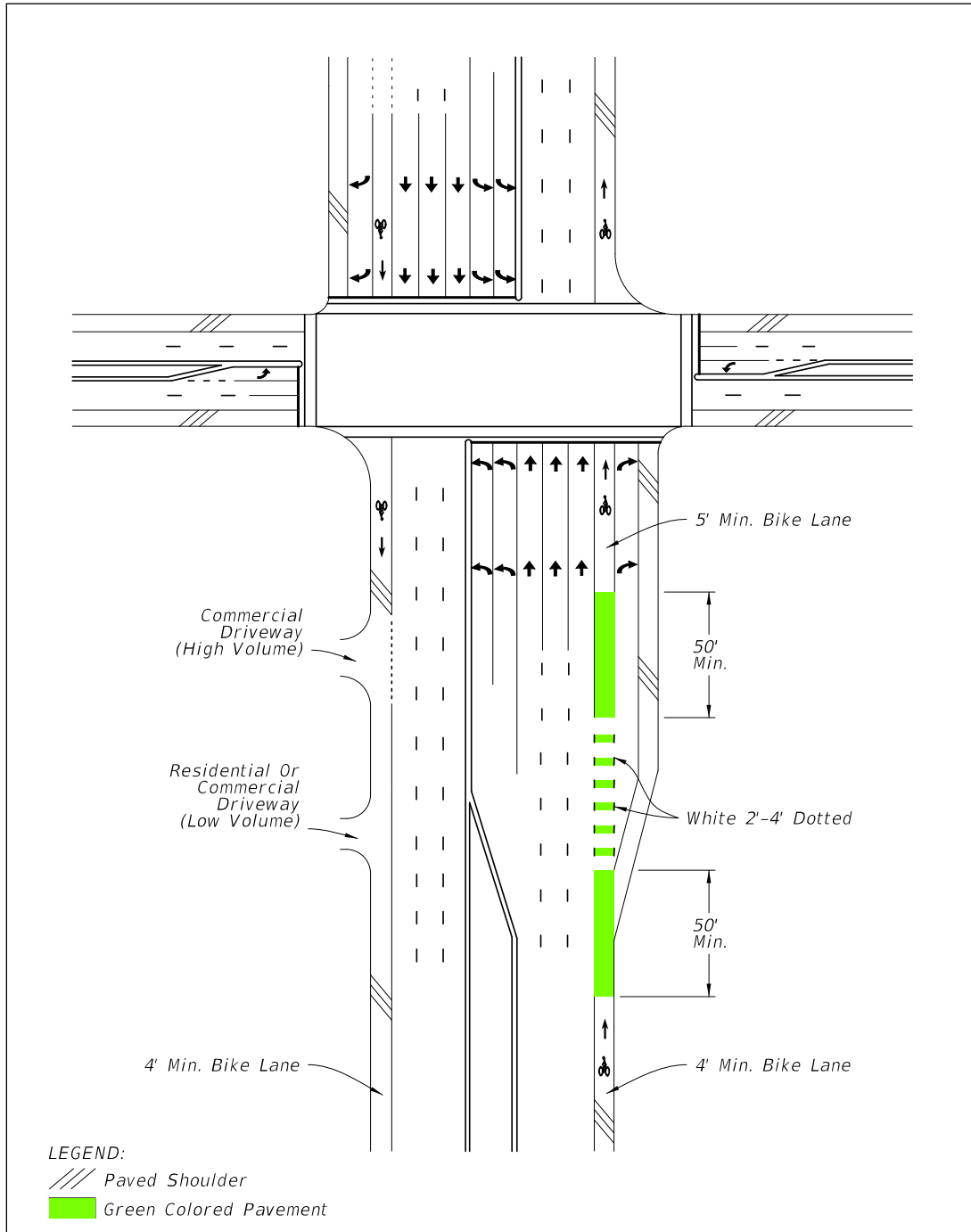

Figure 9 – 21 Green Bicycle Lane with Right Turn Drop Lane

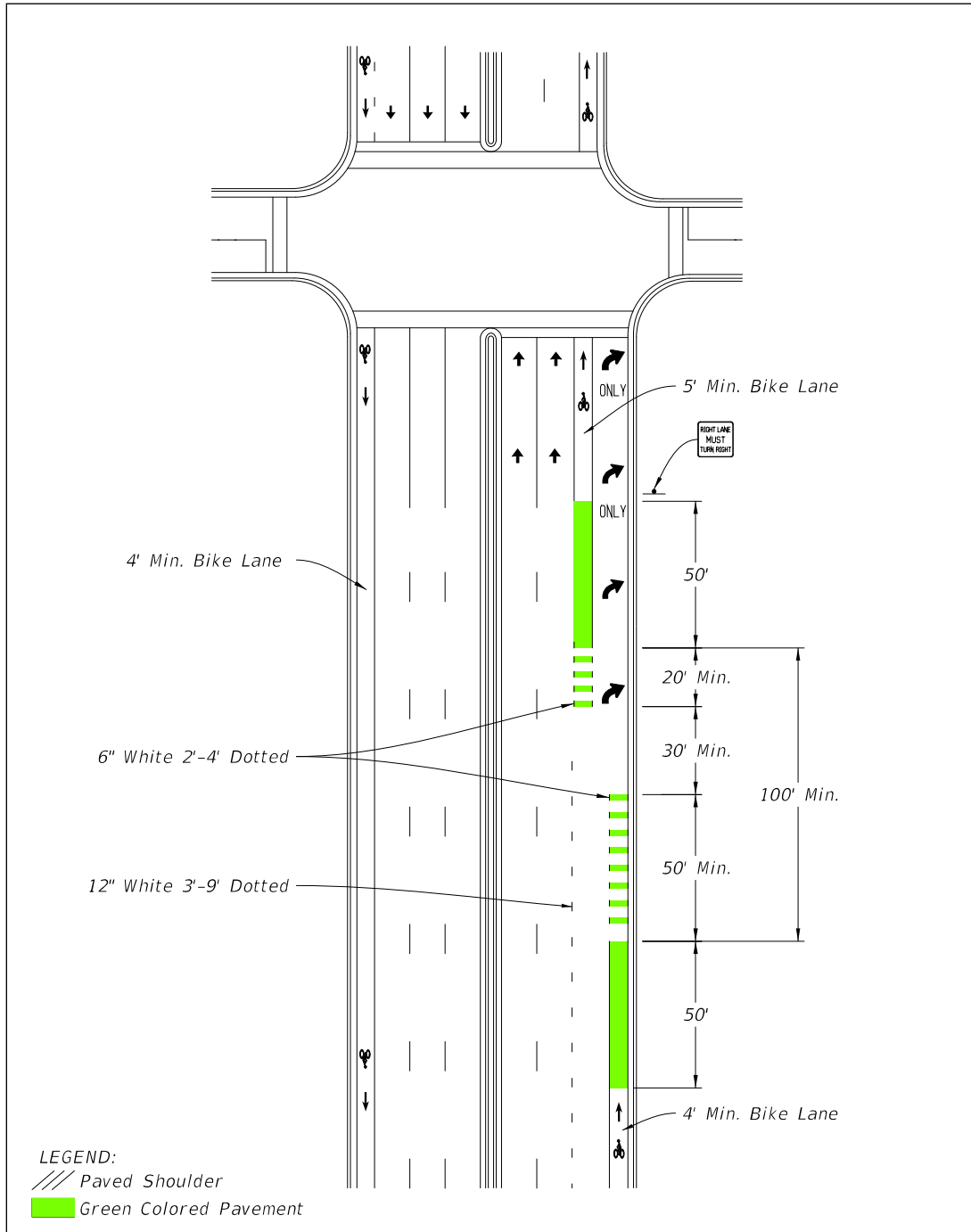

Figure 9 – 22 Green Bicycle Lane with Channelized Right Turn Lane

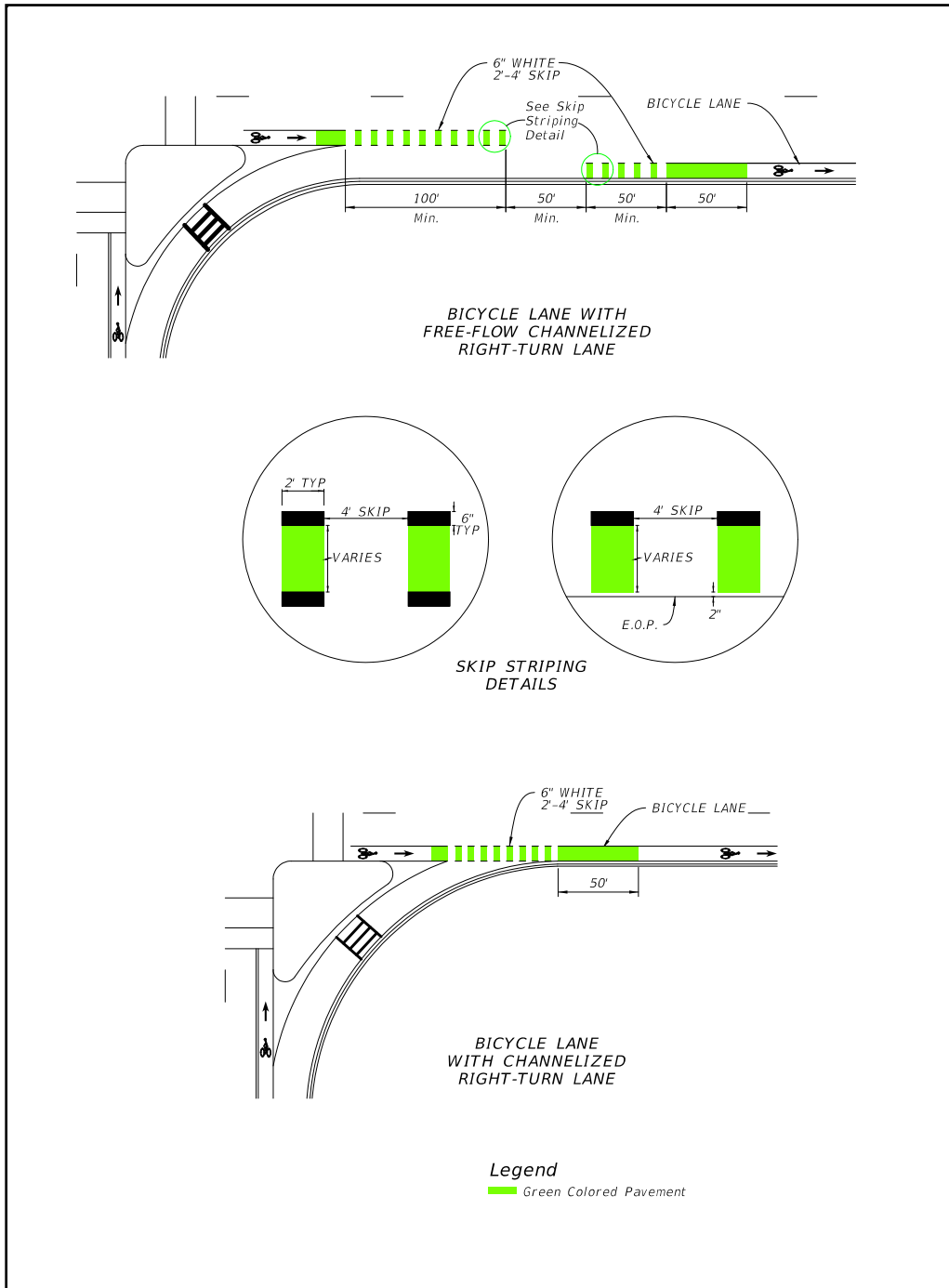
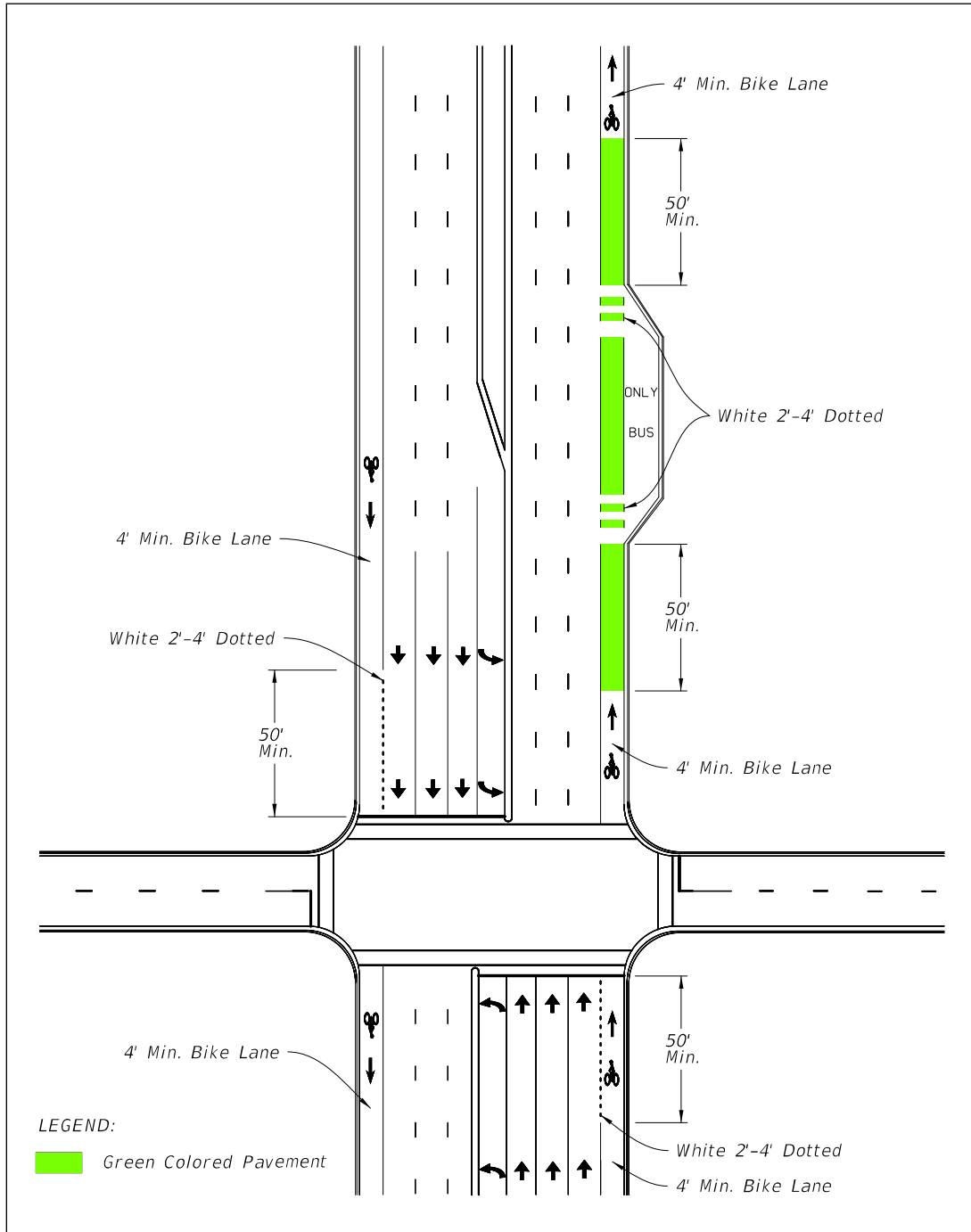

Figure 9 – 23 Green Bicycle Lane with Bus Bay



B.65 Paved Shoulders

A paved shoulder is a portion of the roadway which has been delineated by edge line striping. Adding, widening or improving paved shoulders often can be an acceptable way to accommodate bicyclists. However, when a shoulder is intended to serve as a bicycle facility and is adjacent to a curb, guardrail or other roadside barrier, a minimum 5-foot clear width between the traveled way and the face of the barrier is required. Additional shoulder width is desirable if the posted speed exceed 50 mph, or the percentage of trucks, buses, or recreational vehicles is high (>10%).

Ground-in rumble strips should not be included in paved shoulders if a minimum clear width of 4 feet outside of the rumble strip cannot be provided.

B.76 Wide Outside Lanes

Wide outside lanes on curbed roadways are through lanes that provide a minimum of 14 feet in width, which allows most motor vehicles to pass cyclists safely within the travel lane. Bicycle lanes are preferred for arterial and collector roadways, however, in some conditions, such as resurfacing projects, wide outside lanes may be the only practical option for a bicycle facility.

B.87 Shared Lane Markings

The shared lane marking is an optional pavement marking for roadways where bicyclists and motor vehicles are intended to share the lane and no bicycle lane or paved shoulder exists or is feasible. Shared lane markings should be limited to roadways with a posted speed of 35 mph or less. They are not intended to be placed on every roadway without bicycle facilities or on shared use paths.

Shared lane markings provide guidance to cyclists on their lateral positioning, especially on roadways with on-street parking or lanes that are too narrow to share side by side with a motor vehicle. They also help to discourage wrong way riding and encourage safer passing of bicyclists by motorists. Shared lane markings may be used to identify an alternate route as part of an approved temporary traffic control plan. Figure 9 – 24 provides the dimensions for shared lane markings.

Shared lane markings should be placed as follows:

Figure 9 – 24 Shared Lane Marking

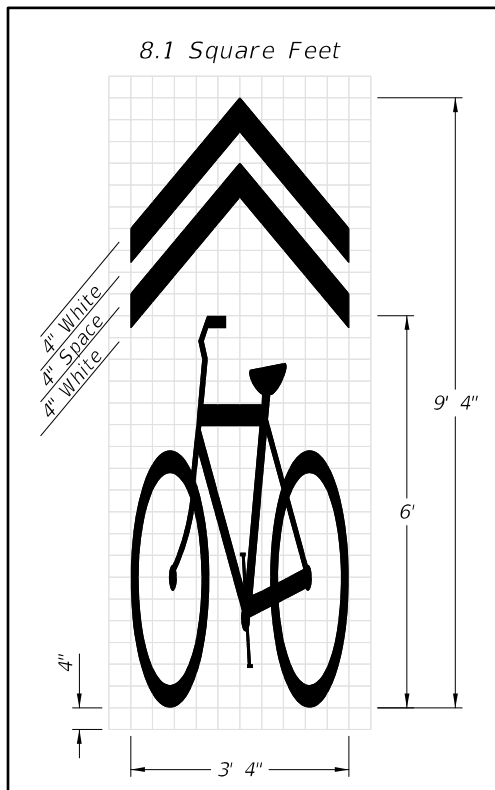

- If used on a roadway without on-street parking that has an outside travel lane that is 14 feet wide or less, the Shared Lane Markings should be centered in the travel lane (Figure 9 – 25).
- If used on a roadway with on-street parking, the Shared Lane Markings should be centered in the travel lane (Figure 9 – 26).
- Shared Lane Markings should be placed immediately after an intersection and spaced at intervals not greater than 250 feet thereafter.

**Figure 9 – 25 Shared Lane Marking Placement
(No Designated Parking, Lane Width \leq 14 Feet)**

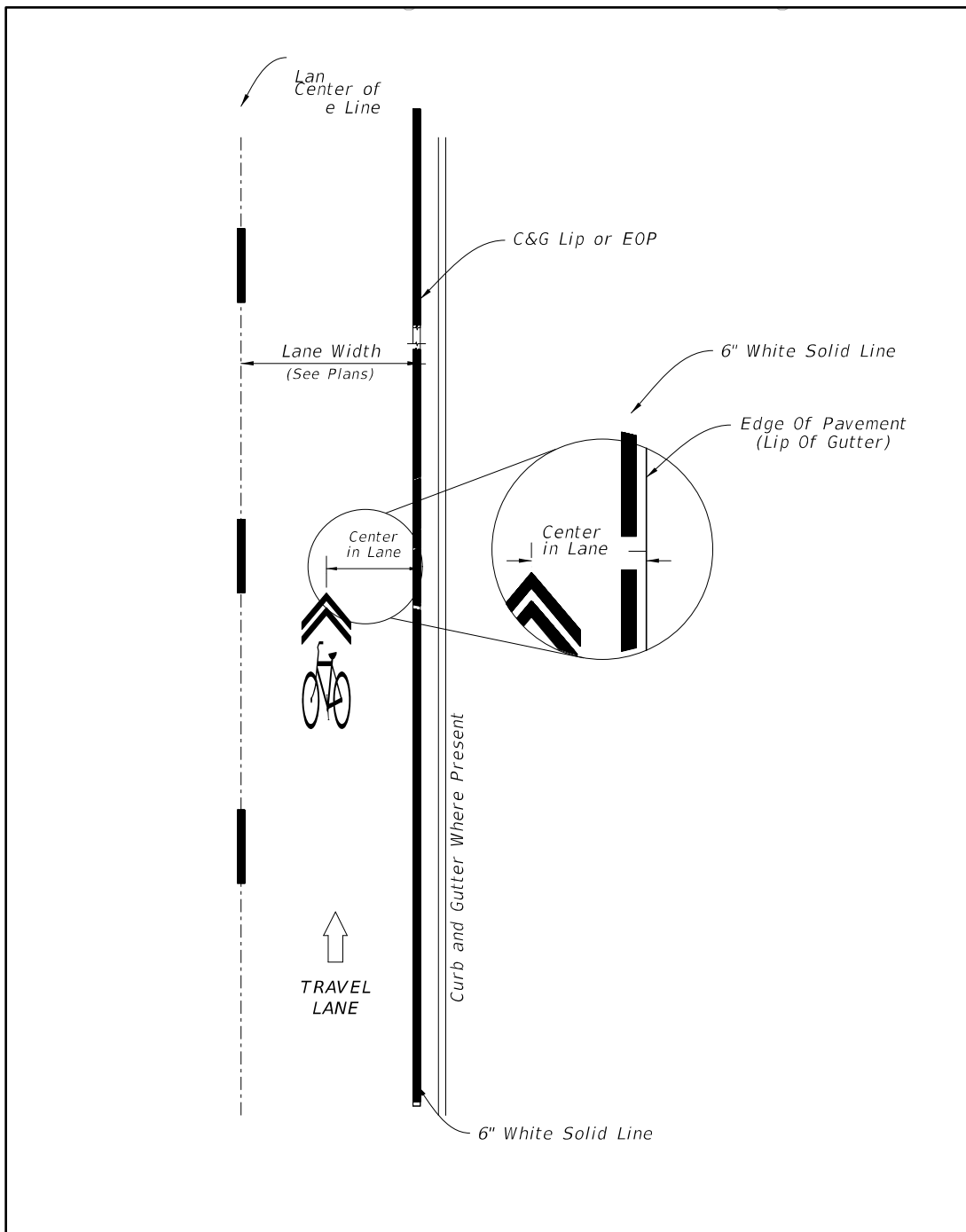

**Figure 9 – 26 Shared Lane Marking Placement
(With On-Street Parking)**

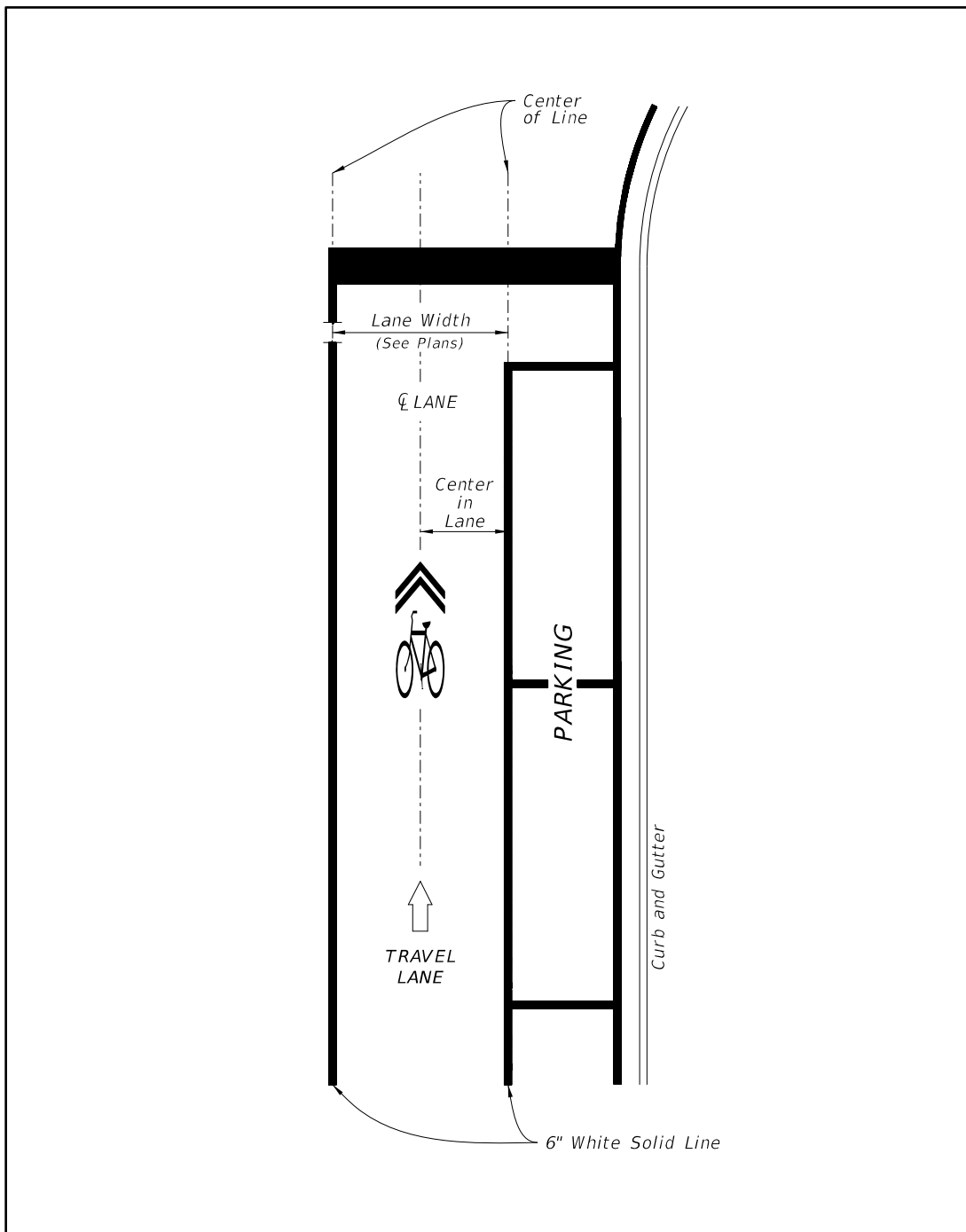

B.98 Bicycles May Use Full Lane Sign

The Bicycle May Use Full Lane sign (R4-11) may be used on roadways where no bicycle lanes or adjacent shoulders useable by bicyclists are present and where travel lanes are less than 14' wide. The **MUTCD** provides additional information on the use of the sign.

C SHARED USE PATHS

Shared use paths are paved facilities physically separated from motorized vehicular traffic by an open space or barrier and either within the highway right of way or an independent right of way, with minimal cross flow by motor vehicles. They are used by bicyclists, pedestrians, runners, skaters, and in some cases equestrians. The bicycle's operating characteristics will govern the design of shared use paths, along with requirements for accessibility since they also serve as pedestrian facilities.

In addition to the design criteria provided in this manual, the following documents provide criteria and guidance in the design of shared use paths:

- United States Department of Transportation ADA Standards for Transportation Facilities (2006) and as required by 49 C.F.R 37.41 or 37.43.
- United States Department of Justice ADA Standards (2010) as required by 28 C.F.R 35 (title II) and 36 (title III).
- Public Rights-of-Way Accessibility Guidelines (PROWAG) provides additional information for the design of pedestrian facilities.

The 2020 Florida Building Code, Accessibility, 7th Edition as required by 61G20-4.002 contains ADA requirements for accessibility to sites, facilities, buildings, and elements by people with disabilities.

~~The 2006 Americans with Disabilities Act—Standards for Transportation Facilities and the 202012 Florida Building Code, Accessibility Code (7th Edition) impose additional requirements for the design and construction of shared use paths since they serve as pedestrian facilities.~~

Shared use paths serve a variety of purposes. They can provide a school age child, a recreational cyclist, or a person with a disability an alternative to busy roadways. Shared use paths can be located along former rail corridors, the banks of rivers or canals, and through parks and forests. Shared use paths can also provide access to areas otherwise served only by limited access highways. For transportation purposes, they should be thought of as an extension of the roadway network for non-motorized users. The inclusion of a shared use path should not be considered as an alternative to providing on-street facilities, but, rather, as a supplement.

For additional information on shared use path design, refer to the [*AASHTO Guide for the Development of Bicycle Facilities \(2012, 4th Edition\)*](#).

C.1 Width and Clearance

The useable width and horizontal clearance for a shared use path are primary design considerations. The minimum paved width for a two-way path is 10 feet. Typically, widths range from 10 to 14 feet, with the wider values applicable to areas with high use or a wider variety of users, on steep grades, through curves, or used by larger maintenance vehicles.

In very rare circumstances, a reduced width of 8 feet may be used where the following conditions prevail:

- Bicycle traffic is expected to be low, even on peak days or during peak hours.
- Pedestrian use of the facility is not expected to be more than occasional.
- Horizontal and vertical alignments provide frequent, well-designed passing and resting opportunities.
- The path will not be regularly subjected to maintenance vehicle loading conditions that would cause pavement edge damage.

In addition, a path width of 8 feet may be used for a short distance due to a physical constraint such as an environmental feature, bridge abutment, utility structure, or fence.

A minimum 2 foot wide graded, [clear](#) area with a maximum 1:6 slope shall ~~be~~ be maintained adjacent to both sides of the path; however, 3 feet or more is desirable to provide clearance from trees, poles, walls, fences, guardrails, or other lateral obstructions. See Chapter 8, Section D Barrier Separation and Chapter 4 – [Roadside Design](#), Figure 4 – 8 Location of Guardrail for information on when and how longitudinal barriers should be utilized,

Where the path is adjacent to canals, ditches, or slopes steeper than 1:3, a wider separation should be considered. A minimum 5 foot separation from the edge of the path pavement to the top of the slope is desirable. Depending on the height of embankment and condition at the bottom, a physical barrier, such as a railing or chain link fence may need to be provided.

Where ~~the a clear~~~~recovery~~ area adjacent to the shared use path is less than 5 feet wide, physical barriers or rails are recommended in the following situations:

- Slopes 1:3 or steeper, with a drop of 6 feet or greater.
- Slopes 1:3 or steeper, adjacent to a parallel body of water or other substantial obstacle
- Slopes 1:2 or steeper, with a drop of 4 feet or greater; and
- Slopes 1:1 or steeper, with a drop of 1 foot or greater.

The [AASHTO Guide for the Development of Bicycle Facilities \(2012, 4th Edition\)](#) provides additional information on the design of barriers or railings.

The desirable vertical clearance to obstructions is 10 feet. Fixed objects should not be permitted to protrude within the vertical or horizontal clearance of a shared use path. The recommended minimum vertical clearance that can be used in constrained areas is 8 feet. In some situations, vertical clearance greater than 10 feet may be needed to permit passage of maintenance and emergency vehicles.

C.2 Separation Between Shared Use Paths and Roadways

When shared use paths are located adjacent to a roadway, a separation shall be provided. This demonstrates to both path users and motorists that the shared use path is a separate facility.

The minimum distance between a path and ~~roadway~~ ~~the face of curb or edge of traveled way (where there is no curb)~~ shall ~~be~~ be 5 feet. On roadways with curb, the distance is measured from the face of curb to the nearest edge of the path. On roadways with flush shoulders, this separation is measured from the:

- Paved shoulder - outside edge of the paved shoulder to the inside edge of the path
- Unpaved shoulders - outside edge of the traveled way to the inside edge of the path
- Where the separation is less than 5 feet, a physical barrier or railing should be provided between the path and the roadway.

A barrier or railing between the path and adjacent highway should not impair sight distance at intersections, and should be designed to limit the potential for injury to

errant motorists or bicyclists. The barrier or railing need not be of size and strength to redirect errant motorists toward the roadway, unless other conditions indicate the need for a crashworthy barrier.

Barriers or railings at the outside of a structure or steep fill embankment that not only define the edge of the path but also prevent bicyclists from falling over the rail to a substantially lower elevation should be a minimum of 42" high. Barriers at other locations that serve only to separate the area for motor vehicles from the path should generally have a minimum height equivalent to the height of a standard guard rail.

When a path is placed along a high-speed highway, a separation greater than 5 feet is desirable.

C.3 Design Speed

For paths in relatively flat areas (grades less than or equal to 4%), a design speed of 18 mph shall be used. When a sustained downgrade greater than 4% exists, refer to the [*AASHTO Guide for the Development of Bicycle Facilities \(2012, 4th Edition\)*](#) for further guidance,

C.4 Horizontal Alignment

The typical adult bicyclist is the design user for horizontal alignment. Please refer to the *AASHTO Guide for the Development of Bicycle Facilities (2012, 4th Edition)* for further information on determining the minimum radius of curves on shared use paths.

Shared use paths should be transitioned as necessary towards the roadway at intersections to provide a more functional crossing location that also meets driver expectation.

C.5 Accessibility

Since nearly all shared use paths are intended to be used by pedestrians, they fall under the accessibility requirements of the Americans with Disabilities Act.

Where a shared use path is contained within a street or highway right of way, the grade of the shared use path shall not exceed the general grade established for the adjacent street or highway. Where a shared use path is not contained within a street or highway right of way, the grade of the shared use path shall be 5 percent

maximum.

Where compliance with the maximum grade requirements for shared use paths is not practicable due to existing terrain or infrastructure, right-of-way availability, a notable natural feature, or similar existing physical constraints, compliance is required to the extent practicable.

The cross slope of a shared use path shall be 2% maximum.

Pull boxes, manholes (and other utility covers), and other types of existing surface features in the location of a proposed curb ramp or detectable warning should be relocated when feasible. When relocation is not feasible, the feature shall be adjusted to meet the ADA requirements for surfaces (including the provision of a nonslip top surface, and adjustment to be flush with and at the same slope as the adjacent surface).

The detectable warning systems are designed to work with concrete surfaces. In areas where the path has an asphalt surface, the engineer must specify an appropriate detectable warning system. In these cases, consider including a short section of concrete that will accommodate any system.

If curb ramps or blended transitions are included in the path design, they ~~shall~~should be parallel to and the full width of the approaching path width. Shared use path crossings shall meet the same grade and cross slope requirements as sidewalks where the grade should not exceed 5%, and the maximum cross slope shall be no more than 2%.

Project design shall include an evaluation of existing driveways to determine if it is feasible to upgrade nonconforming driveway turnouts to meet maximum cross slope criteria. Nonconforming driveways are not required to be upgraded if it is not feasible within the scope of the project.

Chapter 8 – Pedestrian Facilities provides additional information regarding accessible design of shared use paths.

C.6 Shared Use Path – Roadway Intersections

Shared use path crossings fall into three basic categories:

- Grade Separated Crossings – Crossings consisting of either a bridge over the roadway or an underpass beneath the roadway.
- Sidepath/Intersection Crossings – Crossings that are located within the functional area of an intersection of two or more roadways and the path is running parallel with the roadway. Sidepath crossings are typically parallel to one of the intersecting roadways. See Figure 9 – 27 Mid-Block and Sidepath Crossings Relative to Intersection Functional Area.
- Midblock Crossings – Crossings that are located outside the functional area of an intersection. See Figure 9 – 27 Mid-Block and Sidepath Crossings Relative to Intersection Functional Area

Figure 9 – 27 Mid-Block and Sidepath Crossings Relative to Intersection Functional Area

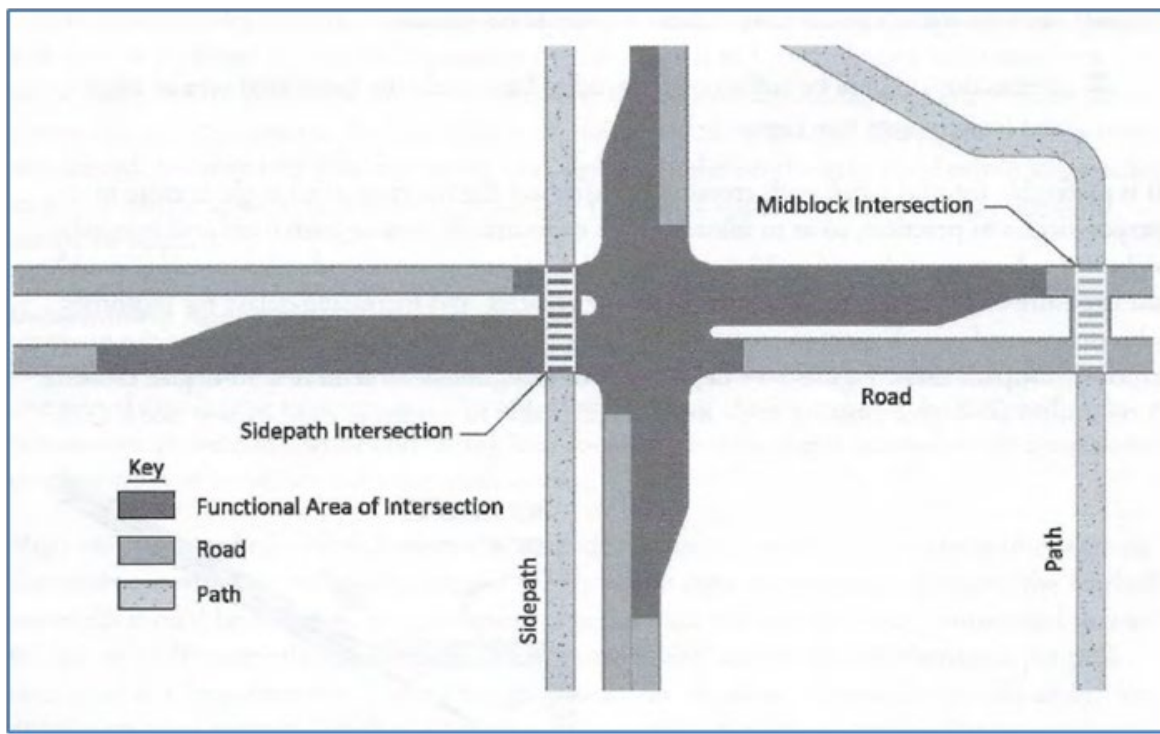

Source: [2012 AASHTO Guide to Bicycle Facilities](#)

C.6.a Grade Separated Crossings

Grade separated crossings involve considerable expense but may be

warranted in certain locations. The need for a grade separated crossing should be based on an engineering analysis to assess existing and future path user characteristics and volume, motor vehicle traffic volume and speed, opportunity for improved at-grade crossings in close proximity, feasibility of accessible design, consistency with existing and future surrounding land use and activities, and long term maintenance costs and responsibility. For further information on conducting such an analysis, see the [AASHTO Guide to Bicycle Facilities, 4th Edition Section 5.2.10](#) and the discussion of grade-separated crossings in the [AASHTO Guide for the Planning, Design, and Operation of Pedestrian Facilities](#).

C.6.b Sidepath Crossings

Sidepath crossings have unique operational and design challenges. One key factor that must be addressed is intersection sight distance. Given their proximity to motor vehicle intersections, sidepath intersection sight distance requirements must consider both what is needed for the drivers of motor vehicles crossing in each direction as well as bicyclists and pedestrians.

In cases where a shared use path is located parallel to and within the roadway corridor, the traffic control on the sidepath shall be consistent with that on the parallel roadway. The path shall be aligned to allow the placement of the stop bar on side streets a minimum of 4 feet in advance of the crosswalk, and crosswalks shall be marked. The crosswalk width shall be equal to or greater than the approach width of the path.

Where a shared use path is located parallel to a high speed roadway and crossing an access or exit ramp or lane, moving the crossing away from the intersection to a midblock location may be considered. This allows for motorists to first enter or exit the high speed roadway and then turn attention to the pathway crossing. When this is done, care should be taken to insure the midblock location is clearly outside the functional area of the intersection and designed accordingly.

See the [AASHTO Guide to Bicycle Facilities, 4th Edition, Sections 5.2.2 and 5.3.4](#) which covers these operational issues in detail and provides several factors to be considered for proper design for further information.

C.6.c Midblock Shared Use Path Crossings

The design of a midblock shared use path crossing is similar in many ways to designing a multi-leg intersection. As with sidepath crossings, a key design element is intersection sight distance. The basic criteria for establishing intersection sight distance for shared use path crossings is based on the same methodology presented in the **AASHTO Greenbook** for conventional intersections but with adjustments to account for the design vehicle and design speed of the shared use path. As with conventional intersections, the dimensions of the clear sight triangle are dependent on the type of traffic control.

The **AASHTO Guide to Bicycle Facilities, 4th Edition Section 5.3.2** provides additional information on the details and methodology for the proper design of midblock crossings including several examples.

C.6.c.1 Intersections with Yield Control

The **AASHTO Guide to Bicycle Facilities** indicates that it is preferable to provide shared use path intersection sight distance based on yield control for all midblock crossings. See Figure 9 – 28 Yield Sight Triangles and Table 9 – 2 Formulas for Lengths of Roadway and Path Legs – Yield Condition and the formulas to compute the lengths of the roadway leg (a) and path leg (b) for yield control. Table 9 – 3 Intersection Sight Distance Calculated Lengths of Roadway and Path Lengths provides calculated sight distance values based on Figure 9 – 28 and Table 9 – 2 for a range of roadway design speeds and a shared use path design speed of 18 mph.

Figure 9 – 28 Yield Sight Triangles

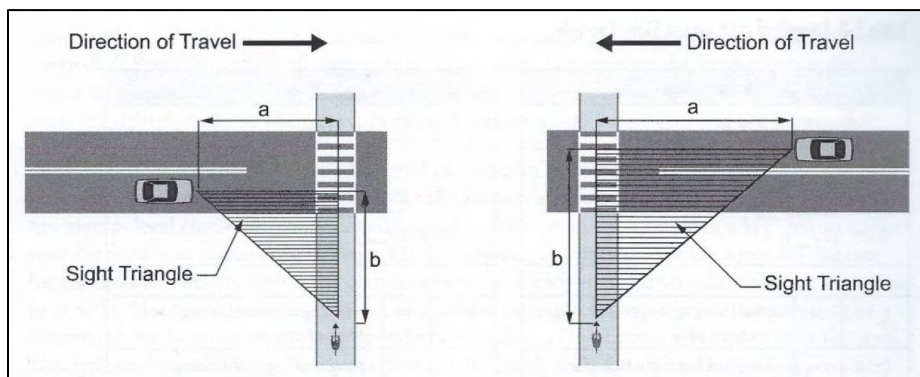

Table 9 – 2 Formulas for Lengths of Roadway and Path Legs – Yield Condition

<u>Length of Roadway Leg (a)</u>	<u>Length of Path Leg (b)</u>
$t_a = \frac{S}{1.47 V_{\text{path}}}$ $t_g = t_a + \frac{w + L_a}{1.47 V_{\text{path}}}$ $a = 1.47 V_{\text{road}} t_g$	$t_a = \frac{1.47 V_e - 1.47 V_b}{a_i}$ $t_g = t_a + \frac{w + L_a}{0.88 V_{\text{road}}}$ $b = 1.47 V_{\text{path}} t_g$
<u>t_g</u> ≡ Travel time to reach and clear the path (s)	<u>t_g</u> ≡ Travel time to reach and clear the path (s)
<u>a</u> ≡ length of leg sight triangle along the path approach (ft)	<u>b</u> ≡ Length of leg sight triangle along the path approach (ft)
<u>t_a</u> ≡ Travel time to reach the road from the decision point for a path user that does not stop (s)	<u>t_a</u> ≡ Travel time to reach the path from the decision point for a motorist that does not stop (s).
<u>w</u> ≡ Width of the intersection to be crossed (ft)	<u>V_e</u> ≡ Speed at which the motorist would enter the intersection after deceleration (mph) (assumed 0.60 x road design speed)
<u>L_a</u> ≡ Typical bicycle length = 6 ft (see AASHTO Guide for other design users)	<u>V_b</u> ≡ Speed of which braking by the motorist begins (mph) (same as road design speed)
<u>V_{path}</u> ≡ Design speed of the path (mph)	<u>a_i</u> ≡ Motorist deceleration rate (ft/s ²) on intersection approach when braking to a stop not initiated (assume 5.0 ft/s ²)
<u>V_{road}</u> ≡ Design speed of the road (mph)	<u>w</u> ≡ Width of intersection to be crossed.
<u>S</u> ≡ Stopping sight distance for the path user traveling at design speed.	<u>L_a</u> ≡ Length of the design vehicle (ft)
	<u>V_{path}</u> ≡ Design speed of the path
	<u>V_{road}</u> ≡ Design speed of the road (mph)

**Table 9 – 3 Intersection Sight Distance
 Calculated Lengths of Roadway and Path Lengths**

<u>Roadway Design Speed (mph)</u>	<u>Length of Roadway Leg a (feet)</u>		<u>Length of Path Leg b (feet)</u>
	<u>Length for Crossing 2 Roadway Traffic Lanes</u>	<u>Additional Length for each Additional Traffic Lane Crossed</u>	
<u>20</u>	<u>182</u>	<u>13</u>	<u>109</u>
<u>25</u>	<u>228</u>	<u>17</u>	<u>115</u>
<u>30</u>	<u>273</u>	<u>20</u>	<u>124</u>
<u>35</u>	<u>319</u>	<u>23</u>	<u>136</u>
<u>40</u>	<u>364</u>	<u>27</u>	<u>148</u>
<u>45</u>	<u>410</u>	<u>30</u>	<u>161</u>
<u>50</u>	<u>456</u>	<u>33</u>	<u>174</u>
<u>55</u>	<u>501</u>	<u>37</u>	<u>188</u>
<u>60</u>	<u>547</u>	<u>40</u>	<u>202</u>

Notes:

1. Above lengths a and b based on:

- Design Speed of Path = 18 mph
- Stopping Sight Distance for path user = 134 feet
- Shared Use Path Width at Roadway Crossing = 12 feet
- Path Design Vehicle Length = 6 feet (bicycle)
- Road Width = 2 traffic lanes @ 12 feet each = 24 feet
- Roadway Design Vehicle Length = 19 feet (passenger vehicle)
- Roadway Approach Grade ≤ 3.0%
- Path Approach Grade = 0.0%

For other design conditions see AASHTO Guide to Bicycle Facilities.

2. The line of sight is measured 2.7 feet above the surface of the path and roadway.

C.6.c.2 Intersections with Signal Control or Stop Control

Where intersection sight distance based on yield control cannot be provided, signal control or stop control should be considered. For midblock crossings with signal control or stop control on either the roadway or the path, the roadway and path approaches shall provide the minimum stopping sight distance to obey the control and execute a stop before entering the intersection. An unobstructed view of a path user located at the stopped position on the path should be visible to the motorist and vice versa. The [AASHTO Guide for the Development of Bicycle Facilities](#) provides additional details for the proper design of signal control and stop control intersections.

C.7.6 Structures

The minimum clear width on structures ~~shall~~should be the same as the approach ~~width of the~~ shared use path, plus ~~a~~the minimum 2 foot wide clear area on each side should be provided.~~s.~~ Access by emergency, patrol and maintenance vehicles should be considered in establishing the design clearances of structures on shared use paths. Where practical, a path vertical clearance of 10 feet (on the structure) is desirable for adequate vertical shy distance.

Where compliance with the requirement for a maximum running slope of 5% is not practicable due to existing terrain or infrastructure, right-of-way availability, a notable natural feature, or similar existing physical constraints, compliance is required to the extent practicable.

Ramps on new structures that are part of a shared use path and serve as the accessible route shall have a running slope between 5% minimum and 8.3% maximum. The cross slope of ramp runs shall be 2% maximum.~~not steeper than 1:12 and cross slope not steeper than 1:48.~~ Landings are required at the top and the bottom of each ramp run.

C.8.7 Pavement Markings and Signage

The MUTCD regulates the design and use of all traffic control devices on shared use paths. Figure 9 – ~~29~~7 Sign Placement on Shared Use Paths provides the minimum criteria for the placement of signs along or over a shared use path. The maximum height from the outside edge of the path to the bottom elevation of a sign is five feet. Signs on shared use paths should follow the dimensions provided

in **Table 9B-1 Bicycle Sign and Plaque Sizes, MUTCD**. Guidance on the placement of stop or yield lines and crosswalks on roadways intersecting with shared use paths is provided in the [MUTCD, Part 3](#).

Figure 9 – 297 Sign Placement on Shared Use Paths

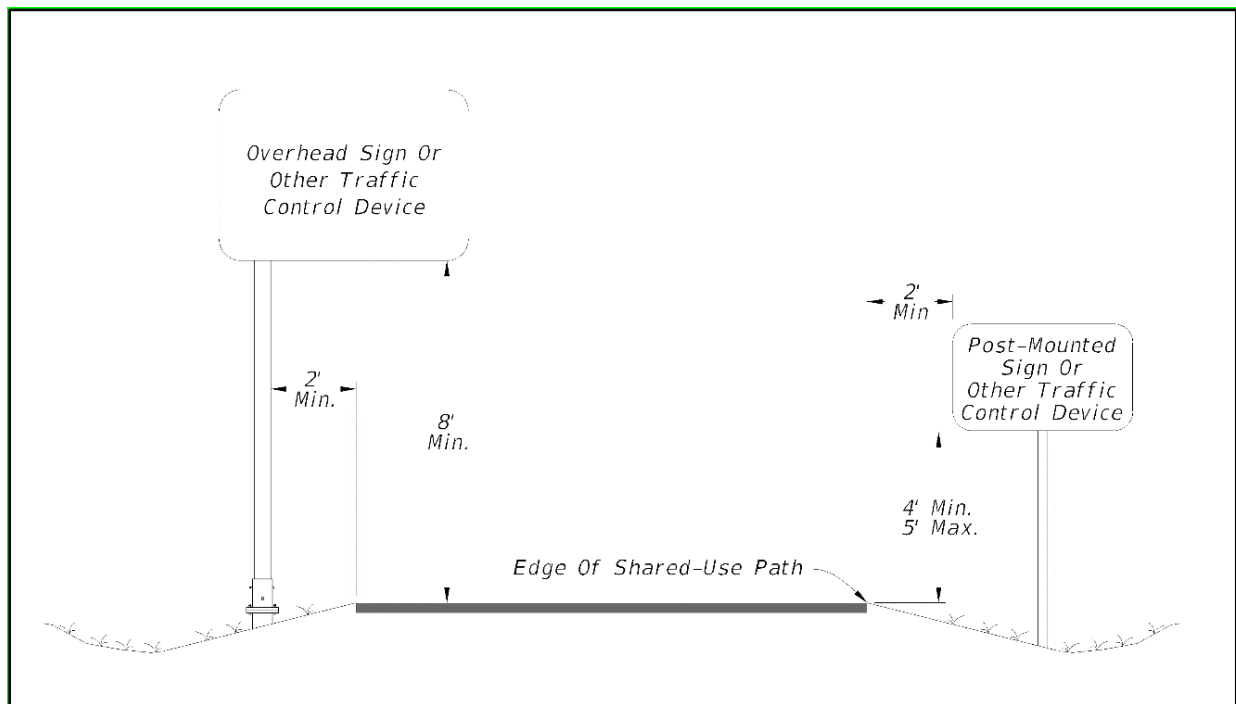

D RAILROAD CROSSINGS

Railroad-highway grade crossings should ideally be at a right angle to the rails. This can be accomplished either as a separate path or a widened shoulder. The greater the crossing deviated from this ideal crossing angle, the greater is the potential for a bicyclist's front wheel to be trapped in the flangeway, causing loss of steering control. If the crossing angle is less than approximately 45 degrees, an additional paved shoulder of sufficient width should be provided to permit the bicyclist to cross the track at a safer angle, preferable perpendicularly. Where this is not possible, and where train speeds are low, commercially available compressible flangeway fillers may enhance bicyclist operation. It is also important that the roadway approach be at the same elevation as the rails. For more information, see Figure 4 – 28 Correction for Skewed Railroad Grade Crossing – Separate Pathway in the [AASHTO Guide for the Development of Bicycle Facilities](#).

E STRUCTURES

All new bridges over roadways and shared use paths shall be designed to meet the vertical clearance standards specified in **Chapter 3, Section C.7.j.4.(b)**, and **Chapter 17, Section C.3.b**.

All bridges that include provisions for pedestrians shall provide pedestrian accommodations and design considerations that meet the provisions of the ADA.

Bridges over roadways should be covered or screened to reduce the likelihood of objects being dropped or thrown below. If the bridge is enclosed, the visual tunnel effect may require widening the bridge to provide a feeling of security for all bridge users. The area adjacent to overpasses may be fenced to prevent unsafe crossings and to channel pedestrians to the vertical separation structure.

F REFERENCES FOR INFORMATIONAL PURPOSES

- USDOT/FHWA ADA Standards for Accessible Design (ADAAG)
<http://www.access-board.gov/guidelines-and-standards/buildings-and-sites/about-the-ada-standards/ada-standards><https://www.fhwa.dot.gov/programadmin/pedestrians.cfm>
- AASHTO – Guide for the Development of Bicycle Facilities, 2012, 4th Edition
<https://bookstore.transportation.org/><https://store.transportation.org/Common/DownloadContentFiles?id=1096>
- NACTO Urban Streets Design Guide
<http://nacto.org/usdg>
- FHWA Policy Memo for Flexibility in Pedestrian and Bicycle Facility Design
https://www.fhwa.dot.gov/environment/bicycle_pedestrian/guidance/http://www.fhwa.dot.gov/environment/bicycle_pedestrian/guidance/design_guidance/design_flexibility.cfm
- ~~Storm Drain Handbook~~[Drainage Handbooks](#), Florida Department of Transportation, October 2014
<https://www.fdot.gov/roadway/drainage/manualsandhandbooks.shtm><http://www.dot.state.fl.us/rddesign/Drainage/files/StormDrainHB.pdf>
- ~~Manual on~~
- ~~Manual on~~ Uniform Traffic Control Devices, May 2012
http://mutcd.fhwa.dot.gov/pdfs/2009r1r2/pdf_index.htm
- ~~NACTO, Urban Bikeway Design Guide~~
<https://nacto.org/publication/urban-bikeway-design-guide/cycle-tracks/>

THIS PAGE INTENTIONALLY LEFT BLANK

CHAPTER 10

MAINTENANCE AND RESURFACING

A	INTRODUCTION	10-1
B	MAINTENANCE	10-1
B.1	Objectives	10-1
B.2	Policy	10-1
B.3	Identification of Needs.....	10-2
B.3.a	Inspection.....	10-2
B.3.b	Crash Records.....	10-2
B.4	Establishment of Priorities.....	10-3
B.5	Establishment of Procedures	10-3
B.5.a	Emergency Maintenance	10-3
B.5.b	Routine Maintenance	10-4
B.5.c	Special Maintenance.....	10-5
B.5.d	Pavement Maintenance	10-5
C	RESURFACING	10-7
C.1	Accessibility Requirements	10-7
C.2	Railroad-Highway Grade Crossing Near or Within Project Limits	10-8
C.3	Safety Improvements	10-8
C.3.a	Pavement Safety Edge	10-8
C.4	Federal Aid Project Requirements	10-11
D	REFERENCES FOR INFORMATIONAL PURPOSES	10-13

FIGURES

Figure 10 – 1	Two Lane Road with Safety Edge	10-9
Figure 10 – 2	Safety Edge Detail (No Paved Shoulders)	10-11

THIS PAGE INTENTIONALLY LEFT BLANK

CHAPTER 10

MAINTENANCE AND RESURFACING

A INTRODUCTION

In order to provide for the safe and efficient movement of all modes of traffic, it is essential to maintain all aspects of the road and right of way at the highest reasonable level of safety. Improvements consistent with upgrading safety standards or accommodating changes in traffic are also required to maintain the facility in a quality condition. Maintenance and resurfacing are costly operations; therefore, every effort should be made to provide the maximum safety benefit from each operation. The fact that a major portion of the maintenance effort is necessary to merely preserve the economic investment in a facility should not be considered as justification for sacrificing the requirements for maintaining or improving the safety characteristics of a street or highway.

B MAINTENANCE

B.1 Objectives

The major objectives of a maintenance program include the following:

- Maintain all highway features and components in the best possible condition.
- Improve sub-standard features, with the ultimate goal to at least meet minimum standards.
- Provide for minimum disruptions and hazards to traffic during maintenance operations.
- Location and reporting of inadequate safety features.

B.2 Policy

Each highway agency responsible for maintenance shall develop and maintain a program of highway maintenance for the entire highway network under its jurisdiction. This program should include the following activities:

- Identify needs

- Establish priorities
- Establish procedures
- Establish and maintain a regular program of maintenance for all aspects

The program should be regularly evaluated and suitably modified to promote the maintenance of streets and highways that result in the best practicable condition.

B.3 Identification of Needs

The identification of maintenance needs is the first stage in the development of a successful maintenance program, and is required when any portion of the highway system is in a sub-standard condition. Action is also required to correct any situation which is hazardous or may become hazardous in the near future. This may be accomplished by both regular inspection of the highway network and proper analysis of crash records.

B.3.a Inspection

Periodic and systematic inspection of the entire highway network under each agency's jurisdiction is required to identify situations requiring improvements, and corrections or repairs. These inspections should be conducted by maintenance or traffic operations personnel, or other qualified personnel who are trained in the aspects of highway maintenance requirements.

B.3.b Crash Records

A regular program of crash investigations, record keeping, and analysis should be established to provide information for recommended highway modification and corrective maintenance requirements. Cooperation among maintenance, traffic operations, and police agencies is required, and activities of these agencies should be coordinated in accordance with the guidelines set forth in the ***National Highway Traffic Safety Administration (NHTSA) Program Guideline No. 21 (II), Identification and Surveillance of Crash Locations***. Inspection of the highway network and analysis of crash records should be utilized to provide feedback for modification of design and construction procedures.

B.4 Establishment of Priorities

The maintenance activities determined to be necessary by the identification program should be carried out on a priority basis. The establishment of priorities should be based, to a large extent, upon the objective of promoting highway safety. A high priority should be given to the improvement or correction of situations that may result in fatal or serious crashes. Preservation of highway investment and promotion of efficient traffic operations are important maintenance objectives. Every effort should be made to ensure the highest safety payoff from the maintenance dollar.

B.5 Establishment of Procedures

Standard procedures and methods for maintenance operations should be established for efficient, rapid, and safe completion of the required work. All maintenance work shall be conducted in accordance with the Standards set forth in **Chapter 11 – Work Zone Safety**. Each maintenance agency should develop its own Maintenance Manual or utilize the Maintenance Manuals of ~~the~~ the FDOT. Such manuals should specify the methods, procedures, equipment, personnel qualifications, and other aspects of the work necessary to ensure successful completion of maintenance operations. Procedures should be developed for emergency, routine, and special operations.

B.5.a Emergency Maintenance

Emergency maintenance operations are those required to immediately restore the highway to a safe condition. Emergency maintenance work should be carried out by personnel who are specially trained and qualified. Work units, which should be available on a twenty-four hour basis, should be connected with the emergency response communications system. Emergency operations would include the following:

1. The removal of debris from crashes, cargo spillage, or other causes. This activity should be conducted in accordance with the guidelines set forth in the **NHTSA Program Guideline No. 16, Debris Hazard Control and Cleanup**.
2. Replacement of inoperative traffic control devices.
3. Repair or replacement of damaged highway safety components such as lighting, traffic control devices, redirection devices, and energy absorbing devices.

4. Repair or correction of any situation that provides an immediate or unexpected hazard to the public.
5. Assistance in any activity during emergency response operations.

B.5.b Routine Maintenance

Routine maintenance operations are those that may be predicted and planned in advance. These operations, which may be preventive or corrective in nature, should be conducted on a regularly scheduled basis using standard procedures. Proper scheduling of these operations should be utilized to provide minimum disruptions and hazards to the driving public. Routine maintenance may include operations such as:

1. Cleaning and debris removal from the pavement, shoulders, and roadside clear zones.
2. Mowing and other vegetation control operations to provide a smooth recovery area and to maintain proper sight distance.
3. Cleaning and inspection of gutters, ditches, and other drainage structures.
4. Structural inspection and preventive maintenance on bridges and other structures.
5. Cleaning, replacement, and maintenance of roadway lighting fixtures.
6. Replacement and maintenance of traffic control devices.
7. Inspection and maintenance of redirection and energy absorbing devices (**Chapter 4 – Roadside Design**).
8. Inspection and maintenance of emergency response communication systems and access facilities.
9. Inspection and maintenance of pavement and shoulders, with particular emphasis on maintaining shoulders flush with the pavement (**Chapter 5 – Pavement Design and Construction**).
10. Inspection and maintenance of all highway components and safety features.
11. Inspection and maintenance of pedestrian pavements, crossings, etc., with particular emphasis on sidewalk cracks, joint separations, accumulated debris, adjacent landscape materials, etc.).

12. Thin pavement overlay that is intended to preserve the pavement, retard its future deterioration and maintain its functional condition.

B.5.c Special Maintenance

Special maintenance operations are defined as those projects that are neither urgent nor routine in nature, but are occasionally required to improve or maintain a street or highway in a quality condition. Since these projects can be planned in advance of the initiation of any work, procedures that provide for efficient, rapid, and safe operations can be developed. To avoid continuing disruptions of traffic, the quality and durability of these improvements, corrections, and repairs should be maintained at the highest practicable level. Special maintenance should include the upgrading of the highway safety features, as well as the repair or replacement of damaged or deteriorated highway components. These operations should be designed to upgrade or maintain the street or highway in accordance with the Standards presented in this Manual.

B.5.d Pavement Maintenance

The primary purpose of pavement maintenance is to ensure the pavement characteristics prescribed in **Chapter 5 – Pavement Design And Construction**, are reasonably maintained. Each agency with responsibility for maintenance of streets and highways shall establish a meaningful pavement maintenance system (including shoulders and drainage structures) for the entire system under its jurisdiction. This program should include:

1. A process that monitors the serviceability of the existing streets and highways and identifies the pavement sections that are inadequate.
2. A systematic plan of maintenance activities designed to correct structural deficiencies and to prevent rapid deterioration.
3. A preservation program, with assigned priorities, designed to resurface, reconstruct, or replace pavements when they are no longer structurally serviceable.

Pavement maintenance requires a substantial portion of the total maintenance budget for streets and highways. It is necessary to ensure highway safety. The reduction of hydroplaning and splashing is essential for promoting safe and efficient operation during wet weather conditions. The elimination of driving discomfort, and vehicle damage caused by

deteriorated pavements, provides additional economic justification for maintaining the pavement in a fully serviceable condition.

It is recognized that a comprehensive preservation program is expensive. Adequate financing is required to successfully carry out these activities. The establishment of appropriate budget priorities and careful planning can assist in developing and conducting a pavement maintenance and preservation program that will, within a reasonable number of years, bring substandard pavements up to the required level of serviceability and will maintain the adequacy of the entire system.

C RESURFACING

In addition to the design criteria provided in this chapter, the [United States Department of Transportation ADA Standards for Transportation Facilities \(2006\)](#) as required by [49 C.F.R 37.41 or 37.43](#), [United States Department of Justice ADA Standards \(2010\)](#) as required by [28 C.F.R 35 \(title II\) and 36 \(title III\)](#), and the [2020 Florida Building Code, Accessibility, 7th Edition](#) as required by [61G20-4.002](#) contains ADA requirements for accessibility in the public right of way, for transportation facilities, and for sites, facilities, buildings, and elements by people with disabilities.

[The Public Rights-of-Way Accessibility Guidelines \(PROWAG\)](#) provides additional information for the design of pedestrian facilities.

~~as required by [49 C.F.R 37.41 or 37.43](#) and the as required by [61G20-4.002](#) impose additional requirements for the design and construction of resurfacing projects.~~

C.1 Accessibility Requirements

If new sidewalk and driveway construction or reconstruction is included on resurfacing projects they shall be designed to meet the requirements of **Section C.7.d** of **Chapter 3 – Geometric Design** and **Chapter 9 – Pedestrian Facilities**. Project design should include an evaluation of existing driveways to determine if it is feasible to upgrade nonconforming driveways.

Existing detectable warnings and curb ramps shall be brought into compliance. This includes installing new detectable warnings for both flush shoulder and curbed roadway connections and signalized driveways where none exist or do not meet current requirements. New curb ramps shall be provided on curbed roadways where none exist and existing substandard curb ramps shall be replaced. Existing ramps not meeting detectable warning requirements which otherwise comply with orientation, slope and width criteria shall be retrofitted with detectable warnings.

Where existing right of way is inadequate or conflicts occur with existing features that cannot be practicably relocated or adjusted (e.g. driveways, drainage inlets, signal poles, pull boxes, utility poles, etc.), pedestrian accessibility shall be provided to the maximum extent feasible, with appropriate documentation signed and sealed by a Professional Engineer (EOR). Other than meeting detectable warning and curb ramp requirements, existing sidewalks and driveways are not required to be upgraded for the sole purpose of meeting requirements for accessibility unless included in the project scope.

C.2 Railroad-Highway Grade Crossing Near or Within Project Limits

Federal-aid projects must be reviewed to determine if a railroad-highway grade crossing is within the limits of or near the terminus of the project. If such railroad-highway grade crossing exists, the project must be upgraded to meet the requirements of the [Manual on Uniform Traffic Control Devices \(2009 Edition with Revision Numbers 1 and 2, May 2012\) \(MUTCD\)](#) in accordance with [Title 23, United States Code \(U.S.C\), Chapter 1, Section 109\(e\)](#) and [23 C.F.R. 646.214\(b\)](#). Please refer to Section C of [Chapter 7 – Rail-Highway Crossings](#) for further information.

C.3 Safety Improvements

Local agencies should strive to upgrade the safety of their facilities during scheduled maintenance intervals especially during pavement resurfacing projects. Particular attention should be paid to improving pedestrian and bicyclist safety using strategies such as crosswalks and bicycle facilities. Investments should also be made in improved guardrail end treatments and bridge-end transitions on high speed facilities.

C.3.a Pavement Safety Edge

Many low-cost strategies exist to improve the long-term safety of streets and highways. One such strategy is the pavement Safety Edge. The Safety Edge provides a higher probability of a vehicle returning safely to the travel lane when it drifts off the pavement. ~~It~~ [The Safety Edge](#) is a wedge-shaped transition of the structural pavement to the unpaved shoulder. The wedge shape eliminates tire scrubbing against the pavement edge and improves vehicle stability as it crosses a drop-off.

The Safety Edge is particularly effective when providing a smooth transition from pavement to shoulder when vertical drop-offs exceed 2 inches. Construction of the Safety Edge typically includes initially pulling the unpaved shoulder for pavement structural course, and then backfilling onto the Safety Edge with installation of sod or turf. The Safety Edge is very effective in mitigating the severity of road-departure crashes should the unpaved shoulder erode away between maintenance intervals.

[A Safety Edge treatment should be provided adjacent to the travel lane on roadways:](#)

- [without curb or paved shoulders.](#)

- with a posted speed of 45 mph or greater, and
- a history of lane departure crashes.

Details for the Safety Edge are included in Figures 10 – 1 Two Lane Road with Safety Edge and 10 – 2 Safety Edge Detail (No Paved Shoulder). ~~Safety Edge is most beneficial when should be constructed adjacent to the pavement edge on rural roadways with no paved shoulder and posted speeds 45 mph and above.~~

Additional information on Safety Edge can be found at **FHWA's Office of Safety – Safety Edge**, including a Design and Construction Guide, Guide Specification, ~~and~~ Safety Evaluation Tech Brief and Case Studies. **FHWA's Crash Modification Factors Clearinghouse** also provides information on the performance of safety edge. The ~~The~~ FDOT has a **Developmental Specification for Safety Edge – Dev330SE** on the FDOT's web site which may be used if approved by the agency having jurisdiction.

Figure 10 – 1 Two Lane Road with Safety Edge

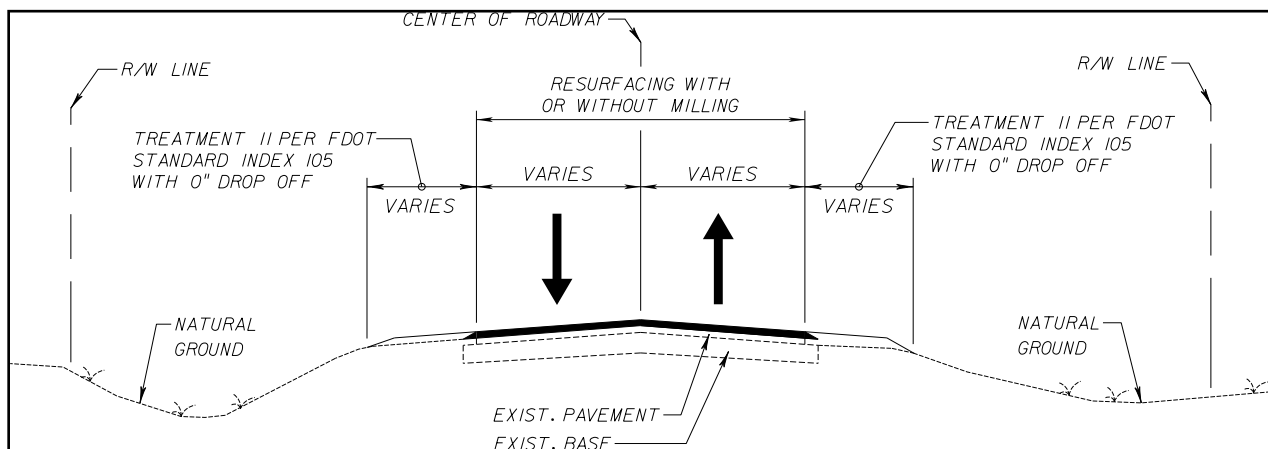

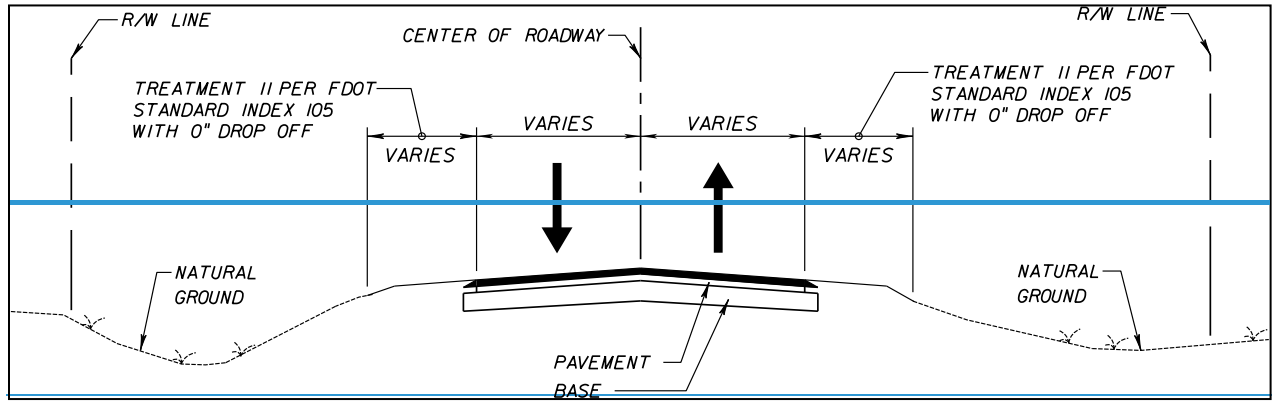
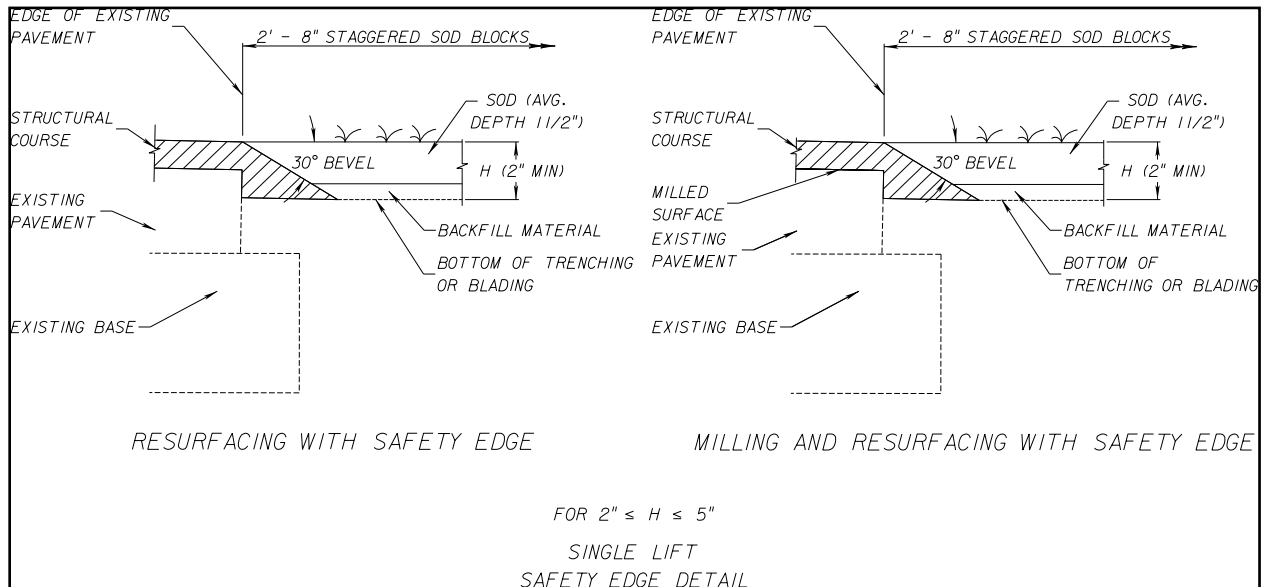

Figure 10 – 2 Safety Edge Detail (No Paved Shoulders)



C.4 Federal Aid Project Requirements

The following are the minimum requirements that a local highway resurfacing project scope must contain for federal-aid assistance including projects in the Local Agency Program (LAP):

1. Rework shoulders to be flush with the pavement and establish turf along the pavement edge.
2. Upgrade or replace existing roadside hardware (guardrail) as necessary for compliance with Federal criteria for 3R projects (as summarized in the [Department FDOT Design Manual, Chapter 215 Roadside Safety](#)).
3. Meet the [latest Manual on Uniform Traffic Control Devices \(2009 Edition with Revision Numbers 1 and 2, May 2012\) \(MUTCD\)](#) standards for signing and pavement marking.
4. Construct or reconstruct, as appropriate, curb cuts and ramps to meet current accessibility requirements.
5. Upgrade the safety of the project by mitigating the impact of crashes involving vehicles, bicycles, and pedestrians.

Note: The local agency may contact the FDOT District Safety Office and

determine locations within the project with crash rates higher than average for similar facility type. The local agency may then identify the causes of the crashes from a review of crash report data provided by the FDOT District Safety Office. Based on this analysis, the local agency may then specify the appropriate crash mitigation measures (additional guardrail, signing, vibratory/audible pavement marking, designated crosswalks or other prudent safety-enhancing strategies).

6. Upgrade railroad crossings to meet the [latest Manual on Uniform Traffic Control Devices \(2009 Edition with Revision Numbers 1 and 2, May 2012\) \(MUTCD\)](#) requirements in accordance with [Title 23, United States Code \(U.S.C\), Chapter 1, Section 109\(e\)](#) and [23 C.F.R. 646.214\(b\)](#). Please refer to **Section C** of **Chapter 7 – Rail-Highway Crossings** for further information.

D REFERENCES FOR INFORMATIONAL PURPOSES

The following is a list of publications that may be referenced for further guidance:

- FHWA Pavement Preservation Definitions, HIAM-20, September 12, 2005,
<http://www.fhwa.dot.gov/pavement/preservation/091205.cfm>
- NCHRP Synthesis 417: Geometric Design Practices for Resurfacing, Restoration, and Rehabilitation,
<https://www.trb.org/Publications/Blurbs/165650.aspx>
- [FHWA Center for Accelerating Innovation – Safety Edge](https://www.fhwa.dot.gov/innovation/everydaycounts/edc-1/safetyedge.cfm)
<https://www.fhwa.dot.gov/innovation/everydaycounts/edc-1/safetyedge.cfm>

THIS PAGE INTENTIONALLY LEFT BLANK

CHAPTER 11

WORK ZONE SAFETY AND MOBILITY

A	INTRODUCTION	11-1
B	REGULATORY REQUIREMENTS	11-2
C	TRANSPORTATION MANAGEMENT PLAN.....	11-3
D	TEMPORARY TRAFFIC CONTROL PLAN (TTCP)	11-6
D.1	Type of Operation	11-6
D.2	Nature of the Work Zone.....	11-7
D.3	TTCP Details.....	11-9
D.3.a	Short Term Transverse Rumble Strips	11-10
D.3.b	Temporary Raised Rumble Strip Sets	11-10
D.4	Work Scheduling	11-11
D.5	Coordination.....	11-13
D.6	Number and Width of Travel Lanes, Bike Lanes, Sidewalks, and Shared Use Paths	11-14
D.7	Clear Zones, Above-Ground Hazards, Drop-Offs, and Temporary Barriers	11-14
D.8	Work Affecting Pedestrian and Bicycle Facilities	11-18
D.8.a	Pedestrian Facilities	11-18
D.8.b	Bicycle Facilities	11-18
D.9	Typical Application Examples	11-20
E	TRANSPORTATION OPERATIONS PLAN.....	11-37
E.1	Contracts and Permits.....	11-37
E.1.a	Utilities.....	11-37
E.1.b	Wildlife Sensitive Lighting.....	11-37
E.2	Inspection and Supervision	11-38
F	PUBLIC INFORMATION PLAN	11-38
G	EVALUATION OF PROGRAM	11-39

TABLES

Table 11 – 1 Work Zone Sign Spacing “X”	11-21
Table 11 – 2 Taper Length “L”	11-21
Table 11 – 3 Buffer Length “U”	11-22
Table 11 – 4 Channelizing Device Spacing.....	11-22

FIGURES

Figure 11 – 1 TMP Development.....	11-4
Figure 11 – 2 Two-Lane Roadway, Single Lane Closure Using Flaggers.....	11-24
Figure 11 – 3 Multi-Lane Roadway, Single Lane Closure.....	11-25
Figure 11 – 4 Sidewalk/Shared Use Path Diversion (Temporary Sidewalk/Shared Use Path)	11-26
Figure 11 – 5 Sidewalk/Shared Use Path Detour (Closure with Reroute).....	11-28
Figure 11 – 6 Bicycle Lane Closure Without Detour	11-29
Figure 11 – 7 Bicycle Lane Closure With On-Road Detour.....	11-31
Figure 11 – 8 Shared Use Path Closure with a Diversion.....	11-33
Figure 11 – 9 On-Road Detour for Shared Use Path	11-35
Figure 11 – 10 Paved Shoulder Closure with Bicycle Diversion onto Temporary Path.....	11-36

THIS PAGE INTENTIONALLY LEFT BLANK

CHAPTER 11

WORK ZONE SAFETY AND MOBILITY

A INTRODUCTION

Construction, maintenance, and utility work, along with traffic incident management, are ~~roadwork~~ operations that may create highway safety and mobility challenges. The changes to normal traffic flow and the introduction of unexpected travelling conditions at many work zones may generate hazardous situations and serious traffic conflicts. A comprehensive plan for work zone safety is required to minimize the risks and effects of these ~~roadwork~~ operations. These comprehensive plans are known as transportation management plans. Any activity within a street, ~~the~~ highway or shared use path corridor/right of way shall follow~~be subjected to~~ the requirements of this chapter~~work zone safety~~.

The general objective of a transportation management plan is to protect workers, traffic incident responders, pedestrians, bicyclists, and motorists during work zone operations. This may be achieved by meeting the following:

- Provide adequate advance warning and information about upcoming work zones
- Promote the use of the appropriate traffic control and protection devices
- Provide pedestrians, ~~bicyclists~~bicyclists, and motorists clear information to understand how to navigate through or around the work zone
- Provide accessible and continuous routes for pedestrians through, in, and/or around construction or maintenance work zones at least to the same level of accessibility that existed prior to the project
- Reduce the consequences of an out-of-control vehicle
- Provide safe access and storage for equipment and material
- Promote the speedy completion of projects (including thorough cleanup of the site)

B REGULATORY REQUIREMENTS

Each agency with responsibilities for construction, maintenance, utility, or traffic incident management, or any roadwork operations on streets and highways shall develop and maintain a program of work zone safety, as set forth in the **Manual on Uniform Traffic Control Devices, 2009 Edition (MUTCD)**, and adopted by **Rule 14 – 15.010, F.A.C.** Additional requirements related to all highway construction projects financed in whole or in part with federal-aid highway funds are provided in **Title 23 Code of Federal Regulations (CFR) 630 Subpart J**, more commonly known as the **Work Zone Safety and Mobility Rule**, and **Temporary Traffic Control Devices Rule (Subpart K)**,~~s~~
~~financed in whole or in part with federal-aid highway funds.~~

When an existing pedestrian facility is in place, an accessible and continuous route for pedestrians through, in, and/or around construction or maintenance work zones must be provided, -in compliance with the **2006 Americans with Disabilities Act Standards for Transportation Facilities** as required by **49 C.F.R 37.41 – Construction of Transportation Facilities by Public Entities** or **37.43 - Alteration of Transportation Facilities by Public Entities**. -The -**2017 Florida Accessibility Code** also includes requirements that apply to work zones, as required by **F.A.C. 61G20-4.002**.

C TRANSPORTATION MANAGEMENT PLAN

A Transportation Management Plan (TMP) lays out a set of strategies for managing work zone impacts of a project. The TMP helps to expand mitigation of work zone impacts beyond traffic safety and control to also address mobility for all users. The scope and content of the TMP required for a project are based on the work zone policies, expected work zone impacts of the project, and whether a project is determined to be significant. For all projects, the TMP will contain a Temporary Traffic Control Plan (TTCP) that addresses traffic safety and control through the work zone and is consistent with the provisions under Part 6 of the **MUTCD**.

If a project is expected to be significant, the TMP for that project must also contain both transportation operations and public information components. The Transportation Operations Plan (TOP) addresses operations and management of the transportation system in the work zone impact area. Examples of TOP strategies include travel demand management, signal retiming, use of Intelligent Transportation Systems (ITS), speed enforcement, and traffic incident management.

The Public Information Plan (PIP) addresses communication with the public and concerned stakeholders, both before and during the project, about the project, what to expect in and around the work zone, and available travel alternatives. Examples of PIP strategies include using brochures, web sites, radio, and/or variable message signs to disseminate this information both pre-trip and in-route.

A significant project is defined as one that alone or in combination with other concurrent projects nearby is anticipated to cause sustained work zone impacts that are greater than what is considered tolerable based on policy or engineering judgement.

Figure 11 – 1 TMP Development provides an overview of the steps taken in developing a Transportation Management Plan. Further information on developing TMPs for projects can be found on [FHWA's Work Zone Management](#) web page.

Figure 11 – 1 TMP Development

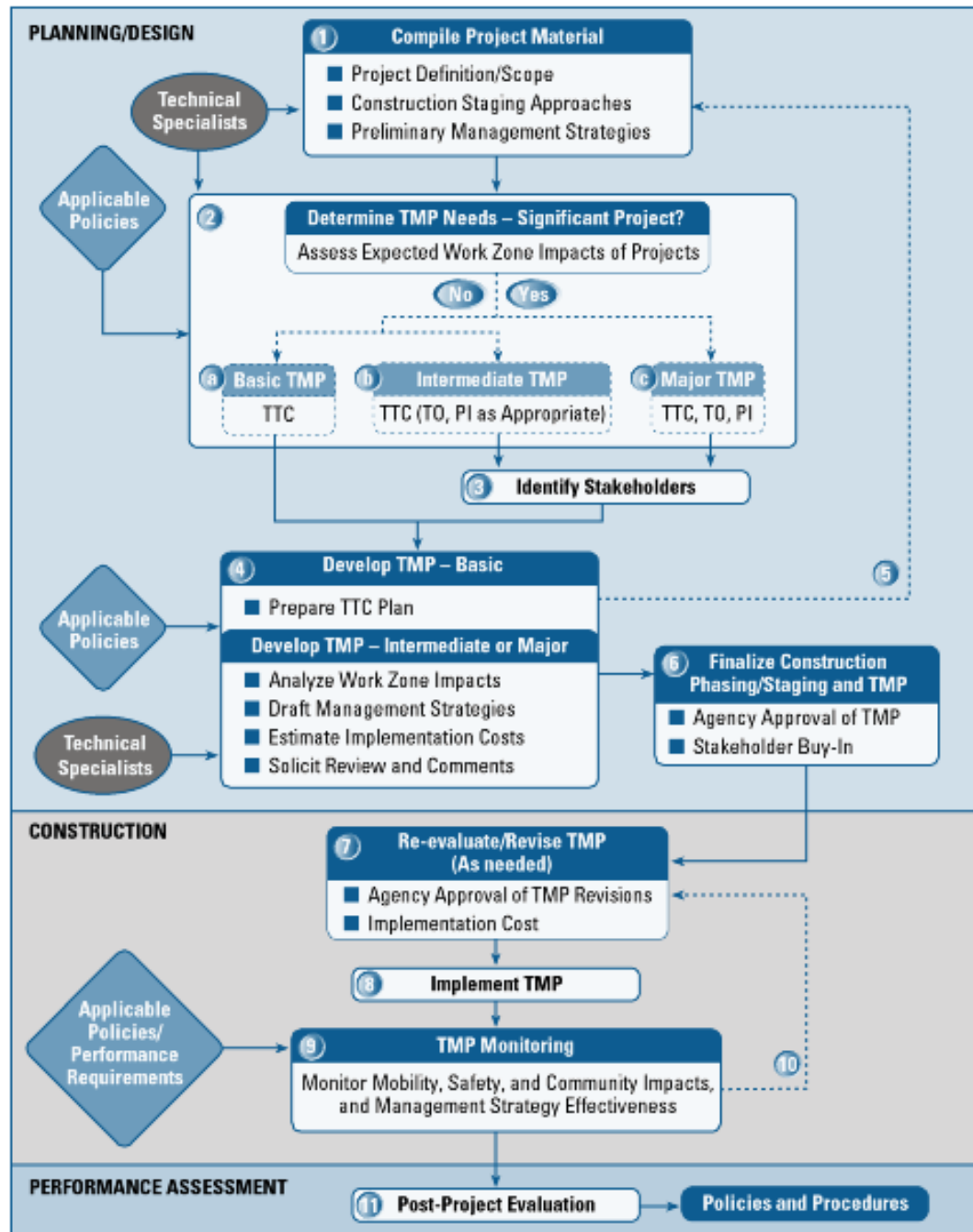

Source: FHWA Figure 6.1 Transportation Management Plans

~~B~~ BACKGROUND

~~Section 316.0745, Florida Statutes, mandates the Department of Transportation compile and publish a manual of traffic control devices for use on the streets and highways of the state. To comply with this statute, the Federal Highway Administration's (FHWA) Manual on Uniform Traffic Control Devices (MUTCD) has been adopted for use in Rule 14-15.010, Florida Administrative Code (F.A.C.).~~

~~MUTCD, Part 6.~~

~~C~~ OBJECTIVES

~~Managing through traffic and maintaining access during construction, maintenance and emergency response roadwork operations is necessary. The goal is to complete roadwork or resolve traffic incidents in a timely manner while minimizing traffic delays, maintaining access to travelers, and most importantly maintaining an acceptable level of safety. The general objective of a program of work zone safety is to protect workers, traffic incident responders, pedestrians, bicyclists, and motorists during roadwork operations. This general objective may be achieved by meeting the following specific objectives:~~

- ~~• Provide adequate advance warning and information about upcoming work zones~~
- ~~• Provide the pedestrians, bicyclists and motorists clear information to understand how to navigate through or around the work zone~~
- ~~• Reduce the consequences of an out-of-control vehicle~~
- ~~• Provide safe access and storage for equipment and material~~
- ~~• Promote the speedy completion of projects (including thorough cleanup of the site)~~
- ~~• Promote the use of the appropriate traffic control and protection devices~~
- ~~• Provide safe passageways for pedestrians through, in, and/or around construction or maintenance work zones~~

~~D~~ POLICY

~~Each agency with responsibilities for construction, maintenance, utility, or traffic incident management, or any roadwork operations on streets and highways shall develop and maintain a program of work zone safety, as set forth in the MUTCD, (Chapter 6A). Additional requirements related to all highway construction projects financed in whole or in part with federal aid highway funds are provided in Title 23 Code of Federal Regulations~~

~~(CFR) 630 Subpart J, more commonly known as the Work Zone Safety and Mobility Rule impose additional requirements for the design and construction of projects financed in whole or in part with federal aid highway funds.~~

DE TEMPORARY TRAFFIC CONTROL PLAN (TTCP) PLANNING OF ROADWORK OPERATIONS

The achievement of work zone safety requires careful and complete planning prior to the initiation of any ~~read~~work. The planning objective is to develop a comprehensive Temporary Traffic Control Plan (TTCP) that includes the following considerations:

- Type of Operation
- Nature of Work Zone
- TTCP Details
- Work Scheduling
- Coordination

DE.1 Type of Operation Project Requirements

DE.1.a Type of Operation

~~Readwork~~ The type of operations may be further classified as routine, unplanned, or planned operations.

DE.1.a.1 Routine Operations

Routine operations would involve projects such as mowing, street cleaning, and preventive maintenance operations conducted on a regularly scheduled basis.

DE.1.a.2 Unplanned Operations

Unplanned operations require prompt, efficient action to restore the ~~facility~~roadway to a safe condition. These include traffic incident management such as clearing vehicle crash or storm debris, addressing hazardous materials spills, repairing or replacing damaged ~~highway~~ safety components and restoring inoperative traffic control devices.

DE.1.a.3 Planned Operations

Planned operations are scheduled ~~readwork~~ projects, neither routine nor time-sensitive in nature, that are occasionally required to maintain or upgrade a street, ~~or~~ highway, sidewalk, or path.

~~DE.21.a~~ **DE.21.b** Nature of the Work Zone ~~Roadwork~~

The development of the ~~TTCP~~ temporary traffic control plan for work zone safety should include consideration of the following factors:

- Length of the project
- Duration and complexity of the work
- Hazards that may be created (e.g., long term drop-offs)
- ~~Time span required~~
- ~~Requirements for continuous operation or occupation of the work zone~~
- ~~Capability of clearing the site during cessation of work activity~~
- ~~The various construction methods, equipment, and procedures that may be utilized. Evaluation of alternate methods should be undertaken to determine the safest and most efficient procedures~~
- ~~The~~ Necessity for storing equipment or material in the facility ~~highway~~ right of way
- Traffic characteristics and patterns
- Effects on nearby businesses and residences, especially when detouring
- Site conditions that may be confusing or distracting
- Limitations on sight distance
- Decreased visibility associated with nighttime operations
- Reasonableness of detour length and complexity
- ~~—~~
- ~~Roadwork~~ Operations that may expose workers to hazards from through traffic
- ~~Hazards to pedestrians, bicyclists or out of control motorists~~ vehicles such as excavations or unguarded structures or equipment
- ~~Equipment inspection and preventive maintenance program~~
- ~~DE.31.c~~ Nature of the Work Zone Impacts

- ~~• The nature of the work zone and the prevailing traffic conditions should, to a large degree, influence the procedures incorporated into the TTCP plan for work zone safety. The development of the TTCP temporary traffic control plan should include consideration of the following factors:~~
- ~~• Location of the work zone in relation to the proximity to side streets, driveways, transit bus stops, schools, parks, places of worship, etc.~~
- ~~• Determination of the type of traffic affected, design vehicle, normal vehicle travelling speed, and existing traffic volumes.~~
- ~~• Distribution of traffic with respect to peak traffic periods (seasonal, day of week, time of day, etc.)~~
- ~~• Truck percentage, frequency of transit vehicles, unique characteristics of pedestrians and bicyclists who commonly travel the corridor (e.g. school children), and direction of traffic is also important for establishing traffic control procedures.~~
- ~~• Presence of Intelligent Transportation Systems (ITS) such as dynamic message boards.~~
- ~~• Site conditions that may be confusing or distracting to the motorist, pedestrian, or bicyclist.~~
- ~~• Limitations on sight distance.~~
- ~~• Decreased visibility associated with nighttime roadwork operations.~~
- ~~• Impacts of detours and diversions to businesses, and residential communities, schools, parks, community services.~~
- ~~• Pedestrian and bicycle accommodations.~~
- ~~• Reasonableness of detour length and complexity.~~

D.3 TTCP Details

Plans should include protection at work zones when work is in progress and when operations have been halted (such as during the night, special events or restrictions, holidays). The TTCP should include provisions for the following:

- Work zone traffic signs
- Channelizing devices
- Temporary barriers (see **Chapter 4 – Roadside Design**)
- The usage of flaggers or temporary traffic signals
- Access and accommodations for pedestrians, bicyclists, and transit users
- Lane widths (see **Section D.6 Number and Width of Travel Lanes, Bike Lanes, Sidewalks, and Shared Use Paths**)
- Drop-off hazards (-see **Chapter 4 – Roadside Design**)
- Above ground hazards (see **Chapter 4 – Roadside Design**)
- Clear zone (see **Chapter 4 – Roadside Design**)
- Sight distance (intersection, stopping)
- Temporary drainage
- Work zone speed
- Lane closure restrictions
- Bus stops, boarding and alighting areas, shelters, lighting
- Traffic control officers and law enforcement
- Adequate work zone space for construction vehicles, workers -and materials
- Night safety (see **Chapter 6 – Lighting**)
- Traffic control and protective devices – including short term transverse rumble strips and temporary raised rumble strip sets (see **Section D.3.1 Short Term Transverse Rumble Strips, Section, D.3.2 Temporary Raised Rumble Strip Sets, and Chapter 18 – Signing and Marking**)
- Detours, including for pedestrians and bicyclists
- Special events

D.3.a Short Term Transverse Rumble Strips

In locations with existing raised rumble strip sets (e.g., intersections, approaches to horizontal curves, toll plazas), maintain or replace the raised rumble strip sets throughout construction. Provide short-term raised rumble strip sets when existing raised rumble strip sets are removed for construction activities, until the permanent raised rumble strip sets are installed. Short-term raised rumble strip sets must be installed prior to opening the road to traffic; therefore, quantities may include multiple applications due to construction phasing. The [FDOT's Standard Plans, Index 546-001](#) and [Standard Specifications, Section 546](#) provide additional information on short term raised rumble strips.

Example of Transverse Rumble Strips



D.3.b Temporary Raised Rumble Strip Sets

Temporary raised rumble strip sets are used to warn vehicular traffic of the upcoming work zone. They may be used to supplement the required signs,

channelizing devices, and flagging operations in the work zone. They are most often used when both of the following conditions occur:

- Lane closure on a two-lane, two-way roadway
- Existing posted speed prior to construction is 55 mph or greater

The FDOT's [Standard Plans, Index 102-603](#) provide additional information on temporary raised rumble strips.

DE.42 Work Scheduling

Proper work scheduling and sequencing of ~~roadwork~~ operations will ~~not only~~ promote efficiency, but also improve the safety aspects. Where feasible, routine operations and special projects should be conducted during periods of low traffic volume to reduce conflicts. Projects that may be carried out concurrently at the same site should be scheduled simultaneously to eliminate successive disruptions of traffic.

Major projects that impede or restrict traffic flow should be coordinated and sequenced with similar projects in adjacent areas, to produce a minimum of disruption to orderly traffic flow in the overall ~~highway~~ network. The scheduling of work at a given location should include consideration of traffic generation (including special events), as well as traffic restrictions by work activities on the surrounding ~~highway~~ network.

DE.53 ~~Traffic Control and Protection~~

~~Plans for traffic control around or through work zones should be developed with safety receiving a high priority. Plans should include protection at work zones when work is in progress and when operations have been halted (such as during the night). Provisions for the protection of work crews, traffic control personnel, bicyclists, pedestrians, (in areas of high pedestrian use, construction of temporary facilities should be considered), and motorists shall be included in the operation plans. The plan for traffic control and protection should consider provisions for the following:~~

Clear view of work zone

Advance warning devices

~~Work zone traffic signs~~

~~Channelizing devices~~

~~Clear view of work zone~~

~~Roadway, sidewalk and shared use path delineation and channeling devices~~

~~Transit Stops – including passenger access~~

~~Clear zone (**Chapter 4 – Roadside Design**)~~

~~Regulatory information~~

~~High-visibility safety apparel for workers~~

~~Traffic control officers and law enforcement~~

~~Hazard warning~~

~~Barriers~~

~~Pedestrian and bicyclist safety~~

~~Access for pedestrians, bicyclists, and motor vehicles~~

~~Access to adjacent properties by the public during construction~~

~~Location of construction vehicles and equipment, including access into and out of the work zone~~

~~Night safety (**Chapter 6 – Lighting**)~~

~~Personnel training~~

~~Traffic control and protective devices – including transverse rumble strips (**Chapter**~~

18— Signing and Marking

~~Transit Stops—including passenger access~~

~~Abrupt changes in geometry (lane narrowing, lane drop, transitions)~~

~~Turning restrictions~~

- ~~• Temporary traffic signals~~

DE.564 Coordination with Others

To ensure safe and efficient roadwork operations, the ~~temporary traffic control plan~~ **TTCP** should be developed and executed in cooperation with interested individuals and agencies, which may include the following:

- ~~Transportation~~ **Highway** agencies
- Police ~~and sheriff's departments~~ agencies
- Emergency ~~responders~~ agencies
- Contractors
- Utilities
- Building departments
- Mass transit ~~providers~~ agencies
- Traffic generators
- ~~Local~~ **R**esidents and businesses
- Neighboring jurisdictions
- School Boards
- Postal Services
- Media
- ~~Trash~~ and recycling pick ups

D.6 Number and Width of Travel Lanes, Bike Lanes, Sidewalks, and Shared Use Paths

The number and width of travel lanes, sidewalks, shared use paths, and bike lanes should be maintained through work zones. The minimum widths for work zone travel lanes, sidewalks, shared use paths, and bike lanes shall be as follows:

- Freeways – 11 feet
- Arterials – 10 feet except on transit or truck routes, where a minimum width outside through lane of 10.5 feet is required
- Collectors – 10 feet
- Local – 10 feet, or to match existing lane widths if less than 10 feet
- Sidewalks – 5 feet
- Shared Use Paths – 8 feet
- Bike Lanes – 4 feet plus 1'offset from barrier or curb

Do not allow traffic control and warning devices to encroach on travel lanes, bike lanes, paved shoulders, sidewalks, and shared use paths open for travel.

D.7 Clear Zones, Above-Ground Hazards, Drop-Offs, and Temporary Barriers

When above-ground hazards or drop-offs occur within the clear zone or adjacent to pedestrian facilities due to construction or maintenance activities, protection devices may be needed. See **Chapter 4 – Roadside Design** for requirements.

~~A drop-off is defined as a drop in elevation, parallel to the adjacent travel lanes, greater than 3" with slope (A:B) greater than 1:4. In superelevated sections, the algebraic difference in slopes should not exceed 0.25. See Figure 11—21xx Drop-off Condition Detail, Table 11—1 Drop-off Protection Requirements and Table 11—2 Clear Zone Widths for Work Zones for further requirements. A setback distance appropriate for the type of barrier selected shall be provided. For further information on setback requirements for various types of barriers, see can be found in **FDOT's Standard Plans, Index 102-100.**~~

For Conditions 1 and 3 provided in Table 11—1xx Drop-off Protection Requirements, any drop-off condition that is created and restored within the

same work period will not be subject to the use of temporary barriers. However, channelizing devices will be required, unless existing permanent curb heights are $\geq 6"$. For curb heights $< 6"$, see Table 11 — 1 Drop-off Protection Requirements.

Drop-offs may be mitigated by placing slopes of optional base material. See the *FDOT Department's Standard Specifications, Section 285* for further information. Slopes shallower than 1:4 may be required to avoid an algebraic difference in slopes greater than 0.25.

Protect any drop-off adjacent to a pedestrian facility with pedestrian longitudinal channelizing devices, temporary barrier wall, or approved handrail. Adjacent to pedestrian facilities, a drop-off is defined as:

— a drop in elevation greater than 10" that is closer than 2 feet from the edge of the sidewalk or shared use path, or

— a slope steeper than 1:2 that begins closer than 2 feet from the edge of the sidewalk or shared use path when the total drop-off is greater than 60".

— Figure 11 — 21xx Drop-Off Detail

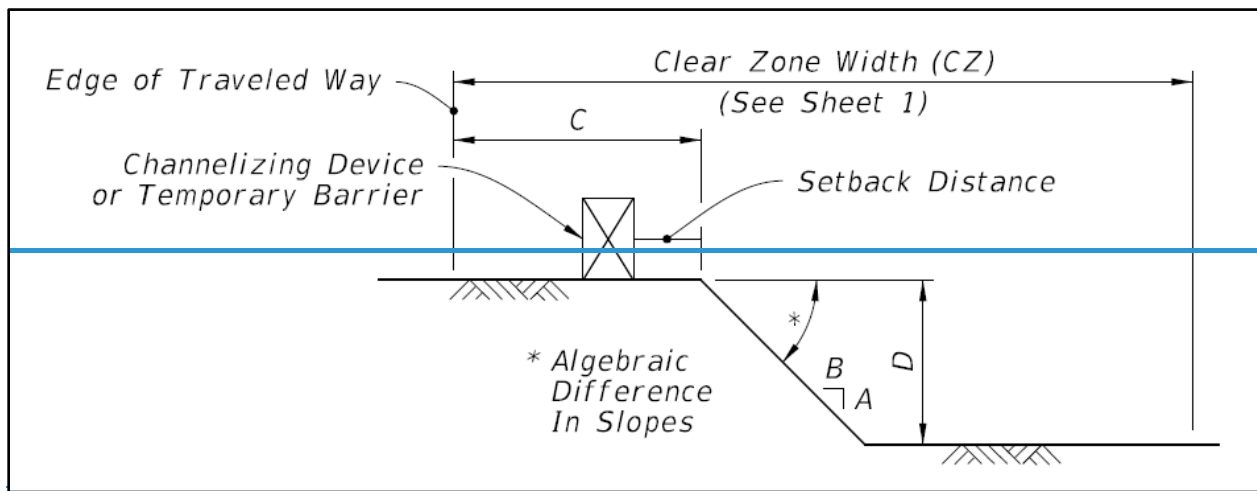

Table 11 – 1x Drop-off Protection Requirements

<u>Condition</u>	<u>D (inches)</u>	<u>C (feet)</u>	<u>Device Required</u>
<u>1</u>	<u>> 3</u>	<u>2 – 12</u>	<u>Temporary Barrier</u>
<u>2</u>	<u>> 3 to ≤ 5</u>	<u>12 – CZ</u>	<u>Channelizing Device</u>
<u>3</u>	<u>> 5</u>	<u>2 – CZ</u>	<u>Temporary Barrier</u>
<u>4</u>	<u>Removal of Bridge or Retaining Wall Barrier</u>		<u>Temporary Barrier</u>
<u>5</u>	<u>Removal of Portions of Bridge Deck</u>		<u>Temporary Barrier</u>

Notes:

- Do not allow any drop-off conditions greater than 3 inches within two feet of the edge of traveled way.
- See Table 114 – 21 Clear Zone Widths for Work Zones Minimum Width of Clear Zone in Chapter 4 – Roadside Design for Clear Zone (CZ) values.

~~The table below gives clear zone widths in work zones for medians and roadside conditions other than for roadside canals. Where roadside canals are present, clear zone widths are to conform with the lateral offset distances to canals described in Chapter 4 – Roadside Design.~~

D.8 Work Affecting Pedestrian and Bicycle Facilities

D.8.a Pedestrian Facilities

When an accessible sidewalk or shared use path is temporarily closed to pedestrians by construction, alterations, maintenance operations, or other conditions, an alternate pedestrian access route complying with Sections 6D.01, 6D.02, and 6G.05 of the **MUTCD** shall be provided. Where provided, pedestrian barricades and channelizing devices shall comply with sections 6F.63, 6F.68, and 6F.71 of the **MUTCD**. The temporary sidewalk or shared use paths shall maintain the same level of accessibility as the existing facility or greater. Minimize diversions and detour lengths.

For a temporary sidewalk, provide a minimum width of 5 feet. In constrained conditions, a minimum sidewalk width of 4 feet may be provided, with a 5' x 5' passing section at least every 200 feet. For a temporary shared use path, provide a minimum width of 8 feet. Both sidewalks and shared use paths shall have a maximum cross slope of 0.02 and running slope of 5%. If the temporary sidewalk or shared use path is contained within a street or highway right of way the maximum running slope shall not exceed the general grade established for the adjacent street or highway.

When temporary sidewalks or shared use paths intersect with streets or driveways, ensure that all curb ramps or blended transitions meet ADA requirements. Detectable warnings shall be provided at intersections with all streets and signalized or stop sign ~~traffic~~ controlled driveways. Detectable warnings are not required for curb ramps or blended transitions diverting pedestrian traffic into a closed lane.

See **Chapter 8 – Pedestrian Facilities** and **Chapter 9 – Bicycle Facilities** for further information. Additional information on designing accessible sidewalks and shared use paths can be found on the **United States Access Board's** web page ~~for **Streets and Sidewalks**~~, including the **(Proposed) Public Rights-of-Way Supplemental Notice of Proposed Rulemaking, Accessibility Guidelines (PROWAG)**. ~~for Pedestrian Facilities in the Public Rights of Way; Shared Use Paths.~~

D.8.b Bicycle Facilities

The continuity of a bicycle facility should be maintained through the work zone. Continuity through the work zone is particularly important where bicyclists have been traveling on a shoulder, bike lane, or shared-use path

prior to the work zone and adjacent to a lane having a posted speed limit \geq 35 miles per hour. If a bicycle lane, paved shoulder, or shared use path on a roadway having a speed limit of 35 mph or higher is closed a separate bicycle facility or detour route should be provided. To maintain room for bicycle lanes, paved shoulders, or a shared use path through the work zone on a multi-lane roadway, one or more travel lanes could be closed.

On roadways where bicyclists currently share lanes with motor vehicle traffic, the TTCF and typical applications for general traffic will usually be adequate for bicyclists as well.

If a bicycle facility detour is unavoidable, it should be as short and direct as practical, using roadways where conditions are appropriate for bicycling. On-road bicyclists should not be directed onto a sidewalk unless no practical alternative is available (such as might be the case on a bridge in the course of a rehabilitation project or roadway with environmental or right of way constraints). If directing cyclists onto a sidewalk, sidewalks should be widened to be at least 6 feet, 7 feet when back of curb.

If a portion of a bicycle facility is to be closed due to construction activities and the detoured facility follows a complex path not in the original corridor, then a full detour plan should be developed and implemented. The TTCF for the detour of the bicycle facility should include all necessary advance warning (W21 series) signs, detour (W4-9 series) signs, and any other TTCF devices necessary to guide bicyclists along the detour route.

If an on-street bicycle facility had a wide outside through travel lane (lanes having a width of at least 14 feet) prior to construction, and construction activities reduce the lane width to less than 14 feet through the work zone, then the Bicycles May Use Full Lane (R4-11) sign and Shared Lane Marking should be used.

Additional requirements for providing for and managing bicycle travel in work zones is found in **Part 6 of the MUTCD**. The minimum TTC sign and plaque sizes for shared-use paths shall conform to those shown in **Table 9B-1 Bicycle Facility Sign and Plaque Minimum Sizes of the MUTCD**. The minimum TTC sign and plaque sizes for on-street bicycle facilities shall conform to **Chapter 6F of the MUTCD**.

D.9 Typical Application Examples

The following figures provide examples of typical applications. Typical applications should be used to develop a site-specific TTCP. Examples are provided for the following scenarios:

Figure 11 – 2 Two-Lane Roadway Lane (Closure Using Flaggers)

Figure 11 – 3 Multi-Lane Roadway Lane (Single Lane Closure)

Figure 11 – 4 Sidewalk/Shared Use Path Diversion (Temporary Sidewalk/Shared Use Path)

Figure 11 – 5 Sidewalk/Shared Use Path Detour (Closure with Reroute)

Figure 11 – 6 Bicycle Lane Closure Without Detour

Figure 11 – 7 Bicycle Lane Closure With On-Road Detour

Figure 11 – 8 Shared Use Path Closure with a Diversion

Figure 11 – 9 On-Road Detour for Shared Use Path

Figure 11 – 10 Paved Shoulder Closure with Bicycle Diversion onto Temporary Path

The recommended spacing for work zone details in the Figures below are provided in Tables 11 – 1 Work Zone Sign Spacing “X”, Table 11 – 2 Taper Length “L”, Table 11 – 3 Buffer Length “U”, and Table 11 – 4 Channelizing Device Spacing. The **MUTCD** provides additional information; for work zone sign spacing see **Table 6H-3**; for taper length see **Table 6H-4**, and for buffer length, see **Table 6C-2**. Provide pavement markings in accordance with **Section 6F-78** of the **MUTCD**. The FDOT’s **The DepartStandard Plans, 102 Series** provides additional information and modifications of typical applications found in the **MUTCD**. ~~Most work zones will require further development of the typical applications to address project specific conditions. For work zone sign spacing, see Table 6H-3; for taper length see Table 6H-4, and for buffer length, see Table 6C-2 of the MUTCD. Provide 6” white lines in accordance with Section 6F-78 of the MUTCD.~~

Table 11 – 1 Work Zone Sign Spacing “X”

<u>Road Type</u>	<u>Min. Spacing (feet)</u>
<u>Arterials and collectors with Work Zone Speed ≤ 40 mph</u>	<u>200</u>
<u>Arterials and collectors with Work Zone Speed ≥ 45 mph</u>	<u>500</u>
<u>Freeways/Limited Access Roadways</u>	<u>1,500</u>

Table 11 – 2 Taper Length “L”

<u>Work Zone Speed (mph)</u>	<u>Min. Length (feet)</u>
<u>≤ 40</u>	<u>$L = WS^2/60$</u>
<u>≥ 45</u>	<u>$L = WS$</u>
<u>Note-: Where W = width of offset in feet</u> <u>S = speed in mph</u>	

Table 11 – 3 Buffer Length “U”

<u>Work Zone Speed (mph)</u>	<u>Min. Length (feet)</u>
<u>25</u>	<u>155</u>
<u>30</u>	<u>200</u>
<u>35</u>	<u>250</u>
<u>40</u>	<u>305</u>
<u>45</u>	<u>360</u>
<u>50</u>	<u>425</u>
<u>55</u>	<u>495</u>
<u>60</u>	<u>570</u>
<u>65</u>	<u>645</u>
<u>70</u>	<u>730</u>
<u>Note: When Buffer Length “U” cannot be attained due to geometric constraints, use the greatest length possible, but not less than 155 feet.</u>	

Table 11 – 4 Channelizing Device Spacing

<u>Speed (mph)</u>	<u>Max. Distance Between Devices (feet)</u>			
	<u>Tubular Markers</u>		<u>Vertical Panels or Opposing Traffic Lane Divider</u>	
	<u>Taper</u>	<u>Tangent</u>	<u>Taper</u>	<u>Tangent</u>
<u>25</u>	<u>25</u>	<u>50</u>	<u>25</u>	<u>50</u>
<u>30 to 45</u>	<u>25</u>	<u>50</u>	<u>30</u>	<u>50</u>
<u>50 to 70</u>	<u>25</u>	<u>50</u>	<u>50</u>	<u>100</u>

~~For a temporary sidewalk, provide a minimum width of 5 feet. In constrained conditions, a minimum sidewalk width of 4 feet may be provided, with a 5' x 5' passing section at least every 200 feet. For a temporary shared use path, provide a minimum width of 8 feet. Both sidewalks and shared use paths shall have a maximum cross slope of 0.02 and running slope of 5%. If the temporary sidewalk or shared use path is contained within a street or highway right of way the maximum running slope shall not exceed the general grade established for the adjacent street or highway.~~

~~When temporary sidewalks or shared use paths intersect with streets or driveways, ensure that all curb ramps or blended transitions meet ADA requirements. Detectable warnings shall be provided at intersections with all streets and signalized or stop sign traffic controlled driveways. Detectable warnings are not required for curb ramps or blended transitions diverting pedestrian traffic into a closed lane. Additional information on designing accessible sidewalks and shared use paths can be found on the [United States Access Board's](#) web page for [Streets and Sidewalks](#), including the Supplemental Notice of Proposed Rulemaking, Accessibility Guidelines for Pedestrian Facilities in the Public Rights of Way; Shared Use Paths.~~

Figure 11 – 2 — Two-Lane Roadway, Single Lane Closure Using Flaggers

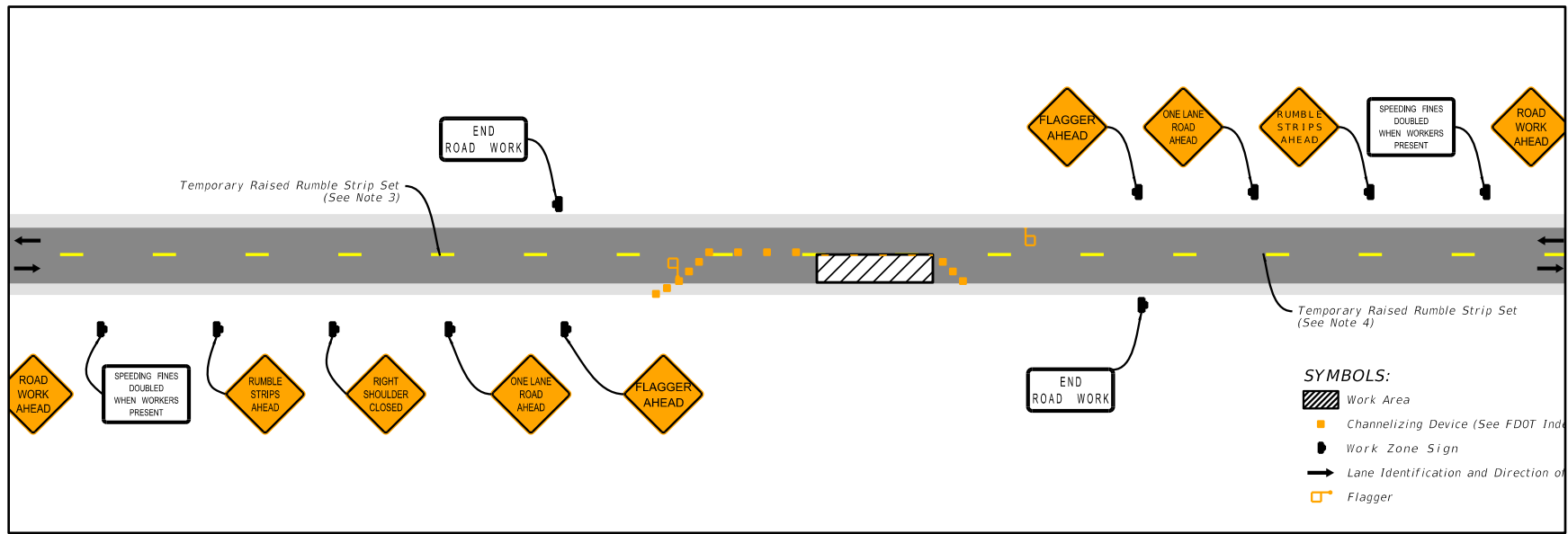

Notes:

1. X = Work Zone Sign Spacing, L = Taper Length, U = Buffer Length, see Table 11 – 1, 11 – 2, and 11 – 3 of this chapter and the MUTCD.
2. See Table 11 – 4 for the required spacing of channelizing devices.
3. If temporary rumble strips are used, include “Rumble Strips Ahead” signs and associated sign spacing distance.
4. “Speeding Fines Doubled When Workers Present” signs may be used,
5. “End Road Work” signs may be included when the work zone is in place for greater than 24 hours.
6. Temporary Pavement Markings are required for work zones greater than 24 hours in duration.
7. For general sign codes refer to FHWA Standards for Highway Signs and Markings. For special signs beginning with MOT-xx, FDOT’s Special Sign Details in the **Standard Plans** provide additional information.

Figure 11 – 3 — Multi-Lane Roadway, Single Lane Closure

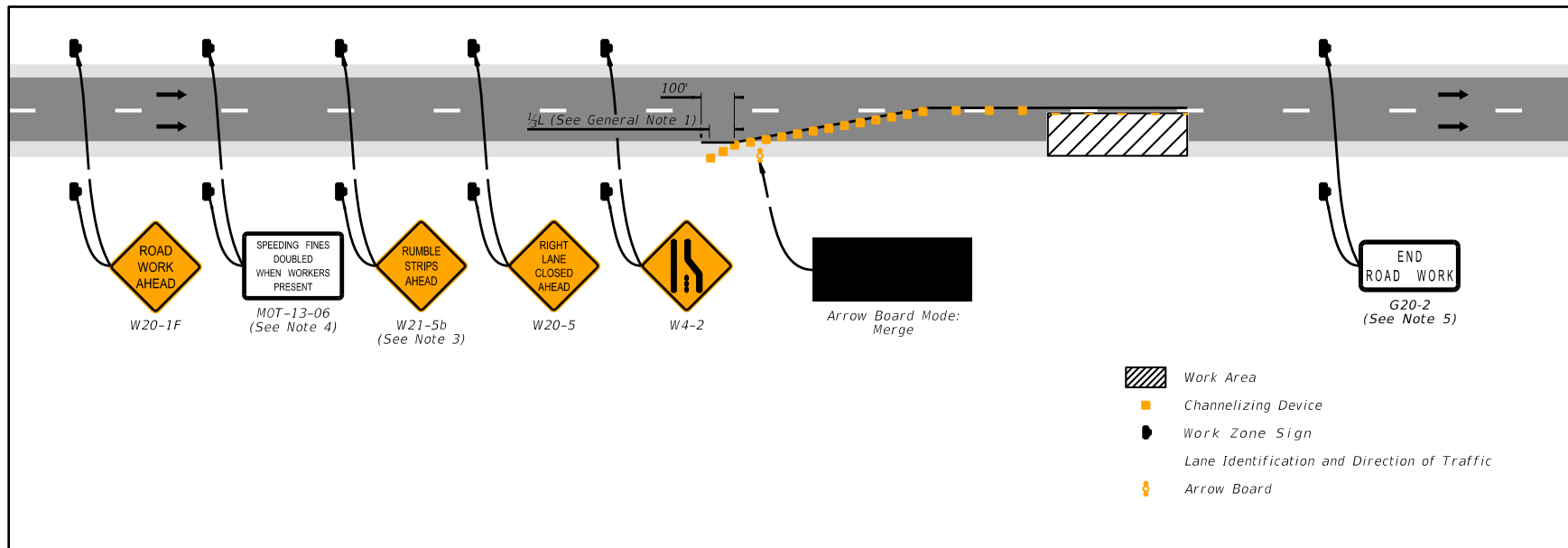

Notes:

1. X = Work Zone Sign Spacing, L = Taper Length, U = Buffer Length, see Table 11 – 1, 11 – 2, and 11 – 3 of this chapter and the MUTCD.
2. See Table 11 – 4 for the required spacing of channelizing devices.
3. If temporary rumble strips are used, include “Rumble Strips Ahead” signs and associated sign spacing distance.
4. “Speeding Fines Doubled When Workers Present” signs may be used.
5. “End Road Work” signs may be included when the work zone is in place for greater than 24 hours
6. Temporary Pavement Markings are required for work zones greater than 24 hours in duration.
7. For general sign codes refer to FHWA Standards for Highway Signs and Markings. For special signs beginning with MOT-xx, FDOT’s Special Sign Details in the Standard Plans provide additional information.

Figure 11 – 4 Sidewalk/Shared Use Path Diversion (Temporary Sidewalk/Shared Use Path)

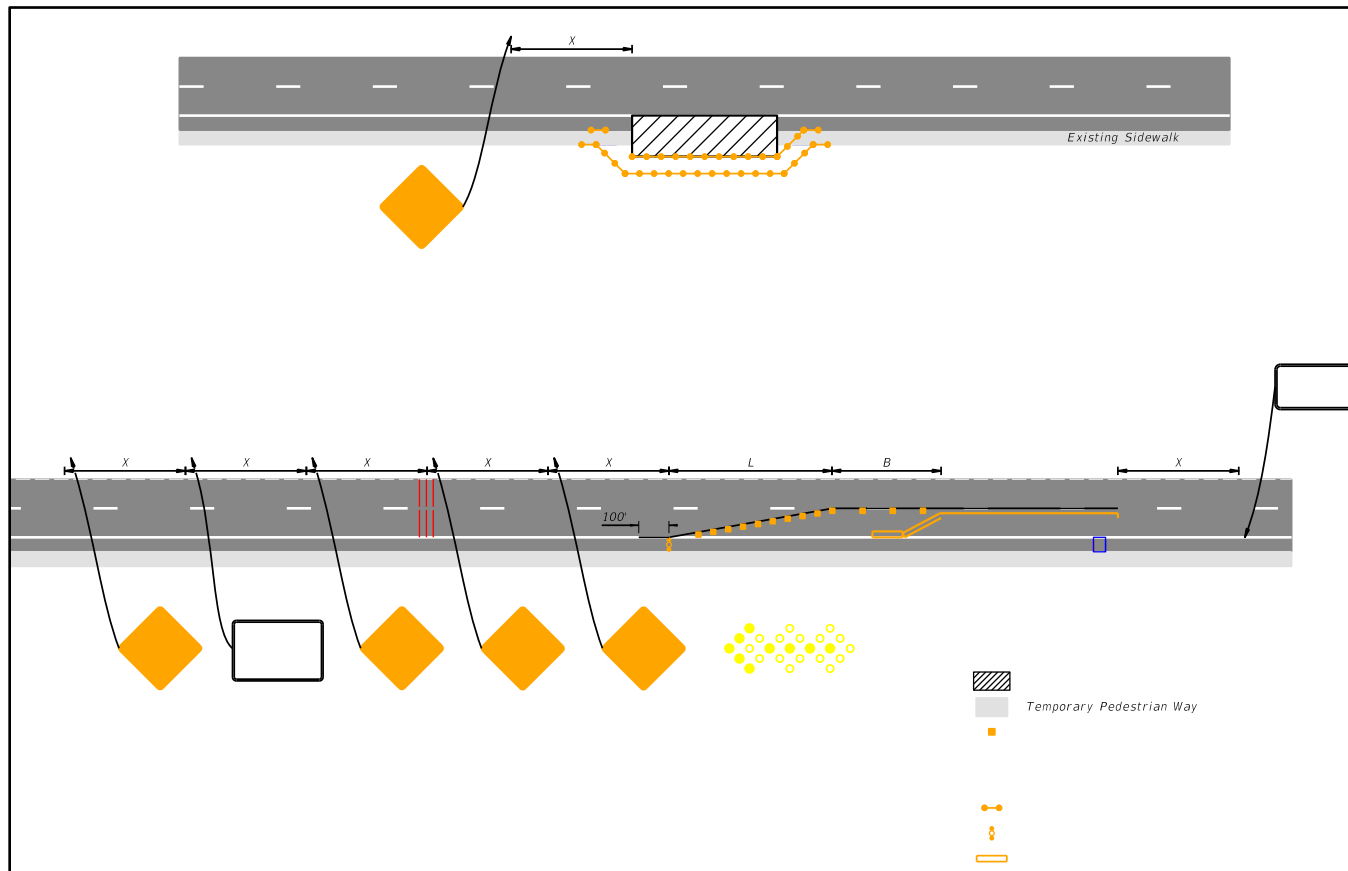

Notes: See following page.

1. X = Work Zone Sign Spacing, L = Taper Length, U = Buffer Length, see Table 11 – 1, 11 – 2, and 11 – 3 of this chapter and the MUTCD.
2. See Table 11 – 4 for the required spacing of channelizing devices.
- ~~4.~~3. Temporary sidewalks and shared use paths shall have a maximum cross-slope of .02. Provide curb ramps or blended transitions with detectable warnings.
- ~~2.~~4. If temporary rumble strips are used, include “Rumble Strips Ahead” signs and associated sign spacing distance.
- ~~3.~~5. “Speeding Fines Doubled When Workers Present” signs may be used.
- ~~4.~~6. “End Road Work” signs may be included when the work zone is in place for greater than 24 hours.
- ~~5.~~7. Temporary Pavement Markings are required for work zones greater than 24 hours in duration.
8. For general sign codes refer to FHWA Standards for Highway Signs and Markings. For special signs beginning with MOT-xx, FDOT’s Special Sign Details in the **Standard Plans** provide additional information.

Figure 11 – 5 Sidewalk/Shared Use Path Detour (Closure with Reroute)

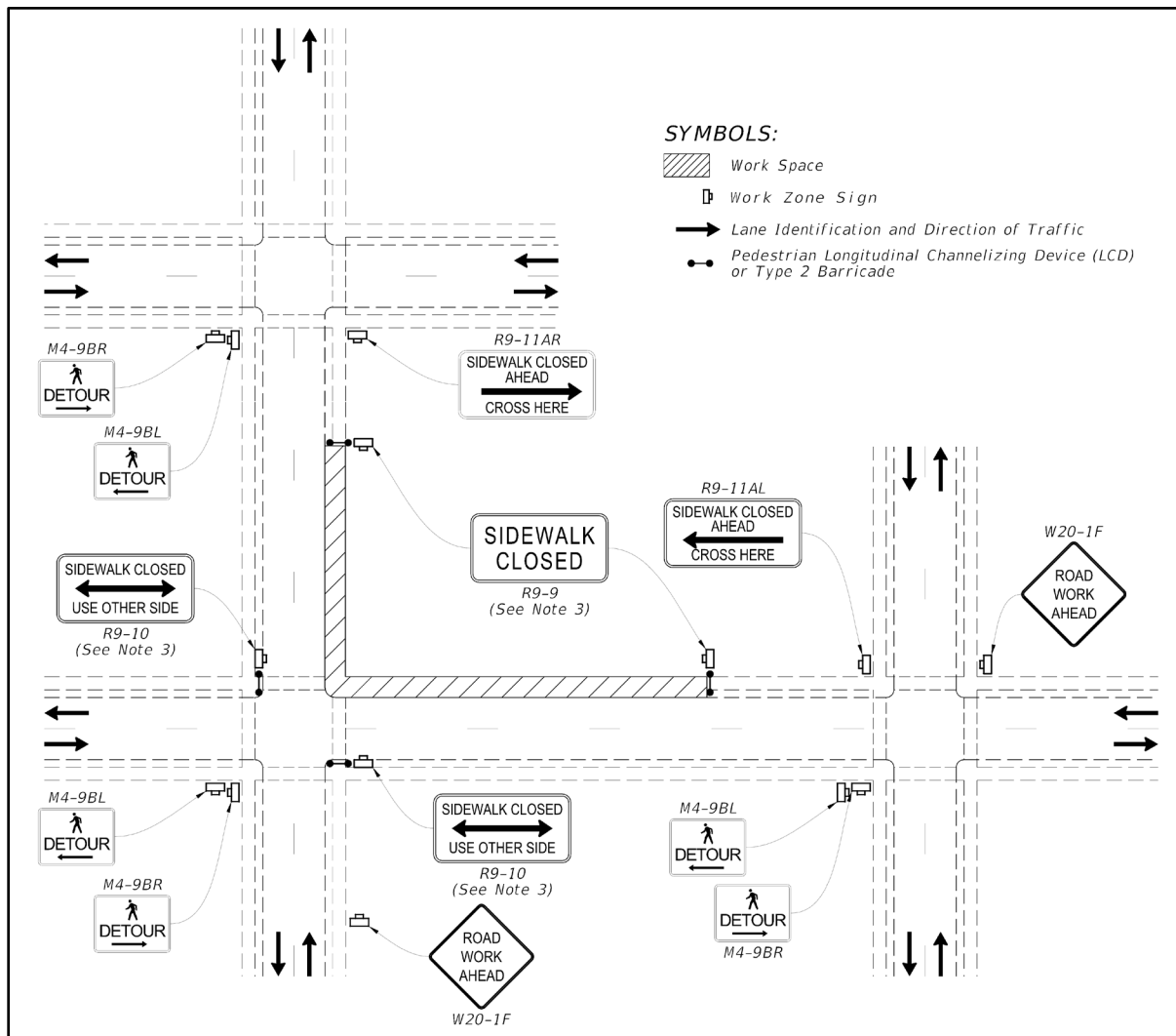

Notes:

1. Cover or deactivate pedestrian traffic signal display(s) controlling closed crosswalks.
2. Place pedestrian longitudinal channelizing devices (LCD) across the full width of the closed crosswalk.
3. "Sidewalk Closed" signs (R9-xx) may be mounted on pedestrian LCDs in accordance with the manufacturer's instructions.

1. See Table 6H-3 Meaning of Letter Codes of the MUTCD for the distances A, B and C between signs.
2. See Table 6-H-4 Formulas of the MUTCD for Determining Taper Length for the distance L. Speeds shall be posted speeds.
3. See Table 11 – 4 for the required spacing of channelizing devices.
4. If the posted speed limit is ≤ 35 mph, and the outside through travel lane is < 14 feet wide, then Bicycles May Use Full Lane (R4-11) signs should be used.
5. If the posted speed limit is ≤ 35 mph, and the outside through travel lane is ≥ 14 feet wide throughout the work zone, then Bicycle Warning (W11-1) signs in association with SHARE THE ROAD (W16-1) plaques should be used.

Figure 11 – 7 ———— **Bicycle Lane Closure with On-Road Detour**

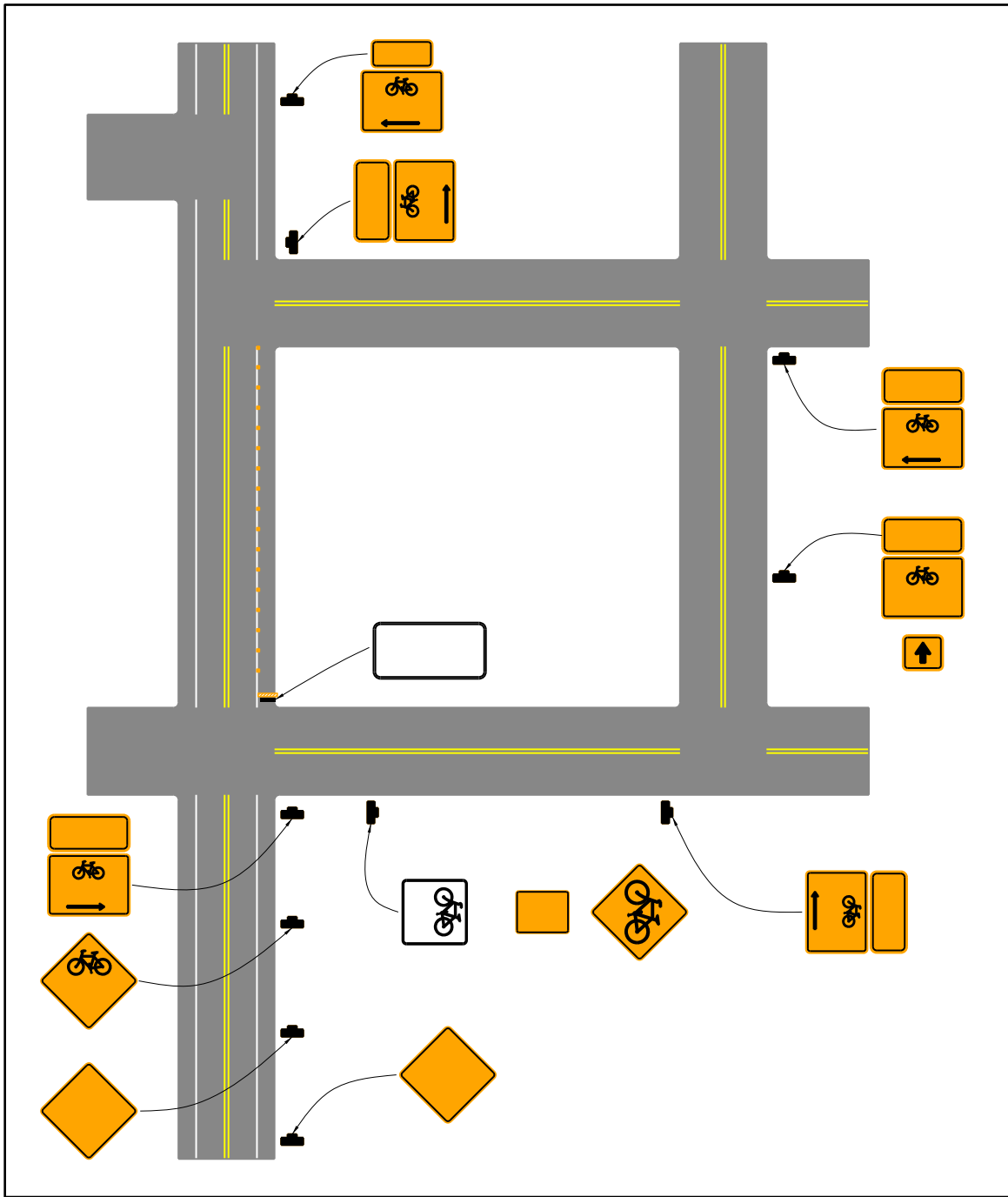

Notes: See following page.

1. See Table 6H-3 Meaning of Letter Codes of the MUTCD for the distances A, B and C between signs.
2. If the posted speed limit is ≤ 40 mph, and the outside through travel lane is < 14 feet wide, then Bicycles May Use Full Lane (R4-11) signs should be used.
3. See Table 11 – 4 for the required spacing of channelizing devices.
4. If the posted speed limit is ≤ 40 mph, and the outside through travel lane is ≥ 14 feet wide throughout the work zone, then Bicycle Warning (W11-1) signs in association with SHARE THE ROAD (W16-1) plaques should be used.
5. A Street Name sign or Bike Route Name sign should be mounted with the Bike Detour sign. Where used, the Street Name sign or Bike Route Name sign shall be placed above the Bike Detour sign. The Street Name sign or Bike Route Name sign may be either white on green or black on orange.

Figure 11 – 8 Shared Use Path Closure with a Diversion

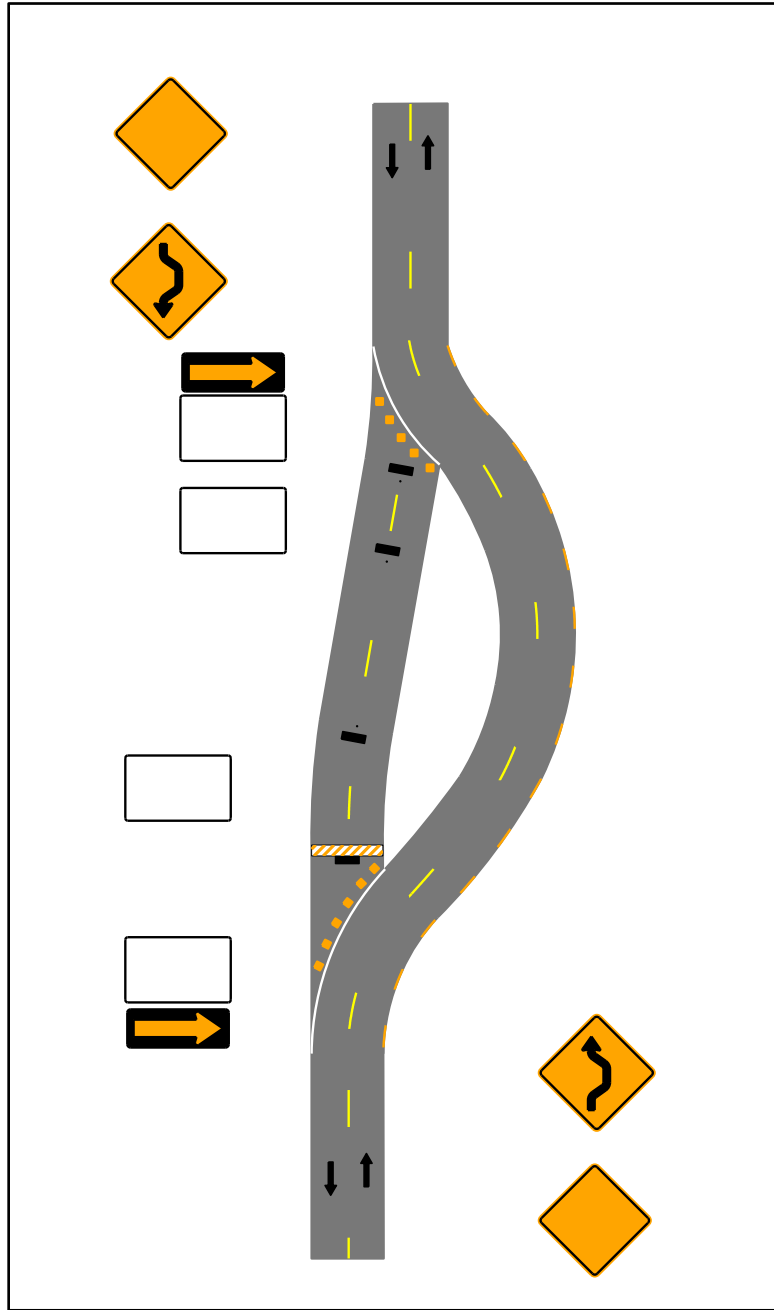

Notes:

1. See MUTCD Table 6H-2 Meaning of Symbols on Typical Application Diagrams.
2. See Table 11 – 4 for the required spacing of channelizing devices.

Figure 11 – 10 Paved Shoulder Closure with Bicycle Diversion onto Temporary Path

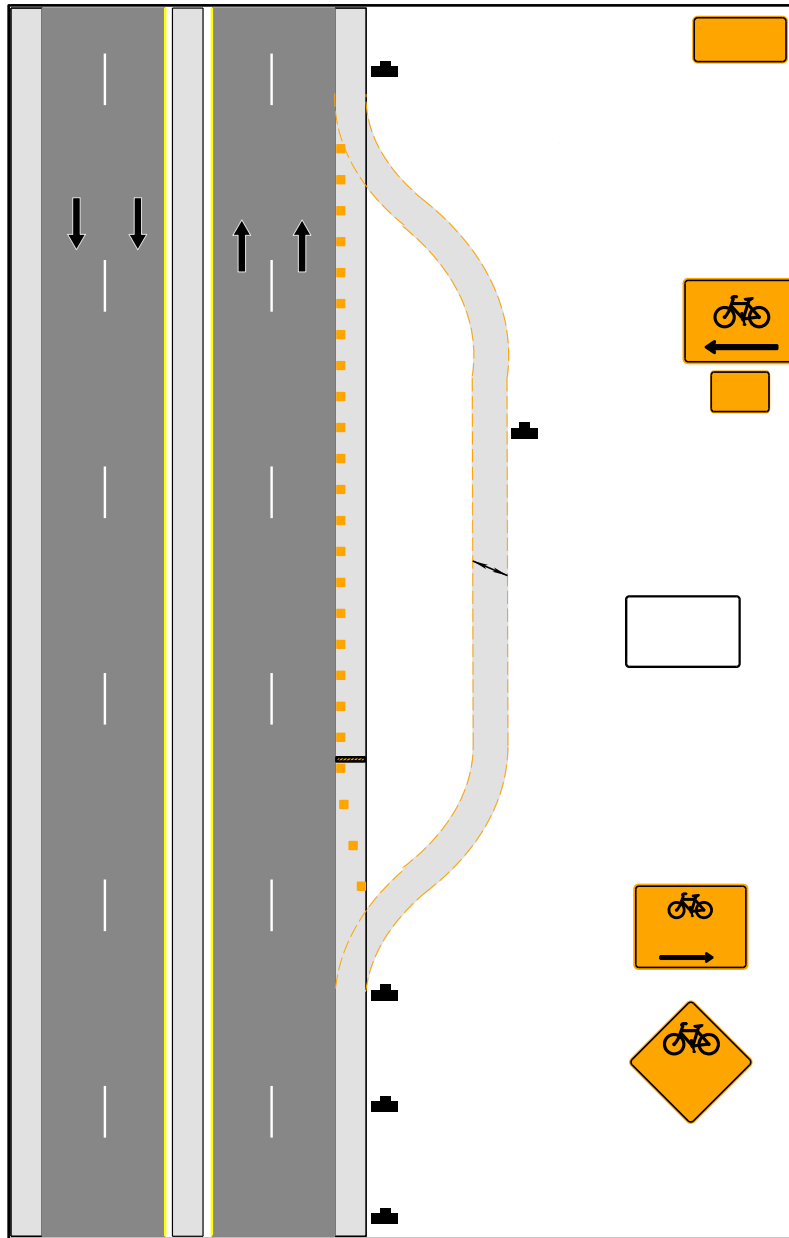

Notes:

1. See Table 6H-3 Meaning of Letter Codes of the MUTCD for the distances A, B and C between signs.
2. See Table 6-H-4 Formulas of the MUTCD for Determining Taper Length for the distance L. Speeds shall be posted speeds.

3. See Table 11 – 4 for the required spacing of channelizing devices.

EF TRANSPORTATION OPERATIONS PLAN ~~WORK ZONE~~ MANAGEMENT

The Transportation Operations Plan (TOP) addresses operations and management of the transportation system in the work zone impact area. ~~Roadwork~~ Management of construction, maintenance, and emergency response operations shall support ~~follow~~ the an appropriate TTCP ~~temporary traffic control plan.~~

F.1 Public Information

~~All reasonable effort should be made to inform the public of the location, duration, and nature of impending roadwork operations. Transit agencies should be given advanced notice of planned operations so they can be responsible for notifying their passengers.~~

EF.12 Contracts and Permits

~~For construction and reconstruction projects, t~~The general work zone layout; planned detours, traffic control and protection procedures; occupational safety and health requirements; and specific traffic control devices required should be incorporated in the contract plans and specifications.

E.1.a Utilities

New utility installations in public rights of way are prohibited unless a permit by the appropriate highway agency with jurisdiction over the facility is issued. Permits for routine maintenance (e.g., deteriorated pole/equipment replacement), minor alterations (e.g., changes in cable, wire, or transformer size), service drops, or emergency work will be determined by the agency with jurisdiction over the facility ~~should generally not be required.~~ Occupational Safety and Health Administration (OSHA) regulations for work zone safety should be reviewed prior to any construction by utility companies involving encroachment into ~~of~~ the transportation facility ~~highway~~ right of way by workers, equipment ~~equipment~~, or material.

E.1.b Wildlife Sensitive Lighting

If lighting is provided in a work zone along coastal roadways where sea turtles may be affected, see Section J of Chapter 6 – Lighting for

requirements and further information. In addition to the resources in Chapter 6, coordinate with the local agencies for additional guidance with providing lighting in work zones.

EF.23 **Inspection and Supervision**

A regular program of inspection and supervision of all construction and maintenance projects shall be established and executed.

F **PUBLIC INFORMATION PLAN**

During construction, the Public Involvement Plan (PIP) serves a public information role, informing people about work zone limits, sidewalk, shared use path or travel lane closures, median changes, detours, business access impacts, work hours, and grand openings. A major function is to provide up-to-date information and solicit concerns to minimize the disruption to residents, businesses, and the traveling public during the construction phase.

Some agencies may hold pre-construction open houses, which can either be formal meetings held in enclosed spaces or informal activities conducted within the project corridor.

Below is a summary of activities which could be included in a PIP:

- Determine need for a project specific public information officer (prior to scope for construction engineering and inspection)
- Handoff meeting from design to construction (after letting)
- Mass mailing of project information flyer/brochure (two to four weeks prior to construction)
- Project information meeting/open house (two to four weeks prior to construction)
- Presentations to other local governments, community groups, or general public as needed
- Construction notices included in weekly traffic report (one week prior and throughout construction)

In addition to traditional public information meetings, some projects may benefit

from other methods such as one-on-one meetings, an up-to-date project website, and social media. Variable message signs (VMS) are routinely used to communicate lane closures and changes in access.

All reasonable effort should be made to inform the public of the location, duration, and nature of impending work. Transit agencies should be given advance notice of planned operations so they can make adjustments in service or routes if needed, and coordinate with passengers.

G EVALUATION OF PROGRAM

The entire program for work zone safety should be periodically evaluated and revised to provide the safest practicable environment for workers, pedestrians, bicyclists, and motorists during roadwork operations.

CHAPTER 12

CONSTRUCTION

A	INTRODUCTION	12-1
B	OBJECTIVES	12-1
C	CONTROL OF THE WORK.....	12-2
C.1	Plans and Contract Documents	12-2
C.1.a	Plans	12-2
C.1.b	Alterations in Plans	12-2
C.1.c	Working Drawings (for Structures).....	12-3
C.1.c.1	General	12-3
C.1.c.2	Submission of Working, Shop, and Erection Drawings	12-3
C.1.c.3	Responsibility for Accuracy of Working Drawings	12-3
C.2	Coordination of Plans, Specifications, and Special Provisions.....	12-4
C.3	Conformity of Work with Plans	12-4
C.4	Conformity of Work Shown in Regulatory Permits	12-5
C.5	Authority of the Construction Engineer.....	12-5
C.6	Engineering and Layout	12-5
C.6.a	Control Points Furnished.....	12-5
C.6.b	Layout of Work.....	12-5
C.6.c	Personnel, Equipment, and Record Requirements	12-5
C.7	Contractor's Supervision	12-6
C.7.a	Prosecution of Work.....	12-6
C.7.b	Contractor's Superintendent	12-6
C.7.c	Supervision for Emergencies	12-6
C.8	General Inspection Requirements.....	12-6
C.8.a	Cooperation by Contractor	12-6
C.8.b	Failure of Construction Engineer to Reject Work During Construction.....	12-7
C.8.c	Qualifications for Services for FDOT Administered Projects.....	12-7

C.9	Final Construction Inspection Maintenance until Final Acceptance ...	12-7
D	CONTROL OF MATERIALS.....	12-7
D.1	Source of Supply and Quality Requirements	12-7
D.1.a	Only Approved Materials to be Used	12-7
D.2	Inspection and Tests at Source of Supply.....	12-8
D.2.a	General	12-8
D.2.b	Cooperation by Contractor	12-8
D.3	Control by Samples and Tests	12-8
D.3.a	Materials to be Tested, Samples.....	12-8
D.3.b	Applicable Standards	12-8
D.4	Quality Control System	12-9
D.4.a	General Requirements	12-9
D.4.b	Documentation.....	12-9
D.4.c	Corrective Actions	12-9

CHAPTER 12

CONSTRUCTION

A INTRODUCTION

The purpose of this chapter is to establish guidelines for field procedures, as they pertain to control of construction projects, supervision, and contract administration. All construction projects require an inspection process to administer the contract, to certify the project has been constructed within reasonable conformance with the plans/specifications, and the materials which were incorporated into the project were properly tested/certified.

All construction projects require:

- An inspection procedure to administer the contract
- Certification

The Engineer of Record (EOR) is a Professional Engineer registered in the State of Florida that develops the criteria and concept for the project, performs the analysis, and is responsible for the preparation of the Plans and Specifications. The Maintaining Authority's Engineer of Record may be in-house staff or a consultant.

The Construction Engineer (CE) is a Professional Engineer registered in the State of Florida that supervises the construction of the project. The Maintaining Authority's Construction Engineer or Designee may assign in-house staff or a consultant to act on their behalf.

B OBJECTIVES

Construction of street and highway facilities is the result of the effort, of the engineer, the contractor, and the owner. Minimum construction standards shall be followed to provide for proper implementation of the design. The following general objectives for roadway construction should be followed to ensure proper construction:

- All construction performed and all materials utilized shall be in reasonably close conformity with the construction plans and contract documents.

- The responsibilities and obligations of the owner, engineer, and contractor should be clearly defined.
- A safe working environment shall be provided in accordance with **Chapter 11 – Work Zone Safety and Mobility**.
- Adequate procedures through established methods of sampling and testing shall be implemented to provide for the control and placement of materials.

C CONTROL OF THE WORK

C.1 Plans and Contract Documents

The Contractor will be furnished an appropriate number of copies of the plans and special provisions as required for the particular project. The Contractor shall have available at the work site, at all times, one copy each of the plans (including relevant Design Standards), Specifications, and Special Provisions.

C.1.a Plans

The plans furnished consist of general drawings showing such details which are necessary to give a comprehensive idea of the construction contemplated. Roadway plans will show, in general, alignment, profile grades, typical cross sections, and general cross sections as necessary. Structure plans, in general, will show in detail all dimensions of the work contemplated.

C.1.b Alterations in Plans

No changes shall be made on any plan or drawing after it is approved by the EOR Engineer, except as authorized in writing by the EOR Engineer. Minor changes may be approved by the Construction Engineer in consultation with the EOR.

All authorized alterations affecting the requirements and information given on the approved plans shall be in writing.

C.1.c Working Drawings (for Structures)

C.1.c.1 General

The Contractor shall furnish such working, shop, and erection drawings, as may be required, to complete the structure in compliance with the design shown on the plans.

C.1.c.2 Submission of Working, Shop, and Erection Drawings

All working, shop, and erection drawings prepared by the Contractor or his agents (subcontractor, fabricator, supplier, etc.) shall be reviewed, dated, stamped, approved, and signed by the Contractor prior to submission to the ~~EOR~~Engineer of Record for review. The Contractor's signed approval of drawings submitted shall confirm he/she has verified the work requirements, field measurements, construction criteria, sequence of assembly and erection, access and clearances, catalog numbers, and other similar data. Each series of drawings shall indicate the specification section and page or drawing number of the contract plans to which the submission applies. The Contractor shall indicate on the working, shop, and erections drawings all deviations from the contract drawings and shall itemize all deviations in his letter of transmittal.

C.1.c.3 Responsibility for Accuracy of Working Drawings

It is understood that approval by the ~~EOR~~Engineer of the Contractor's working drawings does not relieve the Contractor of any responsibility for accuracy of dimensions and details, or for conformity of dimensions and details. The Contractor shall be responsible for agreement and conformity of his working drawings with the approved plans and specifications.

C.2 Coordination of Plans, Specifications, and Special Provisions

The specifications, plans, special provisions, and all supplemental documents are integral parts of the contract, and a requirement occurring in one is as binding as though occurring in all. They are to be complementary and to describe and provide for a complete work.

In cases of discrepancy, the governing order of the documents shall be as follows:

- Special Provisions
- Plans
- Standard Drawings
- Specifications

C.3 Conformity of Work with Plans

All work performed and all materials furnished shall be in reasonably close conformity with the lines, grades, cross sections, dimensions, and material requirements, including tolerances, shown on the plans or indicated in the specifications.

In the event the ~~CE Construction Engineer~~ finds the materials or the finished product in which the materials are used not within reasonably close conformity with the plans and specifications, but reasonably acceptable work has been produced, he/she shall then make a determination if the work shall be accepted and remain in place. In this event, the ~~CE Engineer~~ will document the basis of acceptance by contract modification which will provide for an appropriate adjustment in the contract price for such work or materials as he deems necessary to conform to his determination based on engineering judgment.

In the event the ~~CE Engineer~~ finds the materials, or the finished product in which the materials are used, or the work performed, are not in reasonably close conformity with the plans and specifications and have resulted in an inferior or unsatisfactory product, the work or materials shall be removed and replaced or otherwise corrected by and at the expense of the Contractor.

C.4 Conformity of Work Shown in Regulatory Permits

All work shall be accomplished in accordance with special conditions of the regulatory permits.

C.5 Authority of the Construction Engineer

All work shall be performed to the satisfaction of the CEEngineer.

C.6 Engineering and Layout

C.6.a Control Points Furnished

Horizontal and vertical control points are required at appropriate intervals along the line of the project to facilitate the proper layout of the work. The Contractor shall preserve all control points furnished.

C.6.b Layout of Work

Utilizing the control points furnished, all horizontal and vertical controls shall be established as necessary to construct the work in conformance with the plans and specifications. The work shall include performing all calculations required and setting all stakes needed, such as grade stakes, offset stakes, reference point stakes, slope stakes, and other reference marks or points necessary to provide lines and grades for construction of all roadway, bridge, and miscellaneous items.

C.6.c Personnel, Equipment, and Record Requirements

The Contractor shall employ only competent personnel and utilize only suitable equipment in performing layout work.

Adequate field notes and records shall be kept as layout work is accomplished. These field notes and records shall be available for review by the CEEngineer as the work progresses and copies shall be furnished to the CEEngineer at the time of completion of the project. Any inspection or checking of the Contractor's field notes or layout work by the CEEngineer, and the acceptance of all or any part thereof, shall not relieve the Contractor of his responsibility to achieve the lines, grades, and dimensions shown in the plans and specifications.

C.7 Contractor's Supervision

C.7.a Prosecution of Work

The Contractor shall give the work the constant attention necessary to assure the scheduled progress and shall cooperate fully with the CEEngineer and with other contractors at work in the vicinity.

C.7.b Contractor's Superintendent

The Contractor shall at all times have on the work site, as his/her agent, a competent superintendent capable of thoroughly interpreting the plans and specifications and thoroughly experienced in the type of work being performed, and who shall receive the instructions from the CEEngineer or his/her authorized representatives. The superintendent shall have full authority to execute the orders or directions of the CEEngineer and to supply promptly any materials, tools, equipment, labor, and incidentals which may be required. Such superintendence shall be furnished regardless of the amount of work sublet.

C.7.c Supervision for Emergencies

The Contractor shall have a responsible person available at or reasonably near the work site on a twenty-four hour basis, seven days a week, in order that he/she may be contacted in emergencies and in cases where immediate action must be taken to maintain traffic or to handle any other problems that might arise. The Contractor shall be responsible for initiating, installing, and maintaining all traffic control devices as described in **Chapter 11 – Work Zone Safety and Mobility** and in the plans.

C.8 General Inspection Requirements

C.8.a Cooperation by Contractor

No work shall be done nor materials used without suitable supervision or inspection by the CEEngineer. The Contractor shall furnish the CEEngineer with every reasonable facility for ascertaining whether the work performed and materials used are in accordance with the requirements and intent of the plans and specifications.

C.8.b Failure of Construction Engineer to Reject Work During Construction

If, during or prior to construction operations, the CEEngineer should fail to reject defective work or materials, whether from lack of discovery of such defect or for any reason, such initial failure to reject shall in no way prevent his/her later rejection when such defect is discovered.

C.8.c Qualifications for Services for FDOT Administered Projects

For projects administered by a local government that are wholly or partially funded by the FDOT, there are limitations on who may perform design, and Construction Engineering and Inspection services (CEI). See [F.S. 337.14 \(7\) Application for qualification; certificate of qualification; restrictions, request for hearing](#) for more information.

C.9 Final Construction Inspection Maintenance until Final Acceptance

The Contractor shall maintain all work in first-class condition until it has been completed as a whole and has been accepted by the CEEngineer. When all materials have been furnished, all work has been performed, and the construction contemplated by the contract has been satisfactorily completed, the CEEngineer will make the final inspection.

D CONTROL OF MATERIALS

D.1 Source of Supply and Quality Requirements

D.1.a Only Approved Materials to be Used

Only materials conforming to the requirements of the specifications and approved by the Engineer shall be used in the work. Any materials proposed for use may be inspected or tested at any time during their preparation and use. No material which, after approval, has in any way become unfit for use, shall be used in the work.

D.2 Inspection and Tests at Source of Supply

D.2.a General

The CEEngineer may undertake the inspection of materials at the source of supply.

D.2.b Cooperation by Contractor

The Contractor shall assure the CEEngineer has free entry at all times to such parts of the plant as concern the manufacture or production of the materials ordered, and shall bear all costs incurred in providing all reasonable facilities to assist in determining whether the material furnished complies with the requirements of the specifications.

D.3 Control by Samples and Tests

D.3.a Materials to be Tested, Samples

The CEEngineer may require any or all materials to be subjected to tests by means of samples or otherwise, at production points, after delivery, or both, as he/she may determine.

D.3.b Applicable Standards

Methods of sampling and testing materials shall conform to the CEEngineer's requirements and should be in accordance with **Florida Sampling and Testing Methods (FSTM)** so far as covered therein. Otherwise, they should be in accordance with Standards of AASHTO, ASTM, or other criteria as specifically designated by the CEEngineer. Where an AASHTO, ASTM, or other non-Florida Method is designated, but a Florida Method which is similar exists, sampling and testing should be in accordance with the Florida Method.

Whenever in these Specifications, FSTM, AASHTO, ASTM, or other standards are referenced without identification of the specific time of issuance, the reference should be construed to mean the most current issuance, including interims or addendums thereto, at the time of advertisement for bids for a project.

D.4 Quality Control System

D.4.a General Requirements

The Contractor shall furnish and maintain a quality control system that will provide reasonable assurance that all materials and products submitted for acceptance conform to the contract requirements, whether manufactured or processed by the Contractor or procured from suppliers or subcontractors. The Contractor shall perform or have performed the inspection and tests required to substantiate product conformance to contract requirements and shall also perform or have performed all inspections and tests otherwise required by the contract.

D.4.b Documentation

The Contractor shall maintain adequate records of all inspections and tests. The records shall indicate the nature and number of tests made, the number and type of deficiencies found, the quantities approved and rejected, and the nature of corrective action taken, as appropriate.

D.4.c Corrective Actions

The Contractor shall take prompt action to correct any errors, equipment malfunctions, process changes, or other assignable causes which have resulted or could result in the submission of materials, products, and completed construction which do not conform to the requirements of the specifications.

THIS PAGE INTENTIONALLY LEFT BLANK

CHAPTER 13

PUBLIC TRANSIT

A	INTRODUCTION.....	13-1
B	OBJECTIVE.....	13-2
C	TRANSIT COMPONENTS.....	13-3
C.1	Boarding and Alighting (B&A) Areas	13-3
	Figure 13 – 1 Boarding and Alighting Area for Flush Shoulder Roadways with Connection to the Roadway	13-4
	Figure 13 – 2 Boarding and Alighting Area for Flush Shoulder Roadways with Connection to the Sidewalk.....	13-5
C.2	Shelters.....	13-6
	Figure 13 – 3 Bus Shelter Location	13-6
C.3	Benches	13-7
C.4	Stops and Station Areas	13-7
C.5	Bus Bays (Pullout or Turnout Bays)	13-7
D	PUBLIC TRANSIT FACILITIES	13-7
D.1.	Curb-Side Facilities	13-8
D.2	Street-Side Facilities	13-8
D.3	Bus Stop Lighting	13-8
	Figure 13 – 4 Bus Stop Locations	13-9
E	REFERENCES FOR INFORMATIONAL PURPOSES	13-10

FIGURES

Figure 13 – 1	Boarding and Alighting Area for Flush Shoulder Roadways with Connection to the Roadway	13-4
Figure 13 – 2	Boarding and Alighting Area for Flush Shoulder Roadways with Connection to the Sidewalk.....	13-5
Figure 13 – 3	Bus Shelter Location	13-6
Figure 13 – 4	Bus Stop Locations.....	13-9

CHAPTER 13

PUBLIC TRANSIT

A INTRODUCTION

All modes of transportation (autos, trucks, transit vehicles, rails, aircraft, water craft, bicyclists, and pedestrians) ~~shall~~^{should} be considered when planning, designing, and constructing the surface transportation system. Where there is a demand for highways to serve vehicles, there could also be a demand for public transit or public transportation. Public transit should be considered in all phases of a project, including planning, preliminary design and engineering, design, construction, and maintenance. Coordination with the appropriate public transit provider(s) will help determine the need for transit related infrastructure on a project-by-project basis. The integration of public transit street side facilities along with pedestrian and bicycle facilities furthers the implementation of this goal.

Planning and designing for public transit is important because it is an integral part of the overall surface transportation system. Public transit is defined as passenger transportation service, local or regional in nature, which is available to any person. It operates on established schedules along designated routes or lines with specific stops and is designed to move relatively large numbers of people at one time. Public transit includes bus, light rail, street cars, bus rapid transit and paratransit.

With rising levels of congestion resulting in the use of new strategies to effectively and efficiently manage mobility, there is an increased demand for accessible and user friendly public transit. New strategies include increased emphasis on public transit and new emphasis on Transportation System Management (TSM), as well as Transportation Demand Management (TDM). TSM is the use of low cost capital improvements to increase the efficiency of roadways and transit services such as; retiming traffic signals or predestinating traffic flow. TDM focuses on people reducing the number of personal vehicle trips, especially during peak periods. TDM includes the promotion of alternatives to the single occupant vehicle, including public transportation, carpooling, vanpooling, bicycling, walking, and telecommuting, as well as other methods for reducing peak hour travel.

Federal and State legislation provide the stimulus for planning, designing, and constructing a fully integrated transportation system benefiting the traveling public and

the environment. Examples of legislation include [*Fixing America's Surface Transportation Act \(FAST Act\)*](#), [*Americans with Disabilities Act of 1990 \(ADA\)*](#), and [*Clean Air Act Amendment of 1990 \(CAAA\)*](#). In response to this legislation, the surface transportation system should provide for concurrent use by automobiles, public transit and rail, bicycles, and pedestrians.

B OBJECTIVE

There are ~~a number of~~[several](#) methods to efficiently develop a coordinated surface transportation system. Coordination among agencies is necessary during the planning and design stages to:

- incorporate transit needs and during the construction phase for re-routing bus (and complementary pedestrian) movements, and
- for actual transit agency specific requirements (e.g., bus stop sign replacement, shelter installations, etc.).

For planning purposes, the state and local Transportation Improvement Program (TIP) should be referenced. Additionally, individual transit authorities have ten-year Transit Development Plans (TDPs) that are updated annually. The TDP can be used as a guide for planned transit needs along existing and new transportation corridors so transit consideration and transit enhancements can be incorporated where appropriate.

C TRANSIT COMPONENTS

C.1 Boarding and Alighting (B&A) Areas

Boarding and Alighting (B&A) areas help to create an accessible bus stop by providing a raised platform that is compatible with a bus that kneels or extends a ramp. A B&A area has a firm, stable and slip-resistant surface with a minimum clear length of 8.0 feet (measured perpendicular to the curb or roadway edge), and a minimum clear width of 5.0 feet (measured parallel to the roadway). Firm, stable, and slip resistant B&A areas are required if amenities such as benches or shelters are added to a bus stop. B&A areas are not required at bus stops on flush shoulder roadways where only a bus stop sign is provided. Coordinate with the appropriate public transit provider(s) to determine compatibility with equipment and transit vehicles.

The slope of the B&A area parallel to the roadway shall to the extent practicable, be the same as the roadway. For water drainage, a maximum slope of ~~4:50 (2%)~~ perpendicular to the roadway is allowed. Benches and other site amenities shall not be placed on the B&A area. The B&A area can be located either within or outside the shelter, and shall be connected to streets, sidewalks, or pedestrian circulation paths by an accessible route.

On flush shoulder roadways, a B&A area may be constructed at the shoulder point (or edge of shoulder pavement on roadways with a design speed of 45 mph or less) as shown in Figures 13 – 1 and 13 – 2 Boarding and Alighting Area for Flush Shoulder Roadways. A Type “E” curb (5” curb height) should be used.

A sidewalk and/or ramp provided with the B&A area shall be a minimum of 5 feet in width, and the ramp shall not exceed a slope of 1:12. A detectable warning is required where a sidewalk associated with a B&A area connects to the roadway at grade. Except for the area adjacent to the 5” curb, the areas surrounding the B&A area shall be flush with the adjacent shoulder and side slopes and designed to be traversable by errant vehicles. On the upstream side of the platform, a maximum slope of 1:12 should be provided, and may be grass or a hardened surface. The B&A area (and ramp and level landing if needed) should be constructed with 6” thick concrete.

Figure 13 – 1 Boarding and Alighting Area for Flush Shoulder Roadways with Connection to the Roadway

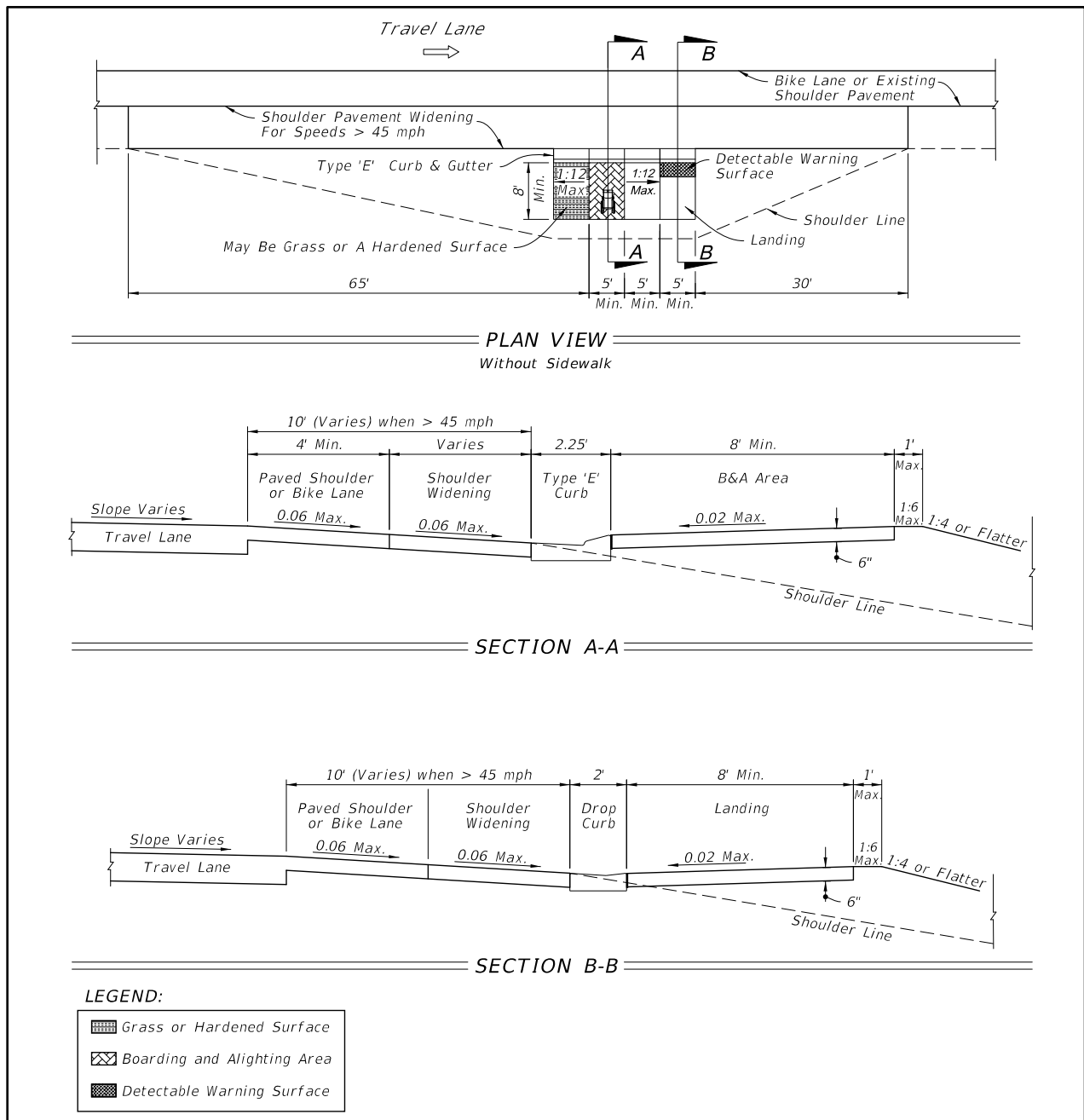
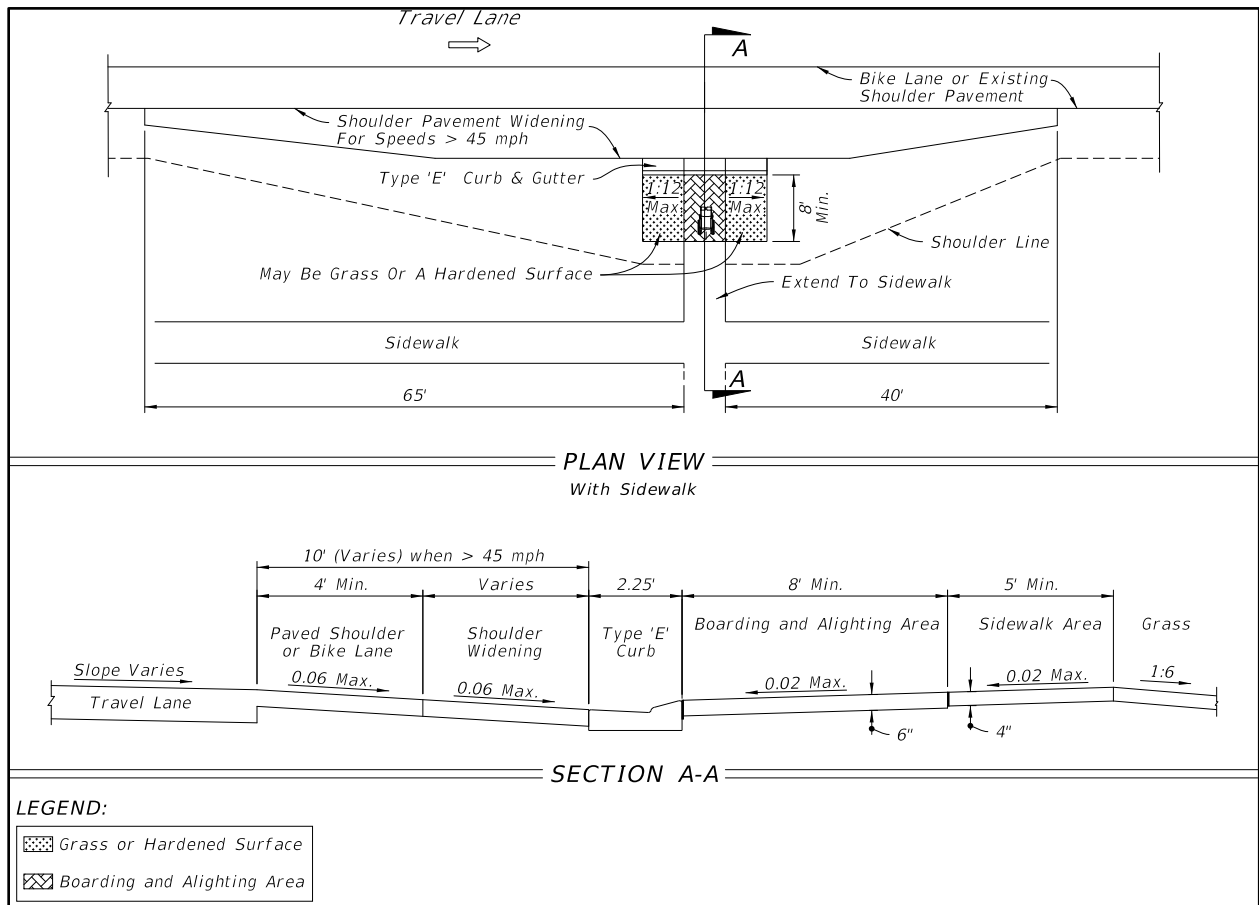

Figure 13 – 2 Boarding and Alighting Area for Flush Shoulder Roadways with Connection to the Sidewalk



C.2 Shelters

Every public transit system has different needs with regards to shelters and corresponding amenities (e.g., benches, information kiosks, leaning posts, trash receptacles, etc.). Shelter foundation and associated pad size vary from stop to stop based on right of way availability, line of sight, and facility usage. New or replaced bus shelters shall be installed or positioned to provide an accessible route from the public way (sidewalk or roadway) to reach a location that has a minimum clear floor area of 30 inches by 48 inches, entirely within the perimeter of the shelter.

Shelters shall be connected by an accessible route to a B&A area. Coordinate with the appropriate public transit provider(s). Where feasible, shelters should provide a location for a bicycle rack. Shelters should be installed at locations where demand warrants installation and in accordance with clear zone criteria in **Chapter 3 – Geometric Design, Section C.10.e** Bus Benches and Transit Shelters and **Chapter 4 – Roadside Design**, Table 4 – ~~24~~ **Lateral Offset** **Minimum Width of Clear Zone** of this Manual.

Figure 13 – 3 Bus Shelter Location

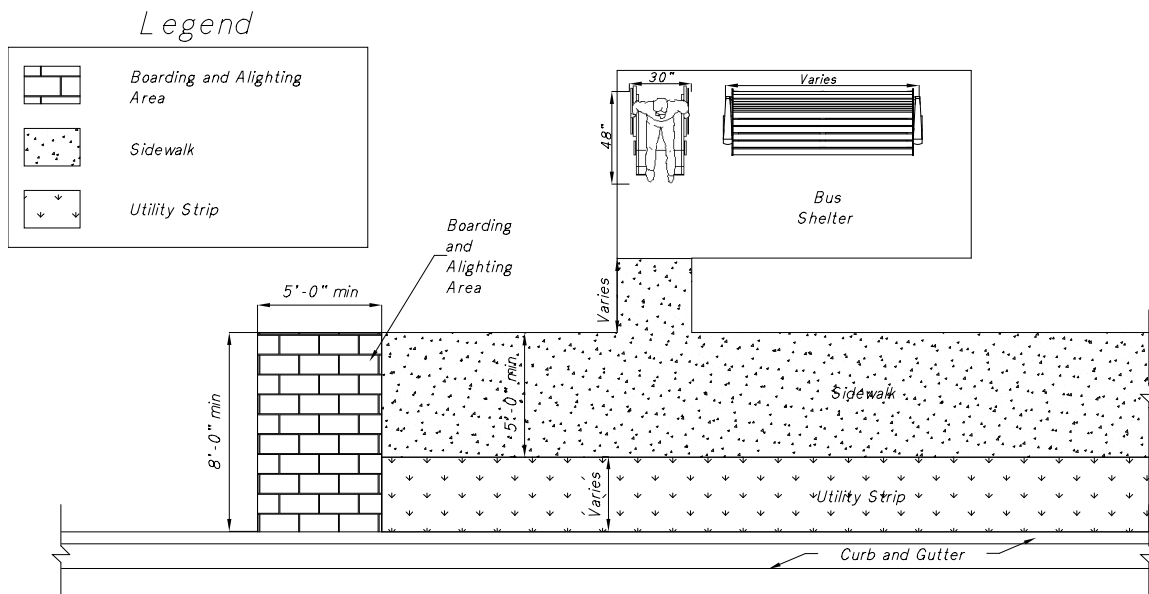

C.3 Benches

If a bench is provided, it should be on an accessible route, out of the path of travel on a sidewalk. Benches shall have an adjacent firm, stable and slip-resistant surface at least 30 inches wide and 48 inches deep to allow a user of a wheelchair to sit next to the bench, permitting the user shoulder-to-shoulder seating with a companion. Connection between the bench, sidewalk and/or bus B&A area shall be provided. Coordinate with the local public transit provider(s).

C.4 Stops and Station Areas

Transit stops should be located so that there is a level and stable surface for boarding vehicles. Locating transit stops at signalized intersections increases the usability for pedestrians with disabilities.

C.5 Bus Bays (Pullout or Turnout Bays)

Bus bays for transit vehicles may be necessary (e.g., extended dwell time, layover needs, safety reasons, high volumes or speed of traffic.). Bus bays can be designed for one or more buses. Coordinate with the local public transit provider(s) to determine the need for bus bays. When possible, bus bays should be located on the far side of a signalized intersection. The traffic signal will create the critical gap needed for bus re-entry into traffic. There are several publications available which provide additional design information for transit system applications. The ~~FDOT Department~~ District Public Transportation Office(s) maintains a library of these publications.

D PUBLIC TRANSIT FACILITIES

When a project includes a public transit route, curb-side and street-side transit facilities for bus stops should be considered in the roadway design process. Transit facilities shall comply with [Chapter 14-20, Florida Administrative Code](#).

The “Accessing Transit: Design Handbook for Florida Bus Passenger Facilities” provides guidance relating to provisions for curb-side and street-side facilities.

D.1. Curb-Side Facilities

Curb-side facilities are the most common, simple, and convenient form of facilities at a bus stop. These include bus stop signs, shelters, bus stop B&A areas, benches, bike racks, leaning rails, and shelter lighting. “Accessing Transit” provides additional details and guidelines for each type of transit facility. Coordinate with the appropriate public transit provider(s) to determine the appropriate type and placement of amenities.

D.2 Street-Side Facilities

Bus stop locations can be categorized as far side, near side and mid-block stops. Bus stops may be designed with a bus bay or pullout to allow buses to pick up and discharge passengers in an area outside of the travel lane. This design feature allows traffic to flow freely without the obstruction of stopped buses. Far side bus stops and bays are preferred. See [Accessing Transit, Version 3 \(2013\)](#) and [Accessing Transit Update \(2017\)](#) for a more detailed discussion of the location of the bus stop or bay.

Bus bays can be closed-ended, open-ended, or nubs/bulbs, and can be positioned near-side, far-side, or mid-block in relation to an intersection, as illustrated in Figure [1323 – 3 Bus Shelter Location](#). The total length of the bus bay should allow room for an entrance taper, a stopping area, and an exit taper as a minimum. However, in some cases it may be appropriate to consider providing acceleration and deceleration lanes depending on the volume and speed of the through traffic. This decision should be based upon site specific conditions. “Accessing Transit” provides detailed bus bay dimensions for consideration with various right of way and access conditions.

D.3 Bus Stop Lighting

Lighting design for bus stops should meet the same criteria for minimum illumination levels, uniformity ratios and max-to-min ratios that are being applied to the adjoining roadway based on **Chapter 6 – Lighting** of this Manual. If lighting is not provided for the adjoining roadway, coordinate with the transit agency to determine if lighting should be provided for the bus stop area, particularly when night transit services are provided. A decision to install lighting for the adjoining bus stop area may include illumination of the bus bay pavement area. The use of solar panel lighting for bus stops is another option that should be considered.

Figure 13 – 4 Bus Stop Locations

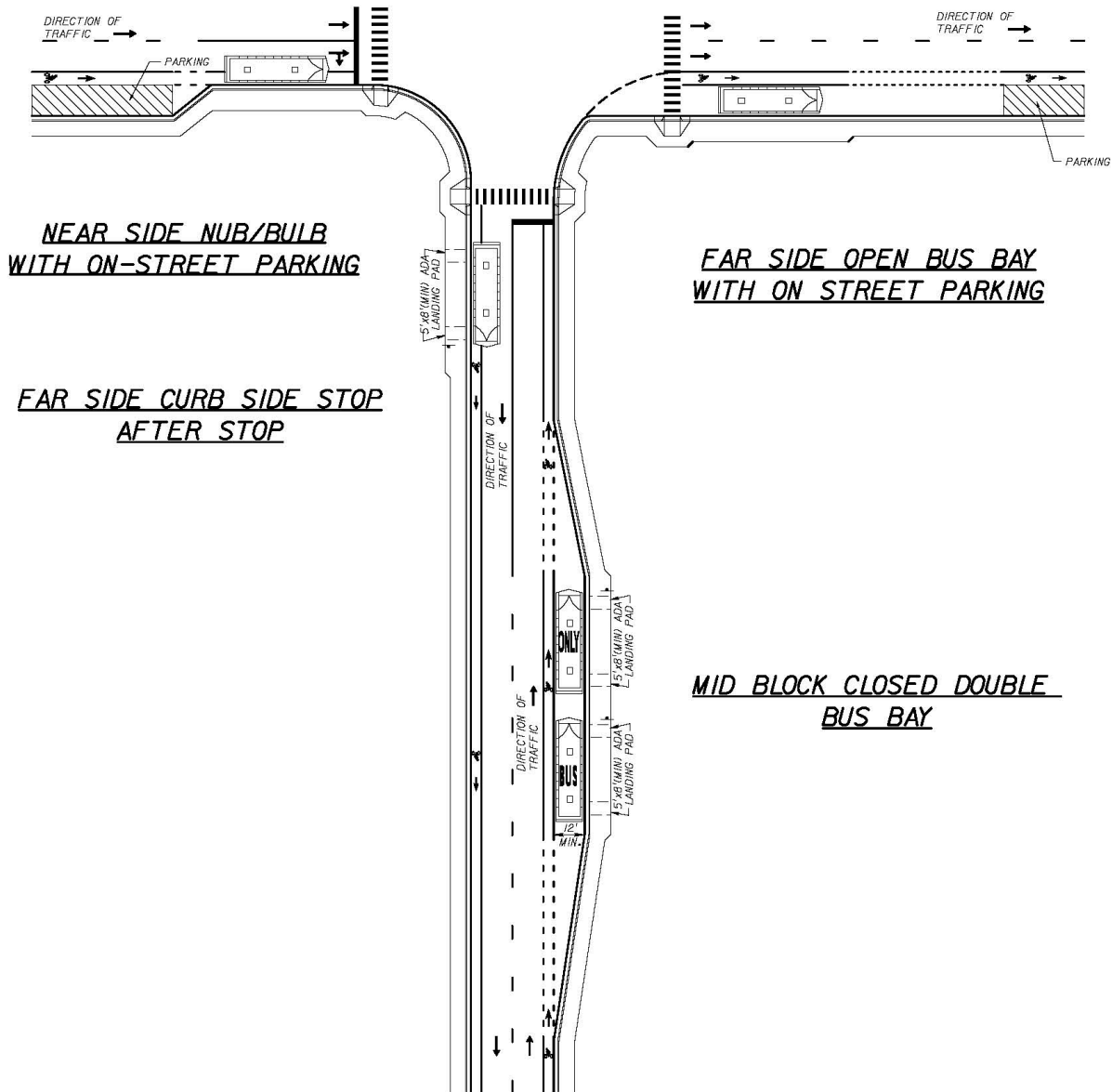

E REFERENCES FOR INFORMATIONAL PURPOSES

The following is a list of publications that may be referenced for further guidance:

- FDOT's Accessing Transit, Design Handbook for Florida Bus Passenger Facilities, Version III, 2013
<http://www.fdot.gov/transit/>
- TCPR Report 155 – Track Design Handbook for Light Rail Transit, Second Edition
http://onlinepubs.trb.org/onlinepubs/tcrp/tcrp_rpt_155.pdf
- Central Florida Commuter Rail Transit Project, Design Criteria – Phase 2 South RFP
~~<https://corporate.sunrail.com/wp-content/uploads/2015/06/P2S-RFP-Design-Criteria-06-15-15.pdf>~~ <http://corporate.sunrail.com/wp-content/uploads/2015/06/P2S-RFP-Design-Criteria-06-15-15.pdf>
- Transit facilities shall comply with Chapter 14-20, Florida Administrative Code, Private Use of Right of Way
<https://www.flrules.org/gateway/ChapterHome.asp?Chapter=14-20>

THIS PAGE INTENTIONALLY LEFT BLANK

CHAPTER 14

DESIGN EXCEPTIONS AND VARIATIONS

A	GENERAL	14-1
B	RECOMMENDATIONS FOR APPROVAL	14-3
C	COORDINATION.....	14-3
D	JUSTIFICATION FOR APPROVAL	14-4
E	DOCUMENTATION FOR APPROVAL OF DESIGN EXCEPTIONS	14-5
F	DOCUMENTATION FOR APPROVAL OF DESIGN VARIATIONS.....	14-8
G	FINAL PROCESSING OF DESIGN EXCEPTIONS AND VARIATIONS.....	14-9

EXHIBITS

Exhibit 14-A	Sample Request Letter for Design Exception or Variation	14-10
--------------	---	-------

THIS PAGE INTENTIONALLY LEFT BLANK

CHAPTER 14

DESIGN EXCEPTIONS AND VARIATIONS

A GENERAL

Uniform minimum standards for design, construction, and maintenance for streets and highways are contained in this Manual and meet or exceed the minimum values established by AASHTO. Consequently, the values given govern the design process. When it becomes necessary to deviate from the Manual's criteria, early documentation and approval are required.

Design Exceptions are required when existing or proposed design elements are below both the criteria in this Manual and AASHTO's new construction criteria for the following Controlling Design Elements.

For projects using safety funds and developed to improve specific safety problems, only the elements identified under the scope of work for the safety improvement project are subject to these approval processes. Existing non-compliant features, within the limits of a safety improvement project do not require approval to remain if the project does not create a non-compliant condition. The Safety Study must identify all applicable Design Exceptions and Variations required based on the proposed scope. For these projects, all applicable Design Exceptions and Variations must be approved prior to the beginning of the design phase.

For drainage projects, only elements identified in the scope of services for the drainage project are subject to these approval processes. The existing features, within the limits of the drainage project that do not meet design criteria, do not require approval to remain (if the project does not create a nonconforming condition).

For landscape-only projects, intersection sight distance Design Variations may be processed by the Responsible Landscape Architect of Record. For design projects with landscaping, intersection sight distance Design Variations must be processed by a Professional Engineer. In cases where intersection sight distance falls below stopping sight distance, a Design Exception for stopping sight distance must be processed by the respective professional.

Maintenance Resurfacing, Ride Only (a.k.a., Ride Rehabilitation) and Skid Hazard Projects do not require Design Exceptions or Variations other than for accessible curb

ramp or blended transition requirements. If compliance with accessible curb ramp or blended transition requirements is determined to be technically infeasible, documentation as a Design Variation is required.

The 10 Controlling Design Elements for high speed (Design Speed \geq 50 mph) roadways are:

- Design Speed
- Lane Width
- Shoulder Width
- Horizontal Curve Radius
- Superelevation Rate
- Stopping Sight Distance
- Maximum Grade
- Cross Slope
- Vertical Clearance
- Design Loading Structural Capacity

The 2 Controlling Design Elements for low speed (Design Speed $<$ 50 mph) roadways are:

- Design Speed
- Design Loading Structural Capacity

When proposed design elements other than the Controlling Elements do not meet the criteria contained in this Manual, sufficient detail and justification of such deviations must be documented by the Responsible Professional Engineer as a Design Variation and submitted to the municipality or county.

This chapter provides the process for documentation and approval of Design Exceptions and Variations. The approved Design Exception or Variation submittal should be included in the project file to clearly document the action taken and the approval given.

~~Projects that comply with design criteria for local subdivision roads and/or residential streets adopted by ordinance do not require a Design Exception or.~~

B RECOMMENDATIONS FOR APPROVAL

Design Exceptions and Variations are recommended by the Professional Engineer responsible for the project design element (Responsible Professional Engineer). All Design Exceptions and Variations require approval from the Maintaining Authority's Professional Engineer or Designee.

For additional information on the process to be followed for a Design Exception or Variation that involves a state facility or located on the National Highway System (NHS), please see [the *FDOT's Design Manual, Chapter 122 Design Exceptions and Design Variations.*](#)

C COORDINATION

In order to allow time to research alternatives and begin analysis and documentation activities, it is critical that Design Exceptions and Variations be identified as early in the process as possible. This is preferably done during the planning phases of projects or as soon as possible during initial design.

When the need for a Design Exception or Variation has been determined, the Responsible Professional Engineer must coordinate with the Maintaining Authority's Professional Engineer or Designee and [FDOT](#)~~the Department~~ (if applicable), to obtain conceptual concurrence and provide any requested documentation.

[FDOT](#) ~~The Department~~ will be involved only if the proposed design on the local (Non-State Highway System (SHS)) roadway is part of an [FDOT](#)~~Department~~ project. For example, an [FDOT](#)~~Department~~ project for a roadway on the SHS includes work on the adjacent local roads, or an [FDOT](#)~~Department~~ project is exclusively on a local (Non-SHS) roadway. In these cases, the [FDOT](#) District Design Engineer will be listed for "concurrence" in the Design Exception or Variation request letter.

D JUSTIFICATION FOR APPROVAL

Sufficient detail and explanation must be given in order for the Maintaining Authority's Professional Engineer or Designee to approve the request for a Design Exception or Variation. The 10 Controlling Design Elements are considered to have significant effects on safety and the strongest case possible must be made if the designer is not able to meet these requirements. All deviations below the minimum criteria and standards in this Manual must be uniquely identified, located, and justified.

A strong case can be made if it can be shown that:

- The required criteria are not applicable to the site specific conditions.
- The project can be as safe by not following the criteria.
- The environmental or community needs prohibit meeting criteria.

Most often a case is made by showing the required criteria are impractical and the proposed design wisely balances all design impacts. The impacts required for documentation are:

- Safety and Operational performance
- Level of Service
- Right of Way impacts
- Community impacts
- Environmental impacts
- Costs
- Usability by all modes of transportation
- Long term and cumulative effects on adjacent sections of roadway

A case should not be made based solely on the basis that:

- ~~Money can be saved~~The Department can save money.
- ~~Time can be saved~~The Department can save time.
- The proposed design is similar to other designs.

E DOCUMENTATION FOR APPROVAL OF DESIGN EXCEPTIONS

Supporting documentation that is generated during the approval process is to accompany each submittal. Design Exceptions should include the following documentation:

1. Submittal/Approval Letter (Example shown in Exhibit 14-A)
2. Project Description:
 - a) General project information, location map, existing roadway characteristics, project limits (mileposts), county section number, work mix, objectives, and obstacles.
 - b) Associated or future limitations that exist as a result of public or legal commitments.
3. Project Schedule and Lifespan:
 - a) Letting date and other important production dates associated with the project.
 - b) Discussion of whether the deficiency is a temporary or permanent condition.
 - c) Future work planned or programmed to address the condition.
4. Exception Description:
 - a) Specific design criteria that will not be met (AASHTO, Florida Greenbook) and a detailed explanation of why the criteria or standard cannot be complied with or is not applicable.
 - b) Proposed value for the project or location and why it is appropriate.
 - c) Plan view, plan sheet, or aerial photo of the location, showing right of way lines and parcel lines of adjacent property.
 - d) Photo of the area of the deficiency.
 - e) Typical section or cross-section.
 - f) Milepost or station location.
5. Alternative Designs Considered:
 - a) Meeting AASHTO or Florida Greenbook criteria, partial correction, and the no-

build (existing) condition.

6. Impacts of the Exception:

a) Safety Performance:

- Anticipated impact on safety, long and short term effects and of any anticipated cumulative effects.
- Summary of the most recent 5-year crash history including any pertinent crash reports.

b) Operational Performance:

- Description of the anticipated impact on operations (long and short term effects) and any anticipated cumulative effects.
- Summary of the amount and character of traffic using the facility.
- Compatibility of the design with adjacent sections of roadway.
- Effects on capacity and Level of Service (proposed criteria vs. AASHTO)

c) Right-of-way

d) Community

e) Environment

f) Usability by all modes of transportation

7. Anticipated Costs:

- a) Description of the anticipated costs (design, right of way, construction, maintenance).

8. Mitigation Measures:

- a) Practical mitigation measures or alternatives that were considered and any selected treatments implemented on the project.

9. Summary and Conclusions

When preparing a Design Exception, the Responsible Professional Engineer should consider potential mitigation strategies that may reduce the adverse impacts to highway safety and traffic operations. Please refer to the [***FHWA Mitigation Strategies for Design Exceptions \(July 2007\)***](#) for examples of mitigation strategies. The [***Highway Safety***](#)

[Manual \(HSM\)](#) and [Highway Capacity Manual](#) provide information on quantifying and evaluating highway safety performance.

Benefit/Cost Analysis:

Calculate a benefit/cost analysis which estimates the cost effectiveness of correcting or mitigating a substandard design element. The “benefit” is the expected reduction in future crash costs and the “cost” is the direct construction and maintenance costs associated with the design. These costs are calculated and annualized so that direct comparison of alternate designs can be made.

A benefit/cost ratio equal to or greater than 1.0 indicates it may be cost effective to implement a particular design; however, the final decision is a management decision which considers all factors and applies sound engineering judgement. Key factors in the analysis are:

- a) Evaluation of crashes by type and cause
- b) Estimate of crash costs (based on property damage and severity of injuries)
- c) Selection of a crash reduction factor based on proposed mitigation strategy
- d) Selection of a discount rate (typically 4% for roadway projects)
- e) Estimate of construction and maintenance costs
- f) Selection of service life of the improvements

NOTE: The [FDOT Design Manual, Chapter 122 Design Exceptions and Design Variations](#) provides guidance for the benefit/cost analysis, and may be used. FDOT provides a useful tool, called [Benefit Cost Analysis Spreadsheet Tool](#) (BCAnalysis.xlsm), to aid in determining the benefit/cost ratio.

Conclusion and Recommendation:

- a) The cumulative effect of other deviations from design criteria
- b) Safety mitigating measures considered and provided
- c) Summarize specific course of action

F DOCUMENTATION FOR APPROVAL OF DESIGN VARIATIONS

When proposed design elements other than the Controlling Elements do not meet the criteria contained in this Manual, sufficient detail and justification of such deviations must be documented by the Responsible Professional Engineer as a Design Variation and submitted to the municipality or county. The documentation, submittal and approval requirements for Design Variations are similar to that for Design Exceptions described in this chapter.

Design Variations should include:

- a) Design criteria versus proposed criteria.
- b) Reason the design criteria are not appropriate.
- c) Justification for the proposed criteria.
- d) Review and evaluation of the most recent 5 years of crash history where appropriate.
- e) Background information which documents or justifies the request.

G FINAL PROCESSING OF DESIGN EXCEPTIONS AND VARIATIONS

After receiving conceptual approval from the designated Professional Engineer representative of the municipality or county, the documentation justifying the Design Exception or Variation shall be signed and sealed by the Responsible Professional Engineer and delivered to the municipality or county. ***Exhibit 14--A Sample Request Letter for Design Exception or Variation*** provides an example of an appropriate format and should be included with the signed and sealed supporting documents. The Design Exception or Variation will be reviewed for completeness and adherence to the requirements of this Chapter.

If the Design Exception satisfies all requirements, the acknowledgment of receipt will be signed by the Maintaining Authority's Professional Engineer or Designee, and, if applicable, forwarded to ~~the Department's~~ the FDOT District Design Engineer for concurrence.

When all signatures are obtained, the Design Exception or Variation will be returned to the Responsible Professional Engineer. The original will be retained by the municipality or County and a copy kept by ~~the Department~~ the FDOT, if applicable.

Exhibit 14-A Sample Request Letter for Design Exception or Variation

TO: _____

DATE: _____

SUBJECT: DESIGN EXCEPTION or DESIGN VARIATION

Local road number or street name: _____

Project description (limits): _____

Type construction (new, rehabilitation, adding lanes, resurfacing, etc.) _____

Design Speed _____

State and/or Federal road number (if applicable): _____

FDOT Financial Project ID No. (if applicable): _____

DESIGN EXCEPTION OR VARIATION FOR THE FOLLOWING ELEMENT:

- | | | |
|--|---|---|
| <input type="checkbox"/> Design Speed | <input type="checkbox"/> Stopping Sight Distance | <input type="checkbox"/> Other (explain): _____ |
| <input type="checkbox"/> Lane Width | <input type="checkbox"/> Maximum Grade | _____ |
| <input type="checkbox"/> Shoulder Width | <input type="checkbox"/> Cross Slope | _____ |
| <input type="checkbox"/> Horizontal Curve Radius | <input type="checkbox"/> Vertical Clearance | |
| <input type="checkbox"/> Superelevation Rate | <input type="checkbox"/> Design Loading Structural Capacity | |

Include a brief statement concerning the project and items of concern.

Attach all supporting documentation to this exhibit in accordance with Chapter 14.

Recommended by: _____
(Responsible Professional Engineer)

Approval: _____
(Maintaining Authority's Professional Engineer or Designee)

Concurrence: _____
FDOT (if applicable)

Concurrence: _____
FHWA (if applicable)

CHAPTER 15

TRAFFIC CALMING

A	INTRODUCTION	15-1
B	PLANNING CRITERIA	15-2
C	INAPPROPRIATE TRAFFIC CALMING TREATMENTS	15-6
C.1	Stop Signs.....	15-6
C.2	Speed Bumps	15-6
C.3	Other Inappropriate Treatments	15-6
D	APPROPRIATE TRAFFIC CALMING TREATMENTS	15-8
D.1	Vertical Treatments.....	15-9
D.2	Horizontal Treatments.....	15-11
D.3	Neighborhood Entry Control.....	15-13
D.4	Diverters.....	15-15
D.5	Other Treatments.....	15-16
E	REFERENCES FOR INFORMATIONAL PURPOSES.....	15-17

TABLES

Table 15 – 1	Vertical Treatments.....	15-9
Table 15 – 2	Horizontal Treatments.....	15-11
Table 15 – 3	Neighborhood Entry Control.....	15-13
Table 15 – 4	Diverters.....	15-15
Table 15 – 5	Other Treatments.....	15-16

FIGURES

Figure 15 – 1	Raised Crosswalk.....	15-10
Figure 15 – 2	Speed Hump.....	15-10
Figure 15 – 3	Chicanes.....	15-12
Figure 15 – 4	Key Roundabout Characteristics	15-12
Figure 15 – 5	Curb Extension or Bulb Out.....	15-14
Figure 15 – 6	Bicycle Lane, Advance Yield Bar and Crosswalk.....	15-16

CHAPTER 15

TRAFFIC CALMING

A INTRODUCTION

As Florida continues to grow, more and more of the major highways in its communities are becoming congested. This has caused many drivers to seek less crowded local residential streets as alternatives to get to their destinations. In many cases, this has meant the use of local residential streets as bypasses. The increase in traffic intrusion, volume, and speeds on residential streets has degraded the livability standards of various neighborhoods in Florida and as a result many residents complain about their environment (noise, air pollution), livability (quality of life, traffic intrusion, excessive volume, and speed of traffic), safety (as well as safety of their children, pets, and property) and physical characteristics (absence of sidewalks, etc.). This chapter provides some guidance to Florida roadway planners, designers, and traffic engineers on how to address concerns about maintaining or enhancing the quality of life in residential neighborhoods by balancing the need for safety for all roadway users and adjacent property owners of the street network and maintaining the integrity of the highways networks as a whole.

B PLANNING CRITERIA

Traffic calming is the combination of mainly physical measures that reduce the negative effects of motor vehicle use, alter driver behavior, and improve conditions for non-motorized street users.

Communities undertaking a traffic calming program shall have a procedure for planning which neighborhoods and roadways qualify for participation in the program. Specifics of these methods shall be developed by the local jurisdictions. The methods will likely vary from locality to locality. However, some issues should be addressed in all communities:

- Through the public involvement process, adjacent residents and road users who are impacted by the situation should be included in identifying the concern(s).
- The need for traffic-calming measures should be confirmed by appropriate studies (license plate survey, speed, volume, crash analyses) studied.
- Once the concerns are clearly identified and confirmed by traffic studies, and documented, it will provide the focus for possible solution, prioritizing, and development of appropriate traffic calming measures. It will also help determine the best approach to address the concerns.
- When developing traffic calming measures, in addition to the affected property owners, emergency response, transit, school, and sanitation officials and any other entities impacted by the installation of such devices should be included in the review process.

Traffic calming may not be the appropriate method in all cases to address vehicle speeds, volumes, and safety. Alternative solutions or educational tools may be considered, as well as coordinated effort with law enforcement.

The application of traffic calming measures should consider possible network and access issues. A system impact analysis should be performed as part of the development process. Vehicular and pedestrian counts, speed data, and crash history of the streets under evaluation should be reviewed. Storm water and environmental impacts also need to be addressed, as well as facility type, urban and rural design factors, and driveway densities.

Design details for each traffic calming measure may vary depending on local conditions. Factors to be considered include both horizontal and vertical deflection, ease of use, emergency vehicle accessibility, ease of maintenance, and facility type. Operational considerations and geometrics are critical factors to consider as well. A list of references and resources to consider in providing more detailed design factors and information can be found at the end of this section. It may be desirable to begin with less restrictive measures and progress to more restrictive ones in stages.

Listed below are some "Do's" and "Don'ts" of the planning process for traffic calming which may be helpful in working through the design process.

Do's and Don'ts of the Planning Process

Do the following:

- Install temporary traffic calming features and monitor them for a period of time before installing the permanent features. Testing features on site prior to permanent installation will relieve resident anxiety about the impact on their own driving patterns and driving behaviors will adjust to the new route circumstances.
- Have an organized program including public involvement. Plans and policies should be approved and supported by the local government. Emphasize the selected treatments(s) will be initially in a "test" mode, with permanency pending the outcome measurement. Be able to describe what is being done to keep traffic off residential streets.
- Channel public resources by prioritizing traffic calming request according to documentable criteria, setting thresholds of volume, speed, etc., to merit treatment.
- Involve the local service agencies, including fire, police, and emergency medical services personnel, from the start.
- Consult with fire department and EMS personnel to develop the preferred design, particularly with speed humps and traffic circles. Set up traffic circles with cones and have fire trucks and other emergency vehicles drive around them; this will help determine what radius is best for the vehicles used in a given area. The same process can be used in the design of speed humps.
- Review traffic patterns in the neighborhood as a whole. Avoid solving the problem on one neighborhood street by just shifting the traffic to another neighborhood street.
- Consider appropriate landscape treatments as part of the traffic calming design and implementation.

- Make certain that all signing, pavement markings, and channelization is in accordance with the [Manual on Uniform Traffic Control Devices \(MUTCD\)](#), the [AASHTO Policy on Geometric Design of Highways and Streets](#), and [Roundabouts: An Informational Guide, Second Edition, National Cooperative Highway Research Program \(NCHRP 672\)](#).
- Check sight distances for vehicles, pedestrians, and bicyclists. Sight distance should be consistent with the dimensions shown in **Chapter 3 – Geometric Design** or **Chapter 16 – Residential Street Design**.
- Become familiar with the traffic calming features used in other communities and assemble references so that residents can be directed where to see them.
- Decide on a safe design speed beforehand and in consultation with neighborhood residents.
- Check sight distances by visiting the site before and after installation. Do parked cars obstruct sight distances? Do landscaping or other features obstruct sight distance?
- Review the illumination at night. Are additional street lights needed? Does landscaping block the light? Is there a shadow on one side of a median or traffic circle that might hide pedestrians from view?
- Review the channelization during the day and night. Is it a clear approach from all directions? Can it be seen at night? Watch the traffic: Is the driving public confused by the signing and channelization? Make adjustments as needed.
- Review the site for utility conflicts. Is there a fire hydrant? Does it need to be moved? Are there existing utilities in the way?
- Check the storm water drainage. Will the storm drain system need to be moved or revised? Can the runoff flow through or around the device?
- Review on-street parking. Will parked cars block the access of emergency vehicles through or around the proposed neighborhood traffic control devices? Add additional no parking zones where needed. Additional enforcement of parking restrictions may be required to keep the traveled path clear.
- Include weekends in traffic counts, as residential streets may have unique travel patterns and high use periods.

Don't do the following:

- Install neighborhood traffic calming features without a well-engineered program supported by the local government and public.
- Install neighborhood traffic calming features on arterial streets (See Section 1.C.2 for a discussion of roadway classifications). Typically, physical devices are not installed on streets with volumes greater than 3,000 vehicles per day, or with posted or operating speeds of greater than 30 MPH.
- Install neighborhood traffic calming features on streets without curbs unless supplemental features or other design considerations are included to keep vehicles within the traveled way.
- Install neighborhood traffic calming features on street with grades of greater than 10 percent.
- Install neighborhood traffic calming features on major truck routes.
- Install neighborhood traffic calming features on primary emergency routes. Contact local fire, emergency service, and police departments to determine these routes. Secondary access routes should be considered on a case-by-case basis.
- Install neighborhood traffic calming features on curving or winding roads with limited sight distance, unless reduced speed limits and adequate warning signs are used in conjunction with the devices.
- Place neighborhood traffic calming features in front of driveways.
- Neglect to check for conflicting utilities or drainage considerations.
- Install physical features on adjacent parallel routes, unless feasible design alternatives have been agreed upon, as this prevents or hinders emergency response.

C INAPPROPRIATE TRAFFIC CALMING TREATMENTS

C.1 Stop Signs

Unwarranted stop signs should not be used for traffic calming for the following reasons:

- Increase midblock speeds along the street because of drivers trying to make up for lost time
- Increase noise because of quick accelerations and decelerations
- Increase pollution
- Reduce drivers' expectation of a uniform flow
- Relocate the problem
- Cause disrespect for stop signs by drivers and bicyclists

Stop signs shall be used only when warranted per the [MUTCD](#).

C.2 Speed Bumps

Speed bumps shall not be used on public streets. Speed bumps are severe treatments 3 to 6 inches high and 1 to 2 feet long that slow drivers to speeds of less than 10 mph. Due to their abrupt rise and required low speed they can be a hazard to motorists and bicyclists. Speed *humps*, as described in Section D under vertical deflection, should not be confused with speed *bumps*.

C.3 Other Inappropriate Treatments

There are some other treatments that have been shown to be ineffective at reducing the speed and volume of traffic on local roadways. While a temporary improvement may result, long-term improvement is not likely; consequently, their use is discouraged. These treatments include the following:

- Novelty signs -While signs such as CHILDREN AT PLAY, SENIORS CROSS HERE and SLOW DEAF CHILD may make an infrequent roadway user aware of a specific local population, most regular users of the roadway are unaffected by the signs.
- Odd speed limit - NEIGHBORHOOD SPEED LIMIT 23 MPH and other odd speed limit signs place a high dependence on police to monitor speeders and

are not consistent with the national practice required by the [MUTCD](#) of posting speeds limits in 5 mph increments.

- Crosswalks – Standard crosswalks marked only with signs and pavement markings do not affect motorists' speeds and should not be used by themselves as traffic calming treatments.
- Bicycle lanes – Standard bicycle lanes are not traffic calming treatments. They can be used to provide space for bicyclists between the sidewalk and travel lanes but should not be used by themselves for traffic calming.
- Speed trailers – While speed trailers can be used as part of a traffic calming program for educational awareness, they have no lasting effect on motorists' behavior.
- Reduced speed limit signs – Reduced speed limits without physical traffic calming measures do not slow drivers and should not be used for traffic calming.
- Rumble strips – These applications have high maintenance requirements and can cause severe noise problems. Also, they can be an obstacle to bicyclists.

D APPROPRIATE TRAFFIC CALMING TREATMENTS

The following sections describe some of the available traffic calming strategies. This list is not exhaustive, nor do the treatments necessarily fall exclusively into only one category.

In a typical traffic calming plan various types of treatments will be used. These plans will be based upon neighborhood preferences combined with engineering judgment.

Design details for traffic calming treatments will vary with application. Specific designs will need to be determined based upon the objective of the installations.

D.1 Vertical Treatments

Vertical treatments are those that depend upon a change in vertical alignment to cause drivers to slow down. When properly used, these treatments can be effective in reducing speeds and crashes. However, consideration should be given to impacts on emergency responders, buses, and, to some extent, bicyclists, and motorcyclists.

Traffic calming features that alter the vertical alignment should not be installed near fire hydrants or mailboxes.

Information on signing and pavement markings for vertical deflections can be found in the [Manual on Uniform Traffic Control Devices \(MUTCD\)](#).

Table 15 – 1 Vertical Treatments

Treatment	Description	Effect	Concerns	Cost
Raised Intersection	A raised plateau where roads intersect. Plateau is generally 4 inches above surrounding street.	Slows vehicles entering intersection and improves pedestrian safety.	Increases difficulty of making a turn.	Medium to High
Raised Crosswalk	Raised pedestrian crossing used in mid-block locations. Crosswalks installed on flat-top portion of speed table. See Figure 15 - 1	Reduces speed and is an effective pedestrian amenity makes pedestrians more visible.	May be a problem for emergency vehicles and vehicles with trailers.	Low to Medium
Speed Humps	Speed humps are parabolic, curved, or sinusoidal in profile, 3 to 4 inches in height and 14 feet long. Comfortable speeds limited to 15 to 20 mph. See Figure 15 - 2.	Reduces speed.	May cause delays for emergency vehicles and impact patient comfort. May have greater impacts on longer wheelbase cars.	Low
Speed Tables	Speed tables are flat-topped speed humps, also 3 to 4 inches high but with a sloped approach taper on each side of a flat top. They are generally 20 to 24 feet long. Comfortable speeds limited to 20 to 25 mph.	Reduces speed.	May cause delays for emergency vehicles and impact patient comfort.	Low
Speed Cushions/ Pillows	Signed speed humps as described above.	Reduces speed.	May not slow all vehicles.	Low

Figure 15 – 1 Raised Crosswalk



Suwannee Street, Tallahassee, Florida

Figure 15 – 2 Speed Hump



Inside Loop Road, Orange County, Florida

D.2 Horizontal Treatments

Horizontal deflection treatments are often more expensive than vertical deflection treatments. However, they have less of an impact on emergency responders and large vehicles with multiple axles. They generally do not create problems for bicyclists and motorcyclists. Because pavement area is usually reduced, additional landscaping may be possible, making horizontal deflection treatments useful as part of neighborhood beautification projects.

Information on striping and signing roundabouts can be found in the [MUTCD](#).

Table 15 – 2 Horizontal Treatments

Treatment	Description	Effect	Concerns	Cost
Angled Slow Point	Angled deviation to deter the path of travel so that the street is not a straight line	Reduces speed and pedestrian crossing distance.	Landscaping must be controlled to maintain visibility. Conflicts may occur with opposing drivers.	Medium to High
Chicanes	Mainline deviation to deter the path of travel so that the street is not a straight line. See Figure 15 - 3.	Reduces speed and pedestrian crossing distance.	A chicane design may warrant additional signing and striping to ensure that drivers are aware of a slight bend in the roadway. Increases the area possible for landscaping.	Medium to High
Mini-Circles	A raised circular island in the center of an existing intersection, typically 15 to 20 feet in diameter. May have mountable truck apron to accommodate large vehicles.	Reduces speed and both the number and severity of crashes.	May restrict larger vehicles. May cause some confusion when not signed properly. Some communities have documented increased crashes when mini-circles replaced all-way stop intersections.	Low to Medium
Roundabouts	A circular intersection with specific design and traffic control features, including yield control of all entering traffic, channelized approaches, geometric curvature. May be appropriate at locations as an alternative to a traffic signal. See Figure 15 - 4.	Reduces vehicle speeds and reinforces a change in the driving environment in transition areas.	May require more space at the intersection itself than other intersection treatments. While Roundabouts have sometimes been considered traffic calming features, they are primarily traffic control measures.	High

Figure 15 – 3 Chicanes

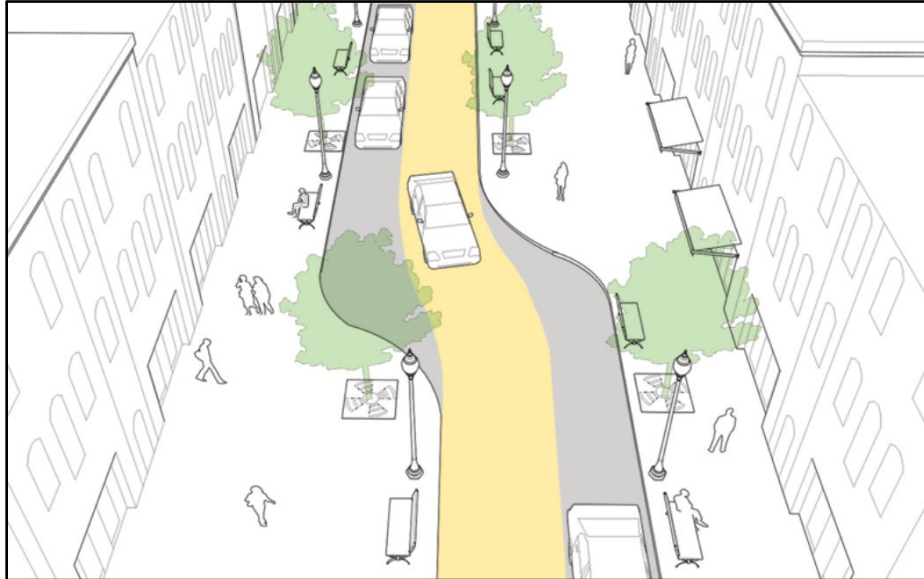

NACTO Urban Street Design Guide, National Association of City Transportation Officials

Figure 15 – 4 Key Roundabout Characteristics

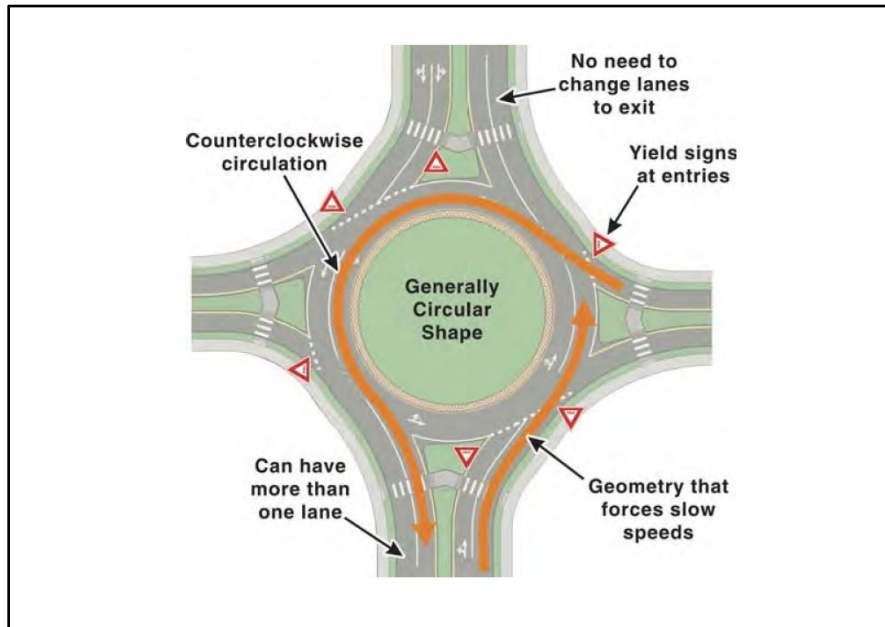

NCHRP Report 672: Roundabouts: An Informational Guide, Second Edition

D.3 Neighborhood Entry Control

Neighborhood entry control treatments include partial street closures and gateway type tools. They are used to reduce speeds and volume at neighborhood access points and may be used in conjunction with neighborhood beautification or enhancement projects and residential area identification.

Table 15 – 3 Neighborhood Entry Control

Treatment	Description	Effect	Concerns	Cost
Chokers	Midblock reduction of the street to a single travel lane for both directions.	Reduces speed and volume.	Costs increase if drainage needs to be rebuilt.	Medium to High
Gateway Treatment or Entrance Features	Treatment to a street that includes a sign, banner, landscaping, and roadway narrowing or other structure that helps to communicate a sense of neighborhood identity.	Reduces entry speed and pedestrian crossing distance. Discourages intrusion by cut through vehicles and identifies the area as residential.	Maintenance responsibility. May lose some on street parking.	Medium to High
Curb Extensions or Bulb-outs	Realignment of curb at intersection or mid-point of a block to decrease pavement width. See Figure 15 - 5.	Visually and physically narrows the roadway, shortens pedestrian crossing distance, increases space for plantings, street furniture.	May impact sight distance, parking, and drainage.	Medium to High
Midblock Median, Slow Point	An island or barrier in the center of a street that separate traffic.	Provides refuge for pedestrians and cyclists.	Landscaping may impede sight distance.	Varies
Lane Narrowing	Street physically narrowed to expand sidewalks and landscaping areas. Could include median, on street parking etc.	Improved pedestrian safety.	May create conflict with opposing drivers in narrow lanes.	Medium to High
One-Way In or One-Way Out Channelization	Intersection reduction of the street to single travel lane with channelization. Also called half road closure.	Reduces speed and traffic.	Costs increase if drainage must be rebuilt. Transfers additional vehicles to other ingress/egress points.	Medium to High
Textured Pavement	A change in pavement texture, and color (e.g., asphalt to brick), that helps make drivers aware of a change in driving environment.	Enhances pedestrian crossings, bike lanes, or on street parking.	Increase maintenance. May increase noise.	Low to Medium

Figure 15 – 5 Curb Extension or Bulb Out



First and Lee Streets, Ft. Myers, Florida

D.4 Diverters

A diverter consists of an island or curbed closure, which prevents certain movements at intersections, and reduces speeds and volumes. By diverting motorists within a neighborhood, they can significantly reduce cut through traffic.

Diverters must be planned with care because they will impact the people who live in the neighborhood more than anyone else. Trip lengths increase, creating inconvenience to residents. Emergency responders must also be considered when diverting traffic.

Bicyclists and pedestrians should be provided access through traffic diverters.

Table 15 – 4 Diverters

Treatment	Description	Effect	Concerns	Cost
Diagonal Diverters	Barrier placed diagonally across an intersection, interrupting traffic flow forcing drivers to make turns.	Eliminates through traffic.	May inhibit access by emergency vehicles and residents and increase trip lengths.	Medium
Forced Turn Barrier/Diverters	Small traffic islands installed at intersections to restrict specific turning movements.	Reduces cut through traffic.	Could impact emergency vehicles response time.	Low to Medium
Road Closures, Cul-de-sac	One or more legs of the intersection closed to traffic.	Eliminates through traffic improving safety for all street users.	May increase volumes on other streets in the area. Access restriction may cause concerns for emergency responders. Additional right of way for proper turnaround at dead ends may be required.	Low to Medium
Median Closures	Small median islands installed at cross streets to prevent through movements and restrict left turns.	Reduces cut through traffic.	Could impact emergency vehicle responses, inhibit access, and increase trip lengths or transfer volumes to other streets.	Low to Medium

D.5 Other Treatments

These treatments are most effective when used in combination with other physical traffic calming features, and should be used as supplements.

Table 15 – 5 Other Treatments

Treatment	Description	Effect	Concerns	Cost
Pavement Markings	Highlighting various area of road to increase driver's awareness of certain conditions such as bike lanes or crosswalks. See Figure 15 - 6.	Inexpensive and may reduce speed.	May not be as effective as a structure such as curb.	Low
Traversable Barriers	A barrier placed across any portion of a street that is traversable by pedestrians, bicycles, and emergency vehicles but not motor vehicles.	Eliminates cut-through traffic.	Inconvenience to some residents.	Medium
Colored Bike Lanes or Shoulders	A bike lane or shoulder painted, covered with a surface treatment, or constructed of a pigmented pavement designed to contrast with the adjacent pavement.	Visually narrows the roadway and may reduce speeds.	May not be effective on roadways with 12 foot lanes.	Low to medium

Figure 15 – 6 Bicycle Lane, Advance Yield Bar, and Crosswalk



Franklin Blvd, Tallahassee, Florida

E REFERENCES FOR INFORMATIONAL PURPOSES

The publications listed below are additional sources, of information related to topics presented in this chapter. Search the Internet Web for up-to-date resources using "traffic+calming" as key words.

- ~~• Manual on Uniform Traffic Control Devices, with Revisions 1 and 2, May 2012 (MUTCD). US Department of Transportation, Federal Highway Administration~~
- Speed Management Safety, FHWA
<https://safety.fhwa.dot.gov/speedmgt/>
- Traffic Calming Measures - Institute of Transportation Engineers;
<https://www.ite.org/technical-resources/traffic-calming/traffic-calming-measures/>
- Canadian Guide to Traffic Calming - Second Edition (2018-), Transportation Association of Canada
<https://www.tac-atc.ca/en/publications/ptm-trafcalm18-e>
- Primer on Traffic Calming, Canadian Institute of Transportation Engineers and Transportation Association of Canada, January 2018
http://www.tac-atc.ca/sites/default/files/site/doc/Bookstore/traffic_calming_-_second_edition.pdf
- ~~• Code of Practice for the Installation of Traffic Control Devices in South Australia, July 2013. Traffic and Operational Standards Section, Department Transportation, P.O. Box. 1, Walkerville, South Australia, 5081. (updated in 2013)~~
- National Cooperative Highway Research Program (NCHRP) Report 672, Roundabouts: An Informational Guide, Second Edition, (2010)
http://onlinepubs.trb.org/onlinepubs/nchrp/nchrp_rpt_672.pdf
- ~~• The Florida Intersection Design Guide. Florida Department of Transportation, <http://www.dot.state.fl.us/officeofdesign/publicationslist.shtm>~~
- ~~• Traffic Calming Measures - Speed Hump, Institute of Transportation Engineers, <http://www.ite.org/traffic/>~~
- ~~• New York State Supplement (2001) to the Manual of Uniform Traffic Control Devices, 2009. Transportation Planning, Highway Safety, and Traffic Engineering Division,~~

~~New York State Department of Transportation, 1220 Washington Avenue, Albany, NY 12232-0204.
<https://www.dot.ny.gov/divisions/operating/oom/transportation-systems/repository/B-2011Supplement-adopted.pdf>~~

- ~~• New York State Vehicle & Traffic Law, (latest edition). New York State Department of Motor Vehicles, Swan Street Building, Empire State Plaza, Albany, NY, 12228.~~
- ~~• Roundabout Design Guidelines, Supplement to the NCHRP 672 (October 2012). Maryland Department of Transportation, State Highway Administration http://sha.md.gov/OHD2/MDSHA_Roundabout_Guidelines.pdf~~
- ~~• Traffic Control Systems Handbook, Revised Edition, 2005, Federal Highway Administration, DC 20590. (Updated in 2013) <http://ops.fhwa.dot.gov/publications/fhwaHop06006/>~~

THIS PAGE INTENTIONALLY LEFT BLANK

CHAPTER 16

RESIDENTIAL STREET DESIGN

A	INTRODUCTION	16-1
B	OBJECTIVES	16-2
C	DESIGN ELEMENTS	16-4
C.1	Design Speed	16-4
C.2	Sight Distance.....	16-4
C.2.a	Stopping Sight Distance.....	16-4
C.2.b	Passing Sight Distance	16-5
C.2.c	Intersection Sight Distance	16-5
C.3	Horizontal Alignment.....	16-6
C.3.a	Minimum Centerline Radius	16-6
C.3.b	Minimum Curb Return Radius.....	16-6
C.4	Vertical Alignment.....	16-7
C.4.a	Vertical Curves.....	16-7
C.5	Cross Section Elements.....	16-7
C.5.a	Width of Roadway.....	16-7
C.5.b	Medians	16-7
C.6	Cul-de-sacs and Turnarounds.....	16-8
C.6.a	Turning Area	16-8
C.7	Pedestrian Considerations	16-8
C.7.a	Sidewalks.....	16-8
C.8	Bicyclist Considerations	16-9
C.8.a	Bicycle Facilities.....	16-9
C.9	Shared Use Paths.....	16-9
C.10	Clear Zone	16-9
D	REFERENCES FOR INFORMATIONAL PURPOSES	16-10

TABLES

Table 16 – 1	Minimum Stopping Sight Distance for Residential Streets	16-4
Table 16 – 2	Minimum Corner Intersection Sight Distance for Residential Streets.	16-5
Table 16 – 3	Minimum Centerline Radii for Residential Streets.....	16-6

CHAPTER 16

RESIDENTIAL STREET DESIGN

A INTRODUCTION

The street is a public way designed for the purposes of serving motor vehicles, bicycles, pedestrians, and transit vehicles. The primary function of residential streets is to provide access to homes that front those streets. The primary consideration, therefore, of residential street design should be to foster a safe and pleasant environment for the residents that live along the street, and safe traveling conditions for motorists, bicyclists and pedestrians. The convenience of motorists is a secondary consideration.

The street design should create an environment that cautions drivers that they are in a residential area where they must safely share the traveling space with pedestrians and bicyclists, both child and adult. Visual cues such as meandering streets, sidewalks, landscaping, signage, narrowed streets, changes in pavement texture (such as brick, stamped, or textured surfaces), and raised crosswalks all serve to heighten drivers' awareness for the need to maintain lower speeds. Incorporating such features into residential street design at inception will reduce or eliminate the need for traffic calming retrofits.

Section B of this chapter discusses the primary objectives of Residential Street Design in more detail, to aid the designer in the selection of proper criteria. **Section C** sets forth specific design criteria for residential streets.

B OBJECTIVES

The basic principles of residential street design are based on four factors:

1. Safety
2. Efficiency of Service
3. Livability and Amenities
4. Economy of Land Use, Construction, and Maintenance

The following 17 principles incorporate these factors. These principles are not intended as absolute criteria, since instances may occur where certain principles conflict. The principles should therefore be used as concepts for layout of proper street systems.

1. Adequate vehicular and pedestrian access should be provided to all parcels.
2. Local street systems should be designed to minimize through traffic movements unless it is specifically desired by the County or municipality to connect residential developments.
3. Street patterns should minimize excessive vehicular travel through connectivity between adjacent residential developments, and to larger street networks.
4. Local street systems should be logical and comprehensible, and systems of street names and house numbers should be simple, consistent, and understandable.
5. Local circulation systems and land-development patterns should not detract from the efficiency of adjacent major streets due to lack of connectivity.
6. Elements in the local circulation system should not have to rely on extensive traffic regulations and enforcement in order to function efficiently and safety.
7. Traffic generators within residential areas should be considered in the local circulation pattern.
8. The planning and construction of residential streets should clearly indicate their local function. The street's residential nature should be obvious to those driving on them.
9. The street system should be designed for a relatively uniform low volume of traffic.
10. Local streets should be designed to discourage excessive speeds.

11. Pedestrian-vehicular conflict points should be minimized.
12. The amount of space in the land development devoted to motor vehicle uses should be minimized.
13. Smaller block sizes may be used to encourage walking or bicycling. See **Chapter 19 – Traditional Neighborhood Development** for more information.
14. The arrangement of local streets should permit economical and practical patterns, shapes, and sizes of development parcels and provide interconnectivity without using arterials or collectors.
15. Local streets should consider and utilize topography from the standpoint of both economics and amenities.
16. Appropriate provisions for transit service within residential areas should be included.
17. Street design should consider horizontal and vertical compatibility and connectivity with sidewalks, bicycle lanes, and pedestrian walkways.

C DESIGN ELEMENTS

C.1 Design Speed

For local residential streets, design speeds of 15 to 30 mph are appropriate, depending on the adjacent development, terrain, available right of way, and other area controls. Alleys and narrow roadways intended to function as shared spaces (that is, could be used to access driveways, for garbage pickup, and travel by walking or bicycling) may have design speeds as low as 10 mph. Design speeds greater than 30 mph in residential areas require increased sight distances and radii which are contrary to the function of a local residential street.

C.2 Sight Distance

C.2.a Stopping Sight Distance

The minimum stopping sight distance is shown in Table 16 – 1 Minimum Stopping Sight Distance for Residential Streets.

Table 16 – 1 Minimum Stopping Sight Distance for Residential Streets

Design Speed (mph)	Stopping Sight Distance (feet)
10	45
15	75
20	125
25	150
30	200

C.2.b Passing Sight Distance

Passing should not be encouraged on local residential streets, and design for passing sight distance is seldom applicable on these streets. If longer straight sections and higher design and posted speeds support passing, the street shall be designed under the design criteria established in **Chapter 3 – Geometric Design**.

C.2.c Intersection Sight Distance

Intersections shall be designed with adequate corner sight distance as set forth in Table 16 – 2 Minimum Corner Intersection Sight Distance for Residential Streets. Intersection design should take into consideration growth of landscaping and other amenities. Where a local residential street intersects a higher-order street, the design criteria of the higher-order street shall control within the right of way of the higher-order street.

Table 16 – 2 Minimum Corner Intersection Sight Distance for Residential Streets

Design Speed (mph)	Corner Intersection Sight Distance * (feet)
10	110
15	160
20	210
25	260
30	310

* Corner sight distance measured from a point on the minor road at least 14.5 feet from the edge of the major road pavement and measured from a height of eye at 3.5 feet on the minor road to a height of object at 3.5 feet on the major road.

Where stop or yield control is not used, the corner sight distance should be a minimum of 300 feet. If restrictions are unavoidable, a minimum of 200 feet is allowed with proper warning signage found in the [Manual on Uniform Traffic Control Devices \(MUTCD\)](#) such as an intersection warning sign (W2 series) or cross traffic does not stop here plaque (W4-4P). To maintain the minimum sight distance, restrictions on height of embankments, locations of buildings, and screening fences may be

necessary. Any landscaping in the sight distance triangle should be low growing, and should not be higher than 3 feet above the level of the intersecting street pavements. Tree overhangs should be trimmed to at least 8 feet above the level of the intersections.

Intersecting streets should meet at approximately right angles. Angles of less than 60 degrees should be avoided.

C.3 Horizontal Alignment

C.3.a Minimum Centerline Radius

The minimum radii for horizontal curves are given in Table 16 – 3 Minimum Centerline Radii for Residential Streets. Typically, superelevation should not be utilized on local residential streets. Where superelevation is appropriate or required, the street shall be designed under the design criteria established in *Chapter 3 – Geometric Design*.

Table 16 – 3 Minimum Centerline Radii for Residential Streets

Design Speed (mph)	Min. Centerline Radius (feet)
10	25
15	50
20	89
25	166
30	275

C.3.b Minimum Curb Return Radius

Where there are substantial pedestrian movements, the minimum radius of curb return where curbs are used, or the outside edge of pavement where curbs are not used shall be 15 feet. A minimum radius of 25 feet is desirable to accommodate turning movements of service vehicles.

C.4 Vertical Alignment

C.4.a Vertical Curves

Vertical curves shall be designed for a minimum stopping sight distance using the design criteria of 30 mph established in **Chapter 3 – Geometric Design**.

C.5 Cross Section Elements

C.5.a Width of Roadway

The minimum width of a two-way residential roadway should be 20 feet from edge-of-pavement to edge-of-pavement (excluding curbs and gutters). Travel lanes should be a minimum of 10 feet wide, and wider where practicable. Under constrained conditions or in some very rural areas, lanes 9 feet or narrower may be used. Refer to **Chapter 4** of the [AASHTO Guidelines for Geometric Design of Very Low-Volume Local Roads \(ADT ≤ 400\)](#). Lanes narrower than 9 feet are prohibited in the absence of a Design Exception as provided for in **Chapter 14 – Design Exceptions and Variations**.

When parking lanes are provided on one or both sides of the roadway, they shall be at least 7 feet wide including the gutter section where applicable.

Where curb and gutter sections are used, the roadway may be narrowed to the travel lane width (plus bike lane if present) at intersections. This will prevent parking close to the intersection, reduce crossing distances for pedestrians, provide space for curb ramps, and reduce turning speeds. By providing intersection curb extensions, the visual width of the roadway can be reduced.

C.5.b Medians

When used in residential areas, medians or traffic separators should conform to **Chapter 3** or **Chapter 19**.

C.6 Cul-de-sacs and Turnarounds

C.6.a Turning Area

A residential street more than 100 feet long and open at one end only shall have a special turning area at the closed end. This turning area should be circular and have a radius appropriate to the types of vehicle expected. The minimum outside radius of a cul-de-sac shall be 30 feet. In constrained circumstances, other turning configurations such as a “hammerhead” may be considered. Cul-de-sacs can detract from connectivity if used excessively or inappropriately.

C.7 Pedestrian Considerations

C.7.a Sidewalks

In residential areas, sidewalks should be provided on both sides of the street. The sidewalks should be located as far as practicable from the travel lanes and usually close to the right of way line. In certain circumstances, such as where lots are very large or there are environmental limitations, sidewalk on only one side may be considered. Along collector roadways shared use paths may be provided in lieu of sidewalks. Connectivity to and between existing public sidewalk or shared use path facilities is desired.

Pedestrian access should be provided to schools, day care facilities, parks, churches, shopping areas, and transit stops within or adjacent to the residential development. Pedestrian access to these destinations and throughout the neighborhood shall be designed for safe and convenient pedestrian circulation. Sidewalks or shared use paths between houses or to connect cul-de-sacs may be used where necessary to provide direct access.

Sidewalks, crosswalks and mid-block crossings shall be constructed under the criteria set forth in **Section C.7.d** of **Chapter 3 – Geometric Design**, and **Chapter 8 – Pedestrian Facilities**.

C.8 Bicyclist Considerations

C.8.a Bicycle Facilities

Residential roadways are generally sufficient to accommodate bicycle traffic. When specific bicycle facilities are desired, they should connect to existing facilities and be designed in accordance with **Chapter 3 – Geometric Design** and **Chapter 9 – Bicycle Facilities**. For bike lane transitions, see **Chapter 9**.

C.9 Shared Use Paths

Shared use paths may be provided in lieu of sidewalks along collector roads in accordance with **Section C.7.a**. When shared use paths are desired, they should connect to other pedestrian and bicycle facilities within or adjacent to the residential area, and connect to schools, day care facilities, parks, churches, shopping areas, and transit stops. Shared use paths shall be designed in accordance with **Section C** of **Chapter 9 – Bicycle Facilities**. Shared use paths may be used by golf carts in certain areas, under certain circumstances in accordance with [Sections 316.212, 316.2125 and 316.2126, F.S.](#)

C.10 Clear Zone

Clear zone requirements for residential streets shall be based on **Chapter 43 – Roadside Design-Geometric-Design**, Table ~~43~~ – 15 Minimum Width of Clear Zone [and Table 4 – 2 Lateral Offset](#).

D REFERENCES FOR INFORMATIONAL PURPOSES

The following is a list of publications that may be referenced for further guidance:

- AASHTO Guidelines for Geometric Design of Very Low-Volume Local Roads (ADT \leq 400):
<https://bookstore.transportation.org/https://aashtojournal.org/2019/05/31/aashto-issues-second-edition-of-low-volume-roads-guidelines/>
- Manual on Uniform Traffic Control Devices (MUTCD)
[Manual on Uniform Traffic Control Devices \(MUTCD\) - FHWA \(dot.gov\)](#)

CHAPTER 17

BRIDGES AND OTHER STRUCTURES

A	INTRODUCTION	17-1
B	OBJECTIVES	17-2
C	DESIGN.....	17-2
C.1	Bridges - General.....	17-2
C.2	Bridge Live Loads	17-2
C.3	Bridge Superstructure	17-3
C.3.a	Girder Transportation.....	17-3
C.3.b	Vertical Clearance.....	17-3
C.3.c	Railings	17-4
C.3.d	Expansion Joints.....	17-4
C.3.e	Drainage	17-5
C.3.f	End Treatments	17-5
C.4	Bridge Substructure	17-5
C.4.a	Scour	17-5
C.4.b	Navigation Aids and Vessel Collision.....	17-6
C.4.c	Pier Locations	17-7
C.4.d	Wildlife Crossing Features	17-7
C.5	Retaining and Noise Walls	17-8
C.6	Sign, Lighting, and Traffic Signal Supports	17-9
C.7	Pedestrian Bridges.....	17-9
D	CONSTRUCTION.....	17-10
E	ROUTINE INSPECTION AND MAINTENANCE	17-11
F	BRIDGE LOAD RATING AND POSTING	17-12
G	RECOMMENDATIONS	17-14
H	REFERENCES FOR INFORMATIONAL PURPOSES	17-15

FIGURES

EXHIBITS

Figure 17 – 1 Bridge with Shelves for Wildlife..... 17-8

CHAPTER 17

BRIDGES AND OTHER STRUCTURES

A INTRODUCTION

Bridges provide safe passage for multimodal traffic over various obstacles along a road or path. This chapter presents guidelines and standards for designing, constructing, inspecting, and maintaining bridges as well as other structures such as walls and supports for signs, lights, and traffic signals. These standards and criteria are necessary due to the critical function these structures serve to communities throughout their lifespan. This chapter establishes uniform minimum standards and criteria for all bridges used by the public for vehicular and/or pedestrian traffic as well as other structures such as walls and supports for signs, lights, and traffic signals. The geometry of structures shall follow the standards and criteria set forth in **Chapters 3, 8, 9, and 13**. Exceptions to these standards and criteria must be processed in accordance with the procedures described in **Chapter 14**.

In addition to the design criteria provided in this chapter, the [United States Department of Transportation ADA Standards for Transportation Facilities \(2006\)](#), [United States Department of Justice ADA Standards \(2010\)](#), [2006 Americans with Disabilities Act Standards for Transportation Facilities](#) as required by [49 C.F.R 37.41 or 37.43](#) and the [2020~~17~~ Florida Accessibility Code for Building Code – Accessibility, 7~~6~~th Edition Construction](#) as required by [61G20-4.002](#) impose additional requirements for the design and construction of pedestrian facilities on bridges or other structures. Examples of facilities include sidewalks and shared use paths, and drainage grates and inlets in or near the accessible route. Significant ADA design considerations exist for all facilities with grades that exceed 5%. [The Public Rights-of-Way Accessibility Guidelines \(PROWAG\) \(~~PROWAG~~\)](#) provide additional information for the design of pedestrian facilities.

Note: This chapter applies to all bridges under local control, except for bridges constructed on or over [the FDOT's~~the Department's~~](#) system. For bridges constructed on and over [the FDOT's~~the Department's~~](#) system, as well as all bridges that will be maintained by [the FDOT~~the Department~~](#), [FDOT~~the Department's~~](#) policies, procedures, [standards~~standards~~](#), and specifications will apply.

B OBJECTIVES

The objectives of this chapter are as follows:

- To prescribe uniform criteria with respect to bridge and miscellaneous structures design and geometric layout.
- To alert owners to the various federal and state requirements to be included in the design, construction, maintenance, and inspection of their bridges and other structures.
- To provide practical suggestions specific to Florida on prudent structural engineering based on experience with statutes, standards, and criteria.

C DESIGN

The design of bridges and other structures shall be led by a licensed professional engineer who shall assume responsible charge of the work. The standards and criteria included here are directed only toward specific considerations that shall be followed. Other considerations are necessary to create a comprehensive bridge design allowing owners and their engineer's flexibility in design. All bridges and other structures shall be designed in accordance with specifications (including guide specifications) published by the American Association of State Highway and Transportation Officials (AASHTO).

C.1 Bridges - General

All bridges and other structures shall be designed in accordance with specifications (including guide specifications) published by the American Association of State Highway and Transportation Officials (AASHTO). At a minimum, the [AASHTO Load and Resistance Factor Design \(LRFD\) Bridge Design Specifications, 9~~8~~7th Edition \(2020~~17~~4\) with Interim Revisions \(2015 and 2016\)](#) shall be used. Any bridge reconstruction (i.e., lengthening, widening, and/or major component replacement) shall be designed as specified in this section. Record of such reconstruction shall be maintained as specified in Section D of this chapter. The remaining design life should be considered in the design.

C.2 Bridge Live Loads

In addition to the notional (HL - 93) design load specified in *LRFD*, bridges shall also require a FL 120 permit load rating greater than 1 as defined in [the FDOT's the Department's FDOT Structures Manual, Volume 1 – Structures Design](#)

[Guidelines, 2022~~1187~~ \(SDG\)](#). This vehicle allows for a more consistent load rating comparison considering the current bridge inventory.

C.3 Bridge Superstructure

The superstructure of a bridge is that portion of the structure that spans between its supports or piers. Considerations that shall be incorporated into the design of all superstructures will include the following:

C.3.a Girder Transportation

The Engineer of Record (EOR) is responsible for investigating the feasibility of transportation for heavy, long and/or deep girder field sections. In general, the EOR should consider the following during the design phase:

- Whether or not multiple routes exist between the bridge site and a major transportation facility.
- The transportation of field sections longer than 130 ft or weighing more than 160,000 pounds requires coordination through [the FDOT's](#)~~the~~ [Department's](#) Permit Office during the design phase of the project. Shorter and/or lighter field sections may be required if access to the bridge site is limited by roadway(s) with sharp horizontal curvature or weight restrictions.
- On steel superstructures, where field splice locations required by design result in lengths greater than 130 feet, design, and detail "Optional Field Splices" in the plans.
- For curved steel box girders, prefabricated trusses, and integral pier cap elements, size field pieces such that the total hauling width does not exceed 16 feet.

C.3.b Vertical Clearance

All new bridges over roadways and shared use paths shall be designed to meet the vertical clearance standards specified in **Chapter 3, Section C.7.j.4.(b)**, and **Chapter 9, Section C.6**.

All new bridges over water shall be designed to meet the following vertical clearance standards:

- To allow debris to pass without causing damage, the clearance between the design flood stage and the low member of bridges shall be

a minimum of two feet. This standard does not apply to culverts and bridge-culverts.

- For crossings subject to boat traffic, the minimum vertical navigation clearance should be:

Tidewater bays and streams	6 feet above Mean High Water *
Freshwater rivers, streams, non-regulated/controlled canals, and lakes	6 feet above Normal High Water
Regulated/controlled lakes and canals	6 feet above control elevation

- * For locations subject to tidal salt / brackish water splashing, a 12-foot vertical clearance above Mean High Water should be considered for bridge durability reasons.

Higher clearances apply for crossings over legislated channels under the control of the U.S. Coast Guard (USCG). Designers should also consider future navigation demands and future shared use path demands in setting the vertical clearance of a bridge.

C.3.c Railings

All traffic, pedestrian, and bicycle railings shall comply with the requirements in **Section 13** of *LRFD*. Traffic railings shall meet the crash requirements of at least Test Level 3 (TL-3) for bridges with design speeds greater than 45 mph and at least TL-2 for design speeds less than or equal to 45 mph.

For pedestrian/bicycle railings, two-pipe guiderails, and details similar to ~~those in the FDOT's Department's~~ [Standard Plans](#) may be mounted on walls or other structures where drop-off hazards are 5 feet or less. Concrete, aluminum or steel railing and details similar in strength and geometry to ~~those in the FDOT's~~ [Standard Plans](#) shall be used (or modified to suit environmental runoff concerns) where drop-off hazards are greater than 5 feet. See [Standard Plans Instructions](#) for more information.

C.3.d Expansion Joints

The number of joints should be minimized to reduce the inspection and maintenance needs of the bridge.

C.3.e Drainage

All bridge designs shall include a drainage design that is specific to its site. Conveyance of drainage off the bridge roadway should be designed to meet spread standards contained in ~~the FDOT's the most recent version of the Department's~~ [Drainage Manual, Chapter 3 \(2022118\)](#) and may include open systems (i.e., scuppers) or closed systems (i.e., inlets and pipes) based on environmental permitting restrictions. Drainage from the bridge should not drop onto traffic below. Longitudinal conveyance piping attached to bridges is expensive and maintenance-intensive, and should be avoided whenever possible.

Conveyance of drainage off pedestrian facilities shall be designed to provide an accessible route for pedestrians. Further guidance on the design of bridge deck drainage may be found in the current version of [FHWA Publication HEC-21, "Design of Bridge Deck Drainage."](#)

C.3.f End Treatments

Requirements for end treatments of structures are given in **Chapter 4 – Roadside Design**. Bridge barriers shall be designed to accommodate connection of a guardrail transition or energy absorbing system.

C.4 Bridge Substructure

The substructure of a bridge consists of all elements below the superstructure including its bearings, piers, and foundations. For guidance on bridges vulnerable to coastal storms, see [SDG, Section 2.5](#). Considerations that shall be incorporated into the design of all substructures include the following:

C.4.a Scour

A hydrologic/hydraulic analysis shall be performed to quantify expected stages and flows at the bridge site. Anticipated substructure scour shall be developed for the following conditions:

Hydraulic Design Flood Frequency	Scour Design Flood Frequency	Scour Design Check Flood Frequency
Q ₁₀	Q ₂₅	Q ₅₀
Q ₂₅	Q ₅₀	Q ₁₀₀
Q ₅₀	Q ₁₀₀	Q ₅₀₀
Notes: "Q" is the common term used for flow rate, an expression of volume of fluid which passes per unit of time. "x" is the return period in years (10, 25, 50, 100, 500).		

Any exceptions to the standards above hydrologic/hydraulic and scour analysis requirements shall be approved in writing by ~~the FDOT's~~ [the Department's local](#) District Drainage Engineer. Methodology for computing bridge hydrology/hydraulics and bridge scour should follow the guidelines set forth in ~~the FDOT's~~ [the Department's Drainage Manual \(2022118\)](#). Further guidance and training may be obtained through [FHWA Hydraulic Engineering Circulars \(HEC\) "HEC-18"](#) and ["HEC-20"](#) and ~~the FDOT's~~ [the Department's](#) training courses on these topics. Additionally, for larger bridges (>120,000 sq. ft.), hydraulic designers may wish to consult with ~~the FDOT~~ [OT's](#) ~~the local Department~~ District Drainage Engineer for case-specific guidance. The [SDG, Section 2.11](#) and [2.12](#) and ~~the FDOT's~~ [the Department's Drainage Manual, \(202218\)](#) provide guidance on scour load combinations with other loads.

C.4.b Navigation Aids and Vessel Collision

All bridges over USCG designated navigable waterways shall include bridge fender systems and consideration for potential vessel collision.

For guidance on navigation aids and bridge fender system design, see [SDG Section 314](#). For guidance on vessel collision design see [SDG, Section 2.11](#) and [LRFD, Section 3.14](#).

C.4.c Pier Locations

All bridges over roadways shall have substructures supports set back from vehicular traffic lanes in accordance with **Chapter 3, Section C.7.j.4.(a)**.

All bridges over water shall have substructure supports located with horizontal clearance requirements as listed below. In this case, horizontal clearance is defined as the clear distance between piers, fender systems, culvert walls, etc., projected by the bridge normal to the flow.

- For crossings subject to boat traffic a minimum horizontal clearance of 10 feet shall be provided.
- Where no boat traffic is anticipated, horizontal clearance shall be provided consistent with debris conveyance needs and structure economy.

C.4.d Wildlife Crossing Features

Consider the use of wildlife connectivity features (e.g. shelves and wildlife fencing) in accordance with the FDOT **FDOT Wildlife Crossing Guidelines** to enhance wildlife mobility and reduce motor vehicle collisions with wildlife. Wildlife crossing features help maintain habitat connectivity, promote wildlife diversity, and enhance motorist safety. Adding shelves into the bridge abutment design is a low cost technique which allows for better wildlife connectivity and makes bridge inspections safer.

Wildlife crossing feature(s) may include new or modified structures, such as bridges, bridges with shelves, specially designed culverts, enlarged culverts or drainage culverts and/or exclusionary devices such as fencing, walls or other barriers, or some combination of these features. Wildlife refers to listed, protected, or otherwise regulated species that the US Fish and Wildlife Service (USFWS) and/or Florida Fish and Wildlife Conservation Commission (FWC) have jurisdiction over.

The National Transportation Library provides additional information on **Wildlife Crossing Structures**.

Figure 17 – 1 Bridge with Shelves for Wildlife



C.5 Retaining and Noise Walls

The design of conventional, anchored, mechanically stabilized, and prefabricated modular retaining wall structures shall meet the requirements of [LRFD Section 11](#). Local agencies should consider using only wall types approved by [the FDOT](#)~~the Department~~. These are described in [Section 3.12](#) of the [SDG](#). Local agencies should also follow the design criteria for retaining walls found in [Section 3.13](#) of the [SDG](#).

The design of noise walls should meet the requirements of the [SDG, Section 3.16](#). For noise walls within the clear zone, their design and/or protection should comply with the following:

- For noise walls attached to the top of traffic railings only use crash tested systems consistent with the design speed of the facility. ~~The FDOT~~[The Department](#) has standards for TL-4 systems that meet the requirements of [NCHRP Report 350 or the Manual for Assessing Safety Hardware \(MASH\)](#).
- Non-crash tested noise walls may be attached to structures if located behind an approved traffic railing and mounted at least five feet from the face of the traffic railing at deck level.

Potential existing off-site stormwater inflows through the proposed wall location should be verified in the field and considered in the wall design. For railings on top of walls, see **Section C.3.c. Railings**.

C.6 Sign, Lighting, and Traffic Signal Supports

The design of sign, lighting, and traffic signal support structures shall meet the requirements of [AASHTO's LRFD Specifications for Structural Supports for Highway Signs, Luminaires and Traffic Signals, 1st Edition, with 2017, 2018, 2019 and 2020 Interim Revisions](#) and the ~~FDOT~~[Department's Structures Manual Volume 3 - FDOT Modifications to LRFD Specifications for Structural Supports for Highway Signs, Luminaires and Traffic Signals \(LRFDLTS-1\)](#).

C.7 Pedestrian Bridges

For guidance on pedestrian bridges, see [SDG Chapter 10](#).

D CONSTRUCTION

During the construction of a bridge or any structure at, over, or near a public facility, safety awareness is necessary and precautions shall be taken to protect the public. Provisions for protecting the public during construction shall be in accordance with the [MUTCD \(2009 Edition with Revision Number 1 and 2, May 2012\)](#) work zone traffic control procedures and the standards and criteria described in **Chapter 11 – Work Zone Safety and Mobility**. Worker safety is the responsibility of the contractor. Temporary barriers shall be installed on all bridges being widened or whose new construction is phased. Spread of stormwater on the bridge deck should be considered in planning temporary traffic routing.

During the construction of a bridge or any structure, records to be kept and maintained throughout its life shall include foundation construction records (pile driving records, shaft tip elevations, borings) and as-built plans. These records provide critical information necessary for future inspection, maintenance, emergency management, enhancement, reconstruction, and/or demolition of these structures. These records shall be delivered to ~~the FDOT's~~ [the Department's](#) local District Structures Maintenance Engineers.

Any proposed changes to the construction details or specifications shall be signed, sealed, and dated by a professional engineer licensed in the State of Florida.

E ROUTINE INSPECTION AND MAINTENANCE

[Title 23, Code of Federal Regulations, Part 650, Subpart C](#), sets forth the **National Bridge Inspection Standards (NBIS)** for bridges on all public roads. **Section 650.3** defines bridges, specifies inspection procedures and frequencies, and indicates minimum qualifications for personnel. Each state is permitted to modify its bridge inspection standards to deviate from the NBIS standards but only following approval from the FHWA.

[Section 335.074, F.S.](#), mandates safety inspection of bridges. Bridge inspectors shall be certified in accordance with [Chapter 14-48, F.A.C.](#) Safety inspection of bridges shall be conducted in accordance with [Chapter 14-48, F.A.C.](#)

~~The FDOT~~~~The Department~~ inspects all bridges in Florida, both on-system and off-system and. ~~The Department~~ provides each local government with copies of its inspection reports. Each local government should maintain these reports to be responsive to Metropolitan Planning Organization requests for bridge rehabilitation, replacement, or enhancement designations. Please see the following for further information: [Bridge and Other Structures Reporting Manual 850-010-030](#).

All on-system and off-system bridges are assigned a Bridge Number by ~~the FDOT~~~~the Department~~. For new bridges, local agencies shall contact the ~~FDOT's~~~~Department's~~ local District Structures Maintenance Engineers to have a number assigned.

F BRIDGE LOAD RATING AND POSTING

[Section 335.074, F.S. Safety Inspection of Bridges](#) requires that bridges on a public transportation facility be inspected for structural soundness and safety at regular intervals. The inspection shall consider age, traffic characteristics, state of maintenance, and known deficiencies of the bridge. The governmental entity having maintenance responsibility for any such bridge shall be responsible for having inspections performed and reports prepared.

As required by [Section 335.074, F.S.](#), each inspection shall be reported to ~~the FDOT~~[the Department](#), using the Bridge Load Rating Summary Table form shown in ~~Exhibit A~~[the FDOT ~~FDOT~~ Bridge Load Rating Manual](#). Further information for preparing a bridge load rating summary and fillable form may be found on ~~the FDOT's~~[the Department's Office of Maintenance, Bridge Load Rating](#) web site.

Upon receipt of an inspection report that recommends reducing the weight limit on a bridge, the governmental entity having maintenance responsibility for the bridge shall load post the bridge within 30 days in accordance FS 335.074(5). Further requirements for reporting and posting of weight, size or speed limits on bridges are found in this statute, [Section 316.555 F.S. Weight, load, speed limits may be lowered](#). The appropriate signage shall be promptly installed in accordance with the [MUTCD](#).

For new construction or reconstruction projects, the bridge owner is responsible for providing ~~the FDOT~~[the Department](#) with a load rating and completed Bridge Load Rating Summary Table (~~see Exhibit A — Bridge Load Rating Summary Table~~) within 90 days of opening for on-system bridges or 180 days for off-system bridges. The bridge owner should consider requiring the engineer of record to perform the load rating.

EXHIBIT A — Bridge Load Rating Summary Table

Bridge No.							Analysis Method: LRFR-LRFD	FDOT Bridge Load Rating Summary Form (Page 1 of 1)			
Bridge Name											
Description											

Rating Type	Rating Type	Gross Axle Weight (tons)	Moment/Shear/Service		Dead Load Factor	Live Load Factor	Live Load Distrib. Factor (axles)	Rating Factor	Span No. - Girder No., Interior/Exterior, %SparL	Pontis RF Weight (tons)
Level	Vehicle	Weight	Member Type	Limit	DC	LL	LLDF	RF	Governing Location	RATING
Inventory	HL93	36	Member Type	Limit Test	NA	NA				
Operating	HL93	36	Member Type	Limit Test	NA	NA				
Permit	FL120	60	Member Type	Limit Test	NA	NA				
Max Span	FL120	60	Member Type	Limit Test	NA	NA				
Legal	SU2	17	Member Type	Limit Test	NA	NA				
	SU3	33	Member Type	Limit Test	NA	NA				
	SU4	35	Member Type	Limit Test	NA	NA				
	C3	28	Member Type	Limit Test	NA	NA				
	C4	36.7	Member Type	Limit Test	NA	NA				
	C5	40	Member Type	Limit Test	NA	NA				
ST5	40	Member Type	Limit Test	NA	NA					

<i>Original</i> Design Load	enter Original Design Load	Performed by:	Date:
Rating Type, <i>Analysis</i>	enter Rating Type	Checked by:	Date:
Distribution Method	enter Distribution Method	Sealed By:	Date:
Impact Factor	enter IM (axle loading)	FL P.E. No.:	
FL120 Gov. Span Length	enter Gov Length (feet)	Cert. Auth. No.:	
Recommended Posting	enter Posting (70)	Phone & email:	
Rec. SU Posting	enter SU posting (tons)	Company:	
Rec. C Posting	enter C posting (tons)	Address:	
Rec. ST5 Posting	enter ST5 posting (tons)	<i>P.E. Seal</i>	
Floor Beam Present?	FLOOR BEAM PRESENT?		
Segmental Bridge?	SEGMENTAL BRIDGE?		
Project No. & Reason	FIN No. Update		
Status	Status		
Software Name, Version	Enter Software Name & Version		
COMMENTS BY THE ENGINEER			
Page 1/XX. Contents: summary, narrative, plans, calcs, check.			

This 04-24-2015 table is based on requirements within the 2015 FDOT Bridge Load Rating Manual, and the BMS Coding Guide; see <http://www.fdot.state.fl.us/state/maintenance/office/oadRating.shtml>

G RECOMMENDATIONS

- Involve the public in determining “*the appropriate aesthetics based upon scale, color, and architectural style, materials used to construct the facility, and the landscape design and landscape materials around the facility...*” (Section 336.045, F.S.).
- ~~Resist the temptation to enhance the aesthetics of a bridge with non-structural appurtenances and features that are novel and therefore may have safety challenges (otherwise, consult with FDOTthe Department on these safety issues).~~
- Consider the potential for future expansion of a bridge’s capacity (vehicular transit and pedestrian) in its layout and bridge-type selection.
- Use the FDOT’s~~the Department’s~~ objective construction unit prices (contained in the Structures Design Guidelines, Sections 9.2 and 9.3) to select bridge type(s) to consider for final design.
- ~~Consider the use of alternative designs (i.e., steel superstructures vs. concrete superstructures) to increase bidding competition on very large bridge construction projects.~~
- ~~Invest in a comprehensive subsurface investigation of the site before any significant design of the bridge occurs (which will also help avoid unforeseen conditions during construction).~~
- ~~Consult with other local officials on experiences relating to construction of other bridges in the area.~~
- ~~Consider using FDOT’sthe Department’s Standard Specifications for Road and Bridge Construction with notes on the plans referencing the Owner as the local governmental agency and the Engineer as the owner’s engineer.~~
- ~~Consider the constructability, inspectability, and maintainability of all bridge components before they are incorporated into the project’s final design.~~
- ~~Include drainage pass-throughs in wall designs.~~
- ~~Provide qualified construction inspection personnel for all phases of bridge construction.~~
- ~~Maintain all design and construction records in a safe, protected, and secure location throughout the life of the bridge.~~

H REFERENCES FOR INFORMATIONAL PURPOSES

The publications referenced in this chapter can be obtained from the following websites.

- FDOT Publications may be found at:
<http://www.fdot.gov/publications/>
- AASHTO, all publications may be ordered from:
bookstore.transportation.org
- FHWA “HEC-18” and “HEC-20” may be found at:
http://www.fhwa.dot.gov/engineering/hydraulics/library_listing.cfm
- 2006 Americans with Disabilities Act Standards for Transportation Facilities
<http://www.access-board.gov/guidelines-and-standards/transportation/facilities/ada-standards-for-transportation-facilities>
<https://www.access-board.gov/files/ada/ADAdotstandards.pdf>
- 2017 Florida Accessibility Code for Building Construction
<https://codes.iccsafe.org/public/document/FAC2017>

CHAPTER 18

SIGNING AND MARKING

A	INTRODUCTION	18-1
B	BACKGROUND	18-1
C	SIGNS	18-2
C.1	Advance Street Name Signs	18-2
C.1.a	Standards.....	18-2
C.1.b	Installation.....	18-2
C.1.c	Sign Design.....	18-3
C.2	Advance Traffic Control Signs.....	18-5
C.3	Overhead Street Name Signs	18-5
C.3.a	Standards.....	18-5
C.3.b	Installation.....	18-6
C.3.c	Sign Design.....	18-6
C.3.d	Internally Illuminated Overhead Street Name Signs	18-6
C.4	Community Wayfinding Guidance.....	18-7
C.5	DMS Overview	18-7
C.6	Design Details for Signs.....	18-7
D	PAVEMENT MARKINGS.....	18-8
D.1	Pavement Markings	18-8
D.2	Reflective Pavement Markers	18-8
E	AUDIBLE AND VIBRATORY TREATMENTS.....	18-8
E.1	Longitudinal Audible Vibratory Treatments	18-8
E.2	Transverse Rumble Strips.....	18-9
F	RAILROAD DYNAMIC ENVELOPE PAVEMENT MARKING AND SIGNAGE	18-9

TABLES

Table 18 – 1 Design Guidelines for Advance Street Name Signs..... 18-3

FIGURES

Figure 18 – 1 Examples of Advance Street Name Signs 18-4

CHAPTER 18

SIGNING AND MARKING

A INTRODUCTION

Signing and pavement markings help improve highway safety by providing guidance information to road users. Both signs and pavement markings should provide sufficient visibility to meet the user's needs. The design of signs and pavement markings should complement the basic highway design. Designers and engineers should also be aware of the capabilities and needs of seniors, and consider appropriate measures to better meet their needs and capabilities.

Sections C and D of this chapter specifically discuss traffic control devices for both signing and pavement marking that accommodate not only the needs of all types of road users, but also the special needs of seniors.

B BACKGROUND

[Section 316.0745, F.S.](#), requires ~~the FDOT~~the Department to compile and publish a manual of uniform traffic control devices for use on the streets and highways of the state. To comply with this statute, the Federal Highway Administration's (FHWA) [Manual on Uniform Traffic Control Devices \(MUTCD\)](#) has been adopted for use in [Rule 14-15.010, F.A.C.](#): All references in this chapter are in conformance with the **MUTCD**:

The [Manual on Speed Zoning for Highways, Roads, and Streets in Florida \(2019\)](#), is adopted for use by the State of Florida under [Rule 14-15.012, F.A.C.](#) This manual is prepared by ~~the FDOT~~the Department in compliance with [Chapter 316, of the Florida Statutes](#), to promote uniformity in the establishment of state, municipal, and county speed and school zones throughout the State.

C SIGNS

C.1 Advance Street Name Signs

The use of advance street name signs provides advance notification to road users to assist them in making safe roadway decisions. Signs should be used for signalized or non-signalized intersections that are classified as a minor arterial or higher, or a cross street that provides access to a traffic generator or possesses other comparable physical or traffic characteristics deemed to be critical or significant.

C.1.a Standards

The words Street, Boulevard, Avenue, etc., may be abbreviated, deleted, or reduced in size to conserve sign panel length. However, if confusion would result due to similar street names in the area, the deletion should not be made.

Use of the local name is preferred on advance street name signs. When a cross street has a different name on each side of the intersection, both names shall be shown with an arrow beside each name to designate direction. Additional legend such as NEXT SIGNAL or XX FEET may be added.

C.1.b Installation

Advance street name signs should be installed in advance of the intersection in accordance with the distances shown in “Condition A” of [Table 2C-4. Guidelines for Advance Placement of Warning Signs of the MUTCD](#). These distances are to be considered the minimum for a single lane change maneuver, and should be measured from the begin taper point for the longest auxiliary lane designed for the intersection. The degree of traffic congestion and the potential number of lane change maneuvers that may be required should also be considered when determining the advance placement distance.

C.1.c Sign Design

Advance street name signs shall be designed in accordance with [Part 2 Signs](#) of the [MUTCD](#). The lettering for the signs shall be composed of a combination of lower case letters with initial upper case letters.

Letter height should conform to Table 18 – 1 Design Guidelines for Advance Street Name Signs. Various layouts for advance street name signs are shown in Figure 18 – 1 Examples of Advance Street Name Signs.

Table 18 – 1 Design Guidelines for Advance Street Name Signs

Posted Speed Limit	Street Name Legend	Next Signal or Intersection
	Letter Size (inches) Series E Modified (EM) Upper/Lower Case Letters	Letter Size (inches) Series D (D) Upper Case Letters
35 mph or less	8 EM	6 D
40 mph or greater	10.67 EM	8 D

Figure 18 – 1 Examples of Advance Street Name Signs



C.2 Advance Traffic Control Signs

Advance Traffic Control signs, i.e., Stop Ahead (W3-1), Yield Ahead (W3-2), and Signal Ahead (W3-3) signs, shall be installed on an approach to a primary traffic control device that is not visible for a sufficient distance to permit the driver to respond to the device. The visibility criteria for traffic signals shall be based on having a continuous view of at least two signal faces for the distance specified in [Table 4D-2. Minimum Sight Distance for Signal Visibility](#) of the [MUTCD](#).

An Advance Traffic Control sign may be used for additional emphasis of the primary traffic control device, even when the visibility distance to the device is satisfactory.

C.3 Overhead Street Name Signs

Overhead street name signs with mixed-case lettering should be used at major intersections (with multi-lane approaches) as a supplement to post mounted street name signs.

C.3.a Standards

Overhead street name signs shall only be used to identify cross streets, not destinations such as cities or facilities. To avoid the need for lighting of overhead signs, they should have a minimum maintained retroreflectivity value as shown in [Table 2A-3. Minimum Maintained Retroreflectivity Levels, MUTCD](#). Roadway geometry and forward sight distance will also influence the need for overhead sign lighting.

The words Street, Boulevard, Avenue, etc., may be abbreviated, deleted, or reduced in size to conserve sign panel length. The border should be eliminated on overhead street name signs to minimize sign panel size. When a cross street is known by both a route number and a local name, use of the local name is preferred.

When a cross street has a different name on each side of the intersection, two options are permitted:

- When two sign panels are used, install one sign panel on the left and the other sign panel on the right side of the signal heads; or
- When one sign panel is used, the left name should be displayed over the right name. Arrows should be provided to indicate which side of the intersection the street name applies.

C.3.b Installation

Due to the possibility of hurricane strength winds, overhead street name signs should not be installed on span wire but should be mounted to the strain pole or mast arm.

The location of the overhead street name sign on a signal strain pole and/or mast arm may vary. However, it shall not interfere with the motorist's view of the signal heads. The preferred location is shown in [the FDOT's the Standard Plans](#). In the case of separate street names on each side of the street, where separate signs are used, one sign should be placed to the right of the signal heads and the other sign to the left of the signal heads.

C.3.c Sign Design

On roadways with speeds of 40 mph or above, the sign panel should be at least 24 inches in height with the length determined by text. At a minimum, use 8-inch upper case and 6-inch lower case lettering for the street name. If block numbering text is included, use 6-inch all upper case lettering on the second line. The preferred font is Series E-Modified; however, Series E may be used to accommodate the amount of legend so as not to exceed the 96-inch maximum length.

Where structurally possible, overhead street name signs should be designed in compliance with the FHWA recommendations for older drivers using a minimum lettering size of 10-inch upper case with 9-inch lower case.

C.3.d Internally Illuminated Overhead Street Name Signs

An internally illuminated overhead street name sign may be used to improve night-time visibility. Internally illuminated overhead street name signs should have a standardized height of 24-inches and a length not to exceed 108-inches (nine feet).

A Series E Modified or Series E font, which may vary to accommodate the amount of text on the panel should be used.

The sign design shall be in accordance with the [MUTCD](#). When possible, the text should utilize the following text attributes in descending order to limit the maximum width:

- 10-inch upper case with 8-inch lower case, Type EM font
- 10-inch upper case with 8-inch lower case, Type E font
- 8-inch upper case with 6-inch lower case, Type EM font
- 8-inch upper case with 6-inch lower case, Type E font

Internally illuminated overhead street name signs shall be on [the FDOT's](#)~~the~~ [Department's *Approved Products List \(APL\)*](#).

C.4 Community Wayfinding Guidance

Community wayfinding guide signs should be developed and approved through local resolution with criteria for the destinations shown on the community wayfinding guide sign system plan. Any wayfinding guide sign should be used in accordance with [Rule 14-51.030, F.A.C.](#) The intent is to provide guidance and navigation information to local cultural, historical, recreational, and tourist activities. No destination should be displayed for the purpose of advertising.

C.5 DMS Overview

The main purpose of dynamic message signs (DMS) is to convey timely and important en-route and roadside information to motorists and travelers. Further information on how DMS signs may be used can be found in [the FDOT's policy on *Displaying Messages on Dynamic Message Signs Permanently Mounted on the State Highway System*](#).

C.6 Design Details for Signs

The [MUTCD](#) shall govern all sign details. At a minimum, the “Conventional Road” size shall be used on signs intended for motor vehicle operators.

Shared use path sign sizing for traffic control shall follow the “Shared-Use Path” sizing and height shown in the MUTCD. See **Chapter 9 – Bicycle Facilities** for additional requirements on the signing of shared use paths.

D PAVEMENT MARKINGS

D.1 ~~6-inch~~ Pavement Markings

6-inch pavement markings should be used for all pavement center line, lane separation line and edge line markings. The *FDOT Design Manual, Chapter 230* provides additional information, including material options.

D.2 Reflective Pavement Markers

To provide greater emphasis and increase visibility to the pavement markings, especially during wet/night conditions, ~~—, reflective~~ (R~~aised~~) P~~p~~avement M~~arkers~~ (RPMs) may be placed at 40-foot spacings along the centerline markings of roadways should be used. More information on RPM configurations is shown in the FDOT's *Standard Plans, Index 76-001*.

E AUDIBLE AND VIBRATORY TREATMENTS

E.1 Longitudinal Audible Vibratory Treatments

Longitudinal ~~A~~audible and ~~V~~vibratory ~~T~~treatments (AVTs) are an effective low-cost countermeasure to reduce the severity and frequency of roadway lane departure crashes. They include cylindrical ground-in rumble strips, sinusoidal ground-in rumble strips and profiled thermoplastic. They are most effective on high-speed roadways with flush shoulders. They should not be placed within the limits of intersections or crosswalks.

Audible ~~V~~vibratory ~~T~~treatments (AVTs) ~~s~~ are designed to improve the opportunity for a safe recovery for distracted, drowsy, or otherwise inattentive drivers who may unintentionally drift over the edge or center line. Due to the difficulty in determining where a driver will depart the lane, it is recommended that treatments be installed system-wide or in corridors. Their use should be determined on the suitability of the cross-section and appropriateness in the surrounding land use context. shall be provided for edge lines and center lines on flush-shoulder roadways with a posted speed of 50 mph or greater and lane widths of 11 feet or greater. Sections where advisory speeds are used due to restricted horizontal or vertical geometry shall not be excluded. AVTs shall not be placed within the limits of crosswalks.

~~Considerations that may limit the acceptability and effectiveness include low speeds, noise for adjacent residences, and pavement width. More information on these types of treatments are shown in the FDOT Department's *Standard Plans, Index 546-010* and *FDOT Design Manual, Chapter 210 Arterials and*~~

Collectors. AVT options include sinusoidal ground-in rumble strips and profiled thermoplastic. The sinusoidal ground-in rumble strip option provides the most economical and durable solution with less noise pollution.

E.2 Transverse Rumble Strips

Transverse rumble strips may be used to alert the driver in rural areas to upcoming stop conditions or abrupt changes in alignment. Factors influencing their use include crash history, roadway geometry and surrounding land use (noise pollution). They should not be placed in crosswalks or bicycle facilities. If placed On roadways open to bicycle travel, a minimum clear path of 4 feet on the outside edge should be provided. Sections 3J.02 Transverse Rumble Strip Markings and 6F.87 Rumble Strips, MUTCD provide further information on the use of transverse rumble strips.

See Chapter 11 – Work Zone Safety and Mobility for requirements for installation of short term transverse rumble strips during construction activities.

F RAILROAD DYNAMIC ENVELOPE PAVEMENT MARKING AND SIGNAGE

Railroad Dynamic Envelope pavement markings are used to delineate the area around at-grade railroad crossings where vehicles should not stop. See Chapter 7 – Rail-Highway Grade Crossings for guidance on the design and installation of railroad dynamic envelope pavement markings and signage.

CHAPTER 19

TRADITIONAL NEIGHBORHOOD DEVELOPMENT

A	INTRODUCTION	19-1
B	APPLICATION	19-3
C	PLANNING CRITERIA	19-4
C.1	LAND USE	19-4
C.2	NETWORKS	19-4
D	OBJECTIVES	19-7
E	DESIGN ELEMENTS	19-9
E.1	Design Controls	19-9
E.1.a	Design Speed	19-9
E.1.b	Movement Types	19-9
E.1.c	Design Vehicles	19-10
E.2	Sight Distance	19-11
E.2.a	Stopping Sight Distance	19-11
E.2.b	Passing Sight Distance	19-11
E.2.c	Intersection Sight Distance	19-11
E.3	Horizontal Alignment	19-12
E.3.a	Minimum Centerline Radius	19-12
E.3.b	Minimum Curb Return Radius	19-12
E.4	Vertical Alignment	19-13
E.5	Cross Section Elements	19-13
E.5.a	Introduction	19-13
E.5.b	Lane Width	19-13
E.5.c	Medians	19-15
E.5.d	Turn Lanes	19-16
E.5.e	Parking	19-17
E.6	Cul-de-sacs and Turnarounds	19-17
E.6.a	Turning Area	19-17

E.7	Pedestrian Considerations	19-18
E.7.a	Furniture Zone	19-18
E.7.b	Walking/Pedestrian Zone	19-19
E.7.c	Shy Zone.....	19-19
E.7.d	Mid-Block Crossings	19-19
E.7.e	Curb Extensions.....	19-19
E.8	Bicyclist Considerations	19-20
E.8.a	Bicycle Facilities.....	19-20
E.8.b	Shared Use Paths.....	19-21
E.9	Transit.....	19-21
E.10	Clear Zone	19-21
F	REFERENCES FOR INFORMATIONAL PURPOSES	19-22

TABLES

Table 19 - 1	Curb Return Radii	19-13
Table 19 - 2	Minimum Lane Width	19-14
Table 19 - 3	Recommended Median Width.....	19-16
Table 19 - 4	Parking Lane Width.....	19-17

FIGURES

Figure 19 - 1	Traditional Network	19-5
Figure 19 - 2	Conventional Network.....	19-5
Figure 19 - 3	Lane Width.....	19-14
Figure 19 - 4	Border	19-18

CHAPTER 19

TRADITIONAL NEIGHBORHOOD DEVELOPMENT

A INTRODUCTION

Florida is a national leader in planning, design and construction of Traditional Neighborhood Development (TND) communities, and in the renovation of downtown neighborhoods and business districts. TND refers to the development or redevelopment of a neighborhood or town using traditional town planning principles. Projects should include a range of housing types and commercial establishments, a network of well-connected streets and blocks, civic buildings and public spaces, and include other uses such as stores, schools, and worship within walking distances of residences.

They represent patterns of development aligned with the state's growth management, smart growth and sprawl containment goals. This approach, with its greater focus on pedestrian, bicycle and transit mobility; is distinct from Conventional Suburban Development (CSD). CSDs are comprised largely of subdivision and commercial strip development.

TND communities rely on a strong integration of land use and transportation. A TND has clearly defined characteristics and design features that are necessary to achieve the goals for compact and livable development patterns reinforced by a context-sensitive transportation network. The treatment of land use, development patterns and transportation networks necessary for successful TND communities is a major departure from those same elements currently utilized in other Greenbook chapters.

To provide a design that accomplishes the goals set out in this chapter, designers will be guided by the context of the built environment, established or desired, for a portion of the communities because TND communities rely on a stronger integration of land use and transportation than CSD communities. This chapter provides criteria that may be used for the design of streets within a TND when such features are desired, appropriate and feasible. This involves providing a balance between mobility and livability. This chapter may be used in planning and designing new construction, urban infill, and redevelopment projects.

Section B of this chapter discusses the primary objectives of TND in more detail to aid the designer in the selection of proper criteria. Section C sets forth specific design criteria for the transportation system within TND.

The Department's ***Traditional Neighborhood Development Handbook (2011)*** provides designers guidance in the successful application of this Chapter.

B APPLICATION

A project or community plan may be considered a TND when at least the first seven of the following principles are included:

1. Has a compact, pedestrian-oriented scale that can be traversed in a five to ten-minute walk from center to edge.
2. Is designed with low speed, low volume, interconnected streets with short block lengths, 150 to 500 feet, and cul-de-sacs only where no alternatives exist. Cul-de-sacs, if necessary, should have walkway and bicycle connections to other sidewalks and streets to provide connectivity within and to adjacent neighborhoods.
3. Orients buildings at the back of sidewalk, or close to the street with off-street parking located to the side or back of buildings, as not to interfere with pedestrian activity.
4. Has building designs that emphasize higher intensities, narrow street frontages, connectivity of sidewalks and paths, and transit stops to promote pedestrian activity and accessibility.
5. Incorporates a continuous bike and pedestrian network with wider sidewalks in commercial, civic, and core areas, but at a minimum has sidewalks at least five feet wide on both sides of the street. Accommodates pedestrians with short street crossings, which may include mid-block crossings, bulb-outs, raised crosswalks, specialty pavers, or pavement markings.
6. Uses on-street parking adjacent to the sidewalk to calm traffic, and offers diverse parking options, but planned so that it does not obstruct access to transit stops.
7. Varies residential densities, lot sizes, and housing types, while maintaining an average net density of at least eight dwelling units per acre, and higher density in the center.
8. Integrates at least ten percent of the developed area for nonresidential and civic uses, as well as open spaces.
9. Has only the minimum right of way necessary for the street, median, planting strips, sidewalks, utilities, and maintenance that are appropriate to the adjacent land uses and building types.
10. Locates arterial highways, major collector roads, and other high-volume corridors at the edge of the TND and not through the TND.

The design criteria in this chapter shall only be applicable within the area defined as TND.

C PLANNING CRITERIA

Planning for TND communities occurs at several levels, including the region, the city/town, the community, the block, and, finally, the street and building. Planning should be holistic, looking carefully at the relationship between land use, buildings, and transportation in an integrated fashion. This approach, and the use of form based codes, can create development patterns that balance pedestrian, bicycling, and transit with motor vehicle transportation.

C.1 LAND USE

In addition to its importance in calculating trip generation, the Institute of Transportation Engineers (ITE) recognizes land use as fundamental to establishing context, design criteria, cross-section elements, and right of way allocation. The pedestrian travel that is generated by the land uses is also important to the design process for various facilities.

A well-integrated, or “fine grained”, land use mix within buildings and blocks is essential. These buildings and blocks aggregate into neighborhoods, which should be designed with a mix of uses to form a comprehensive planning unit that aggregates into larger villages, towns, and regions. Except at the regional scale, each of these requires land uses to be designed at a pedestrian scale and to be served by “complete streets” that safely and attractively accommodate many modes of travel.

The proposed land uses, residential densities, building size and placement, proposed parking (on-street and off-street) and circulation, the location and use of open space, and the development phasing are all considerations in facility design for TNDs. ITE recommends a high level of connectivity, short blocks that provide many choices of routes to destinations, and a fine-grained urban land use and lot pattern. Higher residential density and nonresidential intensity, as measured by floor area ratios of building area to site area, are required for well-designed TNDs.

C.2 NETWORKS

Urban networks are frequently characterized as either traditional or conventional. Traditional networks are typically characterized by a relatively non-hierarchical pattern of short blocks and straight streets with a high density of intersections that support all modes of travel in a balanced fashion.

Figure 19 – 1 Traditional Network



New York, NY

Savannah, GA

(Source: VHB)

The typical conventional street network, in contrast, often includes a framework of widely-spaced arterial roads with limited connectivity provided by a system of large blocks, curving streets and a branching hierarchical pattern, often terminating in cul-de-sacs.

Figure 19 – 2 Conventional Network



Walnut Creek, CA

(Source: VHB)

Traditional and conventional networks differ in three easily measurable respects: (1) block size, (2) degree of connectivity and (3) degree of curvature. While the last does not significantly impact network performance, block size and connectivity create very different performance characteristics.

Advantages of traditional networks include:

Distribution of traffic over a network of streets, reducing the need to widen roads;

A highly interconnected network providing a choice of multiple routes of travel for all modes, including emergency services;

More direct routes between origin and destination points, which generate fewer vehicle miles of travel (VMT) than conventional suburban networks;

Smaller block sizes in a network that is highly supportive to pedestrian, bicycle, and transit modes of travel;

A block structure that provides greater flexibility for land use to evolve over time.

It is important in TND networks to have a highly interconnected network of streets with smaller block sizes than in conventional networks. There are several ways to ensure that these goals are achieved.

One method is based upon the physical dimensions used to layout streets and blocks. The following list identifies those parameters:

1. Limit block size to an average perimeter of approximately 1,320 feet.
2. Encourage an average intersection spacing for local streets of 300-400 feet.
3. Limit maximum intersection spacing for local streets to approximately 600 feet.
4. Limit maximum spacing between pedestrian/bicycle connections to approximately 300 feet (that is, it creates mid-block paths and pedestrian shortcuts).

D OBJECTIVES

The basic objectives of a Traditional Neighborhood Development are:

1. Safety
2. Mobility of all users (vehicles, pedestrians, bicyclists and transit)
3. Compact and livable development patterns
4. Context-sensitive transportation network

TND features are based upon the consideration of the following concepts. These concepts are not intended as absolute criteria since certain concepts may conflict. The concepts should therefore be used for the layout of proper street systems.

1. Strong integration of land use and transportation.
2. Very supportive of pedestrian, bicycle, and transit modes.
3. Smaller block sizes to improve walkability, and to create a fine network of streets accommodating bicyclists and pedestrians, and providing a variety of routes for all users.
4. On-street parking is favored over surface parking lots.
5. Limited use of one way streets.
6. Speeds for motor vehicles are ideally kept in the range of 20-35 mph through the design of the street, curb extensions, use of on-street parking, the creation of enclosure through building and tree placement.
7. Street geometry (narrow streets and compact intersections), adjacent land use, and other elements within a TND must support a high level of transit, pedestrian and bicycle activity.
8. Provide access to emergency services, transit, waste management, and delivery trucks.
9. Provide access to property.

This approach to street design requires close attention to the operational needs of transit, fire and rescue, waste collection, and delivery trucks. For this reason, early coordination with transit, fire and rescue, waste collection, and other stakeholder groups is essential. For fire and rescue, determination of the importance of that corridor for community access should be determined, e.g. primary or secondary access.

More regular encroachment of turning vehicles into opposing lanes will occur at intersections. Therefore, frequency of transit service, traffic volumes, and the speeds at those intersections must be considered when designing intersections.

When designing features and streets for TND communities, creativity and careful attention to safety for pedestrians and bicyclists must be balanced with the operational needs of motor vehicles.

Finally, it is very important when designing in TND communities to ensure that a continuous network is created for pedestrians, bicyclists, and transit throughout the community to create higher levels of mobility that are less dependent on automobile travel.

E DESIGN ELEMENTS

The criteria provided in this chapter shall require the approval of the maintaining authority's designated Professional Engineer representative with project oversight or general compliance responsibilities. Approval may be given based upon a roadway segment or specific area.

The criteria provided in this chapter are generally in agreement with AASHTO guidelines with a special emphasis on urban, low-speed environments. Design elements within TND projects not meeting the requirements of this chapter are subject to the requirements for Design Exceptions found in **Chapter 14** of this manual.

E.1 Design Controls

E.1.a Design Speed

The application of design speed for TND communities is philosophically different than for conventional transportation and CSD communities. Traditionally, the approach for setting design speed was to use as high a design speed as practical.

In contrast to this approach, the goal for TND communities is to establish a design speed that creates a safer and more comfortable environment for pedestrians and bicyclists, and is appropriate for the surrounding context.

Design speeds of 20 to 35 mph are desirable for TND streets. Alleys and narrow roadways intended to function as shared spaces may have design speeds as low as 10 mph.

E.1.b Movement Types

Movement types are used to describe the expected driver experience on a given thoroughfare, and the design speed for pedestrian safety and mobility established for each of these movement types. They are also used to establish the components and criteria for design of streets in TND communities.

Yield: Has a design speed of less than 20 mph. Drivers must proceed slowly with extreme care, and must yield to pass a parked car or approaching vehicle. This is the functional equivalent of traffic calming. This type should accommodate bicycle routes through the use of shared lanes.

Slow: Has a design speed of 20-25 mph. Drivers can proceed carefully, with an occasional stop to allow a pedestrian to cross or another car to park. Drivers should feel uncomfortable exceeding design speed due to the presence of parked cars, enclosure, tight turn radii, and other design elements. This type should accommodate bicycle routes through the use of shared lanes.

Low: Has a design speed of 30-35 mph. Drivers can expect to travel generally without delay at the design speed, and street design supports safe pedestrian movement at the higher design speed. This type is appropriate for thoroughfares designed to traverse longer distances, or that connect to higher intensity locations. This type should accommodate bicycle routes through the use of bike lanes.

Design speeds higher than 35 mph should not normally be used in TND communities due to the concerns for pedestrian and bicyclist safety and comfort. There may be locations where planned TND communities border, or are divided by, existing corridors with posted/design speeds higher than 35 mph. In those locations, coordination with the regulating agency should occur with a goal to re-design the corridor and reduce the speed to 35 mph or less. The increase in motorist travel time due to the speed reduction is usually insignificant because TND communities are generally compact.

When the speed reduction cannot be achieved, measures to improve pedestrian safety for those crossing the corridor should be evaluated and installed when appropriate.

E.1.c Design Vehicles

There is a need to understand that street design with narrow streets and compact intersections requires designers to pay close attention to the operational needs of transit, fire and rescue, waste collection, and delivery trucks. For this reason, early coordination with transit, fire and rescue, waste collection, and other stakeholder groups is essential.

Regular encroachment of turning vehicles into opposing lanes will occur at intersections. Therefore, frequency of transit service, traffic volumes, and the speeds at those intersections must be considered when designing intersections. For fire and rescue, determination of the importance of the street for community access should be determined, e.g. primary or secondary access.

The designer should evaluate intersections using turning templates or turning movement analysis software to ensure that adequate operation of vehicles can occur. Treatment of on-street parking around intersections should be evaluated during this analysis to identify potential conflicts between turning vehicles and on-street parking.

E.2 Sight Distance

See *Chapter 3 – Geometric Design, C.3 Sight Distance.*

E.2.a Stopping Sight Distance

See *Chapter 3 – Geometric Design, C.3.a Stopping Sight Distance.*

E.2.b Passing Sight Distance

Due to the importance of low speeds and concerns for pedestrian comfort and safety, passing should be discouraged or prohibited.

E.2.c Intersection Sight Distance

Sight distance should be calculated in accordance with *Chapter 3, Section C.9.b*, using the appropriate design speeds for the street being evaluated. When executing a crossing or turning maneuver after stopping at a stop sign, stop bar, or crosswalk, as required in *Section 316.123, F.S.*, it is assumed that the vehicle will move slowly forward to obtain sight distance (without intruding into the crossing travel lane) stopping a second time as necessary.

Therefore, when curb extensions are used, or on-street parking is in place, the vehicle can be assumed to move forward on the second step movement, stopping just shy of the travel lane, increasing the driver's potential to see further than when stopped at the stop bar. The resulting increased sight distance provided by the two step movement allows parking to be located closer to the intersection.

The **MUTCD** requires that on-street parking be located at least 20 feet from crosswalks. The minimum stopping sight distance is 60 feet for low volume (< 400 ADT) streets. Even on slow speed, low volume urban streets, the combination of curb return, crosswalk width and 20-foot setback to the first parking space may not meet the minimum stopping distance. Justification for locating parking spaces 20 feet from crosswalks may be achieved based on community history with existing installations.

E.3 Horizontal Alignment

E.3.a Minimum Centerline Radius

See **Chapter 3 – Geometric Design, C.4 Horizontal Alignment** and Table 3 – 12 Minimum Radii (feet) for Design Superelevation Rates Low Speed Local Roads ($e_{max} = 0.05$).

E.3.b Minimum Curb Return Radius

Curb return radii should be kept small to keep intersections compact. The use of on-street parking and/or bike lanes increases the effective size of the curb radii, further improving the ability of design vehicles to negotiate turns without running over the curb return.

Table 19 – 1 Curb Return Radii

Movement Type	Design Speed	Curb Radius w/Parallel Parking*
Yield	Less than 20 mph	5-10 feet
Slow	20-25 mph	10-15 feet
Low	30-35 mph	15-20 feet

* Dimensions with parking on each leg of the intersection. Both tangent sections adjacent to the curb return must provide for on-street parking or else curb radii must be evaluated using “design vehicle” and either software or turning templates.

E.4 Vertical Alignment

See *Chapter 3 – Geometric Design, C.5 Vertical Alignment.*

E.5 Cross Section Elements

E.5.a Introduction

As discussed earlier in this chapter, TND street design places importance on how the streets are treated since they are part of the public realm. The street portion of the public realm is shaped by the features and cross section elements used in creating the street. For this reason, it is necessary the designer pay more attention to what features are included, where they are placed, and how the cross section elements are assembled.

E.5.b Lane Width

Travel lane widths should be based on the context and desired speed for the area where the street is located. Table 19-2 shows travel lane widths and associated appropriate speeds. It is important to note that in low speed urban environments, lane widths are typically measured to the curb face instead of the edge of the gutter pan. Consequently, when curb sections with gutter pans are used, the motor vehicle and parking lanes include the width of the gutter pan.

Table 19 – 2 Minimum Lane Width

Movement Type	Design Speed	Travel Lane Width
Yield*	Less than 20 mph	N/A
Slow	20-25 mph	9-10 feet
Low	30-35 mph	10-11 feet

* Yield streets are typically residential two-way streets with parking on one or both sides. When the street is parked both sides, the remaining space between parked vehicles (10 feet minimum) is adequate for one vehicle to pass through. Minimum width for a yield street with parking on both sides should be 24 feet curb face to curb face. Minimum width for a yield street with parking on one side should be 20 feet curb face to curb face, allowing for two 10-foot lanes when the street is not parked.

Figure 19 – 3 Lane Widths shows a typical measurement.

Figure 19 – 3 Lane Width

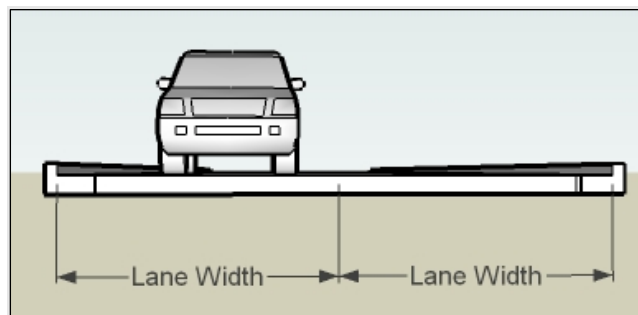

(Source: VHB)

In order for drivers to understand the appropriate driving speeds, lane widths should create some level of discomfort when driving too fast. The presence of on-street parking is important in achieving the speeds shown in Table 19 – 2 Minimum Lane Widths. When bicycle lanes or multi-lane configurations are used, there is more room for vehicles, such as buses, to operate. However car drivers may feel more comfortable driving faster than desired.

Alleys and narrow roadways that act as shared spaces can have design speeds as low as 10 mph, as noted in **Chapter 16 – Residential Street Design**.

Alleys can be designed as either one way or two way. Right of way width should be a minimum of 20 feet with no permanent structures within the right of way that would interfere with vehicle access to garages or parking spaces, access for trash collection, and other operational needs. Pavement width should be a minimum of 12 feet. Coordination with local municipalities on operational requirements is essential to ensure that trash collection and fire protection services can be completed.

E.5.c Medians

Medians used in low-speed urban thoroughfares provide for access management, turning traffic, safety, pedestrian refuge, landscaping, lighting, and utilities. These medians are usually raised with raised curb.

Landscaped medians can enhance the street or help create a gateway entrance into a community. Medians can be used to create tree canopies over travel lanes for multi-lane roadways contributing to a sense of enclosure.

Medians vary in width depending on available right of way and function. Because medians require a wider right of way, the designer must weigh the benefits of a median with the issues of pedestrian crossing distance, speed, context, and available roadside width.

Table 19 – 3 Recommended Median Width

Median Type	Minimum Width	Recommended Width
Median for access control	4 feet	6 feet
Median for pedestrian refuge	6 feet	8 feet
Median for trees and lighting	6 feet [1]	10 feet [2]
Median for single left turn lane	10 feet [3]	14 feet [4]

Table Notes:

- [1] Six feet measured curb face to curb face is generally considered the minimum width for the proper growth of small caliper trees (less than 4 inches),
- [2] Wider medians provide room for larger caliper trees and more extensive landscaping,
- [3] A ten foot lane provides for a turn lane without a concrete traffic separator,
- [4] Fourteen feet provides for a turn lane with a concrete traffic separator.

E.5.d Turn Lanes

The need for turn lanes for vehicle mobility should be balanced with the need to manage vehicle speeds and the potential impact on the border width, such as sidewalk width. Turn lanes tend to allow through vehicles to maintain higher speeds through intersections, since turning vehicles can move over and slow in the turn lane.

Left turn lanes are considered to be acceptable in an urban environment since there are negative impacts to roadway capacity when left turns block the through movement of vehicles. The installation of a left turn lane can be beneficial when used to perform a road diet such as reducing a four lane section to three lanes with the center lane providing for turning movements. In urban areas, no more than one left turn lane should be provided.

Right turns from through lanes do not block through movements, but do create a reduction in speed due to the slowing of turning vehicles. Right turn lanes are used to maintain speed through intersections, and to reduce the potential for rear end crashes. However, the installation of right turn lanes increases the crossing distance for pedestrians and the speed of

vehicles, therefore the use of exclusive right turn lanes are rarely used except at “T” intersections.

E.5.e Parking

On-street parking is important in the urban environment for the success of those retail businesses that line the street, to provide a buffer for the pedestrian, and to help calm traffic speeds. When angle parking is proposed for on-street parking, designers should consider the use of back in angle parking in lieu of front in angle parking.

Table 19 – 4 Parking Lane Width

Movement Type	Design Speed	Parking Lane Width
Slow	20-25 mph	(Angle) 17-18 feet
Slow	20-25 mph	(Parallel) 7 feet
Low	30-35 mph	(Parallel) 7-8 feet

E.6 Cul-de-sacs and Turnarounds

Cul-de-sacs should only be used where no other alternatives exist. Cul-de-sacs should have walkway or bicycle connections to other sidewalks and streets to provide connectivity within and to adjacent neighborhoods.

E.6.a Turning Area

A residential street open at one end only should have a special turning area at the closed end. A residential street more than 100 feet long and open at one end only shall have a special turning area at the closed end. This turning area should be circular and have a radius appropriate to the types of vehicle expected. The minimum outside radius of a cul-de-sac shall be 30 feet. In constrained circumstances, other turning configurations such as a “hammerhead” may be considered.

E.7 Pedestrian Considerations

In urban environments, the “border,” or area between the face of a building or right of way line and the curb face, serves as the pedestrian realm because it is the place for which pedestrian activity is provided, including space to walk, socialize, places for street furniture, landscaping, and outdoor cafes. In an urban environment, the border consists of the furniture, walking and shy zones.

Figure 19 – 4 Border

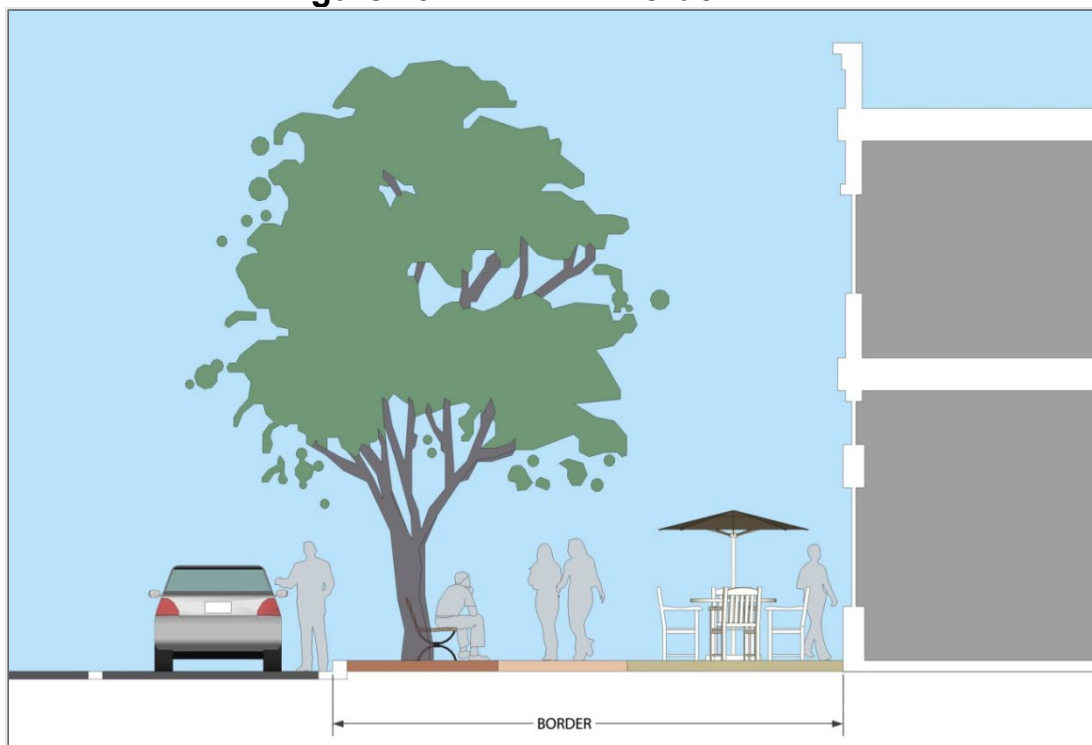

(Source: VHB)

E.7.a Furniture Zone

The furniture zone can be located adjacent to the building face, but more commonly is adjacent to the curb face. The furniture zone contains parking meters, lighting, tree planters, benches, trash receptacles, magazine and newspaper racks, and other street furniture. The furniture zone is separate from the walking/pedestrian and shy zones to keep the walking area clear for pedestrians, including proper access to transit stops.

E.7.b Walking/Pedestrian Zone

Chapter 8 addresses considerations for pedestrians. In a properly designed urban environment, where buildings are at the back of the sidewalk and vehicle speeds are low, the separation from traffic is normally provided by on-street parking, which also helps to calm traffic. The width of the walking/pedestrian zone should be at least four feet and should be increased based on expected pedestrian activity.

E.7.c Shy Zone

The shy zone is the area adjacent to buildings and fences that pedestrians generally “shy” away from. A minimum of one foot is provided as part of the sidewalk width. This space should not be included in the normal walking zone of the sidewalk.

E.7.d Mid-Block Crossings

Properly designed TND communities will not normally require mid-block crossings due to the use of shorter block size. When mid-block crossings are necessary, the use of curb extensions or bulbouts should be considered to reduce the crossing distance for pedestrians.

E.7.e Curb Extensions

Curb extensions are helpful tools for reducing the crossing distance for pedestrians, providing a location for transit stops, managing the location of parking, providing unobstructed access to fire and rescue, and increasing space for landscaping and street furniture.

Designers should coordinate with public works staff to ensure that street cleaning can be achieved with their equipment, and adequate drainage can be provided to avoid ponding at curb extensions.

E.8 Bicyclist Considerations

E.8.a Bicycle Facilities

Chapter 9 contains information on bicycle facilities. This section is directed to designing bike facilities in TND communities. Designing for bicycles on thoroughfares in TND communities should be as follows: bicycles and motor vehicles should share lanes on thoroughfares with design speeds of twenty five mph or less. It is important to recognize that the addition of bike lanes does increase roadway widths and can increase the tendency for drivers to speed.

When bicycle lanes are used in TND communities, they should be a minimum of 5 feet wide and designated as bike lanes. On curb and gutter roadways, a minimum 4-foot width measured from the lip of the gutter is required. The gutter width should not be considered part of the rideable surface area, but this width provides useable clearance to the curb face. Drainage inlets, grates, and utility covers are potential problems for bicyclists. When a roadway is designed, all such grates and covers should be kept out of the bicyclists' expected path. If drainage inlets are located in the expected path of bicyclists, they should be flush with the pavement, well seated, and have bicycle compatible grates.

Where parking is present, the bicycle lane should be placed between the parking lane and the travel lane, and have a minimum width of 5 feet. Designers should consider increasing the bicycle lane to 6 feet in lieu of increasing parallel parking width from 7 to 8 feet. This helps encourage vehicles to park closer to the curb, and provides more room for door swing, potentially reducing conflict with bicyclists.

Shared lane markings, or "sharrows," can be used instead of bicycle lanes adjacent to on-street parking. The sharrow allows the bicyclist to occupy the lane and therefore avoids placing bicyclists in the "door zone", and does not require an increase in lane width or ROW width for the thoroughfare. Guidance for use of the shared lane marking is included in **Chapter 9 – Bicycle Facilities** and the **MUTCD**. See Figure 9 –24 – Shared Lane Marking in **Chapter 9** for a detailed drawing of a shared lane marking.

E.8.b Shared Use Paths

Greenways, waterfront walks, and other civic spaces should include shared use paths, and provide for bicycle storage or parking. Bicycle storage or parking should also be included in areas near transit facilities to maximize connectivity between the modes.

E.9 Transit

See [*Accessing Transit, Design Handbook for Florida Bus Passenger Facilities, Version III, 2013*](#) for information.

E.10 Clear Zone

In urban areas, horizontal clearances, based on clear zone requirements for rural highways, are not practical because urban areas are characterized by lower speed, more dense abutting development, closer spaced intersections and accesses to property, higher traffic volumes, more bicyclists and pedestrians, and restricted right of way. The minimum horizontal clearance shall be 1.5 feet measured from the face of curb.

Streets with curb, or curb and gutter, in urban areas where right of way is restricted do not have roadsides of sufficient widths to provide clear zones; therefore, while there are specific horizontal clearance requirements for these streets, they are based on clearances for normal operation and not based on maintaining a clear roadside for errant vehicles. It should be noted that curb has essentially no redirection capability; therefore, curb should not be considered effective in shielding a hazard.

F REFERENCES FOR INFORMATIONAL PURPOSES

The following publications were either used in the preparation of this chapter, or may be helpful in designing TND Communities and understanding the flexibility in AASHTO design criteria:

- ~~—~~ Designing Walkable Urban Thoroughfares: A Context Sensitive Approach: An ITE Recommended Practice, 2010
 - ~~—~~
<http://www.ite.org/css/><https://www.ite.org/technical-resources/topics/complete-streets/>
- SmartCode ~~9.2~~ ~~—~~ ~~9.2~~
<http://www.smartcodecentral.org/>
- ~~—~~ A Guide for Achieving Flexibility in Highway Design, AASHTO, May, 2004
<https://store.transportation.org/Common/DownloadContentFiles?id=305>
- ~~—~~ Accessing Transit, Design Handbook ~~for Florida Bus Passenger Facilities,~~ ~~2008~~ ~~2017~~, FDOT Public Transit Office ~~—~~:
<http://www.dot.state.fl.us/transit/NewTransitPlanning.shtm><https://www.fdot.gov/fdottransit/transitofficehome/transitplanning.shtm/newtransitfacilitiesdesign.shtm>
- Safe Routes to Schools Program, FDOT Safety Office:
<http://www.dot.state.fl.us/safety/2A-Programs/Programs.shtm>

THIS PAGE INTENTIONALLY LEFT BLANK

CHAPTER 20

DRAINAGE

A	INTRODUCTION.....	20-1
B	OBJECTIVES.....	20-1
C	REGULATORY REQUIREMENTS.....	20-2
C.1	Chapter 62-330, Florida Administrative Code.....	20-2
C.2	Chapter 62-40, Florida Administrative Code.....	20-2
C.3	National Pollutant Discharge Elimination System.....	20-3
D.	STORMWATER MANAGEMENT STRATEGIES.....	20-3
D.1	Watershed Approach to Evaluate Regional Stormwater Solutions (WATERSS)	20-3
D.2	Pond Siting Process.....	20-24
E	OPEN CHANNEL.....	20-42
E.1	Design Frequency.....	20-42
E.2	Hydrologic Analysis.....	20-42
E.3	Hydraulic Analysis.....	20-43
E.3.a	Manning’s “n” Values.....	20-43
E.3.b	Slope.....	20-43
E.3.c	Channel Linings and Velocity.....	20-43
E.3.d	Limitations on Use of Linings.....	20-44
E.4	Construction and Maintenance Considerations.....	20-45
E.5	Safety.....	20-45
E.6	Documentation.....	20-45
F	STORM DRAIN HYDROLOGY AND HYDRAULICS.....	20-46
F.1	Pipe Materials.....	20-46
F.2	Design Frequency.....	20-46
F.3	Design Tailwater.....	20-46
F.4	Hydrologic Analysis.....	20-46
F.4.a	Time of Concentration.....	20-47

F.5	Hydraulic Analysis.....	20-47
F.5.a	Pipe Slopes	20-47
F.5.b	Hydraulic Gradient.....	20-47
F.5.c	Outlet Velocity.....	20-47
F.5.d	Manning’s Roughness Coefficients.....	20-47
F.6	Hydraulic Openings.....	20-48
F.6.a	Entrance Location and Spacing	20-48
F.6.b	Grades	20-49
F.7	Spread Standards	20-49
F.8	Construction and Maintenance Considerations	20-50
F.8.a	Pipe Size and Length.....	20-50
F.8.b	Minimum Clearances.....	20-51
F.9	Green Stormwater Elements for Context Based Design.....	20-51
F.10	Protective Treatment.....	20-54
F.11	Documentation.....	20-55
G	CROSS DRAIN HYDRAULICS.....	20-56
G.1	Design Frequency.....	20-56
G.2	Backwater	20-56
G.3	Tailwater	20-57
G.4	Clearances.....	20-57
G.5	Bridges and Other Structures.....	20-57
H	CULVERT MATERIALS	20-61
H.1	Durability.....	20-61
H.2	Structural Design	20-62
H.3	Hydraulic Capacity.....	20-62

TABLES

Table 20 – 1	Matrix of Typical Innovative Stormwater Management Practices	20-6
Table 20 – 2	Evaluation Factors for Screening of Solutions	20-17
Table 20 – 3	Project Permitting Scenarios Involving Full and Partial Solutions	20-23
Table 20 – 4	Evaluation Factors for Pond Siting Alternatives	20-31
Table 20 – 5	Stormwater Flow Design Frequencies.....	20-42
Table 20 – 6	Spread Criteria.....	20-49
Table 20 – 7	Protective Treatments	20-54
Table 20 – 8	Recommended Minimum Design Flood Frequency	20-56
Table 20 – 9	Bridge Hydraulic Modeling Selection.....	Error! Bookmark not defined.

FIGURES

Figure 20 – 1	WATERSS Process Flowchart	20-5
Figure 20 – 2	Pond Siting Process Flowchart	20-25
Figure 20 – 3	Green Street Elements.....	20-53

THIS PAGE INTENTIONALLY LEFT BLANK

CHAPTER 20

DRAINAGE

A INTRODUCTION

This chapter recognizes that Florida is regularly affected by adverse weather conditions. As such, the proper design of a roadway's drainage system is critical to its function and to the safety of the motoring public as well as pedestrians, bicyclists, and other users of these facilities. Standing water on a roadway can not only create a hazard but could also impede the flow of traffic.

This chapter represents the minimum standards that should be used when designing roadway drainage. As is the case for all elements in a facility's design, the designer must consider site specific conditions and determine the proper level of service the facility's drainage system should provide. The design of drainage facilities should not only consider the system's ability to handle the design storm, but also consider the system's recovery time during an event which exceed the design storm.

B OBJECTIVES

The objective of this chapter is to establish the minimum standards to which a roadway's drainage system is to be designed. In order for the drainage system to function properly, the below guidelines should be used in the design, construction and maintenance of these systems.

- Design and maintain drainage systems to quickly move water out of the travel lanes in order provide a safer environment for users of a facility during adverse weather conditions.
- Design drainage systems by taking into consideration the future maintenance of said system ~~in order~~ to avoid creating hazardous conditions to drivers and maintenance staff during routine servicing.

The FDOT's [Drainage Design Guide \(DDG\)](#) is a reference for designers, providing guidelines and examples of how these objectives can be accomplished. The DDG provides information on the following areas of drainage design:

- Hydrology
- Open Channel
- Culvert
- Bridge Hydraulics
- Storm Drains
- Exfiltration Systems
- Optional Pipe Material
- Stormwater Management Facility
- Temporary Drainage Design

CF REGULATORY REQUIREMENTS

CSTORMWATER MANAGEMENT

F.1 Regulatory Requirements

CF.1.a Chapter 62-330~~25~~, Florida Administrative Code

Chapter 62-330, F.A.C., rules of the Florida Department of Environmental Protection–Protection, implements the comprehensive, statewide environmental resource permit (ERP) program under **Section 373.4131, F.S.** The ERP program governs the following: construction, alteration, operation, maintenance, repair, abandonment, and removal of stormwater management systems, dams, impoundments, reservoirs, appurtenant works, and works (including docks, piers, structures, dredging, and filling located in, on or over wetlands or other surface waters, as defined and delineated in **Chapter 62-340, F.A.C.**)~~specifies minimum water quality treatment standards for new development.~~ **Chapter 62-25 F.A.C.** has been repealed.

CF.21.b Chapter 62-40, Florida Administrative Code

Chapter 62-40, F.A.C., rules of the Florida Department of Environmental Protection outlines basic goals and requirements for surface water protection and management to be implemented and enforced by the Florida Department of Environmental Protection and Water Management Districts.

CF.31.c National Pollutant Discharge Elimination System

The [National Pollutant Discharge Elimination System \(NPDES\)](#) permit program is administered by the U. S. Environmental Protection Agency and delegated to the Florida Department of Environmental Protection in Florida. This program requires permits for stormwater discharges into waters of the United States from industrial activities; and from large and medium municipal separate storm sewer systems (MS4s). Construction projects are within the definition of an industrial activity.

D STORMWATER MANAGEMENT STRATEGIES

D.1 Watershed Approach to Evaluate Regional Stormwater Solutions [\(WATERSS\)](#)

[WATERSS is a regional stormwater management process that promotes collaboration with state and local agencies, water resource managers and stakeholders to implement innovative stormwater management practices. The process is scalable depending on the type, size, complexity, context, and geographic location of the project. It enables the comparison of innovative solutions and partnerships with traditional solutions. The 12 steps detailing the WATERSS process is shown in Figure 20 – 1 WATERSS Process Flow Chart.](#)

[The WATERSS process identifies potential cost savings or additional environmental benefits for implementing feasible, non-traditional stormwater management solutions. Innovative practices include regional ponds, joint-use ponds, stormwater harvesting, land use modifications, upstream compensatory treatment, basin, or resource improvements, well injection, and bio-sorption activated media \(BAM\). These practices along with examples of opportunities that can be leveraged by this process are found in Table 20 – 1 Matrix of Typical Innovative Stormwater Management Practices.](#)

[Collaboration with external partners is essential for the discovery of stormwater management partnership opportunities. This may involve more time and effort than traditional stormwater pond design, which focuses on isolated activities and design of individual ponds. However, collaborative stormwater management solutions have proven to result in substantial environmental and investment benefits across a watershed or region.](#)[Following are steps detailing the WATERSS process](#)



Figure 20 – 1 WATERSS Process Flowchart

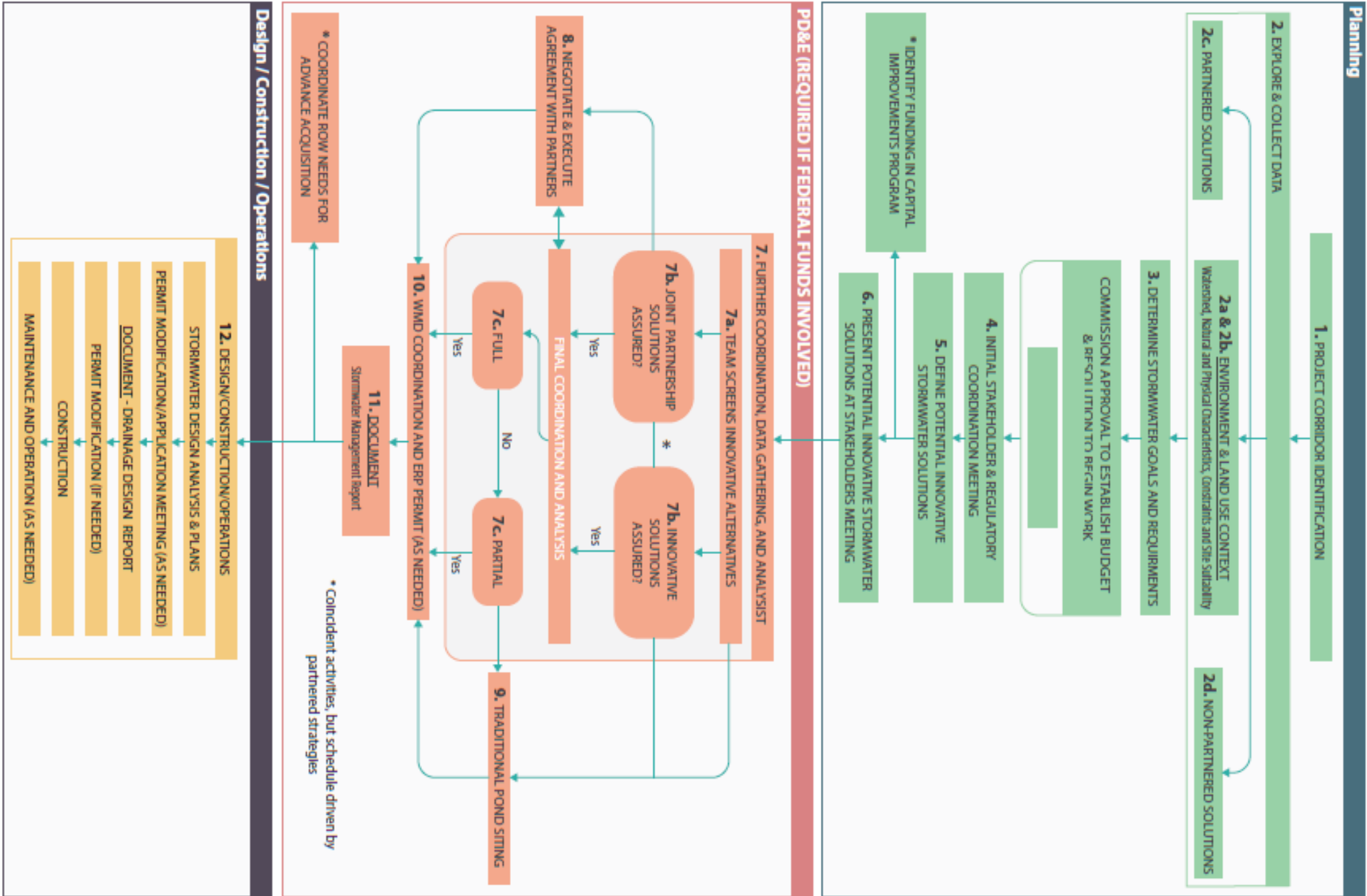

Table 20 – 1 Matrix of Typical Innovative Stormwater Management Practices

<u>Best Management Practice (BMP)</u>	<u>Specific Characteristics</u>	<u>Applicability</u>	<u>Goals</u>	<u>Effectiveness in Meeting Stormwater Quality and Quantity Goals</u>	<u>Pros and Cons</u>	<u>Permitting Hurdles</u>	<u>Costs</u>	<u>Schedule</u>	<u>Design Constraints</u>
Surface Water BMPs									
<u>Regional Pond</u>	<u>Downstream pond sized to accommodate runoff from the upstream basin rather than only onsite runoff from the development.</u>	<u>Desirable when pond Right of Way (ROW) costs are high or land for ponds is unavailable.</u>	<u>Reduce long term pond costs and improve downstream water quality.</u>	<u>Highly effective in that land beyond the onsite project is treated and attenuated.</u>	<u>Pros: improved water quality and attenuation, reduced long term costs.</u> <u>Cons: (1) difficult to coordinate agreements and permit; and (2) possible long piped outfalls.</u>	<u>Minor increase in pollutants to waters of the state immediately downstream between the roadway and the regional pond.</u>	<u>Potential increased ROW costs are recouped by giving away maintenance to local municipalities.</u>	<u>Longer production schedule may be needed to accommodate negotiations with local municipalities and overcoming permitting hurdles.</u>	<u>Sometimes pre-treatment is required onsite, perhaps trapping sediments</u>
<u>Joint-Use Pond</u>	<u>Pond designed to accommodate runoff from two or more landowners. A formal agreement is crafted to outline terms of cooperation.</u>	<u>(1) Often occurs at the request of adjacent property owners to better integrate proposed pond locations into their properties; (2) sometimes initiated by the FDOT to store runoff in downstream golf courses; and (3) sometimes adjacent developments are required to take the FDOT runoff as a condition of county approvals.</u>	<u>Reduce pond ROW acquisition and long-term maintenance costs.</u>	<u>Standard Environmental Resource Permit (ERP) water quality rules are satisfied.</u>	<u>Pros: combining ponds into a single pond reduces costs due to economy of scale; typically, maintenance is assumed by the party other than the FDOT.</u> <u>Cons: (1) co-mingling runoff can expose agency to NPDES responsibilities for offsite runoff; and (2) can be difficult to coordinate agreements</u>	<u>(1) Permits must be obtained/modified for all parties involved; (2) phased construction must be coordinated for future roadway or development expansion; and (3) legal agreement must address the FDOT's right to maintain pond (or hold another public agency as surety) if the developer defaults on his responsibilities.</u>	<u>Combining ponds into a single pond reduces ROW costs due to economy of scale; maintenance is often assumed by the offsite party.</u>	<u>Longer production schedule may be needed to accommodate negotiations with the cooperating party.</u>	<u>The overflow from the combined pond must be able to adequately drain both upstream properties.</u>

<u>Best Management Practice (BMP)</u>	<u>Specific Characteristics</u>	<u>Applicability</u>	<u>Goals</u>	<u>Effectiveness in Meeting Stormwater Quality and Quantity Goals</u>	<u>Pros and Cons</u>	<u>Permitting Hurdles</u>	<u>Costs</u>	<u>Schedule</u>	<u>Design Constraints</u>
<u>Stormwater Harvesting</u>	<u>Stormwater is collected and harvested for irrigation, raw water supply, wetland re-hydration, MFLs, or some other beneficial usage.</u>	<u>Useful when a high demand exists for non-potable water.</u>	<u>Reduce downstream pollutant loadings and provide an alternate water supply.</u>	<u>Highly effective in that land downstream discharge volume is reduced, lowering pollutant loading; usually has only minimal reduction in attenuating peak flow.</u>	<u>Pros: improved water quality and water supply.</u> <u>Cons: difficult to match with water consumers; partners can pull out late in the production schedule.</u>	<u>None, unless water consumer tries to negotiate CUP credits as part of the harvesting.</u>	<u>May need to design storage facility, but could assume the pond and pumping/ infrastructure costs are borne by the water consumer.</u>	<u>Longer production schedule may be needed to discover and negotiate with the water consumer.</u>	<u>(1) No privately-owned pumping/piping infrastructure within L/A ROW;</u> <u>(2) re-use with potential human contact must provide filtration; and</u> <u>(3) avoid the need for a Consumptive Use Permit (CUP) by avoiding the pumping of groundwater.</u>
<u>Land Use Modification</u>	<u>Changing existing land usage to a usage generating less of the pollutant of concern, usually nutrients.</u>	<u>Desirable when pond ROW costs are high or land for ponds is unavailable.</u>	<u>Cost savings.</u>	<u>Standard ERP water quality rules are satisfied due to a reduced pollutant loading.</u>	<u>Pros: cost savings.</u> <u>Cons: involves negotiating with external property owners.</u>	<u>(1) Potential adverse impacts to adjacent properties; and (2) will require additional coordination for the specific permit language and conditions.</u>	<u>Costs are reduced by avoiding expensive ROW adjacent to the highway.</u>	<u>Additional production time may be needed to negotiate with land owners – no ROW condemnation authority.</u>	<u>None.</u>
<u>Upstream Compensatory Treatment</u>	<u>Treating upstream offsite runoff in lieu of onsite runoff.</u>	<u>Desirable when pond ROW costs are high or land for ponds is unavailable.</u>	<u>Cost savings.</u>	<u>Standard ERP water quality rules are satisfied.</u>	<u>Pros: cost savings.</u> <u>Cons: permitting hurdles.</u>	<u>(1) Potential adverse impacts to adjacent properties; and (2) will require additional coordination for the specific permit language and conditions.</u>	<u>Costs are reduced by the selection of an alternate treatment site.</u>	<u>Additional production time may be needed to find and design a suitable upstream treatment alternative.</u>	<u>Requires design of offsite treatment BMP.</u>

<u>Best Management Practice (BMP)</u>	<u>Specific Characteristics</u>	<u>Applicability</u>	<u>Goals</u>	<u>Effectiveness in Meeting Stormwater Quality and Quantity Goals</u>	<u>Pros and Cons</u>	<u>Permitting Hurdles</u>	<u>Costs</u>	<u>Schedule</u>	<u>Design Constraints</u>
<u>Basin/Resource Improvements</u>	<u>In lieu of onsite stormwater treatment, modifications to the basin or downstream resource (e.g., septic tank conversions, circulation enhancements, etc.) are constructed to improve the waterbody's health.</u>	<u>Desirable (1) when pond ROW costs are high or land for ponds is unavailable; and/or (2) when greater environmental benefit is sought.</u>	<u>Potential cost savings and improved downstream environmental benefit.</u>	<u>Highly effective due to significantly increased environmental benefit.</u>	<u>Pros: improved environmental benefit and reduced costs.</u> <u>Cons: significant amount of permitting coordination.</u>	<u>With no specific rules to address this approach, regulatory leadership must provide strong evidence of the improvement's effectiveness.</u>	<u>Significant cost savings can be realized in comparison with pond ROW acquisition.</u>	<u>Longer production schedule may be needed to accommodate discussions with the permitting agencies and/or municipality.</u>	<u>Specialty design services may be required depending on the mitigation strategy.</u>
<u>Groundwater BMPs</u>									
<u>Well Injection (not District 6 coastal zone)</u>	<u>Injecting runoff into the ground via a pipe rather than discharging it downstream.</u>	<u>Useful in springsheds and other areas where groundwater recharge is desirable; typically targets pond bleed down flows.</u>	<u>Increase groundwater recharge; decrease pollutant loadings to surface waters.</u>	<u>Effective in increasing groundwater recharge and reducing downstream surface water pollutant loadings by reducing discharge volume.</u>	<u>Pros: improved groundwater recharge; decreased surface water pollutant loadings.</u> <u>Cons: may need to include a special BAM design within the discharge well.</u>	<u>UIC permitting rules to allow this option are very restrictive. May require additional monitoring efforts and coordination for the specific permit language and conditions.</u>	<u>Additional costs are incurred to construct the injection system; currently, the WMDs offer no incentives such as reduced treatment requirements.</u>	<u>Separate permitting process with independent timelines.</u>	<u>Requires treatment and well injection design downstream of overflow weir.</u>
<u>Bio-sorption Activated Media (BAM)</u>	<u>Media provides a carbon source to promote the cultivation of denitrifying bacteria; also removes phosphorus, though infrequently used for that nutrient.</u>	<u>Useful in springsheds and coastal areas to denitrify during infiltration; useful to treat phosphorus within impaired basins.</u>	<u>Remove nutrients from runoff; eliminate ROW for ponds by using BAM within</u>	<u>Highly effective in removing nutrients.</u>	<u>Pros: improved groundwater quality; can eliminate the need for stormwater ponds in rural typical sections.</u> <u>Cons: design and specifications for BAM are not yet codified</u>	<u>Design practice is new to most WMDs, though included in the BMPTRAINS program; performance measures/expectations are not well established.</u>	<u>Additional costs for BAM material which is sometimes offset by reduced pond ROW; when used to remove phosphorus, the design life of the media is predicted</u>	<u>Longer production schedule may be needed to coordinate design with UCF.</u>	<u>Required residence time within BAM layer may require additional storage in ditches or retention ponds.</u>

<u>Best Management Practice (BMP)</u>	<u>Specific Characteristics</u>	<u>Applicability</u>	<u>Goals</u>	<u>Effectiveness in Meeting Stormwater Quality and Quantity Goals</u>	<u>Pros and Cons</u>	<u>Permitting Hurdles</u>	<u>Costs</u>	<u>Schedule</u>	<u>Design Constraints</u>
			<u>roadside ditches.</u>		<u>into Manuals and Specs.</u>		<u>to be about 20 years and may then need replacement.</u>		

Step 1 – Project Corridor Identification

Identify the overall project characteristics including project location, environment, and land use context (urban vs. rural project), facility type, alternatives being considered, and potential stormwater needs.

Outcome: Watershed issues and concerns, conditions of the corridor(s), and potential stormwater needs.

Step 2 – Explore and Collect Data

A. Identify existing stormwater-related conditions on the project corridor and conduct an initial, desktop-level discovery of potential partnerships and innovative stormwater solutions available. Potential partnerships and initiatives are explored by using Geographic Information System (GIS) support tools, and by querying the National Pollutant Discharge Elimination System (NPDES) Coordinator regarding ongoing Total Maximum Daily Load (TMDL) and Basin Management Action Plan (BMAP) activities. The following information should be included:

- Previous planning studies.
- Existing roadway plans - as built.
- Corridor's context classification.
- Soil types, depth, slope and infiltration rates from natural resources conservation service soil surveys and existing geotechnical data from previous projects.
- Proposed alternative alignments and conceptual typical sections.
- Available topographic data and aerial photography (include local data sources).
- Existing and future land use maps.
- Tax maps & land owner information (can be provided as part of public involvement research).
- Existing right of way maps.
- Copies of any previous stormwater studies or watershed masterplans.
- Available copies of permits for projects within the vicinity.

- Existing agreements (Joint Participation Agreements (JPAs), easements, maintenance agreements, etc.).
- Water supply planning regions.
- Identified springsheds (as appropriate).
- Springs Priority Focus Areas (PFA).
- Water Management District (WMD) mean flow limitations.
- Aquifer storage and recharge wells.
- Parks, golf courses, irrigation, or water storage/recharge opportunities.
- BMAPs's.
- TMDLs with allocations.
- Identified public lands.
- Floodplain.
- Government-owned lands (schools, prisons, WMD lands, etc.).
- Developments of regional impacts (DRIs) and Sector Plans.

B. Investigate and document watershed information, environmental characteristics and constraints that may affect suitability of potential stormwater management solutions. The following list is provided as guidance:

- What are the characteristics of the watershed? Is the watershed fully developed? Mostly rural? A combination?
- Is the project area within a springshed/impaired basin? If so, is there a TMDL or BMAP for the area?
- What types of soils are in the project area?
- Is there an Outstanding Florida Water (OFW) located within the watershed?
- Is the project located in a floodplain?
- Are there wetlands in the area?
- Are there threatened or endangered species or designated habitat which may cause certain types or locations of treatment to be not suitable for stormwater management?

- Are there contamination concerns which will cause a site to be not suitable for treatment?
- Is there land that is a Section 4(f) protected resource?
- Is there land that is protected by conservation easements?
- Is the project located near a designated Wild and Scenic River?
- Are there historic resources in the area?
- Is the project located within an area with a coastal management program?
- Is the project located near Essential Fish Habitat?
- Is the project located within the boundaries of a designated Sole Source Aquifer? There are two defined in Florida: Volusia-Floridan and Biscayne Aquifers.

C. Identify potential innovative stormwater solutions and partners. If the project is in an impaired basin, contact the NPDES Coordinator to obtain the BMAP stakeholder information (<https://floridadep.gov/dear/water-quality-restoration/content/basin-management-action-plans-bmaps>) and discuss a list of potential partners and available projects for funding. Pursue city, county, National Estuary Program, Water Management District, and developer partners. Examples are listed below:

- Regional Pond: If sub-basins are draining to the same outfall or future development is expected in the watershed.
- Additional offsite inflows: If new or additional offsite inflows of stormwater or wastewater are being proposed.
- Stormwater re-use: In urban or suburban areas, contact local governments or golf courses regarding their interest in stormwater as a raw water supply or for irrigation.
- Joint-use Ponds: Determine if there are large existing or proposed developments (residential or commercial) along the highway that might exchange storage on their property for an outfall.
- Springsheds: If the project is in a springshed Priority Focus Area (PFA) then additional scrutiny will be given from regulators on groundwater discharges (dry retention ponds) as opposed to surface water discharges where denitrification can occur. Is the groundwater beneath the project

contaminated with nitrates or are there sources of nitrogen adjacent to the project? If so, the nitrogen-laden water may be pumped directly into the underground Bioabsorption Activated Media (BAM) layer to achieve large removals.

- Tidal or Lake Circulation Improvements: If a BMAP identifies tidal or lake flushing issues, consider improving a roadway crossing with a new or larger bridge or culvert to provide additional flushing.

D. Identify potential innovative stormwater solutions for which a partner is not typically needed. Examples are listed below:

- Regional Pond: If a substantial portion of the project drains to a single water body a regional pond would allow reduction of typical on-site ponds. Would a location downstream have equal or fewer community impacts or other benefits over on-site ponds? Consider if increased project runoff would create or worsen flooding or erosion issues between the project and the pond location? Could the runoff be piped, or the conveyance improved, given the number of parcels and the length of piping required?
- Springsheds: For projects in springsheds, critical water needs area, water supply hardship areas, or areas of nutrient impairment consider the use of a nutrient removal product such as BAM for additional treatment.
- Onsite Irrigation: Consider re-use of the pond treatment volume for irrigation near the project rather than bleeding downstream.
- Wetland Re-hydration: Are nearby wetlands underhydrated?
- Compensatory Treatment: Are there upstream areas that retrofit treatment and attenuation could be done as compensation? Look especially for land already available and runoff with high nutrient loading such as agricultural lands.
- Minimum Flows and Levels: Does the project flow to waterbodies with Minimum Flows and Levels (MFL).

E. Conclude the Explore and Collect Data step with a narrative describing the existing project stormwater conditions, potential partnerships, and innovative stormwater solutions that may be applied on the project.

Outcome: Narrative describing existing project stormwater conditions, potential stormwater management projects, partnerships, and innovative stormwater solutions.

Step 3 – Determine Stormwater Goals and Requirements

Identify and document the stormwater management goals and requirements for the project based on the information discovered in Step 2. Having a general knowledge about the scope of the proposed improvements and potential right of - way needs at the start of this step are essential to estimating the stormwater goals and requirements.

Outcome: A narrative describing identified stormwater management goals and requirements for the project.

Step 4 – Initial Stakeholders and Regulatory Coordination Meeting

Introduce the project to stakeholders and discuss cooperative or regional stormwater management opportunities and understand their priorities. During the initial stakeholders' coordination meeting, present the stormwater goals and opportunities being considered. The presentation should include the following project information:

- Project overview.
- Project baseline schedule including critical milestones.
- Stormwater goals and requirements.
- Potential innovative stormwater solutions that may be considered on the project.
- Preliminary Stormwater Costs (often based on the preliminary expected cost of traditional ponds) and Project Funding.

Outcome: List of potential partnership stormwater management solutions and innovative solutions to be further analysed.

Step 5 – Define Potential Stormwater Management Strategies

Discuss opportunities identified in Step 4 and screen out non-viable stormwater management solutions. Agree on the criteria for selection (includes constraints or limiting factors that may prevent implementation of solutions). These factors may include stormwater goals and requirements, cost, challenges in permitting,

maintainability, constructability, schedule, and environmental considerations. Table 20 – 2 Evaluation Factors for Screening of Solutions provides more information on the types of factors to consider in identifying feasible stormwater management strategies.

Additional evaluation factors could include reliability of partners, compatibility with production schedule, and benefit/cost. This step does not overtly compare solutions, but only eliminates solutions that are flawed or otherwise do not meet the stormwater management goals and requirements. The screening by the stormwater team includes both partnership and non-partnership innovative solutions.

Compile a matrix for the comparison of solutions using the information obtained from Steps 1 through 4. Factors used and the scoring method should be included with the matrix to demonstrate the factors and justify the scoring. An example matrix is provided in Exhibit 20 – 1 Evaluation Matrix Example.

Prepare a work plan for each partnership strategy that is recommended for detail evaluation. Use this plan to facilitate dialogue with the respective stakeholders and secure commitments for all participant's share of the stormwater management solution.

Outcome: A list of viable solutions are identified for further detailed evaluation and to be presented at follow up stakeholder meetings, documented in a memorandum.

Table 20 – 2 Evaluation Factors for Screening of Solutions

<u>Factor</u>	<u>Description/Issues to Consider</u>
<u>Project Needs for Water Quality</u>	<u>Will the solution provide all the water quality credits needed for the project?</u>
<u>Schedule Compatibility</u>	<u>Identify if negotiation and implementation of the solution to obtain water quality credits can be completed within the current project production schedule.</u>
<u>Cost / Benefit</u>	<u>The cost of solution vs. the benefit, i.e., reduction in maintenance costs, right of way costs, construction costs, mitigation costs, etc.</u>
<u>Partner Reliability</u>	<u>Identify if the partner of a solution can be relied upon to work with the agency for the duration of the solution.</u>
<u>Ease of Permitting</u>	<u>Identify if there have been preliminary discussions with the regulatory agencies, and document the feedback received. Is this solution permittable or will extensive negotiations be needed?</u>
<u>Water Quantity/Floodplain Benefit</u>	<u>Identify if the solution will provide water quantity or floodplain benefits and if so, quantify the benefits to be realized from the project.</u>
<u>Public Perception/Acceptance</u>	<u>Identify if the solution will be generally accepted by the public. Will extensive public involvement be required?</u>
<u>Threatened and Endangered Species and Associated Costs</u>	<u>Identify if there are threatened or endangered species which may be impacted by the solution. Identify any costs associated with avoiding or mitigating these impacts.</u>
<u>Wetland Credits</u>	<u>Identify if any wetland credits may be realized by the implementation of the solution and the associated benefit(s) that would be provided to the agency. Identify if the anticipated wetland credits would potentially satisfy mitigation requirements for the project and if there would be additional credits for future projects.</u>

<u>Seagrass Credits</u>	<u>Identify if any seagrass credits may be realized by the implementation of the solution and the associated benefit(s) that would be provided to the agency. Identify if the seagrass credits would satisfy mitigation requirements for the project and if there would be additional credits for future projects.</u>
-------------------------	--

Table 20 – 2 Evaluation Factors for Screening of Solutions (continued)

<u>Factor</u>	<u>Description/Issues to Consider</u>
<u>Section 4(f) Involvement</u>	<u>Identify the presence of potential Section 4(f) properties which may have a use under the definition of Section 4(f) or if there would be a benefit as a result of the solution.</u>
<u>Conservation Lands</u>	<u>Identify the presence of any conservation lands which may affect the suitability of a solution.</u>
<u>Cultural Resources Involvement</u>	<u>Identify the potential presence of cultural resources including archaeological and historical resources which could affect the suitability of a solution.</u>
<u>Public Wellfield Issues</u>	<u>Identify the proximity to any public wellfield locations and if the solution could potentially have a direct impact.</u>
<u>Contamination – Hazardous Materials</u>	<u>Identify if the area to be utilized for the solution is contaminated. Consider the costs associated with the clean-up of the area, and if the contamination will limit the area available for stormwater facilities.</u>
<u>Construction</u>	<u>Identify any construction related impacts of the solution and associated costs, such as additional drainage piping to transport stormwater and access for construction.</u>
<u>Maintenance</u>	<u>Identify the costs and frequencies of maintenance needed to maintain the solution.</u>
<u>Aesthetics</u>	<u>Identify if there are any associated costs or benefits for aesthetics of the solution, such as the cost to install and maintain plantings.</u>

<u>Priority of Regulatory Agencies</u>	<u>Identify if this solution is a priority of the regulatory agencies.</u>
<u>Multiple Benefits/Future Credits/Future Capacity for Other Projects</u>	<u>Identify if the solution will potentially provide for multiple types of credits such as water quality and seagrass. Identify if the project will potentially have credits available for future projects.</u>

Exhibit 20 – 1 Evaluation Matrix Example

<u>Weight of Factor</u>	<u>Factor</u>	<u>Score</u>	<u>W Score</u>	<u>Score</u>	<u>W Score</u>	<u>Score</u>	<u>W Score</u>	<u>Score</u>	<u>W Score</u>
<u>1-10</u>		<u>1-10</u>		<u>1-10</u>		<u>1-10</u>		<u>1-10</u>	
	<u>Alternative Number</u>	<u>A</u>		<u>B</u>		<u>C</u>		<u>D</u>	
	<u>Brief Description of Alternative</u>	<u>Vacant land near school</u>		<u>Home</u>		<u>Developed</u>		<u>Vacant land</u>	
	<u>Parcel Number</u>	<u>101</u>		<u>105</u>		<u>160</u>		<u>170</u>	
	<u>Parcel Size (Acres)</u>	<u>5</u>		<u>4</u>		<u>3.2</u>		<u>6.5</u>	
<u>2</u>	<u>Project Needs for Water Quality</u>	<u>5</u>	<u>10</u>	<u>6</u>	<u>12</u>	<u>5</u>	<u>10</u>	<u>6</u>	<u>12</u>
<u>7</u>	<u>Schedule Compatibility</u>	<u>3</u>	<u>21</u>	<u>8</u>	<u>56</u>	<u>3</u>	<u>21</u>	<u>1</u>	<u>7</u>
<u>10</u>	<u>Cost / Benefit</u>	<u>2</u>	<u>20</u>	<u>8</u>	<u>80</u>	<u>2</u>	<u>20</u>	<u>7</u>	<u>70</u>
<u>10</u>	<u>Partner Reliability</u>	<u>6</u>	<u>60</u>	<u>8</u>	<u>80</u>	<u>6</u>	<u>60</u>	<u>4</u>	<u>40</u>
<u>2</u>	<u>Ease of Permitting</u>	<u>1</u>	<u>2</u>	<u>3</u>	<u>6</u>	<u>1</u>	<u>2</u>	<u>5</u>	<u>10</u>
<u>10</u>	<u>Water Quantity/Floodplain Benefit</u>	<u>7</u>	<u>70</u>	<u>2</u>	<u>20</u>	<u>7</u>	<u>70</u>	<u>3</u>	<u>30</u>
<u>6</u>	<u>Public Perception/Acceptance</u>	<u>4</u>	<u>24</u>	<u>1</u>	<u>6</u>	<u>4</u>	<u>24</u>	<u>2</u>	<u>12</u>
<u>6</u>	<u>Threatened and Endangered Species</u>	<u>10</u>	<u>60</u>	<u>1</u>	<u>6</u>	<u>5</u>	<u>30</u>	<u>6</u>	<u>36</u>
<u>5</u>	<u>Wetland/Seagrass Credits</u>	<u>10</u>	<u>50</u>	<u>10</u>	<u>50</u>	<u>3</u>	<u>15</u>	<u>1</u>	<u>5</u>
<u>6</u>	<u>Section 4(f) Involvement</u>	<u>2</u>	<u>12</u>	<u>6</u>	<u>36</u>	<u>2</u>	<u>12</u>	<u>7</u>	<u>42</u>
<u>6</u>	<u>Conservation Lands</u>	<u>6</u>	<u>36</u>	<u>5</u>	<u>30</u>	<u>6</u>	<u>36</u>	<u>6</u>	<u>36</u>
<u>6</u>	<u>Cultural Resources Involvement</u>	<u>10</u>	<u>60</u>	<u>1</u>	<u>6</u>	<u>1</u>	<u>6</u>	<u>10</u>	<u>60</u>
<u>6</u>	<u>Public Wellfield Issues</u>	<u>10</u>	<u>60</u>	<u>1</u>	<u>6</u>	<u>7</u>	<u>42</u>	<u>10</u>	<u>60</u>
<u>8</u>	<u>Contamination – Hazardous Materials</u>	<u>6</u>	<u>48</u>	<u>3</u>	<u>24</u>	<u>4</u>	<u>32</u>	<u>6</u>	<u>48</u>
<u>9</u>	<u>Construction/Maintenance</u>	<u>5</u>	<u>45</u>	<u>2</u>	<u>18</u>	<u>10</u>	<u>90</u>	<u>5</u>	<u>45</u>
<u>2</u>	<u>Aesthetics</u>	<u>3</u>	<u>6</u>	<u>1</u>	<u>2</u>	<u>10</u>	<u>20</u>	<u>3</u>	<u>6</u>
<u>8</u>	<u>Priority of Regulatory Agencies</u>	<u>10</u>	<u>80</u>	<u>6</u>	<u>48</u>	<u>2</u>	<u>16</u>	<u>10</u>	<u>80</u>
<u>0</u>	<u>Multiple Benefits/Future Credits/Future Capacity for Other Projects</u>	<u>0</u>	<u>0</u>	<u>0</u>	<u>0</u>	<u>0</u>	<u>0</u>	<u>0</u>	<u>0</u>
	<u>Score</u>	<u>664</u>		<u>486</u>		<u>506</u>		<u>599</u>	
	<u>Ranking</u>	<u>4</u>		<u>1</u>		<u>2</u>		<u>3</u>	

Note: "W Score" = Weighted Score

~~Prepare a work plan for each partnership strategy that is recommended for detail evaluation. Use this plan to facilitate dialogue with the respective stakeholders and secure commitments for all participant's share of the stormwater management solution.~~

~~**Outcome:** A list of viable solutions are identified for further detailed evaluation and to be presented at follow up stakeholder meetings, documented in a memorandum.~~

Step 6 – Present Potential Stormwater Strategies at Stakeholders Meeting

~~Present to the stakeholders viable partnership solutions and provide the stakeholders and regulators with an opportunity to provide input. Inform the group about any potential innovative stormwater solutions which are being pursued. This is also an opportunity to learn about any other projects that may be worth considering.~~

~~**Outcome:** Meeting notes and a memorandum that document the findings of the Planning phase.~~

Step 7 – Further Coordination, Data Gathering, and Analysis

~~Coordination with prospective partners continues during this step. In addition to technical investigations, i.e., preliminary soil borings or survey, specific to the solutions being proposed with potential partners, the topics listed under Partnership Solutions in Step 5 should be discussed with potential partners. Share the results of the investigations with water management districts (and other partners) to ascertain the ability to permit the alternative solutions and determine what additional information is needed to resolve the level of alternatives' certainty.~~

~~Where corridors cross several basins, a combination of solutions may be needed to address project stormwater requirements. When a single innovative approach does not fully satisfy stormwater regulatory requirements on the project, different solutions may be applied, including traditional stormwater retention or detention ponds.~~

Outcome: Documentation of satisfaction of stormwater regulatory requirements.

Step 8 – Negotiate and Execute Agreement with Partners

Formal agreements involving partnership solutions are developed by agency legal staff and executed between the agency and its partners. The type of legal agreement will depend on the partnering entity. For example, with state or federal regulatory agencies, a Memorandum of Agreement (MOA) or a Memorandum of Understanding (MOU) may be used, but local governments typically execute a Joint Project Agreement (JPA) or easements.

Outcome: MOU/MOA/JPA

Step 9 – Traditional Pond Siting

Once it has been determined by the Stormwater Team that ponds may be needed to meet regulatory requirements, and that the acquisition of right of way will be required to accommodate these proposed ponds, a Pond Siting Process may commence. An explanation of the Pond Siting Process is in **Section D.2 Pond Siting Process** of this Chapter.

Outcome: Stormwater Management Report.

Step 10 – WMD Coordination and ERP Permit (as needed)

With innovative solutions selected and agreements in place, the stormwater component of the ERP may now be ready for at least a conceptual WMD permit. Different permitting scenarios can be employed, depending on the types of stormwater management solutions selected, as shown in Table 20 – 3 Project Permitting Scenarios Involving Full and Partial Solutions.

If the Design Phase is concurrent with the Preliminary Engineering Phase a Construction ERP permit can be obtained.

Table 20 – 3 Project Permitting Scenarios Involving Full and Partial Solutions

<u>Innovative Solutions -Full</u>	<u>Innovative Solutions -Partial</u>	<u>Pond Siting Process Complete</u>	<u>Resource Requirements Satisfied and Roadway Plans Sufficiently Developed</u>	<u>Conceptual Permit</u>	<u>Construction Permit</u>
<u>ü</u>	=	=	<u>ü</u>		<u>ü</u>
<u>ü</u>	=	=	<u>X*</u>	<u>ü</u>	
=	<u>ü</u>	<u>ü</u>	<u>ü</u>		<u>ü</u>
=	<u>ü</u>	<u>ü</u>	<u>X*</u>	<u>ü</u>	

* Conceptual plans will be needed for the Conceptual Permit application.

Outcome: Appropriate WMD permit.

Step 11 – Document: Stormwater Management Report

The Stormwater Management Report summarizes the memoranda prepared in planning; discusses the stormwater solutions analyzed, and solutions considered but eliminated; and documents the stormwater management solutions which will satisfy the water quality and attenuation needs of the project. This report will include all agreements with stakeholders and a summary of all meetings. If traditional pond siting was pursued the report will contain the preliminary drainage design of the project and, as needed, all traditional pond sites analyzed for design. The memoranda prepared in planning, any agreements with stakeholders, and meeting minutes should be included as attachments to this report.

Outcome: Stormwater Management Report.

Step 12 – Final Design, Final Permits, Construction, and Maintenance

Design and stormwater plans production are finalized. Construction permits are obtained for the project as required. Stakeholder coordination and communication should be continued by the Champion during this time, including the transfer of maintenance responsibility to partners, if agreed upon as part of the partnership.

Outcome: Completed project including transfer of maintenance to partners, if applicable.

D.2 Pond Siting Process

The following pond siting process provides guidance for identifying, evaluating, and selecting locations for stormwater management ponds when those ponds require right of way (ROW) acquisition. The need for ponds may be driven by regulatory water quality, attenuation, and/or floodplain mitigation requirements. An overview is provided in Figure 20 – 2 —Pond Siting Process Flowchart.

Figure 20 – 2 Pond Siting Process Flowchart

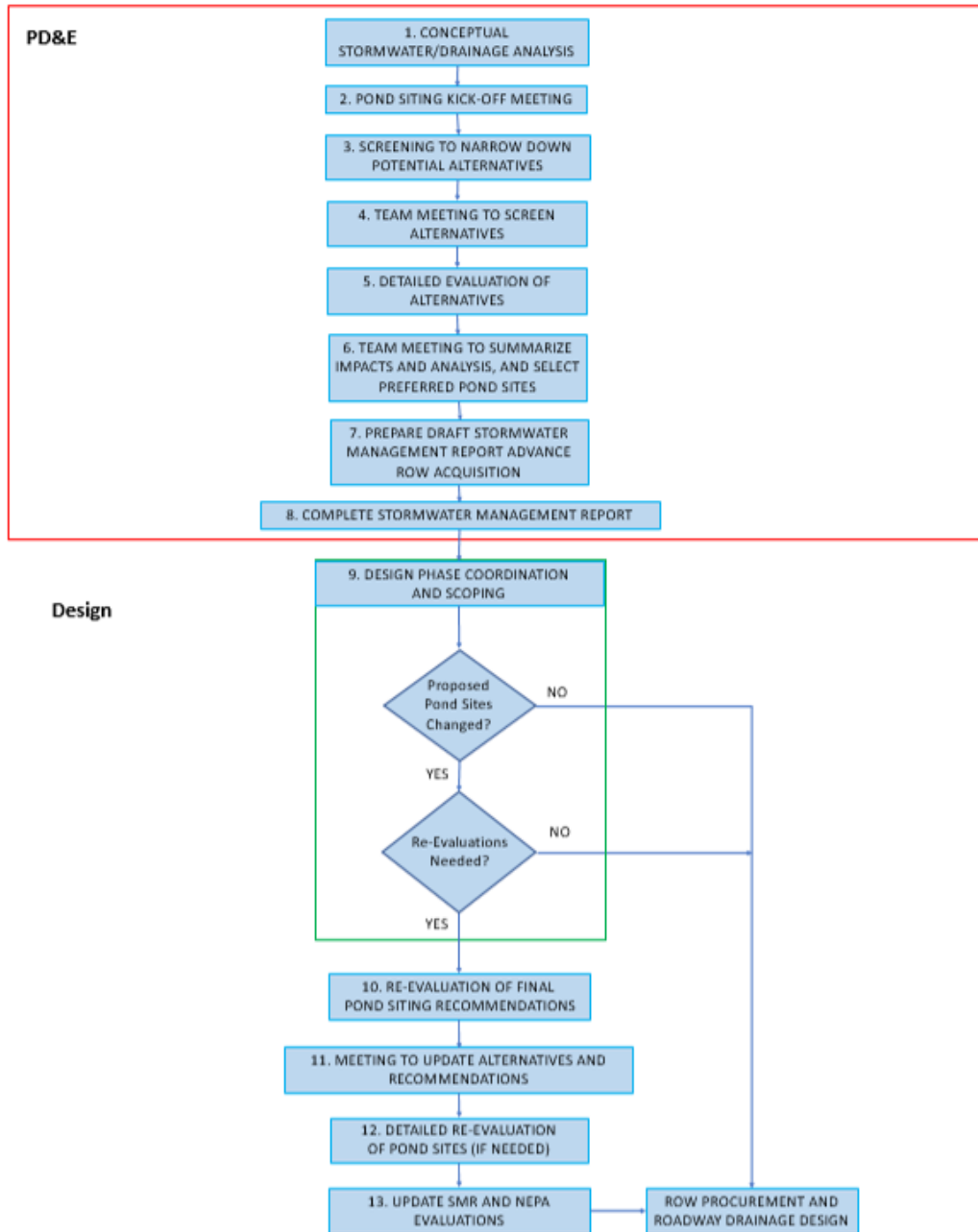

Step 1: Conceptual Stormwater/Drainage Analysis

Once it has been determined that traditional pond sites are needed to meet water quality or quantity requirements or dual evaluation will be needed, the following process can be used for conceptual analysis.

1. Establish drainage design criteria (may include a pre-permit application meeting with agencies). Criteria should include the following:
 - Permitting criteria (water quality and quantity as well as discharge limitations).
 - Rainfall intensity for critical duration events (identify design storm events).
 - Curve numbers or runoff coefficients.
 - Times of concentration.
 - Tailwater criteria (discharge condition and stages).
2. Conduct a review of drainage permit files for the corridor and adjacent developments.
3. Determine drainage basin boundaries using aerial contour maps, old construction plans, and available surveys to identify the primary basins and general outfall locations.
 - Identify high points on the profile to separate the primary basins.
 - Conduct field visits for this determination.
4. Determine major off-site contributing areas.
5. Establish floodplain elevations and potential for encroachment.
6. Identify outfall locations and verify if closed basin criteria apply.
7. Develop generic soils information (obtain from County Soil Conservation Survey or from earlier geotechnical studies conducted in the area).
8. Establish seasonal high ground water table (SHGWT) elevations.
9. Develop design estimates for water quality and water quantity requirements.
10. Develop an initial system model using a routing program.

11. Identify alternative pond design options based on project site conditions and available funding. A general rule of thumb for placement of ponds in relatively flat terrain is to target one pond per mile of corridor. In hilly areas, pond locations are typically much more frequent, as driven by the roadway profile.
12. Identify alternative stormwater management options (consider available funding):
 - Existing stormwater management facilities – are these adequate to handle the proposed improvements (with or without modifications)?
 - Potential exfiltration trench options.
 - Dry detention / retention systems.
 - Wet detention / retention systems.
13. Coordinate with the ROW Office on some initial sites to discuss at the kick-off meeting.
14. Discuss the area's stormwater management with the other agencies involved and estimate the impacts of the potential pond sites and feasibility of being incorporated into the area plan.

Outcome: Conceptual drainage design, including identified types of ponds and their approximate capacity.

Approximate Timeline: 2 months

Step 2: Pond Siting Kick-off Meeting

Before the meeting, coordinate with the right of way and legal staff to identify some initial pond sites to discuss at the kick-off meeting. During the meeting, the following issues should be addressed:

1. Verification of pond design guidelines and criteria (includes District preferences).
2. Identify potential detention / retention pond sites.
3. Assign property ID number to each property to be considered. The ROW Office will provide these numbers.
4. Identify potential joint-use pond sites (public / private).
5. Task team members with an assignment to conduct an impact analysis. Assign impact analysis to team members.

Outcome: A developed framework for future pond site evaluations.

Approximate Timeline: 2 weeks

Step 3: Screening to Narrow Down Potential Alternatives

This evaluation consists of a general review to narrow down potential alternatives. This effort may include site specific geotechnical testing, survey, constructability reviews, etc. Issues to consider when evaluating right of way include:

1. Use existing ROW whenever possible.
2. Minimize the number of parcels required for pond construction along the corridor.
3. Review aerials for potentially available vacant land. Use vacant land whenever possible and economical.
 - Establish why a property is vacant, and if the property owner has plans for development. Land may be vacant because the owner is having difficulty in permitting proposed improvements.

- Consider the development potential of a property.
4. Look at how each pond location is situated on the site. Consider the impacts to the remainder of the parcel and its viability for development. How will it function for its current or future use?
 - Weigh the impacts of a partial ROW acquisition versus a whole acquisition of the property.
 5. Avoid the following types of properties if possible:
 - Residential and commercial relocations.
 - Public and historic facilities.
 - Pond sites directly located on major streets and highways.
 - Pond sites on or adjacent to contaminated sites.
 6. Look at access management issues and how the remainder of the site will operate.
 - Avoid landlocking the remaining property.
 - Consider how maintenance will access the pond site.
 7. Avoid or minimize impacts to existing wetland systems and wildlife habitat. When placing ponds near wetlands, check the potential drawdown effects on the wetlands.
 8. Avoid floodplain impacts.
 9. Minimize utility relocations and review requirements for utility access for maintenance purposes.
 10. Identify if proposed pond sites are candidates for advanced acquisition. If so, the ROW staff must have an increased role and the advanced ROW process identified in the project schedule.

Outcome: Initial evaluation of potential pond sites.

Approximate Timeline: 4 weeks.

Step 4: Team Meeting to Screen Alternatives

For the evaluation of stormwater management ponds several standardized factors should be considered, as shown in Table 20 – 4 Evaluation Factors for Pond Siting Alternatives. The project’s stormwater team has the option of customizing the factors within the matrix to satisfy the particularities of their project. An example of a matrix format is shown in Exhibit 20 – 1 Evaluation Matrix Example.

For consistency, the team should use a ranking for each factor that is agreed upon by the entire group.

Outcome: Pond site alternatives are reduced to 3 sites per basin, with (1) team member assignments allocated for further, more detailed evaluation; and (2) needed survey requested for the alternative sites still under consideration.

Approximate Timeline: 2 - 3 weeks.

Table 20 – 4 Evaluation Factors for Pond Siting Alternatives

<u>Factor</u>	<u>Description/Issues to Consider</u>	<u>Cost \$</u>	<u>Weighted Value</u>
<u>Brief Description of Alternative</u>	<u>Provide a detailed description of the pond site.</u>	<u>N/A</u>	<u>N/A</u>
<u>Parcel Number</u>	<u>Identify the Parcel Number with the Right of Way office.</u>	<u>N/A</u>	<u>N/A</u>
<u>Estimated Parcel Size (Acres)</u>	<u>Provide the total area for the required ROW acquisition. The total area is to include the area to meet the water quality / quantity storage requirements as well as maintenance berm width, slopes, perimeter drainage/conveyance ditch area and access to pond sites for maintenance.</u>	<u>N/A</u>	<u>N/A</u>
<u>Right of Way (Zoning)</u>	<u>Describe the status of the parcel in question. For example, the parcel could be currently under a proposed plan for improvement (Rezoning Request) or the site may currently be located on a commercial site with an active business. Consideration should also be given to existing and proposed zoning.</u>	<u>N/A</u>	<u>If there are no zoning issues with the site add 5 points per acre. If there are potential zoning issues, add zero points.</u>
<u>Land Use</u>	<u>Identify the current and/or proposed land use, which could affect the acquisition costs of the parcel. For example, a partial ROW acquisition of a property could have a significant impact on the use of the remaining parcel.</u>	<u>N/A</u>	<u>Costs will need to be added to the overall site costs and a weighted value applied accordingly.</u>

<u>Right of Way Costs</u>	<u>Identify Right of Way Costs associated with the acquisition of the parcel.</u>	<u>\$</u>	<u>Costs will need to be added to the overall site costs and a weighted value applied accordingly.</u>
<u>Drainage Considerations</u>	<u>Include a description of the system and corresponding outfall location and parameters. Consider pond location such as in the center of the basin, in the low area within the basin, adjacent to the outfall location, and piping needs / costs, etc. Also consider site elevations and the corresponding need to elevate (build-up) the perimeter berm.</u>	<u>\$</u>	<u>Meets the FDOT's needs – points TBD by Team.</u> <u>Meets most needs – points TBD by Team.</u> <u>Other issues between sites will depend on construction costs of a facility at each particular site.</u>
<u>FEMA Flood Zone</u>	<u>Identify the Flood Zone and associated impacts / benefits of a pond within the flood zone. The perimeter berm will affect flood zone storage, while the pond will enhance storage. When right of way is acquired within a low-lying area, the construction of the roadway template may affect adjacent properties' ability to use that area for storage.</u>	<u>N/A</u>	<u>Meets the FDOT's needs – points TBD by Team.</u> <u>Meets most needs – points TBD by Team.</u> <u>Other issues will depend on the benefit to the floodplain at each particular site.</u>
<u>Contamination – Hazardous Materials</u>	<u>Identify if the parcel is contaminated; this will limit the ability to use the site. Consideration of this parcel must include the costs associated with the clean-up of the site.</u>	<u>N/A</u>	<u>Additional costs will need to be added to the overall site costs and a weighted value applied accordingly.</u>
<u>Utilities</u>	<u>Identify existing and proposed utilities within or adjacent to the parcel. The cost of relocating utilities must be included in the consideration of a parcel.</u>	<u>\$</u>	<u>Additional costs will need to be added to the overall site costs, and weighted value applied accordingly.</u>

<u>Threatened & Endangered Species (TES) and associated Mitigation Costs</u>	<u>Identify species as Threatened, Endangered, or Significant. Identify the anticipated mitigation costs.</u>	<u>N/A</u>	<u>Additional costs will need to be added to the overall site costs, and a weighted value applied accordingly.</u>
<u>Noise</u>	<u>Identify noise impacts and corresponding noise abatement, which may impact the location and placement of pond sites.</u>	<u>N/A</u>	<u>Additional costs will need to be added to the overall site costs, and a weighted value applied accordingly.</u>
<u>Wetlands / Protected Uplands and associated Mitigation Costs</u>	<u>High values indicate known habitat or historic presence such as Rookery Area. Medium values may be indicative of relatively undisturbed, natural, or stable habitat types. Low values may indicate disturbed habitats. Identify the cost of mitigating for these impacts.</u>	<u>\$</u>	<u>Additional costs will need to be added to the overall site costs, and a weighted value applied accordingly.</u>
<u>Cultural Resources Involvement and associated Costs</u>	<u>Identify the presence of cultural resources including archaeological and historical resources which could affect the suitability of the site in question and associated costs.</u>	<u>N/A</u>	<u>Additional costs will need to be added to the overall site costs, and a weighted value applied accordingly.</u>
<u>Section 4(f)</u>	<u>Identify the presence of Section 4(F) properties which could affect the suitability of the site in question and associated costs.</u>	<u>N/A</u>	<u>Additional costs will need to be added to the overall site costs, and a weighted value applied accordingly.</u>
<u>Public Wellfield</u>	<u>The proximity to a wellfield site will have a direct impact on the type of drainage facility which can be placed on the corresponding parcel.</u>	<u>N/A</u>	<u>N/A</u>

<u>Aesthetics</u>	<u>Identify the need for landscape buffers, fencing, variable pond shapes, etc.</u>	<u>N/A</u>	<u>No set weighted value is applicable for this item; however, requirements for fencing, landscaping, littoral shelves, etc. which have a direct impact on the area required to physically set the pond needs to be considered. Costs associated with plants, fencing etc. will need to be added to the overall costs of using the site.</u>
<u>Public Opinion / Adjacent Residency Concerns</u>	<u>Identify possible impacts to current or proposed land use (i.e., schools may dictate a dry pond versus a wet pond).</u>	<u>N/A</u>	<u>N/A; however, this factor may affect the type of system selected for a site.</u>
<u>Other</u>	<u>Joint Use potential</u>	<u>N/A</u>	<u>If the ability to use joint use ponds is available, assume a weighted value of 10 per acre-ft of available storage. Otherwise use zero for this value.</u>
<u>Total Applicable Costs</u>	<u>Identify the total cost of the parcel including cost identified from all issues above.</u>	<u>\$</u>	<u>Costs vary significantly between rural and urban locations. This value should be used when comparing final costs between alternative pond locations. Engineering judgment will need to be considered and an acceptable cost modifier applied as agreed to by the team members. Use 1 point per 5% differential</u>

			<u>in cost between alternative sites.</u>
<u>Comments, Advantages, Disadvantages, etc.</u>	<u>Include a detailed description of the Advantages and Disadvantages associated with the parcel in question.</u>	<u>N/A</u>	<u>N/A</u>

Step 5: Detailed Evaluation of Alternatives

Conduct a field review(s) and obtain survey as deemed necessary. The extent of the field review should include the verification of impacts to assess the viability of a potential pond site.

Outcome: Alternatives are fully evaluated in preparation for selecting a preferred pond site in each basin.

Approximate Timeline: 4 weeks.

Step 6: Team Meeting to Summarize Impacts and Analysis, and Select Preferred Pond Sites

During the public involvement process, reasonable efforts must be made to inform the public/affected property owners of the potential impacts to the community/properties of the proposed improvements. As such, properties identified for potential acquisition for retention/detention ponds should be presented to the public in the same manner as acquisition for geometric requirements. Although the proposed right of way acquisition is displayed, the public should be clearly informed that all proposals are preliminary, and subject to change, as the project develops.

Outcome: Selection of preferred pond sites.

Approximate Timeline: 1 week.

Step 7: Prepare Draft Stormwater Management Report/Advanced ROW Acquisition

The Stormwater Management Report should have been incrementally prepared as the pond siting process was unfolding and reviewed by the team. The draft Stormwater Management Report will be presented at the Public Meeting.

Outcome: The Draft Stormwater Management Report should be made available for the Public Meeting.

Approximate Timeline: 1 month.

Step 8: Hold Public Meeting/Workshop

Advertise and host public meeting/workshop to inform the public about the project and pond locations being considered. Gather public input and document comments for further consideration in design. Conceptual project plans, aerial photos, geotechnical information can be provided to improve the public's understanding of project impacts. Ensure notice of meeting is provided in a timely manner.

Outcome: Obtain public input.

Approximate Timeline: 6 weeks.

Step 9: Complete Stormwater Management Report

Finalize Stormwater Management Report and recommendations based on team's evaluation. Exhibit 20 – 2, below, is a sample Table of Contents for Stormwater Management Reports.

1. Discuss and address comments from the Public Meeting.
2. Re-rank recommended and alternative pond sites, if necessary.

Outcome: Final Stormwater Management Report is completed.

Approximate Timeline: 1 week

Exhibit 20 – 2 Sample Table of Contents for Stormwater Management Reports

TABLE OF CONTENTS FOR POND SITING REPORTS

EXECUTIVE SUMMARY

I. INTRODUCTION

[Exhibit A]

II. PROJECT DESCRIPTION

2.1 Site Description [Exhibit B]

2.2 Roadway Improvements [Exhibit C]

III. SITE INFORMATION

3.1 Topography

3.2 Hydrologic Data [Exhibit D]

3.3 Land Use Description

3.4 Wetland and Vegetative Cover

3.5 100-year Floodplain

3.6 Geology and Hydrogeology

3.7 Hazardous Material Assessment

3.8 Habitat Assessment (EFH and Endangered Species Issues)

3.9 Historical and Archaeological Assessment

3.10 Utilities

3.11 Existing Drainage Basins (Predevelopment)

3.12 Regulatory Issues and Design Criteria [Exhibit E]

IV. DRAINAGE SYSTEM DESCRIPTION

4.1 Post Development Conditions

4.2 Pond Siting Selection Criteria

4.3 Pond Siting Alternative Analysis

V. RIGHT OF WAY ACQUISITION COSTS

VI. RECOMMENDATIONS

EXHIBITS

Exhibit A- Location Map

Exhibit B- Existing Roadway Section

Exhibit C- Proposed Roadway Typical Section

Exhibit D- Rainfall Data

Exhibit E- Typical Sections for Stormwater Treatment Ponds

Exhibit F- Pond H Site Plan

Exhibit G- Pond Siting Matrix

APPENDICES

Appendix A- Pond Siting Plan

Appendix B- Geotechnical Data

- a. Excerpts from Draft Preliminary Report of Geotechnical Exploration; S.R. 50 from Hancock Road to Orange County Line, Lake County, Florida by Law Engineering and Environmental Services, Inc. October 2003.
- b. Excerpts from Draft Preliminary Report of Geotechnical Exploration; S.R. 50 from Lake County Line to East Turnpike Ramps, Orange County, Florida by Law Engineering and Environmental Services, Inc. October 2003.
- c. Excerpts from the PD&E Geotechnical Investigation
- d. Excerpts from Soil Survey of Lake County, Florida
- e. Excerpts from Soil Survey of Orange County, Florida

Appendix C- Rainfall

Appendix D- Floodplain Data

Appendix E- Pond Siting Calculations

- a. Water Quality and Attenuation
- b. Pond Area Requirements (Proposed Locations)
- c. Pond Area Requirements (Alternative Locations)
- d. Recovery Time (Preliminary Evaluation)
- e. ICPR Pre-Development Model Input & Results
- f. ICPR Post-Development Model Input & Results

Step 10: Reevaluation of Final Pond Siting Recommendations

If pond sites selected in the Stormwater Management Report have materially changed from their conditions at the time of the completion, the team should reevaluate the pond siting recommendations.

Outcome: Team members have reviewed changed pond sites and additional engineering data is identified for pursuit. Pond site layouts are refined.

Approximate Timeline: 1 week.

Step 11: Detailed Re-Evaluation of Pond Sites (If Needed)

Re-evaluate remaining viable recommended sites and identified alternate sites and conduct field reviews as necessary. Finalize pond site layout with site geometrics for the viable recommended sites and identified alternatives.

Outcome: Changes to previous pond sites are evaluated in preparation for team discussion and updating of documents.

Approximate Timeline: 3 weeks.

Step 12: Update Stormwater Management Report

Review the findings from the previous step, update the matrix as necessary, recommend final pond sites for project, update the Stormwater Management Report based on team evaluations, and finalize the information. Send to right of way mapping the preferred pond sites as specified in the revised Stormwater Management Report. Send right of way requirements to the right of way staff for procurement.

Outcome: Stormwater Management Report is updated, ROW acquisition begins.

Approximate Timeline: 4 weeks.

EC OPEN CHANNEL

This section presents minimum standards for the design of natural or manmade open channels, including roadside ditches, swales, median ditches, interceptor ditches, outfalls, and canals.

EC.1 Design Frequency

Open channels shall be designed to convey and to confine storm water within the ~~ditch~~channel. Standard design frequencies for stormwater flow are shown in Table 20 – ~~54~~ Stormwater Flow Design Frequencies.

Table 20 – ~~54~~ Stormwater Flow Design Frequencies

Facility Types	Frequency
Major roadway	10-year
All other road types	5-year

Site-specific factors may warrant the use of an atypical design frequency. Any increase over pre-development stages shall not significantly change land use values unless flood rights are acquired.

EC.2 Hydrologic Analysis

~~For the design of open channels, use one of the following methods as appropriate for the site:~~ ~~Hydrologic data used for the design of open channels shall be based on one of the following methods as appropriate for the particular site:~~

1. A frequency analysis of observed (gage) data shall be used when available. If insufficient or no observed data is available, one of the procedures below shall be used as appropriate. However, the procedures below shall be calibrated to the extent practical with available observed data for the drainage basin, or nearby similar drainage basins.
 - a) Regional or local regression equation developed by the United States Geological Survey (USGS).

- b) Rational Equation for drainage areas up to 600 acres.
 - c) For outfalls from stormwater management facilities, the method used for the design of the stormwater management facility may be used.
2. For regulated or controlled canals, hydrologic data shall be requested from the controlling entity. Prior to use for design, this data shall be verified to the extent practical.
- 2.3. Stormwater modeling software, approved by the maintaining agency or local government jurisdiction.

EC.3 Hydraulic Analysis

The Manning's Equation shall be used for the design of open channels.

EC.3.a Manning's "n" Values

Recommended Manning's n values for channels with bare soil, vegetative linings, and rigid linings are presented in the FDOT's the [Drainage Manual \(2022\)](#), Table 2.2 Manning's "n" Values for Artificial Channels with Bare Soil and Vegetative Linings and Table 2.3 Manning's "n" Values for Artificial Channels with Rigid Linings. The manual is incorporated by reference in [Rule 14-86.003, F.A.C., Permit, Assurance Requirements, and Exceptions.](#)

The probable condition of the channel when the design event is anticipated shall be considered when a Manning's n value is selected.

EC.3.b Slope

Roadside channels should be designed to have self-cleaning velocities, where possible. Channels should also be designed to avoid standing water in the roadway right-of-way.

EC.3.c Channel Linings and Velocity

The design of open channels shall consider the need for channel linings. When design flow velocities do not exceed the maximum permissible for bare earth, the standard treatment of ditches may consist of grassing and

mulching. For higher design velocities, sodding, ditch paving, or other form of lining shall be provided. Tables for maximum velocities for bare earth and the various forms of channel lining can be found in [the FDOT's the Department's *Drainage Manual \(2022\)*](#), Tables 2.4 Maximum Shear Stress Values and Allowable Velocities for Different Soils and Table 2.5 Maximum Velocities for Various Lining Types.

EC.3.d Limitations on Use of Linings

Grassing or sodding should not be used under the following conditions:

1. Continuous standing or flowing water
2. Areas that do not receive the regular maintenance necessary to prevent overgrowth by taller vegetation
3. Lack of nutrients
4. Excessive soil drainage
5. Areas excessively shaded

To prevent cracking or failure, concrete lining must be placed on a firm, well-drained foundation. Concrete linings are not recommended where expansive clays are present.

When concrete linings are to be used where soils may become saturated, the potential for buoyancy shall be considered. Acceptable countermeasures may include:

1. Increasing the thickness of the lining to add additional weight.
2. For sub-critical flow conditions, specifying weep holes at appropriate intervals in the channel bottom to relieve the upward pressure on the channel.
3. For super-critical flow conditions, using subdrains in lieu of weep holes.

EC.4 Construction and Maintenance Considerations

The type and frequency of maintenance that may be required during the life of drainage channels should be considered during their design, and allowances should be made for the access of maintenance equipment.

EC.5 Safety

The design and location of open channels shall comply with roadside safety and clear zone requirements. See **Chapter 3 – Geometric Design** for clear zone requirements, including special clearance criteria for canals.

EC.6 Documentation

For new construction, design documentation for open channels shall include the hydrologic and the hydraulic analyses, including analysis of channel lining requirements

FD — **STORM DRAIN HYDROLOGY AND HYDRAULICS**

This section presents minimum standards for the design of storm drain systems.

FD.1 Pipe Materials

See Section **HG** for pipe material requirements.

FD.2 Design Frequency

The minimum design storm frequency for the design of storm drain systems shall be 3 years.

Site-specific factors may warrant the use of an atypical design frequency. Any increase over pre-development stages shall not significantly change land use ~~values, unless~~ values unless flood rights are acquired.

FD.3 Design Tailwater

For most design applications where the flow is subcritical, the tailwater will either be above the crown of the outlet or can be considered to be between the crown and critical depth. To determine the energy grade line (EGL), begin with either the tailwater elevation or $(dc + D)/2$, whichever is higher, add the velocity head for full flow and proceed upstream, adding appropriate losses (e.g., exit, friction, junction, bend, entrance).

An exception to the above procedure is an outfall with low tailwater. In this case, a water surface profile calculation would be appropriate to determine the location where the water surface will either intersect the top or end of the barrel and full-flow calculations can begin. In this case, the downstream water surface elevation would be based on critical depth or the tailwater, whichever is higher.

FD.4 Hydrologic Analysis

The Rational Method is the ~~preferred~~ most common method in use for the design of storm drains when the momentary peak-flow rate is desired. Other methods may be used, with permission by the maintaining agency or local government jurisdiction.

FD.4.a ————— **Time of Concentration**

Minimum time of concentration shall be 10 minutes.

FD.5 Hydraulic Analysis

Hydraulic calculations for determining storm drain conduit sizes shall be based on open channel and pressure flow as appropriate. The Manning's equation shall be used.

FD.5.a ————— **Pipe Slopes**

The minimum physical slope should be that which will produce a velocity of 2.5 feet per second (fps) when the storm drain is flowing full. Where not practical or possible in flat terrain, include design features to limit soils from entering the pipes.

FD.5.b **Hydraulic Gradient**

If the hydraulic grade line (HGL) does not rise above the top of any manhole or above an inlet entrance, the storm drainage system is satisfactory. Standard practice is to ensure that the HGL is below the top of the inlet for the design discharge (some local agencies may add an additional safety factor which can be up to 12 inches). Manholes with bolted lids may be used in locations where the top is below the HGL.

FD.5.c ————— **Outlet Velocity**

When discharge exceeds 4 fps, consider special channel lining or energy dissipation. For computation of outlet velocity, the lowest anticipated tailwater condition for the given storm event shall be assumed.

FD.5.d **Manning's Roughness Coefficients**

Standards Manning's Roughness Coefficients can be found in the FDOT's~~the Department's~~ [Drainage Manual \(2022~~2018~~\) Section 3.6.4.](#)

FD.6 Hydraulic Openings

If the hydraulic grade line does not rise above the top of any manhole or above an inlet entrance, the storm drainage system is satisfactory. Standard practice is to ensure that the HGL is below the top of the inlet for the design discharge.

The design stage for a ditch bottom inlet may be allowed to exceed the inlet top when the ditch or swale can accommodate the capacity. Examine where the overtopping elevation could occur to ensure there are no adverse flooding impacts to the roadway or offsite property.

FD.6.a ————— Entrance Location and Spacing

Drainage inlets and other hydraulic openings are sized and located to satisfy hydraulic capacity, structural capacity, safety (pedestrians, cyclists, and motor vehicles), and durability requirements.

Grate inlets and the depression of curb opening inlets should be located outside the through traffic lanes to minimize the shifting of vehicles attempting to avoid them. All grate inlets shall be bicycle safe where used on roadways that allow bicycle travel.

The FDOT's [Drainage Manual \(2022\)](#), [Section 3.7](#) provides guidance on hydraulic openings and protective treatments. Table 3.3 Curb and Inlet Application Guidelines, Table 3.4 Ditch Bottom Inlet Application Guidelines and Table 3-5 Drainage End Treatment – Lateral Offset Criteria in the **Drainage Manual** provide guidance for inlet selection.

Inlet spacing shall consider the following:

- Regardless of the results of the hydraulic analysis, inlets on grade should be spaced at a maximum of 300 feet for 48 inches or smaller pipes.
- Inlets on grade should be spaced at a maximum of 600 feet for pipes larger than 48 inches.
- Inlets should be placed on the upstream side of bridge approaches.
- Inlets should be placed at all low points in the gutter grade.
- Inlets should be placed upstream of intersecting streets.

- Inlets should be placed on the upstream side of a driveway entrance, curb-cut ramp, or pedestrian crosswalk even if the hydraulic analysis places the inlet further down grade or within the feature.
- Inlets should be placed upstream of median breaks.
- Inlets should be placed to capture flow from intersecting streets before it reaches the major highway.
- Flanking inlets in sag vertical curves are standard practice.
- Inlets should be placed to prevent water from sheeting across the highway (i.e., place the inlet before the superelevation transition begins).
- Inlets should not be located in the path where pedestrians walk.

FD.6.b Grades

FD.6.b.1 Longitudinal Gutter Grade

The minimum longitudinal gutter grade shall be 0.3%. Minimum grades can be maintained in very flat terrain by use of a rolling profile.

FD.7 Spread Standards

The spread, in both temporary and permanent conditions, resulting from a rainfall intensity of 4.0 inches per hour shall be limited as shown in Table 20 – ~~62~~ Spread Criteria.

Table 20 – ~~62~~ Spread Criteria

Design Speed (mph)	Spread Criteria*
Design Speed ≤ 30	Crown of Road
30 < Design speed ≤ 45	Keep ½ of lane clear
45 < Design Speed ≤ 55	Keep 8' of lane clear
Design Speed > 55	No encroachment

* The criteria in this column apply to travel, turn, or auxiliary lanes adjacent to barrier wall or curb, in normal or super elevated sections.

In addition to the above standards, for sections with a shoulder gutter, the spread resulting from a 10-year frequency storm shall not exceed 1' 3" outside the gutter in the direction toward the front slope. This distance limits the spread to the face of guardrail posts.

FD.8 Construction and Maintenance Considerations

Proper design shall also consider maintenance concerns of adequate physical access for cleaning and repair.

FD.8.a ————— Pipe Size and Length

Consider using a minimum pipe size of 18" for trunk lines and laterals. 15" hubcaps commonly block smaller pipes resulting in roadway flooding. The minimum pipe diameter for all proposed exfiltration trench pipes (French drain systems) within a drainage system is 18".

The maximum pipe lengths without maintenance access structures are as follows:

Pipes without French Drains:

18" - 42" pipe	300 feet
48" and larger and all box culverts	600 feet

French Drains that have access through only one end:

18" to 30" pipe	150 feet
36" and larger pipe	200 feet

French Drains that have access through both ends:

24" to 30" pipe	300 feet
36" and larger pipe	400 feet

FD.8.b Minimum Clearances

A minimum cover of 1 ft should be provided between the top of pipe and the top of subgrade. A minimum clearance of 1 ft should be provided between storm drainage pipes and other underground facilities (e.g., sanitary sewers). Check with local utility companies, as their clearance requirements may vary from the 1' minimum.

F.9 Green Stormwater Elements for Context Based Design

Drainage systems are often determined by opportunity, feasibility, and topography, rather than context. However, understanding both the existing and future land use and transportation goals can help determine drainage specific options for the proposed design. Future land use and transportation needs can alter the context and change the drainage opportunities available.

The introduction of green streets is one component of a larger drainage design approach to improving the region's stormwater management, and requires a broader based alliance for its planning, funding, maintenance, and monitoring. Green stormwater elements also serve as a visible component of "green Infrastructure" that is incorporated into the aesthetics of the community

The following is a list of drainage considerations that support context based design and minimize the amount of water that leaves the corridor:

- Bioretention/Biofiltration Planter – are stormwater infiltration cells constructed with walled vertical sides, a flat bottom area, and a large surface capacity to capture, treat and manage stormwater runoff from the street. They provide water quality treatment and reduce runoff volumes, and may be applied in more limited rights of way.
- Bioretention Swale – are shallow, vegetated, landscaped depressions with sloped sides.
- Hybrid Bioretention Cell – combines elements of both swales and planters, featuring a walled side opposite a graded side slope to increase vegetated space and infiltrating area, while providing a softer streetscape treatment for people walking.
- Pervious Strips – are long, linear landscaped areas or linear areas of pervious pavement that can capture and slow runoff.

- Street Trees – can contribute significantly to green stormwater management, with large capacity to transpire water, intercept rainfall, and treat water quality, as well as temperature mitigation and air quality improvement.
- Pervious Pavers/Permeable Pavement – allows water to infiltrate through streets, parking bays and sidewalks, reducing runoff. Maintenance of the pavement will affect long term durability.

Green stormwater infrastructure performance can improve over time if facilities are properly maintained. As vegetation establishes, roots can capture and retain more stormwater. Healthy vegetation and soil increases transpiration, reduces urban heat island effects, supports groundwater recharge, and restores natural ecological cycles and resources.

Robust and iterative operations and maintenance plans are critical to fully capitalizing on the potential of green infrastructure. Include maintenance staff in the project planning process to reduce oversights in the design and ensure that green stormwater infrastructure can achieve its full potential. Although all drainage systems require maintenance, green streets will require special attention to long term maintenance requirements and techniques. Maintenance practices and frequency of maintenance need to be established and personnel trained.

Traffic calming features such as curb extensions can be designed as bioretention areas to intercept stormwater and work with existing roadways and pedestrian features by including ADA compliant grate covered channels or inlets. These and other traffic calming features such as speed tables and raised crosswalks should be evaluated for impacts to pavement hydraulics to ensure runoff is managed without violating spread criteria.

The National Association of City Transportation Officials' (NACTO) [Urban Street Stormwater Guide](#) provides additional information on the stormwater elements of green streets. The FDOT's [Standard Plans](#) and ~~FDOT's 2022 Drainage Manual~~ the FDOT's [Drainage Manual](#) provide further information on the design and placement of trench drains, French drains, and underdrains.

The Transportation Research Board's (TRB) data base (TRID) includes several research projects on how pervious pavements perform in Florida titled [Pervious Pavements – Installation, Operations, and Strength, Parts 1, 2, 3 and 4](#).

Figure 20 – 3 Green Street Elements



FD.109 Protective Treatment

Drainage designs shall be reviewed to determine if some form of protective treatment will be required to prevent unauthorized entry to long or submerged storm drain systems, steep ditches, or water control facilities. If other modifications, such as landscaping or providing flat slopes, can eliminate the potential hazard and thus the need for protective treatment, they should be considered first. Areas provided for retention and detention, for example, can often be effectively integrated into parks or other green spaces.

Vehicular and pedestrian safety are attained by differing protective treatments, often requiring the designer to make a compromise in which one type of protection is more completely realized than the other. In such cases, an evaluation should be made of the relative risks and dangers involved to provide the design that gives the best balance. It must be remembered that the function of the drainage feature will be essentially in conflict with total safety, and that only a reduction rather than elimination of all risk is possible.

The three basic types of protective treatment are shown in Table 20 – 7 Protective Treatments.

Table 20 – 7~~3~~ Protective Treatments

Feature	Typical Use The three basic types of protective treatment are shown in Table 20 – 7 3 Protective Treatments.
Grates	To prevent persons from being swept into long or submerged drainage systems.
Guards	To prevent entry into long sewer systems under no-storm conditions, to prevent persons from being trapped.
Fences	To prevent entry into areas of unexpected deep standing water or high velocity water flow, or in areas where grates or guards are warranted but are unsuitable for other reasons.

When determining the type and extent of protective treatment, the following considerations should be reviewed:

- The nature and frequency of the presence of children in the area, e.g., proximity to schools, school routes, and parks, should be established.
- Highway access status should be determined. Protective treatment is usually not warranted within a limited access highway; however, drainage facilities located outside the limited access area or adjacent to a limited access highway should be considered unlimited access facilities.
- Adequate debris and access control would be required on all inlet points if guards or grates are used at outlet ends.
- Hydraulic determinations such as depth and velocity should be based on a 25-year rainfall event.
- The hydraulic function of the drainage facility should be checked and adjusted so the protective treatment will not cause a reduction in its effectiveness.
- Use of a grate may cause debris or persons to be trapped against the hydraulic opening. Grates for major structures should be designed in a manner that allows items to be carried up by increasing flood stages.
- Use of a guard may result in a person being pinned against it. A guard is usually used on outlet ends.
- A fence may capture excessive amounts of debris, which could possibly result in its destruction and subsequent obstruction of the culvert. The location and construction of a fence shall reflect the effect of debris-induced force.

FD.110 Documentation

For new construction, supporting calculations for storm sewer system design shall be documented and provided to facility owner.

GE CROSS DRAIN HYDRAULICS

This section presents standards and procedures for the hydraulic design of cross drains including culverts, bridge-culverts¹, and bridges.

GE.1 Design Frequency

The recommended minimum design flood frequency for culverts is shown in Table 20 – **84** Recommended Minimum Design Flood Frequency. The minimum flood frequency used to design the culvert can be adjusted based on:

An analysis to justify the flood frequencies greater or lesser than the minimum flood frequencies listed below; and

The culvert being located in a National Flood Insurance Program mapped floodplain.

Table 20 – **84 Recommended Minimum Design Flood Frequency**

Roadway Classification	Exceedance Probability (%)	Return Period (Year)
Local Roads and Streets; ADT >3,000 VPD	4%	25
Local Roads and Streets; ADT ≤ 3,000 VPD*	20 - 10%	5 - 10

*At the discretion of the local agency

GE.2 Backwater

Allowable headwater is the depth of water that can be ponded at the upstream end of the culvert during the design flood. The allowable headwater for the design frequency should:

¹ A culvert qualifies as a bridge if it meets the requirements of Item 112 in the [Department's-FDOT's "Bridge Management System \(BMS\) Coding Guide."](#)

- Have a level of inundation that is tolerable to upstream property and roadway for the design discharge,
- Consider a duration or inundation that is tolerable to the upstream vegetation to avoid crop damage; and
- Be lower than the upstream shoulder edge elevation at the lowest point of the roadway within the drainage basin.

If the allowable headwater depth to culvert height ratio (HW/D) is established to be greater than 1.5, the inlet of the culvert will be submerged. Under this condition, the hydraulics designer should provide an end treatment to mitigate buoyancy.

G.3 Tailwater

For the sizing of cross drains and the determination of headwater and backwater elevations, the highest tailwater elevation which can be reasonably expected to occur coincident with the design storm event shall be used.

G.4 Clearances

To permit the passage of debris, a minimum clearance of 2 ft should be provided between the design approach water surface elevation and the low chord of the bridge where practical. Where this is not practicable, the clearance should be established by the hydraulics engineer based on the type of stream and level of protection desired. Additional vertical clearance information can be found in ***Chapter 3 – Geometric Design***.

G.5 Bridges and Other Structures

It is important for the hydraulic engineer to accurately represent the hydraulic condition. The modeling approach should be selected based primarily on its advantages and limitations, though also considering the importance of the structure, potential project impacts, cost, and schedule.

One-dimensional models are best suited for in-channel flows and when floodplain flows are minor. They are also frequently applicable to small streams. For extreme flood conditions, one-dimensional models generally provide accurate results for narrow to moderate floodplain widths. In general, where lateral velocities are small, one-dimensional models provide reasonable results.

Two-dimensional models should be used when flow patterns are complex and one-dimensional model assumptions are significantly violated. If the hydraulic engineer has great difficulty in visualizing the flow patterns and setting up a one-dimensional model that realistically represents the flow field, then two-dimensional modeling should be used.

The National Cooperative Highway Research Program published a report entitled ["Criteria for Selecting Hydraulic Models" \(NCHRP 2006\)](#) that provides a procedure for selecting the most appropriate model for a particular application incorporating site conditions, design elements, available resources, and project constraints.

The following Table 20 – 9 Bridge Hydraulic Modelling Selection may be used to determine the appropriate modeling approach.

Table 20 – 9 Bridge Hydraulic Modeling Selection

Bridge Hydraulic Condition	Hydraulic Analysis Method	
	One-Dimensional	Two-Dimensional
Small Streams	●	□
In-Channel Flows	●	□
Narrow to Moderate-width Floodplains	●	□
Wide Floodplains	□	●
Minor Floodplain Constriction	●	□
Highly Variable Floodplain Roughness	□	●
Highly Sinuous Channels	□	●
Multiple Embankment Openings	□/×	●
Unmatched Multiple Openings in Series	□/×	●
Low Skew Roadway Alignment (<20')	●	□
Moderately Skewed Roadway Alignment (>20' and <30')	□	●
Highly Skewed Roadway Alignment (>30')	×	●
Detailed Analysis of Bends, Confluences and Angle of Attack	×	●
Multiple Channels	□	●
Small Tidal Streams and Rivers	●	□
Large Tidal Waterways and Wind-influenced Conditions	×	●
Detailed Flow Distribution at Bridges	□	●
Significant Roadway Overtopping	□	●
Upstream Controls	×	●
Countermeasure Design	□	●
● well suited or primary use □ possible application or secondary use × unsuitable or rarely used □/× possibly unsuitable depending on application		

See [also](#) Chapter 17 – [Structures](#), Section C.3.e for [additional information on Drainage Criteria for structures.](#)

~~F~~ ~~STORMWATER MANAGEMENT~~

~~F.1~~ ~~Regulatory Requirements~~

~~F.1.a~~ ~~Chapter 62-25, Florida Administrative Code~~

~~Chapter 62-25, F.A.C., rules of the Florida Department of Environmental Protection specifies minimum water quality treatment standards for new development.~~

~~F.1.b~~ ~~Chapter 62-40, Florida Administrative Code~~

~~Chapter 62-40, F.A.C., rules of the Florida Department of Environmental Protection outlines basic goals and requirements for surface water protection and management to be implemented and enforced by the Florida Department of Environmental Protection and Water Management Districts.~~

~~F.1.c~~ ~~National Pollutant Discharge Elimination System~~

~~The National Pollutant Discharge Elimination System (NPDES) permit program is administered by the U. S. Environmental Protection Agency and delegated to the Florida Department of Environmental Protection in Florida. This program requires permits for stormwater discharges into waters of the United States from industrial activities; and from large and medium municipal separate storm sewer systems (MS4s). Construction projects are within the definition of an industrial activity.~~

HG CULVERT MATERIALS

The evaluation of culvert materials shall consider functionally equivalent performance in three areas: durability, structural capacity, and hydraulic capacity.

HG.1 Durability

Culverts shall be designed for a design service life (DSL) appropriate for the culvert function and highway type. -The design service life should be based on factors such as:

- Projected service life of the facility
- Importance of the facility
- Economics
- Potential inconvenience and difficulties associated with repair or replacement, and projected future demands on the facility.

In estimating the projected service life of a material, consideration shall be given to actual performance of the material in nearby similar environmental conditions, its theoretical corrosion rate, potential for abrasion, and other appropriate site factors. Theoretical corrosion rates shall be based on the environmental conditions of both the soil and water. In tannic water, the designer will also need to consider the effect of microbially induced corrosion of concrete pipes, especially in industrial or sewer systems.

At a minimum, the following corrosion indicators shall be considered:

- pH
- Resistivity
- Sulfates
- Chlorides

The FDOT ~~The Department of~~ provides a program called **Culvert Service Life Estimator** for estimating the service life of culverts based on the above criteria. The Culvert Service Life Estimator is based on standard measurement of soil and water parameters. Tannic water can provide an environment for organisms to grow

on the material surface that is not taken into consideration by this tool, which will over-predict the facility life.

To avoid unnecessary site-specific testing, generalized soil maps may be used to delete unsuitable materials from consideration. The potential for future land use changes which may change soil and water corrosion indicators shall also be considered to the extent practical.

HG.2 Structural Design Capacity

The structural design of all culverts, storm drainpipes and drainage structures shall be in accordance with specifications (including guide specifications) published by the American Association of State Highway and Transportation Officials (AASHTO). At a minimum, the **AASHTO Load and Resistance Factor Design (LRFD) Bridge Design Specifications, 9th Edition (2020)** shall be used.

~~AASHTO design guidelines and industry recommendations should be considered in pipe material selection.~~

HG.3 Hydraulic Capacity

The hydraulic evaluation shall establish the hydraulic size for the particular culvert application. For storm drains and cross drains, the design shall use the Manning's roughness coefficient associated with the pipe material selected.

THIS PAGE INTENTIONALLY LEFT BLANK