

## D217 Diverging Diamond Interchanges

### 217.1 General

This chapter provides criteria for the geometric layout of the Diverging Diamond Interchange (DDI). The criteria contained in the FDM are supplemented by guidance provided in the [Federal Highway Administration \(FHWA\) Diverging Diamond Interchange Informational Guide, August 2014.](#)

The DDI is an alternative interchange configuration that combines the basic form of a diamond interchange with a pair of directional crossovers on the cross street. The crossovers serve to transpose the directions of travel along the cross street between the ramp terminals on either side of the controlled access facility. Shifting the through movements to the left side of the street between ramp terminals removes conflicts between left turning vehicle to and from the ramps and opposing through traffic on the cross street. This in turn allows for two-phase signal timing at the crossovers improving the operational efficiency of the interchange.

The DDI design significantly reduces the number of vehicle-to-vehicle conflict points compared to a conventional diamond interchange improving overall safety. The DDI also reduces the severity of conflicts, as conflicts between left-turning movements and the opposing through movement are eliminated. The remaining conflicts are reduced to merge/diverge conflicts for turning movements, and the crossover conflict of the two through movements.

#### 217.1.1 DDI Terminology

**Figure 217.1.1** provides a schematic of typical DDI terminology. The terms shown in this section are standard terms or variables used within this chapter.

**Figure 217.1.1 DDI Terminology**

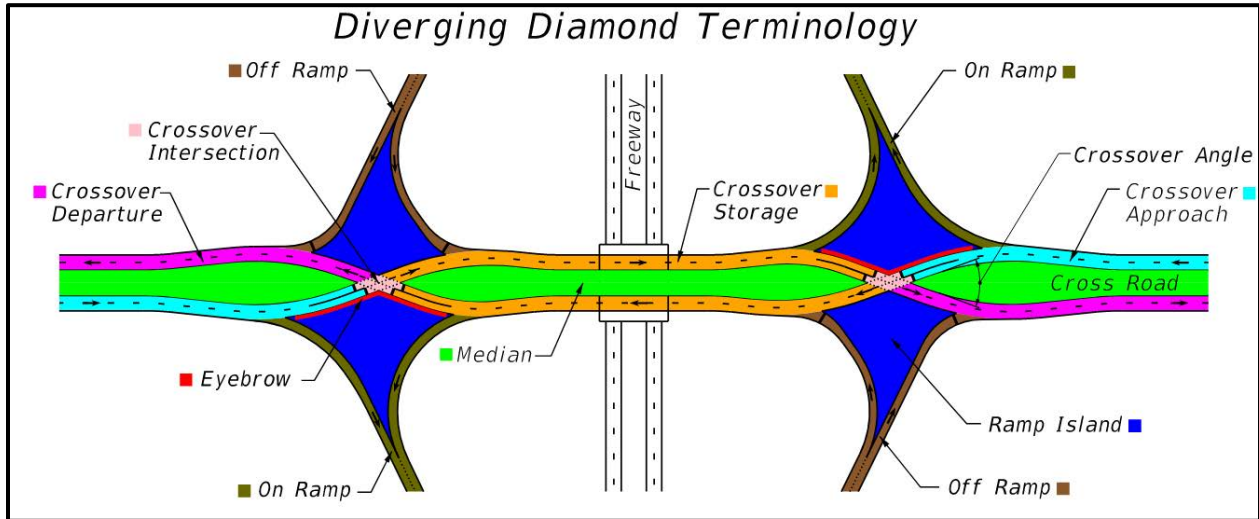

### 217.1.2 DDI Benefits

Benefits of the DDI include improved safety, improved traffic operations, and reduced cost when compared to other interchange types.

Improved Safety: The DDI improves safety by minimizing conflict points and reducing traffic speeds. Conflict points are locations within an intersection where vehicle paths merge, diverge, or cross. Crossing conflict points pose the most serious threat to drivers as they increase the risk of severe angle crashes. The conventional diamond intersection has 26 total and 10 crossing conflict points, whereas the DDI has 14 total and 2 crossing conflict points (see **Figure 217.1.2**). In addition, DDI geometric features encourage slower traffic speeds through the interchange. The combination of reduced conflict points and slower speeds has proven to reduce the number and severity of crashes at DDIs.

**Figure 217.1.2 DDI Conflict Points**

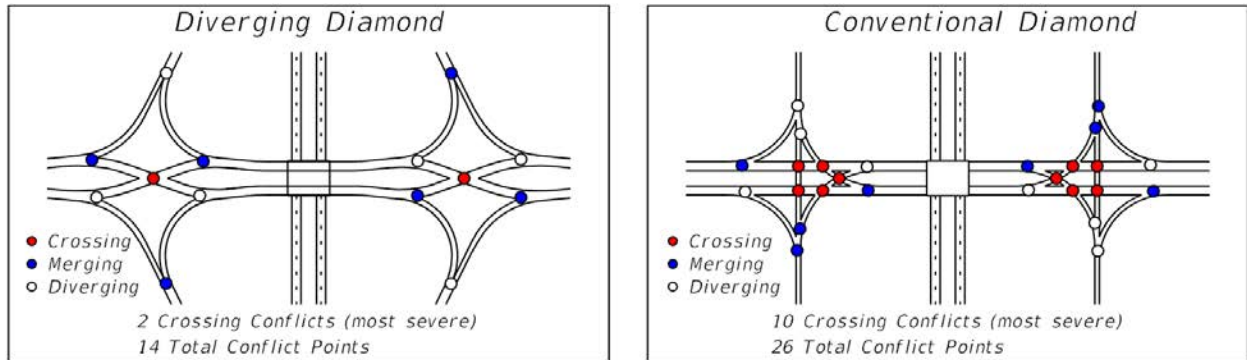

**Improved Traffic Operations:** By transposing travel directions between ramp terminals, the DDI configuration eliminates conflicts between left turning traffic to and from the ramps and through travelers on the crossroad. This allows traffic signals at the DDI to operate with two signal phases as opposed to three or more signal phases at a conventional diamond interchange. Reducing the number of signal phases results in higher capacity, less delay, and smaller queues at the DDI. In addition, DDI ramp signals are easier to coordinate than those of a conventional diamond configuration.

**Improved Pedestrian Accommodation:** The DDI configuration provides safety and operational benefits for non-motorized travelers as well. By reducing the number of required lanes, pedestrian crossings become short two-stage crossings reducing pedestrian exposure time. Further, the efficient two-phase signal timing will reduce pedestrian wait time at the crosswalks.

**Reduced Cost:** The DDI requires less storage than conventional interchanges due to its operational efficiency in processing left turns to and from the freeway ramps. These reduced storage requirements translate into fewer lanes on the crossroad and a reduction in the overall crossroad width. If the crossroad goes over the freeway the bridge width could be reduced. If the crossroad goes under the freeway the bridge length and structure depth can be reduced. Both scenarios can result in significant cost savings. In addition, the smaller footprint of the DDI could reduce project right of way costs.

### 217.1.3 DDI Considerations

DDIs can be implemented to improve a variety of challenges related to mobility, safety, and cost. However, they are not the right solution for every situation. Consider the following when contemplating the DDI option for an interchange study:

- High left turn demand - When left turn demand to and from the ramp terminals is high compared to the through movements on the cross street the DDI option should be considered. DDIs are particularly good at processing large left turn volumes.
- High incidence of angle crashes – When crash history reveals a high incidence of angle crashes the DDI option should be considered. The reduction in conflict points afforded by the DDI has proven to be effective in reducing severe crashes over time.
- Minimizing construction costs – DDIs typically require fewer lanes to accommodate traffic demand than other interchange types. Having fewer lanes allows for a smaller structural footprint which ultimately leads to significant savings in construction costs.
- Salvaging existing bridges - The DDI can be an excellent candidate for interchange retrofit projects. In many instances existing bridges can be salvaged with little or no widening requirements by implementing the DDI alternative. This helps to keep project costs low.
- High through volumes – Because the crossover intersections require split-phasing for the through movements along the arterial, high volumes can create a situation where not enough green time is available to clear one or both through movements within the signal phase. This can create queues that extend back to the other crossover intersection or extend outside of the DDI. Detailed traffic analysis is necessary to ensure that the crossover intersections can adequately accommodate the through volumes.
- Adjacent Signalized Intersections – The presence of signalized intersections close to a DDI can have a negative impact on traffic operations. The two-phase signal operation at the DDI allows higher vehicle throughput that could potentially overload a less efficient 3-phase or 4-phase signal at an adjacent intersection. Queue spillback into the crossover intersection or exit ramp could occur if sufficient storage between the DDI and the adjacent intersection is not provided.

Presence of closely spaced intersections is not necessarily a fatal flaw if they can be reconfigured. Alternative intersection types such as restricted crossing U-turn, median U-turn, and continuous flow intersections are good options to consider in these situations. These intersection types serve to reduce signal phases and improve traffic progression allowing them to efficiently process the increased throughput generated from the DDI. Roundabouts can also work well in some situations when closely spaced to a DDI.

- Signal Progression - Introduction of a DDI within a signalized corridor might not make sense if signal progression is a priority. The crossover intersections at the DDI will make it challenging to coordinate signal progression for through traffic in both directions.
- Accommodating Over-sized Loads – Oversized trucks that exceed vertical clearance of bridges over the freeway can use the ramps on a conventional diamond interchange to bypass the bridges. This direct up-and-over maneuver is not available with the DDI configuration without additional considerations.
- Right of Way Constraints – It is typically necessary to widen the crossroad in the vicinity of a DDI to achieve effective channelization and a proper crossing angle at the crossover intersections. A safe geometric layout may not be achieved if right of way constraints are too restrictive.
- Distance Between Crossover Intersections – Short distances between crossover intersections (less than 300 feet) might not meet through movement storage requirements resulting in queue spillback. This can occur when a Tight Diamond Interchange is retrofitted to a DDI configuration. Vehicular storage requirements between crossover intersections must be verified through detailed operational analysis to assure storage capacity is adequate.

## **217.2 Traffic Operations Study**

The traffic operations study evaluates key operational elements of the DDI. These elements can greatly influence the geometric design. Capacity analysis of the crossovers, queue spillback from adjacent signalized intersections and queue storage between the crossovers will dictate crossover spacing as well as possible changes to the adjacent signalized intersections. Typical data needs for the traffic operations study include:

- Turning movement counts and future growth projections,
- Origin-Destination between the interchange and adjacent signalized intersections, and
- Lane utilization through the interchange (if not an even distribution)

Geometric design and operational analysis are interdependent activities, particularly at a DDI, and require the design engineer and traffic engineer to collaborate throughout the design refinement process. This approach assures the geometric layout and operational

analysis will be consistent with one another. It also leads to a balanced design that best meets the operational and safety needs of the project.

## 217.2.1 Signal Phasing

For detailed discussion on signal phasing and timing at DDI crossover intersections, see Chapter 5 of *NCHRP Report 959: Diverging Diamond Interchanges Informational Guide, Second Edition*.

Signal operations at DDIs differ from those of traditional diamond interchanges. DDIs operate with “split phasing” for the cross-street to allow both crossover movements to proceed independently. Signalized exit ramp movements can run concurrently with the appropriate crossover movement.

Three signal phasing schemes have been developed for DDIs and the choice for which scheme to use will be based on traffic volumes at the interchange. *NCHRP Report 959* describes the three schemes as follows:

- **Two-critical-movement** – This scheme emphasizes the progression for either the cross-street movements or the off-ramp movements and is most applicable for DDIs with one dominant movement. *Figure 217.2.1* provides benefits and challenges for the two-critical-movement phasing scheme.
- **Three-critical-movement** – This scheme emphasizes progression for the cross-street movements and the off-ramp left turn movements and is most applicable for DDIs with one or multiple dominant movements. The three-critical-movement scheme is often the most flexible and most efficient DDI phasing option. *Figure 217.2.2* provides benefits and challenges for the three-critical-movement phasing scheme.
- **Four-critical-movement** – This scheme emphasizes progression for both the cross-street movements and the off-ramp movements and is most applicable to DDIs with low to moderate volume, either dominant through or left-turn movements, and short to medium crossover spacing. The four-critical-movement scheme tends to be less efficient and result in higher delays for DDIs that are approaching capacity but can be a good option for metering traffic for an adjacent intersection. *Figure 217.2.3* provides benefits and challenges for the four-critical-movement phasing scheme.

When beginning an analysis for a DDI where the signal phasing scheme is not yet selected and the corridor features do not clearly align with the descriptions above, a three-critical-movement scheme is likely the most appropriate assumption.

**Figure 217.2.1 Benefits and Challenges of Two-Critical-Movement Phasing**

Benefits	Challenges
+ Ability to coordinate the through movement on the cross-street or dominant left-turn movement from the ramps	- Limited ability to progress multiple movements (e.g., both cross street and movements from the ramps)
+ Generally easy to understand/implement and troubleshoot in the field due to low complexity of phase assignments	- May result in more stops internal to the DDI than other strategies
+ Minimizes lost time because of the low number of phases	
+ Highest potential capacity of the three phasing schemes	
+ Adaptable to any crossover spacing	

Source: NCHRP Report 959: Diverging Diamond Interchanges Informational Guide, Second Edition

**Figure 217.2.2 Benefits and Challenges of Three-Critical-Movement Phasing**

Benefits	Challenges
+ Ability to coordinate through movements on the cross-street and left-turn movements from the ramps	- More complex than two-critical-movement phasing scheme
+ Possible to troubleshoot in the field due to the low complexity of phase assignments	- Less efficient than two-critical-movement phasing scheme
+ Moderate lost time with only three critical phases	- May result in stops internal to DDI for nondominant movements
+ High-capacity phasing scheme for multiple dominant movements	
+ Adaptable to any crossover spacing	

Source: NCHRP Report 959: Diverging Diamond Interchanges Informational Guide, Second Edition

**Figure 217.2.3 Benefits and Challenges of Four-Critical-Movement Phasing**

Benefits	Challenges
+ Ability to progress all movements through the DDI	- Works best with balanced volumes and may be challenging with one or more dominant movements
+ Minimizes stops internal to the DDI (resulting in a better user experience)	- More difficult to understand/implement and troubleshoot in the field due to complexity of phase assignments
+ Most flexible and adaptable phasing scheme	- Highest lost time among the three phasing schemes because of the number of phases
	- Less capacity than other phasing schemes
	- Inefficient for wide crossover spacings

Source: NCHRP Report 959: Diverging Diamond Interchanges Informational Guide, Second Edition

## 217.2.2 Capacity Analysis

Capacity analysis should be conducted for the DDI crossover intersections as well as the adjacent signalized intersections along the corridor. The DDI intersections will have two, three, or four-critical-movement phasing and will typically be more efficient than the existing intersection control. Increased throughput from the DDI could overload adjacent signalized intersections. Therefore, the interaction between the DDI and adjacent intersections must be evaluated.

Capacity analysis for DDIs is typically conducted using Synchro, VISSIM, or other similar analysis tools. Choosing the appropriate tool depends on the stage of plans development the project is in. For projects in early planning with multiple alternatives to evaluate, Synchro would be the appropriate choice for preliminary analysis. Once the DDI has been selected, VISSIM would be chosen for refined analysis. However, VISSIM could also be used for alternatives analysis.

Refer to the *FDOT Traffic Analysis Handbook* for guidance on conducting capacity analysis.

### Synchro Analysis

Synchro is a good tool for determining the feasibility of a DDI alternative. It allows the analyst to quickly determine the basic interchange lane configuration including the number through lanes, number of turn lanes, modification needs at adjacent intersections, initial storage lengths, etc. It gives a good estimate of the DDI footprint and associated



changes to the cross-street corridor. Initial signal phasing and timing plans can also be tested in Synchro to determine the most effective phasing options. Synchro is less labor intensive than VISSIM and accounts for interactions between the DDI crossovers and adjacent intersections. However, Synchro has some disadvantages as described below:

- Synchro assumes uniform lane utilization - Lane utilization at the crossovers is typically not uniform and Synchro does not account for this when calculating queue lengths. **HCM 6<sup>th</sup> Edition** provides guidance on lane utilization at crossovers.
- Modeling traffic on the left side – There is difficulty in coding Synchro models to simulate traffic on the left side of the road between the crossovers.
- Modeling free-flow left turns - There is difficulty in coding Synchro models to simulate free-flow left turn movements from the crossroad to the on-ramps.

The FDOT Traffic Engineering and Operations Office has developed a Synchro DDI template to aid analysts in developing DDI models. It is located on the Intersection Operations and Safety website. This template provides a good starting point when conducting DDI analysis in Synchro. Given the disadvantages noted above, analysts are strongly encouraged to start with this template.

## **VISSIM Analysis**

VISSIM is a good tool for refined evaluation of a DDI. At a minimum, it should be used once the DDI has been selected as the preferred alternative to confirm the lane use and the detailed design elements such as storage lengths and signal timings. Unlike Synchro, the geometric configuration of the DDI and free-flow left turns can be easily modeled in VISSIM. VISSIM can accurately account for the interaction between the DDI and the adjacent signalized intersections as well as queueing between the crossover intersections. Also, VISSIM visualization models are very helpful when educating the public on DDI traffic operations. As lane utilization at the entering crossover of a DDI is known to be non-uniform, proper calibration of look back distances should be considered for vehicles moving into left turn bays ahead of entrance ramps.

### **217.2.3 Exit Ramp Traffic Control**

The left and right turning movements from the freeway exit ramp can operate with either signal or yield control. In most cases there are several advantages to signaling the exit ramp turning movements including:

- Enhanced pedestrian safety due to signalized pedestrian crossings.
- Reduced lane changing and weaving within the interchange area.
- Enhanced safety due to driver sight lines and expectations for the location of approaching traffic. Having traffic on the left side of the roadway violates where drivers' expectation of where oncoming traffic is coming from. **Figure 217.2.4** illustrates the driver expectancy issues.

**Figure 217.2.4 Driver Expectancy Issues for Exit Ramp Movements**

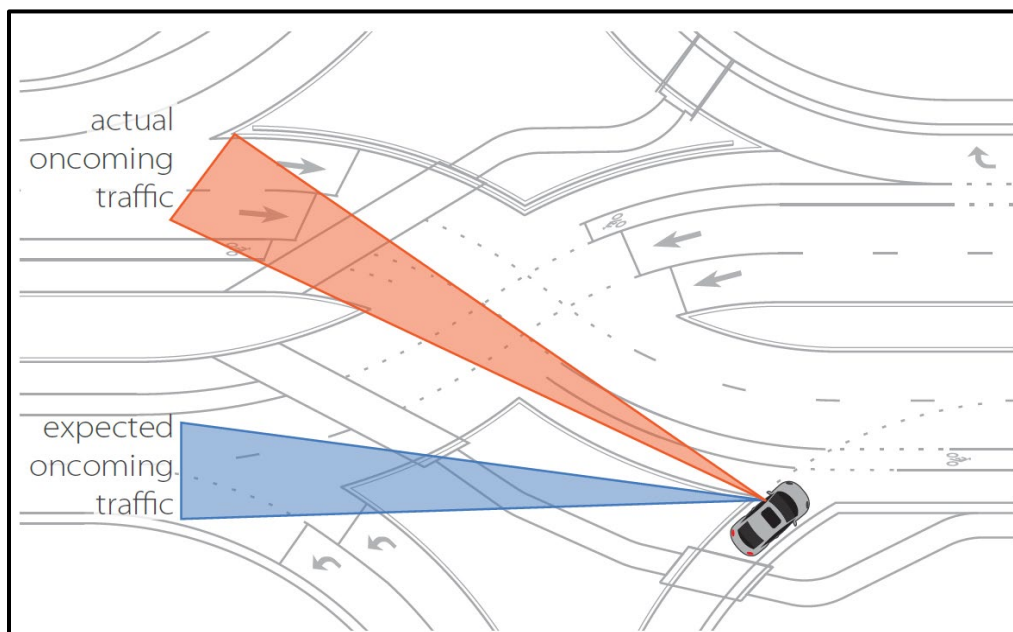

Source: Utah DOT

Due to the driver expectancy issue, right-turn-on-red (RTOR) and left-turn-on-red (LTOR) should be prohibited at locations where the left and right turn exit ramp movements are signalized.

Although signalizing the off-ramp right turn movement and prohibiting turns-on-red is beneficial for the operation and safety of the crossover intersection, it also increases the risk of queue spillback. Queue lengths must be evaluated to ensure that ramp storage is sufficient to prevent spillback onto the freeway.

## 217.2.4 Closely Spaced Adjacent Intersections

The proximity of adjacent signalized intersections to DDI crossovers can have a significant impact on the operational performance of a DDI. DDIs using two- or three-critical-movement signal phasing are typically more efficient than the three or four phase operations of adjacent intersections. Increased throughput at the DDI can lead to a break down in the operations of adjacent intersections. The following items should be evaluated to confirm acceptable operations.

- **Downstream Queue** - The increased throughput of the DDI could increase the queues at adjacent intersections causing spillback into the crossover intersection and/or freeway exit ramp. Modifications to adjacent signalized intersections are often needed to reduce downstream queueing and maintain the overall operation of the corridor.
- **Weaving** - Arterial weaving between the freeway exit ramps and adjacent signalized intersections can also be a concern. Right turning vehicles from the exit ramp wanting to turn left at the adjacent intersection will need to make multiple lane changes. Prohibiting right-turn-on-red at these locations eliminates the lane changing concern because the right turn maneuver will always be protected from conflicting traffic flow.
- **Demand Starvation** - Adjacent signalized intersections could create demand starvation at the DDI crossover. In this situation, the DDI signal turns green with no traffic present because it is being held up by the upstream signal. The less efficient operation at the upstream signal causes the inbound DDI movements to be underutilized. Half-cycles at the crossovers should be considered to improve progression and reduce demand starvation. The first cycle would serve mainline traffic from the upstream intersection while the second cycle would serve vehicle turning left onto the mainline at the upstream intersection. Three or four-critical-movement phasing schemes could also be effective in reducing demand starvation.

## 217.2.5 Lane Utilization

When approaching an interchange, drivers tend to reposition themselves for downstream turns or lane drops. This repositioning creates unbalanced lane utilization through the interchange and can have a significant impact on queueing and delays. Lane utilization should be included as part of the analysis to verify acceptable capacity results. Some items that can influence lane utilization are:

- Vehicles preparing for downstream left or right turns. This can lead to an imbalance in the left or right lanes.
- Shared through/left lanes at the freeway entrance ramps. This could place all the left turns and some of the through vehicles in the left lane at the upstream crossover intersection, possibly creating an imbalance.
- Lane drops downstream of the interchange could cause vehicles coming through the interchange to avoid the through lane that will drop, creating an imbalance in the remaining through lanes.

### **217.2.6 Queue Storage Between Crossovers**

The spacing between the crossover intersections must be evaluated as part of the traffic study. Short distances between the crossovers have a greater risk of insufficient queue storage if not properly addressed through signal timing techniques. This creates the possibility of queue spillback into the upstream crossover. Providing adequate queue storage between crossovers is critical. Four-critical-movement signal phasing may be an option to reduce queuing between crossover intersections.

The treatment of left turns to the freeway can also have a significant impact on queuing between crossovers. Short left turn lanes can create an adverse situation where through vehicles queued at the outbound crossover block the otherwise free-flowing left turn onto the freeway, creating additional queuing between the crossovers. This is especially true when left turns are made from a shared through/left lane and the left turn departure is close to the crossover. It only takes a few queued through vehicles to block the left turn. Traffic analysis should confirm that adequate storage is provided to avoid blocking the left turn movements with queued through vehicles. Exclusive left turn lanes could be used in this situation to eliminate the blockage. It is advantageous to develop dedicated left turn lanes in advance of the upstream crossover to increase capacity and provide for better signing. This reduces lane changing and confusion through the interchange. **Figure 217.2.5** provides a graphical display for developing the left turn lane in advance of the crossover. Blockage by queued through vehicles can also be addressed by proper progression of through vehicles from the inbound crossover to the outbound crossover.

## Figure 217.2.5 Development of Dedicated Left Turn Lane

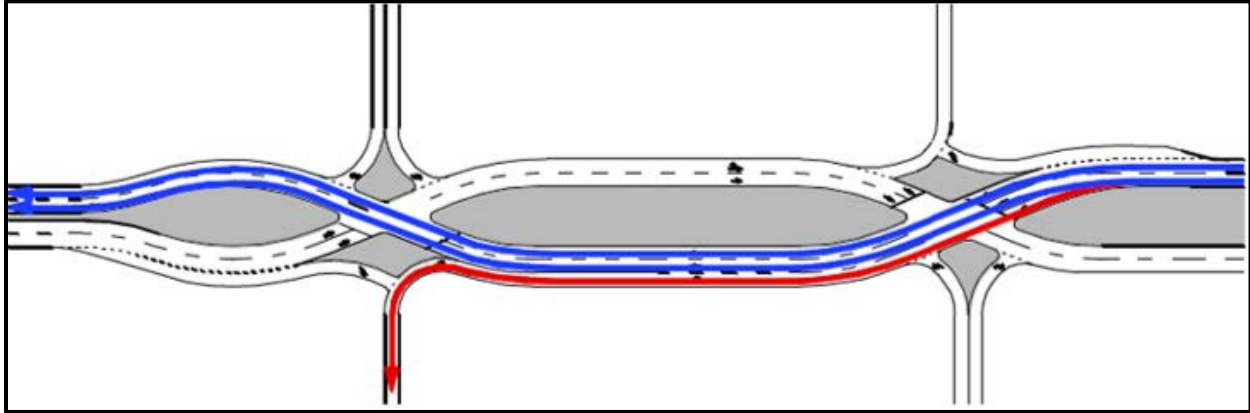

### 217.3 Geometric Design

DDI design is the process of developing roadway geometry that provides a balanced solution to the competing objectives of safety, operational efficiency, and economy. Each DDI requires unique design choices based on project specific constraints, traffic volumes, speeds, topography, and roadway alignments.

DDI design is an iterative process that is conducted in conjunction with traffic operational analysis. Consider Multi-modal features early in the design process to assure the needs of all road users including bicycle, pedestrian, and transit will be accommodated by the proposed facility.

#### 217.3.1 Principles and Objectives

Use the following list of overarching principles and objectives to guide the development of all DDI designs:

- Provide geometry that gradually slows traffic down prior to the crossover intersections and promotes slow, consistent speeds throughout the interchange limits.
- Provide the appropriate number of lanes, lane assignments, and storage lengths to achieve adequate level of service, balanced lane utilization, and lane continuity.
- Provide smooth alignments and channelization that enhance driver comfort and promote vehicles naturally using their intended lane.

- Provide suitable accommodation for the design vehicle for all movements through the interchange.
- Provide multi-modal accommodation for all road users. Consider the context sensitive needs of transit, emergency vehicles, and non-motorized users.
- Provide adequate sight distance and clear sight lines for all conflict points within the interchange including those involving pedestrians and cyclists.
- Provide geometry that allows for proper signing and pavement marking and promotes the principle of driver expectation.

### **217.3.2 Right of Way Requirements**

Right of way requirements tend to be site specific and depend heavily on the design speed of reverse curvature on crossroad alignments at the crossovers. DDIs generally allow for a narrower crossroad typical section as compared to other interchange types due to the elimination of left turn bays. However, it is often necessary to widen the crossroad median to achieve appropriate crossing angles and tangent lengths between reverse curves at the crossovers. The required widening could result in larger right of way impacts than other interchange alternatives in some cases.

### **217.3.3 Design Speed**

The design speed governing reverse curvature at crossover intersections may be reduced by up to 10 mph below the design speed of the approaching roadway. In no case shall a design speed of less than 25 mph be used. The minimum allowable radius for the crossover curves is determined by using **AASHTO Greenbook 2011 Equation 3-8**. Superelevation is assumed to be flat and side friction factors are determined using **AASHTO Greenbook 2011 Figure 3-6**. **Table 217.3.1** provides minimum crossover radii for given design speeds.

**Table 217.3.1 Minimum Crossover Radius**

Design Speed (mph)	25	30	35	40	45
Min. crossover radius (ft)	250	350	500	650	900

DDIs on high speed facilities (50 mph and greater) with right of way or other physical constraints, might be limited to the use of radii in the table above corresponding to 35 mph or less. In these situations, introduce horizontal curvature on the roadway approach geometry to gradually slow approaching traffic down to an appropriate speed prior to entering the crossover intersections. Approach geometry should include a series of reverse curves with successively smaller radii as the roadway approaches the DDI. Place short tangent segments (50-foot min.) between the curves to assure a comfortable, smooth natural path.

The minimum allowable radius for turning roadways at ramp terminals (right and left turns to and from ramps) is determined by the swept path of the design vehicle traveling at 10 mph. Larger radii corresponding to higher design speeds up to and including the crossover intersection design speed can be used for turning roadways when site conditions allow. It is desirable to include deceleration lanes at turning roadways when minimum allowable radii are used due to project constraints.

### 217.3.4 Ramp Terminal Spacing

The distance between ramp terminals is dictated by design considerations, traffic operations, and site constraints. This distance should allow for proper horizontal and vertical alignment design. Conduct detailed operational analysis to verify that terminal spacing satisfies traffic operational needs given project specific traffic forecasts. There is currently no federal standard establishing minimum ramp terminal spacing for DDI design.

### 217.3.5 Crossover Angle

The crossover angle is the acute angle measured between lanes of opposing traffic at a crossover intersection (**Figure 217.1.1**). The crossover angle is a critical design element as it has a significant impact on many other design elements as well as the overall footprint of the interchange. Factors to consider when selecting a crossover angle include:

- Wrong-way movements – Large crossover angles in the range of 40-45 degrees are desirable to discourage drivers from making wrong-way directional movements

into opposing traffic. Flat crossing angles are confusing to drivers and increase the likelihood of wrong-way movements.

- Signal Clearance Time – Research has shown an inverse relationship between crossover angle and signal clearance time. The smaller the crossover angle is, the longer it takes for vehicles, pedestrians, and cyclists to clear the crossover intersection. This adds time to the yellow and all-red phases. Although large crossover angles benefit operations, small crossover angles can be acceptable in constrained conditions.
- Right-of-way/physical constraints – Crossover angles are proportional to the median width between the crossing roadways. Large crossover angles necessitate large medians near the intersection increasing the overall interchange footprint. Large crossover angles are not achievable when Right-of-way and/or physical constraints limit the interchange footprint.
- Crossover Alignments – Roadway alignments passing through a crossover intersection are typically comprised of a pair of reverse curves on either side separated by a tangent segment in the middle. As the crossover angle increases, curve radii and tangent lengths must decrease given a constant median width. Flatter crossover angle help facilitate larger curve radii and longer tangent segments.

Designers should select the largest crossing angle possible subject to balancing the requirements of other geometric parameters such as median width, curve radii, and tangent lengths through the intersection. In unconstrained conditions a crossing angle ranging from 40 to 45 degrees is desirable. In constrained conditions a smaller crossing angle will be needed. The minimum allowable crossing angle for a DDI under constrained conditions is 25 degrees.

### **217.3.6 Eyebrow Design**

In the context of DDI design the “eyebrow” refers to the portion of the ramp island curb face adjacent to the directional roadways at the crossover intersection (**Figure 217.3.1**). A properly designed eyebrow can help mitigate the risk of wrong-way movements. Attention to eyebrow design is particularly important under constrained conditions where large crossing angles are not attainable. A raised island is the recommended standard treatment for eyebrow locations. The vertical face of the island should be located 1.5’ from the edge of travel way. Shoulders are not recommended at eyebrow locations. For crossing angles of 30 degrees or less consider the use of 38” concrete barrier at these locations for enhanced channelization.



The eyebrow should provide a physical obstruction to deter a direct straight-line passthrough between the two opposing approach legs of the crossover intersection. To check the passthrough, construct a line connecting the median edge lines of the opposing approach legs and offset it 6 feet away from the median. The 6-foot offset accounts for the width of a passenger vehicle. If this line passes through the eyebrow, then the passthrough is physically blocked and the probability of wrong-way movements is reduced. **Figure 217.3.1** illustrates the straight-line passthrough design check. It becomes challenging to block the passthrough when the crossover approaches have three or more travel lanes.

**Figure 217.3.1 Straight Line Pass-through Design Check**

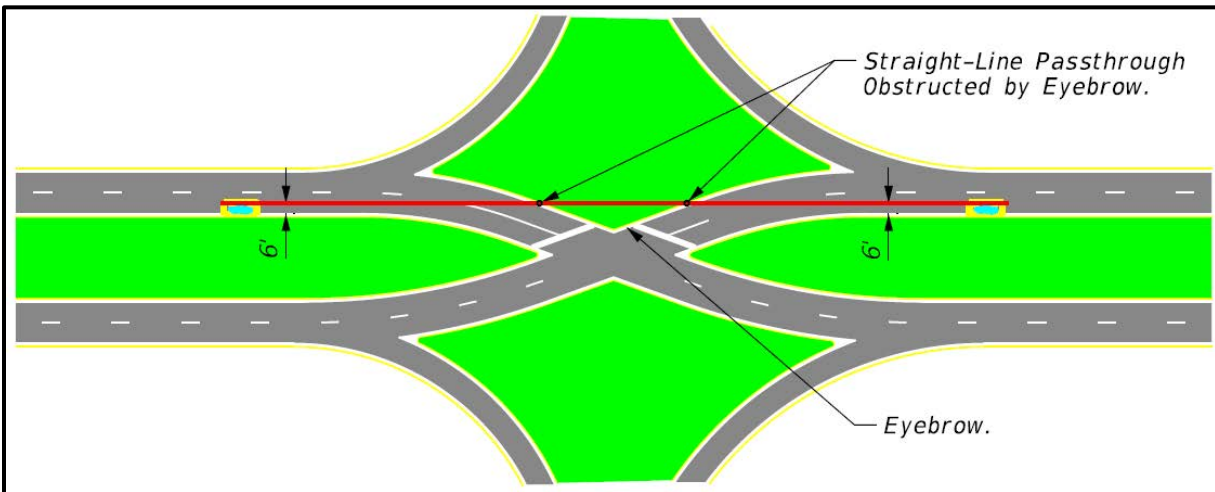

### 217.3.7 Lane Configuration

DDI lane configuration is dictated by traffic operations, geometric design, and signing and marking considerations. When developing DDI lane configurations consider the following:

- Traffic Operational Analysis - Provide operational analysis for opening year and design year traffic forecasts consistent with the lane configuration in the geometric layout. This will confirm that the number of lanes provided result in an adequate level of service and that queue storage requirements will be satisfied.
- Lane Continuity – It is desirable to maintain a consistent number of continuous through lanes from one side of the DDI to the other. Avoid adding or dropping through lanes between crossover intersections. Also, avoid the need for lane changing to stay on the through route.

- Auxiliary Lanes – It is desirable to introduce auxiliary lanes in advance of the crossover intersections. This practice will provide additional storage capacity and reduce lane changing between ramps by allowing for effective signing that directs drivers to the proper lane prior to entering the DDI.

### 217.3.8 Design Vehicle Accommodation

DDI design is governed by the WB-62 FL design vehicle (**Figure 201.6.1**). DDI geometric layouts must satisfy the following:

1. Through lanes and auxiliary lanes on the crossroad must allow for the passage of the design vehicle in-lane with no over-tracking into adjacent lanes, gutters, or shoulders. Lane widening through the crossover curves may be necessary to satisfy this requirement
2. Single lane turning roadways to and from the interchange ramps must allow for the passage of the design vehicle with no over-tracking into adjacent gutters, or shoulders. Provide a standard 15' lane with additional striped-out pavement as necessary to allow for over-tracking of the design vehicle. Locate the striped-out pavement adjacent to the inside lane edge line.
3. Two-lane turning roadways to and from the interchange ramps must allow for the passage of the design vehicle with no encroachment into the adjacent lane, gutter, or shoulder. This requirement must be satisfied assuming the design vehicle can pass through either lane. Provide 12-foot lanes separated by gore striping as necessary to allow for design vehicle over-tracking. (**Exhibit 217.1**).
4. Three-lane turning roadways to and from the interchange ramps must allow for the passage of the design vehicle through either the right- or middle- lane with no encroachment into adjacent lanes, gutter, or shoulder. Provide 12-foot lanes with gore striping separating the right- and middle- lane if necessary, to allow for design vehicle over-tracking (**Exhibit 217.1**).

Under constrained conditions, multi-lane turning roadways can be designed to allow encroachment into adjacent lanes with the approval of the District Design Engineer.

### 217.3.9 Horizontal Alignment

Develop horizontal alignments with smooth, continuous natural paths that allow motorists to comfortably navigate the DDI without abrupt changes in speed or direction. Properly

designed horizontal alignments make it easy for drivers to stay in their intended lane and reduce the risk of sideswipe accidents.

Adhere to the following when developing horizontal alignments:

1. Reverse Curves - Avoid back-to-back reverse curves. Back-to-back reverse curves force an abrupt change in direction making it uncomfortable for drivers to stay in their intended lane. Place a minimum 75-foot tangent section between reverse curves to allow drivers to make a smooth transition from one direction to the other. This requirement applies to all crossroad, ramp, and turning roadway alignments (**Figure 217.3.2**).

**Figure 217.3.2 Tangents Between Reverse Curves**

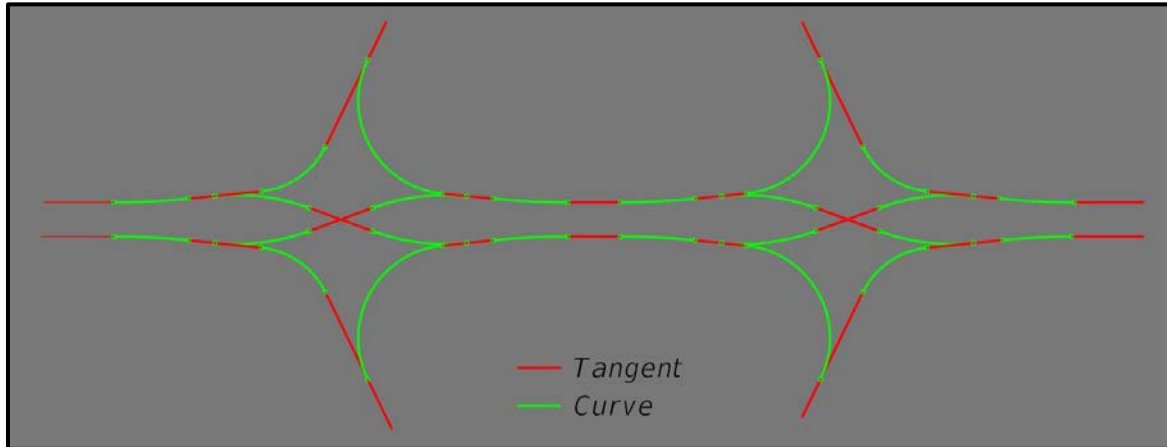

2. Crossover Alignments – It is critical to develop alignments with well-defined channelization to guide drivers through the crossover intersections. Crossover alignment should clearly direct drivers at the stop line into the proper receiving lane on the opposite side of the intersection. To achieve this, provide a tangent segment that extends beyond the lane edges of the intersecting roadway as shown in **Figure 217.3.3**.

**Figure 217.3.3 Tangents at Crossover Intersections**

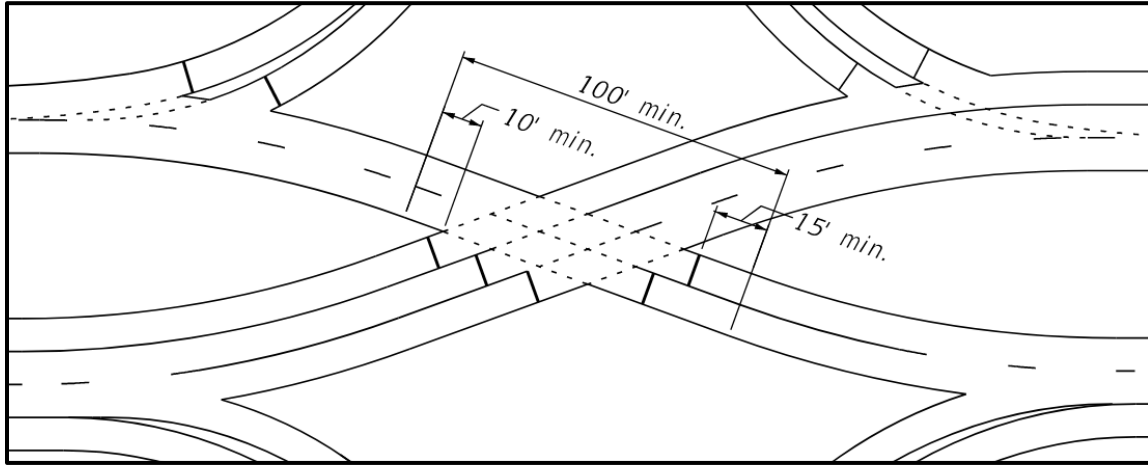

3. Merging Ramp Junctions – When left turning and right turning roadways merge together to form a single lane on-ramp, provide acceleration length beyond the merge point based on operational analysis and taper length based on ramp speed. Minimum values for acceleration length and taper length are shown in **Figure 217.3.4**.

**Figure 217.3.4 Merging Ramp Lanes**

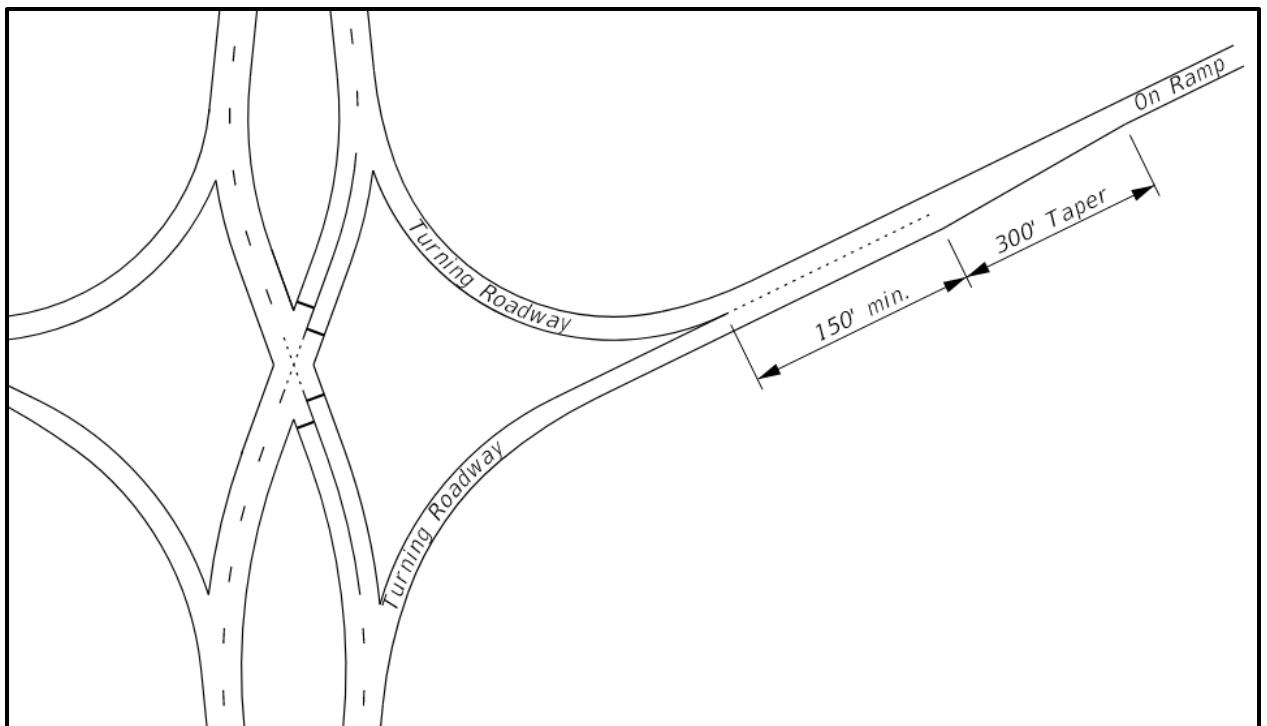

4. Horizontal Curvature – For limiting values on horizontal curvature see **FDM 217.3.3**. There are no curve length restrictions for horizontal curves within the limits of a DDI.

## **217.4 Vertical Alignment**

Develop vertical profiles for the crossroad alignments that satisfy the requirements of **FDM 210.10**. Consider the interaction between vertical alignments and roadway cross slopes through the crossover intersections when developing roadway profiles. The vertical geometry through the crossovers should result in smooth, continuous pavement edge profiles, and adequate cross slopes for drainage.

## **217.5 Superelevation/Cross Slope**

Consider the following when developing superelevation/cross slopes in crossover regions:

1. Crossover regions do not represent a typical roadway situation and typical superelevation criteria for open road conditions do not apply.
2. The cross slope and vertical profiles of each of the opposing roadways through the intersection are interdependent. Development of the roadway surfaces in this region requires a “3-D” approach.
3. The maximum algebraic difference in cross slopes at crossover lines should be limited to 4%.
4. Crossover roadway surfaces should result in smooth, continuous pavement edge profiles.
5. Crossover roadway surfaces should be developed to provide effective drainage. Avoiding low points and flat slopes that do not drain properly.
6. The plans should include detailed crossover intersection details that clearly identify roadway cross slopes, pavement edge profiles, and the location of crossover lines.

## **217.6 Pedestrian Accommodation**

Consider pedestrian accommodation early in the DDI design process to assure a balanced design that meets the safety and mobility needs of all users.

There are two basic methods of routing pedestrians through the core of a DDI. Method 1 provides pedestrian access through walkways located along the outside edges of the interchange. Method 2 uses crosswalks at the crossover intersections to provide access to a walkway down the center of the crossroad. Both routing methods are illustrated in **Figure 217.6.1**.

Regardless of the method used, the DDI configuration has several advantages with respect to pedestrian accommodation as compared to a conventional diamond design. Key advantages include:

- Shorter pedestrian crossing distances due to fewer lanes.
- More available crossing times due to more efficient 2-phase signal timing.
- Reduced pedestrian wait time due to shorter cycle lengths.
- Simplified crossing task due to pedestrians crossing only one direction of travel at a time.
- Opportunities for separated pedestrian facilities due to a smaller DDI footprint

**Figure 217.6.1 Pedestrian Routing Methods**

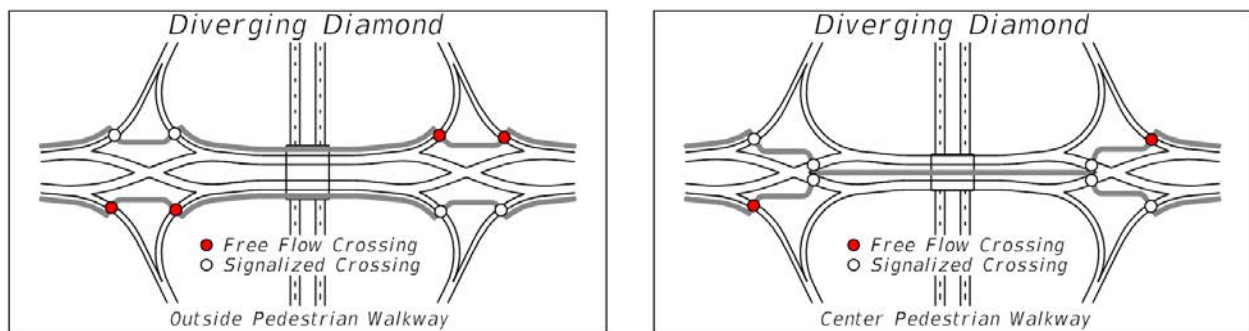

### 217.6.1 Outside Walkway vs. Center Walkway

The preferred method of routing pedestrians through a DDI is center walkway for the following reasons:

- Center walkways improve safety by eliminating the need for crosswalks at the free-flow left turning roadways at the on ramps. Drivers will be less likely to yield to pedestrians at these locations due to free-flow conditions. Further, visibility of

drivers making this left turn maneuver could be limited by the bridge abutment in the case of an underpass configuration.

- Center walkways will improve the line of sight between pedestrians and drivers
- Pedestrians will cross at the signalized crossover intersection consistent with the expectations of both pedestrians and drivers with the center walkway configuration.

### **217.6.2 Cut-Through Walkways**

Provide minimum 10-foot wide cut-through walkways at all locations where the sidewalk crosses a raised median or channelizing island. Cut-through walkways clearly define the walkway boundaries and guide pedestrians to the proper crosswalk locations. Align cut-through walkways perpendicular to cross street centerlines when practical, to minimize crossing distance.

### **217.6.3 Crosswalks**

Consider the following when determining crosswalk location and orientation:

- Locate crosswalks along the most direct path feasible to encourage pedestrian compliance. Indirect paths can lead to pedestrians ignoring marked crosswalks and crossing at less safe unmarked locations.
- All crosswalk locations require sufficient stopping sight distance in accordance with **FDM 210.11.1**.
- Orient uncontrolled crosswalks perpendicular to the roadway to minimize crossing distance unless adjustments are needed for sight distance.
- Design ramps having uncontrolled pedestrian crosswalks with small radius curves to limit vehicular speeds to 25 mph or less at the crossing,
- Orientation of signal controlled crosswalks should balance the competing objectives of providing a direct path (parallel crossing) and minimizing crossing distance (perpendicular crossing) based on context.

See **FDM 222.2.3** for more information on crosswalks.

## **217.6.4 Americans with Disabilities Act (ADA)**

See **FDM 222.1.1** for pedestrian related ADA requirements.

## **217.7 Bicycle Accommodation**

There are three possible treatments for bicycle accommodation at a DDI:

1. Separated bicycle lanes or shared use paths.
2. Marked bicycle lanes.
3. Bicyclists share the driving lanes with vehicular traffic. This treatment should be used only in very low speed conditions.

For information on separated bicycle lanes see **FDM 223.2.4**. For information on shared use paths see **FDM 224**.

Marked bicycle lanes are recommended for DDIs when separated bicycle facilities are not provided. Locate bicycle lanes to the right of the right-most travel lane. Consider including a two foot raised curb in the buffer area of the bicycle lane to comply with **FDM 217.3.6**. For more information on marked bicycle lanes see **FDM 223.2.1**.

## **217.8 Signing and Pavement Marking**

Under Development

## **217.9 Signalization**

Under Development



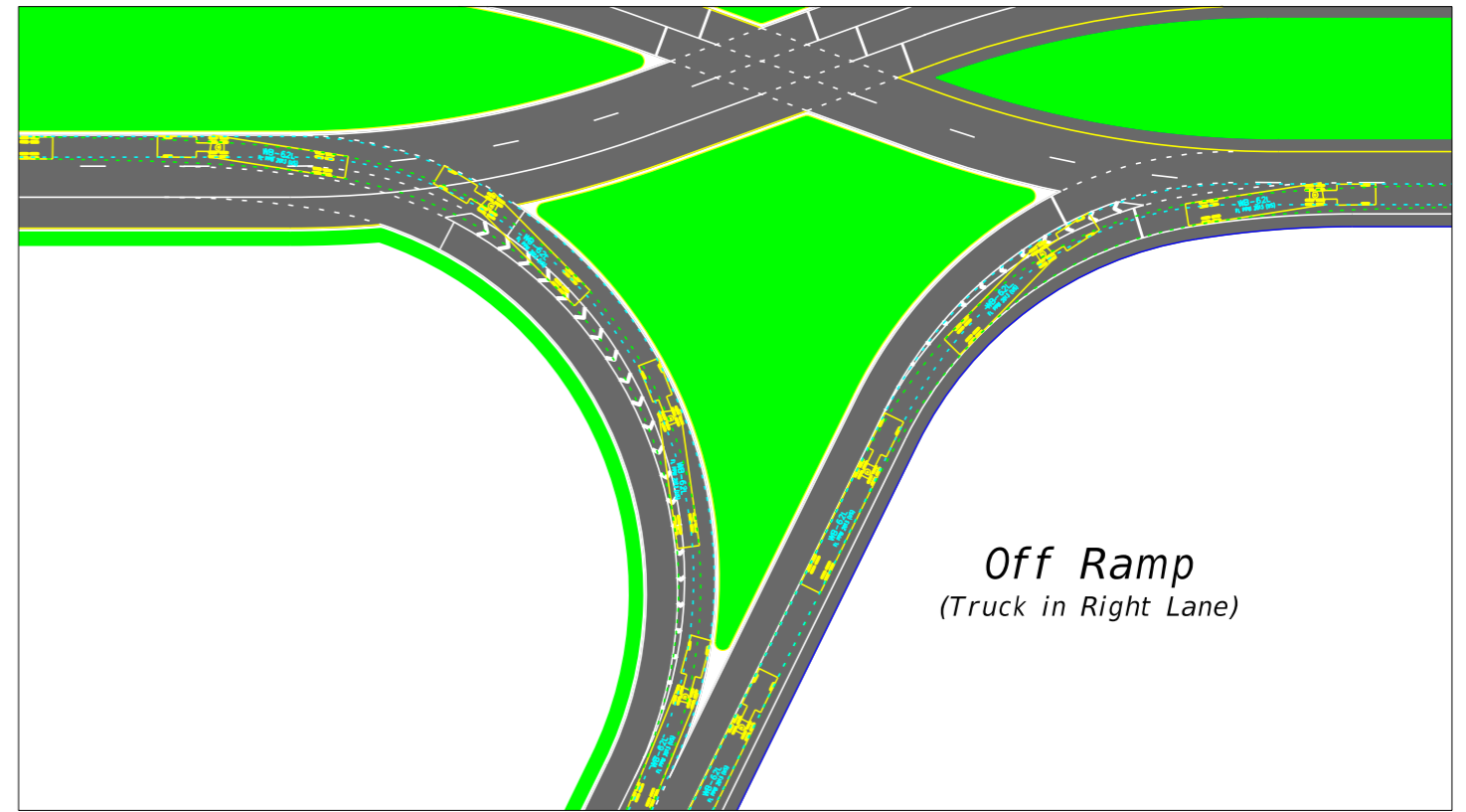
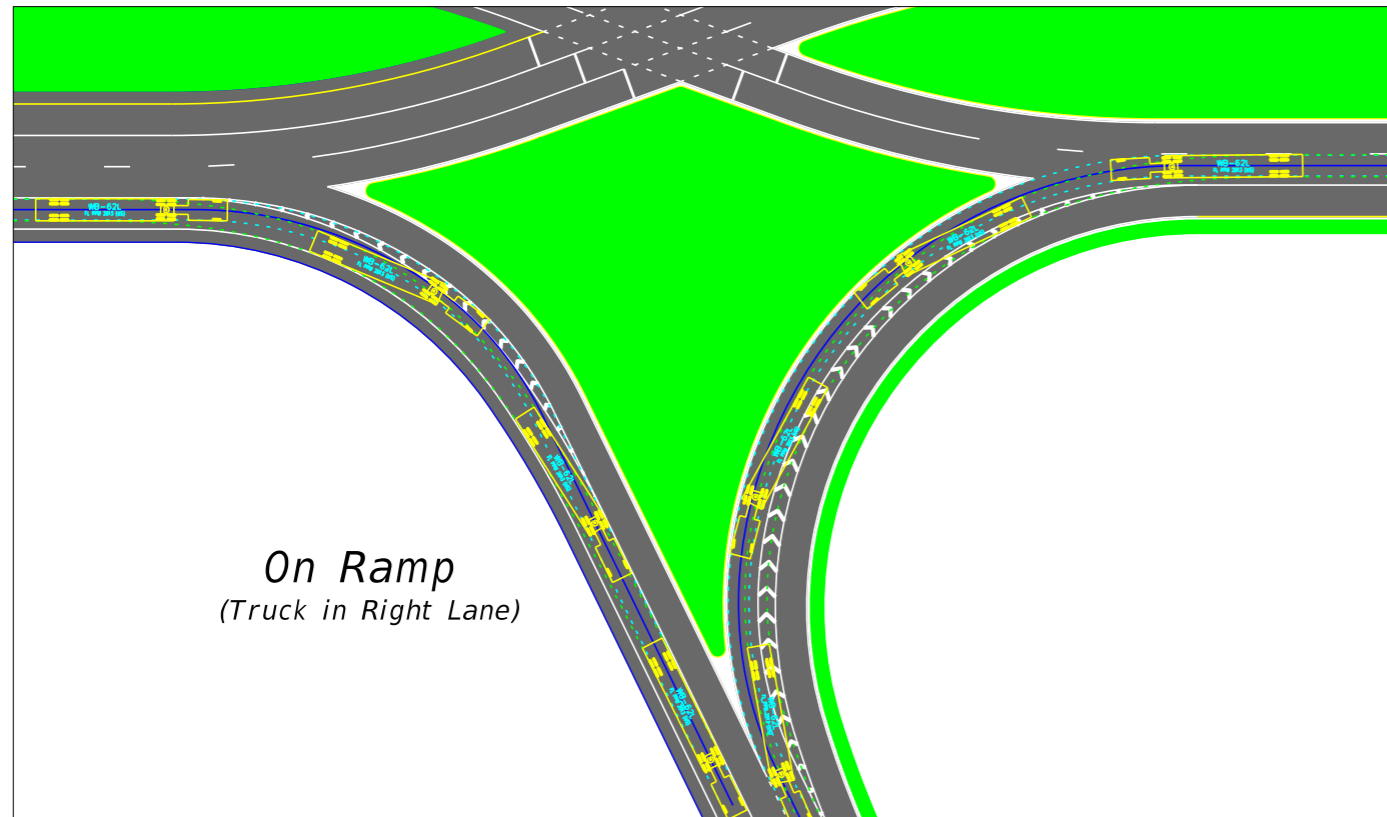
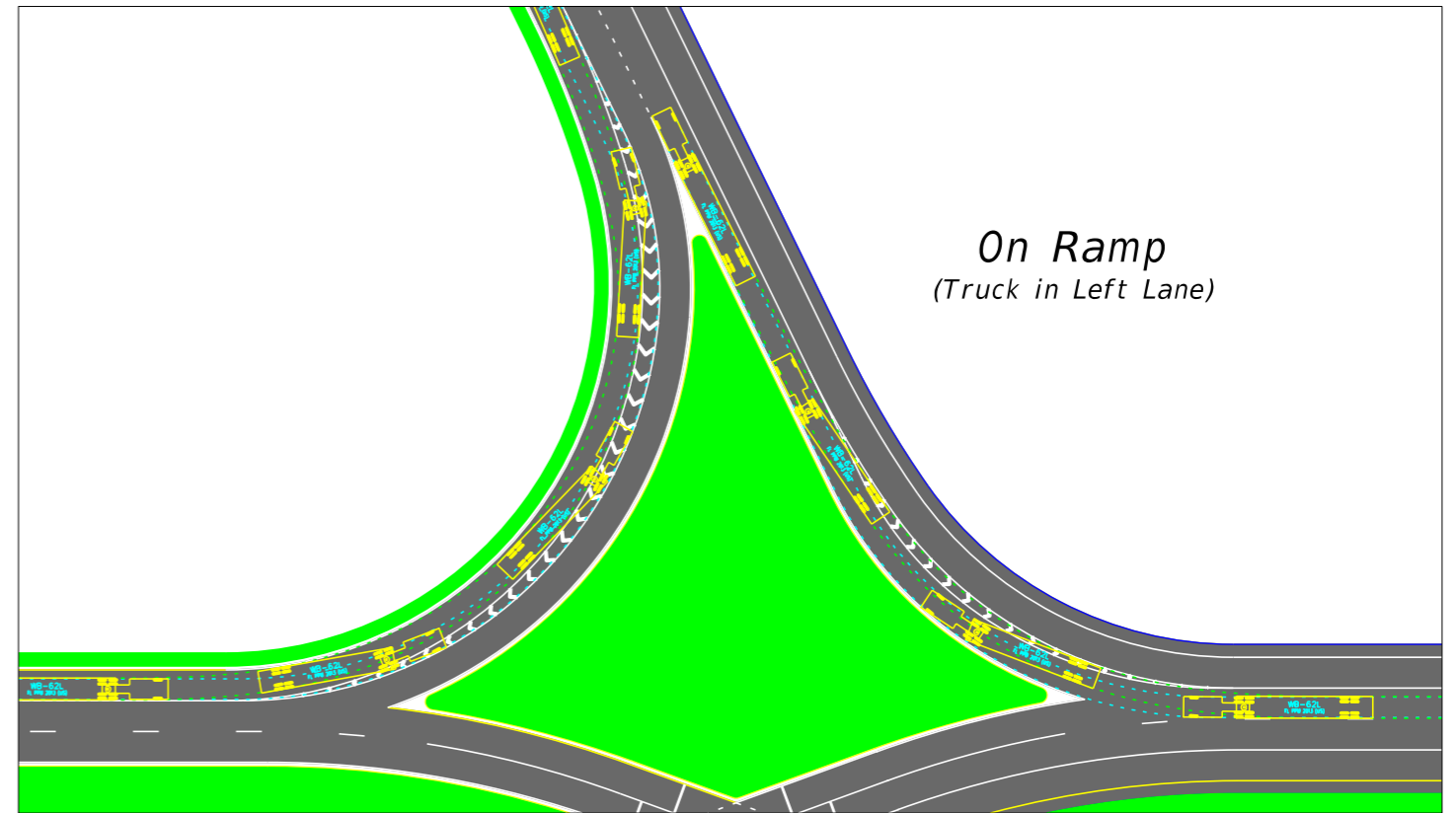
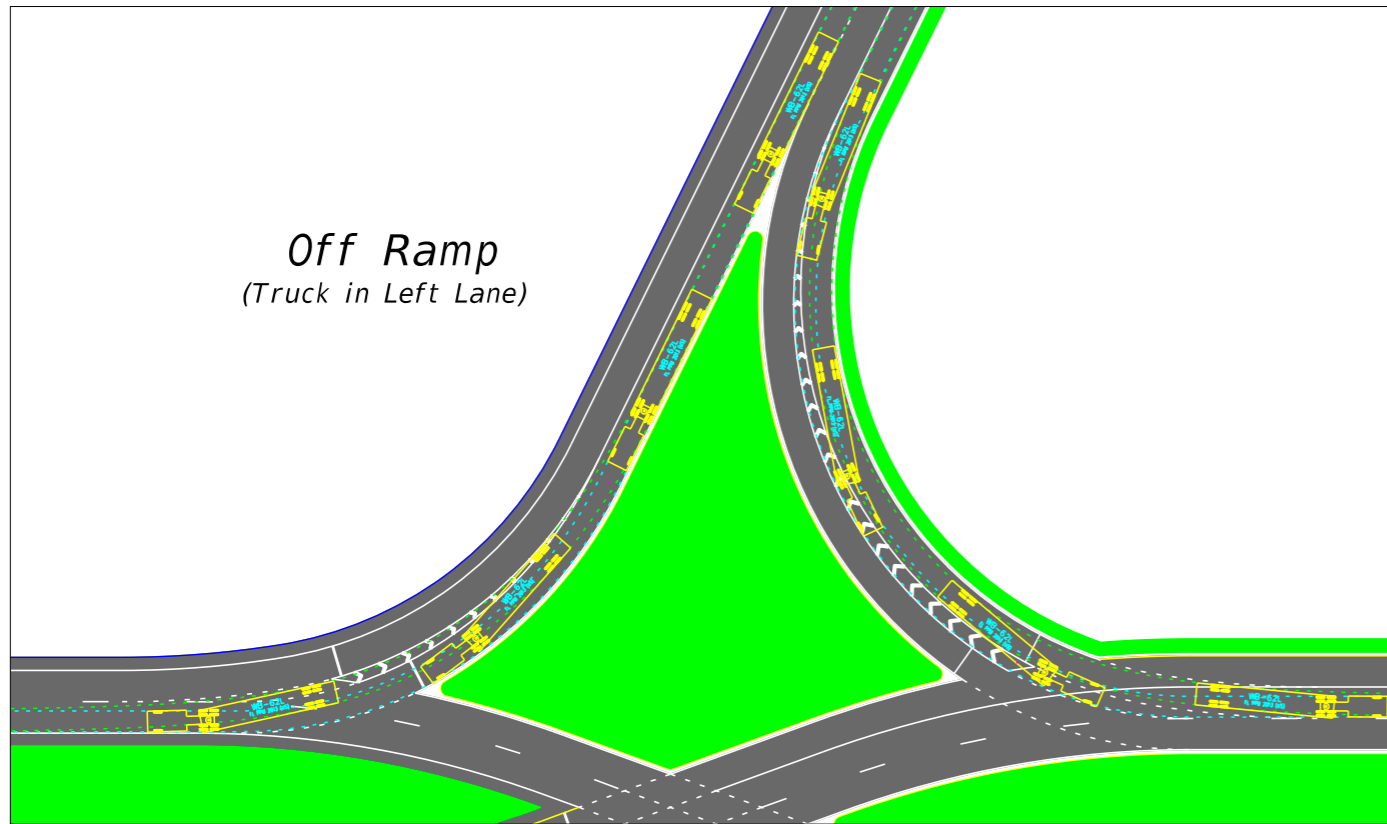

*Design Vehicle Accommodation  
at Multi-Lane Ramp Terminals*

NOT TO SCALE

EXHIBIT 217-1  
07/27/2020