

212 Intersections

212.1 General

This chapter provides design criteria and guidance for the geometric layout of at-grade conventional intersections. Conventional intersections include 3-leg (T), 4-leg, and multi-leg (5 or more legs).

Multi-leg conventional intersections should be avoided. Alternatives to existing multi-leg intersections include:

- (1) Converting to a roundabout.
- (2) Converting one or more legs to a one-way operation.
- (3) Reconfiguring or realigning the intersection to create separate intersections, each with no more than four legs.

See **FDM 201** for design vehicle selection and design speed requirements.

See **FDM 210** for lane width, median width, island dimensions, and deflection angle requirements.

See **FDM 222** for requirements concerning pedestrian facilities and **FDM 223** for bicycle facilities.

212.1.1 Alternative Intersections

Alternative intersection design is a key component of upgrading our transportation facilities and improving the mobility and safety of all road users. These innovative designs are becoming more common as increasing traffic demand exceeds the limitations of traditional intersection solutions.

Alternative intersections offer the potential to improve safety and reduce delay at lower cost and with fewer impacts than traditional solutions such as adding lanes or grade separation. Three of the more common alternative intersection types are:

- Displaced Left-Turn (a.k.a. Continuous Flow Intersection)
- Restricted Crossing U-Turn (RCUT)
- Median U-Turn (MUT)

The FHWA has published comprehensive informational guides for alternative intersections which include guidance on how to plan, design, construct, and operate them. The following links provide access to these guides: [FHWA Alternative Designs](#) and [Alternative Intersections/Interchanges: Informational Report \(AIIR\)](#).

These types of alternate intersection designs should be coordinated with the Central Office Roadway Design Office.

212.1.2 Intersection Control Evaluation

Intersection Control Evaluation (ICE) is a process to determine the most effective intersection configuration for a specified project. Through ICE, multiple alternative and conventional intersection configurations are compared to one another based on safety, operations, cost, and environmental impacts. The ICE procedure provides a transparent and consistent approach to intersection alternatives selection and provides documentation to support decisions made.

ICE policy and procedure is published on the FDOT Traffic Engineering and Operations Office website at the following Link: [Manual on Intersection Control Evaluation](#).

212.2 Intersection Control

Conventional intersections utilize one of four control types; yield, stop, all-way stop and signal.

212.2.1 Yield Control

Certain channelized movements at intersections and interchanges and all approaches to roundabouts are often yield controlled. Refer to the [Manual on Uniform Traffic Control Devices \(MUTCD\)](#) for information on the locations where yield control traffic control devices may be appropriate.

212.2.2 Stop Control

Stop-controlled intersections have one or more legs of the intersection controlled by a "STOP" sign (R1-1).

Intersections with stop control are a common, low-cost control, which require the traffic on the minor roadway to stop before entering the major roadway. It is used where

application of the normal R/W rule is not appropriate for certain approaches at the intersection.

To meet the requirements for the assigned access classification, or where U-turn opportunities exist within a corridor, consider limiting stop-controlled minor roads or driveways to “right-in, right-out” only.

212.2.3 All-Way Stop Control

For an all-way stop intersection, traffic approaching it from all directions is required to stop before proceeding through the intersection. An all-way stop may have multiple approaches and is typically marked with supplemental signing stating the number of approaches.

All-way stop control is most effective at the intersection of low-speed 2-lane roadways not exceeding 1,400 vehicles during the peak hour. All-way stop control should not be used on multilane highways. Guidance for consideration of the application of all-way stop control is provided in the *MUTCD*.

All-way stop control may be used as an interim measure when a traffic signal or roundabout is warranted, but the installation is delayed.

212.2.4 Signal Control

Signalization provides an orderly and predictable movement of motorized and non-motorized traffic throughout the highway transportation system. It also provides guidance and warnings to ensure the safe and informed operation of the traffic stream.

Refer to *FDM 232* for design criteria for signalization.

212.3 Intersection Types

Conventional intersection configurations include flared and channelized intersections (divided and undivided). Flared intersections are illustrated in *Figure 212.3.1* and channelized intersections in *Figure 212.3.2*. See *FDM 210.3* for median and island requirements.

Figure 212.3.1 Flared Intersections

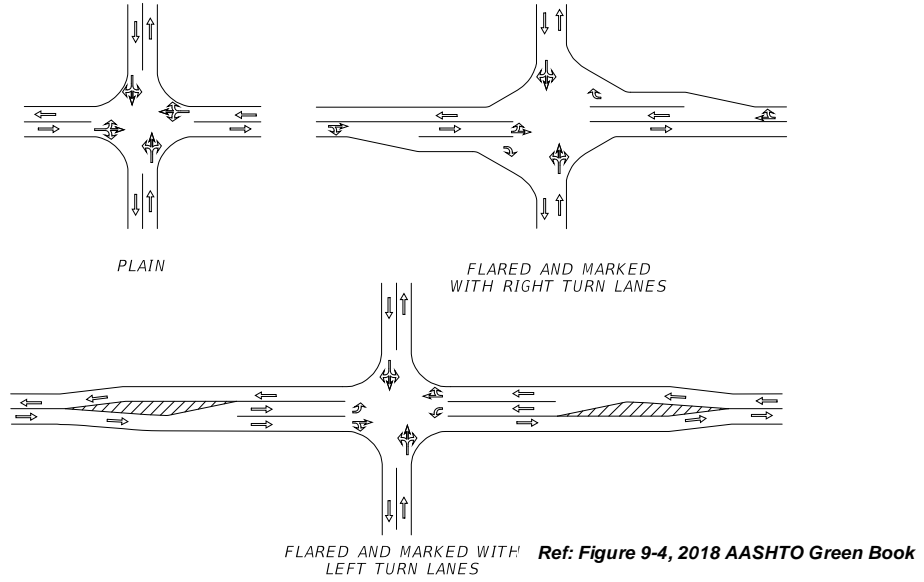
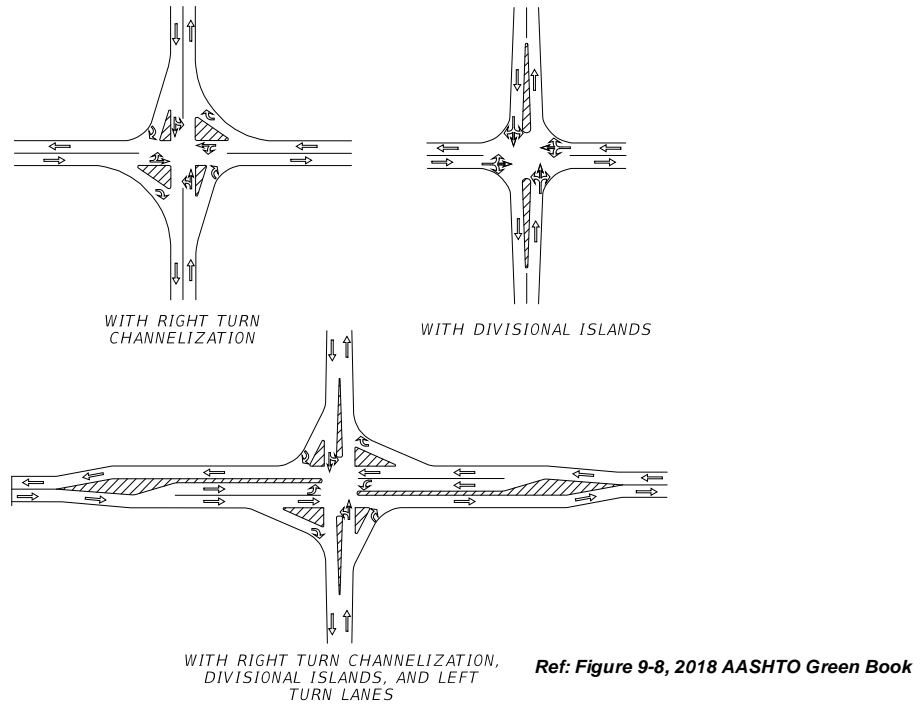

Figure 212.3.2 Channelized Intersections



212.4 Intersection Functional Area

The functional area of an intersection extends in both directions including auxiliary lanes and their associated channelization. This is illustrated in **Figures 212.4.1** and **212.4.2**.

The functional area on the approach to an intersection or driveway consists of three basic elements:

- (1) Perception-reaction-decision distance
- (2) Maneuver distance
- (3) Queue-storage distance (see **FDM 212.14.2**)

These elements are shown in **Figure 212.4.3**. The maneuver distance includes the length needed for both braking and lane-changing when there is a left or right turning lane. In the absence of turn lanes, the maneuver distance is the distance to brake to a comfortable stop. The storage length includes the most distant extent of any intersection-related queue expected to occur during the design period.

Figure 212.4.1
Physical Definition

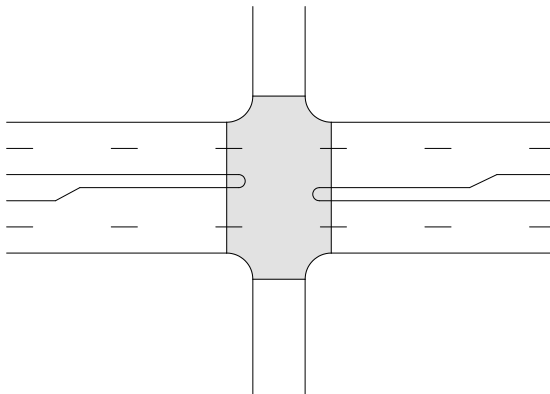

Ref: Figure 9-2, 2018 AASHTO Green Book

Figure 212.4.2
Functional Definition

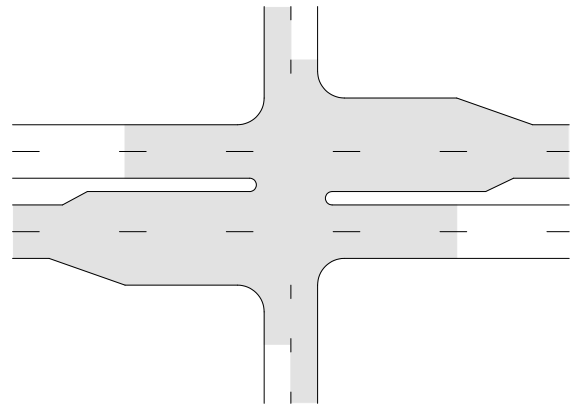

Ref: Figure 9-2, 2018 AASHTO Green Book

Figure 212.4.3 Elements of the Functional Area

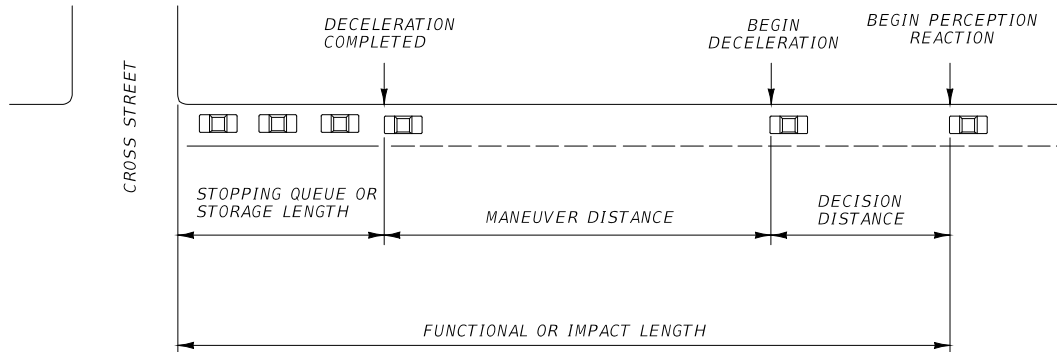

Ref: Figure 9-3, 2018 AASHTO Green Book

See **FDM 127.2 (15)** for limitations on aesthetic applications within intersection functional areas.

212.5 Intersection Angle

The intersection angle between two roadways has a significant influence on the safety and operation of an intersection. Intersection angles are to be as close to 90 degrees as practical. Intersection angles less than 75 degrees should be avoided for the following reasons:

- (1) Heavy skew angles increase the intersection crossing length, exposing vehicles, pedestrians, and cyclists to conflicting traffic streams for longer periods of time. This is of particular concern at stop-controlled approaches on high-speed facilities.
- (2) The road user's sight angle to the crossing leg becomes restricted due to the skew, making it difficult to see conflicting vehicles and to perceive safe crossing gaps.
- (3) Turning movements are difficult because of the skew. Additional pavement may be necessary to accommodate the turning of large trucks.
- (4) Turning movements or positioning may be confusing and require additional channelization.
- (5) Increased open pavement areas of highly skewed intersections increase construction and maintenance costs.

Evaluate intersections with severe skew angles and crash histories for geometric improvements as shown in **Figure 212.5.1**. A high incidence of right-angle crashes is an indicator that improvements may be justified.

Figure 212.5.1 Intersection Reconfigurations

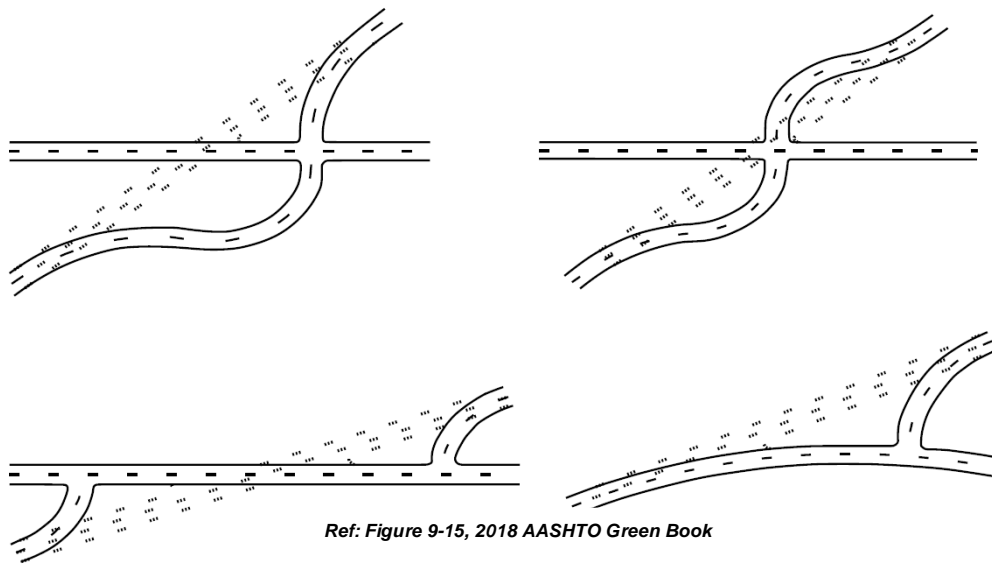

212.6 Lane Tapers

Standard taper lengths for auxiliary lanes are given in **FDM 212.14**. Taper length is based on the following equations:

- (1) Merging Taper (L):
 - (a) For design speeds ≤ 40 mph: $L = (W \cdot S^2) / 60$
 - (b) For design speeds ≥ 45 mph: $L = W \cdot S$

Where:
L = Taper length (feet)
W = Width of offset (feet)
S = Design speed (mph)

- (2) Shifting Taper is equal to Merging Taper (L) / 2.

Minimum deceleration lengths are illustrated in **Exhibit 212-1**. Additional information on lane transitions (add or drop) is provided in **Exhibits 212-2** and **212-3**.

MEDIAN TURN LANES MINIMUM DECELERATION LENGTHS

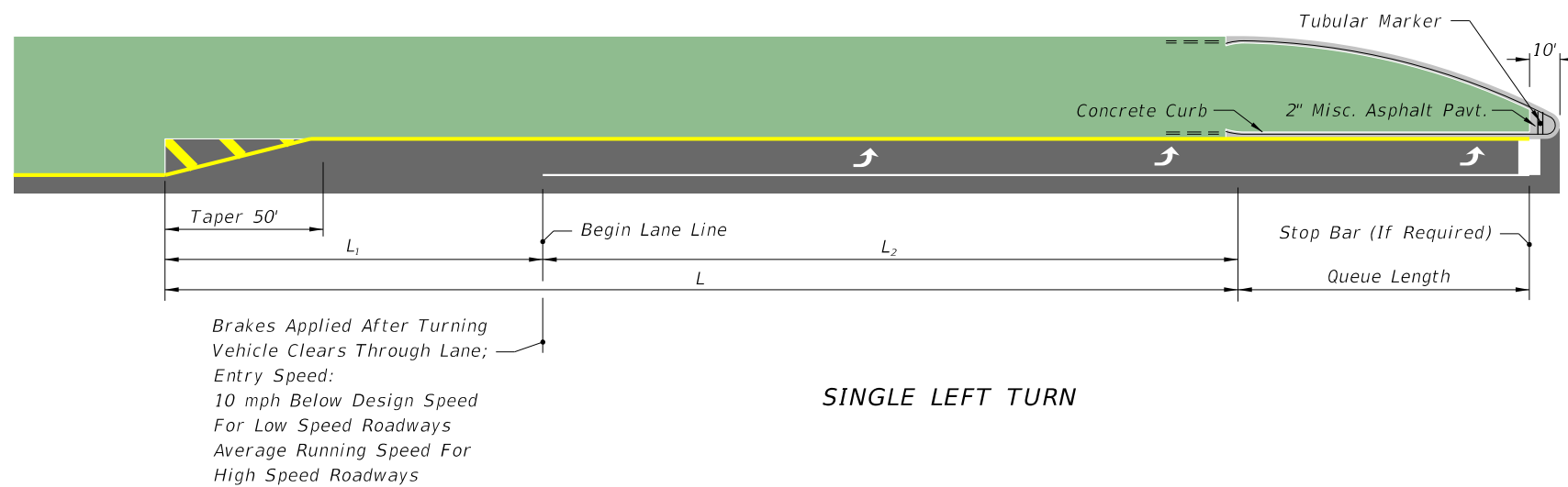
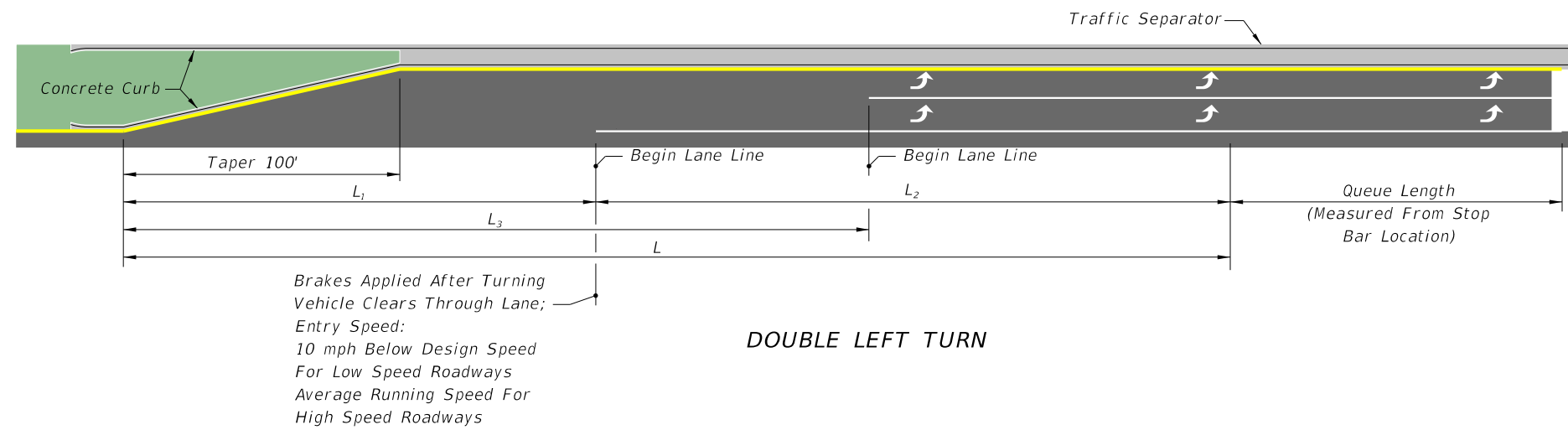

MEDIAN TURN LANES					
Design Speed (mph)	Entry Speed (mph)	Clearance Distance L_1 (ft.)	Brake To Stop Distance L_2 (ft.)	Total Decel. Distance L (ft.)	Clearance Distance L_3 (ft.)
25	15	70	25	95	90
30	20	70	50	120	100
35	25	70	75	145	110
40	30	80	75	155	120
45	35	85	100	185	135
50	44	105	185	290	160
55	48	125	225	350	195
60	52	145	260	405	230
65	55	170	290	460	270
70	58	200	325	525	300

NOTE:

- 1) For C3 Context Classification roadways with Design Speeds of 50 mph, the following values may be used under constrained conditions:
 - Entry Speed of 40 mph
 - Brake to stop distance (L_2) of 135 ft.
 - Total deceleration distance (L) of 240 ft.
- 2) For RRR Projects with Design Speeds of 50 mph and Entry Speeds of 40 mph, existing brake to stop distances (L_2) of 135 ft. and total deceleration distances (L) of 240 ft. may be retained.

NOT TO SCALE

LANE TRANSITIONS: 4-LANE ROADWAYS

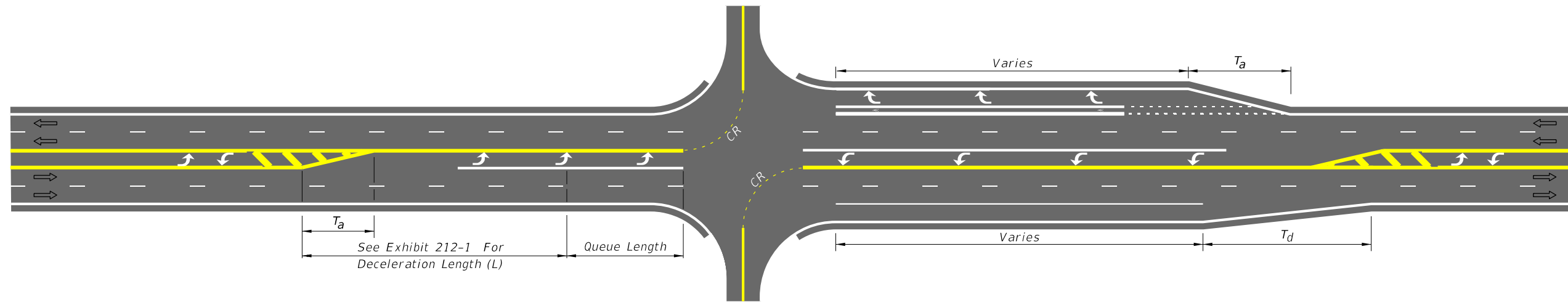

TWO-WAY LEFT-TURN LANES

DESIGN SPEED (mph)	T_a (ft.)	T_d
<30	1:4, 50 ft. min.	1:25
30-45		1:30
>45		1:40

Note: For locations with unrelocatable control points minimum taper rates for lane drop (T_d) will be 1:20.

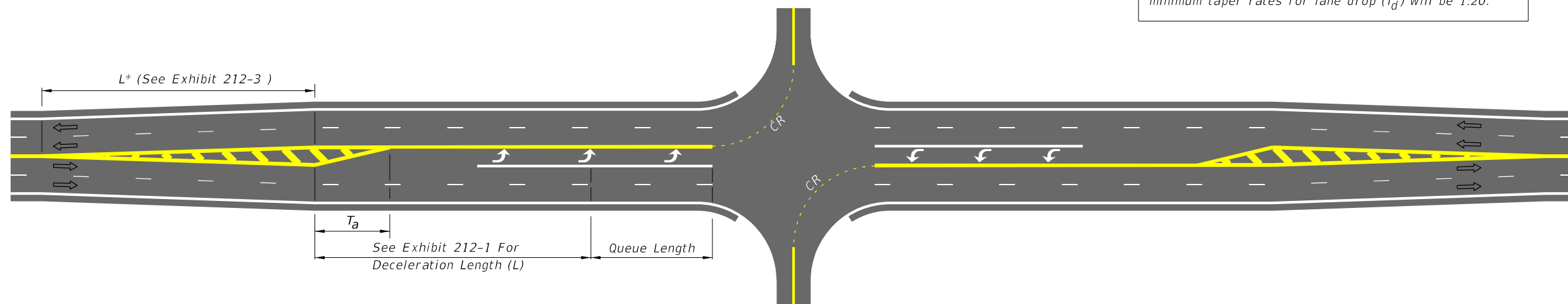

UNDIVIDED FLARED - SYMMETRICAL

NOT TO SCALE

EXHIBIT 212-2
01/01/2025

LANE TRANSITIONS: 2-LANE ROADWAYS

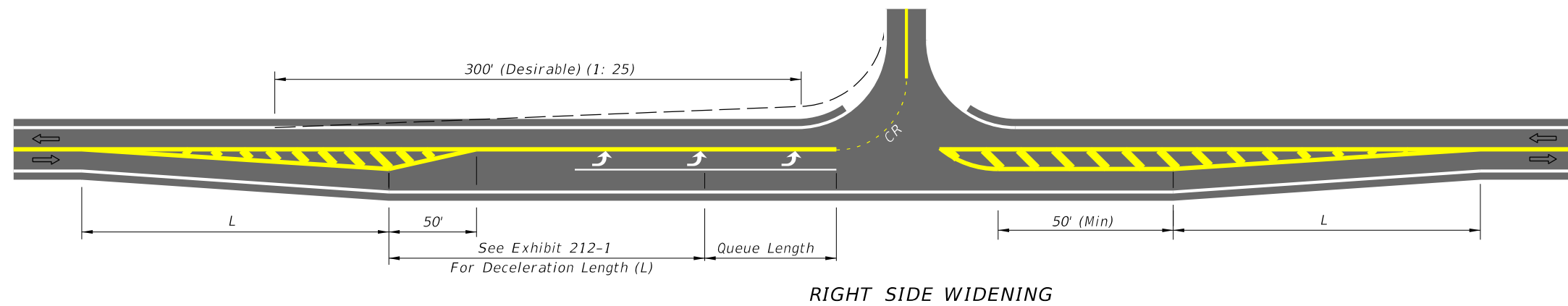
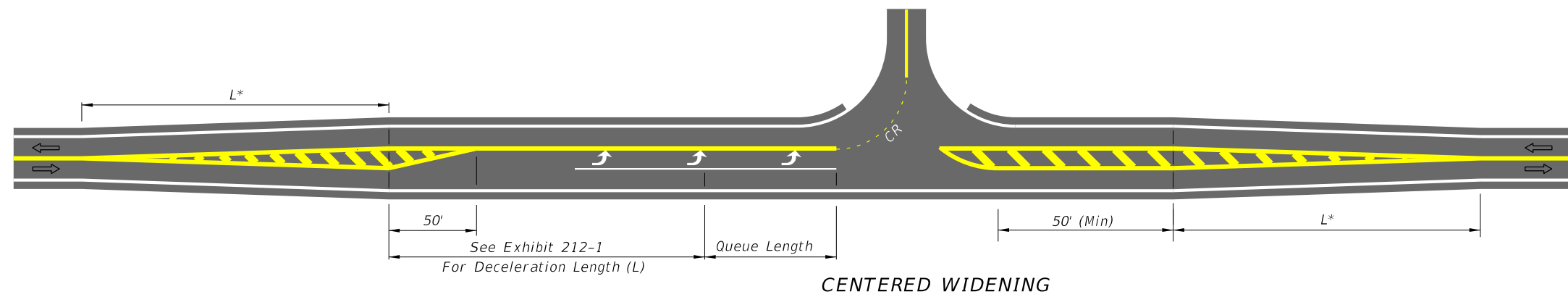
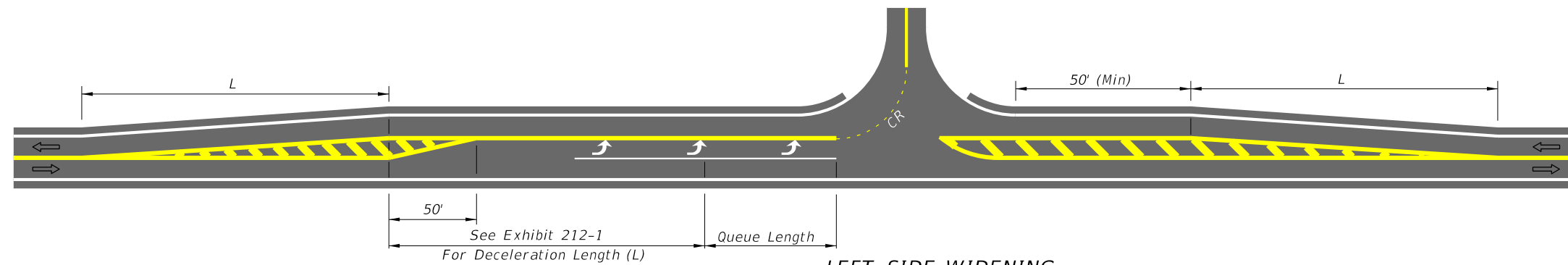

$$L = \frac{WS^2}{60} \text{ FOR DESIGN SPEEDS } \leq 40 \text{ mph}$$

$$L = WS \text{ FOR DESIGN SPEEDS } \geq 45 \text{ mph}$$

WHERE: L = LENGTH OF TAPER, FEET
 W = WIDTH OF LATERAL TRANSITION, FEET
 S = DESIGN SPEED, mph

W = ONE LANE WIDTH
 * W = 1/2 LANE WIDTH

NOTE:
 For RRR Projects the following existing transition lengths (L) for the indicated Design Speed may be retained under constrained conditions:

- 120' for 30 mph
- 150' for 40 mph
- 180' for 50 mph
- 240' for 60 mph

FLARED & PAINTED LEFT TURNS FOR 2-LANE ROADWAYS

NOT TO SCALE

EXHIBIT 212-3
 01/01/2025

212.7 Lane Shifts

Lane shifts through intersections should meet the requirements for non-merging conditions. Pavement markings should be used through the intersection to provide positive guidance to the motorist. The shifting taper length is controlled by the size of the intersection and the deflection angle. Although deflections through intersections are discouraged, there may be conditions where they are necessary.

The maximum deflection angles at intersections to be used in establishing the horizontal alignment are given in **Table 212.7.1**.

Table 212.7.1 Maximum Deflection Angle Through Intersection

Maximum Deflection Angle Through Intersection (DM)					
Design Speed (mph)					
≤ 20	25	30	35	40	45
16° 00'	11° 00'	8° 00'	6° 00'	5° 00'	3° 00'

Notes:
 Deflection angle used is not to cause a lane shift (W) of more than 6 feet from stop bar to stop bar.

212.8 Profile Grades

The profile grade line defines the vertical alignment for construction. The grade line of the mainline road is typically carried through the intersection and the minor crossroad (or cross street) is adjusted to it. This design involves a transition in the crown of the crossroad to an inclined cross section at its junction with the mainline road, as illustrated in **Figure 212.8.1**.

The break in the crossroad profile at the center of the intersection should be accomplished with a vertical curve.

Vertical alignments at or near intersections should provide traffic lanes that are:

- (1) Clearly visible and understandable to drivers for any desired direction of travel,
- (2) Free from the sudden appearance of potential conflicts, and
- (3) Consistent in design with the portions of the highway just traveled.

Steep grades at intersections may increase or decrease stopping or acceleration distance. Avoid grades in excess of 3% on intersecting roads in the vicinity of the intersection. Where conditions make such designs impractical, grades should not exceed 6%.

Provide adequate sight distance along both intersecting roads and across their included corners, even where one or both intersecting roads are on vertical curves. The gradients of intersecting roads should be as flat as practical on those sections that are to be used for the queuing of stopped vehicles.

Figure 212.8.1 Cross Street Intersection Transition

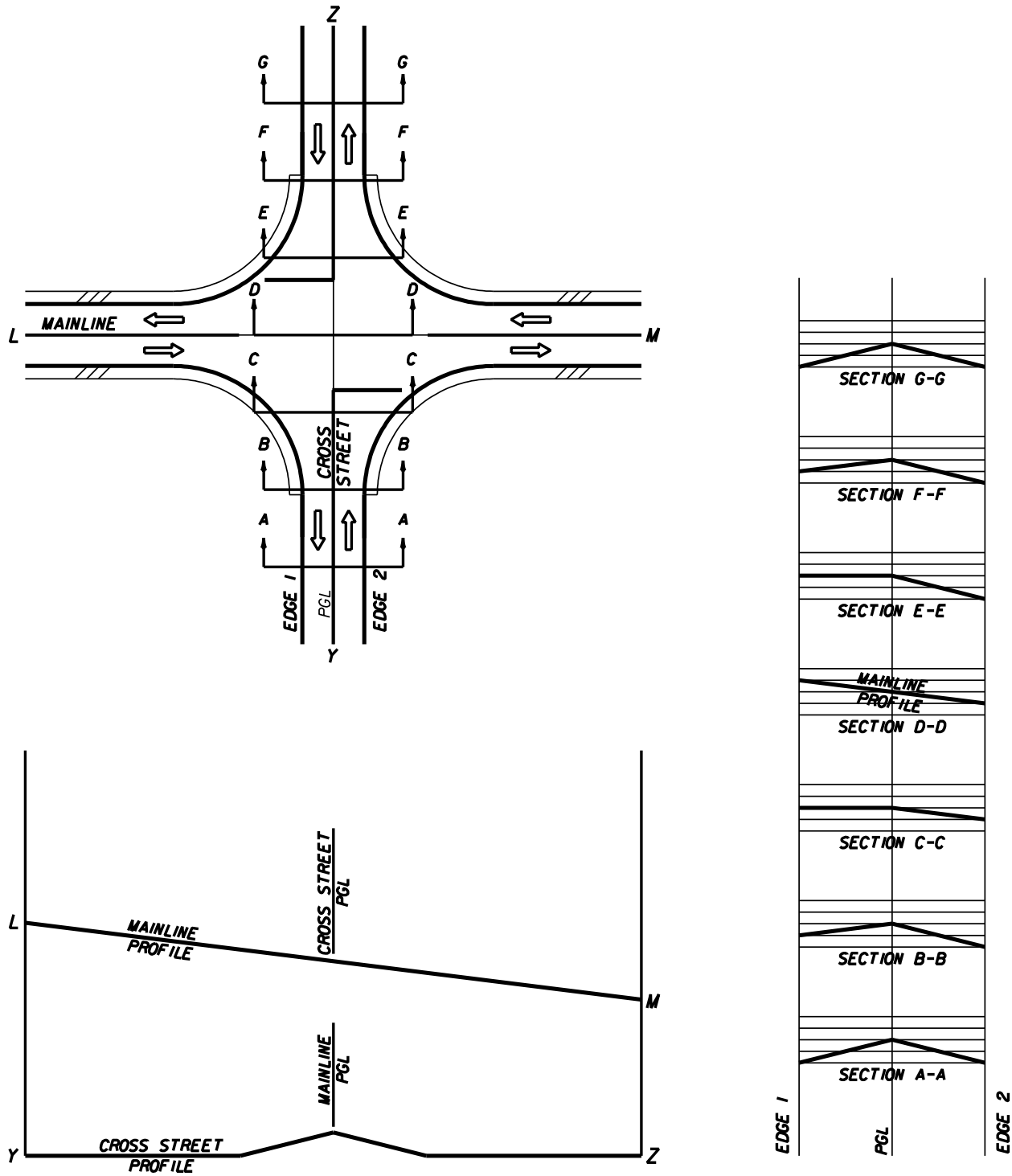

212.8.1 Special Profiles

Special profiles for certain roadway elements may be necessary to ensure a safe, efficient, well-drained and smooth roadway system. Elements that may require special profiles include pavement edges or gutter flow lines at street intersections, profile grade lines, intersection plateaus, curb returns, and special superelevation details. Special profiles are developed at close intervals and large scale to clearly identify all construction details of these elements.

212.8.2 Plateauing

In some instances, it is desirable for the crossroad to receive the same profile considerations as the mainline road. To provide this "equal treatment" with respect to profile, a technique commonly known as intersection plateauing is applied. Plateauing refers to flattening of the intersection and the transition of both roadway profiles and cross slopes on the intersection approaches.

Provide a profile combination that provides a smooth transition and adequate drainage when applying intersection plateauing. Transition slope rates are to meet the values provided in **Table 212.8.1**; however, the minimum length of cross slope transition is 50 feet for design speeds less than or equal to 35 mph and 75 feet for design speeds of 40 mph or greater.

An example of a plateaued intersection design is illustrated in **Figure 212.8.2**.

Table 212.8.1 Slope Rates for Intersection Approaches

Design Speed (mph)	Slope Ratio
25-35	1:100
40	1:125
45-50	1:150
55-60	1:170
65-70	1:190

Figure 212.8.2 Example of Plateaued Intersection

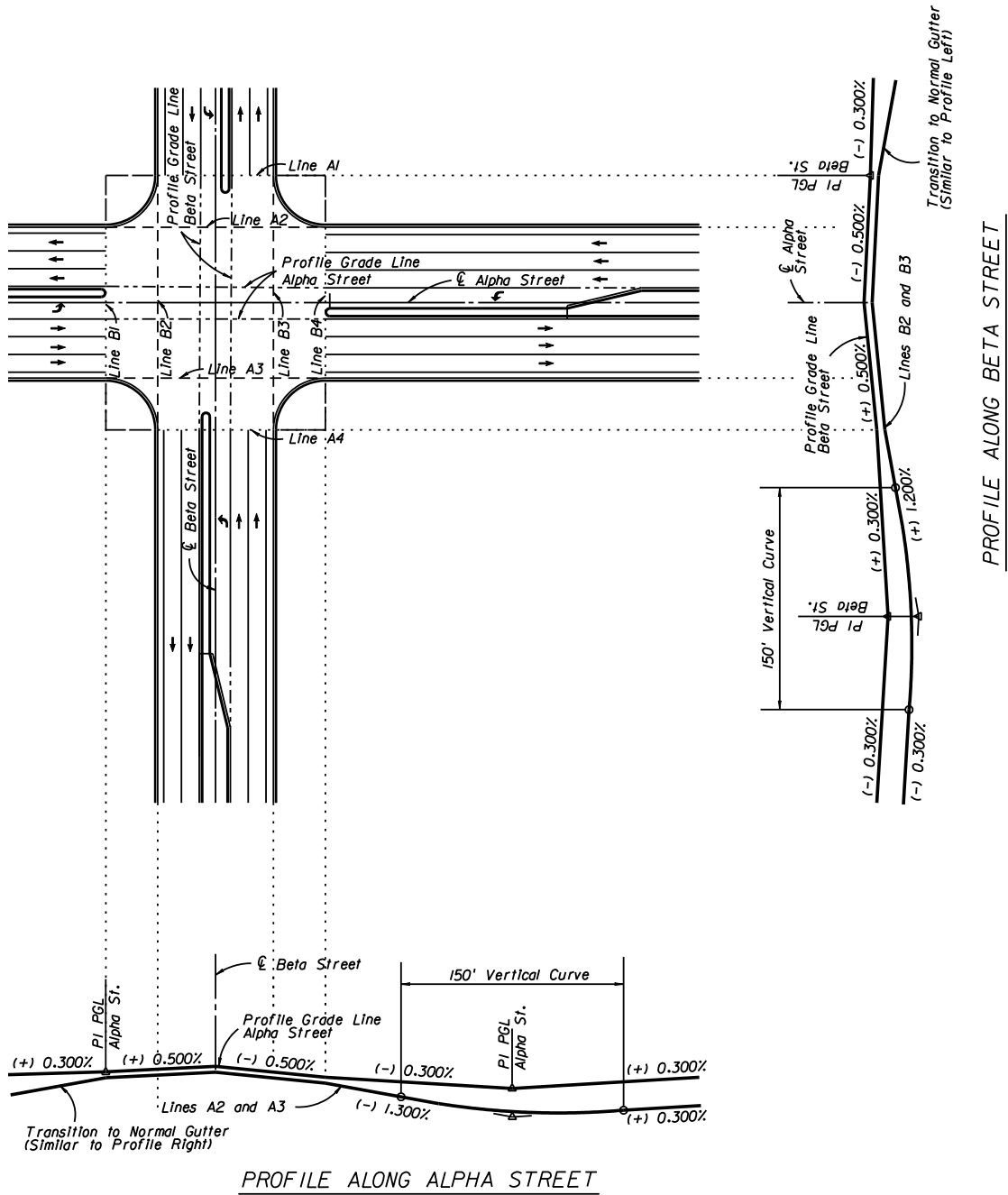

212.9 Median Openings

Locate and design median openings to meet traffic requirements in accordance with the access management plan for the facility. See **FDM 201.4** for more information on access management plans and decision-making.

See **FDM 210.3** for additional requirements for medians at intersections.

The following conditions may require additional median width:

- accommodations for trees (provide space above and below ground for growth)
- offset turn lanes
- directional median openings
- dual and triple left-turn lanes

The overall length of a full median opening is typically the same width as the intersecting road (including shoulders) which is sufficient to accommodate the swept path of left-turning vehicles. Median functions and minimum widths are provided in **Table 212.9.1**.

For un-signalized intersections, median openings should not be longer than the required length to avoid multiple vehicles attempting to stop within the opening.

Table 212.9.1 Minimum Median Width

Median Function	Minimum Width (feet)
Separation of opposing traffic	4
Provision for pedestrian refuge	6
Provision for storage of left-turning vehicles	See Table 210.3.1
Provision for protection of vehicles crossing through lanes	22
Provision for U-turns, left-turn lane to outside lanes	30
Provision for dual left-turn lanes and U-turns	42

The control radius refers to a radius that must be considered in establishing the location of median or traffic separator ends on divided highways and the stop bar on undivided highways. Provide this radius for left-turn movements when appropriate.

Design guidance on minimum edge-of-traveled-way design for various design vehicles is provided in **FDM 212.12.1**.

For the central part of the turn, the use of compound curves is not necessary and the use of simple curves is satisfactory. **Table 212.9.2** provides control radii for minimum-speed turns (10 to 15 mph) that can be used for establishing the location of the median ends.

Table 212.9.2 Control Radii for Minimum Speed Turns

Design Vehicles Accommodated	Control Radius (feet)			
	50 (40 min)	60 (50 min)	75	130
Predominant	P	SU-30	SU-40, WB-40	WB-62FL
Occasional	SU-30	SU-40, WB-40	WB-62	WB-67

212.9.1 U-Turns

Median width should accommodate passenger vehicle (P) left-turn and U-turn maneuvers. If adequate median width does not exist for accommodating U-turns, then consider adding extra pavement width such as a taper or additional shoulder width. See **FDM 210.3** for information on median width criteria.

In cases where U-turn traffic volumes are high, consider the use of jug handles, loop designs, or indirect left-turn designs.

212.10 Stopping Sight Distance

See **FDM 210.11.1** for stopping sight distance requirements.

212.11 Clear Sight Triangles

Establish clear sight triangles to assure that drivers are provided a sufficient view of the intersecting highway to identify gaps in traffic and decide when it is safe to proceed. Document the analysis of sight distance for all intersections.

Clear sight triangles are the areas along intersection approach legs and across their common corners that should be clear of visual hindrances. The dimensions of clear sight triangles are based on design speed, design vehicle, and the type of traffic control used at the intersection.

212.11.1 Stop Control (AASHTO Case B)

Figure 212.11.1 illustrates clear sight triangles for intersections and driveways.

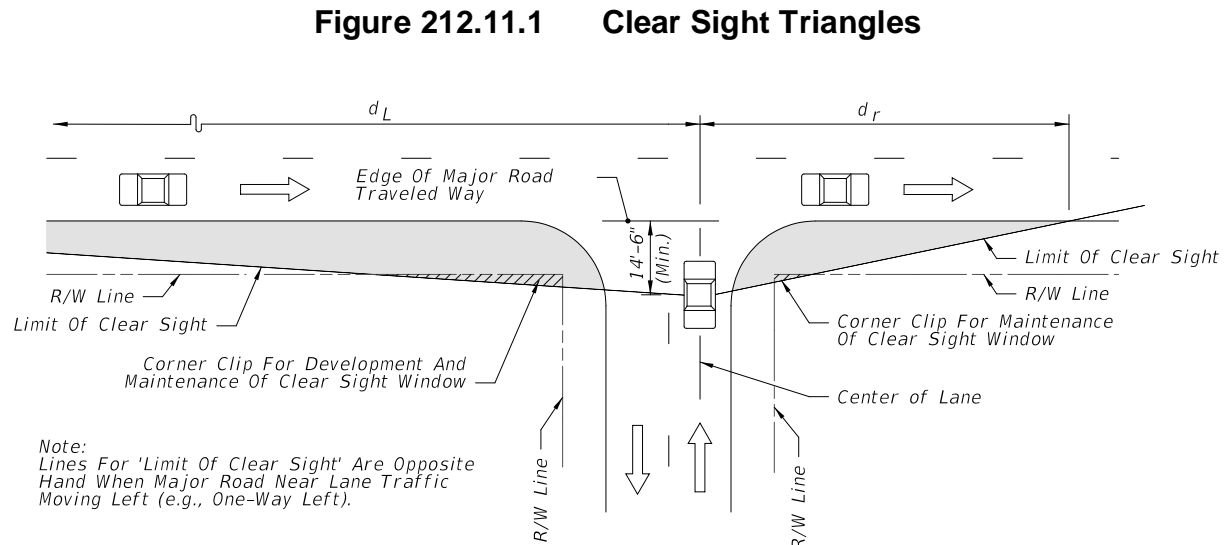

The minimum driver-eye setback of 14.5 feet from the edge of the traveled way may be adjusted on any intersection leg only when justified by a documented, site-specific field study of vehicle stopping position and driver-eye position.

Exhibits 212-4 through **212-7** provide intersection sight distances for stop-controlled intersections. The tables in the exhibits provide sight distance values for Passenger vehicles, Single Unit (SU) Trucks, and Combination vehicles for design speeds ranging from 25 mph to 70 mph. Intersection sight distance based on Passenger vehicles is suitable for most intersections; however, consider the values for SU Vehicles or Combination vehicles for intersections with high truck volumes.

The following guidance applies to **Exhibits 212-4** through **212-7**:

- (1) Limitations
 - (a) The exhibits apply to intersections in all context classifications with stop control or flashing beacon control.
 - (b) The exhibits apply only to intersections with intersecting angles between 60° and 120°, and where vertical and horizontal curves are not present.

(2) Dimensions

- (a) Sight distance (d) is measured from the center of the entrance lane of the crossroad to the center of the near approach lane (right or left) of the highway.
- (b) Distances ' d_L ' and ' d_r ' are measured from the centerline of the entrance lane of the crossroad to a point on the edge of the near side outer traffic lane on the highway.
- (c) Distance ' d_m ' is measured from the centerline of the entrance lane of the crossroad to a point on the median clear zone limit or horizontal clearance limit for the far side road of the highway.

(3) Vertical limits

- (a) Provide a clear sight window throughout the limits of all intersection sight triangles.
- (b) Provide a clear line of sight between vehicles at intersection stop locations and vehicles on the highway throughout the limits of all intersection sight triangles.
- (c) The reference datum between roadways is 3'-6" above respective pavements since observations are made in both directions along the line of sight.

INTERSECTION SIGHT DISTANCE: 2-LANE UNDIVIDED

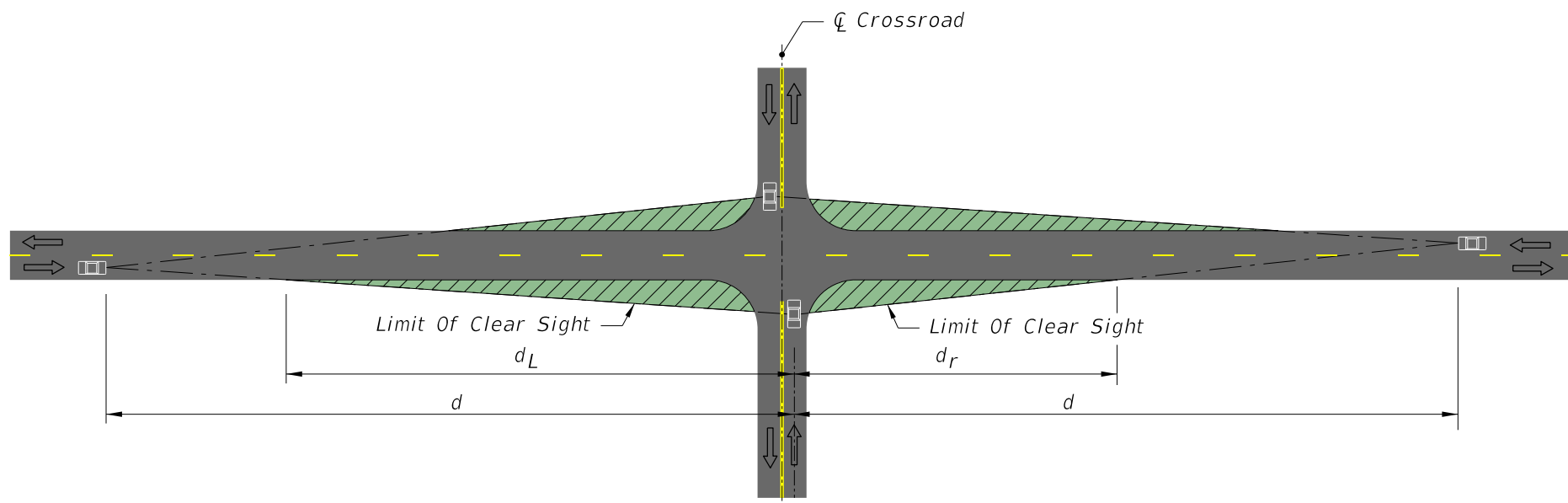

Design Speed (mph)	d (Ft.)	d _L (Ft.)	d _r (Ft.)
≤ 25	280	200	130
30	335	240	155
35	390	275	175
40	445	315	200
45	500	355	225
50	555	395	250
55	610	435	275
60	665	470	300
65	720	510	325
70	775	550	350

Passenger Vehicle

Design Speed (mph)	d (Ft.)	d _L (Ft.)	d _r (Ft.)
≤ 25	350	250	160
30	420	300	190
35	490	350	220
40	560	400	250
45	630	450	285
50	700	495	315
55	770	545	345
60	840	595	375
65	910	645	410
70	980	695	440

SU Vehicle

Design Speed (mph)	d (Ft.)	d _L (Ft.)	d _r (Ft.)
≤ 25	425	300	190
30	510	365	230
35	595	420	265
40	680	480	305
45	765	545	345
50	845	600	380
55	930	660	415
60	1015	720	455
65	1100	780	495
70	1185	840	530

Combination Vehicle

SIGHT DISTANCE (d) AND RELATED DISTANCES (d_L, d_r) (FEET)

2 LANE UNDIVIDED

2-LANE UNDIVIDED

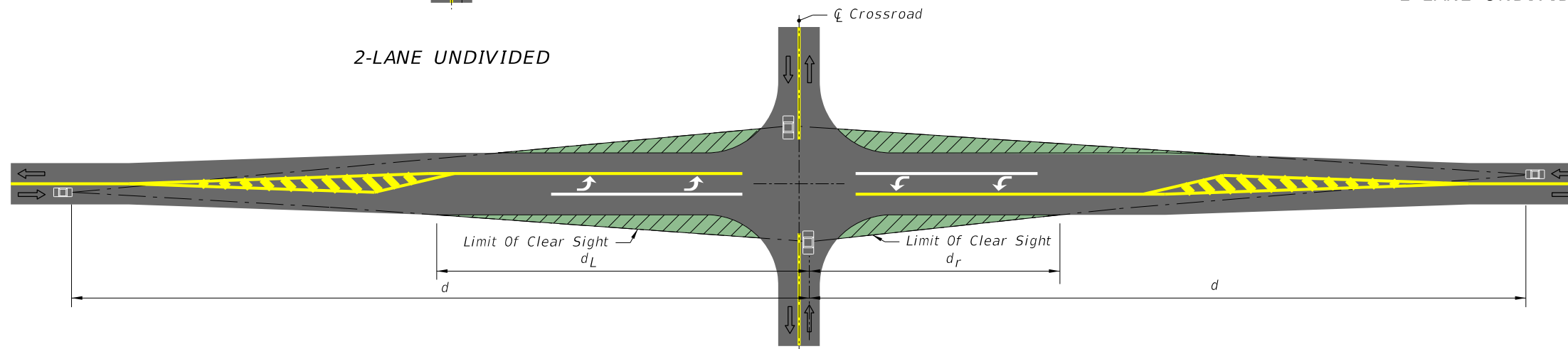

2-LANE WITH LEFT TURN LANE

Design Speed (mph)	d (Ft.)	d _L (Ft.)	d _r (Ft.)
≤ 25	295	165	115
30	355	195	135
35	415	230	160
40	475	260	180
45	530	290	200
50	590	325	225
55	650	355	245
60	710	390	270
65	765	420	290
70	825	455	315

Passenger Vehicle

Design Speed (mph)	d (Ft.)	d _L (Ft.)	d _r (Ft.)
≤ 25	375	205	145
30	450	250	170
35	525	290	200
40	600	330	230
45	675	370	255
50	750	410	285
55	825	455	315
60	900	495	340
65	975	535	370
70	1050	575	395

SU Vehicle

Design Speed (mph)	d (Ft.)	d _L (Ft.)	d _r (Ft.)
≤ 25	450	250	170
30	540	295	205
35	630	345	240
40	720	395	275
45	810	445	305
50	900	495	340
55	990	545	375
60	1080	590	410
65	1170	640	440
70	1260	690	475

Combination Vehicle

SIGHT DISTANCE (d) AND RELATED DISTANCES (d_L, d_r) (FEET)

2-LANE WITH LEFT TURN

NOT TO SCALE

NOTE:

1. See Figure 212.11.1 for origin of clear sight line on the minor road.

LEGEND

Areas Free Of Sight Obstructions

EXHIBIT 212-4
01/01/2025

INTERSECTION SIGHT DISTANCE: 4-LANE UNDIVIDED

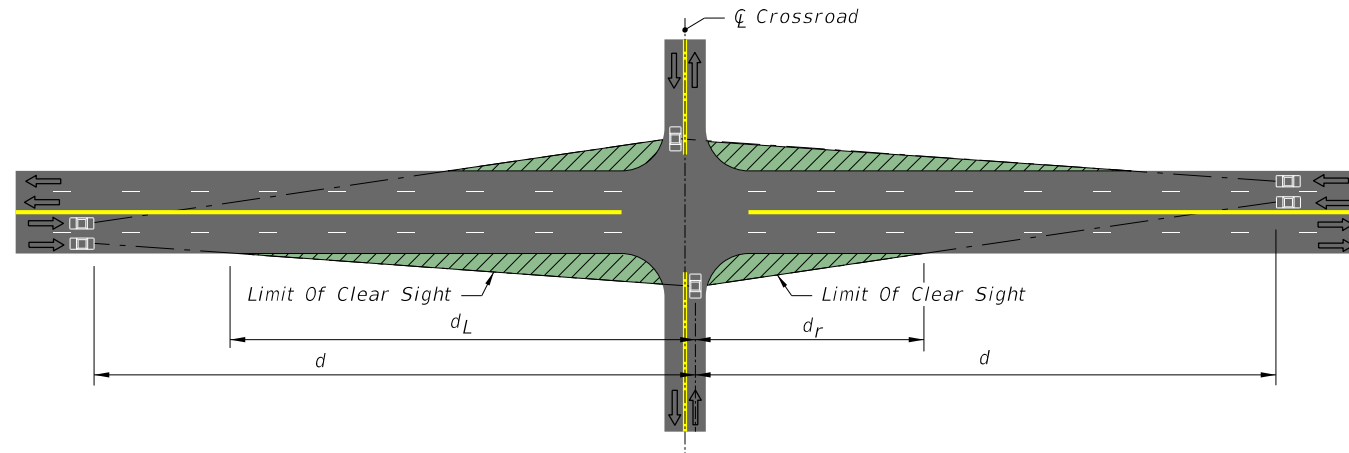

4-LANE UNDIVIDED

Design Speed (mph)	d (Ft.)	d _L (Ft.)	d _r (Ft.)
≤ 25	295	210	100
30	355	255	120
35	415	295	135
40	475	335	155
45	530	375	175
50	590	420	195
55	650	460	215
60	705	500	230
65	765	545	250
70	825	585	270

Passenger Vehicle

Design Speed (mph)	d (Ft.)	d _L (Ft.)	d _r (Ft.)
≤ 25	375	265	125
30	450	320	150
35	525	375	175
40	600	425	200
45	675	480	220
50	750	530	245
55	825	585	270
60	900	640	295
65	975	690	320
70	1050	745	345

SU Vehicle

Design Speed (mph)	d (Ft.)	d _L (Ft.)	d _r (Ft.)
≤ 25	450	320	150
30	540	385	180
35	630	450	205
40	720	510	235
45	810	575	265
50	900	640	295
55	990	700	325
60	1080	765	355
65	1170	830	385
70	1255	890	410

Combination Vehicle

SIGHT DISTANCE (d) AND RELATED DISTANCES (d_L, d_r) (FEET)
4 LANE UNDIVIDED

Design Speed (mph)	d (Ft.)	d _L (Ft.)	d _r (Ft.)
≤ 25	315	175	90
30	375	205	110
35	440	245	130
40	500	275	145
45	565	310	165
50	625	345	180
55	690	380	200
60	750	410	215
65	815	450	235
70	875	480	255

Passenger Vehicle

Design Speed (mph)	d (Ft.)	d _L (Ft.)	d _r (Ft.)
≤ 25	400	220	115
30	480	265	140
35	560	310	165
40	640	350	185
45	720	395	210
50	800	440	230
55	880	485	255
60	960	525	280
65	1040	570	300
70	1120	615	325

SU Vehicle

Design Speed (mph)	d (Ft.)	d _L (Ft.)	d _r (Ft.)
≤ 25	475	260	140
30	570	315	165
35	665	365	195
40	760	420	220
45	855	470	245
50	950	520	275
55	1045	575	300
60	1140	625	330
65	1235	675	355
70	1330	730	385

Combination Vehicle

SIGHT DISTANCE (d) AND RELATED DISTANCES (d_L, d_r) (FEET)
4-LANE UNDIVIDED WITH LEFT TURN LANE

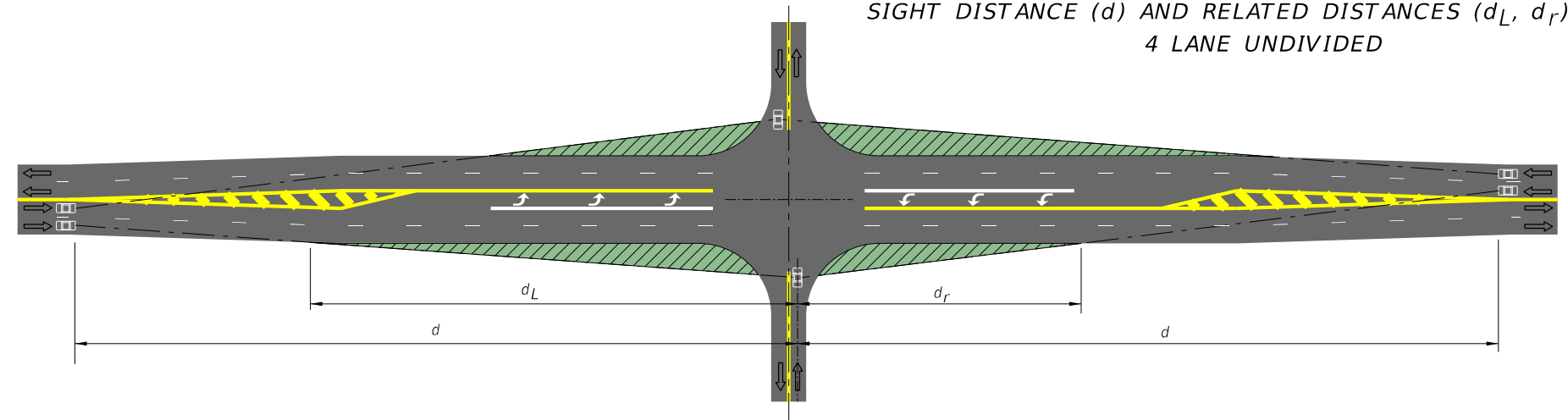

4-LANE UNDIVIDED WITH LEFT TURN LANE

Design Speed (mph)	d (Ft.)	d _L (Ft.)	d _r (Ft.)
≤ 25	315	225	70
30	375	265	80
35	440	315	95
40	500	355	110
45	565	400	120
50	625	445	135
55	690	490	150
60	750	530	160
65	815	580	175
70	875	620	190

Passenger Vehicle

Design Speed (mph)	d (Ft.)	d _L (Ft.)	d _r (Ft.)
≤ 25	405	290	90
30	480	340	105
35	560	400	120
40	640	455	135
45	720	510	155
50	800	570	170
55	880	625	190
60	960	680	205
65	1040	740	220
70	1125	800	240

SU Vehicle

Design Speed (mph)	d (Ft.)	d _L (Ft.)	d _r (Ft.)
≤ 25	475	340	105
30	570	405	125
35	665	470	145
40	760	540	165
45	855	605	185
50	950	675	205
55	1045	740	225
60	1140	810	245
65	1235	875	265
70	1330	945	285

Combination Vehicle

SIGHT DISTANCE (d) AND RELATED DISTANCES (d_L, d_r) (FEET)
4-LANE UNDIVIDED WITH LEFT TURN LANE AND OPTIONAL LANE

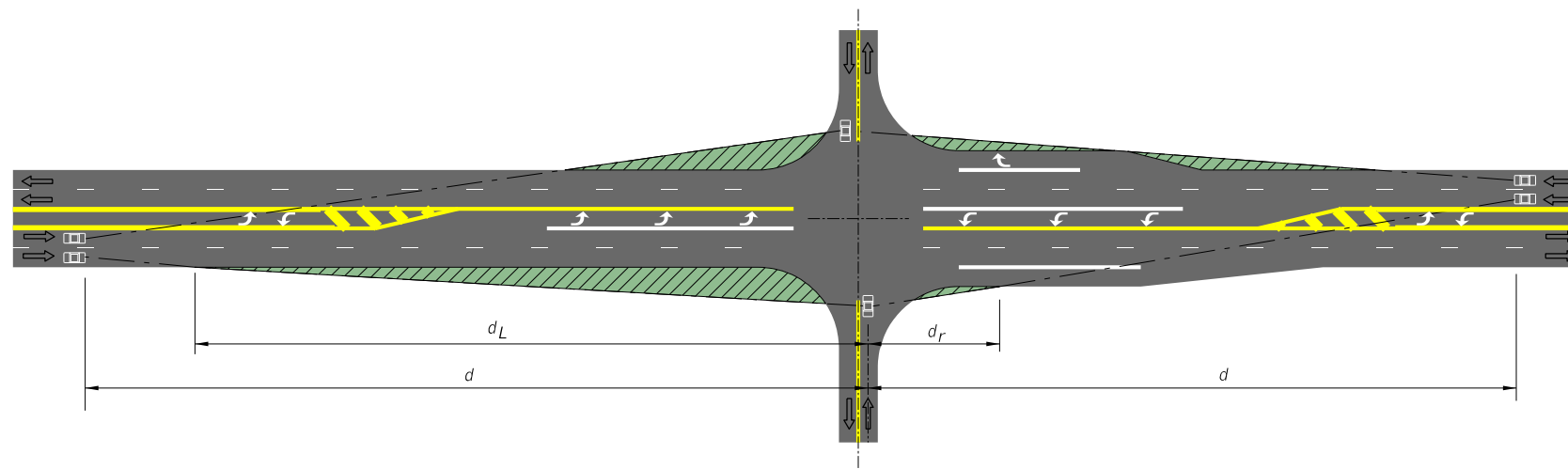

4-LANE UNDIVIDED WITH LEFT TURN LANE AND OPTIONAL LANE

LEGEND

Areas Free Of Sight Obstructions

NOTE:

1. See Figure 212.11.1 for origin of clear sight line on the minor road.

NOT TO SCALE

EXHIBIT 212-5
01/01/2025

INTERSECTION SIGHT DISTANCE: 4-LANE DIVIDED

Median 22' or Less				
Design Speed (mph)	d (Ft.)	d _L (Ft.)	d _r (Ft.)	d _m (Ft.)
≤ 25	330	235	75	270
30	395	280	90	325
35	460	325	100	380
40	525	375	115	430
45	590	420	130	485
50	655	465	145	540
55	720	510	160	590
60	785	555	175	645
65	850	605	185	700
70	920	655	200	755

25'-64' Median				
Design Speed (mph)	d (Ft.)	d _L (Ft.)	d _v (Ft.)	d _{vL} (Ft.)
≤ 25	295	210	275	200
30	355	255	330	240
35	415	295	390	280
40	470	335	445	320
45	530	375	500	360
50	590	420	550	400
55	650	460	610	440
60	705	500	665	480
65	765	545	720	520
70	825	585	775	560

Passenger Vehicle

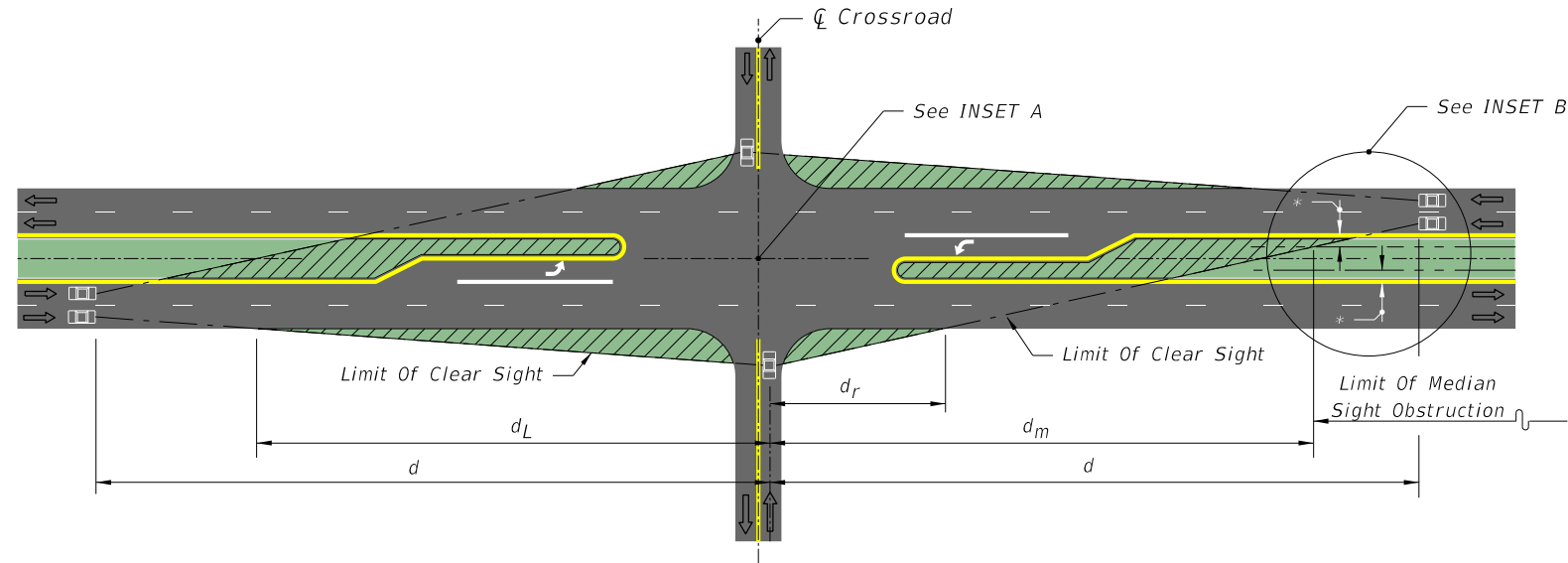

4-LANE DIVIDED

Median 35' or Less				
Design Speed (mph)	d (Ft.)	d _L (Ft.)	d _r (Ft.)	d _m (Ft.)
≤ 25	450	320	90	385
30	540	385	110	460
35	630	450	125	535
40	720	510	145	615
45	810	575	160	685
50	900	640	180	760
55	990	700	195	840
60	1080	765	215	915
65	1170	830	230	990
70	1255	890	250	1060

40'-64' Median				
Design Speed (mph)	d (Ft.)	d _L (Ft.)	d _v (Ft.)	d _{vL} (Ft.)
≤ 25	375	270	350	260
30	450	320	420	310
35	525	375	490	360
40	600	425	560	410
45	675	480	630	460
50	750	530	700	510
55	825	585	770	560
60	900	640	840	610
65	975	690	910	660
70	1050	745	980	710

SU Vehicle

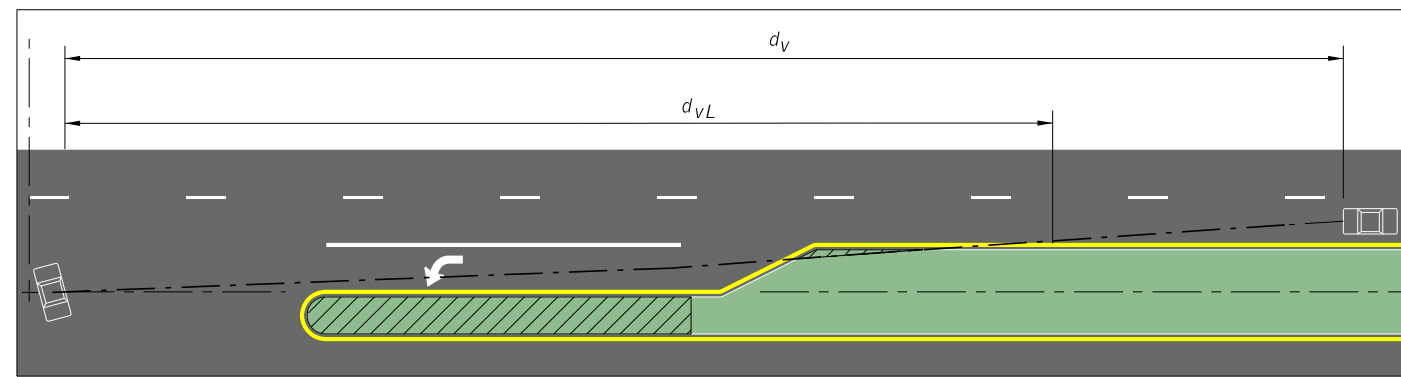

Where The Median Is Sufficiently Wide For The Design Vehicle To Pause In The Median (Vehicle Length Plus 6' Min.) The Clear Line Of Sight To The Right (d_v) Is Measured From The Vehicle Pause Location, i.e., Not From The Cross Road Stop Position; Distances d_r & d_m Do Not Apply.

INSET A

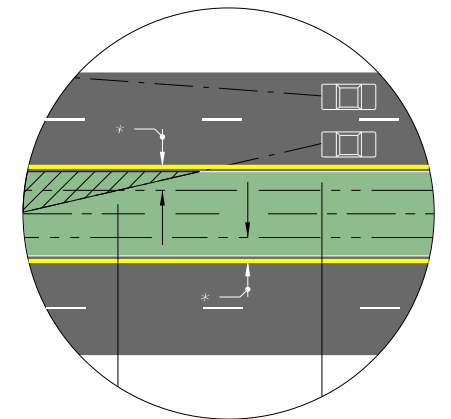

INSET B

* Lateral Offset For Restricted Conditions
Clear Zone For Nonrestricted Conditions

Median 30' or Less				
Design Speed (mph)	d (Ft.)	d _L (Ft.)	d _r (Ft.)	d _m (Ft.)
≤ 25	515	365	100	432
30	615	435	120	520
35	720	510	140	605
40	820	580	160	690
45	925	655	180	780
50	1025	725	200	860
55	1130	800	220	950
60	1230	870	240	1035
65	1335	945	260	1120
70	1440	1020	280	1210

35'-50' Median				
Design Speed (mph)	d (Ft.)	d _L (Ft.)	d _r (Ft.)	d _m (Ft.)
≤ 25	555	395	85	485
30	670	475	105	585
35	780	555	120	680
40	890	630	140	780
45	1000	710	155	875
50	1110	790	170	970
55	1225	870	190	1070
60	1335	945	205	1165
65	1445	1025	225	1265
70	1555	1100	240	1360

64' Median				
Design Speed (mph)	d (Ft.)	d _L (Ft.)	d _r (Ft.)	d _m (Ft.)
≤ 25	585	415	80	520
30	705	500	95	630
35	820	580	110	730
40	935	665	125	835
45	1055	750	145	940
50	1170	830	160	1045
55	1290	915	175	1150
60	1405	995	190	1250
65	1520	1080	205	1355
70	1640	1160	220	1460

Combined Vehicles

Vehicle Type	Vehicle Length (Ft.)
Passenger (P)	19
Single Unit (SU)	30
Large School Bus	40
WB-40	45.5
WB-62FL	73.5

NOTES FOR 4-LANE DIVIDED ROADWAY

- See Figure 212.11.1 for origin of clear sight line on the minor road.
- Values shown in the tables are the governing (controlling) sight distances calculated based on 'AASHTO Case B - Intersection with Stop Control on the Minor Road.'

SIGHT DISTANCES (d) & (d_v) AND RELATED DISTANCES (d_L, d_r, d_m & d_{vL}) (FEET)

LEGEND

Areas Free Of Sight Obstructions

NOT TO SCALE

EXHIBIT 212-6
01/01/2025

INTERSECTION SIGHT DISTANCE: 6-LANE DIVIDED

Median 22' or Less				
Design Speed (mph)	d_x (Ft.)	d_L (Ft.)	d_r (Ft.)	d_m (Ft.)
≤ 25	350	250	65	300
30	415	295	80	355
35	485	345	90	415
40	555	395	105	470
45	625	445	115	530
50	690	490	130	585
55	760	540	140	645
60	830	590	155	705
65	900	640	170	765
70	970	690	180	825

25'-64' MEDIAN				
Design Speed (mph)	d (Ft.)	d_L (Ft.)	d_v (Ft.)	d_{vL} (Ft.)
≤ 25	315	225	275	200
30	375	265	330	240
35	440	315	385	280
40	500	355	445	320
45	565	400	500	360
50	625	445	555	400
55	690	490	610	440
60	750	530	665	480
65	815	580	720	520
70	875	620	775	560

Passenger Vehicle

Median 35' or Less				
Design Speed (mph)	d_x (Ft.)	d_L (Ft.)	d_r (Ft.)	d_m (Ft.)
≤ 25	475	340	75	415
30	570	405	90	495
35	665	470	105	580
40	760	540	120	660
45	855	605	135	745
50	955	675	155	830
55	1050	745	170	915
60	1145	810	185	995
65	1240	880	200	1080
70	1330	940	210	1155

40'-64' Median				
Design Speed (mph)	d (Ft.)	d_L (Ft.)	d_v (Ft.)	d_{vL} (Ft.)
≤ 25	400	285	350	250
30	480	340	420	300
35	560	400	490	350
40	640	455	560	400
45	720	510	630	450
50	805	570	700	500
55	885	625	770	550
60	965	685	840	600
65	1045	740	910	650
70	1125	795	980	700

SU Vehicle

Median 30' or Less				
Design Speed (mph)	d_x (Ft.)	d_L (Ft.)	d_r (Ft.)	d_m (Ft.)
≤ 25	540	385	90	465
30	650	460	110	560
35	755	535	130	655
40	865	615	145	745
45	970	690	165	835
50	1080	765	185	930
55	1185	840	200	1025
60	1290	915	220	1115
65	1400	990	235	1210
70	1510	1070	255	1300

35'-50' Median				
Design Speed (mph)	d_x (Ft.)	d_L (Ft.)	d_r (Ft.)	d_m (Ft.)
≤ 25	585	415	80	520
30	700	495	95	625
35	815	580	115	725
40	930	660	130	825
45	1045	740	145	930
50	1165	825	160	1035
55	1280	905	175	1140
60	1395	990	190	1240
65	1510	1070	210	1340
70	1630	1155	225	1450

Combined Vehicles

64' Median				
Design Speed (mph)	d (Ft.)	d_L (Ft.)	d_r (Ft.)	d_m (Ft.)
≤ 25	610	435	75	550
30	735	520	90	665
35	900	640	110	815
40	980	695	120	885
45	1100	780	135	995
50	1220	865	150	1100
55	1345	955	160	1215
60	1465	1040	175	1320
65	1590	1125	190	1435
70	1710	1210	205	1545

Vehicle Type	Vehicle Length (Ft.)
Passenger (P)	19
Single Unit (SU)	30
Large School Bus	40
WB-40	45.5
WB-62FL	73.5

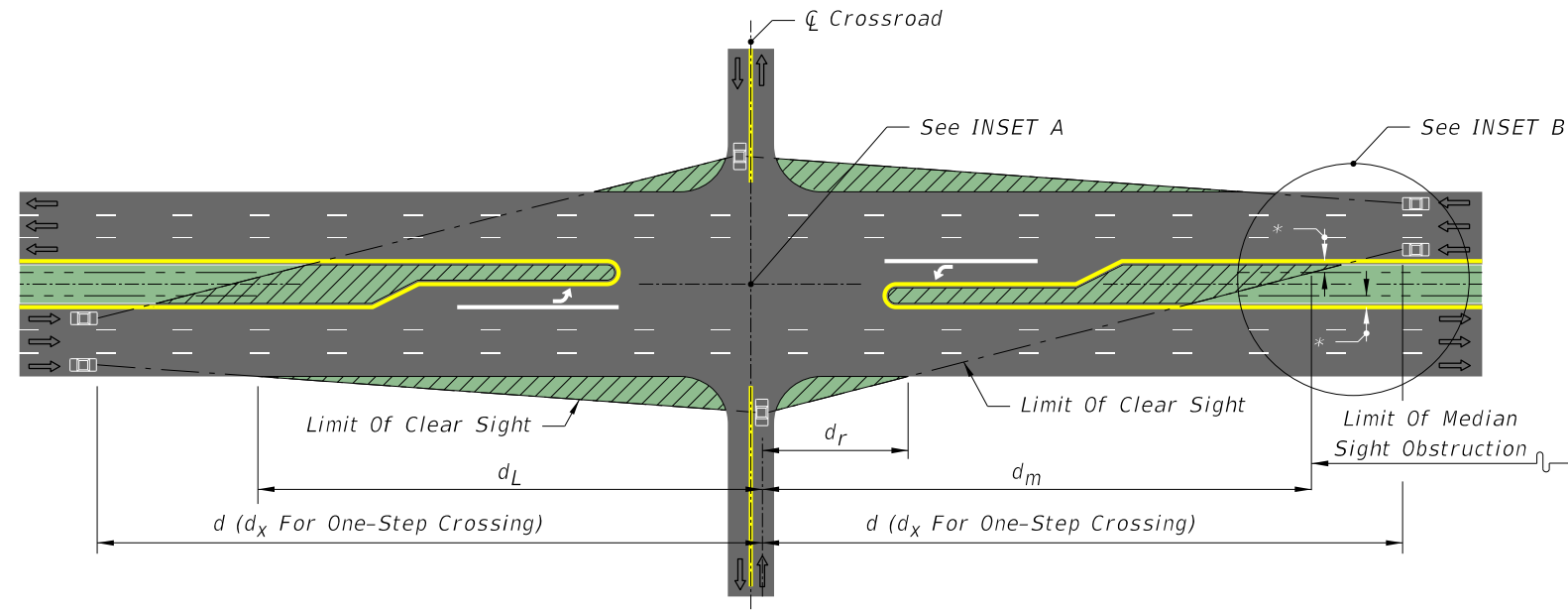

6-LANE DIVIDED

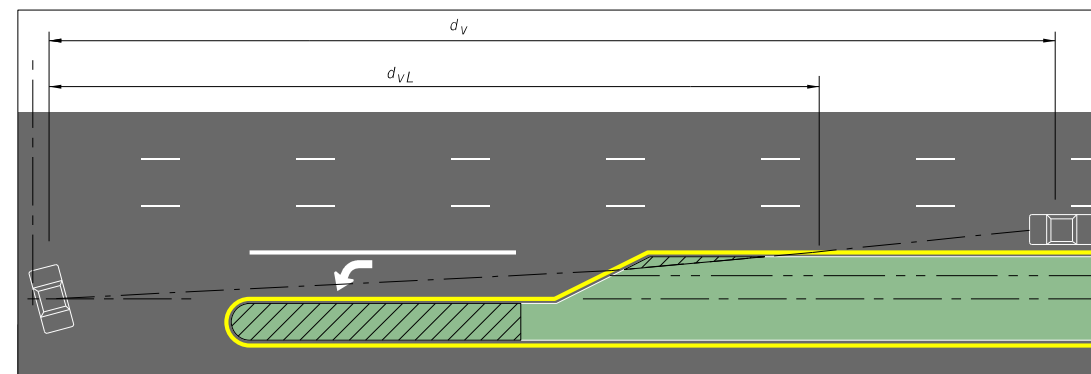

Where The Median Is Sufficiently Wide For The Design Vehicle To Pause In The Median (Vehicle Length Plus 6' Min.) The Clear Line Of Sight To The Right (d_v) Is Measured From The Vehicle Pause Location, i.e., Not From The Cross Road Stop Position; Distances d_r & d_m Do Not Apply.

INSET A

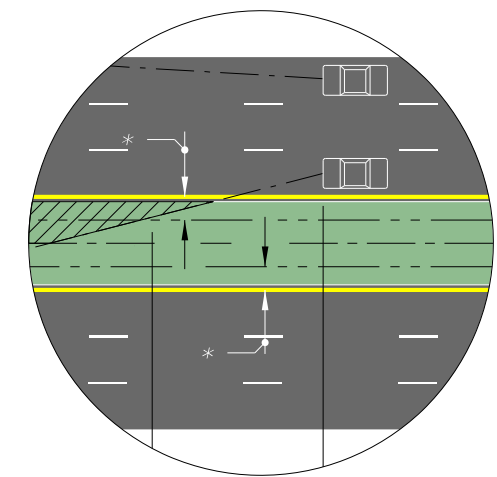

INSET B

* Lateral Offset For Restricted Conditions
Clear Zone For Nonrestricted Conditions

NOTES FOR 6-LANE DIVIDED ROADWAY

- See Figure 212.11.1 for origin of clear sight line on the minor road.
- Values shown in the tables are the governing (controlling) sight distances calculated based on 'AASHTO Case B - Intersection with Stop Control on the Minor Road.'

LEGEND

Areas Free Of Sight Obstructions

NOT TO SCALE

EXHIBIT 212-7
01/01/2025

SIGHT DISTANCES (d), (d_v) & (d_x) AND RELATED DISTANCES (d_L , d_r , d_m & d_{vL}) (FEET)

212.11.2 All-Way Stop Control (AASHTO Case E)

Provide clear sight lines on each of the approach legs for all-way stop controlled intersections.

212.11.3 Signal Control (AASHTO Case D)

For signalized intersections incorporate the following:

- (1) Develop sight distances based on AASHTO 'Case D-Intersections with Signal Control'.
- (2) The first vehicle stopped on any approach leg is visible to the driver of the first vehicle stopped on each of the other approach legs.
- (3) For permissive left-turns, provide sufficient sight distance for left-turning vehicles to select gaps in oncoming traffic and complete the left-turns.
- (4) If a traffic signal is to be placed on two-way flashing operation (i.e., flashing yellow on the major road approaches and flashing red on the minor road approaches) under off-peak or nighttime conditions, provide the appropriate departure sight triangles for AASHTO Case B (Stop Control on the Minor Road).
- (5) If right-turns on red are permitted from any approach leg, then provide the appropriate departure sight triangle to the left for AASHTO Case B above.

212.11.4 Left-Turn from Highway (AASHTO Case F)

Provide sufficient sight distance to accommodate a left-turn maneuver for locations where left turns across opposing traffic are permitted. **Table 212.11.1** provides clear sight distance values for left-turn from highway.

For additional information on determining the sight distance, refer to Chapter 9 of AASHTO's ***A Policy on Geometric Design of Highways and Streets***.

Table 212.11.1 Sight Distance for Left-Turn from Highway

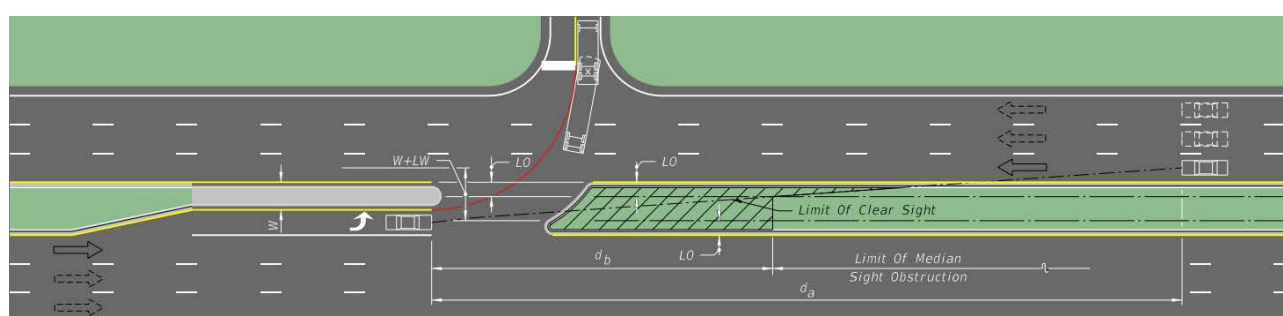

Design Speed (mph)	d_a (feet)								
	1 Lane Crossed			2 Lane Crossed			3 Lane Crossed		
	P	SU	Comb.	P	SU	Comb.	P	SU	Comb.
25	205	240	280	225	265	305	240	290	330
30	245	290	330	265	320	365	290	350	395
35	285	335	385	310	370	425	335	410	460
40	325	385	440	355	425	485	385	465	525
45	365	430	495	400	475	545	430	525	590

d_b (feet) Equations					
10 Foot Lane Lateral Offset (feet)		11 Foot Lane Lateral Offset (feet)		12 Foot Lane Lateral Offset (feet)	
1.5	4	1.5	4	1.5	4
$d_a \left(\frac{W + 2}{W + 10} \right)$	$d_a \left(\frac{W - 0.5}{W + 10} \right)$	$d_a \left(\frac{W + 2.5}{W + 11} \right)$	$d_a \left(\frac{W}{W + 11} \right)$	$d_a \left(\frac{W + 3}{W + 12} \right)$	$d_a \left(\frac{W + 0.5}{W + 12} \right)$

Notes:

- (1) Use the appropriate d_b equation to calculate the required value based on the lane width (LW) and lateral offset (LO). See **FDM 215.2.4** for lateral offset requirements. The d_b value can be interpolated for roadways with left turn lane widths different from travel lane widths (e.g., 11-foot travel lane and a 10-foot left turn lane interpolate d_b from the 10-foot and 11-foot lane calculations). For roadways with non-restricted conditions, d_a and d_b should be based on the geometry for the left-turn storage and on clear zone widths.
- (2) For wide medians where the turning vehicle can approach the through lane at or near 90°, use d values from tables in **Exhibits 212-6** and **212-7**. The clear sight line origin is assumed to be 14.5 feet from the edge of the near travel lane.

212.11.5 On-Street Parking

Table 212.11.2 provides parking restrictions for intersections, including mid-block crossings and roundabout approaches. For additional information, see the following:

- **FDM 210.2.3** for additional information concerning on-street parking.
- **FDM 222.2.6** for information concerning curb extensions (bulb-outs).
- **Chapter 316, [Florida Statutes](#) (F.S.)** for laws governing parking spaces.

Table 212.11.2 Parking Restrictions for Driveways and Intersections

Control Type	Posted Speed (mph)	A - Up Stream (ft)	B – Down Stream (ft)	
			2-Lane	4-Lane or more
Unsignalized	< 35	90	60	45
	35	105	70	50
Signalized	< 35	30	30	30
	35	50	50	50

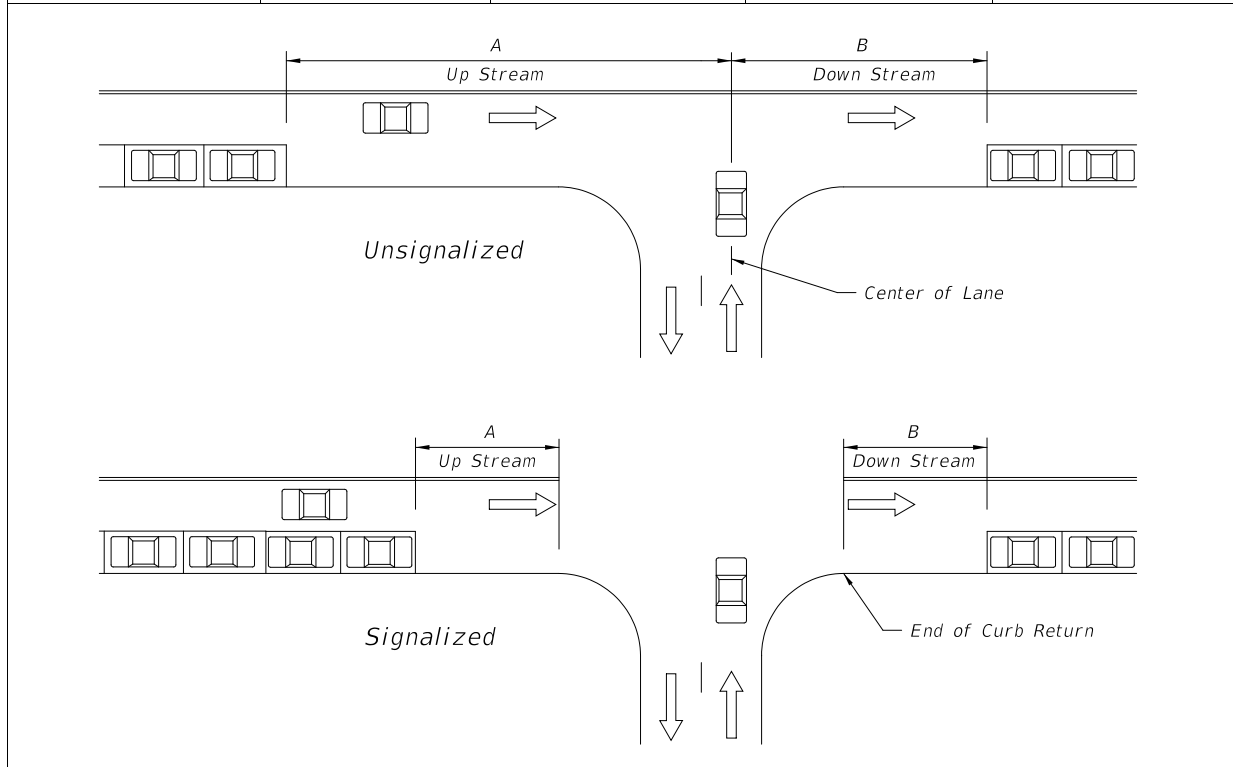

Notes:

- (1) For entrances to one-way streets, the downstream restriction (B) may be reduced to 20 feet.
- (2) Do not place parking within 20 feet of a marked crosswalk.

212.11.6 Trees and Vegetation

Intersections should be designed to accommodate the placement of trees and other desired vegetation (e.g., ground cover plants, trunked plants) in C2T, C3C, C4, C5, and C6 context classifications while still maintaining clear sight triangles. Ground cover plants are naturally low-growing plants with a maximum mature height of ≤ 18 inches. Trunked plants are those with a mature trunk diameter of 4 inches or less (measured 6 inches above the ground).

Maintain clear sight triangles for all approaches. Do not place trees within the hatched-out areas as shown in **Figure 212.11.2**. The hatched-out areas are for ground cover plants only. Coordinate with the Project Landscape Architect for the placement of vegetation and the necessary space above and below ground for tree growth that will maintain clear sight triangles.

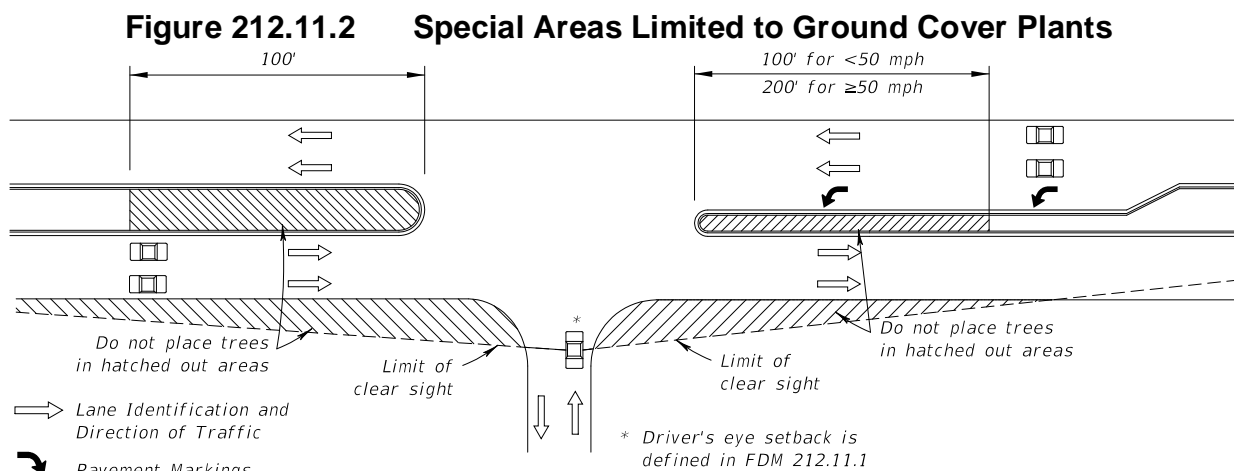

Where left-turns from the major road are permitted, do not locate trees within the distance d_b shown in **Table 212.11.1** (see **FDM 212.11.4**) and not less than the distances shown in **Figure 212.11.2** and the spacings in **Table 212.11.3** as applicable.

212.11.6.1 Clear Sight Window Concept

The clear sight window concept may provide opportunities for vegetation in medians inside the limits of intersection sight triangles. This concept is illustrated in **Figure 212.11.3**. This detail provides the required vertical clear sight limits with respect to the sight line datum. Do not place trees within the hatched-out areas as shown in **Figure**

212.11.2 (even if using the clear sight window concept). The hatched-out areas are for ground cover plants only. Trees may be placed in the median where there is no hatching.

Figure 212.11.3 Window Detail

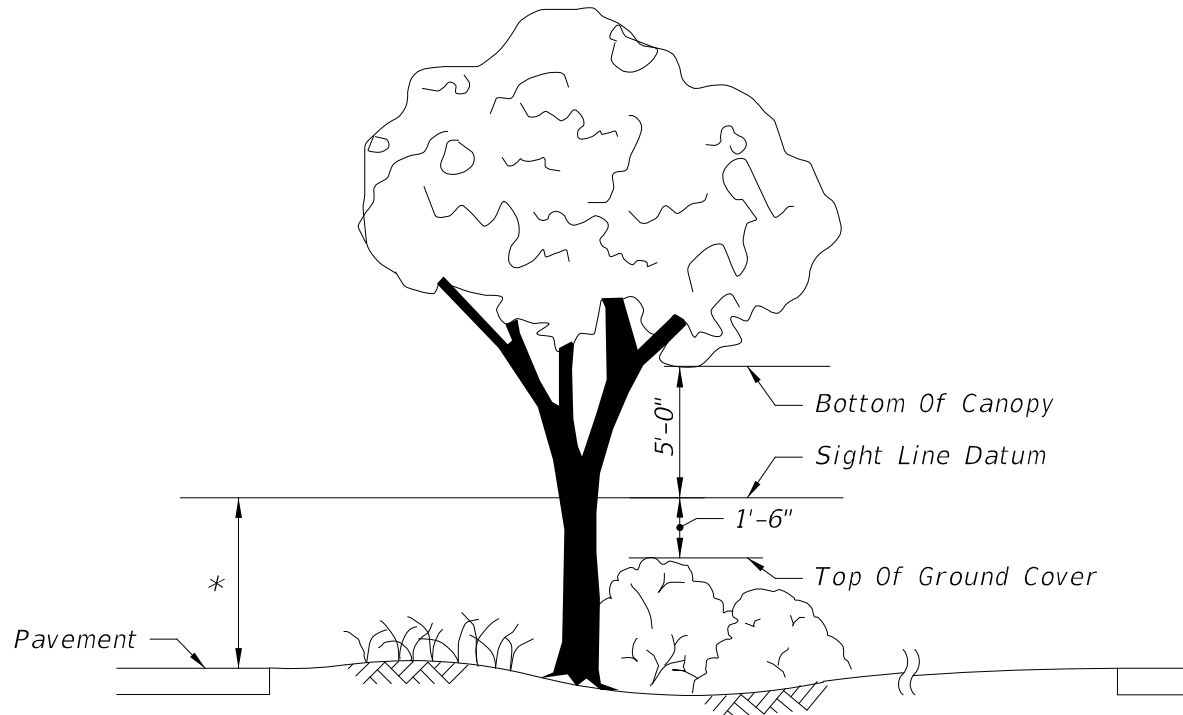

* Since observations are made in both directions, the line-of-sight datum between roadways is 3.5 feet above both pavements.

The horizontal limits of the window are defined by clear sight triangles. Within the limits of clear sight triangles, the following restrictions apply:

- The canopy of trees and trunked plants must be at least 5 feet above the sight line datum.
- The top of the ground cover plants must be at least 1.5 feet below the sight line datum.

See **FDM 270** for additional information about plant selection and placement. Enforcing these limits provides a clear line of sight for approaches to an intersection.

When trees are located in the median of a divided roadway and fall within the limits of a clear sight triangle, conform to **Table 212.11.3** for tree size and spacing. Spacing values

for trees with diameters of 11 inches or less were derived assuming a maximum 6-foot-wide shadow band on a vehicle at the stop bar location when viewed by a mainline driver beginning at sight distance 'd'. This is illustrated in **Figure 212.11.4**. Spacing values for trees with diameters greater than 11 inches and less than or equal to 18 inches were derived assuming a 2 second full view of the vehicle at the stop bar when viewed by the mainline driver beginning at sight distance 'd'. (See **Figure 212.11.5**).

Table 212.11.3 Minimum Tree Spacing

Design Speed (mph)	Minimum Tree Spacing (Center-to-Center of Trunk) (feet)	
	4" < Tree Diameter ≤ 11"	11" < Tree Diameter ≤ 18"
25	20	75
30	25	90
35	30	105
40	35	120
45	40	135
50	50	150
55	55	165
60	60	180

Notes:

- (1) Size and spacing are based on the following conditions:
 - (a) A single line of trees in the median parallel to but not necessarily collinear with the centerline.
 - (b) A straight approaching mainline and intersection angle between 60° and 120°.
 - (c) Space trees with 4" < Dia. ≤ 11" intermixed with trees with 11" < Dia. ≤ 18" based on trees with 11" < Dia. ≤ 18".
- (2) Detail tree size, spacing, and location in the plans for any other conditions.
- (3) Trunked plants may be placed on 20-foot centers.

Figure 212.11.4 Shadow Diagram

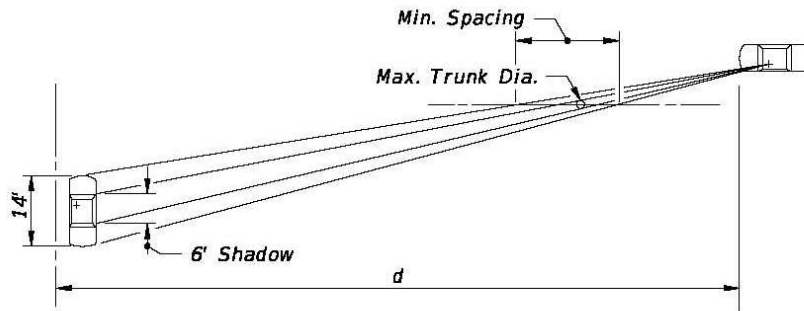

**SHADOW DIAGRAM
TREE SPACING (DIA. 11" OR LESS)**

Figure 212.11.5 Perception Diagram

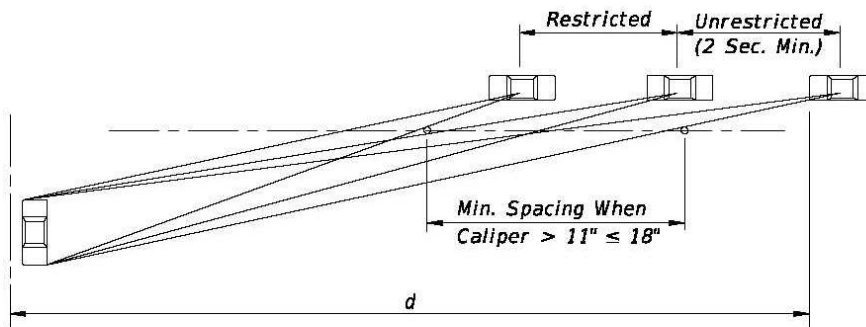

**PERCEPTION DIAGRAM
TREE SPACING (DIA. BETWEEN 11" AND 18")**

212.12 Turning Roadways

Turning roadways are typically designed for use by right-turning traffic at intersections. There are three types of right-turning roadways:

- edge-of-traveled-way design
- design with a corner triangular island
- free-flow design using a simple radius or compound radii

The turning radii and the pavement cross slopes for free-flow right-turns are functions of design speed and design vehicle.

212.12.1 Edge-of-Traveled-Way Design

When the selected design vehicle is to be accommodated within minimum space, corner radii should be based on the required turning path.

Table 212.12.1 provides simple curve radii with and without tapers. **Table 212.12.2** provides symmetric and asymmetric three-centered compound curve radii for a range of design vehicles. These values provide the minimum turning paths attainable at design speeds of 10 mph and less.

Figure 212.12.1 demonstrates the angle of turn for use in these tables.

The minimum edge-of-traveled-way values provided in these tables are based on the assumption that the vehicle is properly positioned within the traffic lane at the beginning and end of the turn (2 feet from the edge-of-traveled-way on the tangents approaching and leaving the intersection curve). Such designs follow closely the inner wheel path of the selected design vehicle, with a clearance of 2 feet or more throughout most of the turn, and with a clearance at no point less than 9 inches. Differences in the inner paths of vehicles turning left and right are not sufficient to be significant in design. For this reason, these edge designs also apply to left-turn maneuvers, such as a left-turn by a vehicle leaving a divided highway at a very low speed.

Figure 212.12.1 Turn Angle for Turning Roadway Designs

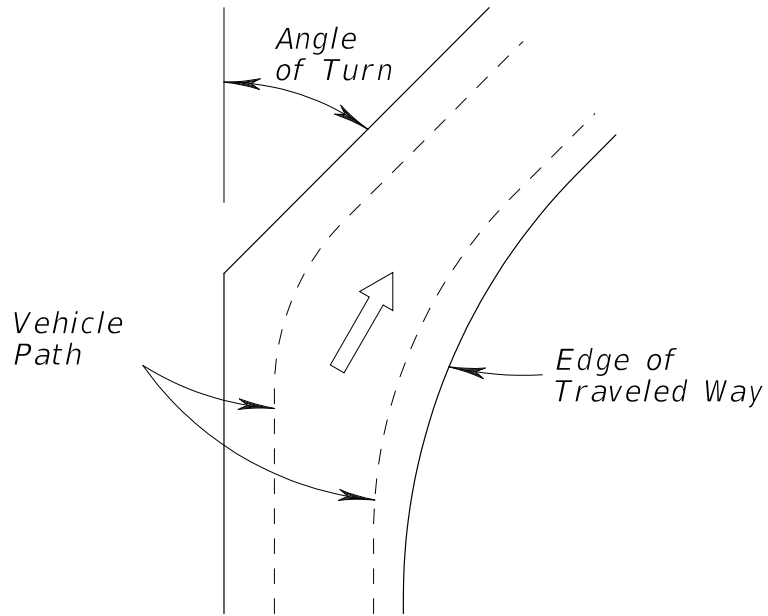

Table 212.12.1 Edge-of-Traveled-Way, Simple Curve Radii

Angle of Turn (degrees)	Design Vehicle	Simple Curve Radius (feet)	Simple Curve Radius with Taper		
			Radius (feet)	Offset (feet)	Taper H:V
30	P	60	----	----	----
	SU-30	100	----	----	----
	SU-40	140	----	----	----
	WB-40	150	----	----	----
	WB-62	360	220	3.0	15:1
	WB-62FL	380	220	3.0	15:1
	WB-67	380	220	3.0	15:1
	WB-92D	365	190	3.0	15:1
	WB-100T	260	125	3.0	15:1
	WB-109D	475	260	3.5	20:1
45	P	50	----	----	----
	SU-30	75	----	----	----
	SU-40	115	----	----	----
	WB-40	120	----	----	----
	WB-62	230	145	4.0	15:1
	WB-62FL	250	145	4.5	15:1
	WB-67	250	145	4.5	15:1
	WB-92D	270	145	4.0	15:1
	WB-100T	200	115	2.5	15:1
	WB-109D	----	200	4.5	20:1
60	P	40	----	----	----
	SU-30	60	----	----	----
	SU-40	100	----	----	----
	WB-40	90	----	----	----
	WB-62	170	140	4.0	15:1
	WB-62FL	200	140	4.5	15:1
	WB-67	200	140	4.5	15:1
	WB-92B	230	120	5.0	15:1
	WB-100T	150	95	2.5	15:1
	WB-109D	----	180	4.5	20:1

Table 212.12.1 Edge-of-Traveled-Way, Simple Curve Radii, cont.

Angle of Turn (degrees)	Design Vehicle	Simple Curve Radius (feet)	Simple Curve Radius with Taper		
			Radius (feet)	Offset (feet)	Taper H:V
75	P	35	25	2.0	10:1
	SU-30	55	45	2.0	10:1
	SU-40	90	60	2.0	10:1
	WB-40	----	60	2.0	15:1
	WB-62	----	145	4.0	20:1
	WB-62FL	----	145	4.0	20:1
	WB-67	----	145	4.5	20:1
	WB-92D	----	110	5.0	15:1
	WB-100T	----	85	3.0	15:1
	WB-109D	----	140	5.5	20:1
90	P	30	20	2.5	10:1
	SU-30	50	40	2.0	10:1
	SU-40	80	45	4.0	10:1
	WB-40	----	45	4.0	10:1
	WB-62	----	120	4.5	30:1
	WB-62FL	----	125	4.5	30:1
	WB-67	----	125	4.5	30:1
	WB-92D	----	95	6.0	10:1
	WB-100T	----	85	2.5	15:1
	WB-109D	----	115	2.9	15:1
105	P	----	20	2.5	8:1
	SU-30	----	35	3.0	10:1
	SU-40	----	45	4.0	10:1
	WB-40	----	40	4.0	10:1
	WB-62	----	115	3.0	15:1
	WB-62FL	----	115	3.0	15:1
	WB-67	----	115	3.0	15:1
	WB-92B	----	80	8.0	10:1
	WB-100T	----	75	3.0	15:1
	WB-109D	----	90	9.2	20:1

Table 212.12.1 Edge-of-Traveled-Way, Simple Curve Radii, cont.

Angle of Turn (degrees)	Design Vehicle	Simple Curve Radius (feet)	Simple Curve Radius with Taper		
			Radius (feet)	Offset (feet)	Taper H:V
120	P	----	20	2.0	10:1
	SU-30	----	30	3.0	10:1
	SU-40	----	35	6.0	8:1
	WB-40	----	35	5.0	8:1
	WB-62	----	100	5.0	15:1
	WB-62FL	----	105	5.2	15:1
	WB-67	----	105	5.2	15:1
	WB-92D	----	80	7.0	10:1
	WB-100T	----	65	3.5	15:1
	WB-109D	----	85	9.2	20:1
135	P	----	20	1.5	10:1
	SU-30	----	30	4.0	10:1
	SU-40	----	40	4.0	8:1
	WB-40	----	30	8.0	15:1
	WB-62	----	80	5.0	20:1
	WB-62FL	----	85	5.2	20:1
	WB-67	----	85	5.2	20:1
	WB-92D	----	75	7.3	10:1
	WB-100T	----	65	5.5	15:1
	WB-109D	----	85	8.5	20:1
150	P	----	18	2.0	10:1
	SU-30	----	30	4.0	8:1
	SU-40	----	35	7.0	8:1
	WB-40	----	30	6.0	8:1
	WB-62	----	60	10.0	10:1
	WB-62FL	----	65	10.2	10:1
	WB-67	----	65	10.2	10:1
	WB-92B	----	65	11.0	10:1
	WB-100T	----	65	7.3	10:1
	WB-109D	----	65	15.1	10:1

Table 212.12.1 Edge-of-Traveled-Way, Simple Curve Radii, cont.

Angle of Turn (degrees)	Design Vehicle	Simple Curve Radius (feet)	Simple Curve Radius with Taper		
			Radius (feet)	Offset (feet)	Taper H:V
180	P	----	15	0.5	20:1
	SU-30	----	30	1.5	10:1
	SU-40	----	35	6.4	10:1
	WB-40	----	20	9.5	5:1
	WB-62	----	55	10.0	15:1
	WB-62FL	----	55	13.8	10:1
	WB-67	----	55	13.8	10:1
	WB-92D	----	55	16.8	10:1
	WB-100T	----	55	10.2	10:1
	WB-109D	----	55	20.0	10:1

Table 212.12.2 Edge-of-Traveled-Way, 3-Centered Compound Curves

Angle of Turn (degrees)	Design Vehicle	3-Centered Compound Curve			
		Curve Radii (ft)	Symmetric Offset (ft)	Curve Radii (ft)	Asymmetric (ft)
30	P	----	----	----	----
	SU-30	----	----	----	----
	SU-40	----	----	----	----
	WB-40	----	----	----	----
	WB-62	----	----	----	----
	WB-62FL	460-175-460	4.0	300-175-550	2.0-4.5
	WB-67	460-175-460	4.0	300-175-550	2.0-4.5
	WB-92D	550-155-550	4.0	200-150-500	2.0-6.0
	WB-100T	220-80-220	4.5	200-80-300	2.5-5.0
	WB-109D	550-250-550	5.0	250-200-650	1.5-7.0

Table 212.12.2 Edge-of-Traveled-Way, 3-Centered Compound Curves, cont.

Angle of Turn (degrees)	Design Vehicle	3-Centered Compound Curve			
		Curve Radii (ft)	Symmetric Offset (ft)	Curve Radii (ft)	Asymmetric (ft)
45	P	----	----	----	----
	SU-30	----	----	----	----
	SU-40	----	----	----	----
	WB-40	----	----	----	----
	WB-62	460-240-460	2.0	120-140-500	3.0-8.5
	WB-62FL	460-175-460	4.0	250-125-600	1.0-6.0
	WB-67	460-175-460	4.0	250-125-600	1.0-6.0
	WB-92D	525-155-525	5.0	200-140-500	1.5-6.0
	WB-100T	250-80-250	4.5	200-80-300	2.5-5.5
	WB-109D	550-200-550	5.0	200-170-650	1.5-7.0
60	P	----	----	----	----
	SU-30	----	----	----	----
	SU-40	----	----	----	----
	WB-40	----	----	----	----
	WB-62	400-100-400	15.0	110-100-220	10.0-12.5
	WB-62FL	400-100-400	8.0	250-125-600	1.0-6.0
	WB-67	400-100-400	8.0	250-125-600	1.0-6.0
	WB-92D	480-110-480	6.0	150-110-500	3.0-9.0
	WB-100T	250-80-250	4.5	200-80-300	2.0-5.5
	WB-109D	650-150-650	5.5	200-140-600	1.5-8.0
75	P	100-25-100	2.0	----	----
	SU-30	120-45-120	2.0	----	----
	SU-40	200-35-200	5.0	60-45-200	1.0-4.5
	WB-40	120-45-120	5.0	120-45-195	2.0-6.5
	WB-62	440-75-440	15.0	140-100-540	5.0-12.0
	WB-62FL	420-75-420	10.0	200-80-600	1.0-10.0
	WB-67	420-75-420	10.0	200-80-600	1.0-10.0
	WB-92B	500-95-500	7.0	150-100-500	1.0-8.0
	WB-100T	250-80-250	4.5	100-80-300	1.5-5.0
	WB-109D	700-125-700	6.5	150-110-550	1.5-11.5

Table 212.12.2 Edge-of-Traveled-Way, 3-Centered Compound Curves, cont.

Angle of Turn (degrees)	Design Vehicle	3-Centered Compound Curve			
		Curve Radii (ft)	Symmetric Offset (ft)	Curve Radii (ft)	Asymmetric (ft)
90	P	100-20-100	2.5	----	----
	SU-30	120-40-120	2.0	----	----
	SU-40	200-30-200	7.0	60-45-200	1.0-4.5
	WB-40	120-40-120	5.0	120-40-200	2.0-6.5
	WB-62	400-70-400	10.0	160-70-360	6.0-10.0
	WB-62FL	440-65-440	10.0	200-70-600	1.0-11.0
	WB-67	440-65-440	10.0	200-70-600	1.0-11.0
	WB-92D	470-75-470	10.0	150-90-500	1.5-8.5
	WB-100T	250-70-250	4.5	200-70-300	1.0-5.0
WB-109D	700-110-700	6.5	100-95-550	2.0-11.5	
105	P	100-20-100	2.5	----	----
	SU-30	100-35-100	3.0	----	----
	SU-40	200-35-200	6.0	60-40-190	1.5-6.0
	WB-40	100-35-100	5.0	100-55-200	2.0-8.0
	WB-62	520-50-520	15.0	360-75-600	4.0-10.5
	WB-62FL	500-50-500	13.0	200-65-600	1.0-11.0
	WB-67	500-50-500	13.0	200-65-600	1.0-11.0
	WB-92D	500-80-500	8.0	150-80-500	2.0-10.0
	WB-100T	250-60-250	5.0	100-60-300	1.5-6.0
WB-109D	700-95-700	8.0	150-80-500	3.0-15.0	
120	P	100-20-100	2.0	----	----
	SU-30	100-30-100	3.0	----	----
	SU-40	200-35-200	6.0	60-40-190	1.5-5.0
	WB-40	120-30-120	6.0	100-30-180	2.0-9.0
	WB-62	520-70-520	10.0	80-55-520	24.0-17.0
	WB-62FL	550-45-550	15.0	200-60-600	2.0-12.5
	WB-67	550-45-550	15.0	200-60-600	2.0-12.5
	WB-92D	500-70-500	10.0	150-70-450	3.0-10.5
	WB-100T	250-60-250	5.0	100-60-300	1.5-6.0
WB-109D	700-85-700	9.0	150-70-500	7.0-17.4	

Table 212.12.2 Edge-of-Traveled-Way, 3-Centered Compound Curves, cont.

Angle of Turn (degrees)	Design Vehicle	3-Centered Compound Curve			
		Curve Radii (ft)	Symmetric Offset (ft)	Curve Radii (ft)	Asymmetric (ft)
135	P	100-20-100	1.5	----	----
	SU-30	100-30-100	4.0	----	----
	SU-40	200-40-200	4.0	60-40-180	1.5-5.0
	WB-40	120-30-120	6.5	100-25-180	3.0-13.0
	WB-62	600-60-600	12.0	100-60-640	14.0-7.0
	WB-62FL	550-45-550	16.0	200-60-600	2.0-12.5
	WB-67	550-45-550	16.0	200-60-600	2.0-12.5
	WB-92D	450-70-450	9.0	150-65-450	7.0-13.5
	WB-100T	250-60-250	5.5	100-60-300	2.5-7.0
	WB-109D	700-70-700	12.5	150-65-500	14.0-18.4
150	P	75-20-75	2.0	----	----
	SU-30	100-30-100	4.0	----	----
	SU-40	200-35-200	6.5	60-40-200	1.0-4.5
	WB-40	100-30-100	6.0	90-25-160	1.0-12.0
	WB-62	480-55-480	15.0	140-60-560	8.0-10.0
	WB-62FL	550-45-550	19.0	200-55-600	7.0-16.4
	WB-67	550-45-550	19.0	200-55-600	7.0-16.4
	WB-92D	350-60-350	15.0	120-65-450	6.0-13.0
	WB-100T	250-60-250	7.0	100-60-300	5.0-8.0
	WB-109D	700-65-700	15.0	200-65-500	9.0-18.4
180	P	50-15-50	0.5	----	----
	SU-30	100-30-100	1.5	----	----
	SU-40	150-35-150	6.2	50-35-130	5.5-7.0
	WB-40	100-20-100	9.5	85-20-150	6.0-13.0
	WB-62	800-45-800	20.0	100-55-900	15.0-15.0
	WB-62FL	600-45-600	20.5	100-55-400	6.0-15.0
	WB-67	600-45-600	20.5	100-55-400	6.0-15.0
	WB-92B	400-55-400	16.8	120-60-400	9.0-14.5
	WB-100T	250-55-250	9.5	100-55-300	8.5-10.5
	WB-109D	700-55-700	20.0	200-60-500	10.0-21.0

For curbed intersections, the effective turning radius must be considered in addition to the actual curb radius. As shown in **Figure 212.12.2**, where a parking lane (or bike lane) is present, the vehicle turn is offset from the edge of the roadway by the width of the parking lane or bike lane, creating an “effective turning radius” that is larger than the physical curb radius. Where there is no parking lane or bike lane, the corner radius and effective turning radius are the same. To minimize pedestrian crossing distance, designers should provide the shortest curb radius possible or provide bulbouts within the effective turning radius area. The corner radii should follow the guidance in **Table 212.12.3**, and accommodate the following:

- The control vehicle, design vehicle, and design speed for each street
- Available R/W
- Angle of turn between intersection legs
- Presence of on-street parking or a bike lane
- The width and number of lanes on the intersecting street

Figure 212.12.2 Actual Curb Radius Vs Effective Radius

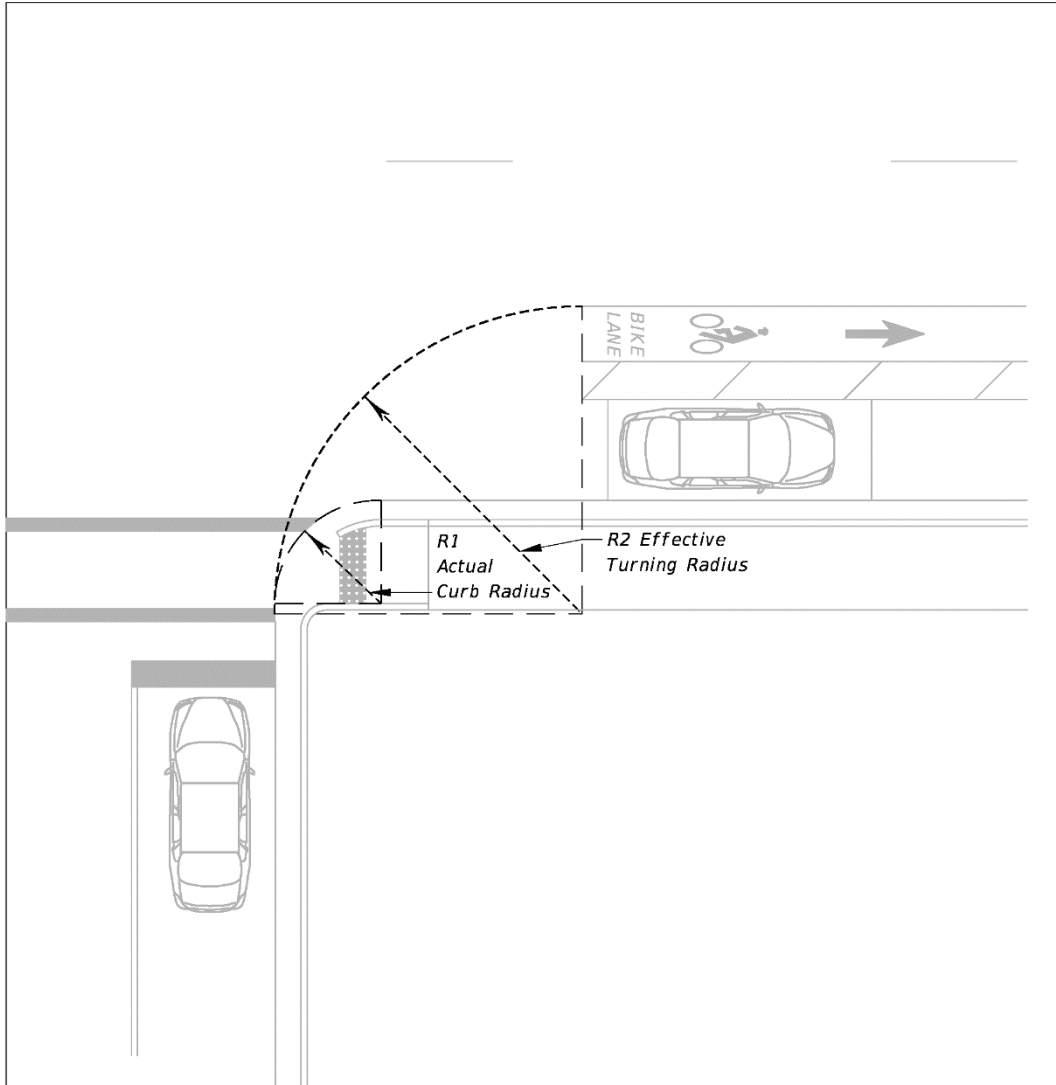

Table 212.12.3 Recommended Corner Radii

R1 Actual Curb Radius (feet)	R2 Effective Turning Radius (feet)	Operational Characteristics
5-30	25 - 30	P vehicles and SU vehicles with minor lane encroachment
5-40	40	P vehicles, SU vehicles, and WB-40 vehicles with minor encroachment
5-50	50	All vehicles up to WB-40
<p>Notes:</p> <p>(1) Table 212.12.3 assumes perpendicular intersections. For skewed intersections, establish radius using AutoTurn or turning templates.</p> <p>(2) Confirm the actual curb radius using AutoTurn or turn templates.</p>		

Guidelines for corner radii in C4, C5, and C6 context classifications without on-street parking or a bike lane are as follows:

- (1) Radii of 15 to 25 feet are adequate for passenger vehicles. These radii are suitable for minor cross streets where there is little occasion for trucks to turn and at major intersections where there are parking lanes;
- (2) Radii of 25 feet or more should be provided at minor cross streets on new construction or reconstruction projects;
- (3) Radii of 30 feet or more should be provided at minor cross streets where practical so that an occasional truck can turn without too much encroachment;
- (4) Radii of 40 feet or more or preferably three-centered curves or simple curves with tapers to fit the paths of large truck combinations, should be provided where such combinations or buses turn frequently. Where speed reductions would cause problems, larger radii should be considered; and,
- (5) Curb radii should be coordinated with crosswalk distances or special designs should be used to make crosswalks efficient for all pedestrians. Where larger radii are used, an intermediate refuge or median island is desirable or crosswalks may need to be offset so that crosswalk distances are not excessive. See **FDM 210.3** for additional information on islands.

212.12.2 Turning Roadways with Corner Islands

Consider providing a corner island at an intersection where paved areas are excessively large or do not establish proper channelization of traffic. Corner islands can provide delineation for through and turning traffic. In addition, corner islands shorten crosswalks and give pedestrians and bicyclists a refuge area. See **FDM 210.3.2** for island requirements.

Channelized right-turn lanes can be designed with a flat or near perpendicular angle of entry to the cross street (see **Figure 212.12.3**). The flat angle of entry is most appropriate for higher-speed turning movements with no pedestrian accommodations. Large turning radii and angles of entry into the cross street allow higher turning speeds, reduced traffic delays, and the turning movement of large trucks. The higher speeds, angle of entry and large radii adversely impact pedestrian safety at the crosswalk.

The near perpendicular angle of entry is preferred where pedestrian facilities are provided. Tight turning radii and angles of entry into the cross street accommodate the following:

- Slower turning speeds,
- Reduced cross walk length,
- Improved pedestrian visibility,
- Improved sight distance,
- Decreased angle of driver head turning,
- Reduced right-of-way impacts.

Figure 212.12.3 Channelized Right Turn Lanes

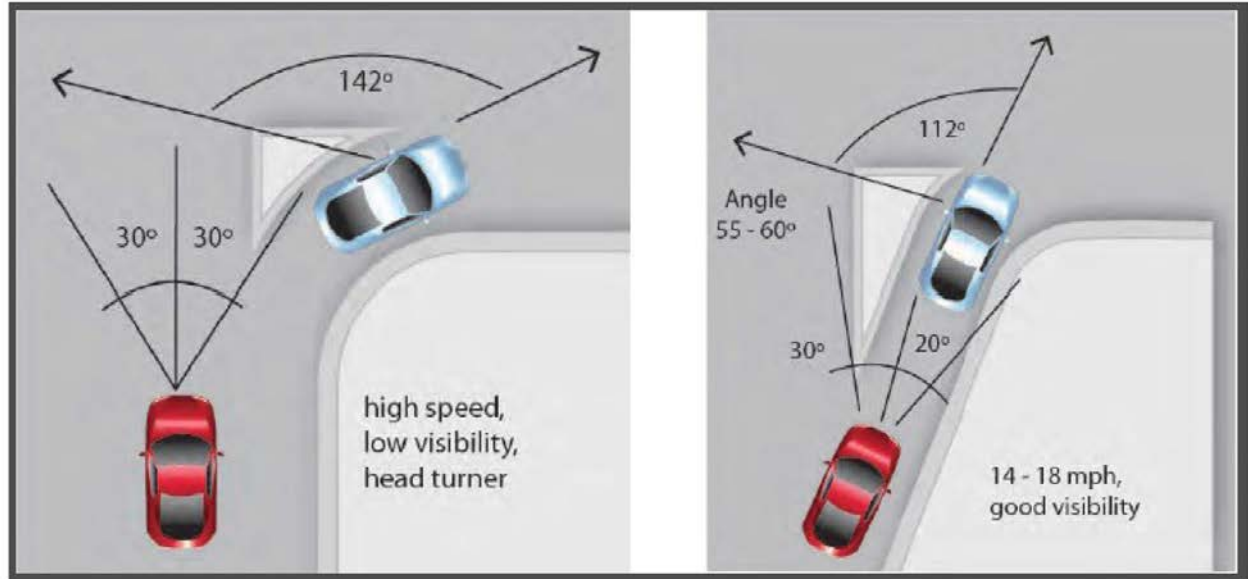

Ref: Figure 9-19, 2018 AASHTO Green Book

Consider the near perpendicular right-turn lane design in **Figure 212.12.4** when the following conditions are met:

- Context Classifications C2T, C3, C4, C5 and C6
- Low-speed roadway (design speeds of 45 mph and less)
- Pedestrian traffic is expected
- No acceleration lane is provided

This design includes the previously-mentioned benefits to passenger cars and pedestrians with striping and a scalene triangle shaped corner island. An approaching deceleration lane is preferred to provide vehicles additional time to stop for crossing pedestrians. The crosswalk is set back 20 feet minimum from the end of the island to allow room for a passenger car to wait for a gap in traffic without blocking the crosswalk. As shown in **Figure 212.12.4**, the outside curb radii can be designed to accommodate over-tracking of large vehicles such as single-unit trucks, transit, or Florida Interstate Semi-trailers (WB-62FL).

Figure 212.12.4 Near Perpendicular Right-Turn Lane

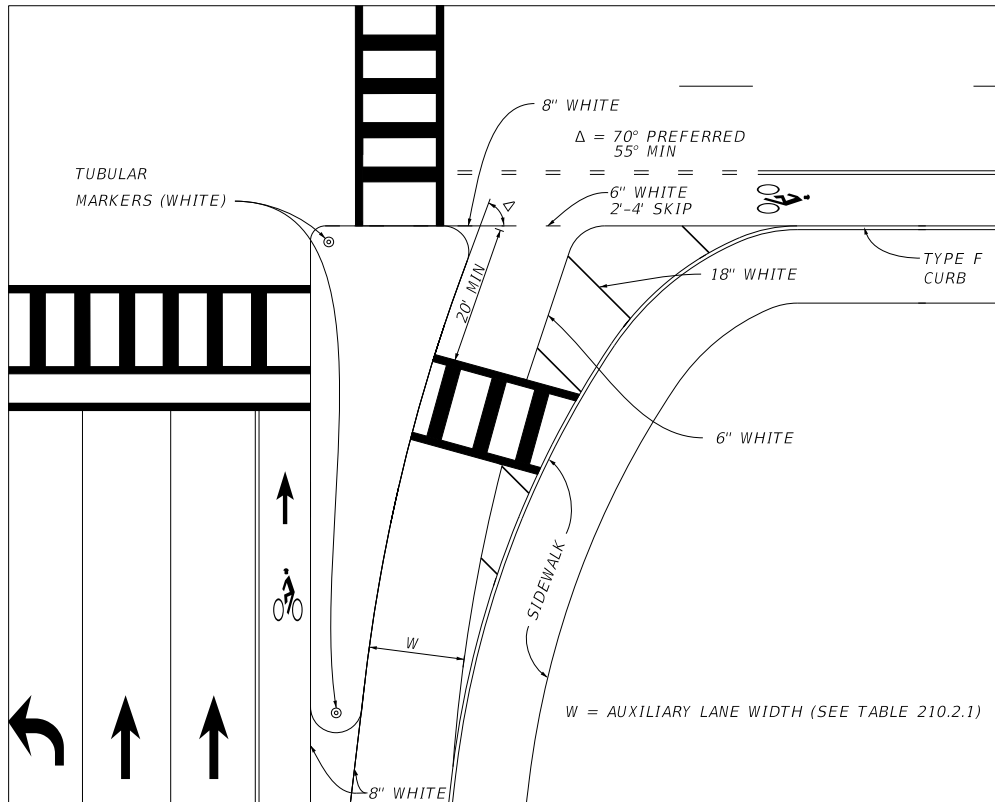

212.12.3 Mountable Truck Aprons

Truck aprons are used to manage the turning movements of vehicles where pedestrian or bicycle facilities are present. A truck apron is a mountable portion of an intersection designed to:

- Manage the turning speed of passenger vehicles
- Accommodate the turning movements of large trucks
- Minimize instances of off-tracking over street corners when making turns
- Reduce risks to bicyclists and pedestrians.

Design a mountable truck apron by either of these methods:

- Attach to a full height curb and allow water to flow along the apron's outer edge.
- Separate from the full height curb to allow water to flow along the curb's edge.

See **Figure 212.12.5** for additional details.

Locate all traffic equipment, bicycle features, and pedestrian features (e.g., detectable warning surfaces, bicycle stop bars, curb ramps, etc.) behind the mountable surface area. The design of a mountable truck apron at intersections should incorporate Type RA curbs. See **FDM 213.3.8** for additional truck apron requirements. Cross slopes shown in **Figure 213.3.2** may be adjusted based on intersection site conditions.

Figure 212.12.5 Mountable Truck Apron

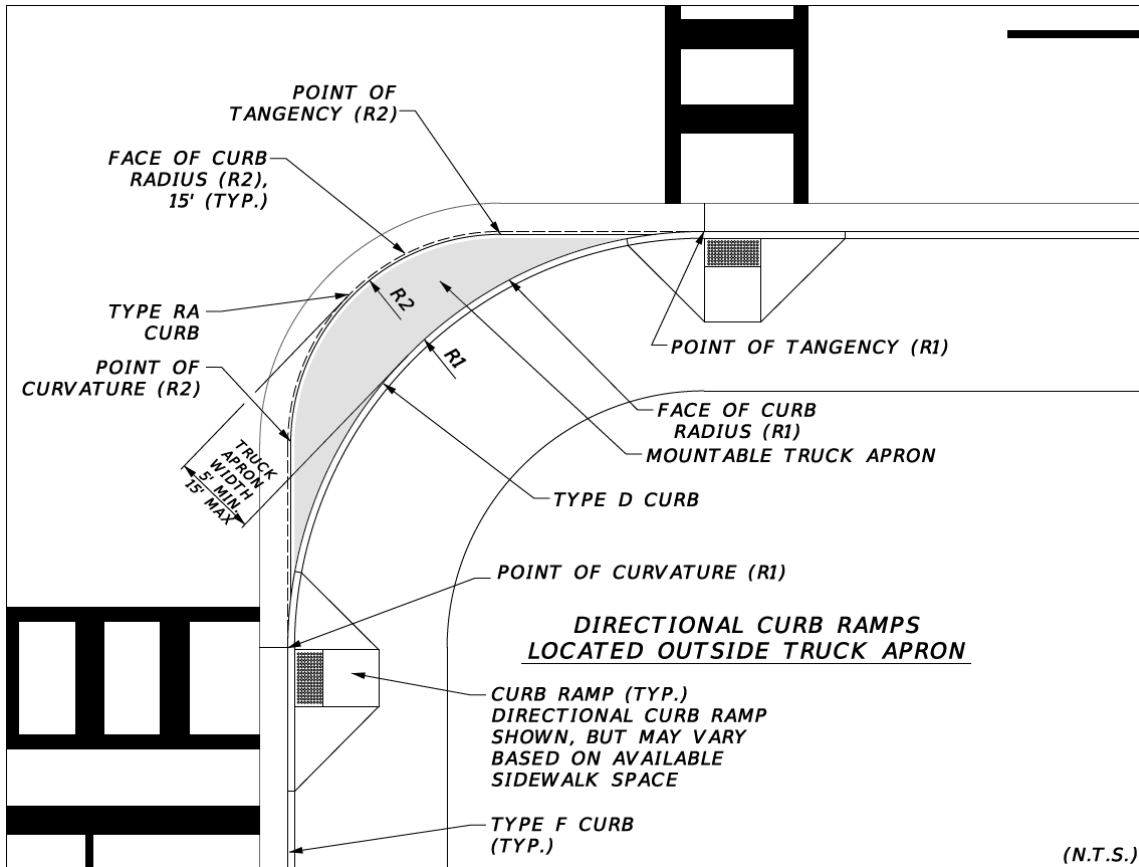

212.12.4 Free-Flow Design

Provide superelevation on free-flow turning roadways. An important part of the design on some intersections is the design of a free-flow alignment for turns. Ease and smoothness of operation can result when the free-flow turning roadway is designed with compound curves preceded by a deceleration lane. Turning radii and pavement cross slope for free-flow right-turns at speeds greater than 10 mph are a function of the design speed and design vehicle. In general, the design speed of the turning roadway should be equal to or within 10 to 20 mph less than the through roadway design speed.

It is desirable to provide as much superelevation as practical on intersection curves, particularly where the intersection curve is sharp and on a downgrade. However, the short curvature and short lengths of turning roadways often prevents the development of a desirable rate of superelevation. **Table 212.12.4** provides the minimum superelevation rates in relation to design speed. The wide variation in likely speeds on intersection curves precludes the need for precision, so only the minimum superelevation rate is given for each design speed and intersection curve radius.

Table 212.12.4 Superelevation Rates for Turning Roadways

	Design Speed (mph)							
	10	15	20	25	30	35	40	45
Minimum Superelevation Rate	NC	NC	0.02	0.04	0.06	0.08	0.09	0.10
Minimum Radius (feet)	25	50	90	150	230	310	430	540

See **FDM 210.9** for additional superelevation criteria.

212.12.5 Dual and Triple Left-Turns

Double and triple turn lanes require turning radii that will accommodate the selected design vehicles turning simultaneously. The radius of curvature in combination with the track width of the design vehicles will establish the required width within the turn. Lane lines (i.e., guidelines) and width requirements should be determined by plotting the swept paths of the selected design vehicles. For preliminary layout of intersection geometry, use the swept path of the design vehicle on the inside turning lane to locate the median nose and crosswalk on the crossing street (at the receiving point of the left-turn).

The design of dual turns should accommodate a SU-40 vehicle and a P vehicle turning simultaneously, as illustrated in **Figure 212.12.6**.

Figure 212.12.6 P and SU Design Vehicles Turning Simultaneously

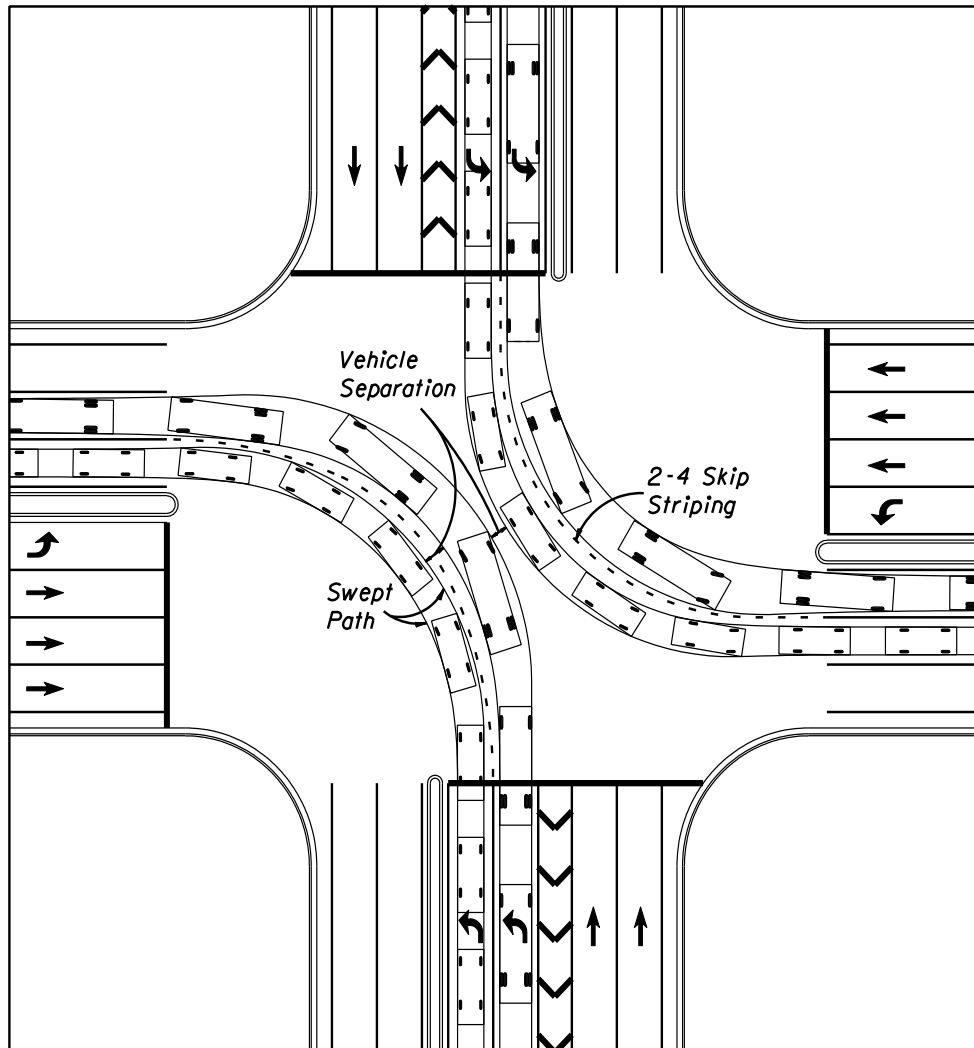

The design of triple left-turns should accommodate a WB-62FL (outside lane), a SU-40 (center or inside lane), and a P vehicle (center or inside lane) turning simultaneously.

Establish the control radius for the inside turning lane based on the guidance in **FDM 212.14.5** and **Table 212.9.2**. Establish the inside edge of the outer lane by providing a minimum 4-foot separation between swept paths of the selected design vehicles traveling in the same direction. Except for turns with large radii, the inside edge of the outer lane will not be concentric with the selected control radius. The radius for the inside edge of the outer turn lane should be determined by analysis of the plotted swept path of the design vehicles.

Provide at least 8 feet of separation between vehicles traveling in opposing directions. The separation may be less than 8 feet when:

- (1) Turning paths are highly visible and speeds are low, or
- (2) Signal left-turn phases are not concurrent for the opposing directions.

212.13 Islands

See **FDM 210.3** for island criteria.

212.14 Auxiliary Lanes

The primary function of auxiliary lanes at intersections is to accommodate speed changes, storage and maneuvering of turning traffic. The length of the auxiliary lane is the sum of the deceleration length, queue length and approach end taper. Pavement marking requirements for auxiliary lanes are included in [Standard Plans, Index 711-001](#).

212.14.1 Deceleration Length

The required total deceleration length is that needed for a safe and comfortable stop from the design speed of the highway. See **Exhibit 212-1** for minimum deceleration lengths (including taper) for left-turn lanes.

Right-turn lane tapers and lengths are identical to left-turn lanes under stop control conditions. Right-turn lane tapers and lengths are site-specific for free-flow or yield conditions.

212.14.2 Queue Length

The queue length provided should be based on a traffic study.

For low-volume intersections where a traffic study is not justified, a minimum 50-foot queue length (2 vehicles) should be provided for C1, C2, and C3R context classifications. A minimum 100-foot queue length (4 vehicles) should be provided in C2T, C3C, C4, C5, and C6 context classifications. Locations with over 10% truck traffic should accommodate at least one car and one truck.

For queue lengths at signalized intersections, refer to **FDM 232.2**.

212.14.3 Approach End Taper

The length of approach end tapers is 50 feet for a single turn lane and 100 feet for two or more turn lane, as shown **Exhibit 212-1**. These taper lengths apply to all design speeds.

212.14.4 Offset Left-Turn Lanes

The alignment of opposing left-turn lanes and the horizontal and vertical curvature on the approaches are the principal geometric design elements that determine how much sight distance is available to a left-turning driver. Vehicles queuing in opposing left-turn lanes restrict each other's view of oncoming traffic in the through lanes. The level of restricted view depends on the alignment of opposing left-turn lanes with respect to each other and the type of vehicles in the opposing queue.

The offset distance is defined as the distance between the left edge of the turn lane and the right edge of the opposing turn lane. If the offset distance is to the left of the turn lane, it is considered a negative offset; and if it is to the right of the turn lane, it is considered a positive offset, as illustrated in **Figure 212.14.1**.

Figure 212.14.1 Negative and Positive Offset Left Turns

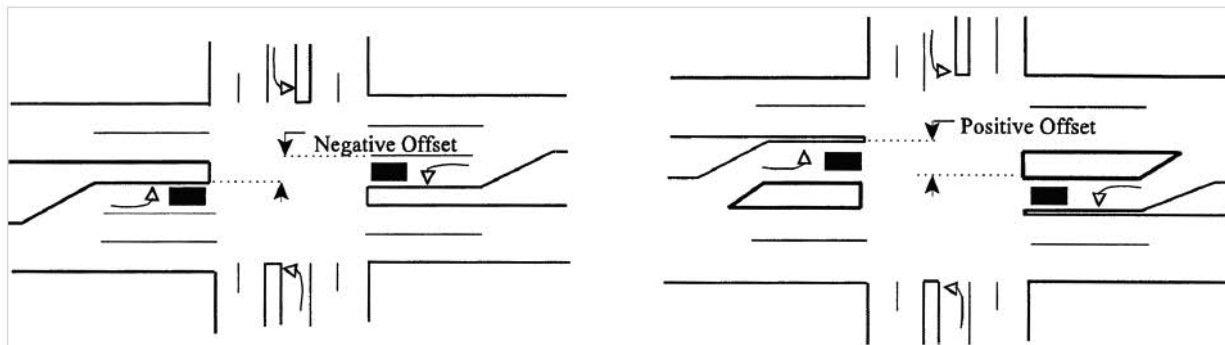

The conventional method of designing left-turn lanes is to place the left-turn lanes adjacent to the through lanes. This design creates a negative offset which restricts the sight distance of the left-turning driver's view of oncoming traffic when another vehicle is in the opposing turn lane. **Figure 212.14.2** indicates the negative offset when the conventional design is used.

Figure 212.14.2 Opposing Left Turns (22' Median with Negative 10' Offset)

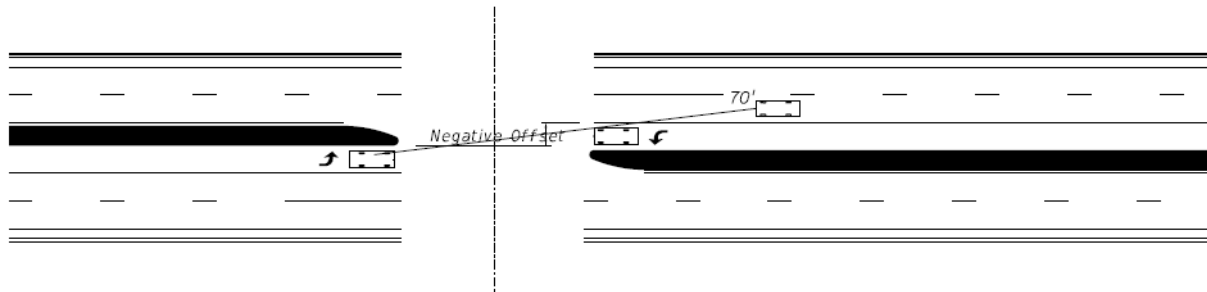

On curbed roadway designs, offset left-turn lanes should be used with median widths greater than 18 feet. A 4-foot traffic separator should be used when possible to channelize the left-turn and provide separation from opposing traffic.

Consider offset left-turn lanes at C1, C2, and C3R context classification intersections with high turning movements. For median widths of 30 feet or less, use a parallel offset left-turn lane. Stripe the area between the offset left-turn lane and the through traffic lane where vehicles are moving in the same direction. For medians wider than 30 feet, consider a tapered offset left-turn lane. An offset left is illustrated in **Figure 212.14.3**.

2018 AASHTO Green Book Figure 9-41 illustrates the design of parallel and tapered left-turn lanes.

Figure 212.14.3 Typical Opposing Left-Turns (22-Foot Median with Negative 1-Foot Offset)

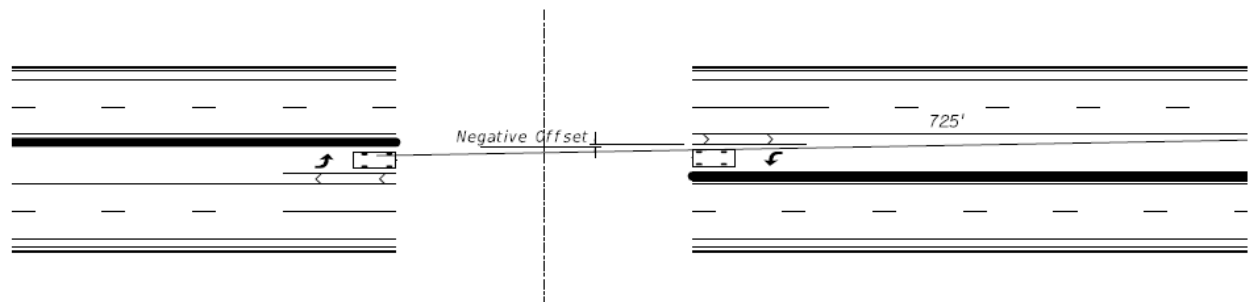

At locations where the full offset distances cannot be obtained, it is recommended that the minimum offset distances shown in **Table 212.14.1** be provided to achieve minimum required sight distances according to design speed. It is recommended that the "Opposing Truck" values be used where the opposing left-turn traffic includes a moderate to heavy volume of large trucks.

Table 212.14.1 Minimum Offset Distances for Left-Turn Lanes

Design Speed (mph)	Minimum Offset (feet)	
	Opposing Car	Opposing Truck
≤ 30	1.0	3.0
35	1.5	3.5
40 - 45	2.0	4.0
50 - 55	2.5	4.5
60 - 65	3.0	4.5
70	3.0	5.0

212.14.5 Directional Median Openings

Directional (channelized) median openings are designed to accommodate left-turn movements from the through roadway and prevent or discourage left-turn and crossing movements by traffic from a side road or driveway. Directional median openings are to be provided in accordance with the access management plan for the roadway.

The design of a directional median opening must accommodate the swept path of the predominant design vehicle. Channelization may be achieved using a combination of traffic separators, islands, and tubular markers. See **FDM 210** for additional information on islands. See **Standard Plans, Index 520-020** for standard details for 4 feet, 6 feet and 8.5 feet wide traffic separators. See **FDM 230.2.7** for additional information on tubular markers.

Typical layouts for directional median openings for high-speed roadways with 40-foot-wide medians are provided in **Exhibits 212-8, 212-9** and **212-10**. Type E curb and raised islands in conjunction with the minimum offsets shown in these figures may be used on high-speed roadways for directional median openings.

DIRECTIONAL MEDIAN OPENING: SU & WB-40 PARALLEL TURN BAY

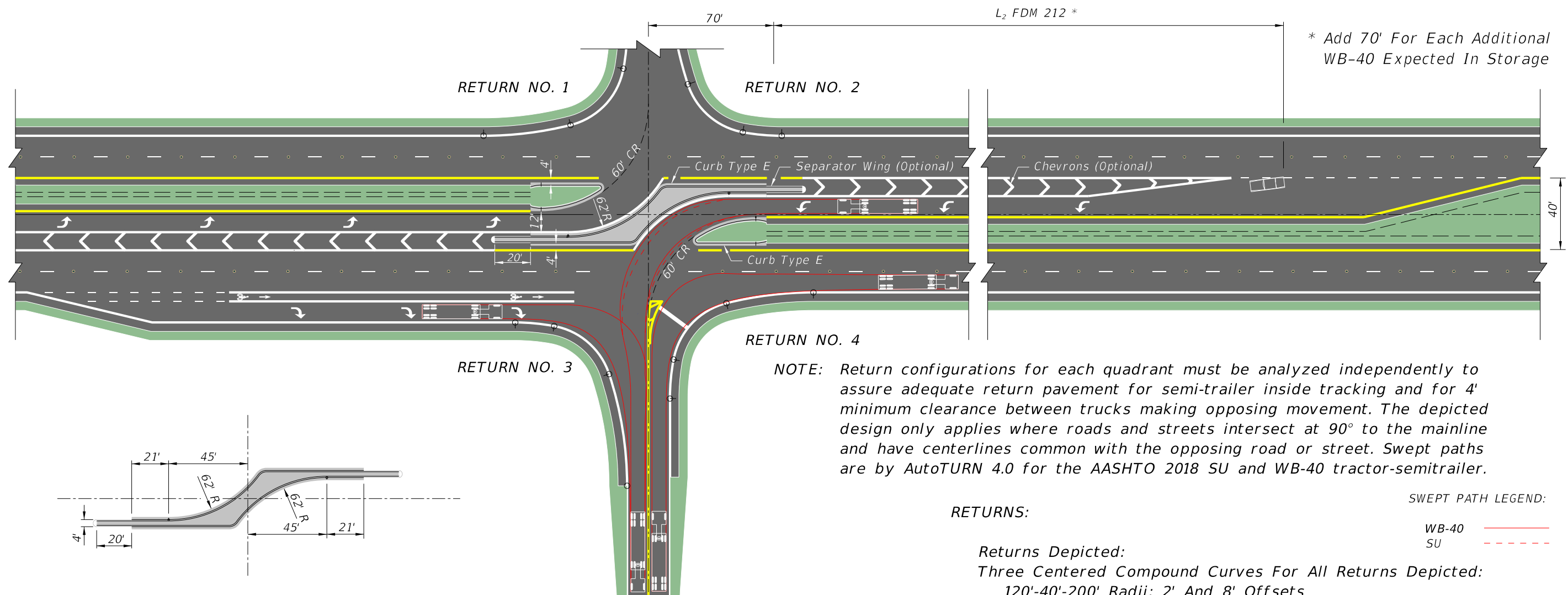

* Add 70' For Each Additional WB-40 Expected In Storage

NOTE: Return configurations for each quadrant must be analyzed independently to assure adequate return pavement for semi-trailer inside tracking and for 4' minimum clearance between trucks making opposing movement. The depicted design only applies where roads and streets intersect at 90° and have centerlines common with the opposing road or street. Swept paths are by AutoTURN 4.0 for the AASHTO 2018 SU and WB-40 tractor-semi-trailer.

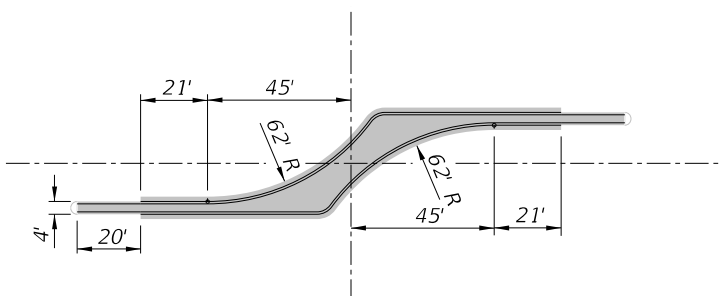

RETURNS:

Returns Depicted:
 Three Centered Compound Curves For All Returns Depicted:
 120'-40'-200' Radii; 2' And 8' Offsets
 Simple Curve With Tapers Not Shown:
 40' Radius; 1:15 And 1:8 Tapers With
 2' And 8' Offsets Tested (Practical Fit)

SWEPT PATH LEGEND:
 WB-40 ——— (solid red line)
 SU - - - - - (dashed red line)

QUADRANT NOS. 1 & 2 VACANT

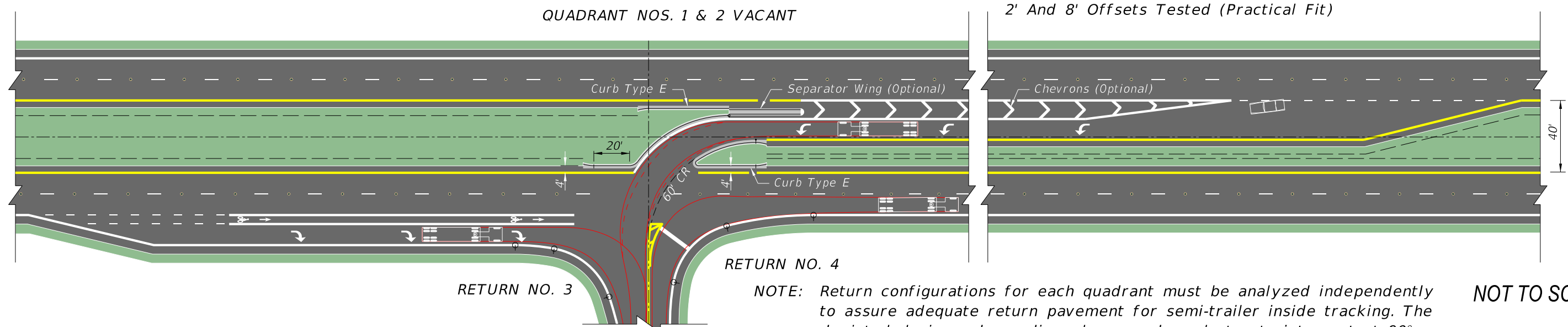

NOTE: Return configurations for each quadrant must be analyzed independently to assure adequate return pavement for semi-trailer inside tracking. The depicted design only applies where roads and streets intersect at 90° to the mainline. Swept paths are by AutoTURN 4.0 for the AASHTO 2018 SU and WB-40 tractor-semi-trailer.

NOT TO SCALE

DIRECTIONAL MEDIAN OPENING: WB-62 PARALLEL TURN BAY

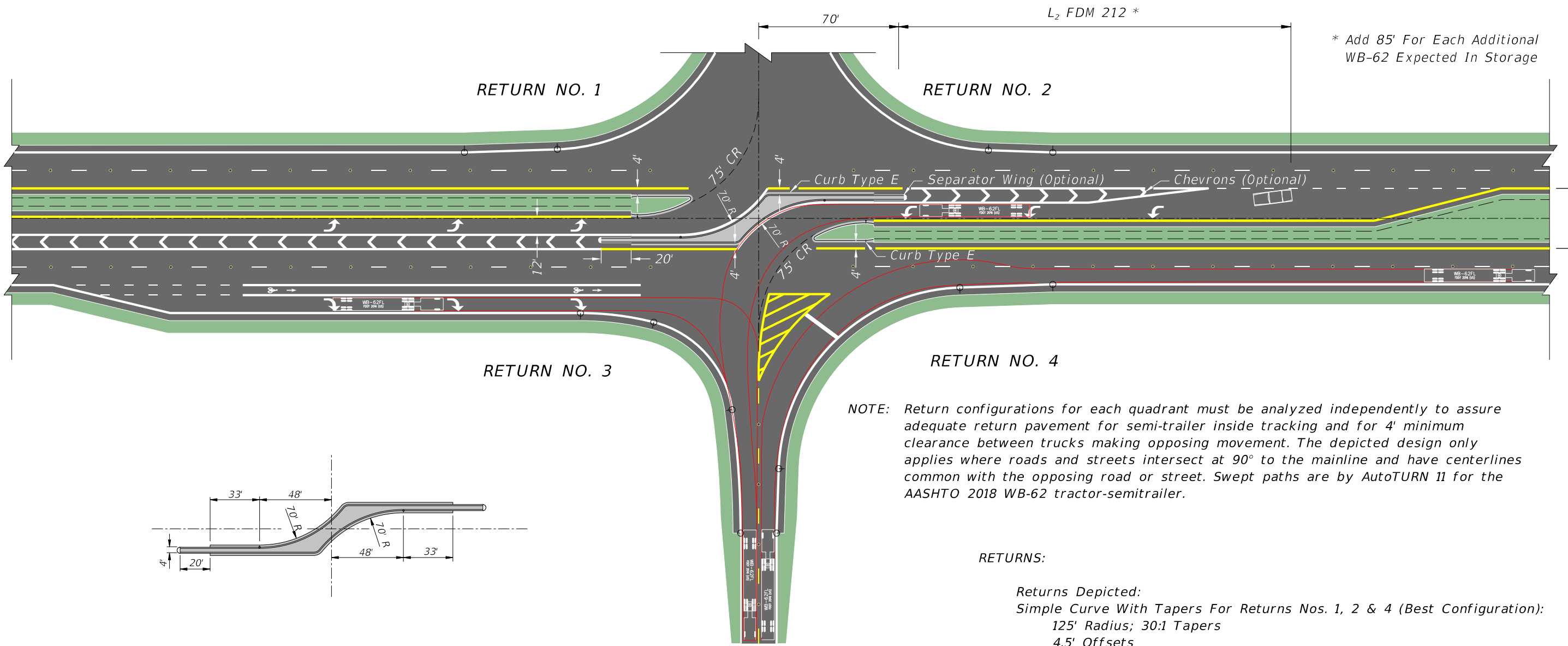

NOTE: Return configurations for each quadrant must be analyzed independently to assure adequate return pavement for semi-trailer inside tracking and for 4' minimum clearance between trucks making opposing movement. The depicted design only applies where roads and streets intersect at 90° to the mainline and have centerlines common with the opposing road or street. Swept paths are by AutoTURN 11 for the AASHTO 2018 WB-62 tractor-semitrailer.

RETURNS:

Returns Depicted:
 Simple Curve With Tapers For Returns Nos. 1, 2 & 4 (Best Configuration):
 125' Radius; 30:1 Tapers
 4.5' Offsets

Three Centered Compound Curves For Return No. 3:
 200'-70'-600' Radii; 1' And 11' Offsets

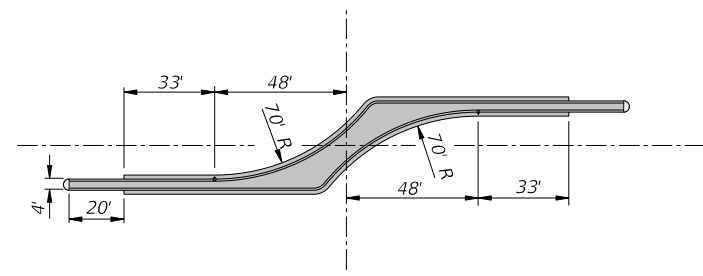

QUADRANT NOS. 1 & 2 VACANT

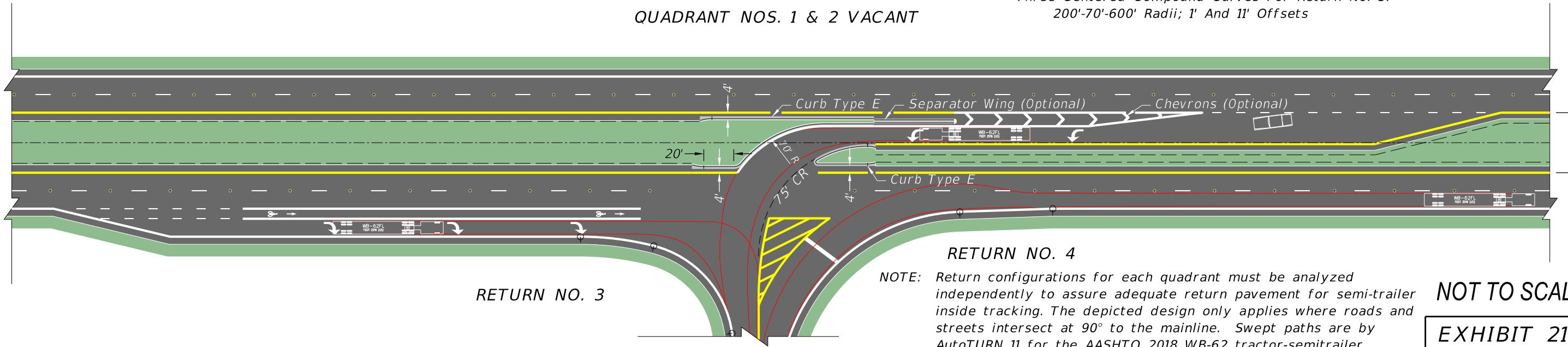

NOTE: Return configurations for each quadrant must be analyzed independently to assure adequate return pavement for semi-trailer inside tracking. The depicted design only applies where roads and streets intersect at 90° to the mainline. Swept paths are by AutoTURN 11 for the AASHTO 2018 WB-62 tractor-semitrailer.

NOT TO SCALE
EXHIBIT 212-9
01/01/2025

DIRECTIONAL MEDIAN OPENING: SU & WB-40 TAPERED TURN BAY

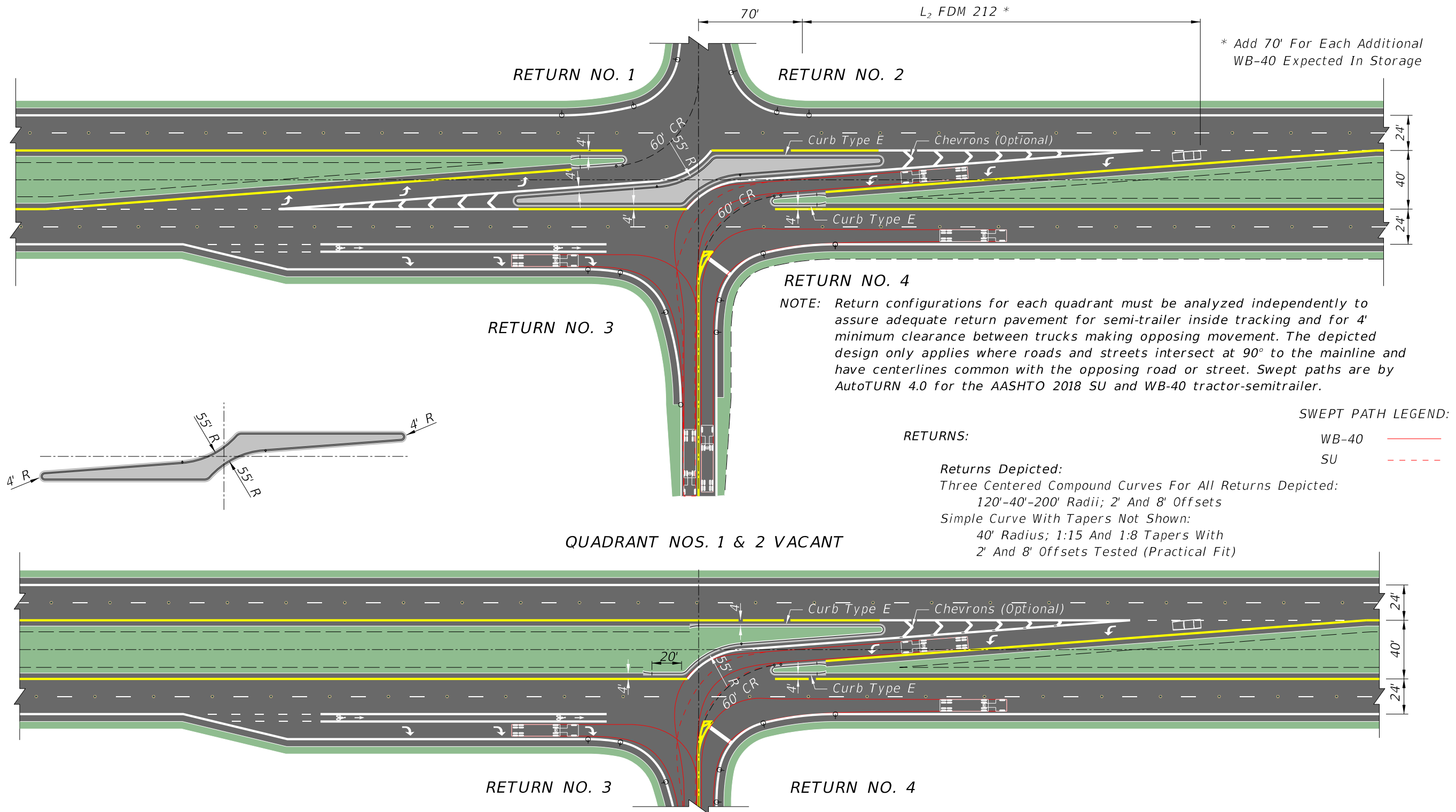

NOTE: Return configurations for each quadrant must be analyzed independently to assure adequate return pavement for semi-trailer inside tracking and for 4' minimum clearance between trucks making opposing movement. The depicted design only applies where roads and streets intersect at 90° to the mainline and have centerlines common with the opposing road or street. Swept paths are by AutoTURN 4.0 for the AASHTO 2018 SU and WB-40 tractor-semi-trailer.

SWEPT PATH LEGEND:

- RETURNS:**
- WB-40 ————
 - SU - - - - -
- Returns Depicted:**
- Three Centered Compound Curves For All Returns Depicted:
 - 120'-40'-200' Radii; 2' And 8' Offsets
 - Simple Curve With Tapers Not Shown:
 - 40' Radius; 1:15 And 1:8 Tapers With 2' And 8' Offsets Tested (Practical Fit)

NOTE: Return configurations for each quadrant must be analyzed independently to assure adequate return pavement for semi-trailer inside tracking. The depicted design only applies where roads and streets intersect at 90° to the mainline. Swept paths are by AutoTURN 4.0 for the AASHTO 2018 SU and WB-40 tractor-semi-trailer.

NOT TO SCALE