

211 Limited Access Facilities

211.1 General

This chapter includes criteria for Limited Access (LA) Facilities (tolled and non-tolled), including:

- (1) Interstates
- (2) Freeways
- (3) Expressways
- (4) Interchange ramps servicing high-speed LA Facilities
- (5) Collector-distributor roads (C-D) servicing high-speed LA Facilities

Design Turnpike Projects in accordance with Interstate criteria unless Turnpike Project criteria is provided.

Managed lanes design is an iterative process best performed in a collaborative environment involving various disciplines (e.g., managed lanes planning, PD&E, construction, maintenance, traffic operations, transportation systems management and operations). Coordinate with the Turnpike Toll Systems and Tolls Design Offices in Phase I of the design process. An explanation of the process and considerations is given in the FDOT [Managed Lanes Guidebook](#).

Many design criteria are related to Design Speed (e.g., vertical and horizontal geometry, sight distance). When the minimum design values are not met, an approved Design Exception or Design Variation is required. See **FDM 201.5** for information on Design Speed. See **FDM 122** for information on Design Exceptions and Design Variations.

The following manuals and documents provide additional information for the design of LA Facilities:

- [General Tolling Requirements \(GTR\)](#) - Use this document for design criteria and requirements for tolling on Turnpike and Non-Turnpike projects.
- **AASHTO's A Policy on Geometric Design of Highways and Streets (AASHTO Green Book)**.
- **A Policy on Design Standards – Interstate System, 2016 Edition (AASHTO)**.
- **Managed Lanes Guidebook**.
- [Traffic Engineering Manual \(TEM\)](#) - This manual is used to supplement [Manual on Uniform Traffic Control Devices \(MUTCD\)](#) standards and guidelines with

Florida-specific signs and pavement markings used on the State Highway System by the Department's Traffic Operations Offices.

Example roadway typical sections are included in the exhibits in **FDM 913**. Criteria regarding lanes, medians, and shoulders for bridges are illustrated in **FDM 260.1.1**. Subsequent sections of this chapter contain specific information and criteria regarding these and other typical section elements, as well as geometric features.

Existing project features which were constructed to meet minimum metric design criteria but are mathematically slightly less than equivalent minimum English design criteria, do not require Design Exceptions or Design Variations to remain. On reconstruction projects, every effort should be made to use current criteria and standards.

Specific requirements for toll site design (e.g., toll siting, toll facility demolition/renovation, toll facility site, toll facility building, and toll facility gantry) are given in the [General Tolling Requirements \(GTR\)](#).

211.1.1 Interstate Resurfacing Projects

Interstate resurfacing projects that do not meet the criteria in this chapter may use the AASHTO interstate standards that were in effect at the time of original construction or inclusion into the interstate system for the following elements:

- Horizontal alignment
- Vertical alignment
- Median width
- Traveled way width
- Shoulder width

Place documentation in Project Suite Enterprise Edition (PSEE) within the Design Development Documentation Module.

211.2 Travel Lanes and Auxiliary Lanes

Provide 12-foot travel lanes and auxiliary lanes on LA Facilities.

211.2.1 Ramps

On tangent sections, provide a 15-foot traveled way for one-lane ramps and 24-foot traveled way for two-lane ramps. Provide a 36-foot traveled way for three-lane ramps plus 12-feet for each additional lane for ramps with more than three lanes.

Consider providing a greater lane width for one-lane ramps where accommodation of future resurfacing is a factor.

Ramp widths in other areas such as terminals are controlled by the curvature and the vehicle type selected as the design control. Minimum ramp widths for turning roadways are given in **Table 211.2.1**. Typical details for ramp terminals are provided in the [Standard Plans, Index 000-525](#).

Table 211.2.1 Minimum Ramp Widths - Turning Roadways

Radius To Inside of Curve (feet)	Minimum Ramp Width (feet)		
	1-Lane		2-Lane
	Case I-C Traveled Way Width	Case II-B Traveled Way Width + Outside Paved Shoulder Width	Case III-A Traveled Way Width
	One-lane, one-way operation – no provision for passing a stalled vehicle	One-lane, one-way operation – with provision for passing a stalled vehicle	Two-lane operation – either one-way or two-way
50	23	26	29
75	20	23	27
100	18	22	26
150	17	21	24
200	16	20	24
300	15	20	24
400	15	19	24
≥ 500	15	19	24

Notes:

- (1) For case application, see **AASHTO Green Book**.
 - (a) Case I - Bus and combination trucks govern design.
 - (b) Case II - SU vehicles govern design, some consideration for semitrailer combination trucks.
 - (c) Case III – P vehicles govern design, some consideration for SU trucks.
- (2) **AASHTO** adjustments do not apply.

211.2.2 Pavement Cross Slopes

For roadways, the maximum number of travel lanes with cross slope in one direction is three lanes except as shown in **Figure 211.2.1**, which prescribes standard pavement cross slopes. A Design Variation or a Design Exception is required when proposed pavement cross slopes do not meet the requirements shown in **Figure 211.2.1**.

Outside auxiliary lane cross slopes must match or exceed the adjacent travel lane cross slope. The auxiliary lane cross slope cannot exceed the values in **Figure 211.2.1**. In superelevation transitions, do not exceed the maximum algebraic differences shown in **Table 211.2.2**.

The maximum algebraic difference in cross slope between adjacent through lanes is 0.04. The maximum algebraic difference in cross slope between a through lane and an auxiliary lane at a turning roadway terminal is given in **Table 211.2.2**.

Cross slopes on bridges are to be on a uniform, straight-line rate, typically 0.02 (See **FDM 260.4**). Use transitions to adjust for differences in cross slope between the approach roadway section and the required straight-line slope for bridge decks. Whenever possible the transition should be accomplished on the roadway section, outside the limits of the bridge and approach slabs. This will require detailing of the transition(s) in the roadway plans. Coordination between the Roadway, Drainage and Structures designers in the development of transitions is required to ensure compatibility and harmonizing at bridge approaches.

For shoulder cross slope transitions at bridge approaches, use the adjacent travel lane transition rate where feasible. The minimum length of transition is 100 feet.

Figure 211.2.1 Standard Pavement Cross Slopes

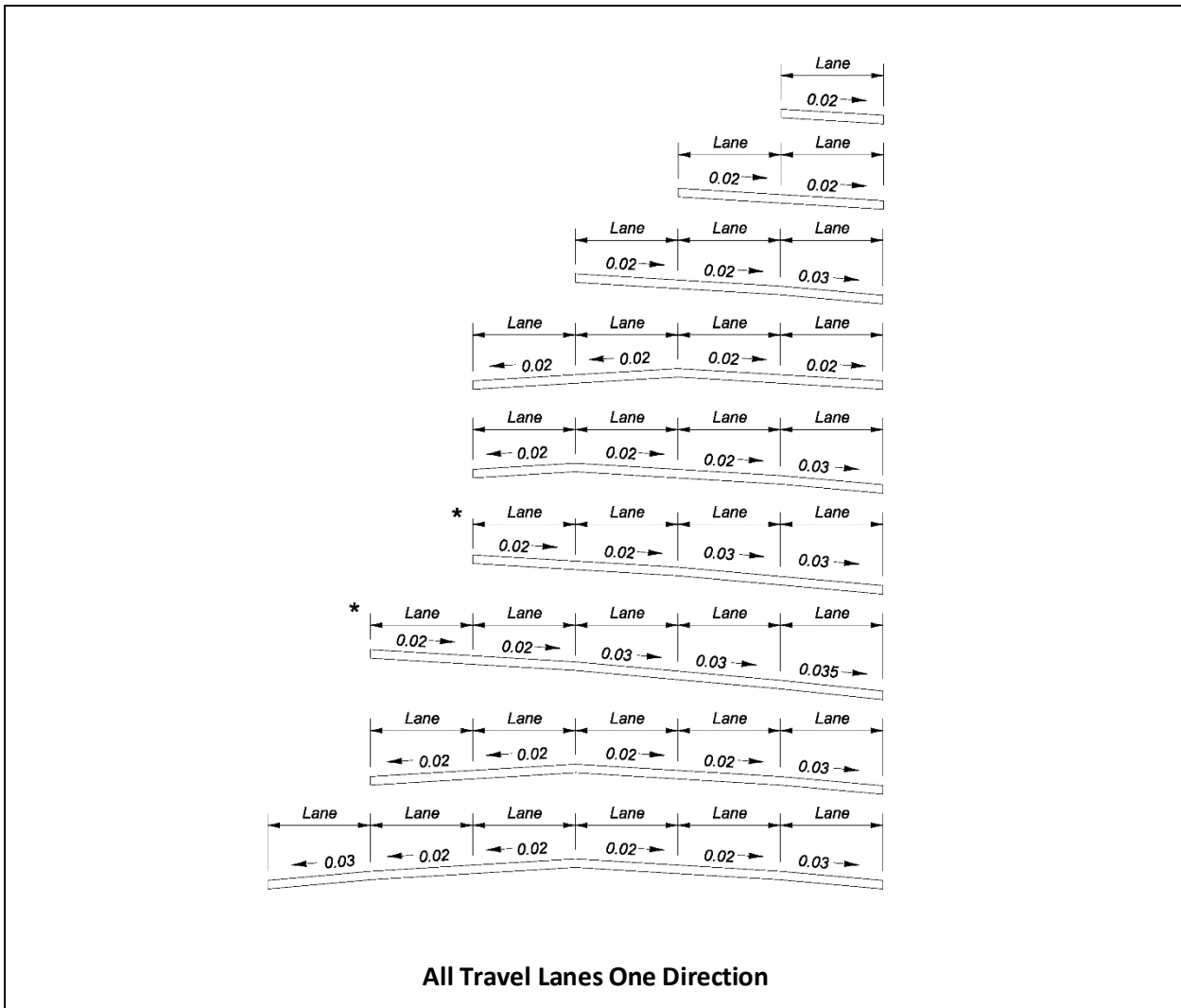

Notes:

- (1) These sections show only the standard slopes for adjoining travel lanes; they do not prescribe needed lanes, lane usage or typical section requirements other than lane slope.
- (2) Maximum pavement cross slopes for tangent sections are:
 - (a) 0.03 for Design Speeds greater than 45 mph
 - (b) 0.035 may only be used for 5-lanes sloped in one direction as shown above.
- (3) The maximum change in cross slope between adjacent through lanes is 0.04.
- (4) 4 or 5 lanes sloped in one direction (*) may be used with Design Speeds of 65 mph or less and longitudinal grades not exceeding 5%.

Table 211.2.2 Maximum Algebraic Difference in Cross Slope at Turning Roadway Terminals

Design Speed of Exit or Entrance Curve (mph)	Maximum Algebraic Difference in Cross Slope at Crossover Line (%)
Less than 35	6.0
35 and over	5.0

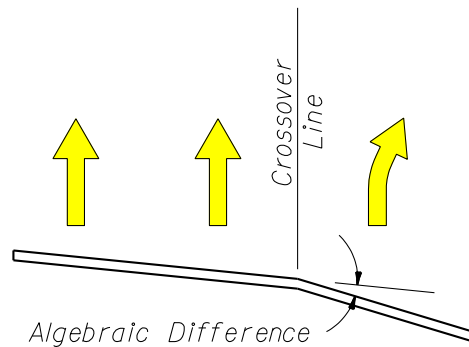
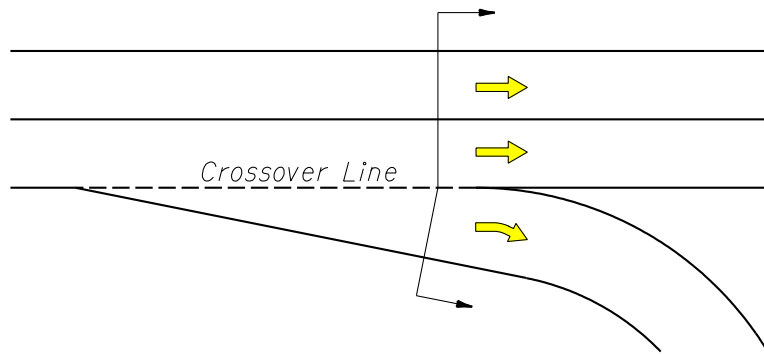

211.2.2.1 Existing Pavement Cross Slopes

Review the existing pavement and shoulder cross slopes for compliance with criteria. Field-verify existing pavement and shoulder cross slopes by one of the following:

- (1) Full Digital Terrain Model for the roadway width – evaluate cross slope on tangent sections at 100-foot intervals.
- (2) Vehicle Mounted Scanner – prior to design, using the results of the scan, determine roadway limits where cross slope is potentially out of tolerance and request Digital Terrain Model of the roadway width for these limits. Evaluate cross slope on tangent sections at 100-foot intervals.

If cross slopes do not meet the values in **Table 211.2.3**, additional cross sections may be required by the designer to develop cross slope correction details and estimate material quantities. Resurfaced pavement and shoulder cross slopes should meet new construction criteria. When cross slope correction is not practical, documentation in the design file is required. If existing conditions are within the allowable range shown in **Table 211.2.3**, the term “Match Existing” may be used on the Typical Section(s) to indicate that the existing cross slope is to remain. Superelevation requirements are covered in **FDM 211.8**.

When cross slope correction is necessary, work closely with the District Pavement Design Engineer and the District Bituminous Engineer to determine the appropriate method of correction. Tabulate existing cross slopes in the plans at 100-foot intervals within the limits of cross slope correction. Include cross slope correction details showing the method of correction in the plans (see examples in **FDM 913**). Do not show cross slope correction details on the roadway cross sections. Base cross slope correction material quantities on the method of correction shown in cross slope correction details.

Table 211.2.3 Allowable Range for Existing Pavement Cross Slopes

Facility or Feature	Standard (ft./ft.)	Allowable Range (ft./ft.)
Travel Lanes	0.02	0.015 - 0.025
Travel Lanes	0.03	0.025 - 0.035
Outside Shoulder	0.06	Adjacent Lane Cross Slope - 0.080
Median (left) Shoulder	0.05	0.020 - 0.080

Notes:

- (1) Standard cross slope (0.02 or 0.03) as designated in **Figure 211.2.1**.
- (2) The algebraic difference in cross slope between adjacent travel lanes must not exceed 0.04. The maximum algebraic difference in cross slope between a through lane and an auxiliary lane at a turning roadway terminal must meet **Table 211.2.2**.
- (3) When existing shoulders are to remain, the algebraic difference between the shoulder cross slope and adjoining roadway pavement cross slope must be ≤ 0.07 .
- (4) Outside auxiliary lanes must match or exceed adjacent travel lane cross slopes with a maximum cross slope of 0.035.

211.2.3 Hydroplaning Risk Analysis

Hydroplaning is caused by water film thickness on the pavement where driver expectations, vehicle maintenance, roadway geometry, or pavement condition could create a loss of friction between the tires and the pavement. Conduct a hydroplaning risk analysis that includes:

- Wet weather crash analysis
 - Identify trends in roadway location(s)
 - Review pertinent details in the crash records data (e.g. tire tread conditions, weather conditions, speed, driver attentiveness, roadway geometry, pavement condition, etc.)
- Pavement Conditions Report (e.g. could rutting contribute to water film thickness?)

211.2.3.1 Hydroplaning Prediction Tool

The hydroplaning prediction tool estimates the water film thickness on the pavement being analyzed and the speed at which hydroplaning may theoretically occur. This information may support utilizing a non-compliant typical section pavement cross slope.

The hydroplaning prediction tool is required for projects with the following:

- Additional contributing pavement (ex: managed lane separation, paved shoulder, paved gore, auxiliary lane, etc.) is added to the standard pavement cross slope sections shown in **Figure 211.2.1**.
- Superelevated sections as outlined in **Table 211.2.4**.
- Ungrooved bridge decks that exceed the requirements outlined above. Grooved bridge decks do not require an analysis.

The Hydroplaning Prediction Tool can be downloaded under Design Aids at:

<https://www.fdot.gov/roadway/drainage/hydroplaning>

Table 211.2.4 Hydroplaning Prediction Tool Requirements in Superelevated Sections

Project Type	Number of Lanes Draining in One Direction		
	Less Than 3 Lanes	3 Lanes	More Than 3 Lanes
Capacity Improvements & New Alignments	Not required	<ul style="list-style-type: none"> • Only when superelevation of lowest lane is less than 3% or • When there have been 2 or more wet weather crashes within the available 5-year crash data⁽¹⁾ 	Always required
RRR	Not required	<ul style="list-style-type: none"> • Only required when there have been 2 or more wet weather crashes within the available 5-year crash data⁽¹⁾ 	
Notes:			
(1) Wet weather crashes attributable to substandard geometric conditions that are approximately within the same location that would not be address with milling & resurfacing.			

For bridge transitions, evaluate mitigating strategies such as shortening transitions and staggering the cross-slope transitions prior to evaluating more costly solutions (e.g. bridge replacement and pavement type changes that require additional design details and a benefit-cost analysis.)

211.2.3.2 Hydroplaning Risk Analysis Documentation

When a hydroplaning risk analysis is performed, document the risk evaluation in a report format. At a minimum, the report should include:

- Identification of location(s)
- Substandard geometric or pavement condition(s) with the attributable wet weather crash analysis per **FDM 211.2.3**
- Potential mitigation strategies

If geometric or textured pavement mitigating strategies are evaluated, provide a benefit-cost analysis.

Submit the preliminary analysis with the 15% Line and Grade or Draft Typical Section Package (whichever is submitted first). Provide a final recommendation in conjunction with the Final Typical Section Package.

211.2.4 Roadway Transitions

The minimum merging roadway transition length (L) is calculated as follows:

- (1) Use $L = WS$ for Design Speeds ≥ 45 mph
- (2) Use $L = WS^2/60$ for Design Speeds ≤ 40 mph

Where: L = length of taper, feet

W = width of lateral transition, feet

S = Design Speed, mph

Exhibits 210-1 through **210-6** illustrate standard roadway transitions. For conditions not addressed in these exhibits, use the following:

- (1) Merging Taper = L
- (2) Shifting Taper = L/2
- (3) Shoulder Taper = L/3

Where there is an abrupt change in a roadway typical section (e.g., a 4-lane section to a 6-lane section), a striped lane transition may be considered when all the following conditions are met:

- New pavement widths are not substantially greater than the joining pavement,
- Grade differentials are slight, and
- Future widening is expected.

211.2.5 Number of Lanes on the State Highway System

See **Section 335.02(3)** of the *Florida Statutes* for the number of lanes to be provided on the State Highway System. Nothing in this statute precludes a number of lanes in excess of ten lanes. The Department will determine the appropriate number of lanes based on traffic demand. Consideration will be given to availability of right of way and the capacity to accommodate other modes of transportation within existing rights of way.

Topic No.: 525-030-020a Capacity Improvement Alternatives is the Department policy to assist in the identification of the most appropriate option for widening projects on all LA Facilities on the State Highway System (SHS). This policy applies to the Interstate System and to Florida's Turnpike Enterprise facilities.

211.3 Medians

Median width is the distance between the inside (median) edge of the travel lane of each roadway. Required median widths are given in **Table 211.3.1**.

Median ditches must be designed to meet the following requirements:

- Have sufficient depth to provide positive drainage of the adjacent subgrades. Typically, this requires a median depth of at least one foot below the subgrade shoulder point.
- Have recoverable side slopes within the clear zone in order to facilitate the recovery of errant vehicles. See **FDM 215** for additional information on roadside safety.
- Have sufficient longitudinal gradient and hydraulic capacity to ensure good drainage.

Table 211.3.1 Minimum Median Widths

Facility Type		Minimum Median Width (feet)
Interstate, Without Barrier		64
Freeway and Expressway, Without Barrier	Design Speed ≥ 60 mph	60
	Design Speed < 60 mph	40
All, With Barrier		26
Notes:		
(1) For Interstate (without barrier), provide an 88-foot median width when future lanes are planned.		

Facilities that have the ability to be expanded for additional capacity in the future will be designed to accommodate that future expansion. For example, a 4-lane high-speed facility that has the potential to expand to a 6-lane facility (without managed lanes) may be designed with a 50-foot median with barrier (e.g. guardrail, high tension cable barrier) instead of the required 60-foot median. A 50-foot median will accommodate a future 2-foot concrete median barrier, two 12-foot travel lanes and two 12-foot shoulders.

211.3.1 Bridge Median

See **FDM 260.5** for information on bridge medians.

211.3.2 Median Crossovers

This section addresses permanent median crossovers (i.e., median openings). The criteria in this section does not apply to contra-flow crossovers placed for facilitating hurricane evacuation, nor does it apply to temporary construction crossovers.

Permanent median crossovers are necessary to avoid excessive travel distances for emergency vehicles, law enforcement vehicles, and maintenance vehicles. Provide median crossovers only when there is a documented request and need for such a feature; however, they are to be limited in number and strategically located. The District Design Engineer (DDE) and the District Traffic Operations Engineer (DTOE) jointly approve the location of median openings.

The following **AASHTO Green Book** crossover recommendations have been adopted by the Department as requirements for permanent crossovers:

- (1) Not spaced closer than 3 miles apart.
- (2) Located only in areas with above-minimum stopping sight distance and without superelevated curves.
- (3) Not located within 1,500 feet of the end of a speed-change taper (of a ramp or facility widening/narrowing) or any structure (bridge, overpassing facility or overhead sign).
- (4) Not located where the median width is less than 25 feet.

Crossover locations that do not meet the above criteria require approval by the State Roadway Design Engineer. Non-conforming crossovers on Interstate facilities require approval by the State Roadway Design Engineer and Federal Highway Administration (FHWA).

The following additional FDOT criteria are also requirements for permanent crossovers:

- (1) Not located within 1.5 miles of any interchange.
- (2) Not located where the median width is less than 40 feet.
- (3) Not located in urban areas
- (4) Where continuous median barrier is present, openings for crossovers should not be greater than 5 miles apart between interchanges.

Typical layouts for the design of median crossovers are provided in **Exhibits 211-1** and **211-2**. These typical layouts may not cover all situations but are provided as a guide for developing site-specific designs. Designs should accommodate the types of emergency vehicles expected to use the crossover. Law enforcement vehicles and typical ambulance-sized vehicles can usually be easily accommodated. The typical layouts illustrated in the exhibits accommodate a SU design vehicle. To the extent practical, designs should accommodate larger emergency response vehicles such as fire trucks. This may require obtaining information from local emergency responders on the size and configuration of vehicles used. Except where median widths are wider than normal, fire trucks and other larger vehicles will likely not be able to make U-turns without encroaching or crossing travel lanes. As a minimum, designs should provide for the necessary minimum radii and width to allow the largest design vehicle to enter the crossover and stop as close to perpendicular to traffic as practical. All designs should be tested by superimposing the turning path of the design vehicle to ensure the crossover will operate as expected.

On Interstate facilities, the FHWA directs that median shoulders approaching the crossover utilize the standard shoulder width, or existing shoulder width. FHWA advocates that the safety benefits derived by making the crossovers appear less

conspicuous outweigh the benefits obtained by providing paved shoulders to accommodate acceleration and deceleration lanes for emergency vehicles, law enforcement, or other authorized vehicles.

The profile of the crossover is to conform as close as practical with travel way shoulder slopes and median side slopes so that the crossover is inconspicuous as possible to traffic. The paved width of the crossover should not be any wider than that necessary to provide for the largest design vehicle. Shoulder width for the crossover should be 8 feet minimum. Side slopes of the crossover (parallel with the mainline travel way) are to be 1:10 or flatter. However, side slopes may be transitioned to match the slope of a pipe culvert safety end treatment where a culvert crossing underneath the crossover is necessary to provide for proper median drainage.

For each proposed location, determine drainage requirements and make appropriate provisions. The drainage culvert shown in the exhibits are for example only. Either a mitered end section (1:4) or preferably a u-endwall with grate (1:6) should be used for culverts parallel with the mainline. In some cases, existing median ditches are shallow and there will be minimal clearances available for even small size culverts.

Provide a pavement design equivalent to a Limited Access shoulder pavement (i.e., 12-inch Stabilized Subgrade, Base Group 1, and 1.5 inch Structural Course).

A "No U-turn" sign (R3-4) with an "Official Use Only" plaque (FTP-65-06) is required for permanent crossovers. To improve nighttime visibility for approaching emergency responders, yellow RPMs are installed on the outside yellow edge line in advance of the crossover. See **Standard Plans, Index 706-001** for RPM placement.

Florida Administrative Code, [Rule 14-97](#), Section 14-97.003(3) (Access Control Classification System and Access Management Standards) regulates the location of driveway connections and median openings in interchange areas on arterial roads. This standard should be applied in accordance with the District procedures for implementing the Rule, and should not be confused with minimum requirements for LA R/W.

211.3.2.1 Existing Crossovers

On reconstruction and resurfacing projects, evaluate the location of existing crossovers for conformance to the above criteria. For those locations that do not meet the criterion in **FDM 211.3**, do one of the following:

- (1) Remove or relocate crossover as a part of the project.
- (2) Crossover locations that do not meet the **AASHTO Green Book** criteria require approval by the State Roadway Design Engineer to remain. Non-conforming

crossovers on Interstate facilities require approval by the State Roadway Design Engineer and Federal Highway Administration (FHWA) to remain.

- (3) Crossover locations that meet the **AASHTO Green Book** criteria, but do not meet additional FDOT criteria, require approval by the District Design Engineer to remain.

211.3.3 Managed Lanes Separation

Managed lanes are always separated from the general use lanes. Median openings and crossovers are prohibited within managed lanes.

There are four types of managed lanes separation treatments:

- (1) Barrier separation; see **Figure 211.3.1**
- (2) Contiguous separation with tubular markers; see **Figure 211.3.2**
- (3) Wide buffer separation; see **Figure 211.3.3**
- (4) Grade separation; see **Figure 211.3.4**

Managed lane separation type and width must be approved by the District Design Engineer. The maximum width for the contiguous separation is 3 feet. In developing the contiguous separation width, consideration should be given to transitions between new and adjacent roadway segment treatments and should be done in consultation with the DTOE. Install tubular markers per the **TEM**, Chapter 4. Use barrier separation or grade separation when implementing a reversible managed lane system. See the **Managed Lanes Guidebook** for factors to consider in determining separation type.

The maximum spacing and placement of tubular markers is provided in the **TEM**. If, based on operational and safety analysis, the EOR or the district wishes to increase the maximum allowable spacing, a Design Variation must be approved by the Chief Engineer.

When a wide buffer separation is selected, the buffer may include a grassed median or pavement. Paved wide buffers should be no more than 12 feet wide.

Figure 211.3.1 Managed Lanes Barrier Separation Typical Section

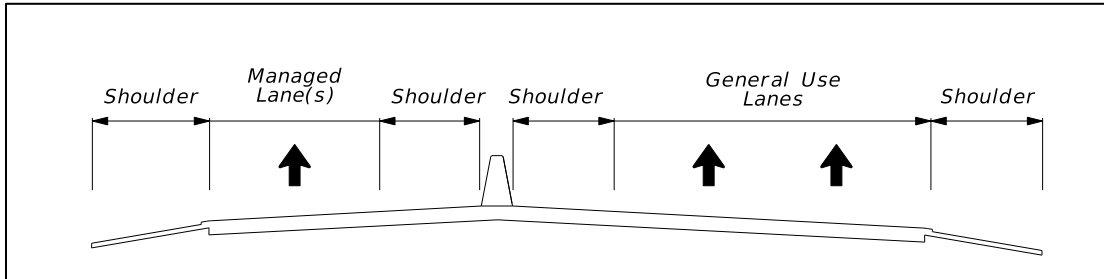

Figure 211.3.2 Managed Lanes Contiguous Separation with Tubular Marker Typical Section

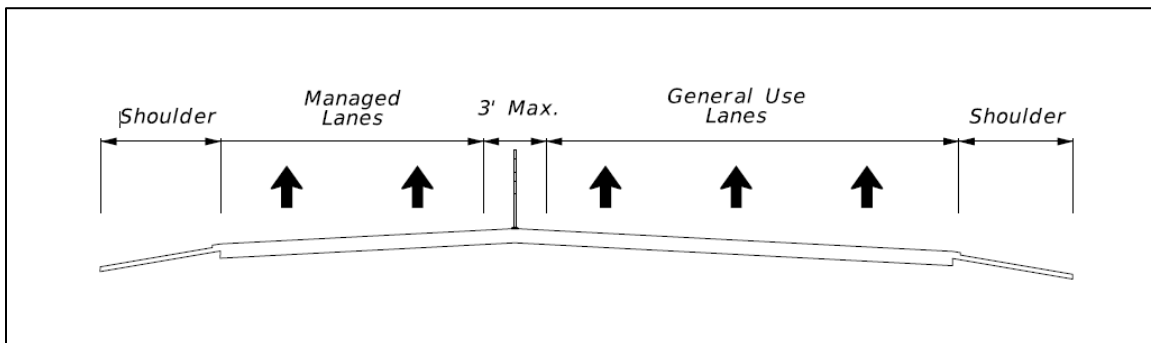

Figure 211.3.3 Managed Lanes Wide Buffer Separation Typical Section

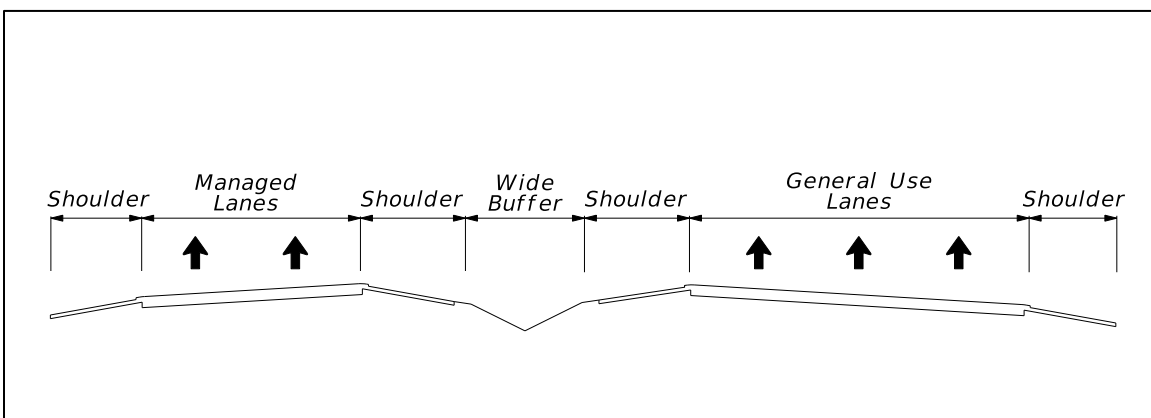
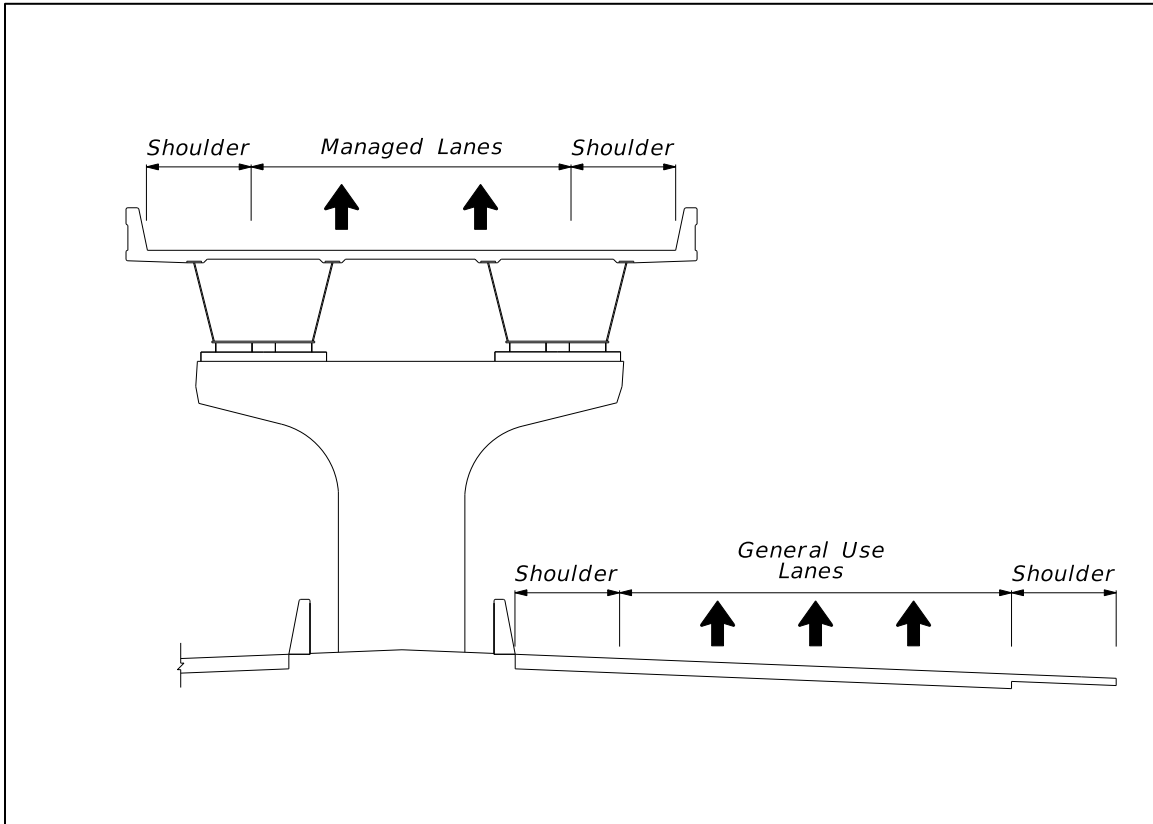
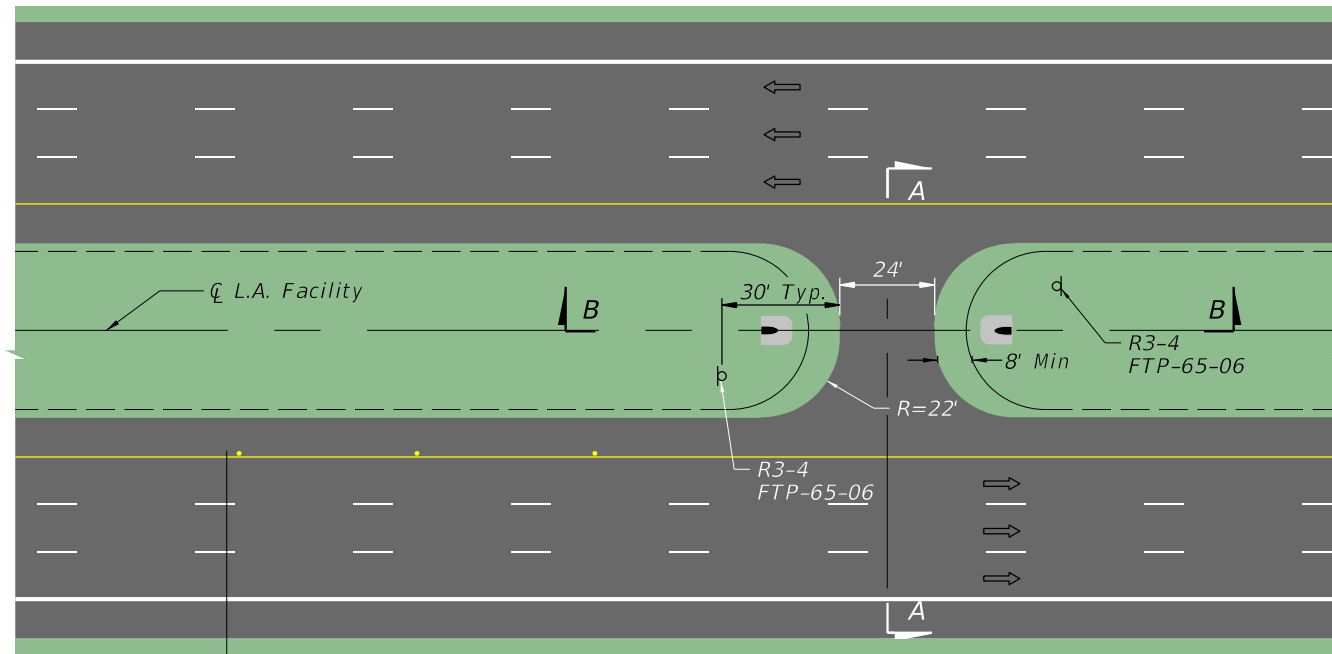

Figure 211.3.4 Managed Lanes Grade Separation Typical Section



MEDIAN CROSSOVERS TYPICAL LAYOUTS AND SECTIONS



Yellow RPMs Placed in Accordance with Standard Plans, Index 706-001
(Typical Each Side)

PLAN VIEW - 6 LANES (OR MORE)

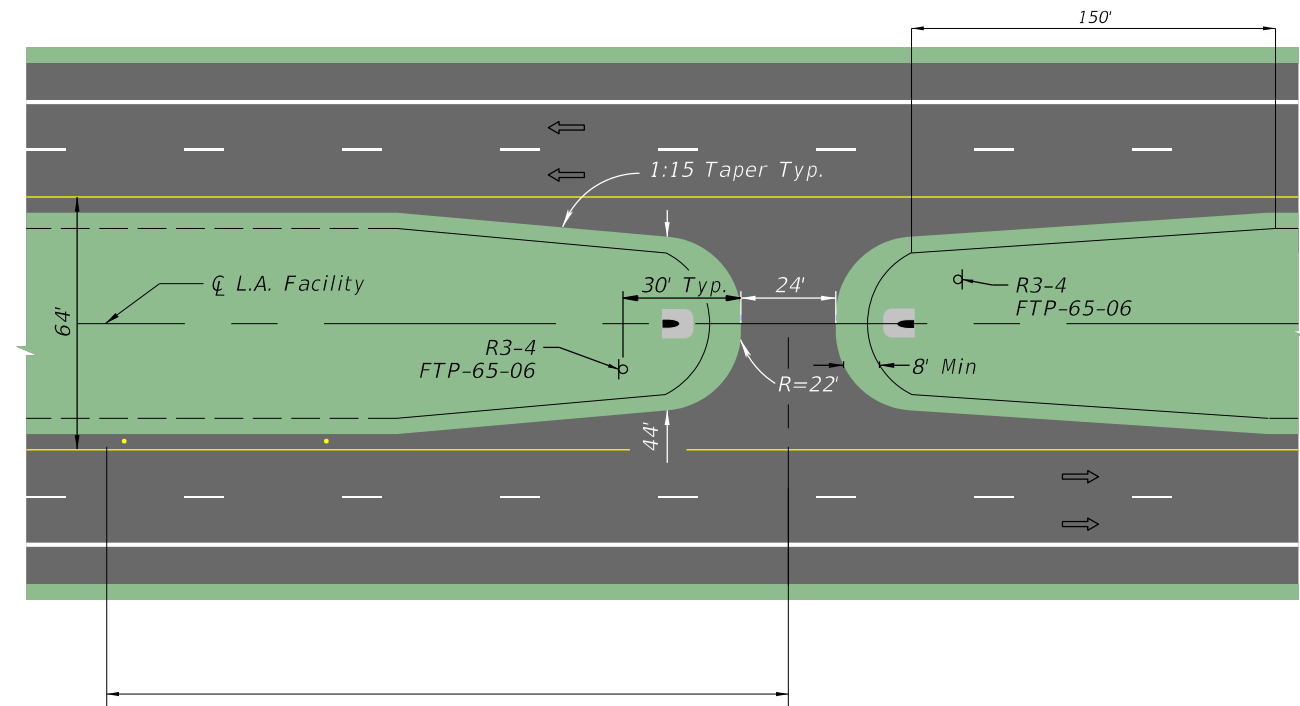

Yellow RPMs Placed in Accordance with Standard Plans, Index 706-001
(Typical Each Side)

PLAN VIEW - 4 LANES

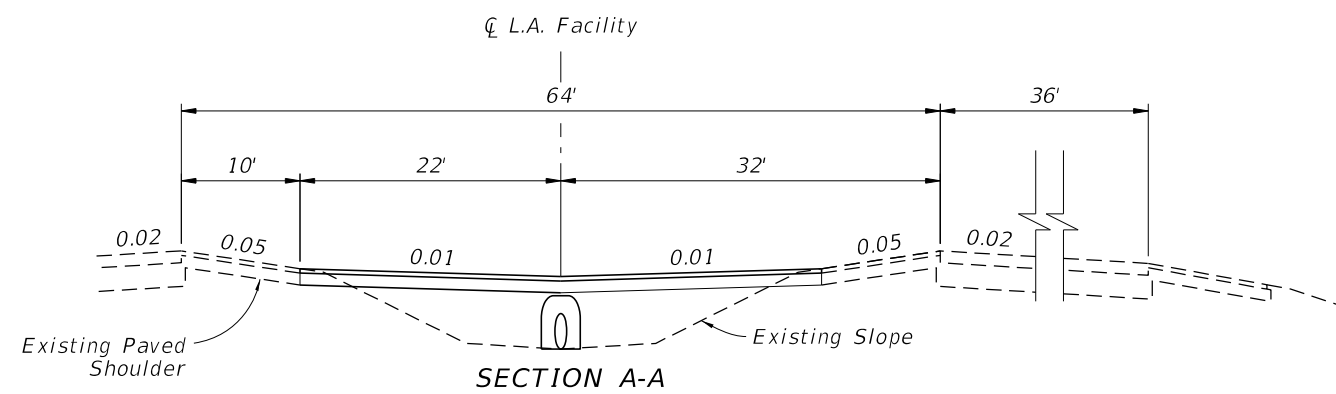

SECTION A-A

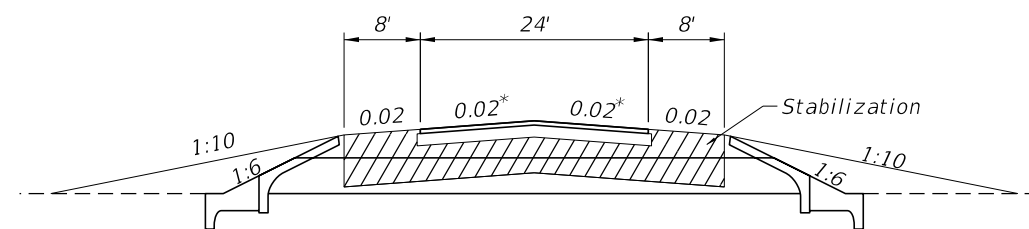

SECTION B-B

* For freeway grades 2% or greater,
match freeway grade

LEGEND:

Ⓟ Sign



OFFICIAL
USE ONLY

R3-4
(36"x36")

FTP-65-06
(36"x18")

NOT TO SCALE

EXHIBIT 211-1
01/01/2025

MEDIAN BARRIER OPENING FOR MEDIAN CROSSOVERS TYPICAL LAYOUT

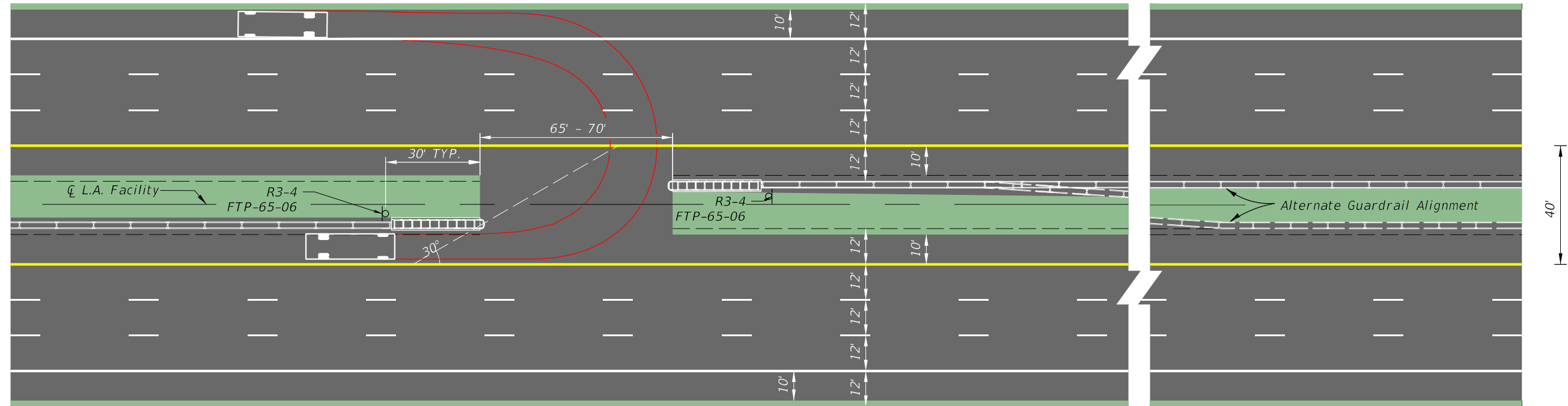

PLAN VIEW

LEGEND:

 Crash Cushion

 Barrier

 Sign

 SU Vehicle



R3-4
(36" x 36")



FTP-65-06
(36" x 18")

NOTES:

1. Provide Yellow RPMs placed outside yellow edge line in advance of crossover as shown in Standard Plans, Index 706-001.
2. Minimum turning radius for SU vehicle shown, and were generated by AutoTURN.
3. For lane and median configurations other than the 6-lane, 40-foot median shown here, adjustments in turn radii or additional pavement may be required.

NOT TO SCALE

EXHIBIT 211-2
01/01/2025

211.4 Shoulders

Roadway shoulder width is measured from the edge of the traveled way to the shoulder break. A portion of the shoulder is required to be paved. Minimum shoulder widths and paved widths are given in **Table 211.4.1**.

Use shoulder gutter for the following conditions:

- On embankments higher than 20 feet
- On embankments higher than 10 feet where the longitudinal slope is greater than 2 percent
- On embankments, with slopes steeper than 1:6 for more than five feet vertically, to minimize erosion
- At bridge ends where concentrated flow from the bridge deck could otherwise run down the slope
- In areas of guardrail where embankment slopes are steeper than 1:4 and any pavement is sloped toward the embankment.

Refer to **FDM 260.3** for bridge shoulder widths.

See the **GTR** for paved shoulder requirements at tolling locations.

211.4.1 Managed Lanes Shoulders

The required width for managed lanes shoulders depends on the type of separation between the managed lanes and the general use lanes. When retrofitting managed lanes in constrained conditions, shoulder widths in **Table 211.4.1** may not be achievable without a Design Variation or Design Exception. Consult the [Highway Safety Manual](#) on safety tradeoffs when narrowing shoulder widths.

Table 211.4.1 Minimum Shoulder Widths

Lane Type	# Lanes (One Direction)	Without Shoulder Gutter (feet)				With Shoulder Gutter (feet)			
		Outside or Right		Median Or Left On Divided Roadways		Outside or Right		Median Or Left On Divided Roadways	
		Full Width	Paved Width	Full Width	Paved Width	Full Width	Paved Width	Full Width	Paved Width
Travel Lanes	2-Lane	12	10	8	4	15.5	8	13.5	6
	3-Lane or more	12	10	12	10	15.5	8	15.5	8
Managed Lanes	1-Lane	12	12	12	12	17.5	10	17.5	10
	2-Lane	12	12	12	12	17.5	10	17.5	10
Ramps	1-Lane	6	4	6	2	11.5	4	11.5	4
	2-Lane Non-Interstate	10	8	8	4	15.5	8	13.5	6
	2-Lane Interstate	12	10	8	4	15.5	8	13.5	6
	3-Lane or more	12	10	12	10	15.5	8	15.5	8
C-D Roads	1-Lane	6	4	6	2	11.5	4	11.5	4
	2-Lane	12	10	8	4	15.5	8	13.5	6
	3-Lane or more	12	10	12	10	15.5	8	15.5	8
Aux. Lanes	ALL	12	10	8	4	15.5	8	11.5	4

Notes:

Without shoulder gutter:

- (1) For Florida's Turnpike projects with 3-Lanes or more in One Direction on the mainline, provide 12-foot inside and outside paved width shoulders adjacent to travel lanes with High Volume AADT or greater than 10% trucks.
- (2) For all other LA Facilities, consider 12-foot outside paved width shoulders adjacent to travel lanes with High Volume AADT or greater than 10% trucks.
- (3) Pave the entire width of shoulders adjacent to concrete barriers. See **FDM 215.4.6.1**

With shoulder gutter:

- (1) Ramp shoulder pavement less than 6 feet in width that adjoins shoulder gutter must match the type, depth, and cross slope of the ramp travel lane.

211.4.2 Shoulder Cross Slopes

The standard cross slope is 0.06 on the outside shoulder and 0.05 on the median (or left) shoulder for all roadway and ramp sections. **Figure 211.4.1** illustrates shoulder cross slopes in relationship to roadway cross slopes for normal and superelevated sections. For 5-foot (or less) paved shoulders, see **Figure 211.4.2**. When the inside travel lane is sloping toward the median, the inside shoulder cross slope may be increased to 0.06.

For projects constructed with concrete pavement, the first one foot of the outside shoulder is cast with the outside travel lane and will have the same cross slope (and superelevation) as the outside lane. Superelevation of the shoulder pavement is to be rotated about the outside edge of the outside slab.

Figure 211.4.1 Shoulder Superelevation

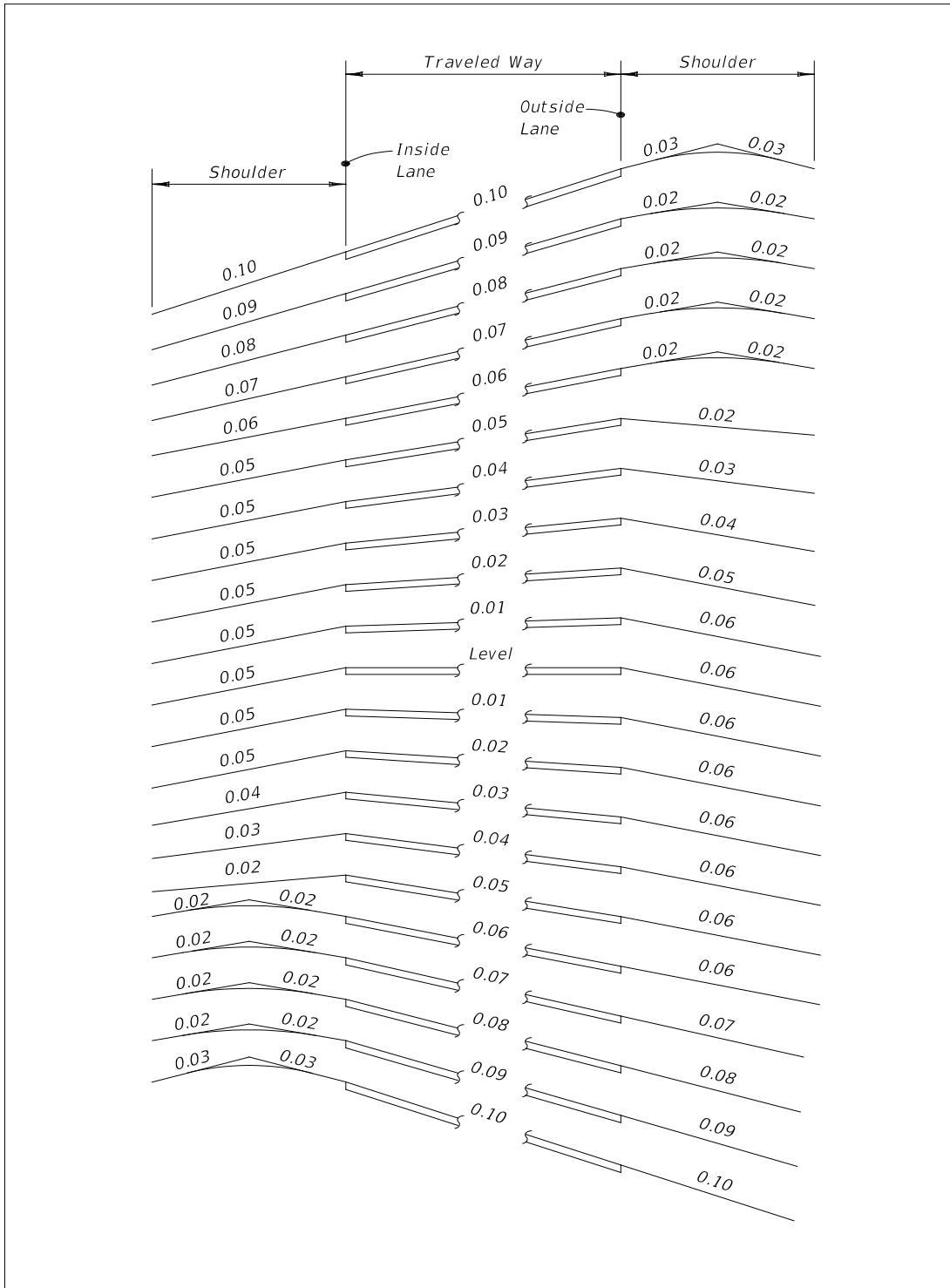
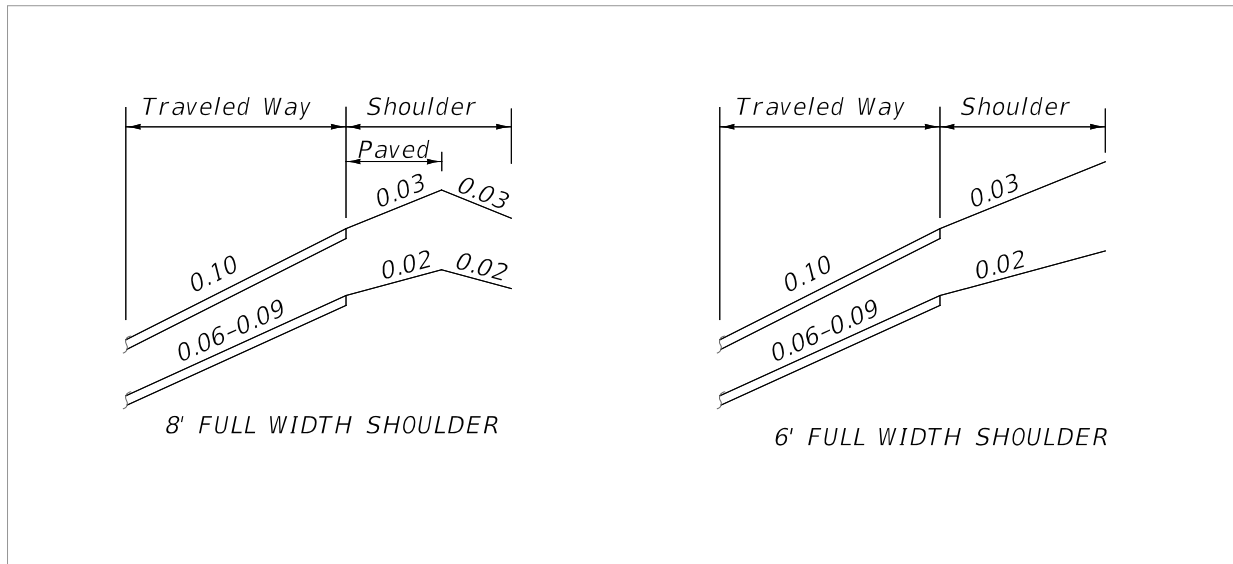

Figure 211.4.2 Special Ramp Shoulder Superelevation



211.4.2.1 Shoulder Rocking

When a minimum 0.3% longitudinal gutter grade cannot be maintained using uniform shoulder cross slopes, shoulder rocking may be used to achieve positive drainage. The cross slope for shoulders may be varied from minimum 0.03 (not flatter than the adjacent lane) to a maximum 0.06 in tangent sections. The design must maintain a balance between inlet spacing and flat shoulder cross slopes. To achieve a minimum distance of 100 feet between the high and low points, a 0.24% minimum longitudinal gutter grade may be used.

For shoulder rocking designed in conjunction with new single-slope concrete barriers, see the [Standard Plans Instructions](#) for **Index 521-001**.

Where existing F-Shape barriers are being used, the varying shoulder surface may intersect the barrier face within the lower 3-inch vertical portion (a.k.a., the reveal). F-Shape barriers must remain embedded in the pavement at least 1 inch deep at all locations.

For outside shoulder rocking, use one of the three options below to meet minimum spread criteria. Options 1 and 2 are preferred. Consider Option 3 only when the first two options are not feasible, as determined by the District Roadway Design and Drainage Engineers.

- Option 1: Use concrete barrier with inlets to collect storm water.
- Option 2: Use guardrail with shoulder gutter and inlets to collect storm water.
- Option 3: Use guardrail in conjunction with a permanent turf reinforcement mat in fill sections with a front slope steeper than 1:4 (maximum slope of 1:2) and maximum height of 10 feet. Shear stress calculations are required to be submitted for the design/selection of the permanent turf reinforcement mat.

See **FDM 915** for shoulder rocking gutter profile plan requirements.

211.4.3 Limits of Friction Course on Paved Shoulders

Extend the friction course 8 inches onto both the median and outside paved shoulders of roadways.

For locations where median barrier wall is continuous and the shoulder slopes toward the travel lane, construct the inside shoulder pavement flush with the friction course placed on the adjacent travel lane. This will address concerns for trapping water on the shoulder as demonstrated in **Figure 211.4.3**.

Figure 211.4.3 Flush Shoulder Pavement

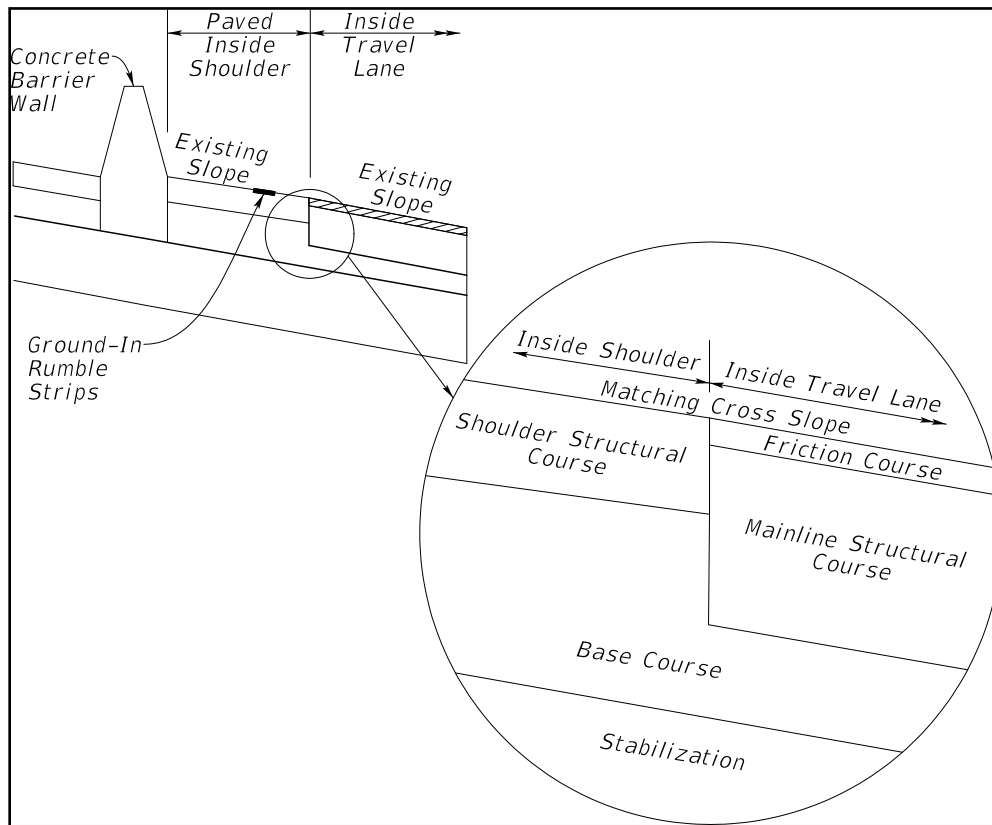

211.4.4 Audible and Vibratory Treatment

Audible and vibratory treatments provide a lane departure warning. Include either ground-in rumble strips or profiled thermoplastic audible and vibratory treatment on LA Facilities.

211.4.4.1 Ground-in Rumble Strips

Use ground-in rumble strips on mainline flexible pavement shoulders in accordance with **Standard Plans, Index 546-010**. Use the skip array on both inside and outside shoulders. Use the continuous array in advance of bridge ends for a distance of 1,000 feet or back to the gore recovery area for mainline interchange bridges. **Figure 211.4.4** provides guidance for placement of ground-in rumble strips.

Exclude ground-in rumble strips at the following locations:

- (1) On bridges, terminate at the approach slab joint.
- (2) At mainline toll sites within the toll loop pavement area.
- (3) On All Electronic Tolling (AET) facilities within the tolling area as defined in the **GTR**.
- (4) On outside shoulders of entrance ramp terminals, terminate at the point of the physical gore and resume at the end of the acceleration lane taper.
- (5) On outside shoulders of exit ramp terminals, terminate at the start of the deceleration lane taper, and resume at the point of the physical gore.
- (6) On either side of median crossover openings, terminate within 400 feet.

211.4.4.2 Profiled Thermoplastic

Use profiled thermoplastic for inside and outside edge line pavement markings on roadways with rigid pavement shoulders.

Figure 211.4.4 Placement of Ground-In Rumble Strips

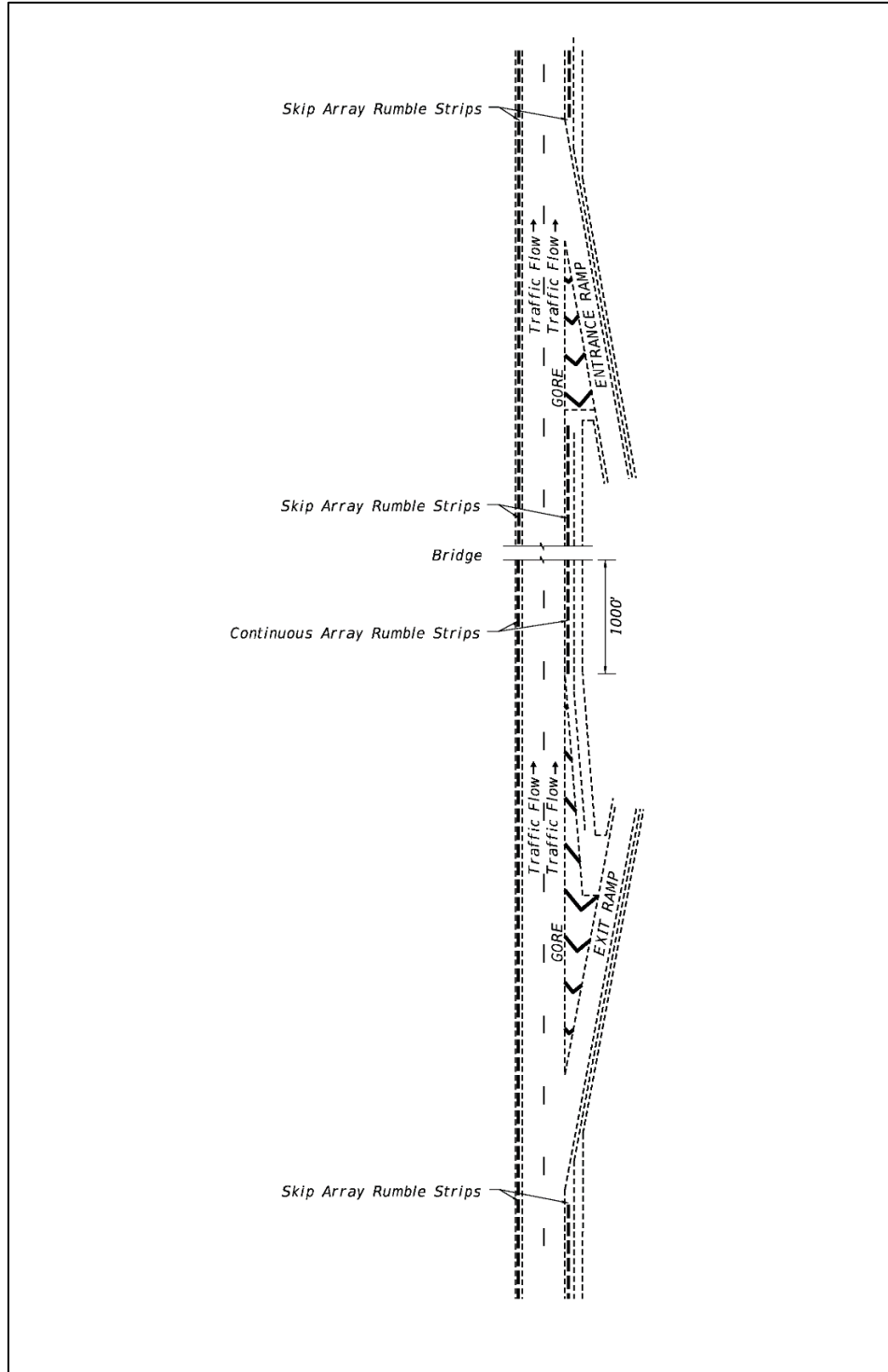

211.4.5 Emergency Refuge Areas

Consider including Emergency Refuge Areas (ERAs) in areas where additional shoulder widths are deemed necessary (e.g., law enforcement, vehicle refuge). Coordinate with Traffic Operations, Maintenance, and Law Enforcement to determine if ERAs would be appropriate for the roadway facility.

For managed lanes projects, consider ERAs where deemed necessary in coordination with Traffic Operations, Maintenance, and Law Enforcement. Coordinate with the Turnpike Toll Systems and Tolls Design Offices during Phase I of the design process. For managed lanes in constrained conditions, a staggered shoulder may be designed to allow storage of disabled or damaged vehicles.

211.4.6 Emergency Shoulder Use (ESU)

Emergency Shoulder Use (ESU) increases traffic capacity for hurricane evacuations by using existing paved shoulders as temporary travel lanes. ESU is typically implemented on evacuation routes as follows:

- On median shoulder when median paved shoulder width is at least 10 feet, or
- On outside shoulder when median paved shoulder width is less than 10 feet.

ESU evacuation routes are listed at:

<https://www.fdot.gov/emergencymanagement/esu/>

Provide a minimum of 10-foot paved shoulder that is usable for travel on ESU routes identified on the Department's Emergency Management website. A portion of the shoulder gutter (when present) may be included in the usable 10-foot width; see **Figure 211.4.5**.

Figure 211.4.5 Useable Shoulder Width with Shoulder Gutter

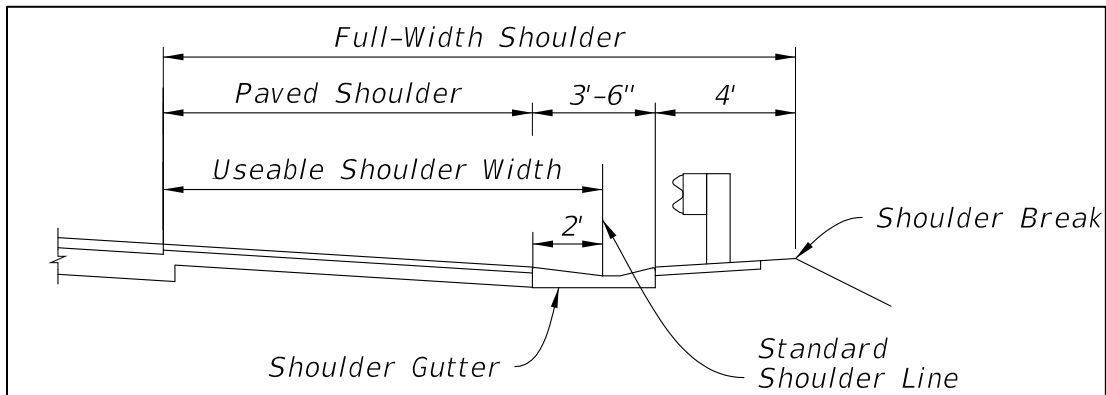

On resurfacing projects where paved or usable shoulder widths are less than 10 feet, do one of the following:

- Provide shoulder modifications to allow for acceptable ESU usage, or
- Identify a future project that will provide the required shoulder modifications.

Locate median barrier in accordance with **FDM 215**. When possible, do not locate median barrier adjacent to the shoulder identified for ESU evacuation.

See **FDM 240.2.1.1** for ESU requirements during construction.

211.4.7 Use of Curb

Type F Curb may be used in areas with Design Speeds of 45 mph or less. Type E Curb may be used in areas with Design Speeds of 55 mph or less. This applies to both median and outside shoulder locations. All curbs are prohibited in areas with Design Speeds greater than 55 mph.

211.4.7.1 Existing Curb

There are infrequent sections of curbed roadways in combination with guardrail on LA Facilities. When there is no crash history associated with these applications, the curb may remain when approved by the District Design Engineer (DDE). Approval by DDE is documented through the development of the Typical Section Package.

211.5 Roadside Slopes

Side slopes within the clear zone are typically 1:6 or flatter. When site conditions require the use of steeper slopes, refer to new construction criteria included in **FDM 215**.

See **FDM 210.6** for roadside slope requirements.

211.6 Border Width

For new construction, the required border width is 94-feet, which is measured from the outside edge of traveled way to the R/W line. This width may be reduced in the area of a crossroad terminal, as long as the design meets the requirements for clear zone, lateral offsets, drainage, and maintenance access.

Fencing, or in special cases, walls or barriers are to contain LA Facilities. These treatments are to be continuous and appropriate for each location. Treatment height and type may vary under special conditions. The treatment is typically placed at or near the LA R/W line, but the location may be adjusted based on site-specific conditions (e.g., ponds, trees, bridges). Placement information and additional data is provided in **Standard Plans, Indexes 550-001, 550-002, and 550-004**.

211.6.1 Border Width on Reconstruction & Resurfacing Projects

For reconstruction and resurfacing projects where additional R/W will not be acquired, a Design Variation is not required when the following minimum border width is met:

- (1) The border width accommodates:
 - (a) Roadside design components such as signing, drainage features, guardrail, fencing and clear zone
 - (b) The construction and maintenance of the facility
 - (c) Permitted public utilities
- (2) Along ramps and mainline lanes where roadside barriers are used and thus clear zone is not applicable, the minimum border width from the back of a barrier or retaining wall must be 10 feet if maintenance vehicles have sufficient access from public R/W that is contiguous and unimpeded to the facility.
- (3) If the maintenance access is not continuous along a barrier or wall, and thus maintenance vehicles and equipment would need to turn around, then a sufficient

turnaround area must be provided that is acceptable and approved by Maintenance.

- (4) Maintenance accessibility includes the ability for equipment and vehicles to maneuver around obstacles including fences, lights, signs, side slopes and ponds.

211.7 Horizontal Alignment

The centerline (CL) or baseline (BL) of construction defines the horizontal alignment for roadway and bridge construction. The CL or BL construction is a series of tangents connected by horizontal curves established by the Engineer of Record (EOR). The CL or BL construction is often the same alignment as the BL of survey.

Horizontal alignment should be consistent with the anticipated operating speed and with the environmental, physical, and economic constraints. Design Speed is the principal factor controlling horizontal alignment.

Avoid placing horizontal curves, points of intersection (PI) and superelevation transitions within the limits of a structure or approach slabs. Placement of stationing equations within the limits of a structure should be avoided. Such equations unnecessarily increase the probability of error in both the design and construction phases.

211.7.1 Deflections in Alignment

The point where tangents intersect is known as the point of intersection (PI). Avoid the use of a PI with no horizontal curve; however, there may be conditions where it is necessary. The maximum deflection along the mainline and ramps without a horizontal curve is as follows:

- Design Speed \leq 40 mph is 2°00'00".
- Design Speed \geq 45 mph is 0°45'00".

211.7.2 Horizontal Curves

A horizontal curve should not be introduced near the crest of a vertical curve. The combination of horizontal and vertical curves can greatly reduce sight distance; i.e., hide the horizontal curve from the approaching driver. The condition can be avoided by having the horizontal curvature lead the vertical curvature; i.e., the horizontal curve is made longer than the vertical curve.

Flatter curvature with shorter tangents is preferable to sharp curves connected by long tangents; i.e., avoid using minimum horizontal curve lengths. Avoid long tangents followed by sharp curves.

Table 211.7.1 provides the desirable horizontal curve lengths to be used in establishing the horizontal alignment. Desirable curve lengths for interstate, freeways and expressways are based on 30-times the Design Speed (30V), where V = Design Speed in mph. Desired curve lengths for low-speed ramps are based on 15-times the Design Speed (15V), and high-speed ramps are based on 30V.

Table 211.7.1 Length of Horizontal Curve

Length Of Horizontal Curve (feet)										
Interstate, Freeway and Expressways based on Design Speed (mph)										
	25	30	35	40	45	50	55	60	65	70
Desirable	N/A	N/A	N/A	N/A	N/A	1500	1650	1800	1950	2100
Minimum	N/A	N/A	N/A	N/A	N/A	750	825	900	975	1050
Ramps based on Design Speed (mph)										
	25	30	35	40	45	50	55	60	65	70
Desirable	400	450	525	600	675	1500	1650	1800	1950	2100
Minimum	400	400	400	400	400	750	825	900	975	1050
Notes: Provide the desirable length; however, when desired length cannot be attained, provide the greatest length possible, but not less than the minimum.										

211.8 Superelevation

The criteria contained in **FDM 210.9** is applicable for Interstates, Freeways, and Expressways. The RRR criteria contained in **FDM 210.9.2** applies to Limited Access resurfacing projects.

Superelevation rates of 0.10 maximum are required on high-speed LA Facilities, except for the portion of a ramp that adjoins an arterial. For the portion of a ramp that adjoins an arterial, match the superelevation rate of the arterial. The terminal and the area abutting the LA Facility are controlled by Limited Access criteria and must be designed for a 0.10 maximum superelevation rate.

211.9 Vertical Alignment

The profile grade line defines the vertical alignment for roadway and bridge construction. The profile grade line is a series of tangents connected by vertical curves. For undivided highways, the profile grade line is typically located at the horizontal centerline of the roadway. For divided highways, a profile grade line should be established for each direction of travel.

Meeting vertical alignment criteria assures proper transitions, sight distances, and clearances.

LA facilities play a critical role during hurricane evacuation and re-entry in the aftermath. Designing the mainline travel lanes to be above the 100-year flood plain elevation (established by FEMA or other pertinent studies) is a requirement on Florida's Turnpike Facilities and should be considered for all LA facilities. See **FDM 210.10.3** for all other vertical clearance requirements.

Minimum vertical clearances for bridges structures are given in **FDM 260.6**.

211.9.1 Grades

The slope or grade of each tangent is expressed in percent rise (+) or fall (-); e.g., +2.000% or -2.000%. The maximum grades that may be used in establishing the vertical alignment are given in **Table 211.9.1**.

Table 211.9.1 Maximum Grades

Facility Type	Maximum Grades (percent)									
	Design Speed (mph)									
	25	30	35	40	45	50	55	60	65	70
LA Facilities	N/A	N/A	N/A	N/A	N/A	4	4	3	3	3
Ramps	7	7	6	6	5	5	4	4	3	3

Notes:

- (1) For roadways with significant (10% or more) heavy truck traffic, the maximum grade used should not exceed 4%.
- (2) For resurfacing projects, when existing grades do not meet the above requirements but meet the standards in effect at the time of construction, the existing grade may remain.

For new construction or when the vertical profile is being significantly modified, the desired minimum profile grade is 0.5%; 0.3% is the minimum when 0.5% cannot be achieved. When practicable, develop roadway profiles to avoid the need for shoulder rocking, with consideration for future widening and resurfacing.

The point where tangents intersect is known as the vertical point of intersection (VPI). When two tangent grades intersect and no vertical curve is provided, the “kink” is known as the point of intersect (PI). The maximum change in grade (i.e., algebraic change) without a vertical curve is provided in **Table 210.10.2**.

211.9.2 Vertical Curves

A vertical curve must be provided when the change in grade of two intersecting tangent grades exceed the values shown in **Table 210.10.2**. A vertical curve is identified by a curve length (L) which is equal to the product of the K value (K) and the algebraic difference in grades (A).

Tables 211.9.2 and **211.9.3** contain vertical alignment criteria for Interstates, Freeways, Expressways, and ramps.

Table 211.9.2 K Values for Vertical Curves

Type of Curve	Minimum K Values for Vertical Curves									
	Design Speed (mph)									
	25	30	35	40	45	50	55	60	65	70
Interstate										
Sag	N/A					115	136	157	181	206
Crest (New Construction)	N/A					185	245	313	401	506
Crest (Resurfacing)	N/A					114	151	193	247	312
Freeway and Expressways										
Sag	N/A					96	115	136	157	181
Crest (New Construction)	N/A					136	185	245	313	401
Crest (Resurfacing)	N/A					84	114	151	193	247
Ramps										
Sag	26	37	49	64	79	96	115	136	157	181
Crest (New Construction)	19	31	47	70	98	136	185	245	313	401
Crest (Resurfacing)	12	19	29	44	61	84	114	151	193	247
<p>Notes: Length, $L = KA$ Where: K = Rate of vertical curvature (a.k.a., K value) L = Length of vertical curve, (feet) A = Algebraic difference in grades, (percent)</p> <p>(1) New construction K values are based on an eye height of 3.5 feet and an object height of 6 inches. Resurfacing K values are based on an eye height of 3.5 feet and an object height of 2 feet.</p> <p>(2) The minimum curve length must not be less than values shown in Table 211.9.3.</p> <p>(3) Vertical curves within a system interchange are to use K values based on the higher system.</p> <p>(4) Use interstate, freeway, or expressway K values on vertical curves located within the ramp terminal area. Ramp vertical curve K values are used for ramps outside of the ramp terminal area.</p>										

Table 211.9.3 Minimum Vertical Curve Length

Type of Curve	Curve Length (feet)									
	Design Speed (mph)									
	25	30	35	40	45	50	55	60	65	70
Interstate, Freeway and Expressways										
Sag	N/A					800				
Crest (Open Highway)	N/A					1,000				
Crest (Within Interchanges)	N/A					1,800				
Ramps										
Sag	75	90	105	120	135	200	250	300	350	400
Crest						300	350	400	450	500

211.10 Sight Distance

The **AASHTO Greenbook** has a thorough discussion on sight distance. Consider the following aspects of sight distances:

- (1) Stopping Sight Distance: Sight distances needed for stopping, which are applicable on all highways
- (2) Decision Sight Distance: Sight distances needed for decisions at complex locations (e.g., merging tapers, ramps, weaving sections)

211.10.1 Stopping Sight Distance

Stopping sight distance is influenced by both vertical and horizontal alignments. A roadway designed to criteria employs a horizontal alignment, a vertical alignment, and a cross section that provide at least the minimum stopping sight distance through the entire facility.

Minimum stopping sight distances are provided in **Table 211.10.1** and **Table 211.10.2**. Stopping sight distance eye height is 3.5 feet and object heights are the following:

- 6 inches for new construction
- 2 feet for resurfacing

Minimum stopping sight distances greater than shown in **Table 211.10.1** and **Table 211.10.2** should be considered when drivers require additional time to make decisions.

Table 211.10.1 Minimum Stopping Sight Distance for Interstate

Grade (percent)		Minimum Stopping Sight Distance (feet)				
		Design Speed				
		50	55	60	65	70
Downgrade	≤ 2	495	570	645	730	820
	3	516	595	673	767	861
	4	524	605	685	781	878
	5	534	616	698	797	896
	6	544	628	713	813	915
	7	554	640	727	831	935
	8	565	654	744	850	957
	9	577	668	761	870	981
Upgrade	≤ 2	495	570	645	730	820
	3	475	544	613	697	780
	4	469	537	605	687	768
	5	463	531	597	678	758
	6	458	525	590	669	748
	7	453	518	583	661	738
	8	449	513	576	653	729
	9	445	508	570	646	721

Table 211.10.2 Minimum Stopping Sight Distance for Freeways, Expressways, and Ramps

Grade (percent)		Minimum Stopping Sight Distance (feet)									
		Design Speed (mph)									
		25	30	35	40	45	50	55	60	65	70
Downgrade	≤ 2	155	200	250	305	360	425	495	570	645	730
	3	158	205	257	315	378	446	520	598	682	771
	4	160	208	261	320	385	454	530	610	696	788
	5	162	211	266	326	392	464	541	623	712	806
	6	165	215	271	333	400	474	553	638	728	825
	7	167	218	276	339	408	484	565	652	746	845
	8	170	222	281	346	417	495	579	669	765	867
	9	173	227	287	354	427	507	593	686	785	891
Upgrade	≤ 2	155	200	250	305	360	425	495	570	645	730
	3	147	190	237	289	344	405	469	538	612	690
	4	146	188	234	285	339	399	462	530	602	678
	5	144	186	231	281	335	393	456	522	593	668
	6	143	184	229	278	331	388	450	515	584	658
	7	142	182	226	275	327	383	443	508	576	648
	8	141	180	224	272	323	379	438	501	568	639
	9	139	179	222	269	320	375	433	495	561	631

211.10.2 Decision Sight Distance

The **AASHTO Green Book, Chapter 3** provides a detailed discussion on decision sight distance.

The geometric design developed for LA Facilities considers locations where decision sight distance is critical such as interchanges, toll facilities, lane drops, and managed lanes ingress/egress locations. Decision sight distance requirements are in the **AASHTO Green Book**. If it is not practical to provide decision sight distance at these locations, or if relocation of the critical decision points is not feasible, special attention will be given to the use of suitable traffic control devices for providing advance warning of the substandard condition.

Do not place managed lane ingress or egress within the limits of a Design Variation or Design Exception processed for sight distance.

211.11 Structures

Refer to **FDM 260** for information on bridge structures.

211.12 Interchange and Ramp Spacing

Interchange spacing is measured along the freeway or interstate centerline between the centerlines of the crossroads. Refer to **FDM 201.4** for the minimum spacing between adjacent interchanges.

In urban areas, spacing less than one mile may be used with C-D roads or grade-separated (braided) ramps.

The spacing between interchanges may also be dependent on the ramp connection spacing. The minimum connection spacing between the painted noses of adjacent ramps is provided in **Figure 211.12.1**. Additional information on interchanges is in the **AASHTO Green Book**.

Figure 211.12.1 Ramp Connection Spacing

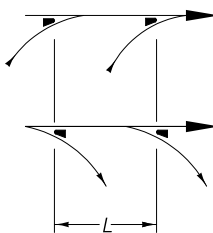
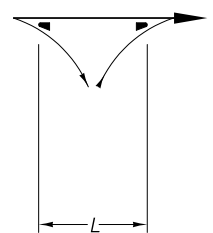
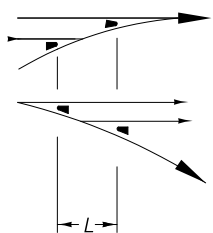
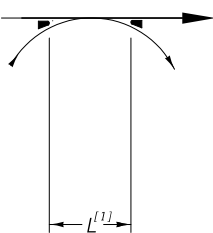
On-On or Off-Off		Off-On		Turning Roadways		On-Off (Weaving)		
								
LA Facility	C-D Road	LA Facility	C-D Road	System ^[2] Interchange	Service ^[3] Interchange	A	B or C	D
1,000 ft.	800 ft.	500 ft.	400 ft.	800 ft.	600 ft.	2,000 ft.	1,600 ft.	1,000 ft.
▲ Painted Nose (see Figure 211.13.1)								
<p><i>L</i> = Minimum distance in feet from painted nose to painted nose (See figure 211.13.1)</p> <p>A Between two interchanges connected to a LA Facility: a system interchange^[2] and a service interchange^[3]</p> <p>B Between two interchanges connected to a C-D Road: a system interchange^[2] and a service interchange^[3]</p> <p>C Between two interchanges connected to a LA Facility: both service interchanges^[3]</p> <p>D Between two interchanges connected to a C-D Road: both service interchanges^[3]</p> <p>Notes:</p> <p>These values are based on operational experience, need for flexibility, and signing. Check them in accordance with the procedures outlined in the Highway Capacity Manual and use the larger value.</p> <p>[1] With justification, these values may be reduced for cloverleaf ramps.</p> <p>[2] A system interchange is a LA Facility-to-LA Facility interchange.</p> <p>[3] A service interchange is a LA Facility-to-local road interchange.</p>								

Ref: Figure 10-70, 2018 AASHTO Green Book

211.12.1 Weaving Sections

Weaving sections are defined in **2018 AASHTO Green Book, Section 2.4**.

When an entrance is followed by an exit, the minimum distance between gore noses is governed by weaving considerations per the procedure outlined in the [Highway Capacity Manual](#). On-off Weaving is illustrated in **Figure 211.12.1**. If the minimum weaving distance cannot be provided, replace the weaving maneuver with physical separation; e.g., grade separation or barrier. For more information regarding barriers, refer to **FDM 215**.

211.12.1.1 Braided Ramps

Ramps that are grade-separated and cross over one another are known as braided ramps. They are typically used to achieve the required ramp spacing by converting the on-off connection into an off-on connection. An example of braided ramps is shown in **Figure 211.12.2**. These configurations are used on a limited basis because of the large cost typically associated with them.

Figure 211.12.2 Braided Ramp Configuration

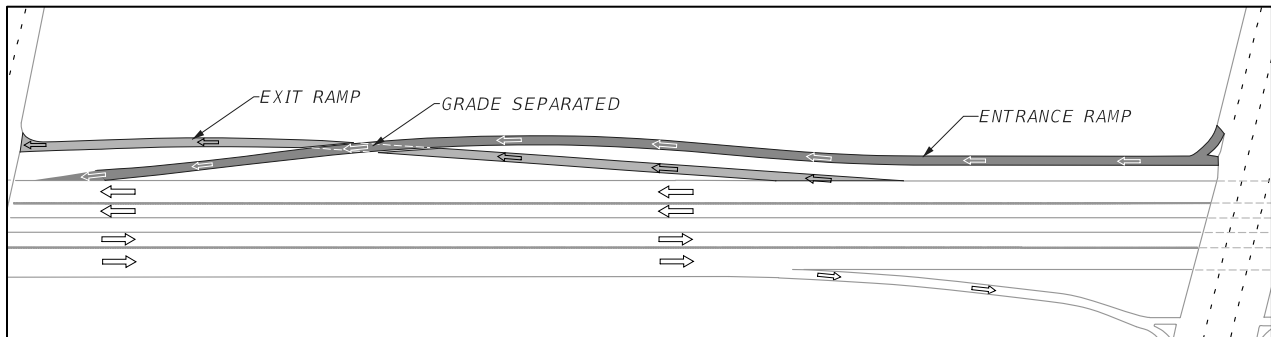

When combining general use lane or general toll lane exits and managed lane exits in a braided ramp configuration, the managed lane exit merges on the right side of the general use lanes as illustrated in **Figure 211.12.3**. Operational analysis determines the actual lane configuration. Refer to the **Traffic Analysis Handbook** and the **Interchange Access Request User's Guide** for guidance on analysis requirements.

Figure 211.12.3 Braided Managed Lane and General Use Lane Exits

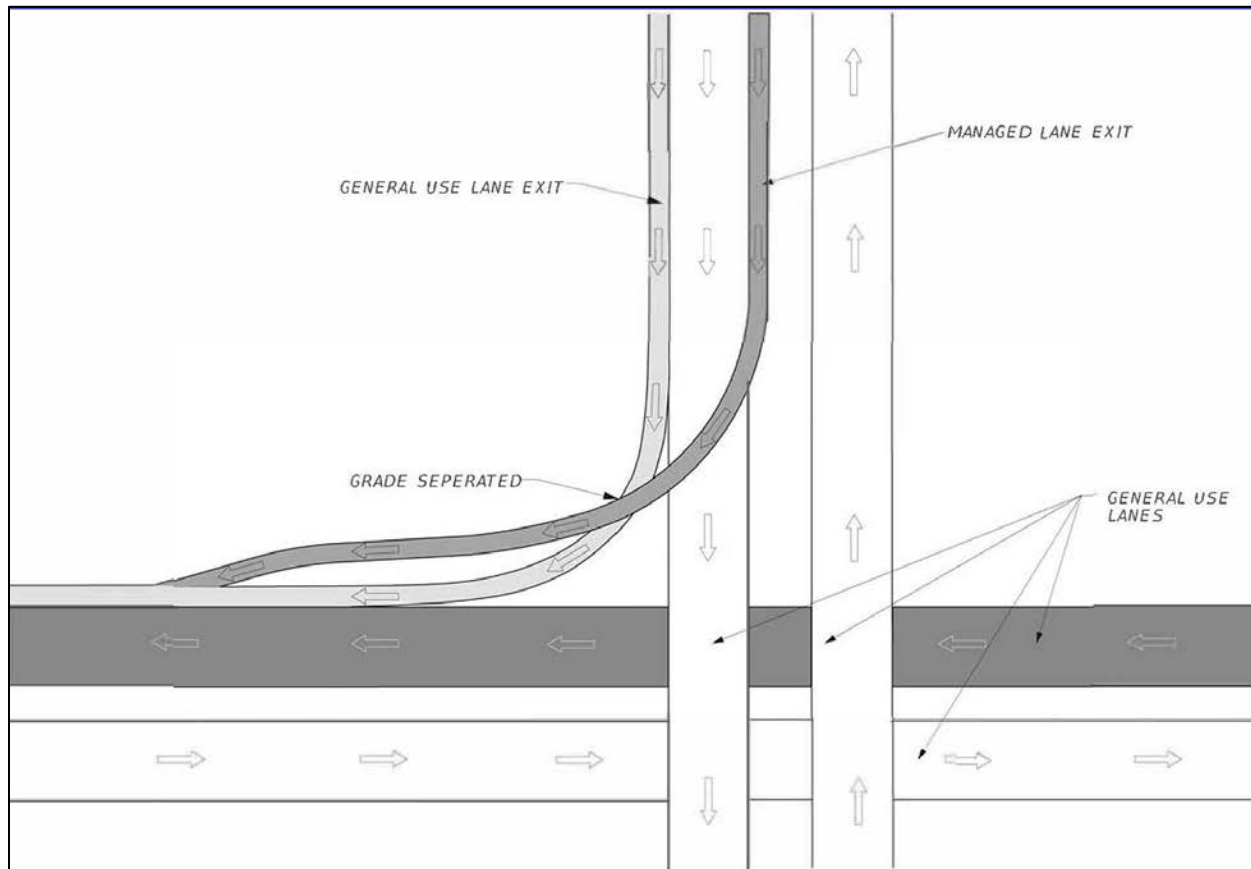

211.12.2 Interchange Connections

When a series of interchanges are closely spaced, attention must be given to the uniformity of interchange patterns and to lane balance. Refer to the concepts discussed in the **2018 AASHTO Green Book**. Auxiliary lanes may be required to conform to lane balance requirements.

Successive auxiliary lanes less than 1,500 feet apart are prohibited. Auxiliary lanes may continue through an interchange to avoid this condition.

211.13 Ramp Terminals

Taper type and parallel type ramp terminals can be used to enter and exit an LA Facility. The selection of either a parallel or taper type depends on the geometrics and anticipated

traffic conditions of the highway as well as the roadway that connects to the ramp. The Design Speed of entrance and exit ramps for LA Facilities should be gradually decreased from the LA mainline Design Speed to the Design Speed of the ramp. The minimum ramp speed used to design the first curve adjacent to the LA mainline is 20 mph below the LA mainline Design Speed. The preferred ramp type is parallel. Use of taper type ramp terminals must be approved by the District Design Engineer. Existing tapered ramps that are not being altered by construction may remain in place.

Typical geometric configurations for the taper and parallel type ramps are depicted in **Standard Plans Index 000-525**. **Figure 211.13.1** illustrates a basic configuration and terminology used when designing ramp terminals. The taper and parallel type ramp terminals are discussed in the paragraphs below.

Figure 211.13.1 Ramp Gore

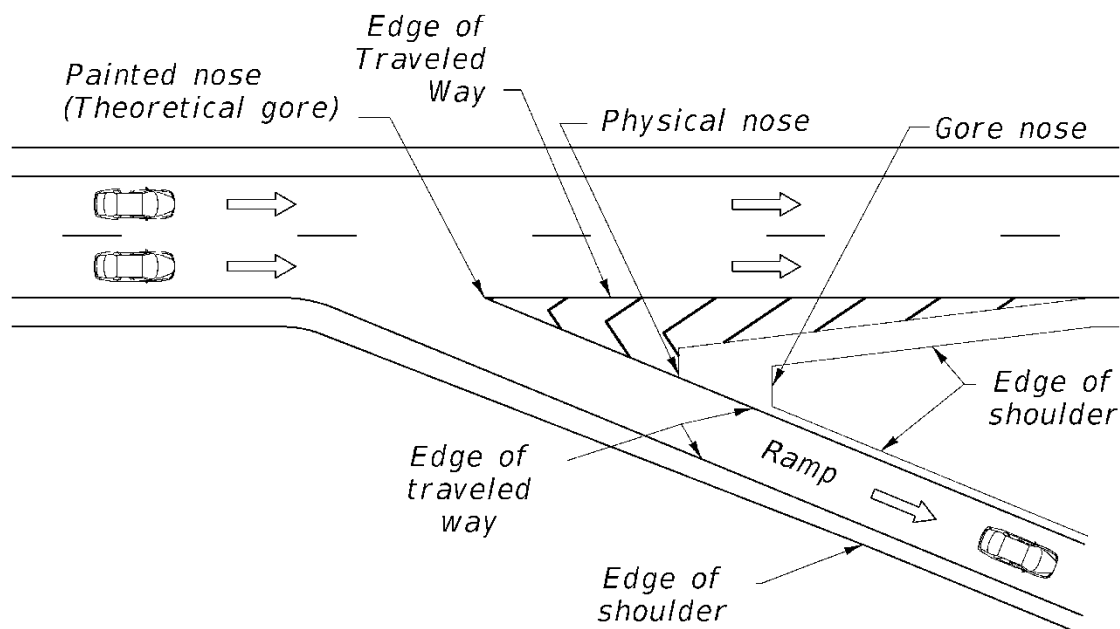

Taper Type Exit Ramp Terminals

For single lane taper type exit terminals, the recommended divergence angle is ± 4 degrees. The speed change can be achieved off the traveled way as the exiting vehicle moves along the taper onto the ramp proper. The length available for deceleration (L) should be measured from a point where the right edge of the tapered wedge is about 12 feet from the right edge of the right through lane to the point of initial curvature or the first horizontal curve on the exit ramp. The taper type ramp terminal is not to be used where

a minimum 50 mph Design Speed cannot be maintained. For such ramps, parallel deceleration lanes must be used in place of tapers with lengths set according to AASHTO. For additional information, see the *AASHTO Green Book*.

Figure 211.13.2 below shows a typical design for a taper type exit terminal.

Figure 211.13.2 Taper Type Exit Ramp Terminal

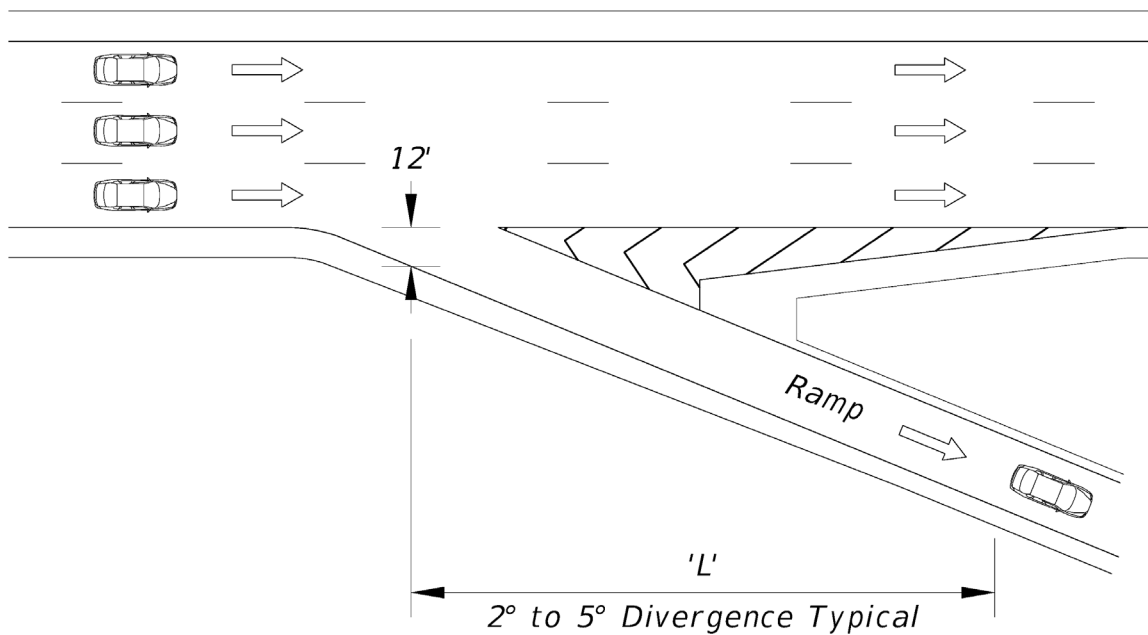

For two-lane exit ramp terminals, it is usually appropriate to develop an auxiliary lane upstream from the exit. A length of 1,500 feet is recommended to develop the full capacity of a two-lane exit. As with single lane exits, attention should be given to obtaining the appropriate deceleration distance between the exit and the first horizontal curve on the ramp. The length available for safe deceleration (L) on a two-lane taper type exit is measured from a point where the right edge of the tapered wedge along the left or inside exit lane is about 12 feet from the right edge of the right through lane. This is to ensure that any extent of the auxiliary lane is not used to determine the length needed for safe deceleration, since vehicles using the left exit lane would be entering the ramp at LA mainline speed. See **Figure 211.13.1**. The typical design for two-lane taper type exit terminals is shown in **Figure 211.13.3** below.

Figure 211.13.3 Two-Lane Taper Type Exit Ramp Terminal

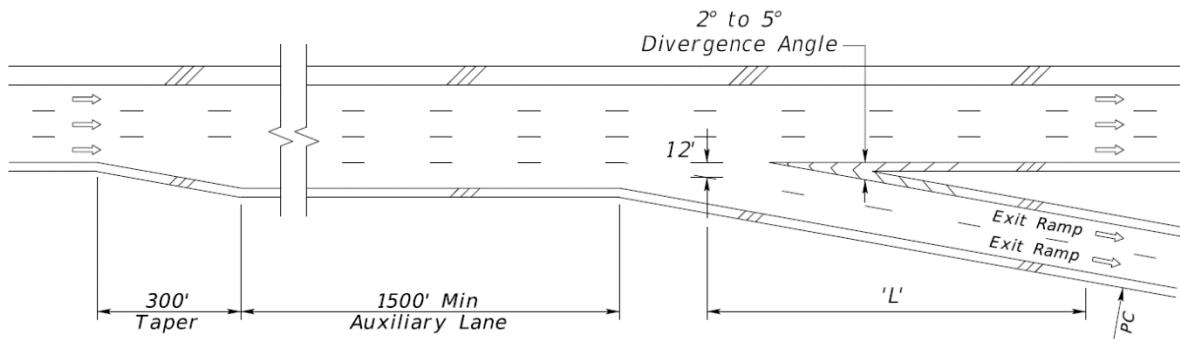

Parallel Type Exit Ramp Terminals

A single lane parallel type exit terminal usually begins with a taper, followed by an added lane that is parallel to the LA mainline traveled way. The parallel type exit terminal should be used when:

- The exit is partially hidden over the crest of a vertical curve, and
- The turning roadway speed is less than 60% of the through roadway speed.

In cases that have limited sight distance and close connections to a signal-controlled arterial, parallel type terminals should be used to allow for sufficient deceleration. The length available for deceleration (L) should be measured from the point where the added lane attains a 12-foot width to the point where the alignment of the ramp roadway departs from the alignment of the freeway. Lengths of at least 800 feet are desirable. The taper portion of a parallel type deceleration lane should have a taper of 15:1 to 25:1. For additional information, see the **AASHTO Green Book**. **Figure 211.13.4** shows a typical design for a parallel type exit terminal.

Figure 211.13.4 Parallel Design Type Exit Ramp Terminal

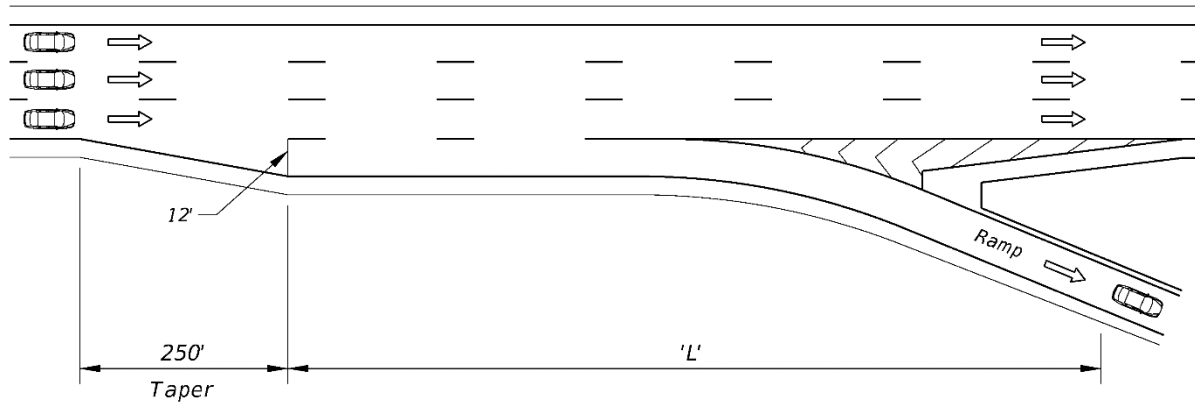

For two-lane exit ramp terminals, it is usually appropriate to add an auxiliary lane upstream from the exit. A length of 1,500 ft is recommended to develop the full capacity of a two-lane exit. As with single lane exits, attention should be given to obtaining the appropriate deceleration distance between the exit and the first horizontal curve on the ramp. See **Table 211.3.1**. The operation for a two-lane parallel type exit is different from the taper type in that vehicles in the outer through lane of the LA mainline must move two lanes to the right to use the right lane of the ramp. The total length from the beginning of the first taper to the point where the ramp traveled way departs from the right-hand through lane of the LA mainline ranges from 2,500 feet to 3,500 feet depending on the turning volumes thresholds provided in the **AASHTO Green Book**. This is to ensure that any extent of the auxiliary lane is not used to determine the length needed for safe deceleration, since vehicles using the left or inside lane would be entering the ramp at LA mainline speed.

Typical design for two-lane parallel type exit terminals is shown in **Figure 211.13.5** below.

Figure 211.13.5 Two-Lane Parallel Design Type Exit Ramp Terminal

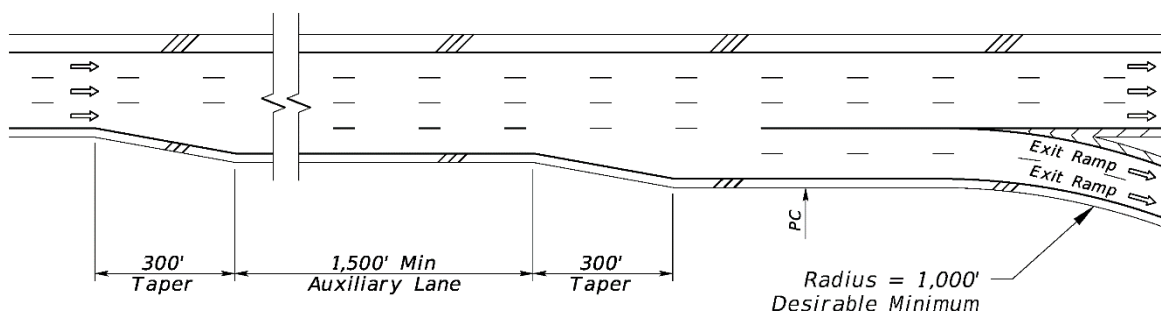

Minimum Deceleration Lengths

Minimum deceleration lengths (L) for various combinations of Design Speeds for the LA mainline and for the ramp roadway for both taper type and parallel type exit terminals are given in **Table 211.13.1** below. Grade adjustments are given in the **AASHTO Green Book**.

Table 211.13.1 Minimum Deceleration Lengths (L) for Taper and Parallel Type Exit Terminals

Deceleration Length (feet) for Design Speed of Exit Curve (mph)									
LA Mainline Design Speed	Stop Condition (0)	15	20	25	30	35	40	45	50
30	235	200	170	140	-	-	-	-	-
35	280	250	210	185	150	-	-	-	-
40	320	295	265	235	185	155	-	-	-
45	385	350	325	295	250	220	-	-	-
50	435	405	385	355	315	285	225	175	-
55	480	455	440	410	380	350	285	235	-
60	530	500	480	460	430	405	350	300	240
65	570	540	520	500	470	440	390	340	280
70	615	590	570	550	520	490	440	390	340

Source: 2018 AASHTO Green Book, Table 10-6

Entrance Type Ramp Terminals

The taper type entrance usually operates smoothly for volumes up to and including the design capacity of merging areas. The parallel type entrance terminal should be used when a bridge is located within the merging lane and when turning roadway speed is less than 60% of LA mainline speed. At entrance ramps on an ascending grade, the portion of the ramp intended for acceleration and the ramp terminal should closely parallel the through roadway profile to permit entering drivers to have a clear view of the through road ahead.

The length of the acceleration lane for taper and parallel type entrance ramp terminals is determined by the **AASHTO Green Book**.

The taper type ramp terminal is not to be used where a minimum 50 mph Design Speed cannot be maintained.

The parallel type entrance terminal should be used when a bridge is located within the merging lane and when turning roadway speed is less than 60% of LA mainline speed. The length of the acceleration lane is determined by **2018 AASHTO Green Book, Table 10-4**.

The parallel type exit terminal should be used when the exit is partially hidden over the crest of vertical curve and when the turning roadway speed is less than 60% of the LA mainline speed. The length of the deceleration lane is determined by **2018 AASHTO Green Book, Table 10-6**.

The selection of either a parallel or taper type depends on the geometrics and anticipated traffic conditions of the LA mainline as well as the roadway that the ramp is connecting to. In cases that have limited sight distance and close connections to a signal-controlled arterial, parallel type terminals should be used to allow for sufficient deceleration. For additional information, see the **2018 AASHTO Green Book**.

At entrance ramps on an ascending grade, the portion of the ramp intended for acceleration and the ramp terminal should closely parallel the LA mainline profile to permit entering drivers to have a clear view of the LA mainline ahead.

The Design Speed of entrance and exit ramps for LA Facilities should be gradually decreased from the LA mainline Design Speed to the Design Speed of the ramp. The minimum speed used to design the first curve adjacent to the LA mainline is 20 mph below the Design Speed of the LA mainline.

Figure 211.13.1 illustrates a basic configuration and terminology used when designing ramp terminals.

211.14 Managed Lanes Access Points and Access Types

The design of managed lanes access points is based on major origin and destination patterns, the locations of toll facilities, and the locations of existing interchanges with the general use lanes. The operational analysis associated with managed lanes access points is performed using the methodology in the Highway Capacity Manual and/or microsimulation. Refer to the *Traffic Analysis Handbook* and the *Interchange Access Request User's Guide* for guidance on analysis requirements.

Perform an operational analysis to determine the required length of the weave segment that will accommodate the weave demand. Base the analysis on 1000 feet per lane change weaving length (see *Exhibits 211-3 to 211-6*). Adjust the weave segment length as needed based on the analysis. Perform a safety analysis as required in the *Interchange Access Request User's Guide*.

An access point serves one of three uses:

- (1) Point of entry to the managed lanes
- (2) Intermediate point of entry/ingress or exit/egress
- (3) Termination of managed lanes

When determining the point of entry and the termination of managed lanes, consideration is given to future phased implementation plans for the corridor depicted in the ultimate managed lanes diagram. Avoid temporary access points.

Avoid locating a managed lanes access point in the same weaving area as other highway weaving movements (i.e., interchange on-ramps, interchange off-ramps, or auxiliary lanes). Access points are located to provide the required weave length between the managed lanes and general use lanes. If placed closer than the required minimum weave length, additional traffic control devices are added to prohibit vehicles from cutting across traffic to get into the managed lane or get out to the interchange exit.

Traffic operational analyses must demonstrate that queuing from vehicles exiting the managed lanes to the general use lanes will not encroach on the managed lanes.

Refer to **Section 2.42** of the *TEM* for guidelines on managed lanes entrance/ingress and exit/egress signs and signing sequence.

211.14.1 Managed Lanes Access Types

On Florida's managed lanes, the following types of access are used:

- Slip Ramps
- Weave Lanes
- Weave Zones
- Direct Connect
- Continuous Access

Slip ramps, weave lanes, and weave zones on the Interstate do not require an interchange access request. A weave lane or weave zone is used in constrained conditions for intermediate ingress and egress points and requires approval of the District Design Engineer. Continuous access is prohibited for use with express lanes and may require increased enforcement.

Direct connect ramps are used for system-to-system connections between managed lanes facilities, toll facilities, major arterials, park-and-ride facilities, and transit facilities. Direct connect ramps on the Interstate require an interchange access request (refer to the *Interchange Access Request User's Guide*). Refer to the *Managed Lanes Guidebook* for further information.

Standard geometric details are shown in *Exhibits 211-3* through *211-8*. The associated signing and pavement marking requirements at ingress and egress locations are shown in *Exhibits 211-9* through *211-12*.

BEGIN MANAGED LANES TYPICAL INGRESS FOR MANAGED LANES WITH CONTIGUOUS SEPARATION

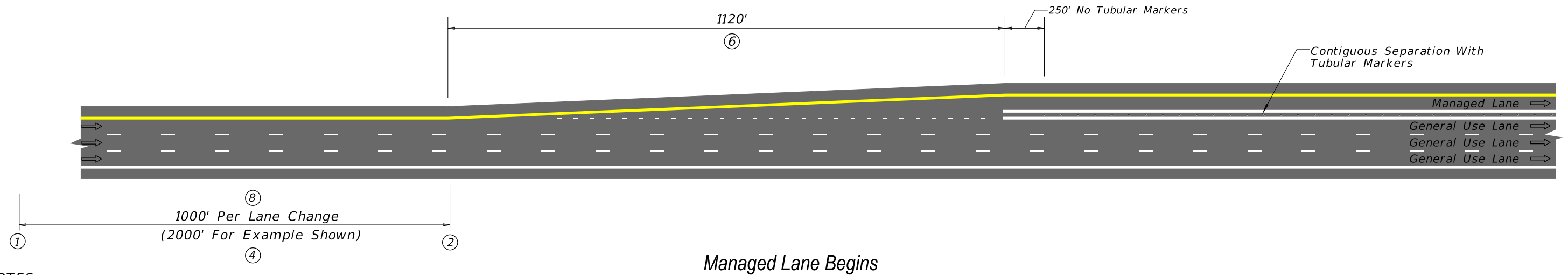
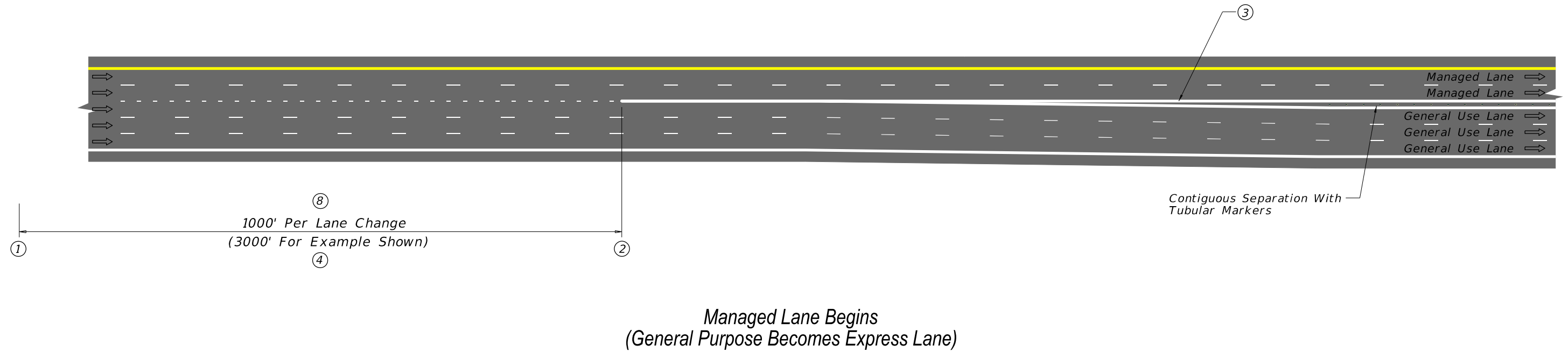

NOTES:

- ① Begin weave distance
- ② End weave distance
- ③ Per FDM 210.8.1 maximum deflections without horizontal curves, 0° 45' or 76.39:1 (use 80:1)
- ④ This weave zone to allow traffic in outside general use lane to get into outside managed lane.
- ⑤ The 1000' dimension is the starting weave length and may need to be increased based upon site-specific operational analysis.
- ⑥ Taper length based on $L=WS$. 70:1 taper as shown assumes 70 MPH design speed.
Where:
W = Width Of Lateral Transition
In Feet
S = Design Speed

NOTE:

The dimensions shown in this Exhibit are typical values, and may need to be increased based upon site-specific operational analysis.

NOT TO SCALE

EXHIBIT 211-3
01/01/2025

END MANAGES LANES TYPICAL EGRESS FOR MANAGED LANES WITH CONTIGUOUS SEPARATION

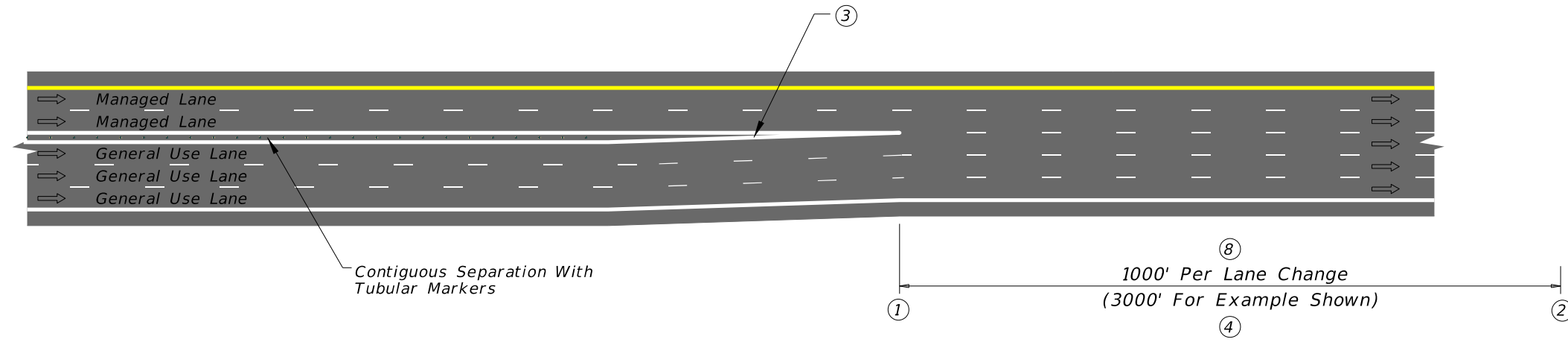

Managed Lanes Become General Purpose Lanes

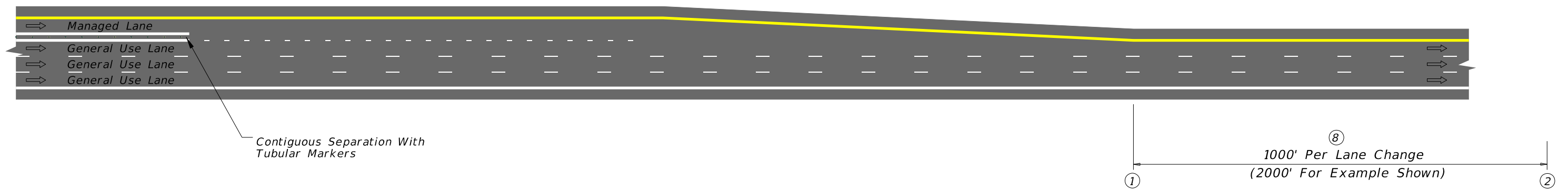

Managed Lane Ends

NOTES:

- ① Begin weave distance
- ② End weave distance
- ③ Per FDM 210.8.1 maximum deflections without horizontal curves, 0° 45' or 76.39:1 (use 80:1)
- ④ This weave zone to allow traffic in outside managed lane to get into outside general use lane.
- ⑧ The 1000' dimension is the starting weave length and may need to be increased based upon site-specific operational analysis.

NOTE:

The dimensions shown in this Exhibit are typical values, and may need to be increased based upon site-specific operational analysis.

NOT TO SCALE

EXHIBIT 211-4
01/01/2025

SLIP RAMP TYPICAL INGRESS & EGRESS FOR MANAGED LANES WITH CONTIGUOUS SEPARATION

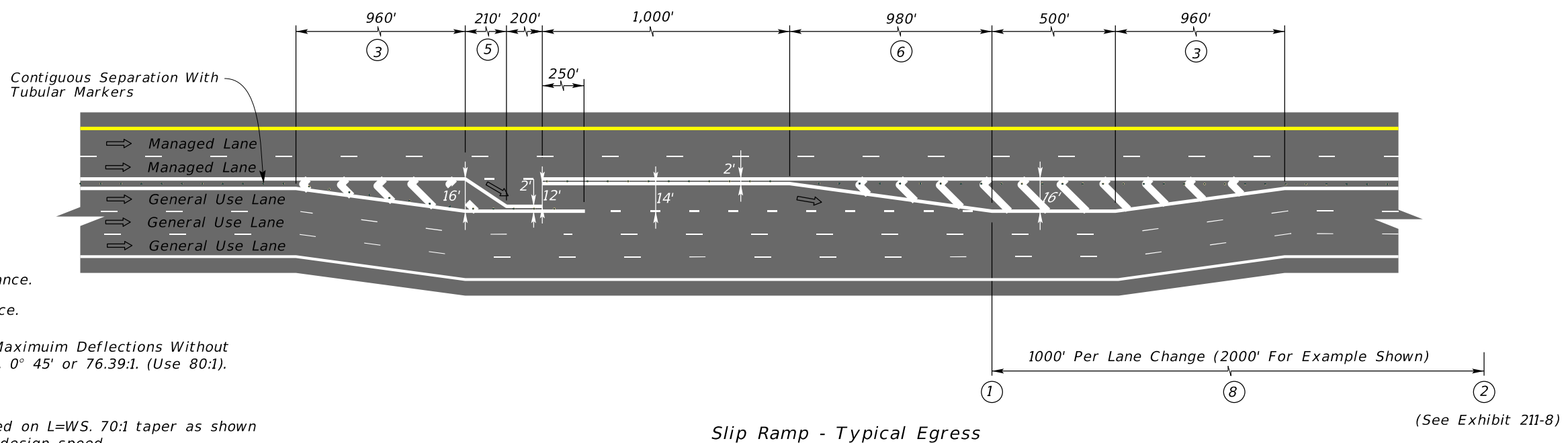
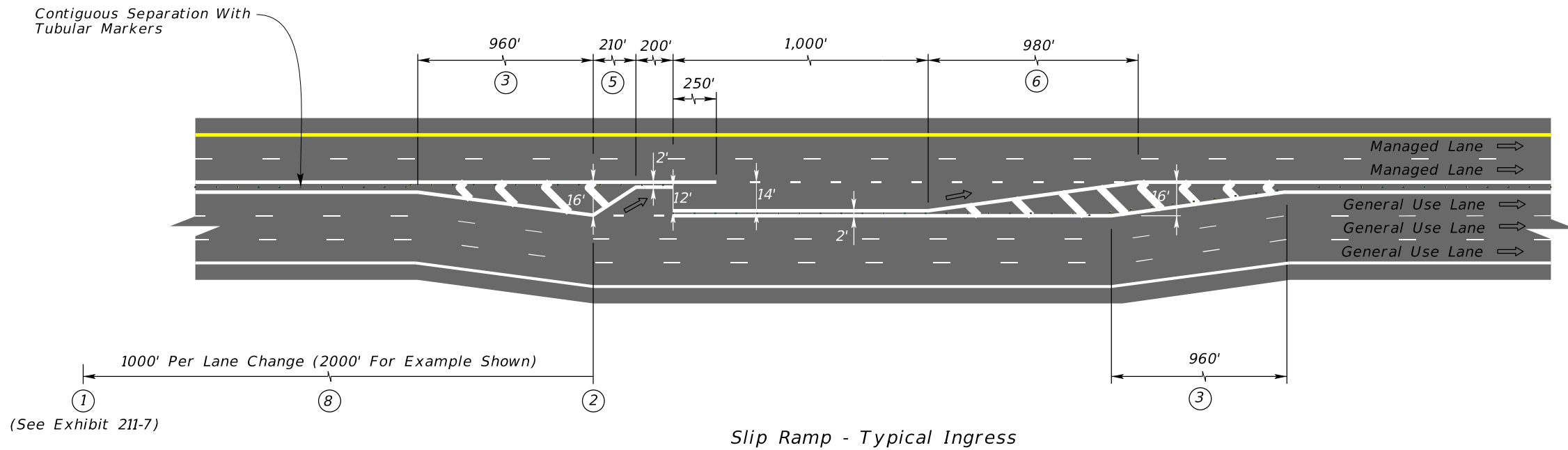

Notes:

- ① Begin weave distance.
- ② End weave distance.
- ③ Per FDM 210.8.1, Maximum Deflections Without Horizontal Curves, 0° 45' or 76.39:1. (Use 80:1).
- ⑤ 15:1 taper.
- ⑥ Taper length based on $L=WS$. 70:1 taper as shown assumes 70 MPH design speed.
Where:
W = Width Of Lateral Transition
In Feet
S = Design Speed
- ⑧ The 1000' dimension is the starting weave length and may need to be increased based upon site-specific operational analysis.

NOTE:

The dimensions shown in this Exhibit are typical values, and may need to be increased based upon site-specific operational analysis.

NOT TO SCALE

EXHIBIT 211-5
01/01/2025

WEAVE SECTIONS TYPICAL INGRESS & EGRESS FOR MANAGED LANES WITH CONTIGUOUS SEPARATION

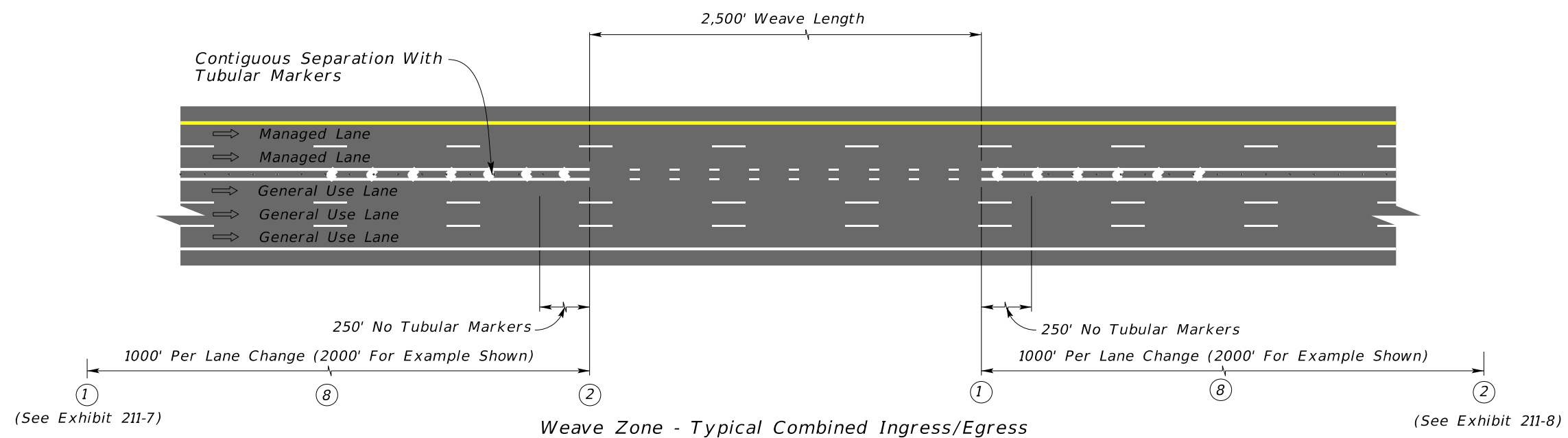
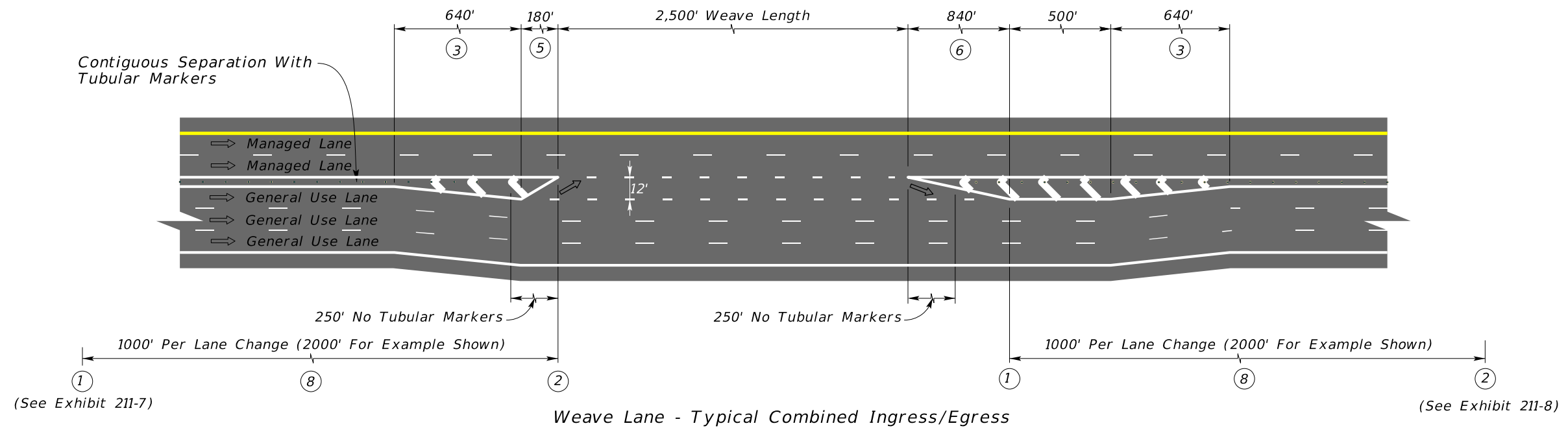

Notes:

- ① Begin weave distance.
- ② End weave distance.
- ③ Per FDOT PPM, Table 2.8.1a, Maximum Deflections Without Horizontal Curves, 0° 45' or 76.39:1. (Use 80:1).
- ④ 15:1 taper.
- ⑤ Taper length based on $L=WS$. 70:1 taper as shown assumes 70 MPH design speed.
Where:
 W = Width Of Lateral Transition
 In Feet
 S = Design Speed
- ⑥ The 1000' dimension is the starting weave length and may need to be increased based upon site-specific operational analysis.

NOTE:

The dimensions shown in this Exhibit are typical values, and may need to be increased based upon site-specific operational analysis.

NOT TO SCALE

EXHIBIT 211-6
01/01/2025

MANAGED LANES ENTRANCE TERMINAL CONFIGURATIONS

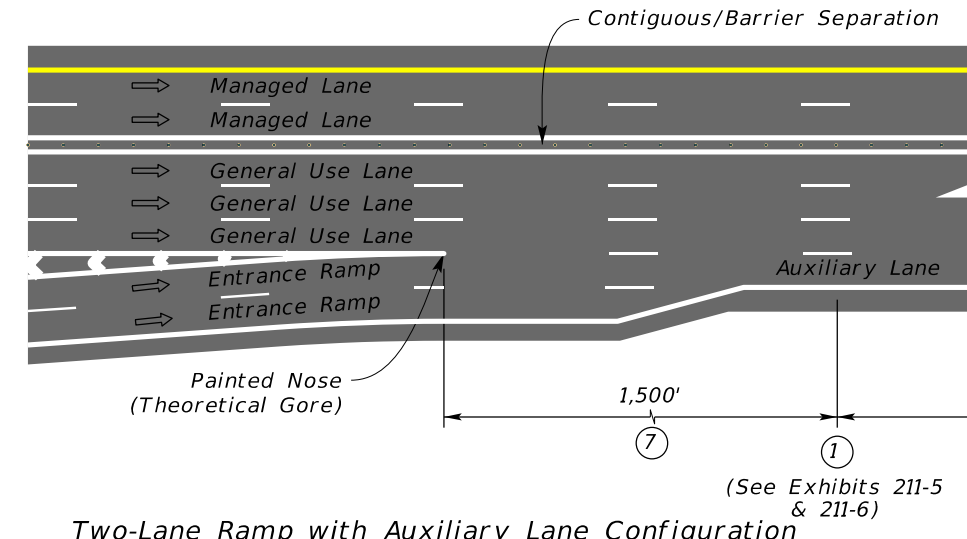
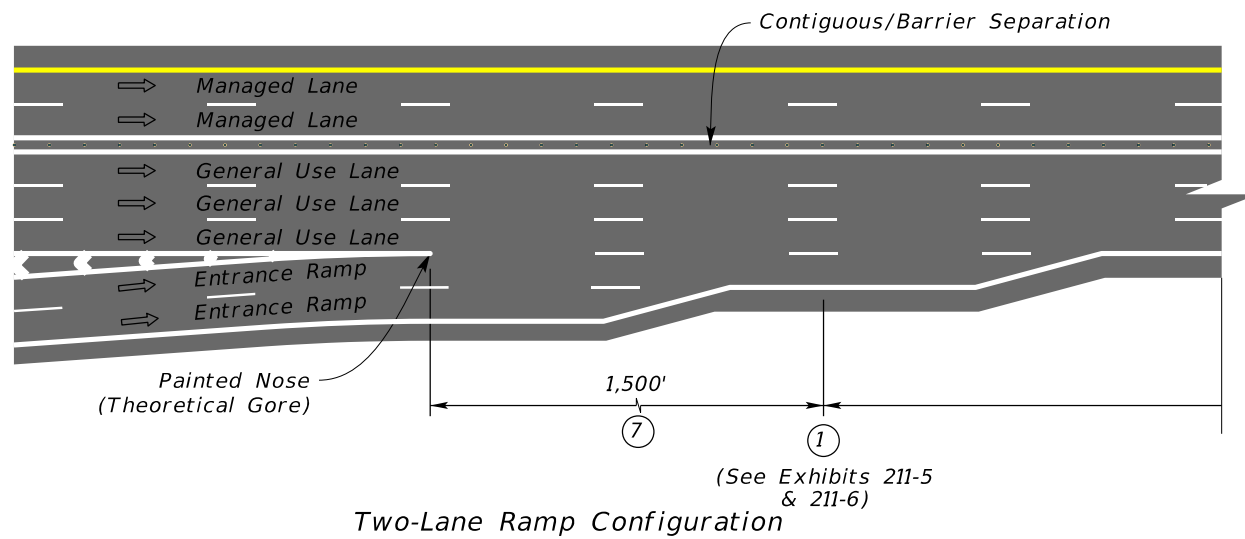
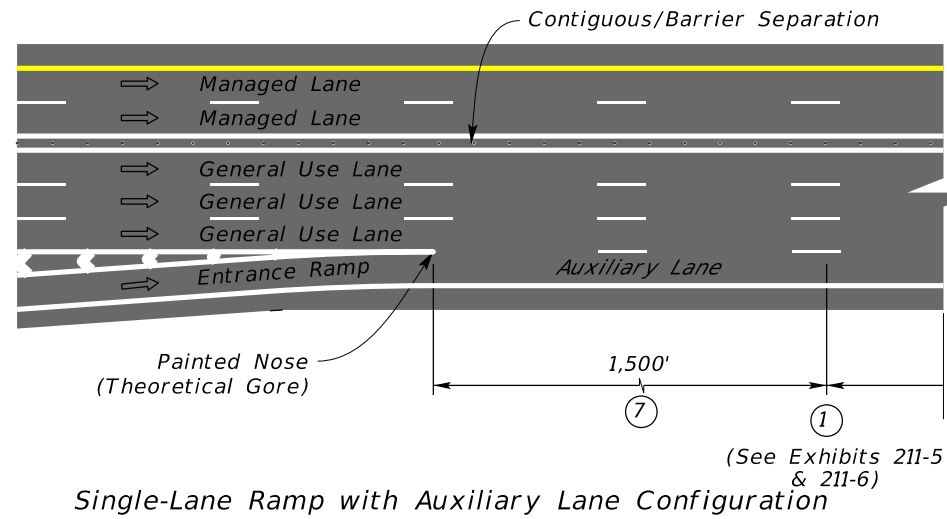
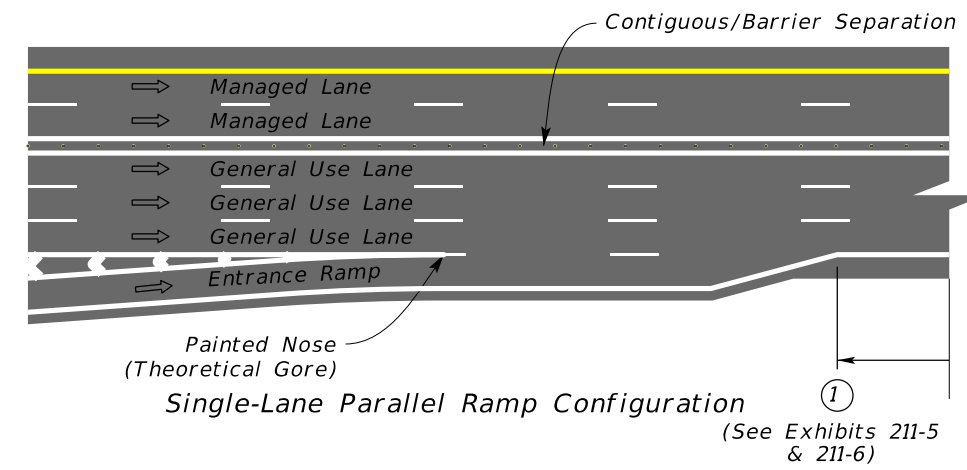
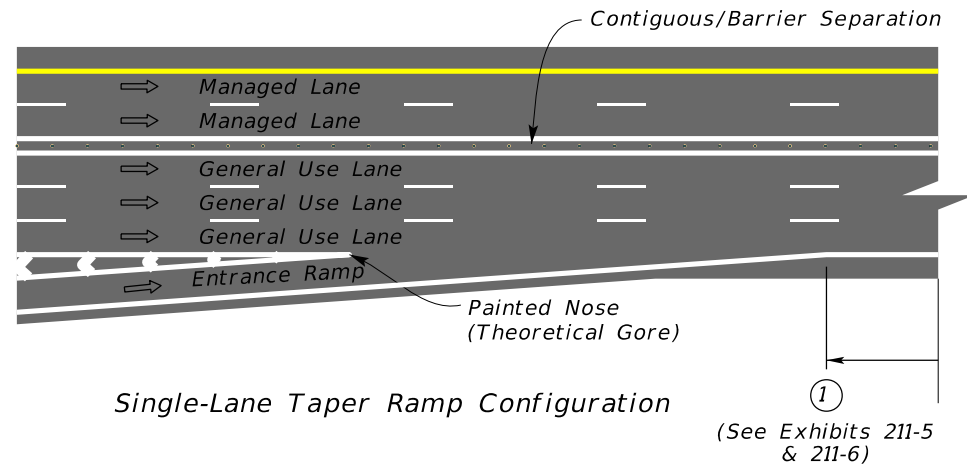

Notes:

- ① Begin weave distance.
- ⑦ 1,500' intended to allow ramp traffic to merge into the outside general use lane.

NOTE:

The dimensions shown in this Exhibit are typical values, and may need to be increased based upon site-specific operational analysis.

NOT TO SCALE

MANAGED LANES EXIT TERMINAL CONFIGURATIONS

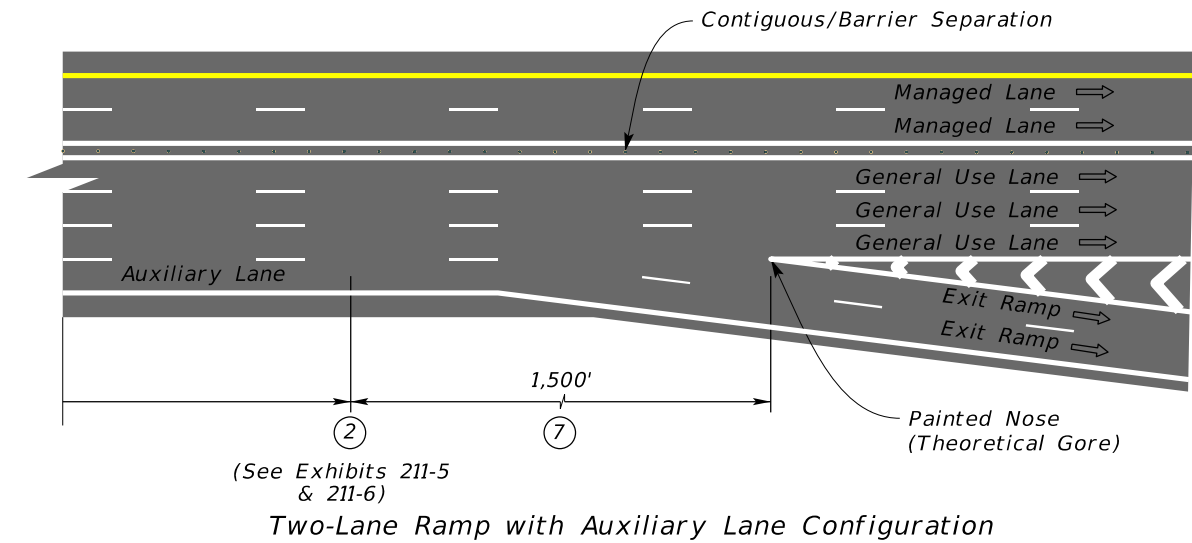
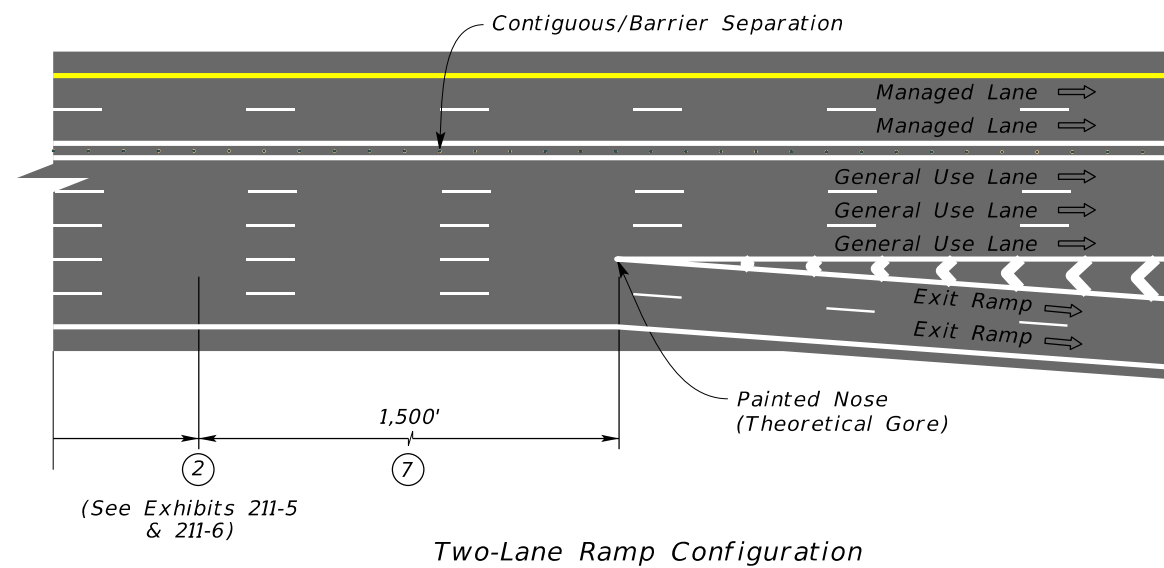
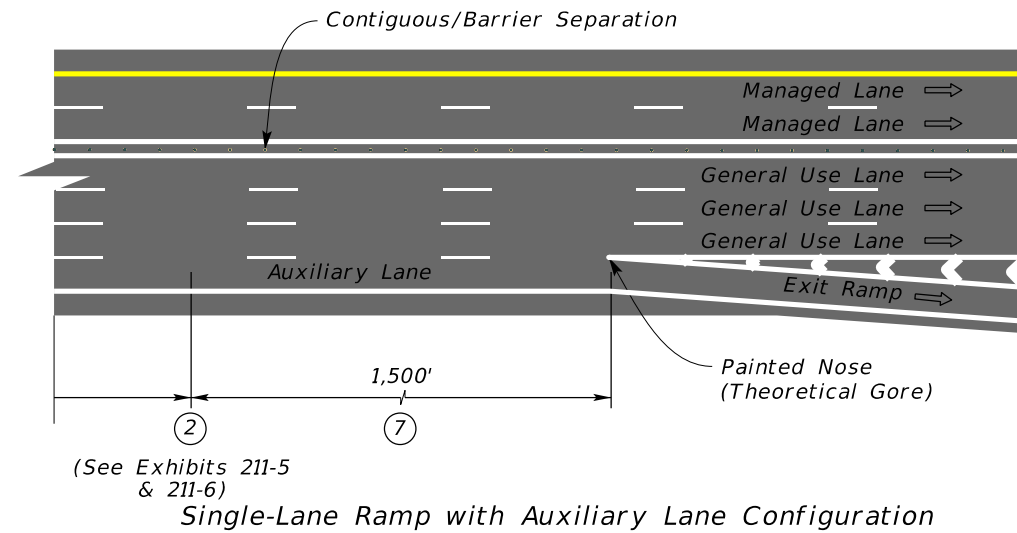
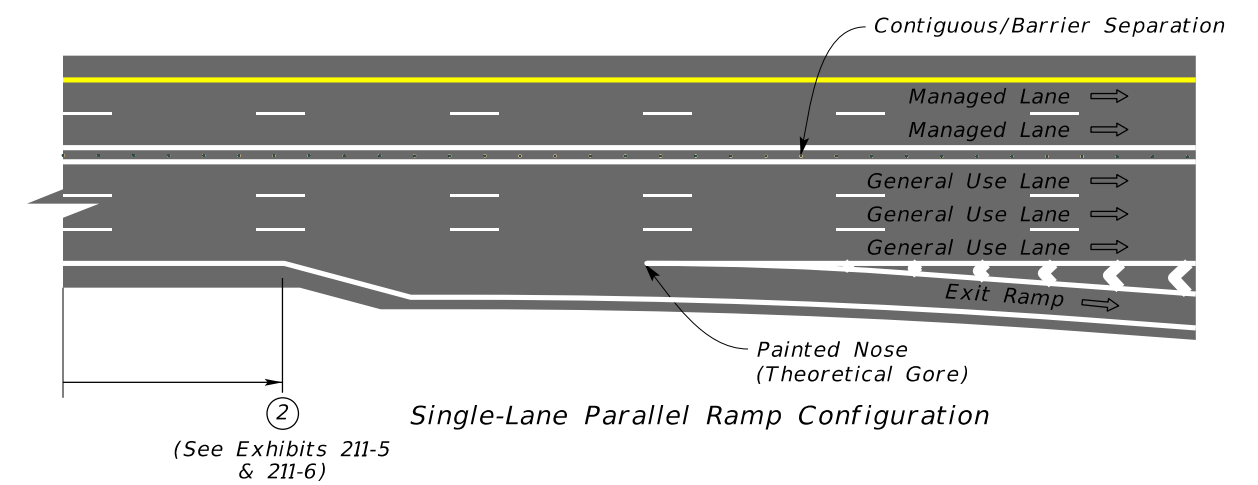
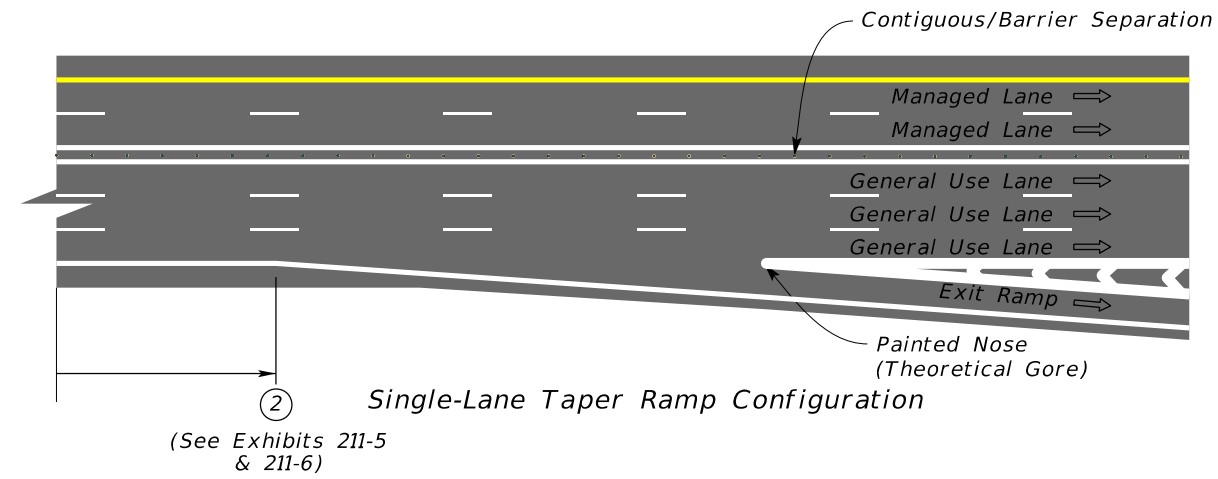

Notes:

- ② End weave distance.
- ⑦ 1,500' intended to allow traffic in the outside general use lane to access the exit ramp.

NOTE:

The dimensions shown in this Exhibit are typical values, and may need to be increased based upon site-specific operational analysis.
See Standard Plans 711-001 and 711-003 for gore striping information.

NOT TO SCALE

**EXHIBIT 211-8
01/01/2025**

MANAGED LANES TYPICAL PAVEMENT MARKINGS FOR SLIP RAMP INGRESS & EGRESS

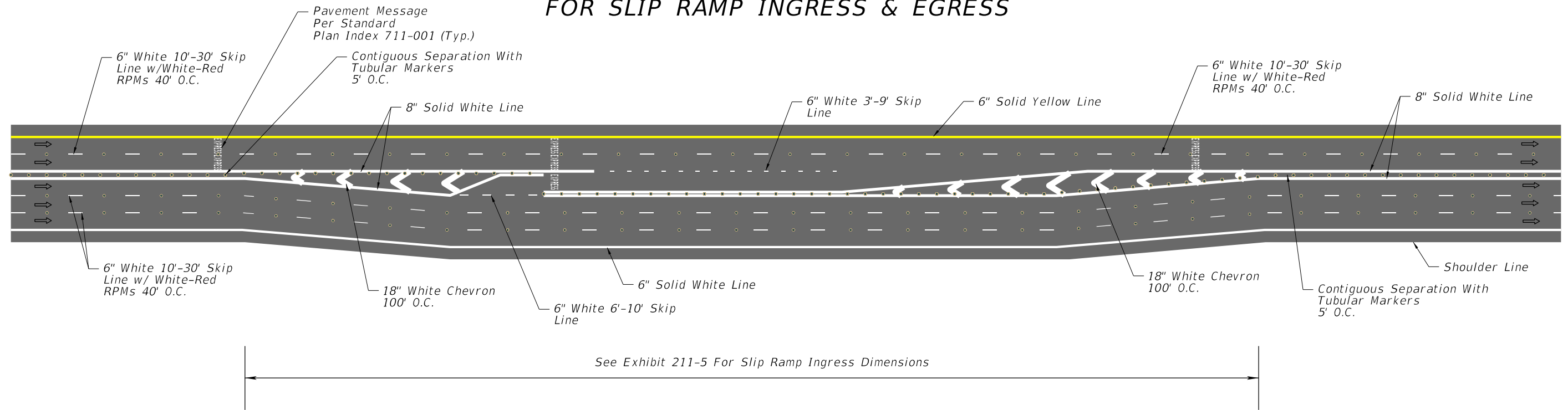

RPMs- RAISED PAVEMENT MARKERS
O.C. - ON CENTER

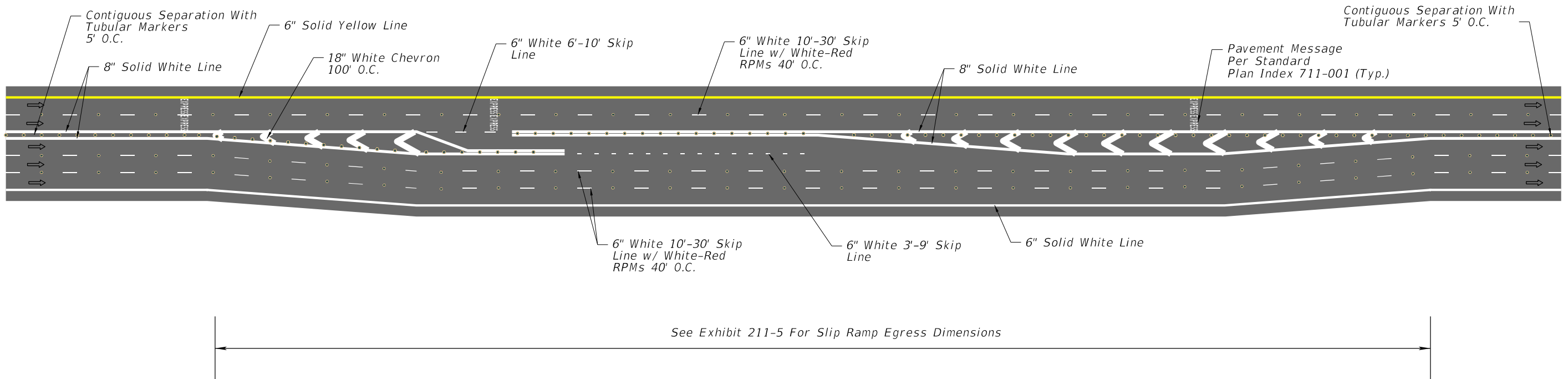

RPMs- Raised Pavement Markers
O.C.- On Center

NOT TO SCALE

EXHIBIT 211-9
01/01/2025

MANAGED LANES TYPICAL PAVEMENT MARKINGS FOR WEAVE SECTIONS INGRESS & EGRESS

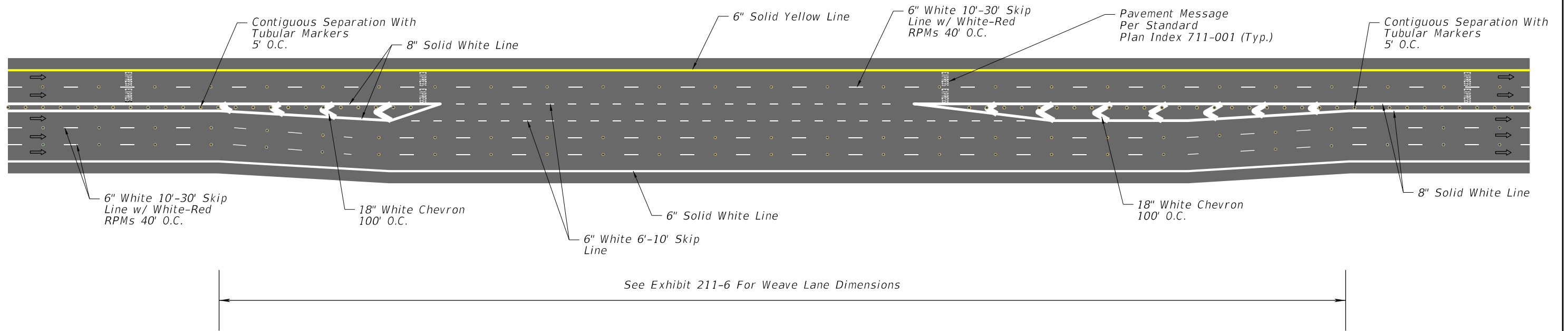

RPMs- Raised Pavement Markers
O.C.- On Center

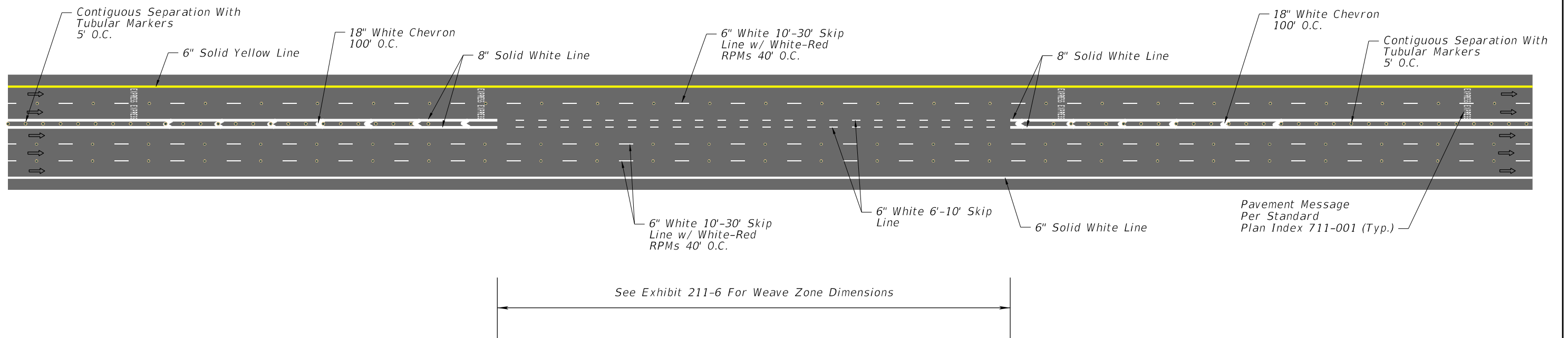

RPMs- Raised Pavement Markers
O.C.- On Center

NOT TO SCALE

EXHIBIT 211-10
01/01/2025

MANAGED LANES TYPICAL PAVEMENT MARKINGS FOR BEGIN MANAGED LANES

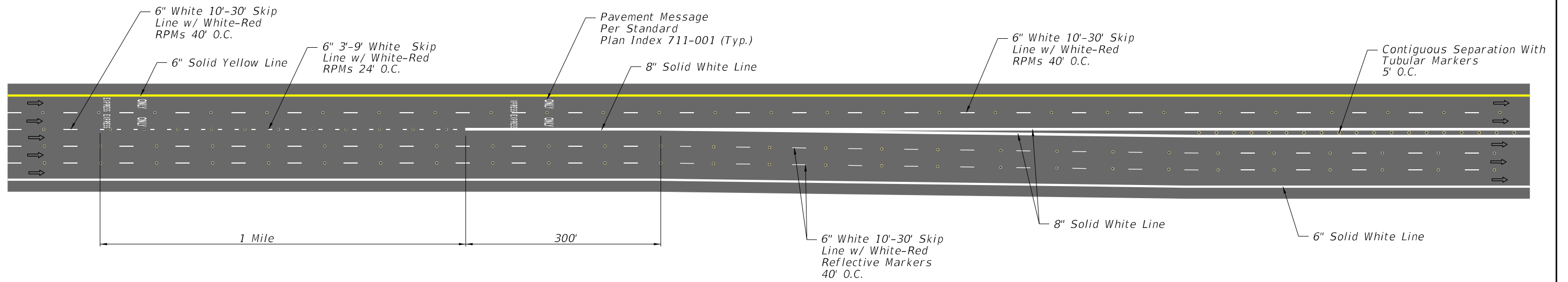

Managed Lane Begins
(General Purpose Becomes Managed Lane)

RPMs- Raised Pavement Markers
O.C.- On Center

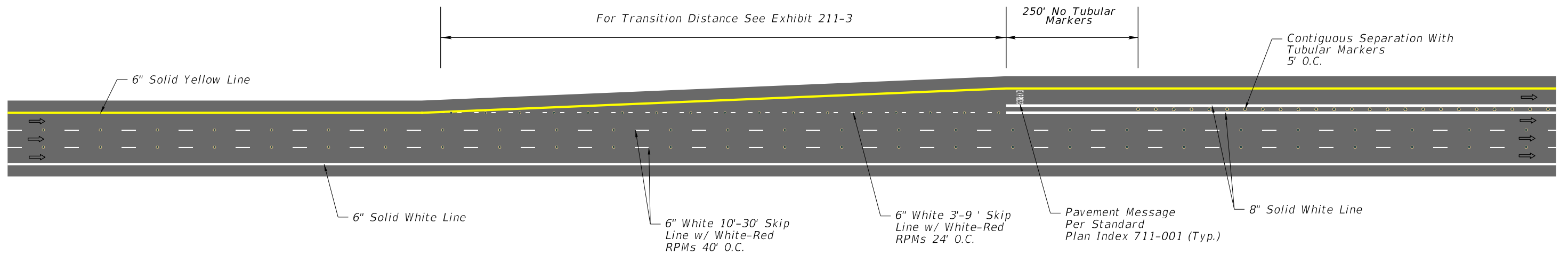

Managed Lane Begins

RPMs- Raised Pavement Markers
O.C.- On Center

NOT TO SCALE

EXHIBIT 211-11
01/01/2025

MANAGED LANES TYPICAL PAVEMENT MARKINGS FOR END MANAGED LANES

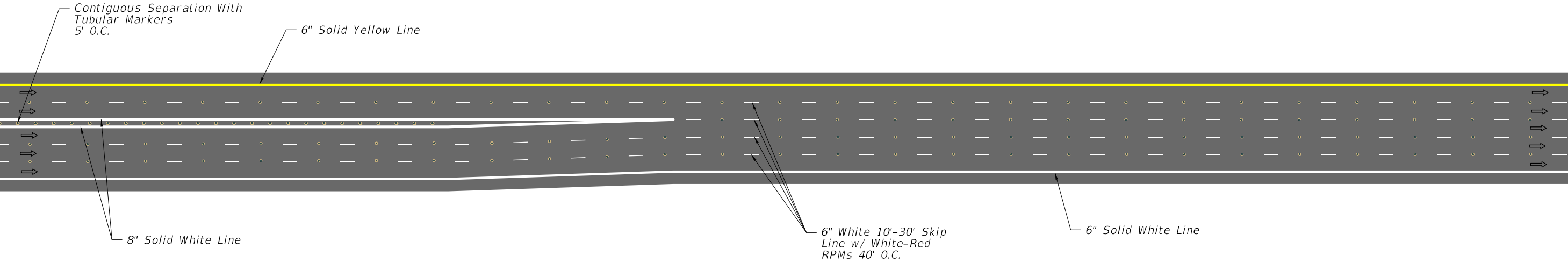

Managed Lanes Become General Purpose Lanes

RPMs- Raised Pavement Markers
O.C.- On Center

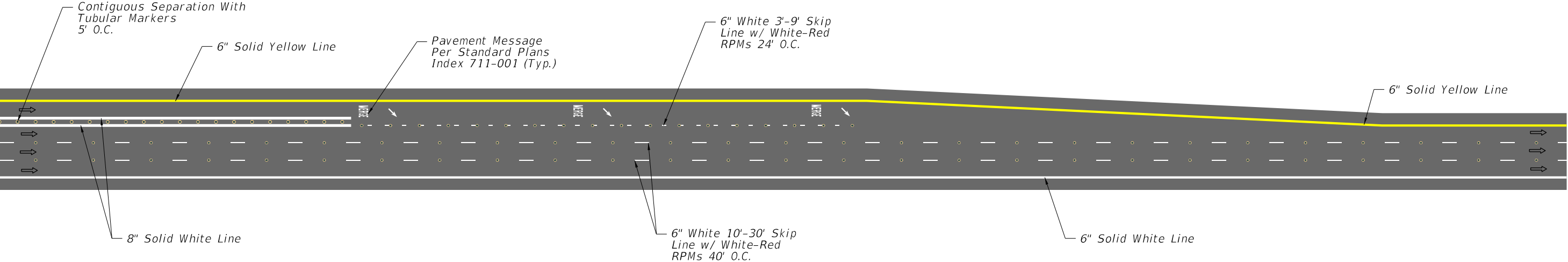

Managed Lane Ends

RPMs- Raised Pavement Markers
O.C.- On Center

NOT TO SCALE

EXHIBIT 211-12
01/01/2025

211.15 Limited Access Right of Way

The following criteria will be used in establishing Limited Access limits along crossroads at interchanges. LA R/W will end at the same station for both sides of the crossroad based on the greatest distance from the LA facility.

- (1) Extend the LA R/W along the crossroad 1,320 feet measured from the end of the taper of the ramp furthest from the interchange. See **Florida Administrative Code, Rule 14-97** for additional information.
- (2) In constrained conditions, for rural interchanges, LA R/W will extend along the crossroad as far as the first intersection with an arterial road or a minimum distance of 300 feet beyond the end of the acceleration or deceleration taper. Where no taper is used, the LA R/W will extend a minimum distance of 300 feet beyond the radius point of the return.
- (3) In constrained conditions, for interchanges in urban areas, the criteria given above will apply except that the LA R/W will end a minimum of 100 feet beyond the end of taper or the radius point of the return.
- (4) Extend LA R/W along crossroads overpassing LA facilities (no interchange) 200 feet from the LA facility R/W line. This distance may be reduced or omitted if the crossroad profile provides adequate sight distance for existing or proposed driveways. The fence is generally tied into the crossroad structure end bent unless required along the crossroad.

Any reduction in the 300 feet rural and 100 feet urban minimum values shown above for LA R/W limits must be approved by FHWA for interstate projects and by the District Design Engineer for non-interstate facilities.

211.16 Maintenance Access

Accommodation of access for maintenance is integral to the roadway typical section on LA facilities. Specific requirements for the area immediately adjacent to toll sites is contained within the **GTR**. Requirements for access through various roadside safety devices are contained within **FDM 215**.

Along ramps and mainline lanes where roadside barriers are used, the minimum border width from the back of a barrier or retaining wall is 10 feet. Provide sufficient access from public R/W that is contiguous and unimpeded to the LA facility for maintenance vehicles.

If the maintenance access is not continuous along a barrier or wall, and thus maintenance vehicles and equipment would need to turn around, then a sufficient turnaround area must be provided that is acceptable and approved by the District Maintenance Engineer.

Maintenance accessibility includes the ability for equipment and vehicles to maneuver around obstacles including fences, lights, signs, side slopes, and ponds.

The maximum continuous length of a guardrail or barrier wall run along the outside of the roadway is 2,500 feet between end terminals. An access opening must be provided when long guardrail or barrier wall runs are broken up. Coordinate with the District Maintenance Engineer and District ITS Design Engineer on the final access location points to meet the needs of maintenance and operations. The preferred typical detail for roadside guardrail access openings is depicted in the ***Standard Plans Instructions for Index 536-001***.

211.17 Roadway and Bridge Approach Slab Evaluation

Resurfacing Projects – Perform a qualitative evaluation for approach slabs throughout the limits of the project to ensure they are providing a smooth transition to the bridge. When deficiencies are identified, summarize the potential underlying causes, and provide a recommendation for correcting the deficiencies.

Capacity Improvement Projects – Perform the same qualitative evaluation as required for the resurfacing projects and include in the design documentation submitted with the preliminary geometry and grade submittal. Existing bridges and approach slabs that are scheduled for complete reconstruction do not need to be evaluated for corrective measures.

211.18 Interchange Areas Bicycle and Pedestrian Facilities

Provide a shared use path to move pedestrians and bicyclists through interchange locations where pedestrian and bicycle facilities are required. See ***FDM 224*** for the types of shared use paths and associated criteria for each. For existing interchanges where a shared use path cannot be provided, a Design Variation is not required.

The shared use path can be continuous through the entire influence area of the interchange or can be used only at ramp intersection locations. A continuous path through the entire interchange is preferred but may not always be feasible. See the ***Interchange Access Request User's Guide*** to determine if an Interchange Access Request (IAR) or break in Limited Access R/W is required.

211.18.1 Bicycle Ramps

Connect bicycle lanes to the shared use path using bicycle ramps (***FDM 223.2.6***). Terminate bicycle lanes at the approach to the interchange and resume the bicycle lane

at the far side of the interchange. A conceptual layout of entry and exit bicycle ramps to a shared use path from a bicycle lane is provided in **Figure 211.18.1**. See **FDM 230** and the **TEM** for additional information on pavement marking and signing.

Figure 211.18.1 Conceptual Layout of Bicycle Ramps at Interchange Areas

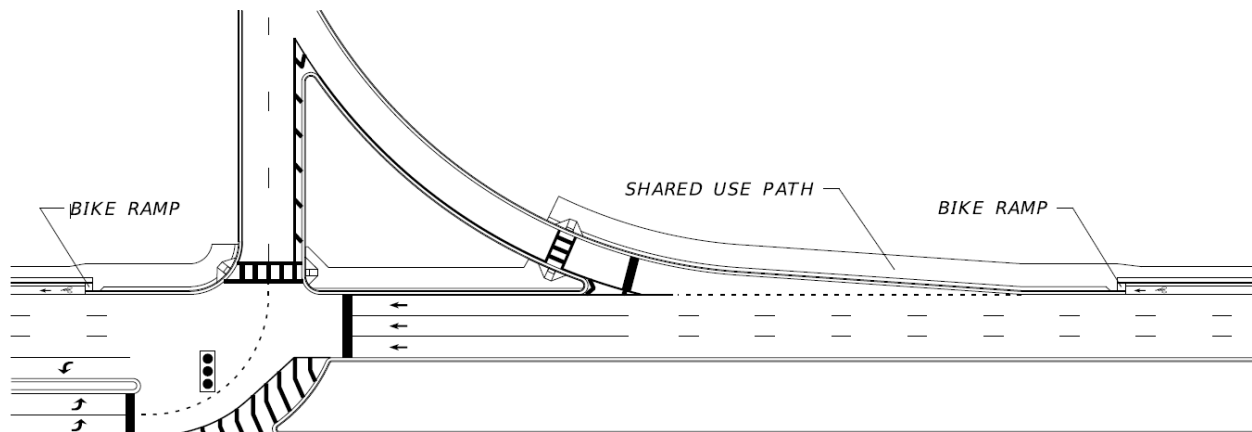

For existing interchanges where a bicycle ramp cannot be provided, a Design Variation is not required. Consider any of the following mitigation strategies, in addition to the required keyhole lane, where there is not an option lane:

- Provide an “exit ramp” from the bicycle lane to a sidewalk and an “entry ramp” from the sidewalk to the bicycle lane.
- Provide supplemental green markings within the keyhole lane. See FDM 223 for information on bicycle facilities.
- Add speed management strategies to lower speeds through the conflict area. See FDM 202 on speed management.

Where there is an option lane, discontinue the bicycle lane on the approach to the interchange and resume at the far side of the interchange.

211.18.2 Refuge Island at Ramp Intersections

Design corner channelization islands as refuge islands that meet the criteria in **FDM 210.3.2.3**.

211.18.3 Intersection Angle with Crossroad

Provide an intersecting angle consistent with intersection design criteria in **FDM 212**.

When the intersecting angle cannot be between 75 to 90 degrees, process a Design Variation, and consider the following mitigation strategies:

- Signalize the free-flowing or yield on/off-ramp movement, or
- Provide a pedestrian signal or Rectangular Rapid-Flashing Beacon (RRFB) for the pedestrian crossing. For the criteria of a RRFB, refer to the **TEM**

A conceptual layout of a low-angle ramp intersection with mitigation strategies is provided in **Figure 211.18.2**.

For existing interchanges, a Design Variation is only required when the mitigation strategies are not met. Existing ramp configurations do not require a Design Variation on RRR projects.

Figure 211.18.2 Example of Mitigation for Low-Angle Ramp

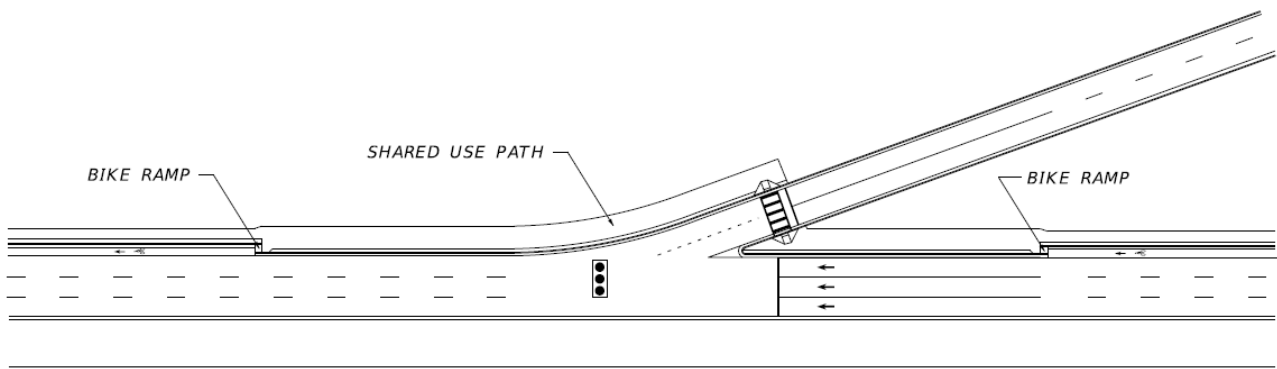

211.18.4 Signing and Pavement Markings

See **FDM 230.6** for typical signing and pavement markings for bicycle and pedestrian facilities through interchange areas.