

## 210 Arterials and Collectors

### 210.1 General

Design criteria presented in this chapter apply to new construction and reconstruction projects on arterials and collectors on the State Highway System. Roadways not on the State Highway System which are impacted by these new construction and reconstruction projects should also be designed in accordance with this manual; however, districts may allow the use of the Manual of Uniform Minimum Standards for Design, Construction and Maintenance for Streets and Highways (commonly known as the "[Florida Greenbook](#)").

This chapter also provides minimum criteria to be used with Resurfacing, Restoration, and Rehabilitation (RRR) projects as described in **FDM 210.1.1**.

Facilities on the Strategic Intermodal System (SIS) are subject to special standards and criteria for number of lanes, Design Speed, access, and Level of Service. Design all SIS and Emerging SIS Highway Intermodal Connectors in accordance with the SIS criteria contained in this manual. With approval by the District Design Engineer, the **Florida Greenbook** may be used on SIS facilities that are not on the State Highway System.

Many design criteria are related to Design Speed; e.g., vertical and horizontal geometry, sight distance. The minimum design values are closely related to traffic safety and require an approved Design Exception or Design Variation when they are not met. See **FDM 201** for information on Design Speed. See **FDM 122** for information on Design Exceptions and Design Variations.

Example roadway typical sections are included in the exhibits in **FDM 913**. Criteria regarding lanes, medians, and shoulders for bridges are illustrated in **FDM 260.1.1**. Subsequent sections of this chapter contain specific information and criteria regarding these and other typical section elements, as well as geometric features.

Existing project features which were constructed to meet minimum metric design criteria but are mathematically slightly less than equivalent minimum English design criteria do not require Design Exceptions or Design Variations to remain.

#### 210.1.1 Criteria for RRR Projects

Criteria for RRR projects provided in this chapter are the minimum values allowed for roadway and structure elements to remain on the State Highway System without obtaining a Design Exception or Design Variation (see **FDM 122**). Existing project features are to meet new construction criteria when RRR criteria are not provided.

New features installed on RRR projects are to meet new construction criteria. However, RRR criteria may be used for establishing the minimum requirements for adding auxiliary lanes, keyhole lanes, or other minor intersection improvements with the understanding that when existing R/W is adequate, new construction criteria will be used to the maximum extent feasible.

### **210.1.2 Railroad-Highway Grade Crossing**

If a railroad-highway grade crossing is within or near the limits of the project, and there are federal funds associated with the project, see **FDM 220.2.4** for requirements.

### **210.1.3 Aviation and Spaceports**

If an airport or spaceport is within 10 nautical miles of the project, refer to **FDM 110.5.1** for requirements.

## **210.2 Lanes**

Design criteria for lane widths and pavement slopes are given by lane type, Design Speed and context classification. Minimum travel, auxiliary, and two-way left-turn lane widths are provided in **Table 210.2.1**. Refer to **FDM 202** for speed management information and **FDM 211** for ramp lane widths.

Additional traveled way width may be provided in curves on undivided 2-lane roadways to accommodate large trucks. See **AASHTO Green Book** for guidance and information on traveled way widening in horizontal curves. Two-way left-turn lane widths (flush median) may be used on 3-lane and 5-lane typical sections with Design Speeds  $\leq 40$  mph. On new construction projects, flush medians are to include sections of raised or restrictive median and islands to enhance vehicular, bicycle, and pedestrian safety, improve traffic efficiency, and attain the standards of the Access Management Classification of that highway system. Sections of raised or restrictive median and islands are recommended on RRR projects.

**Table 210.2.1 Minimum Travel and Auxiliary Lane Widths**

Context Classification		Travel (feet)			Auxiliary (feet)			Two-Way Left Turn (feet)	
		Design Speed (mph)			Design Speed (mph)			Design Speed (mph)	
		25-35	40-45	≥ 50	25-35	40-45	≥ 50	25-35	40
<b>C1</b>	Natural	N/A	N/A	12	N/A	N/A	12	N/A	
<b>C2</b>	Rural	N/A	N/A	12	N/A	N/A	12		
<b>C2T</b>	Rural Town	11	11	N/A	11	11	N/A	12	12
<b>C3</b>	Suburban	10	11	12	10	11	12	11	12
<b>C4</b>	Urban General	10	11	N/A	10	11	N/A	11	12
<b>C5</b>	Urban Center	10	N/A	N/A	10	N/A	N/A	11	N/A
<b>C6</b>	Urban Core	10	N/A	N/A	10	N/A	N/A	11	N/A

**Notes:**

N/A indicates this combination of Design Speed and context classification is outside the intended design range and should be avoided. See **Table 201.5.1** for context classifications and Design Speed ranges.

**Travel Lanes:**

- (1) Minimum 11-foot travel lanes on designated freight corridors, SIS facilities, or when truck volumes exceed 10% on very low-speed roadways (Design Speed ≤ 35 mph) (regardless of context classification).
- (2) Minimum 12-foot travel lanes on all undivided two-lane, two-way roadways. However, very low-speed and low-speed table values may be used for roadway sections with both of the following:
  - (a) C2T, C4, C5, or C6 context classification.
  - (b) Tangent horizontal alignment or curve radii large enough to accommodate the design vehicle within the travel lane in accordance with **AASHTO Green Book**.
- (3) Consider wider lanes on very low-speed roadways (Design Speed ≤ 35 mph) when transit is present.
- (4) Travel lanes should not exceed 14 feet in width.
- (5) On RRR projects, 11-foot lanes may remain on divided multilane roadways with C3 context classifications and 50 mph design speeds.

**Auxiliary Lanes:**

- (1) Table values for right turn lanes may be reduced by 1 foot when a bicycle keyhole is present.
- (2) Median turn lanes should not exceed 15 feet in width.
- (3) For high-speed curbed roadways, 11-foot minimum lane widths are allowed for the following:
  - (a) Dual left turn lanes.
  - (b) Single left turn lanes at directional median openings.
- (4) For RRR projects, 9-foot right-turn lanes are allowed on very low-speed roadways (Design Speed ≤ 35 mph).

**Two-Way Left-Turn Lanes:**

For RRR projects, the values in the table may be reduced by 1-foot.

## 210.2.1 Bicycle Lanes

**FDM 223** contains criteria for the accommodation of bicyclists.

## 210.2.2 Transit Facilities

Coordinate with the District Modal Development Office and local transit agency for the need for public transit facilities. **FDM 225** contains additional guidelines for street side bus stop facilities, location, and design.

## 210.2.3 On-Street Parking

On-street parking is a key element of urban contexts C6, C5, and C4, but may also be found in C2T. It provides necessary parking supply in these locations, helps manage traffic speeds, and provides separation between the sidewalk and the travel lanes. In these context zones, leave existing on-street parking in place unless local plans call for its removal. Where on-street parking is not present in C6, C5, or C4, determine whether it should be added per local plan, for speed management, or to increase available parking.

On-street parking is allowed on facilities with Posted Speeds of 35 mph or less. It is typically located at the outside edge of the roadway between the travel lane and the sidewalk. In C6 and C5 contexts it may sometimes be located within the median of a divided low-speed urban street. Median parking provides additional parking supply as well as speed management.

On-street parking may be either parallel or angle (traditional or reverse). See **Chapter 316, F.S.** for laws governing parking spaces.

[Standard Plans](#), **Index 711-001** provides dimensions and additional requirements for on-street parking.

See **FDM 223** for bicycle accommodations on roadways with on-street parking.

Parking restrictions to assure adequate clear sight triangles are provided in **FDM 212.11.5**.

### 210.2.3.1 Existing On-Street Parking

For RRR projects with existing on-street parking and a Posted Speed greater than 35 mph, process a single Design Variation that addresses all of the following design elements:

- Intersection Sight Distance
- Stopping Sight Distance (as applicable)
- On-street parking

The single Design Variation described above should include all affected intersections within a corridor; i.e., it is not necessary to process individual Design Variations for each location. In addition to processing a Design Variation, consider the following mitigation strategies:

- Use speed mitigation strategies described in **FDM 202** to achieve a Target Speed of 35 mph.
- When possible, provide a 2-foot wide buffer between the on-street parking spaces and the travel lane.

#### **210.2.4 Pavement Cross Slopes**

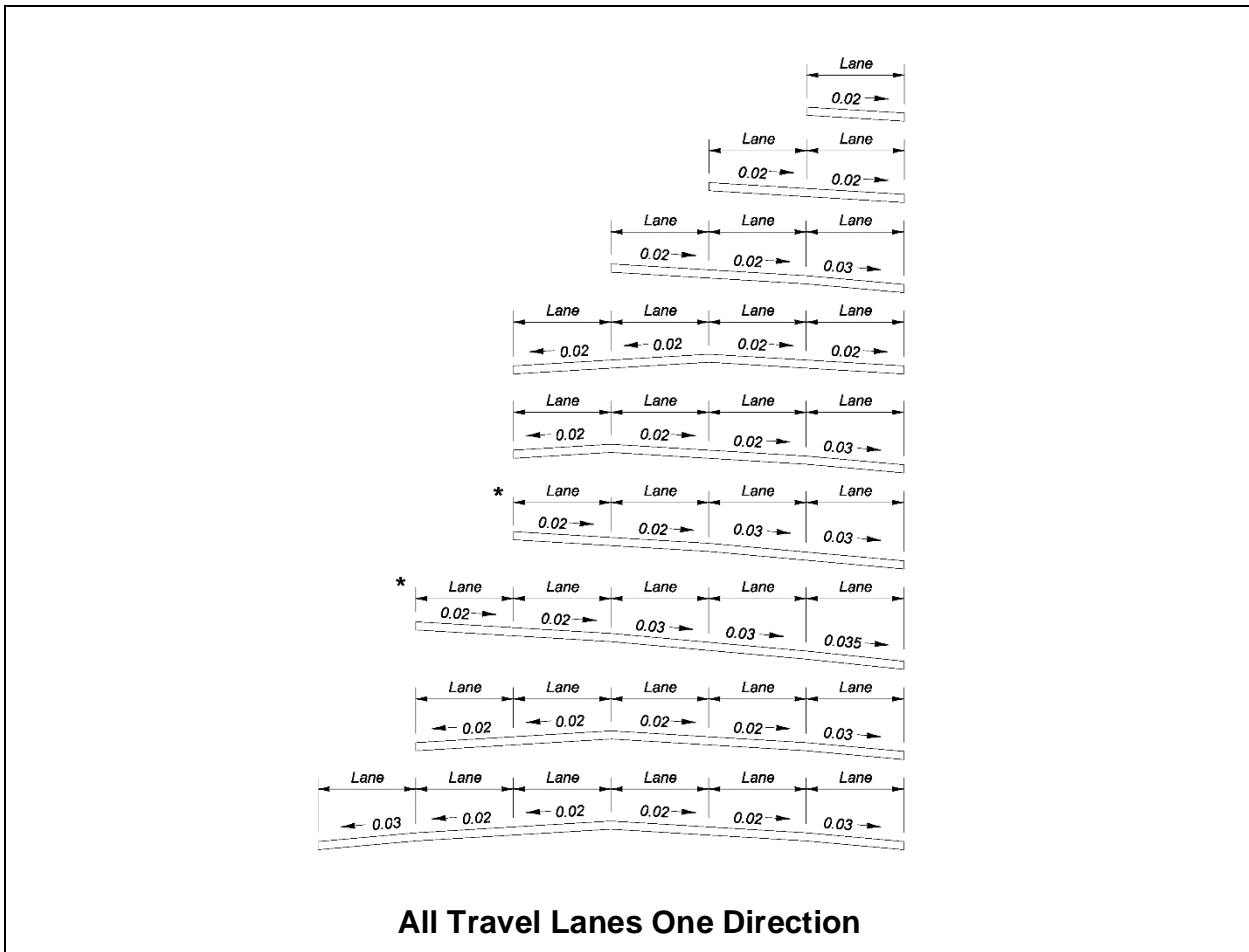
For roadways, the maximum number of travel lanes with cross slope in one direction is three lanes except as shown in **Figure 210.2.1**, which prescribes standard pavement cross slopes. A Design Variation or a Design Exception is required when proposed pavement cross slopes do not meet the requirements shown in **Figure 210.2.1**.

Outside auxiliary lane cross slopes must match or exceed the adjacent travel lane cross slope. The outside auxiliary lane cross slope cannot exceed the values in **Figure 210.2.1**. In superelevation transitions for separated free-flow turning roadways, do not exceed the maximum algebraic differences shown in **Table 210.2.2**.

The maximum algebraic difference in cross slope between adjacent through lanes is 0.04. The maximum algebraic difference in cross slope between a through lane and an auxiliary lane at a turning roadway terminal is given in **Table 210.2.2**.

Cross slopes on bridges are to be on a uniform, straight-line rate, typically 0.02 (see **FDM 260.4**). Use transitions to adjust for differences in cross slope between the approach roadway section and the required straight-line slope for bridge decks. Whenever possible, the transition should be accomplished on the roadway section, outside the limits of the bridge and approach slabs. This will require detailing of the transition(s) in the roadway plans. Coordination between the Roadway, Drainage and Structures designers in the development of transitions is required to ensure compatibility and harmonizing at bridge approaches.

**Figure 210.2.1 Standard Pavement Cross Slopes**

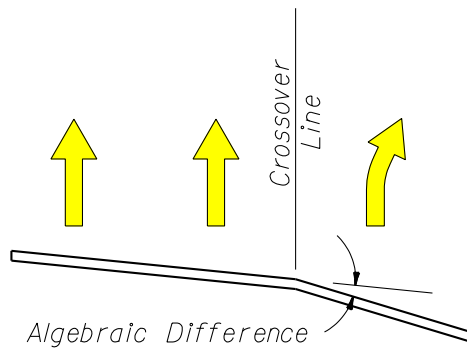
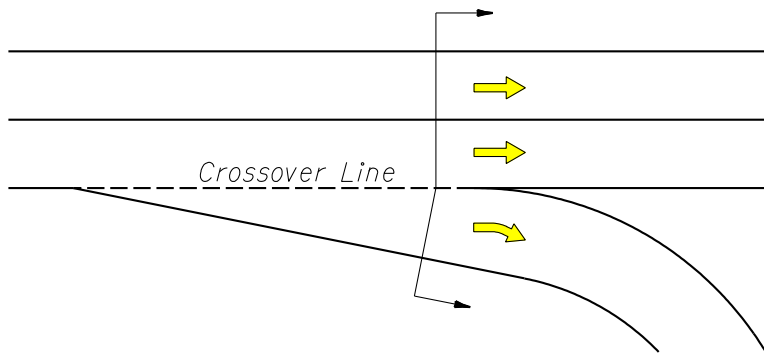


**Notes:**

- (1) These sections show only the standard slopes for adjoining travel lanes; they do not prescribe needed lanes, lane usage or typical section requirements other than lane slope. These slopes are not applicable to parabolic crowns.
- (2) Maximum pavement cross slopes for tangent sections are:
  - (a) 0.04 for Design Speeds of 45 mph or less
  - (b) 0.03 for Design Speeds greater than 45 mph
  - (c) 0.035 may only be used for 5-lanes sloped in one direction as shown above.
- (3) The maximum change in cross slope between adjacent through lanes is 0.04.
- (4) Slopes on multi-purpose lanes may be 0.03 to 0.05. Portions of multi-purpose lanes that are reserved for parking and access isles for the physically disabled are to have cross slopes not exceeding 1:50 (0.02) in all directions.
- (5) 4 or 5 lanes sloped in one direction (\*) may be used with Design Speeds of 65 mph or less and longitudinal grades not exceeding 5%.

**Table 210.2.2 Maximum Algebraic Difference in Cross Slope at Turning Roadway Terminals**

Design Speed of Exit or Entrance Curve (mph)	Maximum Algebraic Difference in Cross Slope at Crossover Line (%)
Less than 35	6.0
35 and over	5.0



### 210.2.4.1 RRR Criteria for Cross Slopes

Review the existing pavement and shoulder cross slopes for compliance with criteria. Field-verify existing pavement and shoulder cross slopes by one of the following:

- (1) Full Digital Terrain Model for the roadway width – evaluate cross slope on tangent sections at 100-foot intervals.
- (2) Vehicle Mounted Scanner – prior to design, using the results of the scan, determine roadway limits where cross slope is potentially out of tolerance and request Digital Terrain Model of the roadway width for these limits. Evaluate cross slope on tangent sections at 100-foot intervals.

If cross slopes do not meet the values in **Table 210.2.3**, additional cross sections may be required to develop cross slope correction details and estimate material quantities. Resurfaced pavement and shoulder cross slopes should meet new construction criteria. When cross slope correction is not practical, documentation in the design file is required. If existing conditions are within the allowable ranges shown in **Table 210.2.3**, the term “Match Existing” may be used on the Typical Section(s) to indicate that the existing cross slope is to remain. Superelevation requirements are covered in **FDM 210.9**.

When cross slope correction is necessary, work closely with the District Pavement Design Engineer and the District Pavement Materials Engineer to determine the appropriate method of correction. Tabulate existing cross slopes in the plans at 100-foot intervals within the limits of cross slope correction. Include cross slope correction details showing the method of correction in the plans (see examples in **FDM 913**). Do not show cross slope correction details on the roadway cross sections. Base cross slope correction material quantities on the method of correction shown in cross slope correction details.



**Table 210.2.3 RRR Criteria for Existing Roadway Cross Slopes**

Facility or Feature	Standard (ft/ft)	Allowable Range (ft/ft)
<b>Two-Lane Roads</b>	0.020	0.015 - 0.030
<b>Multilane Roads</b>	0.020	0.015 - 0.040
	0.030	0.025 - 0.040
	0.035	0.030 - 0.040
<b>Outside Shoulders</b>	0.060	Adjacent Lane Cross Slope - 0.080
<b>Inside Shoulders</b>	0.050	0.020 - 0.080
<b>Parking Lanes</b>	0.050	0.015 - 0.050
<p><b>Notes:</b></p> <ul style="list-style-type: none"> <li>(1) Existing multilane curbed roadways may have outside travel or auxiliary lanes with a maximum cross slope of 0.05.</li> <li>(2) Outside auxiliary lanes on flush shoulder roadways must match or exceed the adjacent travel lane cross slopes with a maximum cross slope of 0.04.</li> <li>(3) The maximum algebraic difference between adjacent through lanes must not exceed 0.06.</li> <li>(4) When existing shoulders are to remain, the algebraic difference between the shoulder cross slope and adjoining roadway pavement cross slope must be <math>\leq 0.07</math>.</li> <li>(5) Parking spaces and access aisles dedicated to serving persons with disabilities must have cross slopes no steeper than 0.02 (1:50) in any direction.</li> </ul>		

Existing curbed roadways originally constructed with a parabolic crown section may be resurfaced using a series of tangents with a cross slope range from 0.015 to 0.05.

### 210.2.4.2 Hydroplaning Risk Analysis

Hydroplaning risk analysis procedures are outlined in **FDM 211**. A hydroplaning risk analysis is required for projects with design speeds greater than or equal to 45 mph and cross slopes that do not meet the requirements shown in **Figure 210.2.1** or **Table 210.2.3**. This analysis supports the utilization of a non-standard typical section and the benefit-cost analysis of correcting pavement cross slope. For projects with Design Speeds of 60 mph or greater with 3 or more lanes sloped in one direction, refer to **FDM 211** for determination of when a hydroplaning risk analysis is required.

## 210.2.5 Lane Tapers

The minimum merging roadway transition length (L) is calculated as follows:

- (1) Use  $L = (W \cdot S^2) / 60$  for Design Speeds  $\leq 40$  mph
- (2) Use  $L = W \cdot S$  for Design Speeds  $\geq 45$  mph

Where: L = length of taper, feet

W = width of lateral transition, feet

S = Design Speed, mph

**Exhibits 210-1** through **210-6** illustrate standard roadway transitions. For conditions not addressed in these exhibits, use the following minimum taper lengths:

- Merging Taper = L
- Shifting Taper = L/2
- Shoulder Taper = L/3

Where there is an abrupt change in roadway typical section (e.g., a 4-lane section to a 6-lane section), a striped lane transition may be considered when all the following conditions are met:

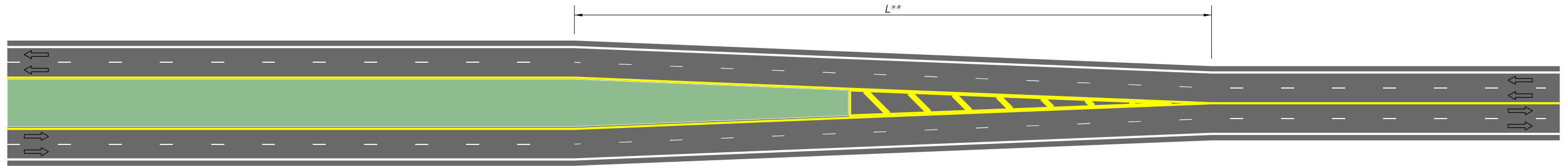
- New pavement widths are not substantially greater than the joining pavement,
- Grade differentials are slight, and
- Future widening is expected.

## 210.2.6 Number of Lanes on the State Highway System

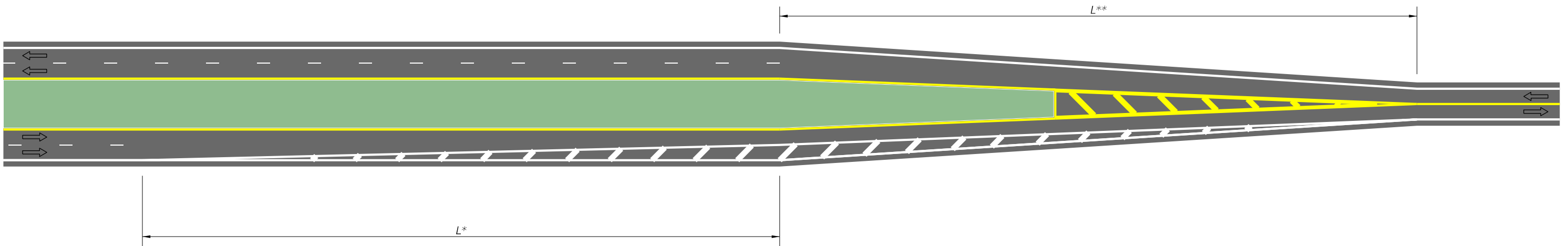
See **Section 335.02(3)** of the **Florida Statutes** for the number of lanes to be provided on the State Highway System. Nothing in this statute precludes a number of lanes in excess of ten lanes. The Department will determine the appropriate number of lanes based on traffic demand. Consideration will be given to availability of right of way and the capacity to accommodate other modes of transportation within existing rights of way.

Exceptions to **Section 335.02(3)** of the **Florida Statutes** will be addressed on a case-by-case basis, with final approval resting with the FDOT Secretary.

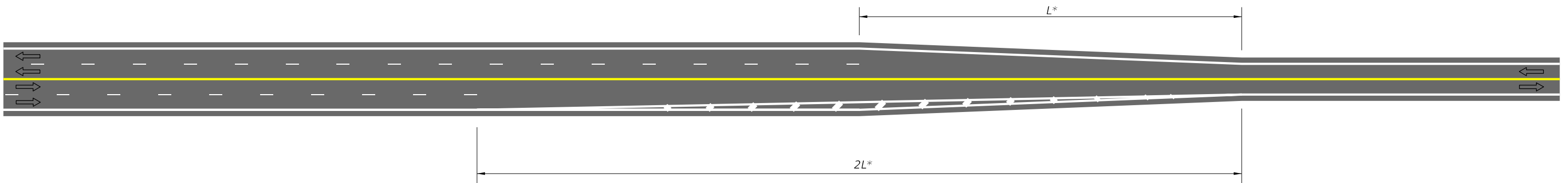
# LANE DIVERGENCE AND CONVERGENCE FOR CENTERED ROADWAYS



4-LANE DIVIDED TO 4-LANE UNDIVIDED



4-LANE DIVIDED TO 2-LANE UNDIVIDED



4-LANE UNDIVIDED TO 2-LANE UNDIVIDED

$L = \frac{WS^2}{60}$  FOR DESIGN SPEEDS  $\leq 40$  mph

$L = WS$  FOR DESIGN SPEEDS  $\geq 45$  mph

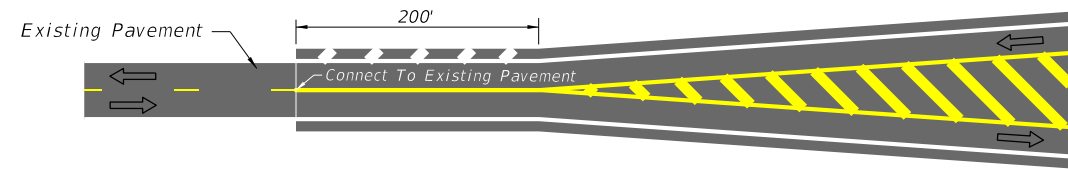
WHERE:  $L$  = LENGTH OF TAPER, FEET  
 $W$  = WIDTH OF LATERAL TRANSITION, FEET  
 $S$  = DESIGN SPEED, mph

\*  $W$  = ONE LANE WIDTH  
 \*\*  $W$  = 1/2 MEDIAN WIDTH

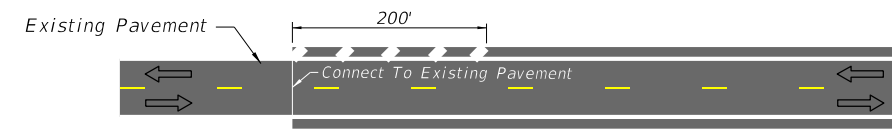
NOT TO SCALE

EXHIBIT 210-1  
 01/01/2025

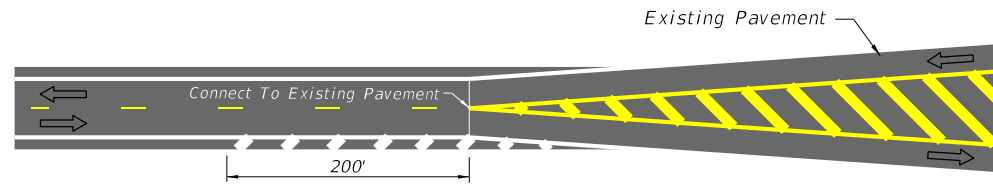
# PAVED SHOULDER TREATMENT AT TRANSITIONS AND CONNECTIONS



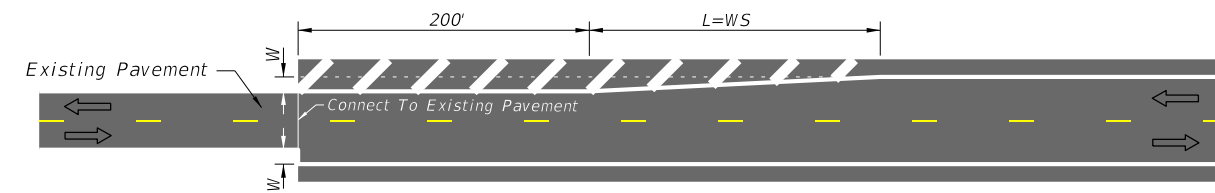
CONNECTING FLARE WITH PAVED SHOULDERS TO EXISTING ROADWAY WITHOUT PAVED SHOULDERS



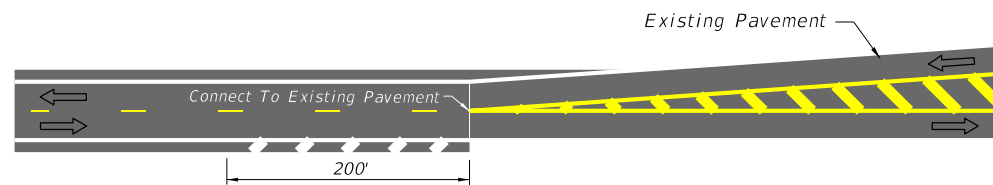
CONNECTING SIMILAR WIDTH PAVEMENTS



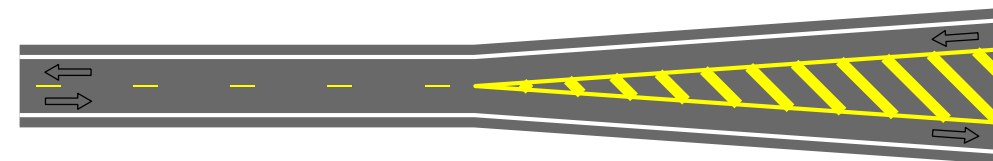
CONNECTING ROADWAY WITH PAVED SHOULDERS TO EXISTING SYMMETRICAL FLARE WITHOUT PAVED SHOULDERS



CONNECTING DIFFERENT WIDTH PAVEMENTS



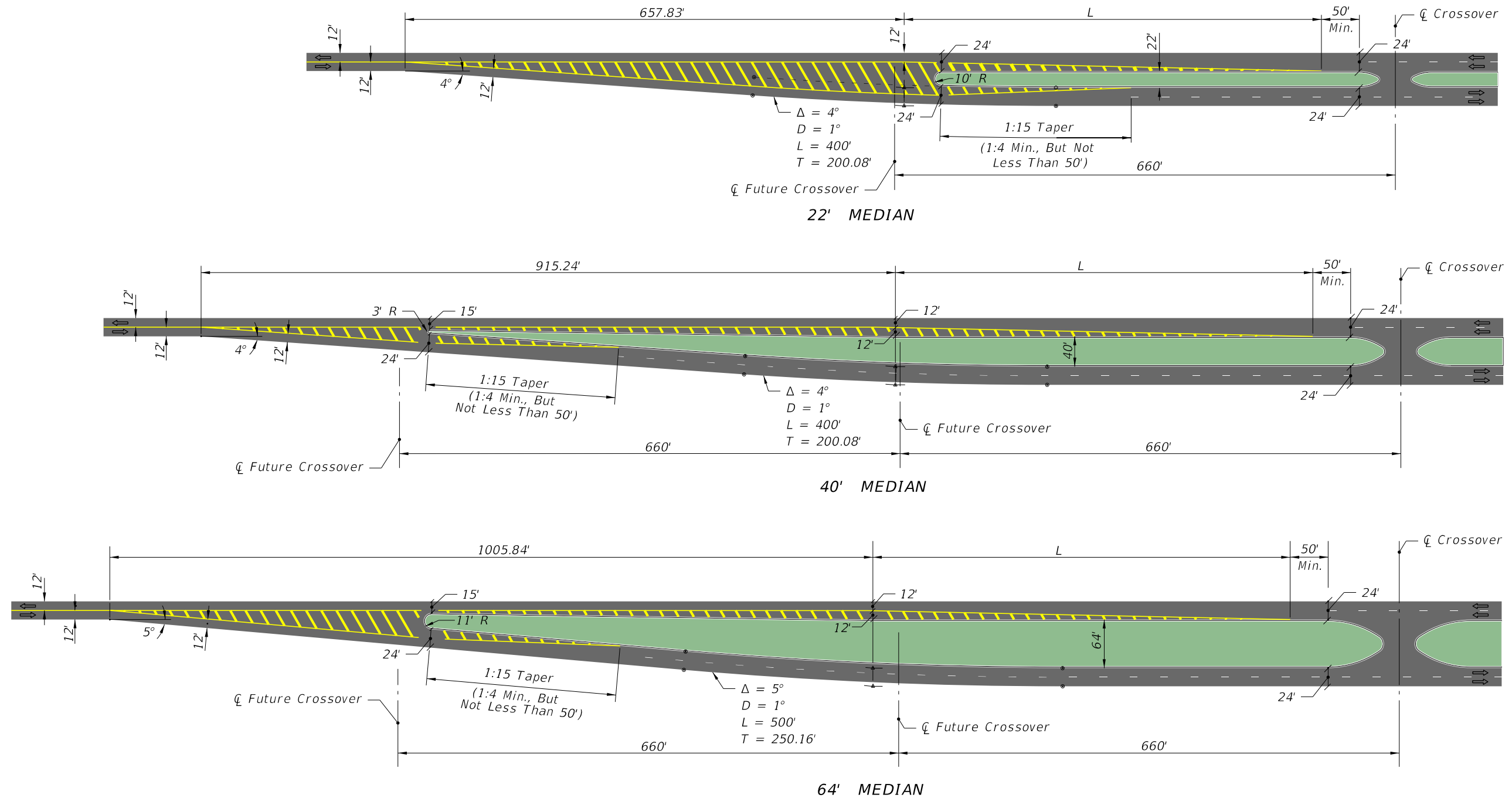
CONNECTING ROADWAY WITH PAVED SHOULDERS TO EXISTING ASYMMETRICAL FLARE WITHOUT PAVED SHOULDERS



FLARED - PAVED SHOULDERS

NOT TO SCALE

## TWO LANE TO FOUR LANE TRANSITION: LEFT ROADWAY CENTERED ON APPROACH ROADWAY



$$L = \frac{WS^2}{60} \quad \text{FOR DESIGN SPEEDS} \leq 40 \text{ mph}$$

$$L = WS \quad \text{FOR DESIGN SPEEDS} \geq 45 \text{ mph}$$

WHERE: L = LENGTH OF TAPER, FEET  
W = WIDTH OF LATERAL TRANSITION, FEET  
S = DESIGN SPEED, mph

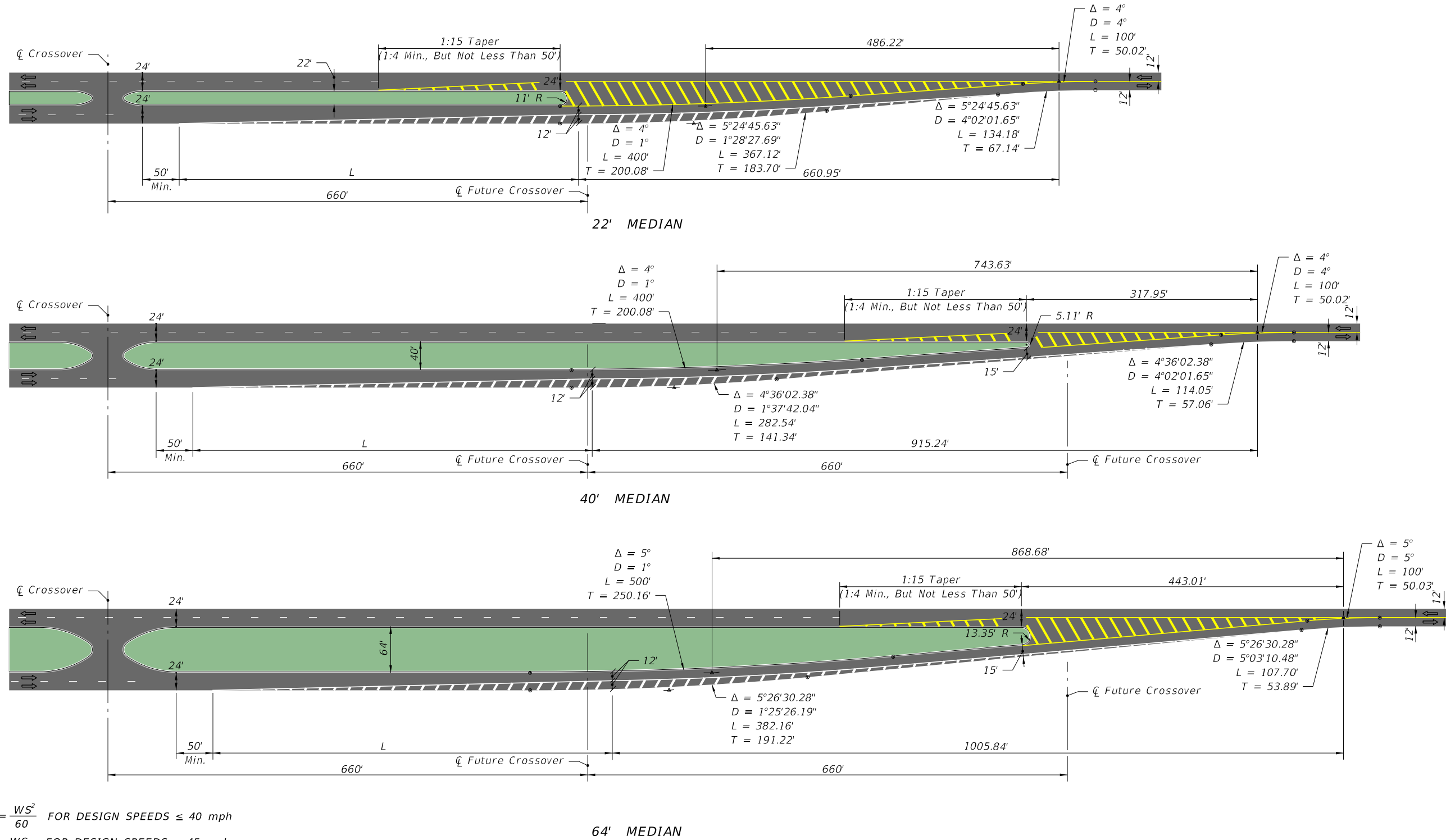
### NOTES FOR EXHIBITS 210-3 THRU 210-6:

1. The transition details as represented on Exhibits 210-3 thru 210-6 are intended as guidelines only. The transition lengths, curved data, nose radii and offsets are based upon tangent alignment, design speeds  $\leq 45$  mph, and the median and lane widths shown.
2. Approach lane departures ( $\Delta = 5^\circ$ ) are suitable for design speeds up to 60 mph. Interior curves ( $D = 1^\circ$ ) in normal crown may be used with design speeds up to 45 mph. Merging curves ( $D \geq 5^\circ$ ) will require superelevation.

NOT TO SCALE

EXHIBIT 210-3  
01/01/2025

## FOUR LANE TO TWO LANE TRANSITION: LEFT ROADWAY CENTERED ON THRU ROADWAY



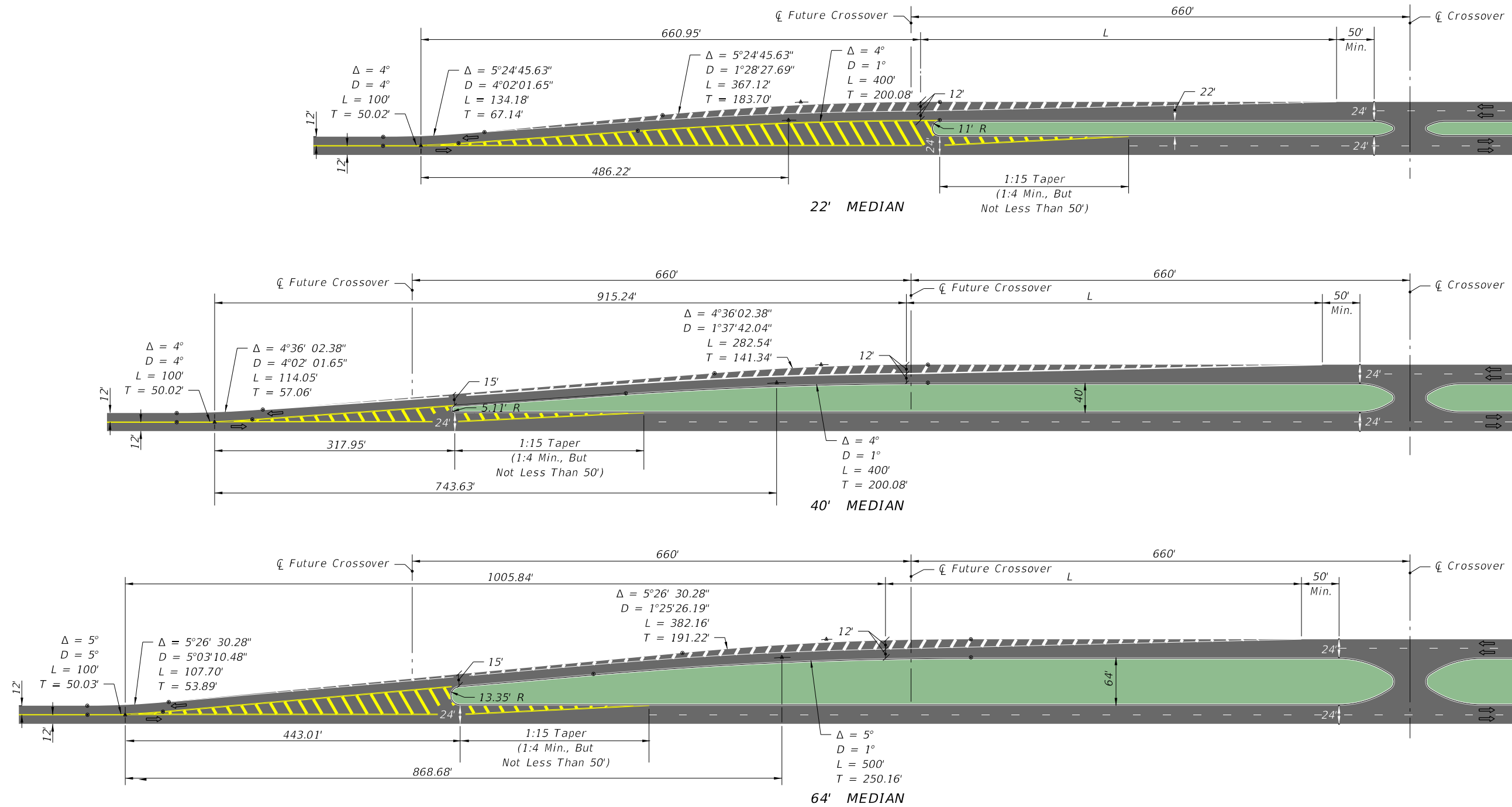
$L = \frac{WS^2}{60}$  FOR DESIGN SPEEDS  $\leq 40$  mph  
 $L = WS$  FOR DESIGN SPEEDS  $\geq 45$  mph

WHERE: L = LENGTH OF TAPER, FEET  
W = WIDTH OF LATERAL TRANSITION, FEET  
S = DESIGN SPEED, mph

NOT TO SCALE

EXHIBIT 210-4  
01/01/2025

## TWO LANE TO FOUR LANE TRANSITION: RIGHT ROADWAY CENTERED ON APPROACH ROADWAY



$$L = \frac{WS^2}{60} \text{ FOR DESIGN SPEEDS } \leq 40 \text{ mph}$$

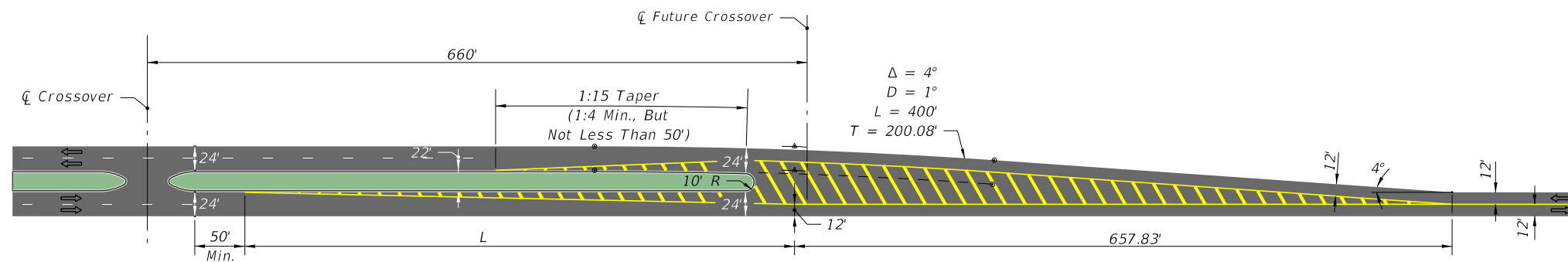
$$L = WS \text{ FOR DESIGN SPEEDS } \geq 45 \text{ mph}$$

WHERE: L = LENGTH OF TAPER, FEET  
W = WIDTH OF LATERAL TRANSITION, FEET  
S = DESIGN SPEED, mph

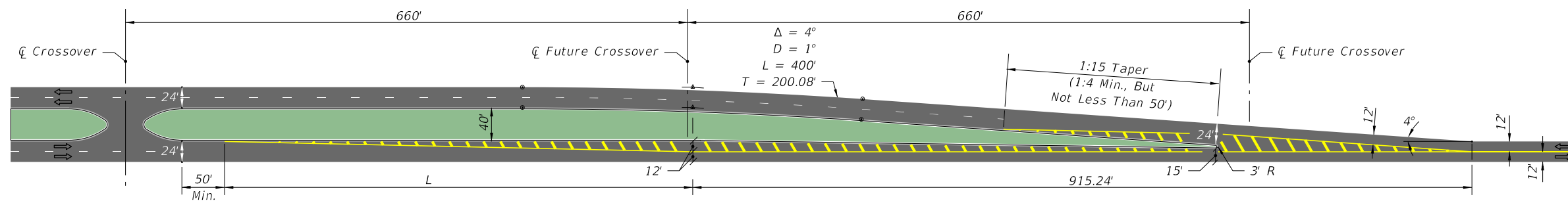
NOT TO SCALE

EXHIBIT 210-5  
01/01/2025

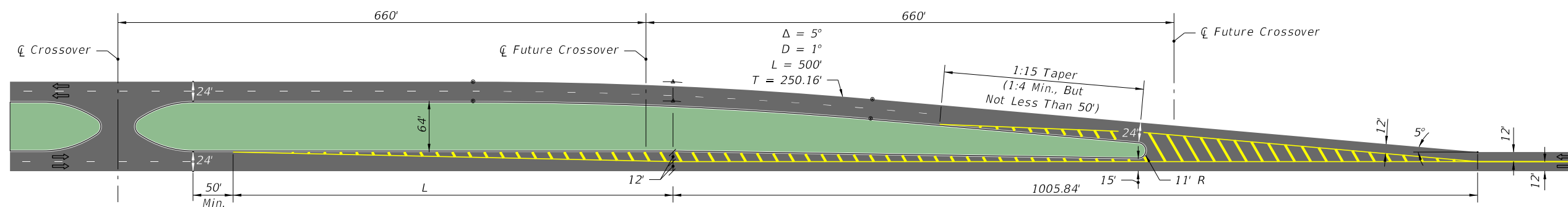
**FOUR LANE TO TWO LANE TRANSITION:  
RIGHT ROADWAY CENTERED ON THRU ROADWAY**



22' MEDIAN



40' MEDIAN



64' MEDIAN

$L = \frac{WS^2}{60}$  FOR DESIGN SPEEDS  $\leq 40$  mph  
 $L = WS$  FOR DESIGN SPEEDS  $\geq 45$  mph

WHERE: L = LENGTH OF TAPER, FEET  
 W = WIDTH OF LATERAL TRANSITION, FEET  
 S = DESIGN SPEED, mph

NOT TO SCALE



## 210.3 Medians, Islands, and Hardened Centerlines

### 210.3.1 Medians

Median width is expressed as the dimension between the inside edges of travel lanes. Medians perform the following functions:

- Provide separation of opposing traffic to minimize risk of head-on crashes,
- Provide a recovery area for errant vehicles,
- Provide a stopping area in case of emergencies,
- Allow space for speed changes and storage of left-turning and U-turning vehicles,
- Minimize headlight glare,
- Provide width for future lanes,
- Provide pedestrian refuge,
- Control access.

Provide a raised or restrictive median (i.e., not a two-way left turn lane or centerline pavement marking) on divided roadways that have a Design Speed of 45 mph or greater. Median widths for divided roadways are given in **Table 210.3.1**.

Median ditches must be designed to meet the following requirements:

- Have sufficient depth to provide positive drainage of the adjacent sub-grades. Typically, this requires a median depth of at least one foot below the sub-grade shoulder point.
- Have recoverable side slopes within the clear zone in order to facilitate the recovery of errant vehicles. See **FDM 215** for additional information on roadside safety.
- Have sufficient longitudinal gradient and hydraulic capacity to ensure good drainage.

See **FDM 260.5** for information on bridge medians.

**Table 210.3.1 Median Widths**

Context Classification	Curbed Roadways and Flush Shoulder Roadways (feet)	High Speed Curbed Roadways (feet)	Flush Shoulder Roadways (feet)	
	Design Speed (mph)			
	25-35	40-45	50-55	≥ 50
C1 Natural	N/A	N/A	30	40
C2 Rural	N/A	N/A	30	40
C2T Rural Town	15.5	22	N/A	N/A
C3 Suburban	22	22	30	40
C4 Urban General	15.5	22	N/A	N/A
C5 Urban Center	15.5	N/A	N/A	N/A
C6 Urban Core	15.5	N/A	N/A	N/A

**Notes:**

- (1) On reconstruction projects where existing curb locations are fixed due to severe right of way constraints, the minimum median width may be reduced to 19.5 feet for Design Speeds = 45 mph, and to 15.5 feet for Design Speeds ≤ 40 mph.
- (2) A minimum 6-foot median may be used within C5 and C6 context classifications only where left-turn lanes are not expected.
- (3) N/A indicates this combination of Design Speed and context classification is outside the intended design range and should be avoided. See **Table 201.5.1** for context classifications and Design Speed ranges.

## 210.3.2 Islands

An island is an area between traffic lanes that provides one or more of these primary functions:

- (1) Channelization Islands: To control and direct traffic movements (usually turning) at intersections or driveways.
- (2) Median Islands and Traffic Separators: To separate traffic in opposing or same direction (usually through movements), manage access points and turning movements, provide for delineation of narrow roadway medians, and provide for drainage. Typically referred to as “divisional islands” when separating traffic in opposing directions.
- (3) Refuge Islands: To provide refuge for pedestrians.

Islands are generally elongated or triangular in shape and are located in areas where motorized vehicle use is restricted. The placement of mast arms in channelizing islands is discouraged.

Island delineation is divided into three types:

- (1) Curbing that raises the island,
- (2) Pavement markings or reflectorized markers placed on paved areas,
- (3) Pavement edges, possibly supplemented by delineators or a mounded-earth treatment beyond and adjacent to the pavement edges.

Delineation of small islands is primarily by curbs. Large curbed islands may be sufficiently delineated by color and texture contrast of vegetative cover, mounded earth, shrubs, signs, or any combination of these. Use tubular markers at island noses as channelizing devices in addition to delineation. Curbed islands should not be used on high-speed flush shoulder roadways. Standard markings for islands are provided in the **Standard Plans, Index 711-001**. See **FDM 202** for more information on speed management.

### 210.3.2.1 Channelization Islands

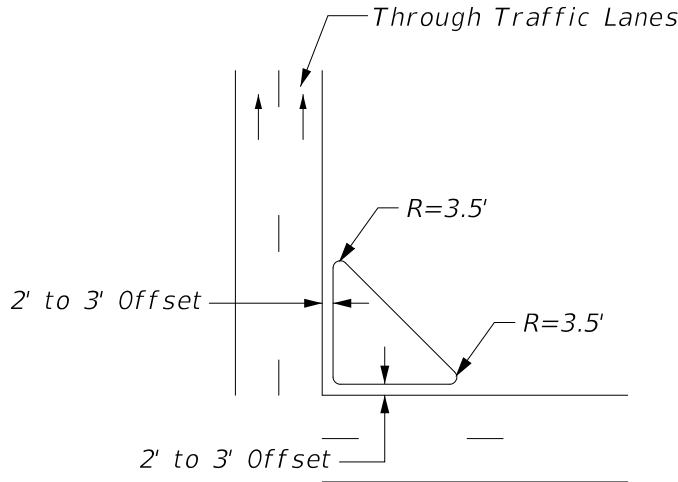
Islands must be large enough to command attention. Meet the following requirements when designing channelization islands:

- (1) Curbed islands should have an area of 100 square feet or more, however, must not be less than:
  - (a) 50 square feet for intersections within C4, C5, or C6 context classifications
  - (b) 75 square feet for intersections within C1, C2, C2T, or C3 context classifications
- (2) Triangular islands should be at least 15 feet on a side, but not less than 12 feet after rounding of corners.
- (3) Side dimensions of curbed islands should not exceed 100 feet on high-speed facilities (e.g., high-speed curbed roadway).

The approach and departure noses are rounded with radii of at least 3.5 feet. **Figure 210.3.1** illustrates a small island with a parallel offset. **Figure 210.3.2** illustrates a large island with a tapered offset.

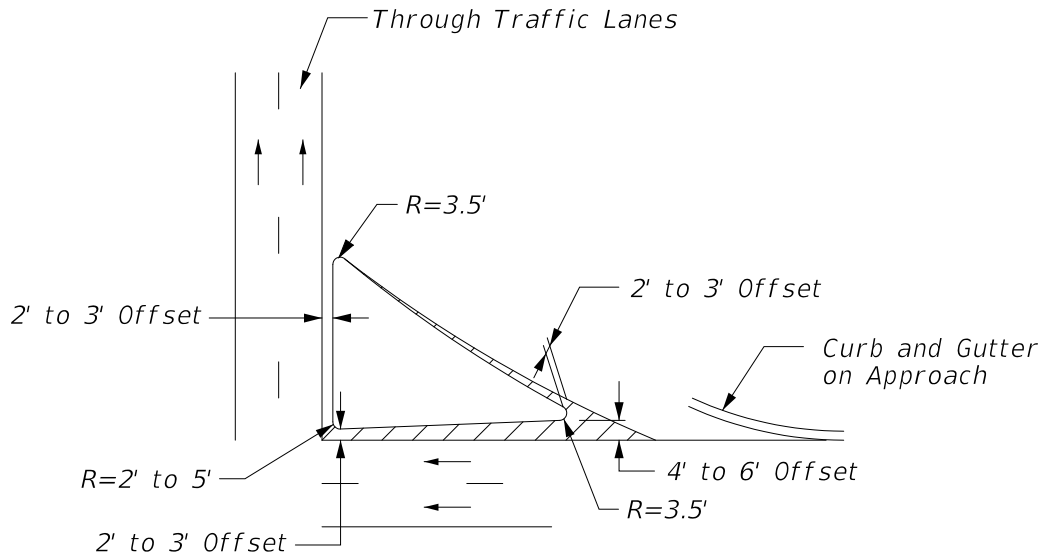
Approach ends of the island should be offset from the edges of the traveled way in order to funnel drivers smoothly into the desired path. The amount that a curbed island is offset from the through-traffic lane is influenced by the type of edge treatment and other factors such as island contrast, length of taper or auxiliary pavement preceding the curbed island. If a bike lane is adjacent to an island curb, no offset is needed.

**Figure 210.3.1 Typical Small Curbed Island**



*SMALL ISLAND*

**Figure 210.3.2 Typical Large Curbed Island**



*LARGE ISLAND*

Where there are no curbs on the approach traveled way, the minimum offset of the edge of the curbed island to the through lane should be 1.5 to 3.5 feet. Where the approach roadway has a Type E curb, a similar curb on the island may be located at the edge of the through lane if there is sufficient length of curbed island to provide a gradual taper from the nose offset. Type F curbs should be offset from the through traveled way edge, regardless of the size of the curbed island. For intermediate and large-size islands that are uncurbed, offsets are desirable but not required. Fixed objects within the island areas must meet clear zone and lateral offset criteria found in **FDM 215.2.3** and **215.2.4**.

### 210.3.2.2 Median Islands and Traffic Separators

Meet the following requirements when designing median islands and traffic separators:

- (1) A minimum of 4 feet wide and 25 feet long. See **FDM 223.2.4** for width of separation for separated bicycle lanes.
- (2) 100 feet or more in length is allowed on high-speed roadways when providing high visibility for the islands.
- (3) Approach noses should be offset 2 to 6 feet from the through (approach) lanes to minimize impacts. Pavement markings in advance of the nose can be used to transition from the centerline to the edge of island.
- (4) The shape of the island should be based on design turning paths and the island function. Curvilinear tapers comprised of parabolic or circular curves generally suffice.
- (5) The length of the island should be related to the approach speed. An estimate is to use the length based on 3 seconds of driving time to the intersection.
- (6) Median islands should begin on tangent alignments and on upgrades or beyond crest vertical curves. In some cases, it is appropriate to extend a median island to avoid its introduction on a horizontal curve or within an area of limited sight distance.
- (7) Approach noses must extend across the crosswalk at intersections to control left-turn speeds and encourage pedestrian use of the crosswalk. Use tubular markers as shown in the figures as channelizing devices.
  - (a) For median island widths greater than or equal to 6 feet, use a refuge island. **Figure 210.3.3** illustrates the geometrics for curbed roadways (i.e., standard 6-foot nose extension and minimum nose extension for RRR projects).
  - (b) For median island widths less than 6 feet, use hardened centerlines. See **FDM 210.3.3** for hardened centerlines.

*Commentary: At intersections, median islands and hardened centerlines are effective at improving vehicle approach angles to the crosswalks resulting in increased visibility of the pedestrians. They are also effective in managing vehicle left-turn speeds which is in-line with the Safe System approach. These factors also provide increased confidence for pedestrians that they will be safer when crossing within the designated crosswalk.*

**Standard Plans, Index 520-020** provides detailed dimensional design for traffic separators.

See **FDM 222.2.3.1** for more information on crosswalks at intersections.

### 210.3.2.3 Refuge Islands

Refuge islands provide an area for pedestrians and bicyclists to stop before finishing the crossing of a roadway. Complex intersections can be made more navigable and midblock crossings can be facilitated with refuge islands. Refuge islands have specific design criteria to support pedestrian or bicyclist movement. See **FDM 222** for more information on pedestrian facilities.

Refuge islands must be a minimum of 6 feet wide in the dimension between the traveled ways; however, the preferred width is 8 feet or greater. For curbed roadways, this dimension is from face of curb to face of curb. Consider the refuge island's storage capacity for higher volumes of pedestrian and bicycle traffic, as well as the space needed for pedestrians or bicyclists with items such as strollers, wheelchairs, wagons, cargo bikes, box bikes, and bikes with trailers.

Provide a clear path through the island without obstruction by objects such as poles, signposts, or utility boxes. The width of the clear path through the island must be at least 5 feet to meet ADA requirements and should be equal to the width of the crosswalk. For additional requirements and information on intersection refuge islands, see **Figure 210.3.3**. See **FDM 213.3.5** for additional dimensional requirements for roundabout splitter islands. See **FDM 222.2.3.2** for more information on midblock crossings. For more information on depressed and raised sidewalks, see **Standard Plans, Index 522-002**.

Refuge islands may be enhanced by low-growing landscaping of 18 inches tall or less and stormwater management features. See [Drainage Manual, FDM 916](#) (Drainage Sheets), **FDM 270** (Planting Designs), **FDM 271** (Irrigation Designs), and **FDM 273** (Landscape Maintenance Guide).

Examples of refuge islands at midblock crossings are shown in **Figures 210.3.4** and **210.3.5**. For more information on pavement markings, see **Standard Plans, Index 711-001**.

**FDM 212.12** provides information on the design of turning roadways with corner islands.

Roundabout splitter islands provide pedestrian refuge and are discussed in **FDM 213.3.5**.

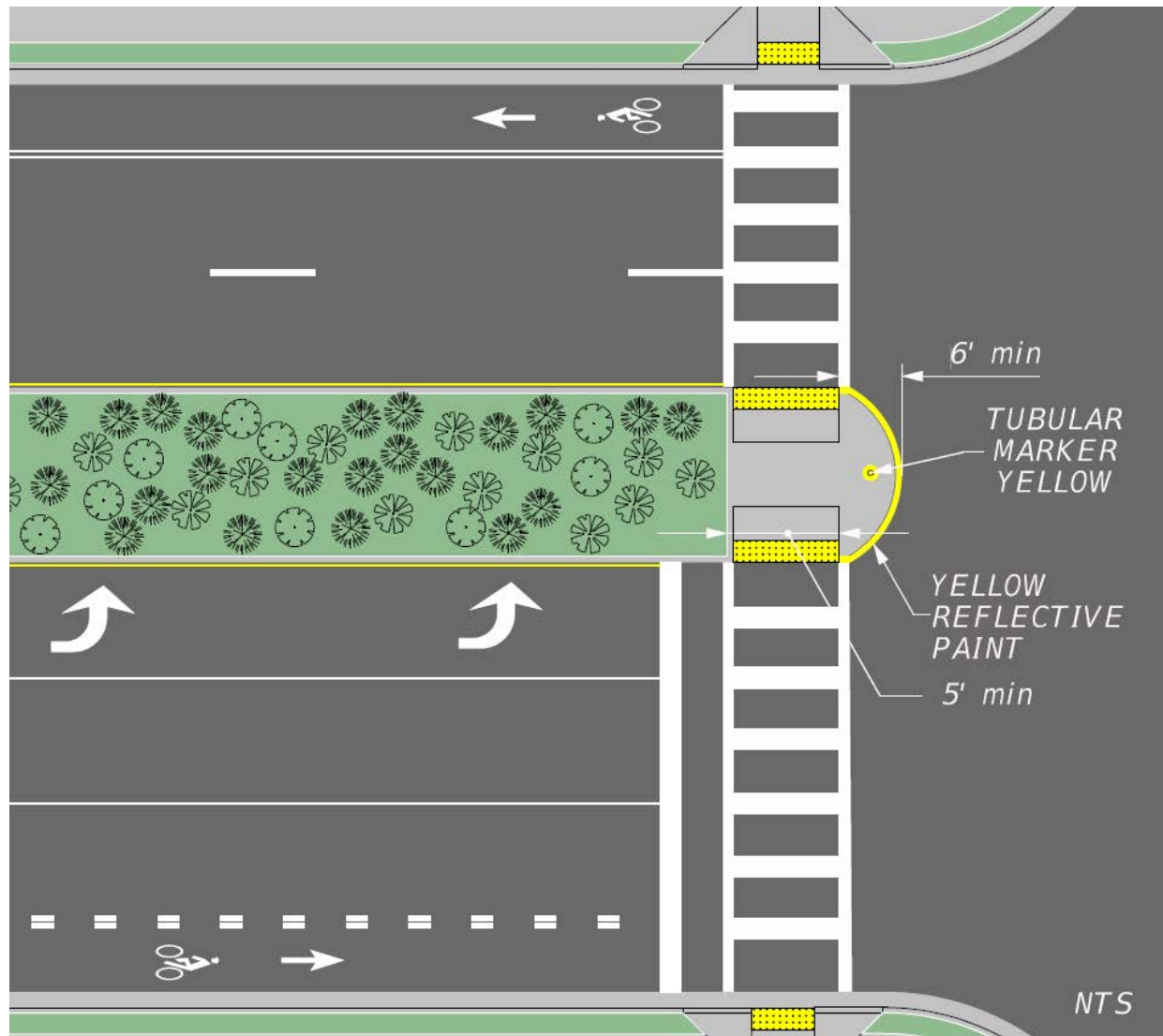
*Commentary: The FDM figures depict ideal situations. Site specific conditions and RRR scenarios may require working around obstacles, such as drainage structures, that may result in final configurations different than shown in the FDM figures. For example, crosswalks may need to be angled slightly, offset from the intersection more than is illustrated, or other modifications.*

*It may be necessary to assess tradeoffs between various safety measures. When doing so, approach decisions by considering which safety measure is most likely to reduce serious and fatal injury crashes. Consider prioritizing the safety measure that is most likely to reduce system kinetic energy. Look for creative solutions to work through concerns. For example, in some situations, signs or turn restrictions could help address pedestrian visibility concerns, and careful application of Design and Control Vehicle concepts could help address turning movements.*



**Figure 210.3.3 Intersection Refuge Island**

**For New and Reconstruction Projects with Raised Crossings:**

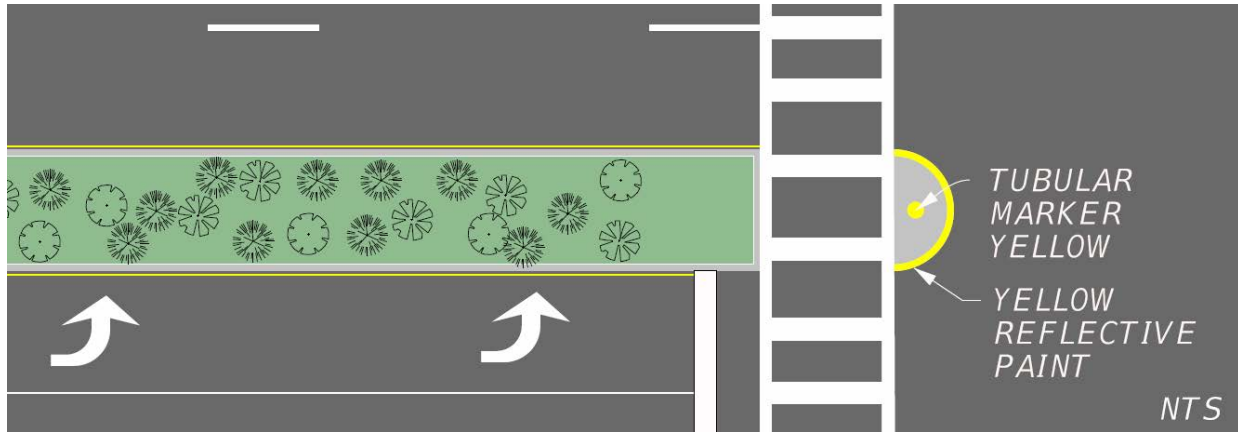


**Notes:**

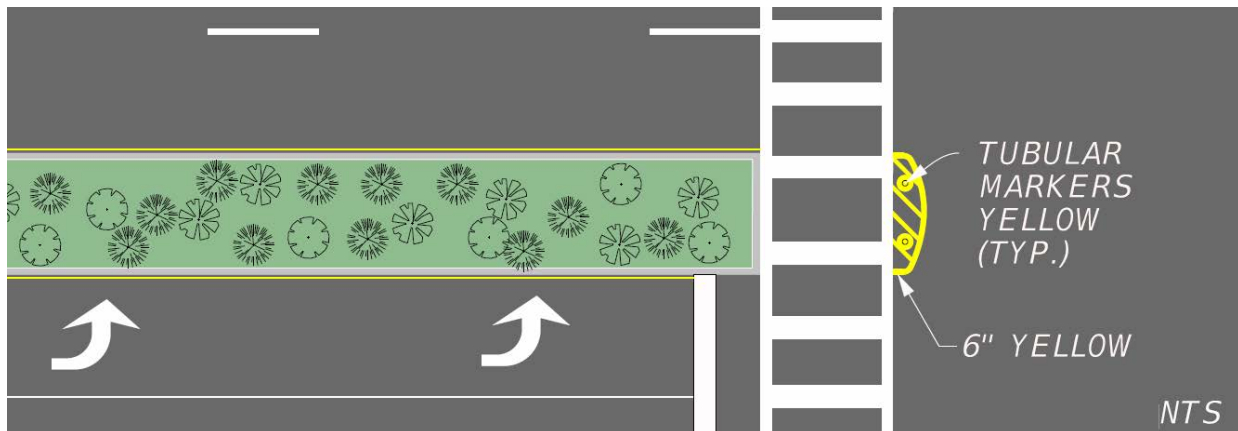
- The median nose must be a concrete separator as shown in Standard Plan 520-020. Match the curb profile that is used for the adjacent median.

### Figure 210.3.3 Intersection Refuge Island (Cont.)

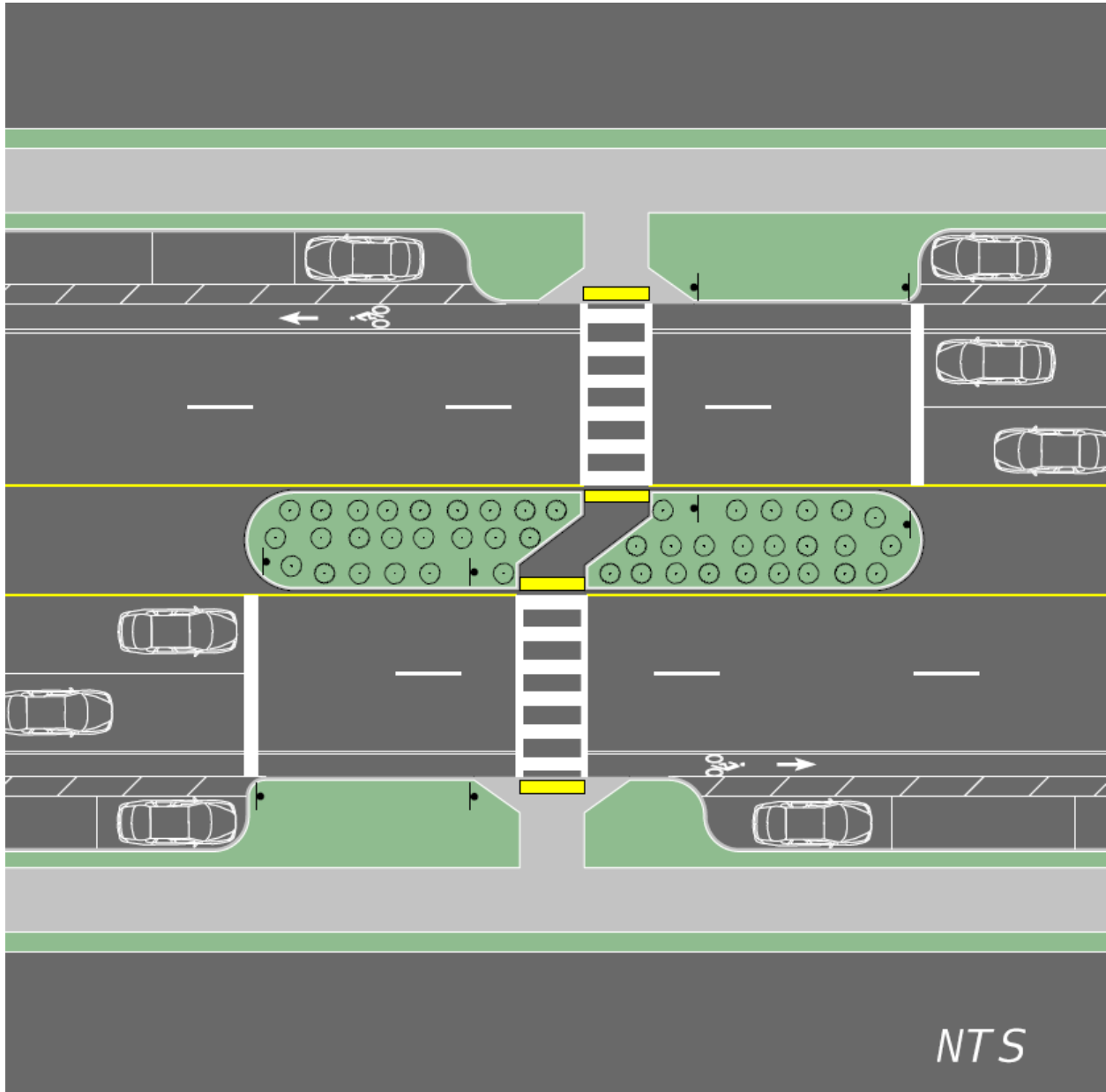
For New and Reconstruction Projects with Depressed Crossings:



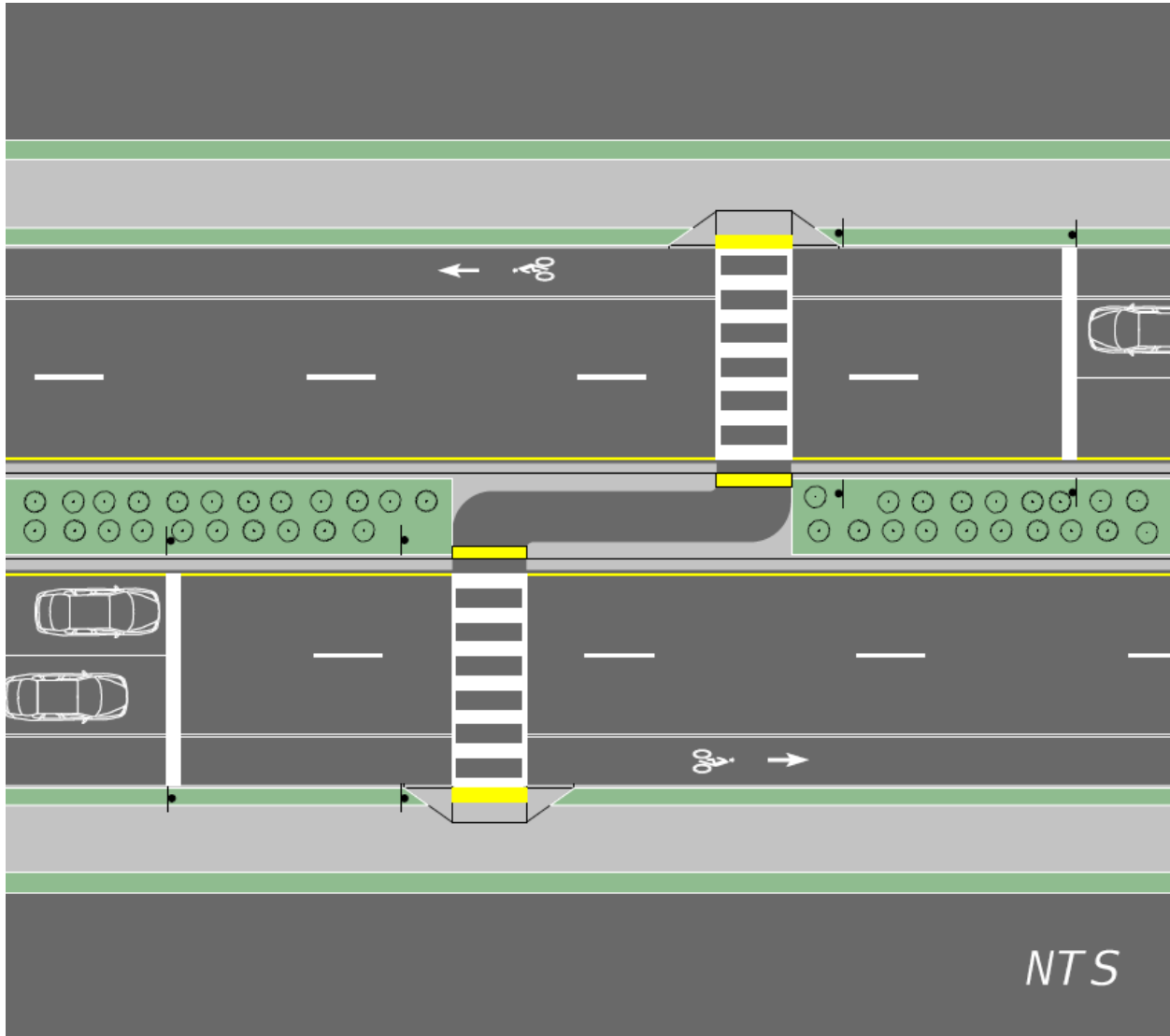
For RRR Projects Where Concrete Median Nose is Not Constructible in Constrained Conditions:



**Figure 210.3.4 Midblock Refuge Island Example #1**



**Figure 210.3.5 Midblock Refuge Island Example #2**



### 210.3.2.4 Corner Islands

Where the inside edges of the traveled way for right-turns are designed to accommodate semi-trailer combinations or where the design permits passenger vehicles to turn at speeds greater than 10 mph, the pavement area within the intersection may become excessively large and may create longer crossing paths for pedestrians. This may also occur at intersections with turning angles greater than 90 degrees. To avoid this condition, a corner channelizing island can be provided to form a separate turning roadway.

**FDM 212.12** provides information on the design of turning roadways with corner islands.

### 210.3.3 Hardened Centerlines

Hardened centerlines are an extension of the traffic separator or centerline past the crosswalk. Hardened centerlines improve pedestrian safety by reducing the turning speeds of left-turning motorists and by improving their approach angle to the crosswalk to increase pedestrian visibility. See **FDM 222** for more information on pedestrian facilities.

Provide a hardened centerline where it is not possible to provide a pedestrian refuge island.

The nose extension can be no less than 2 feet long and must provide 1-foot of clear distance from the edge of the crossing traffic lane or bicycle lane. A 6-foot nose extension is preferred, but the designer can adjust the length to balance control of the left-turning vehicle with the design vehicle turning path.

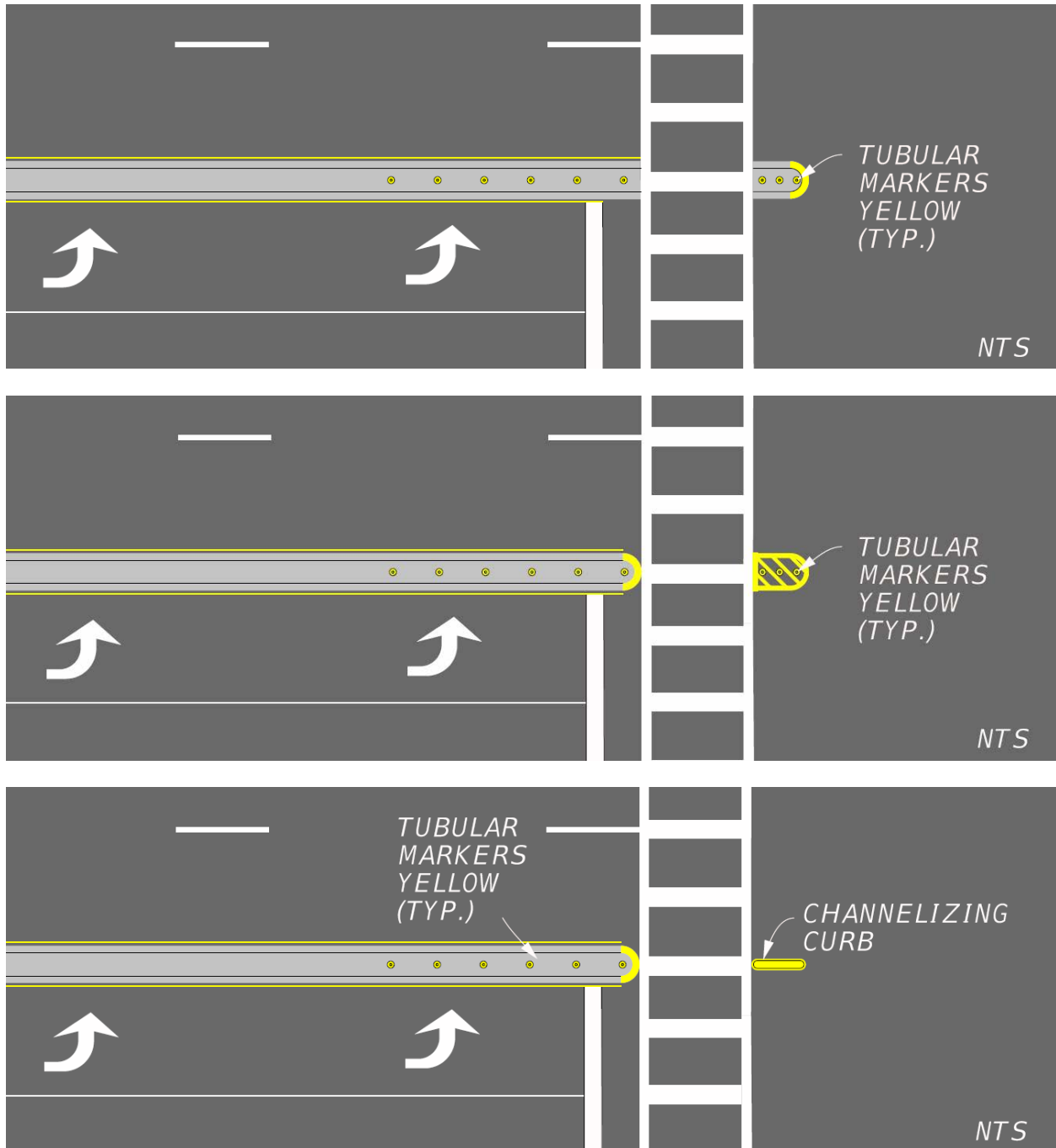
Where applicable, space multiple tubular markers a minimum of 2 feet and a maximum of 5 feet apart. Provide tubular markers for a minimum of 25 feet along the traffic separator or centerline approaching the crosswalk.

If tubular markers on the nose extension are not practicable to accommodate sight distance or turning radii, use a “channelizing curb” for the nose extension. Use **Developmental Specification Dev703** for channelizing curb. Detail channelizing curb in the plans showing the length of the nose extension as described above. Channelizing curb products are typically prefabricated in 6-foot lengths with additional length for the endcaps.

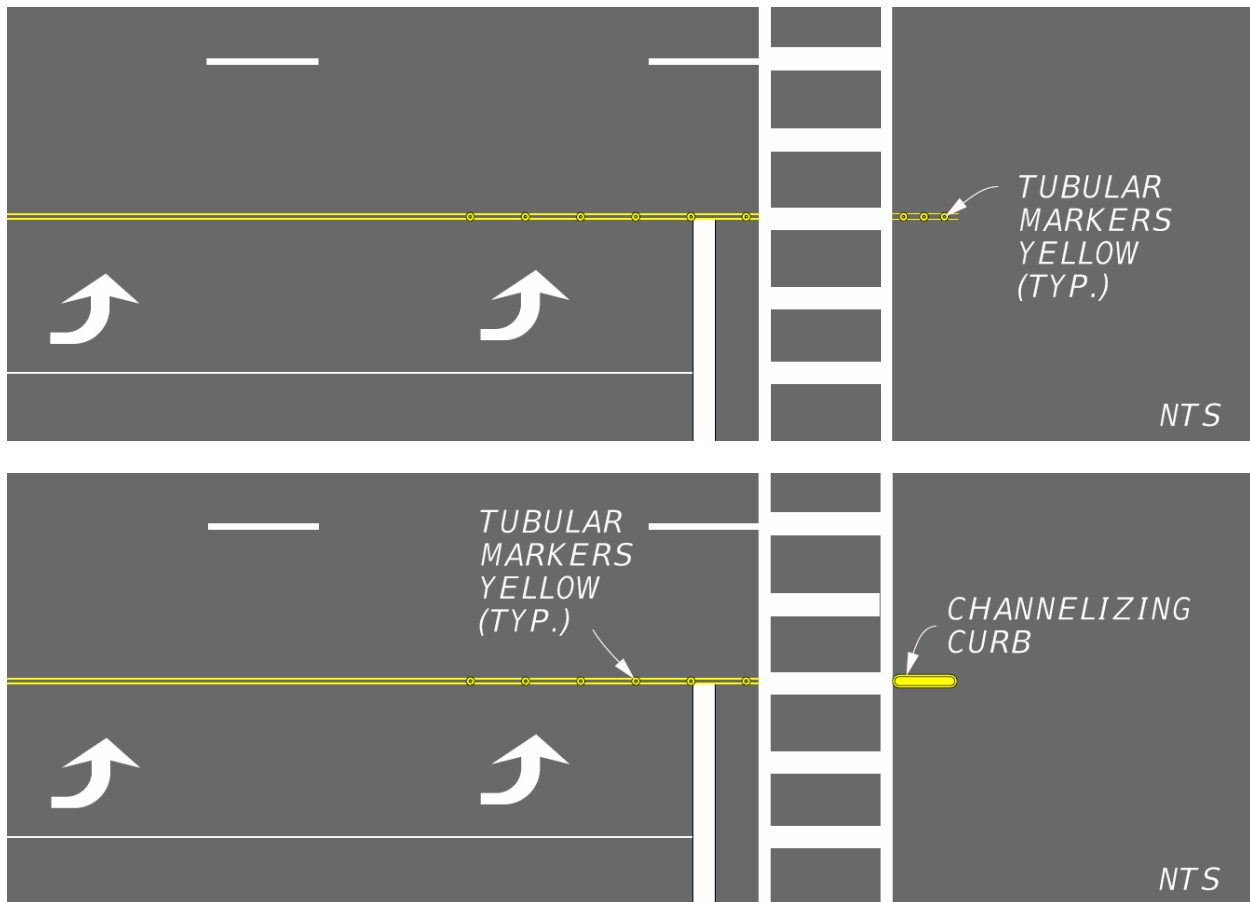
Hardened centerlines may be used with offset left-turn lanes.

Hardened centerlines may be omitted on RRR or other minor projects where they require the movement or reconstruction of curb ramps for accommodation.

**Figure 210.3.6 Hardened Centerline with Traffic Separator**



**Figure 210.3.7 Hardened Centerline without Traffic Separator**



## 210.4 Shoulders

Roadway shoulder width is measured from the edge of the traveled way to the shoulder break. A portion of the shoulder is required to be paved on all roadways on the State Highway System. A paved shoulder is the portion of the roadway contiguous with the traveled way for accommodation of errant vehicles, stopped vehicles, bicycle traffic, and emergency use.

When it is determined that the Helmeted Bicyclist Symbol and Bicycle Lane Arrow pavement markings (see **FDM 223.2.2**) will be placed on the shoulder of a flush shoulder roadway, the paved width for the outside shoulder without shoulder gutter must be either 5 feet as shown in **Table 210.4.1** or 8 feet.

*Commentary: Paved shoulder widths greater than 5 feet and less than 8 feet are challenging to construct on flush shoulder roadways.*

*Standard asphalt paving machines have a main screed width of 8 feet or 10 feet (10 feet screed is most common), with 5-foot-wide extensions, connected at pivot points, on either side of the paver. The pivot points are the only locations on the paver where a cross slope break can be constructed. As such, up to a 5-foot-wide shoulder can be paved in conjunction with the adjacent travel lane. Shoulder widths that are 8-feet-wide or greater can be paved with a standard paver.*

*Due to these dimensional limitations of standard asphalt paving machines, constructing a paved shoulder width that is greater than 5 feet and less than 8 feet is challenging, and should be avoided when possible.*

Shoulder widths for roadways are given in **Table 210.4.1**. See **Figure 210.4.1** for an illustration of roadway shoulders. Refer to **FDM 211** for ramp shoulder widths. Refer to **FDM 260.3** for bridge shoulder widths.

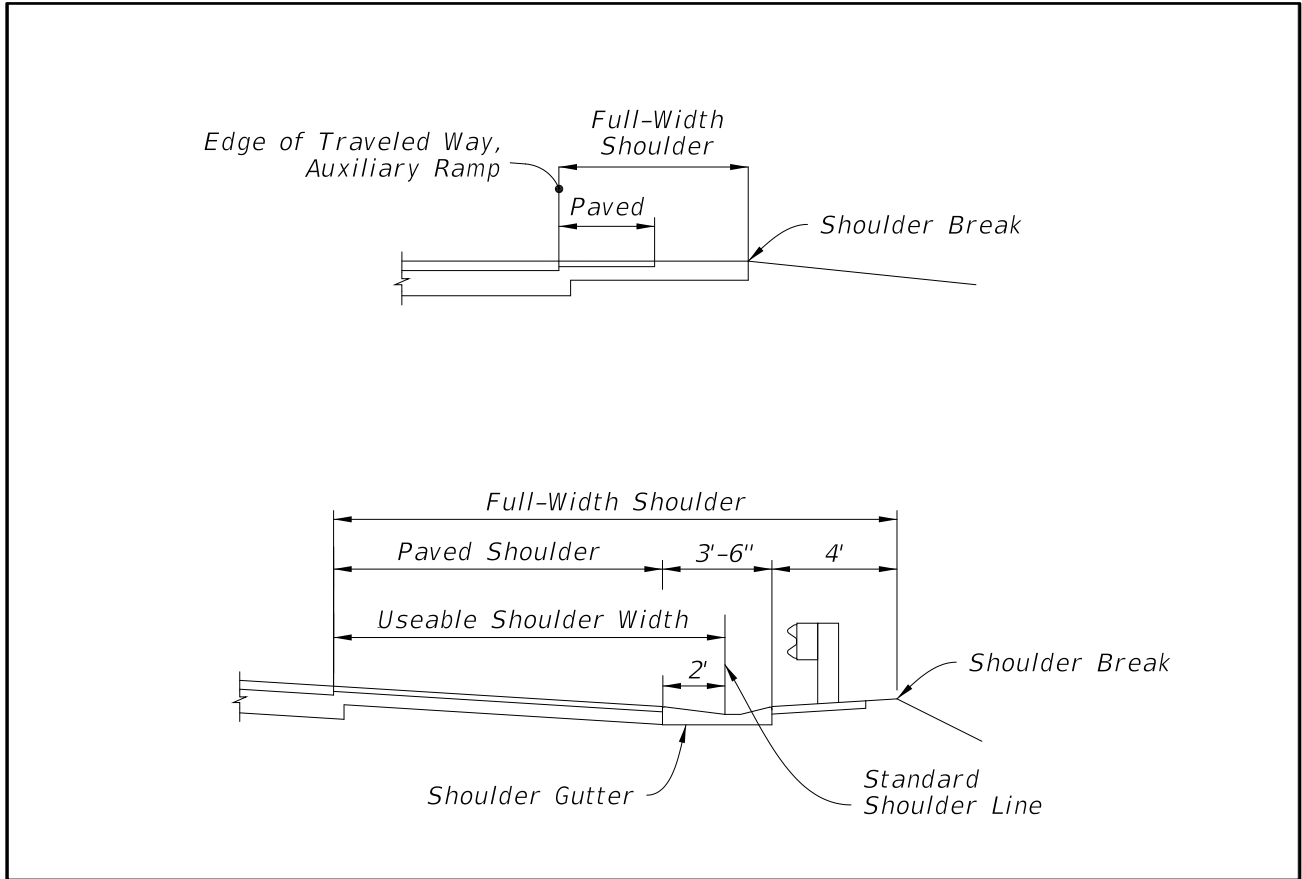
Use shoulder gutter for the following conditions:

- On embankments higher than 20 feet
- On embankments higher than 10 feet where the longitudinal slope is greater than 2 percent
- On embankments, with slopes steeper than 1:6 for more than five feet vertically, to minimize erosion
- At bridge ends where concentrated flow from the bridge deck could run down the slope
- In areas of guardrail where embankment slopes are steeper than 1:4 and any pavement is sloped toward the embankment.

Construct roadway paved shoulders up to the railroad crossing shoulder pavement as shown in **Standard Plans, Index 830-T01**. For additional information, see **FDM 220** and **Standard Plans, Index 509-070**.



**Figure 210.4.1 Shoulder Width Identification**



**Table 210.4.1 Standard Shoulder Widths**

Lane Type	# Lanes (One Direction)	Without Shoulder Gutter				With Shoulder Gutter			
		Outside		Median Or Left		Outside		Median Or Left	
		Full Width (feet)	Paved Width (feet)	Full Width (feet)	Paved Width (feet)	Full Width (feet)	Paved Width (feet)	Full Width (feet)	Paved Width (feet)
Travel Lanes	4-Lanes or more	10	5	10	4	15.5	8	15.5	8
	3-Lanes	10	5	10	4	15.5	8	15.5	8
	1-Lane & 2-Lanes	10	5	8	4	15.5	8	13.5	6
Aux. Lanes	ALL	10	5	8	4	11.5	4	11.5	4

**Notes:**

**Without shoulder gutter:**

- (1) Consider 12-foot outside full width shoulder adjacent to travel lanes with high AADT or greater than 10% trucks.
- (2) Consider providing a minimum 10-foot median shoulder where continuous barrier or guardrail is present.
- (3) Outside shoulder widths for auxiliary lanes typically match those of the adjacent roadway; however, width may be reduced to 6-foot shoulder with 2-foot paved for right turn lanes when a bicycle keyhole is present.
- (4) Pave the entire width of shoulders adjacent to concrete barriers. See **FDM 215.4.6.1**.
- (5) For RRR projects:
  - (a) an existing full width shoulder of 6-feet or greater may be retained
  - (b) the following minimum existing outside paved shoulder widths may also be retained:
    - i. 4-foot adjacent to travel lane
    - ii. 2-foot adjacent to auxiliary lane
  - (c) an existing unpaved median or left shoulder may be retained. Consider providing a 4-foot median or left paved shoulder adjacent to travel and auxiliary lanes where there are documented safety or maintenance concerns.

**With shoulder gutter:**

- (1) Paved shoulders less than 6 feet in width with adjoining shoulder gutter must be the same type, depth, and cross slope as the roadway pavement.
- (2) Shoulders must extend 4 feet beyond the back of shoulder gutter and have a 0.06 cross slope back toward the gutter.
- (3) Required shoulder widths for auxiliary lanes typically match those of the adjacent roadway.

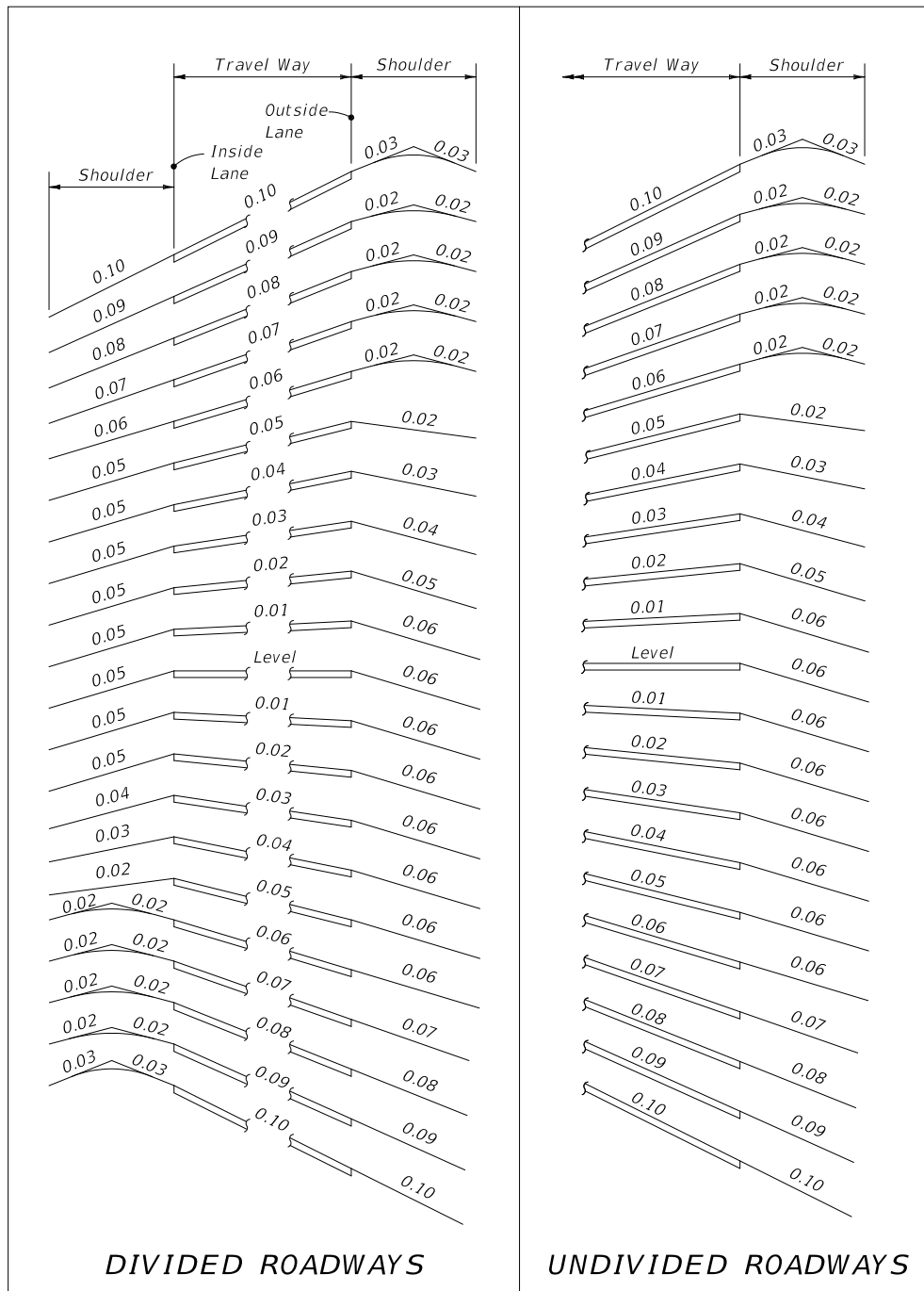
## 210.4.1 Shoulder Cross Slopes

The standard cross slope is 0.06 on the outside shoulder and 0.05 on the median (or left) shoulder. **Figure 210.4.2** illustrates shoulder cross slopes in relationship to roadway cross slopes for normal and superelevated sections. For 5-foot (or less) paved shoulders, see **Figure 210.4.3**. If the inside travel lane is sloping toward the median, the inside shoulder cross slope may be increased to 0.06.

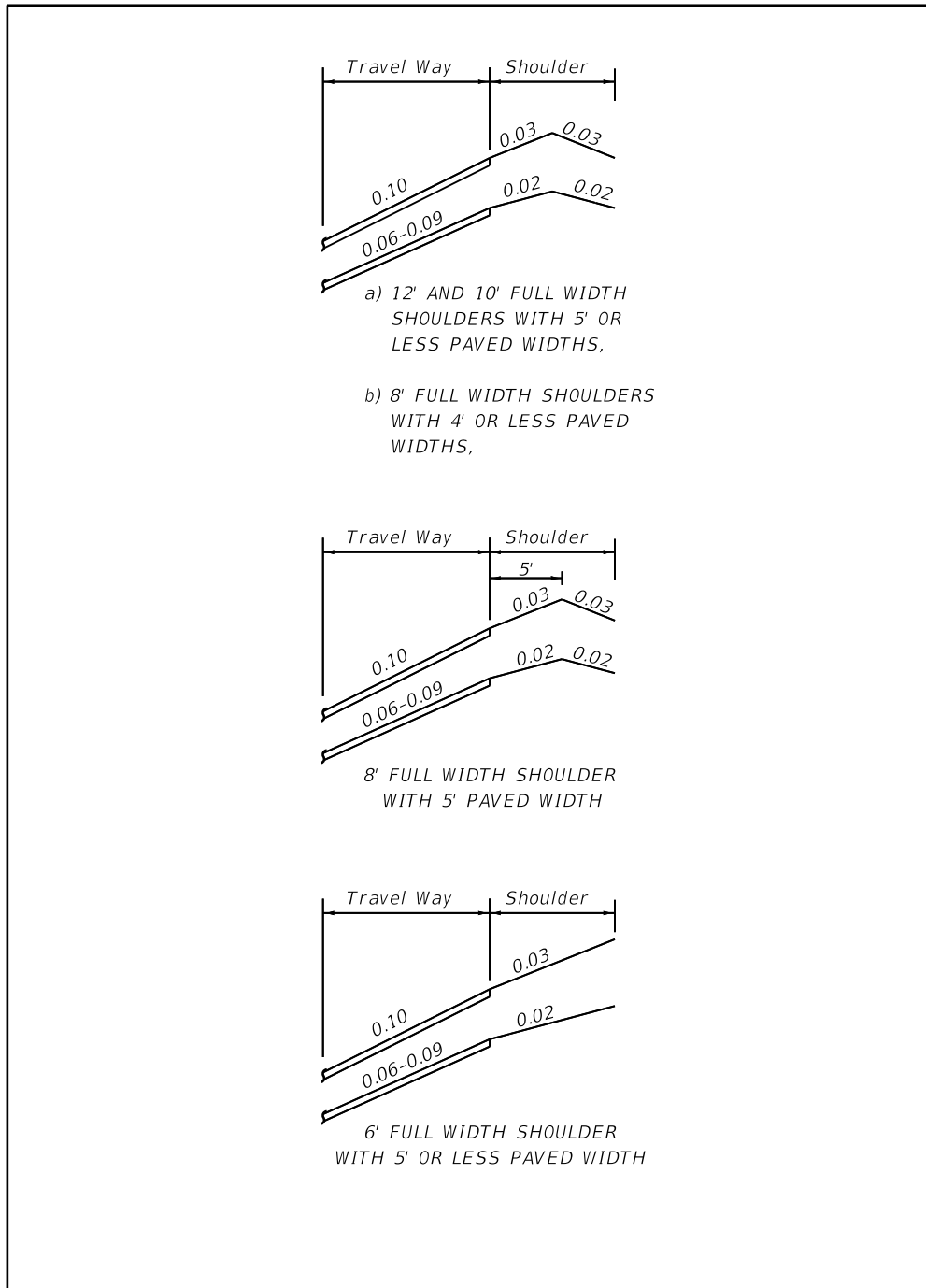
For projects constructed with concrete pavement, the first one foot of the outside shoulder is cast with the outside travel lane and will have the same cross slope (and superelevation) as the outside lane. Superelevation of the shoulder pavement is to be rotated about the outside edge of the outside slab.

For shoulder cross slope criteria on bridges, see **FDM 260.4**.

**Figure 210.4.2 Shoulder Superelevation**



**Figure 210.4.3 Special Shoulder Superelevation**



## 210.4.2 Typical Paving under Bridges

See **FDM 260.7** for requirements for paving under bridges.

## 210.4.3 Limits of Friction Course on Paved Shoulders

Extend friction course over the full width of the median and outside paved shoulders.

## 210.4.4 RRR Shoulder Treatment

Identify the shoulder treatment option in the plans when using **Standard Plans, Index 570-010**. Use Treatment I only if the shoulder is established with good soil and turf and there is no significant shoulder erosion. Use Treatment II when an existing shoulder meets the overlay thickness requirements for Treatment I, but there is significant shoulder erosion.

## 210.4.5 Narrow Bridge Shoulder Warning Devices

The **Standard Plans, Index 700-106** provides details for the shoulder treatment to be used on flush shoulder roadway approaches to a narrow bridge. This index provides standards for the placement of signing, striping, object markers, and raised pavement markers (RPMs) for use at structures where the bridge shoulder width is less than the width of the useable shoulder on the approach roadway.

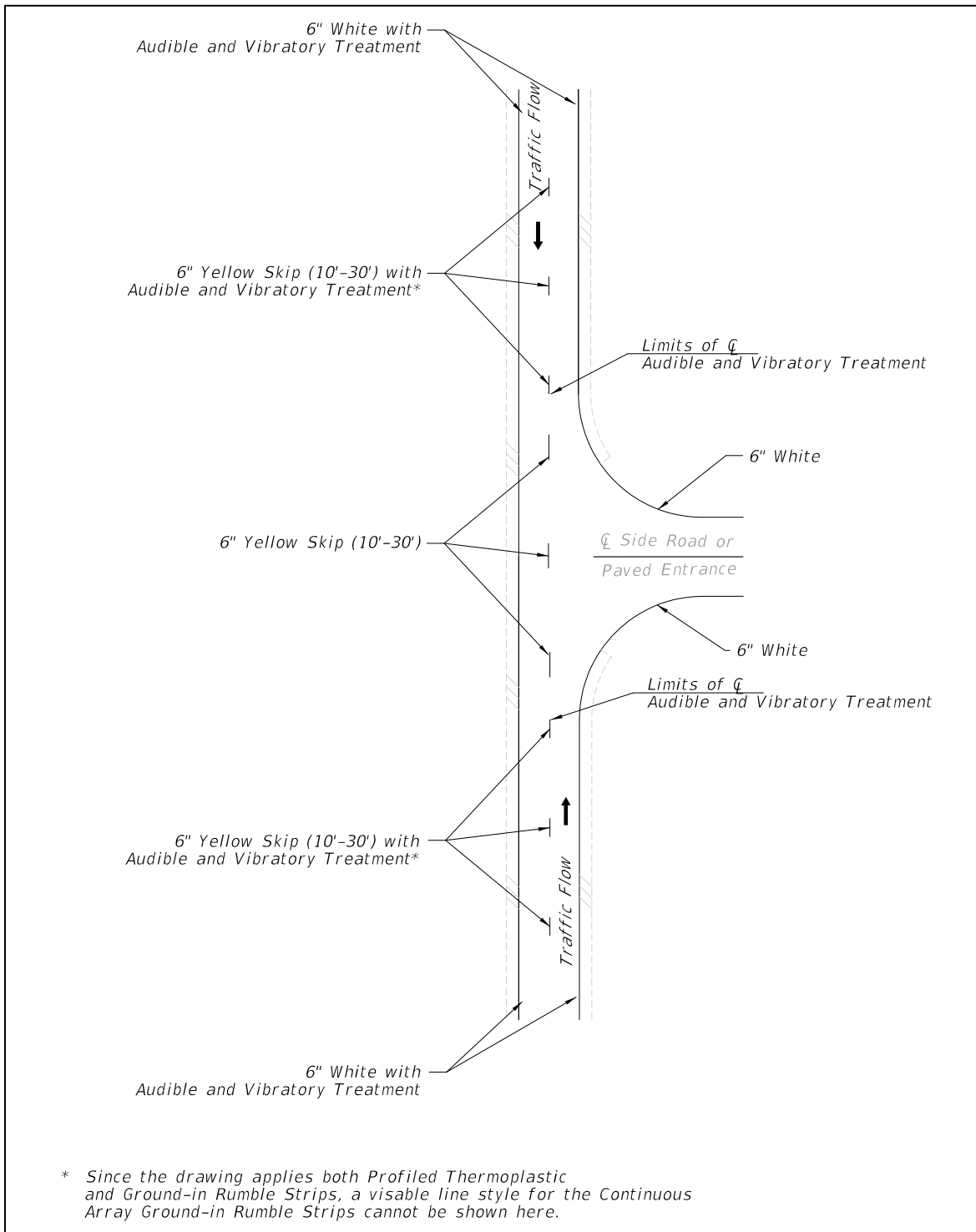
## 210.4.6 Audible and Vibratory Treatment

Provide audible and vibratory treatment (AVT) for edge lines and center lines on flush shoulder roadways with a Posted Speed of 50 mph or greater. Do not place edge line AVTs on lanes that are less than 11 feet wide. Do not exclude sections of the project where advisory speeds are used due to restricted horizontal or vertical geometry. Do not place AVTs within the limits of crosswalks.

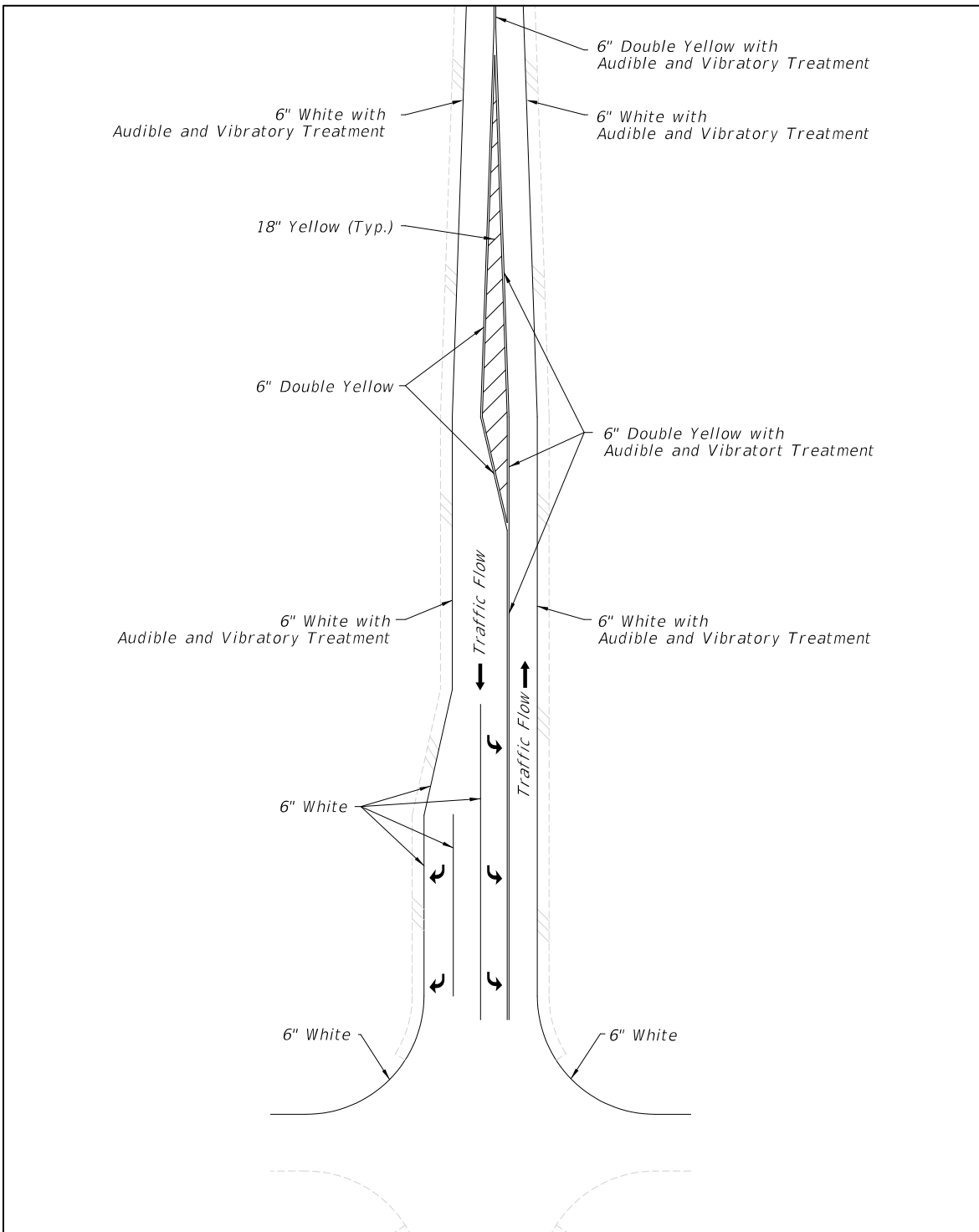
Use sinusoidal ground-in rumble strips on flexible pavements as shown in **Standard Plans, Index 546-020**.

Use profiled thermoplastic on rigid pavements. Otherwise, the use of profiled thermoplastic for any project including RRR, permits, push-button safety, and restriping projects must be approved by the State Roadway Design Engineer. **Figure 210.4.4** provides guidance for placement of AVTs. See **FDM 940** for information regarding plan requirements. Ground-in rumble strips are to be quantified in the Signing and Marking Plans component.

**Figure 210.4.4 Audible and Vibratory Treatment Placement**

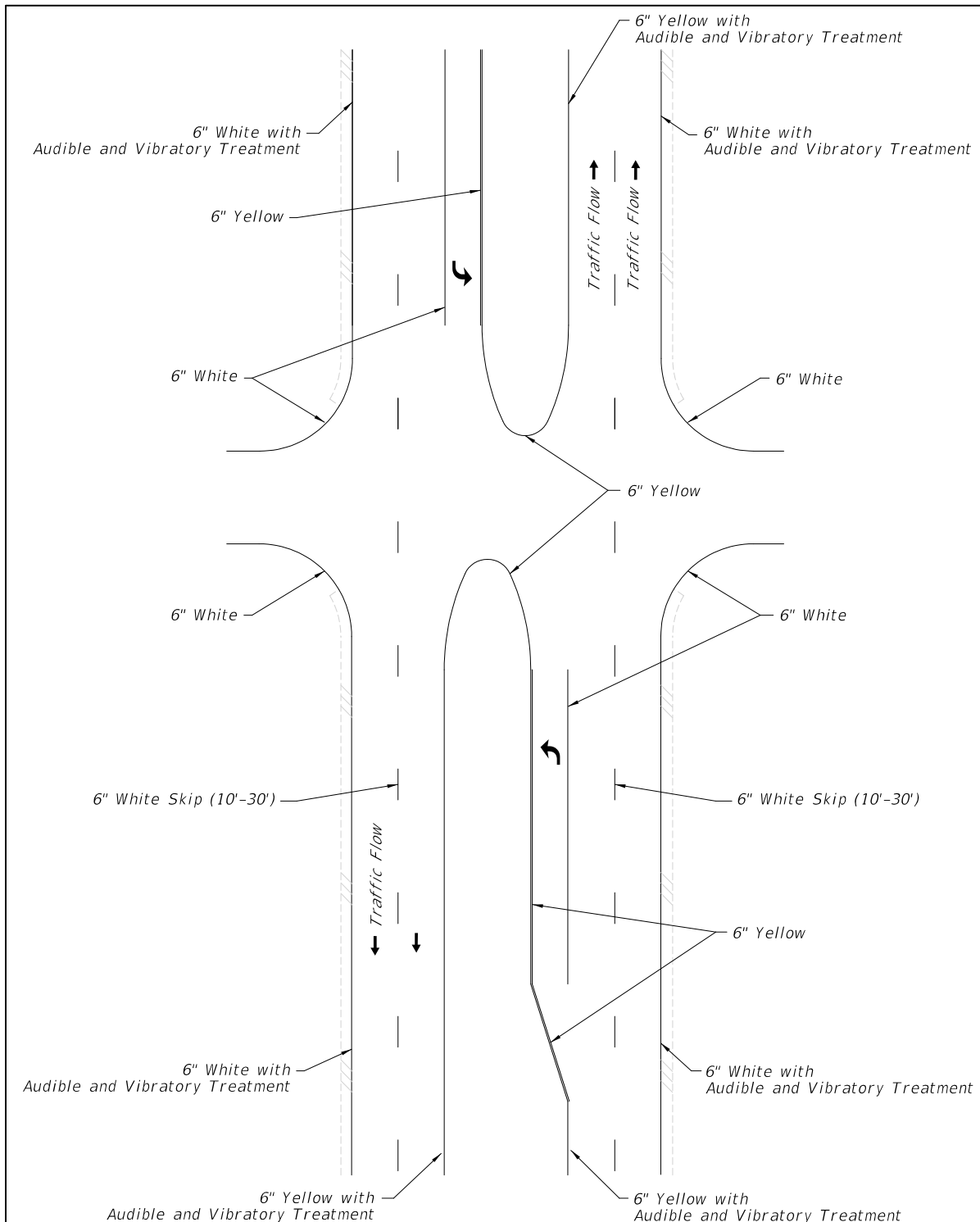


**Figure 210.4.4 Audible and Vibratory Treatment Placement (Cont.)**

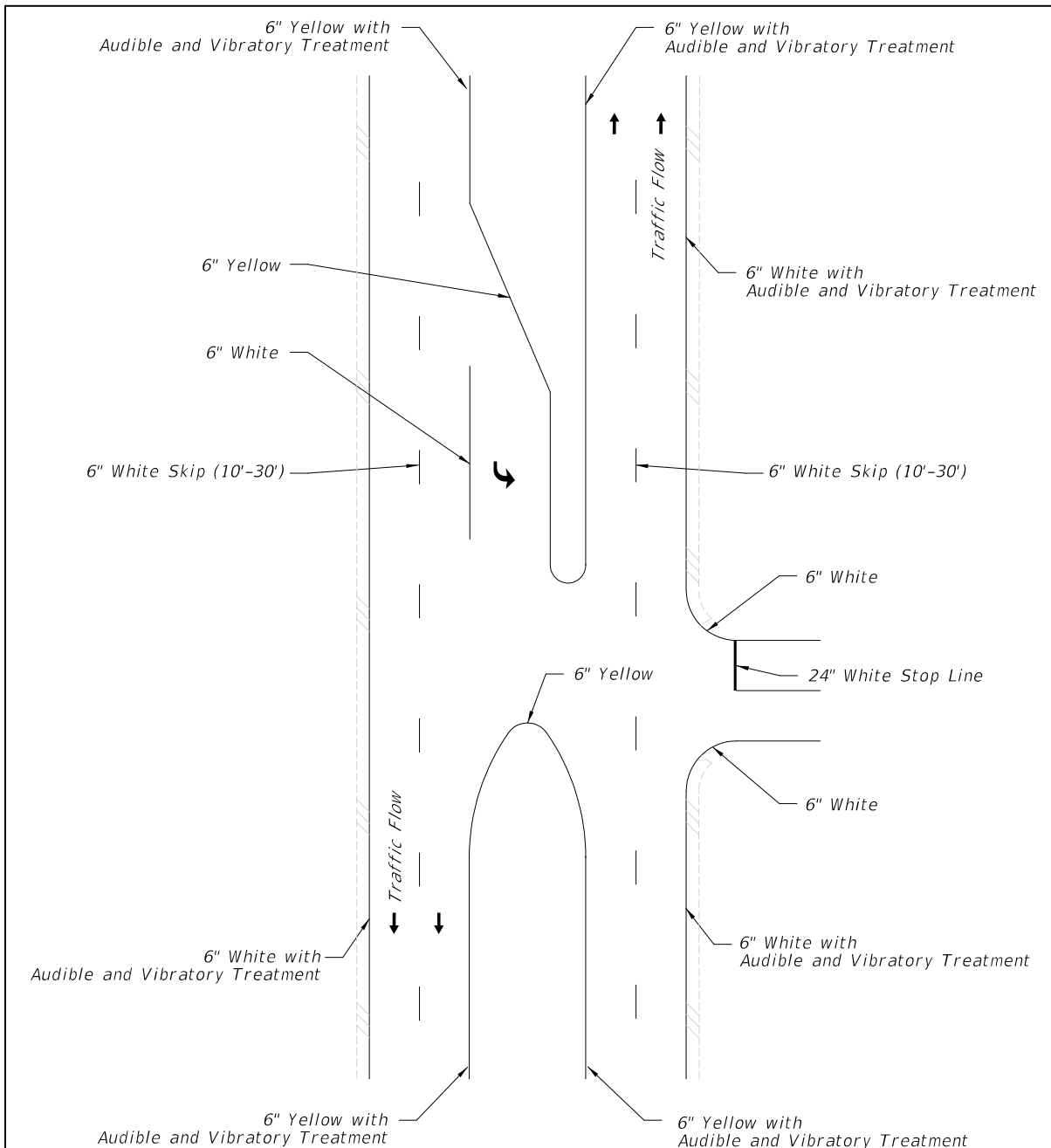




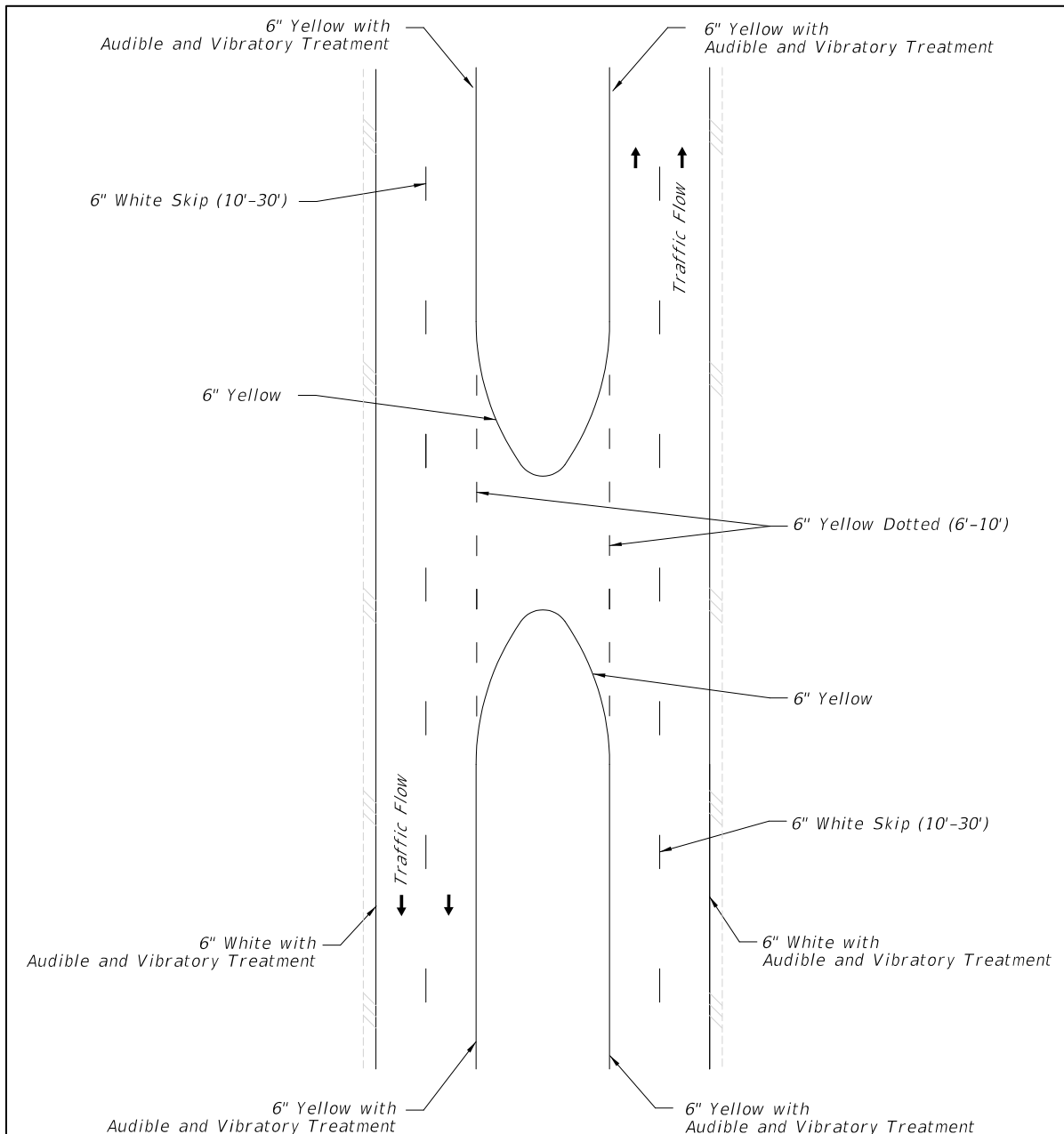
**Figure 210.4.4 Audible and Vibratory Treatment Placement (Cont.)**



**Figure 210.4.4 Audible and Vibratory Treatment Placement (Cont.)**



**Figure 210.4.4 Audible and Vibratory Treatment Placement (Cont.)**



## 210.5 Curbed Roadways

The term “curbed” includes all types of curbs and curb and gutter that are used on the State Highway System and detailed in ***Standard Plans, Index 520-001***.

The method of collecting and conveying drainage runoff and the availability of R/W determines the cross section; i.e. flush shoulder or curbed. When it is determined that a closed drainage system will be used, the selection of curb type will be based on the Design Speed.

Curbed roadways with Design Speeds of 45 mph or less typically use Type F curb on the outside and Type E curb on the median (or left) side.

See ***FDM 215.2.7.2*** for additional information regarding curbs and their placement.

### 210.5.1 High-Speed Curbed Roadways

Curbs may be used on roadways where the anticipated operating speeds require a Design Speed of 50-55 mph and:

- (1) Curbs are necessary to control drainage, or
- (2) R/W is constrained

High-speed curbed sections are typically used within C3 context classification and transitional areas.

High-speed curbed roadways are to use Type E curb on both the median and the outside. Provide an offset from the edge of the traveled way to the lip of gutter as follows:

- (1) 4-foot to median curb for 4-lane roadway sections.
- (2) 6.5-foot to median curb for 6-lane roadway sections.
- (3) 6.5-foot to outside curb for all roadway sections.

The above median offsets are not required for left-turn lanes adjacent to traffic separators or Type E curb. Outside offsets for right-turn lanes may be reduced to 4.5 feet when a bicycle keyhole is provided.

## 210.6 Roadside Slopes

Criteria and details for roadside slopes are included in **FDM 215**.

The following guidance is being provided to designers for consideration during project design. Additional sod requirements are provided in the **Standard Plans, Indexes 570-001 and 571-010**.

- Sod should be considered for slopes 1:4 or steeper. For all other areas, refer to the **Drainage Manual**, Chapter 2, Table 2.5, for additional guidance on maximum velocity for each lining type.
- Sod should be used for projects with less than 10,000 square feet of disturbed area.
- Sod should be considered for narrow areas less than six feet.
- A minimum 48" of sod should be considered for back of sidewalk areas as applicable.
- Sod should be considered in areas of concentrated runoff (i.e., bottom of vertical curves, insides of superelevated curves, tangent sections, and outsides of curves). Refer to **Standard Plans, Index 570-001** for sodding requirements.
- Refer to **Standard Plans, Index 570-010** for milling and resurfacing projects or major projects with portions of milling and resurfacing.

## 210.7 Border Width

Border width provides space for:

- (1) Roadside design components such as signing, signals, lighting, drainage features, guardrail, fencing and clear zone, sidewalks with ADA provisions, traffic control devices, fire hydrants, storm drainage features, bus and transit features, permitted public utilities and space for aesthetic features such as sod and other landscape items,
- (2) A buffer between vehicles and pedestrians,
- (3) Construction and maintenance of the facility, and
- (4) Permitted public utilities.

Required border width is provided in **Table 210.7.1**. Border width is measured to the R/W line as follows:

- Flush shoulder roadways: from the shoulder break.
- Curbed roadways: from the outside edge of pavement (lip of gutter).
- High-speed curbed roadways: from the outside edge of the traveled way.

**Table 210.7.1 Minimum Border Width**

Context Classification	Minimum Border Width (Feet)					
	Curbed and High-Speed Curbed Design Speed (mph)				Flush Shoulder Design Speed (mph)	
	25-40	45	50	55	25-45	≥ 50
<b>C1</b> Natural	N/A	N/A	29	35	N/A	40
<b>C2</b> Rural	N/A	N/A	29	35	N/A	40
<b>C2T</b> Rural Town	12	14	N/A	N/A	33	N/A
<b>C3</b> Suburban	12	14	29	35	33	40
<b>C4</b> Urban General	12	14	N/A	N/A	33	N/A
<b>C5</b> Urban Center	12	N/A	N/A	N/A	N/A	N/A
<b>C6</b> Urban Core	14	N/A	N/A	N/A	N/A	N/A

**Notes:**

- (1) On low-speed curbed roadways that have an adjacent bike lane, the required border width shown in the table may be reduced by 2 feet.
- (2) On existing roadways:
  - (a) When R/W is not being acquired:
    - i. Unmodified existing border width may remain (e.g., a resurfacing only project).
    - ii. Modified existing border width must not be less than 8 feet (e.g., when adding a right-turn lane).
  - (b) When R/W is being acquired, border width should meet new construction criteria shown in the table. Provide a segment of sufficient length to assure continuity.
- (3) N/A indicates this combination of Design Speed and context classification is outside the intended design range and should be avoided. See **Table 201.5.1** for context classifications and Design Speed ranges.

## 210.8 Horizontal Alignment

The centerline (CL) or baseline (BL) of construction defines the horizontal alignment for roadway and bridge construction. The CL or BL of construction is a series of tangents connected by horizontal curves established by the Engineer of Record (EOR). The CL or BL of construction may be the same alignment as the BL of survey.

Horizontal alignment should be consistent with the anticipated operating speeds and with environmental, physical, and economic constraints. Design Speed is the principal factor controlling horizontal alignment.

Avoid placing horizontal curves, points of intersection (PI), and superelevation transitions within the limits of a structure or approach slabs. Placement of stationing equations within the limits of a structure should be avoided. Such equations unnecessarily increase the probability of error in both the design and construction phases.

### 210.8.1 Deflections in Alignment

The point where tangents intersect is known as the PI. Avoid the use of a PI with no horizontal curve; however, there may be conditions where it is necessary (e.g., closely spaced intersections in areas with limited R/W). The maximum deflection without a horizontal curve is as follows:

- Flush shoulder and curbed roadways with Design Speeds of 40 mph and less is 2°00'00".
- Flush shoulder roadways with Design Speeds of 45 mph and greater is 0°45'00".
- Curbed roadways with Design Speeds of 45 mph is 1°00'00".
- High-speed curbed roadways with Design Speeds of 50 mph and greater is 0°45'00".

#### 210.8.1.1 Intersections

Refer to **FDM 212** for information regarding deflections through intersections.

## 210.8.2 Horizontal Curves

A horizontal curve should not be introduced near the crest of a vertical curve. The combination of horizontal and vertical curves can negatively impact sight distance and can also greatly reduce the approaching driver’s ability to perceive a horizontal curve ahead. The condition can be avoided by having the horizontal curvature lead the vertical curvature; i.e., the horizontal curve is made longer than the vertical curve.

Flatter curvature with shorter tangents is preferable to sharp curves connected by long tangents; i.e., avoid using minimum horizontal curve lengths.

**Table 210.8.1** provides the horizontal curve lengths to be used in establishing the horizontal alignment. Refer to **Table 210.8.3** for compound curves.

**Table 210.8.1 Length of Horizontal Curve**

Desired Length Based on Design Speed (mph)										
mph	25	30	35	40	45	50	55	60	65	70
feet	400	450	525	600	675	750	825	900	975	1050
Desired Length Based on Deflection Angle						<b>Notes:</b> (1) The desired horizontal curve length shall be the greater of the lengths based on Design Speed and based on deflection angle. (2) When desirable horizontal curve length cannot be attained, provide the greatest attainable length possible, but not less than 400 feet.				
degrees	5°	4°	3°	2°	1°					
feet	500	600	700	800	900					

### 210.8.2.1 Existing Horizontal Curves

Evaluate existing curves against the values shown in **Table 210.8.2**. The review should include crash history and an on-site review for evidence of roadway departure or operational problems in the area of concern.



**Table 210.8.2 Minimum Radius for Evaluation of Existing Horizontal Curves**

Maximum Superelevation ( $e_{max}$ )		Minimum Radius (feet)									
		Design Speed (mph)									
		25	30	35	40	45	50	55	60	65	70
0.10	SHS	160	231	323	432	559	694	881	1091	1348	1637
	RRR	120	188	276	388	521	674	849	1042	1273	1528
0.05	SHS	194	286	402	533	694	881	N/A	N/A	N/A	N/A
	RRR	140	223	332	468	637	849	N/A	N/A	N/A	N/A

Condition #1 – A horizontal curve that meets or exceeds the SHS minimum radius shown in **Table 210.8.2** is satisfactory unless there is a significant crash history (3 or more crashes within the most recent available 5-year location verified data) or other evidence of safety or operational problems. If problems are identified, include corrective measures in the project.

Condition #2 – A horizontal curve that is below the SHS minimum radius shown in **Table 210.8.2** but meets or exceeds the RRR minimum radius shown in **Table 210.8.2** must be reviewed for specific safety problems at the curve. If the review indicates that significant operational or safety problems exist, the curve should be reconstructed. If problems are identified but reconstruction is not warranted, include corrective measures in the project.

Condition #3 – A horizontal curve that does not meet the RRR minimum radius shown in **Table 210.8.2** must be reconstructed or a Design Exception or Design Variation must be obtained. A reconstructed curve must meet the new construction values shown in **Tables 210.8.1, 210.9.1, 210.9.2, and 210.9.3.**

### 210.8.2.2 Compound Curves

Although the use of compound curves is discouraged, there may be conditions where it is necessary. Avoid sudden changes from flat to sharp curves. For compound curves on open highways, the ratio of the flatter radius to the sharper radius is not to exceed 1.5:1. For compound curves on turning roadways and at intersections, a ratio of 2:1 may be used where the flatter radius precedes the sharper radius in the direction of travel.

The length of compound curves (arc length) for turning lanes are provided in **Table 210.8.3**.

**Table 210.8.3 Minimum Compound Curves Arc Lengths on Turning Roadways**

Minimum Arc Length (feet)							
	Radius (feet)						
	100	150	200	250	300	400	≥ 500
<b>Desirable</b>	65	70	100	120	150	180	200
<b>Minimum</b>	40	50	65	85	100	120	150

**Notes:**  
 (1) Provide the desirable arc length. When the desirable length cannot be attained, provide the greatest attainable length possible, but not less than the minimum values.

### 210.8.2.3 Reverse Curves

Reverse curves are curves in opposite directions on a common tangent that are located in close proximity to each other. Avoid using reverse curves unless a sufficient length (see **FDM 210.9.1**) of tangent is included between the curves to provide for superelevation transitions.

## 210.9 Superelevation

Use a maximum superelevation rate of 0.10 on high-speed roadways. Tabulated superelevation rates for high-speed roadways are provided in **Table 210.9.1**.

Use a maximum superelevation rate of 0.05 on low-speed roadways. Tabulated superelevation rates for low-speed roadways are provided in **Table 210.9.2**.

Design non-limited access ramps using the arterial roadway criteria. Additional data is contained in the **Standard Plans, Index 000-510** and **000-511**.

Provide the following minimum lengths of full superelevation within horizontal curves:

- (1) 100 feet for Design Speeds  $\leq$  45 mph.
- (2) 200 feet for Design Speeds  $\geq$  50 mph.

### **210.9.1 Superelevation Transitions**

The standard superelevation transition places 80% of the transition on the tangent and 20% on the curve. Superelevation transition slope rates are provided in **Table 210.9.3**.

In transition sections where the travel lane(s) cross slope is less than 1.5%, provide one of the following minimum grade criteria:

- (1) Maintain a minimum profile grade of 0.5%.
- (2) Maintain a minimum edge of pavement grade of 0.2% (0.5% for curbed roadway).

When superelevation is required for reverse curves, a suitable tangent length between the curves is determined as follows:

- (1) 80% of the transition for each curve should be located on the tangent.
- (2) Tangent length is equal to or greater than the sum of the two 80% distances.
- (3) Where alignment constraints require an adjustment to the superelevation transition, no more than 50% of the transition may be placed on the curve.

### **210.9.2 RRR Criteria for Superelevation**

Superelevation and transition requirements are provided in **FDM 210.9**.

For all curves:

- If there are any crashes within the last 5 years that are attributed to superelevation, correct the superelevation rates to the new construction values provided in **Tables 210.9.1** and **210.9.2**.

For low-speed curves:

- If the existing superelevation rates are within 0.5% (+/-) of the new construction values in **Table 210.9.2**, superelevation rate correction is not required.
- If the existing superelevation rates are not within 0.5% (+/-) of the new construction values in **Table 210.9.2**, correct the superelevation rates. A Design Variation is required to leave the deficient curve in place.

For high-speed curves and all ramps (regardless of speed):

- If the existing superelevation rates are within the range of derived values from the  $e_{\max} = 6\%$  and  $e_{\max} = 12\%$  tables in ***AASHTO A Policy on Geometric Design of Highways and Streets (AASHTO Green Book)***, superelevation rate correction is not required.
- If the existing superelevation rates are outside of the range of derived values from the ***AASHTO Green Book***  $e_{\max} = 6\%$  and  $e_{\max} = 12\%$  tables, correct the superelevation rates. A Design Exception is required to leave the deficient curve in place.

### 210.9.2.1 Superelevation Correction

This type of work may involve variable depth milling and asphalt layers. Provide the following information in the plans:

- (1) Details showing how the transition from normal cross slope to superelevation is to be achieved.
- (2) A table that summarizes the estimated quantities for milling, overbuild, and structural courses will be necessary.
- (3) Cross sections depicting superelevation correction for the following locations:
  - (a) At the PC and at the PT.
  - (b) Fifty feet before and after the PC and PT.
  - (c) At 300-foot intervals within the curve.

For curbed roadways, superelevation correction should be provided by reconstructing or adjusting the curve to accommodate overbuild. When a correction is not possible, provide other measures appropriate to improve identified safety or operational problems.

**Table 210.9.1 Superelevation Rates for  $e_{max} = 0.10$**

Superelevation Rates ( $e_{max} = 0.10$ ) Tabulated Values										
Degree of Curve (D)	Radius R (ft.)	Design Speed (mph)								
		30	35	40	45	50	55	60	65	70
0° 15'	22,918	NC	NC	NC	NC	NC	NC	NC	NC	NC
0° 30'	11,459	NC	NC	NC	NC	NC	NC	RC	RC	RC
0° 45'	7,639	NC	NC	NC	NC	RC	RC	0.023	0.025	0.028
1° 00'	5,730	NC	NC	NC	RC	0.021	0.025	0.030	0.033	0.037
1° 15'	4,584	NC	NC	RC	0.022	0.026	0.031	0.036	0.041	0.046
1° 30'	3,820	NC	RC	0.021	0.026	0.031	0.037	0.043	0.048	0.054
	*R <sub>NC</sub>									
2° 00'	2,865	RC	0.022	0.028	0.034	0.040	0.048	0.055	0.062	0.070
	*R <sub>RC</sub>									
2° 30'	2,292	0.021	0.028	0.034	0.041	0.049	0.058	0.067	0.075	0.085
3° 00'	1,910	0.025	0.032	0.040	0.049	0.057	0.067	0.077	0.087	0.096
3° 30'	1,637	0.029	0.037	0.046	0.055	0.065	0.075	0.086	0.095	0.100
4° 00'	1,432	0.033	0.042	0.051	0.061	0.072	0.083	0.093	0.099	D <sub>max</sub> = 3° 30'
5° 00'	1,146	0.040	0.050	0.061	0.072	0.083	0.094	0.098	D <sub>max</sub> = 4° 15'	
6° 00'	955	0.046	0.058	0.070	0.082	0.092	0.099	D <sub>max</sub> = 5° 15'		
7° 00'	819	0.053	0.065	0.078	0.089	0.098	D <sub>max</sub> = 6° 30'			
8° 00'	716	0.058	0.071	0.084	0.095	0.100		D <sub>max</sub> = 8° 15'		
9° 00'	637	0.063	0.077	0.089	0.098	D <sub>max</sub> = 10° 15'				
10° 00'	573	0.068	0.082	0.094	0.100		Notes:			
11° 00'	521	0.072	0.086	0.097	D <sub>max</sub> = 10° 15'					
12° 00'	477	0.076	0.090	0.099		D <sub>max</sub> = 13° 15'				
13° 00'	441	0.080	0.093	0.100	D <sub>max</sub> = 17° 45'					
14° 00'	409	0.083	0.096	D <sub>max</sub> = 17° 45'						
15° 00'	382	0.086	0.098		D <sub>max</sub> = 17° 45'					
16° 00'	358	0.089	0.099	D <sub>max</sub> = 17° 45'						
18° 00'	318	0.093	D <sub>max</sub> = 17° 45'							
20° 00'	286	0.097		D <sub>max</sub> = 17° 45'						
22° 00'	260	0.099	D <sub>max</sub> = 17° 45'							
24° 00'	239	0.100		D <sub>max</sub> = 17° 45'						
		D <sub>max</sub> = 24° 45'								
* NC/RC ( - - ) and RC/e ( — ) Break Points (Radius in feet)										
Break Points	Design Speed (mph)									
	30	35	40	45	50	55	60	65	70	
R <sub>NC</sub>	3349	4384	5560	6878	8337	9949	11709	13164	14714	
R <sub>RC</sub>	2471	3238	4110	5087	6171	7372	8686	9783	10955	

- NC = Normal Crown (-0.02)  
 RC = Reverse Crown (+0.02)  
 R<sub>NC</sub> = Minimum Radius for NC  
 R<sub>RC</sub> = Minimum Radius for RC
- (1) Rates for intermediate D's and R's are to be interpolated.
  - (2) Degree of Curvature (D) on high-speed curbed roadways must not exceed: 2° 30' for 50 mph and 2° 00' for 55 mph.
  - (3) Degree of Curvature (D) on interstates must not exceed 3° 00' for 70 mph.

**Table 210.9.2 Superelevation Rates for  $e_{max} = 0.05$**

Superelevation Rates ( $e_{max} = 0.05$ ) Tabulated Values					
Degree of Curve ( <i>D</i> )	Radius ( <i>R</i> ) (feet)	Design Speed (mph)			
		25-30	35	40	45
2° 00'	2,865	NC	NC	NC	NC
2° 15'	2,546				
2° 45'	2,083				NC
3° 00'	1,910				RC
3° 45'	1,528			NC	
4° 00'	1,432			RC	
4° 45'	1,206				
5° 00'	1,146		NC		
5° 15'	1,091		RC		
5° 30'	1,042				
5° 45'	996				
6° 00'	955				RC
6° 15'	917				0.022
6° 30'	881				0.024
6° 45'	849				0.027
7° 00'	819	NC			0.030
7° 15'	790	RC			0.033
7° 30'	764				0.037
7° 45'	739				0.041
8° 00'	716			RC	0.045
8° 15'	694			0.022	0.050
8° 30'	674			0.025	$D_{max} = 8° 15'$
8° 45'	655			0.027	
9° 00'	637			0.030	
9° 30'	603			0.034	
10° 00'	573			0.040	
10° 30'	546		RC	0.047	
11° 00'	521		0.023	$D_{max} = 10° 45'$	
11° 30'	498		0.026		
12° 00'	477		0.030		
13° 00'	441		0.036		
14° 00'	409	RC	0.045		
15° 00'	382	0.023	$D_{max} = 14° 15'$		
16° 00'	358	0.027			
17° 00'	337	0.032			
18° 00'	318	0.038			
19° 00'	302	0.043			
20° 00'	286	0.050			
		$D_{max} = 20° 00'$			

**Notes:**  
 (1) NC = Normal Crown (-0.02), RC = Reverse Crown (+0.02)  
 (2) Rates for intermediate *D*'s and *R*'s are to be interpolated.  
 (3) Design Speeds of 25 mph are to be designed as 30 mph.

**Table 210.9.3 Superelevation Transition Slope Rates**

# Lanes One Direction	Superelevation Transition Slope Rates						
	$e_{max} = 0.10$				$e_{max} = 0.05$		
	Design Speed (mph)				Design Speed (mph)		
	25-40	45-50	55-60	65-70	25-35	40	45
1-Lane & 2-Lane	1:175	1:200	1:225	1:250	1:100	1:125	1:150
3-Lane	---	1:160	1:180	1:200			
4-Lane or more	---	1:150	1:170	1:190			

**Notes:**

**$e_{max} = 0.10$ :**

- (1) The length of superelevation transition is to be determined by the relative slope rate between the travel way edge of pavement and the profile grade, except that the minimum length of transition is 100 feet.
- (2) For additional information on transitions, see the **Standard Plans, Index 000-510**.

**$e_{max} = 0.05$ :**

- (1) The length of superelevation transition is to be determined by the relative slope rate between the travel way edge of pavement and the profile grade, except that the minimum length of transition is 50 feet for Design Speeds of 25-35 mph and 75 feet for Design Speeds of 40-45 mph.
- (2) A slope rate of 1:125 may be used for Design Speeds of 45 mph under restricted conditions.
- (3) For additional information on transitions, see the **Standard Plans, Index 000-511**.

## 210.10 Vertical Alignment

The profile grade line defines the vertical alignment for roadway and bridge construction. The profile grade line is a series of tangents connected by vertical curves. For undivided highways, the profile grade line is typically located at the horizontal centerline of the roadway. For divided highways, a profile grade line should be established for each direction of travel.

Vertical alignments must meet criteria in the **FDM** to assure proper transitions, sight distances, and clearances.

### 210.10.1 Grades

The slope or grade of each tangent is expressed in percent rise (+) or fall (-); e.g., +2.000% or -2.000%. The maximum grades that may be used in establishing the vertical alignment are given in **Table 210.10.1**.

**Table 210.10.1 Maximum Grades**

Context Classification	Maximum Grades (percent)								
	Design Speed (mph)								
	25-30	35	40	45	50	55	60	65	70
C1 Natural C2 Rural	N/A	N/A	N/A	N/A	4	4	3	3	3
C2T Rural Town C3 Suburban C4 Urban General	8	7	7	6	6	5	N/A	N/A	N/A
C5 Urban Center C6 Urban Core	8	8	N/A	N/A	N/A	N/A	N/A	N/A	N/A

**Notes:**

- (1) Maximum grade used should not exceed 4% when truck volume  $\geq$  10% for all context classifications.
- (2) For RRR projects, when existing grades do not meet the above requirements but meet the standards in effect at the time of construction, the existing grades may remain.
- (3) N/A indicates this combination of Design Speed and context classification is outside the intended design range and should be avoided. See **Table 201.5.1** for context classifications and Design Speed ranges.

The point where tangents intersect is known as the vertical point of intersection (VPI). When two tangent grades intersect and no vertical curve is provided, the “kink” is known as the point of intersect (PI). The maximum change in grade (i.e., algebraic change) without a vertical curve is provided in **Table 210.10.2**.



**Table 210.10.2 Maximum Change in Grade without Vertical Curve**

Maximum Change In Grade Without Vertical Curve (percent)								
Design Speed (mph)								
25-30	35	40	45	50	55	60	65	70
1.00	0.90	0.80	0.70	0.60	0.50	0.40	0.30	0.20

### 210.10.1.1 Curbed Roadway

The minimum distance between VPIs on curbed roadways is 250 feet. The minimum grade on curbed roadways is 0.30%.

### 210.10.2 Vertical Curves

A vertical curve must be provided when the change in grade of two intersecting tangent grades exceed the values shown in **Table 210.10.2**. A vertical curve is identified by a curve length (L) which is equal to the product of the K value (K) and the algebraic difference in grades (A).

**Table 210.10.3** provides minimum K-Values and **Table 210.10.4** provides minimum vertical curve lengths.

**Table 210.10.3 K Values for Vertical Curves**

	Minimum K Values For Curves									
	Design Speed (mph)									
	25	30	35	40	45	50	55	60	65	70
<b>Sag</b>	26	37	49	64	79	96	115	136	157	181
<b>Crest (new const.)</b>	19	31	47	70	98	136	185	245	313	401
<b>Crest (RRR Criteria)</b>	12	19	29	44	61	84	114	151	193	247

**Notes:**

**Length,  $L = KA$**

Where: K = Rate of vertical curvature

L = Length of vertical curve, (feet)

A = Algebraic difference in grades, (percent)

- (1) New Construction K values are based on an eye height of 3.5 feet and an object height of 6 inches. RRR Criteria K values are based on an eye height of 3.5 feet and an object height of 2 feet.
- (2) The minimum curve length must not be less than values shown in **Table 210.10.4**.

**Table 210.10.4 Minimum Vertical Curve Lengths**

	Minimum Curve Length (feet)									
	Design Speed (mph)									
	25	30	35	40	45	50	55	60	65	70
<b>Sag</b>	75	90	105	120	135	200	250	300	350	400
<b>Crest</b>						300	350	400	450	500

### 210.10.2.1 RRR Criteria for Vertical Curves

**Table 210.10.3** provides RRR Criteria K values to be used to check the sufficiency of existing crest vertical curves. **2001 AASHTO Green Book** revised its K values to reflect a 2-foot object height; FDOT has not adopted this change for new construction but these K values can be used to check existing curves. An existing crest vertical curve that does not meet the minimum RRR Criteria K value requires a Design Exception or Design Variation to remain.

When crash data indicates that an evaluation is required, consider the following:

- (1) The nature of potential hazards hidden by a hill crest.
- (2) The location of the hazard in relation to the portion of the highway where sight distance falls below new construction criteria.
- (3) Effectiveness of other options such as relocating or correcting the hazard.
- (4) Providing warning signs.

Sag vertical curves do not typically pose stopping sight distance problems. A sag vertical curve that does not meet the minimum K value in **Table 210.10.3** and does not have a crash history does not require a Design Exception or Design Variation to remain.

### 210.10.3 Vertical Clearances

Consider the following vertical clearance requirements when developing the vertical alignment:

- (1) Minimum clearances for bridge structures are given in **FDM 260.6** and **FDM 260.8**.
- (2) Minimum clearance from the bottom of the roadway base course to the Base Clearance Water Elevation is 3 feet, except as noted below. These exceptions will require a reduction in the design resilient modulus in accordance with the [Flexible Pavement Design Manual](#). Coordinate with the Pavement Design Engineer for the following facilities:
  - (a) 2-lane roadways in context classifications C1, C2, C2T and C3 and all ramps may be reduced to a 2-foot clearance.
  - (b) Low points on ramps at crossroads may be reduced to a 1-foot clearance.
  - (c) All other facilities in context classifications C4 through C6 may be reduced to a 1-foot clearance.

- (3) The relationship between the pavement elevation and the Design Flood Elevation is discussed in **Section 4.4 (3)** of the **FDOT Drainage Manual (Topic No. 625-040-002)**.
- (4) **Drainage Manual, Appendix C** lists minimum cover and maximum fill heights for all types of culverts.
- (5) For utility clearances, refer to the [Utility Accommodation Manual](#).
- (6) The required clearance for new overhead sign structures is 17.5 feet. This clearance is the least distance measured between the lowest point on the sign structure and the traffic lane or shoulder directly below the sign structure. For any construction affecting existing overhead sign clearances, the minimum vertical clearance is 17 feet.
- (7) The required clearance for new walk-in Dynamic Message Sign (DMS) structures is 19.5 feet. This clearance is the least distance measured between the lowest point on the DMS structure and the traffic lane or shoulder directly below the DMS structure. For any construction affecting existing DMS, the minimum vertical clearance is 19 feet.
- (8) The required clearance for new signals on span wires, mast arms, or other structures is 17.5 feet. This clearance is the least distance measured between the lowest point on the signal structure and the traffic lane or shoulder directly below the signal structure. For any construction affecting existing signal clearances, FDOT minimum vertical clearance is 17 feet. Vertical clearances between 15 feet and 17 feet require a Design Variation. Signal clearances less than 15 feet are not allowed.

#### **210.10.4 RRR Criteria for Vertical Alignment**

Vertical alignment must be reviewed together with the horizontal alignment to assure that the necessary balance of standards is realized and that the combination is both safe and pleasing.

The alignment should be reviewed to see if the following principles are satisfied by the existing vertical alignment:

- (1) The stopping sight distance provided meets or exceeds the values in **Table 210.11.1**.
- (2) Grades do not significantly affect truck operations.
- (3) There are no hidden dips which could obscure traffic or hazards.
- (4) Steep grades and sharp vertical curves do not exist at or near an intersection.

- (5) Sufficient grades and, when necessary, special gutter grades exist to adequately drain urban projects.
- (6) Adequate sight distance exists for traffic signals (e.g., beyond overpasses, etc.).

When any of the above conditions do not exist, evaluate for hazardous conditions and determine if corrective measures are warranted.

## 210.11 Sight Distance

The **AASHTO Green Book** has a thorough discussion on sight distance. Consider the following aspects of sight distances:

- (1) Stopping Sight Distance: Sight distances needed for stopping, which are applicable on all highways
- (2) Intersection Sight Distance: Sight distances needed by a motorist to see approaching vehicles before their line of sight is blocked by an obstruction near the intersection
- (3) Passing Sight Distance: Sight distances needed for the passing of overtaken vehicles, applicable only on two-lane highways
- (4) Decision Sight Distance: Sight distances needed for decisions at complex locations (e.g., merging tapers, ramps, weaving sections)

### 210.11.1 Stopping Sight Distance

Stopping sight distance is defined as the distance needed for drivers to see an object on the roadway ahead and bring their vehicles to a safe stop before colliding with the object. The distances are derived for various Design Speeds based on assumptions for driver reaction time, the braking ability of most vehicles under wet pavement conditions, and the friction provided by most pavement surfaces.

Stopping sight distance is influenced by both vertical and horizontal alignment. A roadway designed to criteria employs a horizontal alignment, vertical alignment, and a cross section that provides at least the minimum stopping sight distance through the entire facility.

Minimum stopping sight distances are provided in **Table 210.11.1**. Stopping sight distance eye height is 3.5 feet and object heights are the following:

- 6 inches for new construction
- 2 feet for RRR

Minimum stopping sight distances greater than shown in **Table 210.11.1** should be considered when drivers require additional time to make decisions.

**Table 210.11.1 Minimum Stopping Sight Distance**

Grade (percent)		Minimum Stopping Sight Distance (feet)									
		Design Speed (mph)									
		25	30	35	40	45	50	55	60	65	70
Downgrade	≤ 2	155	200	250	305	360	425	495	570	645	730
	3	158	205	257	315	378	446	520	598	682	771
	4	160	208	261	320	385	454	530	610	696	788
	5	162	211	266	326	392	464	541	623	712	806
	6	165	215	271	333	400	474	553	638	728	825
	7	167	218	276	339	408	484	565	652	746	845
	8	170	222	281	346	417	495	579	669	765	867
	9	173	227	287	354	427	507	593	686	785	891
Upgrade	≤ 2	155	200	250	305	360	425	495	570	645	730
	3	147	190	237	289	344	405	469	538	612	690
	4	146	188	234	285	339	399	462	530	602	678
	5	144	186	231	281	335	393	456	522	593	668
	6	143	184	229	278	331	388	450	515	584	658
	7	142	182	226	275	327	383	443	508	576	648
	8	141	180	224	272	323	379	438	501	568	639
	9	139	179	222	269	320	375	433	495	561	631

### 210.11.2 Intersections

Information and requirements on sight distance at intersections is contained in **FDM 212**.

### 210.11.3 Passing Sight Distance

Passing sight distance is the minimum distance that would enable a vehicle to pass another vehicle without interfering with oncoming vehicles traveling at the Design Speed. The minimum passing sight distance is sufficient only for the passing of a single or isolated vehicle.

Minimum passing sight distances for 2-lane, 2-way roadways are provided in **Table 210.11.2**. Values shown in this table are based on an eye height of 3.5 feet and an object height of 3.5 feet.

**Table 210.11.2 Minimum Passing Sight Distance**

	Minimum Passing Sight Distance For 2-Lane, 2-Way Roadways (feet)									
	Design Speed (mph)									
	25	30	35	40	45	50	55	60	65	70
New Const.	900	1090	1280	1470	1625	1835	1985	2135	2285	2480
RRR	450	500	550	600	700	800	900	1000	1100	1200

The **2011 AASHTO Green Book** revised its passing sight distance values, and FDOT has not adopted this change for new construction. The new construction passing sight distance values in **Table 210.11.2** should be used to check the vertical and horizontal geometry on new alignments to provide as many passing zones as possible.

The values shown in the [Manual on Uniform Traffic Studies \(MUTS\)](#) are used as the warrants for placing no-passing zone pavement markings for all projects. The RRR values in **Table 210.11.2** should be used to verify existing pavement markings, in accordance with the No Passing Zone Study procedure included in the **MUTS**.

### 210.11.4 Decision Sight Distance

**AASHTO Green Book, Chapter 3** provides a detailed discussion on decision sight distance.