



2024 FDOT Design Manual
200 Series: Design Criteria

200 Context Based Design

200.1 General

Designs for highway and bridge projects are based on established design controls for the various elements of the project such as width of roadway, side slopes, horizontal and vertical alignment, drainage considerations and intersecting roads.

The design criteria presented in this manual are based on:

- Functional Class
- Design Speed
- Context Class

200.2 Highway Functional Classification

Functional classification is the grouping of highways by the character of service and connectivity they provide. The **AASHTO** publication ***A Policy on Geometric Design of Highways and Streets*** presents an excellent discussion on highway functional classifications. **Table 200.2.1** summarizes the primary characteristics of each functional classification.

Table 200.2.1 Design Types

Functional Classification	Primary Characteristics
Limited Access Facilities	<ul style="list-style-type: none"> • Limited access • Through traffic movements • Primary freight routes • Guided by FHWA Design Standards
Principal Arterial	<ul style="list-style-type: none"> • Through traffic movements • Longer distance traffic movements • Primary freight routes
Minor Arterial	<ul style="list-style-type: none"> • Connections between local areas and network principal arterials • Connections for through traffic between arterial roads • Access to public transit and through movements • Pedestrian and bike movements
Collector	<ul style="list-style-type: none"> • Carry traffic with trips ending in a specific area • Access to commercial and residential centers • Access to public transportation • Pedestrian and bicycle movements
Local Roads	<ul style="list-style-type: none"> • Direct property access—residential and commercial • Pedestrian and bicycle movements

This manual provides design criteria for roads on the State Highway System (SHS) based on the following functional classification groups:

- (1) Limited Access (LA) Facilities (Interstate, Freeways, and Expressways)
- (2) Arterials and Collectors

The [Florida Greenbook](#) provides criteria for local roads.

200.3 Design Speed

See *FDM 201* for discussion on Design Speed.

200.4 Context Classification

Projects are uniquely planned and designed to be in harmony with the surrounding land use characteristics and the intended uses of the roadway. To this end, a context classification system comprising eight context classifications has been adopted. **Table 200.4.1** describes the context classifications that will determine key design criteria elements for arterials and collectors.

Criteria for LA Facilities are independent of the adjacent land uses; therefore, context classifications shown in **Table 200.4.1** do not apply to these facilities.

Additional information on context classifications and guidance on the determination of the context classification is provided in the [FDOT Context Classification Guide](#).

Contact the District Complete Streets Coordinator to obtain the appropriate context classification for project roadway segments.

Table 200.4.1 Context Classifications

Context Classification		Description of Adjacent Land Use
C1	Natural	Lands preserved in a natural or wilderness condition, including lands unsuitable for settlement due to natural conditions.
C2	Rural	Sparsely settled lands; may include agricultural land, grassland, woodland, and wetlands.
C2T	Rural Town	Small concentrations of developed areas immediately surrounded by rural and natural areas; includes many historic towns.
C3R	Suburban Residential	Mostly residential uses within large blocks and a disconnected/sparse roadway network.
C3C	Suburban Commercial	Mostly non-residential uses with large building footprints and large parking lots. Buildings are within large blocks and a disconnected/sparse roadway network.
C4	Urban General	Mix of uses set within small blocks with a well-connected roadway network. May extend long distances. The roadway network usually connects to residential neighborhoods immediately along the corridor or behind the uses fronting the roadway.
C5	Urban Center	Mix of uses set within small blocks with a well-connected roadway network. Typically concentrated around a few blocks and identified as part of the community, town, or city of a civic or economic center.
C6	Urban Core	Areas with the highest densities and with building heights typically greater than four floors within FDOT classified Large Urbanized Areas (population >1,000,000). Many are regional centers and destinations. Buildings have mixed uses, are built up to the roadway, and are within a well-connected roadway network.

201 Design Controls

201.1 General

Designs for highway and bridge projects are based on established design controls for the various elements of the project such as width of roadway, side slopes, horizontal and vertical alignment, drainage considerations and intersecting roads. Selection of the appropriate criteria and standards is influenced by traffic volume and composition, desired levels of service, functional classification, terrain features, context classification, and environmental considerations.

The identification of applicable design controls is needed to achieve:

- (1) Optimum safety.
- (2) Desired capacity and Level of Service.
- (3) Design consistency.
- (4) Cost effective designs.

201.1.1 Capacity and Level of Service

The AASHTO publication *A Policy on Geometric Design of Highways and Streets*, the Transportation Research Board *Highway Capacity Manual*, and FDOT's [Quality/Level of Service \(Q/LOS\) Handbook](#) provide detailed analysis and calculation procedures used in determining the number and configuration of lanes required and the resulting levels of service provided. As illustrated in those texts the following factors greatly influence capacity and Level of Service:

- Roadway gradients and roadside developments
- Number, spacing, and types of crossings and intersections
- Traffic volumes and composition
- Signalization progression and interconnectivity

Design of signalized intersections should ensure an adequate Level of Service through the design year of the facility, especially when right of way acquisition is being considered. The capacity of an at-grade arterial or collector is primarily controlled by its ability to move traffic through signalized intersections, rather than the mid-block through lane capacity.

Use the operational analysis methods in the Highway Capacity Manual for design of signalized intersections. Information or assumptions on basic intersection geometrics, lane utilization, and movement-specific traffic volumes are provided by the designer. The primary output of the operational analysis method is Level of Service and delay at a signalized intersection; however, this method can be used to determine geometric requirements, signal timing, or service flow volumes.

Signal timing is interactive with geometric design. Changes to geometrics, such as adding a turn lane, must consider changes to the signal timing simultaneously. Department-approved software, including the Highway Capacity Software, should be used to simulate the operation of independent or interconnected signals. Output from these programs can be used for the analysis and evaluation of proposed designs.

201.1.2 Design Consistency

Design consistency is achieved when the geometric features of the roadway are consistent with the operational characteristics expected by the driver. Design consistency alleviates driver uncertainty and inappropriate driver response. Following the criteria contained in this manual will assure design consistency; however, special attention should be given at locations where sudden changes in Design Speed, alignment or cross section occur, and in the development of intersection designs.

Roadways may traverse through a variety of context classifications. As the context changes, the Design Speed for the roadway will also change. Changes in Design Speed may also occur based on FDOT policy or to conform to operational or geometric conditions. Consistent signing and pavement marking designs in transition areas is an important aspect in meeting driver expectancy. See **FDM 201.5** for information on Design Speed.

Two examples of sudden change in cross section are where a narrow bridge exists and when the number of travel lanes increase or decrease. The FDOT [Standard Plans](#) provide guidance on accepted practices in these areas. Changes in the cross section may also occur when there is a change in the context classification.

Critical design elements that affect design consistency, driver expectancy, and vehicular operation include:

- Horizontal and vertical alignment
- Embankments, slopes, and guardrail applications
- Bridge width and roadway shoulders
- Pavement crown, cross slope, and superelevation

- Signing and delineation
- Placement of signal, lighting, and utility poles

201.2 Context Classification

Context classification is a design control that determines key design criteria elements for arterials and collectors. Criteria for LA Facilities are independent of the adjacent land uses; therefore, context classifications do not apply to these facilities and they are assigned the code “LA” for “Limited Access” where a context classification is required, such as in the Roadway Characteristics Inventory. However, where a limited access facility connects to the non-limited access state road system, the context classification of the non-limited access facility must be considered to provide a context-appropriate transition between access classifications. Each state road has been assigned a context classification, and this information can be obtained from the District Complete Streets Coordinator. The following is a list of the Department’s adopted context classifications:

- C1 – Natural
- C2 – Rural
- C2T – Rural Town
- C3R – Suburban Residential
- C3C – Suburban Commercial
- C4 – Urban General
- C5 – Urban Center
- C6 – Urban Core

Additional information on context classification is included in **FDM 200**. Contact the District Complete Streets Coordinator to obtain the appropriate context classification for project roadway segments.

201.3 Traffic and Design Year

To provide for an interconnected transportation system that insures the mobility of people and goods, designs should satisfy capacity needs at an acceptable level of service through the design year. Forecasted traffic demand and volume are used to establish the number of travel and turn lanes, turn lane storage, signal timing, and right of way requirements. Forecasted traffic should account for anticipated future land use development.

The design year is the year for which the proposed improvement is designed. The FDOT **Project Traffic Forecasting Handbook** states that the design year is usually 20 years from the Opening Year, but design period may range in years from the present to 20 years depending on the project type.

Design year period typically used on FDOT projects are as follows:

- 20 years for new construction and reconstruction projects
- 15 years for lighting projects
- 10 years for signalization projects
- 10 years for improvements included with RRR projects
- 0-10 years for safety and operational improvements

Traffic forecasting is also used in pavement design to determine the vehicular loadings on the pavement. The proposed pavement design must provide structural strength through the pavement's service life. Refer to the FDOT [Pavement Design Manuals](#) for guidance on selecting an appropriate design period for flexible and rigid pavements.

Traffic forecasts are developed during the Project Development and Environmental (PD&E) study of a project. A Project Traffic Analysis Report is generally required. When a PD&E study is not conducted, traffic forecasts must be prepared early in the design phase. Project traffic used for design must be attested to by completing **Form 130b**, located in **FDM 103**.

Traffic data used for design includes:

- (1) AADT for the current year, opening year and design year.
- (2) Existing hourly traffic volumes over minimum of 24-hour period, including peak hour turning movements and pedestrian counts.
- (3) Directional distribution factor (D).
- (4) Standard K factor (K).
- (5) Truck factors (T) for daily and peak hour.
- (6) Design Speed and proposed Posted Speed.
- (7) Design vehicle for geometric design.
- (8) Peak turning movements at signalized and problem intersections and major traffic generators.
- (9) Movements for future traffic generators that are scheduled during the service life should be considered.

201.4 Access Management

Regulation of access is necessary to preserve the functional integrity of the State Highway System and to promote the safe and efficient movement of people and goods within the state. Under **Florida Statutes 335.18**, the Legislature authorized FDOT to develop rules to administer the "State Highway System Access Management Act". These are **Rule 14-96** and **Rule 14-97**; see **Tables 201.4.1, 201.4.2** and **201.4.3**. Designs are to comply with the statute, the rules, adopted procedures and directives, and the district program.

Table 201.4.1 Rule 14-97 - Freeway Interchange Spacing

Access Class	Area Type	Segment Location	Interchange Spacing (miles)
1	Area Type 1	CBD & CBD Fringe For Cities In Urbanized Areas	1.0
	Area Type 2	Existing Urbanized Areas Other Than Area Type 1	2.0
	Area Type 3	Transitioning Urbanized Areas, and Urban Areas Other Than Area Type 1 or 2	3.0
	Area Type 4	Rural Areas	6.0

Table 201.4.2 Rule 14-97 - Arterial Access Classifications & Standards

Access Class	Median Type	Connection Spacing (feet)		Median Opening Spacing (feet)		Signal Spacing (feet)
		>45 mph	≤45 mph	Directional	Full	
2	Restrictive with Service Roads	1320	660	1320	2640	2640
3	Restrictive	660	440	1320	2640	2640
4	Non-Restrictive	660	440			2640
5	Restrictive	440	245	660	2640 >45 mph 1320 ≤ 45 mph	
6	Non-Restrictive	440	245			1320
7	Both Median Types	125		330	660	1320

Notes:

- (1) "Restrictive" physically prevent vehicle crossing.
- (2) "Non-Restrictive" allow turns across at any point.
- (3) Speeds shown in this table are posted speeds.

Interchange Ramp Areas:

Connections within the interchange ramp area require the following spacing from the end of the ramp taper:

- 440 feet ≤ 45 mph
- 660 feet > 45 mph
- 1,320 feet on Access Class 2 Facilities > 45 mph

Median openings within the interchange ramp area require the following standard distance from the end of the ramp taper:

- 2,640 feet for full median opening
- 1,320 feet for directional median opening

Table 201.4.3 Rule 14-97 - Interim Access Management Standards

Posted Speed (mph)	Connection Spacing (feet)	Median Opening Spacing (feet)		Signal Spacing (feet)
		Directional	Full	
35 mph or less	245	660	1320	1320
36 - 45 mph	440	660	1320	1320
Over 45 mph	660	1320	2640	1320

In addition, FDOT adopted the ***Median Opening and Access Management Decision Process (Topic No. 625-010-021)***, which further defines the principles and processes for FDOT to implement the Access Management Statute and Rules.

Each district has established an Access Management Review Committee to guide actions in access management and median decisions through all FDOT's processes. Various district offices are responsible for driveway permit connections and administering other parts of the program.

Each roadway on the State Highway System is assigned an access classification which determines what roadway features and access connection modifications are appropriate to adhere to the program.

During the PD&E phase, a conceptual access management plan is prepared for the preferred alternative. Access management issues are addressed in the Preliminary Engineering Report. Designs are to implement access management decisions and commitments made during the PD&E phase.

For projects that did not go through a PD&E phase, access connections within the project limits are to be evaluated for compliance with the assigned access classification. Driveways, signal, and median opening spacing should be considered in the analysis of safety and operational problems. Modifications or closures to access may be the solution in certain cases.

Rule 14-97.003(3)(b) gives FDOT the authority to alter, relocate or replace connections in order to meet current FDOT standards.

Rule 14-96.011 allows FDOT to revoke a permit "...if the connection causes a safety or operational problem on the State Highway System substantiated by an engineering study...".

Rule 14-97.003(3)(b) provides guidance on the treatment of existing features in the highway improvement process:

“Existing lawful connections, median openings, and signals are not required to meet the access management standards. Existing access management features will generally be allowed to remain in place, but shall be brought into conformance with access management standards when significant change occurs or as changes to the roadway design allow.”

Where revisions are necessary due to operational or safety problems, it may not be possible to upgrade a median opening or driveway connection to the current standards because of existing conditions or constraints. In these cases, provide the best solution, based on good engineering practice.

Median Opening and Access Management Decision Process (Topic No. 625-010-021) requires the following:

- (1) Any significant change to driveway access will be shown in the plans or the driveway will be replaced in the same location, width and configuration (number of lanes).
- (2) Access design and impacts to a right of way acquisition parcel should be determined prior to the right of way phase.
- (3) Changes to access details or decisions must be coordinated with District Right of Way and General Counsel’s offices in addition to the Access Management Review Committee.

Properties that abut a roadway on the State Highway System has a right to reasonable access to the roadway. A means of reasonable access cannot be denied except on the basis of safety and operational concerns as provided in **Section 335.184, Florida Statutes**. Nothing in **Section 335.184** limits FDOT's authority to restrict the operational characteristics of a particular means of access. Service roads provide reasonable access.

It should be noted that if there are any conflicts between this manual and the statute and rules, the statute and rules will govern.

201.5 Design Speed

Design Speed is a principal design control that regulates the selection of many of the project standards and criteria used for design. The selection of an appropriate Design

Speed must consider many factors. The AASHTO publication, ***A Policy on Geometric Design of Highways and Streets***, has a thorough discussion on Design Speed.

There are three categories of Design Speed:

High Speed: Design Speeds 50 mph and greater.

Low Speed: Design Speeds of 45 mph and less.

Very Low Speed: Design Speeds 35 mph and less.

201.5.1 Design Speed Selection

Design Speed should be selected early in the design process and should reflect the Target Speed (see below). Select a context-appropriate Design Speed to attain a desired degree of safety, mobility, and efficiency. Where the initial recommended Target Speed value is not feasible to attain in a single project, the Target Speed should be as close to the initial Target Speed values as can be achieved within the constraints of the project. Adjust both the Design Speed and Target Speed as appropriate to achieve a single value appropriate to the project. Select Design Speeds in increments of 5 mph.

Target Speed is the highest speed at which vehicles should operate on a thoroughfare in a specific context, consistent with the level of multi-modal activity generated by adjacent land uses, to provide both mobility for motor vehicles and a supportive environment for pedestrians, bicyclists, and public transit users. Determine appropriate Target Speed for all non-limited access projects where a Design Speed is also required. The Target Speed must:

- Be within the range of Design Speeds for the context classification (see ***Table 201.5.1***),
- Reflect the needs of safety, quality of life, and economic development of the corridor, and
- Be established by a team that includes, but is not limited to, Design, Traffic Operations, Safety, Planning, and Program Management offices.

It is expected that initial Target Speed values may be modified during project scoping to achieve the Target Speed as additional information is gathered and project scoping decisions are made. See the ***FDOT Context Classification Guide*** for more information about determining appropriate Target Speed.

In general, the Target Speed for C1 and C2 roadways should be on the higher end of the Design Speed range, with justification provided for lower speeds. In C2T through C6,

consider starting with Target Speeds on the lower end of the range with justification provided for higher speeds.

It is considered a best practice to provide initial Target Speed values as part of the Context Classification determination. These initial values can be an effective starting point for the establishment of the Target Speed. For RRR projects where the initial Target Speed value is below the existing Design Speed or Posted Speed Limit, see **FDM 202** for Speed Management techniques to better align the Design Speed with Target Speed. In many cases, the Design Speed and the initial Target Speed values may both need to be changed to arrive at a Target Speed appropriate for the project.

*Commentary: The 85th-percentile observed speed is a starting point when traffic engineers conduct a speed study for setting speed limits (see the **FDOT Speed Zoning Manual** for more information, if desired.). The 85th percentile speed should be considered when selecting the Target Speed, but the Target Speed does not have to match the 85th-percentile speed.*

In many cases, speed management is required because the existing 85th-percentile speed is too high for current conditions, so setting Target Speed equal to the existing 85th-percentile speed would fail to accomplish the speed management objectives. The primary value of knowing the existing 85th percentile speed is to understand the potential magnitude of speed management interventions that may be required to achieve a selected Target Speed. Large speed reductions of more than 10 mph, for instance, may need to be approached incrementally over several projects, rather than achieved at once on a single project.

The District Design Engineer (DDE) and the District Traffic Operations Engineer (DTOE) jointly approve the selected Design and Posted Speeds. This approval is a declaration that the Posted Speed will not exceed the selected Design Speed. This is to be documented on the Typical Section Package as described in **FDM 120.2.3**.

Table 201.5.1 provides an allowable range of mainline Design Speeds on the State Highway System. **Table 201.5.2** provides the minimum Design Speeds allowed on ramps.

Modification for Non-Conventional Projects:

See RFP for Design Speed and Target Speed.

Table 201.5.1 Design Speed

Limited Access Facilities (Interstates, Freeways, and Expressways)		
Area	Allowable Range (mph)	SIS Minimum (mph)
Rural and Urban	70	70
Urbanized	50-70	60
Arterials and Collectors		
Context Classification	Allowable Range (mph)	SIS Minimum (mph)
C1 Natural	55-70	65
C2 Rural	55-70	65
C2T Rural Town	25-45	40
C3 Suburban	35-55	50
C4 Urban General	25-45	45
C5 Urban Center	25-35	-
C6 Urban Core	25-30	-
<p>Notes:</p> <ul style="list-style-type: none"> (1) SIS Minimum Design Speed may be reduced to 35 mph for C2T Context Classification when appropriate design elements are included to support the 35-mph speed, such as on-street parking. (2) SIS Minimum Design Speed may be reduced to 45 mph for curbed roadways within C3 Context Classification. (3) For SIS facilities on the State Highway System, a selected Design Speed less than the SIS Minimum Design Speed requires a Design Variation as outlined in SIS Procedure (Topic No. 525-030-260). (4) For SIS facilities not on the State Highway System, a selected Design Speed less than the SIS Minimum Design Speed may be approved by the District Design Engineer following a review by the District Planning (Intermodal Systems Development) Manager. (5) SIS minimum Design Speed may be reduced to 30 mph for C2T, C3, and C4 for facilities with a transit route. 		

Table 201.5.2 Ramp Design Speeds

Ramp Connection Type	Minimum Design Speed (mph)
Loops and Semi-Direct	30
Outer Cloverleaf	35
Intermediate Portions of Long Ramps	40
Direct Connection	50
<p><u>Express Lane Direct Connections:</u></p> <p>(1) Design Speeds higher than the minimum shown above should be used when practical. A Design Speed of 60 mph is desirable.</p> <p>(2) Design Variations for Design Speed will not be approved for Express Lane Direct Connections with a Design Speed below 40 mph.</p>	

201.5.1.1 Collector-Distributor Roads

The Design Speed for collector-distributor roads must not be more than 10 mph below the Design Speed of the primary facility when direct ingress or egress to the Limited Access facility is provided. C-D road segments more than one intersection away from a LA facility should be assigned a Target Speed in accordance with their context classification.

201.5.1.2 Express Lanes

Express lanes Design Speed will be the same Design Speed as the adjacent general use lanes or general toll lanes in roadways that have buffer and wide buffer separation. In cases of barrier and grade separation the Design Speed can be equal to or greater than that of the adjacent general use lanes or general toll lanes, but never less than the general use lanes or general toll lanes. Minimum ramp Design Speeds for Express Lanes ramps are included in **Table 201.5.2**.

201.5.2 Post-Construction Speed Study

The District Traffic Operations Engineer (DTOE) typically conducts a speed investigation within one year after a new construction or reconstruction project is completed. A change in Posted Speed limit may be proposed based on engineering and traffic investigations

described in the Department's *Manual on Speed Zoning for Highways, Roads and Streets in Florida* (a.k.a. [Speed Zoning Manual](#)).

When a speed study indicates that a higher Posted Speed is warranted, a modification of Posted Speed limit may be made under the authority of the District Traffic Operations Engineer (per the Traffic Regulation Approval Process, [FDOT Procedure No. 750-010-011](#)).

To assign a Posted Speed higher than the Design Speed, the DTOE, working with the District Design Engineer (DDE) must process a Design Exception or Design Variation for each design element that does not meet the criteria for the higher speed.

Further explanation on how Posted Speed limits are developed can also be found on the State Traffic Operations web page:

<https://www.fdot.gov/traffic/FAQs/>

201.5.3 RRR Projects

Select a Design Speed consistent with the Target Speed (see *FDM 201.5.1*), context classification of the roadway and project scope. The Design Speed used for a RRR project must be no higher than the Design Speed used in the original design of the highway.

When the Posted Speed is greater than the Design Speed used in the original design of the highway:

- (1) Process a Design Variation or Design Exception for each design element that does not meet the criteria for the higher Posted Speed. Refer to Design Variations and Design Exceptions that were processed when the higher Posted Speed was implemented.
- (2) Use criteria based on the Posted Speed:
 - (a) when correcting a specific highway feature that has a significant crash history
 - (b) for any new highway feature
- (3) For replacement of highway features, use criteria based on the Posted Speed to the greatest extent possible, but not less than the Design Speed.

When the Design Speed used in the original design of the highway is higher than the existing Posted Speed, the Design Speed may be reduced to match the existing Posted Speed, as long as the values in *Table 201.5.1* are still met. Speed management

strategies (per **FDM 202**) should be used in conjunction with reduction of Design Speed. No Design Variation is required to lower the Design Speed to match the existing Posted Speed.

Include Design Speed, Target Speed, Design Variations, and Design Exceptions in the Typical Section Package. See **FDM 120.2.3**.

If the existing Design Speed or Posted Speed meets AASHTO's criteria but is not within the allowable range shown in **Table 201.5.1**, a Design Variation is not required to maintain the existing Design or Posted Speed. When Posted Speed exceeds the allowable range, roadway elements that encourage lower operating speeds should be included with the project. See **FDM 202** for examples of roadway elements that encourage lower operating speeds.

201.6 Design Vehicle

The Design Vehicle is the largest vehicle that is accommodated without encroachment on to curbs (when present) or into adjacent travel lanes. The type of Design Vehicle is influenced by the functional and context classification of a roadway, the role of the roadway in the network, and the land uses served.

The selected Design Vehicle affects:

- Horizontal and vertical alignments
- Lane widths and lane assignments
- Roundabout inscribed circle diameter
- Intersection turning radii and sight distance
- Auxiliary lane storage length, and acceleration and deceleration lengths

When considering dual left turn or right turn lanes, the Design Vehicle should generally be considered as turning simultaneously with a passenger car.

AASHTO's A Policy on Geometric Design of Highways and Streets provides general guidance on the selection of a design vehicle. **AASHTO** also provides the dimensions and turning characteristics for a variety of standard design vehicles; e.g., P, SU, WB-40, WB-62.

Florida Statutes allow truck-trailer combinations that are similar to the AASHTO WB-62 Interstate Semitrailer with some slight modifications. This modified WB-62 design vehicle is defined as the Florida Interstate Semitrailer (WB-62FL) and is often used as the design

vehicle on the SHS. In addition, the Florida's Turnpike and other truck routes allow tandem tractor trailers. Use the AASHTO WB-109D as the design vehicle for tandem truck routes.

201.6.1 Control Vehicle

The Control Vehicle is one that is infrequent and is accommodated by allowing:

- Encroachment into opposing lanes if no raised median is present
- Minor encroachment on to curbs and areas within the curb return if no critical infrastructure such as traffic signal poles are present.

Control Vehicles may be appropriate at intersections for curbed roadways within C4, C5 and C6 context classifications. When considering U-turns, the Control Vehicle may be used as the Design Vehicle.

201.6.2 WB-62FL

When designing for a WB-62FL at intersections, the design elements (e.g., control radii, return radii) can be based on the criteria tables and figures in **AASHTO** for a WB-62. In addition, when designing features for complex or constrained intersections (e.g., roundabouts, multi-lane turns, directional median openings, ramps) the geometric design elements should be checked against the turning movement of a WB-62FL. The Florida Interstate Semitrailer WB-62FL is illustrated in **Figure 201.6.1**.

Figure 201.6.1 WB-62FL

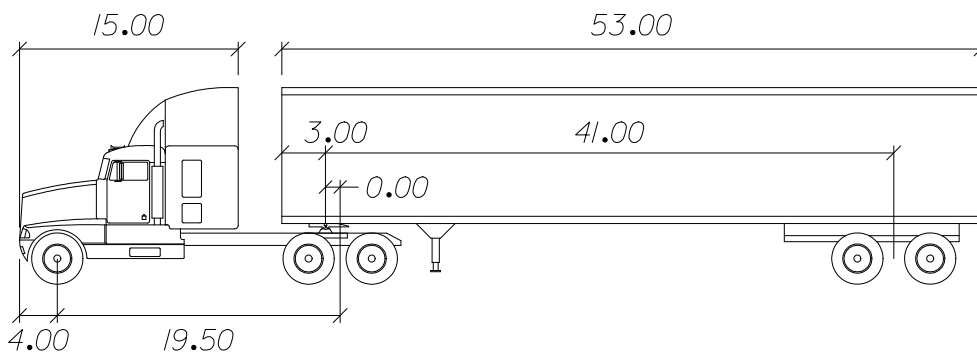

<i>WB-62FL</i>		<i>feet</i>	
<i>Tractor Width :</i>	<i>8.00</i>		<i>Lock to Lock Time: 6.00 seconds</i>
<i>Trailer Width :</i>	<i>8.50</i>		<i>Steering Angle : 28.40 degrees</i>
<i>Tractor Track :</i>	<i>8.00</i>		<i>Articulating Angle: 70.00 degrees</i>
<i>Trailer Track :</i>	<i>8.50</i>		

202 Speed Management

202.1 General

This chapter describes strategies that may be used to achieve desired operating speeds across all context classifications. The strategies described in this chapter are national best practices for low-speed facilities and are allowable on arterials and collectors when consistent with the context classification of the roadway.

The **FDM** recognizes a range of design speeds for each context classification. For very low speed conditions (35 mph or less) the context classification design speed range indicates the upper end of desirable operating speeds. For instance, the design speed range for C4 is 25-45 mph, but in conditions where on-street parking is present, a 35 mph or lower design speed should be used. Additionally, when the current design speed of a roadway exceeds the allowable range for the context classification or exceeds the target speed for conditions within the roadway, the strategies described in this chapter can be used to achieve a lower operating speed.

202.1.1 Lane Repurposing Projects

Lane repurposing projects (a.k.a., “road diets”) are intended to reconfigure the existing cross section to allow other uses. This type of project typically does not move existing curbs, but with the removal of a travel lane(s) may provide space to implement the speed management strategies discussed in this chapter. Lane repurposing alone is not a speed management strategy but is included here to facilitate the use of other strategies.

See **FDM 126** for information on lane repurposing projects.

202.2 Speed Management Concepts

Low speed areas will typically have characteristics where conventional controls, such as centerline horizontal curvature, have limited applicability, such as:

- C6, C5 and C2T segments, which may be only a few blocks long and may already be built out, with limited possibility for roadway realignment
- C4 and C3 segments which are only a few blocks long and where reconstruction is not planned (such as a RRR project)
- Any project where interventions are part of a RRR project rather than a reconstruction or realignment, so curb lines are assumed to be fixed.

The strategies shown in **Table 202.3.1** are intended to be implemented on RRR projects but may also be incorporated into New Construction or Reconstruction projects. For new construction or reconstruction projects, provide a centerline curvature to support the desired lower speed, in addition to the other techniques described in this chapter. Shorter segments with smaller curve radii will generally yield better results, compared to applying speed management strategies to a facility originally designed for high speeds. In town centers, respecting the existing or proposed street grid will help provide frequent intersections for speed management as well as circulation for traffic and pedestrians.

Table 202.3.1 indicates the appropriate context classification, Target Speed range, and potential techniques that may be applicable to achieve the indicated Target Speed. The strategies shown in this table are not exhaustive. Creativity, judgment, and experience in the use of low-speed strategies are encouraged. Successful strategies typically incorporate one or more of the following speed management concepts:

- **Enclosure:** Enclosure is the sense that the roadway is contained in an “outside room” rather than in a limitless expanse of space. Drivers’ sense of speed is enhanced by providing a frame of reference in this space. The same sense of enclosure that provides a comfortable pedestrian experience also helps drivers remain aware of their travel speed. Street trees, buildings close to the street, parked cars, and terminated vistas help to keep drivers aware of how fast they are traveling. This feedback system is an important element of speed management.
- **Engagement:** Engagement is the visual and audial input connecting the driver with the surrounding environment. Low speed facilities utilize engagement to help bring awareness to the driver resulting in lower operating speeds. As the cognitive load on a driver’s decision-making increases, drivers need more time for processing and will manage their speed accordingly. Uncertainty is one element of engagement – the potential of an opening car door, for instance, alerts drivers to drive more cautiously. On-street parking and proximity of other moving vehicles in a narrow-lane are important elements of engagement, as are architectural detail, shop windows, and even the presence of pedestrians.
- **Deflection:** Deflection is the horizontal or vertical movement of the driver from the intended path of travel. Deflection is used to command a driver’s attention and manage speeds. Being a physical sensation, deflection is the most visceral and powerful of the speed management strategies. Whereas enclosure and engagement rely in part on psychology, deflection relies primarily on physics. Examples include roundabouts, splitter medians (horizontal deflection), and raised intersections (vertical deflection). Deflection may not be appropriate if they hinder truck or emergency service vehicle access.

202.2.1 Target Speed

Target Speed is the highest speed at which vehicles should operate on a thoroughfare in a specific context, consistent with the level of multi-modal activity generated by adjacent land uses, to provide both mobility for motor vehicles and a supportive environment for pedestrians, bicyclists, and public transit users.

References:

- **FHWA webpage:**
https://www.fhwa.dot.gov/planning/css/design/controls/factsheet3_ite.cfm
- **Speed Zoning Manual 9.4**
- **FDOT Context Classification Guide** (July 2020)

Ideally, the Target Speed, Posted Speed, and Design Speed should all be the same where speeds are 45 mph or less. However, Design Speed and Posted Speed will often take time to change and may even need to be changed over the course of several projects. Target Speed can be set immediately and serves as the “target or goal” for Design Speed and Posted Speed on a project. Establish a Target Speed for any non-limited access project where a design speed is also required, per **FDM 201.5.1. Table 202.3.1** indicates the speed management strategies that should be used to achieve a desired Target Speed. The district planning office should include a recommended Target Speed along with other documentation of the Context Classification for a project.

The Design Speed of the roadway should be changed to match the Target Speed per **FDM 201**. Recognizing this may have to occur incrementally depending on the magnitude of the difference between the current Design Speed and the Target Speed, adjust both the Target Speed and Design Speed during initial scoping if needed, based on project needs and constraints. See **FDM 201** for information on Design Speed and changes in Design Speed on RRR projects. Speed studies per the Speed Zoning Manual should be conducted as well to determine if the Target Speed strategies are working and to reset the Posted Speed as the operating speeds change over time.

202.3 Speed Management Strategies

When selecting appropriate strategies from **Table 202.3.1**, consider:

- context classification
- desired operating speed
- community vision
- multimodal needs (safety, operations)
- design and emergency vehicles
- access management

Descriptions of each speed management strategy are provided in the following sections of this chapter. Typically, the strategies provided in **Table 202.3.1** are most effective when several are used together. Use existing conditions to the greatest extent possible to support speed management. In particular, existing street grids with short blocks and frequent intersections represent excellent speed management opportunities already in place. Accentuate and use such opportunities where they exist.

202.3.1 Roundabouts

Roundabouts are effective as a transition from a higher speed context to a lower speed context. On the State Highway System (SHS), modern roundabouts are standard, but smaller roundabouts (sometimes referred to as “mini-roundabouts”) may be appropriate in contexts where operating speeds of 25 mph or less are desired. See **FDM 213** for roundabout design criteria.

When used in series, roundabouts can help maintain a low-speed condition as an alternative to vertical deflection, stop signs, or traffic signalization. To limit the potential of drivers accelerating between roundabouts in series, spacing should not exceed one mile on low-speed roadways and half-mile on very low speed roadways.

202.3.2 On-Street Parking

In addition to providing parking supply and separating pedestrians from the travel lane, on-street parking can be used to manage speeds when the parking lane is located directly adjacent to the travel lane. For best effect, the parking lane should be of the standard size for the type of parking used (parallel or reverse angle), and the travel lane should be of the minimum width that will accommodate the design vehicle. Effective speed management can be achieved by maximizing the engagement between the parking lane and the travel lane. Where parking is used for speed management, avoid the following:

- Installing a bicycle lane between the parking lane and the travel lane
- Travel lanes wider than 11 feet.

Consider providing additional strategies such as curb extensions, and shorts blocks, with on-street parking.

See **FDM 210.2.3** for on-street parking design criteria.

202.3.3 Chicanes

A chicane is a very low speed treatment using deflection of the roadway centerline to achieve horizontal deflection within existing curb. Chicanes place vertical barriers (e.g., curbs, on-street parking) to require vehicle operators to make frequent horizontal movements. To be effective, the chicane deflection should be the width of a parking lane or no less than half of the travel lane width. Transition distance between chicanes is typically 100 feet or more.

An example of a chicane strategy is the placement of on-street parking on alternating sides of the street. This alternating on-street parking pattern may be placed from one block to the next, or within a single block (depending on block length and transition distances). This creates a centerline shift, as illustrated in **Figure 202.3.1**.

To accommodate a WB-62FL Design Vehicle, chicanes should not be shorter than one block. For smaller trucks, buses and emergency vehicles, chicanes should not be shorter than half a-block.

Figure 202.3.1 Concept Sketch - Midblock Chicane



202.3.4 Lane Narrowing

Use of narrow lanes (less than 12') alone has limited effect on operating speeds. This effect can, however, enhance engagement as traffic volumes increase. The visible narrowing of travel lanes may be used as a transition device to clearly indicate a change

in context. For instance, narrowing two 12-foot lanes to two 11-foot or 10-foot lanes by shifting the lane lines slightly and introducing a hatch in the newly created edge space has been shown to alert drivers of a change in condition or context. To maximize effectiveness, lane narrowing should be used in conjunction with other low speed strategies (e.g., introduction of parking, creation of a median, beginning a chicane).

See **FDM 210.2** for lane width criteria on the SHS.

202.3.5 Horizontal Deflection

Horizontal deflection is the redirection of the driver in the horizontal plane through the introduction of a curve, splitter island, or other redirection device. Horizontal deflection is the operating principle behind roundabouts and chicane treatments. Designers may conceive additional ways to introduce horizontal deflection using these same principles.

FDM 210.8.1 has criteria for horizontal deflection of tangent sections of roadway. **FDM 212.7** provides criteria for horizontal deflection through intersections.

202.3.6 Street Trees

To be most effective as a speed management strategy, street trees should be close to the roadway and should form a continuous “wall” effect. When used this way, the street trees reinforce a sense of enclosure. As with most of these strategies, street trees along the roadway will be more effective when used in conjunction with other strategies. For speed management purposes, designers are encouraged to use street trees whenever possible.

FDM 212.11 and **FDM 215.2.4** provide criteria on the placement of street trees. The installation of street trees may require a maintenance agreement with local agency.

202.3.7 Short Blocks

Short blocks of 500 feet or less manage speed by limiting driver acceleration distance between intersections. If used in conjunction with marked crosswalks, short blocks also create engagement. Accentuate the presence of the short blocks to reinforce low-speed and pedestrian-supportive contexts. Creation and enforcement of short blocks can take many forms, from the control of intersections on physically short blocks to the simulation of short blocks achieved by introducing midblock crossings on longer block segments. On reconstruction projects, preserve existing short block networks wherever possible, particularly in established town centers with an existing street grid.

Where physical short blocks already exist, such as most C6 and C5 contexts and many C4 and C2T contexts, consider marking crosswalks at unsignalized intersections to reinforce the presence of the short blocks; see **FDM 222.2.3.1** and [Traffic Engineering Manual \(TEM\) 5.2](#) for criteria on marking unsignalized crosswalks. This concept is illustrated in **Figure 202.3.2**.

Where physical short blocks do not exist, installation of mid-block crossings can be used to simulate the short-block effect, as illustrated in **Figure 202.3.3**.

Figure 202.3.2 Concept Sketch – Mark Crossings to Emphasize Short Blocks

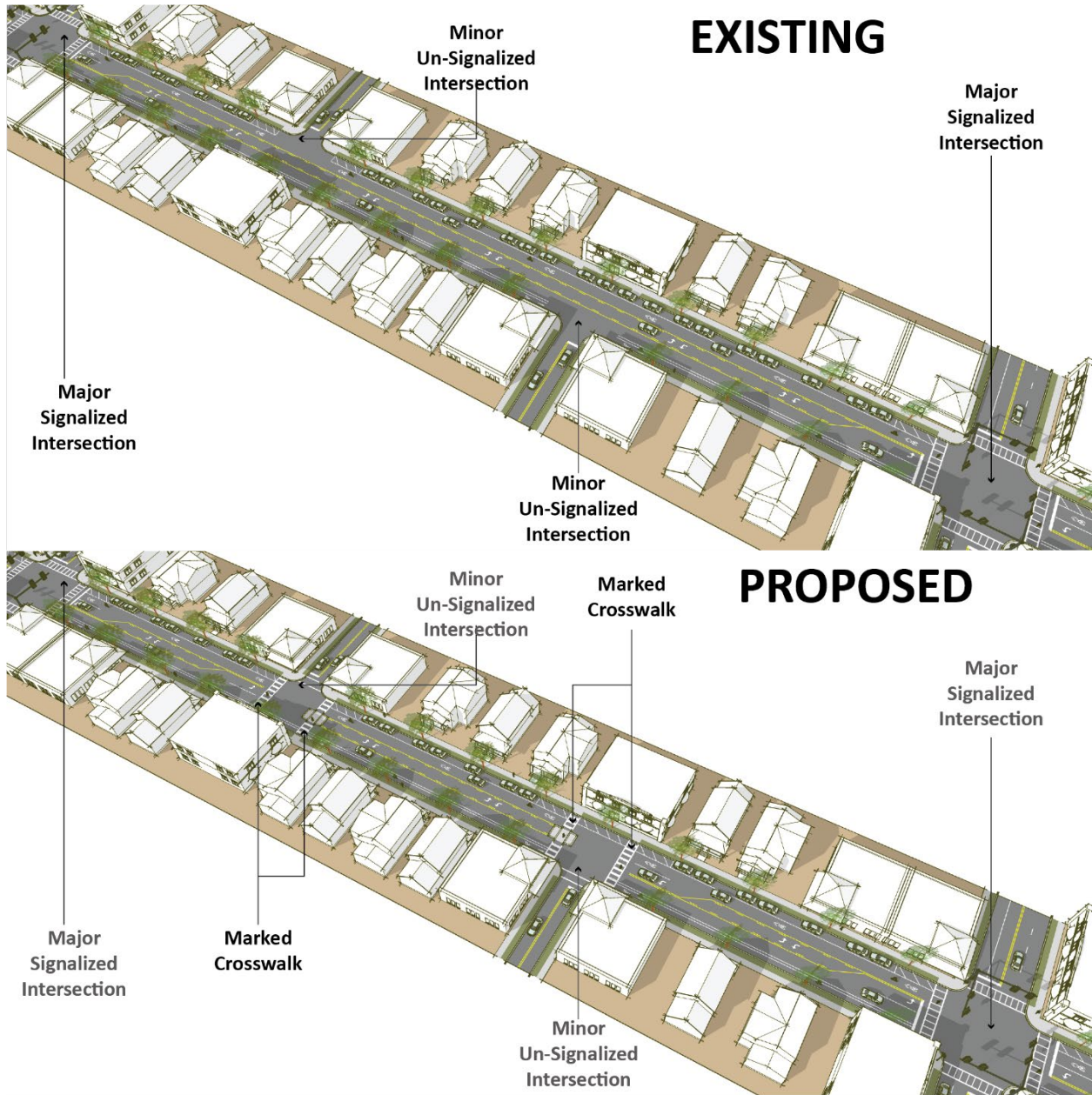
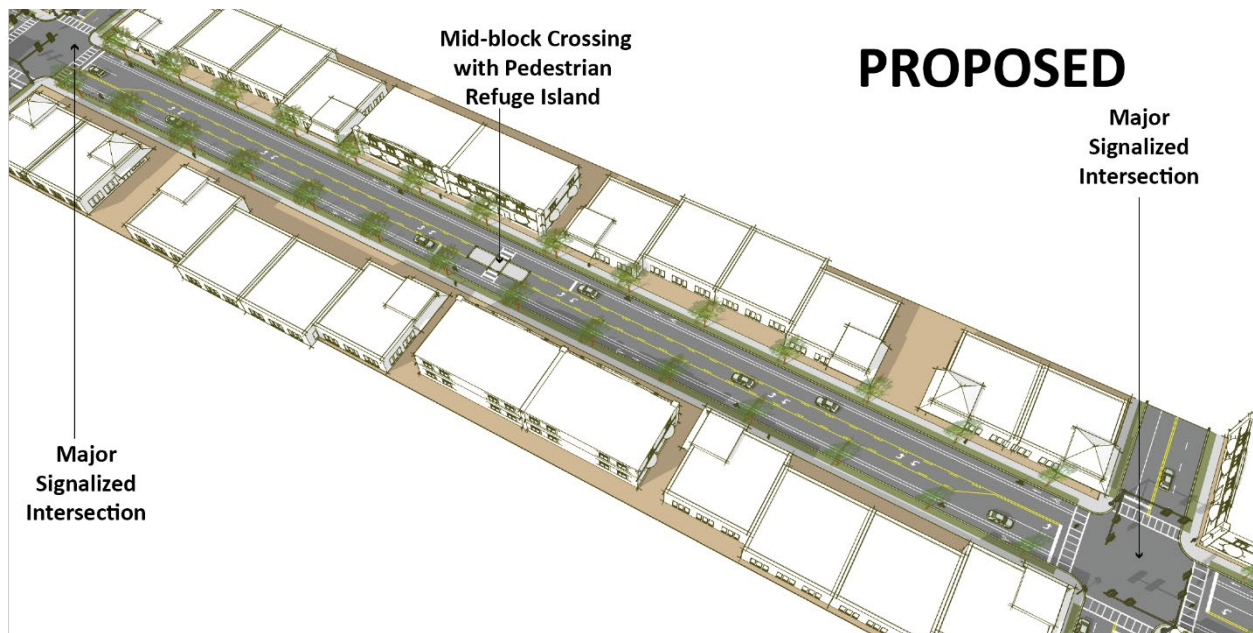

Figure 202.3.3 Concept Sketch- Add a Midblock Crossing to Long Block



202.3.8 Vertical Deflection

Like horizontal deflection, vertical deflection is a proven technique for speed management. When deflection is proposed, coordinate with local public works and emergency services to ensure emergency vehicle access will not be adversely affected.

Speed tables and raised intersections may be considered only for Target Speeds of 30 mph or less. Create speed tables by modifying the details in ***Developmental Standard Plan D520-030*** for Raised Crosswalks. Extend the raised crosswalk surface to a width greater than or equal to the axle spacing of the Design Vehicle and omit the crosswalk marking, unless the speed table is also serving as a raised crosswalk.

Raised intersections are site specific and must be designed to meet the needs of each individual intersection. **Figure 202.3.4** shows a concept drawing of a simple raised intersection indicating critical design considerations. Design more complex intersections with additional lanes or signalization using the same considerations. Mark all legs of vertically-deflected intersections, either raised or with adjacent raised crosswalks, using special emphasis crosswalk markings.

Raised crosswalks may be considered at mid-block crossings for Target Speeds of 30 mph or less. Raised crosswalks are not allowed at intersections within the turning path

of the design vehicle. For more information on raised crosswalks, see the [Developmental Standard Plans D520-030](#).

Figure 202.3.4 Concept Sketch - Raised Intersection

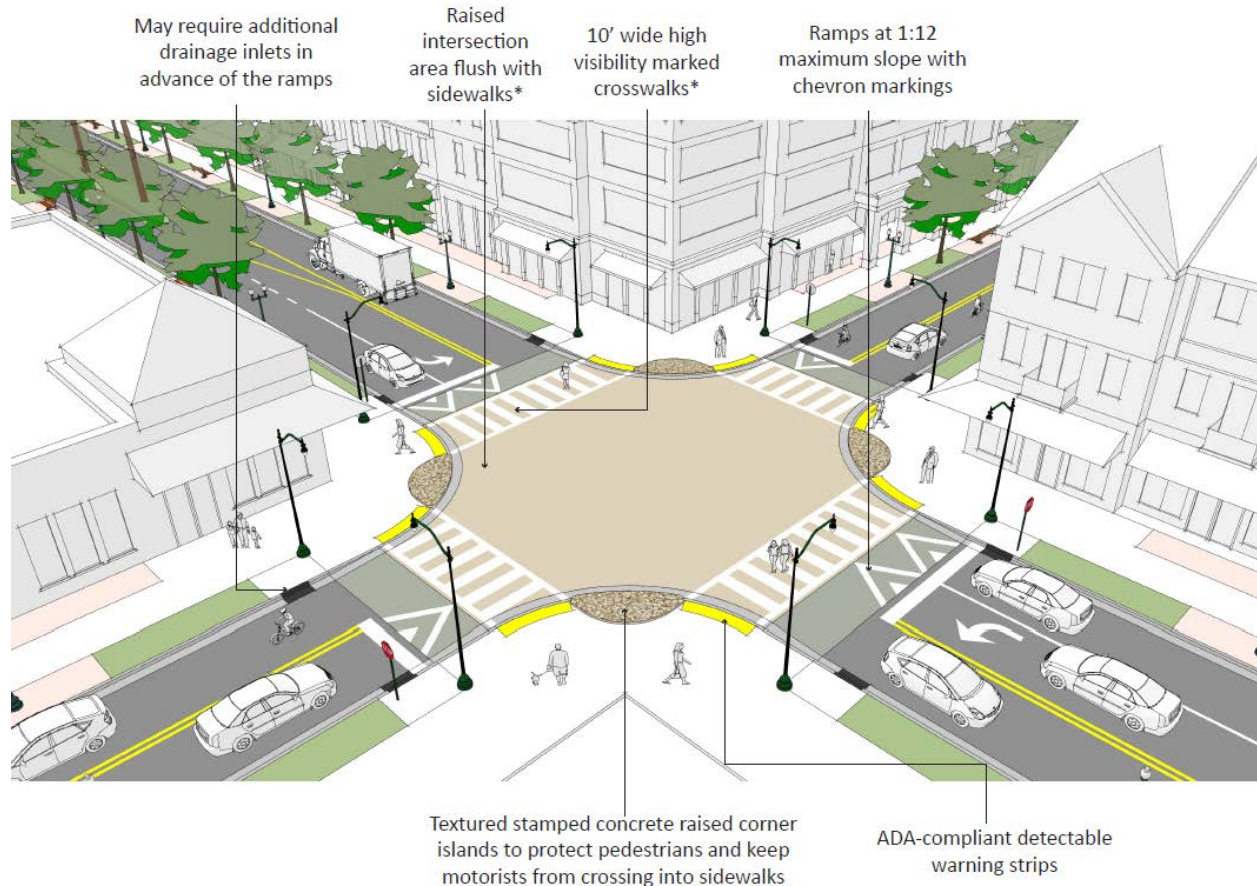

*Note: Recommend raised intersection pavement and crosswalks be patterned and colored for increased visibility. Pattern and color should be coordinated with Department and local agencies.

202.3.9 Speed Feedback Signs

Speed feedback signs are a traffic operations strategy that is effective in helping to enforce school zone Posted Speeds. However, this strategy may also require active participation by law enforcement.

The signs provide immediate feedback to drivers when the Posted Speed is exceeded, which may help to reduce unintentional speeding. They are most effective at managing operating speeds for short distances (about 1,000 feet) following the sign and when

combined with other measures such as high emphasis crosswalk markings and islands. Coordinate with the District Traffic Operations Engineer on the use of this device.

202.3.10 Posted Speed Pavement Marking

Posted Speed markings placed directly on the pavement adjacent to Posted Speed signs, reinforce a change in Posted Speed (e.g., at transition areas, on approach to a pedestrian crossing). This strategy should be considered when a Posted Speed reduction may be unexpected (e.g., transition from a C1 or C2 context to a C2T context, an approach to a pedestrian crossing in a rural area, or a transition from a low-speed to a very low-speed condition). Coordinate with the District Traffic Operations Engineer on the use of Posted Speed pavement marking.

202.3.11 Islands

Islands at crossings can provide deflection as well as engagement to help manage operating speeds. Unlike continuous raised medians, islands are short sections used in specific locations. When combined with a crosswalk, the island may provide refuge for pedestrians as well as speed management. See **FDM 210** for island criteria.

Islands on curved roadway sections can prevent lane departures by forcing drivers to stay within the travel lane. These are especially effective in locations where drivers increase speed by overrunning the centerline striping on a shorter-radius curve.

202.3.12 Curb Extensions (Bulb-Outs)

Curb extensions are portions of the curb line extended out into the roadway to provide engagement and deflection. Curb extensions are commonly used at either end of a parking lane. They also shorten crossing distance for pedestrians and may provide space for landscaping or community aesthetic features.

Curb extensions create engagement by extending the curb line to be adjacent to the travel lane. When used at the beginning of a parking lane or as part of a chicane, the curb extension also provides deflection. In some instances, longitudinally extended bulb-outs inside the existing curb lines may be used to narrow the entire length of a roadway segment. In this case, the existing drainage system is preserved, and drainage provided through the new curb extensions to existing inlets. Curb extensions at intersections should be designed using a CADD-based vehicle turning path (e.g., AutoTurn) to verify the appropriate design and control vehicles are accommodated.

See **FDM 222.2.6** for curb extension criteria.

202.3.13 Rectangular Rapid Flashing Beacons and Pedestrian Hybrid Beacons

The Rectangular Rapid Flashing Beacon (RRFB) and Pedestrian Hybrid Beacon (PHB) traffic control devices are “beacons” rather than signals and consequently have a less restrictive warranting processes. When combined with marked crosswalks, they can be used to establish shorter block lengths. They may also create engagement and thereby help manage operating speeds. See [TEM 5.2](#) and coordinate with the District Traffic Operations Engineer on the application of these devices.

202.3.14 Terminated Vista

The terminated vista creates enclosure by providing an enclosed (terminated) view ahead (vista), indicating a street segment does not extend indefinitely. The terminated vista places a building, tree, artwork, or natural view in the driver’s central vision to indicate that a stop or change of direction is imminent. This is illustrated in **Figure 202.3.5** by an oak tree terminating the vista where the roadway bears to the left.

The terminated vista is a valued and well-understood town planning tool to create a sense of place and enclosure for pedestrians. The effect on drivers is similar. Roundabouts are a common type of terminated vista, especially where a tall vertical element is included in the center island of the roundabout. Other terminated vistas can be created at T-intersections, median splitter islands, and off-set block configurations.

Figure 202.3.5 Concept Sketch – Terminated Vista Example



Table 202.3.1 Strategies to Achieve Desired Operating Speed

Context Classification	Target Speed (mph)	Strategies																
		Lane Repurposing	Roundabouts	On-Street Parking	Chicanes	Lane Narrowing	Horizontal Deflections	Street Trees	Short Blocks	Speed Tables	Raised Intersections	Raised Crosswalks	Speed Feedback Sign	Pedestrian Refuge Islands	Bulb-Outs	RRFBs	PHBs	Terminated Vistas
C2T	40-45		X			X	X					X				X		
	35	X	X	X		X	X	X	X			X	X	X	X	X	X	X
	30	X	X	X	X	X	X	X	X	X	X	X	X	X	X	X	X	X
	25	X	X	X	X	X	X	X	X	X	X	X	X	X	X	X	X	X
C3R, C3C	40-45		X			X	X					X				X		
	35	X	X			X	X					X	X	X	X	X	X	
C4	40-45		X			X	X					X				X		
	35	X	X	X		X	X	X	X			X	X	X	X	X	X	
	30	X	X	X	X	X	X	X	X	X	X	X	X	X	X	X	X	X
	25	X	X	X	X	X	X	X	X	X	X	X	X	X	X	X	X	X
C5	35	X	X	X		X	X	X	X			X	X	X	X	X	X	
	30	X	X	X	X	X	X	X	X	X	X	X	X	X	X	X	X	X
	25	X	X	X	X	X	X	X	X	X	X	X	X	X	X	X	X	X
C6	30	X	X	X	X	X	X	X	X	X	X	X	X	X	X	X	X	X
	25	X	X	X	X	X	X	X	X	X	X	X	X	X	X	X	X	X

Notes:

1. For C1 and C2 (55-70 mph): Speed Management Strategies are not used on high-speed roadways. See **FDM 202.4** for information on transitions from high-speed to low-speed facilities.
2. For C3R and C3C (50-55 mph): Project-specific; see **FDM 202.4**.

202.4 Transition Zones

Roadways may traverse more than one context classification. As the context changes, the design criteria for the roadway will also change. The transition from C1 (Natural) or C2 (Rural) context classification to a higher classification such as C2T (Rural Town) provides a potentially abrupt change in the recommended design speed and design users.

For example, the land use surrounding SR 26 through Newberry, Florida transitions from C2 (Rural) to C2T (Rural Town) over the course of a few blocks (see **Figure 202.4.1**). Such conditions require a transition zone to alert drivers to the context change and to notify them to adjust their behavior and expectations accordingly. Changes in Posted Speed as part of transition zones must comply with the requirement of the [Speed Zoning for Highways, Roads, and Streets in Florida](#).

Figure 202.4.1 Example of Transition Zone (SR 26 through Newberry, FL)

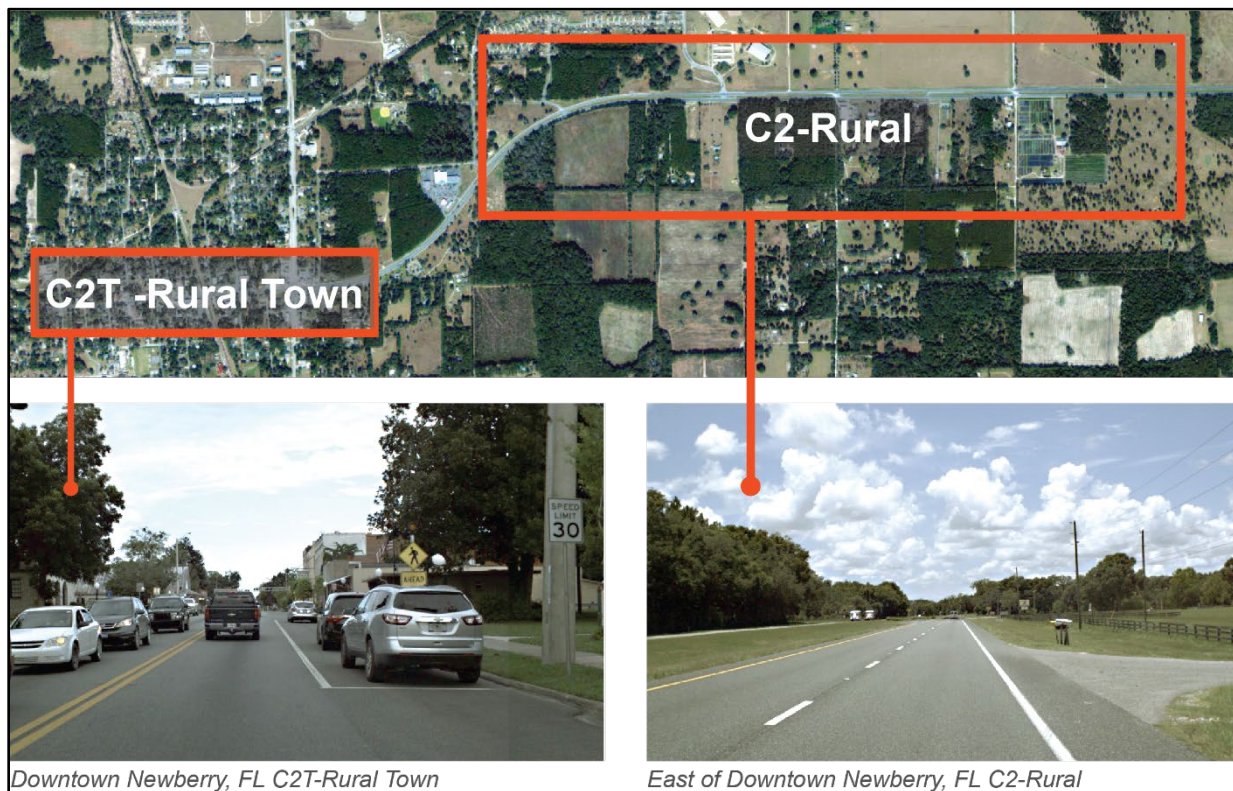

Transition zones have two distinct sections, as illustrated in **Figure 202.4.2**:

- (1) Perception-Reaction Area and

(2) Deceleration Area

Figure 202.4.2 Transition Zone from C1/C2 to C2T Context Classification

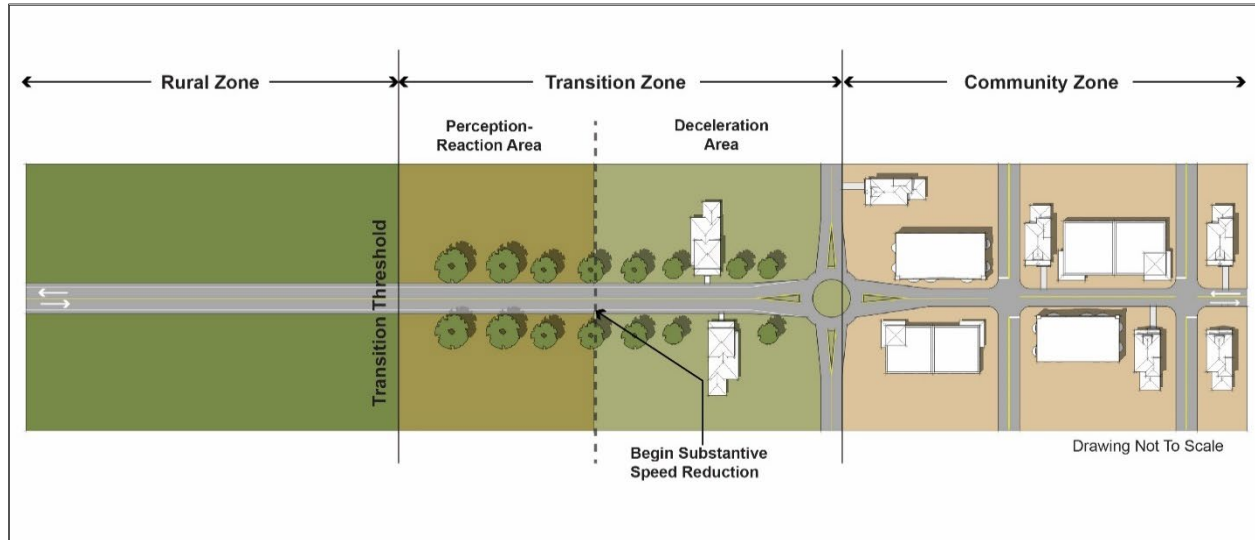

In the perception-reaction area, drivers are made aware of the need to reduce speed. This section will include visual cues to alert the driver of an upcoming deceleration. These cues may include:

- Signage, including warning signs such as “Reduced Speed Ahead” signs, or gateways signs where appropriate.
- Pavement markings: lane narrowing can be highlighted with the use of a wider outside stripe. The Posted Speed may be placed on the pavement.
- Curb changes: from flush paved shoulders to curbed roadway.
- Architectural elements such as type, location, and spacing of lighting or landscaping.

In the deceleration area, drivers are expected to slow down to an operating speed that matches the context of the community being approached. In the deceleration area, there is a noticeable change in roadway characteristics. The length of the deceleration area is a function of design speed, sight distance, and design criteria of the new context classification. Transition from a high-speed to low-speed cross section can be accomplished through a variety of features, including but not limited to:

- Horizontal deflection (e.g., splitter islands, chicanes, roundabouts)
- Lane narrowing

- Lane repurposing
- Introduction of curb and gutter
- Street enclosure through vertical landscaping
- Signage or gateway treatments, including speed feedback signs
- Posted Speed pavement markings

A combination of strategies is more effective for reducing speed. **Figures 202.4.3** and **202.4.4** provide an example of horizontal deflection and lane narrowing at the entrance of a rural town.

Figure 202.4.3 Example of a Transition Zone from 60 to 30 mph
(SR 636, entrance to town of Wauchula, Florida)

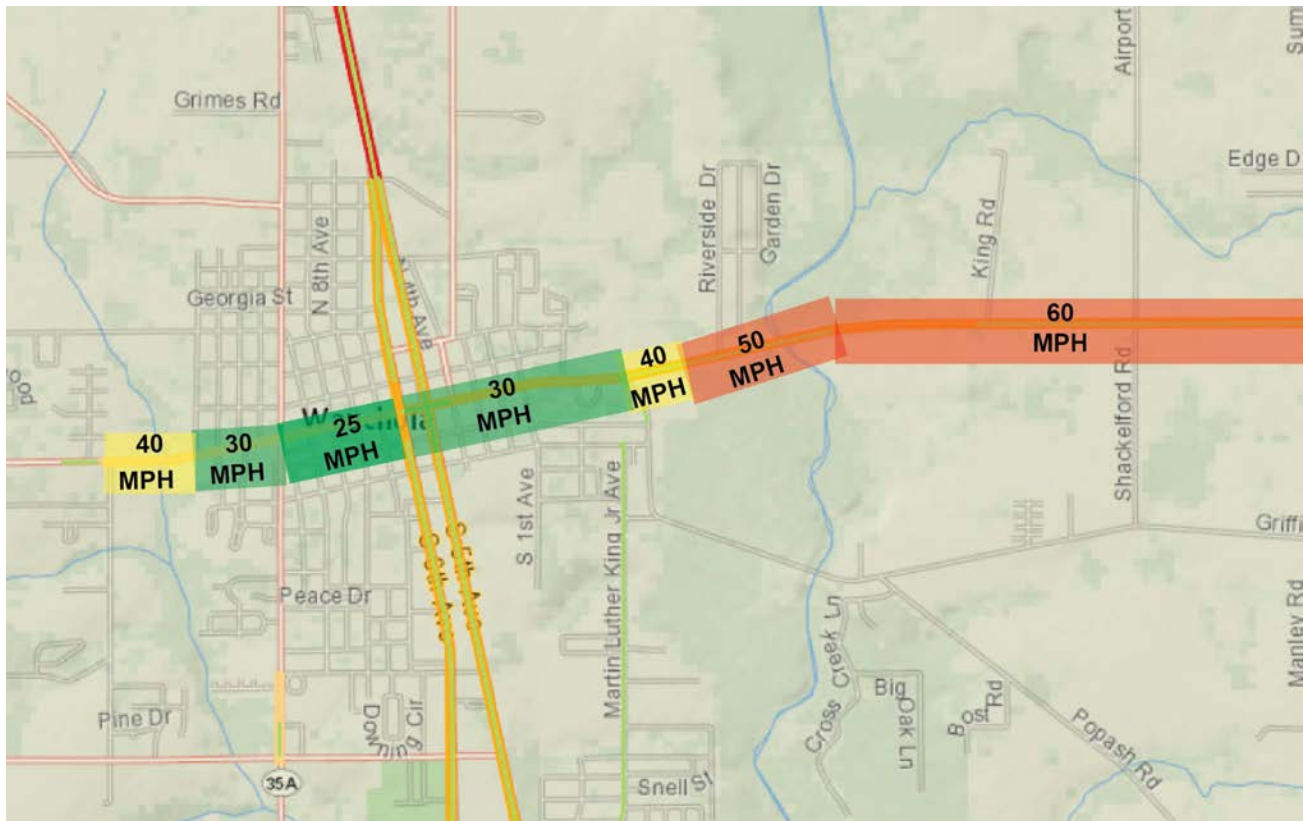

**Figure 202.4.4 Section Change Near Transition from 40 to 30 mph
(Entrance to Wauchula, FL, showing lane narrowing)**



Photo by FDOT District 1

210 Arterials and Collectors

210.1 General

Design criteria presented in this chapter apply to new construction and reconstruction projects on arterials and collectors on the State Highway System. Roadways not on the State Highway System which are impacted by these new construction and reconstruction projects should also be designed in accordance with this manual; however, districts may allow the use of the Manual of Uniform Minimum Standards for Design, Construction and Maintenance for Streets and Highways (commonly known as the "[Florida Greenbook](#)").

This chapter also provides minimum criteria to be used with Resurfacing, Restoration, and Rehabilitation (RRR) projects as described in **FDM 210.1.1**.

Facilities on the Strategic Intermodal System (SIS) are subject to special standards and criteria for number of lanes, design speed, access, and level of service. Design all SIS and Emerging SIS Highway Intermodal Connectors in accordance with the SIS criteria contained in this manual. With approval by the District Design Engineer, the [Florida Greenbook](#) may be used on SIS facilities that are not on the State Highway System.

Many design criteria are related to design speed; e.g., vertical and horizontal geometry, sight distance. The minimum design values are closely related to traffic safety and require an approved Design Exception or Design Variation when they are not met. See **FDM 201** for information on Design Speed. See **FDM 122** for information on Design Exceptions and Design Variations.

Example roadway typical sections are included in the exhibits in **FDM 913**. Criteria regarding lanes, medians, and shoulders for bridges are illustrated in **FDM 260.1.1**. Subsequent sections of this chapter contain specific information and criteria regarding these and other typical section elements, as well as geometric features.

Existing project features which were constructed to meet minimum metric design criteria but are mathematically slightly less than equivalent minimum English design criteria, do not require Design Exceptions or Design Variations to remain.

210.1.1 Criteria for RRR Projects

Criteria for RRR projects provided in this chapter are the minimum values allowed for roadway and structure elements to remain on the State Highway System without obtaining a Design Exception or Design Variation (see **FDM 122**). Existing project features are to meet new construction criteria when RRR criteria are not provided.

New features installed on RRR projects are to meet new construction criteria. However, RRR criteria may be used for establishing the minimum requirements for adding auxiliary lanes, keyhole lanes, or other minor intersection improvements with the understanding that when existing R/W is adequate, new construction criteria will be used to the maximum extent feasible.

210.1.2 Railroad-Highway Grade Crossing

If a railroad-highway grade crossing is within or near the limits of the project, and there are Federal Funds associated with the project, see **FDM 220.2.4** for requirements.

210.1.3 Aviation and Spaceports

If an airport or spaceport is within 10 nautical miles of the project, refer to **FDM 110.5.1** for requirements.

210.2 Lanes

Design criteria for lane widths and pavement slopes are given by lane type, design speed and context classification. Minimum travel, auxiliary, and two-way left-turn lane widths are provided in **Table 210.2.1**. Refer to **FDM 202** for speed management information and **FDM 211** for ramp lane widths.

Additional traveled way width may be provided in curves on undivided 2-lane roadways to accommodate large trucks. See **AASHTO Green Book, Section 3.3.10** for guidance and information on traveled way widening in horizontal curves. Two-way left turn lane widths (flush median) may be used on 3-lane and 5-lane typical sections with design speeds ≤ 40 mph. On new construction projects, flush medians are to include sections of raised or restrictive median and islands to enhance vehicular, bicycle, and pedestrian safety, improve traffic efficiency, and attain the standards of the Access Management Classification of that highway system. Sections of raised or restrictive median and islands are recommended on RRR projects.

Table 210.2.1 Minimum Travel and Auxiliary Lane Widths

Context Classification		Travel (feet)			Auxiliary (feet)			Two-Way Left Turn (feet)	
		Design Speed (mph)			Design Speed (mph)			Design Speed (mph)	
		25-35	40-45	≥ 50	25-35	40-45	≥ 50	25-35	40
C1	Natural	11	11	12	11	11	12	N/A	
C2	Rural	11	11	12	11	11	12		
C2T	Rural Town	11	11	12	11	11	12	12	12
C3	Suburban	10	11	12	10	11	12	11	12
C4	Urban General	10	11	12	10	11	12	11	12
C5	Urban Center	10	11	12	10	11	12	11	12
C6	Urban Core	10	11	12	10	11	12	11	12

Notes:

Travel Lanes:

1. Minimum 11-foot travel lanes on designated freight corridors, SIS facilities, or when truck volume exceeds 10% on very low speed roadways (design speed ≤ 35 mph) (regardless of context).
2. Minimum 12-foot travel lanes on all undivided 2-lane, 2-way roadways. However, Very Low-Speed and Low-Speed table values may be used for roadway sections with both of the following:
 - a. C2T, C4, C5 or C6 context classification
 - b. Tangent horizontal alignment or curve radii large enough to accommodate the design vehicle within the travel lane in accordance with **AASHTO Green Book, Section 3.3.10**
3. 10-foot travel lanes are typically provided on very low speed roadways (design speed ≤ 35 mph) but should consider wider lanes when transit is present.
4. Travel lanes should not exceed 14 feet in width.

Auxiliary Lanes:

- (1) Auxiliary lanes are typically the same width as the adjacent travel lane.
- (2) Table values for right turn lanes may be reduced by 1 foot when a bicycle keyhole is present.
- (3) Median turn lanes should not exceed 15 feet in width.
- (4) For high-speed curbed roadways, 11-foot minimum lane widths are allowed for the following:
 - Dual left turn lanes
 - Single left turn lanes at directional median openings.
- (5) For RRR Projects, 9-foot right turn lanes on very low speed roadways (design speed ≤ 35 mph) are allowed.

Two-way Left Turn Lanes:

- (1) Two-way left turn lanes are typically one foot wider than the adjacent travel lanes.
- (2) For RRR Projects, the values in the table may be reduced by 1-foot.

210.2.1 Bicycle Lanes

FDM 223 contains criteria for the accommodation of bicyclists.

210.2.2 Transit Facilities

Coordinate with the District Modal Development Office and local transit agency for the need for public transit facilities. **FDM 225** contains additional guidelines for street side bus stop facilities, location, and design.

210.2.3 On-Street Parking

On-street parking is a key element of urban contexts C6, C5, and C4, but may also be found in C2T. It provides necessary parking supply in these locations, helps manage traffic speeds, and provides separation between the sidewalk and the travel lanes. In these context zones, leave existing on-street parking in place unless local plans call for its removal. Where on-street parking is not present in C6, C5, or C4, determine whether it should be added per local plan, for speed management, or to increase available parking.

On-street parking is allowed on facilities with posted speeds of 35 mph or less. It is typically located at the outside edge of the roadway between the travel lane and the sidewalk. In C6 and C5 contexts it may sometimes be located within the median of a divided low speed urban street. Median parking provides additional parking supply as well as speed management.

On-street parking may be either parallel or angle (traditional or reverse). See **Chapter 316, F.S.** for laws governing parking spaces.

[Standard Plans](#), **Index 711-001** provides dimensions and additional requirements for on-street parking.

See **FDM 223** for bicycle accommodations on roadways with on-street parking.

Parking restrictions to assure adequate clear sight triangles are provided in **FDM 212.11.5**.

210.2.3.1 Existing On-Street Parking

For RRR projects with existing on-street parking and a posted speed greater than 35 mph, process a single Design Variation that addresses all of the following design elements:

- Intersection Sight Distance
- Stopping Sight Distance (as applicable)
- On-street parking

The single Design Variation described above should include all affected intersections within a corridor; i.e., it is not necessary to process individual Design Variations for each location. In addition to processing a Design Variation, consider the following mitigation strategies:

- Use speed mitigation strategies described in **FDM 202** to achieve a target speed of 35 mph.
- When possible, provide a 2' buffer between the on-street parking spaces and the travel lane.

210.2.4 Pavement Cross Slopes

For roadways, the maximum number of travel lanes with cross slope in one direction is three lanes except as shown in **Figure 210.2.1**, which prescribes standard pavement cross slopes. A Design Variation or a Design Exception is required when proposed pavement cross slopes do not meet the requirements shown in **Figure 210.2.1**.

Outside auxiliary lane cross slopes must match or exceed adjacent travel lane cross slope. The outside auxiliary lane cross slope cannot exceed the values in **Figure 210.2.1**. In superelevation transitions for separated free flow turning roadways, do not exceed the maximum algebraic differences shown in **Table 210.2.2**.

The maximum algebraic difference in cross slope between adjacent through lanes is 0.04. The maximum algebraic difference in cross slope between a through lane and an auxiliary lane at a turning roadway terminal is given in **Table 210.2.2**.

Cross slopes on bridges are to be on a uniform, straight-line rate, typically 0.02 (see **FDM 260.4**). Use transitions to adjust for differences in cross slope between the approach roadway section and the required straight-line slope for bridge decks. Whenever possible the transition should be accomplished on the roadway section, outside the limits of the bridge and approach slabs. This will require detailing of the transition(s) in the roadway plans. Coordination between the Roadway, Drainage and Structures designers in the development of transitions is required to ensure compatibility and harmonizing at bridge approaches.

Figure 210.2.1 Standard Pavement Cross Slopes

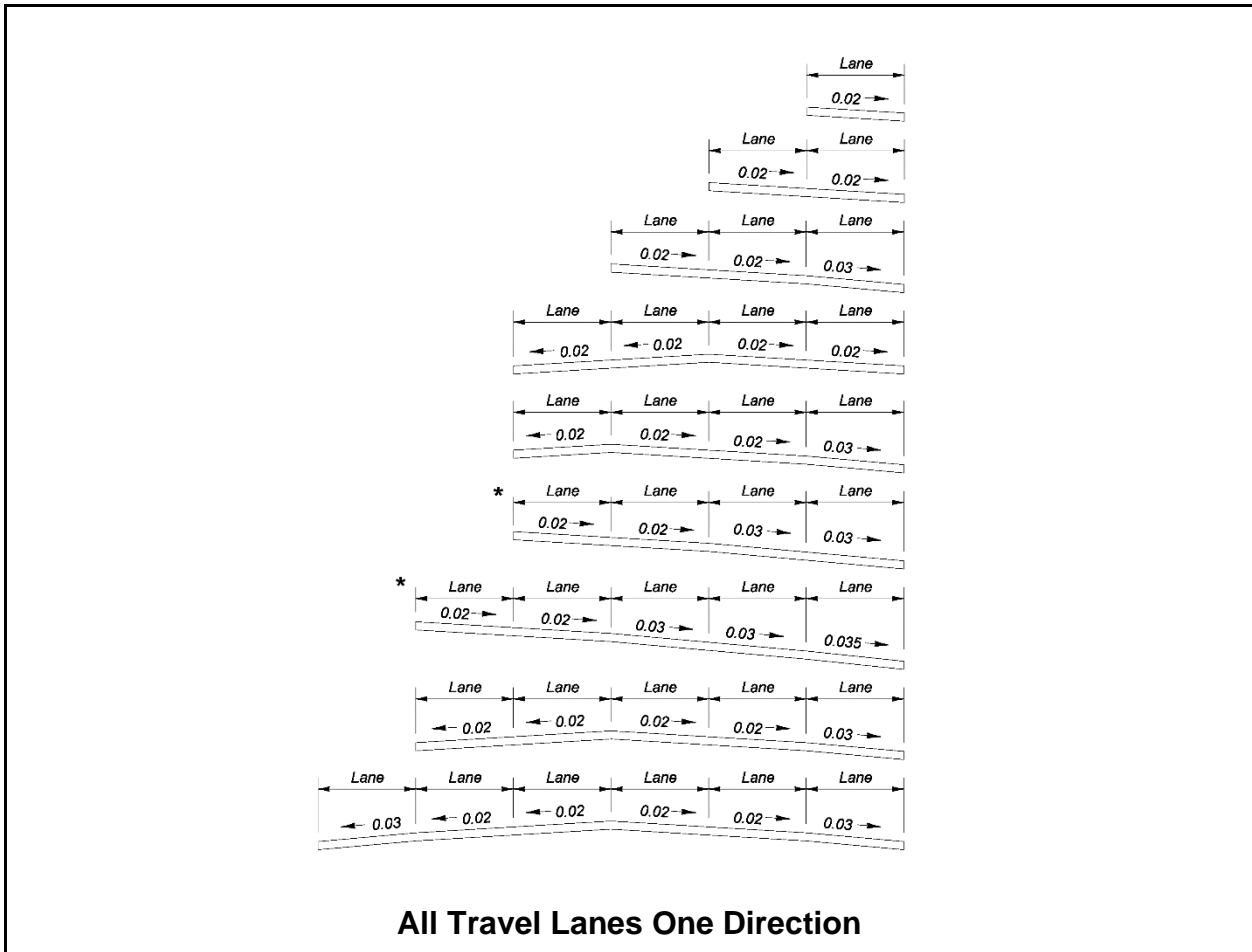

Notes:

- (1) These sections show only the standard slopes for adjoining travel lanes; they do not prescribe needed lanes, lane usage or typical section requirements other than lane slope. These slopes are not applicable to parabolic crowns.
- (2) Maximum pavement cross slopes for tangent sections are:
 - (a) 0.04 for design speeds of 45 mph or less
 - (b) 0.03 for design speeds greater than 45 mph
 - (c) 0.035 may only be used for 5-lanes sloped in one direction as shown above.
- (3) The maximum change in cross slope between adjacent through lanes is 0.04.
- (4) Slopes on multi-purpose lanes may be 0.03 to 0.05. Portions of multi-purpose lanes that are reserved for parking and access isles for the physically disabled are to have cross slopes not exceeding 1:50 (0.02) in all directions.
- (5) 4 or 5 lanes sloped in one direction (*) may be used with design speed 65 mph or less and longitudinal grades not exceeding 5%.

Table 210.2.2 Maximum Algebraic Difference in Cross Slope at Turning Roadway Terminals

Design Speed of Exit or Entrance Curve (mph)	Maximum Algebraic Difference in Cross Slope at Crossover Line (%)
Less than 35	6.0
35 and over	5.0

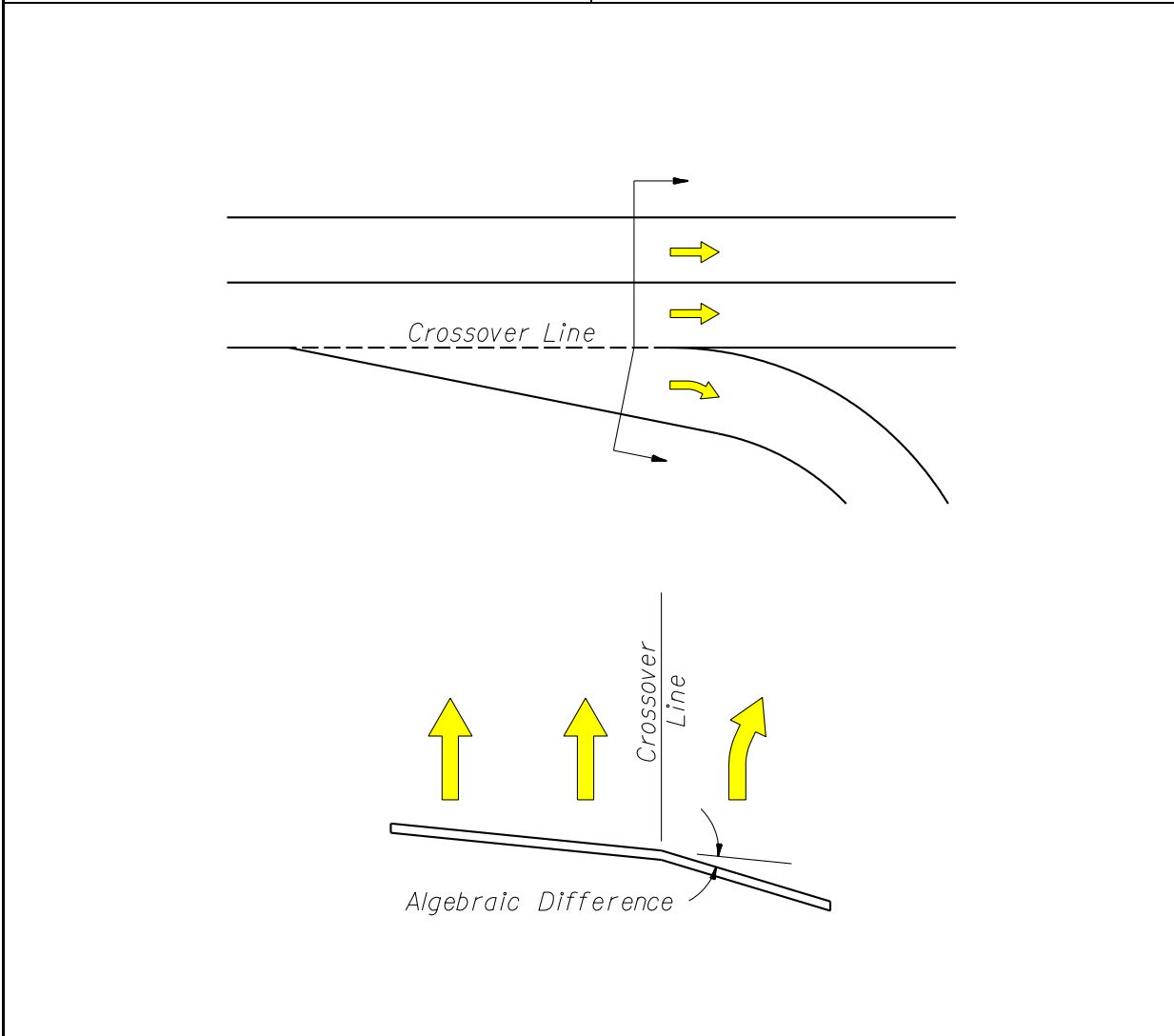

210.2.4.1 RRR Criteria for Cross Slopes

Review the existing pavement and shoulder cross slopes for compliance with criteria. Field verify existing pavement and shoulder cross slopes by one of the following:

- (1) Full Digital Terrain Model for the roadway width – evaluate cross slope on tangent sections at 100-foot intervals.
- (2) Vehicle Mounted Scanner – prior to design, using the results of the scan, determine roadway limits where cross slope is potentially out of tolerance and request Digital Terrain Model of the roadway width for these limits. Evaluate cross slope on tangent sections at 100-foot intervals.

If cross slopes do not meet the values in **Table 210.2.3**, additional cross sections may be required to develop cross slope correction details and estimate material quantities. Resurfaced pavement and shoulder cross slopes should meet new construction criteria. When cross slope correction is not practical, documentation in the design file is required. If existing conditions are within the allowable range shown in **Table 210.2.3**, the term “Match Existing” may be used on the Typical Section(s) to indicate that the existing cross slope is to remain. Superelevation requirements are covered in **FDM 210.9**.

When cross slope correction is necessary, work closely with the District Pavement Design Engineer and the District Pavement Materials Engineer to determine the appropriate method of correction. Tabulate existing cross slopes in the plans at 100-foot intervals within the limits of cross slope correction. Include cross slope correction details showing the method of correction in the plans (see examples in **FDM 913**). Do not show cross slope correction details on the roadway cross sections. Base cross slope correction material quantities on the method of correction shown in cross slope correction details.

Table 210.2.3 RRR Criteria for Existing Roadway Cross Slopes

Facility or Feature	Standard (ft/ft)	Allowable Range (ft/ft)
Two-Lane Roads	0.020	0.015 - 0.030
Multilane Roads	0.020	0.015 - 0.040
	0.030	0.025 - 0.040
	0.035	0.030 - 0.040
Outside Shoulders	0.060	Adjacent Lane Cross Slope - 0.080
Inside Shoulders	0.050	0.020 - 0.080
Parking Lanes	0.050	0.015 - 0.050
<p>Notes:</p> <ul style="list-style-type: none"> (1) Existing multilane curbed roadways may have outside travel or auxiliary lanes with a maximum cross slope of 0.05. (2) Outside auxiliary lanes on flush shoulder roadways must match or exceed adjacent travel lane cross slopes with a maximum cross slope of 0.04. (3) The maximum algebraic difference between adjacent through lanes must not exceed 0.06. (4) When existing shoulders are to remain, the algebraic difference between the shoulder slope and adjoining roadway pavement slope must be ≤ 0.07. (5) Parking spaces and access aisles dedicated to serving persons with disabilities must have cross slopes no steeper than 0.02 (1:50) in any direction. 		

Existing curbed roadways originally constructed with a parabolic crown section may be resurfaced using a series of tangents with a cross slope range from 0.015 to 0.05.

210.2.4.2 Hydroplaning Risk Analysis

The hydroplaning risk analysis predicts the water film thickness on the pavement being analyzed and the speed at which hydroplaning may occur. This information may support utilizing a non-compliant typical section when weighed against the cost of correcting pavement cross slope. For projects with design speeds of 60 mph or greater with 3 or more lanes sloped in one direction, refer to **FDM 211** for guidance for when a hydroplaning analysis is required and analysis procedures.

210.2.5 Lane Tapers

The minimum merging roadway transition length (L) is calculated as follows:

- (1) Use $L = (W \cdot S^2)/60$ for design speeds ≤ 40 mph
- (2) Use $L = W \cdot S$ for design speeds ≥ 45 mph

Where: L = length of taper, feet

W = width of lateral transition, feet

S = design speed, mph

Exhibit 210-1 through **210-6** illustrate standard roadway transitions. For conditions not addressed in these figures, use the following minimum taper lengths:

- Merging Taper = L
- Shifting Taper = L/2
- Shoulder Taper = L/3

Where an abrupt change in roadway typical (e.g., 4-lane section to a 6-lane section) a striped lane transition may be considered when all the following conditions are met:

- New pavement widths are not substantially greater than the joining pavement,
- Grade differentials are slight, and
- Future widening is expected.

210.2.6 Number of Lanes on the State Highway System

See **Section 335.02(3)** of the **Florida Statutes** for the number of lanes to be provided on the State Highway System. Nothing in this statute precludes a number of lanes in excess of ten lanes. The Department will determine the appropriate number of lanes based on traffic demand. Consideration will be given to availability of right of way and the capacity to accommodate other modes of transportation within existing rights of way.

Exceptions to **Section 335.02(3)** of the **Florida Statutes** will be addressed on a case-by-case basis, with final approval resting with the Secretary of Transportation.

LANE DIVERGENCE AND CONVERGENCE FOR CENTERED ROADWAYS

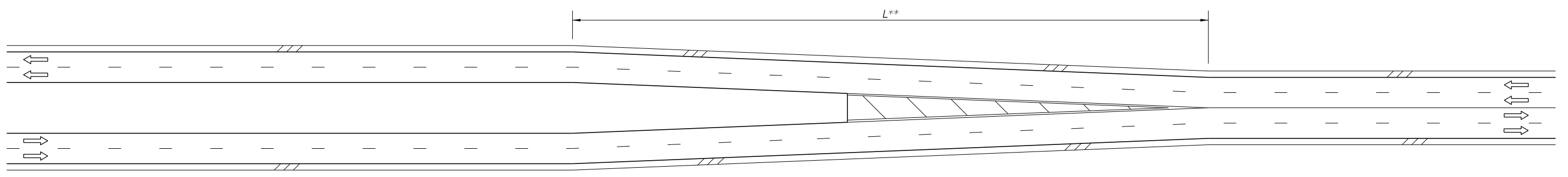

4-LANE DIVIDED TO 4-LANE UNDIVIDED

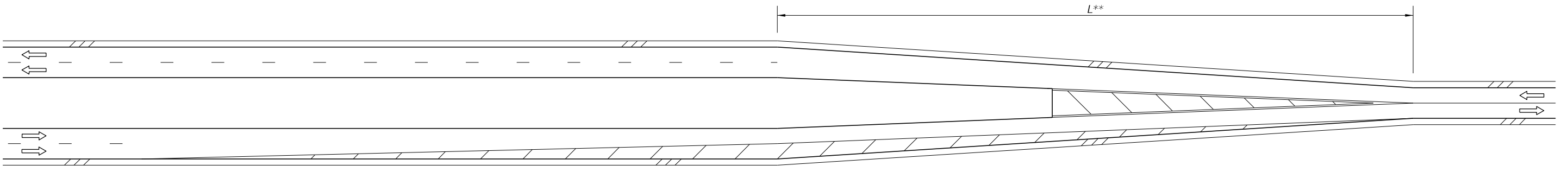

4-LANE DIVIDED TO 2-LANE UNDIVIDED

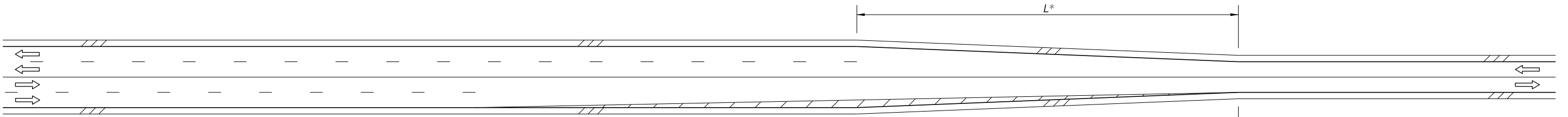

4-LANE UNDIVIDED TO 2-LANE UNDIVIDED

$L = \frac{WS^2}{60}$ FOR DESIGN SPEEDS ≤ 40 mph
 $L = WS$ FOR DESIGN SPEEDS ≥ 45 mph

WHERE: L = LENGTH OF TAPER, FEET
 W = WIDTH OF LATERAL TRANSITION, FEET
 S = DESIGN SPEED, mph

* W = ONE LANE WIDTH
 ** W = 1/2 MEDIAN WIDTH

NOT TO SCALE

EXHIBIT 210-1
01/01/2018

PAVED SHOULDER TREATMENT AT TRANSITIONS AND CONNECTIONS

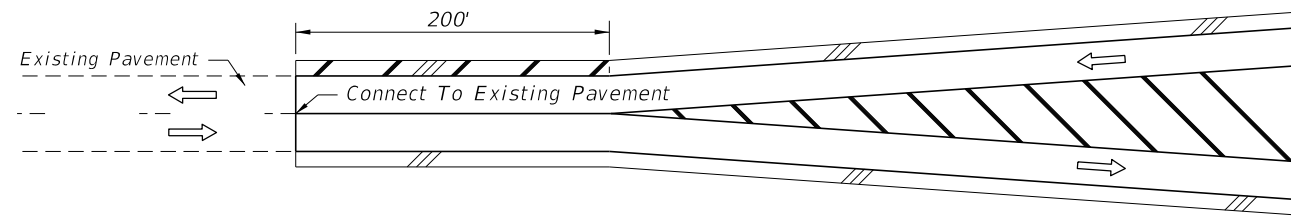

CONNECTING FLARE WITH PAVED SHOULDERS TO EXISTING ROADWAY WITHOUT PAVED SHOULDERS

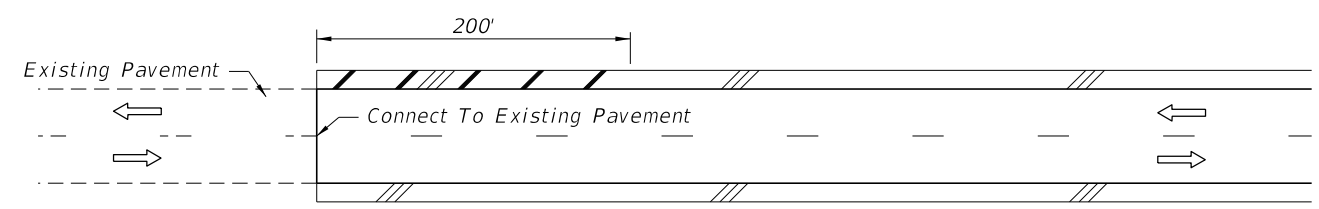

CONNECTING SIMILAR WIDTH PAVEMENTS

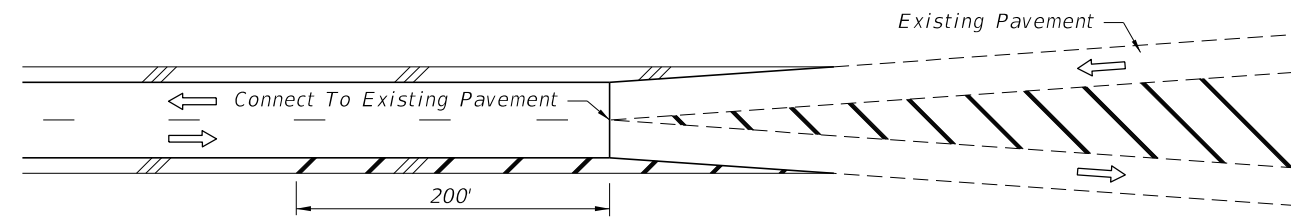

CONNECTING ROADWAY WITH PAVED SHOULDERS TO EXISTING SYMMETRICAL FLARE WITHOUT PAVED SHOULDERS

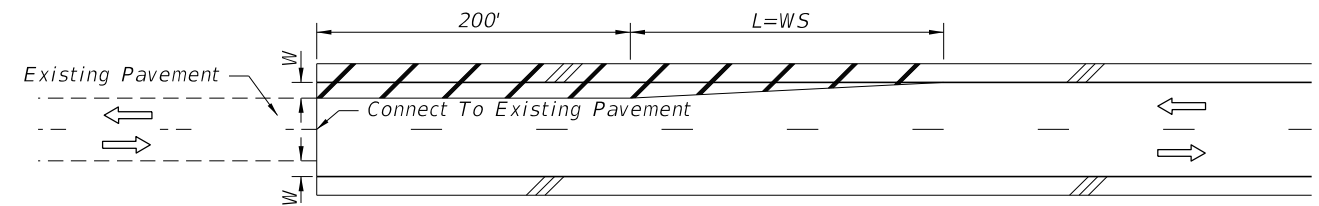

CONNECTING DIFFERENT WIDTH PAVEMENTS

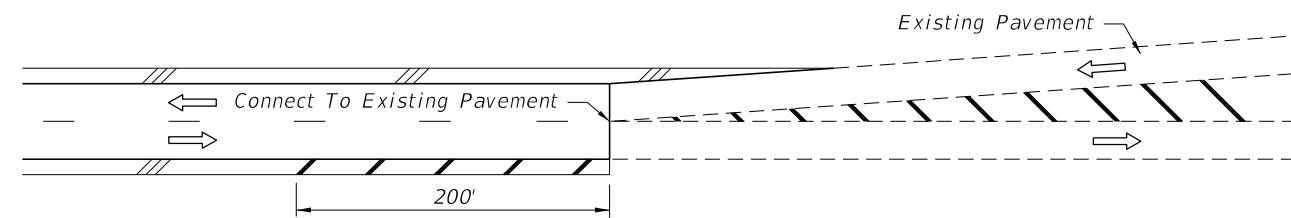

CONNECTING ROADWAY WITH PAVED SHOULDERS TO EXISTING ASYMMETRICAL FLARE WITHOUT PAVED SHOULDERS

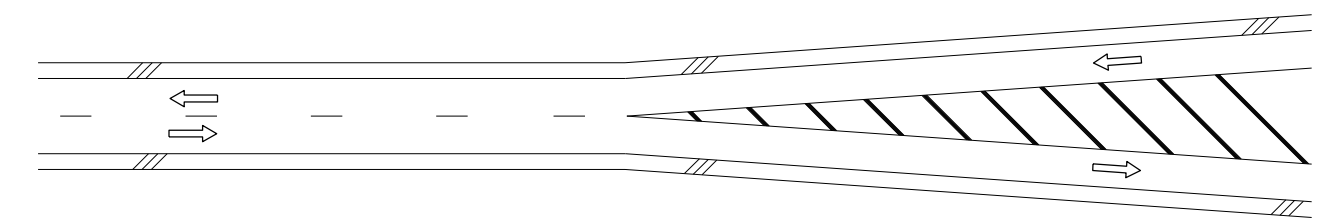

FLARED - PAVED SHOULDERS

NOT TO SCALE

EXHIBIT 210-2
01/01/2018

TWO LANE TO FOUR LANE TRANSITION: LEFT ROADWAY CENTERED ON APPROACH ROADWAY

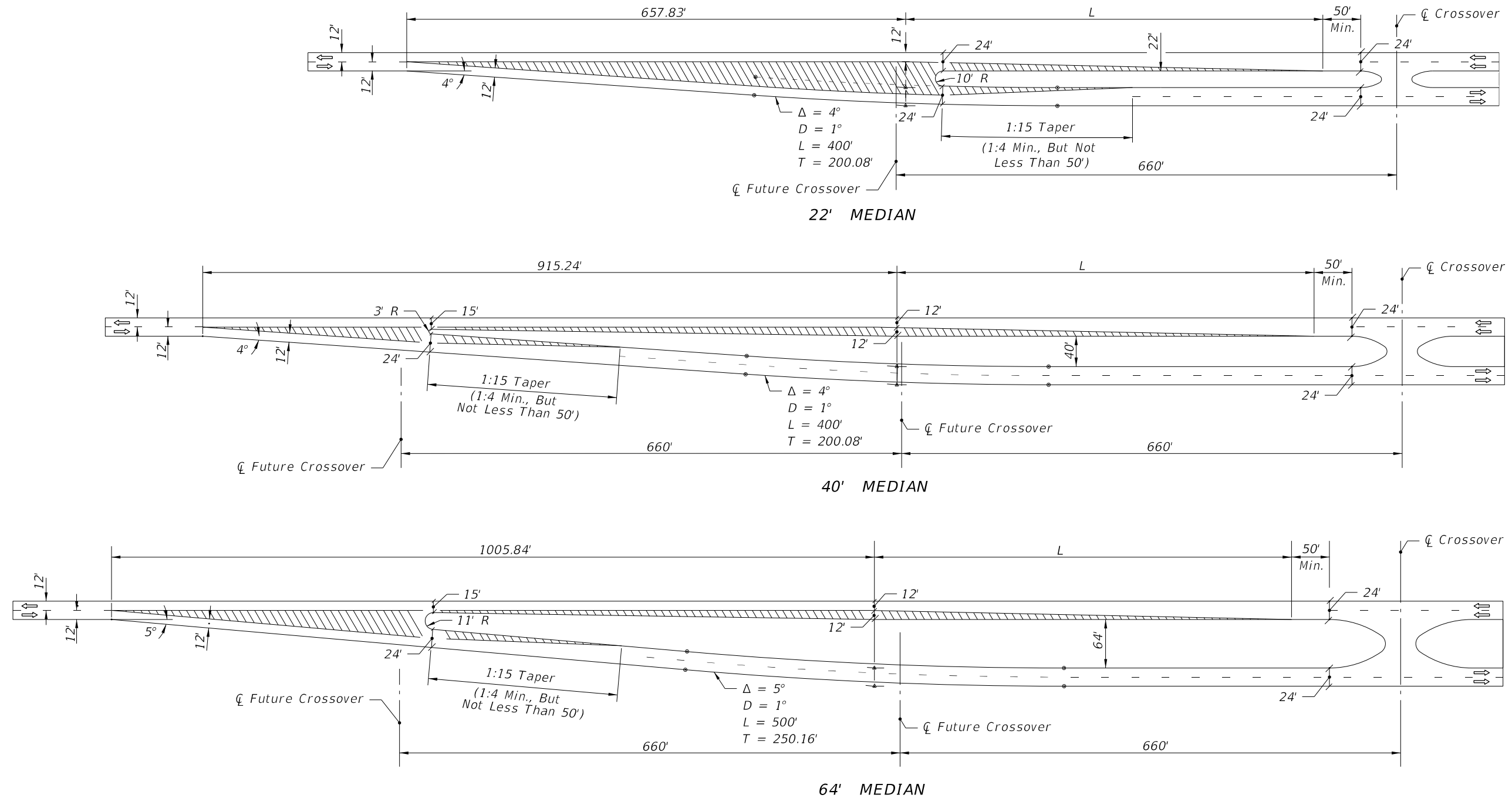

NOTES FOR EXHIBITS 210-3 THRU 210-6:

1. The transition details as represented on Exhibits 210-3 thru 210-6 are intended as guidelines only. The transition lengths, curved data, nose radii and offsets are based upon tangent alignment, design speeds ≤ 45 mph, and the median and lane widths shown.
2. Approach lane departures ($\Delta = 5^\circ$) are suitable for design speeds up to 60 mph. Interior curves ($D = 1^\circ$) in normal crown may be used with design speeds up to 45 mph. Merging curves ($D \geq 5^\circ$) will require superelevation.

$$L = \frac{WS^2}{60} \quad \text{FOR DESIGN SPEEDS } \leq 40 \text{ mph}$$

$$L = WS \quad \text{FOR DESIGN SPEEDS } \geq 45 \text{ mph}$$

WHERE: L = LENGTH OF TAPER, FEET
W = WIDTH OF LATERAL TRANSITION, FEET
S = DESIGN SPEED, mph

NOT TO SCALE

EXHIBIT 210-3
01/01/2024

FOUR LANE TO TWO LANE TRANSITION: LEFT ROADWAY CENTERED ON THRU ROADWAY

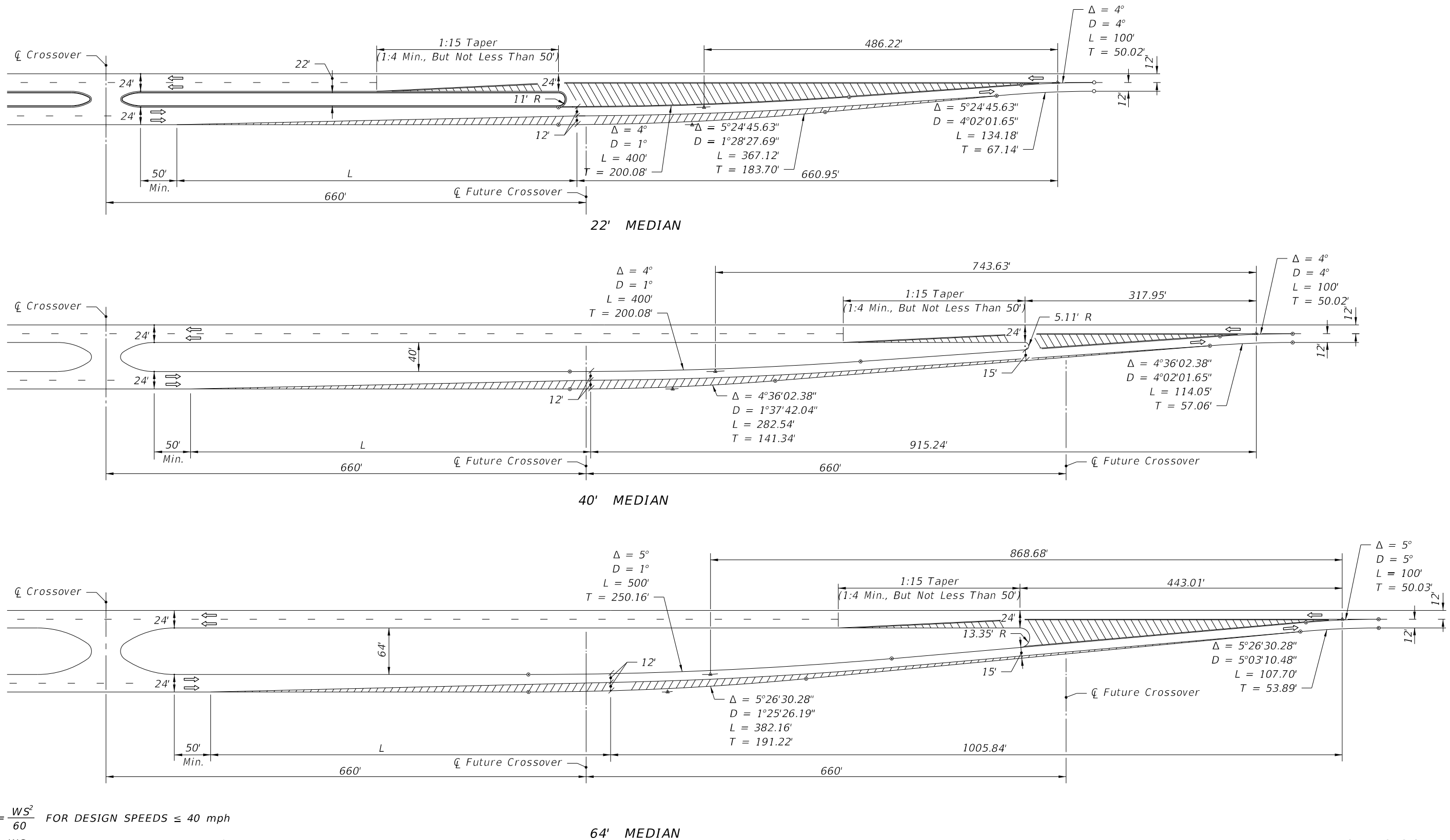

$L = \frac{WS^2}{60}$ FOR DESIGN SPEEDS ≤ 40 mph

$L = WS$ FOR DESIGN SPEEDS ≥ 45 mph

WHERE: L = LENGTH OF TAPER, FEET
W = WIDTH OF LATERAL TRANSITION, FEET
S = DESIGN SPEED, mph

NOT TO SCALE

EXHIBIT 210-4
01/01/2018

TWO LANE TO FOUR LANE TRANSITION: RIGHT ROADWAY CENTERED ON APPROACH ROADWAY

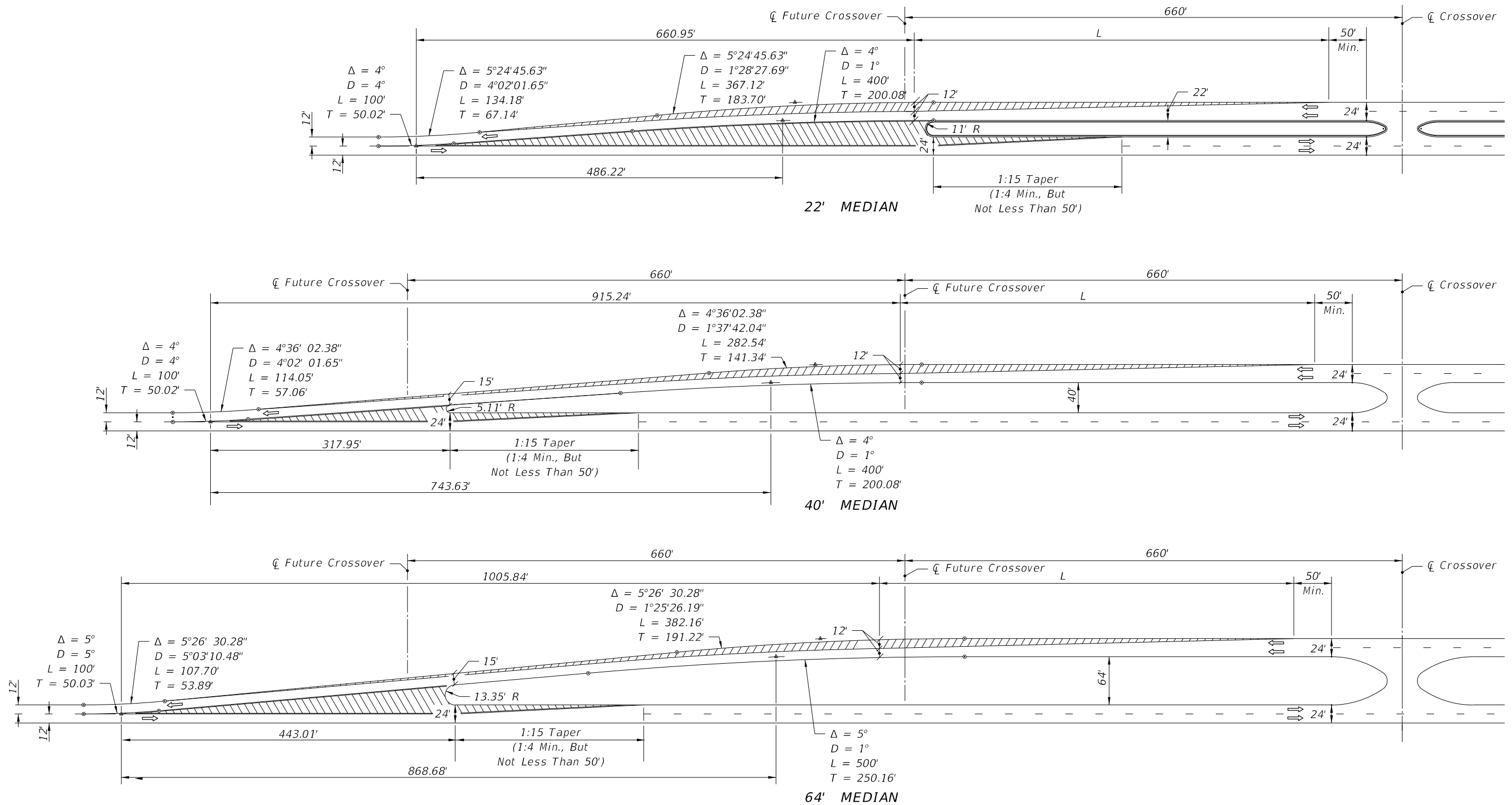

$$L = \frac{WS^2}{60} \text{ FOR DESIGN SPEEDS } \leq 40 \text{ mph}$$

$$L = WS \text{ FOR DESIGN SPEEDS } \geq 45 \text{ mph}$$

WHERE: L = LENGTH OF TAPER, FEET
W = WIDTH OF LATERAL TRANSITION, FEET
S = DESIGN SPEED, mph

NOT TO SCALE

EXHIBIT 210-5
01/01/2018

FOUR LANE TO TWO LANE TRANSITION: RIGHT ROADWAY CENTERED ON THRU ROADWAY

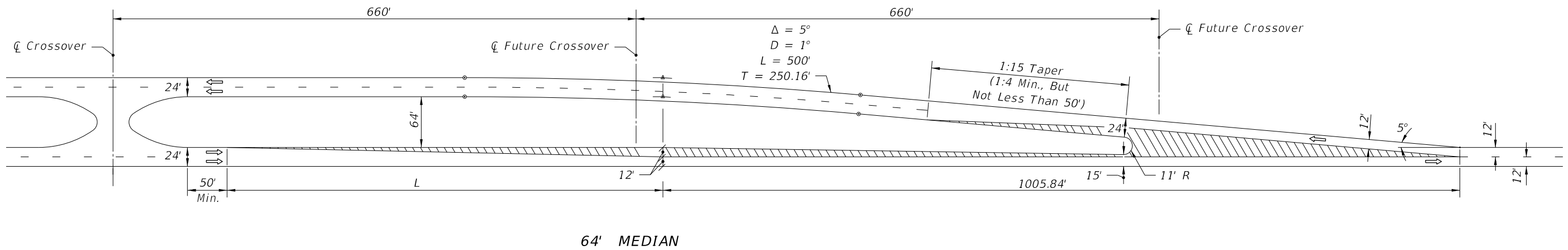
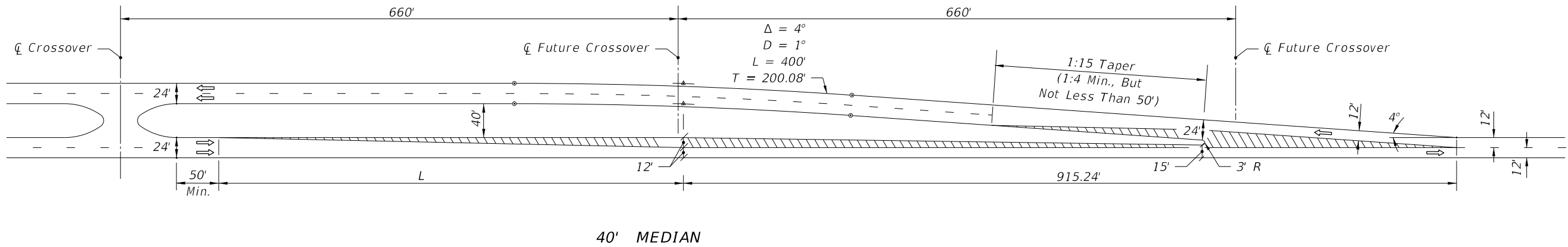
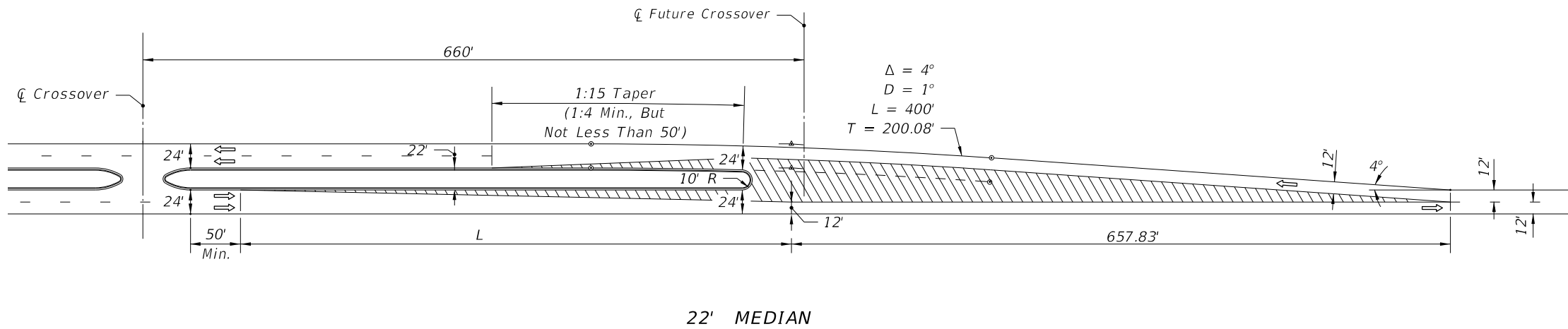

$$L = \frac{WS^2}{60} \text{ FOR DESIGN SPEEDS } \leq 40 \text{ mph}$$

$$L = WS \text{ FOR DESIGN SPEEDS } \geq 45 \text{ mph}$$

WHERE: L = LENGTH OF TAPER, FEET
 W = WIDTH OF LATERAL TRANSITION, FEET
 S = DESIGN SPEED, mph

NOT TO SCALE

EXHIBIT 210-6
 01/01/2018

210.3 Medians, Islands, and Hardened Centerlines

210.3.1 Medians

Median width is expressed as the dimension between the inside edges of travel lanes. Medians perform the following functions:

- Provide separation of opposing traffic to minimize risk of head on crashes,
- Provide a recovery area for errant vehicles,
- Provide a stopping area in case of emergencies,
- Allow space for speed changes and storage of left-turning and U-turning vehicles,
- Minimize headlight glare,
- Provide width for future lanes,
- Provide pedestrian refuge,
- Control access.

Provide a raised or restrictive median (i.e., not a two-way left turn lane or centerline pavement marking) on divided roadways that have a design speed of 45 mph or greater. Median widths for divided roadways are given in **Table 210.3.1**.

Median ditches must be designed to meet the following requirements:

- Have sufficient depth to provide positive drainage of the adjacent sub-grades. Typically, this requires a median depth of at least one foot below the sub-grade shoulder point.
- Have recoverable side slopes within the clear zone in order to facilitate the recovery of errant vehicles. See **FDM 215** for additional information on roadside safety.
- Have sufficient longitudinal gradient and hydraulic capacity to ensure good drainage.

See **FDM 260.5** for information on bridge medians.

Table 210.3.1 Median Widths

Context Classification	Curbed Roadways and Flush Shoulder Roadways (feet)	High Speed Curbed Roadways (feet)	Flush Shoulder Roadways (feet)	
	Design Speed (mph)			
	25-35	40-45	50-55	≥ 50
C1 Natural	N/A	N/A	30	40
C2 Rural	N/A	N/A	30	40
C2T Rural Town	15.5	22	N/A	N/A
C3 Suburban	22	22	30	40
C4 Urban General	15.5	22	N/A	N/A
C5 Urban Center	15.5	N/A	N/A	N/A
C6 Urban Core	15.5	N/A	N/A	N/A

Notes:

- (1) On reconstruction projects where existing curb locations are fixed due to severe right of way constraints, the minimum median width may be reduced to 19.5 feet for design speeds = 45 mph, and to 15.5 feet for design speeds ≤ 40 mph.
- (2) A minimum 6-foot median may be used within C5 and C6 context classifications only where left turn lanes are not expected.
- (3) N/A indicates this combination of design speed and context classification is outside the intended design range and should be avoided. See **Table 201.5.1** for context classifications and design speed ranges.

210.3.2 Islands

An island is an area between traffic lanes that provide one or more of these primary functions:

- (1) Channelization Islands: To control and direct traffic movement (usually turning) at intersections or driveways.
- (2) Median Islands and Traffic Separators: To separate traffic in opposing or same direction (usually through movements), manage access points and turning movements, provide for delineation of narrow roadway medians, and provide for drainage. Typically referred to as “divisional islands” when separating traffic in opposing directions.
- (3) Refuge Islands: To provide refuge for pedestrians.

Islands are generally elongated or triangular in shape and located in areas where motorized vehicle use is restricted. The placement of mast arms in channelizing islands is discouraged.

Island delineation is divided into three types:

- (1) Curbing that raises the island,
- (2) Pavement markings or reflectorized markers placed on paved areas,
- (3) Pavement edges, possibly supplemented by delineators or a mounded-earth treatment beyond and adjacent to the pavement edges.

Delineation of small islands is primarily by curbs. Large, curbed islands may be sufficiently delineated by color and texture contrast of vegetative cover, mounded earth, shrubs, signs, or any combination of these. Use tubular markers at island noses as channelizing devices in addition to delineation. Curbed islands should not be used on high-speed flush shoulder roadways. Standard markings for islands are provided in the [Standard Plans](#), *Index 711-001*. See *FDM 202* for more information on speed management.

210.3.2.1 Channelization Islands

Islands must be large enough to command attention. Meet the following requirements when designing channelization islands:

- (1) Curbed islands should have an area of 100 square feet or more, however, must not be less than:
 - (a) 50 square feet for intersections within C4, C5, or C6 Context Classification
 - (b) 75 square feet for intersections within C1, C2, C2T or C3 Context Classification
- (2) Triangular islands should be at least 15 feet on a side, but not less than 12 feet, after rounding of corners.
- (3) Side dimensions of curbed islands should not exceed 100 feet on high-speed facilities (e.g., high speed curbed roadway).

The approach and departure noses are rounded with radii of at least 3.5 feet. **Figure 210.3.1** illustrates a small island with a parallel offset. **Figure 210.3.2** illustrates a large island with a taper offset.

Approach ends of the island should be offset from the edges of the traveled way in order to funnel drivers smoothly into the desired path. The amount that a curbed island is offset from the through-traffic lane is influenced by the type of edge treatment and other factors such as island contrast, length of taper or auxiliary pavement preceding the curbed island. If a bike lane is adjacent to an island curb, no offset is needed.

Figure 210.3.1 Typical Small Curbed Island

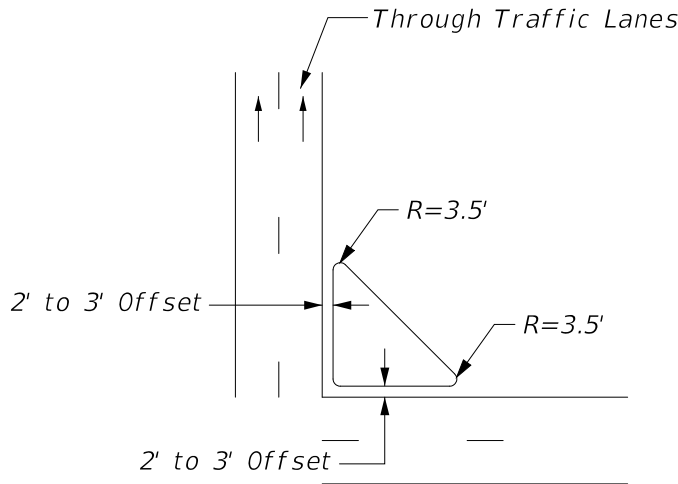

SMALL ISLAND

Figure 210.3.2 Typical Large Curbed Island

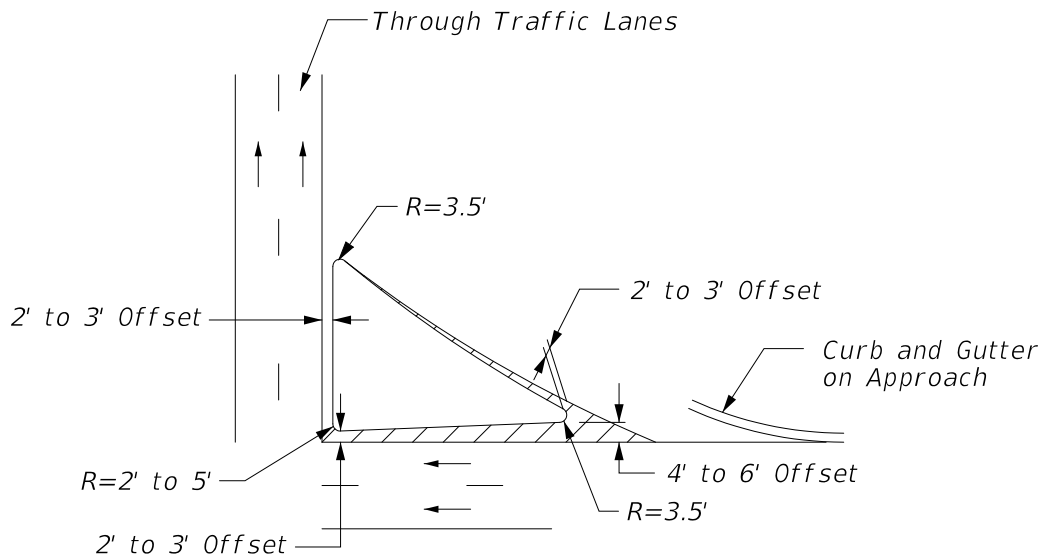

LARGE ISLAND

Where there are no curbs on the approach traveled way, the minimum offset of the edge of the curbed island to the through lane should be 1.5 to 3.5 feet. Where the approach roadway has a Type E curb, a similar curb on the island may be located at the edge of the through lane if there is sufficient length of curbed island to provide a gradual taper from the nose offset. Type F curbs should be offset from the through traveled way edge, regardless of the size of the curbed island. For intermediate and large-size islands that are uncurbed, offsets are desirable but not required. Fixed objects within the island areas must meet clear zone and lateral offset criteria found in **FDM 215.2.3** and **215.2.4**.

210.3.2.2 Median Islands and Traffic Separators

Meet the following requirements when designing median islands and traffic separators:

- (1) A minimum of 4 feet wide and 25 feet long. See **FDM 223.2.4** for width of separation for separated bicycle lanes.
- (2) 100 feet or more in length is allowed on high-speed roadways when providing high visibility for the islands.
- (3) Approach noses should be offset 2 to 6 feet from the through (approach) lanes to minimize impacts. Pavement markings in advance of the nose can be used to transition from the centerline to the edge of island.
- (4) The shape of the island should be based on design turning paths and the island function. Curvilinear tapers comprised of parabolic or circular curves generally suffice.
- (5) The length of the island should be related to the approach speed. An estimate is to use the length based on 3-second driving time to the intersection.
- (6) Median islands should begin on tangent alignments and on upgrades or beyond crest vertical curves. In some cases, it is appropriate to extend a median island to avoid its introduction on a horizontal curve or within an area of limited sight distance.
- (7) Approach noses must extend across the crosswalk at intersections to control left-turn speeds and encourage pedestrian use of the crosswalk. Use tubular markers as shown in the figures as channelizing devices.
 - (a) For median island widths greater than or equal to 6 feet, use a refuge island. **Figure 210.3.3** illustrates the geometrics for curbed roadways (i.e., standard 6-foot nose extension and minimum nose extension for RRR projects).
 - (b) For median island widths less than 6 feet, use hardened centerlines. See **FDM 210.3.3** for hardened centerlines.

Commentary: At intersections, median islands and hardened centerlines are effective at improving vehicle approach angles to the crosswalks resulting in increased visibility of the pedestrians. They are also effective in managing vehicle left-turn speeds which is in-line with the Safe System approach. These factors also provide increased confidence for pedestrians that they will be safer when crossing within the designated crosswalk.

[Standard Plans](#), [Index 520-020](#) provides detailed dimensional design for traffic separators.

See [FDM 222.2.3.1](#) for more information on crosswalks at intersections.

210.3.2.3 Refuge Islands

Refuge islands provide an area for pedestrians and bicyclists to stop before finishing the crossing of a roadway. Complex intersections can be made more navigable and midblock crossings can be facilitated with refuge islands. Refuge islands have specific design criteria to support pedestrian or bicyclist movement. See [FDM 222](#) for more information on Pedestrian Facilities.

Refuge islands must be a minimum of 6 feet wide in the dimension between the traveled ways; however, the preferred width is 8 feet or greater. For curbed roadways, this dimension is from face of curb to face of curb. Consider the refuge island's storage capacity for higher volumes of pedestrian and bicycle traffic, as well as the space needed for pedestrians or bicyclists with items such as strollers, wheelchairs, wagons, cargo bikes, box bikes, and bikes with trailers.

Provide a clear path through the island without obstruction by objects such as poles, signposts, or utility boxes. The width of the clear path through the island must be at least 5 feet to meet ADA requirements and should be equal to the width of the crosswalk. For additional requirements and information on intersection refuge islands see [Figure 210.3.3](#). See [FDM 213.3.5](#) for additional dimensional requirements for roundabout splitter islands. See [FDM 222.2.3.2](#) for more information on midblock crossings. For more information on depressed and raised sidewalks, see [Standard Plans, Index 522-002](#).

Refuge islands may be enhanced by low-growing landscaping of 18 inches tall or less and stormwater management features. See [Drainage Manual, FDM 916](#) (Drainage Structures Sheet), [FDM 270](#) (Planting Designs), [FDM 271](#) (Irrigation Designs), and [FDM 273](#) (Landscape Maintenance Guide).

Examples of refuge islands at midblock crossings are shown in [Figures 210.3.4](#) and [210.3.5](#). For more information on pavement markings, see [Standard Plans, Index 711-001](#).

FDM 212.12 provides information on the design of turning roadways with corner islands.

Roundabout splitter islands provide pedestrian refuge and are discussed in **FDM 213.3.5**.

Commentary: The FDM figures depict ideal situations. Site specific conditions and RRR scenarios may require working around obstacles, such as drainage structures, that may result in final configurations different than shown in the FDM figures. For example, crosswalks may need to be angled slightly, off-set from the intersection more than is illustrated, or other modifications.

It may be necessary to assess tradeoffs between various safety measures. When doing so, approach decisions by considering which safety measure is most likely to reduce serious and fatal injury crashes. Consider prioritizing the safety measure that is most likely to reduce system kinetic energy. Look for creative solutions to work through concerns. For example, in some situations, signs or turn restrictions could help address pedestrian visibility concerns, and careful application of Design and Control Vehicle concepts could help address turning movements.

Figure 210.3.3 Intersection Refuge Island

For New and Reconstruction Projects with Raised Crossings:

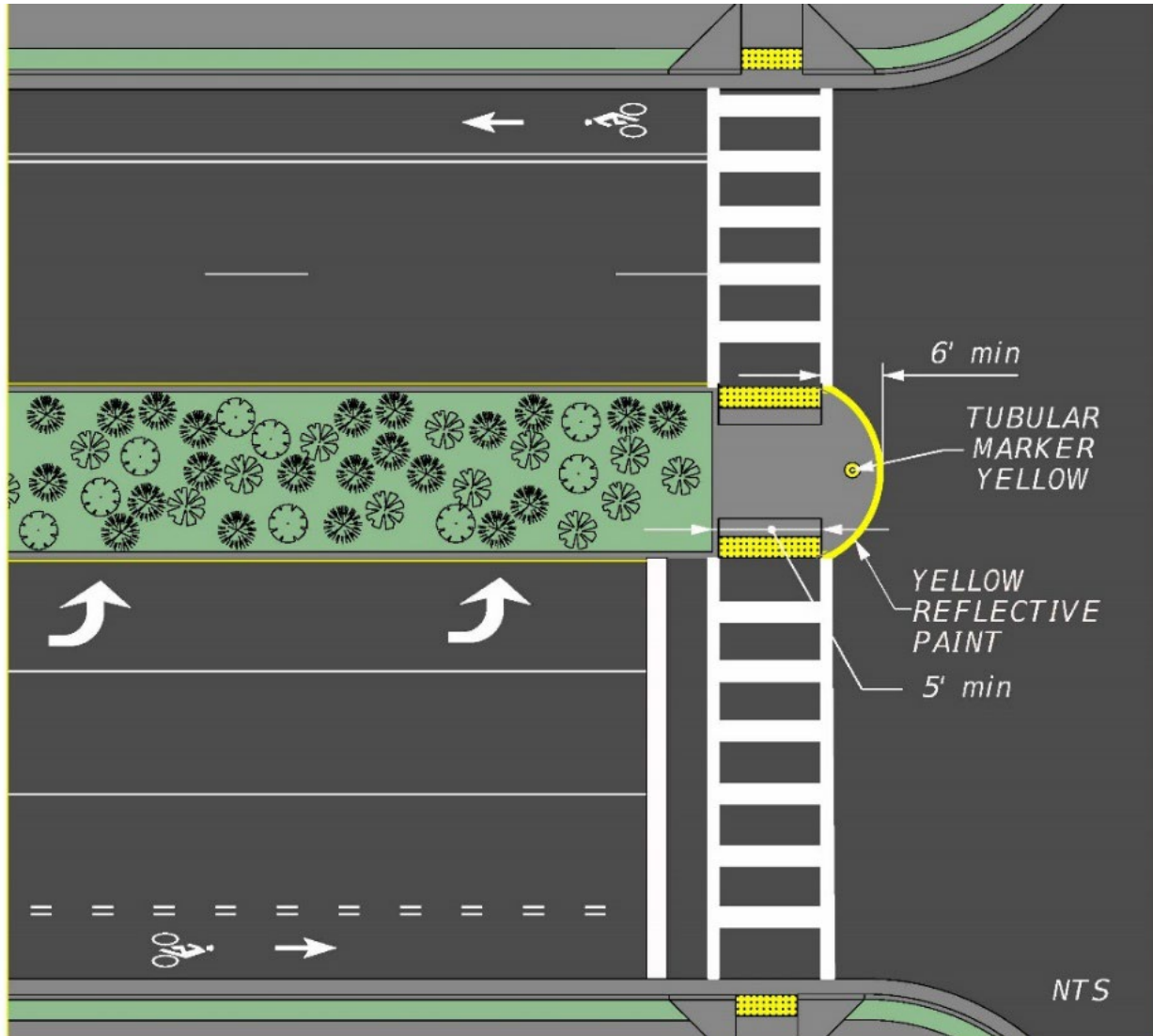

Notes:

- The median nose must be a concrete separator as shown in Standard Plan 520-020. Match the curb profile that is used for the adjacent median.

Figure 210.3.3 Intersection Refuge Island (Cont.)

For New and Reconstruction Projects with Depressed Crossings:

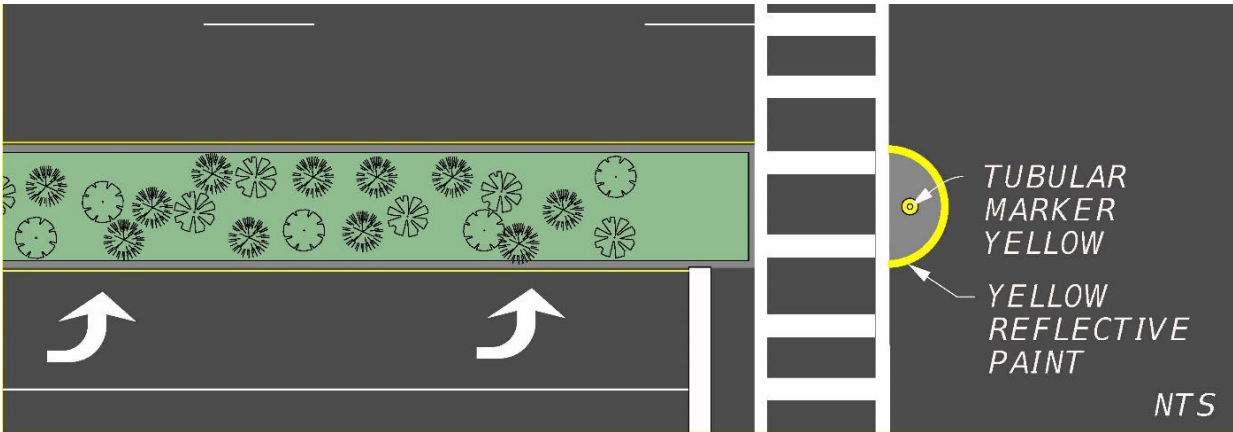

For RRR Projects Where Concrete Median Nose is Not Constructible in Constrained Conditions:

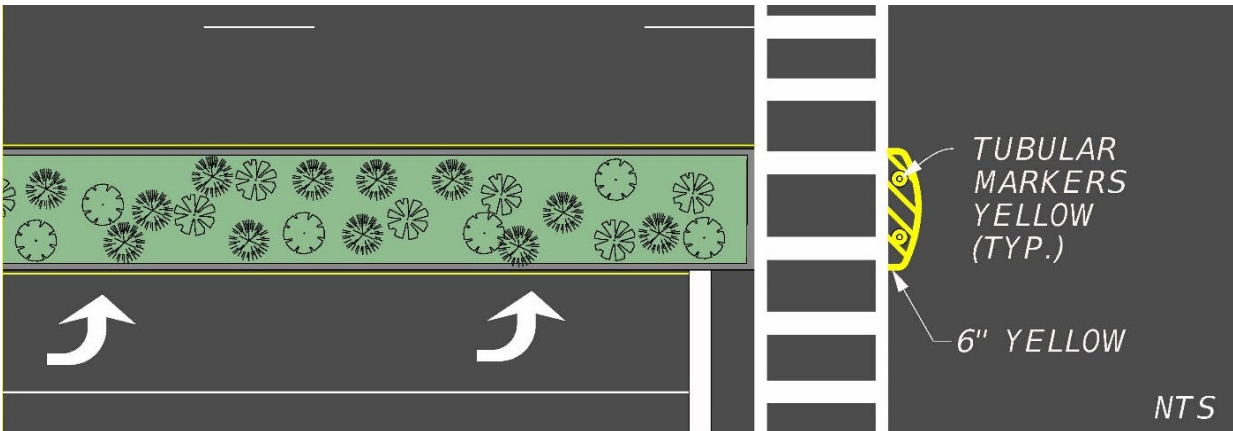

Figure 210.3.4 Midblock Refuge Island Example #1

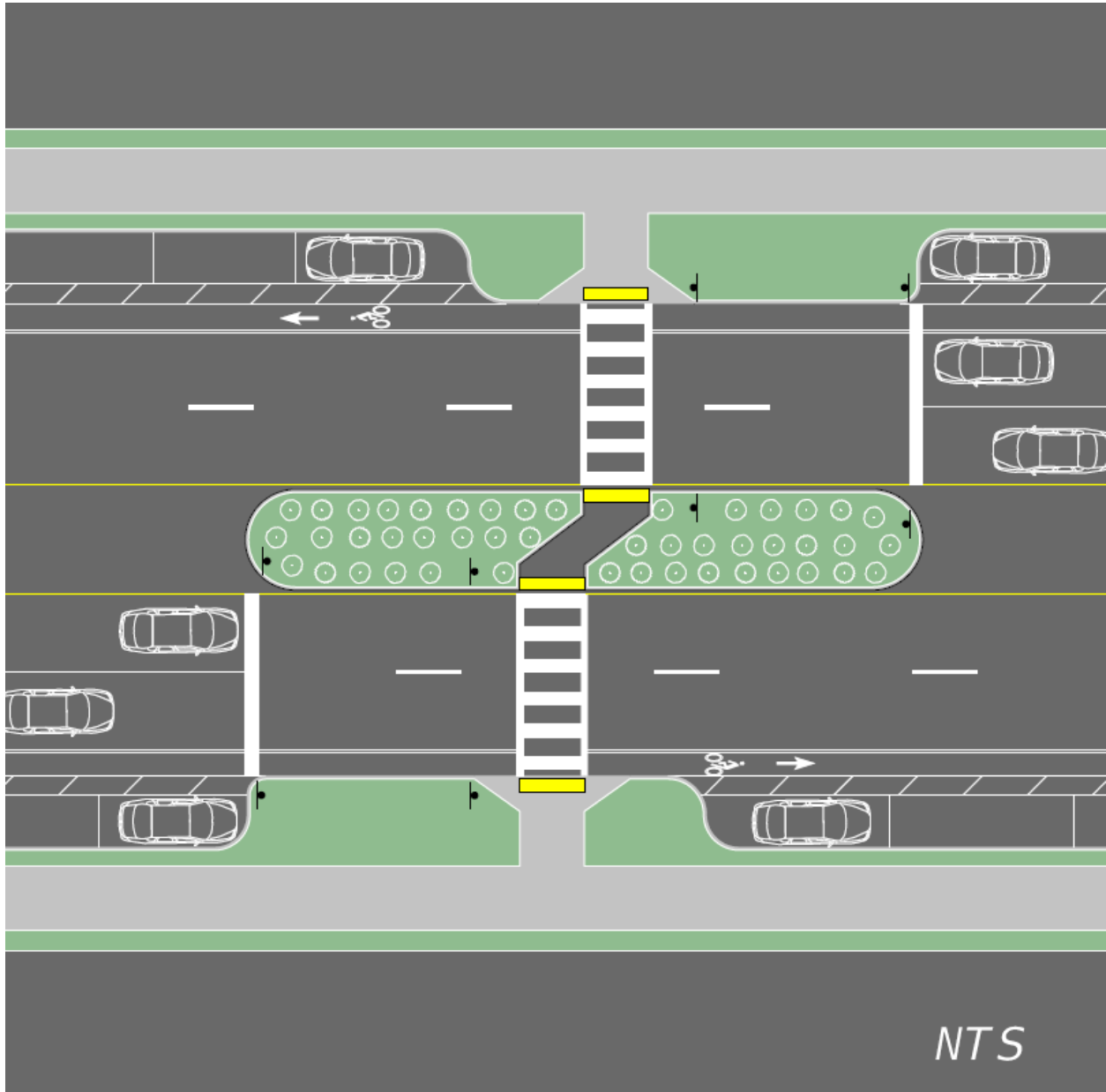
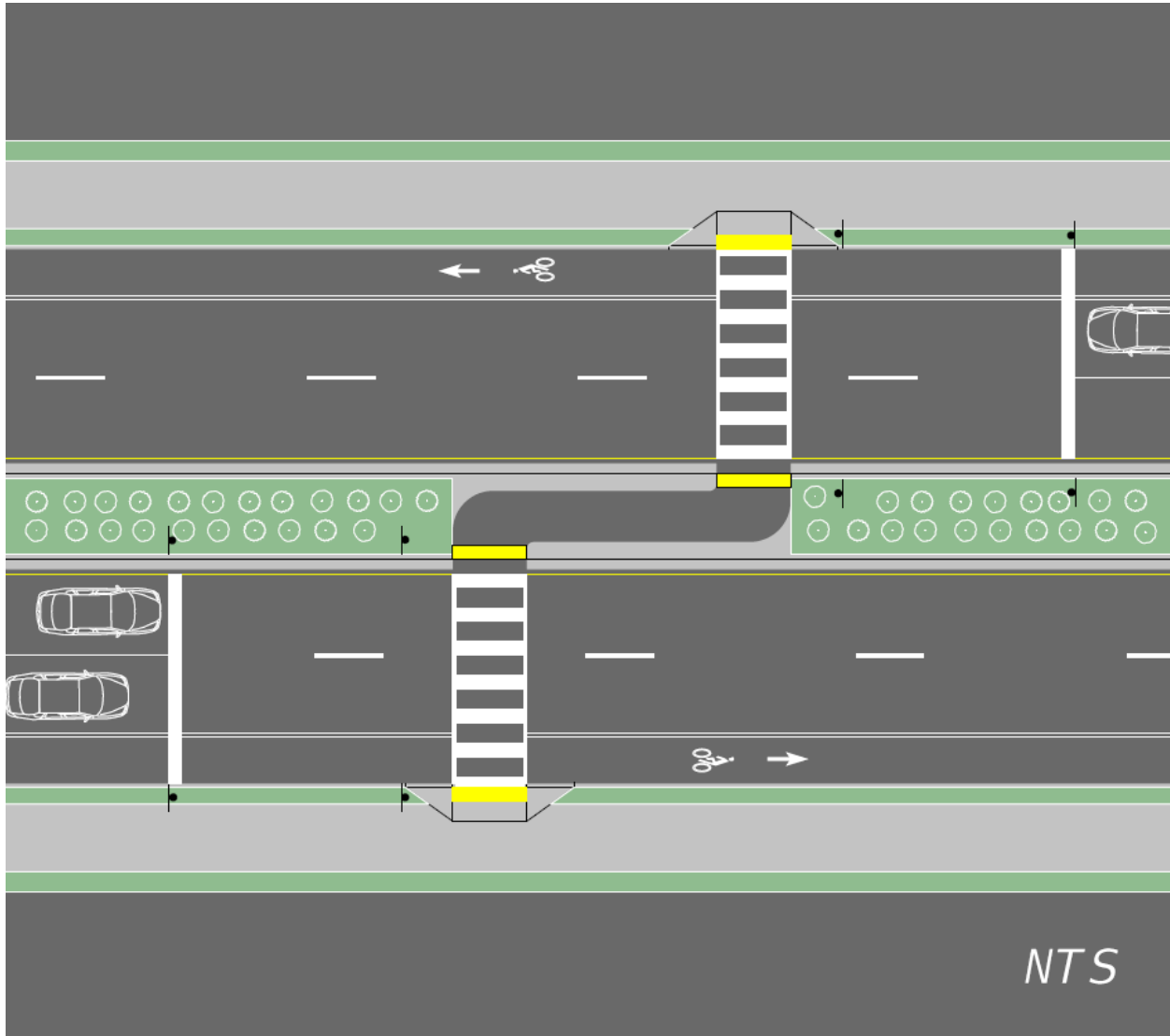

Figure 210.3.5 Midblock Refuge Island Example #2



210.3.2.4 Corner Islands

Where the inside edges of the traveled way for right turns are designed to accommodate semi-trailer combinations or where the design permits passenger vehicles to turn at speeds greater than 10 mph, the pavement area within the intersection may become excessively large and may create longer crossing paths for pedestrians. This may also occur at intersections with turning angles greater than 90 degrees. To avoid this condition, a corner channelizing island can be provided to form a separate turning roadway.

FDM 212.12 provides information on the design of turning roadways with corner islands.

210.3.3 Hardened Centerlines

Hardened Centerlines are an extension of the traffic separator or centerline past the crosswalk. Hardened Centerlines improve pedestrian safety by reducing the turning speeds of left-turning motorists and by improving their approach angle to the crosswalk to increase pedestrian visibility. See **FDM 222** for more information on Pedestrian Facilities.

Provide a hardened centerline where it is not possible to provide a pedestrian refuge island.

The nose extension can be no less than 2 feet long and must provide 1-foot of clear distance from the edge of the crossing traffic lane or bicycle lane. A 6-foot nose extension is preferred, but the designer can adjust the length to balance control of the left turning vehicle with the design vehicle turning path.

Where applicable, space multiple tubular markers a minimum of 2 feet and a maximum of 5 feet apart. Provide tubular markers for a minimum of 25 feet along the traffic separator or centerline approaching the crosswalk.

If tubular markers on the nose extension are not practicable to accommodate sight distance or turning radii, use a “channelizing curb” for the nose extension. Use **Developmental Specification Dev703** for channelizing curb. Detail channelizing curb in the plans showing the length of the nose extension as described above. Channelizing curb products are typically prefabricated in 6-foot lengths with additional length for the endcaps.

Hardened centerlines may be used with offset left turn lanes.

Figure 210.3.6 Hardened Centerline with Traffic Separator

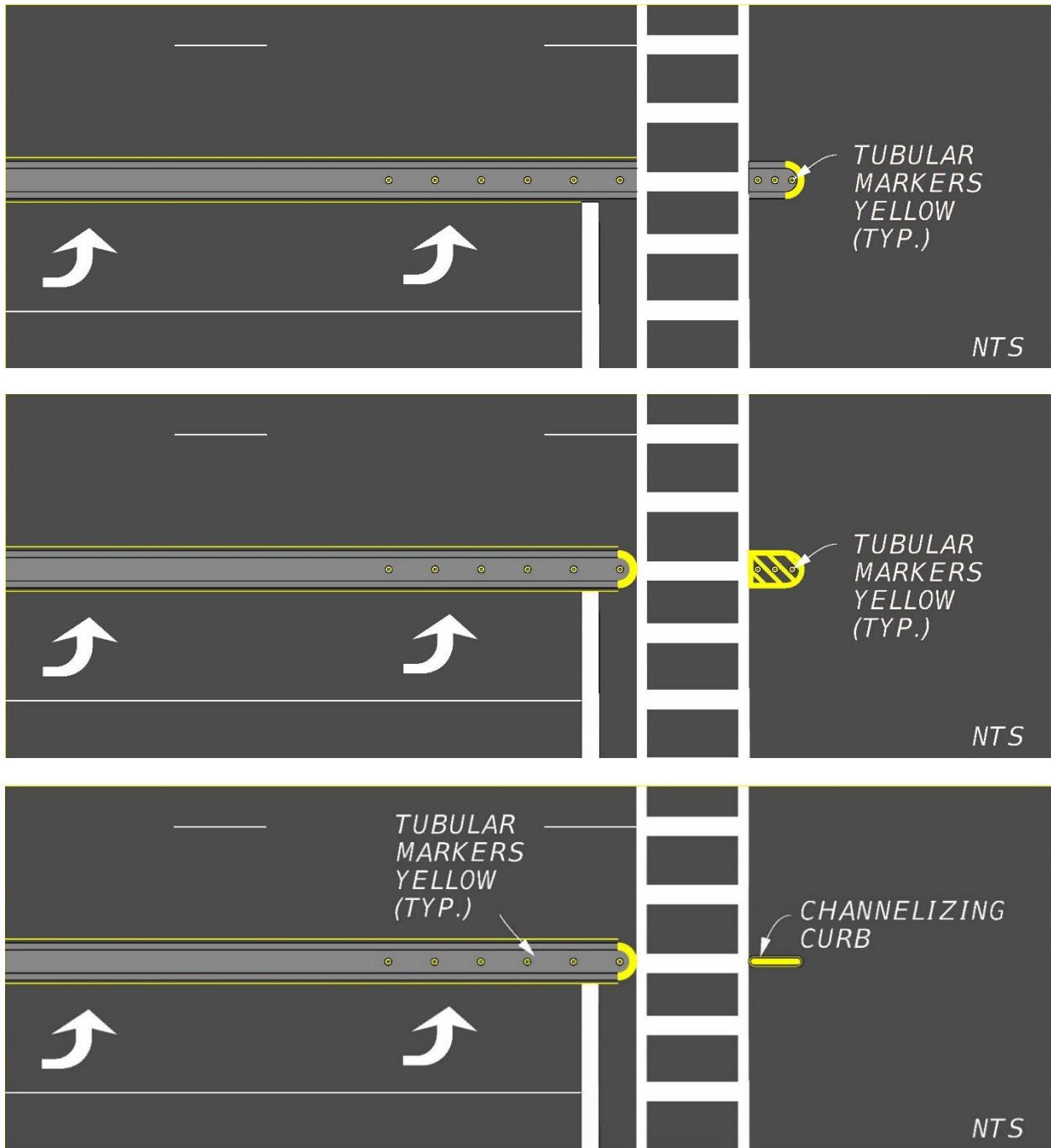
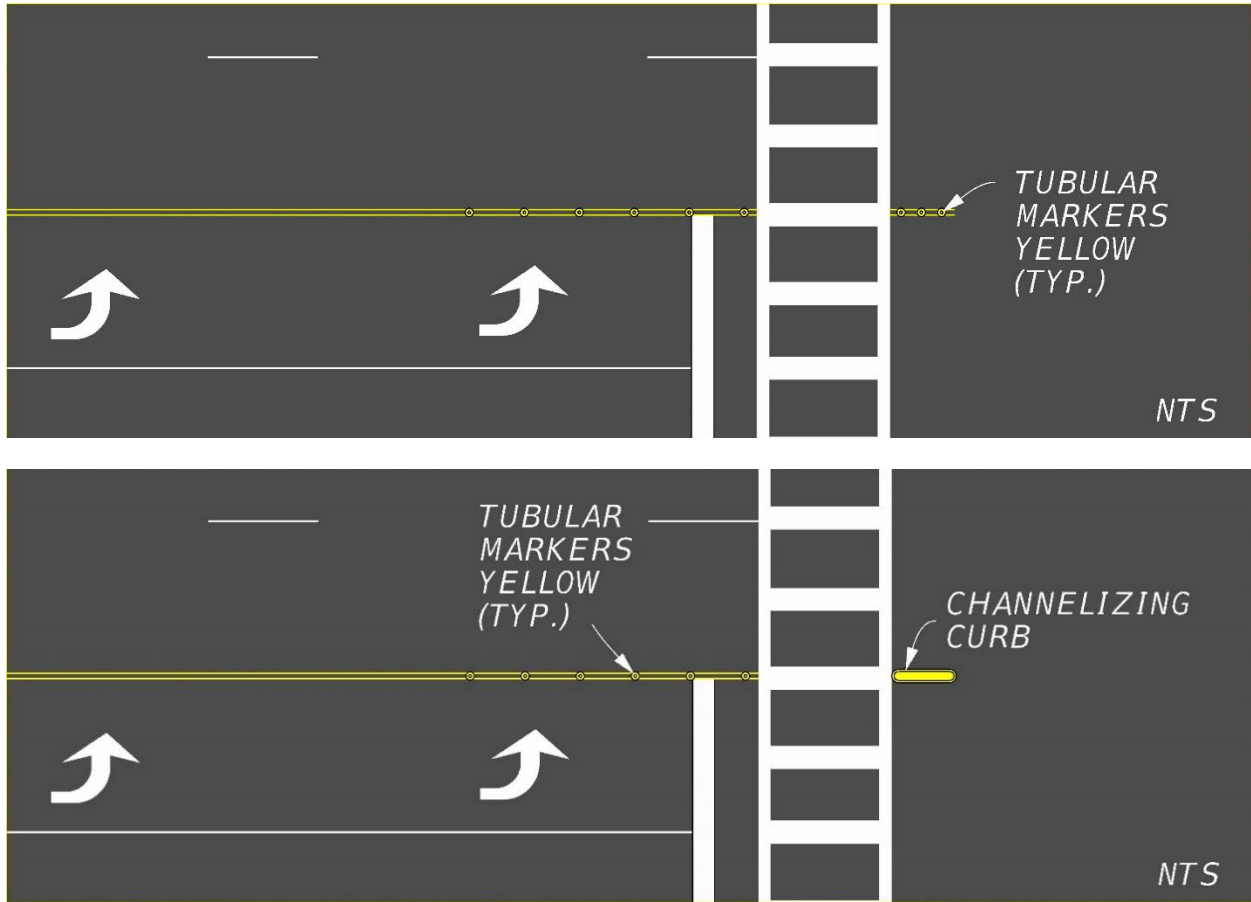

Figure 210.3.7 Hardened Centerline without Traffic Separator



210.4 Shoulders

Roadway shoulder width is measured from the edge of the traveled way to the shoulder break. A portion of the shoulder is required to be paved on all roadways on the State Highway System. A paved shoulder is the portion of the roadway contiguous with the traveled way for accommodation of errant vehicles, stopped vehicles, bicycle traffic, and emergency use.

When it is determined that the Helmeted Bicyclist Symbol and Bicycle Lane Arrow pavement markings (see **FDM 223.2.2**) will be placed on the shoulder of a flush shoulder roadway, the paved width for Outside Shoulder without Shoulder Gutter must be 8 feet instead of the 5 feet shown in **Table 210.4.1**.

Commentary: Paved shoulder widths greater than 5 feet and less than 8 feet are challenging to construct on flush shoulder roadways.

Standard asphalt paving machines have a main screed width of 8 feet or 10 feet (10 feet screed is most common), with 5-foot-wide extensions, connected at pivot points, on either side of the paver. The pivot points are the only locations on the paver where a cross slope break can be constructed. As such, up to a 5-foot-wide shoulder can be paved in conjunction with the adjacent travel lane. Shoulder widths that are 8-feet-wide or greater can be paved with a standard paver.

Due to these dimensional limitations of standard asphalt paving machines, constructing a paved shoulder width that is greater than 5 feet or less than 8 feet is challenging, and should be avoided when possible.

Shoulder widths for roadways are given in **Table 210.4.1**. See **Figure 210.4.1** for an illustration of roadway shoulders. Refer to **FDM 211** for ramp shoulder widths. Refer to **FDM 260.3** for bridge shoulder widths.

Use shoulder gutter for the following conditions:

- On embankments higher than 20 feet
- On embankments higher than 10 feet where the longitudinal slope is greater than 2 percent
- On embankments, with slopes steeper than 1:6 for more than five feet vertically, to minimize erosion
- At bridge ends where concentrated flow from the bridge deck would run down the slope

- In areas of guardrail where embankment slopes are steeper than 1:4 and any pavement is sloped toward the embankment.

Construct roadway paved shoulders up to the railroad crossing shoulder pavement as shown in [Standard Plans, Index 830-T01](#). For additional information see [FDM 220](#) and [Standard Plans, Index 509-070](#).

Figure 210.4.1 Shoulder Width Identification

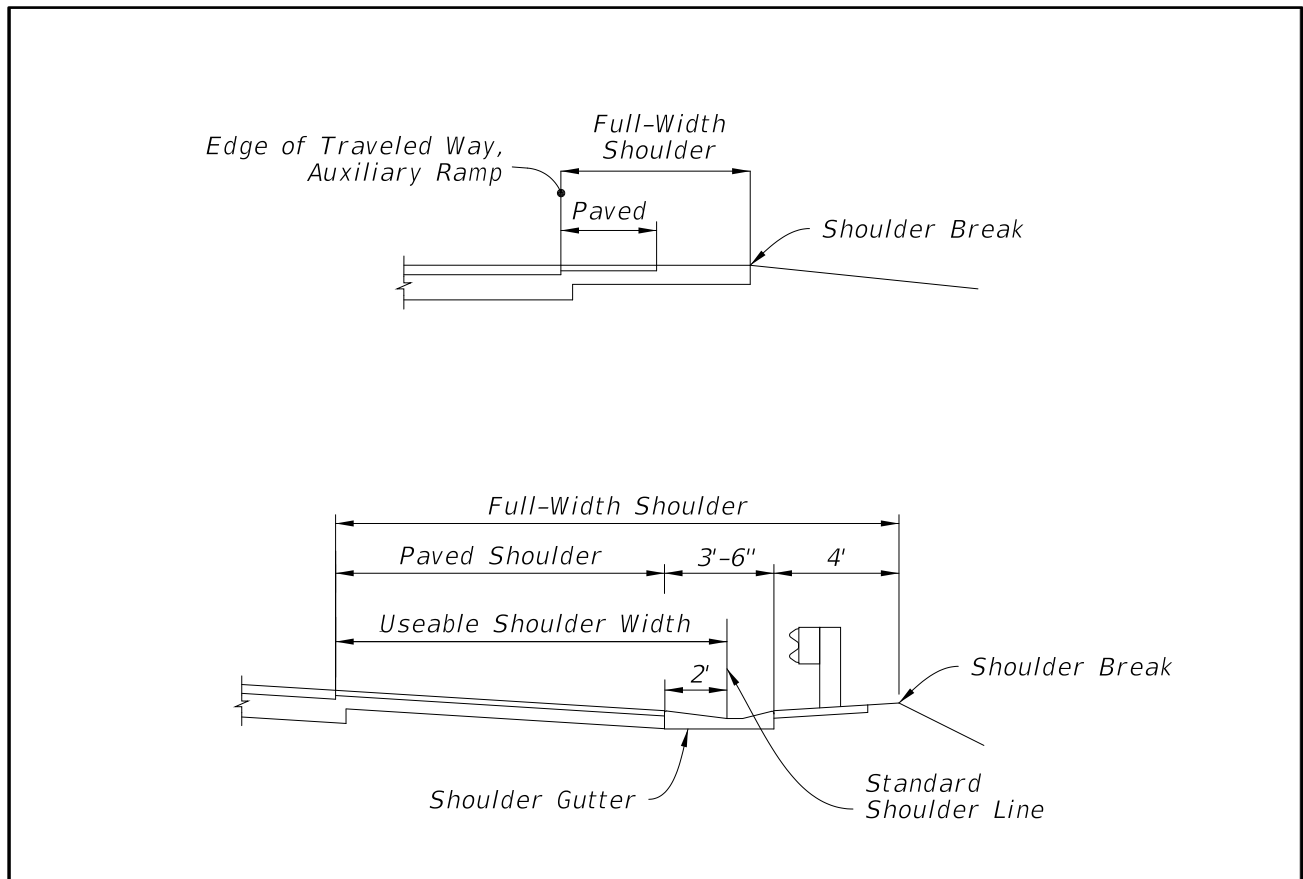

Table 210.4.1 Standard Shoulder Widths

Lane Type	# Lanes (One Direction)	Without Shoulder Gutter				With Shoulder Gutter			
		Outside		Median Or Left		Outside		Median Or Left	
		Full Width (feet)	Paved Width (feet)	Full Width (feet)	Paved Width (feet)	Full Width (feet)	Paved Width (feet)	Full Width (feet)	Paved Width (feet)
Travel Lanes	4-Lanes or more	10	5	10	4	15.5	8	15.5	8
	3-Lanes	10	5	10	4	15.5	8	15.5	8
	1-Lane & 2-Lanes	10	5	8	4	15.5	8	13.5	6
Aux. Lanes	ALL	10	5	8	4	11.5	4	11.5	4

Notes:

Without shoulder gutter:

- (1) Consider 12-foot outside full width shoulder adjacent to travel lanes with high AADT or greater than 10% trucks.
- (2) Consider providing a minimum 10-foot median shoulder where continuous barrier or guardrail is present.
- (3) Outside shoulder widths for auxiliary lanes typically match those of the adjacent roadway; however, width may be reduced to 6-foot shoulder with 2-foot paved for right turn lanes when a bicycle keyhole is present.
- (4) Pave the entire width of shoulders adjacent to concrete barriers. See **FDM 215.4.6.1**.
- (5) For RRR Projects:
 - (a) an existing full width shoulder of 6-foot or greater may be retained
 - (b) the following minimum existing outside paved shoulder widths may also be retained:
 - i. 4-foot adjacent to travel lane
 - ii. 2-foot adjacent to auxiliary lane
 - (c) an existing unpaved median or left shoulder may be retained. Consider providing a 4-foot median or left paved shoulder adjacent to travel and auxiliary lanes where there are documented safety or maintenance concerns.

With shoulder gutter:

- (1) Paved shoulders less than 6 feet in width with adjoining shoulder gutter must be the same type, depth, and cross slope as the roadway pavement.
- (2) Shoulders must extend 4 feet beyond the back of shoulder gutter and have a 0.06 cross slope back toward the gutter.
- (3) Required shoulder widths for auxiliary lanes typically match those of the adjacent roadway.

210.4.1 Shoulder Cross Slopes

The standard cross slope is 0.06 on the outside shoulder and 0.05 on the median (or left) side. **Figure 210.4.2** illustrates shoulder cross slopes in relationship to roadway cross slopes for normal and superelevated sections. For 5-foot (or less) paved shoulders, see **Figure 210.4.3**. If the inside travel lane is sloping toward the median, then the inside shoulder cross slope may be increased to 0.06.

For projects constructed with concrete pavement, the first one foot of the outside shoulder is cast with the outside travel lane and will have the same cross slope (and superelevation) as the outside lane. Superelevation of the shoulder pavement is to be rotated about the outside edge of the outside slab.

For shoulder cross slope criteria on bridges see **FDM 260.4**.

Figure 210.4.2 Shoulder Superelevation

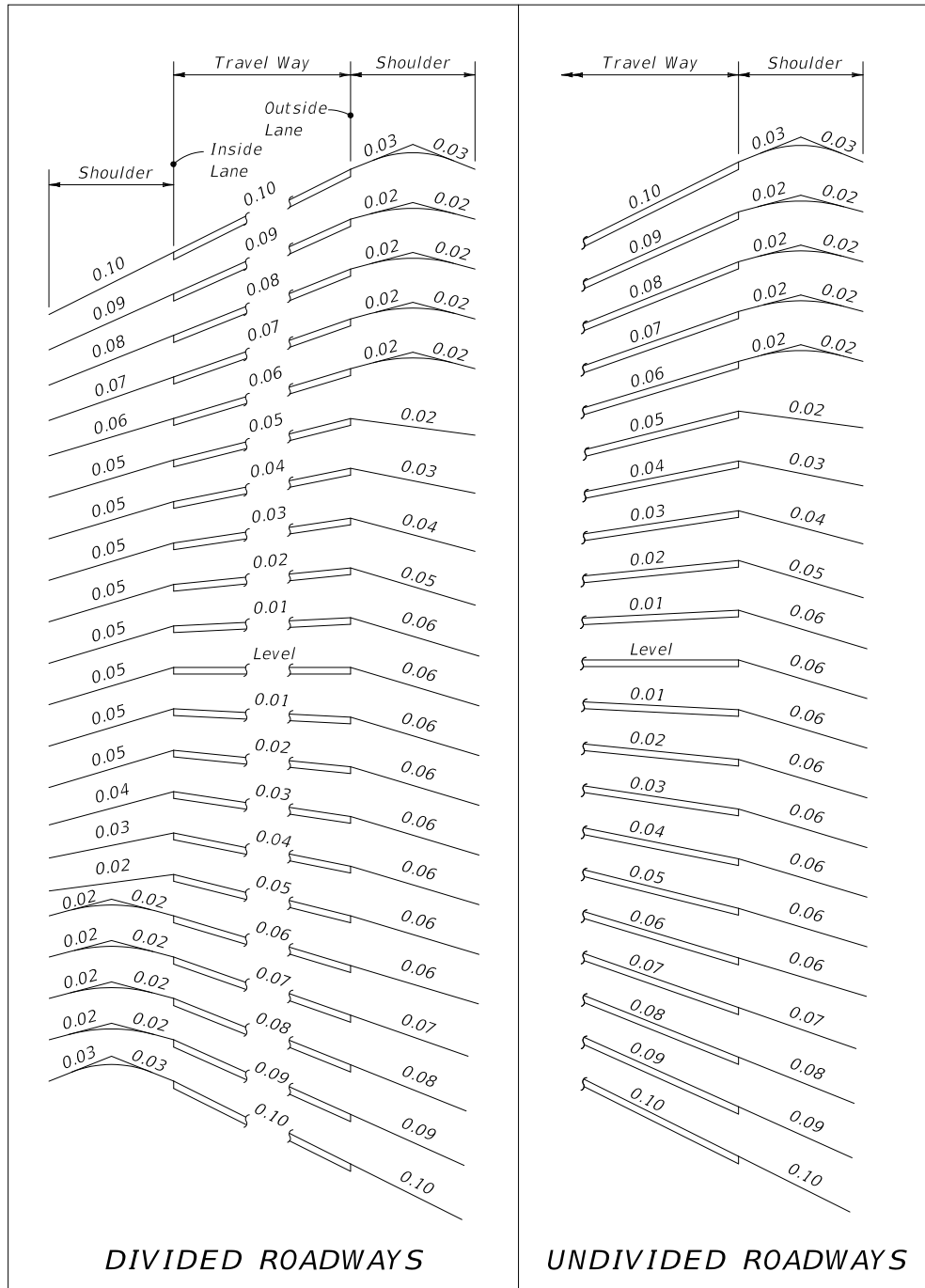
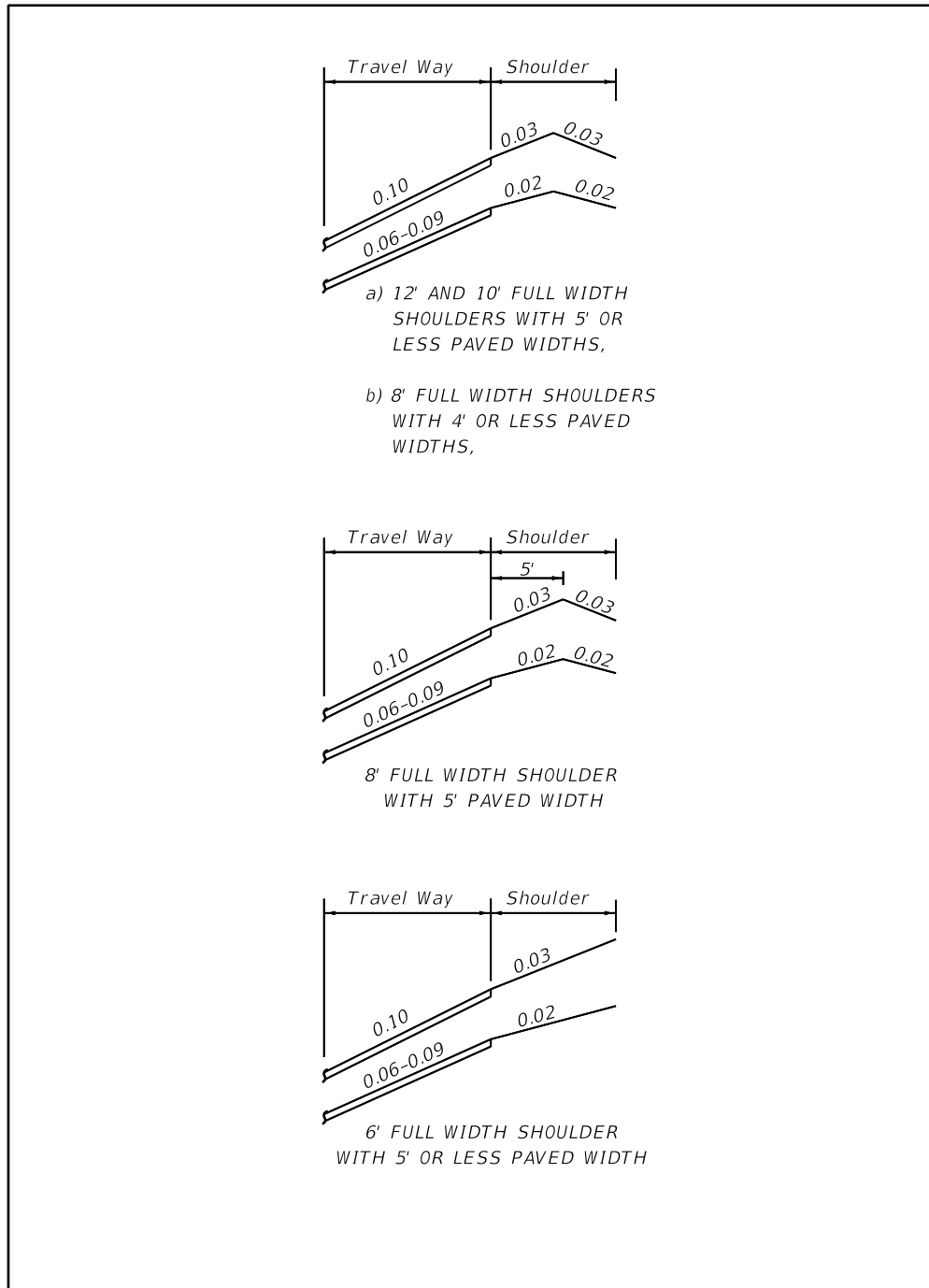

Figure 210.4.3 Special Shoulder Superelevation



210.4.2 Typical Paving under Bridge

See **FDM 260.7** for requirements for paving under bridges.

210.4.3 Limits of Friction Course on Paved Shoulders

Extend friction course (closed and open graded) over the full width of the median and outside paved shoulders.

210.4.4 RRR Shoulder Treatment

Identify the shoulder treatment option in the plans when using [Standard Plans, Index 570-010](#). Use Treatment I only if the shoulder is established with good soil and turf, and there is no significant shoulder erosion. Use Treatment II when an existing shoulder meets the overlay thickness requirements for Treatment I, but there is significant shoulder erosion.

210.4.5 Narrow Bridge Shoulder Warning Devices

The [Standard Plans, Index 700-106](#), provides details for the shoulder treatment to be used on flush shoulder roadway approaches to a narrow bridge. This index provides standards for the placement of signing, striping, object markers, and raised pavement marking (RPMs) for use at structures where the bridge shoulder width is less than the width of the useable shoulder on the approach roadway.

210.4.6 Audible and Vibratory Treatment

Provide audible and vibratory treatment (AVT) for edge lines and center lines on flush-shoulder roadways with a posted speed of 50 mph or greater. Do not place edge line AVTs on lanes that are less than 11 feet wide. Do not exclude sections of the project where advisory speeds are used due to restricted horizontal or vertical geometry. Do not place AVTs within the limits of crosswalks.

Use sinusoidal ground-in rumble strips on flexible pavements as shown in [Standard Plans, Index 546-020](#).

Use profiled thermoplastic on rigid pavements. Otherwise, use of profiled thermoplastic for any project including RRR, permits, push-button safety, and restriping projects must be approved by the State Roadway Design Engineer. **Figure 210.4.4** provides guidance for placement of AVTs. See **FDM 940** for information regarding plan requirements. Ground-in rumble strips are to be quantified in the Signing and Marking Plans component set.

Figure 210.4.4 Audible and Vibratory Treatment Placement

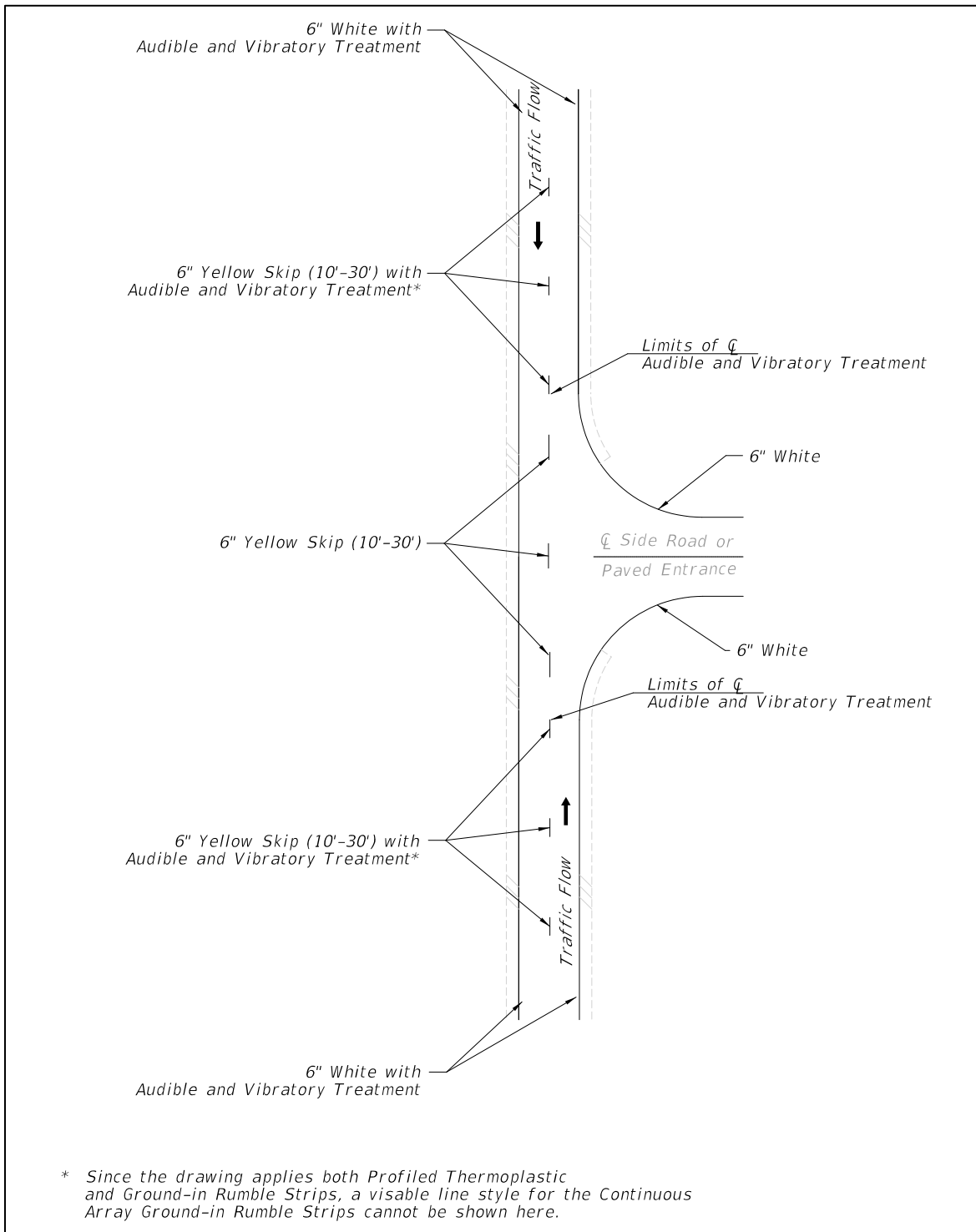

Figure 210.4.4 Audible and Vibratory Treatment Placement (Cont.)

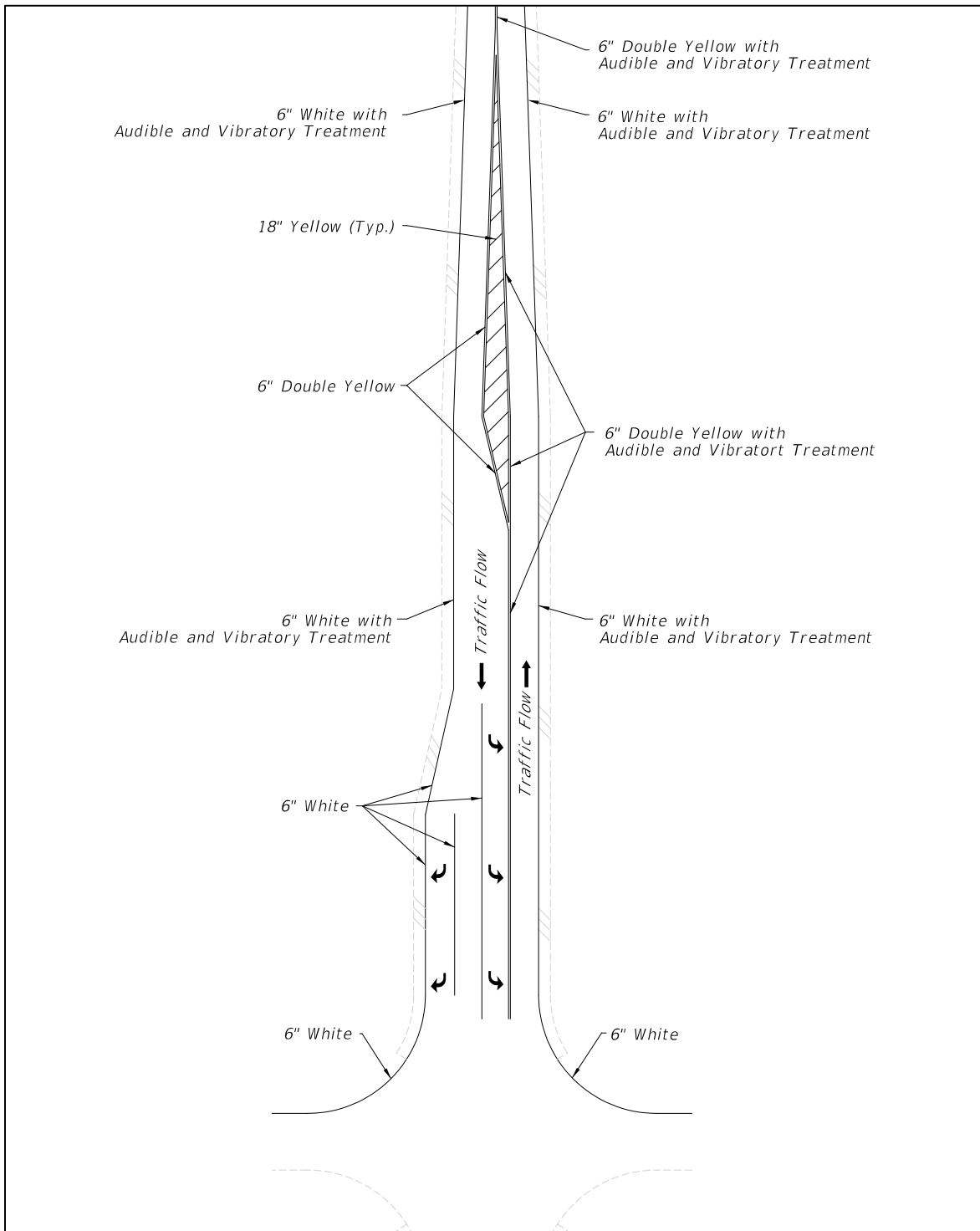

Figure 210.4.4 Audible and Vibratory Treatment Placement (Cont.)

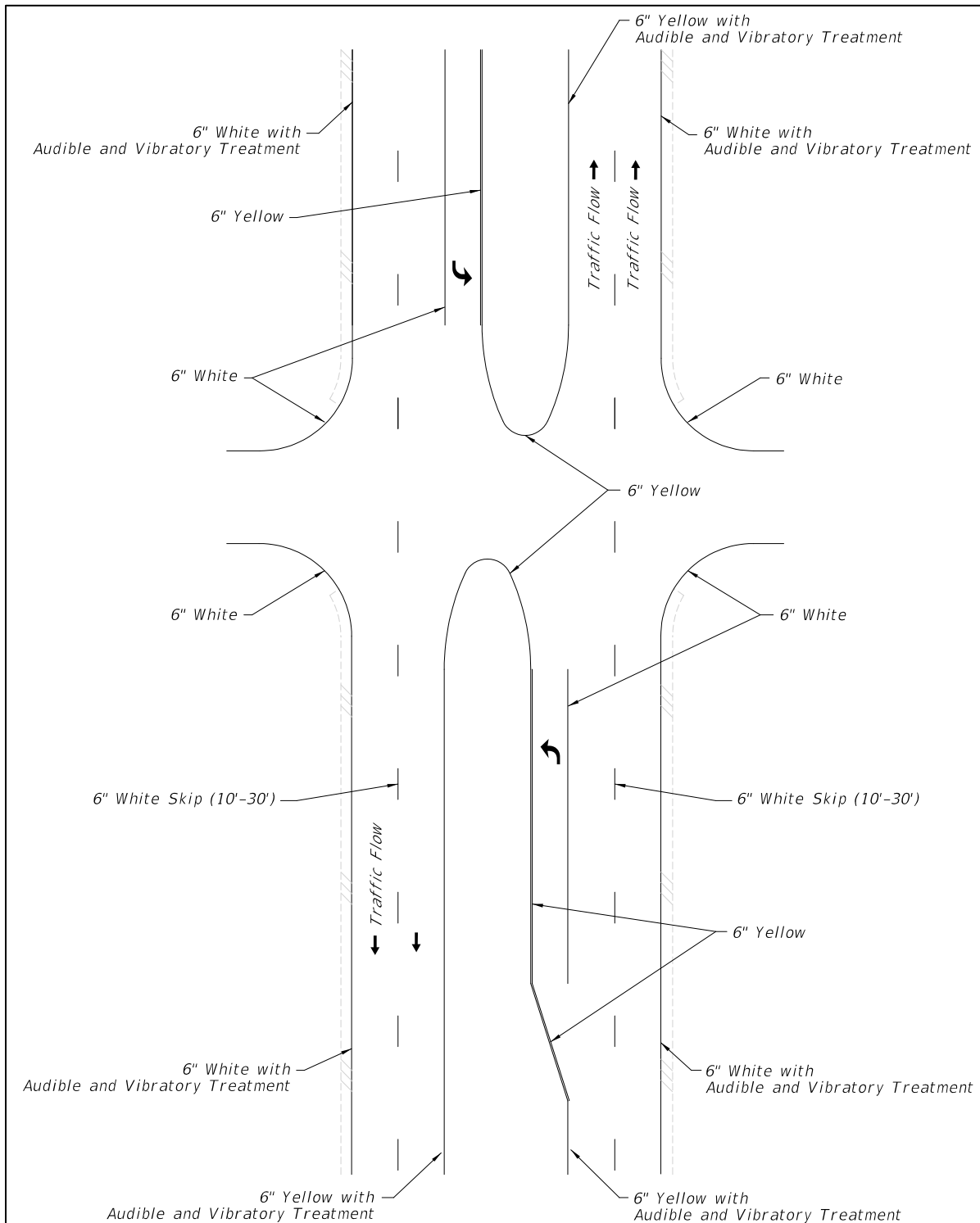

Figure 210.4.4 Audible and Vibratory Treatment Placement (Cont.)

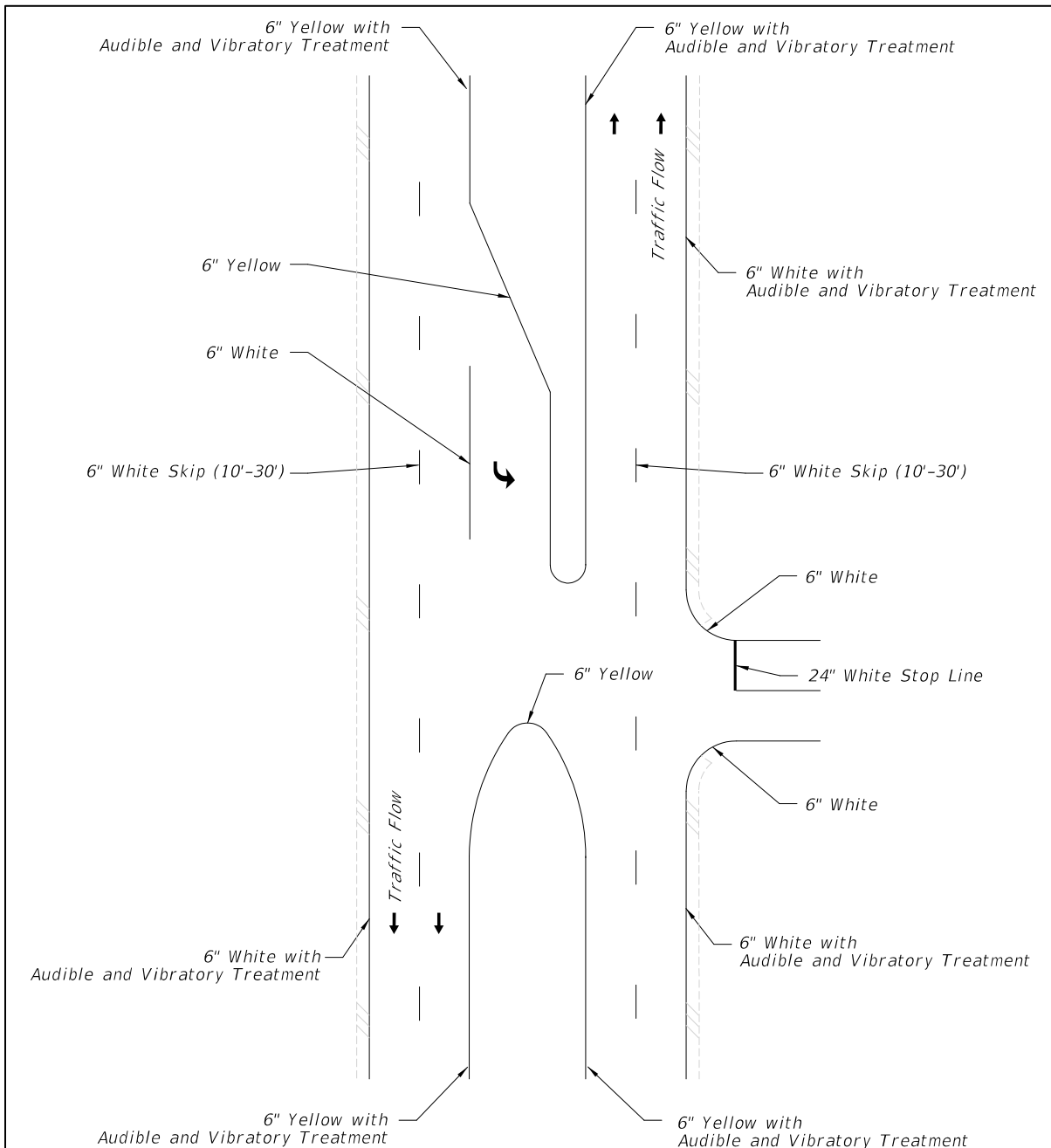
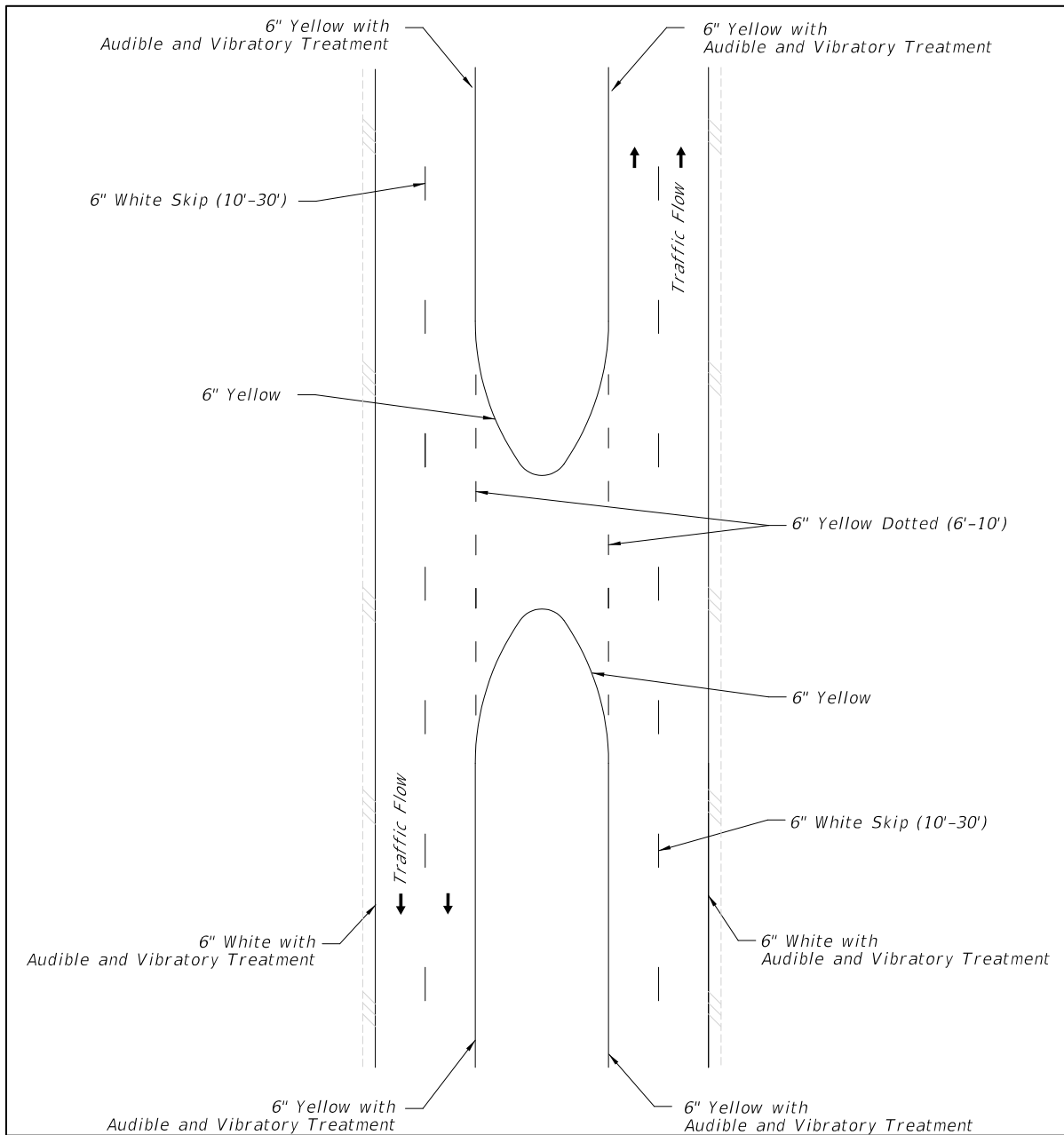

Figure 210.4.4 Audible and Vibratory Treatment Placement (Cont.)



210.5 Curbed Roadways

The term “curbed” includes all types of curbs and curb and gutter that are used on the state highway system and detailed in [Standard Plans, Index 520-001](#).

The method of collecting and conveying drainage runoff and the availability of R/W determines the cross section; i.e. flush shoulder or curbed. When it is determined that a closed drainage system will be used, the selection of curb type will be based on the design speed.

Curbed roadways with design speeds of 45 mph or less, typically use Type F curb on the outside and Type E curb on the median (or left) side.

See **FDM 215.2.7.2**, for additional information regarding curbs and their placement.

210.5.1 High-Speed Curbed Roadways

Curbs may be used on roadways where the anticipated operating speeds require a design speed of 50-55 mph and:

- (1) Curbs are necessary to control drainage, or
- (2) R/W is constrained

High speed curbed sections are typically used within C3 context classification and transitional areas.

High speed curbed roadways are to use Type E curb on both the median and outside. Provide an offset from the edge of the traveled way to the lip of gutter as follows:

- (1) 4-foot to median curb for 4-lane roadway sections.
- (2) 6.5-foot to median curb for 6-lane roadway sections.
- (3) 6.5-foot to outside curb for all roadway sections.

The above median offsets are not required for left turn lanes adjacent to traffic separators or Type E curb. Outside offsets for right turn lanes may be reduced to 4.5-foot when a bicycle keyhole is provided.

210.6 Roadside Slopes

Criteria and details for roadside slopes are included in **FDM 215**.

The following guidance is being provided to designers for consideration during project design. Additional sod requirements are provided in the [Standard Plans, Indexes 570-001](#) and [571-010](#).

- Sod should be considered for slopes 1:4 or steeper. For all other areas, refer to [FDOT Drainage Manual](#), Chapter 2, Table 2.5, for additional guidance on maximum velocity for each lining type.
- Sod should be used for projects with less than 10,000 square feet of disturbed area.
- Sod should be considered for narrow areas less than six feet.
- A minimum 48" of sod should be considered for back of sidewalk areas as applicable.
- Sod should be considered in areas of concentrated runoff (i.e., bottom of vertical curves, inside areas of superelevated curves, tangent sections, and outside of curves). Refer to [Standard Plans, Index 570-001](#) for sodding requirements.
- Refer to [Standard Plans, Index 570-010](#) for milling and resurfacing projects or major projects with portions of milling and resurfacing.

210.7 Border Width

Border width provides space for:

- (1) Roadside design components such as signing, signals, lighting, drainage features, guardrail, fencing and clear zone, sidewalks with ADA provisions, traffic control devices, fire hydrants, storm drainage features, bus and transit features, permitted public utilities and space for aesthetic features such as sod and other landscape items.
- (2) A buffer between vehicles and pedestrians,
- (3) Construction and maintenance of the facility, and
- (4) Permitted public utilities.

Required border width is provided in **Table 210.7.1**. Border width is measured to the R/W line as follows:

- **Flush shoulder roadways:** from the shoulder break.
- **Curbed roadways:** from the outside edge of the pavement (lip of gutter).
- **High-speed curbed roadways:** from the outside edge of the traveled way.

Table 210.7.1 Minimum Border Width

Context Classification	Minimum Border Width (Feet)					
	Curbed and High-Speed Curbed Design Speed (mph)				Flush Shoulder Design Speed (mph)	
	25-40	45	50	55	25-45	≥ 50
C1 Natural	N/A	N/A	29	35	N/A	40
C2 Rural	N/A	N/A	29	35	N/A	40
C2T Rural Town	12	14	N/A	N/A	33	N/A
C3 Suburban	12	14	29	35	33	40
C4 Urban General	12	14	N/A	N/A	33	N/A
C5 Urban Center	12	N/A	N/A	N/A	N/A	N/A
C6 Urban Core	14	N/A	N/A	N/A	N/A	N/A

Notes:

- (1) On low-speed curbed roadways that have an adjacent bike lane, the required border width shown in the table may be reduced by 2 feet.
- (2) On existing roadways:
 - a. When R/W is not being acquired:
 - i. Unmodified existing border width may remain (e.g., a resurfacing only project)
 - ii. Modified existing border width must not be less than 8 feet (e.g., when adding a right turn lane)
 - b. When R/W is being acquired, border width should meet new construction criteria shown in the table. Provide a segment of sufficient length to assure continuity.
- (3) N/A indicates this combination of design speed and context classification is outside the intended design range and should be avoided. See **Table 201.5.1** for context classifications and design speed ranges.

210.8 Horizontal Alignment

The centerline (CL) or baseline (BL) of construction defines the horizontal alignment for roadway and bridge construction. The CL or BL of construction is a series of tangents connected by horizontal curves established by the Engineer of Record (EOR). CL or BL of construction may be the same alignment as the BL of survey.

Horizontal alignment should be consistent with the anticipated operating speed and with environmental, physical, and economic constraints. Design speed is the principal factor controlling horizontal alignment.

Avoid placing horizontal curves, point of intersection (PI), and superelevation transitions within the limits of a structure or approach slabs. Placement of stationing equations within the limits of a structure should be avoided on contract plans. Such equations unnecessarily increase the probability of error in both the design and construction phase.

210.8.1 Deflections in Alignment

The point where tangents intersect is known as the PI. Avoid the use of a PI with no horizontal curve; however, there may be conditions where it is necessary (e.g., closely spaced intersections in areas with limited R/W). The maximum deflection without a horizontal curve are as follows:

- Flush shoulder and curbed roadways with design speed 40 mph and less is 2°00'00".
- Flush shoulder roadways with design speed 45 mph and greater is 0°45'00".
- Curbed roadways with design speed of 45 mph is 1°00'00".
- High speed curbed roadways with design speed 50 mph and greater is 0°45'00".

210.8.1.1 Intersections

Refer to **FDM 212** for information regarding deflections through intersections.

210.8.2 Horizontal Curves

A horizontal curve should not be introduced near the crest of a vertical curve. The combination of horizontal and vertical curves can negatively impact sight distance and can also greatly reduce the approaching driver’s ability to perceive a horizontal curve ahead. The condition can be avoided by having the horizontal curvature lead the vertical curvature; i.e., the horizontal curve is made longer than the vertical curve.

Flatter curvature with shorter tangents is preferable to sharp curves connected by long tangents; i.e., avoid using minimum horizontal curve lengths.

Table 210.8.1 provides the horizontal curve lengths to be used in establishing the horizontal alignment. Refer to **Table 210.8.3** for compound curves.

Table 210.8.1 Length of Horizontal Curve

Desired Length Based on Design Speed (mph)										
mph	25	30	35	40	45	50	55	60	65	70
feet	400	450	525	600	675	750	825	900	975	1050
Desired Length Based on Deflection Angle						Notes: (1) The desired horizontal curve length shall be the greater of the lengths based on design speed and length based on deflection angle. (2) When desirable horizontal curve length cannot be attained, provide the greatest attainable length possible, but not less than 400 feet.				
degrees	5°	4°	3°	2°	1°					
feet	500	600	700	800	900					

210.8.2.1 Existing Horizontal Curves

Evaluate existing curves against the values shown in **Table 210.8.2**. The review should include crash history and an on-site review for evidence of roadway departure or operational problems in the area of concern.

Table 210.8.2 Minimum Radius for Evaluation of Existing Horizontal Curves

Maximum Superelevation (e_{max})		Minimum Radius (feet)									
		Design Speed (mph)									
		25	30	35	40	45	50	55	60	65	70
0.10	SHS	160	231	323	432	559	694	881	1091	1348	1637
	RRR	120	188	276	388	521	674	849	1042	1273	1528
0.05	SHS	194	286	402	533	694	881	N/A	N/A	N/A	N/A
	RRR	140	223	332	468	637	849	N/A	N/A	N/A	N/A

Condition #1 – A horizontal curve that meets or exceeds the SHS minimum radius shown in **Table 210.8.2** is satisfactory unless there is a significant crash history (3 or more crashes within the most recent available 5-year location verified data) or other evidence of safety or operational problems. If problems are identified, include corrective measures in the project.

Condition #2 – A horizontal curve that is below the SHS minimum radius shown in **Table 210.8.2** but meets or exceeds the RRR minimum radius shown in **Table 210.8.2** must be reviewed for specific safety problems at the curve. If the review indicated significant operational or safety problems exist, the curve should be reconstructed. If problems are identified but reconstruction is not warranted, include corrective measures in the project.

Condition #3 – A horizontal curve that does not meet the RRR minimum radius shown in **Table 210.8.2** must be reconstructed or a Design Exception or Design Variation obtained. A reconstructed curve must meet the new construction values shown in **Tables 210.8.1, 210.9.1, 210.9.2, and 210.9.3.**

210.8.2.2 Compound Curves

Although the use of compound curves is discouraged, there may be conditions where it is necessary. Avoid sudden changes from flat to sharp curves. For compound curves on open highways, the ratio of the flatter radius to the sharper radius is not to exceed 1.5:1. For compound curves on turning roadways and at intersections, a ratio of 2:1 may be used where the flatter radius precedes the sharper radius in the direction of travel.

The length of compound curves (arc length) for turning lanes are provided in **Table 210.8.3.**

Table 210.8.3 Minimum Compound Curves Arc Lengths on Turning Roadways

Minimum Arc Length (feet)							
	Radius (feet)						
	100	150	200	250	300	400	≥ 500
Desirable	65	70	100	120	150	180	200
Minimum	40	50	65	85	100	120	150

Notes:
 (1) Provide the desirable arc length. When the desirable length cannot be attained, provide the greatest attainable length possible, but not less than the minimum values.

210.8.2.3 Reverse Curves

Reverse curves are curves in opposite directions on a common tangent that are located in close proximity to each other. Avoid using reverse curves unless a sufficient length (see **FDM 210.9.1**) of tangent is included between the curves to provide for superelevation transition.

210.9 Superelevation

Use a maximum superelevation rate of 0.10 on high-speed roadways. Tabulated superelevation rates for high-speed roadways are provided in **Table 210.9.1**.

Use a maximum superelevation rate of 0.05 on low-speed roadways. Tabulated superelevation rates for low-speed roadways are provided in **Table 210.9.2**.

Design non-limited access ramps using the arterial roadway criteria. Additional data is contained in the [Standard Plans](#), **Index 000-510** and **000-511**.

Provide the following minimum lengths of full superelevation within horizontal curves:

- (1) 100 feet for design speed ≤ 45 mph.
- (2) 200 feet for design speeds ≥ 50 mph.

210.9.1 Superelevation Transitions

The standard superelevation transition places 80% of the transition on the tangent and 20% on the curve. Superelevation transition slope rates are provided in **Table 210.9.3**.

In transition sections where the travel lane(s) cross slope is less than 1.5%, provide one of the following grade criteria:

- (1) Maintain a minimum profile grade of 0.5%
- (2) Maintain a minimum edge of pavement grade of 0.2% (0.5% for curbed roadway).

When superelevation is required for reverse curves, a suitable tangent length between the curves is determined as follows:

- (1) 80% of the transition for each curve should be located on the tangent.
- (2) Tangent length is equal to or greater than the sum of the two 80% distances.
- (3) Where alignment constraints require an adjustment to the superelevation transition, not more than 50% of the transition may be placed on the curve.

210.9.2 RRR Criteria for Superelevation

Superelevation and transition requirements are provided in **FDM 210.9**.

For all curves:

- If there are any crashes within the last 5 years that are attributed to superelevation, correct the superelevation rates to the new construction values provided in **Tables 210.9.1** and **210.9.2**.

For Low-Speed Curves:

- If the existing superelevation rates are within 0.5% (+/-) of the new construction values in **Table 210.9.2**, superelevation rate correction is not required.
- If the existing superelevation rates are **not** within 0.5% (+/-) of the new construction values in **Table 210.9.2**, correct the superelevation rates. A Design Variation is required to leave the deficient curve in place.

For High-Speed Curves and all ramps (regardless of speed):

- If the existing superelevation rates are within the range of derived values from the $e_{\max} = 6\%$ and $e_{\max} = 12\%$ tables in **AASHTO A Policy on Geometric Design of**

Highways and Streets (AASHTO Green Book), superelevation rate correction is not required.

- If the existing superelevation rates are outside of the range of derived values from the **AASHTO Green Book** $e_{\max} = 6\%$ and $e_{\max} = 12\%$ tables, correct the superelevation rates. A Design Exception is required to leave the deficient curve in place.

210.9.2.1 Superelevation Correction

This type of work may involve variable depth milling and asphalt layers. Provide the following information in the plans:

- (1) Details showing how the transition from normal cross slope to superelevation is to be achieved.
- (2) A table that summarizes the estimated quantities for milling, overbuild, and structural courses will be necessary.
- (3) Cross sections depicting superelevation correction for the following locations:
 - (a) At the PC and at the PT.
 - (b) Fifty feet before and after the PC and PT.
 - (c) At 300 ft. intervals within the curve.

For curbed roadways, superelevation correction should be provided by reconstructing or adjusting the curve to accommodate overbuild. When a correction is not possible, provide other measures appropriate to improve identified safety or operational problems.

Table 210.9.1 Superelevation Rates for $e_{max} = 0.10$

Superelevation Rates ($e_{max} = 0.10$) Tabulated Values																	
Degree of Curve (D)	Radius R (ft.)	Design Speed (mph)															
		30	35	40	45	50	55	60	65	70							
0° 15'	22,918	NC	NC	NC	NC	NC	NC	NC	NC	NC							
0° 30'	11,459	NC	NC	NC	NC	NC	NC	RC	RC	RC							
0° 45'	7,639	NC	NC	NC	NC	RC	RC	0.023	0.025	0.028							
1° 00'	5,730	NC	NC	NC	RC	0.021	0.025	0.030	0.033	0.037							
1° 15'	4,584	NC	NC	RC	0.022	0.026	0.031	0.036	0.041	0.046							
1° 30'	3,820	NC	RC	0.021	0.026	0.031	0.037	0.043	0.048	0.054							
	*R _{NC}																
2° 00'	2,865	RC	0.022	0.028	0.034	0.040	0.048	0.055	0.062	0.070							
	*R _{RC}																
2° 30'	2,292	0.021	0.028	0.034	0.041	0.049	0.058	0.067	0.075	0.085							
3° 00'	1,910	0.025	0.032	0.040	0.049	0.057	0.067	0.077	0.087	0.096							
3° 30'	1,637	0.029	0.037	0.046	0.055	0.065	0.075	0.086	0.095	0.100							
4° 00'	1,432	0.033	0.042	0.051	0.061	0.072	0.083	0.093	0.099	D _{max} = 3° 30'							
5° 00'	1,146	0.040	0.050	0.061	0.072	0.083	0.094	0.098	D _{max} = 4° 15'								
6° 00'	955	0.046	0.058	0.070	0.082	0.092	0.099	D _{max} = 5° 15'	D _{max} = 6° 30'	D _{max} = 8° 15'							
7° 00'	819	0.053	0.065	0.078	0.089	0.098	D _{max} = 6° 30'										
8° 00'	716	0.058	0.071	0.084	0.095	0.100	D _{max} = 8° 15'	D _{max} = 10° 15'	D _{max} = 13° 15'	D _{max} = 17° 45'							
9° 00'	637	0.063	0.077	0.089	0.098	D _{max} = 10° 15'	D _{max} = 13° 15'	D _{max} = 17° 45'	D _{max} = 24° 45'								
10° 00'	573	0.068	0.082	0.094	0.100												
11° 00'	521	0.072	0.086	0.097	D _{max} = 10° 15'	D _{max} = 13° 15'	D _{max} = 17° 45'	D _{max} = 24° 45'	D _{max} = 24° 45'	D _{max} = 24° 45'							
12° 00'	477	0.076	0.090	0.099													
13° 00'	441	0.080	0.093	0.100	D _{max} = 13° 15'	D _{max} = 17° 45'	D _{max} = 24° 45'	D _{max} = 24° 45'	D _{max} = 24° 45'	D _{max} = 24° 45'							
14° 00'	409	0.083	0.096	D _{max} = 13° 15'													
15° 00'	382	0.086	0.098														
16° 00'	358	0.089	0.099	D _{max} = 17° 45'	D _{max} = 24° 45'	D _{max} = 24° 45'	D _{max} = 24° 45'	D _{max} = 24° 45'	D _{max} = 24° 45'	D _{max} = 24° 45'							
18° 00'	318	0.093	D _{max} = 17° 45'														
20° 00'	286	0.097															
22° 00'	260	0.099	D _{max} = 24° 45'	D _{max} = 24° 45'	D _{max} = 24° 45'	D _{max} = 24° 45'	D _{max} = 24° 45'	D _{max} = 24° 45'	D _{max} = 24° 45'	D _{max} = 24° 45'							
24° 00'	239	0.100															
		D _{max} = 24° 45'	D _{max} = 24° 45'	D _{max} = 24° 45'	D _{max} = 24° 45'	D _{max} = 24° 45'	D _{max} = 24° 45'	D _{max} = 24° 45'	D _{max} = 24° 45'	D _{max} = 24° 45'							
<p>Notes:</p> <p>NC = Normal Crown (-0.02) RC = Reverse Crown (+0.02) R_{NC} = Minimum Radius for NC R_{RC} = Minimum Radius for RC</p> <p>(1) Rates for intermediate D's and R's are to be interpolated. (2) Degree of Curvature (D) on high speed curbed roadways must not exceed: 2° 30' for 50 mph and 2° 00' for 55 mph. (3) Degree of Curvature (D) on interstate must not exceed 3° 00' for 70 mph.</p>																	
* NC/RC (- -) and RC/e (—) Break Points (Radius in feet)																	
Break Points	Design Speed (mph)																
	30	35	40	45	50	55	60	65	70								
R _{NC}	3349	4384	5560	6878	8337	9949	11709	13164	14714								
R _{RC}	2471	3238	4110	5087	6171	7372	8686	9783	10955								

Table 210.9.2 Superelevation Rates for $e_{max} = 0.05$

Superelevation Rates ($e_{max} = 0.05$) Tabulated Values					
Degree of Curve (D)	Radius (R) (feet)	Design Speed (mph)			
		25-30	35	40	45
2° 00'	2,865	NC	NC	NC	NC
2° 15'	2,546				
2° 45'	2,083				NC
3° 00'	1,910				RC
3° 45'	1,528			NC	
4° 00'	1,432			RC	
4° 45'	1,206				
5° 00'	1,146		NC		
5° 15'	1,091		RC		
5° 30'	1,042				
5° 45'	996				
6° 00'	955				RC
6° 15'	917				0.022
6° 30'	881				0.024
6° 45'	849				0.027
7° 00'	819	NC			0.030
7° 15'	790	RC			0.033
7° 30'	764				0.037
7° 45'	739				0.041
8° 00'	716			RC	0.045
8° 15'	694			0.022	0.050
8° 30'	674			0.025	D _{max} =
8° 45'	655			0.027	8° 15'
9° 00'	637			0.030	
9° 30'	603			0.034	
10° 00'	573			0.040	
10° 30'	546		RC	0.047	
11° 00'	521		0.023	D _{max} =	
11° 30'	498		0.026	10° 45'	
12° 00'	477		0.030		
13° 00'	441		0.036		
14° 00'	409	RC	0.045		
15° 00'	382	0.023	D _{max} =		
16° 00'	358	0.027	14° 15'		
17° 00'	337	0.032			
18° 00'	318	0.038			
19° 00'	302	0.043			
20° 00'	286	0.050			
		D _{max} = 20° 00'			

Notes:
 (1) NC = Normal Crown (-0.02), RC = Reverse Crown (+0.02)
 (2) Rates for intermediate D's and R's are to be interpolated.
 (3) Design speeds of 25 mph are to be designed as 30 mph.

Table 210.9.3 Superelevation Transition Slope Rates

# Lanes One Direction	Superelevation Transition Slope Rates						
	$e_{max} = 0.10$				$e_{max} = 0.05$		
	Design Speed (mph)				Design Speed (mph)		
	25-40	45-50	55-60	65-70	25-35	40	45
1-Lane & 2-Lane	1:175	1:200	1:225	1:250	1:100	1:125	1:150
3-Lane	---	1:160	1:180	1:200			
4-Lane or more	---	1:150	1:170	1:190			

Notes:

$e_{max} = 0.10$:

- (1) The length of superelevation transition is to be determined by the relative slope rate between the travel way edge of pavement and the profile grade, except that the minimum length of transition is 100 feet.
- (2) For additional information on transitions, see the [Standard Plans, Index 000-510](#).

$e_{max} = 0.05$:

- (1) The length of superelevation transition is to be determined by the relative slope rate between the travel way edge of pavement and the profile grade, except that the minimum length of transition is 50 feet for design speeds 25-35 mph and 75 feet for design speeds 40-45 mph.
- (2) A slope rate of 1:125 may be used for 45 mph under restricted conditions.
- (3) For additional information on transitions, see the [Standard Plans, Index 000-511](#).

210.10 Vertical Alignment

The profile grade line defines the vertical alignment for roadway and bridge construction. The profile grade line is a series of tangents connected by vertical curves. For undivided highways the profile grade line is typically located at the horizontal centerline of the roadway. For divided highways a profile grade line should be established for each direction of travel.

Vertical alignments must meet criteria in the **FDM** to assure proper transitions, sight distances, and clearances.

210.10.1 Grades

The slope or grade of each tangent is expressed in percent rise (+) or fall (-); e.g., +2.000% or -2.000%. The maximum grades that may be used in establishing the vertical alignment is given in **Table 210.10.1**.

Table 210.10.1 Maximum Grades

Context Classification	Maximum Grades (percent)								
	Design Speed (mph)								
	25-30	35	40	45	50	55	60	65	70
C1 Natural C2 Rural	N/A	N/A	N/A	N/A	4	4	3	3	3
C2T Rural Town C3 Suburban C4 Urban General	8	7	7	6	6	5	N/A	N/A	N/A
C5 Urban Center C6 Urban Core	8	8	N/A	N/A	N/A	N/A	N/A	N/A	N/A

Notes:

- (1) Maximum grade used should not exceed 4% when truck volume \geq 10% for all context classifications.
- (2) For RRR projects, when existing grades do not meet the above requirements but meet the standards in effect at the time of construction, the existing grade may remain.
- (3) N/A indicates this combination of design speed and context classification is outside the intended design range and should be avoided. See **Table 201.5.1** for context classifications and design speed ranges.

The point where tangents intersect is known as the vertical point of intersection (VPI). When two tangent grades intersect and no vertical curve is provided, the “kink” is known as the point of intersect (PI). The maximum change in grade (i.e., algebraic change) without a vertical curve is provided in **Table 210.10.2**.

Table 210.10.2 Maximum Change in Grade without Vertical Curve

Maximum Change In Grade Without Vertical Curve (percent)								
Design Speed (mph)								
25-30	35	40	45	50	55	60	65	70
1.00	0.90	0.80	0.70	0.60	0.50	0.40	0.30	0.20

210.10.1.1 Curbed Roadway

The minimum distance between VPIs on curbed roadways is 250 feet. The minimum grade on curbed roadways is 0.30%.

210.10.2 Vertical Curves

A vertical curve must be provided when the change in grade of two intersecting tangent grades exceed the values shown in **Table 210.10.2**. A vertical curve is identified by a curve length (L) which is equal to the product of the K value (K) and the algebraic difference in grades (A).

Table 210.10.3 provides minimum K-Values, and **Table 210.10.4** provides minimum vertical curve lengths.

Table 210.10.3 K Values for Vertical Curves

	Minimum K Values For Curves									
	Design Speed (mph)									
	25	30	35	40	45	50	55	60	65	70
Sag	26	37	49	64	79	96	115	136	157	181
Crest (new const.)	19	31	47	70	98	136	185	245	313	401
Crest (RRR Criteria)	12	19	29	44	61	84	114	151	193	247

Notes:

Length, $L = KA$

Where: K = Rate of vertical curvature

L = Length of vertical curve, (feet)

A = Algebraic difference in grades, (percent)

- (1) New Construction K values are based on an eye height of 3.5 feet and an object height of 6 inches. RRR Criteria K values are based on an eye height of 3.5 feet and an object height of 2 feet.
- (2) The minimum curve length must not be less than values shown in **Table 210.10.4**.

Table 210.10.4 Minimum Vertical Curve Lengths

	Minimum Curve Length (feet)									
	Design Speed (mph)									
	25	30	35	40	45	50	55	60	65	70
Sag	75	90	105	120	135	200	250	300	350	400
Crest						300	350	400	450	500

210.10.2.1 RRR Criteria for Vertical Curves

Table 210.10.3 provides RRR Criteria K values to be used to check the sufficiency of existing crest vertical curves. **2001 AASHTO Green Book** revised its K values to reflect a 2-foot object height; FDOT has not adopted this change for new construction but these K values can be used to check existing curves. An existing crest vertical curve that does not meet the minimum RRR Criteria K value requires a Design Exception or Design Variation to remain.

When crash data indicates that an evaluation is required, consider the following:

- (1) The nature of potential hazards hidden by a hill crest.
- (2) The location of the hazard in relation to the portion of the highway where sight distance falls below new construction criteria.
- (3) Effectiveness of other options such as relocating or correcting the hazard.
- (4) Providing warning signs.

Sag vertical curves do not typically pose stopping sight distance problems. A sag vertical curve that does not meet the minimum K value in **Table 210.10.3** and does not have a crash history, does not require a Design Exception or Design Variation to remain.

210.10.3 Vertical Clearances

Consider the following vertical clearance requirements when developing the vertical alignment:

- (1) Minimum clearances for bridge structures are given in **FDM 260.6 and FDM 260.8**.
- (2) Minimum clearance from the bottom of the roadway base course to the Base Clearance Water Elevation is 3 feet, except as noted below. These exceptions will require a reduction in the design resilient modulus in accordance with the [Flexible Pavement Design Manual](#). Coordinate with the Pavement Design Engineer for the following facilities:
 - (a) 2-lane roadways in context classification C1, C2, C2T and C3, and all ramps may be reduced to a 2-foot clearance.
 - (b) Low point on ramps at crossroads may be reduced to a 1-foot clearance.
 - (c) All other facilities in context classifications C4 through C6 may be reduced to a 1-foot clearance.

- (3) The relationship between the pavement elevation and the Design Flood Elevation is discussed in **Section 4.4 (3)** of the **FDOT Drainage Manual (Topic No. 625-040-002)**.
- (4) The [Drainage Manual, Appendix C](#) lists minimum covers and maximum fill heights for all types of culverts.
- (5) For utility clearances, refer to the [Utility Accommodation Manual](#).
- (6) The required clearance for new overhead sign structures is 17.5 feet. This clearance is the least distance measured between the lowest point on the sign structure and the traffic lane or shoulder directly below the sign structure. For construction affecting existing overhead sign clearances, the minimum vertical clearance is 17 feet.
- (7) The required clearance for new walk-in Dynamic Message Sign (DMS) structures is 19.5 feet. This clearance is the least distance measured between the lowest point on the DMS structure and the traffic lane or shoulder directly below the DMS structure. For any construction affecting existing DMS, the minimum vertical clearance is 19 feet.
- (8) The required clearance for new signals on span wires, mast arms, or other structures is 17.5 feet. This clearance is the least distance measured between the lowest point on the signal structure and the traffic lane or shoulder directly below the signal structure. For any construction affecting existing signal clearances, FDOT minimum vertical clearance is 17 feet. Vertical clearances between 15 feet and 17 feet require a Design Variation. Signal clearances less than 15 feet are not allowed.

210.10.4 RRR Criteria for Vertical Alignment

Vertical alignment must be reviewed together with the horizontal alignment to assure that the necessary balance of standards is realized and that the combination is both safe and pleasing.

The alignment should be reviewed to see if the following principles are satisfied by the existing vertical alignment:

- (1) The stopping sight distance provided meets or exceeds the values in **Table 210.11.1**.
- (2) Grades do not significantly affect truck operations.
- (3) There are no hidden dips which could obscure traffic or hazards.
- (4) Steep grades and sharp vertical curves do not exist at or near an intersection.

- (5) Sufficient grades and, when necessary, special gutter grades exist to adequately drain urban projects.
- (6) Adequate sight distance exists for traffic signals (e.g., beyond overpasses, etc.).

When any of the above conditions do not exist, evaluate for hazardous conditions and determine if corrective measures are warranted.

210.11 Sight Distance

The **AASHTO Green Book** has a thorough discussion on sight distance. Consider the following aspects of sight distances:

- (1) Stopping Sight Distance: Sight distances needed for stopping, which are applicable on all highways
- (2) Intersection Sight Distance: Sight distances needed by a motorist to see approaching vehicles before their line of sight is blocked by an obstruction near the intersection.
- (3) Passing Sight Distance: Sight distances needed for the passing of overtaken vehicles, applicable only on two-lane highways
- (4) Decision Sight Distance: Sight distances needed for decisions at complex locations (e.g., merging tapers, ramps, weaving sections)

210.11.1 Stopping Sight Distance

Stopping sight distance is defined as the distance needed for drivers to see an object on the roadway ahead and bring their vehicles to safe stop before colliding with the object. The distances are derived for various design speeds based on assumptions for driver reaction time, the braking ability of most vehicles under wet pavement conditions, and the friction provided by most pavement surfaces.

Stopping sight distance is influenced by both vertical and horizontal alignment. A roadway designed to criteria employs a horizontal, vertical alignment, and a cross section that provides at least the minimum stopping sight distance through the entire facility.

Minimum stopping sight distances are provided in **Table 210.11.1**. Values shown in this table are based on eye height of 3.5 feet and an object height of 6 inches.

Minimum stopping sight distances greater than shown in **Table 210.11.1** should be considered when drivers require additional time to make decisions.

Table 210.11.1 Minimum Stopping Sight Distance

Grade (percent)		Minimum Stopping Sight Distance (feet)									
		Design Speed (mph)									
		25	30	35	40	45	50	55	60	65	70
Downgrade	≤ 2	155	200	250	305	360	425	495	570	645	730
	3	158	205	257	315	378	446	520	598	682	771
	4	160	208	261	320	385	454	530	610	696	788
	5	162	211	266	326	392	464	541	623	712	806
	6	165	215	271	333	400	474	553	638	728	825
	7	167	218	276	339	408	484	565	652	746	845
	8	170	222	281	346	417	495	579	669	765	867
	9	173	227	287	354	427	507	593	686	785	891
Upgrade	≤ 2	155	200	250	305	360	425	495	570	645	730
	3	147	190	237	289	344	405	469	538	612	690
	4	146	188	234	285	339	399	462	530	602	678
	5	144	186	231	281	335	393	456	522	593	668
	6	143	184	229	278	331	388	450	515	584	658
	7	142	182	226	275	327	383	443	508	576	648
	8	141	180	224	272	323	379	438	501	568	639
	9	139	179	222	269	320	375	433	495	561	631

210.11.2 Intersections

Information and requirements on sight distance at intersections is contained in **FDM 212**.

210.11.3 Passing Sight Distance

Passing sight distance is the minimum distance that would enable a vehicle to pass another vehicle without interfering with oncoming vehicles traveling at the design speed. The minimum passing sight distance is sufficient only for the passing of a single or isolated vehicle.

Minimum passing sight distances for 2-lane, 2-way roadways are provided in **Table 210.11.2**. Values shown in this table are based on eye height of 3.5 feet and an object height of 3.5 feet.

Table 210.11.2 Minimum Passing Sight Distance

	Minimum Passing Sight Distance For 2-Lane, 2-Way Roadways (feet)									
	Design Speed (mph)									
	25	30	35	40	45	50	55	60	65	70
New Const.	900	1090	1280	1470	1625	1835	1985	2135	2285	2480
RRR	450	500	550	600	700	800	900	1000	1100	1200

The **2011 AASHTO Green Book** revised its passing sight distance values, and FDOT has not adopted this change for new construction. The new construction passing sight distance values in **Table 210.11.2** should be used to check the vertical and horizontal geometry on new alignments to provide as many passing zones as possible.

The values shown in the [Manual on Uniform Traffic Studies \(MUTS\)](#) are used as the warrants for placing no-passing zone pavement markings for all projects. The RRR values in **Table 210.11.2** should be used to verify existing pavement markings, in accordance with the No Passing Zone Study procedure included in the [MUTS](#).

210.11.4 Decision Sight Distance

The **AASHTO Green Book, Chapter 3** provides a detailed discussion on decision sight distance.

211 Limited Access Facilities

211.1 General

This chapter includes criteria for Limited Access (LA) Facilities (tolled and non-tolled), including:

- (1) Interstates
- (2) Freeways
- (3) Expressways
- (4) Interchange ramps servicing high speed LA Facilities
- (5) Collector-distributor roads (C-D) servicing high speed LA Facilities

Design Turnpike Projects in accordance with Interstate criteria unless Turnpike Project criteria is provided.

Managed lanes design is an iterative process best performed in a collaborative environment involving various disciplines (e.g., managed lanes planning, PD&E, construction, maintenance, traffic operations, transportation systems management and operations). Coordinate with the Turnpike Toll Systems and Tolls Design Offices in Phase I of the design process. An explanation of the process and considerations is given in the [FDOT Managed Lanes Guidebook](#).

Many design criteria are related to design speed (e.g., vertical and horizontal geometry, sight distance). When the minimum design values are not met, an approved Design Exception or Design Variation is required. See **FDM 201.5** for information on Design Speed. See **FDM 122** for information on Design Exceptions and Design Variations.

The following manuals and documents provide additional information for the design of LA Facilities:

- [General Tolling Requirements \(GTR\)](#) -Use this document for design criteria and requirements for tolling on Turnpike and Non-Turnpike projects.
- **AASHTO's A Policy on Geometric Design of Highways and Streets (AASHTO Green Book)**
- **A Policy on Design Standards – Interstate System, 2016 Edition (AASHTO)**
- [FDOT Managed Lanes Guidebook](#)
- [Traffic Engineering Manual \(TEM\)](#) - This manual is used to supplement the [Manual on Uniform Traffic Control Devices \(MUTCD\)](#)'s standards and

guidelines with Florida specific signs and pavement markings used on the State Highway System by the Department's Traffic Operations Offices.

Example roadway typical sections are included in the exhibits in **FDM 913**. Criteria regarding lanes, medians, and shoulders for bridges are illustrated in **FDM 260.1.1**. Subsequent sections of this chapter contain specific information and criteria regarding these and other typical section elements, as well as geometric features.

Existing project features which were constructed to meet minimum metric design criteria but are mathematically slightly less than equivalent minimum English design criteria, do not require Design Exceptions or Design Variations to remain. On reconstruction projects, every effort should be made to use current criteria and standards.

Specific requirements for toll site design (e.g., toll siting, toll facility demolition/renovation, toll facility site, toll facility building, and toll facility gantry) are given in the [General Tolling Requirements \(GTR\)](#).

211.1.1 Interstate Resurfacing Projects

Interstate resurfacing projects that do not meet the criteria in this chapter may use the AASHTO interstate standards that were in effect at the time of original construction or inclusion into the interstate system for the following elements.

- Horizontal alignment
- Vertical alignment
- Median width
- Traveled way width
- Shoulder width

Place documentation in Project Suite Enterprise Edition (PSEE) within the Design Development Documentation Module.

211.2 Travel Lanes and Auxiliary Lanes

Provide 12-foot travel lanes and auxiliary lanes on LA Facilities.

211.2.1 Ramps

On tangent sections, provide a 15-foot traveled way for one-lane ramps and 24-foot traveled way for two-lane ramps. Provide a 36-foot traveled way for three-lane ramps and 12-feet for each additional lane for ramps with more than three lanes.

Consider providing a greater lane width for one-lane ramps where accommodation of future resurfacing is a factor.

Ramp widths in other areas such as terminals are controlled by the curvature and the vehicle type selected as the design control. Minimum ramp widths for turning roadways are given in **Table 211.2.1**. Typical details for ramp terminals are provided in the [Standard Plans](#), **Index 000-525**.

Table 211.2.1 Minimum Ramp Widths - Turning Roadways

Radius To Inside of Curve (ft.)	Minimum Ramp Width (ft.)		
	1-Lane		2-Lane
	Case I-C Traveled Way Width	Case II-B Traveled Way Width + Outside Paved Shoulder Width	Case III-A Traveled Way Width
	One-lane, one-way operation – no provision for passing a stalled vehicle	One-lane, one-way operation – with provision for passing a stalled vehicle	Two-lane operation – either one-way or two-way
50	23	26	29
75	20	23	27
100	18	22	26
150	17	21	24
200	16	20	24
300	15	20	24
400	15	19	24
≥ 500	15	19	24

Notes:

- (1) For case application, see **AASHTO Green Book**.
 - (a) Case I - Bus and combination trucks govern design.
 - (b) Case II - SU vehicles govern design, some consideration for semitrailer combination trucks.
 - (c) Case III – P vehicles govern design, some consideration for SU trucks.
- (2) **AASHTO** adjustments do not apply.

211.2.2 Pavement Cross Slopes

For roadways, the maximum number of travel lanes with cross slope in one direction is three lanes except as shown in **Figure 211.2.1**, which prescribes standard pavement cross slopes. A Design Variation or a Design Exception is required when proposed pavement cross slopes do not meet the requirements shown in **Figure 211.2.1**.

Outside auxiliary lane cross slopes must match or exceed adjacent travel lane cross slope. The auxiliary lane cross slope cannot exceed the values in **Figure 211.2.1**. In superelevation transitions, do not exceed the maximum algebraic differences shown in **Table 211.2.2**.

The maximum algebraic difference in cross slope between adjacent through lanes is 0.04. The maximum algebraic difference in cross slope between a through lane and an auxiliary lane at a turning roadway terminal is given in **Table 211.2.2**.

Cross slopes on bridges are to be on a uniform, straight-line rate, typically 0.02 (See **FDM 260.4**). Use transitions to adjust for differences in cross slope between the approach roadway section and the required straight-line slope for bridge decks. Whenever possible the transition should be accomplished on the roadway section, outside the limits of the bridge and approach slabs. This will require detailing of the transition(s) in the roadway plans. Coordination between the Roadway, Drainage and Structures designers in the development of transitions is required to ensure compatibility and harmonizing at bridge approaches.

For shoulder cross slope transitions at bridge approaches, use adjacent travel lane transition rate where feasible. The minimum length of transition is 100 feet.

Figure 211.2.1 Standard Pavement Cross Slopes

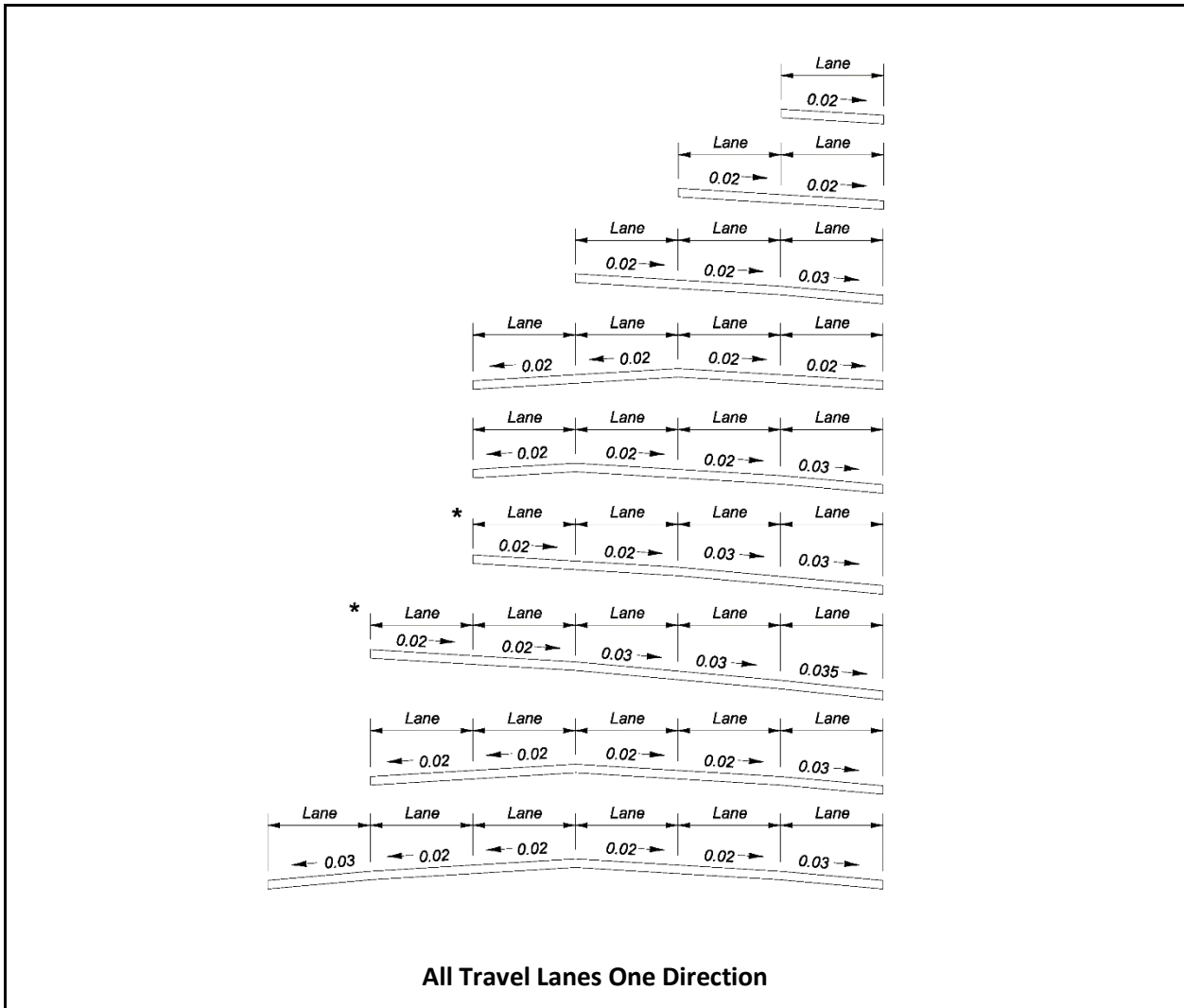

Notes:

- (1) These sections show only the standard slopes for adjoining travel lanes; they do not prescribe needed lanes, lane usage or typical section requirements other than lane slope.
- (2) Maximum pavement cross slopes for tangent sections are:
 - (a) 0.03 for design speeds greater than 45 mph
 - (b) 0.035 may only be used for 5-lanes sloped in one direction as shown above.
- (3) The maximum change in cross slope between adjacent through lanes is 0.04.
- (4) 4 or 5 lanes sloped in one direction (*) may be used with design speed 65 mph or less and longitudinal grades not exceeding 5%.

Table 211.2.2 Maximum Algebraic Difference in Cross Slope at Turning Roadway Terminals

Design Speed of Exit or Entrance Curve (mph)	Maximum Algebraic Difference in Cross Slope at Crossover Line (%)
Less than 35	6.0
35 and over	5.0

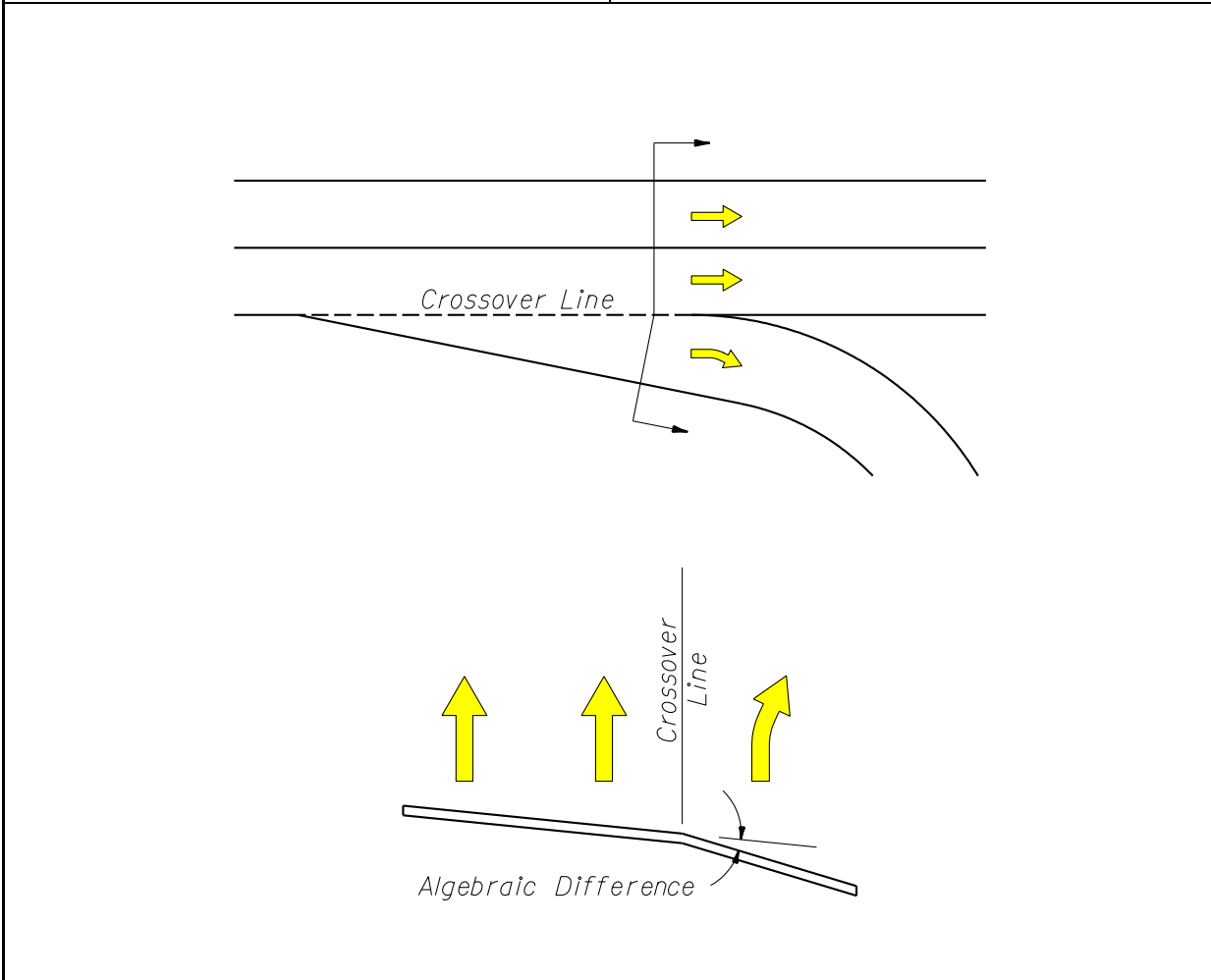

211.2.2.1 Existing Pavement Cross Slopes

Review the existing pavement and shoulder cross slopes for compliance with criteria. Field verify existing pavement and shoulder cross slopes by one of the following:

- (1) Full Digital Terrain Model for the roadway width – evaluate cross slope on tangent sections at 100-foot intervals.
- (2) Vehicle Mounted Scanner – prior to design, using the results of the scan, determine roadway limits where cross slope is potentially out of tolerance and request Digital Terrain Model of the roadway width for these limits. Evaluate cross slope on tangent sections at 100-foot intervals.

If cross slopes do not meet the values in **Table 211.2.3**, additional cross sections may be required by the designer to develop cross slope correction details and estimate material quantities. Resurfaced pavement and shoulder cross slopes should meet new construction criteria. When cross slope correction is not practical, documentation in the design file is required. If existing conditions are within the allowable range shown in **Table 211.2.3**, the term “Match Existing” may be used on the Typical Section(s) to indicate that the existing cross slope is to remain. Superelevation requirements are covered in **FDM 211.8**.

When cross slope correction is necessary, work closely with the District Pavement Design Engineer and the District Bituminous Engineer to determine the appropriate method of correction. Tabulate existing cross slopes in the plans at 100-foot intervals within the limits of cross slope correction. Include cross slope correction details showing the method of correction in the plans (see examples in **FDM 913**). Do not show cross slope correction details on the roadway cross sections. Base cross slope correction material quantities on the method of correction shown in cross slope correction details.

Table 211.2.3 Allowable Range for Existing Pavement Cross Slopes

Facility or Feature	Standard (ft./ft.)	Allowable Range (ft./ft.)
Travel Lanes	0.02	0.015 - 0.025
Travel Lanes	0.03	0.025 - 0.035
Outside Shoulder	0.06	Adjacent Lane Cross Slope - 0.080
Median (left) Shoulder	0.05	0.020 - 0.080

Notes:

- (1) Standard cross slope (0.02 or 0.03) as designated in **Figure 211.2.1**.
- (2) The algebraic difference in cross slope between adjacent travel lanes must not exceed 0.04. The maximum algebraic difference in cross slope between a through lane and an auxiliary lane at a turning roadway terminal must meet **Table 211.2.2**.
- (3) When existing shoulders are to remain, the algebraic difference between the shoulder slope and adjoining roadway pavement slope must be ≤ 0.07 .
- (4) Outside auxiliary lanes must match or exceed adjacent travel lane cross slopes with a maximum cross slope of 0.035.

211.2.3 Hydroplaning Risk Analysis

The hydroplaning risk analysis predicts the water film thickness on the pavement being analyzed and the speed at which hydroplaning may theoretically occur. This information may support utilizing a non-compliant typical section when weighed against the cost of correcting pavement cross slope.

A hydroplaning analysis is required for projects with the following:

Additional contributing pavement (ex: managed lane buffer, paved shoulder, paved gore, auxiliary lane, etc.) is added to the standard pavement cross slope sections shown in **Figure 211.2.1**.

Superelevated sections as outlined in **Table 211.2.4**.

Ungrooved bridge decks that exceed the requirements outlined above. Grooved bridge decks do not require an analysis.

Include hydroplaning calculations in the hydroplaning analysis. Where a risk is identified, provide a risk evaluation in report format that includes identification and benefit-cost

analysis of mitigating strategies. Submit the preliminary analysis with the 15% line and grade or Draft Typical Section Package (whichever is submitted first). Provide a final recommendation in conjunction with the Final Typical Section Package.

Table 211.2.4 Hydroplaning Analysis Requirements in Superelevated Sections

Project Type	Number of Lanes Draining in One Direction		
	Less Than 3 Lanes	3 Lanes	More Than 3 Lanes
Capacity Improvements & New Alignments	Not required	Only when superelevation of lowest lane is less than 3% or when there have been 2 or more wet weather crashes within the available 5-year crash data	Always required
RRR	Not required	Only required when there have been 2 or more wet weather crashes within the available 5-year crash data	
Notes:			
(1) Wet weather crashes attributable to hydroplaning conditions.			

For bridge transitions, evaluate mitigating strategies such as shortening transitions and staggering the cross slope transitions prior to evaluating more costly solutions (i.e. bridge replacement and pavement type changes that require additional design details and a benefit-cost analysis.)

Use the HP Program and the Design Guidance: Hydroplaning Risk Analysis to perform hydroplaning risk analysis. The Hydroplaning Tools can be downloaded under Design Aids at:

<https://www.fdot.gov/roadway/drainage/hydroplaning>

211.2.4 Roadway Transitions

The minimum merging roadway transition length (L) is calculated as follows:

- (1) Use $L = WS$ for design speeds ≥ 45 mph

(2) Use $L = WS^2/60$ for design speeds ≤ 40 mph

Where: L = length of taper, feet

W = width of lateral transition, feet

S = design speed, mph

Exhibits 210-1 through **210-6** illustrate standard roadway transitions. For conditions not addressed in these figures, use the following:

(1) Merging Taper = L

(2) Shifting Taper = L/2

(3) Shoulder Taper = L/3

Where an abrupt change in roadway typical (e.g., 4-lane section to a 6-lane section) a striped lane transition may be considered when all the following conditions are met:

- New pavement widths are not substantially greater than the joining pavement,
- Grade differentials are slight, and
- Future widening is expected.

211.2.5 Number of Lanes on the State Highway System

See **Section 335.02(3)** of the *Florida Statutes* for the number of lanes to be provided on the State Highway System. Nothing in this statute precludes a number of lanes in excess of ten lanes. The Department will determine the appropriate number of lanes based on traffic demand. Consideration will be given to availability of right of way and the capacity to accommodate other modes of transportation within existing rights of way.

Topic No.: 525-030-020a Capacity Improvement Alternatives is the Department policy to assist in the identification of the most appropriate option for widening projects on all LA Facilities on the State Highway System (SHS). This policy applies to the Interstate System and to Florida's Turnpike Enterprise facilities.

211.3 Medians

Median width is the distance between the inside (median) edge of the travel lane of each roadway. Required median widths are given in **Table 211.3.1**.

Median ditches must be designed to meet the following requirements:

- Have sufficient depth to provide positive drainage of the adjacent subgrades. Typically, this requires a median depth of at least one foot below the subgrade shoulder point.
- Have recoverable side slopes within the clear zone in order to facilitate the recovery of errant vehicles. See **FDM 215** for additional information on roadside safety.
- Have sufficient longitudinal gradient and hydraulic capacity to ensure good drainage.

Table 211.3.1 Minimum Median Widths

Facility Type		Minimum Median Width (ft.)
Interstate, Without Barrier		64
Freeway and Expressway, Without Barrier	Design Speed ≥ 60 mph	60
	Design Speed < 60 mph	40
All, With Barrier		26
Notes:		
(1) For Interstate (without barrier), provide an 88-foot median width when future lanes are planned.		

Facilities that have the ability to be expanded for additional capacity in the future will be designed to accommodate that future expansion. For example, a 4-lane high-speed facility that has the potential to expand to a 6-lane facility (without managed lanes) may be designed with a 50-foot median with barrier (e.g. guardrail, high tension cable barrier) instead of the required 60-foot median. A 50-foot median will accommodate a future 2-foot concrete median barrier, two 12-foot travel lanes and two 12-foot shoulders.

211.3.1 Bridge Median

See **FDM 260.5** for information on bridge medians.

211.3.2 Median Crossovers

This section addresses permanent median crossovers (i.e., median openings). The criteria in this section does not apply to contra-flow crossovers placed for facilitating hurricane evacuation, nor does it apply to temporary construction crossovers.

Permanent crossovers are necessary to avoid excessive travel distances for emergency vehicles, law enforcement vehicles, and maintenance vehicles. Provide median crossovers only when there is a documented request and need for such a feature; however, they are to be limited in number and strategically located. The District Design Engineer (DDE) and the District Traffic Operations Engineer (DTOE) jointly approve the location of median openings.

The following **AASHTO Green Book** crossover recommendations have been adopted by the Department as requirements for permanent crossovers:

- (1) Not spaced closer than 3 miles apart.
- (2) Located only in areas with above-minimum stopping sight distance and without superelevated curves.
- (3) Not located within 1,500 feet of the end of a speed-change taper (of a ramp or facility widening/narrowing) or any structure (bridge, overpassing facility or overhead sign).
- (4) Not located where the median width is less than 25 feet.

Crossover locations that do not meet the above criteria require approval by the State Roadway Design Engineer. Non-conforming crossovers on Interstate facilities require approval by the State Roadway Design Engineer and Federal Highway Administration (FHWA).

The following additional FDOT criteria are also requirements for permanent crossovers:

- (1) Not located within 1.5 miles of any interchange.
- (2) Not located where the median width is less than 40 feet.
- (3) Not located in urban areas
- (4) Where continuous median barrier is present, openings for crossovers should not be greater than 5 miles apart between Interchanges.

Typical layouts for the design of median crossovers are provided in **Exhibits 211-1** and **211-2**. These typical layouts may not cover all situations, but are provided as a guide for developing site-specific designs. Designs should accommodate the types of emergency vehicles expected to use the crossover. Law enforcement vehicles and typical ambulance sized vehicles can usually be easily accommodated. The typical layouts illustrated in the exhibits accommodate a SU design vehicle. To the extent practical, designs should accommodate larger emergency response vehicles such as fire trucks. This may require obtaining information from local emergency responders on the size and configuration of vehicles used. Except where median widths are wider than normal, fire

trucks and other larger vehicles will likely not be able to make U-turns without encroaching or crossing travel lanes. As a minimum, designs should provide for the necessary minimum radii and width to allow the largest design vehicle to enter the crossover and stop as close to perpendicular to traffic as practical. All designs should be tested by superimposing the turning path of the design vehicle to insure the crossover will operate as expected.

On Interstate facilities, the FHWA directs that median shoulders approaching the crossover utilize the standard shoulder width, or existing shoulder width. FHWA advocates that the safety benefits derived by making the crossovers appear less conspicuous outweigh the benefits obtained by providing paved shoulders to accommodate acceleration and deceleration lanes for emergency vehicles, law enforcement, or other authorized vehicles.

The profile of the crossover is to conform as close as practical with travel way shoulder slopes and median side slopes so that the crossover is inconspicuous as possible to traffic. The paved width of the crossover should not be any wider than that necessary to provide for the largest design vehicle. Shoulder width for the crossover should be 8 feet minimum. Side slopes of the crossover (parallel with the mainline travel way) are to be 1:10 or flatter. However, side slopes may be transitioned to match the slope of a pipe culvert safety end treatment where a culvert crossing underneath the crossover is necessary to provide for proper median drainage.

For each proposed location, determine drainage requirements and make appropriate provisions. The drainage culvert shown in the exhibits are for example only. Either a mitered end section (1:4) or preferably a u-endwall with grate (1:6) should be used for culverts parallel with the mainline. In some cases existing median ditches are shallow and there will be minimal clearances available for even small size culverts.

Provide a pavement design equivalent to a Limited Access shoulder pavement (i.e., 12-inch Stabilized Subgrade, Base Group 1, and 1.5 inch Structural Course).

A "No U-turn" sign (R3-4) with an "Official Use Only" plaque (FTP-65-06) is required for permanent crossovers. To improve nighttime visibility for approaching emergency responders, yellow RPMs are installed on the outside yellow edge line in advance of the crossover. See [Standard Plans](#), **Index 706-001** for RPM placement.

Florida Administrative Code, [Rule 14-97](#), Section 14-97.003(3) (Access Control Classification System and Access Management Standards) regulates the location of driveway connections and median openings in interchange areas on arterial roads. This standard should be applied in accordance with the District procedures for implementing the Rule, and should not be confused with minimum requirements for LA R/W.

211.3.2.1 Existing Crossovers

On reconstruction and resurfacing projects, evaluate the location of existing crossovers for conformance to the above criteria. For those locations that do not meet the criterion in **FDM 211.3**, do one of the following:

- (1) Remove or relocate crossover as a part of the project
- (2) Crossover locations that do not meet the **AASHTO Green Book** criteria require approval by the State Roadway Design Engineer to remain. Non-conforming crossovers on Interstate facilities require approval by the State Roadway Design Engineer and Federal Highway Administration (FHWA) to remain.
- (3) Crossover locations that meet the **AASHTO Green Book** criteria, but do not meet additional FDOT criteria require approval by the District Design Engineer to remain.

211.3.3 Managed Lanes Separation

Managed lanes are always separated from the general use lanes. Median openings and crossovers are prohibited within managed lanes.

There are five types of managed lanes separation treatments:

- (1) Barrier separation; see **Figure 211.3.1**
- (2) Buffer separation with tubular markers; see **Figure 211.3.2**
- (3) Wide buffer separation; see **Figure 211.3.3**
- (4) Grade separation; see **Figure 211.3.4**
- (5) Buffer separation with pavement marking; see **Figure 211.3.5**

The minimum standard buffer width for the buffer separation is 4 feet. Any variation from a 4-foot-buffer width must be approved by the District Design Engineer. Install tubular markers per the [TEM](#), Chapter 4. Use barrier separation or grade separation when implementing a reversible managed lane system. See the [FDOT Managed Lanes Guidebook](#) for factors to consider in determining separation type.

The maximum spacing and placement of tubular markers is provided in the [TEM](#). If, based on operational and safety analysis, the EOR or the district wishes to increase the maximum allowable spacing, a Design Variation must be approved by the Chief Engineer.

When a wide buffer separation is selected, the buffer may include a grassed median or pavement. Paved wide buffers should be no more than 12 feet wide.

Figure 211.3.1 Managed Lanes Barrier Separation Typical Section

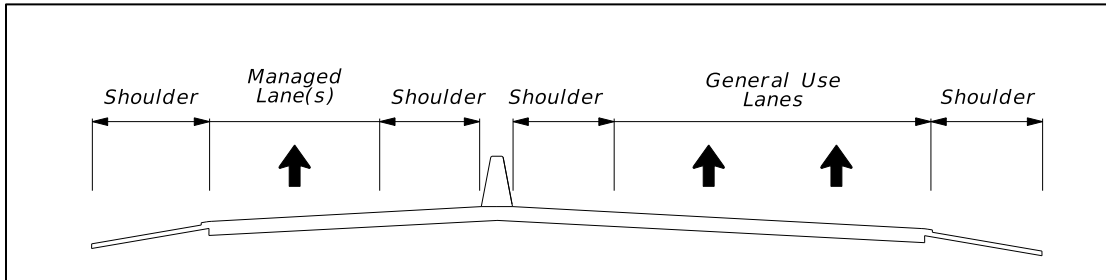

Figure 211.3.2 Managed Lanes Buffer Separation with Tubular Marker Typical Section

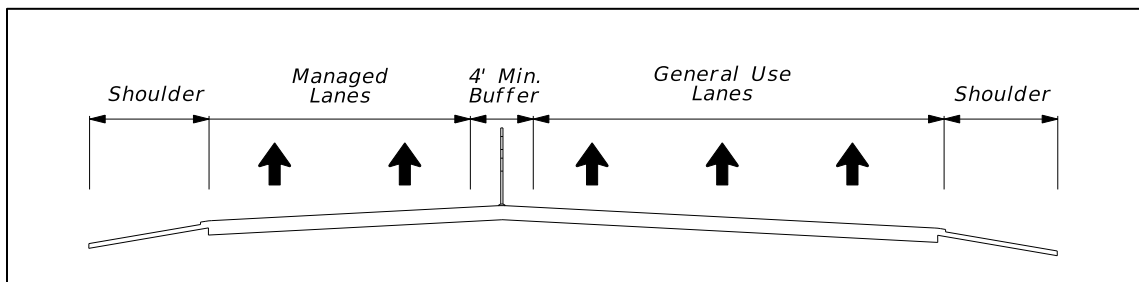

Figure 211.3.3 Managed Lanes Wide Buffer Separation Typical Section

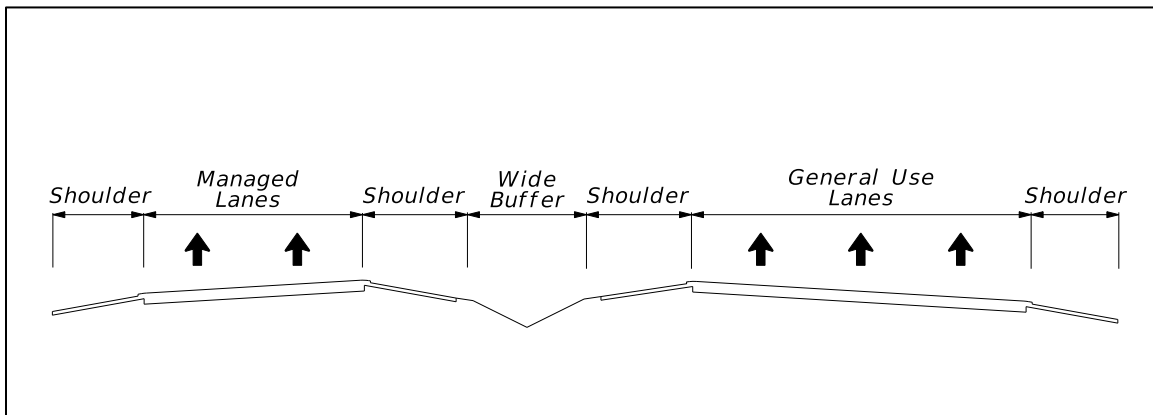

Figure 211.3.4 Managed Lanes Grade Separation Typical Section

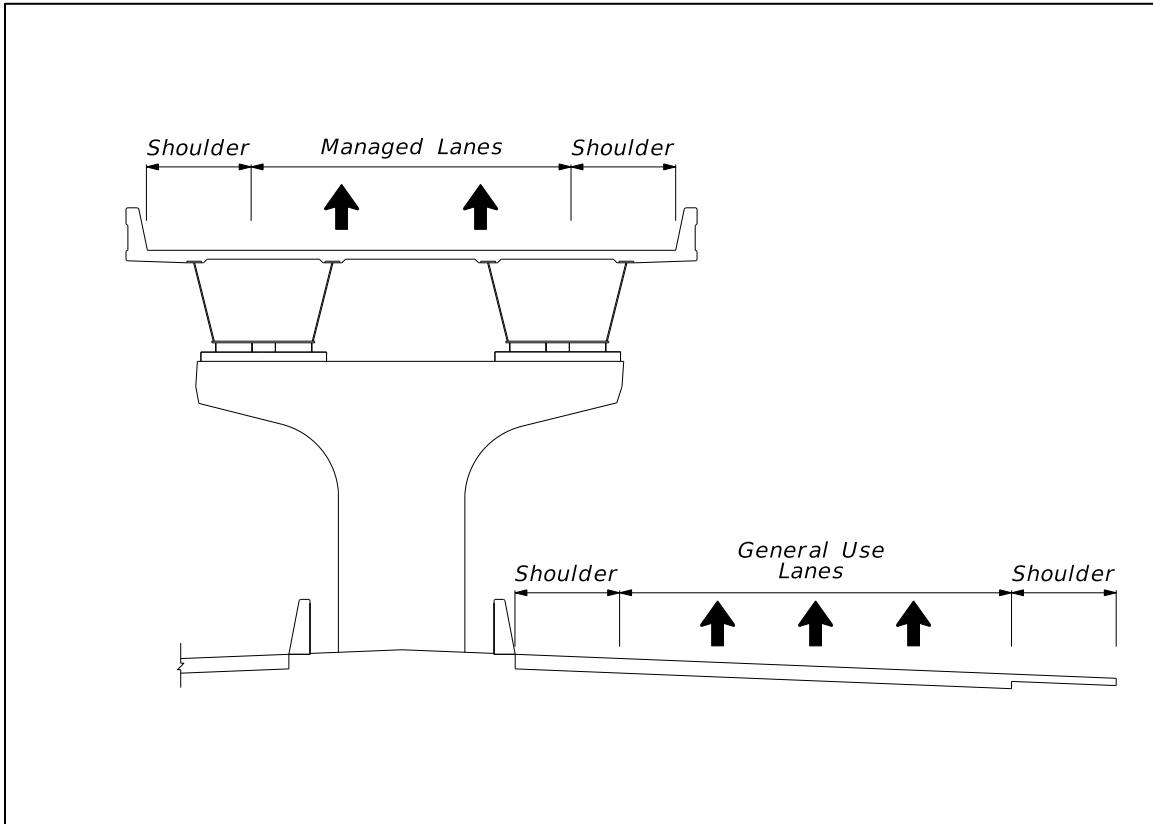
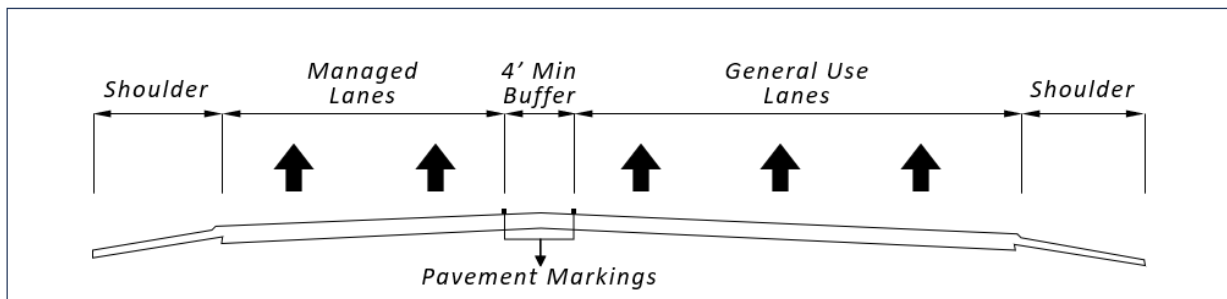
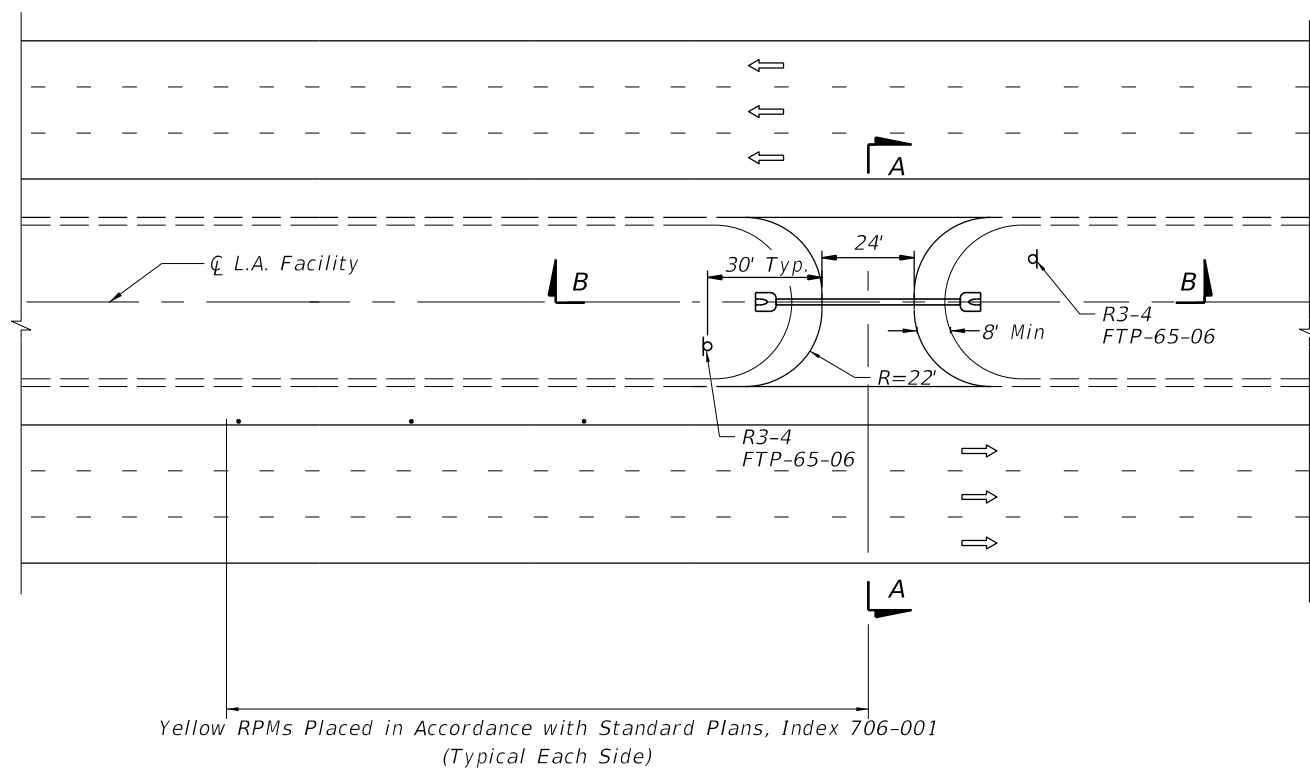

Figure 211.3.5 Managed Lanes Buffer Separation with Pavement Marking Typical Section



MEDIAN CROSSOVERS TYPICAL LAYOUTS AND SECTIONS



PLAN VIEW - 6 LANES (OR MORE)

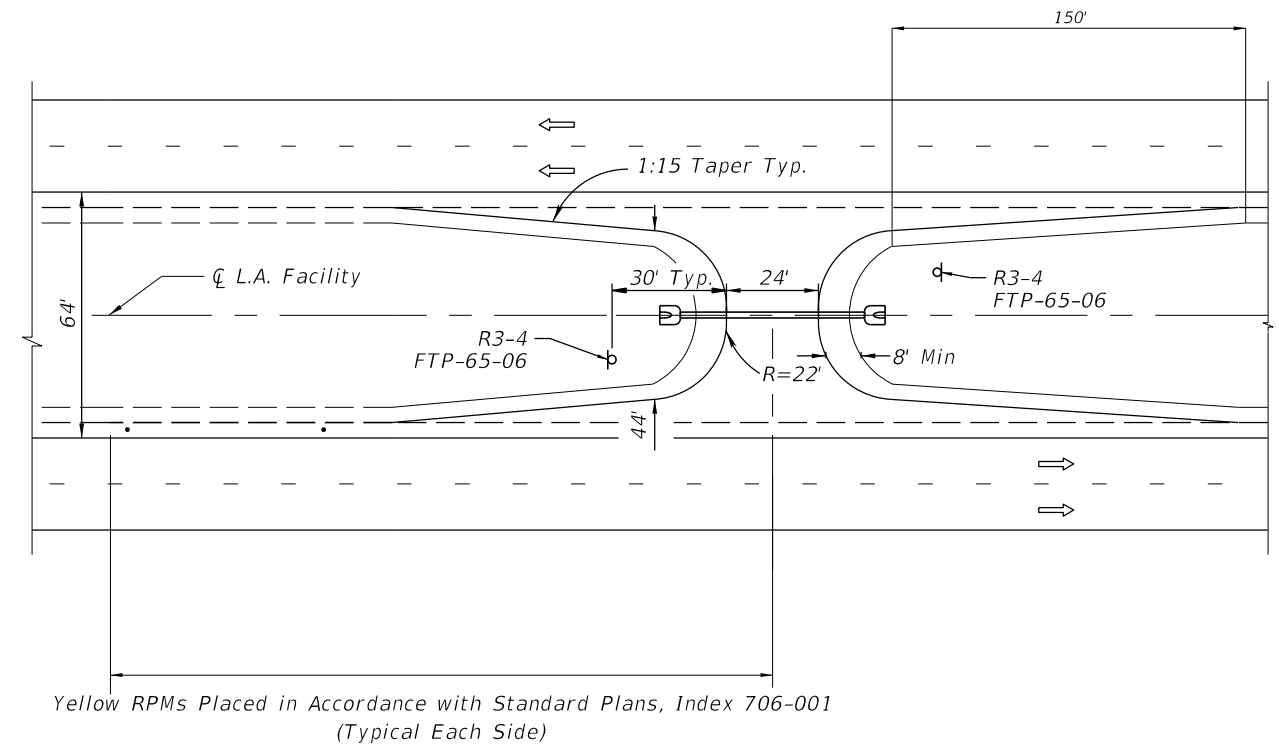

PLAN VIEW - 4 LANES

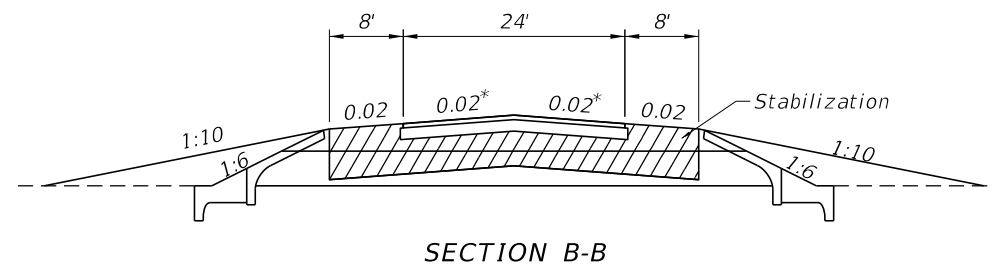
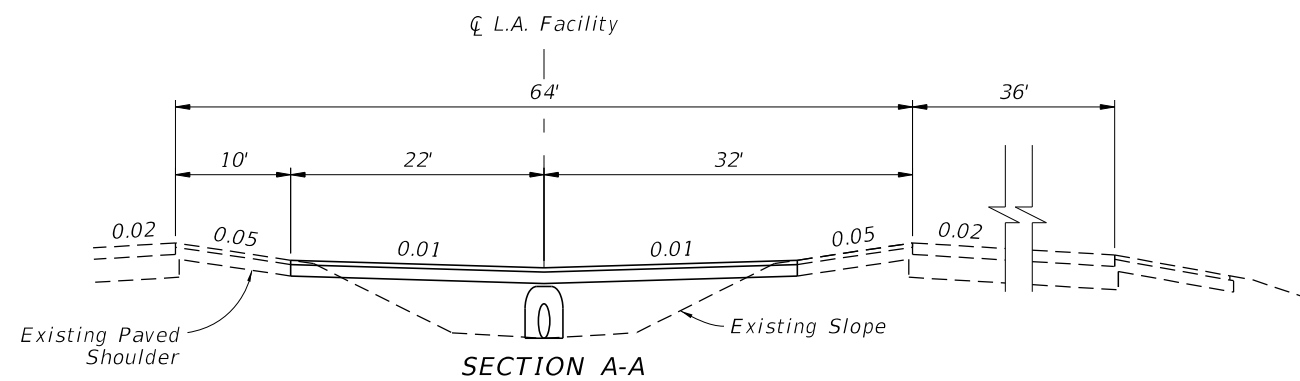

LEGEND:

Ⓟ Sign



R3-4
(36"x36")



FTP-65-06
(36"x18")

* For freeway grades 2% or greater,
match freeway grade

NOT TO SCALE

**EXHIBIT 211-1
01/01/2018**

MEDIAN BARRIER OPENING FOR MEDIAN CROSSOVERS TYPICAL LAYOUT

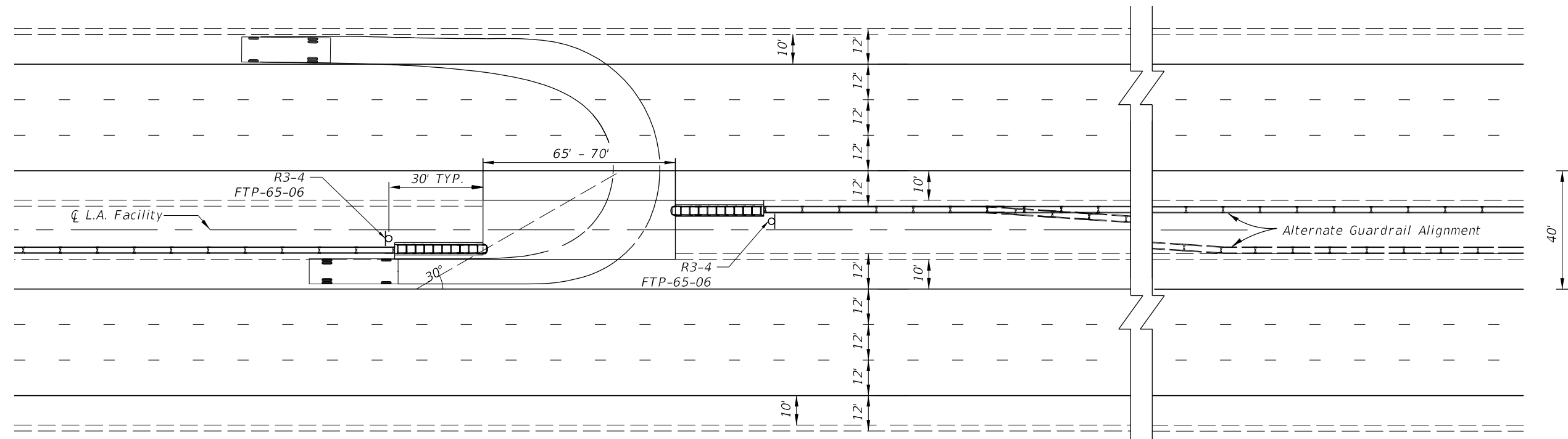

PLAN VIEW

LEGEND:

 Crash Cushion

 Barrier

 Sign

 SU Vehicle



R3-4
(36"x36")



FTP-65-06
(36"x18")

NOTES:

1. Provide Yellow RPMs placed outside yellow edge line in advance of crossover as shown in Standard Plans, Index 706-001.
2. Minimum turning radius for SU vehicle shown, and were generated by AutoTURN.
3. For lane and median configurations other than the 6-lane, 40-foot median shown here, adjustments in turn radii or additional pavement may be required.

NOT TO SCALE

EXHIBIT 211-2
01/01/2019

211.4 Shoulders

Roadway shoulder width is measured from the edge of the traveled way to the shoulder break. A portion of the shoulder is required to be paved. Minimum shoulder widths and paved widths are given in **Table 211.4.1**.

Use shoulder gutter for the following conditions:

- On embankments higher than 20 feet
- On embankments higher than 10 feet where the longitudinal slope is greater than 2 percent
- On embankments, with slopes steeper than 1:6 for more than five feet vertically, to minimize erosion
- At bridge ends where concentrated flow from the bridge deck otherwise would run down the slope
- In areas of guardrail where embankment slopes are steeper than 1:4 and any pavement is sloped toward the embankment.

Refer to **FDM 260.3** for bridge shoulder widths.

See [General Tolling Requirements \(GTR\)](#) for paved shoulder requirements at tolling locations.

211.4.1 Managed Lanes Shoulders

The required width for managed lanes shoulders depends on the type of separation between the managed lanes and the general use lanes. When retrofitting managed lanes in constrained conditions, shoulder widths in **Table 211.4.1** may not be achievable without a Design Variation or Design Exception. Consult the [Highway Safety Manual](#) on safety tradeoffs when narrowing shoulder widths.

Table 211.4.1 Minimum Shoulder Widths

Lane Type	# Lanes (One Direction)	Without Shoulder Gutter (feet)				With Shoulder Gutter (feet)			
		Outside or Right		Median Or Left On Divided Roadways		Outside or Right		Median Or Left On Divided Roadways	
		Full Width	Paved Width	Full Width	Paved Width	Full Width	Paved Width	Full Width	Paved Width
Travel Lanes	2-Lane	12	10	8	4	15.5	8	13.5	6
	3-Lane or more	12	10	12	10	15.5	8	15.5	8
Managed Lanes	1-Lane	12	12	12	12	17.5	10	17.5	10
	2-Lane	12	12	12	12	17.5	10	17.5	10
Ramps	1-Lane	6	4	6	2	11.5	4	11.5	4
	2-Lane Non-Interstate	10	8	8	4	15.5	8	13.5	6
	2-Lane Interstate	12	10	8	4	15.5	8	13.5	6
	3-Lane or more	12	10	12	10	15.5	8	15.5	8
C-D Roads	1-Lane	6	4	6	2	11.5	4	11.5	4
	2-Lane	12	10	8	4	15.5	8	13.5	6
	3-Lane or more	12	10	12	10	15.5	8	15.5	8
Aux. Lanes	ALL	12	10	8	4	15.5	8	11.5	4

Notes:

Without shoulder gutter:

- (1) For Florida's Turnpike projects with 3-Lanes or more in One Direction, provide 12-foot inside and outside paved width shoulders adjacent to travel lanes with High Volume AADT or greater than 10% trucks.
- (2) For all other LA Facilities, consider 12-foot outside paved width shoulders adjacent to travel lanes with High Volume AADT or greater than 10% trucks.
- (3) Pave the entire width of shoulders adjacent to concrete barriers. See **FDM 215.4.6.1**

With shoulder gutter:

- (1) Ramp shoulder pavement less than 6 feet in width that adjoins shoulder gutter must match the type, depth, and cross slope of the ramp travel lane.

211.4.2 Shoulder Cross Slopes

The standard cross slope is 0.06 on the outside shoulder and 0.05 on the median (or left) side for all roadway and ramp sections. **Figure 211.4.1** illustrates shoulder cross slopes in relationship to roadway cross slopes for normal and superelevated sections. For 5-foot (or less) paved shoulders, see **Figure 211.4.2**. When the inside travel lane is sloping toward the median, the inside shoulder cross slope may be increased to 0.06.

For projects constructed with concrete pavement, the first one foot of the outside shoulder is cast with the outside travel lane and will have the same cross slope (and superelevation) as the outside lane. Superelevation of the shoulder pavement is to be rotated about the outside edge of the outside slab.

Figure 211.4.1 Shoulder Superelevation

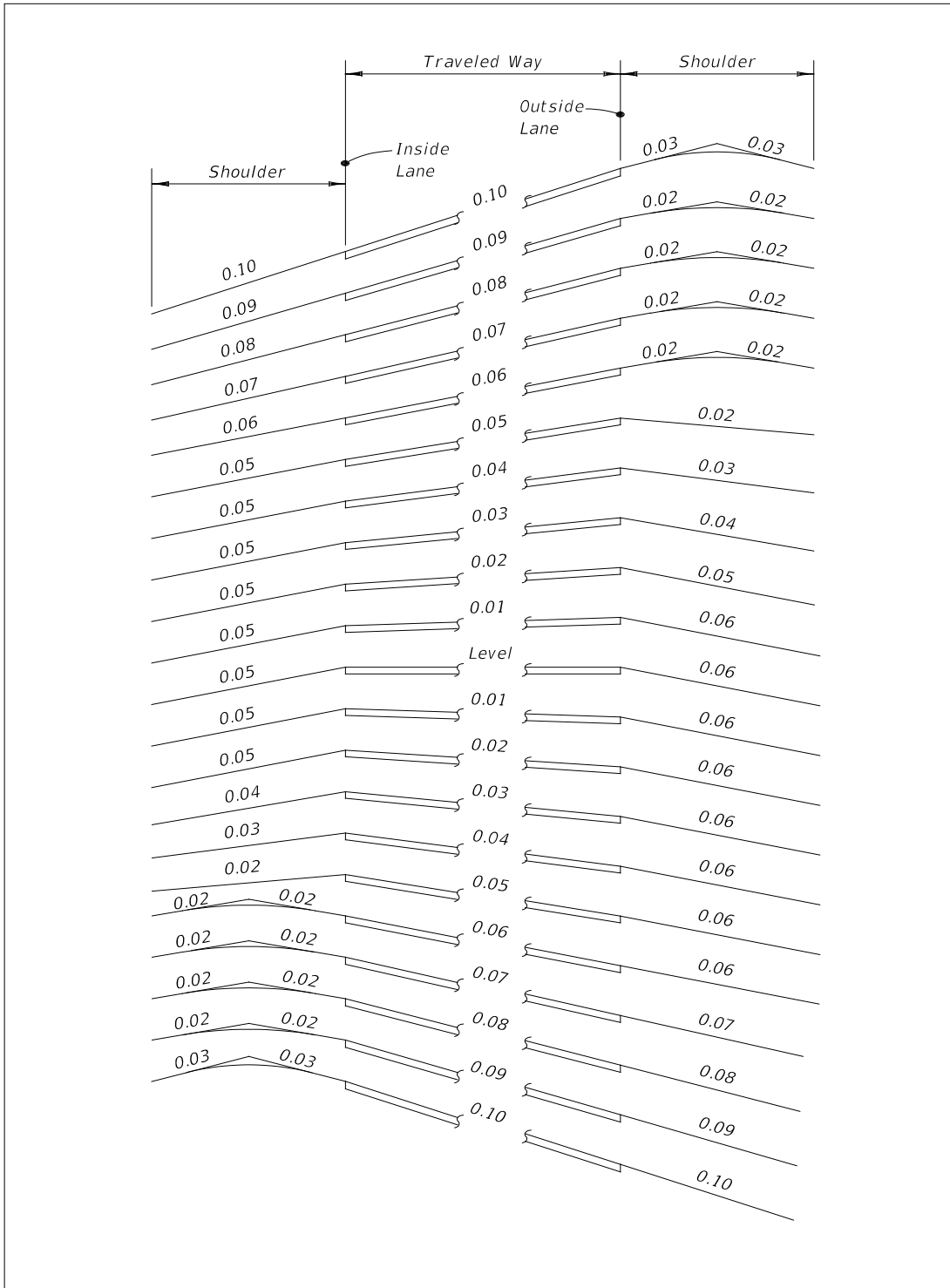
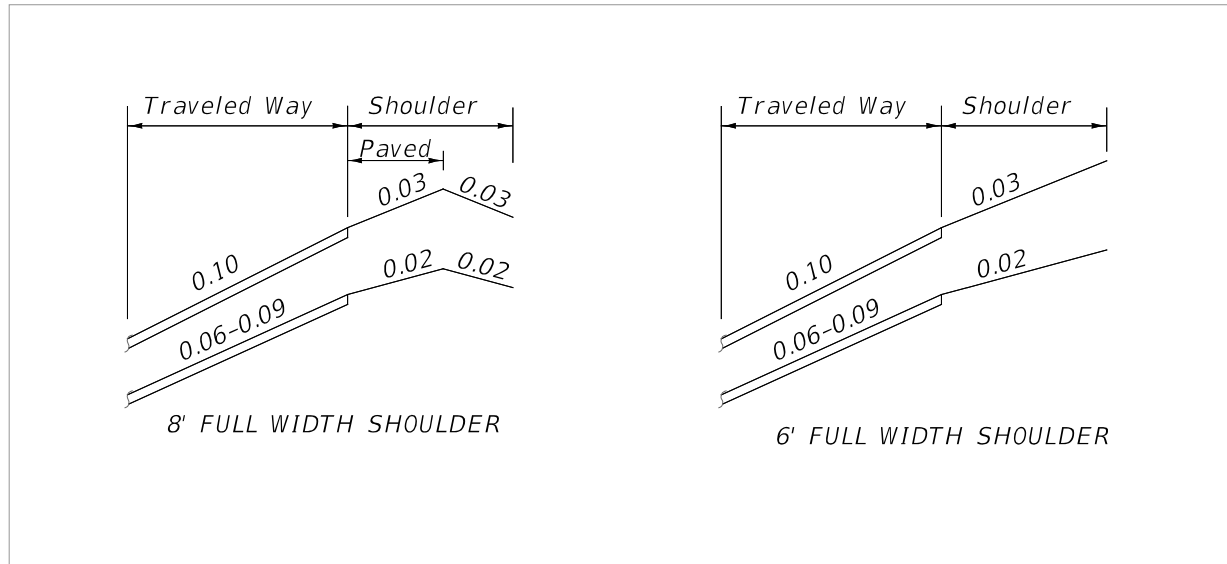

Figure 211.4.2 Special Ramp Shoulder Superelevation



211.4.2.1 Shoulder Rocking

When a minimum 0.3% longitudinal gutter grade cannot be maintained using uniform shoulder cross slopes then shoulder rocking may be used to achieve positive drainage. The cross slope for shoulders may be varied from minimum 0.03 (not flatter than adjacent lane) to a maximum 0.06 in tangent sections. The design must maintain balance between inlet spacing and flat shoulder cross slopes. To achieve a minimum distance of 100 feet between the high and low points, a 0.24% minimum longitudinal gutter grade may be used.

For shoulder rocking designed in conjunction with new single-slope concrete barriers, see the [Standard Plans Instructions](#) for **Index 521-001**.

Where existing F-Shape barriers are being used, the varying shoulder surface may intersect the barrier face within the lower 3-inch vertical portion (a.k.a., the reveal). F-Shape barriers must remain embedded in the pavement at least 1 inch deep at all locations.

For outside shoulder rocking, use one of the three options below to meet minimum spread criteria. Options 1 and 2 are preferred. Consider Option 3 only when the first two options are not feasible, as determined by the District Roadway Design and Drainage Engineers.

Option 1: Use concrete barrier with inlets to collect storm water.

- Option 2: Use guardrail with shoulder gutter and inlets to collect storm water.
- Option 3: Use guardrail in conjunction with a permanent turf reinforcement mat in fill sections with a front slope steeper than 1:4 (maximum slope of 1:2) and maximum height of 10 feet. Shear stress calculations are required to be submitted for the design/selection of the permanent turf reinforcement mat.

See **FDM 915** for shoulder rocking gutter profile plan requirements.

211.4.3 Limits of Friction Course on Paved Shoulders

Extend the friction course 8 inches onto both the median and outside paved shoulders of roadways.

For locations where median barrier wall is continuous and shoulder slopes toward the travel lane, construct the inside shoulder pavement flush with the friction course placed on the adjacent travel lane. This will address any concerns for trapping water on the shoulder as demonstrated in **Figure 211.4.3**.

Figure 211.4.3 Flush Shoulder Pavement

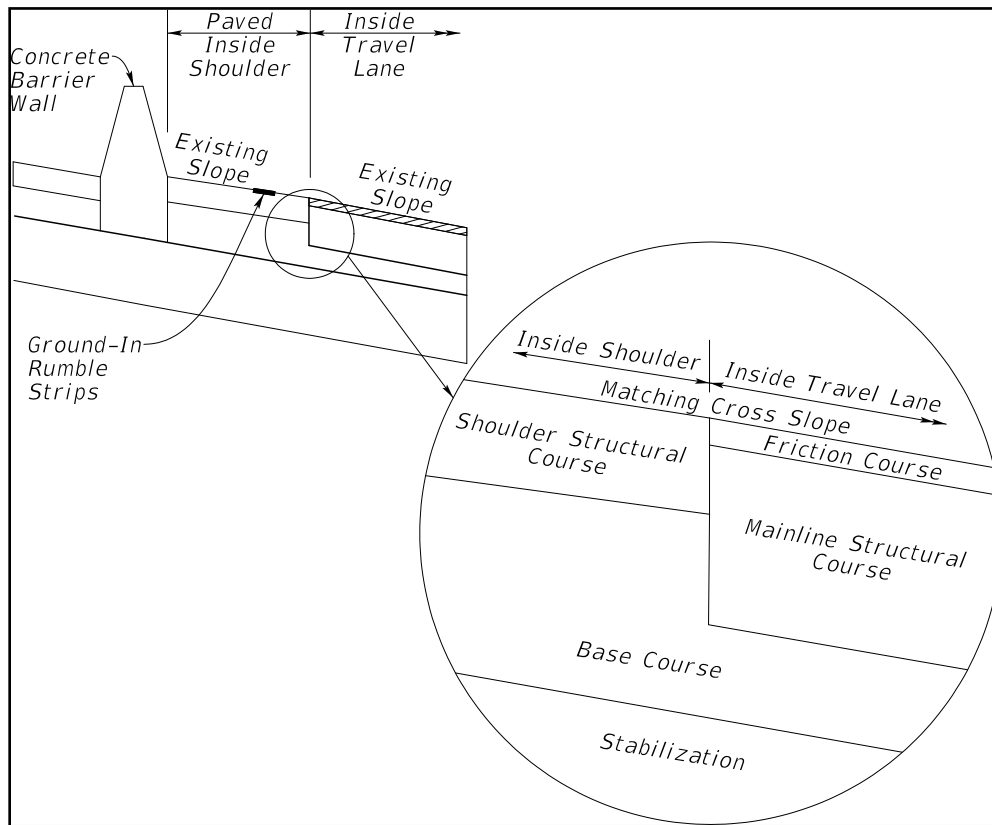

211.4.4 Audible and Vibratory Treatment

Audible and vibratory treatments provide a lane departure warning. Include either ground-in rumble strips or profiled thermoplastic audible and vibratory treatment on LA Facilities.

211.4.4.1 Ground-in Rumble Strips

Use ground-in rumble strips on mainline flexible pavement shoulders in accordance with [Standard Plans, Index 546-010](#). Use the skip array on both inside and outside shoulders. Use the continuous array in advance of bridge ends for a distance of 1,000 feet or back to the gore recovery area for mainline interchange bridges. **Figure 211.4.4** provides guidance for placement of ground-in rumble strips.

Exclude ground-in rumble strips at the following locations:

- (1) On bridges, terminate at the approach slab joint.
- (2) At mainline toll sites within the toll loop pavement area.
- (3) On All Electronic Tolling (AET) facilities within the tolling area as defined in the [**General Tolling Requirements \(GTR\)**](#).
- (4) On outside shoulders of entrance ramp terminals, terminate at the point of the physical gore and resume at the end of the acceleration lane taper.
- (5) On outside shoulders of exit ramp terminals, terminate at the start of the deceleration lane taper, and resume at the point of the physical gore.
- (6) On either side of median crossover openings, terminate within 400 feet.

211.4.4.2 Profiled Thermoplastic

Use profiled thermoplastic for inside and outside edge line pavement markings on roadways with rigid pavement shoulders.

Figure 211.4.4 Placement of Ground-In Rumble Strips

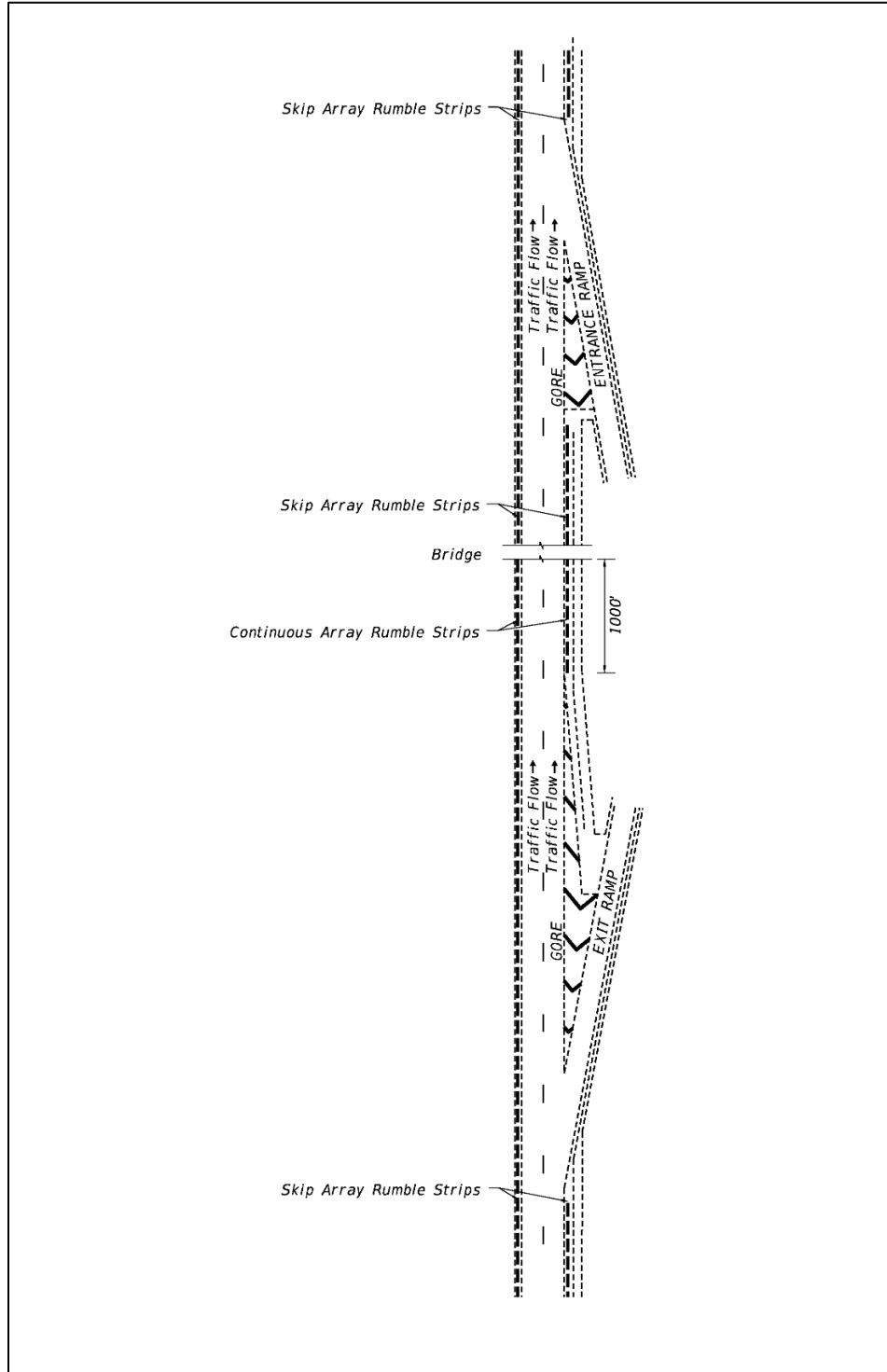

211.4.5 Emergency Refuge Areas

Consider including Emergency Refuge Areas (ERAs) in areas where additional shoulder widths are deemed necessary (e.g., law enforcement, vehicle refuge). Coordinate with Traffic Operations, Maintenance, and Law Enforcement to determine if ERAs would be appropriate for the roadway facility.

For managed lanes projects, consider ERAs where deemed necessary in coordination with Traffic Operations, Maintenance, and Law Enforcement. Coordinate with the Turnpike Toll Systems and Tolls Design Offices during Phase I of the design process. For managed lanes in constrained conditions, a staggered shoulder may be designed to allow storage of disabled or damaged vehicles.

211.4.6 Emergency Shoulder Use (ESU)

Emergency Shoulder Use (ESU) increases traffic capacity for hurricane evacuations by using existing paved shoulders as temporary travel lanes. ESU is typically implemented on evacuation routes as follows:

- On median shoulder when median paved shoulder width is at least 10 feet, or
- On outside shoulder when median paved shoulder width is less than 10 feet.

ESU evacuation routes are listed at:

<https://www.fdot.gov/emergencymanagement/esu/>

Provide a minimum of 10-foot paved shoulder that is useable for travel on ESU routes identified on the Department's Emergency Management website. A portion of the shoulder gutter (when present) may be included in the useable 10-foot width; see **Figure 211.4.5**.

Figure 211.4.5 Useable Shoulder Width with Shoulder Gutter

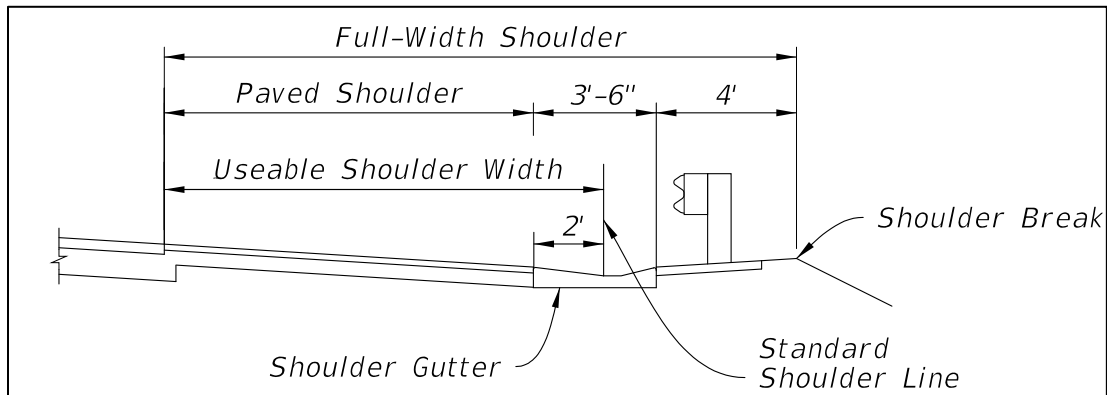

On resurfacing projects where paved or usable shoulder widths are less than 10 feet, do one of the following:

- Provide shoulder modifications to allow for acceptable ESU usage, or
- Identify a future project that will provide the required shoulder modifications.

Locate median barrier in accordance with **FDM 215**. When possible, do not locate median barrier adjacent to the shoulder identified for ESU evacuation.

See **FDM 240.2.1.1** for ESU requirements during construction.

211.4.7 Use of Curb

Type F Curb may be used in areas with design speeds 45 mph or less. Type E Curb may be used in areas with design speeds 55 mph or less. This applies to both median and outside shoulder locations. All curb is prohibited in areas with design speeds greater than 55 mph.

211.4.7.1 Existing Curb

There are infrequent sections of curbed roadways in combination with guardrail on LA Facilities. When there is no crash history associated with these applications, the curb may remain when approved by the District Design Engineer (DDE). Approval by DDE is documented through the development of the Typical Section Package.

211.5 Roadside Slopes

Side slopes within the clear zone are typically 1:6 or flatter. When site conditions require the use of steeper slopes, refer to new construction criteria included in **FDM 215**.

See **FDM 210.6** for Roadside Slope requirements.

211.6 Border Width

For new construction the required border width is 94-feet, which is measured from the outside edge of traveled way to the R/W line. This width may be reduced in the area of a crossroad terminal, as long as the design meets the requirements for clear zone, lateral offsets, drainage, and maintenance access.

Fencing, or in special cases, walls or barriers are to contain LA Facilities. These treatments are to be continuous and appropriate for each location. Treatment height and type may vary under special conditions. The treatment is typically placed at or near the LA R/W line, but location may be adjusted based on site-specific conditions (e.g., ponds, trees, bridges). Placement information and additional data is provided in [Standard Plans](#), [Indexes 550-001](#), [550-002](#), and [550-004](#).

211.6.1 Border Width on Reconstruction & Resurfacing Projects

For reconstruction and resurfacing projects where additional R/W will not be acquired, a Design Variation is not required when the following minimum border width is met:

- (1) The border width accommodates:
 - (a) Roadside design components such as signing, drainage features, guardrail, fencing and clear zone
 - (b) The construction and maintenance of the facility
 - (c) Permitted public utilities
- (2) Along ramps and mainline lanes where roadside barriers are used and thus clear zone is not applicable, the minimum border width from the back of a barrier or retaining wall must be 10 feet if maintenance vehicles have sufficient access from public R/W that is contiguous and unimpeded to the facility.
- (3) If the maintenance access is not continuous along a barrier or wall, and thus maintenance vehicles and equipment would need to turn around, then a sufficient

turnaround area must be provided that is acceptable and approved by Maintenance.

- (4) Maintenance accessibility includes the ability for equipment and vehicles to maneuver around obstacles including fences, lights, signs, side slopes and ponds.

211.7 Horizontal Alignment

The centerline (CL) or baseline (BL) of construction defines the horizontal alignment for roadway and bridge construction. The CL or BL construction is a series of tangents connected by horizontal curves established by the Engineer of Record (EOR). CL or BL construction is often the same alignment as the BL of survey.

Horizontal alignment should be consistent with the anticipated operating speed and with environmental, physical, and economic constraints. Design speed is the principal factor controlling horizontal alignment.

Avoid placing horizontal curves, points of intersection (PI) and superelevation transitions within the limits of a structure or approach slabs. Placement of stationing equations within the limits of a structure should be avoided on contract plans. Such equations unnecessarily increase the probability of error in both the design and construction phase.

211.7.1 Deflections in Alignment

The point where tangents intersect is known as the point of intersection (PI). Avoid the use of a PI with no horizontal curve; however, there may be conditions where it is necessary. The maximum deflection along the mainline and ramps without a horizontal curve are as follows:

- Design speed \leq 40 mph is 2°00'00".
- Design speed \geq 45 mph is 0°45'00".

211.7.2 Horizontal Curves

A horizontal curve should not be introduced near the crest of a vertical curve. The combination of horizontal and vertical curves can greatly reduce sight distance; i.e., hide the horizontal curve from the approaching driver. The condition can be avoided by having the horizontal curvature lead the vertical curvature; i.e., the horizontal curve is made longer than the vertical curve.

Flatter curvature with shorter tangents is preferable to sharp curves connected by long tangents; i.e., avoid using minimum horizontal curve lengths. Avoid long tangents followed by sharp curves.

Table 211.7.1 provides the desirable horizontal curve lengths to be used in establishing the horizontal alignment. Desirable curve lengths for interstate, freeways and expressways are based on 30-times the design speed (30V), where V = design speed in mph. Desired curve lengths for low-speed ramps are based on 15-times the design speed (15V), and high-speed ramps are based on 30V.

Table 211.7.1 Length of Horizontal Curve

Length Of Horizontal Curve (ft.)										
Interstate, Freeway and Expressways based on Design Speed (mph)										
	25	30	35	40	45	50	55	60	65	70
Desirable	N/A	N/A	N/A	N/A	N/A	1500	1650	1800	1950	2100
Minimum	N/A	N/A	N/A	N/A	N/A	750	825	900	975	1050
Ramps based on Design Speed (mph)										
	25	30	35	40	45	50	55	60	65	70
Desirable	400	450	525	600	675	1500	1650	1800	1950	2100
Minimum	400	400	400	400	400	750	825	900	975	1050
Notes: Provide the desirable length; however, when desired length cannot be attained, provide the greatest length possible, but not less than the minimum.										

211.8 Superelevation

The criteria contained in **FDM 210.9** is applicable for Interstates, Freeways, and Expressways. The RRR criteria contained in **FDM 210.9.2** applies to Limited Access resurfacing projects.

Superelevation rates of 0.10 maximum are required on high speed LA Facilities, except for the portion of a ramp that adjoins an arterial. For the portion of a ramp that adjoins to an arterial, match the superelevation rate of the arterial. The terminal and the area abutting the LA Facility is controlled by Limited Access criteria and must be designed for 0.10 maximum superelevation rate.

211.9 Vertical Alignment

The profile grade line defines the vertical alignment for roadway and bridge construction. The profile grade line is a series of tangents connected by vertical curves. For undivided highways the profile grade line is typically located at the horizontal centerline of the roadway. For divided highways a profile grade line should be established for each direction of travel.

Meeting vertical alignment criteria assures proper transitions, sight distances, and clearances.

LA facilities play a critical role during hurricane evacuation and re-entry in the aftermath. Designing the mainline travel lanes to be above the 100-year flood plain elevation (established by FEMA or other pertinent studies) is a requirement on Florida's Turnpike Facilities and should be considered for all LA facilities. See **FDM 210.10.3** for all other vertical clearance requirements.

Minimum vertical clearances for bridges structures is given in **FDM 260.6**.

211.9.1 Grades

The slope or grade of each tangent is expressed in percent rise (+) or fall (-); e.g., +2.000% or -2.000%. The maximum grades that may be used in establishing the vertical alignment is given in **Table 211.9.1**.

Table 211.9.1 Maximum Grades

Facility Type	Maximum Grades (percent)									
	Design Speed (mph)									
	25	30	35	40	45	50	55	60	65	70
LA Facilities	N/A	N/A	N/A	N/A	N/A	4	4	3	3	3
Ramps	7	7	6	6	5	5	4	4	3	3

Notes:

- (1) For roadways with significant (10% or more) heavy truck traffic the maximum grade used should not exceed 4%.
- (2) For resurfacing projects, when existing grades do not meet the above requirements but meet the standards in effect at the time of construction, the existing grade may remain.

For new construction or when the vertical profile is being significantly modified, the desired minimum profile grade is 0.5%; 0.3% is the minimum when 0.5% cannot be achieved. When practicable, develop roadway profiles to avoid the need for shoulder rocking, with consideration for future widening and resurfacing.

The point where tangents intersect is known as the vertical point of intersection (VPI). When two tangent grades intersect and no vertical curve is provided, the “kink” is known as the point of intersect (PI). The maximum change in grade (i.e., algebraic change) without a vertical curve is provided in **Table 210.10.2**.

211.9.2 Vertical Curves

A vertical curve must be provided when the change in grade of two intersecting tangent grades exceed the values shown in **Table 210.10.2**. A vertical curve is identified by a curve length (L) which is equal to the product of the K value (K) and the algebraic difference in grades (A).

Tables 211.9.2 and **211.9.3** contain vertical alignment criteria for Interstates, Freeways, Expressways, and ramps.

Table 211.9.2 K Values for Vertical Curves

Type of Curve	Minimum K Values for Vertical Curves									
	Design Speed (mph)									
	25	30	35	40	45	50	55	60	65	70
Interstate										
Sag	N/A					115	136	157	181	206
Crest (New Construction)	N/A					185	245	313	401	506
Crest (Resurfacing)	N/A					114	151	193	247	312
Freeway and Expressways										
Sag	N/A					96	115	136	157	181
Crest (New Construction)	N/A					136	185	245	313	401
Crest (Resurfacing)	N/A					84	114	151	193	247
Ramps										
Sag	26	37	49	64	79	96	115	136	157	181
Crest (New Construction)	19	31	47	70	98	136	185	245	313	401
Crest (Resurfacing)	12	19	29	44	61	84	114	151	193	247
<p>Notes: Length, $L = KA$ Where: K = Rate of vertical curvature (a.k.a., K value) L = Length of vertical curve, (feet) A = Algebraic difference in grades, (percent)</p> <p>(1) New construction K values are based on an eye height of 3.5 feet and an object height of 6 inches. Resurfacing K values are based on an eye height of 3.5 feet and an object height of 2 feet.</p> <p>(2) The minimum curve length must not be less than values shown in Table 211.9.3.</p> <p>(3) Vertical curves within a system interchange are to use K values based on the higher system.</p> <p>(4) Use interstate, freeway, or expressway K values on vertical curves located within the ramp terminal area. Ramp vertical curve K values are used for ramps outside of the ramp terminal area.</p>										

Table 211.9.3 Minimum Vertical Curve Length

Type of Curve	Curve Length (ft.)									
	Design Speed (mph)									
	25	30	35	40	45	50	55	60	65	70
Interstate, Freeway and Expressways										
Sag	N/A					800				
Crest (Open Highway)	N/A					1,000				
Crest (Within Interchanges)	N/A					1,800				
Ramps										
Sag	75	90	105	120	135	200	250	300	350	400
Crest						300	350	400	450	500

211.10 Sight Distance

The **AASHTO Greenbook** has a thorough discussion on sight distance. Consider the following aspects of sight distances:

- (1) Stopping Sight Distance: Sight distances needed for stopping, which are applicable on all highways
- (2) Decision Sight Distance: Sight distances needed for decisions at complex locations (e.g., merging tapers, ramps, weaving sections)

211.10.1 Stopping Sight Distance

Stopping sight distance criteria is provided in *Tables 211.10.1* and *211.10.2*.

Table 211.10.1 Minimum Stopping Sight Distance for Interstate

Grade (percent)		Minimum Stopping Sight Distance (ft.)				
		Design Speed				
		50	55	60	65	70
Downgrade	≤ 2	495	570	645	730	820
	3	516	595	673	767	861
	4	524	605	685	781	878
	5	534	616	698	797	896
	6	544	628	713	813	915
	7	554	640	727	831	935
	8	565	654	744	850	957
	9	577	668	761	870	981
Upgrade	≤ 2	495	570	645	730	820
	3	475	544	613	697	780
	4	469	537	605	687	768
	5	463	531	597	678	758
	6	458	525	590	669	748
	7	453	518	583	661	738
	8	449	513	576	653	729
	9	445	508	570	646	721

Table 211.10.2 Minimum Stopping Sight Distance for Freeways, Expressways, and Ramps

Grade (percent)		Minimum Stopping Sight Distance (ft.)									
		Design Speed (mph)									
		25	30	35	40	45	50	55	60	65	70
Downgrade	≤ 2	155	200	250	305	360	425	495	570	645	730
	3	158	205	257	315	378	446	520	598	682	771
	4	160	208	261	320	385	454	530	610	696	788
	5	162	211	266	326	392	464	541	623	712	806
	6	165	215	271	333	400	474	553	638	728	825
	7	167	218	276	339	408	484	565	652	746	845
	8	170	222	281	346	417	495	579	669	765	867
	9	173	227	287	354	427	507	593	686	785	891
Upgrade	≤ 2	155	200	250	305	360	425	495	570	645	730
	3	147	190	237	289	344	405	469	538	612	690
	4	146	188	234	285	339	399	462	530	602	678
	5	144	186	231	281	335	393	456	522	593	668
	6	143	184	229	278	331	388	450	515	584	658
	7	142	182	226	275	327	383	443	508	576	648
	8	141	180	224	272	323	379	438	501	568	639
	9	139	179	222	269	320	375	433	495	561	631

211.10.2 Decision Sight Distance

The **AASHTO Green Book, Chapter 3** provides a detailed discussion on decision sight distance.

The geometric design developed for LA Facilities considers locations where decision sight distance is critical such as interchanges, toll facilities, lane drops, and managed lanes ingress/egress locations. Decision sight distance requirements are in **AASHTO Green Book, Section 3.2.3**. If it is not practical to provide decision sight distance at these locations, or if relocation of the critical decision points is not feasible, special attention will be given to the use of suitable traffic control devices for providing advance warning of the sub-standard condition.

Do not place managed lane ingress or egress within the limits of a Design Variation or Design Exception processed for sight distance.

211.11 Structures

Refer to **FDM 260** for information on bridge structures.

211.12 Interchange and Ramp Spacing

Interchange spacing is measured along the freeway or interstate centerline between the centerlines of the crossroads. Refer to **FDM 201.4** for the minimum spacing between adjacent interchanges.

In urban areas, spacing less than one mile may be used with C-D roads or grade-separated (braided) ramps.

The spacing between interchanges may also be dependent on the ramp connection spacing. The minimum connection spacing between the painted noses of adjacent ramps is provided in **Figure 211.12.1**. Additional information on interchanges is in **AASHTO Green Book, Chapter 10**.

Figure 211.12.1 Ramp Connection Spacing

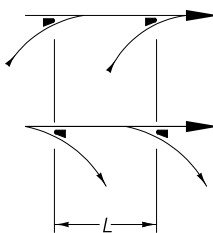
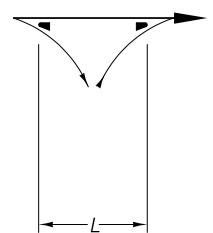
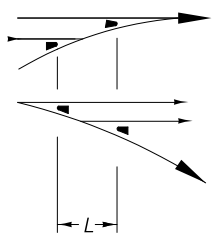
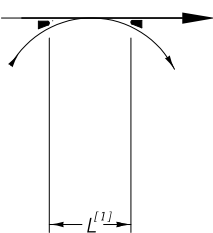
On-On or Off-Off		Off-On		Turning Roadways		On-Off (Weaving)		
								
LA Facility	C-D Road	LA Facility	C-D Road	System ^[2] Interchange	Service ^[3] Interchange	A	B or C	D
1,000 ft.	800 ft.	500 ft.	400 ft.	800 ft.	600 ft.	2,000 ft.	1,600 ft.	1,000 ft.
▲ Painted Nose (see Figure 211.13.1)								
<p><i>L</i> = Minimum distance in feet from painted nose to painted nose (See figure 211.13.1) A Between two interchanges connected to a LA Facility: a system interchange^[2] and a service interchange^[3] B Between two interchanges connected to a C-D Road: a system interchange^[2] and a service interchange^[3] C Between two interchanges connected to a LA Facility: both service interchanges^[3] D Between two interchanges connected to a C-D Road: both service interchanges^[3].</p> <p>Notes: These values are based on operational experience, need for flexibility, and signing. Check them in accordance with the procedures outlined in the Highway Capacity Manual and use the larger value.</p> <p>[1] With justification, these values may be reduced for cloverleaf ramps. [2] A system interchange is a LA Facility-to-LA Facility interchange. [3] A service interchange is a LA Facility-to-local road interchange.</p>								

Ref: Figure 10-70, 2018 AASHTO Green Book

211.12.1 Weaving Sections

Weaving sections are defined in **2018 AASHTO Green Book, Section 2.4.**

When an entrance is followed by an exit, the minimum distance between gore noses is governed by weaving considerations per the procedure outlined in the [Highway Capacity Manual \(HCM\)](#). On-off Weaving is illustrated in **Figure 211.12.1**. If the minimum weaving distance cannot be provided, replace the weaving maneuver with physical separation; e.g., grade separation or barrier. For more information regarding barriers, refer to **FDM 215**.

211.12.1.1 Braided Ramps

Ramps that are grade-separated and cross over one another are known as braided ramps. They are typically used to achieve the required ramp spacing by converting the on-off connection into an off-on connection. An example of braided ramps is shown in **Figure 211.12.2**. These configurations are used on a limited basis because of the large cost typically associated with them.

Figure 211.12.2 Braided Ramp Configuration

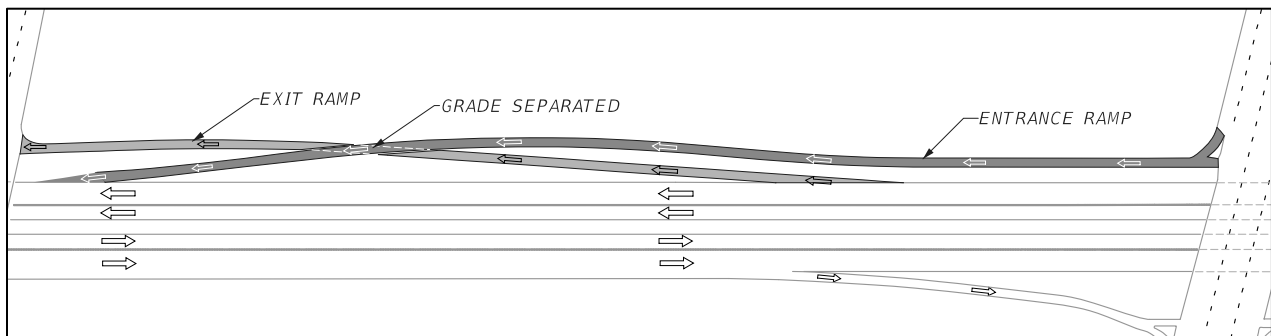

When combining general use lane or general toll lane exits and managed lane exits in a braided ramp configuration, the managed lane exit merges on the right side of the general use lanes as illustrated in **Figure 211.12.3**. Operational analysis determines the actual lane configuration. Refer to **Traffic Analysis Handbook** and **Interchange Access Request User's Guide** for guidance on analysis requirements.

Figure 211.12.3 Braided Managed Lane and General Use Lane Exits

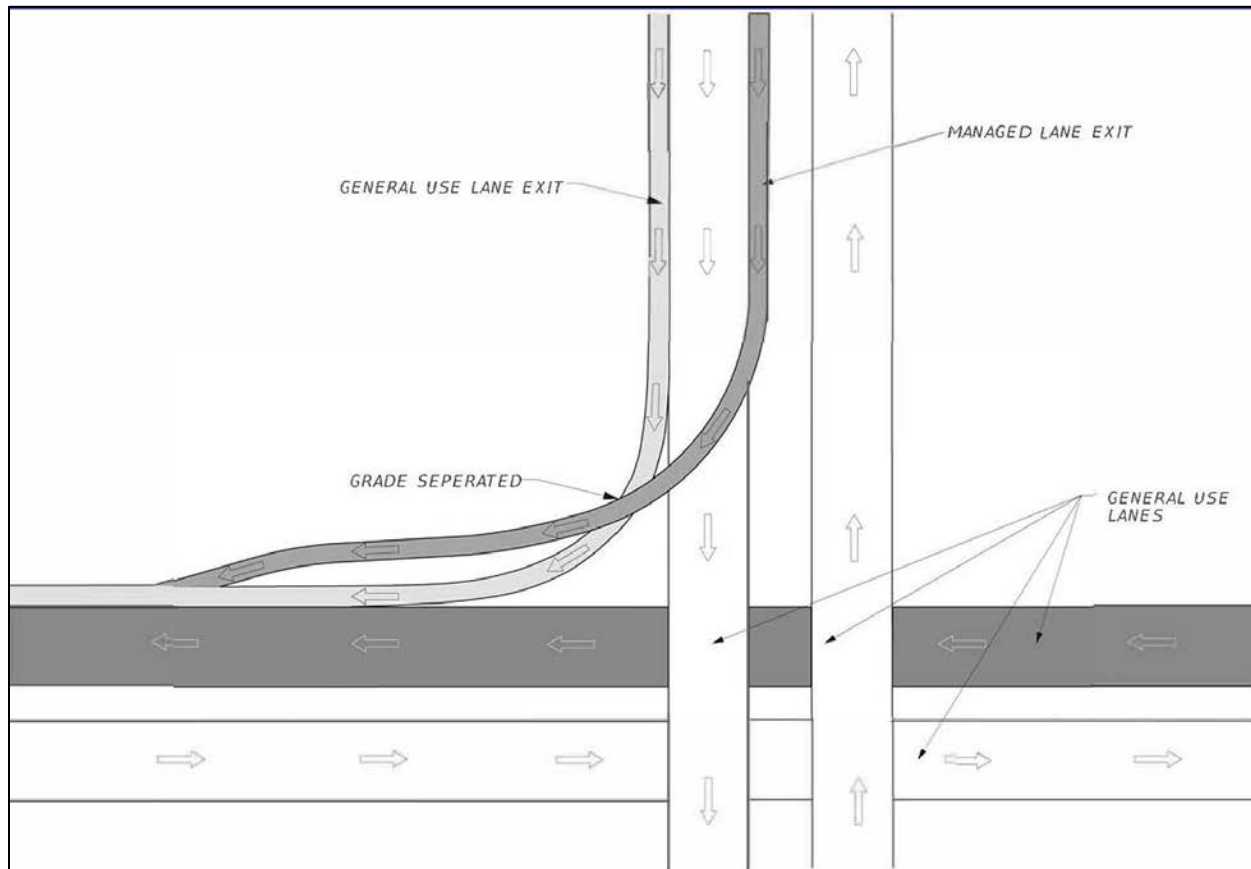

211.12.2 Interchange Connections

When a series of interchanges are closely spaced, attention must be given to the uniformity of interchange patterns and to lane balance. Refer to the concepts discussed in the **2018 AASHTO Green Book, Section 10.9.5**. Auxiliary lanes may be required to conform to lane balance requirements.

Successive auxiliary lanes less than 1,500 feet apart are prohibited. Auxiliary lanes may continue through an interchange to avoid this condition.

211.13 Ramp Terminals

Taper type and parallel type ramp terminals can be used to enter and exit a LA Facility. The selection of either a parallel or taper type depends on the geometrics and anticipated

traffic conditions of the highway as well as the roadway that connects to the ramp. Design speed of entrance and exit ramps for LA Facilities should be gradually decreased from the LA mainline design speed to the design speed of the ramp. The minimum ramp speed used to design the first curve adjacent to the LA mainline is 20 mph below the LA mainline design speed. The preferred ramp type is parallel. Use of taper type ramp terminals must be approved by District Design Engineer. Existing tapered ramps that are not being altered by construction may remain in place.

Typical geometric configuration for the taper and parallel types are depicted in [Standard Plans Index 000-525](#). **Figure 211.13.1** illustrates a basic configuration and terminology used when designing ramp terminals. The taper and parallel type ramp terminals are discussed in the paragraphs below.

Figure 211.13.1 Ramp Gore

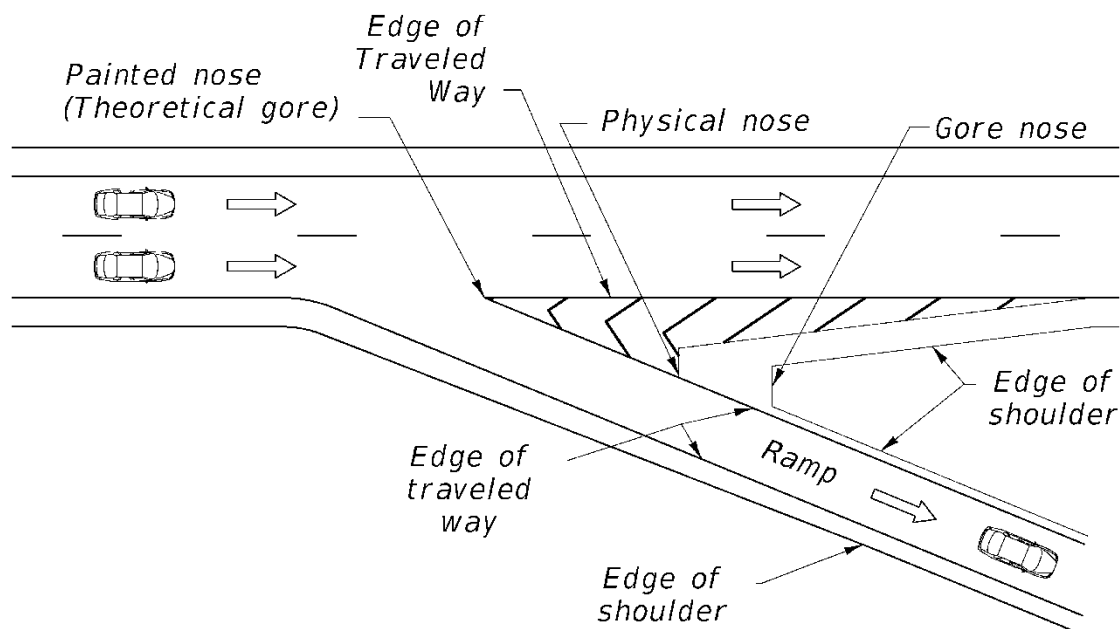

Taper Type Exit Ramp Terminals

For single lane taper type exit terminal, the recommended divergence angle is ± 4 degrees. The speed change can be achieved off the traveled way as the exiting vehicle moves along the taper onto the ramp proper. The length available for deceleration (L) should be measured from a point where the right edge of the tapered wedge is about 12 ft from the right edge of the right through lane to the point of initial curvature or the first horizontal curve on the exit ramp. The taper type ramp terminal is not to be used where

a minimum of 50 mph design speed cannot be maintained. For such ramps, parallel deceleration lanes must be used in place of tapers with lengths set according to AASHTO. For additional information, see the *AASHTO Green Book*.

Figure 211.13.2 below shows a typical design for a taper type exit terminal.

Figure 211.13.2 Taper Type Exit Ramp Terminal

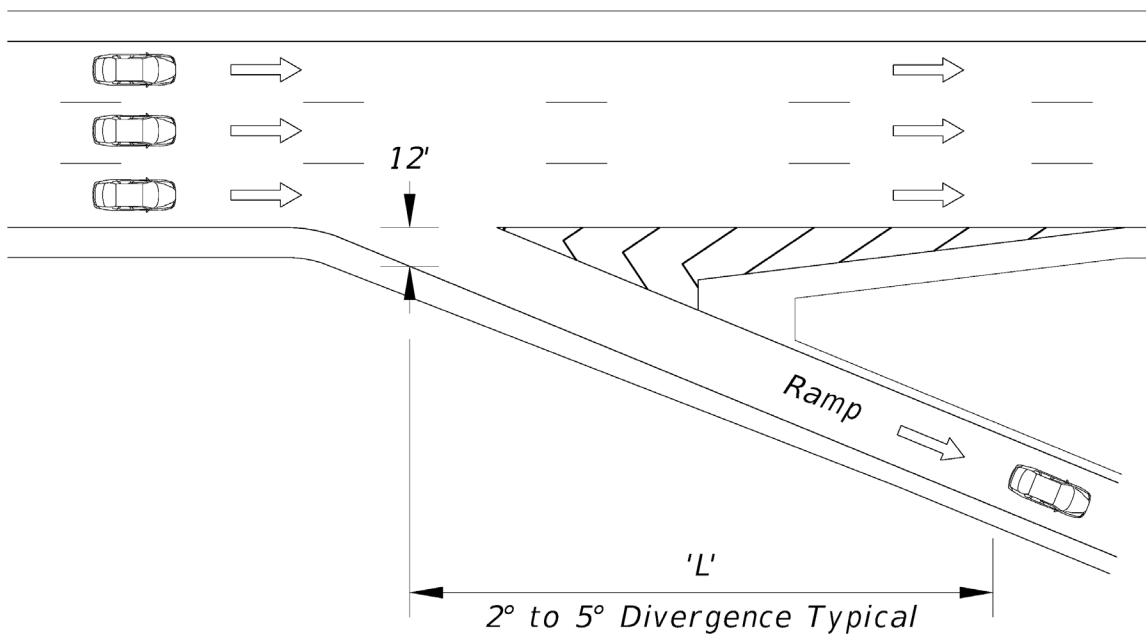

For two-lane exit type ramp terminals, it is usually appropriate to develop an auxiliary lane upstream from the exit. A length of 1,500 ft is recommended to develop the full capacity of a two-lane exit. As with single lane exits, attention should be given to obtaining the appropriate deceleration distance between the exit and first horizontal curve on the ramp. The length available for safe deceleration (L) on a two-lane taper type exit is measured from a point where the right edge of the tapered wedge along the left or inside exit lane is about 12 ft from the right edge of the right through lane. This is to ensure that any extent of the auxiliary lane is not used to determine length needed for safe deceleration, since vehicles using the left exit lane would be entering the ramp at LA mainline speed. See **Figure 211.13.1**. Typical design for two-lane taper type exit terminals is shown in **Figure 211.13.3** below.

Figure 211.13.3 Two-Lane Taper Type Exit Ramp Terminal

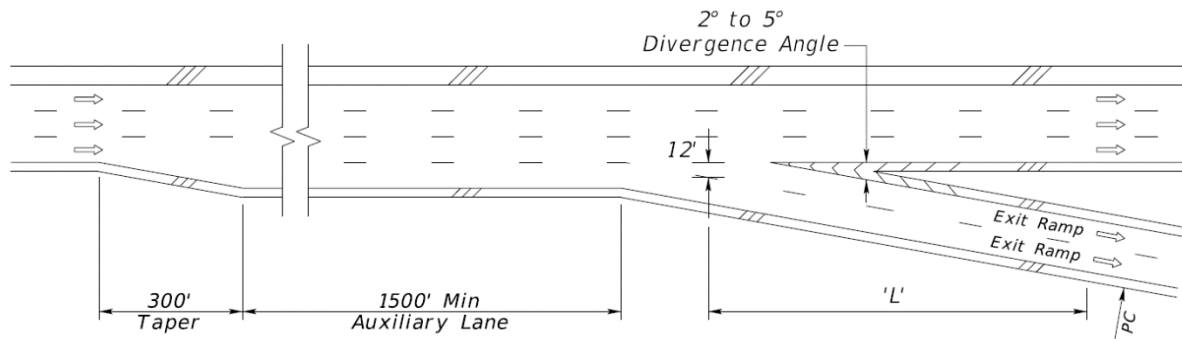

Parallel Type Exit Ramp Terminals

A single lane parallel type exit terminal usually begins with a taper, followed by an added lane that is parallel to the LA mainline traveled way. The parallel type exit terminal should be used when:

- the exit is partially hidden over the crest of vertical curve and
- when turning roadway speed is less than 60% of the through roadway speed.

In cases that have limited sight distance and close connections to a signal-controlled arterial, parallel type terminals should be used to allow for sufficient deceleration. The length available for deceleration (L) should be measured from the point where the added lane attains a 12-ft width to the point where the alignment of the ramp roadway departs from the alignment of the freeway. Lengths of at least 800 ft are desirable. The taper portion of a parallel type deceleration lane should have a taper of 15:1 to 25:1. For additional information, see the **AASHTO Green Book**. **Figure 211.13.4** shows a typical design for a parallel type exit terminal.

Figure 211.13.4 Parallel Design Type Exit Ramp Terminal

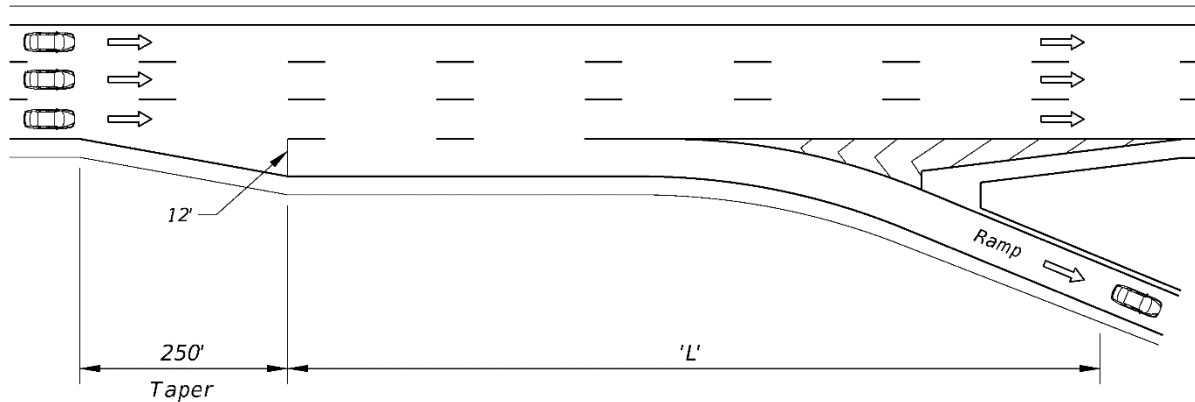

For two-lane exit type ramp terminals, it is usually appropriate to add an auxiliary lane upstream from the exit. A length of 1,500 ft is recommended to develop the full capacity of a two-lane exit. As with single lane exits, attention should be given to obtaining the appropriate deceleration distance between the exit and first horizontal curve on the ramp. See **Table 211.3.1**. The operation for a two-lane parallel type exit is different from the taper type in that vehicles in the outer through lane of the LA mainline must move two lanes to the right to use the right lane of the ramp. The total length from the beginning of the first taper to the point where the ramp traveled way departs from the right-hand through lane of the LA mainline range from 2,500 ft to 3,500 ft depending on the turning volumes thresholds provided in the **AASHTO Green Book**. This is to ensure that any extent of the auxiliary lane is not used to determine length needed for safe deceleration, since vehicles using the left or inside lane would be entering the ramp at LA mainline speed.

Typical design for two-lane parallel type exit terminals is shown in **Figure 211.13.5** below.

Figure 211.13.5 Two-Lane Parallel Design Type Exit Ramp Terminal

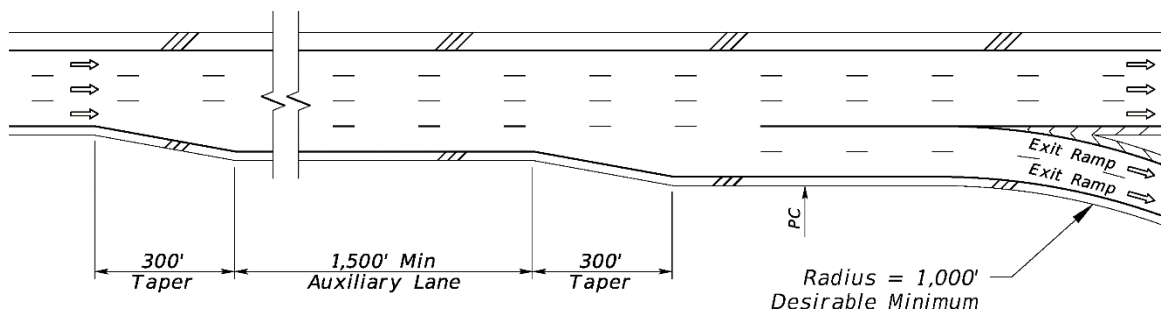

Minimum Deceleration Lengths

Minimum deceleration lengths (L) for various combinations of design speeds for the LA mainline and for the ramp roadway for both taper type and parallel type exit terminals are given in **Table 211.13.1** below. Grade adjustments are given in the **AASHTO Green Book**.

Table 211.13.1 Minimum Deceleration Lengths (L) for Taper and Parallel Type Exit Terminals

Deceleration Length (ft.) for Design Speed of Exit Curve (mph)									
LA Mainline Design Speed	Stop Condition (0)	15	20	25	30	35	40	45	50
30	235	200	170	140	-	-	-	-	-
35	280	250	210	185	150	-	-	-	-
40	320	295	265	235	185	155	-	-	-
45	385	350	325	295	250	220	-	-	-
50	435	405	385	355	315	285	225	175	-
55	480	455	440	410	380	350	285	235	-
60	530	500	480	460	430	405	350	300	240
65	570	540	520	500	470	440	390	340	280
70	615	590	570	550	520	490	440	390	340

Source: 2018 AASHTO Green Book, Table 10-6

Entrance Type Ramp Terminals

The taper type entrance usually operates smoothly for volumes up to and including the design capacity of merging areas. The parallel type entrance terminal should be used when a bridge is located within the merging lane and when turning roadway speed is less than 60% of LA mainline speed. At entrance ramps on an ascending grade, the portion of the ramp intended for acceleration and the ramp terminal should closely parallel the through roadway profile to permit entering drivers to have a clear view of the through road ahead.

The length of the acceleration lane for taper and parallel type entrance ramp terminals is determined by the **AASHTO Green Book**.

The taper type ramp terminal is not to be used where a minimum of 50 mph design speed cannot be maintained.

The parallel type entrance terminal should be used when a bridge is located within the merging lane and when turning roadway speed is less than 60% of LA mainline speed. The length of the acceleration lane is determined by **2018 AASHTO Green Book, Table 10-4**.

The parallel type exit terminal should be used when the exit is partially hidden over the crest of vertical curve and when turning roadway speed is less than 60% of the LA mainline speed. The length of the deceleration lane is determined by **2018 AASHTO Green Book, Table 10-6**.

The selection of either a parallel or taper type depends on the geometrics and anticipated traffic conditions of the LA mainline as well as the roadway that the ramp is connecting to. In cases that have limited sight distance and close connections to a signal-controlled arterial, parallel type terminals should be used to allow for sufficient deceleration. For additional information, see the **2018 AASHTO Green Book, Section 10.9.6**.

At entrance ramps on an ascending grade, the portion of the ramp intended for acceleration and the ramp terminal should closely parallel the LA mainline profile to permit entering drivers to have a clear view of the LA mainline ahead.

Design speed of entrance and exit ramps for LA Facilities should be gradually decreased from the LA mainline design speed to the design speed of the ramp. The minimum speed used to design the first curve adjacent to the LA mainline is 20 mph below the design speed of the LA mainline.

Figure 211.13.1 illustrates a basic configuration and terminology used when designing ramp terminals.

211.14 Managed Lanes Access Points and Access Types

The design of managed lanes access points is based on major origin and destination patterns, the location of toll facilities, and the location of existing interchanges with the general use lanes. The operational analysis associated with managed lanes access points is performed using the methodology in the Highway Capacity Manual and/or microsimulation. Refer to [Traffic Analysis Handbook](#) and [Interchange Access Request User's Guide](#) for guidance on analysis requirements.

Perform an operational analysis to determine the required length of the weave segment that will accommodate the weave demand. Base the analysis on 1000 feet per lane change weaving length (See **Exhibits 211-3 to 211-6**). Adjust the weave segment length as needed based on the analysis. Perform a safety analysis as required in the [Interchange Access Request User's Guide](#).

An access point serves one of three uses:

- (1) Point of entry to the managed lanes
- (2) Intermediate point of entry/ingress or exit/egress
- (3) Termination of managed lanes

When determining the point of entry and the termination of managed lanes, consideration is given to future phased implementation plans for the corridor depicted in the ultimate managed lanes diagram. Avoid temporary access points.

Avoid locating a managed lanes access point in the same weaving area as other highway weaving movements (i.e., interchange on-ramps, interchange off-ramps, or auxiliary lanes). Access points are located to provide the required weave length between the managed lanes and general use lanes. If placed closer than the required minimum weave length, additional traffic control devices are added to prohibit vehicles from cutting across traffic to get into the managed lane or get out to the interchange exit.

Traffic operational analyses must demonstrate that queuing from vehicles exiting the managed lanes to the general use lanes will not encroach on the managed lanes.

Refer to **Section 2.42** of the [TEM](#) for guidelines on managed lanes entrance/ingress and exit/egress signs and signing sequence.

211.14.1 Managed Lanes Access Types

On Florida's managed lanes, the following types of access are used:

- Slip Ramps
- Weave Lanes
- Weave Zones
- Direct Connect
- Continuous Access

Slip ramps, weave lanes, and weave zones on the Interstate do not require an interchange access request. A weave lane or weave zone is used in constrained conditions for intermediate ingress and egress points and requires approval of the District Design Engineer. Continuous access is prohibited for use with express lanes and may require increased enforcement.

Direct connect ramps are used for system-to-system connection between managed lanes facilities, toll facilities, major arterials, park-and-ride facilities, and transit facilities. Direct connect ramps on the Interstate require an interchange access request (Refer to the [Interchange Access Request User's Guide](#)). Refer to the [Managed Lanes Guidebook](#) for further information.

Standard geometric details are shown in **Exhibits 211-3** through **211-8**. The associated signing and pavement marking requirements at ingress and egress locations are shown in **Exhibits 211-9** through **211-12**.

**BEGIN EXPRESS LANES TYPICAL INGRESS FOR
EXPRESS LANES WITH BUFFER SEPERATION**

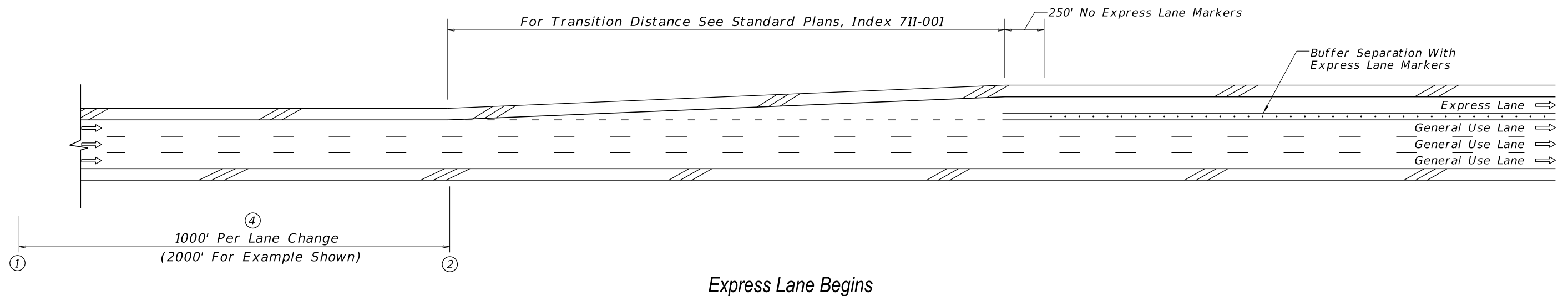
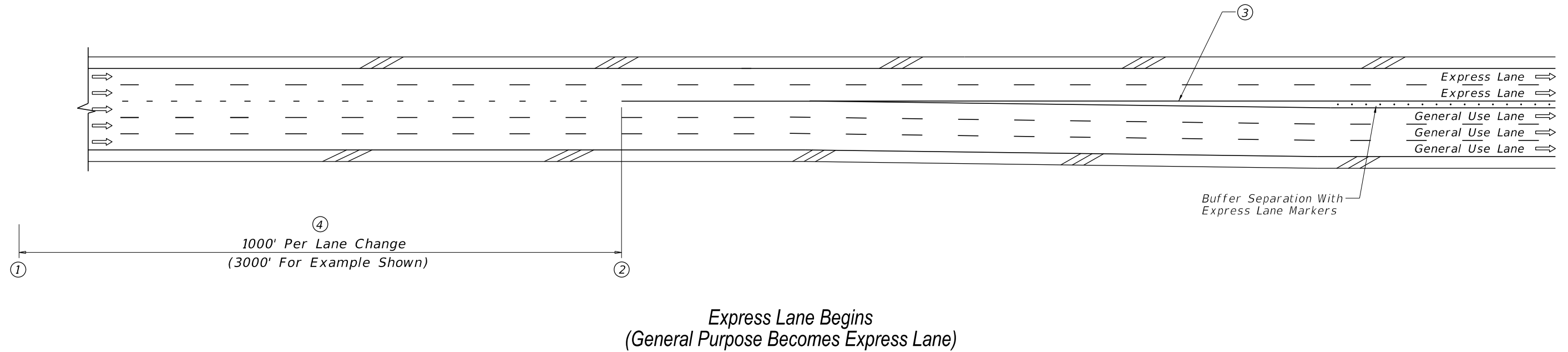

NOTES:

- ① Begin weave distance
- ② End weave distance
- ③ Per FDM 210.8.1 maximum deflections without horizontal curves, 0° 45' or 76.39:1 (use 80:1)
- ④ This weave zone to allow traffic in outside general use lane to get into outside express lane

NOTE:

The dimensions shown in this Exhibit are typical values, and may need to be increased based upon site-specific operational analysis.

NOT TO SCALE

**EXHIBIT 211-3
01/01/2019**

END EXPRESS LANES TYPICAL EGRESS FOR EXPRESS LANES WITH BUFFER SEPERATION

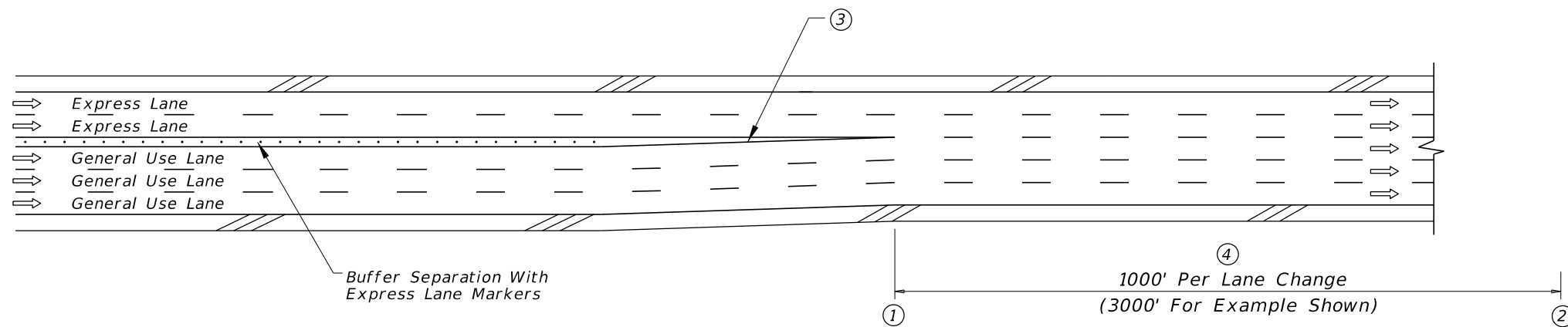

Express Lanes Become General Purpose Lanes

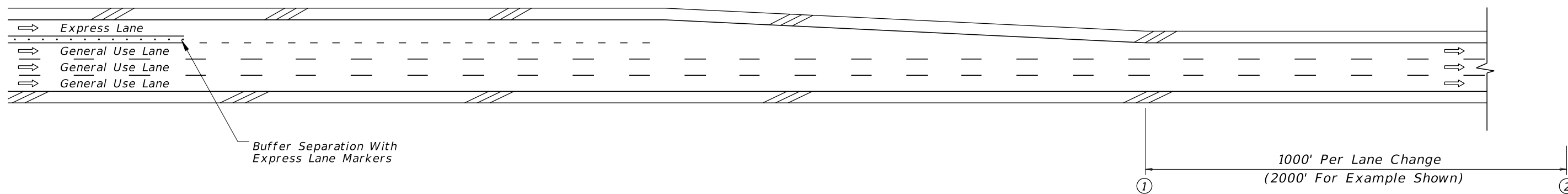

Express Lane Ends

NOTES:

- ① Begin weave distance
- ② End weave distance
- ③ Per FDM 210.8.1 maximum deflections without horizontal curves, 0° 45' or 76.39:1 (use 80:1)
- ④ This weave zone to allow traffic in outside express lane to get into outside general use lane

NOTE:

The dimensions shown in this Exhibit are typical values, and may need to be increased based upon site-specific operational analysis.

NOT TO SCALE

EXHIBIT 211-4
01/01/2019

SLIP RAMP TYPICAL INGRESS & EGRESS FOR EXPRESS LANES WITH BUFFER SEPARATION

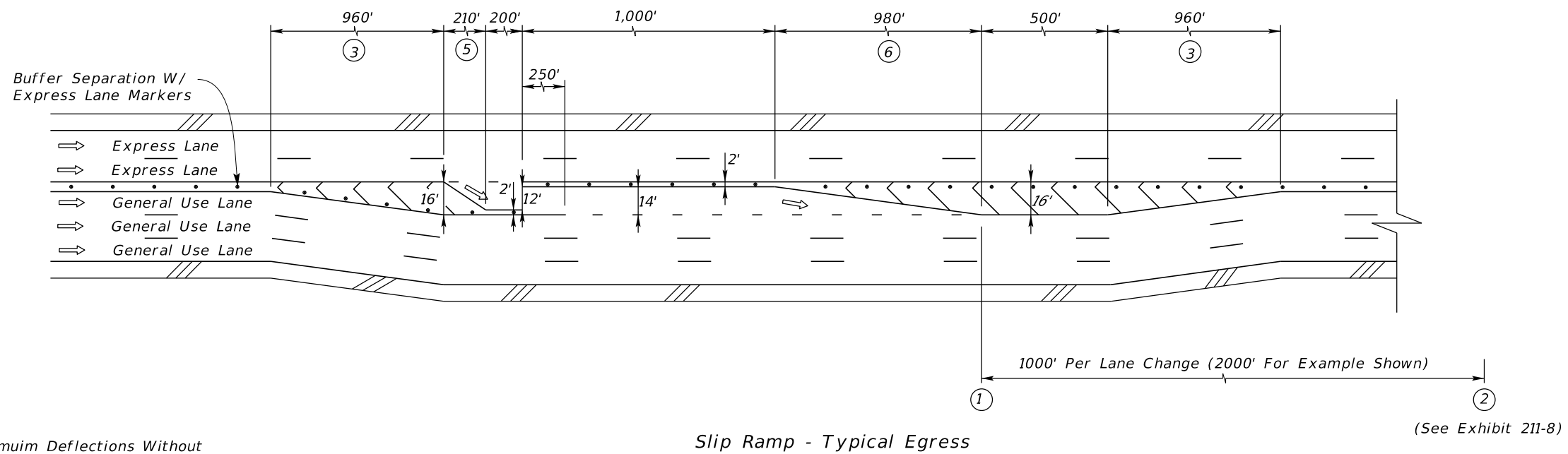
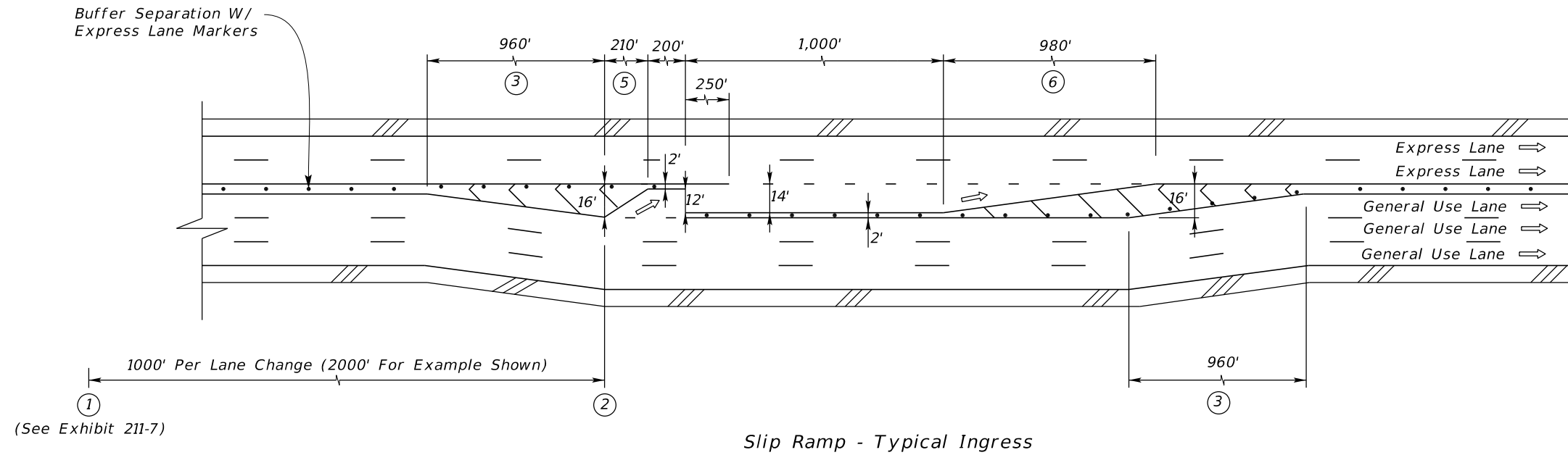

Notes:

- ① Begin weave distance.
- ② End weave distance.
- ③ Per FDM 210.8.1, Maximum Deflections Without Horizontal Curves, 0° 45' or 76.39:1. (Use 80:1).
- ⑤ 15:1 taper.
- ⑥ Taper length based on $L=WS$. 70:1 taper as shown assumes 70 MPH design speed.
Where:
W = Width Of Lateral Transition
In Feet
S = Design Speed

NOTE:

The dimensions shown in this Exhibit are typical values, and may need to be increased based upon site-specific operational analysis.

NOT TO SCALE

EXHIBIT 211-5
01/01/2019

WEAVE SECTIONS TYPICAL INGRESS & EGRESS FOR EXPRESS LANES WITH BUFFER SEPARATION

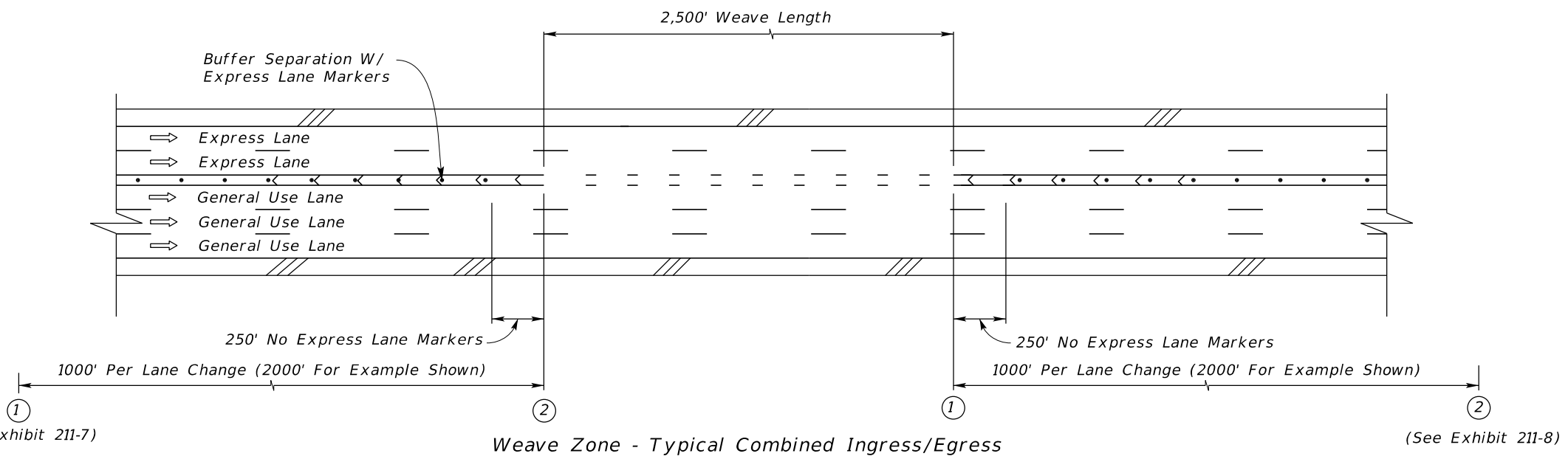
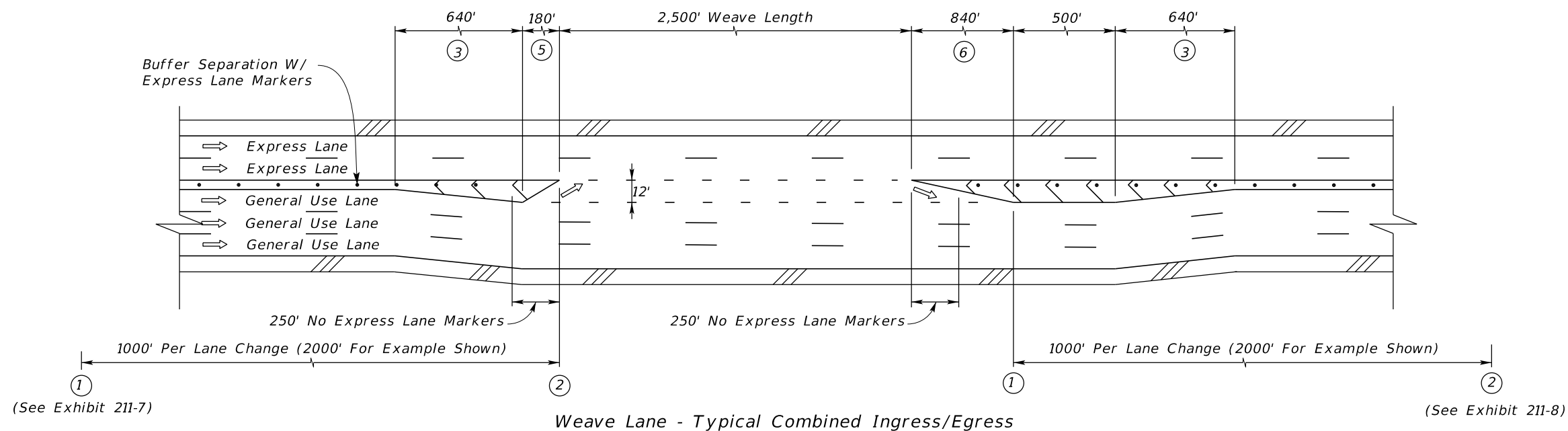

- Notes:**
- ① Begin weave distance. (See Exhibit 211-7)
 - ② End weave distance.
 - ③ Per FDOT PPM, Table 2.8.1a, Maximum Deflections Without Horizontal Curves, 0° 45' or 76.39:1. (Use 80:1).
 - ⑤ 15:1 taper.
 - ⑥ Taper length based on $L=WS$. 70:1 taper as shown assumes 70 MPH design speed.
Where:
W = Width Of Lateral Transition
In Feet
S = Design Speed

NOTE:
The dimensions shown in this Exhibit are typical values, and may need to be increased based upon site-specific operational analysis.

NOT TO SCALE
EXHIBIT 211-6
01/01/2019

MANAGED LANES ENTRANCE TERMINAL CONFIGURATIONS

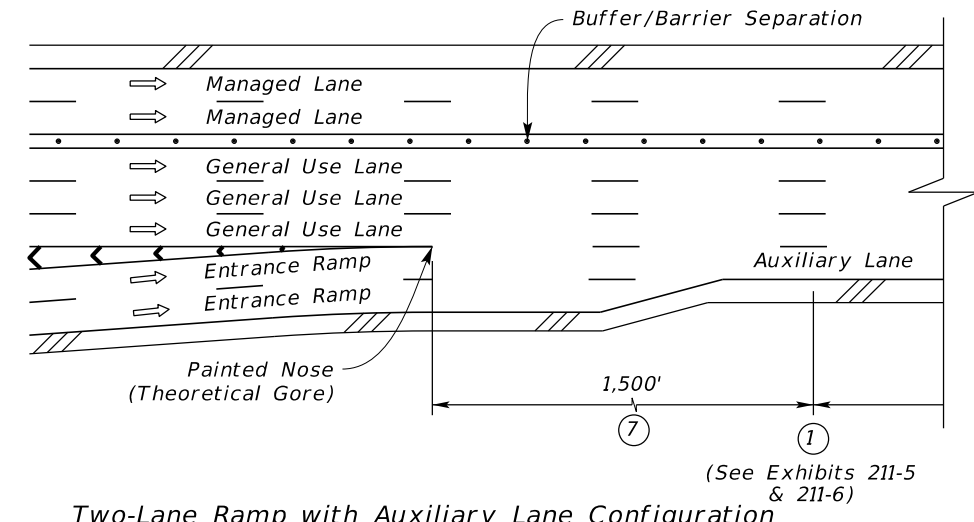
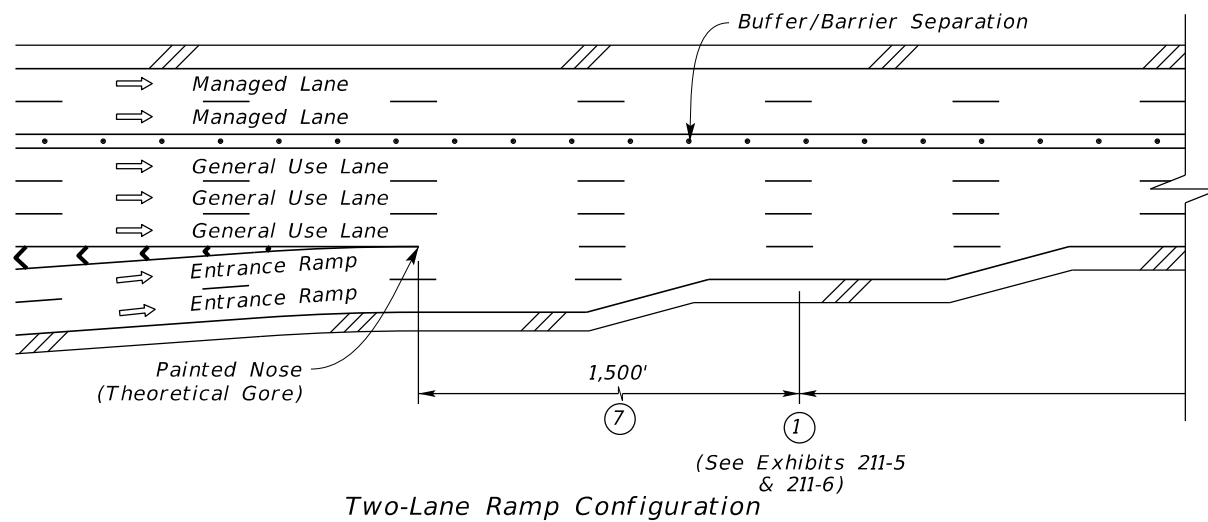
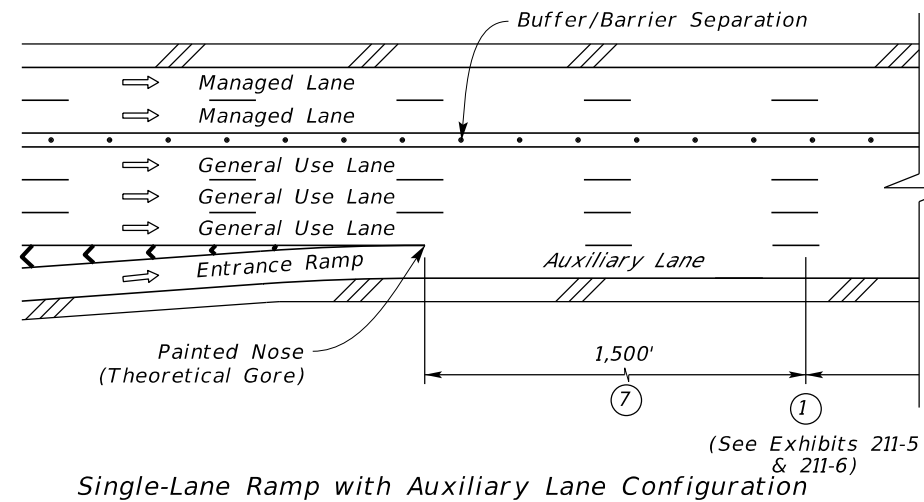
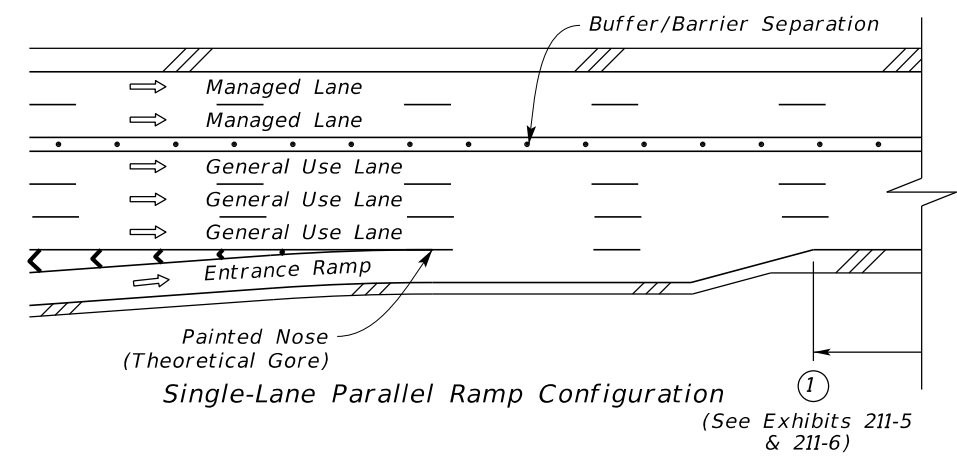
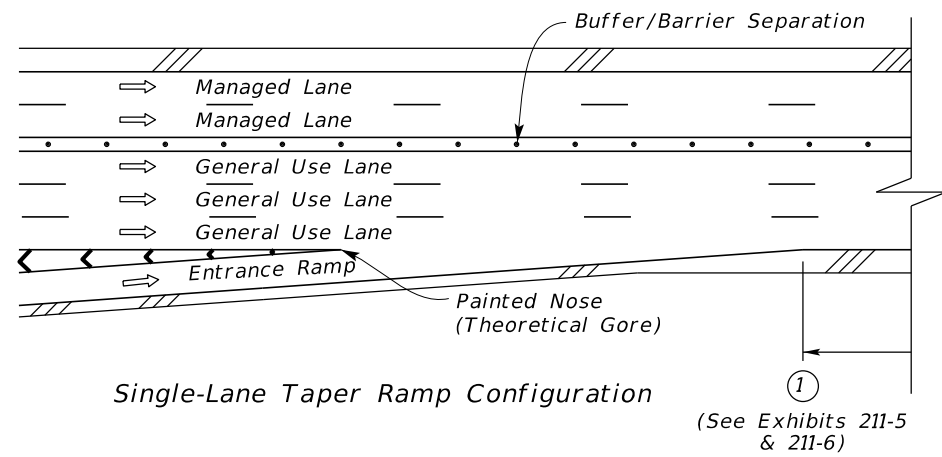

Notes:

- ① Begin weave distance.
- ⑦ 1,500' intended to allow ramp traffic to merge into the outside general use lane.

NOTE:

The dimensions shown in this Exhibit are typical values, and may need to be increased based upon site-specific operational analysis.

NOT TO SCALE

**EXHIBIT 211-7
01/01/2022**

MANAGED LANES EXIT TERMINAL CONFIGURATIONS

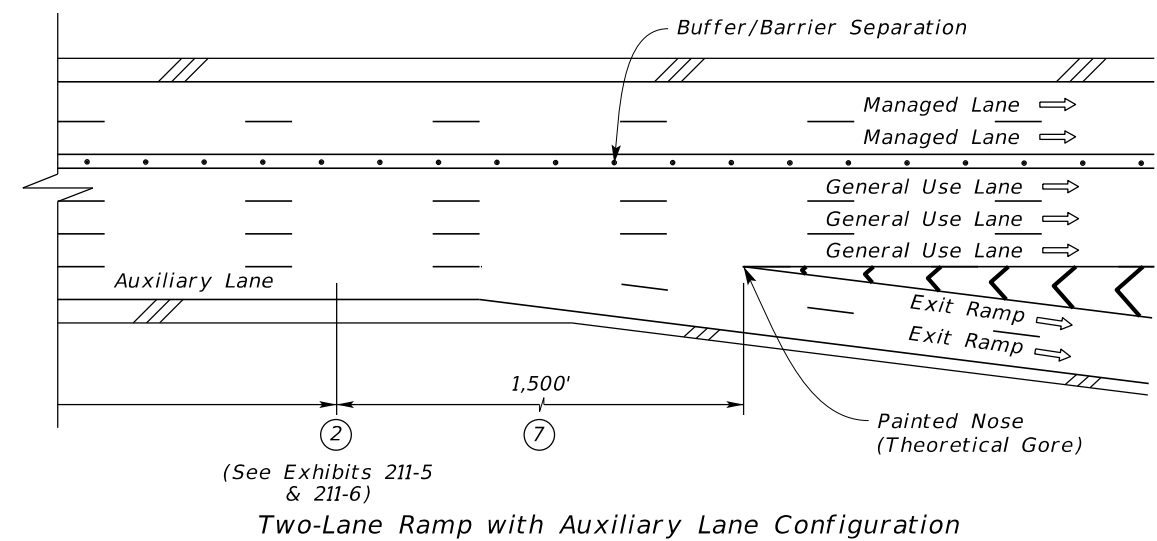
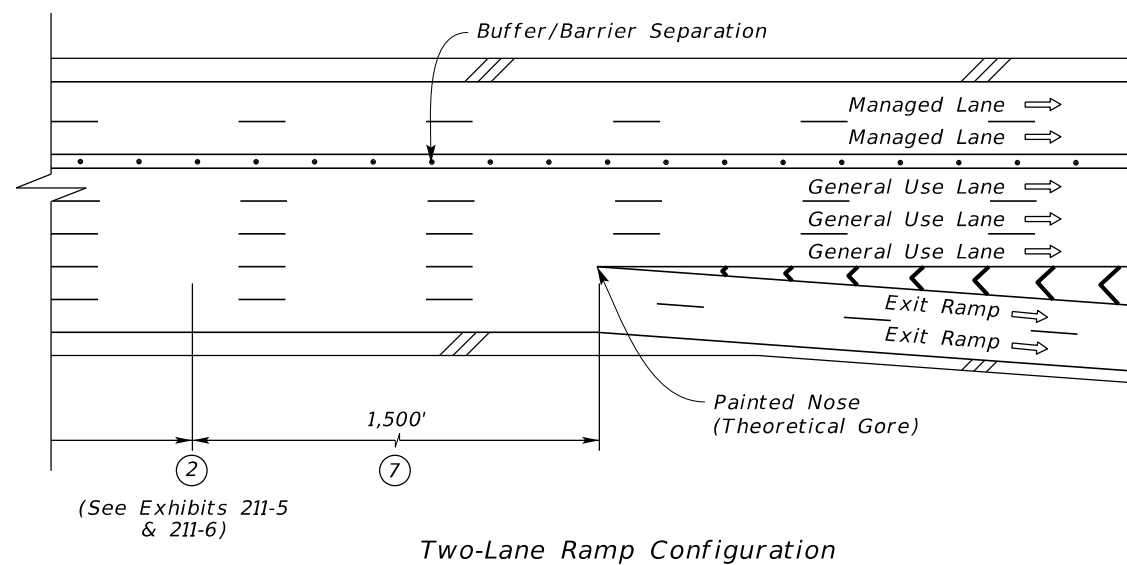
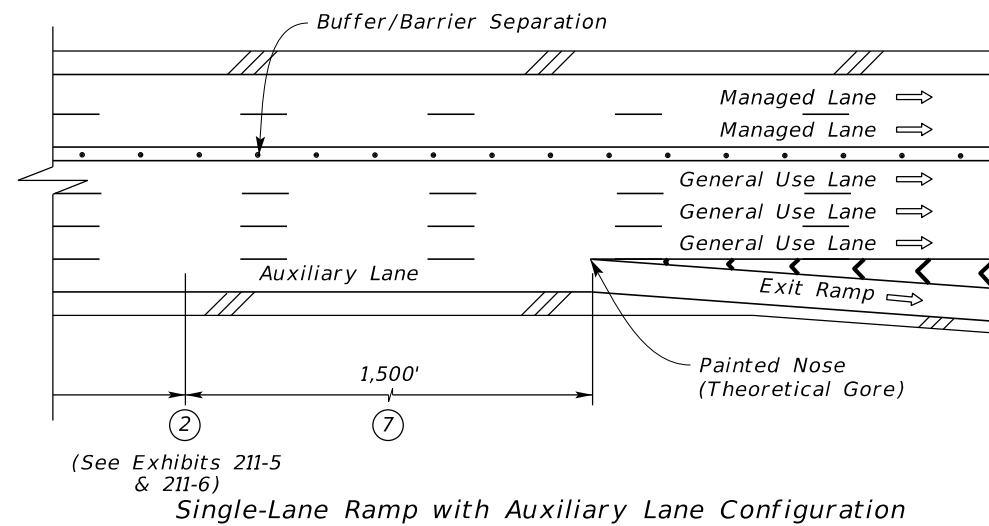
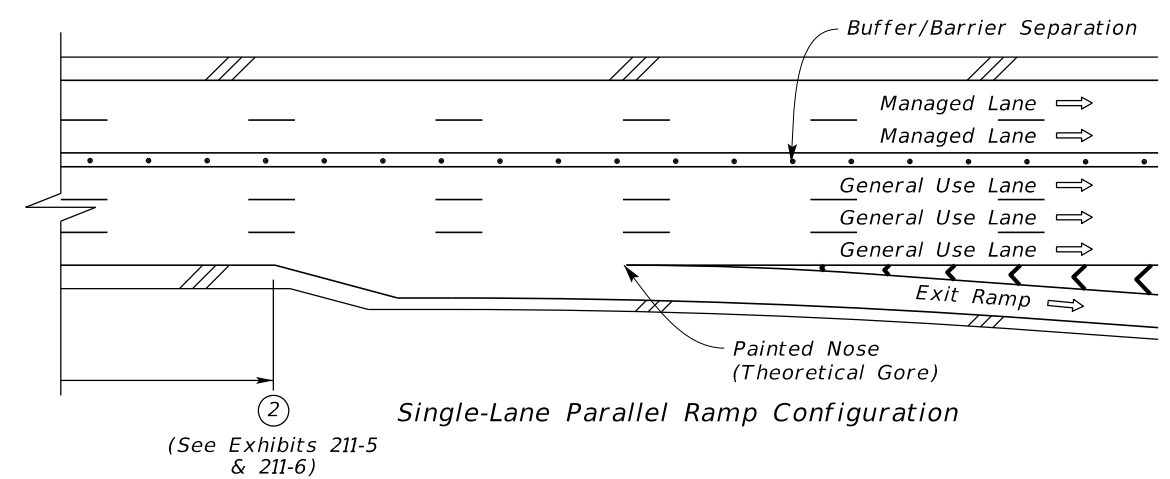
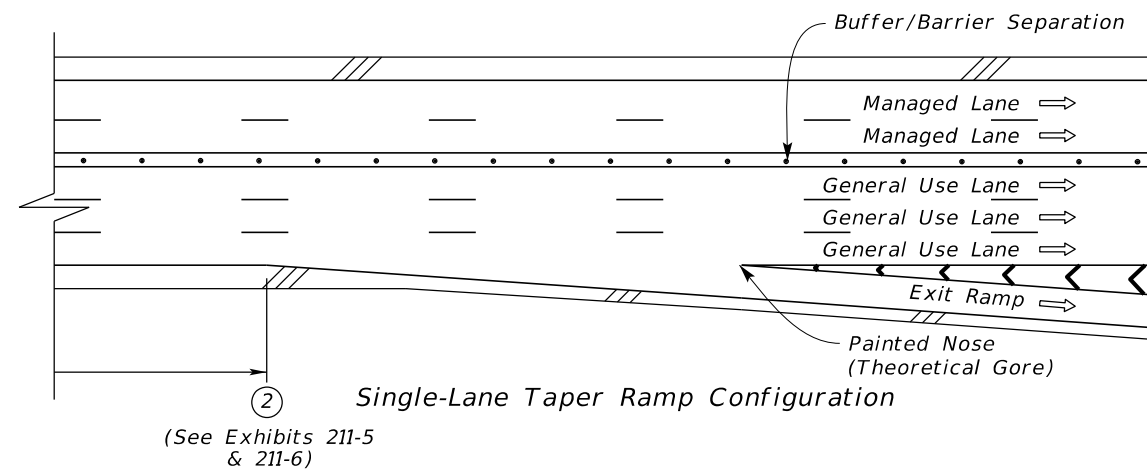

Notes:

- ② End weave distance.
- ⑦ 1,500' intended to allow traffic in the outside general use lane to access the exit ramp.

NOTE:

The dimensions shown in this Exhibit are typical values, and may need to be increased based upon site-specific operational analysis.

See Standard Plans 711-001 and 711-003 for gore striping information.

NOT TO SCALE

EXHIBIT 211-8
01/01/2022

MANAGED LANES TYPICAL PAVEMENT MARKINGS FOR SLIP RAMP INGRESS & EGRESS

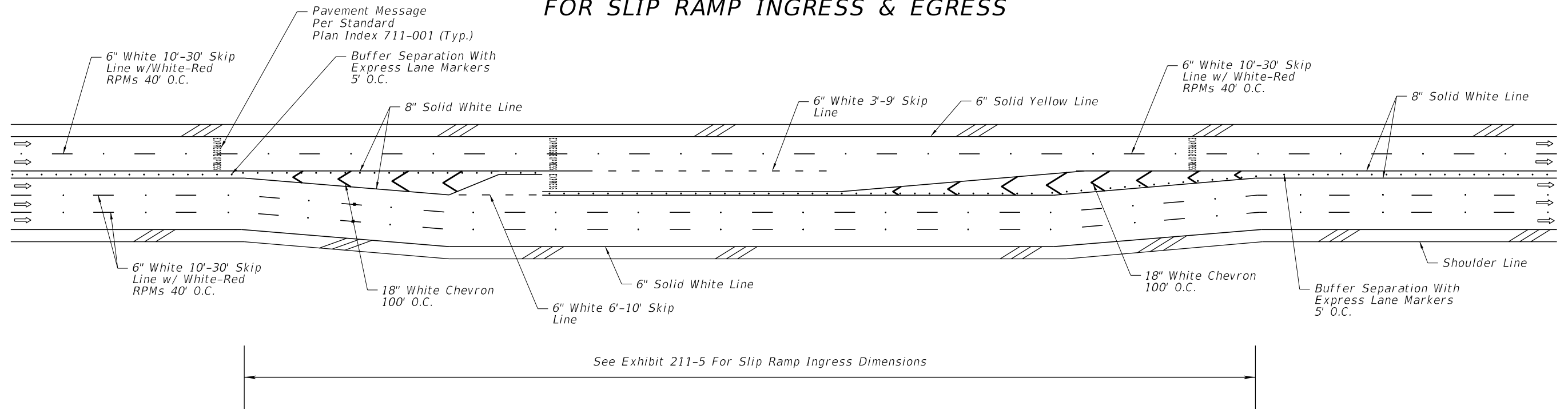

RPMs- RAISED PAVEMENT MARKERS
O.C. - ON CENTER

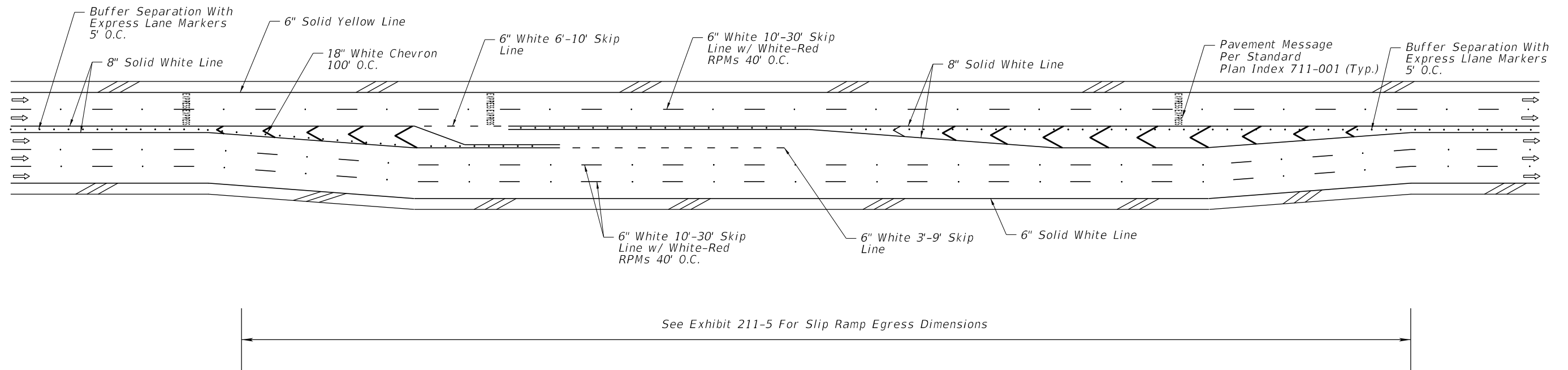

RPMs- Raised Pavement Markers
O.C.- On Center

NOT TO SCALE

EXHIBIT 211-9
01/01/2021

MANAGED LANES TYPICAL PAVEMENT MARKINGS FOR WEAVE SECTIONS INGRESS & EGRESS

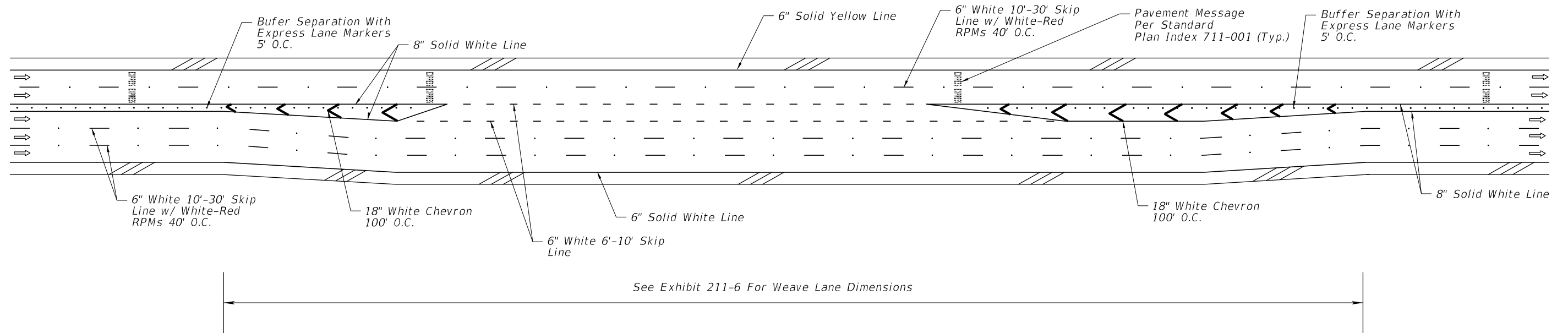

RPMs- Raised Pavement Markers
O.C.- On Center

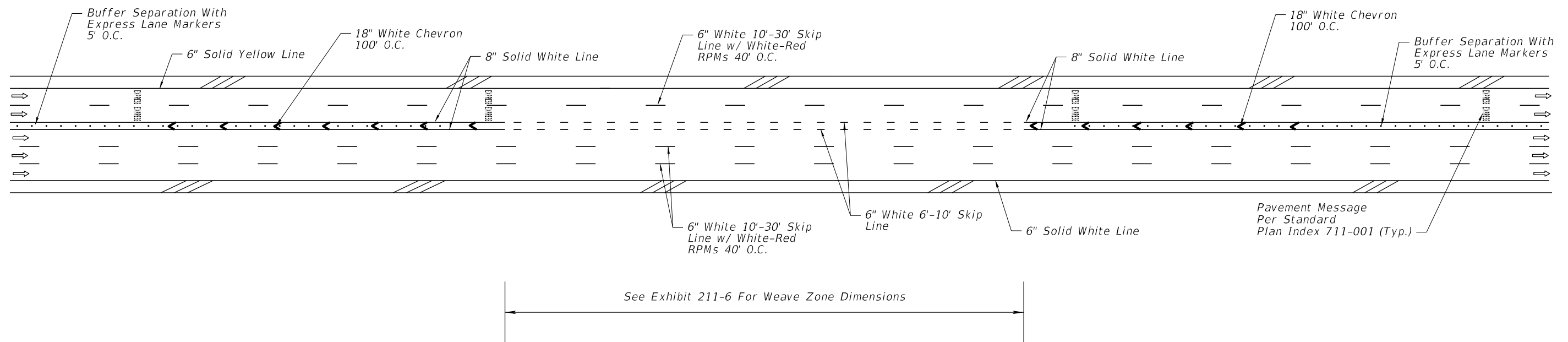

RPMs- Raised Pavement Markers
O.C.- On Center

NOT TO SCALE

EXHIBIT 211-10
01/01/2021

MANAGED LANES TYPICAL PAVEMENT MARKINGS FOR BEGIN MANAGED LANES

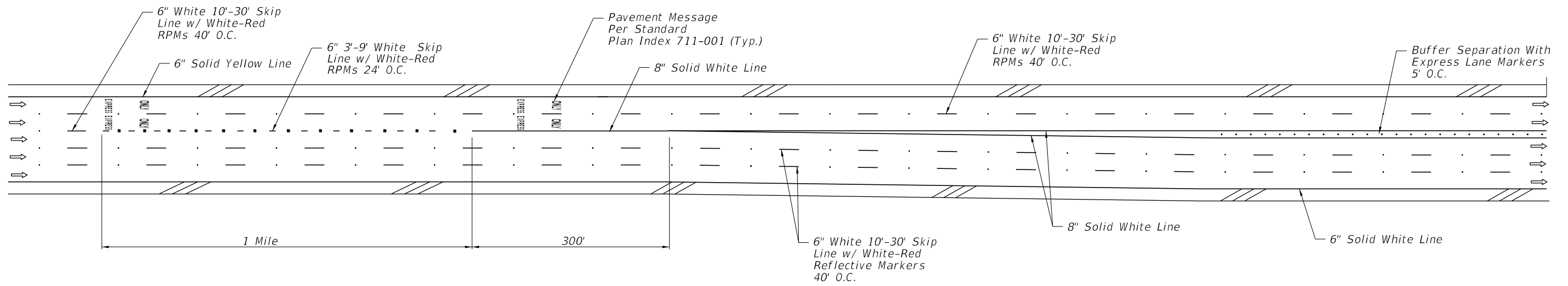

**Managed Lane Begins
(General Purpose Becomes Managed Lane)**

RPMs- Raised Pavement Markers
O.C.- On Center

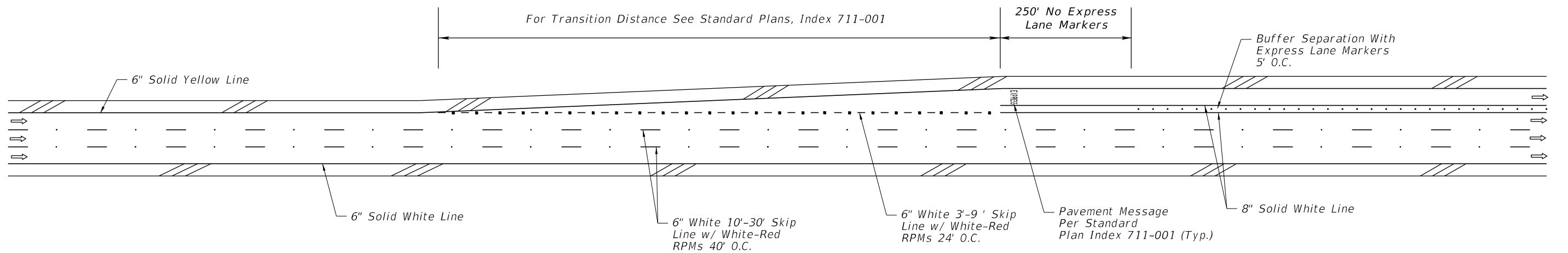

Managed Lane Begins

RPMs- Raised Pavement Markers
O.C.- On Center

NOT TO SCALE

EXHIBIT 211-11
01/01/2021

MANAGED LANES TYPICAL PAVEMENT MARKINGS FOR END MANAGED LANES

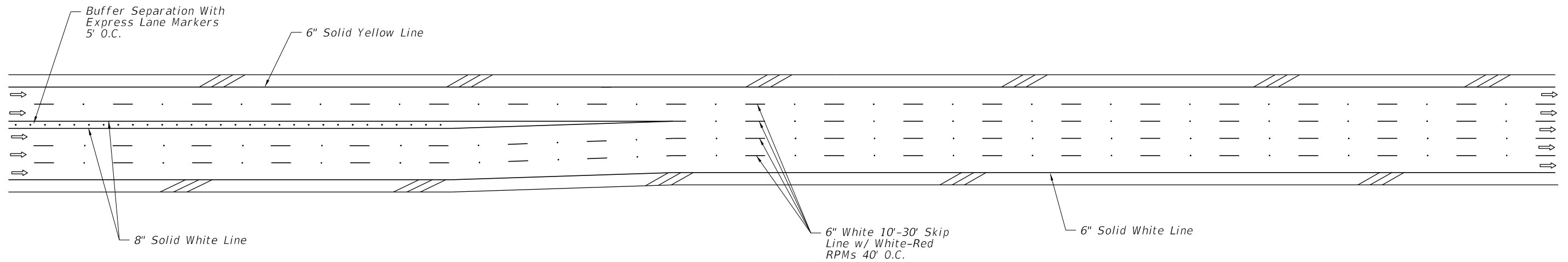

Managed Lanes Become General Purpose Lanes

RPMs- Raised Pavement Markers
O.C.- On Center

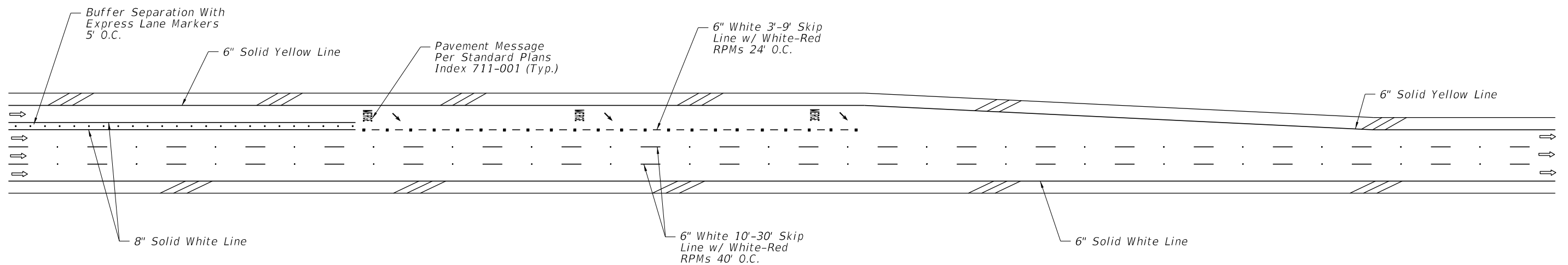

Managed Lane Ends

RPMs- Raised Pavement Markers
O.C.- On Center

NOT TO SCALE

EXHIBIT 211-12
01/01/2021

211.15 Limited Access Right of Way

The following criteria will be used in establishing Limited Access limits along crossroads at interchanges. LA R/W will end at the same station for both sides of the crossroad based on the greatest distance from the LA facility.

- (1) Extend the LA R/W along the crossroad 1,320 feet measured from the end of the taper of the ramp furthest from the interchange. See ***Florida Administrative Code, Rule 14-97*** for additional information.
- (2) In constrained conditions, for rural interchanges, LA R/W will extend along the crossroad as far as the first intersection with an arterial road or a minimum distance of 300 feet beyond the end of the acceleration or deceleration taper. Where no taper is used, the LA R/W will extend a minimum distance of 300 feet beyond the radius point of the return.
- (3) In constrained conditions, for interchanges in urban areas, the criteria given above will apply except that the LA R/W will end a minimum of 100 feet beyond the end of taper or the radius point of the return.
- (4) Extend LA R/W along crossroads overpassing LA facilities (no interchange) 200 feet from the LA facility R/W line. This distance may be reduced or omitted if the crossroad profile provides adequate sight distance for existing or proposed driveways. The fence is generally tied into the crossroad structure end bent unless required along the crossroad.

Any reduction in the 300 feet rural and 100 feet urban minimum values shown above for LA R/W limits must be approved by FHWA for interstate projects and by the District Design Engineer for non-interstate facilities.

211.16 Maintenance Access

Accommodation of access for maintenance is integral to the roadway typical section on LA facilities. Specific requirements for the area immediately adjacent to toll sites is contained within the ***General Tolling Requirements (GTR)***. Requirements for access through various roadside safety devices is contained within ***FDM 215***.

Along ramps and mainline lanes where roadside barriers are used, the minimum border width from the back of a barrier or retaining wall is 10 feet. Provide sufficient access from public R/W that is contiguous and unimpeded to the LA facility for maintenance vehicles.

If the maintenance access is not continuous along a barrier or wall, and thus maintenance vehicles and equipment would need to turn around, then a sufficient turnaround area must be provided that is acceptable and approved by the District Maintenance Engineer.

Maintenance accessibility includes the ability for equipment and vehicles to maneuver around obstacles including fences, lights, signs, side slopes, and ponds.

The maximum continuous length of a guardrail or barrier wall run along the outside of the roadway is 2,500 feet between end terminals. An access opening must be provided when long guardrail or barrier wall runs are broken up. Coordinate with the District Maintenance Engineer and District ITS Design Engineer on the final access location points to meet the needs of maintenance and operations. The preferred typical detail for roadside guardrail access openings is depicted in the [Standard Plans Instructions \(SPI\) for Index 536-001](#).

211.17 Roadway and Bridge Approach Slab Evaluation

Resurfacing Projects – Perform a qualitative evaluation for approach slabs throughout the limits of the project to ensure they are providing a smooth transition to the bridge. When deficiencies are identified, summarize the potential underlying causes, and provide a recommendation for correcting the deficiencies.

Capacity Improvement Projects – Perform the same qualitative evaluation as required for the resurfacing projects and include in the design documentation submitted with the preliminary geometry and grade submittal. Existing bridges and approach slabs that are scheduled for complete reconstruction do not need to be evaluated for corrective measures.

211.18 Interchange Areas Bicycle and Pedestrian Facilities

Provide a shared use path to move pedestrians and bicyclists through interchange locations where pedestrian and bicycle facilities are required. See **FDM 224** for the types of shared use paths and associated criteria for each. For existing interchanges where a shared use path cannot be provided, a design variation is not required.

The shared use path can be continuous through the entire influence area of the interchange or can be used only at ramp intersection locations. A continuous path through the entire interchange is preferred but may not always be feasible. See the [Interchange Access Request User's Guide](#) to determine if an Interchange Access Request (IAR) or break in Limited Access R/W is required.

211.18.1 Bicycle Ramps

Connect bicycle lanes to the shared use path using bicycle ramps (**FDM 223.2.6**). Terminate bicycle lanes at the approach to the interchange and resume the bicycle lane at the far side of the interchange. A conceptual layout of entry and exit bicycle ramps to a shared use path from a bicycle lane is provided in **Figure 211.18.1**. See **FDM 230** and the **TEM** for additional information on pavement marking and signing.

Figure 211.18.1 Conceptual Layout of Bicycle Ramps at Interchange Areas

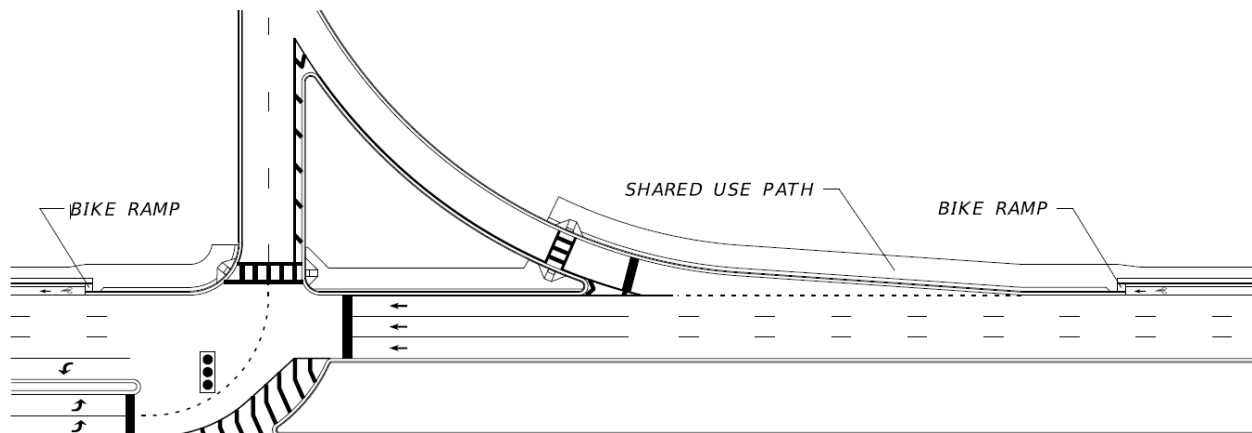

For existing interchanges where a bicycle ramp cannot be provided, a design variation is not required. Consider any of the following mitigation strategies, in addition to the required keyhole lane, where there is not an option lane:

- Provide an “exit ramp” from the bicycle lane to a sidewalk and an “entry ramp” from the sidewalk to the bicycle lane.
- Provide supplemental green markings within the keyhole lane. See FDM 223 for information on bicycle facilities.
- Add speed management strategies to lower speeds through the conflict area. See FDM 202 on Speed Management.

Where there is an option lane, discontinue the bicycle lane on the approach to the interchange and resume at the far side of the interchange.

211.18.2 Refuge Island at Ramp Intersections

Design corner channelization islands as refuge islands that meet the criteria in **FDM 210.3.2.3**.

211.18.3 Intersection Angle with Crossroad

Provide an intersecting angle consistent with intersection design criteria in **FDM 212**.

When the intersecting angle cannot be between 75 to 90 degrees, process a design variation, and consider the following mitigation strategies:

- Signalize the free-flowing or yield on/off-ramp movement or
- Provide a pedestrian signal or Rectangular Rapid-Flashing Beacon (RRFB) for the pedestrian crossing. For the criteria of a RRFB, please refer to [TEM 5.2.5.2](#).

A conceptual layout of a low-angle ramp intersection with mitigation strategies is provided in **Figure 211.18.2**.

For existing interchanges, a Design Variation is only required when the mitigation strategies are not met. Existing ramp configuration does not require a Design Variation on RRR projects.

Figure 211.18.2 Example of Mitigation for Low-Angle Ramp

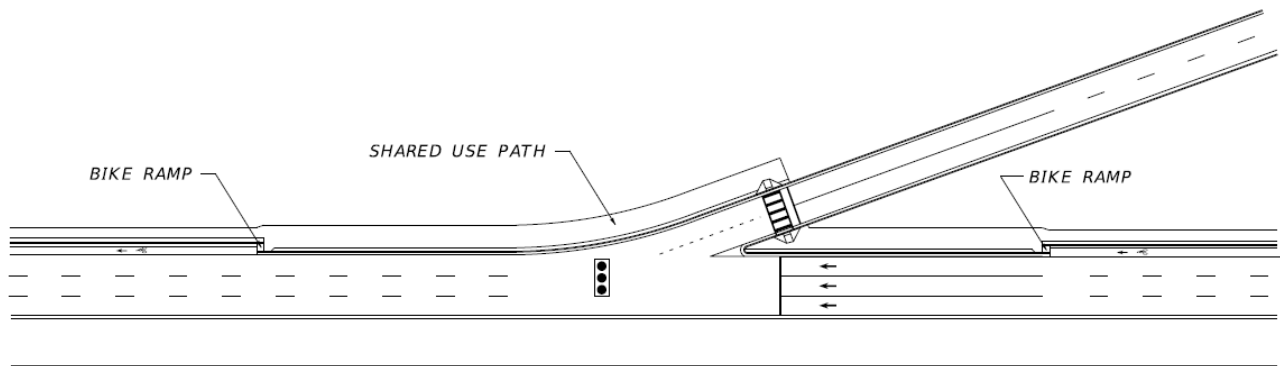

211.18.4 Signing and Pavement Markings

See **FDM 230.6** for typical signing and pavement markings for bicycle and pedestrian facilities through interchange areas.

212 Intersections

212.1 General

This chapter provides design criteria and guidance for the geometric layout of at-grade conventional intersections. Conventional intersections include 3-leg (T), 4-leg, and Multi-leg (5 or more legs).

Multi-leg conventional intersections should be avoided. Alternatives to existing multi-leg intersections include:

- (1) Converting to a roundabout.
- (2) Converting one or more legs to a one-way operation
- (3) Reconfiguring or realigning the intersection to create separate intersections, each with no more than four legs.

See **FDM 201** for design vehicle selection and design speed requirements.

See **FDM 210** for lane width, median width, island dimensions, and deflection angle requirements.

See **FDM 222** for requirements concerning pedestrian facilities and **FDM 223** for bicycle facilities.

212.1.1 Alternative Intersections

Alternative intersection design is a key component of upgrading our transportation facilities and improving the mobility and safety of all road users. These innovative designs are becoming more common as increasing traffic demand exceed the limitations of traditional intersection solutions.

Alternative intersections offer the potential to improve safety and reduce delay at lower cost and with fewer impacts than traditional solutions such as adding lanes or grade separation. Three of the more common alternative intersection types are:

- Displaced Left Turn (a.k.a. Continuous Flow Intersection)
- Restricted Crossing U-Turn (RCUT)
- Median U-Turn (MUT)

The FHWA has published comprehensive informational guides for alternative intersections which include guidance on how to plan, design, construct, and operate them. The following links provide access to these guides: [FHWA Alternative Designs](#) and [Alternative Intersections/Interchanges: Informational Report \(AIR\)](#).

These types of alternate intersection designs should be coordinated with the Central Office Roadway Design.

212.1.2 Intersection Control Evaluation

Intersection Control Evaluation (ICE) is a process to determine the most effective intersection configuration for a specified project. Through ICE, multiple alternative and conventional intersection configurations are compared to one another based on safety, operations, cost, and environmental impacts. The ICE procedure provides a transparent and consistent approach to intersection alternatives selection and provides documentation to support decisions made.

ICE policy and procedure is published on the FDOT Traffic Engineering and Operations Office website at the following Link: [Manual on Intersection Control Evaluation](#).

212.2 Intersection Control

Conventional intersections utilize one of four control types; yield, stop, all-way stop and signal.

212.2.1 Yield Control

Certain channelized movements at intersections and interchanges, and all approaches to roundabouts are often yield controlled. Refer to the [Manual on Uniform Traffic Control Devices \(MUTCD\)](#) for information on the locations where yield control traffic control devices may be appropriate.

212.2.2 Stop Control

Stop-controlled intersections have one or more legs of the intersection controlled by a "STOP" sign (R1-1).

Intersections with stop control are a common, low-cost control, which require the traffic on the minor roadway to stop before entering the major roadway. It is used where

application of the normal R/W rule is not appropriate for certain approaches at the intersection.

To meet the requirements for the assigned access classification, or where U-turn opportunities exist within a corridor, consider limiting stop controlled minor roads or driveways to “right-in, right-out” only.

212.2.3 All-Way Stop Control

For an all-way stop intersection, traffic approaching it from all directions is required to stop before proceeding through the intersection. An all-way stop may have multiple approaches and typically marked with a supplemental signing stating the number of approaches.

All-way stop control is most effective at the intersection of low-speed, 2-lane roadways not exceeding 1,400 vehicles during the peak hour. All-way stop control should not be used on multilane highways. Guidance for consideration of the application of all-way stop control is provided in the *MUTCD*.

All-way stop control may be used as an interim measure when a traffic signal or roundabout is warranted, but the installation is delayed.

212.2.4 Signal Control

Signalization provides an orderly and predictable movement of motorized and non-motorized traffic throughout the highway transportation system. It also provides guidance and warnings to ensure the safe and informed operation of the traffic stream.

Refer to *FDM 232* for design criteria for signalization.

212.3 Intersection Types

Conventional intersection configurations include flared and channelized intersections (divided and undivided). Flared intersections are illustrated in *Figure 212.3.1* and channelized intersections in *Figure 212.3.2*. See *FDM 210.3* for median and island requirements.

Figure 212.3.1 Flared Intersections

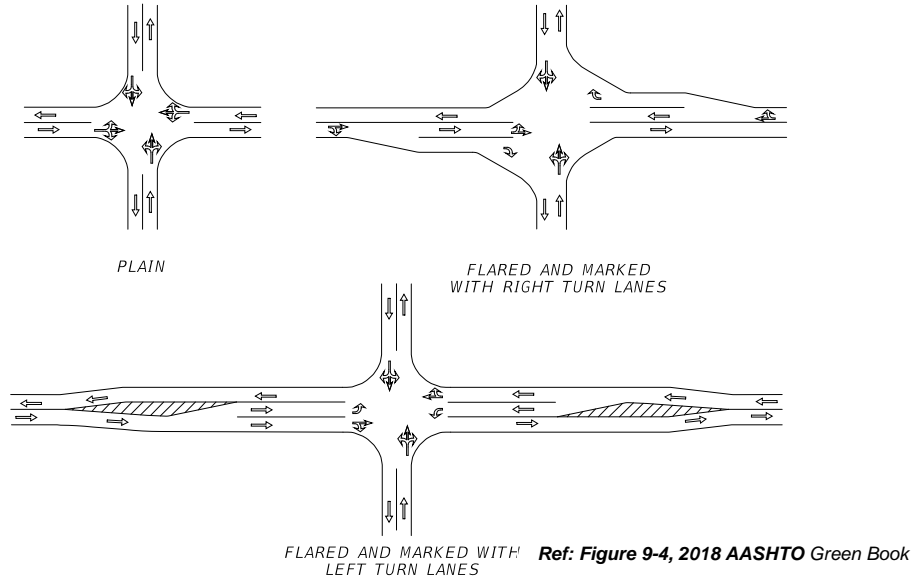
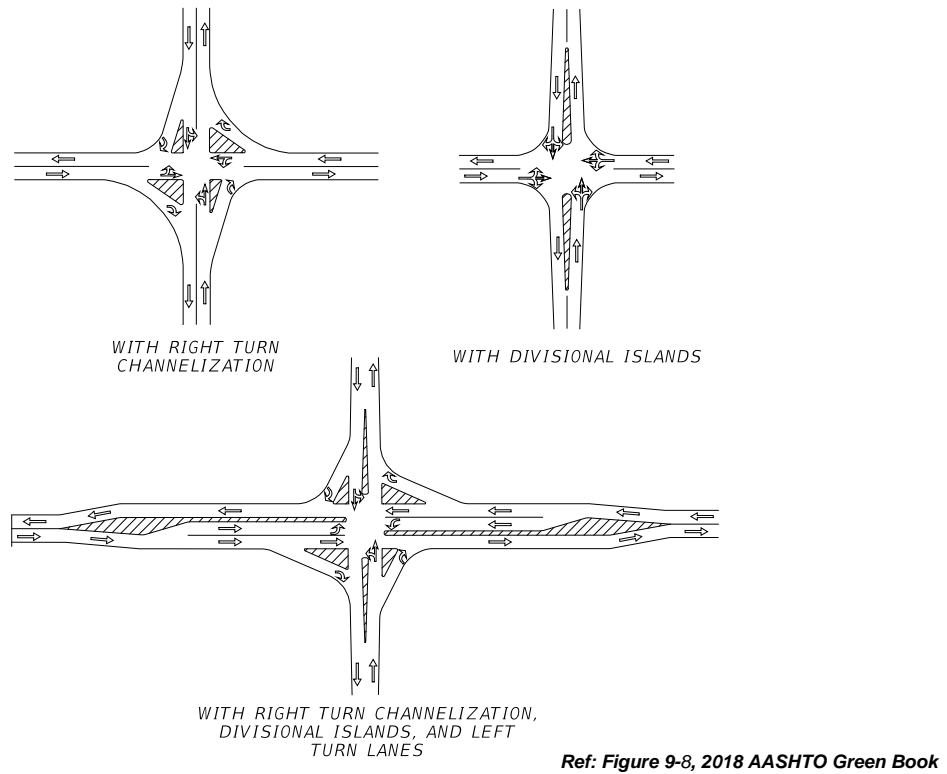

Figure 212.3.2 Channelized Intersections



212.4 Intersection Functional Area

The functional area of an intersection extends in both directions including auxiliary lanes and their associated channelization. This is illustrated in **Figures 212.4.1** and **212.4.2**.

The functional area on the approach to an intersection or driveway consists of three basic elements:

- (1) Perception-reaction-decision distance
- (2) Maneuver distance
- (3) Queue-storage distance (see **FDM 212.14.2**)

These elements are shown in **Figure 212.4.3**. The maneuver distance includes the length needed for both braking and lane changing when there is a left or right turning lane. In the absence of turn lanes, the maneuver distance is the distance to brake to a comfortable stop. The storage length includes the most distant extent of any intersection-related queue expected to occur during the design period.

Figure 212.4.1
Physical Definition

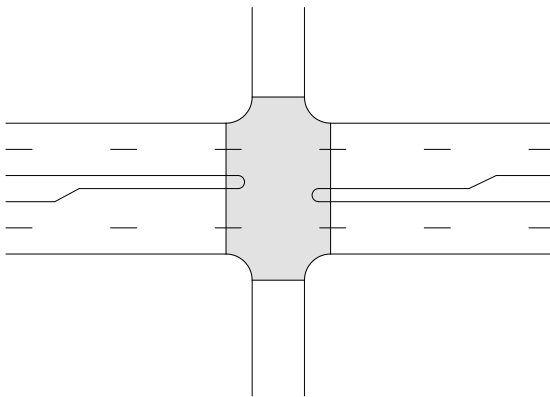

Ref: Figure 9-2, 2018 AASHTO Green Book

Figure 212.4.2
Functional Definition

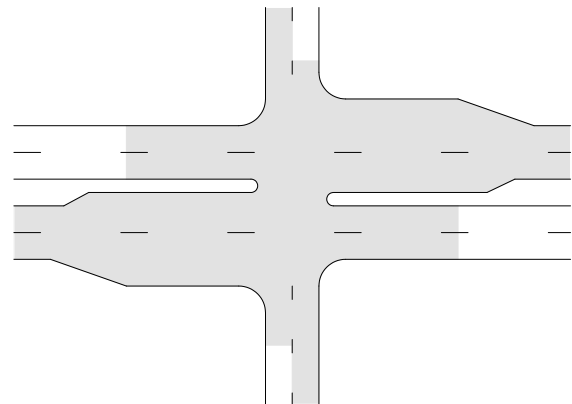

Ref: Figure 9-2, 2018 AASHTO Green Book

Figure 212.4.3 Elements of the Functional Area

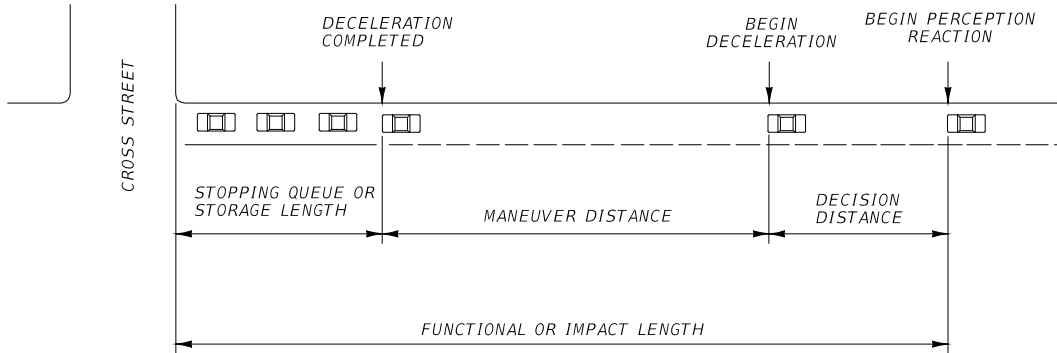

Ref: Figure 9-3, 2018 AASHTO Green Book

212.5 Intersection Angle

The intersection angle between two roadways has a significant influence on the safety and operation of an intersection. Intersection angles are to be as close to 90 degrees as practical. Intersection angles less than 75 degrees should be avoided for the following reasons:

- (1) Heavy skew angles increase the intersection crossing length, exposing vehicles, pedestrians, and cyclists to conflicting traffic streams for longer periods of time. This is of particular concern at stop-controlled approaches on high-speed facilities.
- (2) The road user's sight angle to the crossing leg becomes restricted due to the skew, making it difficult to see conflicting vehicles and to perceive safe crossing gaps.
- (3) Turning movements are difficult because of the skew. Additional pavement may be necessary to accommodate the turning of large trucks.
- (4) Turning movements or positioning may be confusing and require additional channelization.
- (5) Increased open pavement areas of highly skewed intersections increase construction and maintenance costs.

Evaluate intersections with severe skew angles and crash histories for geometric improvements as shown in **Figure 212.5.1**. A high incidence of right-angle crashes is an indicator that improvements may be justified.

Figure 212.5.1 Intersection Reconfigurations

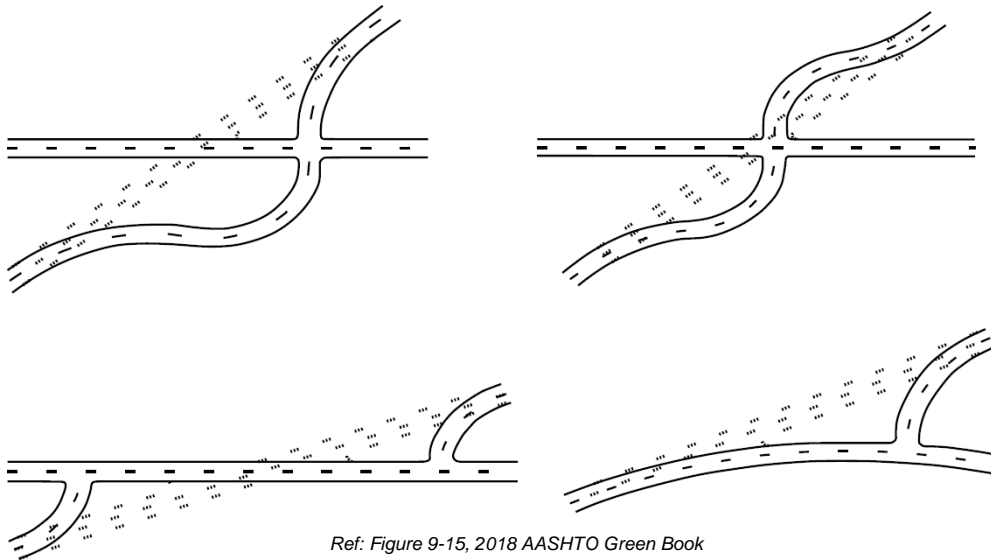

Ref: Figure 9-15, 2018 AASHTO Green Book

212.6 Lane Tapers

Standard taper lengths for auxiliary lanes are given in **FDM 212.14**. Taper length is based on the following equations:

- (1) Merging Taper (L):
 - (a) For design speeds ≤ 40 mph: $L = (W \cdot S^2) / 60$
 - (b) For design speeds ≥ 45 mph: $L = W \cdot S$

Where:

- L = Taper length (feet)
- W = Width of offset (feet)
- S = Design speed (mph)

- (2) Shifting Taper is equal to Merging Taper (L) / 2.

Minimum deceleration lengths are illustrated in **Exhibit 212-1**. Additional information on lane transitions (add or drop) are provided in **Exhibits 212-2** and **212-3**.

MEDIAN TURN LANES MINIMUM DECELERATION LENGTHS

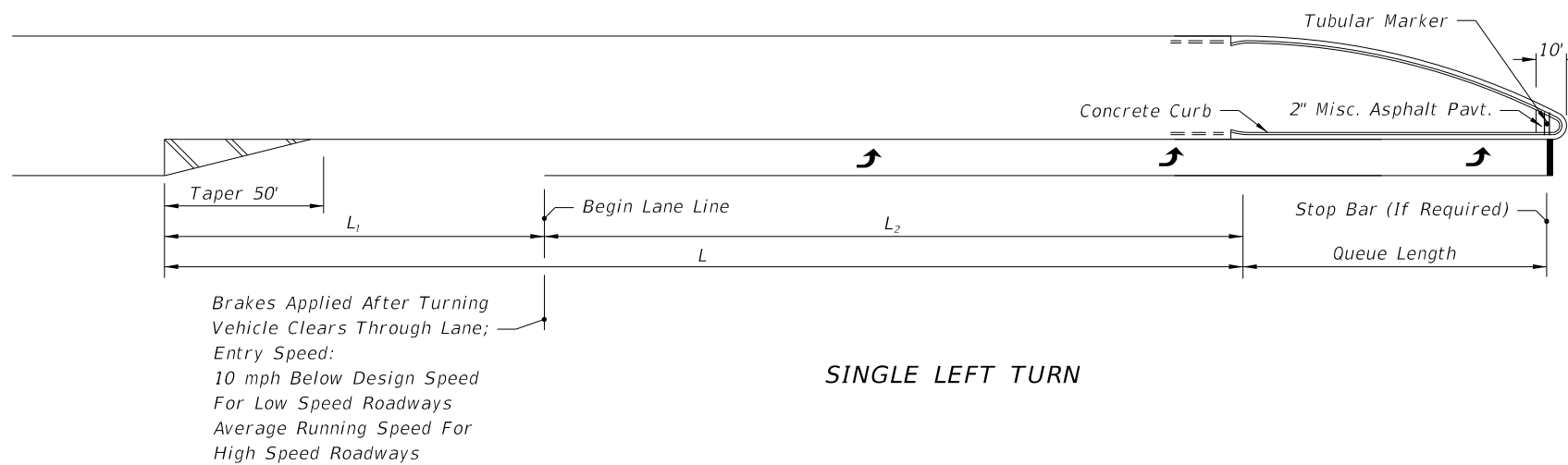
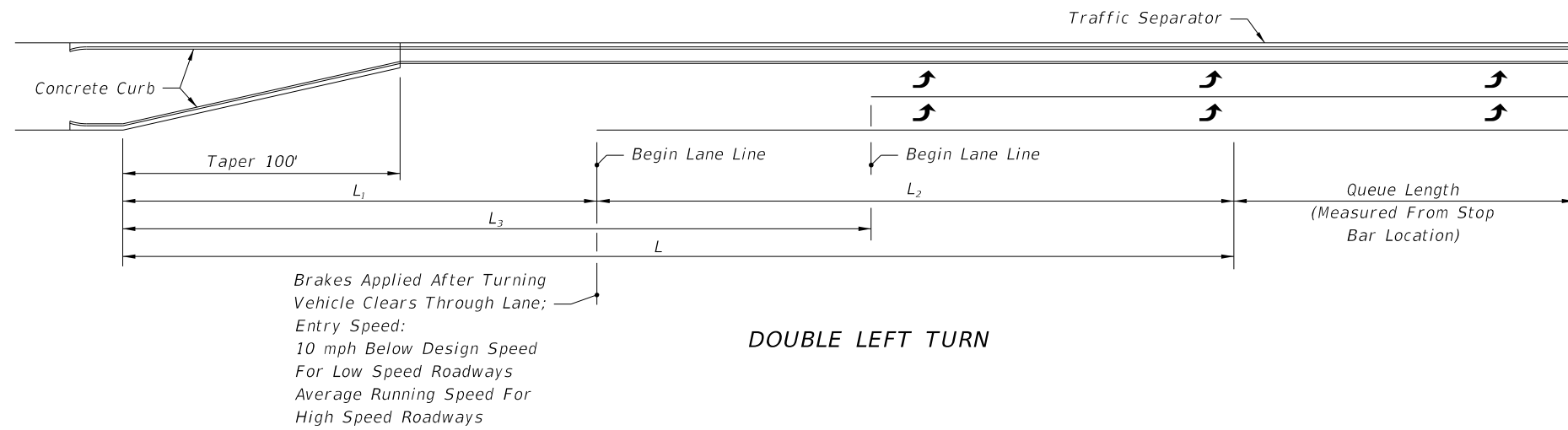

MEDIAN TURN LANES					
Design Speed (mph)	Entry Speed (mph)	Clearance Distance L_1 (ft.)	Brake To Stop Distance L_2 (ft.)	Total Decel. Distance L (ft.)	Clearance Distance L_3 (ft.)
25	15	70	25	95	90
30	20	70	50	120	100
35	25	70	75	145	110
40	30	80	75	155	120
45	35	85	100	185	135
50	44	105	185	290	160
55	48	125	225	350	195
60	52	145	260	405	230
65	55	170	290	460	270
70	58	200	325	525	300

NOTE:

- 1) For C3 Context Classification roadways with Design Speeds of 50 mph, the following values may be used under constrained conditions:
 - Entry Speed of 40 mph
 - Brake to stop distance (L_2) of 135 ft.
 - Total deceleration distance (L) of 240 ft.
- 2) For RRR Projects with Design Speeds of 50 mph and Entry Speeds of 40 mph, existing brake to stop distances (L_2) of 135 ft. and total deceleration distances (L) of 240 ft. may be retained.

NOT TO SCALE

LANE TRANSITIONS: 4-LANE ROADWAYS

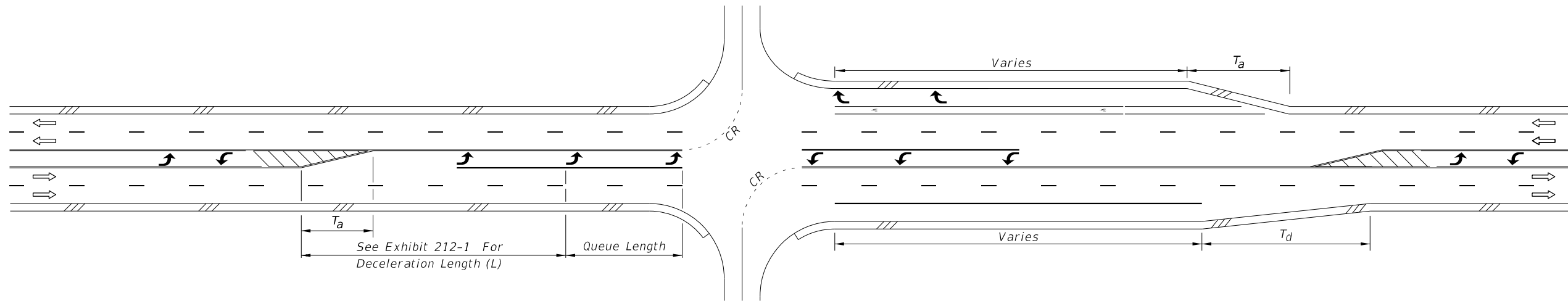

TWO-WAY LEFT-TURN LANES

DESIGN SPEED (mph)	T_a (ft.)	T_d
<30	1:4, 50 ft. min.	1:25
30-45		1:30
>45		1:40

Note: For locations with unrelocatable control points minimum taper rates for lane drop (T_d) will be 1:20.

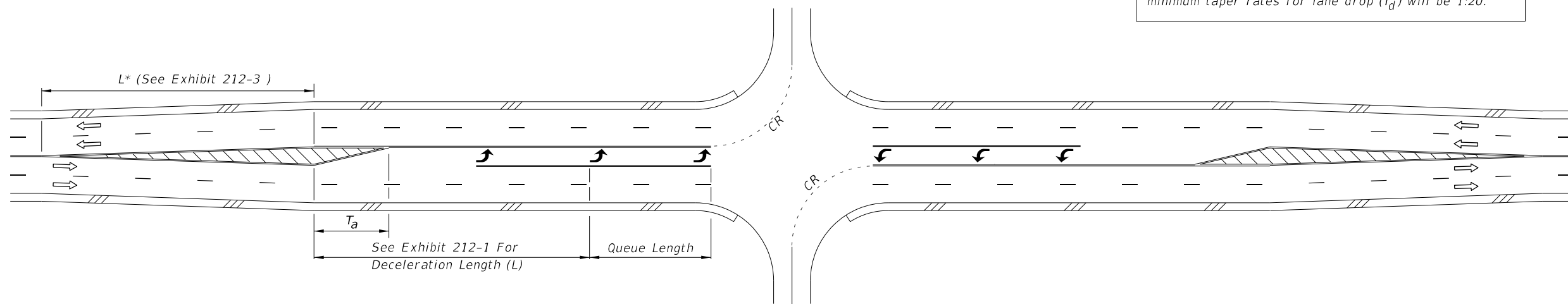

UNDIVIDED FLARED - SYMMETRICAL

NOT TO SCALE

LANE TRANSITIONS: 2-LANE ROADWAYS

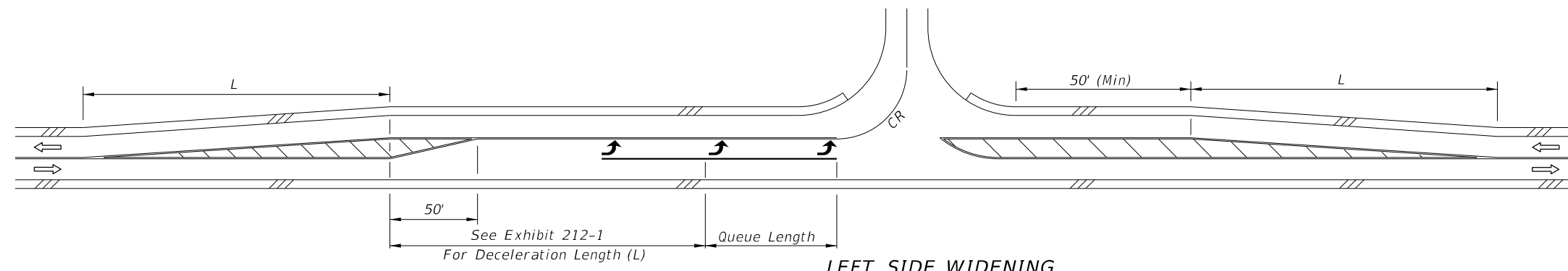

LEFT SIDE WIDENING

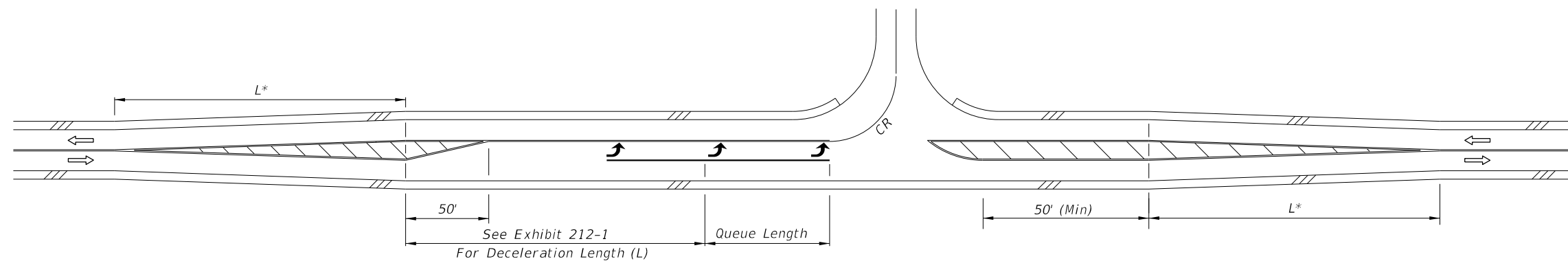

CENTERED WIDENING

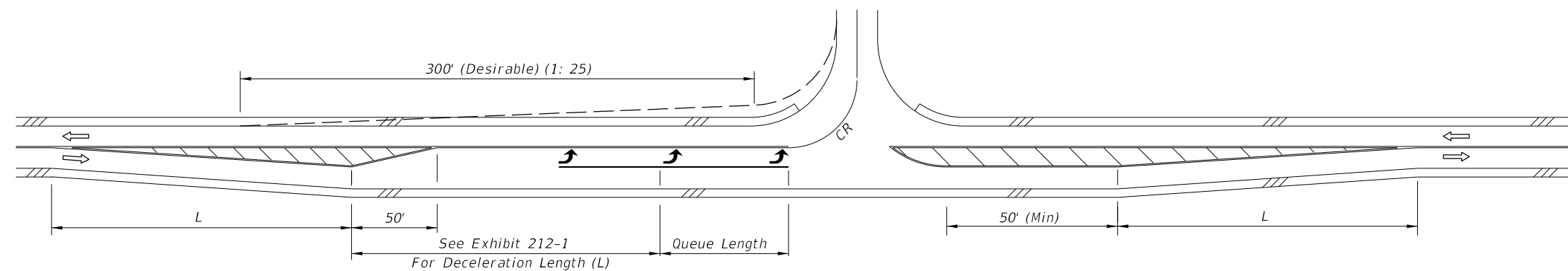

RIGHT SIDE WIDENING

$$L = \frac{WS^2}{60} \text{ FOR DESIGN SPEEDS } \leq 40 \text{ mph}$$

$$L = WS \text{ FOR DESIGN SPEEDS } \geq 45 \text{ mph}$$

WHERE: L = LENGTH OF TAPER, FEET
 W = WIDTH OF LATERAL TRANSITION, FEET
 S = DESIGN SPEED, mph

W = ONE LANE WIDTH

* W = 1/2 LANE WIDTH

NOTE:
 For RRR Projects the following existing transition lengths (L) for the indicated Design Speed may be retained under constrained conditions:

- 120' for 30 mph
- 150' for 40 mph
- 180' for 50 mph
- 240' for 60 mph

FLARED & PAINTED LEFT TURNS FOR 2-LANE ROADWAYS

NOT TO SCALE

EXHIBIT 212-3
 01/01/2024

212.7 Lane Shifts

Lane shifts through intersections should meet the requirements for non-merging conditions. Pavement markings should be used through the intersection to provide positive guidance to the motorist. The shifting taper length is controlled by the size of the intersection and the deflection angle. Although deflections through intersections are discouraged, there may be conditions where they are necessary.

The maximum deflection angles at intersections to be used in establishing the horizontal alignment are given in **Table 212.7.1**.

Table 212.7.1 Maximum Deflection Angle Through Intersection

Maximum Deflection Angle Through Intersection (DM)					
Design Speed (mph)					
≤ 20	25	30	35	40	45
16° 00'	11° 00'	8° 00'	6° 00'	5° 00'	3° 00'

Notes:
 Deflection angle used is not to cause a lane shift (W) of more than 6 feet from stop bar to stop bar.

212.8 Profile Grades

The profile grade line defines the vertical alignment for construction. The grade line of the mainline road is typically carried through the intersection and the minor crossroad (or cross street) is adjusted to it. This design involves a transition in the crown of the crossroad to an inclined cross section at its junction with the mainline road, as illustrated in **Figure 212.8.1**.

The break in the crossroad profile at the center of the intersection should be accomplished with a vertical curve.

Vertical alignments at or near intersections should provide traffic lanes that are:

- (1) Clearly visible and understandable to drivers for any desired direction of travel,
- (2) Free from sudden appearance of potential conflicts, and
- (3) Consistent in design with the portions of the highway just traveled.

Steep grades at intersections may increase or decrease stopping or acceleration distance. Avoid grades in excess of 3% on intersecting roads in the vicinity of the intersection. Where conditions make such designs impractical, grades should not exceed 6%.

Provide adequate sight distance along both intersecting roads and across their included corners, even where one or both intersecting roads are on vertical curves. The gradients of intersecting roads should be as flat as practical on those sections that are to be used for storage of stopped vehicles.

Figure 212.8.1 Cross Street Intersection Transition

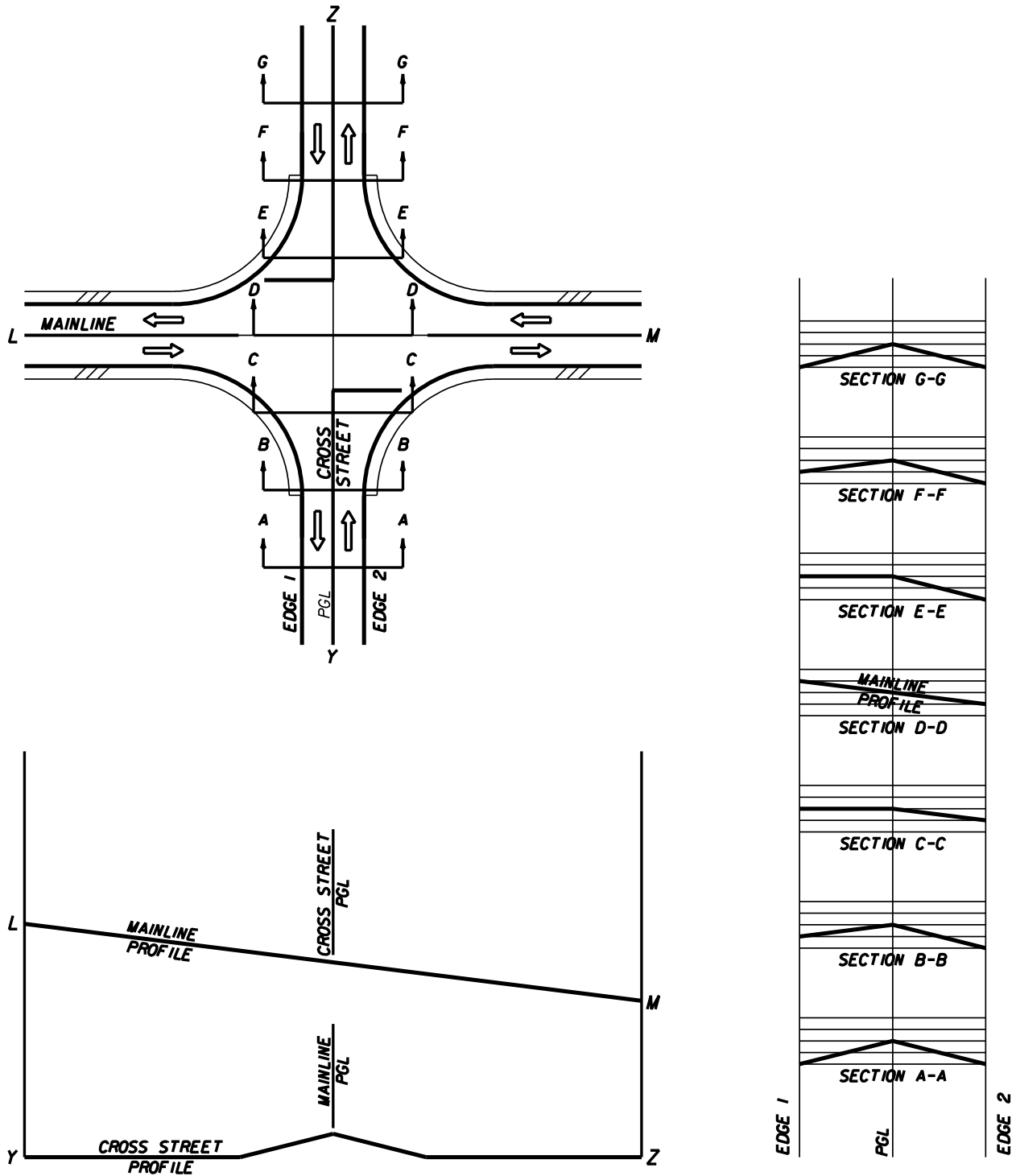

212.8.1 Special Profiles

Special profiles for certain roadway elements may be necessary to ensure a safe, efficient, well-drained and smooth roadway system. Elements that may require special profiles include pavement edges or gutter flow lines at street intersections, profile grade lines, intersection plateaus, curb returns, and special superelevation details. Special profiles are developed at close intervals and large scale to clearly identify all construction details of these elements.

212.8.2 Plateauing

In some instances, it is desirable for the crossroad to receive the same profile considerations as the mainline road. To provide this "equal treatment", with respect to profile, a technique commonly known as intersection plateauing is applied. Plateauing refers to flattening of the intersection and the transition of both roadway profiles and cross slopes on the intersection approaches.

Provide a profile combination that provides a smooth transition and adequate drainage when applying intersection plateauing. Transition slope rates are to meet the values provided in **Table 212.8.1**; however, the minimum length of cross slope transition is 50 feet for design speeds less than or equal to 35 mph and 75 feet for design speeds of 40 mph or greater.

An example of a plateaued intersection is illustrated in **Figure 212.8.2**.

Table 212.8.1 Slope Rates for Intersection Approaches

Design Speed (mph)	Slope Ratio
25-35	1:100
40	1:125
45-50	1:150
55-60	1:170
65-70	1:190

Figure 212.8.2 Example of Plateaued Intersection

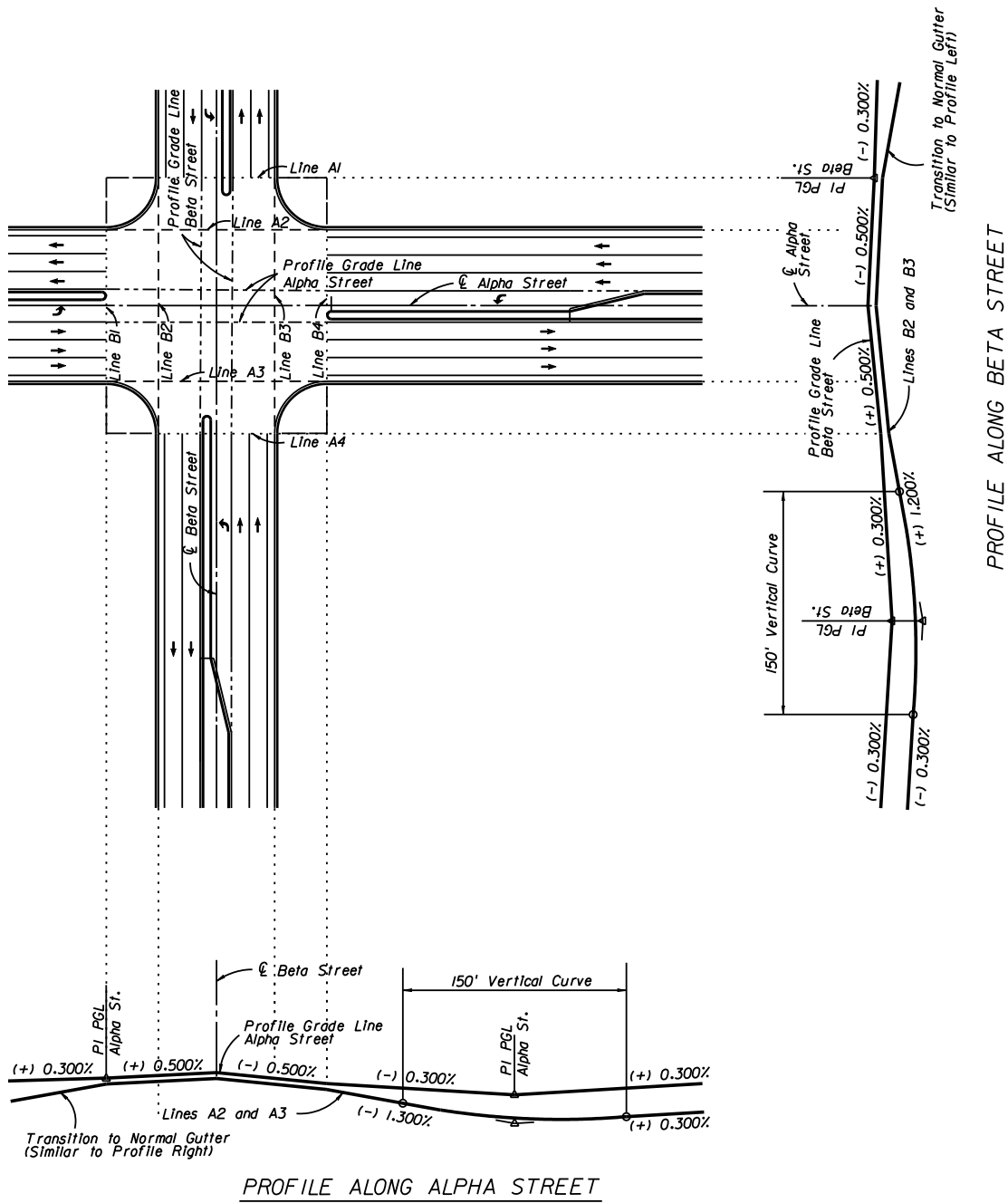

212.9 Median Openings

Locate and design median openings to meet traffic requirements in accordance with the access management plan for the facility. See **FDM 201.4** for more information on access management plans and decision making.

See **FDM 210.3** for additional requirements for medians at intersections.

The following conditions may require additional median width:

- accommodation for trees (provide space above and below ground for growth)
- offset turn lanes
- directional median openings
- dual and triple left turn lanes

The overall length of a full median opening is typically the same width as the intersecting road (including shoulders) which is sufficient to accommodate the swept path of left turning vehicles. Median functions and minimum widths are provided in **Table 212.9.1**.

For un-signalized intersections, median openings should not be longer than the required length to avoid multiple vehicles attempting to stop within the opening.

Table 212.9.1 Minimum Median Width

Median Function	Minimum Width (feet)
Separation of opposing traffic	4
Provision for pedestrian refuge	6
Provision for storage of left-turning vehicles	See Table 210.3.1
Provision for protection of vehicles crossing through lanes	22
Provision for U-turns, left turn lane to outside lanes	30
Provision for Dual Left Turn Lanes and U Turns	42

The control radius refers to a radius that must be considered in establishing the location of median or traffic separator ends on divided highways and the stop bar on undivided highways. Provide this radius for left-turn movements when appropriate.

Design guidance on minimum edge-of-traveled-way design for various design vehicles is provided in **FDM 212.12.1**.

For the central part of the turn the use of compound curves is not necessary and the use of simple curves is satisfactory. **Table 212.9.2** provides control radii for minimum-speed turns (10 to 15 mph) that can be used for establishing the location of the median ends.

Table 212.9.2 Control Radii for Minimum Speed Turns

Design Vehicles Accommodated	Control Radius (feet)			
	50 (40 min)	60 (50 min)	75	130
Predominant	P	SU-30	SU-40, WB-40	WB-62FL
Occasional	SU-30	SU-40, WB-40	WB-62	WB-67

212.9.1 U-Turns

Median width should accommodate passenger vehicle (P) left-turn and U-turn maneuvers. If adequate median width does not exist for accommodating U-turns, then consider adding extra pavement width such as a taper or additional shoulder width. See **FDM 210.3** for information on median width criteria.

In cases where U-turn traffic volumes are high, consider the use of jug handles, loop designs, or indirect left turn designs.

212.10 Stopping Sight Distance

See **FDM 210.11.1** for stopping sight distance requirements.

212.11 Clear Sight Triangles

Establish clear sight triangles to assure that drivers are provided a sufficient view of the intersecting highway to identify gaps in traffic and decide when it is safe to proceed. Document the analysis of sight distance for all intersections.

Clear sight triangles are the areas along intersection approach legs and across their common corners that should be clear of visual hindrances. Dimensions of clear sight triangles are based on design speed, design vehicle, and the type of traffic control used at the intersection.

212.11.1 Stop Control (AASHTO Case B)

Figure 212.11.1 illustrates clear sight triangles for intersections and driveways.

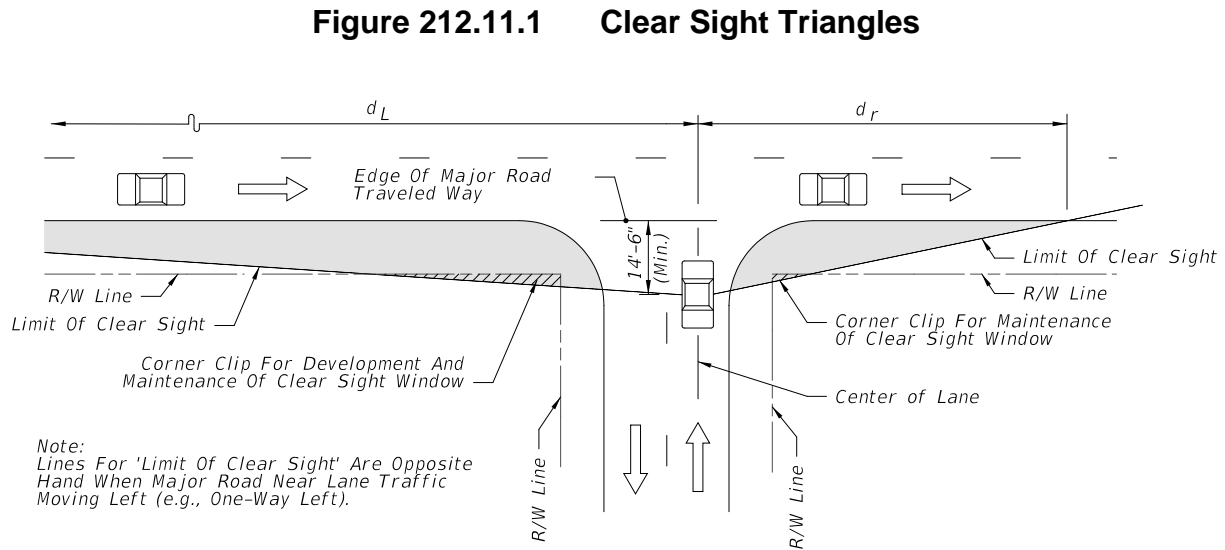

The minimum driver-eye setback of 14.5 feet from the edge of the traveled way may be adjusted on any intersection leg only when justified by a documented, site-specific field study of vehicle stopping position and driver-eye position.

Exhibits 212-4 through **212-7** provide intersection sight distances for stop-controlled intersections. The tables in the exhibits provide sight distance values for Passenger vehicles, Single Unit (SU) Trucks, and Combination vehicles for design speeds ranging from 25 mph to 70 mph. Intersection sight distance based on Passenger vehicles is suitable for most intersections; however, consider the values for SU Vehicles or Combination vehicles for intersections with high truck volumes.

The following guidance applies to **Exhibits 212-4** through **212-7**:

- (1) Limitations
 - (a) The exhibits apply to intersections in all context classifications with stop control or flashing beacon control.
 - (b) The exhibits apply only to intersections with intersecting angles between 60° and 120°, and where vertical and horizontal curves are not present.

(2) Dimensions

- (a) Sight distance (d) is measured from the center of the entrance lane of the crossroad to the center of the near approach lane (right or left) of the highway.
- (b) Distances ' d_L ' and ' d_r ' are measured from the centerline of the entrance lane of the crossroad to a point on the edge of the near side outer traffic lane on the highway.
- (c) Distance ' d_m ' is measured from the centerline of the entrance lane of the crossroad to a point on the median clear zone limit or horizontal clearance limit for the far side road of the highway.

(3) Vertical limits

- (a) Provide a clear sight window throughout the limits of all intersection sight triangles.
- (b) Provide a clear line of sight between vehicles at intersection stop locations and vehicles on the highway throughout the limits of all intersection sight triangles.
- (c) The reference datum between roadways is 3'-6" above respective pavements since observations are made in both directions along the line of sight.

INTERSECTION SIGHT DISTANCE: 2-LANE UNDIVIDED

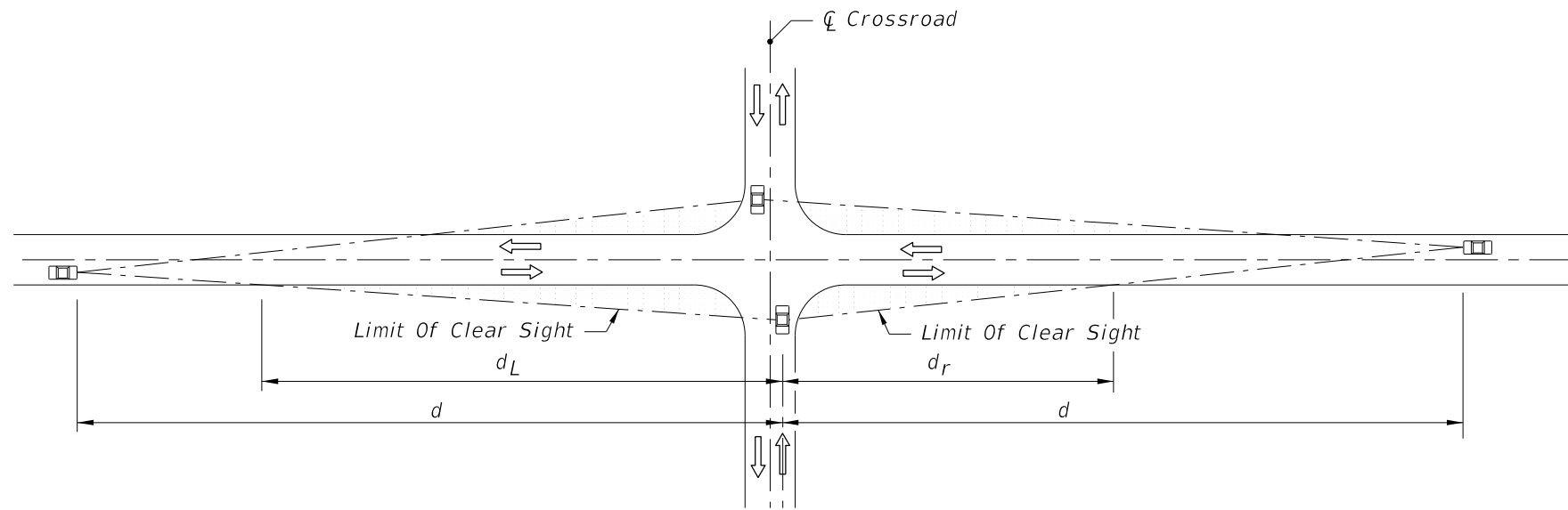

Design Speed (mph)	d (Ft.)	d _L (Ft.)	d _r (Ft.)
≤ 25	280	200	130
30	335	240	155
35	390	275	175
40	445	315	200
45	500	355	225
50	555	395	250
55	610	435	275
60	665	470	300
65	720	510	325
70	775	550	350

Passenger Vehicle

Design Speed (mph)	d (Ft.)	d _L (Ft.)	d _r (Ft.)
≤ 25	350	250	160
30	420	300	190
35	490	350	220
40	560	400	250
45	630	450	285
50	700	495	315
55	770	545	345
60	840	595	375
65	910	645	410
70	980	695	440

SU Vehicle

Design Speed (mph)	d (Ft.)	d _L (Ft.)	d _r (Ft.)
≤ 25	425	300	190
30	510	365	230
35	595	420	265
40	680	480	305
45	765	545	345
50	845	600	380
55	930	660	415
60	1015	720	455
65	1100	780	495
70	1185	840	530

Combination Vehicle

SIGHT DISTANCE (d) AND RELATED DISTANCES (d_L, d_r) (FEET)

2 LANE UNDIVIDED

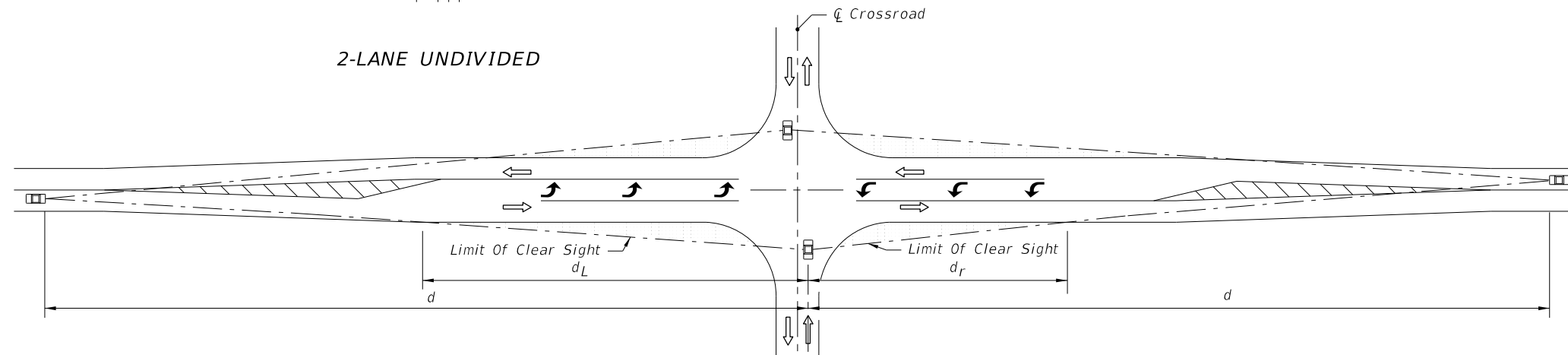

2-LANE UNDIVIDED

2-LANE WITH LEFT TURN LANE

Design Speed (mph)	d (Ft.)	d _L (Ft.)	d _r (Ft.)
≤ 25	295	165	115
30	355	195	135
35	415	230	160
40	475	260	180
45	530	290	200
50	590	325	225
55	650	355	245
60	710	390	270
65	765	420	290
70	825	455	315

Passenger Vehicle

Design Speed (mph)	d (Ft.)	d _L (Ft.)	d _r (Ft.)
≤ 25	375	205	145
30	450	250	170
35	525	290	200
40	600	330	230
45	675	370	255
50	750	410	285
55	825	455	315
60	900	495	340
65	975	535	370
70	1050	575	395

SU Vehicle

Design Speed (mph)	d (Ft.)	d _L (Ft.)	d _r (Ft.)
≤ 25	450	250	170
30	540	295	205
35	630	345	240
40	720	395	275
45	810	445	305
50	900	495	340
55	990	545	375
60	1080	590	410
65	1170	640	440
70	1260	690	475

Combination Vehicle

SIGHT DISTANCE (d) AND RELATED DISTANCES (d_L, d_r) (FEET)

2-LANE WITH LEFT TURN

NOT TO SCALE

NOTE:

1. See Figure 212.11.1 for origin of clear sight line on the minor road.

LEGEND

Areas Free Of Sight Obstructions

EXHIBIT 212-4
01/01/2023

INTERSECTION SIGHT DISTANCE: 4-LANE UNDIVIDED

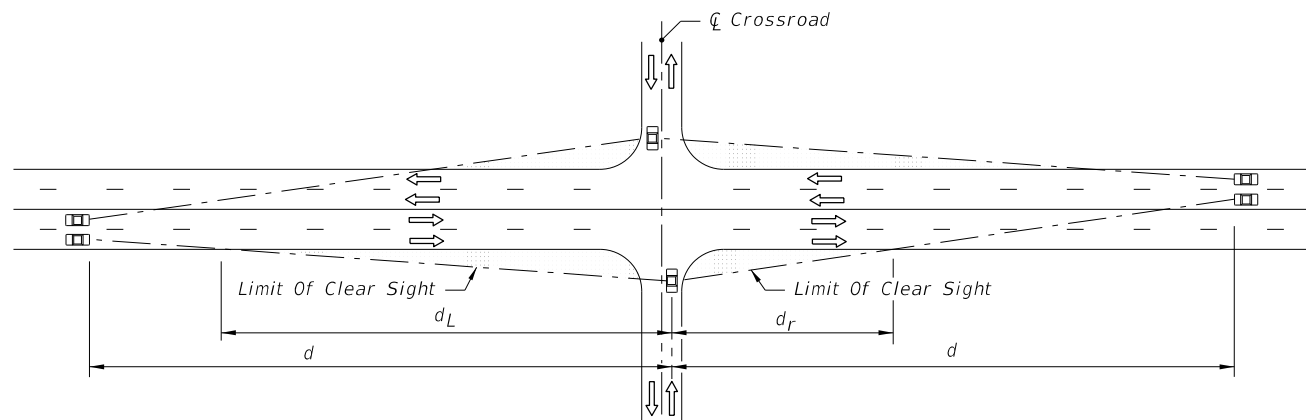

4-LANE UNDIVIDED

Design Speed (mph)	d (Ft.)	d _L (Ft.)	d _r (Ft.)
≤ 25	295	210	100
30	355	255	120
35	415	295	135
40	475	335	155
45	530	375	175
50	590	420	195
55	650	460	215
60	705	500	230
65	765	545	250
70	825	585	270

Passenger Vehicle

Design Speed (mph)	d (Ft.)	d _L (Ft.)	d _r (Ft.)
≤ 25	375	265	125
30	450	320	150
35	525	375	175
40	600	425	200
45	675	480	220
50	750	530	245
55	825	585	270
60	900	640	295
65	975	690	320
70	1050	745	345

SU Vehicle

Design Speed (mph)	d (Ft.)	d _L (Ft.)	d _r (Ft.)
≤ 25	450	320	150
30	540	385	180
35	630	450	205
40	720	510	235
45	810	575	265
50	900	640	295
55	990	700	325
60	1080	765	355
65	1170	830	385
70	1255	890	410

Combination Vehicle

SIGHT DISTANCE (d) AND RELATED DISTANCES (d_L, d_r) (FEET)
4 LANE UNDIVIDED

Design Speed (mph)	d (Ft.)	d _L (Ft.)	d _r (Ft.)
≤ 25	315	175	90
30	375	205	110
35	440	245	130
40	500	275	145
45	565	310	165
50	625	345	180
55	690	380	200
60	750	410	215
65	815	450	235
70	875	480	255

Passenger Vehicle

Design Speed (mph)	d (Ft.)	d _L (Ft.)	d _r (Ft.)
≤ 25	400	220	115
30	480	265	140
35	560	310	165
40	640	350	185
45	720	395	210
50	800	440	230
55	880	485	255
60	960	525	280
65	1040	570	300
70	1120	615	325

SU Vehicle

Design Speed (mph)	d (Ft.)	d _L (Ft.)	d _r (Ft.)
≤ 25	475	260	140
30	570	315	165
35	665	365	195
40	760	420	220
45	855	470	245
50	950	520	275
55	1045	575	300
60	1140	625	330
65	1235	675	355
70	1330	730	385

Combination Vehicle

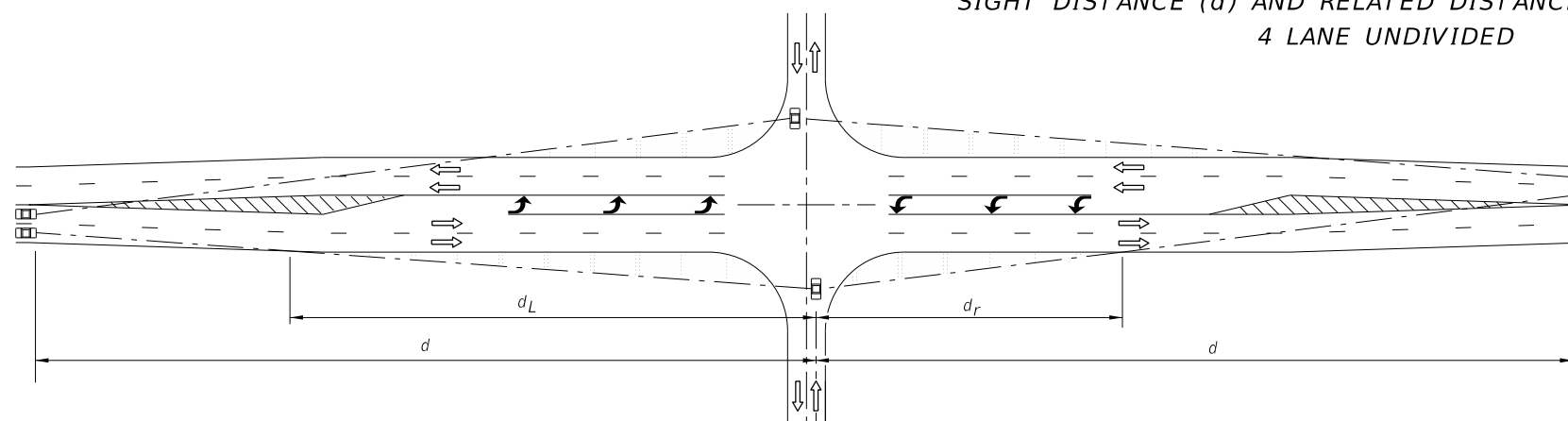

4-LANE UNDIVIDED WITH LEFT TURN LANE

SIGHT DISTANCE (d) AND RELATED DISTANCES (d_L, d_r) (FEET)
4-LANE UNDIVIDED WITH LEFT TURN LANE

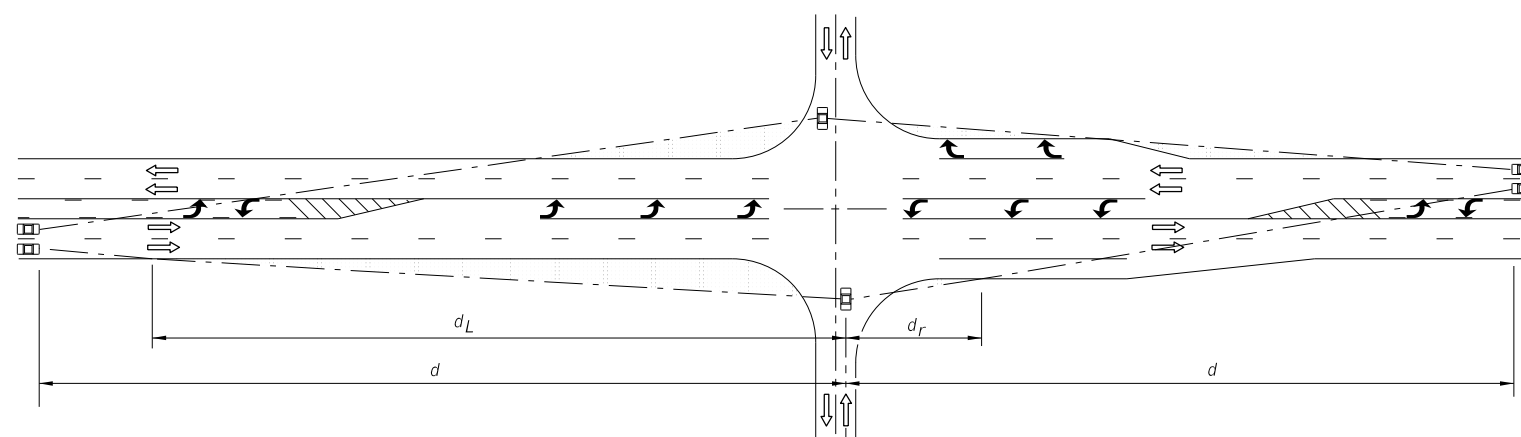

4-LANE UNDIVIDED WITH LEFT TURN LANE AND OPTIONAL LANE

Design Speed (mph)	d (Ft.)	d _L (Ft.)	d _r (Ft.)
≤ 25	315	225	70
30	375	265	80
35	440	315	95
40	500	355	110
45	565	400	120
50	625	445	135
55	690	490	150
60	750	530	160
65	815	580	175
70	875	620	190

Passenger Vehicle

Design Speed (mph)	d (Ft.)	d _L (Ft.)	d _r (Ft.)
≤ 25	405	290	90
30	480	340	105
35	560	400	120
40	640	455	135
45	720	510	155
50	800	570	170
55	880	625	190
60	960	680	205
65	1040	740	220
70	1125	800	240

SU Vehicle

Design Speed (mph)	d (Ft.)	d _L (Ft.)	d _r (Ft.)
≤ 25	475	340	105
30	570	405	125
35	665	470	145
40	760	540	165
45	855	605	185
50	950	675	205
55	1045	740	225
60	1140	810	245
65	1235	875	265
70	1330	945	285

Combination Vehicle

SIGHT DISTANCE (d) AND RELATED DISTANCES (d_L, d_r) (FEET)
4-LANE UNDIVIDED WITH LEFT TURN LANE AND OPTIONAL LANE

LEGEND

Areas Free Of Sight Obstructions

NOTE:

1. See Figure 212.11.1 for origin of clear sight line on the minor road.

NOT TO SCALE

EXHIBIT 212-5
01/01/2023

INTERSECTION SIGHT DISTANCE: 4-LANE DIVIDED

Median 22' or Less				
Design Speed (mph)	d (Ft.)	d _L (Ft.)	d _r (Ft.)	d _m (Ft.)
≤ 25	330	235	75	270
30	395	280	90	325
35	460	325	100	380
40	525	375	115	430
45	590	420	130	485
50	655	465	145	540
55	720	510	160	590
60	785	555	175	645
65	850	605	185	700
70	920	655	200	755

25'-64' Median				
Design Speed (mph)	d (Ft.)	d _L (Ft.)	d _v (Ft.)	d _{vL} (Ft.)
≤ 25	295	210	275	200
30	355	255	330	240
35	415	295	390	280
40	470	335	445	320
45	530	375	500	360
50	590	420	550	400
55	650	460	610	440
60	705	500	665	480
65	765	545	720	520
70	825	585	775	560

Passenger Vehicle

Median 35' or Less				
Design Speed (mph)	d (Ft.)	d _L (Ft.)	d _r (Ft.)	d _m (Ft.)
≤ 25	450	320	90	385
30	540	385	110	460
35	630	450	125	535
40	720	510	145	615
45	810	575	160	685
50	900	640	180	760
55	990	700	195	840
60	1080	765	215	915
65	1170	830	230	990
70	1255	890	250	1060

SU Vehicle

40'-64' Median				
Design Speed (mph)	d (Ft.)	d _L (Ft.)	d _v (Ft.)	d _{vL} (Ft.)
≤ 25	375	270	350	260
30	450	320	420	310
35	525	375	490	360
40	600	425	560	410
45	675	480	630	460
50	750	530	700	510
55	825	585	770	560
60	900	640	840	610
65	975	690	910	660
70	1050	745	980	710

Median 30' or Less				
Design Speed (mph)	d (Ft.)	d _L (Ft.)	d _r (Ft.)	d _m (Ft.)
≤ 25	515	365	100	432
30	615	435	120	520
35	720	510	140	605
40	820	580	160	690
45	925	655	180	780
50	1025	725	200	860
55	1130	800	220	950
60	1230	870	240	1035
65	1335	945	260	1120
70	1440	1020	280	1210

35'-50' Median				
Design Speed (mph)	d (Ft.)	d _L (Ft.)	d _r (Ft.)	d _m (Ft.)
≤ 25	555	395	85	485
30	670	475	105	585
35	780	555	120	680
40	890	630	140	780
45	1000	710	155	875
50	1110	790	170	970
55	1225	870	190	1070
60	1335	945	205	1165
65	1445	1025	225	1265
70	1555	1100	240	1360

Combined Vehicles

64' Median				
Design Speed (mph)	d (Ft.)	d _L (Ft.)	d _r (Ft.)	d _m (Ft.)
≤ 25	585	415	80	520
30	705	500	95	630
35	820	580	110	730
40	935	665	125	835
45	1055	750	145	940
50	1170	830	160	1045
55	1290	915	175	1150
60	1405	995	190	1250
65	1520	1080	205	1355
70	1640	1160	220	1460

Vehicle Type	Vehicle Length (Ft.)
Passenger (P)	19
Single Unit (SU)	30
Large School Bus	40
WB-40	45.5
WB-62FL	73.5

SIGHT DISTANCES (d) & (d_v) AND RELATED DISTANCES (d_L, d_r, d_m & d_{vL}) (FEET)

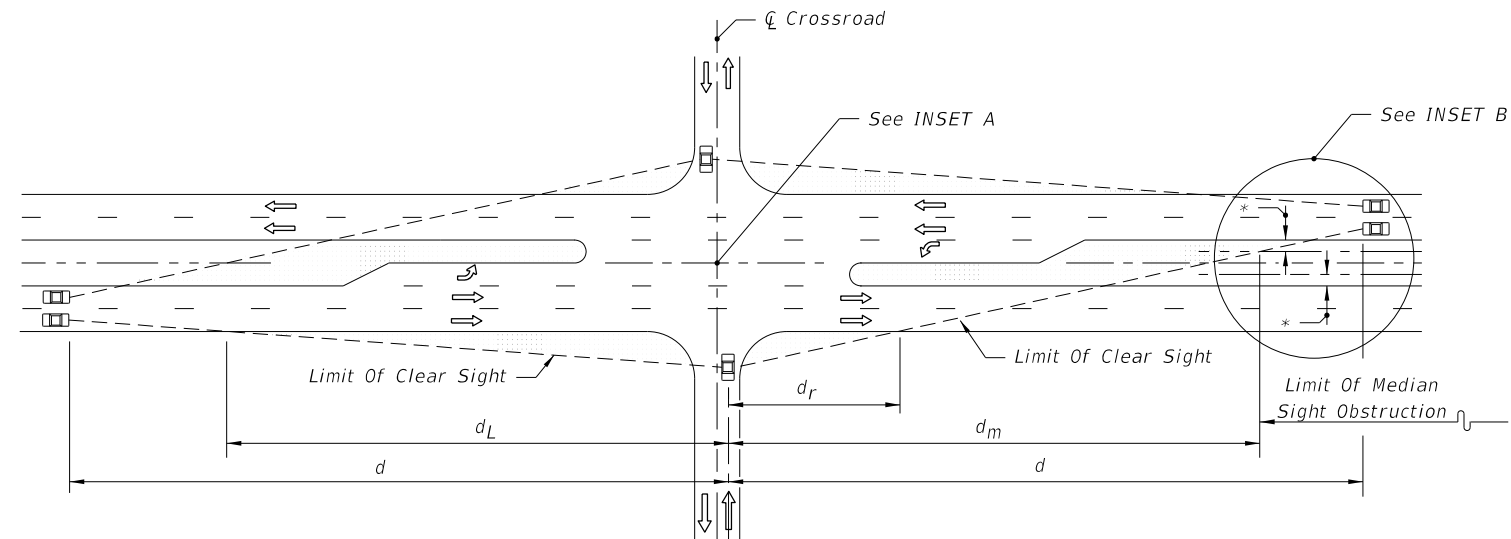

4-LANE DIVIDED

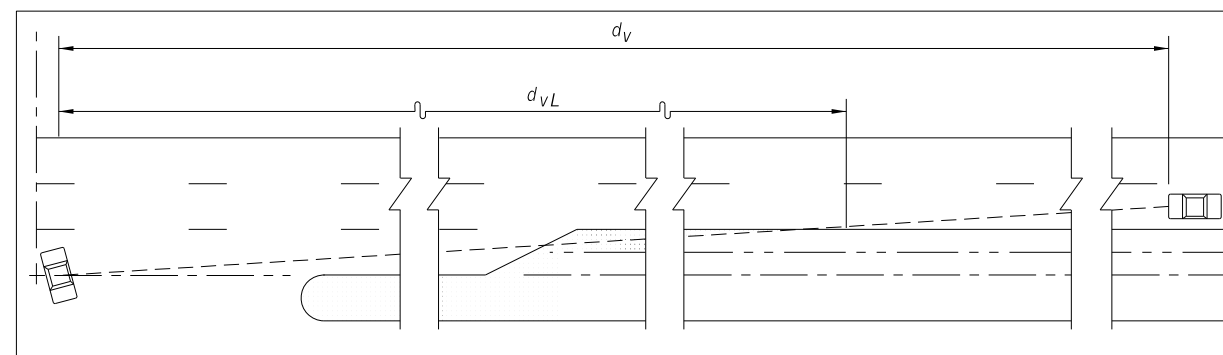

Where The Median Is Sufficiently Wide For The Design Vehicle To Pause In The Median (Vehicle Length Plus 6' Min.) The Clear Line Of Sight To The Right (d_v) Is Measured From The Vehicle Pause Location, i.e., Not From The Cross Road Stop Position; Distances d_r & d_m Do Not Apply.

INSET A

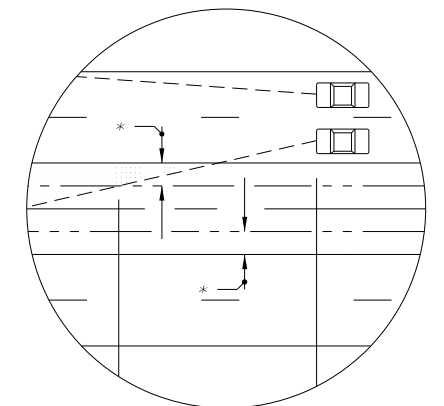

INSET B

* Lateral Offset For Restricted Conditions
Clear Zone For Nonrestricted Conditions

NOTES FOR 4-LANE DIVIDED ROADWAY

- See Figure 212.11.1 for origin of clear sight line on the minor road.
- Values shown in the tables are the governing (controlling) sight distances calculated based on 'AASHTO Case B - Intersection with Stop Control on the Minor Road.'

LEGEND

Areas Free Of Sight Obstructions

NOT TO SCALE

EXHIBIT 212-6
01/01/2023

INTERSECTION SIGHT DISTANCE: 6-LANE DIVIDED

Median 22' or Less				
Design Speed (mph)	d_x (Ft.)	d_L (Ft.)	d_r (Ft.)	d_m (Ft.)
≤ 25	350	250	65	300
30	415	295	80	355
35	485	345	90	415
40	555	395	105	470
45	625	445	115	530
50	690	490	130	585
55	760	540	140	645
60	830	590	155	705
65	900	640	170	765
70	970	690	180	825

25'-64' MEDIAN				
Design Speed (mph)	d (Ft.)	d_L (Ft.)	d_v (Ft.)	d_{vL} (Ft.)
≤ 25	315	225	275	200
30	375	265	330	240
35	440	315	385	280
40	500	355	445	320
45	565	400	500	360
50	625	445	555	400
55	690	490	610	440
60	750	530	665	480
65	815	580	720	520
70	875	620	775	560

Passenger Vehicle

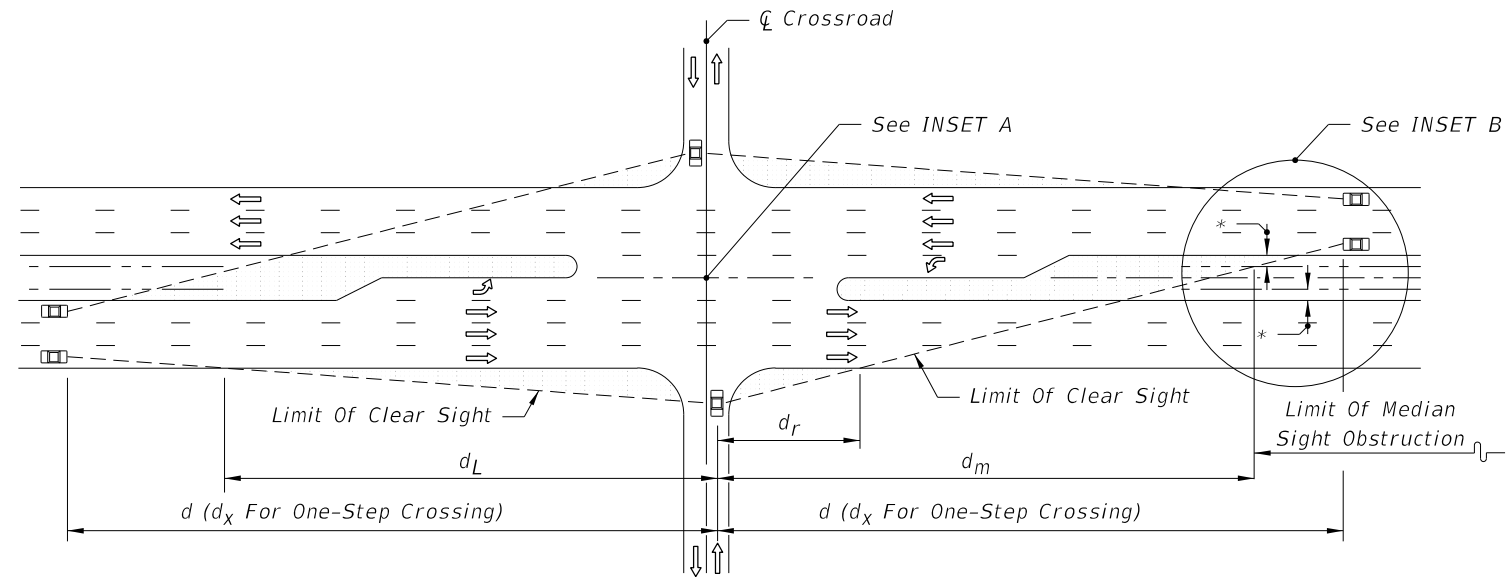

Median 35' or Less				
Design Speed (mph)	d_x (Ft.)	d_L (Ft.)	d_r (Ft.)	d_m (Ft.)
≤ 25	475	340	75	415
30	570	405	90	495
35	665	470	105	580
40	760	540	120	660
45	855	605	135	745
50	955	675	155	830
55	1050	745	170	915
60	1145	810	185	995
65	1240	880	200	1080
70	1330	940	210	1155

40'-64' Median				
Design Speed (mph)	d (Ft.)	d_L (Ft.)	d_v (Ft.)	d_{vL} (Ft.)
≤ 25	400	285	350	250
30	480	340	420	300
35	560	400	490	350
40	640	455	560	400
45	720	510	630	450
50	805	570	700	500
55	885	625	770	550
60	965	685	840	600
65	1045	740	910	650
70	1125	795	980	700

SU Vehicle

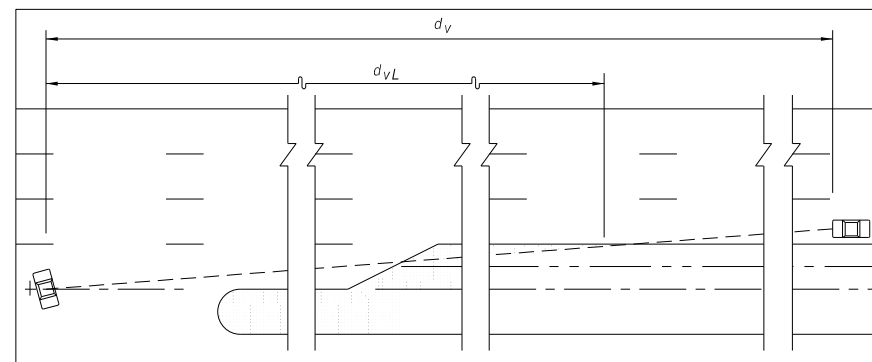

Where The Median Is Sufficiently Wide For The Design Vehicle To Pause In The Median (Vehicle Length Plus 6' Min.) The Clear Line Of Sight To The Right (d_v) Is Measured From The Vehicle Pause Location, i.e., Not From The Cross Road Stop Position; Distances d_r & d_m Do Not Apply.

INSET A

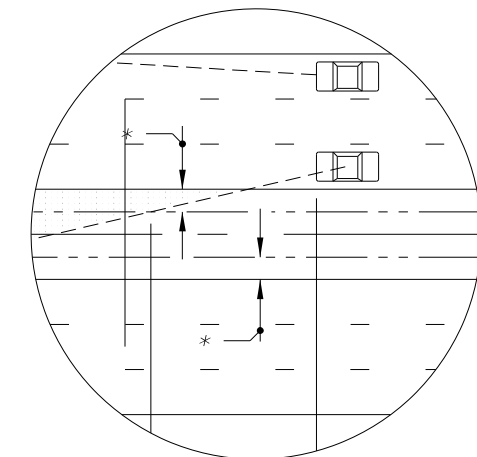

INSET B

* Lateral Offset For Restricted Conditions
Clear Zone For Nonrestricted Conditions

Median 30' or Less				
Design Speed (mph)	d_x (Ft.)	d_L (Ft.)	d_r (Ft.)	d_m (Ft.)
≤ 25	540	385	90	465
30	650	460	110	560
35	755	535	130	655
40	865	615	145	745
45	970	690	165	835
50	1080	765	185	930
55	1185	840	200	1025
60	1290	915	220	1115
65	1400	990	235	1210
70	1510	1070	255	1300

35'-50' Median				
Design Speed (mph)	d_x (Ft.)	d_L (Ft.)	d_r (Ft.)	d_m (Ft.)
≤ 25	585	415	80	520
30	700	495	95	625
35	815	580	115	725
40	930	660	130	825
45	1045	740	145	930
50	1165	825	160	1035
55	1280	905	175	1140
60	1395	990	190	1240
65	1510	1070	210	1340
70	1630	1155	225	1450

64' Median				
Design Speed (mph)	d (Ft.)	d_L (Ft.)	d_r (Ft.)	d_m (Ft.)
≤ 25	610	435	75	550
30	735	520	90	665
35	900	640	110	815
40	980	695	120	885
45	1100	780	135	995
50	1220	865	150	1100
55	1345	955	160	1215
60	1465	1040	175	1320
65	1590	1125	190	1435
70	1710	1210	205	1545

Combined Vehicles

Vehicle Type	Vehicle Length (Ft.)
Passenger (P)	19
Single Unit (SU)	30
Large School Bus	40
WB-40	45.5
WB-62FL	73.5

NOTES FOR 6-LANE DIVIDED ROADWAY

- See Figure 212.11.1 for origin of clear sight line on the minor road.
- Values shown in the tables are the governing (controlling) sight distances calculated based on 'AASHTO Case B - Intersection with Stop Control on the Minor Road.'

SIGHT DISTANCES (d), (d_v) & (d_x) AND RELATED DISTANCES (d_L , d_r , d_m & d_{vL}) (FEET)

LEGEND

Areas Free Of Sight Obstructions

NOT TO SCALE

EXHIBIT 212-7
01/01/2023

212.11.2 All-Way Stop Control (AASHTO Case E)

Provide clear sight lines on each of the approach legs for all-way stop controlled intersections.

212.11.3 Signal Control (AASHTO Case D)

For signalized intersections incorporate the following:

- (1) Develop sight distances based on AASHTO 'Case D-Intersections with Signal Control'.
- (2) The first vehicle stopped on any approach leg is visible to the driver of the first vehicle stopped on each of the other approach legs.
- (3) For permissive left turns provide sufficient sight distance for left turning vehicles to select gaps in oncoming traffic and complete left turns.
- (4) If a traffic signal is to be placed on two-way flashing operation (i.e., flashing yellow on the major road approaches and flashing red on the minor road approaches) under off peak or nighttime conditions, then provide the appropriate departure sight triangles for AASHTO Case B (Stop Control on the Minor Road).
- (5) If right turns on red are permitted from any approach leg, then provide the appropriate departure sight triangle to the left for AASHTO Case B above.

212.11.4 Left Turn from Highway (AASHTO Case F)

Provide sufficient sight distance to accommodate a left turn maneuver for locations where left turns across opposing traffic are permitted. **Table 212.11.1** provides clear sight distance values for left turn from highway.

For additional information on determining the sight distance refer to Chapter 9 of AASHTO's ***A Policy on Geometric Design of Highways and Streets***.

Table 212.11.1 Sight Distance for Left Turn from Highway

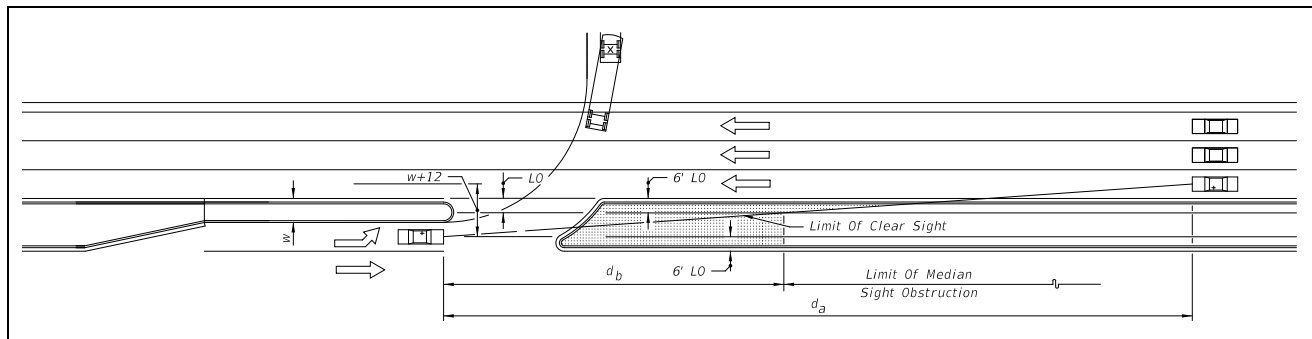

Design Speed (mph)	d_a (feet)								
	1 Lane Crossed			2 Lane Crossed			3 Lane Crossed		
	P	SU	Comb.	P	SU	Comb.	P	SU	Comb.
25	205	240	280	225	265	305	240	290	330
30	245	290	330	265	320	365	290	350	395
35	285	335	385	310	370	425	335	410	460
40	325	385	440	355	425	485	385	465	525
45	365	430	495	400	475	545	430	525	590

Notes:

- (1) Provide a lateral offset (LO) of 6' as shown in the diagram above. d_b may be determined by the equation $d_b = d_a (w/(w+12))$. For roadways with non-restricted conditions, d_a and d_b should be based on the geometry for the left turn storage and on clear zone widths.
- (2) For wide medians where the turning vehicle can approach the through lane at or near 90°, use d values from tables in **Exhibits 212-6** and **212-7**. (The clear sight line origin is assumed to be 14.5 feet from the edge of the near travel lane.

212.11.5 On-Street Parking

Table 212.11.2 provides parking restrictions for intersections, including mid-block crossings and roundabout approaches. For additional information, see the following:

- **FDM 210.2.3** for additional information concerning on-street parking.
- **FDM 222.2.6** for information concerning curb extensions (bulb-outs).
- **Chapter 316, [Florida Statutes \(F.S.\)](#)**, for laws governing parking spaces.

Table 212.11.2 Parking Restrictions for Driveways and Intersections

Control Type	Posted Speed (mph)	A - Up Stream (ft)	B – Down Stream (ft)	
			2-Lane	4-Lane or more
Unsignalized	< 35	90	60	45
	35	105	70	50
Signalized	< 35	30	30	30
	35	50	50	50

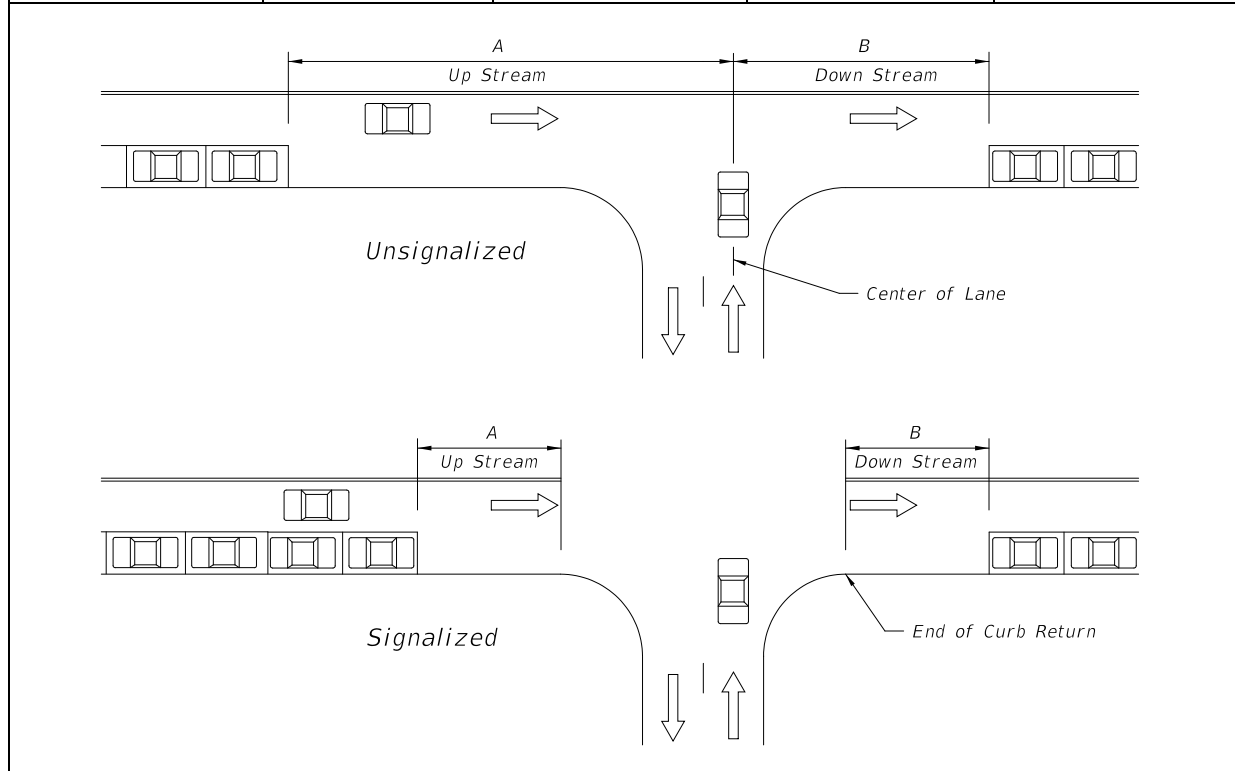

Notes:

- (1) For entrances to one-way streets, the downstream restriction (B) may be reduced to 20 feet.
- (2) Do not place parking within 20 feet of a marked crosswalk.

212.11.6 Trees and Vegetation

Intersections should be designed to accommodate the placement of trees and other desired vegetation (e.g., ground cover plants, trunked plants) in C2T, C3C, C4, C5, and C6 context classifications while still maintaining clear sight triangles. Ground cover plants are naturally low-growing plants with a maximum mature height of ≤ 18 inches. Trunked plants are those with a mature trunk diameter of 4 inches or less (measured 6 inches above the ground).

Maintain clear sight triangles for all approaches. Do not place trees within the hatched-out areas as shown in **Figure 212.11.2**. The hatched-out areas are for ground cover plants only. Coordinate with the Project Landscape Architect for the placement of vegetation and the necessary space above and below ground for tree growth that will maintain clear sight triangles.

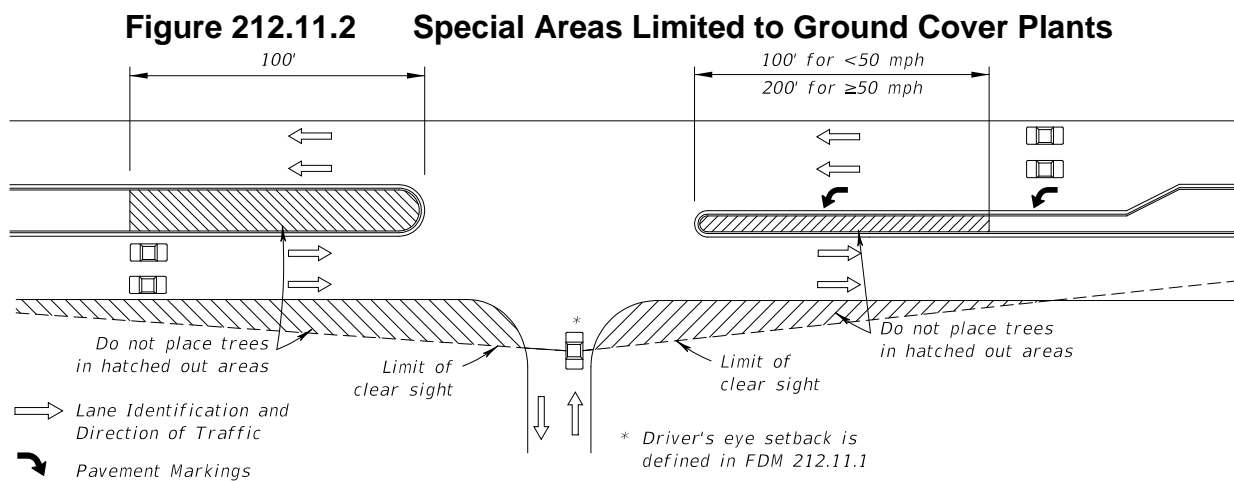

Where left turns from the major road are permitted, do not locate trees within the distance d_b shown in **Table 212.11.1** (see **FDM 212.11.4**) and not less than the distances shown in **Figure 212.11.2** and the spacings in **Table 212.11.3** as applicable.

212.11.6.1 Clear Sight Window Concept

The clear sight window concept may provide opportunities for vegetation within the limits of intersection sight triangles. This concept is illustrated in **Figure 212.11.3**. This detail provides the required vertical clear sight limits with respect to the sight line datum. Do not place trees within the hatched-out areas as shown in **Figure 212.11.2** (even if using the clear sight window concept). The hatched-out areas are for ground cover plants only.

Figure 212.11.3 Window Detail

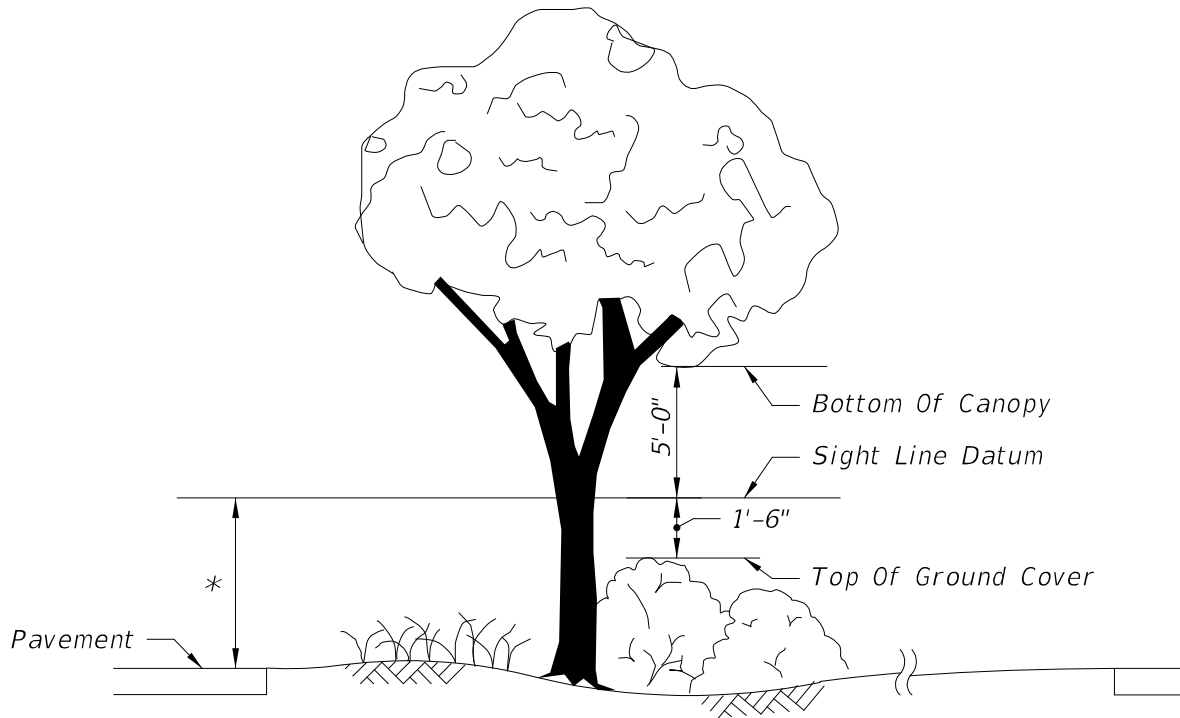

- * Since observations are made in both directions, the line-of-sight datum between roadways is 3.5 feet above both pavements.

The horizontal limits of the window are defined by clear sight triangles. Within the limits of clear sight triangles, the following restrictions apply:

- Canopy of trees and trunked plants must be at least 5 feet above the sight line datum.
- The top of the ground cover plants must be at least 1.5 feet below the sight line datum.

See **FDM 270** for additional information about plant selection and placement. Enforcing these limits provides a clear line of sight for approaches to an intersection.

When trees are located in the median of a divided roadway and fall within the limits of a clear sight triangle, conform to **Table 212.11.3** for tree size and spacing. Spacing values for trees with diameter of 11 inches or less were derived assuming a maximum 6-foot-wide shadow band on a vehicle at the stop bar location when viewed by a mainline driver beginning at sight distance 'd'. This is illustrated in **Figure 212.11.4**. Spacing values for

trees with diameter greater than 11 inches and less than or equal to 18 inches were derived assuming a 2 second full view of the vehicle at the stop bar when viewed by the mainline driver beginning at sight distance 'd'. (See **Figure 212.11.5**).

Table 212.11.3 Minimum Tree Spacing

Design Speed (mph)	Minimum Tree Spacing (Center-to-Center of Trunk) (feet)	
	4" < Tree Diameter ≤ 11"	11" < Tree Diameter ≤ 18"
25	20	75
30	25	90
35	30	105
40	35	120
45	40	135
50	50	150
55	55	165
60	60	180

Notes:

- (1) Size and spacing are based on the following conditions:
 - (a) A single line of trees in the median parallel to but not necessarily collinear with the centerline.
 - (b) A straight approaching mainline and intersection angle between 60° and 120°.
 - (c) Space trees with 4" < Dia. ≤ 11" intermixed with trees with 11" < Dia. ≤ 18" based on trees with 11" < Dia. ≤ 18".
- (2) Detail tree size, spacing, and location in the plans for any other conditions.
- (3) Trunked Plants may be placed on 20-foot centers.

Figure 212.11.4 Shadow Diagram

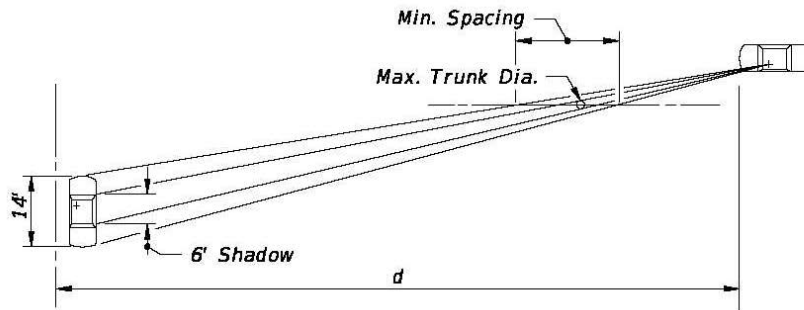

**SHADOW DIAGRAM
TREE SPACING (DIA. 11" OR LESS)**

Figure 212.11.5 Perception Diagram

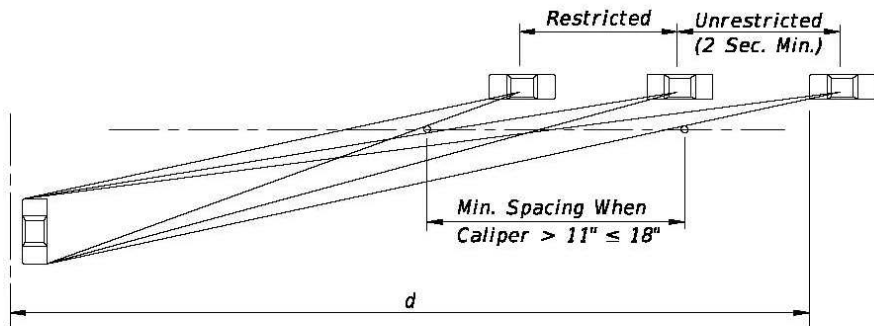

**PERCEPTION DIAGRAM
TREE SPACING (DIA. BETWEEN 11" AND 18")**

212.12 Turning Roadways

Turning roadways are typically designed for use by right-turning traffic at intersections. There are three types of right-turning roadways:

- edge-of-traveled-way design
- design with a corner triangular island
- free-flow design using a simple radius or compound radii

The turning radii and the pavement cross slopes for free-flow right turns are functions of design speed and design vehicle.

212.12.1 Edge-of-Traveled-Way Design

When selected design vehicle is to be accommodated within minimum space, corner radii should be based on the required turning path.

Table 212.12.1 provides simple curve radii with and without tapers. **Table 212.12.2** provides symmetric and asymmetric three centered compound curve radii for a range of design vehicles. These values provide the minimum turning paths attainable at design speeds of 10 mph and less.

Figure 212.12.1 demonstrates the angle of turn for use in these tables.

The minimum edge-of-traveled-way values provided in these tables are based on the assumption that the vehicle is properly positioned within the traffic lane at the beginning and end of the turn (2 feet from the edge-of-traveled-way on the tangents approaching and leaving the intersection curve). Such designs follow closely the inner wheel path of the selected design vehicle, with a clearance of 2 feet or more throughout most of the turn, and with a clearance at no point less than 9 inches. Differences in the inner paths of vehicles turning left and right are not sufficient to be significant in design. For this reason, these edge designs also apply to left-turn maneuvers, such as a left turn by a vehicle leaving a divided highway at a very low speed.

Figure 212.12.1 Turn Angle for Turning Roadway Designs

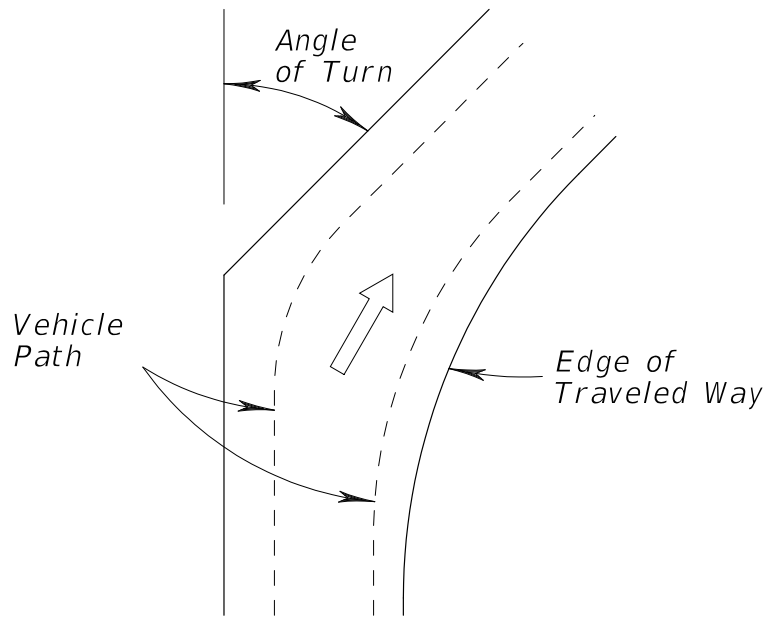

Table 212.12.1 Edge-of-Traveled-Way, Simple Curve Radii

Angle of Turn (degrees)	Design Vehicle	Simple Curve Radius (feet)	Simple Curve Radius with Taper		
			Radius (feet)	Offset (feet)	Taper H:V
30	P	60	----	----	----
	SU-30	100	----	----	----
	SU-40	140	----	----	----
	WB-40	150	----	----	----
	WB-62	360	220	3.0	15:1
	WB-62FL	380	220	3.0	15:1
	WB-67	380	220	3.0	15:1
	WB-92D	365	190	3.0	15:1
	WB-100T	260	125	3.0	15:1
	WB-109D	475	260	3.5	20:1
45	P	50	----	----	----
	SU-30	75	----	----	----
	SU-40	115	----	----	----
	WB-40	120	----	----	----
	WB-62	230	145	4.0	15:1
	WB-62FL	250	145	4.5	15:1
	WB-67	250	145	4.5	15:1
	WB-92D	270	145	4.0	15:1
	WB-100T	200	115	2.5	15:1
	WB-109D	----	200	4.5	20:1
60	P	40	----	----	----
	SU-30	60	----	----	----
	SU-40	100	----	----	----
	WB-40	90	----	----	----
	WB-62	170	140	4.0	15:1
	WB-62FL	200	140	4.5	15:1
	WB-67	200	140	4.5	15:1
	WB-92B	230	120	5.0	15:1
	WB-100T	150	95	2.5	15:1
	WB-109D	----	180	4.5	20:1

Table 212.12.1 Edge-of-Traveled-Way, Simple Curve Radii, cont.

Angle of Turn (degrees)	Design Vehicle	Simple Curve Radius (feet)	Simple Curve Radius with Taper		
			Radius (feet)	Offset (feet)	Taper H:V
75	P	35	25	2.0	10:1
	SU-30	55	45	2.0	10:1
	SU-40	90	60	2.0	10:1
	WB-40	----	60	2.0	15:1
	WB-62	----	145	4.0	20:1
	WB-62FL	----	145	4.0	20:1
	WB-67	----	145	4.5	20:1
	WB-92D	----	110	5.0	15:1
	WB-100T	----	85	3.0	15:1
	WB-109D	----	140	5.5	20:1
90	P	30	20	2.5	10:1
	SU-30	50	40	2.0	10:1
	SU-40	80	45	4.0	10:1
	WB-40	----	45	4.0	10:1
	WB-62	----	120	4.5	30:1
	WB-62FL	----	125	4.5	30:1
	WB-67	----	125	4.5	30:1
	WB-92D	----	95	6.0	10:1
	WB-100T	----	85	2.5	15:1
	WB-109D	----	115	2.9	15:1
105	P	----	20	2.5	8:1
	SU-30	----	35	3.0	10:1
	SU-40	----	45	4.0	10:1
	WB-40	----	40	4.0	10:1
	WB-62	----	115	3.0	15:1
	WB-62FL	----	115	3.0	15:1
	WB-67	----	115	3.0	15:1
	WB-92B	----	80	8.0	10:1
	WB-100T	----	75	3.0	15:1
	WB-109D	----	90	9.2	20:1

Table 212.12.1 Edge-of-Traveled-Way, Simple Curve Radii, cont.

Angle of Turn (degrees)	Design Vehicle	Simple Curve Radius (feet)	Simple Curve Radius with Taper		
			Radius (feet)	Offset (feet)	Taper H:V
120	P	----	20	2.0	10:1
	SU-30	----	30	3.0	10:1
	SU-40	----	35	6.0	8:1
	WB-40	----	35	5.0	8:1
	WB-62	----	100	5.0	15:1
	WB-62FL	----	105	5.2	15:1
	WB-67	----	105	5.2	15:1
	WB-92D	----	80	7.0	10:1
	WB-100T	----	65	3.5	15:1
	WB-109D	----	85	9.2	20:1
135	P	----	20	1.5	10:1
	SU-30	----	30	4.0	10:1
	SU-40	----	40	4.0	8:1
	WB-40	----	30	8.0	15:1
	WB-62	----	80	5.0	20:1
	WB-62FL	----	85	5.2	20:1
	WB-67	----	85	5.2	20:1
	WB-92D	----	75	7.3	10:1
	WB-100T	----	65	5.5	15:1
	WB-109D	----	85	8.5	20:1
150	P	----	18	2.0	10:1
	SU-30	----	30	4.0	8:1
	SU-40	----	35	7.0	8:1
	WB-40	----	30	6.0	8:1
	WB-62	----	60	10.0	10:1
	WB-62FL	----	65	10.2	10:1
	WB-67	----	65	10.2	10:1
	WB-92B	----	65	11.0	10:1
	WB-100T	----	65	7.3	10:1
	WB-109D	----	65	15.1	10:1

Table 212.12.1 Edge-of-Traveled-Way, Simple Curve Radii, cont.

Angle of Turn (degrees)	Design Vehicle	Simple Curve Radius (feet)	Simple Curve Radius with Taper		
			Radius (feet)	Offset (feet)	Taper H:V
180	P	----	15	0.5	20:1
	SU-30	----	30	1.5	10:1
	SU-40	----	35	6.4	10:1
	WB-40	----	20	9.5	5:1
	WB-62	----	55	10.0	15:1
	WB-62FL	----	55	13.8	10:1
	WB-67	----	55	13.8	10:1
	WB-92D	----	55	16.8	10:1
	WB-100T	----	55	10.2	10:1
	WB-109D	----	55	20.0	10:1

Table 212.12.2 Edge-of-Traveled-Way, 3-Centered Compound Curves

Angle of Turn (degrees)	Design Vehicle	3-Centered Compound Curve			
		Curve Radii (ft)	Symmetric Offset (ft)	Curve Radii (ft)	Asymmetric (ft)
30	P	----	----	----	----
	SU-30	----	----	----	----
	SU-40	----	----	----	----
	WB-40	----	----	----	----
	WB-62	----	----	----	----
	WB-62FL	460-175-460	4.0	300-175-550	2.0-4.5
	WB-67	460-175-460	4.0	300-175-550	2.0-4.5
	WB-92D	550-155-550	4.0	200-150-500	2.0-6.0
	WB-100T	220-80-220	4.5	200-80-300	2.5-5.0
	WB-109D	550-250-550	5.0	250-200-650	1.5-7.0

Table 212.12.2 Edge-of-Traveled-Way, 3-Centered Compound Curves, cont.

Angle of Turn (degrees)	Design Vehicle	3-Centered Compound Curve			
		Curve Radii (ft)	Symmetric Offset (ft)	Curve Radii (ft)	Asymmetric (ft)
45	P	----	----	----	----
	SU-30	----	----	----	----
	SU-40	----	----	----	----
	WB-40	----	----	----	----
	WB-62	460-240-460	2.0	120-140-500	3.0-8.5
	WB-62FL	460-175-460	4.0	250-125-600	1.0-6.0
	WB-67	460-175-460	4.0	250-125-600	1.0-6.0
	WB-92D	525-155-525	5.0	200-140-500	1.5-6.0
	WB-100T	250-80-250	4.5	200-80-300	2.5-5.5
	WB-109D	550-200-550	5.0	200-170-650	1.5-7.0
60	P	----	----	----	----
	SU-30	----	----	----	----
	SU-40	----	----	----	----
	WB-40	----	----	----	----
	WB-62	400-100-400	15.0	110-100-220	10.0-12.5
	WB-62FL	400-100-400	8.0	250-125-600	1.0-6.0
	WB-67	400-100-400	8.0	250-125-600	1.0-6.0
	WB-92D	480-110-480	6.0	150-110-500	3.0-9.0
	WB-100T	250-80-250	4.5	200-80-300	2.0-5.5
	WB-109D	650-150-650	5.5	200-140-600	1.5-8.0
75	P	100-25-100	2.0	----	----
	SU-30	120-45-120	2.0	----	----
	SU-40	200-35-200	5.0	60-45-200	1.0-4.5
	WB-40	120-45-120	5.0	120-45-195	2.0-6.5
	WB-62	440-75-440	15.0	140-100-540	5.0-12.0
	WB-62FL	420-75-420	10.0	200-80-600	1.0-10.0
	WB-67	420-75-420	10.0	200-80-600	1.0-10.0
	WB-92B	500-95-500	7.0	150-100-500	1.0-8.0
	WB-100T	250-80-250	4.5	100-80-300	1.5-5.0
	WB-109D	700-125-700	6.5	150-110-550	1.5-11.5

Table 212.12.2 Edge-of-Traveled-Way, 3-Centered Compound Curves, cont.

Angle of Turn (degrees)	Design Vehicle	3-Centered Compound Curve			
		Curve Radii (ft)	Symmetric Offset (ft)	Curve Radii (ft)	Asymmetric (ft)
90	P	100-20-100	2.5	----	----
	SU-30	120-40-120	2.0	----	----
	SU-40	200-30-200	7.0	60-45-200	1.0-4.5
	WB-40	120-40-120	5.0	120-40-200	2.0-6.5
	WB-62	400-70-400	10.0	160-70-360	6.0-10.0
	WB-62FL	440-65-440	10.0	200-70-600	1.0-11.0
	WB-67	440-65-440	10.0	200-70-600	1.0-11.0
	WB-92D	470-75-470	10.0	150-90-500	1.5-8.5
	WB-100T	250-70-250	4.5	200-70-300	1.0-5.0
	WB-109D	700-110-700	6.5	100-95-550	2.0-11.5
105	P	100-20-100	2.5	----	----
	SU-30	100-35-100	3.0	----	----
	SU-40	200-35-200	6.0	60-40-190	1.5-6.0
	WB-40	100-35-100	5.0	100-55-200	2.0-8.0
	WB-62	520-50-520	15.0	360-75-600	4.0-10.5
	WB-62FL	500-50-500	13.0	200-65-600	1.0-11.0
	WB-67	500-50-500	13.0	200-65-600	1.0-11.0
	WB-92D	500-80-500	8.0	150-80-500	2.0-10.0
	WB-100T	250-60-250	5.0	100-60-300	1.5-6.0
	WB-109D	700-95-700	8.0	150-80-500	3.0-15.0
120	P	100-20-100	2.0	----	----
	SU-30	100-30-100	3.0	----	----
	SU-40	200-35-200	6.0	60-40-190	1.5-5.0
	WB-40	120-30-120	6.0	100-30-180	2.0-9.0
	WB-62	520-70-520	10.0	80-55-520	24.0-17.0
	WB-62FL	550-45-550	15.0	200-60-600	2.0-12.5
	WB-67	550-45-550	15.0	200-60-600	2.0-12.5
	WB-92D	500-70-500	10.0	150-70-450	3.0-10.5
	WB-100T	250-60-250	5.0	100-60-300	1.5-6.0
	WB-109D	700-85-700	9.0	150-70-500	7.0-17.4

Table 212.12.2 Edge-of-Traveled-Way, 3-Centered Compound Curves, cont.

Angle of Turn (degrees)	Design Vehicle	3-Centered Compound Curve			
		Curve Radii (ft)	Symmetric Offset (ft)	Curve Radii (ft)	Asymmetric (ft)
135	P	100-20-100	1.5	----	----
	SU-30	100-30-100	4.0	----	----
	SU-40	200-40-200	4.0	60-40-180	1.5-5.0
	WB-40	120-30-120	6.5	100-25-180	3.0-13.0
	WB-62	600-60-600	12.0	100-60-640	14.0-7.0
	WB-62FL	550-45-550	16.0	200-60-600	2.0-12.5
	WB-67	550-45-550	16.0	200-60-600	2.0-12.5
	WB-92D	450-70-450	9.0	150-65-450	7.0-13.5
	WB-100T	250-60-250	5.5	100-60-300	2.5-7.0
	WB-109D	700-70-700	12.5	150-65-500	14.0-18.4
150	P	75-20-75	2.0	----	----
	SU-30	100-30-100	4.0	----	----
	SU-40	200-35-200	6.5	60-40-200	1.0-4.5
	WB-40	100-30-100	6.0	90-25-160	1.0-12.0
	WB-62	480-55-480	15.0	140-60-560	8.0-10.0
	WB-62FL	550-45-550	19.0	200-55-600	7.0-16.4
	WB-67	550-45-550	19.0	200-55-600	7.0-16.4
	WB-92D	350-60-350	15.0	120-65-450	6.0-13.0
	WB-100T	250-60-250	7.0	100-60-300	5.0-8.0
	WB-109D	700-65-700	15.0	200-65-500	9.0-18.4
180	P	50-15-50	0.5	----	----
	SU-30	100-30-100	1.5	----	----
	SU-40	150-35-150	6.2	50-35-130	5.5-7.0
	WB-40	100-20-100	9.5	85-20-150	6.0-13.0
	WB-62	800-45-800	20.0	100-55-900	15.0-15.0
	WB-62FL	600-45-600	20.5	100-55-400	6.0-15.0
	WB-67	600-45-600	20.5	100-55-400	6.0-15.0
	WB-92B	400-55-400	16.8	120-60-400	9.0-14.5
	WB-100T	250-55-250	9.5	100-55-300	8.5-10.5
	WB-109D	700-55-700	20.0	200-60-500	10.0-21.0

For curbed intersections, the effective turning radius must be considered in addition to the actual curb radius. As shown in **Figure 212.12.2**, where a parking lane (or bike lane) is present, the vehicle turn is offset from the edge of the roadway by the width of the parking lane or bike lane, creating an “effective turning radius” that is larger than the physical curb radius. Where there is no parking lane or bike lane, the corner radius and effective turning radius are the same. To minimize pedestrian crossing distance, designers should provide the shortest curb radius possible or provide bulbouts within the effective turning radius area. The corner radii should follow the guidance in **Table 212.12.3**, and accommodate the following:

- The control vehicle, design vehicle, and design speed for each street
- Available R/W
- Angle of turn between intersection legs
- Presence of on-street parking or a bike lane
- The width and number of lanes on the intersecting street

Figure 212.12.2 Actual Curb Radius Vs Effective Radius

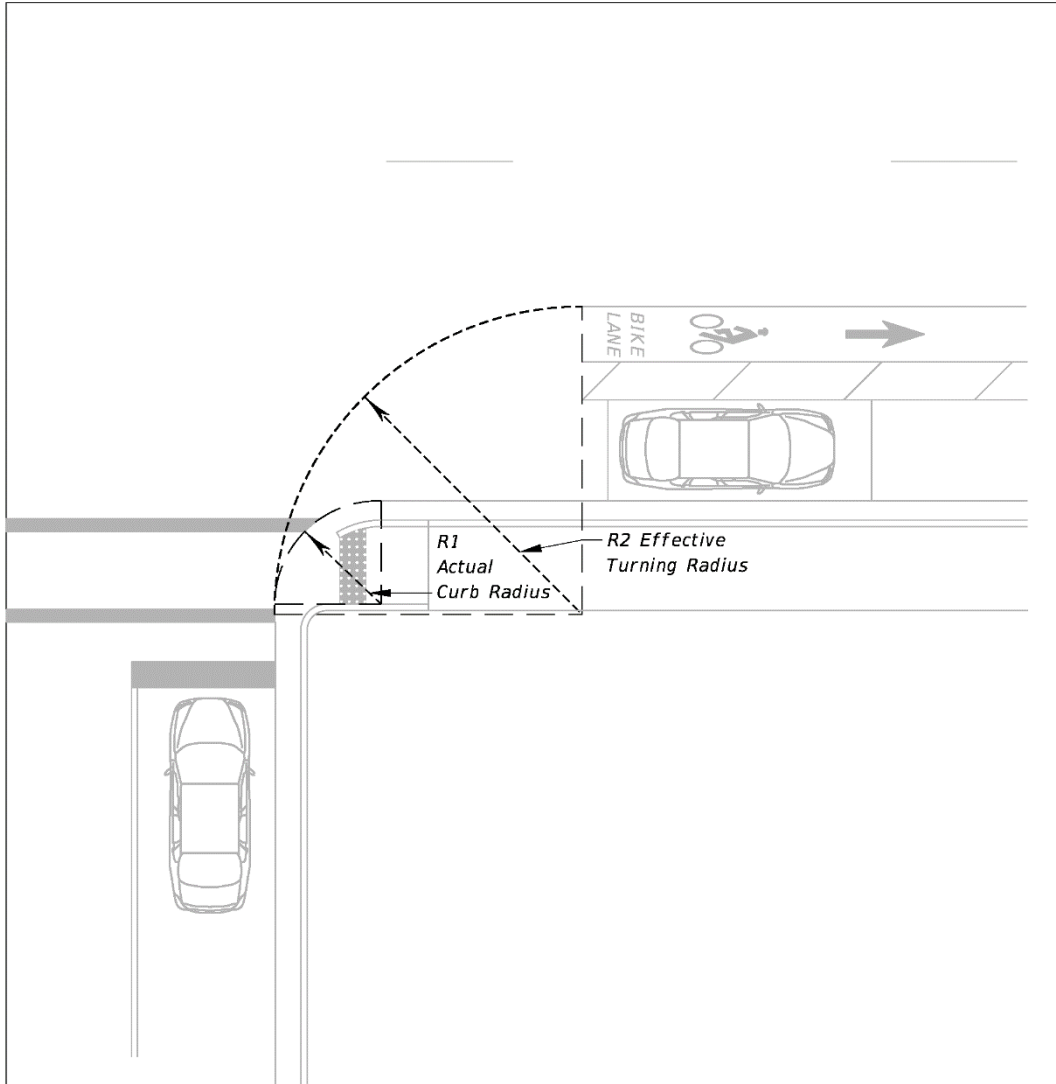

Table 212.12.3 Recommended Corner Radii

R1 Actual Curb Radius (ft)	R2 Effective Turning Radius (ft)	Operational Characteristics
5-30	25 - 30	P vehicles and SU vehicles with minor lane encroachment
5-40	40	P vehicles, SU vehicles, and WB-40 vehicles with minor encroachment
5-50	50	All vehicles up to WB-40
<p>Notes:</p> <p>(1) Table 212.12.3 assumes perpendicular intersections. For skewed intersections, establish radius using AutoTurn or turning templates.</p> <p>(2) Confirm the actual curb radius using AutoTurn or turn templates.</p>		

Guidelines for corner radii in C4, C5, and C6 context classification without on-street parking or a bike lane are as follows:

- (1) Radii of 15 to 25 feet are adequate for passenger vehicles. These radii are suitable for minor cross streets where there is little occasion for trucks to turn and at major intersections where there are parking lanes;
- (2) Radii of 25 feet or more should be provided at minor cross streets on new construction or reconstruction projects;
- (3) Radii of 30 feet or more should be provided at minor cross streets where practical so that an occasional truck can turn without too much encroachment;
- (4) Radii of 40 feet or more or preferably three-centered curves or simple curves with tapers to fit the paths of large truck combinations, should be provided where such combinations or buses turn frequently. Where speed reductions would cause problems, larger radii should be considered; and,
- (5) Curb radii should be coordinated with crosswalk distances or special designs should be used to make crosswalks efficient for all pedestrians. Where larger radii are used, an intermediate refuge or median island is desirable or crosswalks may need to be offset so that crosswalk distances are not excessive. See **FDM 210.3** for additional information on islands.

212.12.2 Turning Roadways with Corner Islands

Consider providing a corner island at an intersection where paved areas are excessively large or do not establish proper channelization of traffic. Corner islands can provide delineation for through and turning traffic. In addition, corner islands shorten crosswalks and give pedestrians and bicyclists a refuge area. See **FDM 210.3.2** for island requirements.

Channelized right turn lanes can be designed with a flat or near perpendicular angle of entry to the cross street (see **Figure 212.12.3**). The flat angle of entry is most appropriate for higher speed turning movements with no pedestrian accommodations. Large turning radii and angles of entry into the cross street allow higher turning speeds, reduced traffic delays, and the turning movement of large trucks. The higher speeds, angle of entry and large radii adversely impacts pedestrian safety at the crosswalk.

The near perpendicular angle of entry is preferred where pedestrian facilities are provided. Tight turning radii and angles of entry into the cross street accommodate the following:

- Slower turning speeds,
- Reduced cross walk length,
- Improved pedestrian visibility,
- Improved sight distance
- Decreased angle of driver head turning
- Reduced right-of-way impacts.

Figure 212.12.3 Channelized Right Turn Lanes

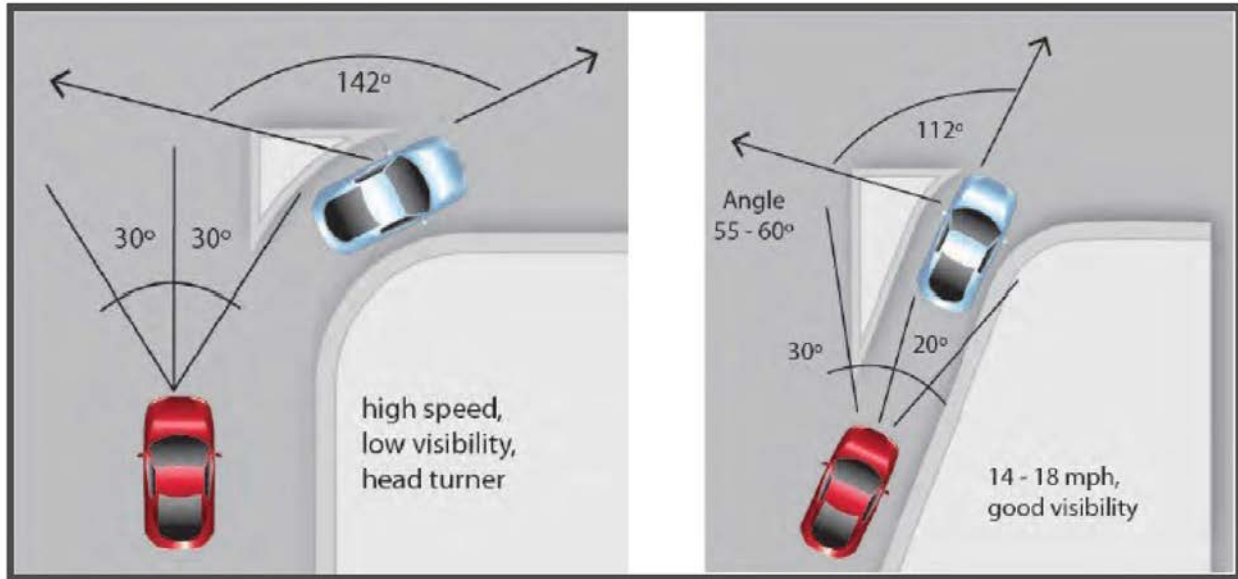

Ref: Figure 9-19, 2018 AASHTO Green Book

Consider the near perpendicular right turn lane design in **Figure 212.12.4** when the following conditions are met:

- Context Classification C2T, C3, C4, C5 and C6
- Low speed roadway (design speeds 45 mph and less)
- Pedestrian traffic is expected
- No acceleration lane is provided

This design includes the previously mentioned benefits to passenger cars and pedestrians with striping and a scalene triangle shaped corner island. An approaching deceleration lane is preferred to provide vehicles additional time to stop for crossing pedestrians. The crosswalk is set back 20 feet minimum from the end of the island to allow room for a passenger car to wait for a gap in traffic with out blocking the crosswalk. As shown in **Figure 212.12.4**, the outside curb radii can be designed to accommodate over tracking of large vehicles such as single-unit trucks, transit, or Florida Interstate Semi-trailers (WB-62FL).

Figure 212.12.4 Near Perpendicular Right Turn Lane

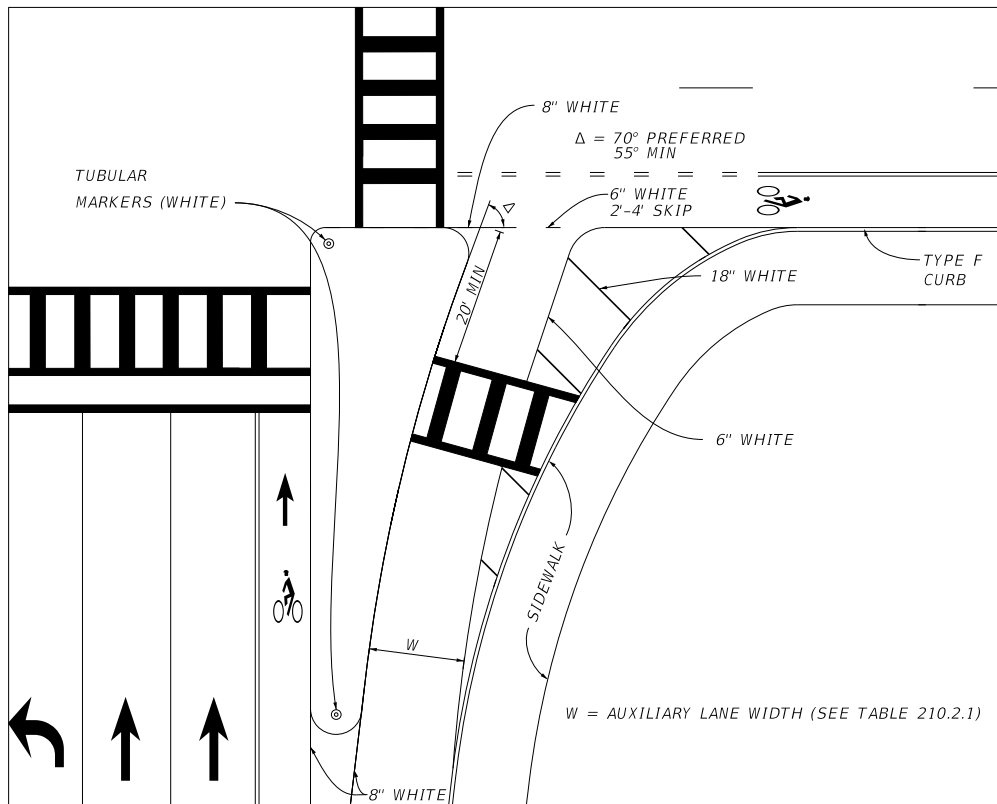

212.12.3 Mountable Truck Aprons

Truck aprons are used to manage the turning movements of vehicles where pedestrian or bicycle facilities are present. A truck apron is a mountable portion of an intersection designed to:

- Manage the turning speed of passenger vehicles
- Accommodate the turning movements of large trucks
- Minimize instances of off tracking over street corners when making turns
- Reduce risks to bicyclists and pedestrians.

Design a mountable truck apron by either of these methods:

- Attach to a full height curb and allow water to flow along the apron's outer edge.
- Separate from the full height curb to allow water to flow along the curb's edge.

See **Figure 212.12.5** for additional details.

Locate all traffic equipment, bicycle features, and pedestrian features (e.g., detectable warning surfaces, bicycle stop bars, curb ramps, etc.) behind the mountable surface area. Design of a mountable truck apron at intersections should incorporate Type RA curbs. See **FDM 213.3.8** for additional truck apron requirements. Cross slopes shown in **Figure 213.3.2** may be adjusted based on intersection site conditions.

Figure 212.12.5 Mountable Truck Apron

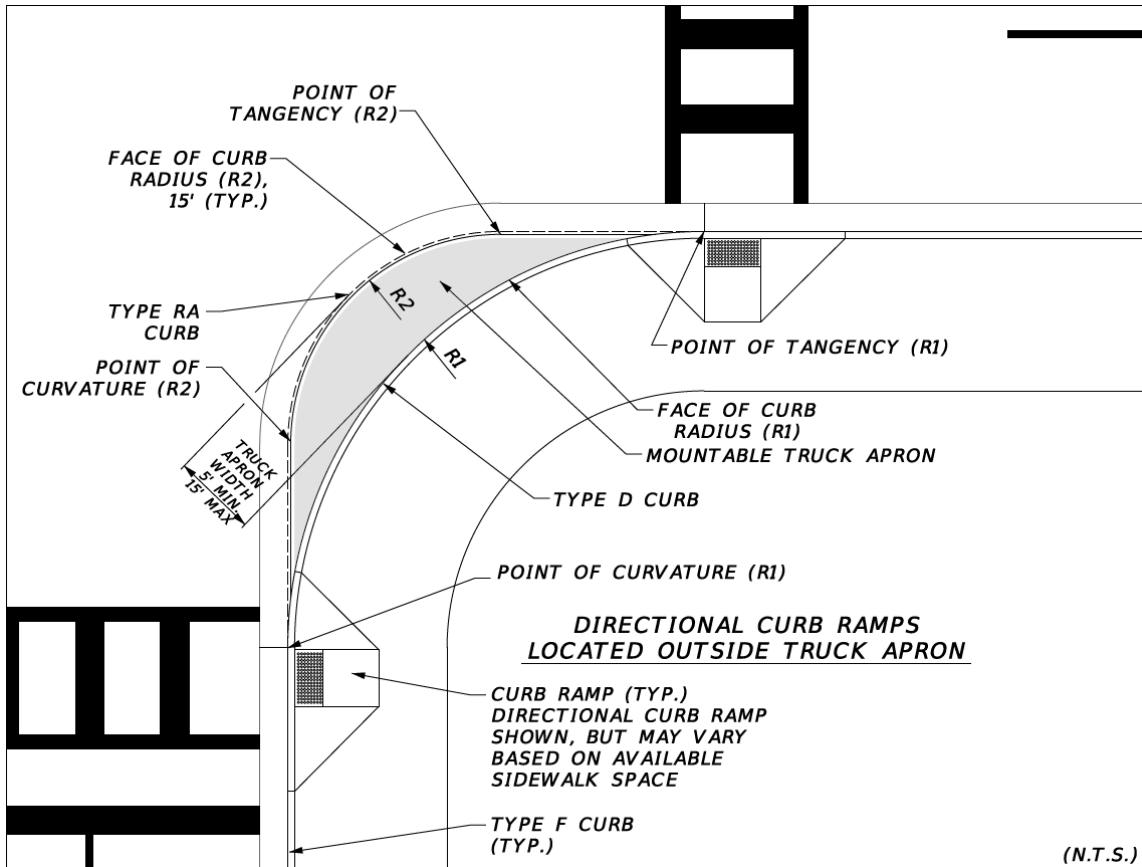

212.12.4 Free-Flow Design

Provide superelevation on free flow turning roadways. An important part of the design on some intersections is the design of a free-flow alignment for turns. Ease and smoothness of operation can result when the free flow turning roadway is designed with compound curves preceded by a deceleration lane. Turning radii and pavement cross slope for free flow right turns at speeds greater than 10 mph are a function of the design speed and design vehicle. In general, the design speed of the turning roadway should be equal to, or within 10 to 20 mph less than the through roadway design speed.

It is desirable to provide as much superelevation as practical on intersection curves, particularly where the intersection curve is sharp and on a downgrade. However, the short curvature and short lengths of turning roadways often prevents the development of a desirable rate of superelevation. **Table 212.12.4** provides the minimum superelevation rates in relation to design speed. The wide variation in likely speeds on intersection curves precludes the need for precision, so only the minimum superelevation rate is given for each design speed and intersection curve radius.

Table 212.12.4 Superelevation Rates for Turning Roadways

	Design Speed (mph)							
	10	15	20	25	30	35	40	45
Minimum Superelevation Rate	NC	NC	0.02	0.04	0.06	0.08	0.09	0.10
Minimum Radius (feet)	25	50	90	150	230	310	430	540

See **FDM 210.9** for additional superelevation criteria.

212.12.5 Dual and Triple Left Turns

Double and triple turn lanes require turning radii that will accommodate the selected design vehicles turning simultaneously. The radius of curvature in combination with the track width of the design vehicles will establish the required width within the turn. Lane lines (i.e., guidelines) and width requirements should be determined by plotting the swept paths of the selected design vehicles. For preliminary layout of intersection geometry, use the swept path of the design vehicle on the inside turning lane to locate the median nose and crosswalk on the crossing street (at the receiving point of the left turn).

Design of dual turns should accommodate a SU-40 vehicle and a P vehicle turning simultaneously, as illustrated in **Figure 212.12.6**.

Figure 212.12.6 P and SU Design Vehicles Turning Simultaneously

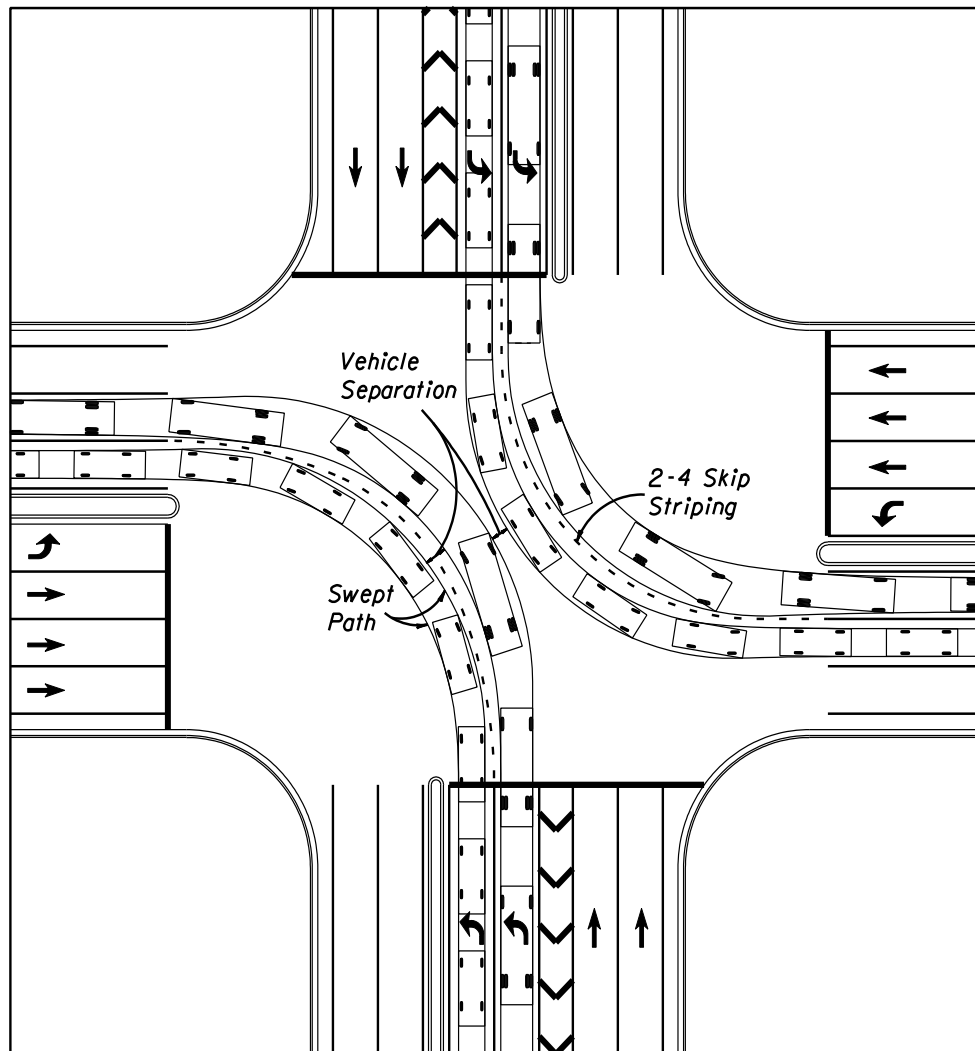

Design of triple left turns should accommodate a WB-62FL (outside lane), a SU-40 (center or inside lane), and a P vehicle (center or inside lane) turning simultaneously.

Establish control radius for the inside turning lane based on the guidance in **FDM 212.14.5** and **Table 212.9.2**. Establish the inside edge of the outer lane by providing a minimum 4-foot separation between swept paths of the selected design vehicles traveling in the same direction. Except for turns with large radii, the inside edge of the outer lane will not be concentric with the selected control radius. Radius for the inside edge of the outer turn lane should be determined by analysis of the plotted swept path of the design vehicles.

Provide minimum 8-foot separation between vehicles traveling in opposing direction. Separation may be less than 8 feet when:

- (1) Turning paths are highly visible and speeds are low, or
- (2) Signal left turn phases are not concurrent for the opposing directions.

212.13 Islands

See **FDM 210.3** for island criteria.

212.14 Auxiliary Lanes

The primary function of auxiliary lanes at intersections is to accommodate speed changes, storage and maneuvering of turning traffic. The length of the auxiliary lanes is the sum of the deceleration length, queue length and approach end taper. Pavement marking requirements for auxiliary lanes are included in [Standard Plans](#), **Index 711-001**.

212.14.1 Deceleration Length

The required total deceleration length is that needed for a safe and comfortable stop from the design speed of the highway. See **Exhibit 212-1** for minimum deceleration lengths (including taper) for left turn lanes.

Right turn lane tapers and lengths are identical to left turn lanes under stop control conditions. Right turn lane tapers and lengths are site-specific for free-flow or yield conditions.

212.14.2 Queue Length

The queue length provided should be based on a traffic study.

For low volume intersections where a traffic study is not justified, a minimum 50-foot queue length (2 vehicles) should be provided for C1, C2, and C3R context classifications. A minimum 100-foot queue length (4 vehicles) should be provided in C2T, C3C, C4, C5, and C6 context classifications. Locations with over 10% truck traffic should accommodate at least one car and one truck.

For queue lengths at signalized intersections, refer to **FDM 232.2**.

212.14.3 Approach End Taper

The length of approach end tapers is 50 feet for a single turn lane and 100 feet for two or more turn lanes, as shown **Exhibit 212-1**. These taper lengths apply to all design speeds.

212.14.4 Offset Left Turn Lanes

The alignment of opposing left-turn lanes and the horizontal and vertical curvature on the approaches are the principal geometric design elements that determine how much sight distance is available to a left-turning driver. Vehicles queuing in opposing left-turn lanes restrict each other's view of oncoming traffic in the through lanes. The level of restricted view depends on the alignment of opposing left-turn lanes with respect to each other and the type of vehicles in the opposing queue.

The offset distance is defined as the distance between the left edge of the turn lane and the right edge of the opposing turn lane. If the offset distance is to the left of the turn lane it is considered a negative offset, and if it is to the right of turn lane it is considered a positive offset, as illustrated in **Figure 212.14.1**.

Figure 212.14.1 Negative and Positive Offset Left Turns

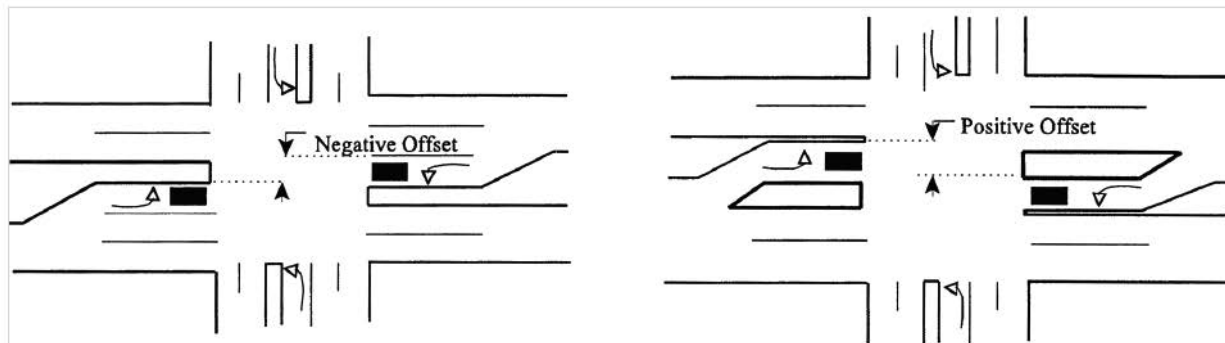

The conventional method of designing left turn lanes is to place the left turn lanes adjacent to the through lanes. This design creates a negative offset which restricts the sight distance of the left-turning driver's view of oncoming traffic when another vehicle is in the opposing turn lane. **Figure 212.14.2** indicates the negative offset when the conventional design is used.

Figure 212.14.2 Opposing Left Turns (22' Median with Negative 10' Offset)

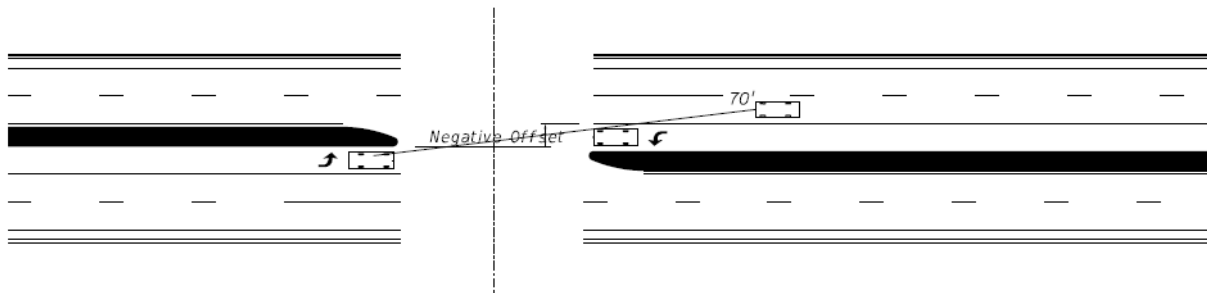

On curbed roadway designs, offset left-turn lanes should be used with median widths greater than 18 feet. A 4-foot traffic separator should be used when possible to channelize the left turn and provide separation from opposing traffic.

Consider offset left-turn lanes at C1, C2, and C3R context classification intersections with high turning movements. For median widths 30 feet or less, use a parallel offset left-turn lane. Stripe the area between the offset left-turn lane and the traffic lane where vehicles are moving in the same direction. For medians wider than 30 feet, consider a tapered offset left-turn lane. An offset left is illustrated in **Figure 212.14.3**.

2018 AASHTO Green Book Figure 9-41 illustrates the design of parallel and tapered left turn lanes.

Figure 212.14.3 Typical Opposing Left Turns (22' Median with Negative 1' Offset)

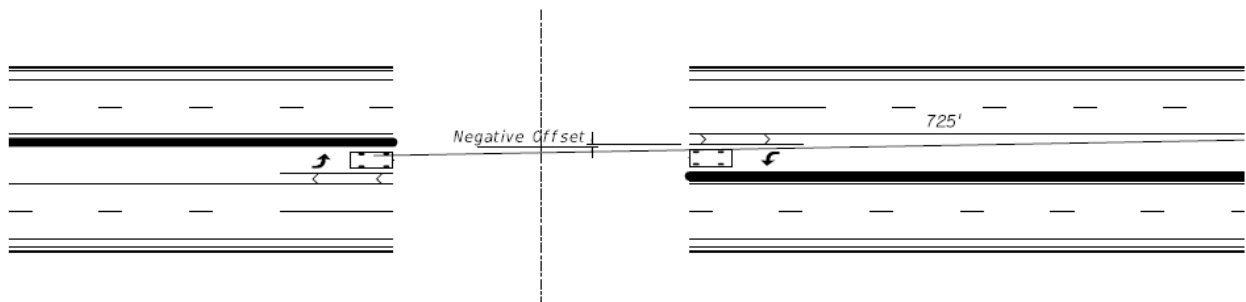

At locations where the full offset distances cannot be obtained, it is recommended that the minimum offset distances shown in **Table 212.14.1** be provided to achieve minimum required sight distances according to design speed. It is recommended that the "Opposing Truck" values be used where the opposing left-turn traffic includes a moderate to heavy volume of large trucks.

Table 212.14.1 Minimum Offset Distances for Left-Turn Lanes

Design Speed (mph)	Minimum Offset (feet)	
	Opposing Car	Opposing Truck
≤ 30	1.0	3.0
35	1.5	3.5
40 - 45	2.0	4.0
50 - 55	2.5	4.5
60 - 65	3.0	4.5
70	3.0	5.0

212.14.5 Directional Median Openings

Directional (channelized) median openings are designed to accommodate left-turn movements from the through roadway and prevent or discourage left-turn and crossing movements by traffic from a side road or driveway. Directional median openings are to be provided in accordance with the access management plan for the roadway.

The design of a directional median opening must accommodate the swept path of the predominant design vehicle. Channelization may be achieved using a combination of traffic separators, islands, and tubular markers. See **FDM 210** for additional information on islands. See [Standard Plans](#), **Index 520-020** for standard details for 4 feet, 6 feet and 8.5 feet wide traffic separators. See **FDM 230.2.7** for additional information on tubular markers.

Typical layouts for directional median openings for high-speed roadways with 40-foot-wide medians are provided in **Exhibits 212-8, 212-9** and **212-10**. Type E curb and raised islands in conjunction with the minimum offsets shown in these figures may be used on high-speed roadways for directional median openings.

DIRECTIONAL MEDIAN OPENING: SU & WB-40 PARALLEL TURN BAY

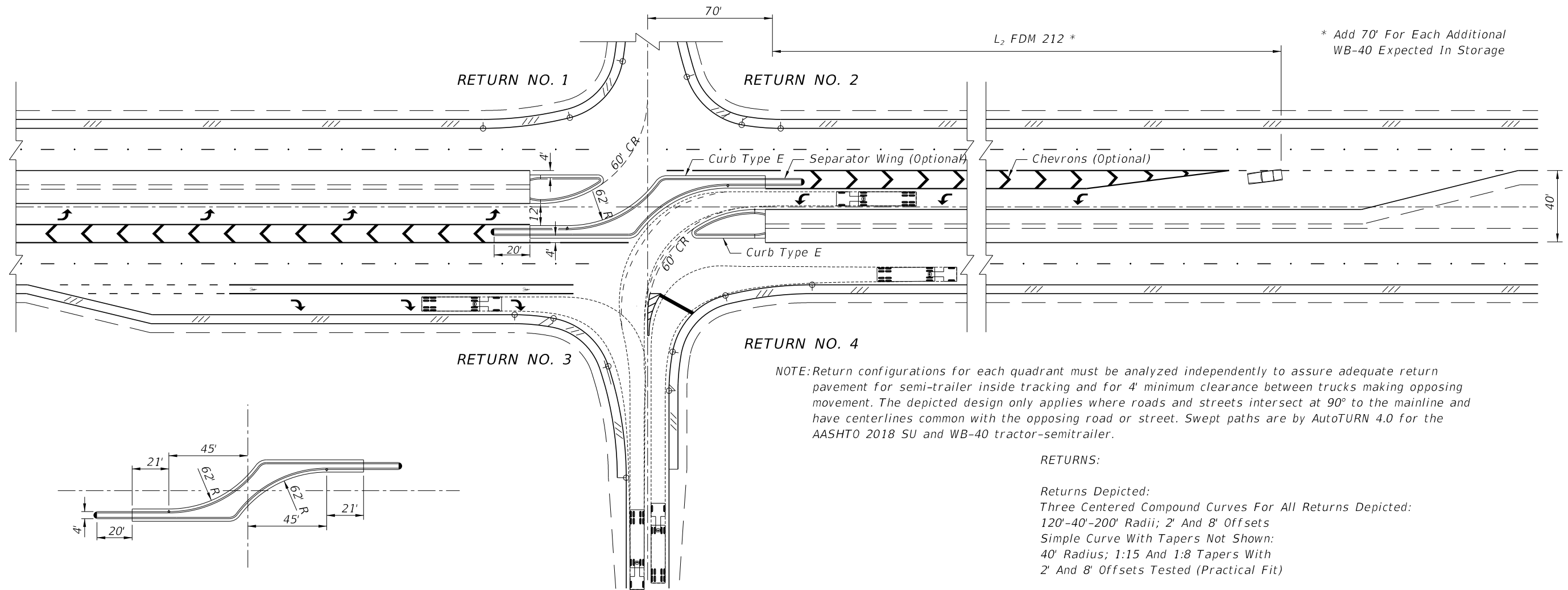

NOTE: Return configurations for each quadrant must be analyzed independently to assure adequate return pavement for semi-trailer inside tracking and for 4' minimum clearance between trucks making opposing movement. The depicted design only applies where roads and streets intersect at 90° to the mainline and have centerlines common with the opposing road or street. Swept paths are by AutoTURN 4.0 for the AASHTO 2018 SU and WB-40 tractor-semitrailer.

RETURNS:

Returns Depicted:
 Three Centered Compound Curves For All Returns Depicted:
 120'-40'-200' Radii; 2' And 8' Offsets
 Simple Curve With Tapers Not Shown:
 40' Radius; 1:15 And 1:8 Tapers With
 2' And 8' Offsets Tested (Practical Fit)

SWEPT PATH LEGEND:

WB-40 -----
 SU - - - - -

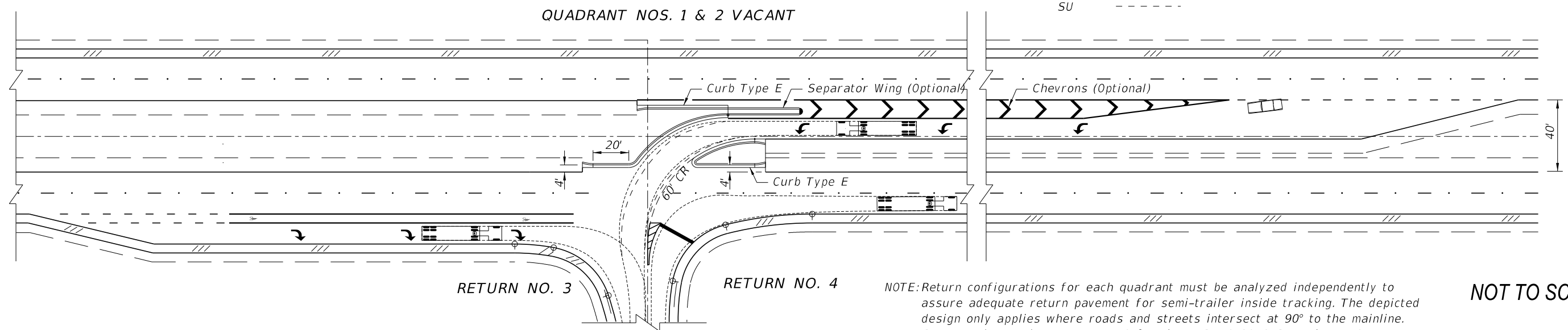
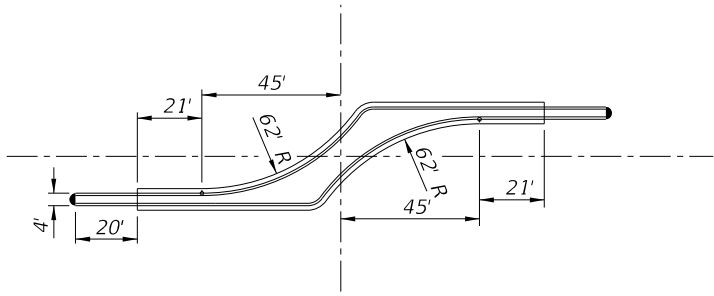

NOTE: Return configurations for each quadrant must be analyzed independently to assure adequate return pavement for semi-trailer inside tracking. The depicted design only applies where roads and streets intersect at 90° to the mainline. Swept paths are by AutoTURN 4.0 for the AASHTO 2018 SU and WB-40 tractor-semitrailer.

NOT TO SCALE

DIRECTIONAL MEDIAN OPENING: WB-62 PARALLEL TURN BAY

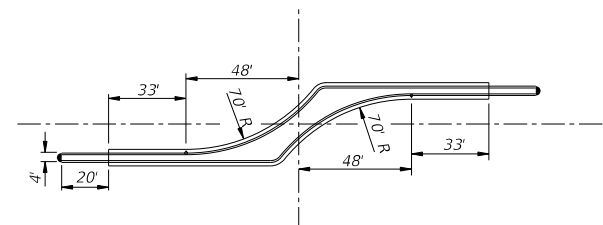
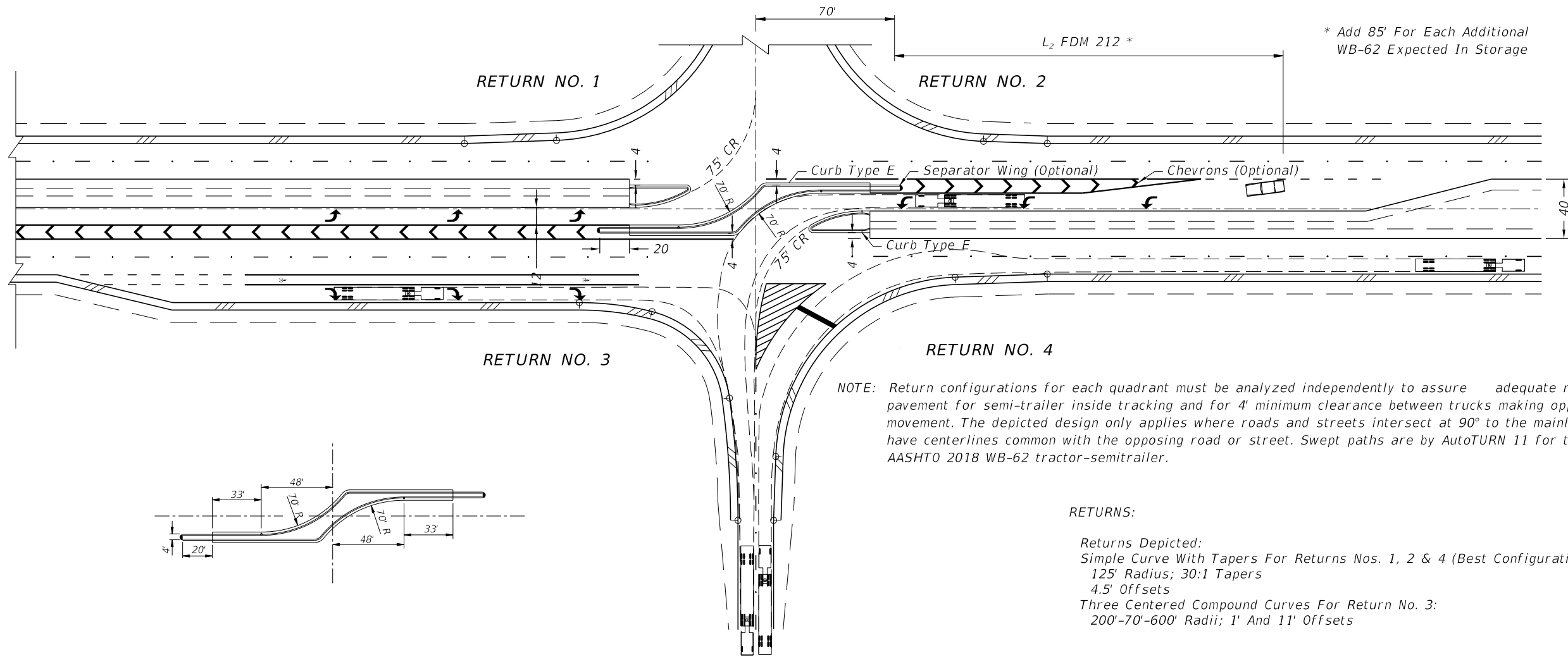

RETURNS:

Returns Depicted:
 Simple Curve With Tapers For Returns Nos. 1, 2 & 4 (Best Configuration):
 125' Radius; 30:1 Tapers
 4.5' Offsets
 Three Centered Compound Curves For Return No. 3:
 200'-70'-600' Radii; 1' And 11' Offsets

QUADRANT NOS. 1 & 2 VACANT

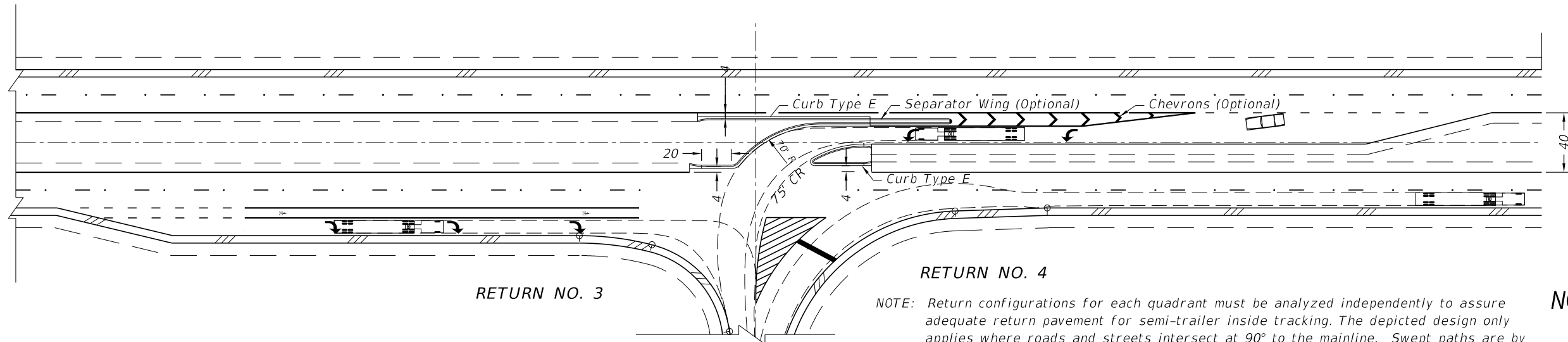

NOT TO SCALE

DIRECTIONAL MEDIAN OPENING: SU & WB-40 TAPERED TURN BAY

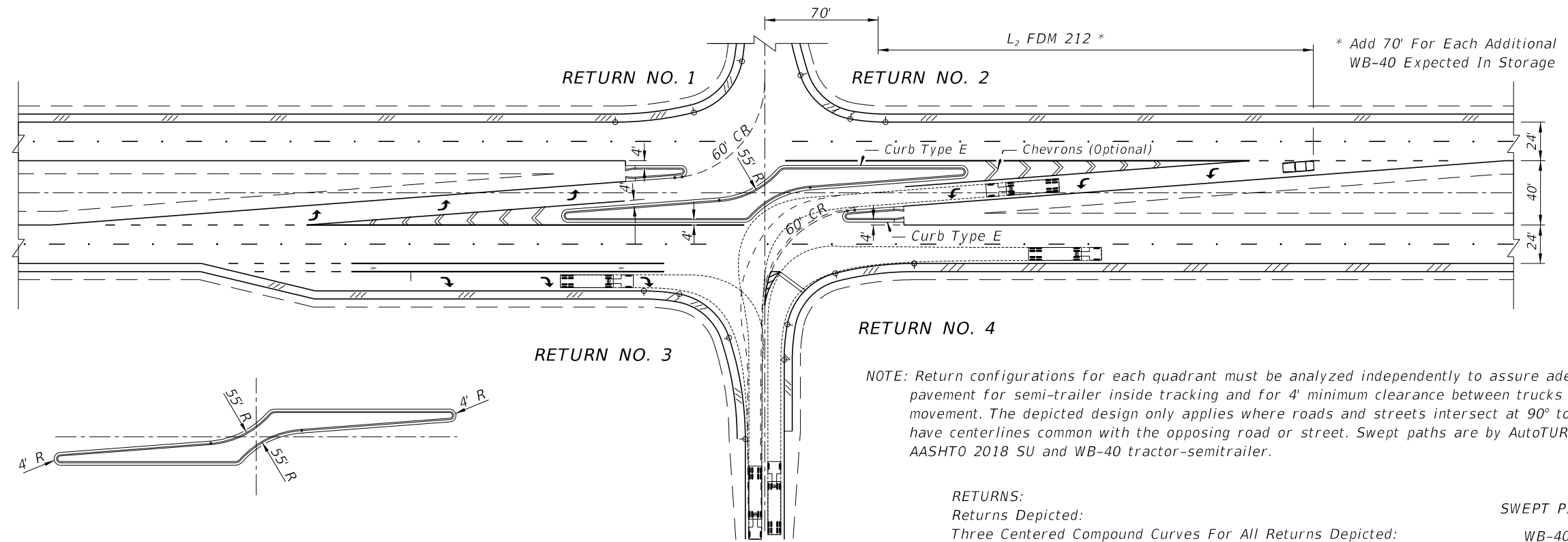

QUADRANT NOS. 1 & 2 VACANT

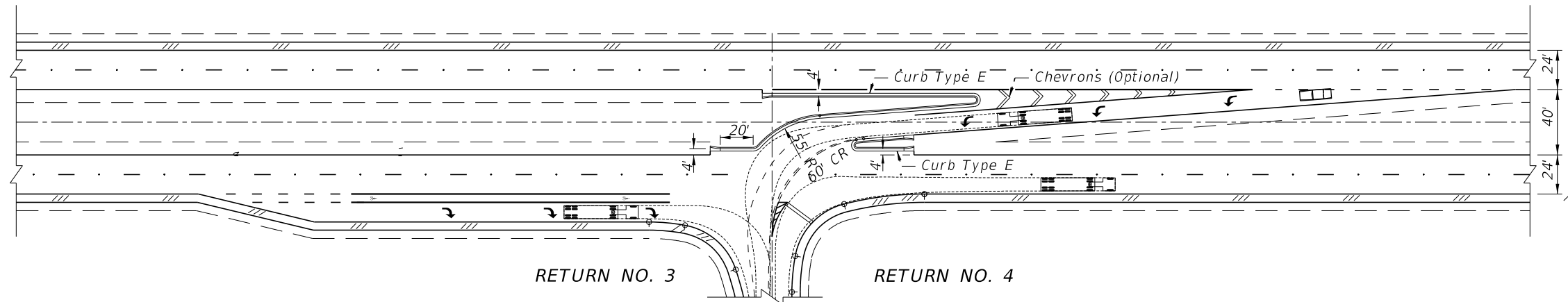

NOT TO SCALE

213 Modern Roundabouts

213.1 General

This chapter provides design criteria for the geometric layout of modern roundabouts. The criteria contained in the FDM are supplemented by guidance provided in the [*National Cooperative Highway Research Program \(NCHRP\) Report 672, Roundabouts: An Informational Guide*](#).

Only single-lane and two-lane modern roundabouts are to be constructed on the SHS. Partial three-lane roundabouts may be acceptable under certain conditions.

Exhibit 213-1 illustrates the elements of a modern roundabout that are discussed in this chapter.

213.1.1 Roundabout Evaluation

Roundabout evaluation is governed by the Intersection Control Evaluation process. See the ***Intersection Control Evaluation (ICE) Manual*** for requirements at the following web address:

https://www.fdot.gov/traffic/TrafficServices/Intersection_Operations.shtm

MODERN ROUNDABOUT DETAILS

*Min Offset From Lane Edge Line to Face of Curb:
 18" With Type E Curb
 15" With Traffic Separator

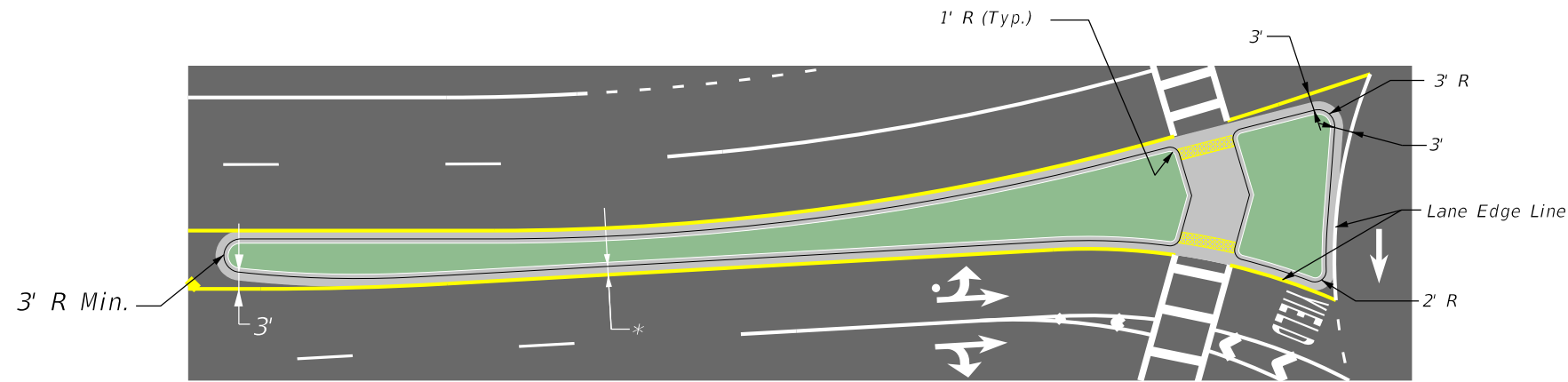

SPLITTER ISLAND DETAIL

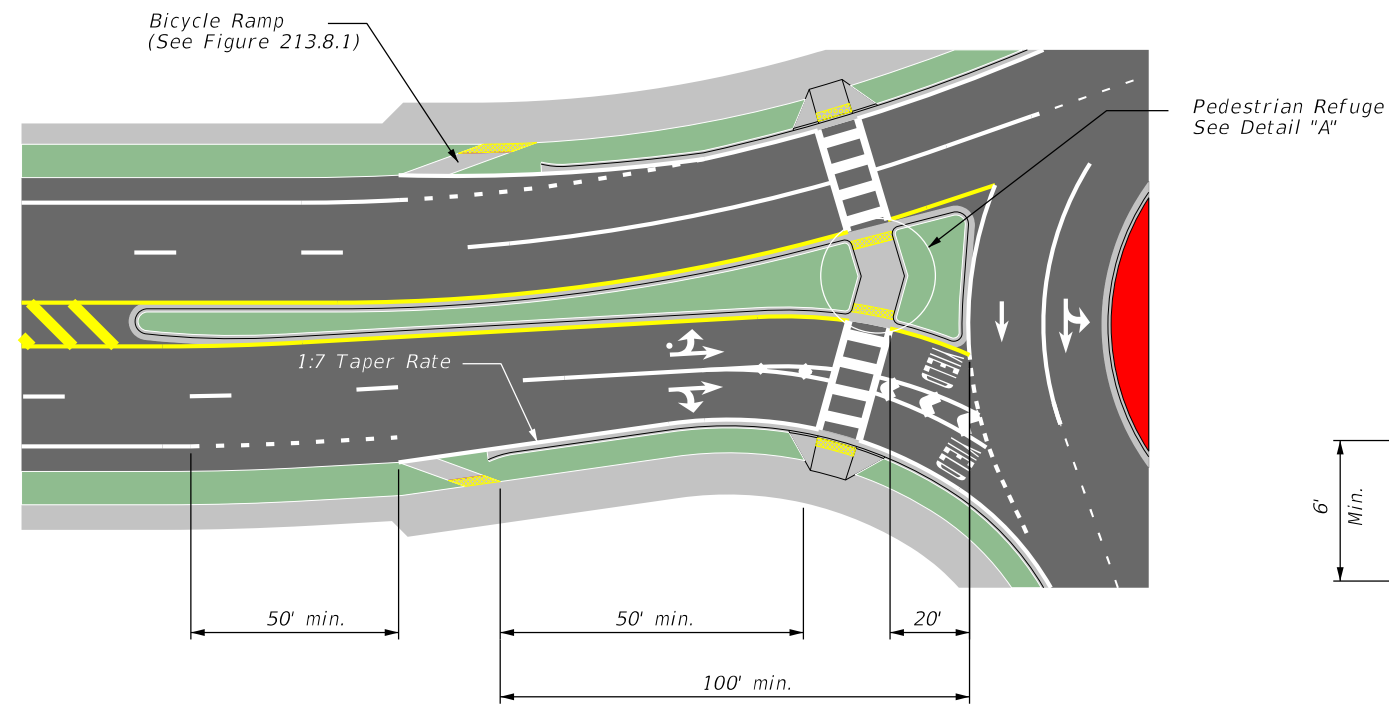
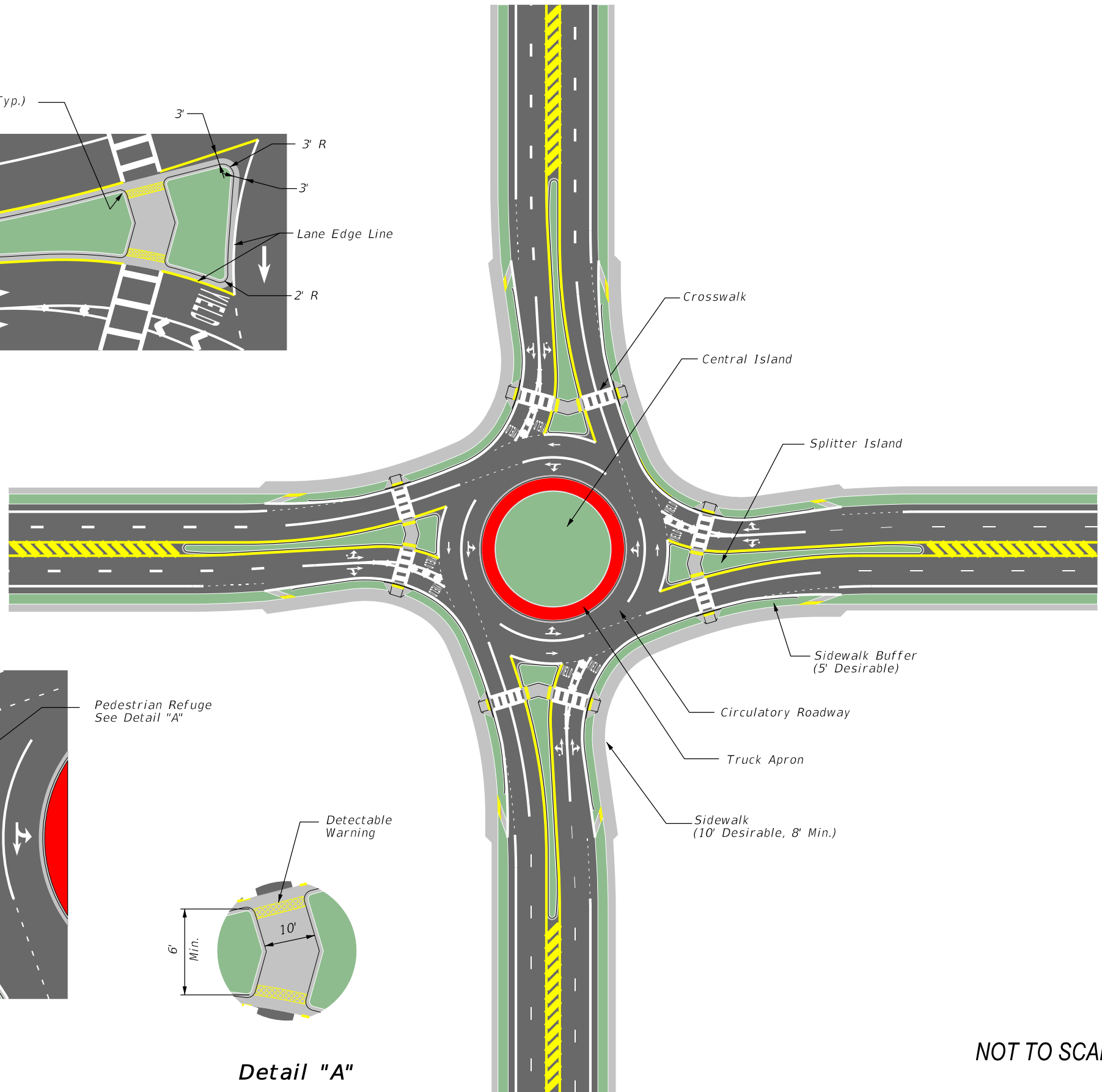

BICYCLE AND PEDESTRIAN DETAIL

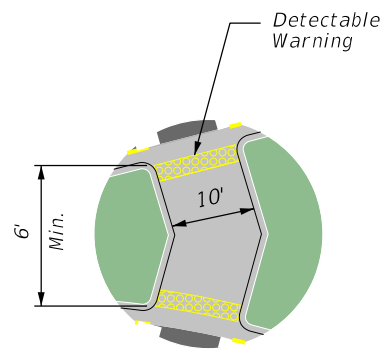

Detail "A"

NOT TO SCALE

213.2 Operational Analysis

Use the methodology in the current edition of the [Highway Capacity Manual \(HCM\)](#) when conducting a roundabout operational analysis. Two commonly used software packages consistent with the [HCM](#) are HCS and SIDRA. When SIDRA is used, run the analysis in [HCM](#) mode to be consistent with [HCM](#) methodology. For more information on HCS and SIDRA, see *Traffic Analysis Handbook, Chapter 6*.

To optimize safety and operation performance, provide only the lanes that are warranted through the traffic operational analysis. Inclusion of unwarranted approach, circulatory or by-pass lanes increases complexity and conflict points. Provide roundabout designs that are simplistic and have pavement widths based on necessity.

Use 20-year design traffic volumes for roundabout design.

213.2.1 Stage Construction

Consider stage construction when traffic operational analysis indicates that a multi-lane roundabout will be required in the design year (20-year design life), but a single-lane roundabout would provide acceptable service for 10 to 15 years (1st resurfacing cycle). Having more lanes than what is warranted in the early years will have a negative effect on safety and operational performance.

When it is determined that staged construction will be utilized, develop the ultimate design first to assure all right-of-way needs for the ultimate project are identified. Then develop the initial design that allows for expansion in the future with minimal “throw-away” work.

213.3 Geometric Design

It is important to develop roadway geometry that encourages drivers to gradually slow down as they approach the roundabout. Roundabout design features that influence vehicular approach speeds include:

- (1) Prominent landscaping in the central island serves to increase visibility of the central island and provides a visual queue to approaching drivers that they are entering a low-speed environment. Roadway approach geometry should work with the landscaping to limit line of sight beyond what is necessary to meet intersection sight distance requirements. See *NCHRP Report 672, 6.7.3* for additional information.

- (2) Raised splitter islands and roadside curb provide visual cues to establish a speed transition zone. Lengthening this transition zone on high-speed facilities can be an effective strategy for slowing down traffic prior to entering a roundabout.
- (3) Geometric features (e.g., inscribed circle diameter (ICD), lane width, entry width, curb locations) introduce deflection and curvature into the driver's path and is the most effective way to slow vehicles down to a safe entry speed.

Typical ranges are as follows:

- (a) Single-lane Roundabout ICD: 120' to 160' with 140' as a good starting point
- (b) Two-lane Roundabout ICD: 160' to 200' with 180' as a good starting point

A chicane is a series of curves that requires the driver to turn slightly right and then slightly left while approaching the roundabout entry. Chicaning should not be excessive but used only to the extent necessary to establish the splitter island and create an offset left alignment.

Tangent segments between reverse curves:

- Provides a smooth natural path for drivers
- Improves the alignment of the approach with the receiving circulatory roadway
- Aids and assists truck drivers in navigating the roundabout

Tangent segments between reverse curves are required for high-speed approaches as discussed in the **FDM 213.3.1**. For low-speed approaches, 50 foot desirable and 25 foot minimum tangent segments are required between reverse curves (i.e., avoid back to back reverse curves).

213.3.1 High-Speed Approach Geometry

Exhibit 213-2 illustrates the Department's desired geometry for a high-speed two-lane undivided highway approaching a single-lane roundabout. High-speed approach geometry uses a series of three curves upstream of the roundabout with successively smaller radii separated by tangent segments. The general approach demonstrated can be applied to high-speed two-lane roundabouts as well.

The approach roadway alignment contains three curves labeled AR1, AR2, and AR3. The Department criteria for minimum curve length on open roadway (400 feet) does not apply within the functional area of the intersection. See **FDM 212.4** for more information on intersection functional area.

AR1

The first curve encountered by the driver as they approach the roundabout is AR1. This curve to the right has the largest radius of the three and is intended to alert the driver that they are approaching a roundabout and need to slow down. This curve also initiates separation between the opposing traffic lanes allowing for the development of the splitter island. The PC of AR1 demarks the area of influence of the intersection. The radius of AR1 is based on the design speed of the approach leg and is determined by using **AASHTO Greenbook 2011 Equation 3-8**. Assuming normal crown, the superelevation rate (e_{max}) is 2%. Side friction factors are dependent on speed and are determined using **AASHTO Greenbook 2011 Figure 3-6**.

AR1 is typically not necessary for divided highway approaches because separation between opposing traffic lanes is already established.

AR2

The second curve approaching the roundabout is AR2. This curve to the left aligns the approach roadway centerline to the left of the roundabout center (offset left). An offset left design allows for proper deflection and speed control. When entering AR2, it is assumed that the driver has decelerated 15-20 mph from the vehicle's approach speed.

Since the curve is to the left and the roadway cross slope is normal crown, the superelevation rate used to calculate AR2 is -2%.

AR3

The final curve entering the roundabout is AR3. This curve to the right guides the driver into the circulatory roadway. AR3 radius is typically between 75 and 100 feet and is determined through the fastest path analysis. At this point it is assumed that the driver has decelerated to an operating speed between 20 and 25 mph.

Tangent Segments

Provide a tangent segment between AR1 and AR2 not less than 100 feet. Provide a tangent segment between AR2 and AR3 not less than 50 feet.

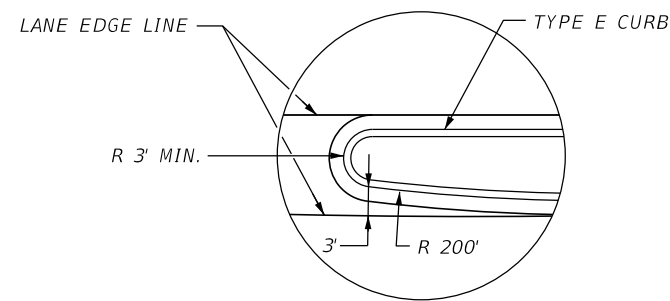

DETAIL A

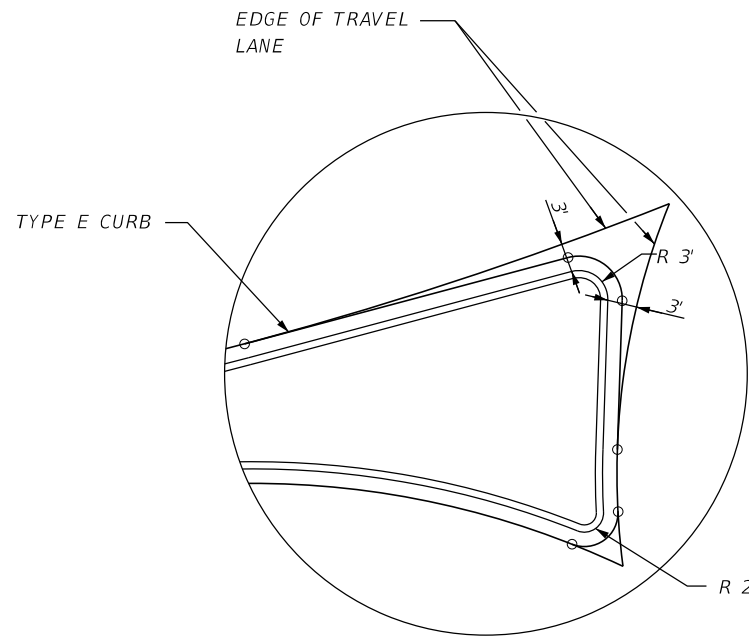

DETAIL B

APPROACH ROADWAY DESIGN SPEED	RADIUS (TYP.)	
	AR1	AR2
50 MPH	1100'	600'
55 MPH	1400'	800'
60 MPH	1800'	950'
≥ 65 MPH	2200'	1100'

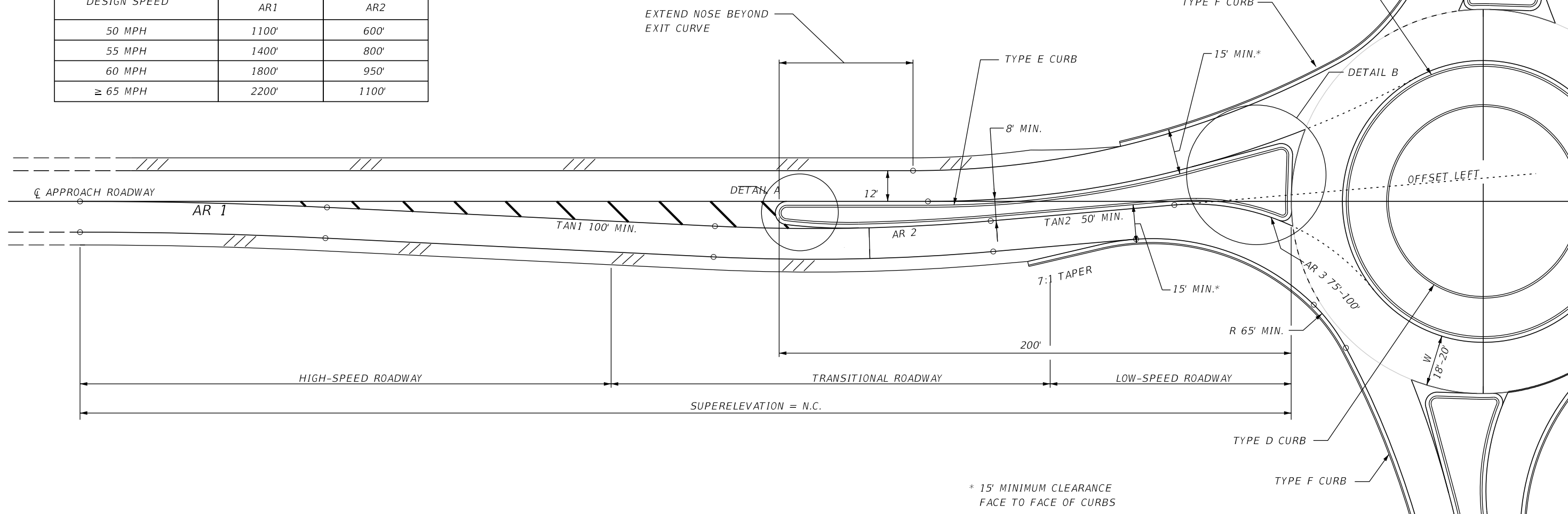

* 15' MINIMUM CLEARANCE
FACE TO FACE OF CURBS

ROUNDBABOUT HIGH SPEED APPROACH DETAILS

NOT TO SCALE

EXHIBIT 213-2
01/01/2022

213.3.2 Alignment of Approach Lane

The alignment of the approach affects the amount of deflection (speed control) that is achieved, the ability to accommodate the design vehicle, and the visibility angles to adjacent legs. The optimal alignment is generally governed by the size and position of the roundabout relative to its approaches.

An offset left alignment is typically preferred as it increases the deflection achieved at the entry to improve speed control and is easier to remove path overlap for multilane entries.

213.3.3 Angle Between Approach Legs

The intersection angle between two roadways has a significant influence on the geometrics and operation of a roundabout. Intersection angles are to be as close to 90 degrees as practical. Consider realigning the approach legs of minor roads when the intersection angle is less than 75 degrees; **Figure 213.3.1** illustrates realignment configurations.

Figure 213.3.1 **Realignment Configurations**

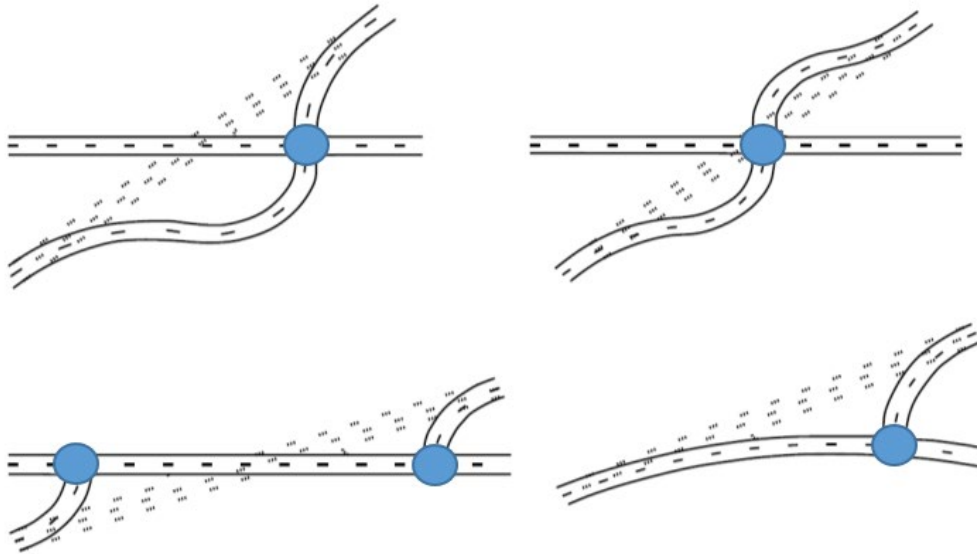

213.3.4 **Roadway Profiles**

The profile grade of the roadways carried through the influence area of the intersection should be as flat as practical to allow the circulatory roadway pavement to slope to the outside. See **FDM 213.3.7** for cross slope requirements.

213.3.5 **Splitter Islands**

Splitter islands generally extend upstream of the yield line to the point at which entering drivers are expected to begin decelerating comfortably. **Exhibit 213-1** provides details for splitter islands. Splitter islands are to use Type E curb or Type I traffic separator.

Locate the crosswalk approximately 20-feet upstream from the yield line. Minimum width for the raised splitter island at crosswalks is 6-foot (between curb faces). The minimum crosswalk width in the splitter island is 10-feet. These dimensions ensure the provision of a pedestrian refuge area within the splitter island.

Minimum length of the splitter island is based on the design speed of the approach leg, as follows:

- 50-foot for design speed 35 mph or less; 100-foot desirable
- 100-foot for design speed 45 mph or less

- 200-foot for design speed 50 mph or greater

Extend the splitter island beyond the PT of the exit curve to discourage exiting traffic from crossing into the path of approaching traffic.

213.3.6 Approach Roadway Width

The width of the roadway at locations with curb on both sides needs to accommodate the design vehicle and be a minimum 15-foot face to face.

213.3.7 Circulatory Roadway

The width of the circulatory roadway is determined from the number of entry lanes and the turning requirements of the design vehicle. Provide only the minimum width necessary to serve the required lane configuration. Typically accommodate a bus without use of the truck apron.

Circulatory roadway lane widths of multilane roundabout do not need to be consistent and typically range from 12-feet to 18-feet. The outside lane is typically larger to provide additional space for the design vehicle and reduce entry and exit path overlap.

Slope the circulatory roadway away from the central island at 2%, 1% minimum.

213.3.8 Truck Apron

Use the standard truck apron design illustrated in **Figure 213.3.2**. Indicate in the plans that the roundabout truck apron is to be red in color that closely matches AMS-STD-595-21105 red.

Figure 213.3.2 Standard Truck Apron Design

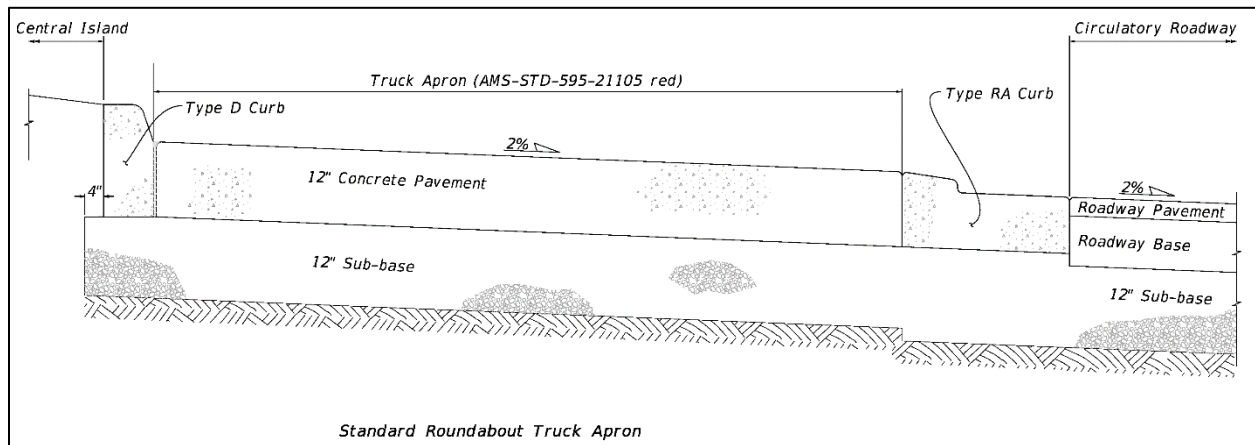

213.4 Path Overlap

The natural path of a vehicle is the path it will take based on the speed and orientation imposed by the roundabout geometry. Path overlap on multi-lane roundabouts occurs when the natural paths of vehicles in adjacent lanes overlap or cross one another; i.e., geometry leads vehicles into the wrong lane. It occurs at entries where the geometry of the right-hand lane tends to lead vehicles into the left-hand circulatory lane. Aligning the approach lanes with the receiving lanes in the circulatory roadway helps drivers maintain their natural trajectory upon entry and significantly reduces potential for path overlap. To reduce path overlap at multi-lane entries, provide a tangent segment between the right-hand entry lane and the circulatory roadway as shown in **Figure 213.4.1**. Extend the tangent segment beyond the dotted extension line at the entry to assure proper alignment of vehicles prior to entering the circulatory roadway.

Path overlap can also occur at multi-lane exits where the geometry or pavement marking tends to lead vehicles from the left-hand circulatory lane into the right-hand exit lane. To reduce path overlap at multi-lane exits, provide a tangent segment between the circulatory roadway and receiving lane as shown in **Figure 213.4.1**. Providing a flat exit radius also helps drivers maintain their natural trajectory upon exiting and significantly reduces potential for path overlap. The potential for increased speeds associated with a flatter exit design should be considered when crosswalks are provided.

Figure 213.4.1 Tangents for Path Overlap

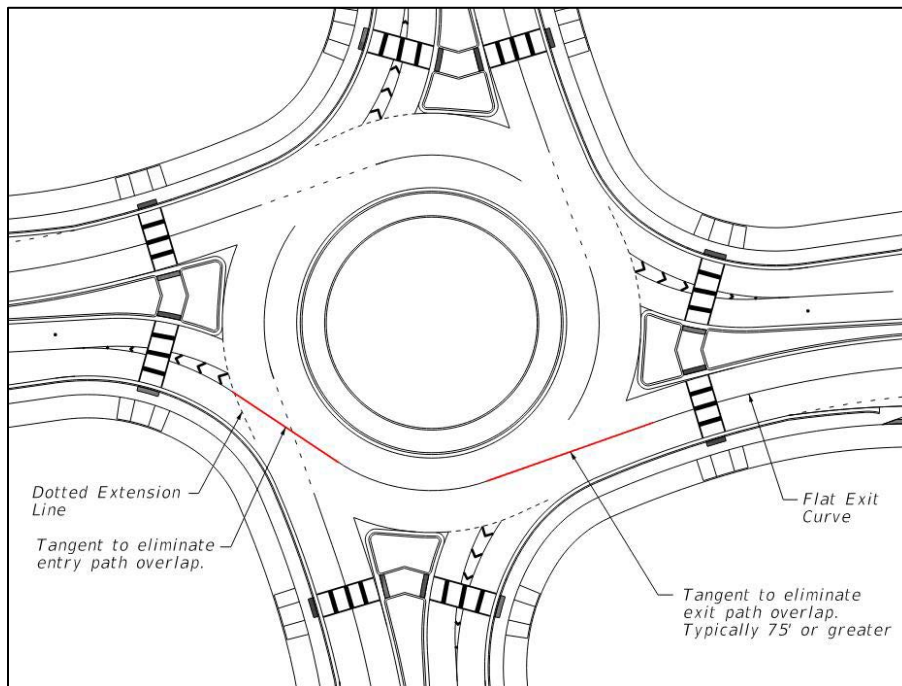

213.5 Spiral Transitions

Spiral transitions are necessary for multi-lane roundabouts when the lane configuration includes exclusive left turn lanes. Spiral transitions are used to guide drivers into the appropriate lane for their desired exit. Drivers that enter the roundabout on the inside lane are pushed to the outside lane allowing them access to their desired exit without the need for a lane change. Inclusion of exclusive left turn lanes and transition spirals complicate the design and should only be provided if warranted through traffic operational analysis.

Figure 213.5.1 illustrates the inclusion of a spiral transition with a lane configuration that includes two circulatory lanes and a single exit lane. The spiral geometry is developed by connecting two semi-circles with different diameters as indicated by the green and red arcs. The smaller diameter (green) represents the inside edge of travel lane adjacent to the truck apron and the larger diameter (red) is equal to smaller diameter plus the width of the inside travel lane. The spiral transition allows for the left turning movement as indicated by the red arrows. Also shown in the figure is the required spiral transition pavement marking.

The central island should be developed (shaped) using curb to enforce the spiral geometry. Use of striping to create the spiral geometry should be avoided.

Figure 213.5.1 Spiral Transition

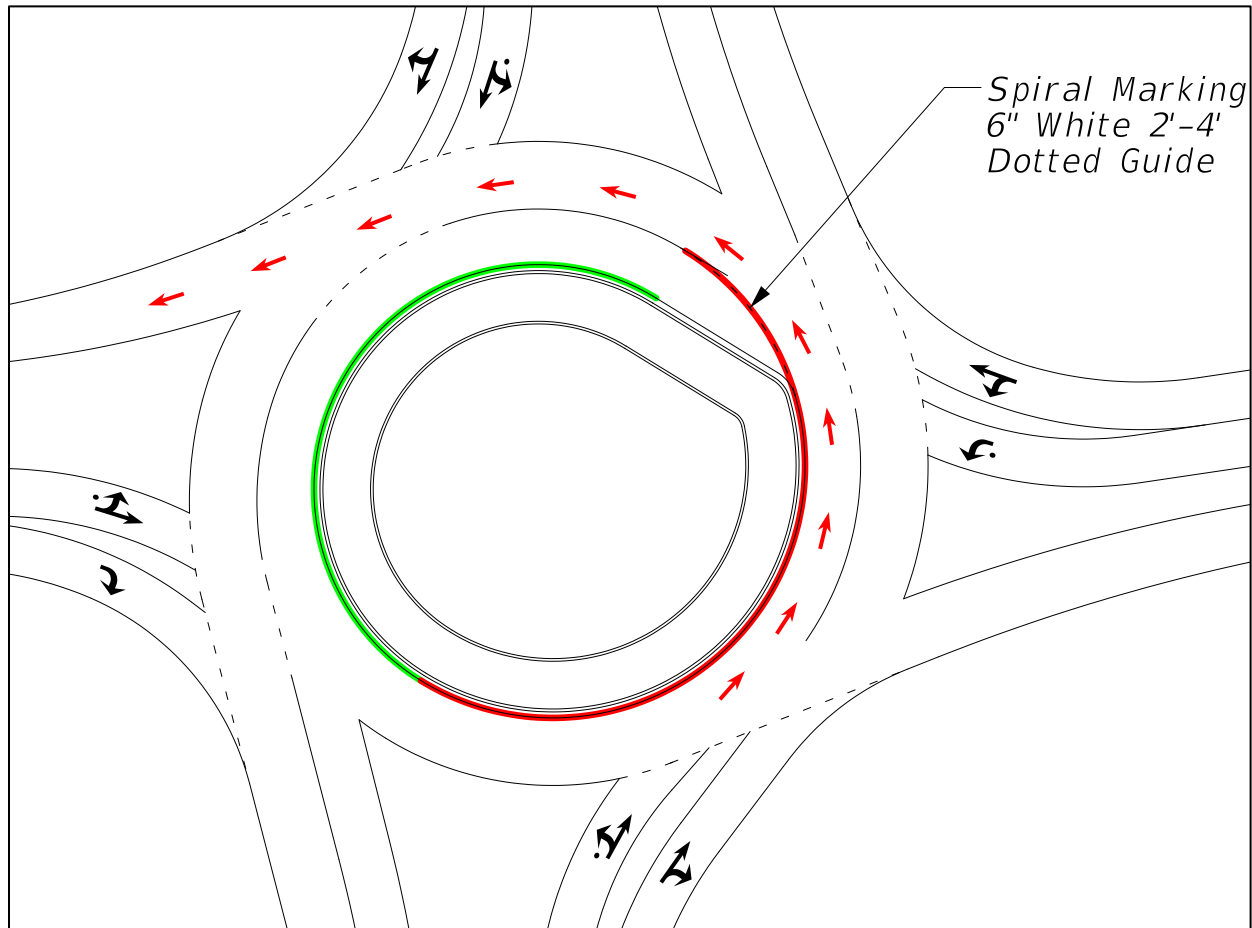

213.6 Fastest Path

Controlling speeds for vehicles entering and traveling through roundabouts is a critical design objective that significantly impacts the safety and comfort of all users. A well-designed roundabout reduces vehicle speeds upon entry and encourages consistency in the relative speeds between conflicting traffic streams. The effectiveness of speed control within a roundabout can be determined by conducting a fastest path performance check.

The fastest path is defined as the radius (R1, R2, R3, R4 and R5) that provides the smoothest and flattest path possible for a single vehicle (assumed 6 feet wide) traversing the roundabout. The fastest path does not consider lane markings when determining the

vehicles path; i.e., drivers will run over striping and use all available pavement. Fastest path movements are shown in **Figure 213.6.1** and are as follows:

Figure 213.6.1 Fastest Path Curves

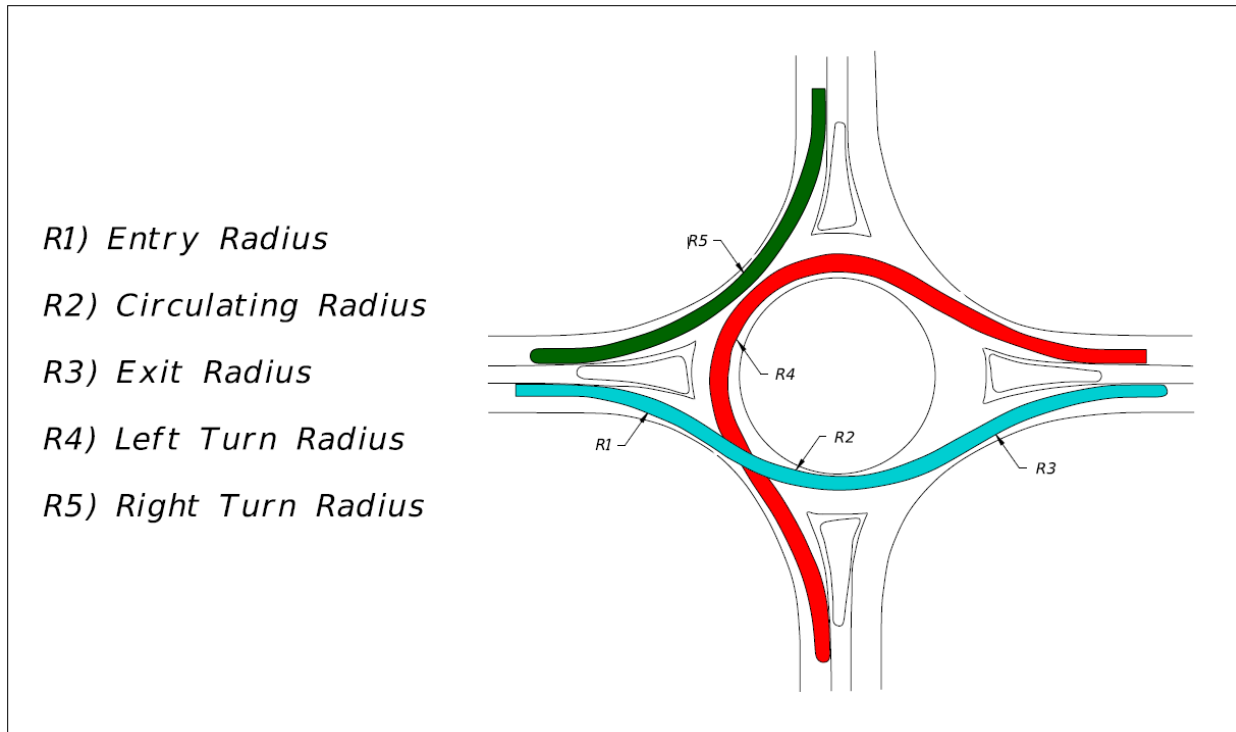

Fastest path speeds must adhere to the following;

- R1 and R5 entry speeds are not to exceed 25 mph for single-lane entries and 30 mph for multi-lane entries.
- R2 and R4 circulating speeds should be no more than 15 mph less than the entry speed.
- R3 exit speeds requires engineering judgement to balance the competing objectives of accommodating the design vehicle and providing a safe environment for pedestrians using the crosswalk.

The fastest path for the through movement (R1, R2, and R3) is illustrated in **Figure 213.6.2**. The fastest path for the right turn movement (R5) is illustrated in **Figure 213.6.3**. Centerline of vehicle path is drawn with a 5-foot offset from face of curb, or a 3-foot offset from the painted edge line.

Figure 213.6.2 Fastest Path for Through Movement

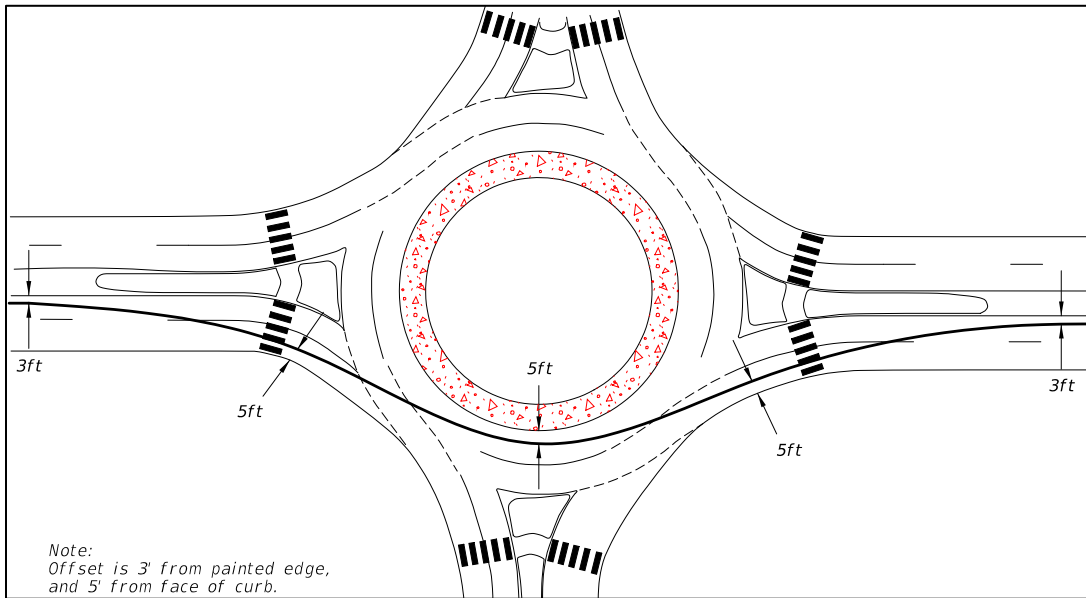
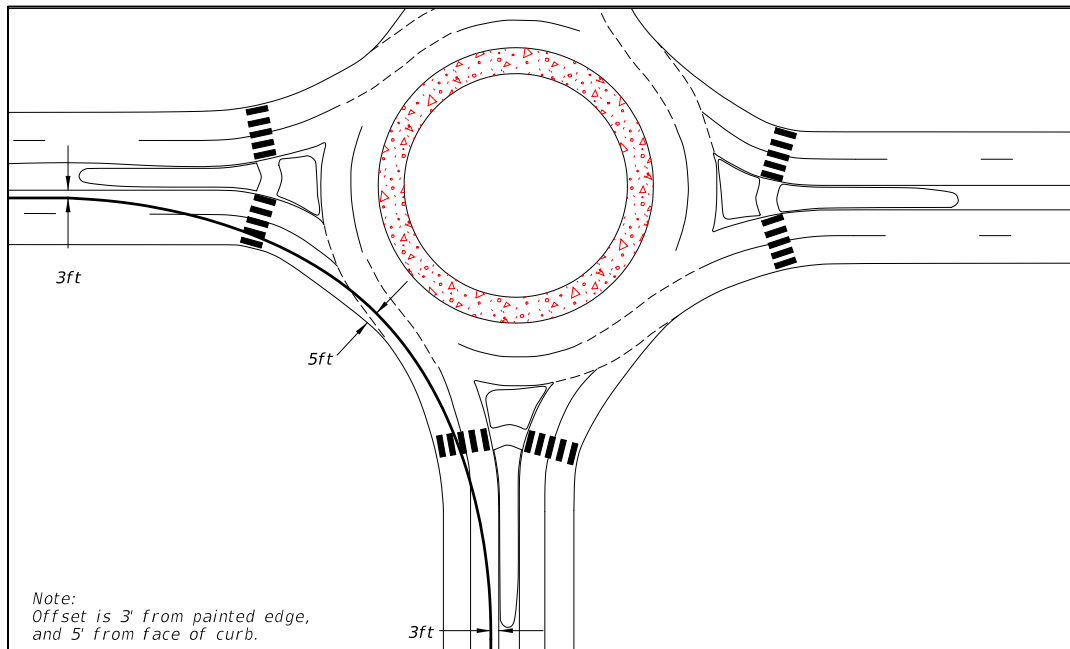

Figure 213.6.3 Fastest Path for Right Turn Movement



213.6.1 Fastest Path Methodology

A CADD-based procedure for conducting fastest path analysis has been adopted by the Department and can be downloaded from the **FDM** web page. For consistency, this step-by-step procedure should be followed when determining R1, R2, R3, R4, and R5.

Calculated speeds for R1, R3 and R5 are based on NCHRP 672 equation 6-1 with a pavement slope of +2%.

Calculated speeds for R2 and R4 are based on NCHRP 672 equation 6-2 with a pavement slope of -2%.

A spread sheet has been developed to assist with these calculations and can be downloaded from the **FDM** web page.

213.7 Design Vehicle Accommodation (Swept Path)

Roundabouts typically accommodate a WB-62FL design vehicle for the through movements on the SHS. A smaller design vehicle may be appropriate for turning movements connecting off-system roads. See **FDM 201.6** for additional information on design vehicle.

Swept path diagrams assure that there is adequate pavement to accommodate the maneuvers of the design vehicle through the roundabout without over-tracking the curb. AUTOTURN is a CADD-based vehicle turning path program that is often used to determine the swept path of the design vehicle.

Provide swept path diagrams for the design vehicle for all turning movements. Develop travel paths using continuous smooth spline curve alignments representative of travel paths experienced in the field.

Provide a minimum 1.5-foot offset from the face of curb to the design vehicle's tire track.

213.7.1 Single-Lane Roundabout

The swept path design vehicle is required to stay within the travel lane and is prohibited from encroaching onto the splitter island, central island, or outside gutter pans. The truck trailer is permitted to mount the RA curb and use the truck apron. **Figure 213.7.1** illustrates a WB-62FL design vehicle swept paths for a single-lane roundabout.

Figure 213.7.1 WB-62FL Swept Paths: Single Lane Roundabout

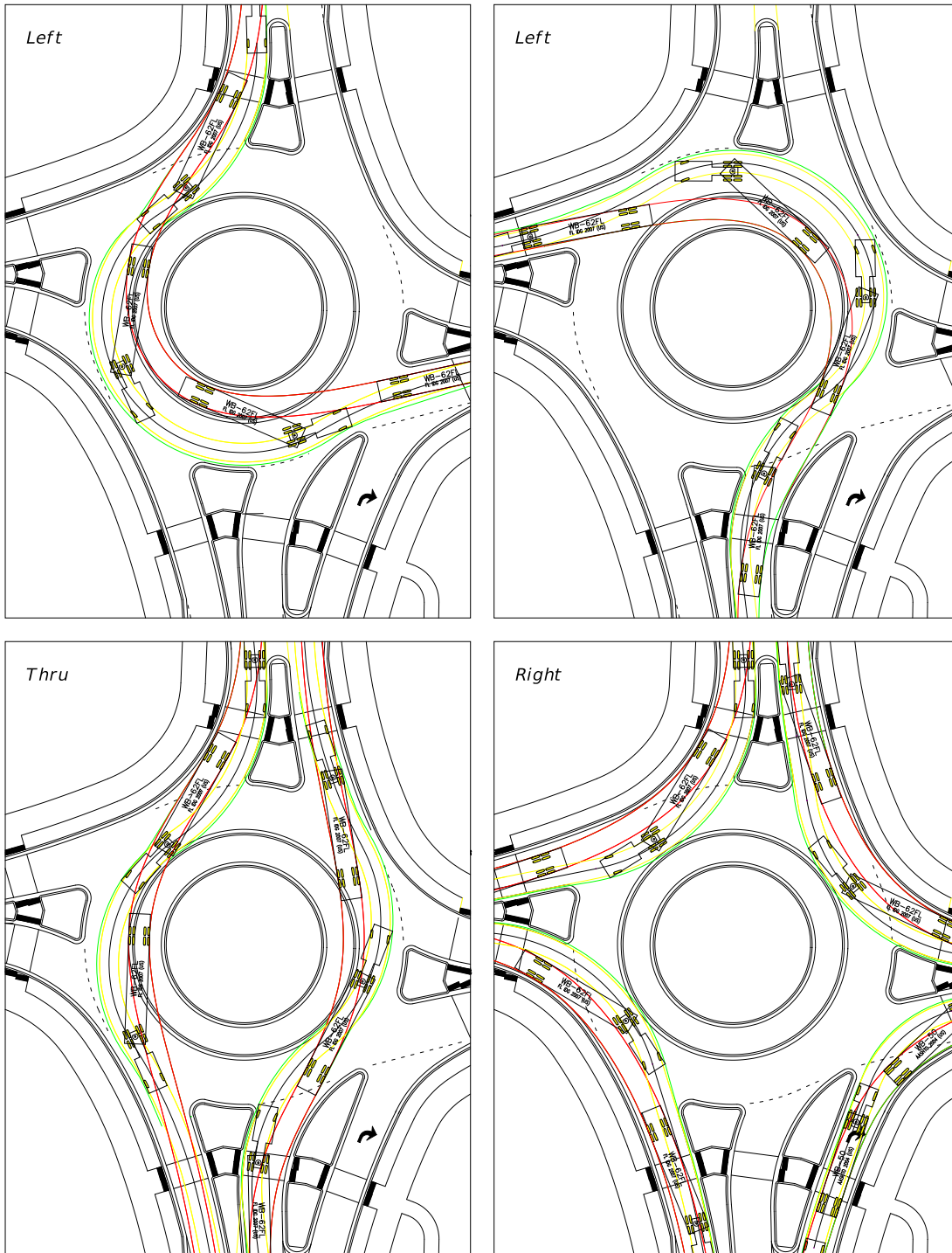

213.7.2 Two-Lane Roundabout

Provide adequate pavement area for the simultaneous passage of the design vehicle and a passenger vehicle through the roundabout and for turning movements. The design vehicle must stay within the travel lanes without encroaching onto the inside or outside gutters. The truck trailer is permitted to mount the RA curb and use the truck apron. Develop swept path diagrams for all turning movements in the following combinations:

- Design vehicle in the outside lane and passenger vehicle in the inside lane
- Design vehicle in the inside lane and passenger vehicle in the outside lane

It is acceptable for the design vehicle path to encroach into the adjacent travel lane within the circulatory roadway when there is sufficient space for the passenger vehicle plus two feet of clearance between the two vehicles.

Use a painted gore when providing in-lane truck accommodations on multilane entries. Typical multi-lane approaches include two 12-foot lanes separated by a 6 to 7-foot painted gore, as shown in **Exhibit 213-1**.

When truck volume is very low, consider allowing the truck-trailer to command both lanes to complete the maneuver.

213.7.3 Exit Radius

An exit radius of 300 to 400 feet should be provided to create a smoother vehicular path and better truck accommodation. Use engineering judgement to balance the competing objectives of accommodating the design vehicle and providing a safe environment for pedestrians. Provide flat exit geometry when no pedestrian facilities are present.

213.8 Bicycle and Pedestrian Accommodation

Exhibit 213-1 provides standard details for pedestrian and bicycle facilities.

213.8.1 Pedestrian Facilities

When there are existing or planned pedestrian facilities on the approach roadways, the following requirements apply:

- (1) Provide sidewalk widths in accordance with **FDM 222**, or consistent with approach sidewalk widths. When bicycle ramps are provided, the desired sidewalk width is 10 feet, but not be less than 8 feet.
- (2) A 5-foot set-back from back of curb to sidewalk is desired; typically not less than 2 feet.
- (3) Provide crosswalks at every approach leg.
 - (a) Provide curb ramps and detectable warning surfaces consistent with **FDM 222** and [Standard Plans, Index 522-002](#).
 - (b) Orient crosswalks perpendicular to the roadway to minimize pedestrian crossing distance.
 - (c) Provide a pedestrian refuge area within the splitter island meeting the requirements of **FDM 213.3.5**.
 - (d) Provide pedestrian crosswalk lighting in accordance with **FDM 231**.

213.8.2 Bicycle Facilities

There are several types of on-road and physically separated bicycle facilities available to accommodate bicycle travel as discussed in **FDM 223**. The following paragraphs outline the requirements for bicycle facilities at roundabouts.

On-road bicycle facilities: On-road bicycle facilities include bicycle lanes and paved shoulders. Terminate on-road bicycle facilities at the upstream end of the roundabout and resume them at the downstream end as shown in **Figure 213.10.1**. Locate termination points close to the roundabout where vehicular speeds are slow. Provide physically separated bicycle facilities with bike ramps at multi-lane roundabouts. This allows cyclists the option to either use the physically separated facility to cross the intersection or enter the travel lane and use the circulatory roadway to cross. Physically separated bike facilities with bike ramps are optional for single lane roundabouts.

Physically separated bicycle facilities: Physically separated bicycle facilities include separated bike lanes, sidewalk level separated bike lanes, and shared use paths. Physically separated facilities should be continuous around the intersection, parallel to the curb line and follow the contours of the circular intersection. **Figure 213.10.1** shows a typical design for a separated bike lane. Details for sidewalk level separated bike lanes and shared use paths are similar. Separation techniques for physically separated bicycle facilities are covered in **FDM 223**. Provide bike ramps at multi-lane roundabouts to allow cyclists on the roadway the option to use the physically separated bike facility to cross the intersection or to stay on the roadway and use the circulatory roadway to cross. Bike ramps are optional for single lane roundabouts.

Design bike ramps in accordance with **FDM 223.2.5**.

213.8.3 Pedestrian Crossings

- Angled Crossings - Angled crossings are the preferred configuration because they minimize pedestrian crossing distance. When developing Angled Crossings, place each leg of the crosswalk perpendicular to the outside curb of the entry and exit lanes and locate the angle point near the center of the splitter island. See **Figure 213.8.1** for an illustration of angled crossings.
- Straight Crossings – Straight crossings are used when providing continuity of a major multi-use path. For Straight Crossings, place the entire crosswalk perpendicular to the centerline of the approach roadway. See **Figure 213.8.1** for an illustration of straight crossings.

Figure 213.8.1 Angled and Straight Crossings

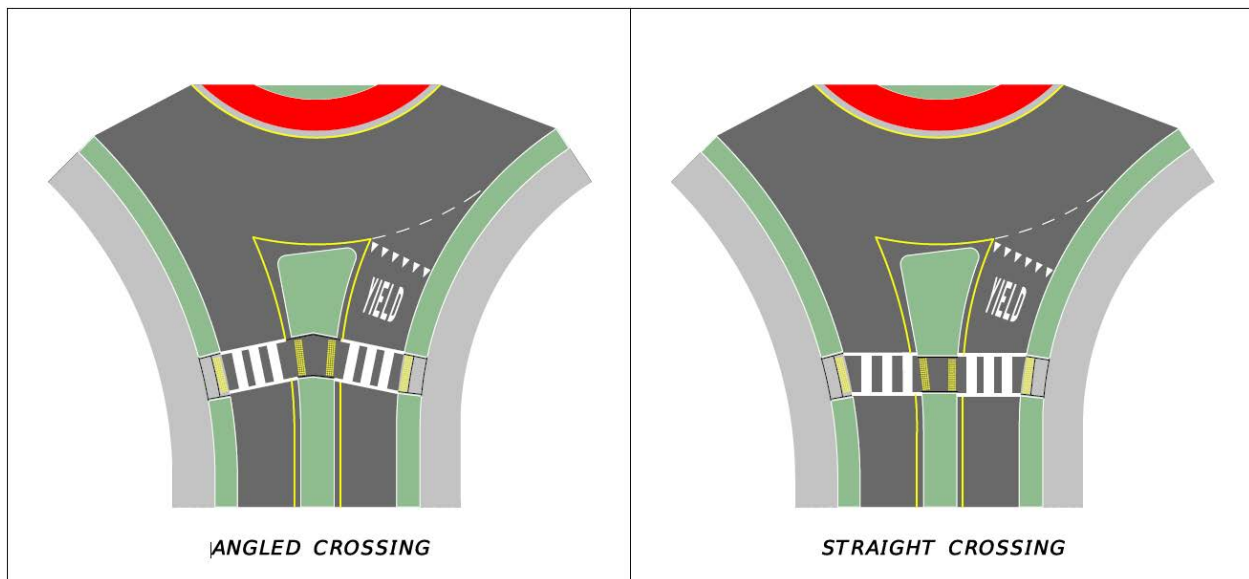

- Offset Crossings - Offset crossings (**Figure 213.8.2**) are used at multi-lane roundabouts where supplemental crossing treatments such as Pedestrian Hybrid Beacons or Rectangular Rapid Flashing Beacons are proposed. When developing offset crossings, locate the approach lane crosswalk 20 feet from the outside of the ICD and the exiting lane crosswalk 50 feet from the outside of the ICD. This design is intentionally opposite the similar “Z-Crossing” found at midblock locations. The longer distance at the exit allows for a 2-car queue between the crosswalk and roundabout.

Figure 213.8.2 Offset Crossings

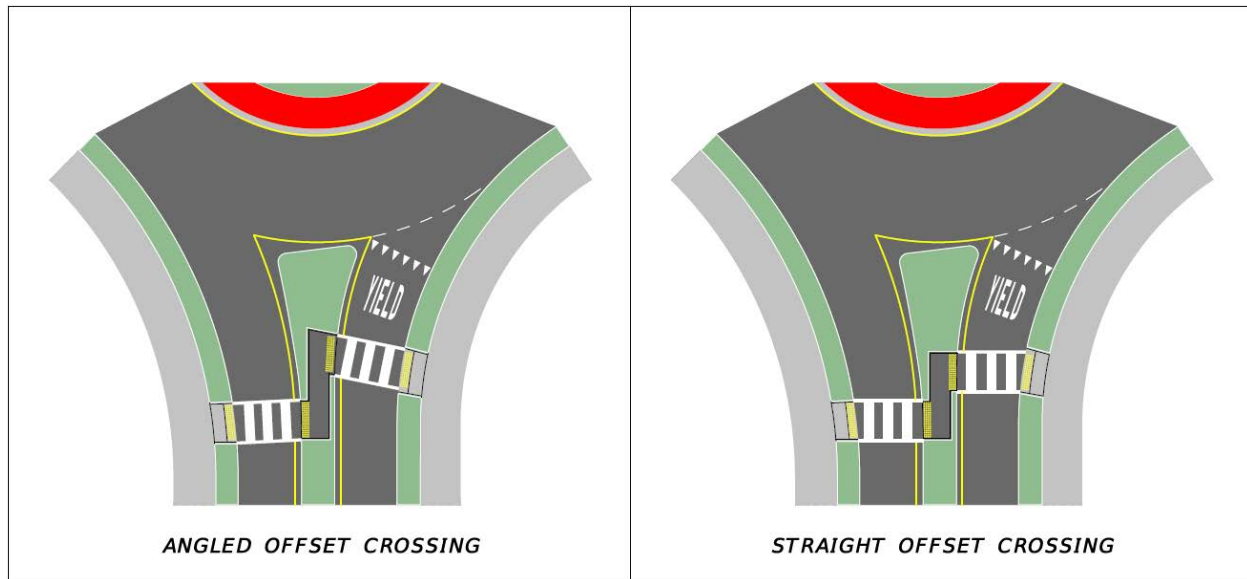

213.9 Landscaping

Create a mounded central island that slopes upward from the truck apron using a slope no flatter than 1:10 and no steeper than 1:6. Provide varying height trees and plants in the central island to enhance driver recognition of the roundabout upon approach. On large roundabout center islands, varying heights, and uneven slopes can increase visual awareness of the roundabout and enhance aesthetics.

Provide quality space above and below ground for trees and other desirable vegetation to grow. Do not construct roundabout center islands on existing road pavement and base. Assure that the soil conditions will support the health and growth of selected trees and plants. Place trees and palms near the center of the central island, and not less than 6 feet from the face of Type D curb. Place shrubs in a simple arrangement to help increase visual awareness of the roundabout.

Coordinate the landscape design in the early stages of plans development to assure that landscaping will be fully integrated into the roundabout design.

Additional information regarding roundabout landscaping is in Chapter 9 of [NCHRP 672](#).

213.9.1 Plant Selection

Select a diverse, low maintenance mix of [Florida Friendly](#) plant species. Select trees 6-foot in height or taller when installed; palm trees 12-foot or taller. The use of native tree species is encouraged. Select shrubs that will recover or regenerate naturally after mechanical damage. Select trees and plants with a variety of height, color, form, and texture. Select trees that will continue to grow in value, after establishment, without routine irrigation.

Plants placed in splitter islands must not exceed 18-inches in height, at full maturity; i.e., do not encroach on sight distance requirements.

If more decorative plantings are requested by local agency or groups, a maintenance agreement should be obtained.

213.10 Signing and Pavement Markings

Well-designed signing and pavement markings will enhance safety and traffic operations by clarifying the rules of the road and proper lane assignments to drivers as they navigate through the roundabout.

Use the standard left-turn arrow with a circular dot on the left-most lane of the approach to multi-lane roundabouts as shown in [Standard Plans, Index 711-001](#). Use standard arrows within the circulatory roadway.

Follow the details presented in [Exhibits 213-3, 213-4, 213-5, and Figure 213.10.1](#) when developing roundabout signing and pavement marking plans to promote consistency throughout the state.

Figure 213.10.1 shows roundabout signs and pavement markings with the bicycle lane. There are options for green or no green color pavement markings depending on the location and conditions. Green-colored pavement is permitted for use with Interim Approval from FHWA. This figure also identifies features that should be included in the design of street crossings.

Additional measures may be needed to induce yielding to bicyclists and pedestrians at crossing locations of multilane roundabouts or roundabouts where exit geometry may prompt faster exiting speeds and reduced chances of yielding by motorists. Consider devices such as a Rapid Flashing Beacon or a Pedestrian Hybrid Beacon.

Figure 213.10.1 Roundabout S&PM with Separated Bicycle Lane

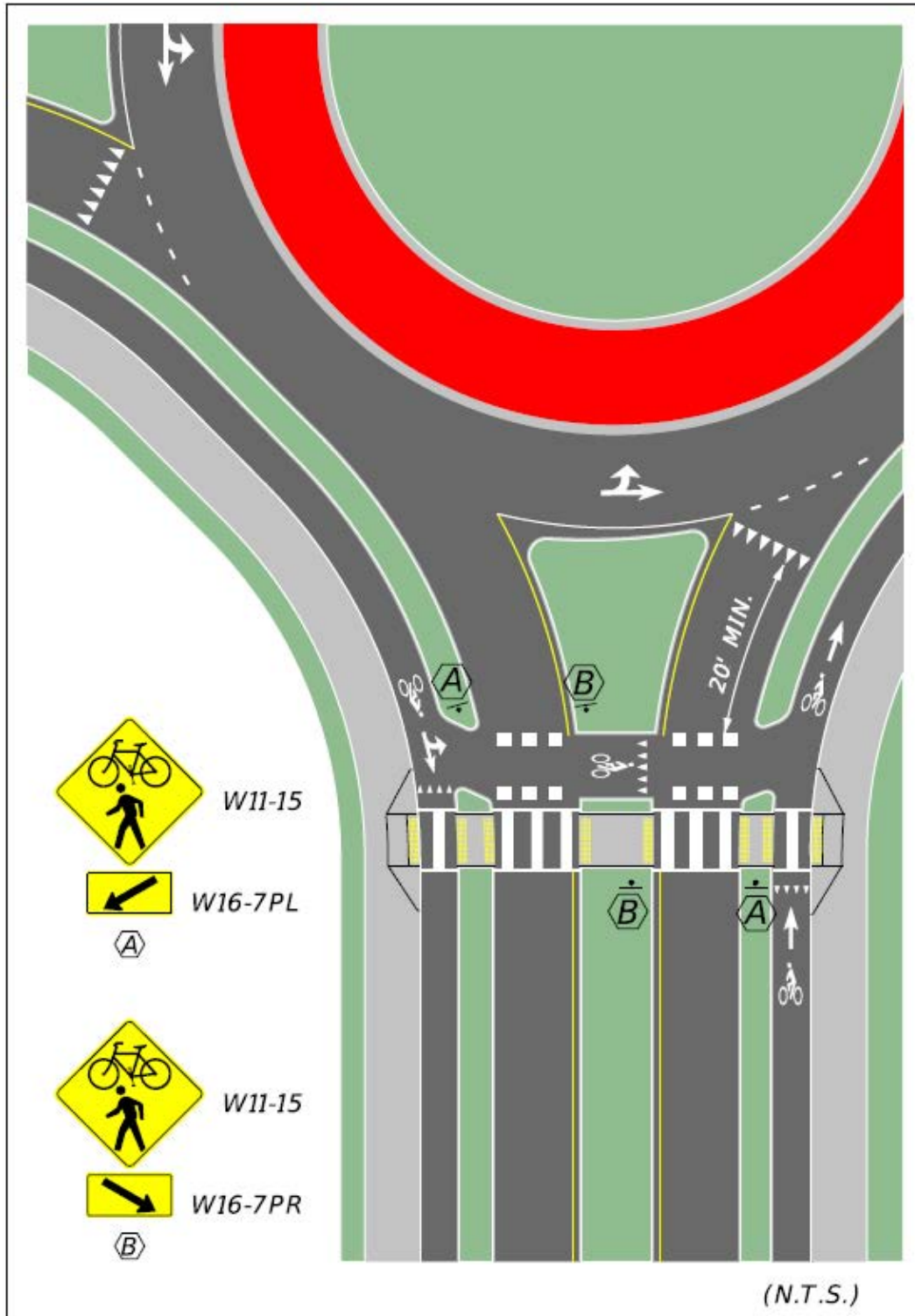

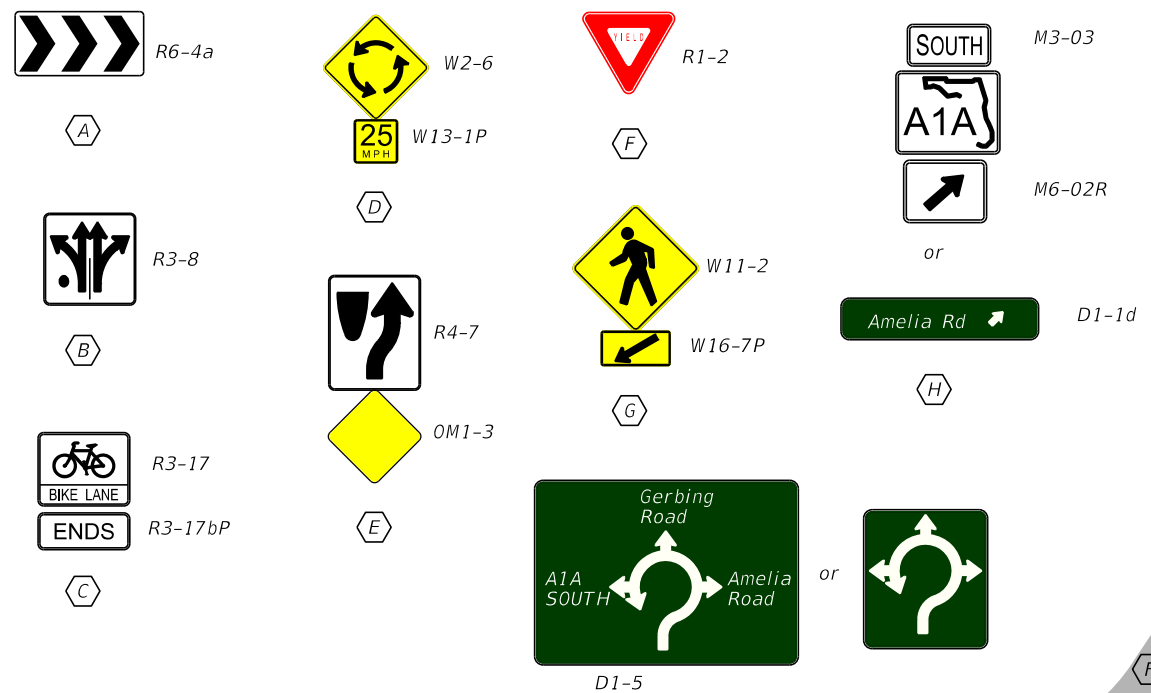

Posted Speed (MPH)	Typical Sign Location	
	Distance Between Signs (ft)	
	A (min)	B
55	800	200
50	700	200
45	600	200
40	500	200
35	400	200
30	300	200
25	150	200

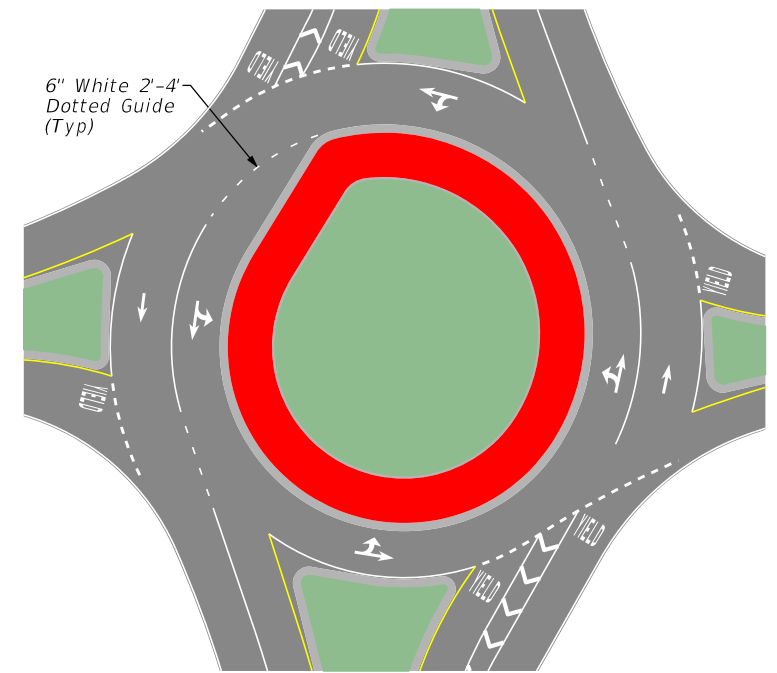
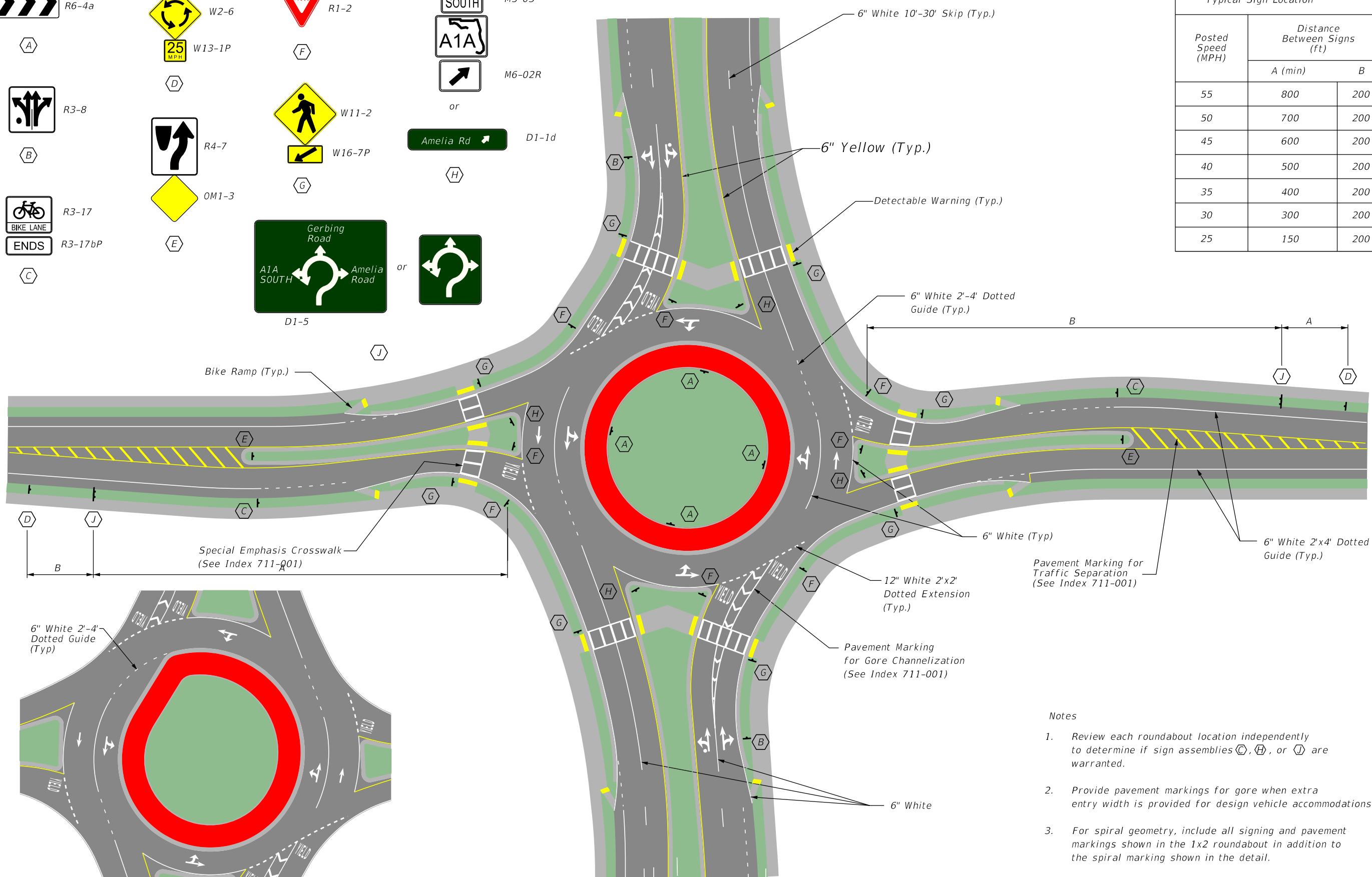

- Notes
1. Review each roundabout location independently to determine if sign assemblies C , H , or J are warranted.
 2. Provide pavement markings for gore when extra entry width is provided for design vehicle accommodations.
 3. For spiral geometry, include all signing and pavement markings shown in the 1x2 roundabout in addition to the spiral marking shown in the detail.

1x2 ROUNDABOUT SIGNING AND PAVEMENT MARKINGS

SPIRAL MARKING DETAIL ³

NOT TO SCALE
EXHIBIT 213-3
01/01/2022

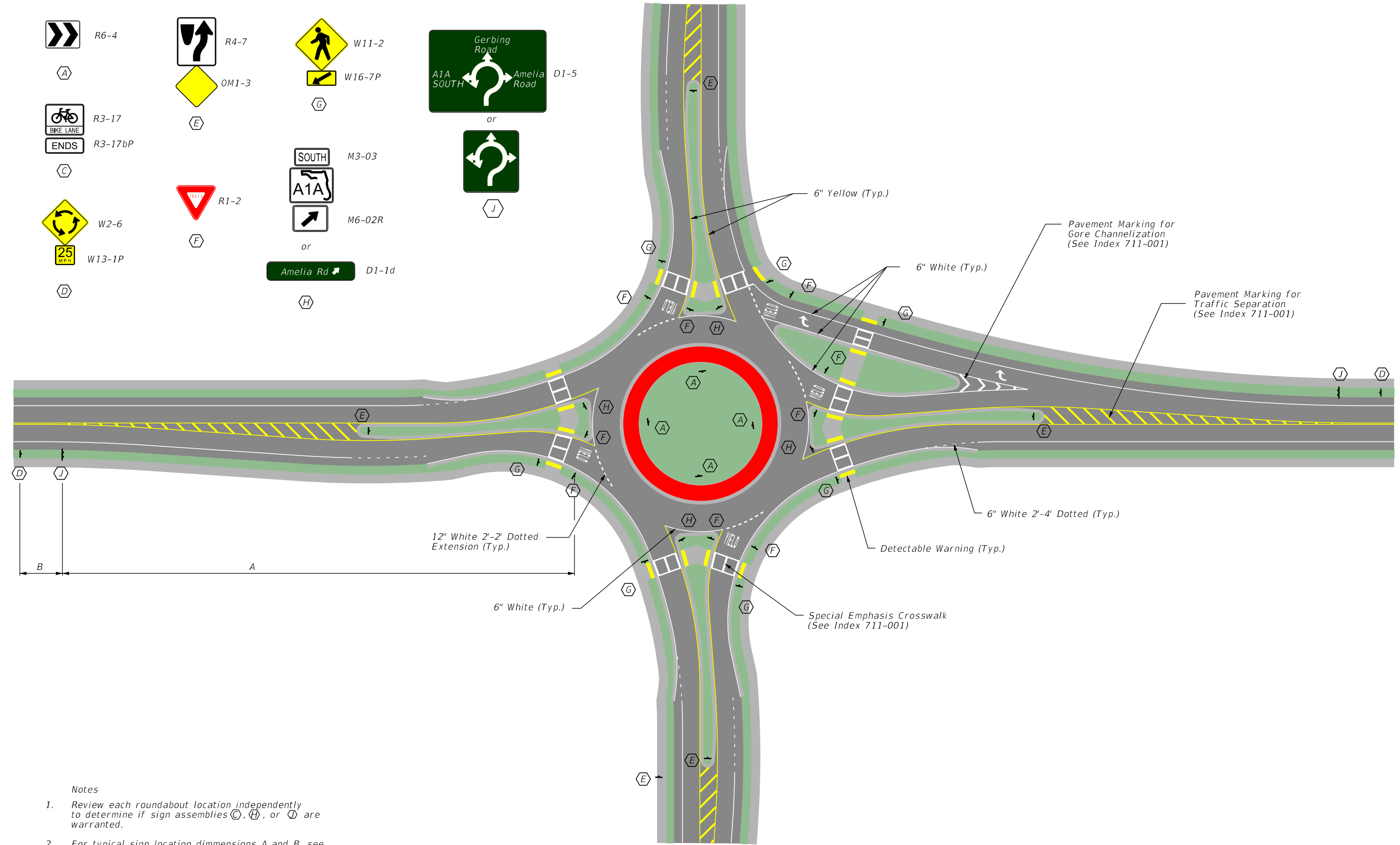

Notes

1. Review each roundabout location independently to determine if sign assemblies C, H, or J are warranted.
2. For typical sign location dimensions A and B, see Exhibit 213-3

**1X1 ROUNDABOUT WITH BYPASS LANE
TYPICAL SIGNING AND PAVEMENT MARKINGS**

NOT TO SCALE

EXHIBIT 213-4
01/01/2022

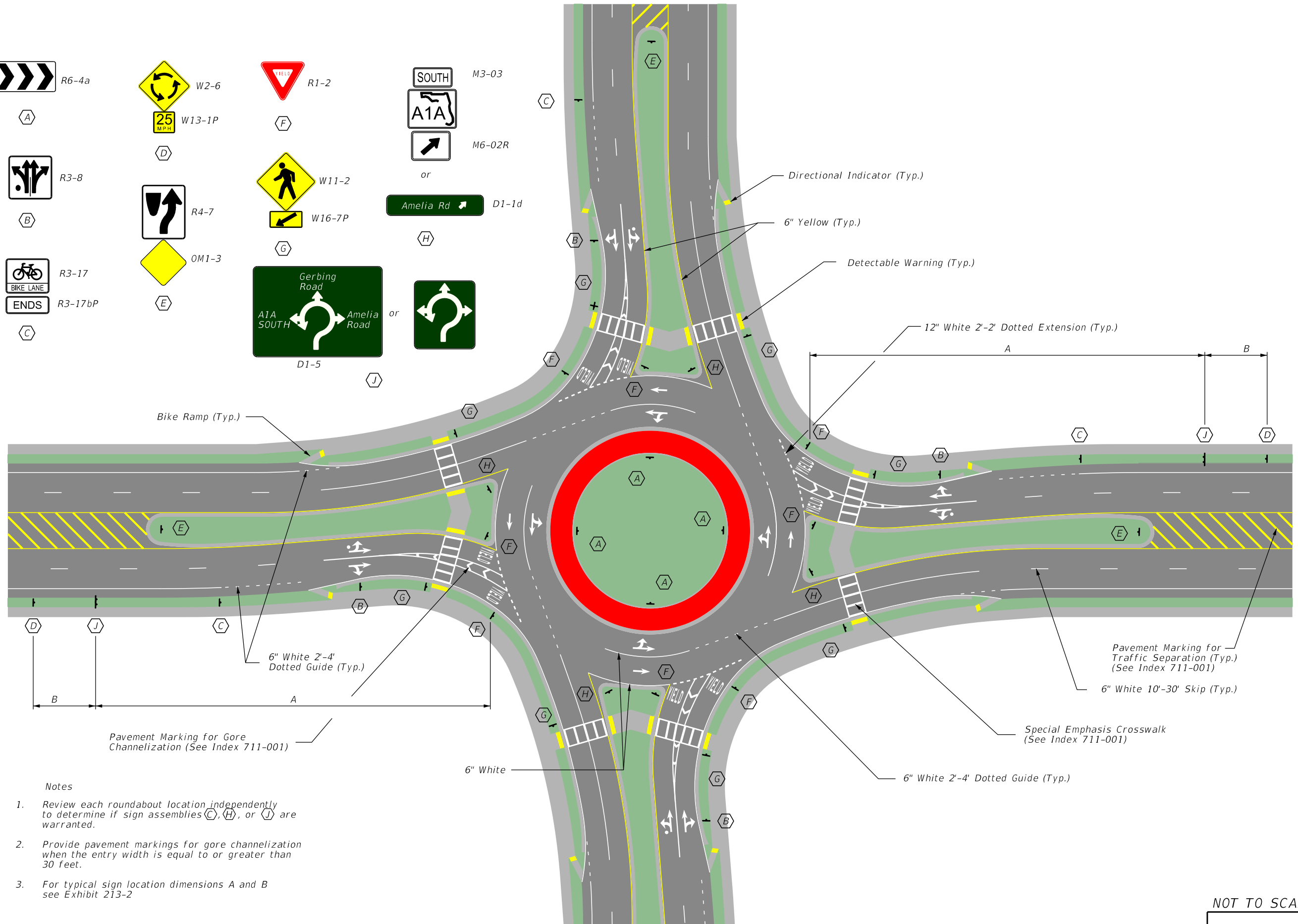
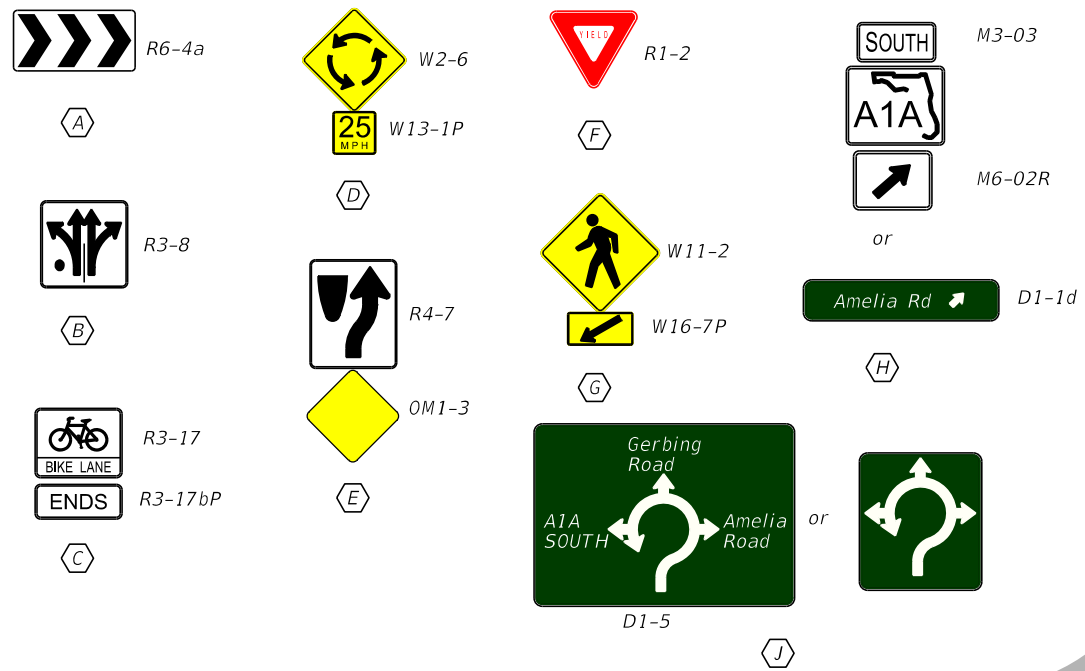

Notes

1. Review each roundabout location independently to determine if sign assemblies (C), (H), or (J) are warranted.
2. Provide pavement markings for gore channelization when the entry width is equal to or greater than 30 feet.
3. For typical sign location dimensions A and B see Exhibit 213-2

NOT TO SCALE

2X2 ROUNDABOUT SIGNING AND PAVEMENT MARKINGS

EXHIBIT 213-5
01/01/2022

213.11 Lighting

Nighttime illumination of roundabouts is required. Provide a minimum 1.5 foot-candles on the roadway surface within the circulatory roadway and at least 200 feet in advance of the splitter islands.

See **FDM 231.3.3** for additional lighting requirements when pedestrian facilities are provided.

213.12 Community Aesthetic Features

Communities commonly desire to place public art or other large aesthetic objects within the central island. These types of features are acceptable provided that:

- Objects are located outside the required sight triangles,
- Not less than 6 feet from the inside edge of the truck apron, and
- Approval is granted through the process outlined in **FDM 127**.

Fountains, or other water spraying features are not permitted.

214 Driveways

214.1 General

This chapter provides driveway design criteria and requirements for connections to the State Highway System. The [FDOT Access Management Guidebook](#) provides further guidance and information on driveways and medians. For additional information and definitions, including Connection Categories, and requirements for obtaining access to the State Highway System, refer to:

- **Florida Administrative Code (F.A.C.), Rule 14-96 (State Highway Connection Permits)** and
- **Rule 14-97, F.A.C. (State Highway System Access Control Classification System and Access Management Standards).**

This criteria applies to new construction, reconstruction, and Resurfacing, Restoration and Rehabilitation (RRR) projects. New Construction criteria must be met for new and reconstruction projects, and for proposed improvements included within RRR projects. For RRR Projects, unaltered driveways that are not in compliance with the new construction criteria in this chapter, [Standard Plans](#), or ADA requirements are not required to be reconstructed.

The terms “driveway”, “connection”, and “turnout” are used in various FDOT manuals, handbooks, and guides. A driveway is an access constructed within a public R/W connecting a public road with adjacent property. The intent is to provide vehicular access in a manner that will not cause the blocking of any sidewalk, border area, or roadway. The term “connection” encompasses a driveway or side road and its appurtenances:

- islands,
- separators,
- transition tapers,
- auxiliary lanes,
- travel way flares,
- drainage pipes and structures,
- crossovers,
- sidewalks,
- curb cut ramps,
- signing,
- pavement marking,
- required signalization,
- maintenance of traffic, or
- other means of access to or from controlled access facilities.

The term “turnout” is typically used to describe the portion of the driveway or side road adjoining the outer roadway (maintained or constructed by the Department). The terms “driveway” and “connection” are used in this chapter.

Driveways should be located and designed to improve the mobility and safety of all road users. The location and design of the connection must consider potential users, context classification, access classification, and site conditions.

This Chapter includes considerations and requirements for the design of driveways defined as Connection Categories A, B, C, or D (see **FDM 214.1.1**). Connection Categories E, F and G (i.e., traffic volume >4,000 trips/day) are designed as Intersections in accordance with **FDM 212**. Side road intersection design, with possible auxiliary lanes and channelization, may be necessary for Connection Category C and D.

214.1.1 Driveway Terminology

Figure 214.1.1 provides a schematic of typical driveway types and the associated terminology. The terms shown in this section are standard terms or variables used within this chapter.

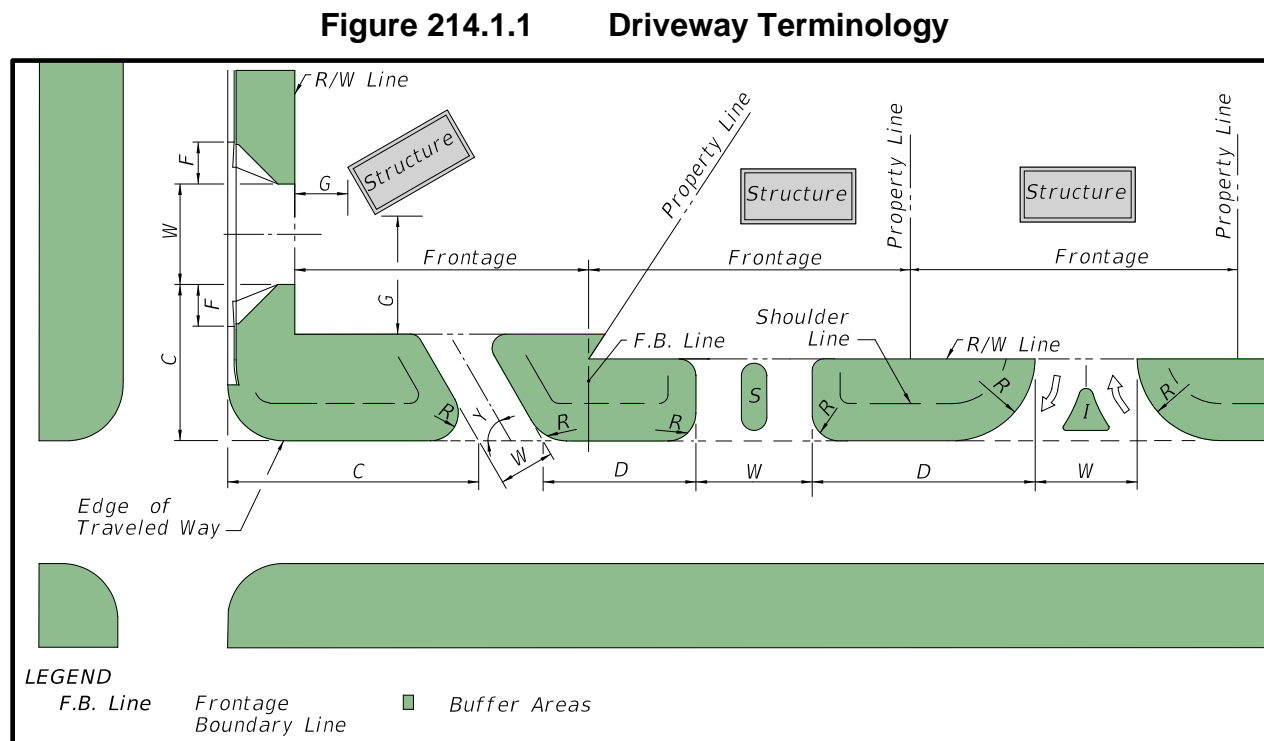

Radius (R) – The radial dimension of curved driveway entry or exit.

Flare (F) – The total length of angled approach/exit at the edge of roadway for a flared driveway.

Driveway Connection Width (W) – Effective width of the driveway, measured between the left edge and the right edge of driveway.

Driveway Connection Spacing (D) – Spacing between driveways from the projected edge line of each driveway (see connection spacing in **Tables 201.4.2** and **201.4.3**).

Corner Clearance (C) – Distance from an intersection, measured from the projected closest edge line of the intersecting roadway to a driveway projected edge line (see connection spacing in **Tables 201.4.2** and **201.4.3**).

Angle (Y) – Angle of the driveway between the driveway centerline and the roadway edge of traveled way.

Setback (G) – Distance from the R/W line to the closest permanent structure.

Driveway Location – Position of driveway in relation to other traffic features such as intersections, neighboring driveways, median openings, and interchanges.

Driveway Length – Distance needed into the site to transition vehicles to the internal circulation system of the site.

Driveway Traffic Separator (S) – Linear islands or raised medians used to separate traffic movements on the driveway.

Channelization Island (I) – Used to facilitate right turns and discourage left turn movements on the driveway.

Connection (Driveway) Category (A through D) are defined as follows:

- A – 1-20 trips/day or 1-5 trips/hour.
- B – 21-600 trips/day or 6-60 trips/hour.
- C – 601-1,200 trips/day or 61-120 trips/hour.
- D – 1,201-4,000 trips/day or 121-400 trips/hour.

Design driveways based on the context classification, expected volume of multimodal traffic, and expected mix of traffic, and design vehicle. See the **FDOT Access Management Guidebook** for descriptions of these categories.

214.1.2 Evaluation of Existing Driveways

Evaluate existing driveways to ensure the design properly balances safety, accessibility, and mobility. The following existing roadway elements play a role in locating driveways on roadway improvement projects:

- Medians
- Median openings
- Adjacent driveways
- Traffic signals
- Adjacent highway features
- Adjacent intersection

Perform a corridor analysis to determine if existing connections, median openings, and signal spacing are in conformance or can be brought into conformance with Department standards. See **FDM 201.4** for Access Management requirements.

Each district has an **Access Management Review Committee (AMRC)** to provide guidance on access management and median decisions. The AMRC also reviews deviations from connection and median opening spacing standards not resolved during the District's staff level review. The AMRC members are appointed by the District Secretary and consist of head level positions within the District. Interested persons may also appear before the AMRC during the project development stage. (See **Section 335.181(2), Florida Statutes** and **Rule 14-96.002(25), F.A.C.**)

When a connection is proposed to be modified as part of a Department project, notice of the Department's intended action will be provided to the property owner pursuant to **Rule 14-96.011(2), Florida Administrative Code**. Property owners have the right to request an administrative hearing. If a hearing is requested, the Department will offer to schedule a meeting on site to consider documents, reports, or studies obtained by the property owner with regards to safety and operational concerns.

214.2 Flared and Radial Return Designs

Driveway connections on the State Highway System use either a flared or a radial return design. Examples of each type are shown in **Figure 214.2.1**.

Figure 214.2.1 Flared and Radial Return Driveway Examples

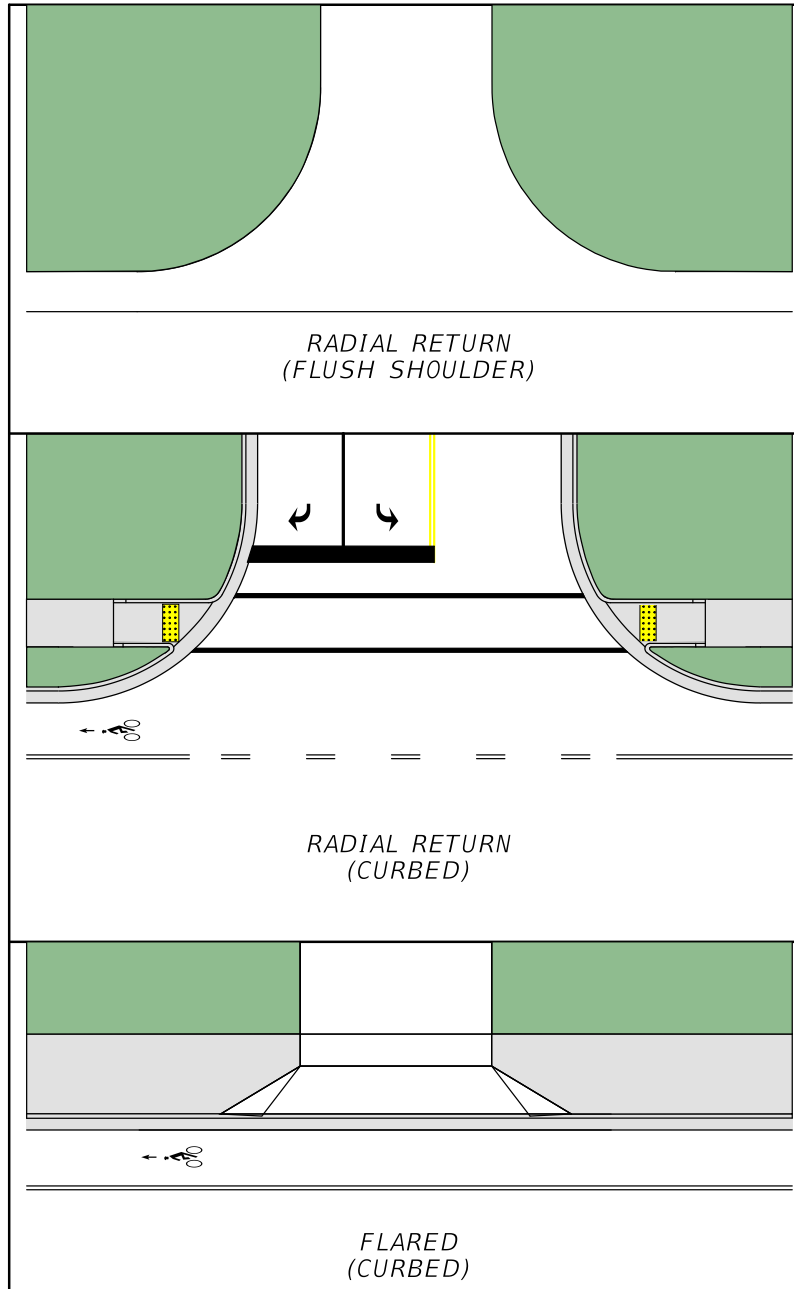

Determine the type of driveway needed based on roadway type (curbed or flush shoulder) and driveway traffic volumes. Flared driveways are used on curbed roadways where driveway traffic does not exceed 600 trips per day or 60 trips per hour (i.e., Connection Categories A and B) as shown in **Table 214.2.1**. Radial return designs are used on all flush shoulder roadways and on curbed roadways with driveway traffic greater than 600 trips per day (i.e., Connection Category C and D).

Provide radial returns for driveways requiring or having a specified median opening with left turn storage and served directly by that opening.

Table 214.2.1 Flared or Radial Driveway

Element Description	Connection Category		
	A	B	C and D
		2-Way	2-Way
Curbed Roadways	Flared	Flared	Radius
Flush Shoulder Roadways	Radius	Radius	Radius

Notes:

- (1) Connection Categories A, B, C, and D are defined in **FDM 214.1.1**.
- (2) Small radii may be used in lieu of flares for curbed roadways with Category B Connections when approved by the Department.

Modification for Non-Conventional Projects:

Delete note 2 from **Table 214.2.1** and see RFP for requirements.

Flared or radial return design determines driveway entry and exit speeds and turning movements. Larger radius or flare allows for quicker and more efficient vehicle access in contexts where motor vehicle movement is a priority. This reduces interference with traffic on the major roadway. Pedestrians may be impacted due to larger driveway openings (e.g., higher vehicle entry speeds and increased pedestrian crossing times), which are undesirable in contexts where pedestrians and speed management are a priority.

Consider the following to determine which type of driveway is needed:

- Design Speed, Posted Speed and Target Speed of roadway
- Driveway traffic volume
- Entry and exit movements (e.g., one-way, two-way, right-in/right-out)
- Available R/W
- Design Vehicle
- Context Classification
- Pedestrian Needs
- Bicyclist Needs

A CADD-based vehicle turning path program (e.g., AUTOTURN) is often used to determine the driveway type and dimensions for the appropriate design vehicle.

Requirements for driveway profiles connected to curbed or flush shoulder roadways are provided in **FDM 214.4**.

For additional information and details on flared driveways see [Standard Plans, Index 522-003](#) and for paved radial driveways see [Standard Plans, Index 330-001](#).

214.3 Driveway Horizontal Geometry

Driveway horizontal geometry should be consistent with the context classification, roadway type (curbed or flush shoulder), driveway traffic volumes, driveway design vehicle, and access classification. This section contains the following design elements for driveway horizontal geometry:

- Radius
- Driveway Width
- Angle of Driveway
- Driveway Traffic Separator and Channelization Island
- Driveway Length
- Driveway Location

Each driveway element listed above is further discussed in the subsequent sections. **Table 214.3.1** contains driveway dimensions for the horizontal geometry elements. This table also provides the requirements for the elements in **Figure 214.1.1**.

Table 214.3.1 Driveway Dimensions

Element	Description	Connection Category		
		A	B 2-Way	C and D 2-Way
Curbed Roadways				
W	Connection Width	12' Min 24' Max	24' Min 36' Max	24' Min 36' Max
F	Flare (Drop Curb)	10' Min	10' Min	N/A
R	Radial Returns (Radius)	N/A	See Note 3	25' Min 50' Std 75' Max
Y	Angle of Driveway	60°- 90°	60°- 90°	60°- 90°
S	Driveway Traffic Separator or Median	N/A	4'-22' Wide	4'-22' Wide
G	Setback	12' Min., All categories.		
C & D	Corner Clearance and Driveway Connection Spacing	See connection spacing in Tables 201.4.2 and 201.4.3		
Flush Shoulder Roadways				
W	Connection Width	12' Min 24' Max	24' Min 36' Max	24' Min 36' Max
F	Flare (Drop Curb)	N/A	N/A	N/A
R	Radial Returns (Radius)	15' Min 25' Std 50' Max	25' Min 50' Std 75' Max	25' Min 50' Std (Or 3-Centered Curves)
Y	Angle of Driveway	60°- 90°	60°- 90°	60°- 90°
S	Driveway Traffic Separator or Median	N/A	4'-22' Wide	4'-22' Wide
G	Setback	12' Min., All categories.		
C & D	Corner Clearance and Driveway Connection Spacing	See connection spacing in Tables 201.4.2 and 201.4.3		
Notes:				
(1) Connection Categories A, B, C, and D are defined in FDM 214.1.1 . (2) 2-Way refers to one entry movement and one exit movement; i.e., not exclusive left or right turn lanes on the connection. (3) Small radii may be used in lieu of flares for curbed roadways in Connection Category B when approved by the Department. (4) The Angle of Driveway for Connection Category A may be reduced with approval by the local Operations/Maintenance Engineer. (5) Design criteria for channelization islands (I) is found in FDM 210.3 . Radial Returns (Radius): (6) Provide the minimum radius for low-speed roadways with driveway design vehicle of a passenger car. (7) Provide the standard radius for high-speed roadways or driveway with large design vehicles (e.g., SU-30). (8) Consider providing the maximum radius or compound curve for high-speed roadways or driveway with large design vehicle (e.g., WB-62).				

Modification for Non-Conventional Projects:

Delete notes 3 and 4 from **Table 214.3.1** and see RFP for requirements.

214.3.1 Radius

Design criteria for radial return driveways are given by road type (curbed or flush shoulder roadways) and connection category. A range of return radii (minimum, standard, and maximum) is provided in **Table 214.3.1**.

The minimum radii will reduce the distance for pedestrians to cross the driveway. See **FDM 214.7** for additional pedestrian requirements.

Use 50-foot radii for driveways intended for daily accommodation of vehicles exceeding 30 feet in length. Provide the following as necessary for safe turning movements where large numbers of multi-unit vehicles will use the connection:

- Increased connection width
- Increased radii
- Auxiliary lanes
- Tapers
- Lane flares
- Separators
- Islands

214.3.1.1 Effective Turning Radius for Right Turns

The effective turning radius is the minimum radius needed to enter or exit a driveway, as illustrated in **Figure 214.3.1**. Additional pavement adjacent to the travel lane (e.g., on-street parking, bike lane, bus bay) will result in the following:

- Increase the effective turning radius for the design vehicle
- The radial return radius (curb radius) may be reduced
- The ability to use a larger design vehicle

Figure 214.3.1 Effective Driveway Radius

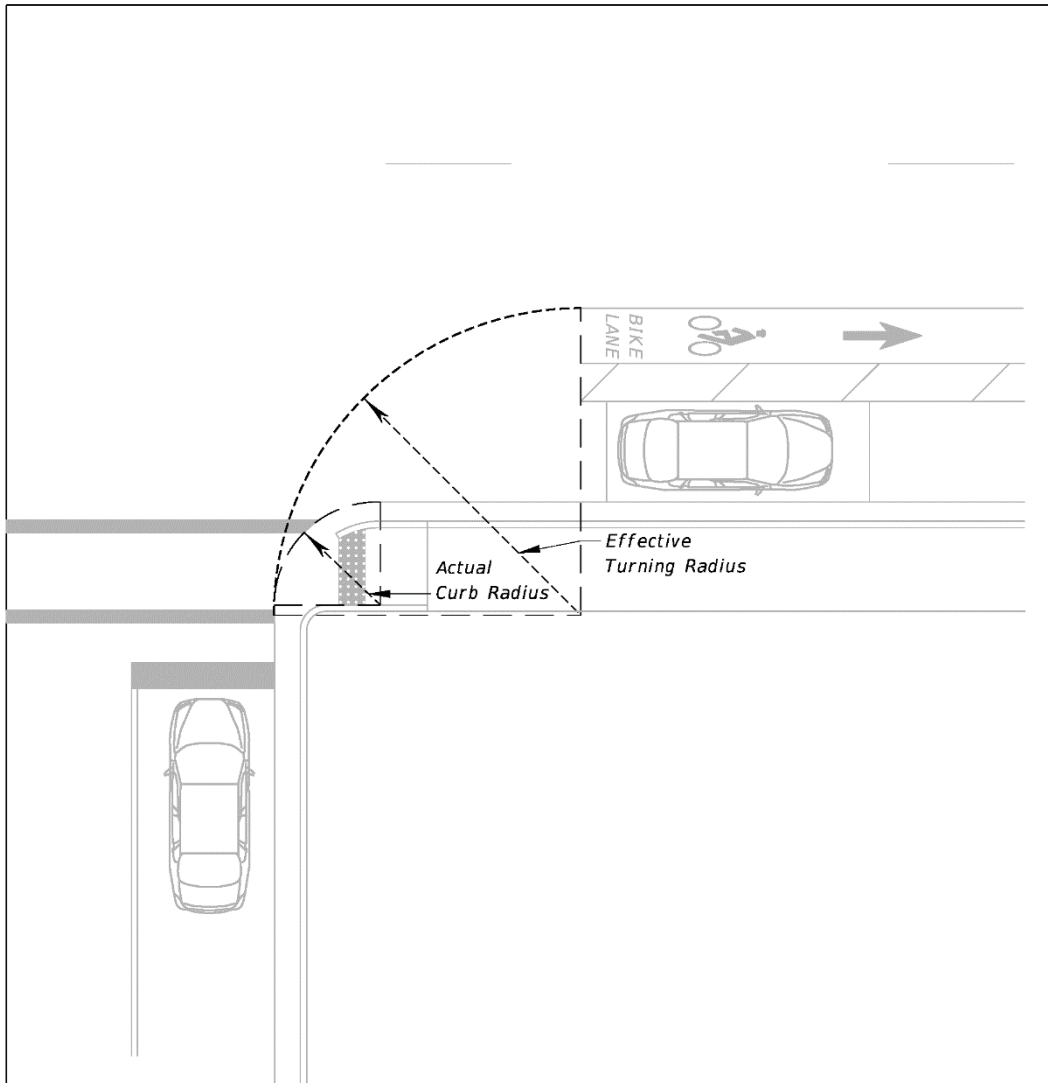

214.3.1.2 Designing for Trucks and Other Large Vehicles

Determine the appropriate design vehicle for each driveway. Driveways designed for large vehicle (i.e. truck and bus) movements may impact other users. The following may result when using larger driveway dimensions for truck movements:

- Some confusion for passenger car drivers
- Increased pedestrian and bicyclist exposure to vehicles

Chapter 4 in the *FDOT Access Management Guidebook* provides additional guidance for designing for large vehicles.

The Department will determine if an auxiliary lane is needed for safe turning movements when large numbers of multi-unit vehicles use the connection. See **FDM 214.5** for more information on exclusive right turn lanes.

214.3.2 Driveway Width

Design criteria for driveway widths are given by Connection Category (A – D) and type of roadway (curbed or flush shoulder). Minimum and maximum driveway widths are provided in **Table 214.3.1**. Design driveway widths based on the design vehicle and number of lanes. Consider increasing driveway width above maximum values when large numbers of multi-unit vehicles will use the connection. The Department will determine if the maximum driveway width is insufficient for safe turning movements.

Modification for Non-Conventional Projects:

Delete last sentence in above paragraph and see RFP for requirements.

Design one-way connections to eliminate unpermitted movements.

When more than two lanes in the driveway connection are required, the 36-foot maximum width may be increased to relieve interference between entering and exiting traffic which adversely affects traffic flow. These cases require documented site-specific study and design.

Consider providing pavement markings to guide drivers exiting or entering a driveway.

214.3.3 Angle of Driveway

The angle of driveway (Y) influences safety and operation of the driveway. It is to be as close to 90 degrees as practical. Design values for angle of driveway are in **Table 214.3.1**. Angles of driveways at the lower end of the allowable range should be avoided for the following reasons:

- (1) Heavy skew angles increase the driveway crossing length, exposing vehicles, pedestrians, and cyclists to conflicting traffic streams for longer periods of time.
- (2) The road user's sight angle to the crossing leg becomes restricted due to the skew, making it difficult to see conflicting vehicles and to perceive safe crossing gaps.

- (3) Turning movements are difficult because of the skew. Additional pavement may be necessary to accommodate the turning of large trucks.
- (4) Turning movements or positioning may be confusing and require additional channelization.
- (5) Increased open pavement areas of highly skewed driveways increase construction and maintenance costs.

214.3.4 Driveway Traffic Separator and Channelization Island

Width requirements for driveway traffic separators are provided in **Table 214.3.1**. For triangular channelization islands, see **FDM 210.3** for criteria and information.

214.3.5 Driveway Length

Driveway length is measured from the edge of roadway traffic lane or bicycle lane to the first conflict point; including the distance to the R/W and the setback (G) to a structure. The setback to a structure is measured from the R/W line to the structure as shown in **Figure 214.1.1** (see **Table 214.3.1** for minimum requirements).

Driveway length and size must accommodate all vehicular queuing, maneuvering, and parking beyond the R/W line. Except for vehicles stopping to enter the highway, the portion of the driveway within the Department R/W must be used only for moving vehicles entering or leaving the highway.

The term driveway length as used in this manual may also be referred to as throat length in other manuals.

214.3.6 Driveway Location

Driveway locations impact the safety and operation of the roadway. Closely spaced driveways increase conflict points and may impede the movement of traffic. Refer to the **2018 AASHTO Green Book, Section 9.11.6** for additional information. Consider the location of driveways in relation to the following:

- Signalized intersections
- Un-signalized connections
- Alternative intersections
- Limited Access interchange ramps

Requirements for driveway spacing and corner clearance are provided in **FDM 201.4** (connection spacing in **Tables 201.4.2** and **201.4.3**) and shown in **Figure 214.1.1**. In addition to corner clearance requirements, driveways should be located outside of the functional areas of adjacent intersections, where practical. The functional area of an intersection is defined in **FDM 212.4**.

See the following for driveway distances to interchange areas and alternative intersections in **Figure 214.3.3**:

- **FDM 214.3.6.2** for d1 values
- Connection spacing in **Tables 201.4.2** and **201.4.3** for d2 requirements

Align corresponding connection through lanes where a driveway is intended to align with a connection across the highway as shown in **Figure 214.3.2**.

Figure 214.3.2 **Aligned Through Lanes**

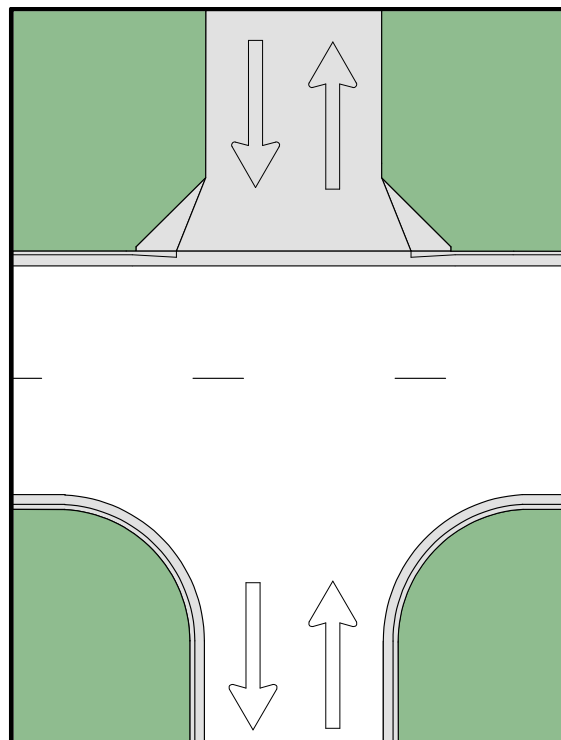

214.3.6.1 Roundabouts

Providing driveway access to a roundabout may be considered only when there are no other reasonable alternatives. Driveways introduce conflict to roundabout operations and increase the likelihood of wrong-way movements. Direct driveway connections must meet the following:

- Design Connection Category B, C, and D driveways as a roadway approach leg, including a splitter island.
- Connection Category A driveways are only allowed on single-lane, low-volume roundabouts. Design Connection Category A driveways as flared connections to provide a visual indication that they are not roadways.
- Provide a means for vehicles to enter the roundabout moving forward; i.e., not backing out of the driveway. This is more critical for Connection Category A driveways where unfamiliar drivers may need to turn around in the driveway.
- Meet the required intersection sight distance (see **FDM 212**).

See **FDM 213** for roundabout criteria and information.

For driveway distances to roundabouts, see **Figure 214.3.3**.

214.3.6.2 Interchange Areas

Access Management on a crossroad at an interchange is critical for the efficient operation of an interchange. Provide adequate connection spacing along the crossroad at an interchange for the following:

- To minimize spillback on the ramp and crossroad approaches to the ramp terminal
- Provide adequate distance for crossroad weaving
- Provide space for merging maneuvers
- Provide space for storage of turning vehicles at access connections on the crossroad

Arterial or collector roadways within 1,320 feet of interchange ramps are areas of special concern (see **Figure 214.3.3**). **Florida Administrative Code, Rule 14-97** requires that the first full median opening be at least 2,640 feet as measured from the end of the taper of the off ramp. The first driveway connection following minimum driveway spacing from the ramp taper furthest from the interchange must be as follows:

- 440 feet on roadways with posted speeds \leq 45 mph

- 660 feet on roadways with posted speeds > 45 mph
- 1,320 feet on Access Class 2 Facilities with posted speeds > 45 mph

For interchanges with speed changes between the ramp tapers, the posted speed is based on the roadway outside the interchange area. These requirements should be applied in accordance with District procedures for implementing the Rule, and should not be confused with the minimum requirements for limited access R/W. See **FDM 211.15** for limited access R/W minimum requirements.

For driveway locations in interchange areas see **Figure 214.3.3**.

Figure 214.3.3 Driveway Locations at Interchange Areas and Alternative Intersections

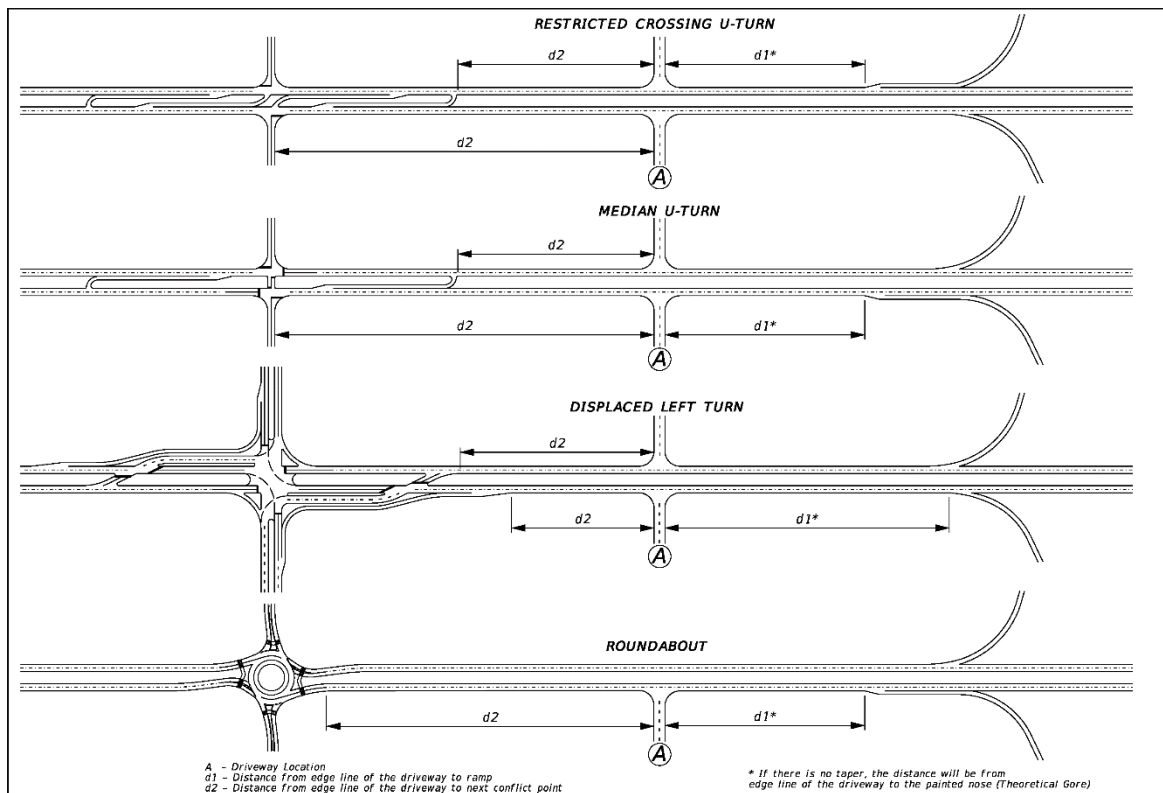

214.4 Driveway Vertical Geometry

The driveway profile defines the vertical geometry for constructing a driveway. The following will impact the design of driveway profiles:

- Roadway type (curbed or flush shoulder)
- Context classification
- Commercial or residential use
- Drainage accommodation
- Utility considerations
- Design speed of roadway (affects steepness of driveway)
- Design vehicle
- Available R/W

Design driveway grades with the following maximum values:

- 10% for commercial
- 28% for residential

Design driveways to avoid ponding and erosion. Drainage requirements are in Chapters 2 and 3 of the *FDOT Drainage Manual*.

214.4.1 Driveway Profile on Curbed Roadways

Requirements for driveway profiles connected to curbed roadways are provided in *Figure 214.4.2*, *Table 214.4.1*, and *FDM 113.2.2*.

To provide the standard sidewalk width, shared use path width, or crossing through the driveway, consider shortening the driveway apron with the appropriate flared driveway. See *FDM 214.7* for more information on pedestrian accommodations for driveways.

Slopes and lengths of flared driveways depend on roadway geometry, design vehicles, sidewalk width, shared use path width, and available R/W.

*Commentary: Driveways can serve as a vertical deflection speed management tool, see **FDM 202** for more information on Speed Management. Requiring motorists to slow down before entering the driveway may increase safety for pedestrians.*

Flared driveways are classified as General, Marginal, or Adverse and are described as follows:

General Applications

These can accommodate representative standard passenger vehicles, and general applications can also accommodate representative standard trucks, vans, buses, and recreational vehicles operating under normal crown and superelevation conditions. Standard pavement cross slopes and superelevation tables are provided in **FDM 210**.

Marginal Applications

These can cause overhang drag for a fully loaded representative standard passenger vehicle when the driveway is located on the low side of a fully-superelevated roadway.

Adverse Applications

These can cause vehicles to drag or slow down and are typically used on very low speed (design speed \leq 35 mph) roadways. This application's slopes can cause overhang drag for representative standard passenger vehicles under fully loaded conditions. The steeper slopes can impede traffic flow by causing drivers leaving the roadway to excessively slow or pause.

Figure 214.4.1 illustrates a comparison between each application. Details for these applications are provided in [Standard Plans](#), **Index 522-003**.

Flared driveways may not accommodate vehicles with low beds, undercarriage, or appendage features. Use site-specific flare designs or Connection Category C and D designs for these vehicles.

Projects that require the reconstruction of an existing commercial driveway may exceed 10% grade when both of the following conditions are met:

- Documentation that an adverse roadway operational or safety impact would not result from the proposed grade is provided; and,
- Approval by District Design Engineer is obtained.

Modification for Non-Conventional Projects:
Delete the above paragraph and see RFP for requirements.

NCHRP Report 659, Guide for the Geometric Design of Driveways contains additional driveway profile information and guidance.

Figure 214.4.1 Comparison of Applications for Flared Driveway Connection

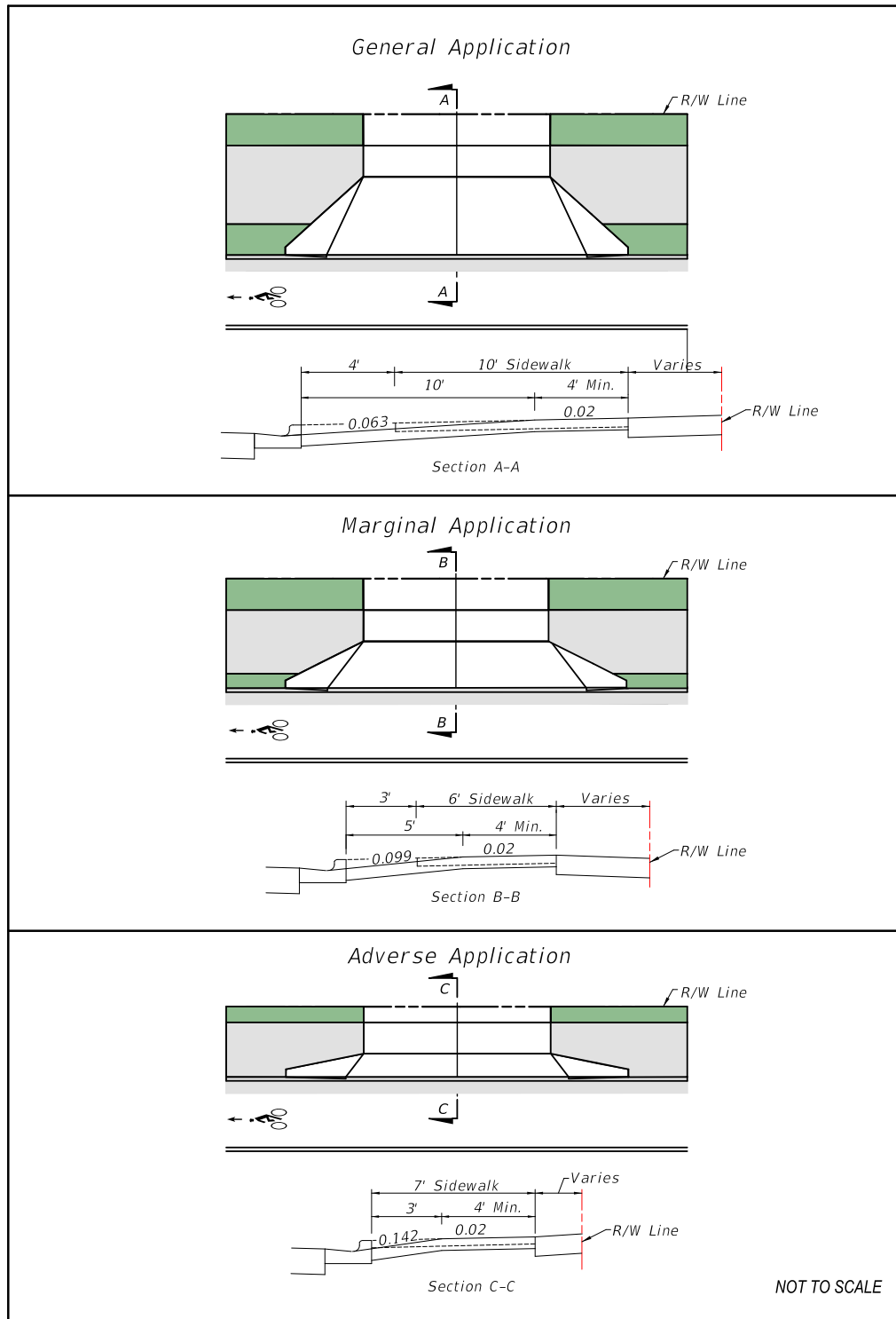
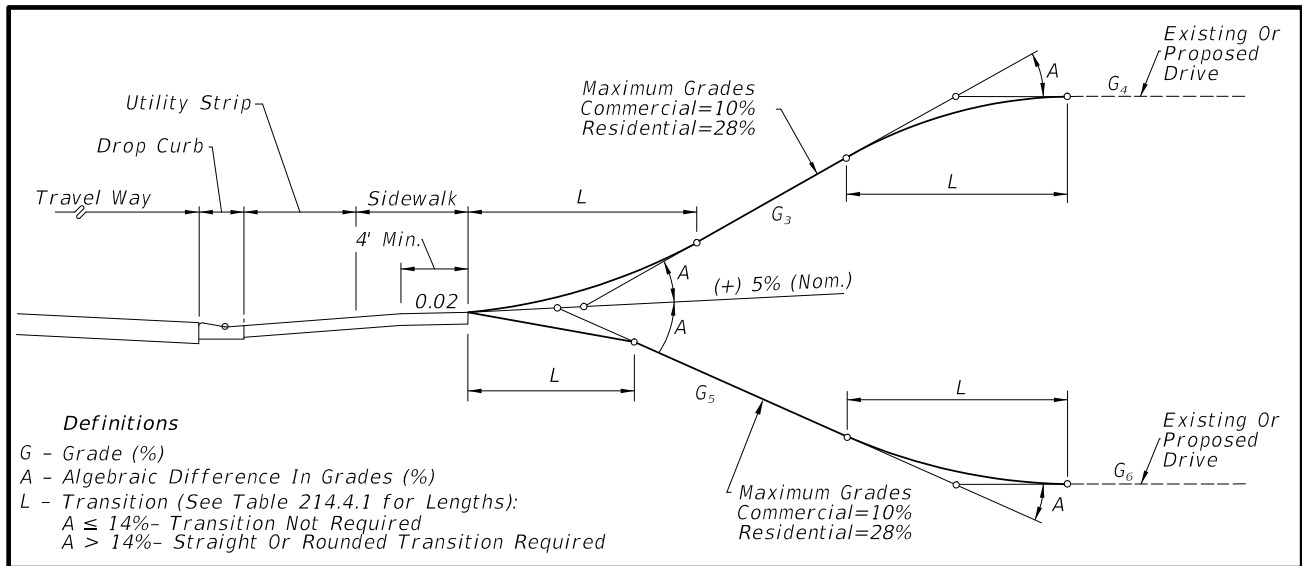

Figure 214.4.2 Curbed Roadway Driveway Profiles



214.4.2 Driveway Profile on Flush Shoulder Roadways

Requirements for driveway profiles connected to flush shoulder roadways are provided in **Figure 214.4.3** and **Table 214.4.1**. Two profile options are included in **Figure 214.4.3**. Option 1 is intended for locations where roadway, driveway taper, and auxiliary lane stormwater runoff volumes are relatively large. Option 2 is intended for locations where the runoff volumes are relatively small or there is no roadside ditch.

Slope or crown the transition (L) nearest the roadway to direct stormwater runoff to the roadside ditch.

Provide driveway profile grades adjacent to superelevated roadways (see G₂ in **Figure 214.4.3**) with the slopes and break-overs shown in **Figure 214.4.4**.

Figure 214.4.3 Flush Shoulder Roadway Driveway Profiles

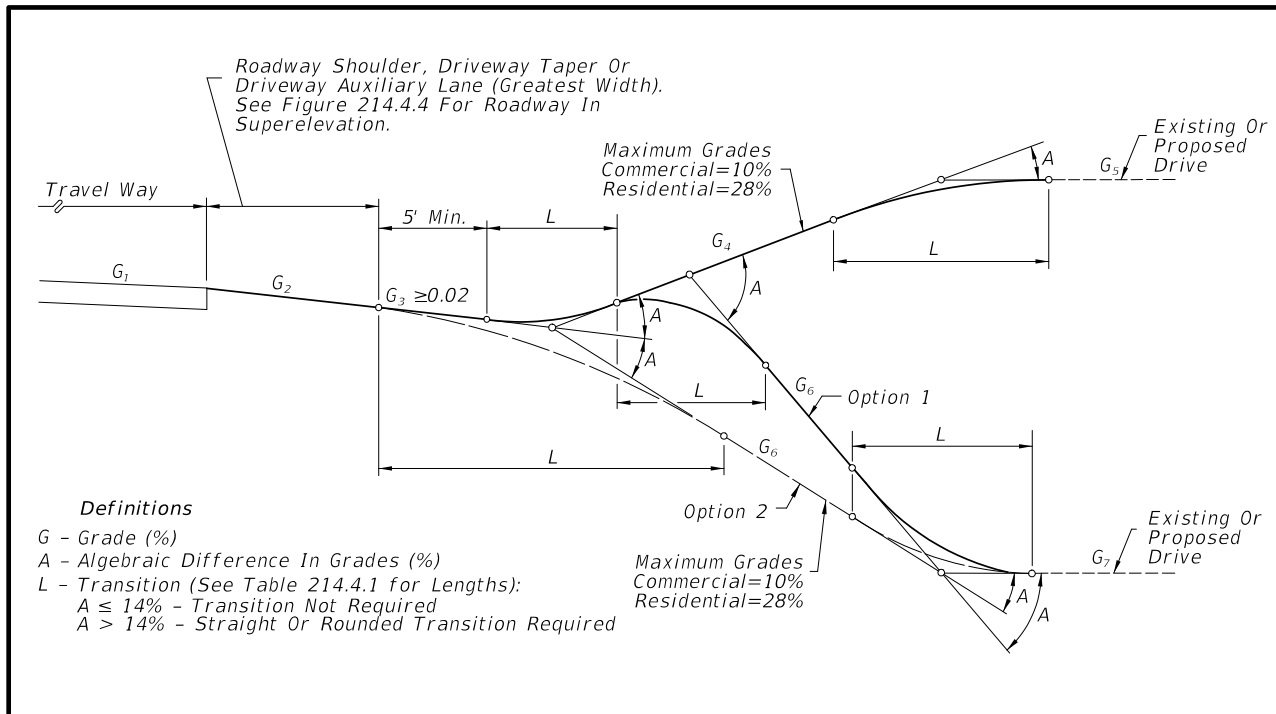

Figure 214.4.4 Driveway Slope for Flush Shoulder Roadway in Superelevation

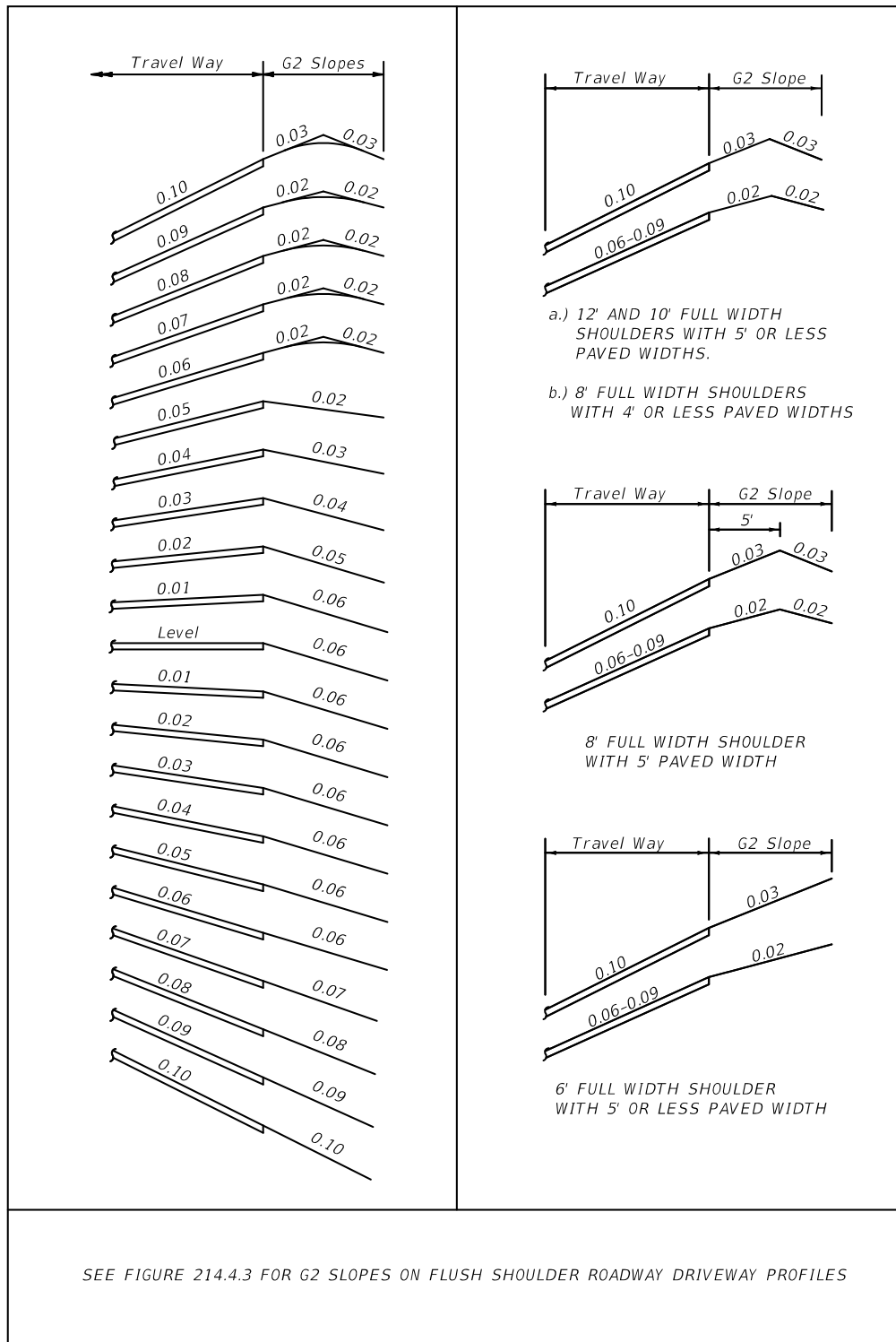

Table 214.4.1 Typical Driveway Profile Transition Lengths

Lengths (L) (Feet)								
A	Crests				Sags			
	Straight		Rounded		Straight		Rounded	
	Desirable	Minimum	Desirable	Minimum	Desirable	Minimum	Desirable	Minimum
6-13%	3	0	5	0	3	0	5	0
14%	3	0	10	0	3	0	10	0
15%	3	2.5	10	3	5	3	10	5
16%	5	3	10	4	6	4	10	6
17%	6	3.5	10	5	8	5	10	7
18%	6	4	10	6	9	6	10	8
19%	7	4.5	10	7	11	7	12	9
20%	8	5	11	8	12	8	13	10
21%	9	5.5	12	9	13	8.5	14	11
22%	10	6	13	10	14	9	16	12
23%	10	6.5	14	10.5	14	9.5	16	12.5
24%	11	7	15	11	15	10	17	13
25%	12	7.5	15	11.5	16	10.5	18	13.5
26%	12	8	16	12	17	11	18	14
27%	13	8.5	17	12.5	17	11.5	19	14.5
28%	14	9	17	13	18	12	20	15
29%	N/A	N/A	22	14	N/A	N/A	21	17
30-31%	N/A	N/A	23	15	N/A	N/A	22	18
32-33%	N/A	N/A	24	16	N/A	N/A	23	20
34-36%	N/A	N/A	26	17	N/A	N/A	25	21
37-38%	N/A	N/A	27	18	N/A	N/A	26	22
39-41%	N/A	N/A	29	19	N/A	N/A	28	24
42-43%	N/A	N/A	30	20	N/A	N/A	29	25
44-46%	N/A	N/A	32	21	N/A	N/A	31	26
47-48%	N/A	N/A	33	22	N/A	N/A	32	27
49-51%	N/A	N/A	34	23	N/A	N/A	34	28
52-54%	N/A	N/A	36	24	N/A	N/A	35	30
55-56%	N/A	N/A	37	25	N/A	N/A	36	31

Notes:

- (1) Rounded: The following types of curvature may be selected: circular, parabolic, or spline.
- (2) Provide the desirable length. When the desirable length cannot be attained, provide the greatest attainable length possible, but not less than the minimum values.

214.5 Right-Turn Lanes

Exclusive right-turn lanes at unsignalized driveways can be used to reduce rear-end collisions, increase capacity, and reduce differentials in speed. Vehicles can wait in a right-turn lane for pedestrians to cross the driveway without impeding the flow of through traffic. Consider right-turn lanes into driveways with high peak hour right-turn volumes on high-speed roadways.

Design right-turn lanes according to **FDM 212.14**.

214.6 Sight Distance at Driveways

Provide intersection sight distance (per **FDM 212.11**) on roadways with design speeds of 40 mph and higher. When intersection sight distance cannot be met on very low speed (design speed \leq 35 mph) roadways, provide the greatest sight distance possible, but not less than minimum stopping sight distance values in **FDM 210.11.1**.

214.7 Pedestrian Accommodations for Driveways

Provide the following at radial or flared return driveways where a pedestrian facility (i.e., sidewalk, shared use path) is required:

- The same width of pedestrian facility across the driveway as the pedestrian facility adjoining the driveway to the greatest extent possible, with a minimum 4-foot-wide crossing for sidewalks and minimum 8-foot-wide crossing for shared use paths.
- Crossings with a maximum cross slope of 2% for flared and unsignalized radial driveways. See **FDM 214.4** and [Standard Plans, Index 522-003](#) for information on the selection of flared driveway applications.

Commentary: Crossing widths of 5 feet or greater will allow a more accessible connection to the pedestrian facility.

Additional requirements for radial driveway crosswalks are in **FDM 222.2.3**. Additional requirements for pedestrian facilities are in **FDM 222** and the [Standard Plans, Indexes 522-001](#) and [522-002](#).

214.8 Permitting

New or modified driveways associated with new or expanded developments must be permitted in accordance with the **Rule 14-96, F.A.C.** Permitted or grandfathered connections modified as part of a Department construction project, and not due to a significant change (as defined in Rule 14-96, F.A.C.), do not require a permit.

The **FDOT Drainage Manual** and **FDOT Drainage Connection Permit Handbook** provides information on National Pollutant Discharge Elimination System (NPDES) requirements.

The [FDOT One Stop Permitting](#) website has additional information and online permit application.

215 Roadside Safety

215.1 General

This Chapter contains roadside safety design criteria for new construction, reconstruction, and Resurfacing, Restoration and Rehabilitation (RRR) projects. New Construction criteria must be met for new and reconstruction projects, and for improvements included with RRR projects.

The design criteria contained in **FDM 210** and **FDM 211** has been developed to minimize the probability that a vehicle will depart the roadway. Design elements that affect roadside safety include horizontal alignment, superelevation, vertical alignment, drainage design, sight distance, lane widths, pavement, pavement markings, cross slopes, median widths, shoulders, and lighting.

The evaluation of Roadside Safety design elements is necessary to address the occasional errant vehicle that does depart the roadway. These design elements include roadside geometries, lateral offsets to potential hazards, and the use of shielding.

The **AASHTO Roadside Design Guide (AASHTO RDG)** provides the foundation for the development of specific criteria contained in this Chapter and the [Standard Plans](#).

215.1.1 RRR Criteria

Criteria for RRR projects provided in this chapter are the minimum values allowed for roadside elements to remain on arterials and collectors without obtaining a Design Exception or Design Variation (see **FDM 122**).

Criteria for RRR projects provided in this chapter may be used for establishing the minimum requirements for adding auxiliary lanes, keyhole lanes, or providing minor intersection improvements with the understanding that when existing right of way (R/W) is adequate, new construction criteria will be used.

Do not apply RRR criteria in this chapter to resurfacing projects on Limited Access (LA) Facilities.

215.2 Roadside Features

215.2.1 Roadside Geometry

Roadside geometry refers to the terrain features (slopes) that a vehicle will encounter when departing a roadway. The components of roadside geometry include front slopes, back slopes, and transverse slopes.

215.2.2 Roadside Slope Classification

Roadside Slopes include areas located beyond the edge of the traffic lane as shown in **Figures 215.2.2** and **215.2.3**. These areas are divided into the following classifications:

- (1) Traversable Slope – Smooth terrain, unobstructed by fixed objects:
 - (a) Recoverable Traversable Slope, 1:4 or flatter
 - (b) Non-Recoverable Traversable Slope, 1:3 or flatter and steeper than 1:4
- (2) Non-Traversable Slope – Rough terrain, obstructed, or slopes steeper than 1:3

215.2.3 Clear Zone Concept

The following provides the definition of the Clear Zone Concept using the slope classifications above. These slope classifications are considered the standard for effective roadside safety design in the **AASHTO RDG**. However, in some cases the Department's roadside slope requirements supersede these values. For Roadside Slope Criteria, see **FDM 215.2.6**.

Providing a sufficient amount of Recoverable Slope adjacent to the roadway provides an opportunity for an errant vehicle to safely recover. The amount of recoverable area provided beyond the traveled way is defined as the clear zone and includes shoulders and bike lanes. The clear zone must be free of roadside hazards, as defined in **FDM 215.3**.

Traversable Back Slopes 1:3 or flatter may be located within the clear zone.

A clear zone width must be provided so that the sum of all Recoverable Slopes is equal to or greater than the required clear zone width obtained from **Table 215.2.1**. Clear zone widths may be widened based on crash history and horizontal curvature; see **AASHTO RDG, Section 3.1**. Clear zone concepts are illustrated in **Figure 215.2.1** and **Figure 215.2.2**.

Figure 215.2.1 Clear Zone Plan View

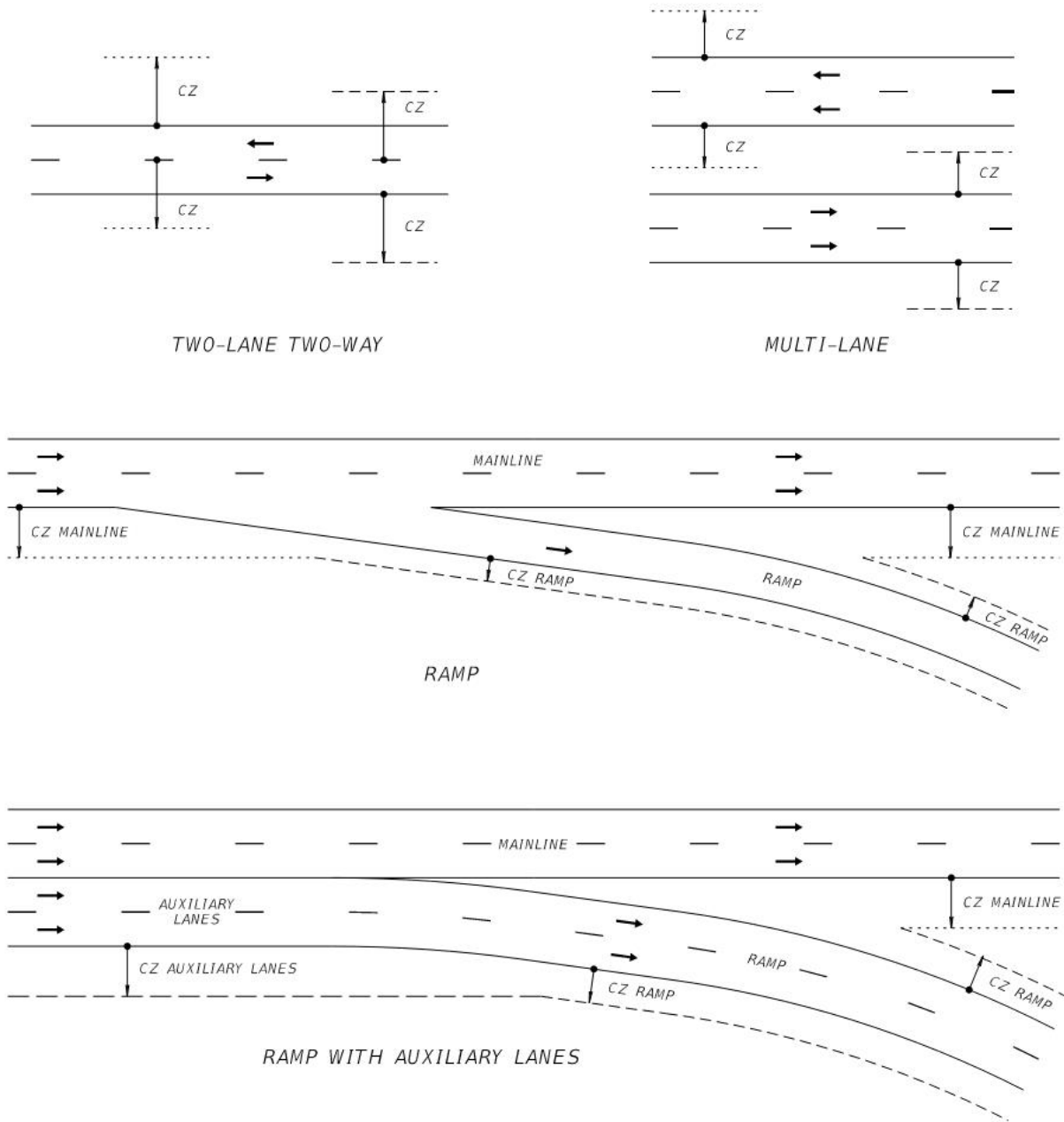
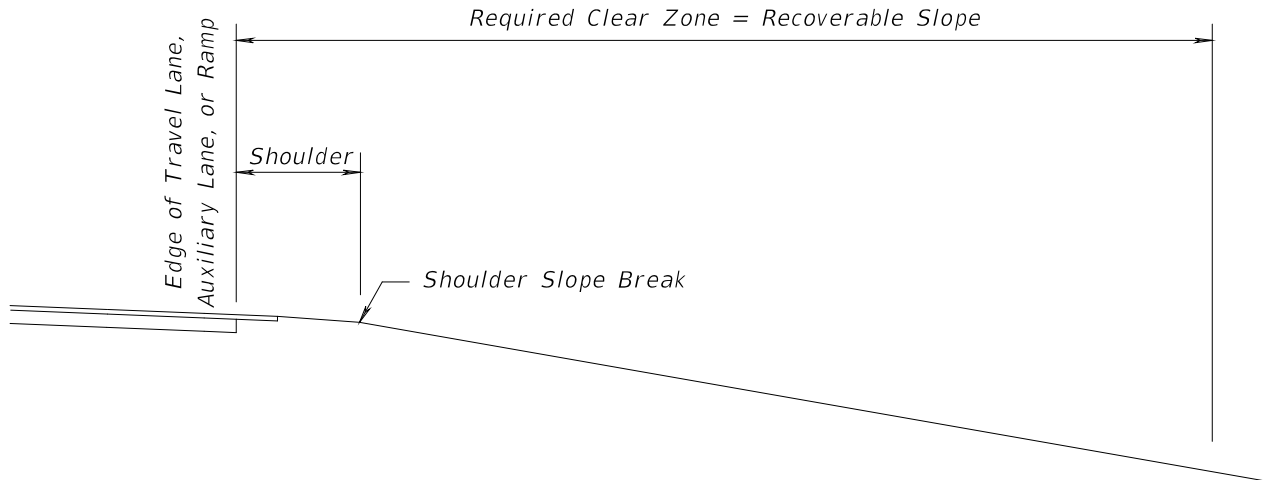

Figure 215.2.2 Clear Zone Concept



When a Traversable Non-Recoverable Slope is present within the clear zone, extend the clear zone width until the amount of Recoverable Slope equals the required clear zone width obtained from **Table 215.2.1**. The additional width provided beyond the Traversable Non-Recoverable Slope is known as the Clear Run-out Area and is illustrated in **Figure 215.2.3**. Provide a 10-foot minimum width for the Clear Run-out Area where R/W allows.

Figure 215.2.3 Adjusted Clear Zone Concept

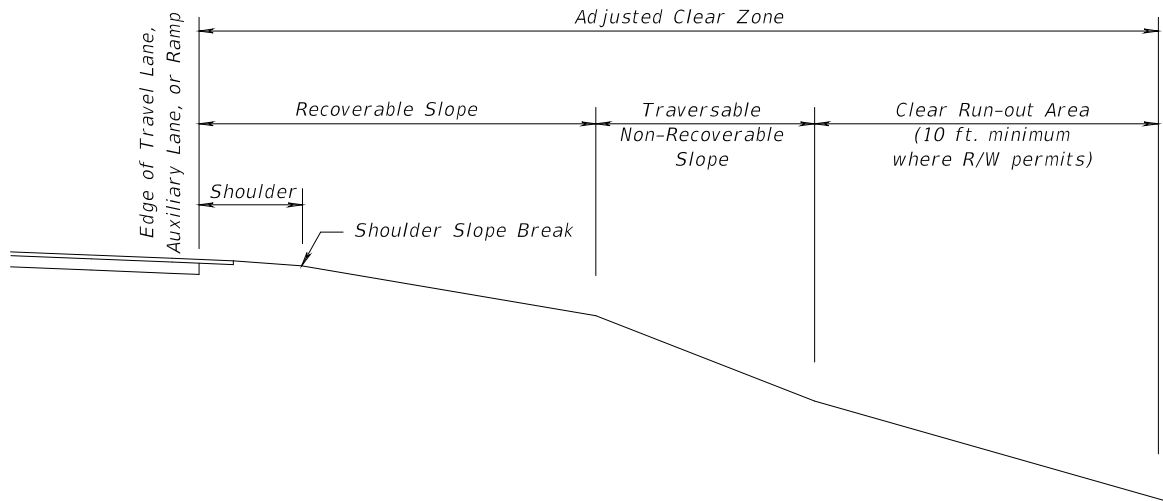

Table 215.2.1 Clear Zone Width Requirements

	Design Speed (mph)						
	≤ 30	35	40	45	50	55	≥ 60
Clear Zone Width for New Construction							
Travel Lanes & Multilane Ramps	12 feet	14 feet	18 feet	24 feet	24 feet	30 feet	36 feet
Auxiliary Lanes & Single Lane Ramps	10 feet	10 feet	10 feet	14 feet	14 feet	18 feet	24 feet
Clear Zone Width for RRR Projects							
Travel Lanes & Multilane Ramps	6 feet	6 feet	6 feet	14 feet	18 feet	18 feet	18 feet
Auxiliary Lanes & Single Lane Ramps	6 feet	6 feet	6 feet	8 feet	8 feet	8 feet	8 feet

Clear zone widths for work zones are provided in [Standard Plans, Index 102-600](#).

215.2.4 Lateral Offset

Lateral offset is the distance from a specified point on the roadway to a roadside hazard. Lateral offset to the roadside hazard is measured as follows:

- Curbed roadways: from face of curb.
- Flush shoulder and high-speed curbed roadways: from outside edge of traveled way.

Lateral offsets apply to all roadways and are determined based on the following:

- Type of facility (i.e., flush shoulder or curbed roadway)
- Design speed
- Design Element
- Project Type (i.e., New Construction, RRR)

Flush shoulder roadways typically have sufficient R/W, to provide the required clear zone widths. Therefore, minimum lateral offset for these roadways is based on maintaining a clear roadside for errant vehicles to recover (i.e., maintaining clear zone width provided in **Table 215.2.1**).

Lateral offsets for curbed roadways should be based on clear zone criteria; however, curbed roadways typically do not have sufficient R/W to provide the required clear zone widths. Therefore, minimum lateral offset on these roadways is based on offset needed for normal operation of the roadway.

At times, it may be necessary to place poles (e.g., signal, light, sign) within the sidewalk. Refer to **FDM 222.2** for minimum unobstructed sidewalk width requirements.

Table 215.2.2 provides minimum lateral offset criteria for roadside features and roadside hazards typically encountered and considered functionally necessary for normal operation of the roadway (e.g., signing, lighting, utilities). For crashworthy objects, meet or exceed the minimum lateral offset criteria provided in **Table 215.2.2**. Locate objects that are not crashworthy as close to the R/W line as practical and no closer than the minimum lateral offset criteria provided.

When a roadside hazard is placed behind a barrier that is justified for other reasons, the minimum lateral offset to the object equals the setback requirements (deflection distance) of the barrier, see **FDM 215.4.6**. Refer to **FDM 215.5** for permissible attachments to barriers.

When determining minimum lateral offset for bridge piers and abutments, coordinate with vertical clearance requirements found in **FDM 210.10.3**. When shielding is used, refer to setbacks to barriers in **FDM 215.4.6** and **FDM 210.10.3**.

Table 215.2.2 Minimum Lateral Offset Criteria

Design Element		Curbed Roadways				High Speed Curbed and Flush Shoulder Roadway
		New Construction		RRR		
		Design Speed				
		25-35 mph	40-45 mph	25-35 mph	40-45 mph	
Light Poles	Conventional	Do not locate in Medians, except in conjunction with barriers that are justified for other reasons. See FDM 215.2.9 .				
		1.5 feet	4.0 feet	1.5 feet	1.5 feet	20 feet from Travel Lane, 14 feet from Auxiliary Lane, or Clear Zone width, whichever is less
	High Mast	Outside Clear Zone				
Signal Poles and Controller Cabinets		Do not locate in Medians, except for PHB in accordance with FDM 215.2.9 .				
		1.5 feet	4.0 feet	1.5 feet	1.5 feet	Outside Clear Zone
Traffic Infraction Detectors		For placement and installation specifications, refer to the State Traffic Engineering and Operations Office web page: http://www.fdot.gov/traffic/				
ITS Poles and Related Items	Pole & Other Aboveground Fixed Objects	Do not locate in Medians, except in conjunction with barriers that are justified for other reasons. See FDM 215.2.9 .				
		1.5 feet	4.0 feet	1.5 feet	4.0 feet	Outside Clear Zone
	Equipment Shelters and Towers	Do not locate within the limited access right of way,				
	Breakaway Objects	1.5 feet	4.0 feet	1.5 feet	4.0 feet	As Close to R/W As Possible
Traffic Control Signs	Single and Multi-Column	Locate in accordance with Standard Plans .				
	Overhead Sign Structures (Includes DMS)	Outside Clear Zone				
Trees	Where the diameter is or is expected to be > 4 inches measured 6 inches above the ground	1.5 feet	4.0 feet	1.5 feet	1.5 feet	Outside Clear Zone
		RRR Projects: (1) Meet New Construction criteria for new plantings.				

Table 215.2.2 Minimum Lateral Offset Criteria (cont.)

Design Element		Curbed Roadways				High Speed Curbed and Flush Shoulder Roadway
		New Construction		RRR		
		Design Speed				
		25-35 mph	40-45 mph	25-35 mph	40-45 mph	
Aboveground Utilities (See <i>FDM 215.2.8</i>)	Existing Utilities	1.5 feet	4.0 feet	1.5 feet	4.0 feet	Outside Clear Zone
	New or Relocated Utilities	4.0 feet				Outside Clear Zone
	RRR Projects: Existing aboveground utilities are not required to be relocated unless one of the following applies: <ul style="list-style-type: none"> The edge of traveled way is being moved closer to the aboveground utility; e.g., addition of an auxiliary lane, or They have been hit 3 times in 5 years. 					
Railroad Grade Crossing Traffic Control Device		Locate in accordance with Standard Plans, Index 509-100 and Index 509-070				
Roadways Overpassing Railroads		For Horizontal Clearances where roadways overpass railroads refer to <i>FDM 220</i> .				
Canal and Drop-off Hazards		See <i>FDM 215.3</i>				
Bridge Piers and Abutments (See <i>FDM 215.4.5.4</i> for Pier Protection criteria and <i>Figures 260.6.3 & 260.6.4</i>)		The greater of the following: <ul style="list-style-type: none"> <u>Inside or Outside Travel Lane:</u> 16 feet from Edge of Travel Lane <u>Outside Auxiliary Lane:</u> 4 feet from Face of Curb <u>Inside Auxiliary Lane (Median):</u> 6 feet from Edge of Auxiliary Lane 			Outside Clear Zone	
Drainage Structures (e.g., wingwalls, endwalls, flared end sections)		RRR Projects: 1.5 feet 4.0 feet				
Mailboxes		Refer to the FDOT Drainage Manual				
Bus Benches and Transit Shelters		Locate in accordance with Standard Plans, Index 110-200				
Pedestrian Railing		Locate in accordance with <i>Rule Chapter 14-20.003, Florida Administrative Code (F.A.C.)</i> . Transit bus benches must be located in accordance with <i>Rule Chapter 14-20.0032, F.A.C.</i>			4.0 feet	Outside Clear Zone
Bicycle/Micromobility Parking		See <i>FDM 223.5</i>				

215.2.5 Control Zones for RRR Projects

Control Zones apply only to RRR projects and do not include aboveground utilities.

Control Zones are high-risk areas where roadway departures occur with greater frequency resulting in increased risk of impact with roadside hazards. To address this condition, lateral offset and clear zone width requirements in Control Zones are to be based on New Construction criteria. A Control Zone violation is when RRR lateral offset requirements are met, but New Construction criteria is not. Process a Design Variation for Control Zone violations.

Control Zones include the following locations:

- (1) A location where an aboveground object has been hit 3 times or more in the last 5 years.
- (2) Intersection Radii – Within the New Construction lateral offset of the return radii of an intersecting street from begin point of tangent (PT) to end point of tangent (PT), see **Figure 215.2.4**.

Figure 215.2.4 Intersection Radii

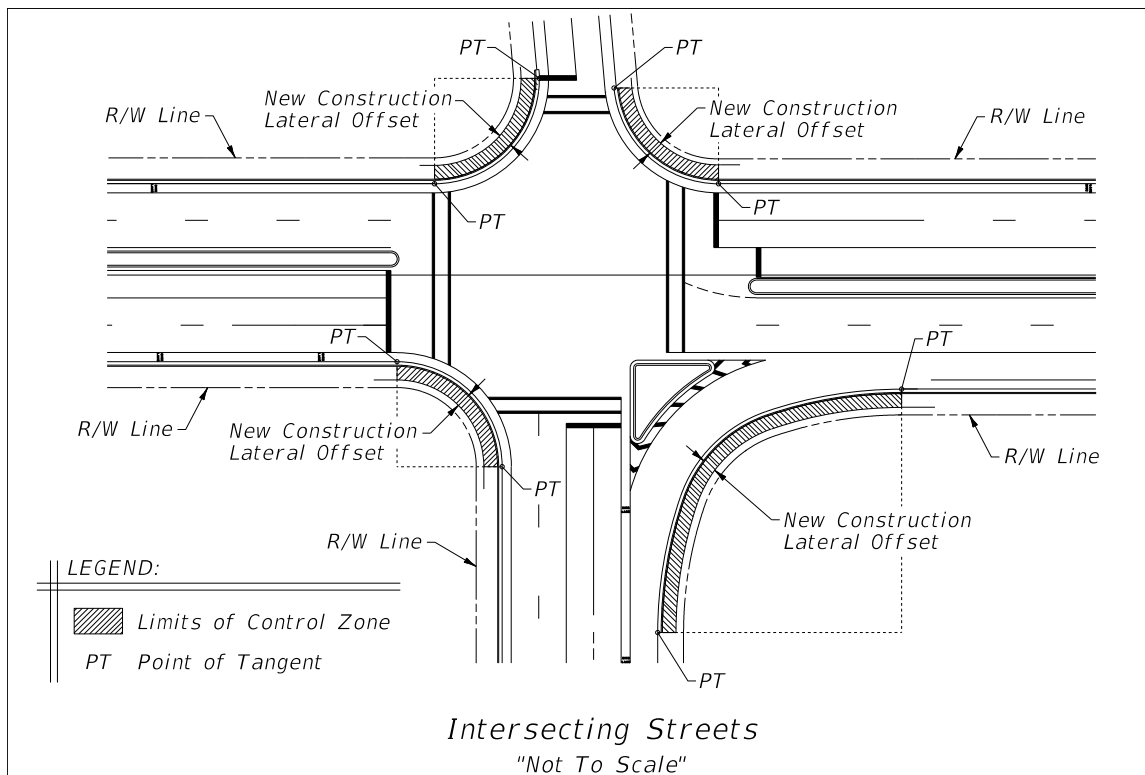

- (3) 'T' Intersection – On the non-intersection side of 'T' intersections within the area directly across and between each radii return point of tangent (PT) extended to the New Construction lateral offset, see **Figure 215.2.5**.

Figure 215.2.5 'T' Intersection

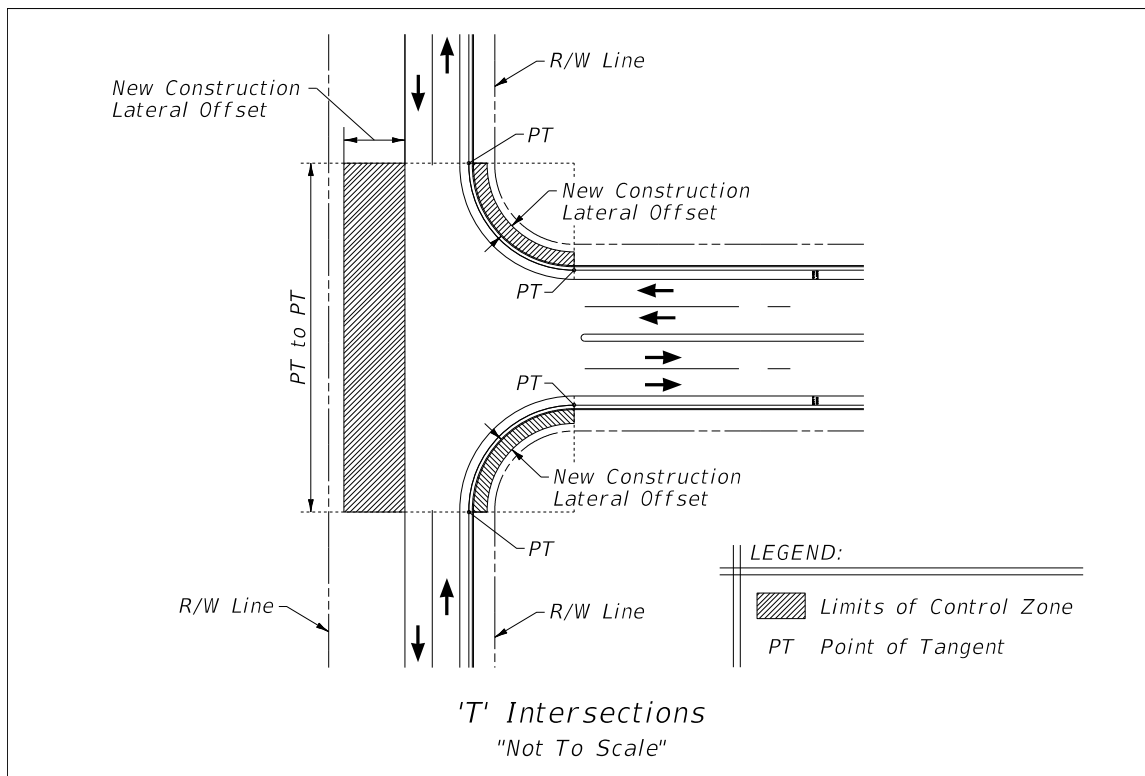

- (4) Right Turn Deceleration – Within the New Construction lateral offset for a length of 100 feet measured downstream from the beginning of the full width lane, see Figure 215.2.6 for right turn deceleration lane on a tangent. For right turn deceleration lane constructed with a reverse curve the beginning of the Control Zone starts at the point of intersection (PI), see **Figure 215.2.7**.
- (5) Merge Section – Within the New Construction lateral offset for a length of 100 feet measured downstream from the beginning of the taper of a skewed merge section. See Figure 215.2.8 for merge section constructed on a tangent. For merge section constructed with a reverse curve the beginning of the Control Zone starts at the point of intersection (PI), see **Figure 215.2.9**.
- (6) Service Facility (i.e., alley way or easement) Driveway – For a distance of 3 feet from a driveway flare within the new construction lateral offset distance at the intersection of a dedicated intersecting service facility, see **Figure 215.2.10**.

Figure 215.2.6 Right Turn Deceleration with Tangent

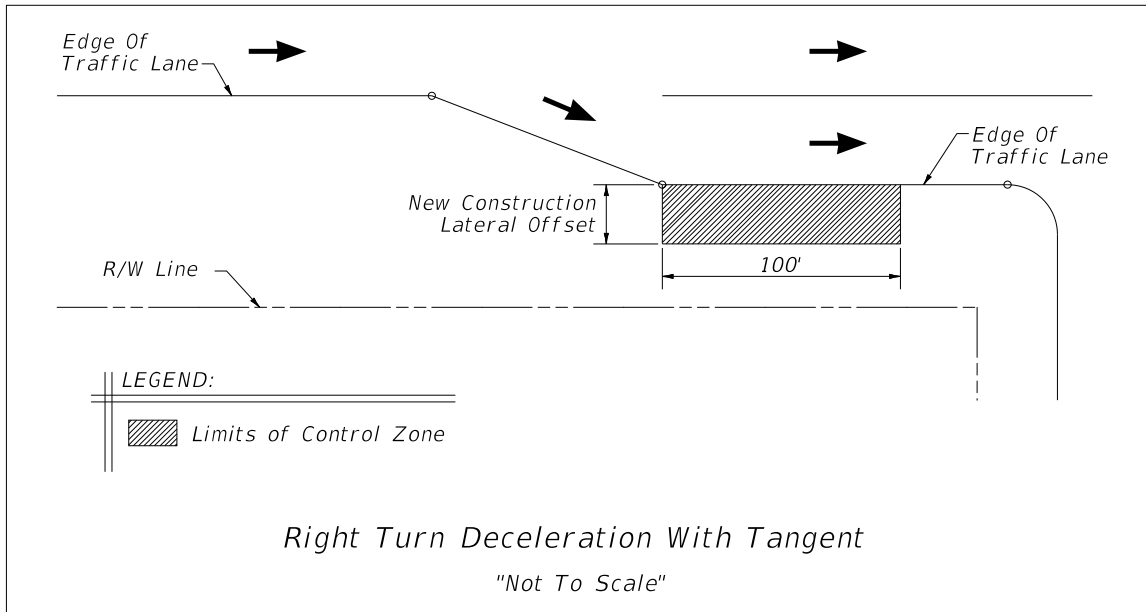

Figure 215.2.7 Right Turn Deceleration with Reverse Curve

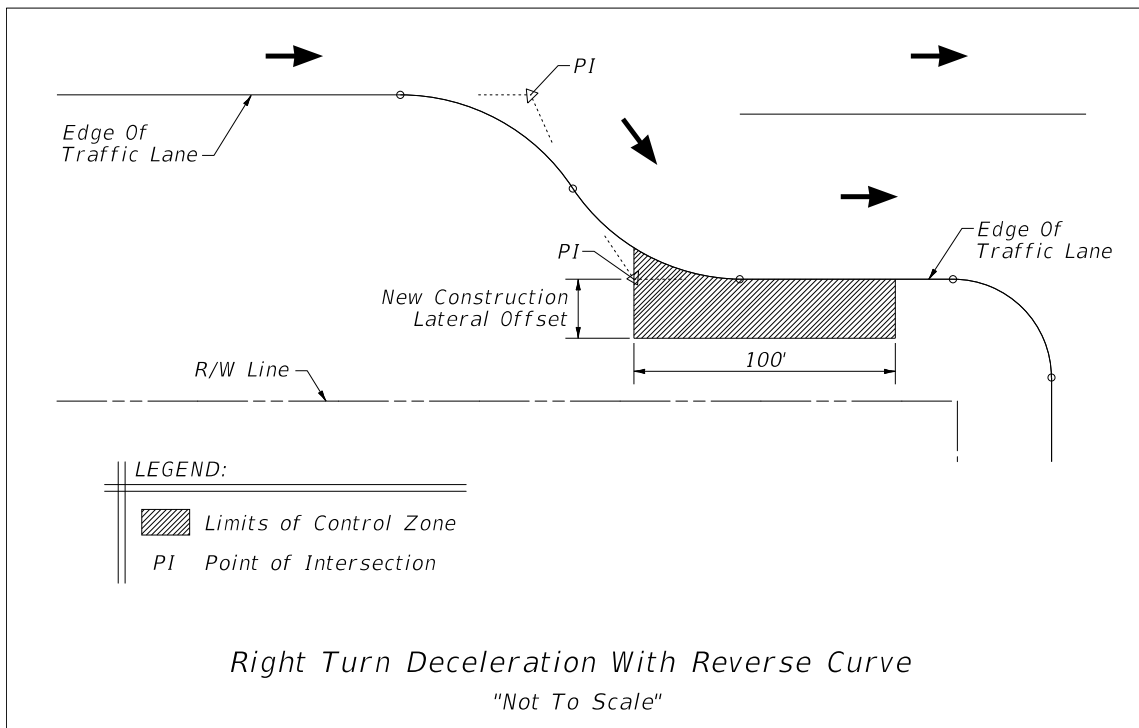

Figure 215.2.8 Merge Section with Tangent

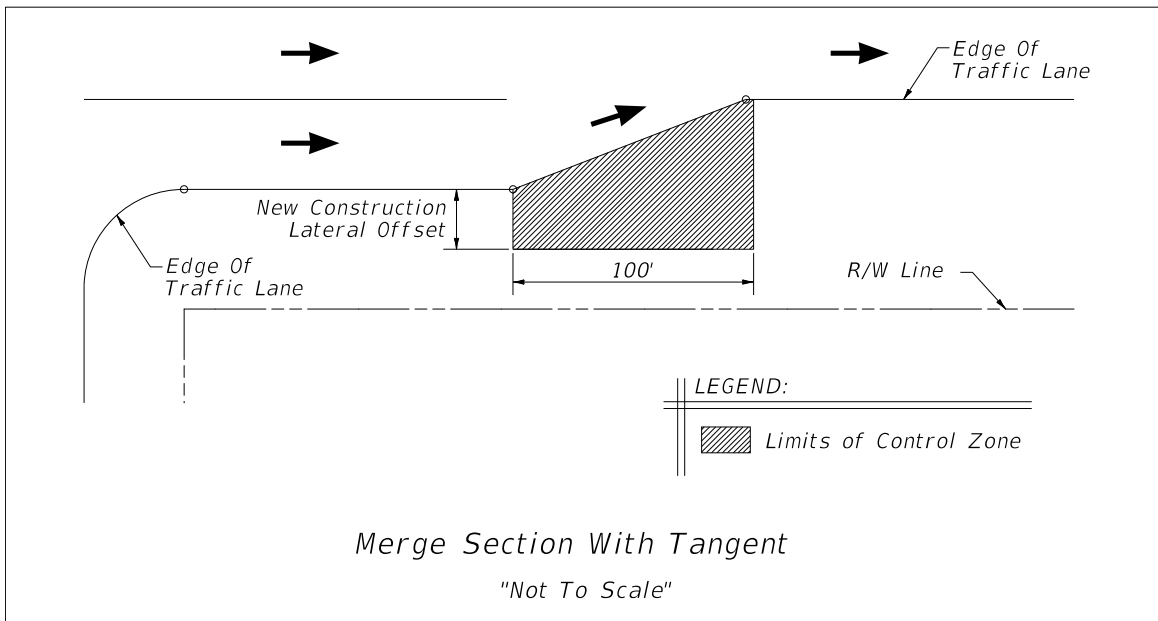

Figure 215.2.9 Merge Section with Reverse Curve

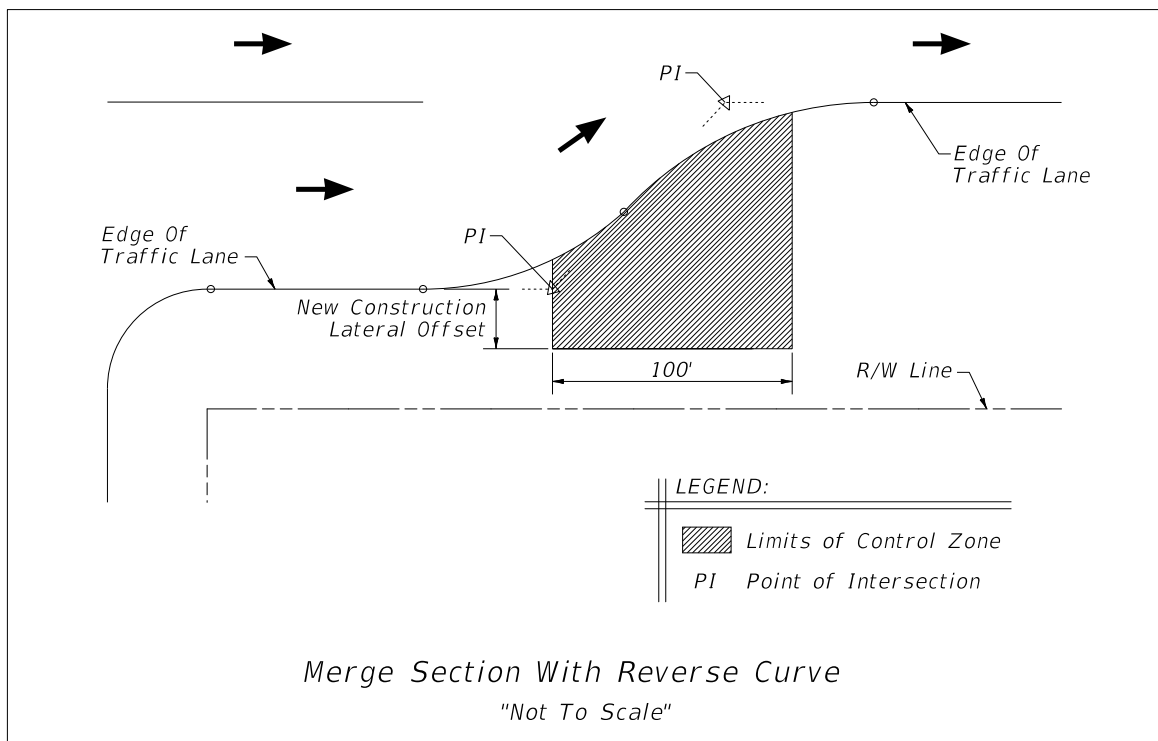
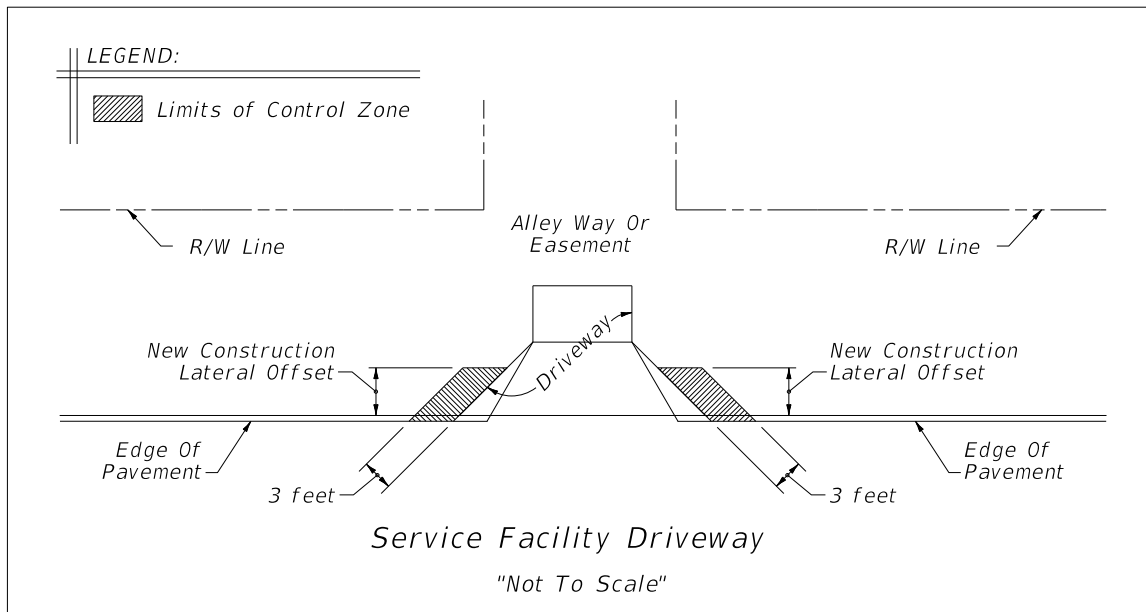
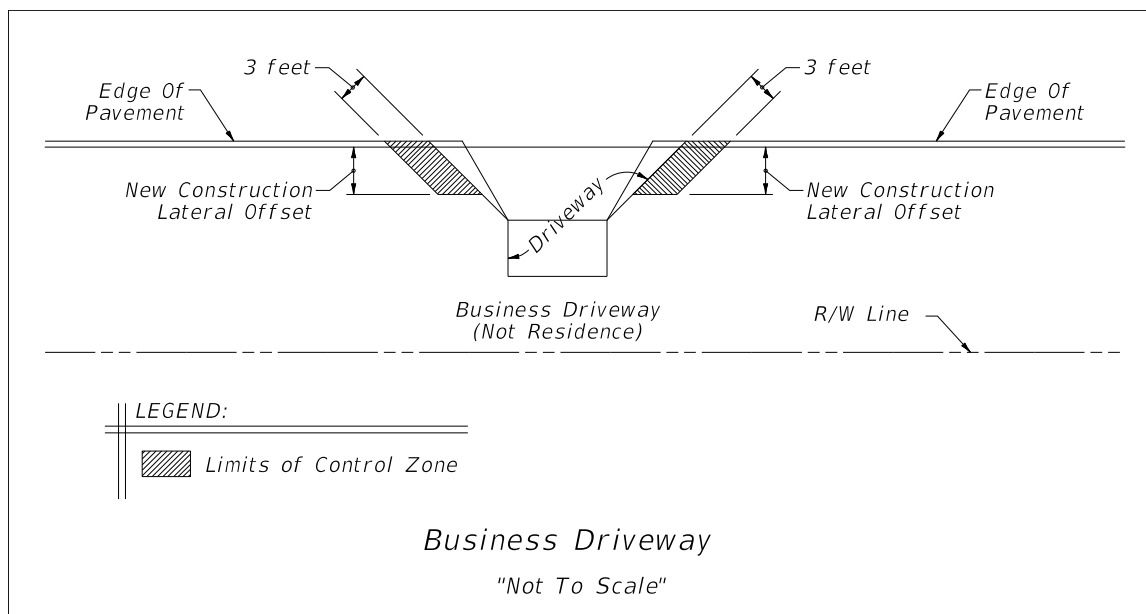

Figure 215.2.10 Service Facility Driveway



- (7) Business (i.e., non-residential) Driveway – For a distance of 3 feet from a driveway flare within the new construction lateral offset distance at the entrance turnout for use other than a private residence, see **Figure 215.2.11**.

Figure 215.2.11 Business Driveway



- (8) Horizontal Curves – Within the New Construction lateral offset in the outside area of a curve when the posted speed is greater than 35 mph and the curve radius is 3000 feet or less, see **Figure 215.2.12**.

Figure 215.2.12 Horizontal Curve

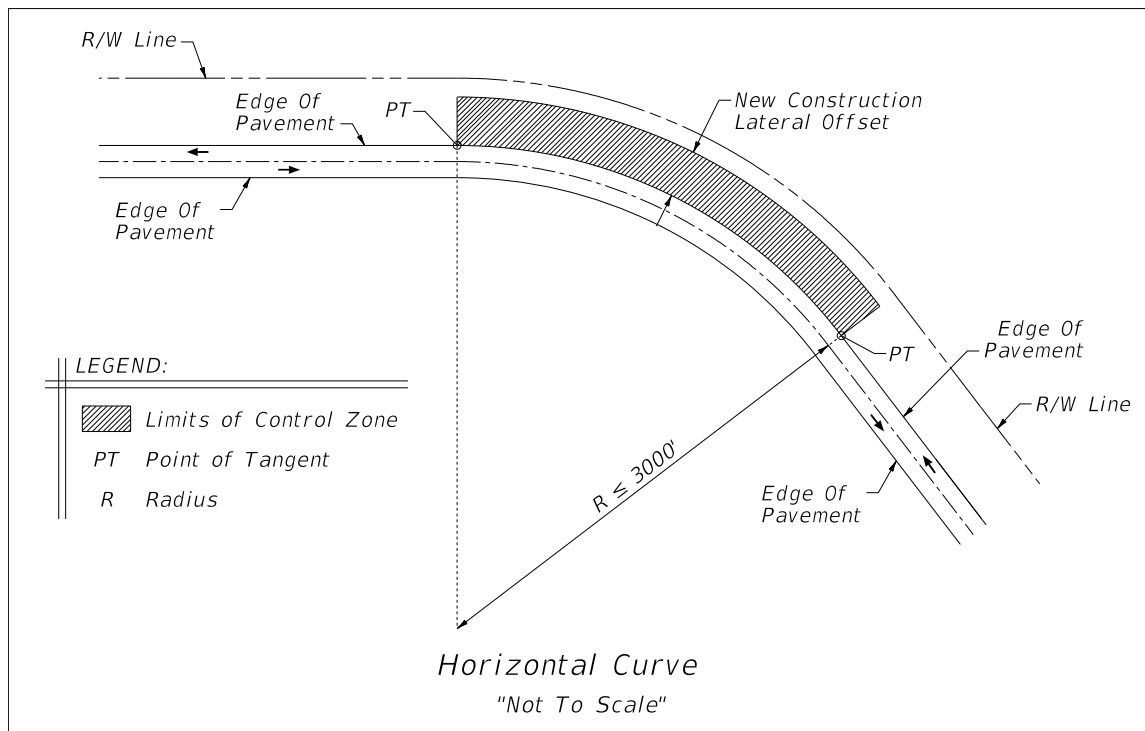

- (9) Roadway Deflection without Curves – Within the New Construction lateral offset of roadway alignments with a deflection (kink) of more than 5 degrees for a distance of 100 feet from the point of intersection of the deflection, see **Figure 215.2.13**.

Figure 215.2.13 Roadway Deflection without Curve

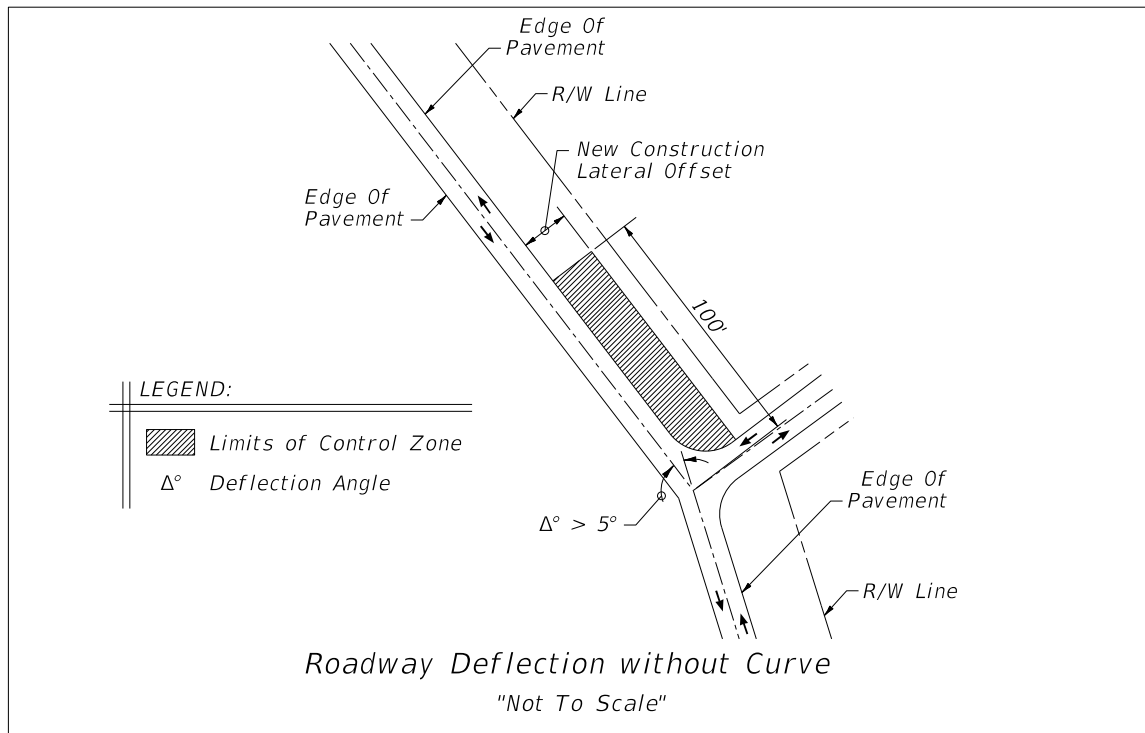

215.2.6 Roadside Slope Criteria

Roadside slopes consist of front slopes, back slopes, and transverse slopes. Roadside slope criteria is provided in **Table 215.2.3**. See **FDM 210.6** for additional roadside slope information. See **FDM 262.1** for additional retaining wall maintenance information.

For sod or turf slopes steeper than 1:3:

- Consider the associated long term erosion control and maintenance costs.
- Slopes higher than 20 feet, provide a 10-foot-wide maintenance berm (1:10 or flatter) at the top and toe.
- Slopes higher than 35 feet, provide a 10-foot-wide maintenance berm (1:10 or flatter) at the top and toe. Include intermediate berm(s) so that the spacing between berms does not exceed 35 feet. Coordinate with the District Drainage, Maintenance, and Landscape Architect's Offices.

For slopes steeper than 1:2 obtain concurrence from the District Geotech Engineer and District Maintenance Engineer.

Table 215.2.3 Roadside Slope Criteria

Type of Slope	Flush Shoulder and High Speed Curbed		Curbed	
	Height of Fill (feet)	Rate	Height of Fill (feet)	Rate
Front Slope	0 – 5	1:6	0-6	1:2 or to suit property owner, not flatter than 1:6.
	5 – 10	1:6 to edge of Clear Zone, then 1:4	> 6	1:3 or to suit property owner, not flatter than 1:6.
	10 – 20	1:6 to edge of Clear Zone, then 1:3		
	> 20	1:2 with guardrail		
Back Slope	All	1:4 or 1:3 with a standard width trapezoidal ditch and 1:6 front slope	All	1:2 or to suit property owner. Not flatter than 1:6.
Transverse Slope	All	1:10 or flatter (freeway & Interstate) 1:4 (others)	All	1:4
Notes:				
(1) Height of fill is the vertical distance from the edge of the outside travel lane to the toe of front slope.				

215.2.6.1 RRR Evaluation of Existing Roadside Slope

Existing roadside slope, and new slopes included with a RRR project, must meet the criteria provided in **Table 215.2.3**, except for the following:

- (1) Front Slopes:
 - (a) For constrained conditions, new slopes at 1:4 may be constructed within the clear zone. New slopes steeper than 1:4 require a Design Variation.
 - (b) Existing 1:3 or flatter slopes within the clear zone may remain.
 - (c) Flattening slopes of 1:3 or steeper at locations where run-off-the-road type crashes are likely to occur (e.g., on the outsides of horizontal curves) should be evaluated.
 - (d) Existing front slopes steeper than 1:3 within the clear zone should be evaluated for shielding.

- (2) Back Slopes:
- (a) For constrained conditions, new slopes at 1:3 may be constructed within the clear zone. New slopes steeper than 1:3 require a Design Variation.
 - (b) Existing 1:2 or flatter slopes may remain.
 - (c) Existing back slopes steeper than 1:3 within the clear zone should be evaluated for shielding.

RRR lateral offset and clear zone requirements must be met when the above criteria are applied.

Modification for Non-Conventional Projects:

Delete **FDM 215.2.6.1** and see RFP for requirements.

215.2.7 Drainage Features

Drainage features in close proximity to travel lanes are often necessary. These features include ditches, curbs, and drainage structures (e.g., transverse/parallel pipes, culverts, endwalls, wingwalls, and inlets). Evaluate the placement of these features as part of roadside safety design. Refer to the [Drainage Manual](#) for information regarding hydraulic design.

Consider the future maintenance of the facility when evaluating the design of roadside topography and drainage features. Routine maintenance or repairs necessary for the continued function of the drainage feature may lead to long-term expenses and disruption to traffic flow.

215.2.7.1 Roadside Ditches

Acceptable cross section slope criteria for roadside ditches within the clear zone is provided in **Figures 215.2.14** and **215.2.15**. These roadside ditch configurations are considered traversable, as described in the **AASHTO RDG**. Adjusted clear zone widths may be required for Non-Recoverable Slopes located within the clear zone (i.e., slopes steeper than 1:4 but flatter than 1:3, see **FDM 215.2.3**). The application of the ditch cross section slopes must be coordinated with Roadside Slope Criteria included in **FDM 215.2.6**.

The [Drainage Manual](#), **Chapter 2** requires a minimum ditch bottom width of 5 feet to accommodate mitered end sections and maintenance mowers. Refer to the [Drainage](#)

Manual for V-bottom ditch limitations. When a ditch bottom width of less than 5 feet is approved by the District Drainage Engineer the slope criteria provided in **Figures 215.2.14** and **215.2.15** may be used.

Figure 215.2.14 Roadside Ditches – Bottom Width 0 to < 4 feet

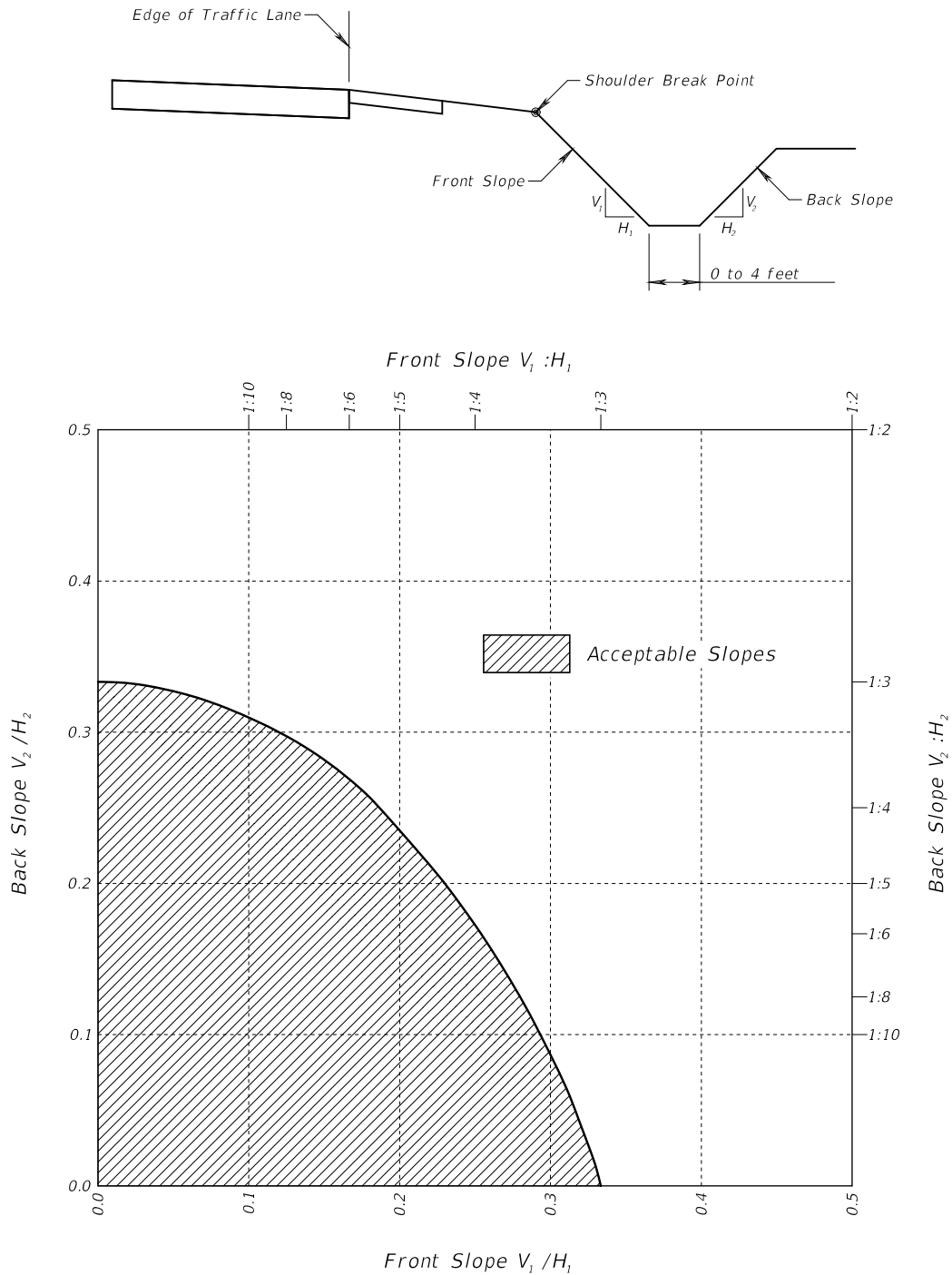

Ref: Figure 3-6, 2011 AASHTO Roadside Design Guide, 4th Edition

Figure 215.2.15 Roadside Ditches – Bottom Width \geq 4 feet

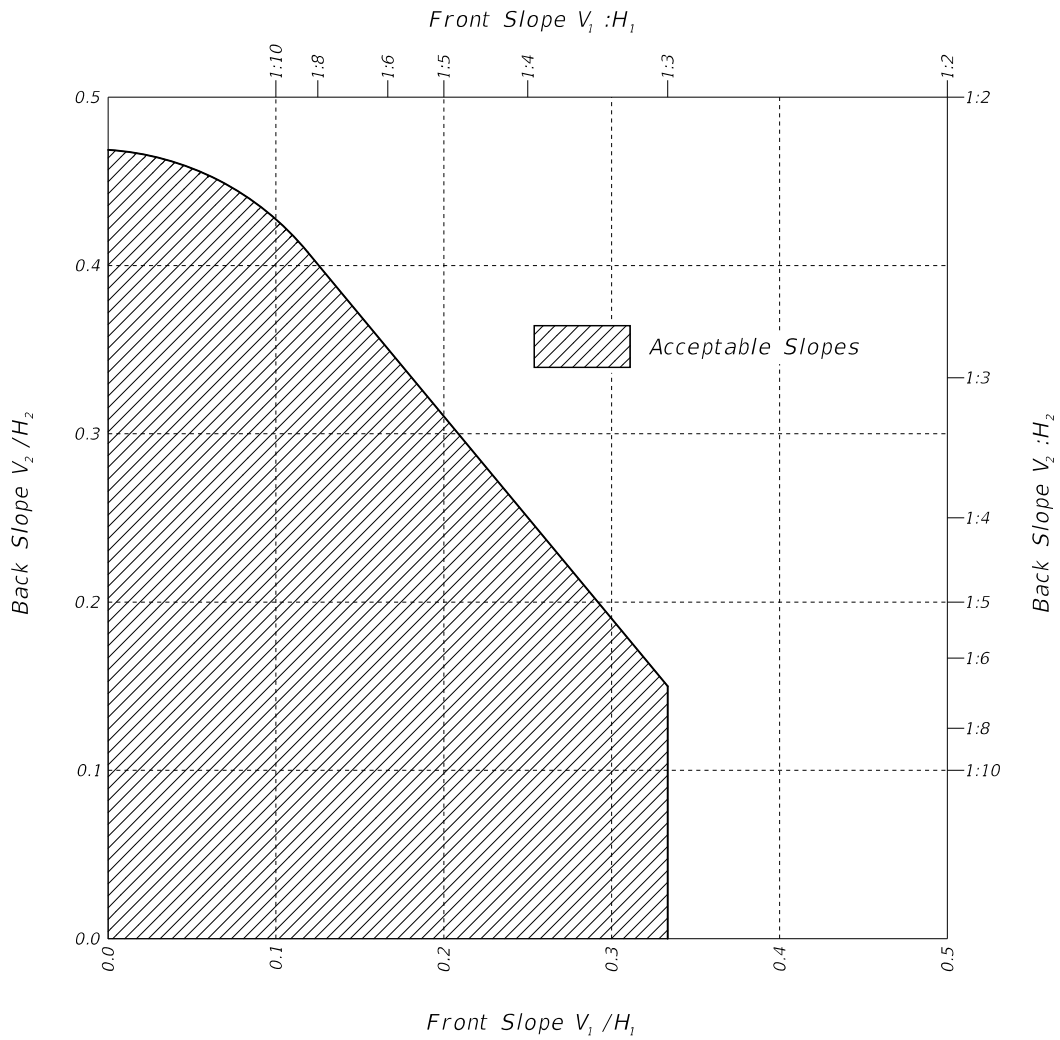
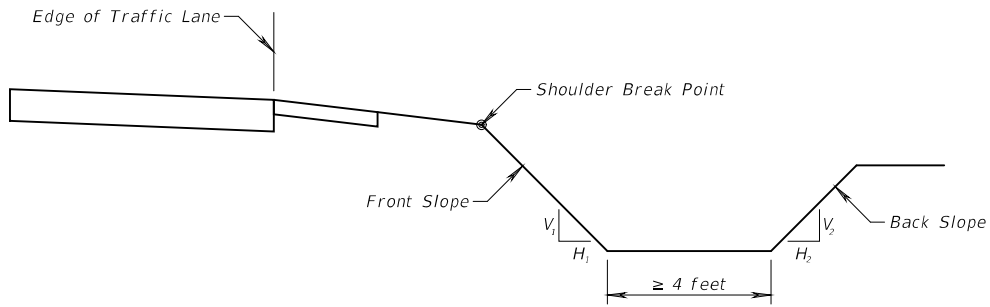

Ref: Figure 3-6, 2011 AASHTO Roadside Design Guide, 4th Edition

215.2.7.2 Curbs, Medians, and Islands

See **FDM 210.5** for information concerning curbed roadways.

Curb has no redirection capability; therefore, do not use curb to mitigate clear zone violations. The addition of curb for the sole purpose of achieving Lateral Offset Criteria is prohibited.

Refer to the **FDM 210.3** and [Standard Plans, Index 520-020](#) (Traffic Separators) for additional information concerning medians and islands.

A bridge mounted traffic separator is to match geometrically with adjacent roadway traffic separator or the face of curb. Design separators in accordance with the [Structures Design Guidelines](#), and [Standard Plans, Index 520-020](#).

Shoulder Gutter is frequently used along roadway fill sections and bridge approaches to prevent excessive runoff down embankment slopes. Refer to the **FDM 210.4** and **211.4** for Shoulder Gutter requirements.

215.2.7.3 Drainage Structures

Drainage structures located along the roadside must provide a traversable design or be located outside the required clear zone. Drainage designs typically contain curb inlets, ditch bottom inlets, endwalls, wingwalls, headwalls, flared end sections or mitered end sections. If not adequately designed or properly located, these features may create hazardous conditions for vehicles. For detailed background information concerning traversable designs, refer to the **AASHTO RDG**.

Details for drainage structures and end treatments are provided in [Standard Plans Index 425 and 430 Series](#). These drainage features have the potential for conflict with a vehicle either departing the roadway or within a commonly traversed section of a roadway. Refer to the [Drainage Manual](#) for standard drainage structures which are permitted within the clear zone.

215.2.7.4 RRR Evaluation of Existing Drainage Features

Evaluate existing drainage structures and end treatments located within the clear zone to determine if they present a hazardous condition and if modification or relocation is necessary. Based on a review of the crash history, modify, or relocate any drainage structures impacted three times in five years.

New drainage features included with a RRR projects must provide a traversable design or be located outside the required clear zone.

215.2.8 Aboveground Utilities

Utility Agency/Owners (UAOs) are cities, counties, utility companies, homeowner associations, private citizens, or businesses organized under the laws of Florida with permission and/or rights to have their aboveground utilities within the Department's R/W. Where aboveground utilities are more than 4 inches above the grade and are not accepted by FDOT as crashworthy they are considered roadside hazards. The below criteria are designed to minimize conflicts between roadside safety requirements and the privilege and rights the UAOs may have. Consult with the District Utilities Office to determine any limitations to the Department's authority to affect the below requirements.

New and existing aboveground utilities are to meet the following requirements:

- (1) Not within the median,
- (2) Outside the new construction lateral offsets in **Table 215.2.2**, and
- (3) As close to the R/W as practical. Aboveground utilities are considered to be as close to the right of way as practical when the location does not cause the utility to do any of the following:
 - (a) encroach onto private property
 - (b) violate National Electrical Safety Codes
 - (c) violate State or Federal codes/regulations
 - (d) conflict with other existing overhead or underground facilities
 - (e) require encroachments onto private property to trim trees
 - (f) requires the utility to remove trees
 - (g) takes individual poles out of alignment with existing pole lines

When the requirements above cannot be met, aboveground utilities may be placed behind Department-approved barriers, allowing for barrier deflection.

215.2.9 Signing, Lighting, Traffic Signals, Intelligent Transportation Systems (ITS), and Other Similar Roadside Features

Locate devices in accordance with the minimum lateral offset criteria provided in **Table 215.2.2** and the following:

- Signing – **FDM 230**
- Lighting – **FDM 231**
- Traffic Signals – **FDM 232**
- ITS – **FDM 233**

These features are not required to meet minimum lateral offset criteria when installed behind a traffic barrier, provided:

- (1) The barrier was justified for other reasons, and
- (2) The device is located within the barrier's Length of Need (See **FDM 215.4.6**).

Post-mounted sign supports and conventional light poles must be breakaway as defined in the **AASHTO LRFD Specifications for Structural Supports for Highway Signs, Luminaires, and Traffic Signals** and the **AASHTO RDG**. Post-mounted supports must be of an acceptable and crashworthy design as detailed in the [Standard Plans](#).

Light poles or traffic signals in the median may become hazardous flying objects to vehicles in an opposing lane when struck. Do not place overhead sign structure (cantilever or truss) supports, conventional light poles, or traffic signal mast arm supports in the median, except in conjunction with barriers that are justified for other reasons. See **FDM 231.1** for additional limitations on placing lighting in the median.

Overhead structural supports for a Pedestrian Hybrid Beacon (PHB) may be placed in the median at midblock crossings if it is not possible to place elsewhere. Place the supports near the center of the median to the greatest extent practicable, while meeting the minimum lateral offsets in **Table 215.2.2**.

Do not locate high mast lighting poles in gore areas within the runout length as defined in the **AASHTO RDG, Section 5.6.4**.

215.2.10 Enhanced Highway Signing Assemblies

Enhanced highway signing assemblies installed in accordance with [Standard Plans, Index 700-120](#) are considered crashworthy and are permitted within the clear zone.

Locate in accordance with the lateral offset criteria provided in **Index 700-101**. Other ground mounted flashing beacon assemblies located within clear zone must be either crash tested or located behind a barrier that has been justified for other reasons. Flashing beacon assemblies that are mounted on mast arms are exempt from this requirement.

215.2.11 Breakaway Devices

The criteria for breakaway supports is covered in the **AASHTO RDG, Chapter 4**. Breakaway devices are designed to be impacted at normal bumper heights with vehicles traveling along relatively flat level ground. If impacted at a significantly higher point the breakaway mechanism may not function as designed resulting in non-activation or improper fracturing of the device. For this reason, do not locate breakaway supports in ditches or along slopes steeper than 1:6.

215.3 Roadside Hazards

215.3.1 Aboveground Hazards

An aboveground hazard is anything within the clear zone that is greater than 4 inches in height and is firm and unyielding or doesn't meet breakaway criteria. Evaluate the location of temporary and permanent aboveground hazards and ensure that their placement is in accordance with the lateral offset and clear zone requirements of **FDM 215.2**.

Curbs are not an aboveground hazard when utilized in accordance with **FDM 210.5**.

215.3.1.1 Work Zone Aboveground Hazards

Aboveground hazards in work zones are considered part of the “work area” and treated with appropriate work zone traffic procedures included in the **Standard Plans, Index 102 Series**. During non-working hours, place aboveground hazards (e.g., objects, materials, equipment) outside clear zone widths for work zones, or behind a barrier.

215.3.2 Canal Hazards

A canal hazard is defined as an open ditch parallel to the roadway for a minimum distance of 1000 feet and with a seasonal water depth in excess of 3 feet for extended periods of time (i.e., 24 hours or more).

Minimal lateral offsets for canal hazards exceed standard clear zone width criteria. Canal hazard lateral offsets are measured from the edge of travel lane, auxiliary lane or ramp to the top of the canal side slope nearest the road. These minimum required distances are illustrated in **Figures 215.3.1** and **215.3.2** and summarized as follows:

- Not less than 60 feet for flush shoulder and curbed roadways with design speeds of 50 mph or greater.
- Not less than 50 feet for flush shoulder roadways with design speeds of 45 mph or less.
- Not less than 40 feet for curbed roadways with design speeds of 45 mph or less.

When new canal or roadway alignment is required, provide distances greater than those above to accommodate future widening of the roadway.

On fill sections, provide a flat berm (1:10 or flatter slope) no less than 20 feet in width between the toe of the roadway front slope and the top of the canal side slope nearest the roadway.

When the slope between the roadway and the "extended period of time" water surface is 1:6 or flatter, the minimum distance can be measured from the edge of the travel lane, auxiliary lane, or ramp to the "extended period of time" water surface, and a berm is not required.

In sections with ditch cuts, provide a minimum of 20 feet between the toe of the front slope and the top of the canal side slope nearest the roadway.

Shield the canal hazard with an approved roadside barrier when the required minimum lateral offset cannot be met. Use the following offset criteria:

- Locate the barrier as far from the traveled way as practical and outside of the clear zone where possible.
- Locate guardrail no closer than 6 feet from the canal front slope.
- Locate High Tension Cable Barrier no closer than 15 feet from the canal front slope.

If the above offset criteria would locate the barrier within the clear zone, instead follow the offset requirements of **FDM 215.4.6.1**.

Figure 215.3.1 Lateral Offset Criteria for Canal Hazards on Flush Shoulder and High-Speed Curbed Roadways

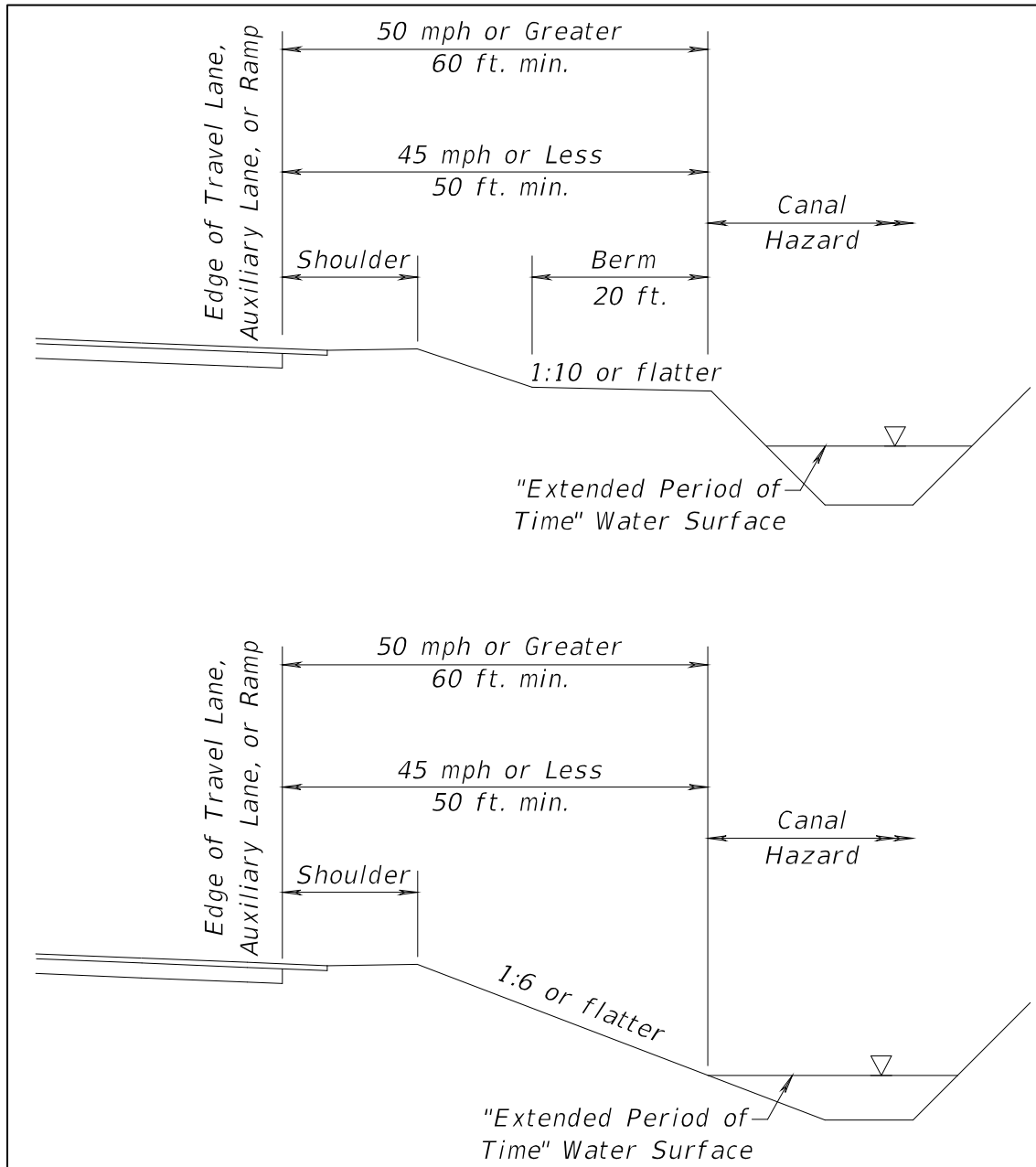
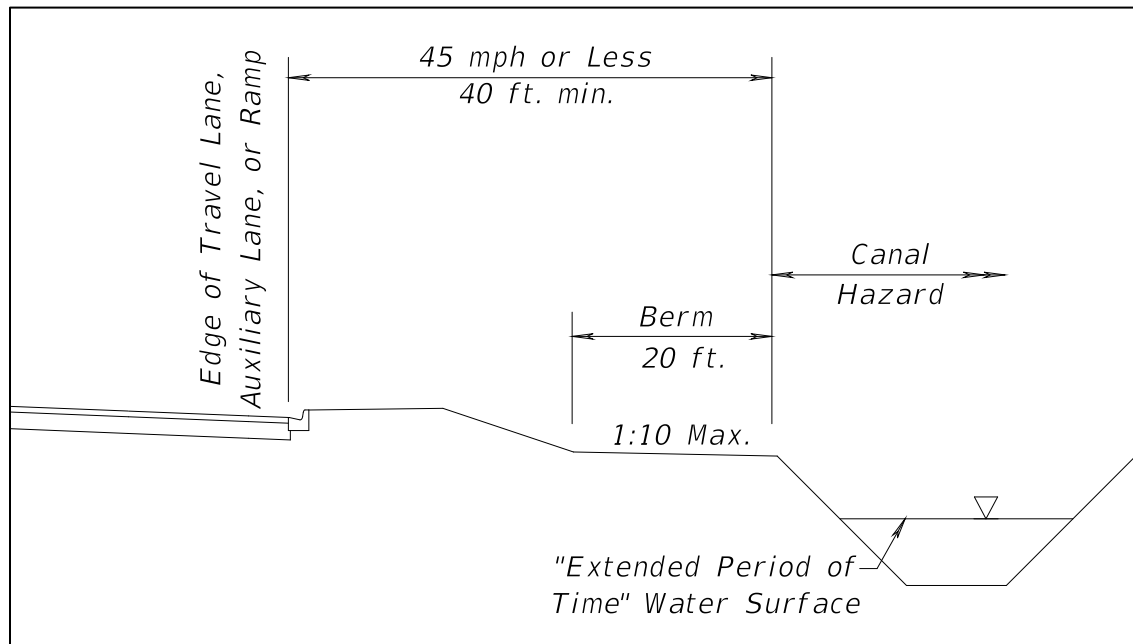

Figure 215.3.2 Lateral Offset Criteria for Canal Hazards on Curbed Roadways



215.3.3 Drop-off Hazard

Drop-off hazards are defined as steep or abrupt downward slopes that can be perilous to vehicle occupants, pedestrians, and cyclists. Shield any drop-off determined to be a hazard using the following guidelines:

- (1) Any vertical faced structure (e.g., retaining wall, wing-wall) located within the clear zone
- (2) For flush shoulder and high-speed curbed roadways, a drop-off of 6 feet or more with a slope steeper than 1:3 located within the clear zone
- (3) For low-speed curbed roadways, a drop-off of 6 feet or greater with a slope steeper than 1:3 located within 22 feet of the traveled way (See **Figure 215.3.3**).
- (4) A drop-off that has had 3 crashes within a 5-year period. Five years of crash data for a particular site can be obtained from the Safety Office.

For drop-off hazards for pedestrians, see **FDM 222.4** and **FDM 224.15**.

Figure 215.3.3 Drop-off Hazard on Low-Speed Curbed Roadways

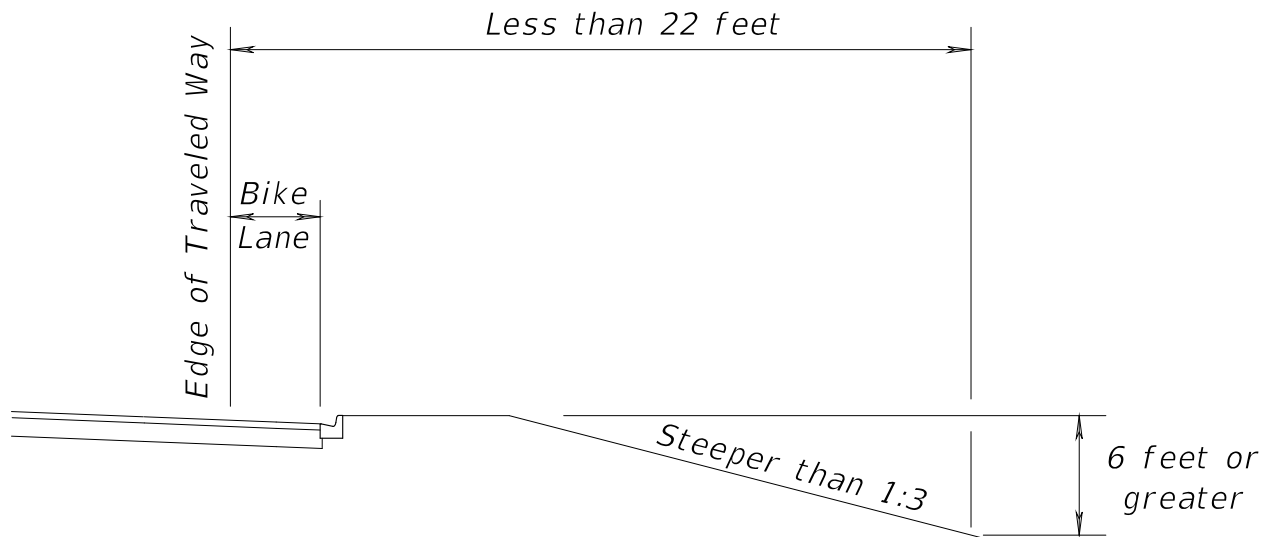

215.3.3.1 Work Zone Drop-offs

For drop-off criteria in work zones see [Standard Plans, Index 102-600](#). Anticipate drop-offs that are likely to occur during construction and provide the appropriate shielding. In locations where shielding is not practical, such as areas with numerous driveways, add a plan note requiring a return to acceptable conditions by the end of each day's construction period.

215.3.4 Additional Hazard Considerations

Engineering judgment should be used when evaluating hazardous conditions, and should consider; roadway geometry, proximity to facility or building, level of activity, and traffic conditions and operations. These conditions may include:

- (1) Bridge piers that are not designed for vehicle impact loads,
- (2) Bicycle and pedestrian facilities,
- (3) Residential buildings, schools, businesses, and
- (4) The presence of personnel in work zones.

Requirements for Bridge Pier Protection are provided in **FDM 215.4.5.4**.

Considerations regarding Positive Protection in Work Zones are provided in **FDM 215.4.9**.

215.4 Longitudinal Barriers, Barrier Transitions, End Treatments & Crash Cushions

Roadside barriers, transitions, end treatments (trailing anchorages and approach terminals), and crash cushions must be full-scale crash tested in accordance with either:

- (1) **NCHRP Report 350: Recommended Procedures for the Safety Performance Evaluation of Highway Features** (NCHRP 350), or
- (2) **AASHTO Manual for Assessing Safety Hardware, 2016 (MASH)**.

Bridge Traffic Railings must be evaluated and designed in accordance with the **Structures Design Guidelines** ([SDG](#)).

The criteria for crash testing specified in **NCHRP 350** and **MASH** provides six Test Levels (TL-1 thru TL-6) for the evaluation of roadside hardware suitability with consideration for vehicle type, mass, speed, and impact angle. Each Test Level provides an increasing level of service in ascending numerical order. For additional information regarding appropriate application of Test Levels for Barrier Type Selection refer to **FDM 215.4.5** and the **AASHTO RDG**.

Barriers, transitions, and end treatments consist of both proprietary and non-proprietary devices. Non-proprietary/Standardized devices are detailed in the [Standard Plans](#). Proprietary products are included on the [APL](#). These devices address the majority of roadside needs on the State Highway System.

Non-standard roadside hardware (i.e. devices not included in either the [Standard Plans](#) or the [APL](#)) may sometimes be needed to address unique situations, but are not permitted without prior approval by the Structures Design Office (SDO) for traffic railings (e.g., bridges, noise walls, wall copings), or the Roadway Design Office (RDO) for other roadside hardware. For additional information on the use of Non-Standard Roadside Safety Hardware refer to **FDM 215.8**.

215.4.1 Longitudinal Barriers

215.4.1.1 Flexible Barrier

Flexible Barrier systems provide the least severe impact conditions with the greatest deflections. The only Department-approved flexible barrier system is High Tension Cable Barrier (HTCB) and is currently available for implementation through the Departments [Developmental Standard Plans](#) process. Detailed information on the usage

requirements and design criteria of HTCB can be found on the Department's Website (<https://www.fdot.gov/design/standardplans/>), which includes the following:

- ***Developmental Standard Plans Instructions, D540-001***
- ***Developmental Standard Plans, Index D540-001***
- ***Developmental Specification, Dev540***

When considering the use of a [Developmental Standard Plans Index](#), review the ***Developmental Standard Plans Usage Process*** included in ***FDM 115***.

215.4.1.2 Semi-Rigid Barrier

The Department's Semi-Rigid Barrier is W-Beam Guardrail per [Standard Plans, Index 536-001](#) and ***536-002***. The available options for W-Beam Guardrail are:

- General, TL-3 Guardrail – Post spacing at 6'-3" (TL-3, MASH)
- Low-Speed, TL-2 Guardrail – Post spacing at 12'-6" (TL-2, MASH)

W-Beam Guardrail, with a rail height of 2'-1" to center of panel and midspan splices, was developed based on the ***31" Midwest Guardrail System (MGS)***. Compatible proprietary components may be referred by the 31" height.

General, TL-3 Guardrail may be used for all design speeds; however, installations on roadways with Design Speeds > 45 mph must have a minimum length of 75 feet, unless attached to a permanent rigid barrier.

Low-Speed, TL-2 Guardrail is limited to use on flush shoulder roadways with Design Speeds ≤ 45 mph.

Installations of W-Beam Guardrail with 8-in offset blocks on wood or steel posts are detailed in [Standard Plans, Index 536-001](#). W-Beam guardrail may also be installed at a reduced post spacing (i.e., less than 6'-3") to reduce deflection of the system. Reduced post spacing may be used for all design speeds in accordance with spacing and setback requirements provided in ***Table 215.4.2***.

The use of Thrie-Beam Guardrail panels is restricted to Thrie-Beam Retrofits (e.g., Metal Traffic Railings) and Barrier Transitions only.

215.4.1.3 Rigid Barrier

Rigid Barriers are assumed to exhibit no deflection under impact conditions; however, crash severity will likely be the highest of all barrier options. Rigid barrier includes Concrete Barriers and Traffic Railings. Concrete barriers are included for roadway applications and Traffic Railings are designed for structural applications (e.g., bridges, noise walls, wall copings).

Align Rigid Barrier parallel to adjacent traffic lanes; this orientation may vary by the maximum taper rates given in the [Standard Plans Instructions](#) for **Index 521-001**.

Modifications to Rigid Barriers require approval from Office of Design (SDO or RDO). Modifications may include the following:

- Reinforcement details
- Surface treatments
- Material substitutions
- Geometric discontinuities along the length of the barrier
- Non-standardized attachments that do not meet the requirements of either this manual or [SDG](#)
- Non-standardized and unfilled pockets or blockouts
- End transition details
- Traffic face geometry

Rigid Barriers include the following:

- (1) Single-Slope Concrete Barriers (roadside applications):
 - (a) Median – [Standard Plans](#), **Index 521-001** (TL-4, MASH)
 - (b) Shoulder – [Standard Plans](#), **Index 521-001** (TL-4, MASH)
 - (c) Curb & Gutter - [Standard Plans](#), **Index 521-001** (TL-2, MASH)
 - (d) Retaining Wall Shielding – [Standard Plans](#), **Index 521-001** (TL-4, MASH)
 - (e) Pier Protection – [Standard Plans](#), **Index 521-002** (TL-5, MASH)

- (2) Traffic Railings (bridges, noise walls, and wall copings):
- (a) Bridges – [Standard Plans](#), **Index 521-422 thru 521-427** (TL-4, MASH) and **Index 428** (TL-5, MASH)
 - (b) Thrie-Beam Retrofits – [Standard Plans](#), **Index 460-470 thru 460-476** (TL-3, MASH) and **Index 460-477** (TL-2, MASH)
 - (c) Vertical Face Retrofits – [Standard Plans](#), **Index 521-480 thru 521-484** (TL-3, MASH)
Note: Use Tapered End Transition, [Standard Plans](#), **Index 521-484**, for Design Speed ≤ 40 mph only. Not permitted within the clear zone of approaching traffic unless site-specific justification is provided and approved by the District Design Engineer.
 - (d) Noise Wall – [Standard Plans](#), **Index 521-509 thru 521-515** (TL-4, MASH) (TL-5 option available from Structures Design Office)
 - (e) Wall Coping – [Standard Plans](#), **Index 521-610** (36" Single-Slope and 42" Vertical, TL-4, MASH), **521-611** (36" Single-Slope and 42" Vertical (FRP), TL-4, MASH), **and 521-620** (42" Single-Slope, TL-5, MASH)

Design bridge railings in accordance with the [SDG](#). Superseded FDOT Standard New Jersey Shape and F-Shape Traffic Railings conforming to the designs shown in [Standard Plans Instructions](#) for **Index 536-002**, "A Historical Compilation of Superseded Florida Department of Transportation 'Structures Standard Drawings' for 'F' and 'New Jersey' Shape Structure Mounted Traffic Railings", are both structurally and functionally adequate for TL-3 MASH.

For information regarding existing traffic railings, see **FDM 215.7.4**.

Details and typical applications of standard bridge railings are provided in **Figures 215.4.1 – 215.4.10**. Refer to **FDM 222.4** for details of pedestrian/bicycle railings and fencing.

Figure 215.4.1 Bridge Traffic Railings – Single Slope Railings

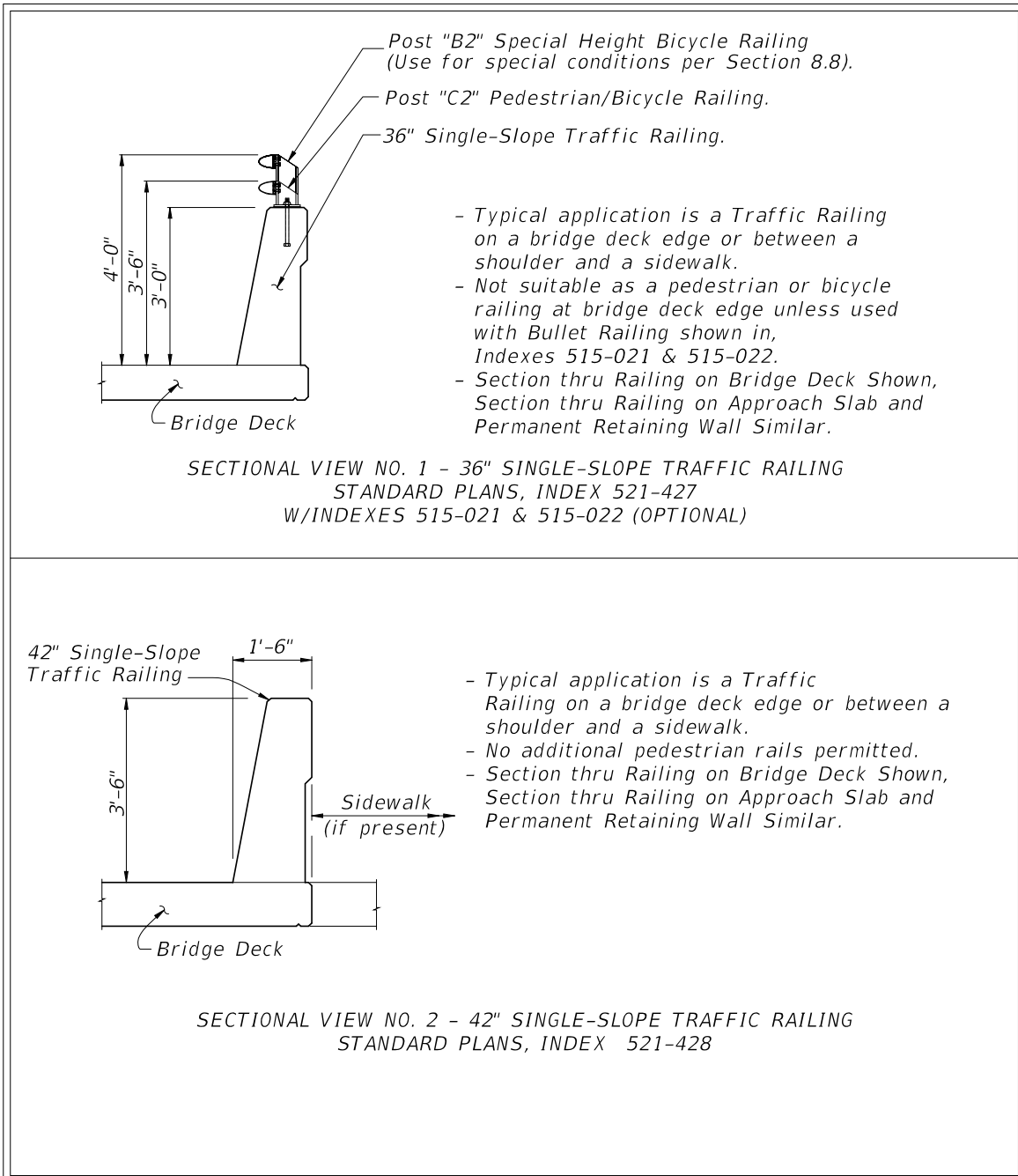

Figure 215.4.2 Bridge Traffic Railings – Vertical Shapes

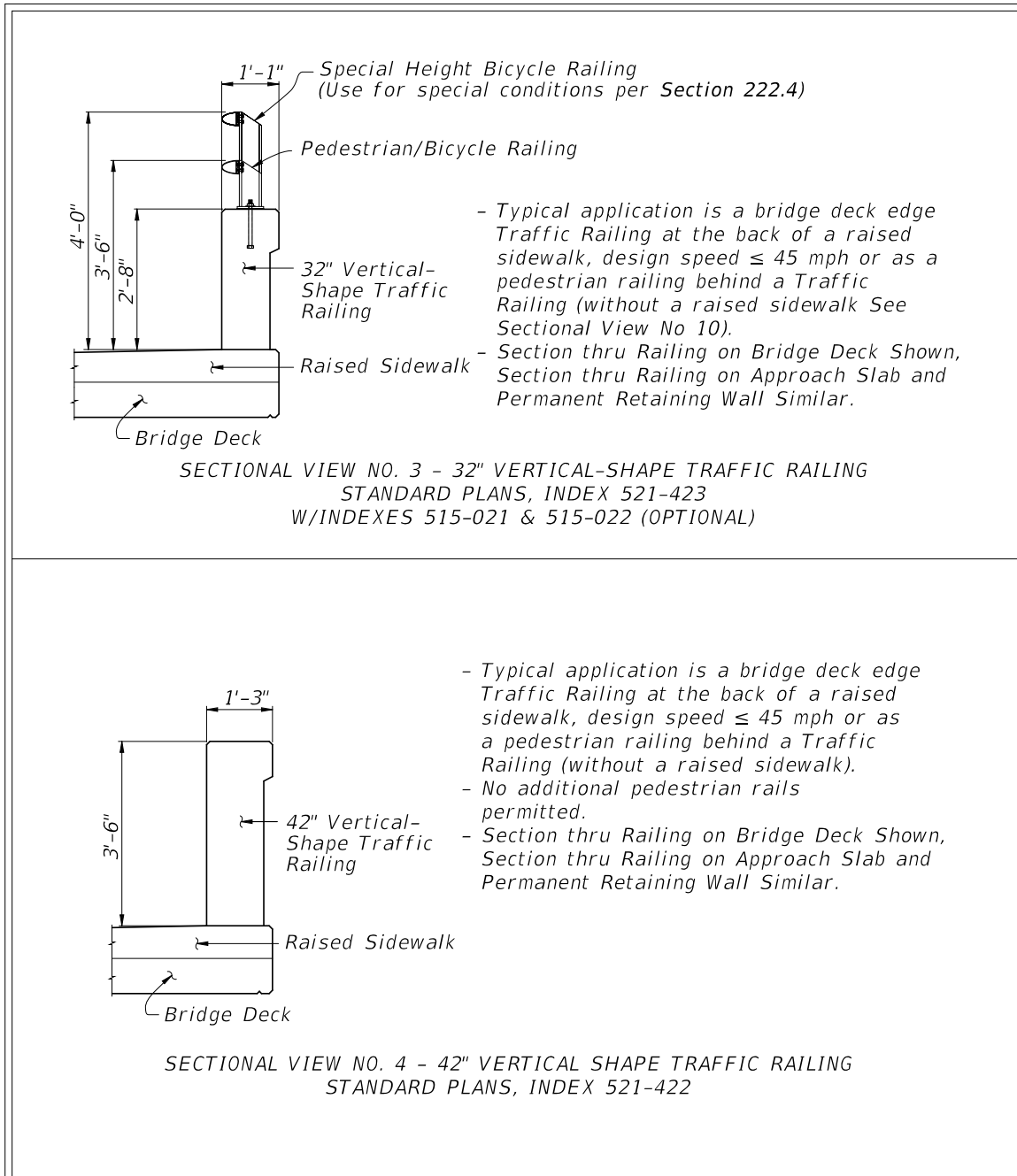

Figure 215.4.3 Bridge Traffic Railings – Other Shapes

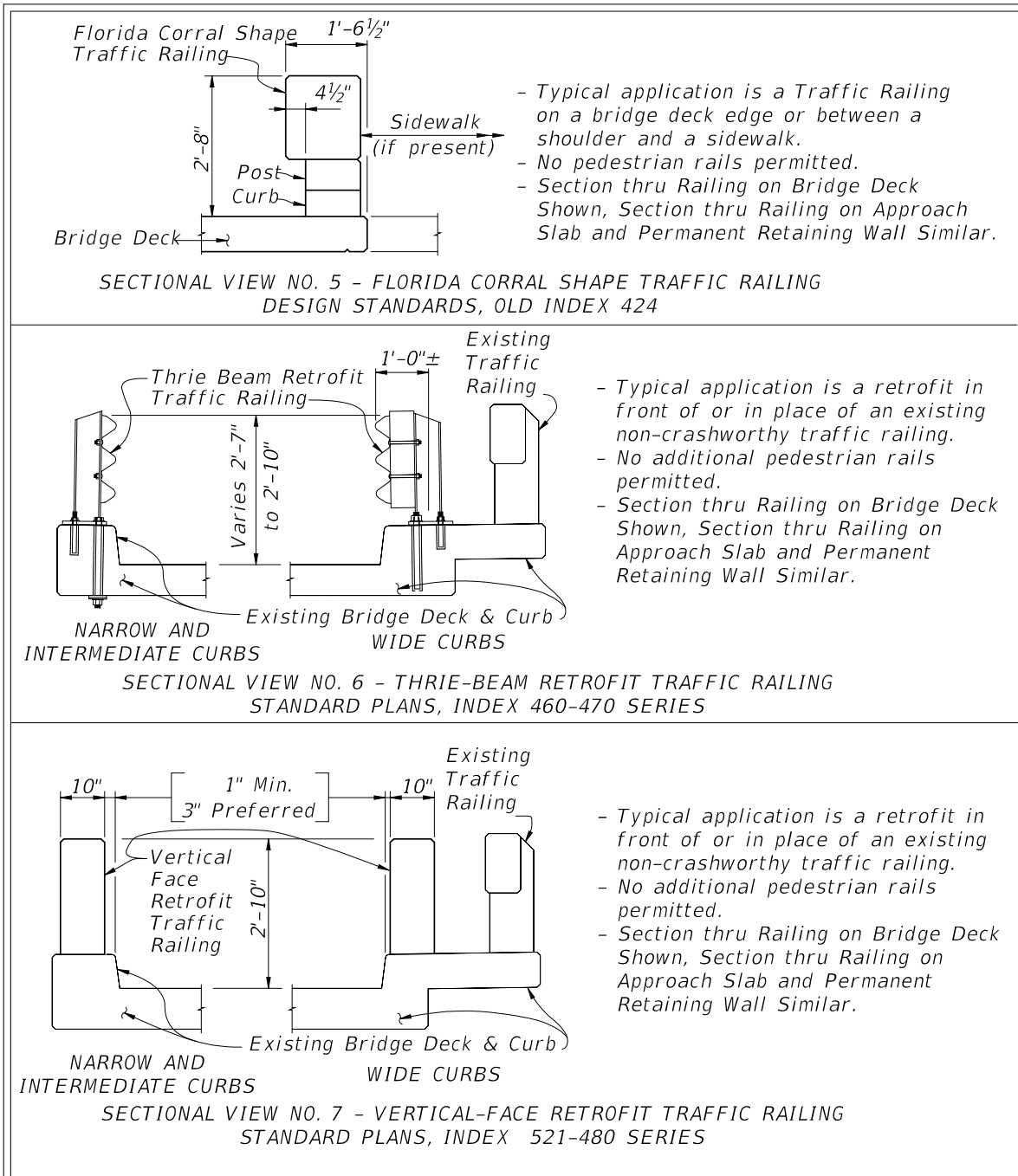
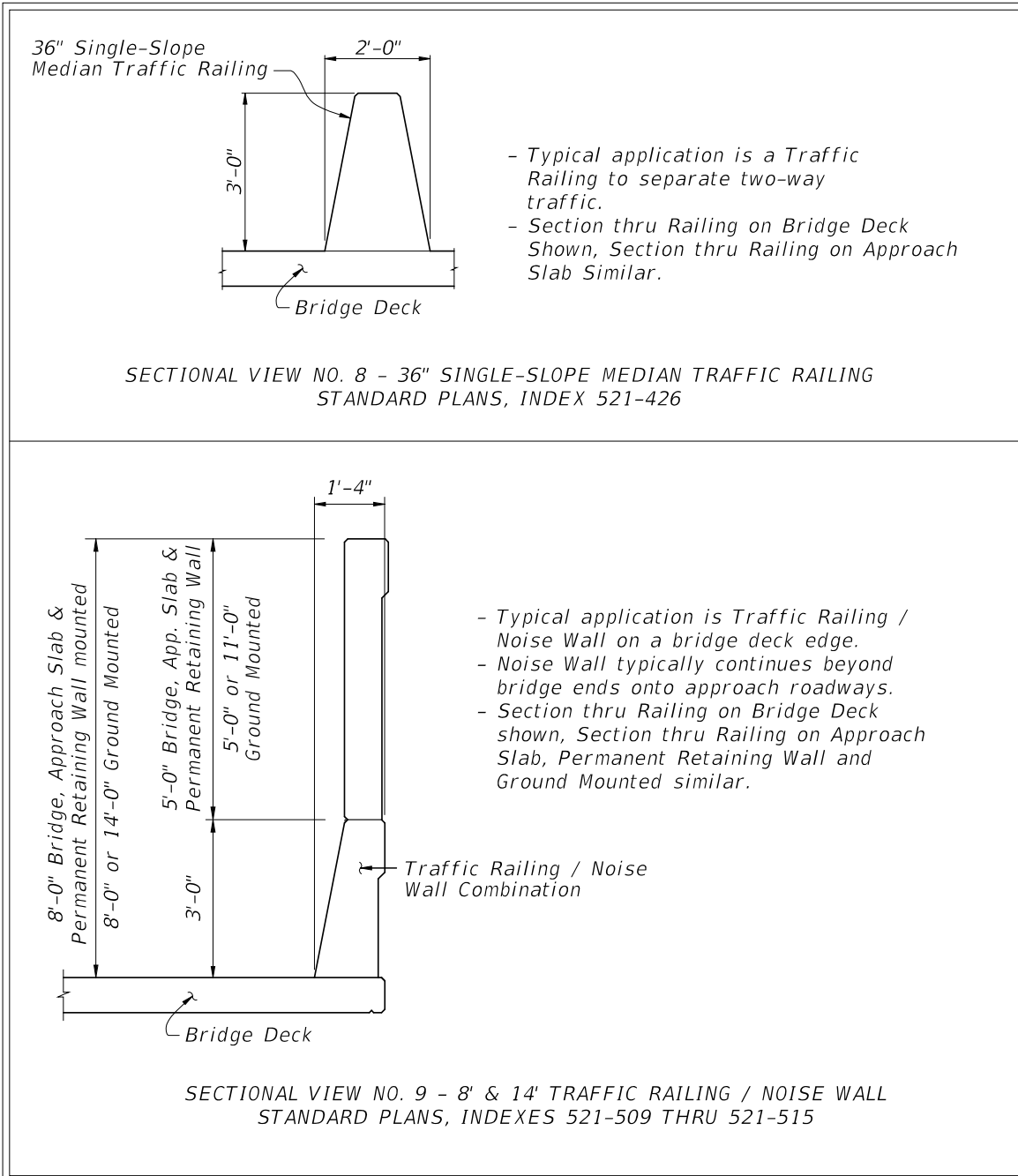

Figure 215.4.4 Bridge Traffic Railings – Median Traffic Railing and Traffic Railing/Noise Wall Combination



215.4.1.4 Temporary Barriers

Temporary Barriers are used in work zones to protect motorists and as Positive Protection to safeguard construction workers while construction activities are taking place. General information about the application of Temporary Barriers can be found in [Standard Plans, Index 102-100](#). For information about the use of Temporary Barriers with bicycle or pedestrian temporary traffic control, see *FDM 240*.

Temporary Barriers are installed in either 'Anchored' or 'Free-standing' conditions based on the barrier type and needed setback distance. See the Installation Data table provided in [Standard Plans, Index 102-100](#) for the lateral offset and setback distance requirements.

Temporary Barriers include the following:

- (1) Low Profile Barrier – [Standard Plans, Index 102-120](#) (TL-2, MASH)
- (2) Type K Barrier – [Standard Plans, Index 102-110](#) (TL-3, NCHRP 350 and MASH)
- (3) Proprietary Temporary Barrier – See *APL* (TL-3, NCHRP 350 and MASH)

Low Profile Barriers are required for Work Zone Speeds of ≤ 45 mph where temporary barrier is needed within 100 feet of an intersection, residential driveway or business entrance. Use of other barriers is not permitted at these locations due to sight distance limitations. Low Profile Barrier can be used on bridges where no drop-off is present. Transitions from Low Profile Barrier to other temporary barriers within a run of barrier (i.e., from begin length of need to end length of need) is not permitted.

Type K Barrier is a portable concrete barrier which has the capability of being anchored (i.e., staked or bolted) to limit deflections or installed in a free-standing configuration. See [Standard Plans, Index 102-110](#) for specific requirements for the use of Type K Temporary Concrete Barrier. Refer to [Standard Plans, Index 102-110](#) for details on transitioning between the Type K Temporary Concrete Barrier on bridges and other concrete barrier systems on the adjoining roadway.

Proprietary Steel Barriers (anchored only), Water Filled Barriers (free-standing only) and portable concrete barriers (free-standing or anchored) must be used in accordance with the Vendor drawings on the [APL](#). To allow for the use of [APL](#) devices refer to temporary barrier the Plans as either 'Anchored' or 'Free-standing', unless specific limitations are required. Proprietary steel barriers listed on the [APL](#) are anchored to limit deflections; however, barrier heights and drainage performance may limit some systems.

Anchored (bolted) temporary barriers are not permitted on bridge superstructures that contain post-tensioned tendons within the concrete deck (top flange of concrete box

girders) or on bridge superstructures consisting of longitudinally prestressed, transversely post-tensioned, solid, or voided concrete slab units.

If Flexible (HTCB, **Index D540-001**) or Semi-Rigid (Guardrail, **Index 536-001**) barrier is used in a temporary configuration or allowed to remain during a portion of the Temporary Traffic Control (TTC) Plan, requirements for the permanent application of barrier must be met (e.g., grading, deflection space, offset from Edge of Traveled Ways).

215.4.2 End Treatments

Non-crashworthy longitudinal barrier ends are hazards for approach direction when terminated within the clear zone. Crashworthy end treatments for each barrier type (i.e., flexible, semi-rigid, and rigid) are provided in the [Standard Plans](#).

Flexible barrier end treatments are vendor specific. For additional information regarding the end treatment of HTCB, refer to [Developmental Standard Plans, Index D540-001](#), as referenced above.

215.4.2.1 Guardrail End Treatments

Guardrail end treatments are necessary to provide crashworthy ends for approaches and anchorage of the guardrail system. For the guardrail to provide adequate redirective capabilities during a vehicle impact, anchorage of the system is needed for tensile (ribbon) strength to develop in the guardrail panels. Approach terminals provide both anchorage of the guardrail system and a crashworthy approach. End treatments for guardrail are categorized as follows:

- (1) Approach Terminals – required for guardrail ends within the clear zone of approaching traffic. Guardrail approach terminals must be a proprietary device listed on the [APL](#). MASH compliant approach terminals are required for new installations. For additional information, see [Standard Plans, Index 536-001](#). Approach terminals are classified by the following:
 - (a) Test Level:
 - i. TL-2 (Design Speeds \leq 45 mph)
 - ii. TL-3 (All Design Speeds)
 - (b) Connection Type:
 - i. Single-Faced (crashworthy on one side)
 - ii. Double-Faced (crashworthy on both sides)

- (2) Crash Cushions – See **FDM 215.4.3** and [Standard Plans, Index 544-001](#).
- (3) Trailing Anchorages – required for anchoring of the trailing ends of guardrail. Trailing anchorages are non-crashworthy as an approach end treatment and are not permitted as a guardrail end treatment on the approach end within the clear zone, unless shielded by another run of barrier. The trailing anchorage is detailed in the [Standard Plans, Index 536-001](#).

215.4.2.2 Rigid Barrier End Treatments

Terminate rigid barrier by either transitioning into another barrier system (e.g., guardrail), or by shielding with a crash cushion. Details and requirements are provided in the [Standard Plans](#).

Sloped concrete end treatment using a vertical height transition, detailed in [Standard Plans, Index 521-001](#), are not permitted within the clear zone of approaching traffic lanes. With sufficient justification the District Design Engineer may grant approval for use of this end treatment within clear zone for very low design speeds (35 mph and less), and only when no other more crashworthy solution is available.

Treatment of the trailing end of rigid barriers is not required unless additional hazards exist beyond the rigid barrier or the barrier is within the clear zone of opposing traffic.

215.4.2.3 Temporary Barrier End Treatments

The required treatments for exposed ends of temporary barriers are:

- (1) Connecting to an existing barrier (smooth, structural connections are required - Refer to [Standard Plans, Indexes 102-100](#) and [102-110](#), or the [APL](#));
- (2) Shield end with a crash cushion as detailed in the [Standard Plans](#) or [APL](#) for the specific type of temporary barrier (i.e. Temporary Concrete, Steel, or Water Filled); or,
- (3) Flaring outside of the Work Zone clear zone (See [Standard Plans, Index 102-600](#))

No modifications to the end treatments included in the [Standard Plans](#) or [APL](#) are permitted. Special conditions may require end treatments other than those included above. If this occurs, consult the State Roadway Design Office (RDO) and provide special details in the Plans.

215.4.3 Crash Cushions

Crash cushions (impact attenuators) are used to protect motorists from the exposed ends of barriers, fixed objects, and other hazards within the clear zone. They are energy absorbing devices that may be redirective non-gating, or non-redirective gating. Crash cushions are classified based on Test Level, as shown for each system on their respective [APL](#) drawings.

The design of a crash cushion system must not create a hazard to opposing traffic. [APL](#) drawings provide details for transitions for optional barrier types with and without bi-directional traffic.

An impacting vehicle should strike the systems at normal height, with the vehicle's suspension system neither collapsed nor extended. Therefore, the terrain surrounding crash cushions must be flat (1:10 or flatter) in advance of and along the entire design length of the system. Curb placement in the approach area of crash cushions is only permitted where project constraints prevent usage of flush shoulders or alternative barrier configurations.

215.4.3.1 Permanent Crash Cushions

Permanent crash cushions must be redirective non-gating. Standard details of systems for typical installations shielding concrete barrier wall ends and guardrail ends can be found on the [APL](#) under **Section 544**. In addition, some of these systems have standard details for shielding wide hazards. For applications not covered in the [APL](#) drawings, crash cushion vendors normally provide design assistance for their systems. Special designs must be detailed in the Plans and based on meeting the performance criteria for the established design speed of the facility (i.e., barrier system Test Level). For additional information, see [Standard Plans](#), *Index 544-001*.

215.4.3.2 Temporary Crash Cushions

Two types of temporary crash cushions are permitted;

- Redirective non-gating crash cushions
- Non-redirective gating crash cushions

Redirective crash cushions will shield hazards by redirecting errant vehicles impacting the side of the crash cushion and decelerate errant vehicles from a direct, in-line impact at the terminus of the crash cushion by absorbing the energy.

Gating crash cushions are designed to decelerate errant vehicles from a direct, in-line impact at the terminus of the crash cushion by absorbing the energy but provide no redirective capabilities for side impacts. Use of gating crash cushions require approval from the State Roadway Design Office (RDO). Gating cushions may be appropriate on low-speed facilities and in work zones with higher speeds where only low impact angle hits are expected. An adequate clear runout area must be provided beyond a gating crash cushion (between the departure line and the clear zone). Plan details for site specific design are required.

Approved temporary crash cushions for use on Department contracts are listed on the [APL](#) under **Section 102**. Sand barrel gating systems are not permitted.

Anchored (bolted) temporary crash cushions are not permitted on bridge superstructures that contain post-tensioned tendons within the concrete deck (top flange of concrete box girders) or on bridge superstructures consisting of longitudinally prestressed, transversely post-tensioned, solid, or voided concrete slab units.

215.4.4 Barrier Transitions

Guardrail transitions are necessary, whenever standard W-Beam guardrail converges with rigid barriers. Guardrail transitions must include sound structural connections, nested panels, and additional posts for increased stiffness. Use the guardrail transitions included in the [Standard Plans](#) as follows:

- (1) General, Guardrail Approach Transition Connection to Rigid Barrier – **Index 536-001** (Single or Double Faced Guardrail, TL-3, MASH), Approved for all Design Speeds
- (2) Low Speed, Guardrail Approach Transition Connection to Rigid Barrier – **Index 536-001** (Single Faced Guardrail only, TL-2, MASH), Only approved for Design Speeds \leq 45 mph
- (3) Trailing End Transition Connection to Rigid Barrier – **Index 536-001** (Test Level N/A), Approved for all Design Speeds.

Various other barrier transitions are detailed throughout the [Standard Plans](#) and [APL](#) drawings for transitions from temporary barriers to permanent rigid barriers and transitions from variable height/shape rigid barriers.

215.4.5 Barrier Type Selection

Consider the following factors when determining the appropriate barrier type:

- (1) Barrier Placement requirements (see **FDM 215.4.6**)
- (2) Traffic characteristics (e.g., volume, percent trucks)
- (3) Site characteristics (e.g., terrain, alignment, geometry, access facility type, access locations, design speed)
- (4) Expected frequency of impacts
- (5) Initial and replacement/repair costs
- (6) Ease of maintenance
- (7) Exposure of workers when conducting repairs/maintenance
- (8) Aesthetics

For additional information about considerations for barrier selections refer to the **AASHTO RDG**. Document barrier type selection decisions and warrants.



215.4.5.1 Longitudinal Barrier Selection

There are three options for longitudinal barrier; HTCB, W-Beam Guardrail, and Rigid Barrier. **Table 215.4.1** provides guidance regarding roadway barrier type selection.

Specific requirements for the selection of HTCB are provided in the [Standard Plans Instructions](#) for **Index D540-001**.

Refer to the [SDG](#) for barrier type and test level selection of Traffic Railings.

Table 215.4.1 Roadway Barrier Type Selection

Barrier Type	Deflection Space Requirement	Order of Bias			Test Level	Design Vehicles
		Initial Cost	Vehicle Impact Severity	Maintenance Cost		
	(feet)					
HTCB	12	LOW	LOW	HIGH	TL-4 (NCHRP 350)	Passenger Car, Pickup Truck, & Single-Unit Truck
W-Beam Guardrail	5				TL-2 & TL-3 (MASH)	Passenger Car & Pickup Truck
Rigid Barrier	0				HIGH	HIGH

215.4.5.2 End Treatment Selection

Select end treatments in accordance with **FDM 215.4.2**, the [Standard Plans](#) and the [Standard Plans Instructions](#) for each applicable barrier type.

215.4.5.3 Crash Cushion Selection

Various types of energy absorbing devices eligible for use on Department projects as crash cushions can be found on the [APL](#). Detailed information about these systems is provided in the [Standard Plans](#), [APL](#), and in each manufacturer’s publications. Each system has unique physical and functional characteristics.

For permanent crash cushion applications, indicate in the Plans the requirements for each given location in accordance with [Standard Plans](#), *Index 544-001*, and *FDM 902*, including the:

- (1) Location (station and side),
- (2) Barrier system (concrete barrier wall or guardrail),
- (3) Design length,
- (4) Design speed,
- (5) Crash test level, and
- (6) Hazard width and length restriction.

Site characteristics and economics dominate crash cushion selection considerations. Some crash cushion systems are relatively low in initial cost, but usually must be completely replaced when struck, so are more appropriate in locations with a low likelihood of collision. There are a number of other systems that have higher initial costs but can be repaired after collisions relatively quickly and inexpensively, so are more appropriate where frequent collisions are anticipated. The ability of maintenance forces to perform routine maintenance and to place a crashed system back into service quickly should be a major consideration. Do not use crash cushions that require stocking unusual and expensive parts or those that are complex to replace.

215.4.5.4 Pier Protection

In addition to consideration for bridge piers as hazards to vehicle occupant safety, consideration must also be given to protection of bridge piers from vehicular collision. The *AASHTO LRFD Bridge Design Specifications* refer to the protection of bridge piers from vehicular collision as Protection of Structures; however, protection of bridge piers is also commonly referred to as Pier Protection. Coordinate with the Structural Engineer of Record to determine if Pier Protection is required.

The process for selection of Pier Protection is presented in *Figure 215.4.5* (Pier Protection Selection Flowchart). The flowchart is only intended as a visual aid for selection of Pier Protection. Refer to *SDG 2.6* for the Department's design policy for Pier Protection.

Figure 215.4.5 Pier Protection Selection Flowchart

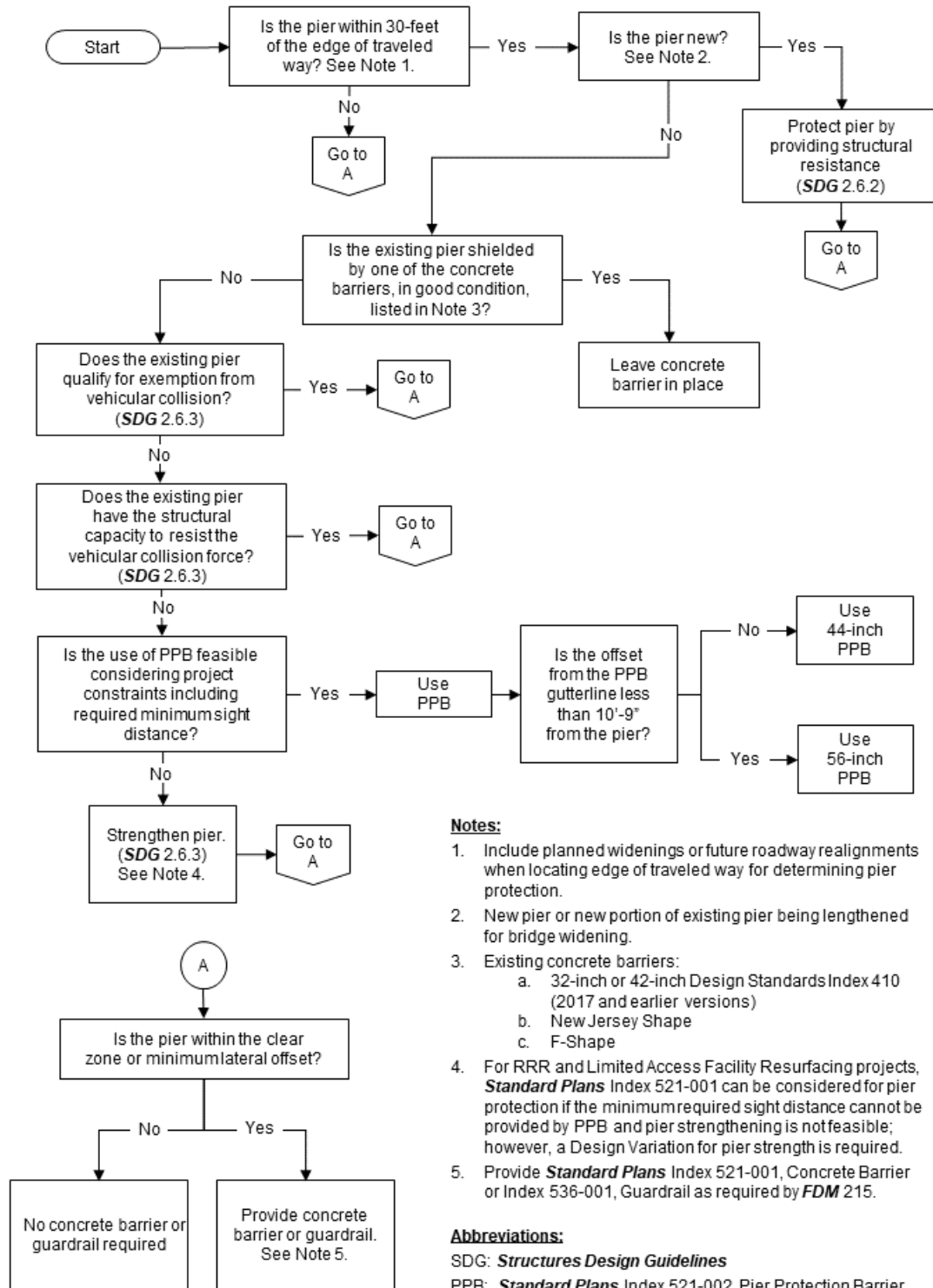

215.4.6 Barrier Placement

The primary design factors associated with barrier placement are:

- (1) Lateral Offset from the Edge of Traveled Way,
- (2) Deflection Space Tolerance,
- (3) Terrain Effects,
- (4) Length of Need,
- (5) Space for End Treatments, and
- (6) Outside Shoulder or Median Application

215.4.6.1 Barrier Offset

Place W-Beam Guardrail and Rigid Barriers at the offsets described below. See [Developmental Standard Plans Instructions](#) for *Index D540-001* for the barrier placement requirements for HTCB.

Requirements for guardrail offsets are illustrated in **Figure 215.4.6**.

For flush shoulder roadways, the standard offset for W-Beam Guardrail, measured from the Edge of Traveled Way to the face of guardrail, is the full shoulder width plus 2 feet, not to exceed 12 feet. The 12-foot offset limit for guardrail is established to reduce the potential for impacts where the vehicle is behaving significantly different than the crash tested conditions (i.e. non-tracking, fish-tailing, excessive approach angle, etc.). Guardrail offsets greater than 12 feet require site-specific justification in accordance with **FDM 215.4.7**, unless the condition is based on requirements of the [Standard Plans](#), **FDM 215.4.6.4** for **Median Barrier**, **FDM 215.3.2** for **Canal Hazards**, or **shoulder gutter segments**. For shoulder gutter segments only, guardrail may be placed with a 14-foot offset to accommodate a 12-foot useable shoulder width.

Note: Consider exceeding the 12-foot offset limit where required to avoid guardrail post conflicts with structures or utilities. This is preferred over the use of encased or special guardrail posts. If the 12-foot offset limit is exceeded, provide site-specific justification per above and extend the shoulder grading to maintain the requirements of **FDM 215.4.6.2**. When curb is present, the preferred configuration is to place the face of guardrail at 5 inches behind the face of curb. For design speeds ≤ 45 mph, the face of guardrail may also be placed between 4 feet and 12 feet behind the face of curb.

Rigid Barrier is typically used when there are barrier deflection or right-of-way limitations. For flush shoulder roadways, the general offset for Rigid Barrier, measured from the Edge

of Traveled way to the barrier gutter line, is the full shoulder width. This offset may vary where differing barrier placement is justified for site-specific conditions (e.g., barrier taper across median, alignment for shielding bridge piers or sign supports, or coordination with drainage structures). Extend adjacent shoulder pavement to close gaps between the nearest paved shoulder and the rigid barrier. Follow additional offset requirements for specific conditions shown in the [Standard Plans](#). Rigid Barrier, with the exception of F-Shape or Single-Slope barriers with a height less than 42", may be used in combination with curbs, and provide an acceptable alternative to the areas excluded for guardrail use in **Figure 215.4.6**.

Figure 215.4.6 Lateral Offset to Guardrail

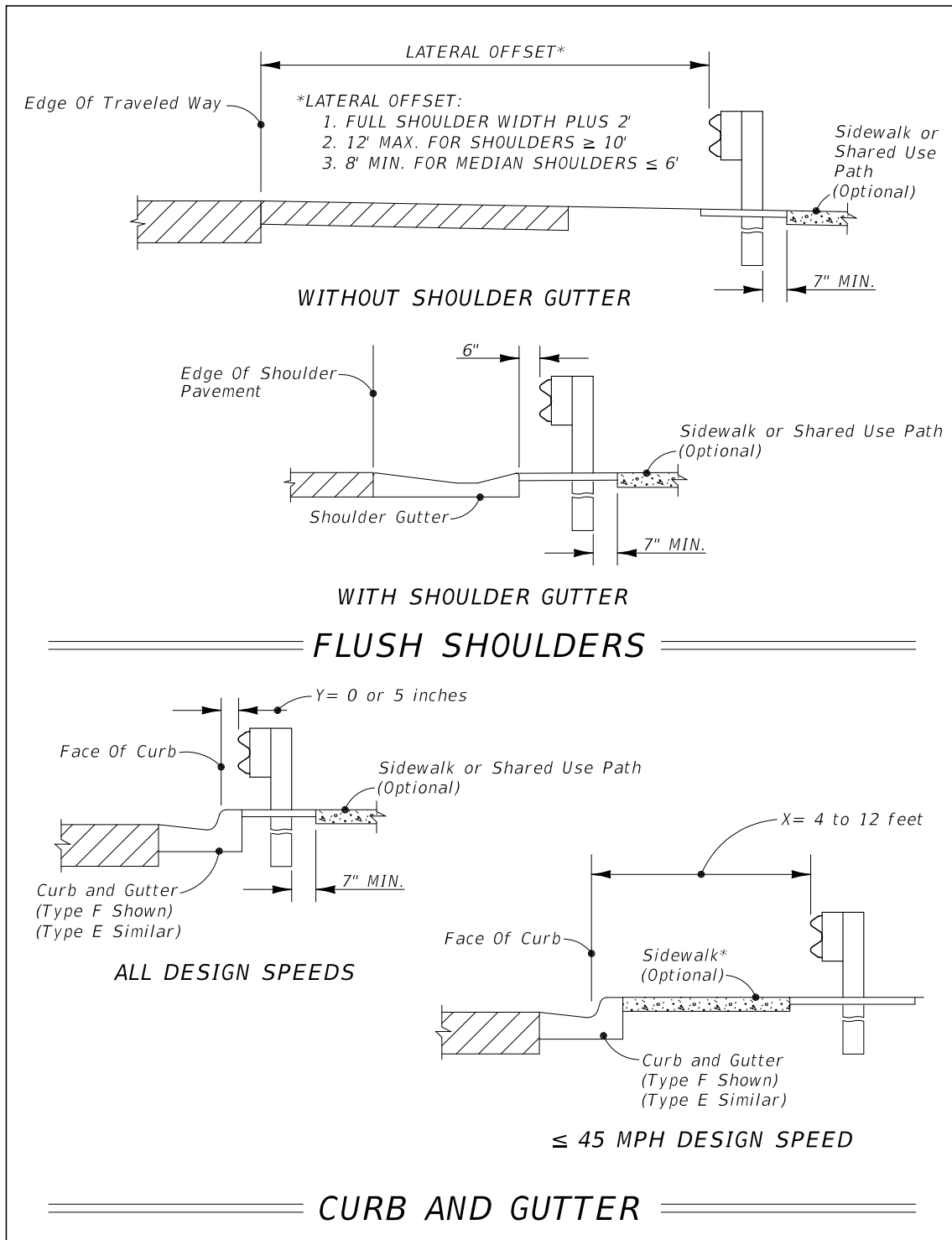

In addition to travel lane lateral offset considerations, an adequate setback must be provided behind the barrier to ensure proper function. Setback is the distance between the face of the barrier and the aboveground hazard behind the barrier. For flexible and semi-rigid barriers, the setback is based on deflection tolerances and is required to prevent the barrier from contacting aboveground hazards or breakaway devices.

For rigid barriers, the setback is required to keep the area above and behind the barrier face free of obstructions that could penetrate or damage the vehicle compartment. This requirement is based on the “Zone of Intrusion” concept as described in the **AASHTO RDG. Table 215.4.2** provides the Setback requirements for FDOT standard barriers. Additionally, **Figure 215.4.7** includes setback distances to rigid barriers for discontinuous elements. Setback requirements for discontinuous items apply to discrete features, such as piers, poles, or sign supports. Apply continuous item setback requirements to other features. See [SDG 6.7](#) for additional bridge railing and setback requirements. These requirements do not apply to devices detailed in the [Standard Plans](#) as attachments to rigid barriers (e.g., pedestrian/bicycle bullet railing, bridge fencing, traffic railing/noise wall combinations).

Table 215.4.2 Minimum Barrier Setback
(Measured from the face of the barrier, as shown in *Figure 215.4.7*)

Barrier Type	Setback Distance
Flexible Barrier	
High Tension Cable Barrier (HTCB)	12 feet, 0 inches
Semi-Rigid Barrier	
W-Beam with Post Spacing @ 6 feet, 3 inches (TL-3)	5 feet, 0 inches
W-Beam with Post Spacing @ 12 feet, 6 inches (TL-2)	5 feet, 0 inches
W-Beam with Post Spacing @ 3 feet, 1.5 inches (½ Spacing)	3 feet, 10 inches
W-Beam with Post Spacing @ 1 foot, 6.75 inches (¼ Spacing)	3 feet, 2 inches
Nested W-Beams with Post Spacing @ 3 feet, 1.5 inches (½ Spacing)	3 feet, 0 inches
Nested W-Beams with Post Spacing @ 1 foot, 6.75 inches (¼ Spacing)	2 feet, 8 inches
Deep Post W-Beam installed on 1:2 Slope Break with Post Spacing @ 6 feet, 3 inches (TL-3)	5 feet, 6 inches
Rigid-Barrier	
Concrete Barrier < 40" Height (Design Speeds ≤ 45 MPH)	0 feet, 0 inches
Concrete Barrier < 40" Height (Design Speeds > 45 MPH) Non-crash Tested Continuous or Discontinuous Items	1 foot, 6 inches
Concrete Barrier ≥ 40" Height	0 feet, 0 inches
Bridge Traffic Railing Non-crash Tested Continuous Items Non-crash Tested Discontinuous Items	5 feet, 0 inches See Figure 215.4.7
Temporary Barriers	
See "Setback Distance" of applicable Standard Plans , Index or APL drawing.	

Figure 215.4.7 Setback Distances for Discontinuous Elements

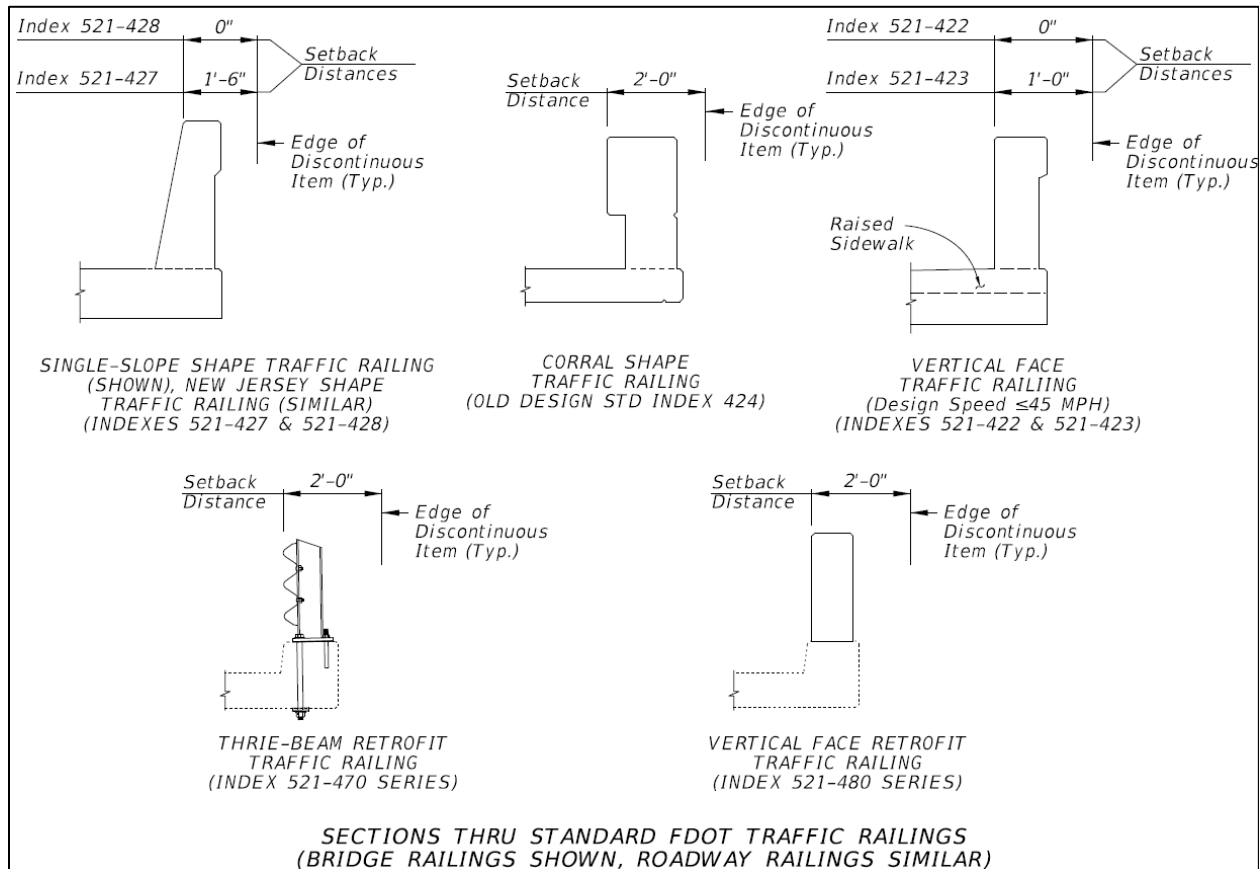

Noise Wall/Traffic Railing combinations located within the setback distance must be crash tested to or accepted as TL-4 under **MASH**. Other continuous items (e.g., glare screens and fences) located within this setback distance must be crash tested to or accepted as TL-3 under **NCHRP 350** or **MASH**.

Back-to-back railings on separated parallel or adjacent bridges are exempt from the bridge traffic railing setback requirements of **Table 215.4.2**, provided the back face of the higher bridge railing is smooth and continuous with no attachments (e.g., sign supports, pedestals, bullet rails, etc.).

See **FDM 215.5** for additional information regarding discontinuous attachments to rigid barriers.

215.4.6.2 Grading Requirement

The terrain effects between the traveled way and a barrier can have a significant impact on whether or not a barrier will perform as intended. Proper grading around a barrier will ensure that as a vehicle approaches a barrier its suspension is not dramatically affected, causing the vehicle to underride or override a barrier.

Install barriers on slopes 1:10 or flatter. Continue the 1:10 slope a minimum 2 feet beyond the barrier (i.e., from either the guardrail post or rigid barrier) before providing a slope break.

With approval of the District Design Engineer and where conditions are constrained, the Deep Post guardrail option may be used in lieu of providing a 2-foot setback to the slope break point. Coordinate the use of the Deep Post guardrail option with the District Drainage Engineer and District Maintenance Engineer. See Deep Post details in [Standard Plans, Index 536-001](#) "Slope Break Condition".

Proper grading around crashworthy end treatments is essential to assure the device performs as intended. Grading requirements are shown in the [Standard Plans](#).

For superelevated roadway sections, a maximum 7% algebraic difference is permitted between the travel lanes and shoulder in advance of barriers. See **FDM 215.4.6.5** for temporary barrier requirements in superelevated roadway sections.

215.4.6.3 Length of Need

Length of need is used to determine the required placement of barrier, relative to hazards. Use the requirements provided in the [Standard Plans Instructions](#) or the [Standard Plans](#) to establish length of need for each barrier type.

Length of need is dependent on:

- (1) Barrier type
- (2) Design speed
- (3) Offset distance to the face of the barrier
- (4) The lesser distance to either the back of the hazard or the clear zone limit

On new construction and reconstruction projects, use clear zone width requirements for new construction in the length of need calculations. For existing hazards on RRR projects,

new barrier installations may be designed using RRR clear zone width requirements for length of need calculations. See **Table 215.2.1**.

When existing project constraints prevent placement of barrier for the full length of need required, place the barrier to the greatest extent possible within the available space. Examples of existing project constraints include canals, side streets, driveways, and railroad crossings. Provide site-specific justification for not meeting the required length of need.

Extend the trailing end of barriers downstream, relative to hazards, in accordance with the [Standard Plans Instructions](#). For Concrete Barrier and Bridge Traffic Railing, see the [Standard Plans Instructions](#) for **Index 521-001**.

215.4.6.4 Continuous Median Barriers

Continuous median barriers are used to mitigate median crossover crashes (i.e., reduce the number of vehicles that might enter opposing lanes of traffic after traversing a median).

Locate continuous median barrier in accordance with guidelines included in the **AASHTO RDG, Section 6.6** and in accordance the [Standard Plans](#).

In locations where a continuous median barrier is present, the length of a barrier opening should be minimized. As shown in **FDM Exhibit 211-3**, the barrier ends on each side of the opening should be offset. Provide crashworthy end treatments or crash cushions to shield the barrier ends when the ends are within the clear zone and fall within the departure angle used to set length of need. Provide crashworthy end treatments or crash cushions when the angle between barrier ends is less than 30 degrees, measured from the direction of mainline travel.

The preferred barrier option for continuous median barrier is High Tension Cable Barrier (HTCB), provided the requirements of the [Developmental Standard Plans Instructions](#) for **Index D540-001** can be met. Evaluate other barrier options when the deflection and placement requirements for HTCB cannot be met.

Include Rub Rail on double faced w-beam guardrail installations as shown in [Standard Plans, Index 536-001](#). Based on the full shoulder width as shown in **Figure 215.4.6**, locate double faced w-beam guardrail at a lateral offset of between 8 feet and 12 feet from the edge of traveled way. For medians with cross slopes of 1:6 or flatter, locate the barrier closest to the traveled way with the most likelihood or history of lane departure (e.g., outside of horizontal curves and sections with outside merge lanes). If median cross slopes greater than 1:6 exist, and HTCB is not feasible, install w-beam guardrail along

both sides of the median or consider a grade separated (bifurcated) median with a concrete barrier.

Use concrete median barrier when the barrier offset requirements for flexible or semi-rigid barrier cannot be met or a higher test level barrier is justified. Implement concrete median barrier in accordance with [Standard Plans, Index 521-001](#).

215.4.6.5 Requirements for Culverts

Roadside barriers placed at a culvert (i.e., box culvert, bridge culvert, or three-sided culvert) should be either W-Beam Guardrail or Bridge Traffic Railing. See **Chapter 6** of the [Structures Design Guidelines](#) for more information regarding bridge traffic railings.

W-Beam Guardrail is the preferred barrier option, provided the grading, post embedment and length of need requirements can be met. A minimum of 4 feet of fill must be provided over the culvert for adequate post embedment and performance. If there is less than 4 feet of fill over the culvert, utilize one of the following options:

- (1) Culverts with total overall widths ≤ 5 feet: use W-Beam Guardrail with a post layout that straddles the outside of the culvert using standard post spacing of 6'-3".
- (2) Culverts with total overall width between 5 feet and 20 feet: use shortened W-Beam guardrail posts (e.g., Encased Post for Shallow Mount). See [Standard Plans, Index 536-001](#).
- (3) Culverts with total overall width > 20 feet: use a project specific designed metal traffic railing similar to the Thrie-Beam Retrofit barriers (i.e., thrie-beam railing attached directly to the culvert headwall), see the [Standard Plans, Index 460 Series](#). Designers should note that the locations of the first and last posts are critical. Headwalls must be a minimum of 18 inches wide and the base plate must be located so that it is located at least 12 inches away from any construction joint or free end of the concrete headwall.

Placement of base plates and bolts in the top slab of the culvert barrel should be avoided because they are difficult to repair and maintain, the necessary anchor embedment lengths are problematic to obtain, and they are potentially damaging to the top of the culvert barrel.

Concrete rigid barrier or bridge traffic railing is typically not used due to the short length of culverts, unless continued along the roadway for other reasons.

215.4.6.6 Temporary Barriers

Installation instructions and flare rates are given in [Standard Plans](#), *Indexes 102-100, 102-110, 102-120* and *102-600*.

A temporary or permanent pavement surface with a maximum cross slope of 1:10 is required when a temporary barrier is used. Refer to [Standard Plans](#), *Index 102-100* for setback distance and asphalt pad requirements.

Show or note the location of temporary barriers in the Temporary Traffic Control (TTC) Plans. Also provide a Work Area Access Plan for projects with work zones shielded with a barrier. For additional information regarding TTC Plans, refer to *FDM 240*.

The presence of barriers on both shoulders may eliminate any effective shoulder width or refuge area. The effective shoulder width is required to ensure an area is available for both disabled vehicles during normal traffic conditions and access for emergency responders during stopped conditions. Therefore, on interstate, freeway, and expressway projects requiring barriers on both sides of the work zone traveled way, provide a minimum 10-foot lateral offset from the edge of the traveled way to the barrier on at least one side of the roadway. Providing refuge to the outside is preferred. For conditions with more than three lanes in one direction, consider a 10-foot lateral offset on both sides of the roadway. See also, *FDM 211.4.6* for Emergency Shoulder Use (ESU) requirements. Existing bridges and grade-separated approaches that are not along an ESU evacuation route need not be widened to meet this requirement. Consider providing this 10-foot lateral offset on arterials and collectors. For all other applications, provide the minimum lateral offset required per [Standard Plans](#), *Index 102-100*.

When using existing barrier during a temporary traffic control operation or when 2-way traffic is placed on a facility that is normally one-way, the existing permanent or temporary barriers must be modified as necessary to ensure their proper crashworthiness during the temporary situation. This will include eliminating non-crashworthy end treatments, snag points or other protrusions normally angled away or hidden from approaching vehicles.

Existing permanent barriers used during temporary traffic control operations must meet grading, offset, and setback (i.e., deflection space) requirements for the permanent installation.

Temporary barriers, as defined in *FDM 215.4.1.4*, located in superelevated roadway sections must be installed on the same roadway cross slope as the travel lanes (i.e., no slope break in advance of the barrier).

215.4.7 Warrants for Roadside Barriers

The installation of roadside barriers presents a hazard in and of itself, and as such, requires an analysis for whether or not the installation of a barrier presents a greater risk than the feature it is intended to shield. The analysis should be completed using the **Roadside Safety Analysis Program (RSAP)** or in accordance with the **AASHTO Highway Safety Manual (HSM)**. Refer to **FDM 122.6** for guidance on evaluating the benefits of shielding using **RSAP** or the **HSM**.

Roadside barriers are recommended when hazards exist within the clear zone and do not meet minimum Lateral Offset, hazards cannot be cost effectively eliminated or corrected, and collisions with the hazards are more serious than collisions with the barriers.

The following conditions within the clear zone are considered more hazardous than a roadside barrier and preclude the requirement for **RSAP** or **HSM** analysis:

- (1) Drop-off Hazards, as defined in **FDM 215.3.3**.
- (2) Bridge piers, abutments and railing ends.
- (3) Non-traversable culverts, pipes and headwalls.
- (4) Non-traversable parallel or perpendicular ditches and canals.
- (5) Canals, ponds and other bodies of water.
- (6) Parallel retaining walls with protrusions or other potential snagging features.
- (7) Retaining walls at an approach angle with the edge of pavement larger than 7 degrees (1:8).
- (8) Non-breakaway sign or luminaire supports.
- (9) Trees greater than 4 inches in diameter measured 6 inches above the ground.
- (10) Utility poles.
- (11) Weaving Sections, as defined in **FDM 211.12.1**.

215.4.7.1 Treatment of Roadside Hazards

If a hazard, including slopes steeper than 1:3, is present within the clear zone, eliminate or shield the hazard, except when any of the following apply:

- Longitudinal barrier or crash cushion would be a greater hazard than the hazard to be shielded
- The likelihood of striking the hazard is negligible

- The expense of shielding the hazard outweighs the benefits in terms of crash reduction as determined through the use of **RSAP** or **HSM** analyses.

If crash data or safety reports indicate that treatment of the hazard will result in fewer or less severe crashes, implement one of the following treatments, in order of priority:

- (1) Eliminate the hazard.
 - (a) Remove the hazard.
 - (b) Relocate the hazard outside the clear zone.
 - (c) Make the hazard traversable or crashworthy.
- (2) Shield the hazard with a longitudinal barrier or crash cushion.

215.4.8 Warrants for Median Barrier

Provide a median barrier on LA Facilities when:

- (1) Reconstruction reduces the median width to less than what is required for the facility. Deviation from this criteria is not permitted. An **RSAP** or **HSM** analysis may be used to evaluate barrier alternatives and supplement the following requirements.
- (2) One or more crossover crashes have occurred in the most recent 5-year period within the limits of 1 mile in advance of the exit ramp gore to 1 mile beyond the entrance ramp gore. The District may require shielding outside these areas after reviewing the most recent 5-year crash history.

On divided arterial and collector projects with design speed greater than 45 mph, review the most recent 5-year crash history for crossover crashes to determine if shielding with a median barrier is warranted. Consider alignment, sight distance, median width and frequency of median openings when evaluating the facility.

215.4.9 Positive Protection in Work Zones

For locations where work zone traffic barriers (i.e., Temporary Barriers) are required, refer to [Standard Plans](#), **Index 102-600**. Work zone traffic barriers have four specific functions:

- (1) Protect traffic from entering work areas (e.g., excavations or material storage sites).
- (2) Provide positive protection for workers.

- (3) Separate two-way traffic.
- (4) Protect construction such as false work for bridges and other exposed objects.

Anticipate when and where barriers will be needed and include this information and the quantities on the Plans. Consider positive protection devices in work zone situations that place workers at increased risk from vehicular traffic, and where positive protection devices offer the highest potential for increased safety for workers and road users, such as:

- (1) Work zones that provide workers no means of escape from vehicular traffic (e.g., tunnels, bridges).
- (2) Long duration work zones (two weeks or more at the same location) resulting in substantial worker exposure to vehicular traffic.
- (3) Projects with anticipated Work Zone speeds greater than 45 mph, especially when combined with high traffic volumes.
- (4) Work operations that place workers close to travel lanes open to traffic.
- (5) Roadside hazards (e.g., drop-offs, unfinished bridge decks) that will remain in place overnight or longer.

Modification for Non-Conventional Projects:

Delete the first sentence of the above paragraph and see RFP for requirements.

215.4.9.1 RRR Evaluation of Shielding in Work Zones

Temporary shielding is not required on RRR projects where existing aboveground objects or drop-offs are located within the “Clear Zone Widths for Work Zones” (See ***Standard Plans, Index 102-600***) when both of the following conditions are met:

- Existing aboveground objects and drop-offs will remain unshielded in the permanent condition
- The lateral offset to the existing aboveground objects or drop-offs will be the same during construction

215.5 Attachments to Barriers

Allowable attachments to flexible or semi-rigid barriers (discontinuous or continuous) are detailed in the [Standard Plans](#).

Use [Standard Plans, Index 700-012](#) for signs attached to rigid barrier. [Standard Plans, Index 700-013](#) can only be used to mount permanent signs to non-median rigid barriers when there is insufficient space for [Standard Plans, Index 700-012](#) and the sign is critical to safety.

Design and detail attachments to rigid barriers in accordance with [SDG 1.9](#). Provide setback distances as shown in [Table 215.4.2](#) and [Figure 215.4.7](#) to non-crash tested discontinuous items (e.g., light poles, sign supports, traffic signal controller boxes, flood gauges) that are attached to or behind rigid barriers located along the outside shoulder. Discontinuous items located within these setback distances must be crash tested to or accepted as TL-3, at a minimum, under [NCHRP 350](#) or [MASH](#) as attachments to traffic railings.

For continuous items attached to rigid barriers, refer to the requirements of [FDM 215.4.6.1](#).

Fender access ladders are exempt from these requirements. Sign panels may be placed within the given setback distances, however the setback to the sign support must be increased to assure sign panels do not extend past the top inside face of the traffic railing.

215.5.1 Median Barrier Attachments

215.5.1.1 Light Poles and Sign Supports

Use [Standard Plans, Index 715-002](#) for light poles installed in conjunction with concrete median barriers or traffic railings. Overhead sign supports may be located on rigid barriers within the median to reduce span or cantilever lengths and provide more cost-effective designs. When placing overhead sign supports on rigid barriers within the median, project specific details that supplement [Standard Plans, Index 521-001](#) (e.g., foundation and reinforcement details) are required to be shown in the Plans.

Single column sign supports mounted on rigid barriers within the median are permitted only when requirements for sign visibility cannot be met by placing the sign supports on the outside of the shoulder barrier or beyond the shoulder. If single column sign supports must be mounted on a median traffic railing, utilize [Standard Plans, Index 700-013](#). The signs listed in [FDM 230.2.5](#) are the only permanent signs that may be used with [Standard Plans, Index 700-013](#).

These requirements also apply to attachments made to back-to-back outside shoulder rigid barriers that are located so close together that the required setback distances cannot be provided for both barriers. The bridge traffic railings and supporting decks shown in [Figure 215.4.7](#) that are located back-to-back are exempt from these requirements.

215.5.1.2 Opaque Visual Barrier

Opaque Visual Barrier is used on top of median concrete barrier and traffic railing to reduce headlight glare from opposing traffic lanes. Opaque Visual Barrier may be considered on LA Facilities that have glare issues when the facility has high-traffic volumes and a separation between opposing traffic lanes of 26 feet or less.

When Opaque Visual Barrier is used, a minimum shoulder width of 4 feet is required on both sides of the median concrete barrier or traffic railing.

[Standard Plans, Index 521-010](#) and the associated [Standard Plans Instructions](#) provide additional information.

215.5.2 Existing Attachments to Barriers and Traffic Railings

Evaluate existing rigid barrier attachments on a case-by-case basis to ensure they are installed in accordance with the *FDM* and [Standard Plans, Indexes 700-012, 700-013, or 715-002](#). Remove existing attachments not meeting these requirements.

215.5.3 Temporary Attachments to Barriers

[Standard Plans, Index 700-012 or Index 700-013](#) may be used for temporary work zone signs when the application of [Standard Plans, Index 102-600](#) cannot be achieved. Use [Standard Plans, Index 700-012](#) only when mounting to the top of the barrier/railing places the sign panel closer than 2 feet from the traveled way.

For additional information on the design of temporary lighting in combination with temporary barrier, refer to *FDM 240.4.2.13*.

215.6 Surface Finishes

Class 5 coatings, tints or stains may be applied to roadway concrete barrier walls in order to be compatible with the treatment of bridge or retaining wall mounted traffic railings or for corridor uniformity. Approval by the District Design Engineer is required for the use of Class 5 coatings, tints, or stains. Abrupt changes of aesthetic treatment of barriers, railings, or parapets from a bridge to a roadway should be avoided. See [SDG, Section 1.4.5](#) for the policy on bridge, noise wall and retaining wall surface finishes.

The Department will cover the cost for coating, tints or stains on roadway concrete barriers only as described above. If a Local Maintaining Agency desires a roadway

concrete barrier with coatings, tints or stains and the concrete barrier does not qualify for such treatment as determined by the Department, the barrier may be treated with approval by the District Secretary. The Local Maintaining Agency must provide the additional construction funding for the coatings, tints, or stains and must commit to cover the associated maintenance costs for the service life of the barrier.

215.7 Existing Barrier Systems

When barrier systems are present on a project for which reconstruction of the roadside is not required, the existing barrier should be evaluated to determine if the barrier meets current structural, functional, and crashworthy requirements. Remove or replace any barrier installation which is found to be non-crashworthy or crash tested prior to **NCHRP 350** test criteria. The evaluation should consider the following:

- (1) Warrants for the barrier. See **FDM 215.4.4**.
- (2) Length of need.
- (3) Guardrail panel height.
- (4) Offset at terminal end.
- (5) Clear deflection distance between the barrier and the shielded object.
- (6) Placement with respect to the traveled way, or face of curb.
- (7) Placement on the proper slope.
- (8) Clear recovery area behind gating end terminals.
- (9) Overall condition of the barrier system.
- (10) Post type and spacing.

In addition to the above evaluation requirements, existing roadside safety hardware must comply with the requirements of the following Sections.

215.7.1 Resetting Guardrail

For installations of guardrail where the barrier is determined to be deficient or requires relocating due to other work, but otherwise determined to consist of panels in good condition, the guardrail may be reset. If the guardrail system is determined to be non-reusable, remove, and replace with new guardrail. Refer to [Standard Specification 538](#) for additional information on reusable and non-reusable guardrail components.

When resetting existing guardrail, the guardrail will be reinstalled as **31" Guardrail** reusing existing guardrail panels and posts (steel only) as shown in the current [Standard Plans, Index 536-001](#). This resetting requires panels be reinstalled with the panel splices located at the midspan; therefore, consideration must be given to the effect this will have on the overall system length and if adjustments to the Begin/End Guardrail Station are needed.

Guardrail approach transition connections to rigid barrier, approach terminals, and trailing anchorages must be replaced with new hardware, panels, and posts when resetting guardrail.

215.7.2 Existing Longitudinal Roadway Barriers

Existing longitudinal guardrail sections that do not conform to **31" Guardrail** must be upgraded or replaced, with the following exceptions:

- (1) **27" Guardrail** – Existing W-Beam guardrail installations installed to a 1'-9" mounting height (27" top height), meeting the requirements of the **2013 Design Standards** with regards to delineation, height, deflection distance, grading, mounting hardware, length of need, and consisting of crashworthy end treatments tested to at least **NCHRP 350**, is acceptable and allowed to remain in place.
- (2) **Thrie-Beam Guardrail** – Existing Thrie-Beam guardrail meeting the installation requirements of **2013 Design Standards** and consisting of crashworthy end treatments tested to at least **NCHRP 350**, is acceptable and allowed to remain in place.
- (3) **Steel Blocks** – Existing **27" Guardrail** constructed with steel blocks, which is not being evaluated for upgrading according to the criteria above, may remain in place for projects with Design Speeds ≤ 45 mph.

Replacing or resetting existing **27" Guardrail** to meet the **31" Guardrail** mounting height requirement is at the discretion of the District. Typically, if 50% or more of an existing run of **27" Guardrail** is affected or if the existing installation is extended by 50% or more, the entire run should be replaced or reset with **31" Guardrail**. The required clear deflection distances for **31" Guardrail** are greater than the requirements for **27" Guardrail** and should be considered when resetting guardrail to the new height.

Modification for Non-Conventional Projects:

Delete the last paragraph and see RFP for requirements.

Existing concrete barriers conforming to the current [Standard Plans](#), *Index 521-001*, F-Shape, New Jersey shape barriers, and approved vertical faced concrete barriers may remain in place. Other concrete barrier shapes must be replaced.

Replacements and new installations must conform to the current [Standard Plans](#).

See *FDM 215.4.5.4* and [SDG](#), *Section 2.6*, for barrier requirements for Pier Protection.

215.7.3 Existing End Treatments & Crash Cushions

Evaluate end treatments to ensure adequate length of need is provided and meet crashworthiness requirements. Remove or replace end treatments and crash cushions which are found to be non-crashworthy or crash tested prior to *NCHRP 350* test criteria. Existing guardrail end treatments must be upgraded or replaced unless they conform to one of the systems identified on the [APL](#), the current [Standard Plans](#), or the *2013 Design Standards*.

Replacements and new installations must conform to the current [Standard Plans](#).

215.7.4 Existing Bridge Traffic Railing

Evaluate bridge traffic and pedestrian railings for conformance to current *FDM* criteria and [Standard Plans](#) whenever improvements are made to a bridge or its approach roadway. For non-compliant bridge railings:

- (1) Retrofit bridge railing to bring them up to current standards, or
- (2) Replace bridge railing, or
- (3) Process a Design Variation, provided that a subsequent project that will remedy this condition is scheduled within a reasonable time.

See [SDG](#) 6.7 for traffic railing requirements, and [SDG](#) 6.8 and the following for pedestrian railing requirements.

Remove existing fences that are not in compliance with [Standard Plans](#), *Indexes 550-010* or *550-011*, and existing pedestrian railings that are mounted on existing traffic railings located between the shoulder and the sidewalk (a.k.a. "inboard" traffic railings). Replace or retrofit the existing pedestrian railing or fence rather than completely removing it if there is a documented issue of traffic incidents involving pedestrians (at the site before installation of the existing pedestrian railing or fence on the inboard traffic railing) that would likely reoccur if the existing installation were to be removed. Use [Standard Plans](#), *Indexes 550-010* or *550-011*, or another crashworthy pedestrian railing or fence that is

compatible with the traffic railing, as appropriate. Retrofit existing bullet-type railings that are to remain on inboard traffic railings and that do not have the bullet railing member(s) oriented towards the traffic side of the railing to match [Standard Plans, Index 515-021](#).

Retrofit existing installations of [Standard Plans, Index 515-021](#), and other similar bullet-type railings, to include rail splice assemblies and tapered end transitions as shown on [Standard Plans, Index 515-022](#) if they are not present. Retrofit the ends of other existing crashworthy traffic railing mounted pedestrian railings to include a similar tapered end transition, or other appropriate approach end transition, if one is not present.

215.7.5 Existing Guardrail to Bridge Railing Transitions

Existing guardrail to bridge traffic railing approach and trailing end transition connections must be upgraded or replaced unless they conform to one of the following systems:

- (1) For approach ends of existing standard New Jersey Shape, F-Shape, and Single-Slope bridge traffic railings:
 - (a) The nested Thrie-Beam approach transition shown as in the current [Standard Plans](#) or the **2013 Design Standards, Index 400**.
 - (b) For retrofitted installations, the appropriate nested Thrie-Beam transition shown in the current [Standard Plans](#) or the **2013 Design Standards, Index 402**.
 - (c) For a design speed ≤ 45 mph the nested w-beam approach transition shown as **Detail J** in the **1998 Roadway and Traffic Design Standards, Index 400**, Sheet 7 of 21. This detail is also shown in the **2000 Roadway and Traffic Design Standards, Index 401**, Sheet 1 of 9.
- (2) For approach ends of existing bridge traffic railing retrofits constructed in accordance with the **1987 through 2000 Roadway and Traffic Design Standards, Index 401, Schemes 1 and 19, "Concrete Safety Barrier"**:
 - (a) The appropriate nested Thrie-Beam transition shown in [Standard Plans, Index 536-002](#).
 - (b) For design speeds ≤ 45 mph the w-beam approach transition shown as **Detail J** in the **1987 Roadway and Traffic Design Standards, Index 400**, Sheet 9 of 13, upgraded as shown in the **2013 Design Standards, Index 403** by the installation of a nested section of W-beam guardrail, additional guardrail posts and offset blocks and a transition block if a curb is not present beyond the bridge end.
 - (c) For design speeds ≤ 45 mph the nested W-beam approach transition shown as **Detail J** in the **1998 Roadway and Traffic Design Standards** Sheet 7 of

- 21, upgraded as shown in the **2013 Design Standards, Index 403** by the installation of a transition block if a curb is not present beyond the bridge end.
- (3) For trailing ends of existing bridge traffic railing retrofits constructed in accordance with the **1987 through 2000 Roadway and Traffic Design Standards, Index 401, Schemes 1 and 19, "Concrete Safety Barrier"**:
 - (a) In the absence of additional hazards on the trailing end, no end treatment is required.
 - (b) When additional hazards are present on the trailing end, a w-beam trailing end treatment as shown in [Standard Plans, Index 536-001](#).
 - (4) For approach ends of existing structurally continuous Post and Beam bridge traffic railings that are not being retrofitted per **FDM 215.7.4**:
 - (a) A custom designed nested Thrie-Beam approach transition based on the current [Standard Plans, Index 536-001](#).
 - (b) A nested Thrie-Beam approach transition based on the current [Standard Plans, Indexes 536-002, 521-404 or 521-405](#).
 - (c) A custom designed nested Thrie-Beam approach transition based on the **1987 through 2000 Roadway and Traffic Design Standards, Index 401, Scheme 29**.
 - (5) For trailing ends of existing structurally continuous Post and Beam bridge traffic railings that are not being retrofitted, per **FDM 215.7.4**:
 - (a) In the absence of additional hazards on the trailing end, no end treatment is required.
 - (b) When additional hazards are present on the trailing end, a w-beam trailing end treatment as shown in the current [Standard Plans, Index 536-001](#) or the **1987 through 2000 Roadway and Traffic Design Standards, Index 401**.
 - (c) When additional hazards are present on the trailing end, a custom designed nested Thrie-Beam approach transition based on any design listed in No. 4 above.
 - (6) For trailing ends of existing standard New Jersey Shape, F-Shape, and Single-Slope traffic railings:
 - (a) The w-beam to Special End Shoe connection shown in the 1980 through FY2016-17 Design Standards, Index 410.

Guardrail replacements and new installations connecting to standard New Jersey Shape F-Shape, and Single-Slope bridge traffic railings must conform to the current [Standard Plans, Index 536-001](#). For guardrail retrofits connecting to existing bridge traffic railings,

see the current [Standard Plans](#), *Indexes 536-002* or *460-477* and their associated [Standard Plans Instructions](#).

Guardrail replacements, retrofits and new installations connecting to structurally continuous post and beam bridge traffic railings must conform to [Standard Plans](#), *Indexes 521-404* or *521-405* and their [Standard Plans Instructions](#). See the [Standard Plans Instructions](#) for details of structurally continuous post and beam traffic railings.

215.8 Non-Standard Roadside Safety Hardware

The use of Non-Standard Roadside Safety Hardware must be approved by the State Roadway Design Office (RDO). Roadside Safety hardware that is not listed on the [APL](#) and not shown in the [Standard Plans](#) is considered Non-Standard. The [APL](#) includes proprietary devices and products that have been evaluated for compliance with FDOT [Standard Specifications](#) and the [Standard Plans](#). The majority of proprietary roadside safety hardware eligible for use on the State Highway System are identified on the [APL](#). However, the devices included on the [APL](#) may not cover every roadside safety application. Unique situations will sometimes require unique devices. Examples of available devices that are not covered by the [APL](#) include but are not limited to barrier wall gates, aesthetic guardrail, temporary steel barriers, and crashworthy stop gates. When the need arises for a unique crashworthy device not included on the [APL](#), carefully investigate the applicability of the device for the situation, as well as the crash performance characteristics of the device. For some of these devices, the State Roadway Design Office (RDO) may have information and be of assistance in establishing the appropriateness of the device for a given situation.

Provide the following documentation when requesting the approval of a device not included in the [Standard Plans](#) or [APL](#):

- (1) FHWA, Federal-Aid Reimbursement Eligibility Letter
- (2) Crash Test Reports, including review of test results. Performance characteristics must be reviewed, including post impact vehicle behavior and post impact test article deflection, and debris scatter.
- (3) Compatibility with adjacent and/or connecting standard roadside safety devices.
- (4) Maintenance requirements and characteristics, including coordination with the District Maintenance Office.
- (5) For devices such as barrier gates, operational plans, and training as appropriate.

Project specific plan details, technical special provisions (TSP), and method of payment will be required and must be coordinated with the appropriate Department Offices.

Other barrier designs may be required by specific site conditions. Site specific conditions are identified and detailed in the plans.

216 Earthwork

216.1 General

Earthwork is a generic term for all items of work, materials and operations required to construct the excavated areas and the embankments of a project.

[FDOT Specifications](#) **Sections 110, 120, and 125** define the terms, method of measurement, basis of payment, and pay items associated with earthwork.

Earthwork on a highway project generally consists of:

- **Clearing and Grubbing** – Removal of existing pavement to prepare the area for proposed construction. See [Standard Specifications](#) **Section 110** for additional requirements.
- **Embankment** – Compacted fill material needed to construct the roadway. See [Standard Specifications](#) **Section 120** for additional requirements.
- **Regular Excavation** – See [Standard Specifications](#) **Section 120** for additional requirements.
- **Subsoil Excavation** – See [Standard Specifications](#) **Section 120** for additional requirements.
- **Excavation for Structures and Pipe** – See [Standard Specifications](#) **Section 125** for additional requirements.

The roadbed is constructed by excavating soil from cut sections and placing soil as embankments in fill sections. A summary of the most common cut and fill sections are described in this chapter.

216.2 Classification of Soils

The Department uses a system of soil classification that places materials into groups and subgroups based on soil fraction, liquid limit, and plasticity index. This classification determines if and where the materials may be placed or left in their existing position on a project. The soils survey, testing and classification of materials must be performed by a qualified geotechnical laboratory. The plans will include the information about the soil classification on the soil survey sheet and by showing the boring data soil boxes on the cross-section sheets. If it is determined that an organic or plastic material must be removed below the finished graded surface, the lower limits of removal of organic or plastic material will be shown to determine the area and volume of subsoil excavation.

216.3 Cross Sections

The details of cut and fill of earthwork are shown on the cross sections. The cross sections of the existing surface are usually obtained by location field survey or photogrammetry. The finished profile grades, typical section details, pavement design details, superelevation and horizontal alignments are used in combination to develop the finished surface at each location where an existing cross section was obtained or generated. Sometimes it is advisable to develop and plot intermediate cross sections or half-sections to accurately determine quantities.

Cross sections cannot be finalized until late in the design process. However, preliminary cross section surfaces, developed early in the design process, can assist the designer in establishing many of the other design elements such as guardrail, shoulder gutter, inlets, and special ditch grades. Preliminary cross sections are also used in performing the Soils Survey. Cross section surfaces should be plotted as soon as the alignment, profile grades and typical section details are established.

For guidance see *FDM 905*.

216.4 Earthwork Pay Items

[Standard Specifications](#), *Sections 120* and *125* define the terms, method of measure, basis of payment, and pay items associated with earthwork. Two terms that are relevant to quantifying earthwork pay items are: existing surface and finished graded surface. The existing surface is defined as the contour of existing natural topography. The finished graded surface (illustrated in *Figure 216.4.1*) is defined as the contour of the finished side slopes, unpaved shoulders, and the bottom of the roadway base and shoulder base for flexible or rigid pavement.

Figures 216.4.2 through 216.4.5 illustrates cut and fill limits and details. Additional criteria and earthwork details are found in the [Standard Plans](#), *Indexes 120-001, 120-002, and 160-001*.

Figure 216.4.1 Finished Graded Surface

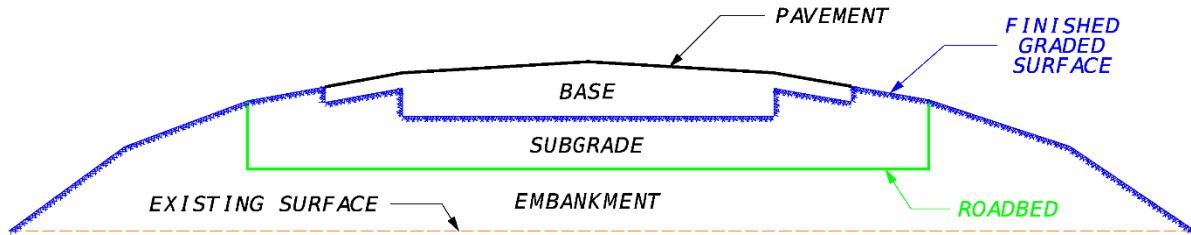

Projects are constructed over natural topography (Case I) or over existing roadbeds (Case II). Project may also have sections where both Case I and Case II apply.

For Case I projects, calculate the Excavation quantities from the existing surface to the finished graded surface.

Figure 216.4.2 Case I Excavation

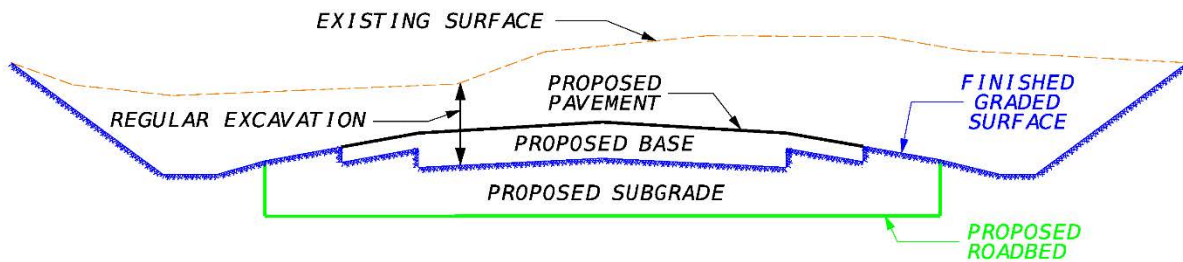

Calculate the Embankment quantities from the existing surface to the finished graded surface.

Figure 216.4.3 Case I Embankment

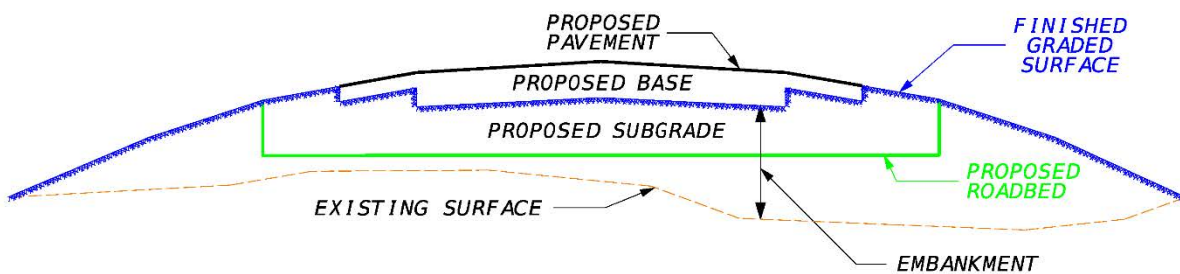

Case II projects may or may not include the removal of existing base material or removal of existing concrete pavement. According to [Standard Specification 120-4.2](#):

- Only the asphalt on existing flexible pavement roadways will be removed (not base material) unless shown in the Plans; and,
- Existing concrete pavement is only to be removed when called for in the Plans.

Coordinate with the District Pavement Materials Office (DPMO) to determine if removal of existing flexible pavement base or concrete pavement is required. If the existing flexible pavement base or the existing concrete pavement are to be removed, this must be indicated in the Plans and included in the Clearing and Grubbing pay items.

Calculate the Excavation quantities for a new roadway as shown in **Figure 216.4.4**. For Case II projects, calculate the Excavation quantities from the existing surface to the finished graded surface of the new road; or if concrete pavement removal is called for in the plans, the calculation is taken from the bottom of the existing concrete to the finished graded surface of the new road.

Figure 216.4.4 Case II Excavation

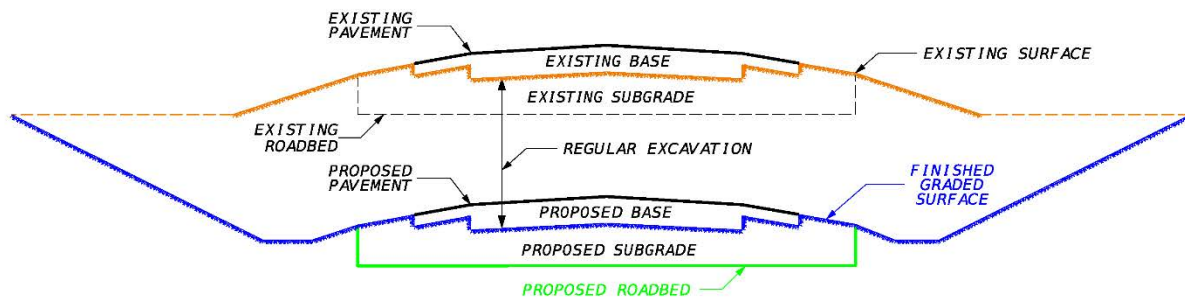

Calculate the embankment quantities for a new roadway as shown in **Figure 216.4.5**. Calculate the Embankment from the top of the existing base to the finished graded surface of the new road (**Figure 216.4.5 Left**) or, if the base removal is called for in the plans, calculate the Embankment from the bottom of the existing surface (finish graded surface) to the finished graded surface of the new road (**Figure 216.4.5 Right**). If concrete pavement removal is called for in the plans, the calculation is taken from the bottom of the existing concrete to the finished graded surface of the new road.

Figure 216.4.5 Case II Embankment

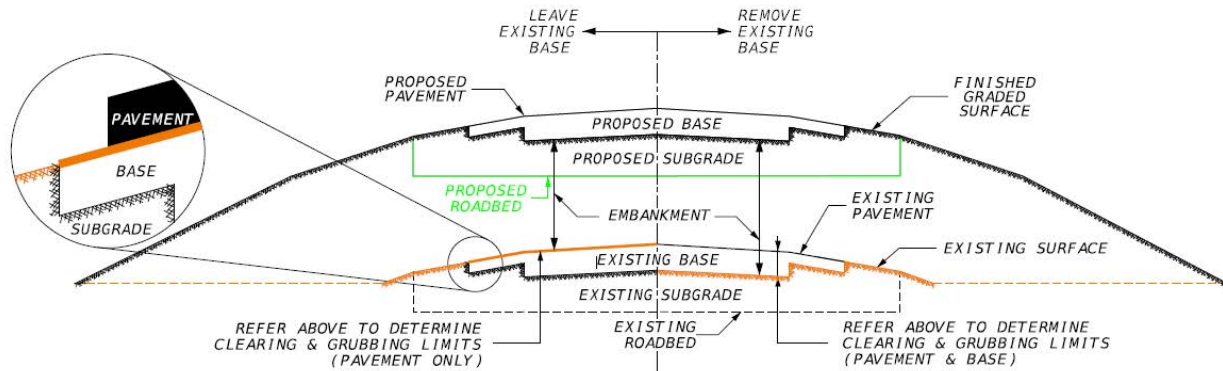

216.4.1 Regular Excavation

Regular excavation is the most general classification of earthwork excavation. Regular excavation consists of the excavation and the utilization or disposal of all materials necessary for the construction of the roadway, ditches, channel changes, etc., except for removal of existing pavement as defined in [Standard Specifications Section 110](#). When Lateral Ditch or Channel excavation pay items are not called for in the plans, the total quantity of all excavation must be paid for as Regular Excavation.

216.4.1.1 Stormwater Treatment Ponds

Retention or detention areas that require considerable excavation should be summarized separately and added to the Regular Excavation. This is especially important if there is a large quantity and the area is removed from the project by some distance.

Some environmental permits now require that the plans call for excavating additional depth below the finish elevation of the bottom of a pond or ditch. They also require that the area of extra depth be replaced with “blanket material” that will either allow for percolation or not allow for percolation as required by the permit. **Figure 216.4.6** shows the limits of pay for excavation in this situation. The depth and type of fill material must be identified in the plans.

Figure 216.4.6 Pond Surface

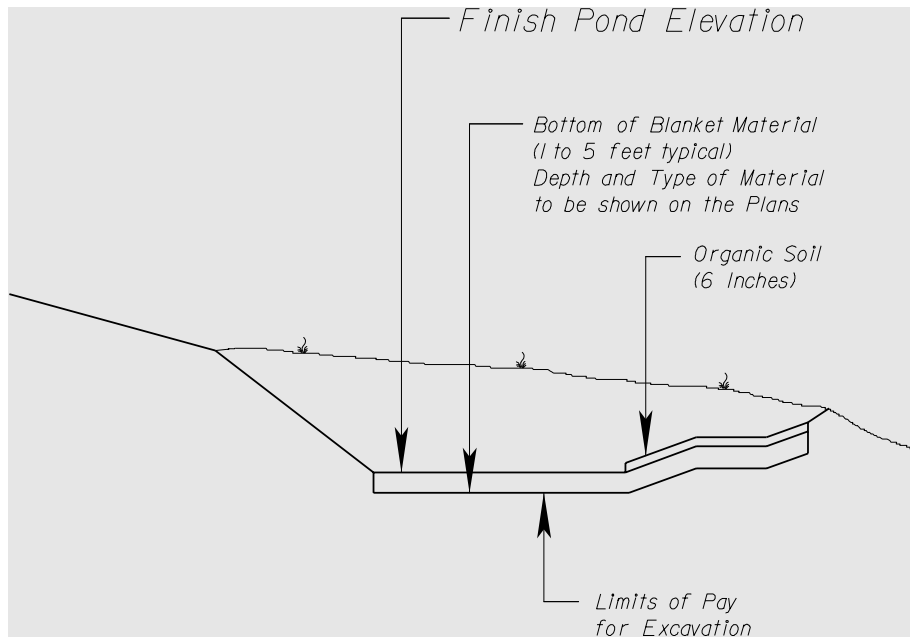

216.4.1.2 Regular Excavation (RRR Projects Only)

The pay item for Regular Excavation (RRR Projects Only) Lump Sum is used on resurfacing (RRR) projects that meet the following conditions:

- (1) There are limited or no cross sections on the project.
- (2) Existing typical sections are reasonably consistent throughout the project.
- (3) If utility adjustments are a consideration on the project, the designer will need to be sure that sufficient data is available to allow the utility to be relocated or adjusted.
- (4) There are no right of way requirements on the project.
- (5) There is no change in the existing horizontal or vertical alignment.
- (6) There are no major special ditches on the project.
- (7) There are no major intersection modifications.
- (8) Show quantity of Excavation in Summary of Earthwork but pay for as 1 Lump Sum.

Regular Excavation (RRR Projects Only) - Lump Sum may be used on intersection improvements and minor widening projects if they comply with the same conditions listed above.

Earthwork will be paid for as Borrow Excavation (Truck Measure) and Regular Excavation (RRR Projects Only) – Lump Sum. The designer will calculate these quantities based on information obtained from the field and the proposed typical section. The designer must conduct a thorough field review to ensure existing field conditions are accurately reflected in earthwork estimates.

216.4.2 Subsoil Excavation

Subsoil Excavation is defined in [Standard Specification Section 120-2.3](#).

The soils investigation survey documents the organic or plastic material found on the project. Likewise, the cross sections and the earthwork calculations must use the lower limits of removal of organic or plastic material in determining the quantities for Subsoil Excavation.

Where future widening of the roadway is anticipated, specify the limits of removal necessary to accommodate the future widening.

At some locations the complete removal of organic or soft soils may not be practical due to the depth. Review the subsoil excavation with the Geotechnical Engineer of Record and where constructability concerns exist, consult with the District Geotechnical Engineer to review design alternatives. If a geosynthetic reinforced design is selected, refer to **FDM 263** for plan content and design requirements. Additional information concerning geotechnical design can be found in the [Soils and Foundations Handbook](#).

Where subsoil excavation is required due to plastic soils, ensure that adequate drainage of the pavement subgrade is provided. **Figure 216.4.7** illustrates the required excavation undercut line (i.e., grade and extent of excavation bottom) for flush shoulder roadways. To accommodate normal undercuts, the side ditches should be at least 3.5 feet below the shoulder break.

For curbed roadways, additional subsoil excavation may be needed beyond that shown in **Figure 216.4.7** or underdrains must be installed in accordance with [Standard Plans, Index 120-002](#). Coordinate the removal of plastic materials with the Drainage Engineer of Record, as it may affect various drainage design elements including the profile grade of the ditch bottoms.

The embankment quantities (areas and volumes) may be checked by calculating the areas and volumes required to fill the excavated areas created by subsoil removal. See example given in **Figure 216.4.8**.

Do not include the payment for subsoil excavation in the pay quantities for other items no matter how small the subsoil quantity.

Figure 216.4.7 Undercut Detail of Plastic Material with Relation to Side Ditches

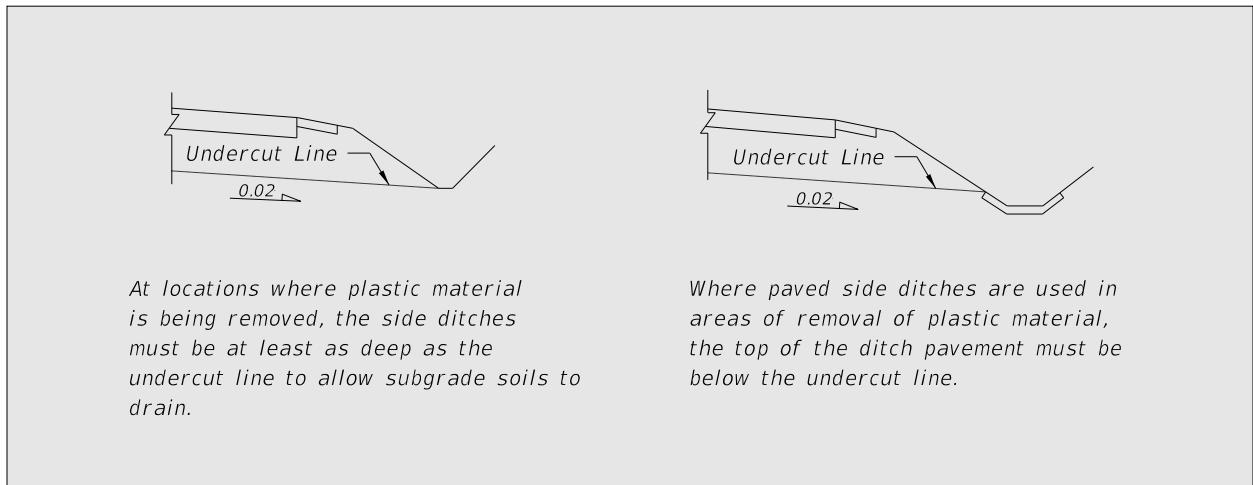
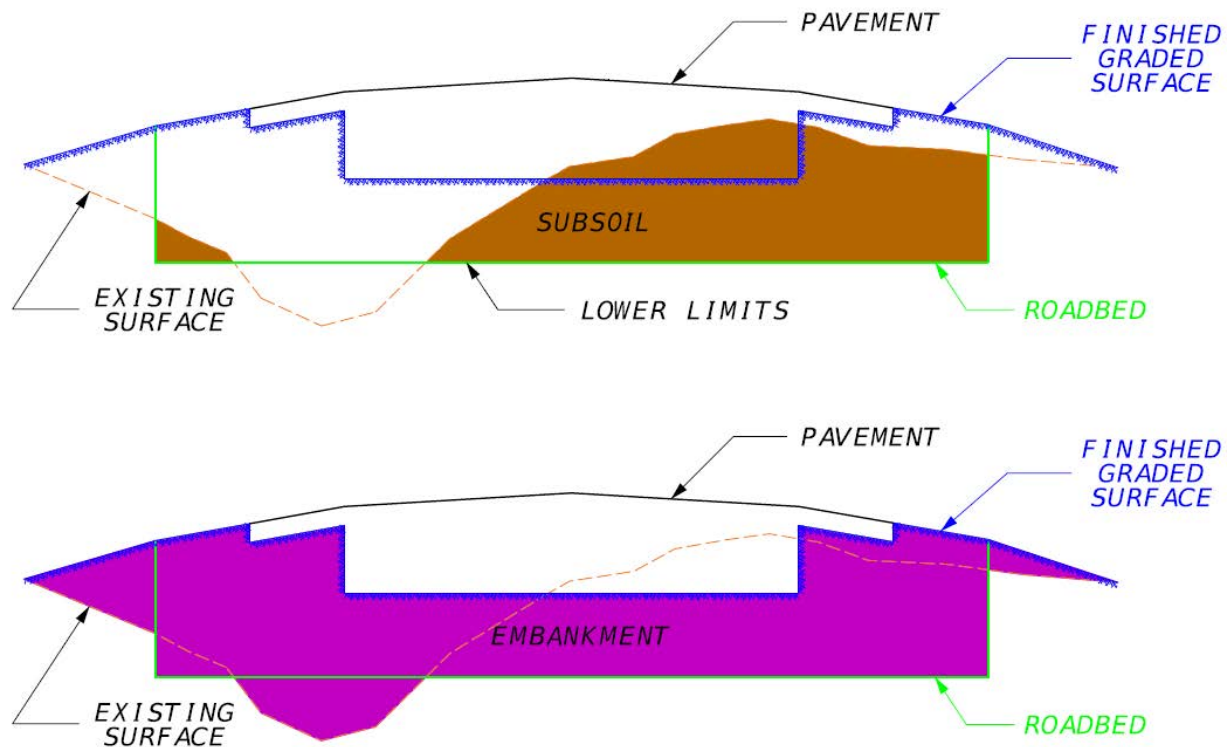

Figure 216.4.8 Excavation and Embankment



Embankment (fill) or Regular Excavation (cut) should be used in conjunction with the pay item Subsoil Excavation. Both Embankment and Regular Excavation are plan quantity items. The quantities are based on the line and grades shown in the plans and would allow construction personnel to field verify the quantities of material used on a project. Subsoil Excavation is a field measure item, and the final pay quantity will be determined by cross section taken when the removal of the material is completed.

216.4.3 Lateral Ditch Excavation

Excavation required to construct inlet and outlet ditches at structures, changes in channels of streams and ditches parallel to the right of way, but separated from the roadway surface, may be designated by the designer as Lateral Ditch Excavation.

On projects with very little of this type of excavation, this earthwork is usually included in the Regular Excavation. If there is a significant amount of Lateral Ditch Excavation, it should be detailed, calculated, and summarized separately in the Summary of Earthwork.

Quantities for **Excavation for Structures and Pipe** must not be included in the quantities for Lateral Ditch or other excavation pay items.

216.4.4 Channel Excavation

The pay item for Channel Excavation consists of the excavation and satisfactory disposal of all material from the limits of the channel as shown in the plans. This work is generally called for by the plans and has lines, grades, typical sections, and other details shown for excavating a channel change or a major modification to an existing channel or stream. This work may be significantly different from regular excavation or lateral ditch excavation, requiring draglines, barges, or other special equipment. It is typically detailed, calculated, and summarized separately.

216.4.5 Borrow Excavation (Truck Measure)

The pay item for Borrow Excavation (Truck Measure) is only used on projects with limited or no cross sections. It is used to indicate that the contractor is to furnish earthwork material from areas provided by him and generally outside the project limits. This could include material with a specific minimum bearing value for building up existing shoulders, when appropriate for the project.

Evaluate the availability of borrow material within the project right of way and conduct an earthwork balance assessment, prior to Phase III. Evaluate any accessibility, drainage, geotechnical, environmental, or environmental restrictions that would affect the determination of available earthwork.

When the designer chooses the method of payment as Borrow Excavation (Truck Measure), a fill adjustment must be made to the net total fill material calculated from the plans to allow for handling. An additional adjustment (truck) is added to obtain a representative volume of material required. This is not a plan quantity item, but it is very important that a realistic determination of quantities be calculated by the designer.

216.4.6 Embankment

Embankment includes placing material, as described in **FDM 216.4**, or above the lower limits of removal of organic or plastic material, as applicable, to the bottom of the proposed roadbed. Refer to **FDM 210.4** and **211.4** for additional requirements for shoulder gutters.

216.5 Earthwork Quantities

Earthwork quantities are typically calculated using surface to surface calculation within the model. For more information, see the *CADD 3D Modeling Course Guide* and [Basis of Estimates](#).

Earthwork quantities may be checked by the method of average end areas:

$$\text{CUBIC YARDS} = \frac{\text{EA1} + \text{EA2} \times \text{LENGTH}}{2} / 27$$

216.5.1 Variation in Quantities

When detailing and determining earthwork quantities, use the most probable base option within the optional base group. A plan note should also be shown in the plans stating which option was used for plotting the cross sections and calculating the earthwork quantities (see *FDM 902*).

216.6 Summary of Earthwork

A subtotal for each group (e.g., mainline, side street, pond) should be shown in the Summary of Earthwork for each earthwork operation (subsoil excavation, regular excavation, and embankment). This summary should be shown on the Summary of Earthwork in the Estimated Quantities Report. See *FDM 902* for information on Estimated Quantities Report. Specify and quantify material necessary to meet the drainage design requirements, such as select material beneath swales, on fill, and ponds designed to percolate runoff.

See Chapter 8 of the *BOE* for examples of Summary of Earthwork.

D217 Diverging Diamond Interchanges

D217.1 General

The Developmental Design Criteria for diverging diamond interchanges can be found on the **FDM Webpage** at [Developmental Design Criteria](#).

See **FDM 100** for more information and procedure for Developmental Design Criteria.

220 Railroads

220.1 General

This chapter provides requirements for highway-railroad crossings on the State Highway System.

220.1.1 Railroad Companies

State-owned rail corridors include the Central Florida Rail Corridor and South Florida Rail Corridor.

Railroad companies currently operating in the state of Florida include:

- (1) CSX Transportation, Incorporated
- (2) Norfolk Southern Corporation
- (3) Florida East Coast Railway Company

Short line railroad companies and terminal switching companies also operate in the state of Florida.

220.1.2 Work Near or Within Railroad R/W

A flagger must be present while any work within railroad R/W is being performed. Railroad companies often impose additional requirements as deemed necessary.

When roadway improvements are adjacent, near, above, or below the railroad R/W, there is potential for impacts to the railroad during construction or for construction materials and equipment to foul the tracks.

220.1.3 Required Coordination

Coordinate projects within or near railroad R/W as follows:

- (1) New at-grade railroad crossings must be permitted in accordance with **Section 335.141, Florida Statutes (F.S.)**. Early coordination with the Central Office is required concerning the Rail Crossing Opening/Closure Program.

- (2) Coordinate the design of traffic control devices with the District Rail Coordinator who will then coordinate with the railroad company. Warning devices that are on within railroad R/W or interact with trains are installed by the railroad company.
- (3) Coordinate with the District Traffic Operations Engineer to determine if a preemptive system is required.
- (4) Coordinate with the Department's Central Office Freight and Multimodal Operations Office to determine if a highway-railroad at grade crossing is located within a designated Quiet Zone.
- (5) Coordinate with the District Rail Coordinator when a waiver is being considered for standard lateral offset requirements for structures; see **FDM 220.3.2**.

Some railroads may require an increase in Railroad Protective Liability Insurance greater than what is provided in the [Standard Specifications](#). The District Specifications Engineer and the District Rail Coordinator will develop a Modified Special Provision and submit it through the Central Specifications Office for special processing. For projects involving CSX Railroad use Special Provision SP0071303.

Modification for Non-Conventional Projects:

Delete **FDM 220.1.3** and see RFP for requirements.

220.2 Highway–Railroad At-Grade Crossing

The roadway should cross the railroad at an angle of or near 90 degrees.

Selection of the warning devices to be used is a function of the geometrics of highway-railroad at-grade crossing (e.g., alignment, profile, sight distance, cross section of both the roadway and the railroad), available R/W, and proximity to signalized intersections.

A highway-railroad at-grade crossing with a high-profiled vertical geometry is considered a “hump crossing” and can adversely affect the safety and operations of road users, posing a risk of low-clearance vehicles and trailers (e.g., low-profile vehicles, vehicles with long wheelbase, “lowboy” towing trailers) becoming stuck on the tracks. A hump crossing is defined as an at-grade crossing not meeting the dimensions and description of the detail entitled, “*Vertical Roadway Alignment Through A Railroad Crossings*” contained in [Standard Plans](#), **Index 830-T01**.

Ensure all new construction and reconstruction at-grade crossings are in accordance with [Standard Plans](#), **Index 830-T01**. For existing humped crossings to remain, install a Low Ground Clearance Grade Crossing (MUTCD W10-5) warning sign with LOW GROUND CLEARANCE (W10-5P) plaque.

Design considerations are discussed in the [Florida Greenbook](#) and the **AASHTO Green Book**.

220.2.1 Traffic Control Devices

Traffic control devices (both roadway and pedestrian) for highway-railroad at-grade crossings consist primarily of signs, pavement markings, flashing light signals, and automatic gates. Consider the following when designing these devices:

- (1) Roadway type
- (2) Volume of vehicular traffic
- (3) Volume of railroad traffic
- (4) Speed of vehicular traffic
- (5) Volume of pedestrian and bicycle traffic
- (6) Crash data
- (7) Geometrics of the crossing

Evaluate highway-railroad at-grade crossings and any of the following as a network to avoid blocking the crossing:

- Stop condition
- Roundabout
- Reduction in the number of lanes

Standards and criteria for design, placement, installment and operation of traffic control devices are located in the [Manual on Uniform Traffic Control Devices \(MUTCD\)](#), the Department's [Standard Plans](#), and **Rule 14-57.013, Florida Administrative Code (F.A.C.)**.

When warning signs or signals are used in advance of a highway-railroad at grade crossing, they must be placed so as not to obstruct the view of the crossing signals.

220.2.1.1 Signing and Pavement Markings

Exhibits 220-1 through **220-4** provide typical signing and pavement markings for Active Grade Crossings. Refer to the [MUTCD](#) for definitions and signing and pavement markings at Passive Grade Crossings.

Do not place turning movement lane-use pavement markings on the upstream approach between the railroad crossing pavement message and the tracks.

Where intersections occur between the W10-1 sign shown in **Exhibits 220-1** through **220-4** and the tracks, place an additional W10-1 sign between the intersection and the railroad gate.

Include Railroad Dynamic Envelope (RDE) pavement markings at Active and Passive Grade Crossings on:

- State Roads,
- State-owned rails, and
- State-owned property.

Design Variations to not install an RDE are to be approved by the Chief Engineer.

The determination of slightly or significantly skewed railroad crossing is at the discretion of the EOR.

Detail RDE pavement markings in the Plans in accordance with [Standard Plans, Index 711-001](#) and the details shown in **Exhibits 220-1** through **220-4**. Ensure the details in the plans include the following:

- (1) Orient RDE pavement markings:
 - (a) In the direction of the travel lanes at all approaches upstream of the crossing (i.e., transverse to the travel lanes).
 - i. For slightly skewed railroads extend the RDE markings transverse across all lanes, as shown in **Exhibits 220-2** and **220-3**.
 - ii. For significantly skewed railroads, step the RDE markings transverse across each lane, as shown in **Exhibit 220-4**.
 - (b) Along the railroad (i.e., parallel to the railroad tracks) for areas between tracks and downstream of the crossing.

- (c) To maximize the visibility of the RDE pattern for both the upstream and downstream sides of the track. Locate markings in a manner to ensure the “X” pattern is identifiable to the motorists and bicyclists and centered in the lanes to the extent practicable.
- (2) Place RDE markings through the foul area as shown in **Exhibits 220-3** and **220-4**. If the railroad owner will not allow the RDE markings through the foul area, or the substrate material will not provide an appropriate bonding surface for the markings, keep the RDE markings outside of the railroad’s foul area as shown in **Exhibits 220-1** and **220-2**.
- (3) Replace all skip lane lines with solid lines for the following distance: From stop bar to stop bar of each approach, then upstream and downstream for a Distance “A” plus 15 feet. For Distance “A”, see table in **Exhibit 220-1**.
- (4) Continue solid longitudinal edge line, lane line, and centerline markings through the RDE pattern, maintaining a 9-inch clear space between the RDE pattern and the longitudinal lane lines or gore areas.
- (5) Refurbish all existing longitudinal lane lines, edge lines, and centerlines to remain in-place for the following minimum distance: From stop bar to stop bar of each approach, then upstream and downstream for a Distance “A” plus 15 feet. For Distance “A”, see table in **Exhibit 220-1**.
- (6) Place RPMs at 10’ maximum on center for the following distance: From stop bar to stop bar of each approach excluding the foul area, then upstream and downstream for a Distance “A” plus 15 feet. For Distance “A”, see table in **Exhibit 220-1**.
- (7) For conditions where multiple tracks are configured non-parallel to each other, maintain the typical RDE pattern and fill the gap between the tracks, as necessary.
- (8) RDE markings must not interfere with any pedestrian crosswalk.
- (9) Consider extending the RDE markings beyond any railroad gates to reduce potential for railroad gates to close on top of stopped vehicles.

Consider the following additional provisions for Active and Passive Grade Crossings:

- For significantly skewed angles, corridor highway lighting for the following minimum distance: From stop bar to stop bar of each approach, then upstream and downstream for a Distance “A” plus 15 feet. For Distance “A”, see table in **Exhibit 220-1**.

- For significantly skewed angles, curves, and intersections directly adjacent to crossings, consider using additional channelization techniques for the roadway alignment. Some channelization techniques include Internally Illuminated RPMs and Tubular Markers. When crest vertical curves impede the visibility of RPMs, Tubular Markers should be used.
- Consider excluding downstream RDE pattern when traffic queuing is not expected.
- Consider the use of through lane-use arrows. For turn lanes, a route shield may be used in conjunction with the through lane-use arrow.
- Remove all existing traffic control signs and pavement markings (e.g., turning signs and turning arrow lane-use pavement markings) from the upstream approach that may lead to driver confusion on the correct turning point for downstream turning movements.
- Ensure placement of all signs allow a clear sight line to all rail signal flasher units. Sight line distance requirements vary by rail company. Consult with the operating railroad for project-specific determination of sight line distance.

For pavement marking material selection, see **FDM 230**.

For side roads with Active and Passive Grade Crossings within 100 feet of the edge of traveled way, include W10-2, W10-3 or W10-4 signs on the mainline state road in accordance with the [MUTCD](#). Include W10-5 with W10-5P as described above in **FDM 220.2**.

RAILROAD CROSSING AT TWO-LANE ROADWAY

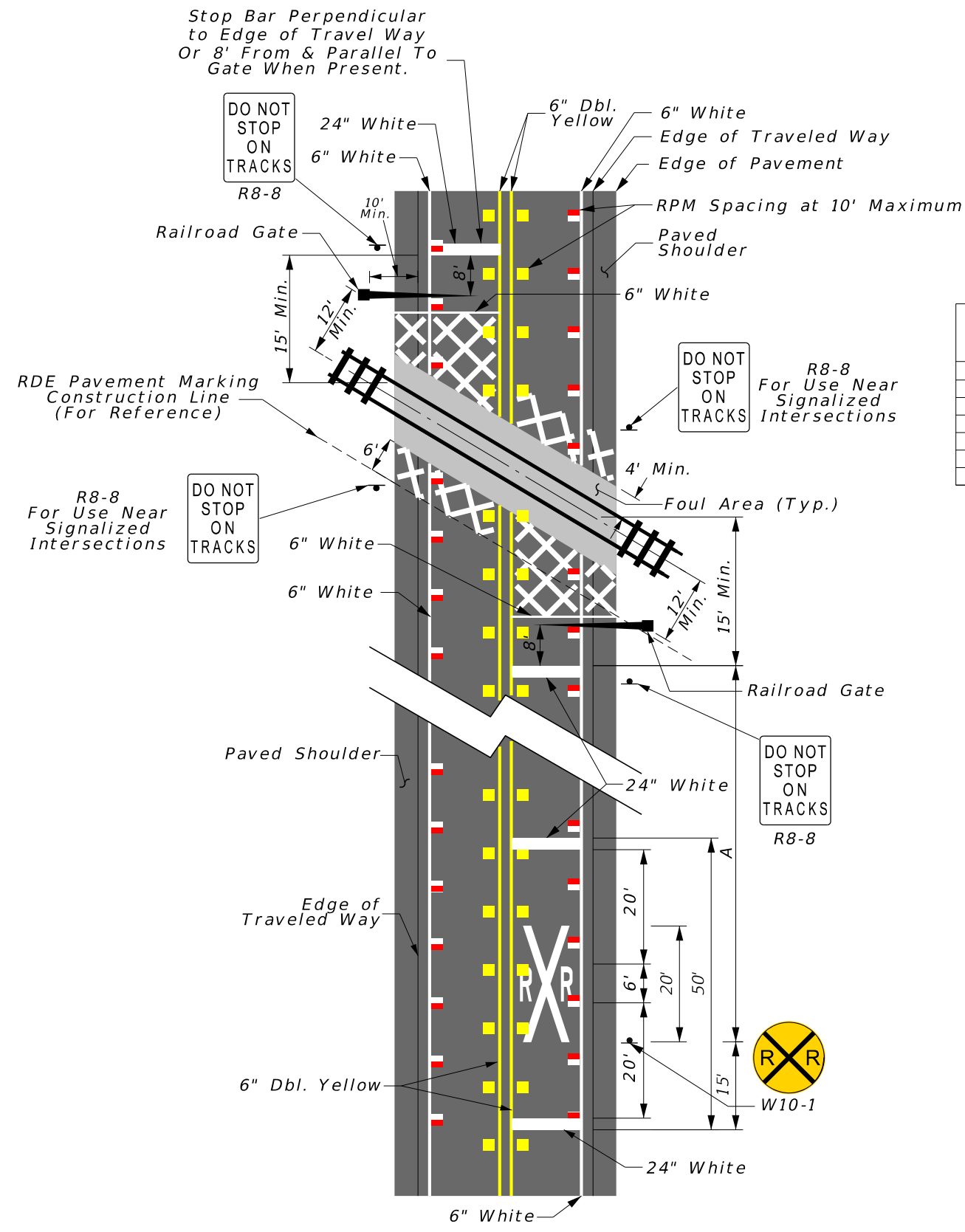

Design Speed (mph)	Distance "A" (ft)
60	400
55	325
50	250
45	175
40	125
35	100
URBAN	85 Min.

NOT TO SCALE

EXHIBIT 220-1
06/03/2024

RAILROAD CROSSING AT MULTILANE ROADWAY

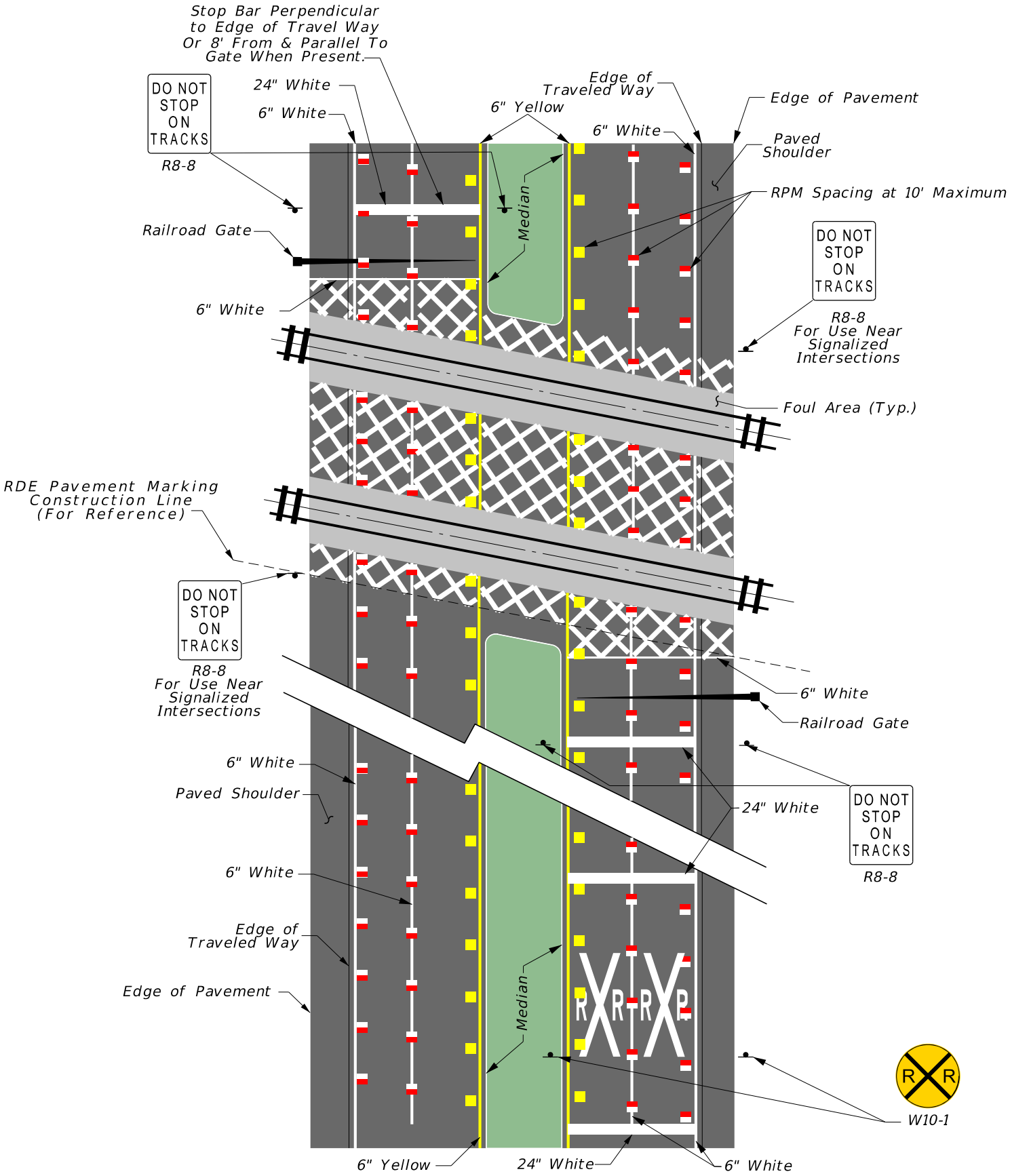

Dimensions not shown for clarity, see Exhibit 220-1.

NOT TO SCALE

EXHIBIT 220-2
06/03/2024

RAILROAD CROSSING AT URBAN MULTILANE ROADWAY WITH TURN LANE

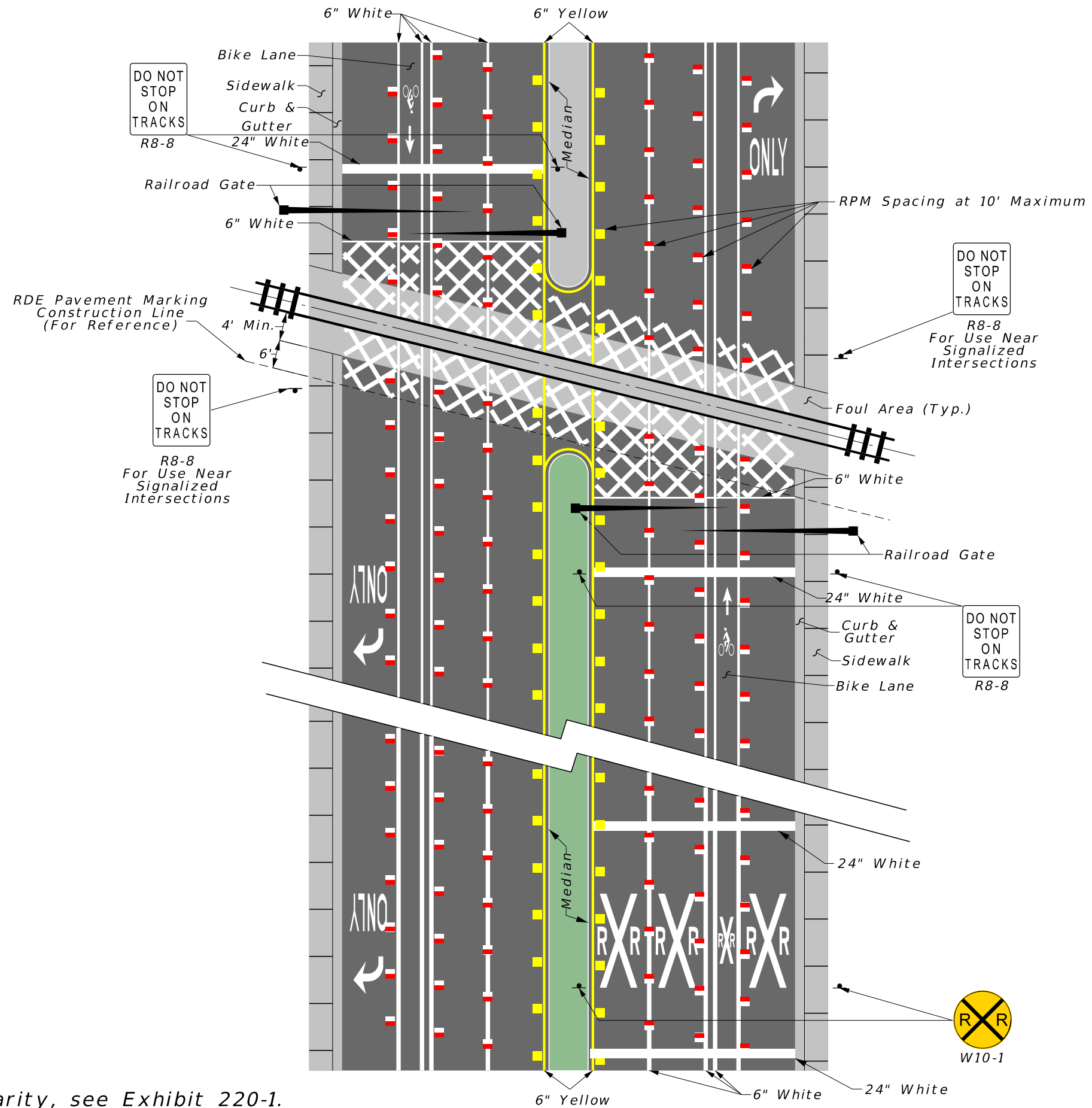

Dimensions not shown for clarity, see Exhibit 220-1.

NOT TO SCALE

EXHIBIT 220-3
06/03/2024

RAILROAD CROSSING WITH SIGNIFICANT SKEW TO THE ROADWAY

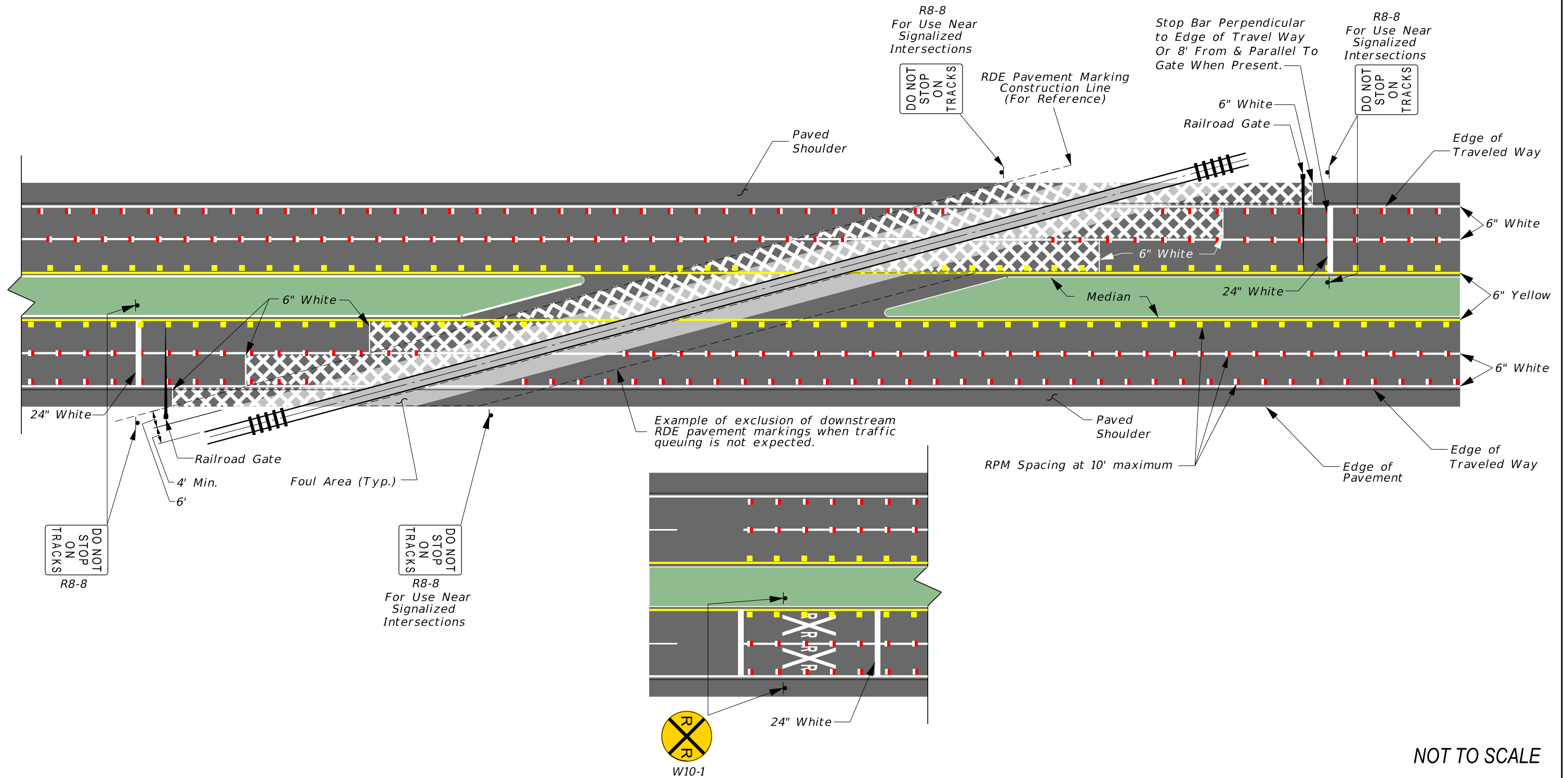

Dimensions not shown for clarity, see Exhibit 220-1.

NOT TO SCALE

EXHIBIT 220-4
06/03/2024

220.2.1.2 Preemption

Highway-railroad at grade crossings may require preemption of traffic signals where signalized highway intersections are in close proximity to a railroad crossing. Preemption requires the railroad and traffic signal control equipment to be interconnected with the traffic signal preempted to operate in a special control mode when trains are approaching. Preemption is required for any of the following conditions:

- (1) Traffic Signal is within 200 ft of a highway-railroad at-grade crossing
- (2) Highway traffic queues have the potential for extending across a nearby railroad crossing, or
- (3) Highway traffic backed up from a nearby downstream railroad crossing could interfere with signalized highway intersections. A study to determine the need for preemption is required for a traffic signal within 500ft of a highway-railroad at-grade crossing

220.2.2 Surfaces

The roadway travel lanes at a highway-railroad at-grade crossing should be constructed for a suitable length with all-weather surfacing. A roadway section equal to the current or proposed cross section of the approach roadway, including any existing or proposed pedestrian walkways, should be carried through the railroad crossing. The railroad crossing surface itself should have a riding quality equivalent to that of the approach roadway. When selecting the type of crossing and the material to be used in its construction, consideration should be given to the character and volume of traffic using the roadway.

220.2.3 Quiet Zones

An at-grade railroad crossing within a designated Quiet Zone must comply with the **Code of Federal Regulations (C.F.R.), Part 222** and the [Standard Plans, Index 509-070](#). Quiet Zone means a segment of a rail line that includes public highway-railroad crossings at which locomotive horns are not routinely sounded.

A public highway-railroad at-grade crossing within a Quiet Zone should be equipped with a Supplemental Safety Measure identified in **C.F.R., Part 222, Appendix A**. Allowable measures include:

- (1) Gates with medians, or channelization using Type IV concrete traffic separators or Type F curb and gutter. Use of temporary channelization devices is not permitted.

- (2) Four quadrant gate and three quadrant gates systems
- (3) One-way streets with gates
- (4) Permanent crossing closures

The railroad crossing should be evaluated to determine if driveways, minor side streets, or turn lanes in close proximity to the crossing require an additional gate.

220.2.4 Railroad Crossing Near or Within Project Limits

Review Federal-aid projects to determine if a railroad-highway at-grade crossing is within the limits of or near the terminus of the project. If such crossing exists, the project must be upgraded to meet the latest [MUTCD](#) requirements in accordance ***Title 23 United States Code (U.S.C.), Chapter 1, Section 109(e)*** and ***C.F.R. 646.214(b)***. These requirements are located in ***Chapter 8*** of the [MUTCD](#). “Near the terminus” is defined as being either of the following:

- (1) If the project begins or ends between the crossing and the MUTCD-mandated advanced placement distance for the advanced (railroad) warning sign. See [MUTCD, Table 2C-4](#) (Condition B, column “0” mph) for this distance.
- (2) An intersection traffic signal within the project is connected to the crossing’s flashing light signal and gate.

220.2.5 Bicycle and Pedestrian Facilities

Extend proposed or existing sidewalks, bike lanes or shared use paths through the rail crossing. See ***FDM 222.2.4*** for additional information.

When a new bicycle or pedestrian crossing is added to an existing roadway, it is considered a new crossing if it is separated from the roadway. See ***FDM 220.1.3*** for information on coordinating new crossings.

220.3 Grade Separated Highway- Railroad Crossing

For railroad crossing over a roadway, the bridge must be designed to carry railway loadings in conformance with the [American Railway Engineering and Maintenance-of-Way Association \(AREMA\) Manual for Railway Engineering](#). See **FDM 260.6** for required vertical clearances between the facilities.

Coordinate the following with the governing railroad company:

- Clearances, Geometrics and Utilities
- Provisions for future tracks
- Maintenance road requirements for off-track equipment
- Need for, and location of crash walls

The railroad company's review and approval is based on the completed Bridge Development Report (BDR)/30% Structures Plans.

Prepare the Structures Plans in accordance with the criteria obtained from the railroad company, the [Structures Manual](#), the [Standard Plans](#), and this manual.

Figure 220.3.1 illustrates the dimensions that are to be obtained from or approved by the railroad company before preparing the BDR/30% Structures Plans.

220.3.1 Bridge Width

For railroad over roadway crossing, the railroad bridge typical section is based on project requirements. For roadway over railroad crossings, see **FDM 210** for information on highway typical sections.

220.3.2 Lateral Offset to Face of Structure

For a roadway over a railroad crossing, measure lateral offset in accordance with **Figure 220.3.1** and **Table 220.3.1**. The railroad company may accept a waiver from standard lateral offset requirements for the widening or replacement of existing bridges.

Lateral offset is measured from the centerline of outside track to the face of pier cap, bent cap, or any other adjacent structure. Minimum lateral offsets are shown in **Table 220.3.1**.

Figure 220.3.1 Track Section

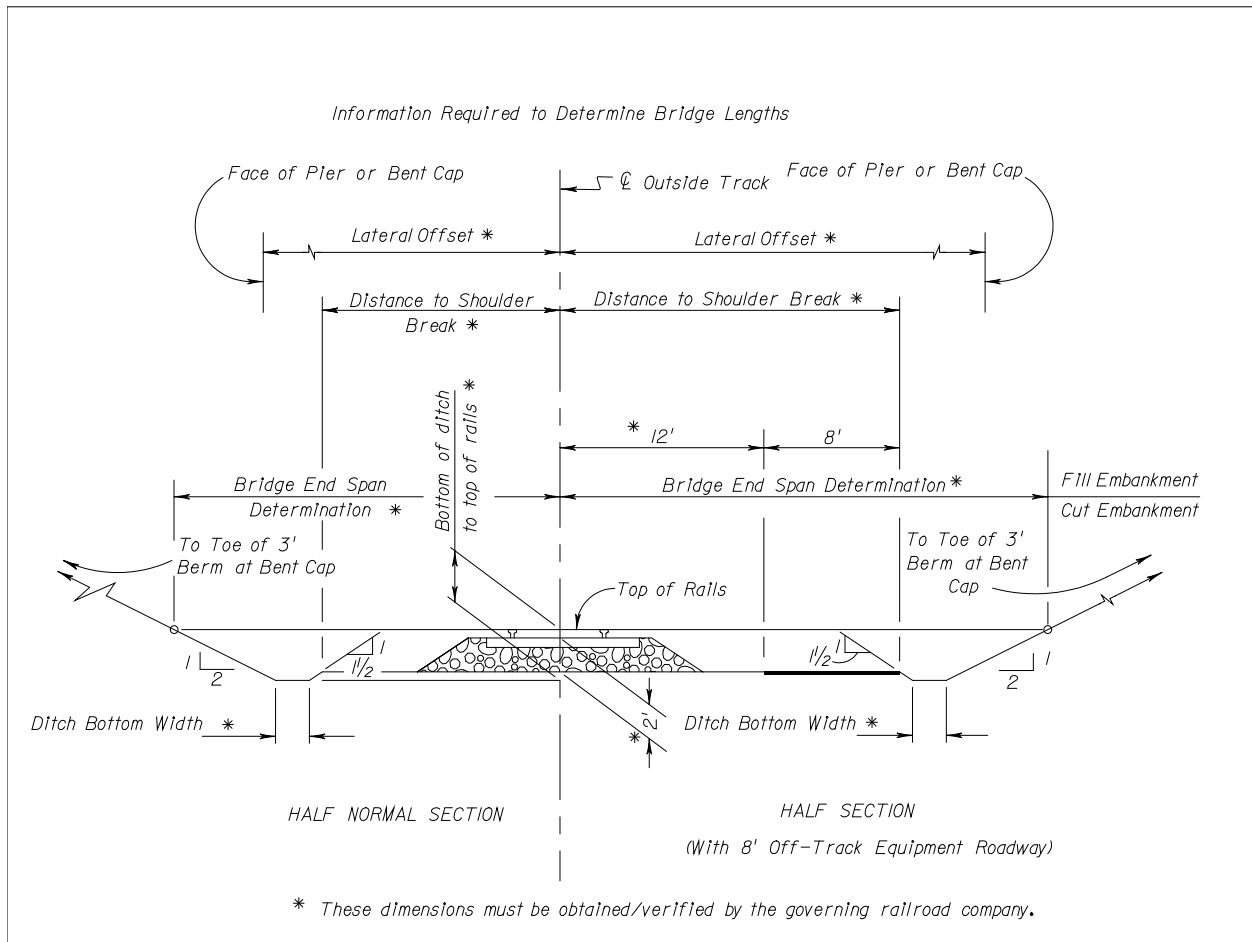

Table 220.3.1 Lateral Offsets for Railroads

Minimum Clearance Requirements	Normal Section	With 8 ft. Required Clearance for Off-Track Equip.	Temporary Falsework Opening
With Crash Walls*	18 ft.	22 ft.	10 ft.
Without Crash Walls	25 ft.	25 ft.	N/A

* See the **Structures Design Guidelines, Section 2.6** for crash wall requirements.

Provide an additional 8-ft. clearance for off-track equipment only when requested by the railroad company.

220.3.2.1 Adjustments for Track Geometry

Increase the minimum lateral offset by a rate of 1.5 inches for each degree of curvature when the track is on a curve.

Increase the minimum lateral offset on the inside of the curve by 3.5 inches horizontally per inch of superelevation when the track is superelevated.

Meet lateral offset requirements found in the [AREMA Manual for Railway Engineering](#) for extremely short radius curves.

220.3.2.2 Adjustments for Physical Obstructions

Columns or piles should be kept out of the ditch to prevent obstruction of drainage. Provide adequate lateral offset to avoid the need for crash walls unless extenuating circumstances dictate otherwise.

Figure 220.3.1 shows horizontal dimensions from the centerline of track to the points of intersection of a horizontal plane at the rail elevation with the embankment slope. This criteria may be used to establish the preliminary bridge length which normally is also the length of bridge eligible for FHWA participation; however, surrounding topography, hydraulic conditions, and economic or structural considerations may warrant a decrease or an increase of these dimensions.

220.3.2.3 Required Foundation Clearances

Place edges of footings no closer than 11 feet from centerline of the track to provide adequate room for sheeting.

220.3.3 Crash Walls

See the [Structures Design Guidelines](#) for crash wall requirements.

220.3.4 Special Considerations

Projects may include any of the following special considerations:

- (1) Shoring and Cribbing requirements during construction should be accounted for in the preparation of the preliminary plans to assure compliance with required

- clearances. Anything within the railroad R/W (e.g., cofferdams, footings, excavation) requires coordination with the District Rail Coordinator for approval by the railroad company.
- (2) Overpasses for electrified railroads may require protection screens.
 - (3) Substructure supports may be located between adjacent tracks or an outside track and the off-track equipment road.
 - (4) Convey drainage from the bridge above the railroad away from the railroad R/W. Open scuppers are to be no closer than 25 feet to the centerline of the nearest track.
 - (5) The District Rail Coordinator must be contacted to see if there are any other requirements when constructing in or near their R/W.
 - (6) Additional consideration should be given to any utilities that may be located within the railroad R/W

220.3.5 Widening of Existing Bridge over Railroad

The requirements for widening an existing roadway or pedestrian bridge over railroad are as follows:

- (1) If existing horizontal or vertical clearances are less than those required for a new structure, the design of the new portion of the structure is not to encroach into the existing clearances.
- (2) Minimum vertical clearance should take into account the track grade and the cross slope of the bridge superstructure. It is desirable to widen on the ascending side of the bridge cross slope.
- (3) Minimum lateral offset should take into account future changes to track geometry, physical obstructions or foundation clearances.
- (4) Temporary construction vertical clearances less than 22 feet and lateral offsets less than 10 feet must be approved by the railroad company. It may not be possible to reduce already restricted vertical clearances on high volume rail lines.
- (5) Meet drainage design requirements for new bridges when widened approach fills are necessary.
- (6) Evaluate the need for crash wall protection in accordance with **SDG 2.6**.
- (7) If the existing railroad is in a cut section, special consideration should be given to the length, depth, and type material of the existing cut section.

- (8) In cases where demolition of the existing structure is required for attachment of the new structure over the railroad's tracks, a method of debris collection should be provided so as not to encroach within the railroad R/W.

Provide a cross section at a right angle to the centerline of the track where the centerline of bridge intersects the centerline of track in the BDR/30% Structures Plans. Where the substructure is not parallel to the track, or the track is curved, provide a section perpendicular to the centerline of the track at each substructure end.

Figure 220.3.2 Section Thru Tracks

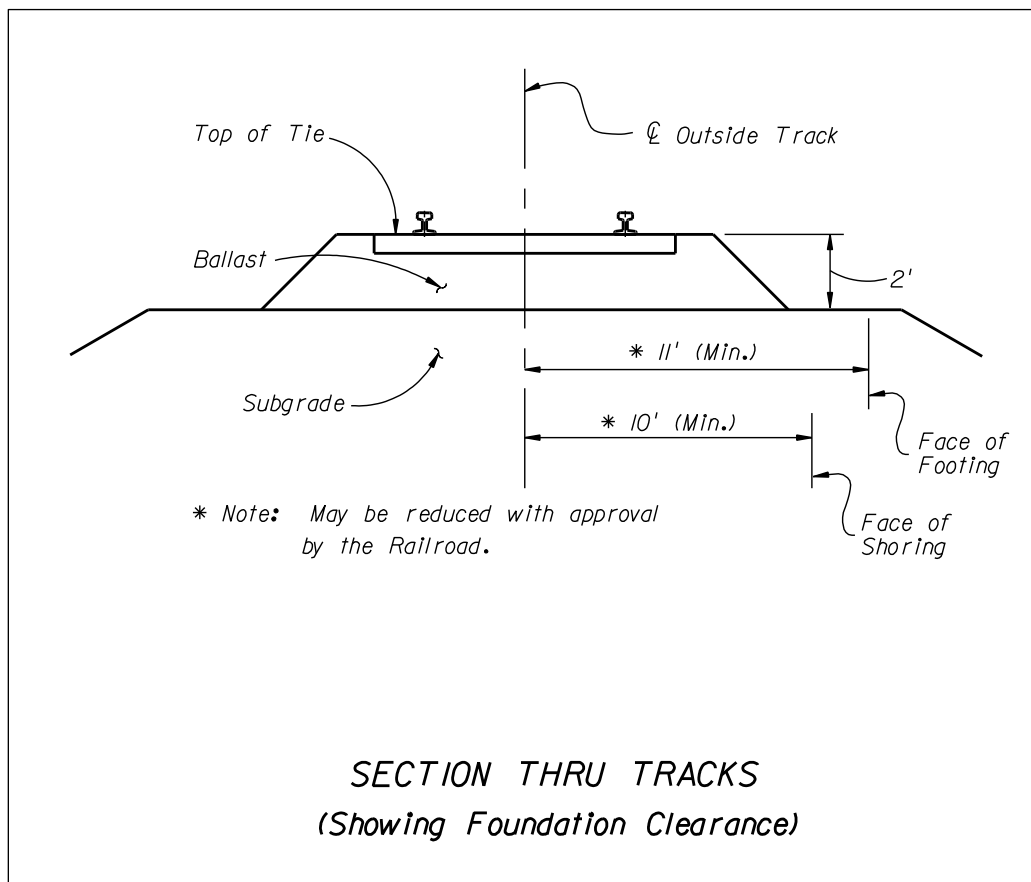

221 Utilities

221.1 General

Identify necessary utility work (e.g., installation, removal, relocation, de-energizing, deactivation, or adjustment of utilities) that is required to construct the project. Obtain agreements or orders to schedule the identified work. Assist the Department with Utility Agency/Owner (UAO) coordination throughout the design process.

Utility work is necessary where:

- (1) Working room is needed for construction
- (2) Clearances are needed to comply with Department requirements
- (3) Occupational Safety and Health Administration (OSHA) (**29 CFR Part 1926**) restricts crane operations
- (4) National Electric Safety Code (NESC), or other regulations are violated.
- (5) Construction equipment may damage utilities
- (6) Utilities are within areas of excavation.

When evaluating the use of design features that reduce or avoid utility conflicts, consider savings in construction time and the total associated savings for the FDOT project and the utilities.

Additional guidance for accommodating utilities within Department R/W are given in the AASHTO publications ***A Guide for Accommodating Utilities within Highway Right-of-Way*** and ***A Policy on Geometric Design of Highways and Streets*** and in the TRB publication ***Policies for Accommodation of Utilities on Highway Rights-of-Way***.

221.2 Utility Work Schedules and Agreements

Certify the project in accordance with the ***Utility Work Agreements and Certification Letter***. With assistance from the District Utilities Office and the Office of General Counsel, obtain the following:

- ***Utility Work Schedules*** ([Form 710-010-05](#))
- Relocation agreements
- Required payments to or by the Department for utility work

When an agreement cannot be obtained, coordinate with the District Utilities Office and the Office of General Counsel to pursue any needed order to relocate.

Modification for Non-Conventional Projects:

Delete ***FDM 221.2*** above and see RFP for requirements.

221.3 Subsurface Utility Locates

Coordinate with the District Utility Office to determine the locations and quality levels needed. Quality levels are defined in Section 3.6 of the [Survey and Mapping Handbook](#). The UAOs may be requested to provide locate information as required by Section 5.2 of the [2017 Utility Accommodation Manual](#).

Obtain quality level “QL A” locate information when proposed construction operations are within 3’ of utilities and verified information is needed to make confident design decisions. The decision to proceed to construction without obtaining quality level “QL A” locate information must be further coordinated with district construction personnel and the UAO.

222 Pedestrian Facilities

222.1 General

This chapter provides the minimum criteria to be used for the design of pedestrian facilities on the State Highway System. The term “pedestrian” used in this chapter includes any person traveling on foot or in a wheelchair. Pedestrians should be expected on all of Florida’s state roadways except where restricted on Limited Access (LA) facilities.

Process a Design Variation when the design criteria for pedestrian facilities in this manual are not met. Reference the following conditions that support not providing a pedestrian facility in the Design Variation documentation:

- (1) The establishment of pedestrian facilities would be contrary to public safety.
- (2) The cost of providing pedestrian facilities would be excessively disproportionate to the need or probable use.
- (3) The presence of other available means for pedestrian traffic. Other available means should meet the following requirements:
 - (a) Meet the design criteria for pedestrian facilities on state roadways.
 - (b) Provide access to the same services, origination and destination sites, and transit connections as the project corridor.
 - (c) Not result in a significant increase in travel time or trip length, exposure to motorized traffic, or substantial elevation changes.
 - (d) Provide appropriate locations to cross limited access, arterial or collector roadways, or railroad corridors.

222.1.1 Americans with Disabilities Act (ADA)

In addition to the criteria presented in the *FDM* and Department’s [Standard Plans](#), the following documents provide Americans with Disabilities Act (ADA) guidance in the design of pedestrian facilities in public R/W:

- ***United States Department of Justice 2010 Americans with Disabilities Act (ADA) Standards for Accessible Design***
- ***United States Department of Transportation 2006 ADA Standards for Transportation Facilities.***

- **Florida Accessibility Code** contains **ADA** requirements for accessibility to sites, facilities, buildings, and elements by individuals with disabilities.

222.2 Pedestrian Facilities

Pedestrian facilities are features or elements used to support pedestrian travel. Pedestrian facilities may include the following:

- Sidewalks
- Curb ramps and blended transitions
- Crosswalks
- At-grade railroad crossings
- Refuge islands
- Curb extensions
- Pedestrian signals
- Public transit loading zones
- Pedestrian bridges
- Shared use paths
- Street furniture

Pedestrian safety can be enhanced through the following measures:

- (1) Maintaining a smooth, clean walking surface, free of obstructions.
- (2) Responsive and appropriate traffic control devices, consistent with guidance in the [Manual on Uniform Traffic Control Devices \(MUTCD\)](#), including providing pedestrian-oriented directional signage.
- (3) Sidewalks and other pedestrian walkways are continuous, and termini connect to existing sidewalk, pedestrian crossing, or access point.
- (4) Providing adequate lighting.

222.2.1 Sidewalk

Sidewalk is a continuous concrete pedestrian walkway as depicted in [Standard Plans Index 522-001](#).

Provide sidewalk on all curbed roadways, except where prohibited by [Section 316.130 \(18\), Florida Statute \(F.S.\)](#). The inclusion of sidewalk on short isolated sections of curbed roadway is not required when:

- Within C1 and C2 context classification, and
- There are no pedestrian facilities leading to, or from the location.

Provide sidewalk on high speed curbed and flush shoulder roadways within C2T, C3C, C4, C5 or C6 context classification; and within C1, C2 or C3R where the demand for use is demonstrated.

For high speed curbed and flush shoulder roadways, place sidewalk in the following order of desirability:

- (1) As near the R/W line as possible.
- (2) Outside of the clear zone.
- (3) Five feet beyond the limits of the full width shoulder.
- (4) At the limits of the full width shoulder.

Sidewalk on flush shoulder roadways is not to be constructed directly adjacent to the roadway or shoulder pavement. Nearing intersections, the sidewalk should be transitioned as necessary to provide a more functional crossing location that also meets driver expectation. Further guidance on the placement of stop or yield lines and crosswalks is provided in the [MUTCD, Part 3](#) and [Standard Plans 711-001](#).

Continue sidewalk across bridge structures when sidewalk is provided on the approach roadway. Also provide sidewalk on new bridges where sidewalk or shared use path is not present along the roadway but may be included with a future project.

Sidewalk should be constructed on both sides of the roadway; however, if sidewalk is constructed on only one side, provide reasonable pedestrian access to destinations (e.g., transit stops, homes, places of work, stores, schools, post offices, libraries, parks) on the opposite side.

For RRR Projects, other than meeting detectable warning and curb ramp requirements, unaltered sidewalks that are not in compliance with **FDM** criteria, [Standard Plans](#), or ADA requirements are not required to be reconstructed.

222.2.1.1 Sidewalk Width

The standard sidewalk width varies by context classification as shown in **Table 222.2.1**.

Table 222.2.1 Standard Sidewalk Widths

Context Classification		Sidewalk Width (feet)
C1	Natural	5
C2	Rural	5
C2T	Rural Town	6
C3	Suburban	6
C4	Urban General	6
C5	Urban Center	10
C6	Urban Core	12
<p><u>Notes:</u></p> <p>(1) For C2T, C3 and C4, sidewalk width may be increased up to 8 feet when the demand is demonstrated.</p> <p>(2) For C5 and C6, when standard sidewalk width cannot be attained, provide the greatest attainable width possible, but not less than 6 feet.</p> <p>(3) For RRR projects, unaltered sidewalk with width 4 feet or greater may be retained within any context classification.</p> <p>(4) See FDM 260.2.2 for sidewalk width requirements on bridges.</p>		

See **FDM 214** for information on sidewalks across driveways.

Provide the following minimum unobstructed sidewalk width (excluding the width of the curb) when there is no practical alternative to placing a pole within the sidewalk:

- 36 inches for aboveground utilities. This 36-inch width may be reduced to 32 inches, not exceeding 24 inches in length, when there is no practical alternative available to avoid an obstruction.
- 48 inches for signal, light, sign poles

When used for plantings and street furniture, the area between the back of curb and the sidewalk should be 5 feet or greater in width. Consider providing treewells in areas where on-street parking is provided.

Appropriate types of street furniture may vary based on frequency and density of pedestrian activity. Street furniture must allow for minimum sidewalk width and vertical clearance as required in this section and **FDM 222.2.1.2**.

Refer to **FDM 223.5** for information on bicycle parking amenities and **FDM 225** for information on public transit facilities as related to use of sidewalk space.

222.2.1.2 Vertical Clearance

Provide a minimum 7-foot vertical clearance over the entire walking surface. See **FDM 260.6** for pedestrian bridge vertical clearance requirements.

222.2.1.3 Grades and Cross Slope

When sidewalk is adjacent to the roadway (i.e., located back of curb or consistent separation from curb), sidewalk grades may mirror the roadway profile. When sidewalk is not adjacent to a traveled way, sidewalk grades are not to exceed 5%, unless accessible ramps are provided.

There should be enough sidewalk cross slope to allow for adequate drainage; however, to comply with ADA requirements, the maximum cross slope is 2%. A clear 1-foot wide graded area with a maximum 1:6 slope should be provided adjacent to the sidewalk. Edge drop-offs should be avoided. When drop-offs cannot be avoided and lie within 2 feet of the edge of sidewalk, they should be shielded as discussed in **FDM 222.4**.

222.2.2 Curb Ramps and Blended Transitions

[Standard Plans](#), **Index 522-002** provides requirements and details for curb ramps and landings that are compliant with Americans with Disabilities Act Standards for Transportation Facilities.

A continuous accessible pedestrian route, including curb ramps and blended transitions (e.g., depressed corners, raised street crossings, flush roadway connections) are required along sidewalks and shared use paths. Provide curb ramps to be the same width as the sidewalk where practicable. Additional information, nomenclature, requirements, and details for curb ramps and landings are provided in the [Standard Plans](#), **Index 522-002**.

Alpha-identifications have been provided in Index 522-002 for the various curb ramp options (e.g., CR-A, CR-B, etc.) to facilitate ease of callouts in the Plans. Use the curb ramp options as follows:

- Curb Ramps CR-A, CR-B & CR-C are for use where ramp and landing depths are not restricted.
- Curb Ramps CR-D, CR-E, CR-F, CR-G and CR-H are for linear pedestrian traffic.
- Curb Ramps CR-K and CR-L are for use where ramp and landing depths are restricted.

Include sidewalk curb ramps at the following locations:

- All intersections and driveways with curbed returns. Include a landing at the top of each ramp.
- On curbed roadways between intersections where a crosswalk has been established.

Pull boxes, manholes (and other utility covers), and other types of existing surface features in the location of a proposed curb ramp or detectable warning should be relocated. When relocation is not feasible, adjust the feature to meet the ADA requirements for surfaces (including the provision of a nonslip top surface, and adjustment to be flush with and at the same slope as the adjacent surface).

Curb ramps should be in line with the crossing and must provide a maximum slope of 1:12 (8.3 percent). At intersections where more than one road is crossed, provide curb ramps at both ends of each crossing. Crossings are required to meet the same grade and cross slope requirements as sidewalks. Where criteria for maximum cross slope cannot be met, process a Design Variation and provide the minimum attainable cross slope. When following the profile grade of the roadway, curb ramp slopes should not exceed 15 feet in length.

Provide transition slopes (flared sides) where a pedestrian circulation path crosses the curb ramp. The maximum slope of transition slopes is 1:10, measured parallel with and adjacent to the curb line.

When altering an existing pedestrian facility and conditions preclude the construction of a curb ramp slope of 1:12, provide a slope from 1:12 to 1:10 with a maximum rise of 6 inches.

Provide a landing at all pedestrian pushbutton locations. The landing must provide a clear area of 30 inches by 48 inches directly in front of the pedestrian pushbutton to allow persons using a wheeled mobility device to actuate the button while remaining stationary. Horizontally center the 48-inch dimension on the pushbutton.

When compliance with Department curb ramp requirements is determined to be technically infeasible (i.e., no engineering solution is available), a Design Variation is required. This may occur where existing right of way is inadequate and where conflicts may occur with existing features which cannot be feasibly relocated or adjusted (e.g., drainage inlets, signal poles, pull and junction boxes, etc.).

222.2.2.1 Driveways

See **FDM 214** for additional information on pedestrian accommodations at driveways.

New and reconstructed driveways are to be in compliance with [Standard Plans, Index 330-001 and 522-003](#).

For RRR Projects, unaltered driveways that are not in compliance with [Standard Plans](#) or ADA requirements are not required to be reconstructed.

222.2.3 Crosswalks

Crosswalks are marked paths where pedestrians can safely cross a roadway. Marking of crosswalks helps drivers better identify the intersection and guides pedestrians to the best crossing location.

Use Special Emphasis crosswalk markings for all marked crosswalks except the following. Use standard crosswalk markings at marked stop-controlled intersection approaches.

Coordinate with the District Traffic Operations Office on proposed new marked crosswalks. For new and existing crosswalks, meet criteria and guidelines in [Traffic Engineering Manual \(TEM\), Section 5.2](#).

[TEM 5.2](#) also contains criteria and guidelines on additional treatments including signals, signing, pavement markings and other treatments at midblock and unsignalized intersections.

For crosswalk signing and pavement markings, see **FDM 230**, [MUTCD](#), and [Standard Plans, Index 711-001](#).

The maximum cross slope for crosswalks is 2%. For crosswalks located at signalized intersections, midblock, or driveways, cross slope may exceed 2% but not greater than 5%.

School Zone crosswalks have additional criteria for signing and pavement markings. For requirements for school signs and markings, see [The Manual on Speed Zoning for Highways, Roads and Streets in Florida, Chapter 15](#).

222.2.3.1 Intersections

Provide crosswalk markings for all legs of a signalized intersection unless there is a documented, project-specific justification not to do so (e.g., physical constraints, safety concern).

When separated right-turn lanes are used, place crosswalks so that an approaching motorist has a clear view of the pedestrian, and the crossing distance is minimized. See [TEM 2.44](#) for signing criteria.

Coordinate with the District Traffic Operations Office for new marked crosswalks at unsignalized intersection locations and meet the criteria and guidelines identified in [TEM 5.2](#).

Commentary: Marked crosswalks at an uncontrolled location may be supplemented with other treatments such as beacons, signals, curb extensions, raised medians, raised traffic islands, and enhanced overhead lighting. See [TEM 5.2](#) for a complete and updated list of these types of treatments.

Additional countermeasure treatments are recommended at locations where any of the following conditions exist:

- (1) Where posted speeds are greater than 35 mph,
- (2) On a roadway with 4 or more lanes without a raised median or raised traffic island that has an ADT of 12,000 or greater, or
- (3) On a roadway with 4 or more lanes with a raised median or raised traffic island that has or is projected to have (within 5 years) an ADT of 15,000 or greater.

As roadway volumes, speeds, and number of travel lanes increase, marked crosswalks are best used in conjunction with other countermeasure treatments.

For controlled intersections with six-lane divided roadways or crossing distances exceeding 80 feet, consider installing a two-stage pedestrian crossing with median refuge island. See [FDM 210](#) for more information on Intersection Refuge Islands and Hardened Centerlines.

222.2.3.2 Midblock

Midblock crosswalks are used to supplement pedestrian crossings in areas between intersections.

Provide illumination for both new and existing midblock crosswalks in accordance with **FDM 231**.

An engineering study is required for all new Midblock Crosswalks. Follow the procedure and guidelines identified in **TEM 5.2**.

Midblock crosswalks are not recommended at locations where any of the following exist:

- (1) The distance from the crosswalk to the nearest intersection (or crossing location) is less than 300 feet.
- (2) The crossing distance exceeds 60 feet (unless a median or a crossing island is provided).
- (3) The sight distance for both the pedestrian and motorist is not adequate.
- (4) The crosswalk cross slope (roadway profile) exceeds 5%.
- (5) The crosswalk grade (roadway cross slope) exceeds normal crown.

See **Figures 210.3.4** and **210.3.5** for examples of midblock crossings with refuge islands. Refer to **FDM 230.6** for information on pavement markings and midblock crossings.

If site conditions are identified that would obstruct the placement of a midblock crosswalk, include additional features in the design to remedy these conditions. Features like overhead signing can help alert motorists and be used to light the crossing. Curb extensions or bulb-outs can improve sight distance and decrease the crossing distance. Adjustment of the profile on the roadway crossing may be required to improve the cross slope of the crosswalk.

The sidewalk median crossing through a raised median will be either depressed or raised, depending on the median width between the backs of curbs (W), as follows:

- (1) Depressed Sidewalk when $W \leq 16$ feet
- (2) Raised Sidewalk when $W > 16$ feet

See **Exhibit 222-1** for more information.

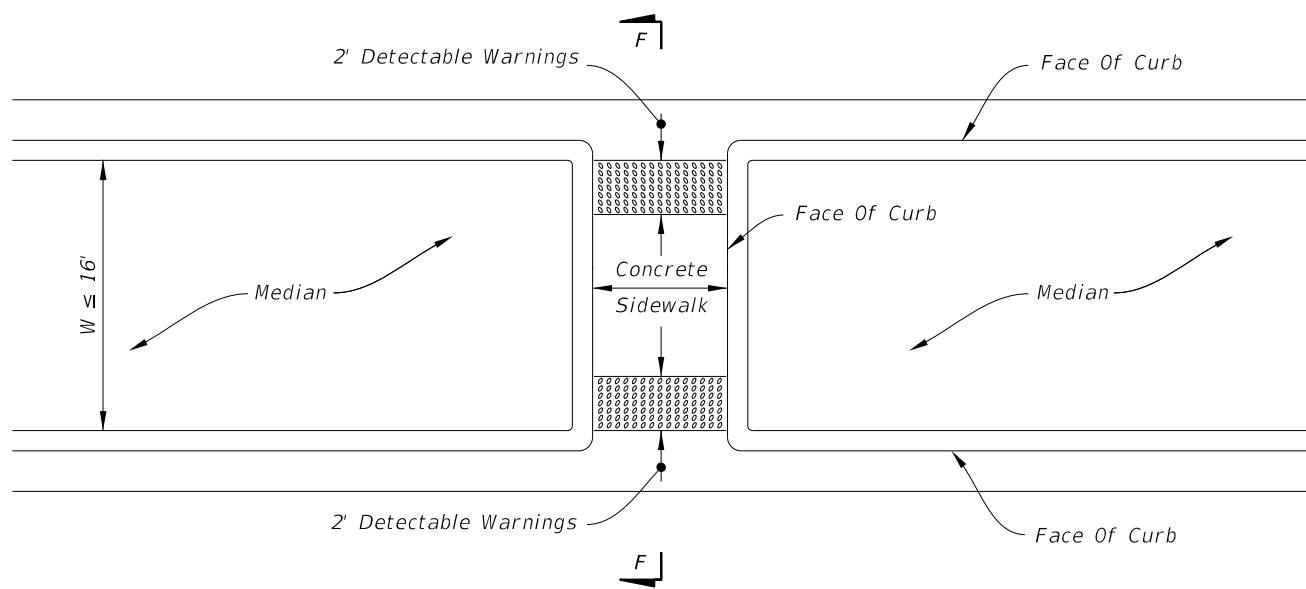

DEPRESSED SIDEWALK

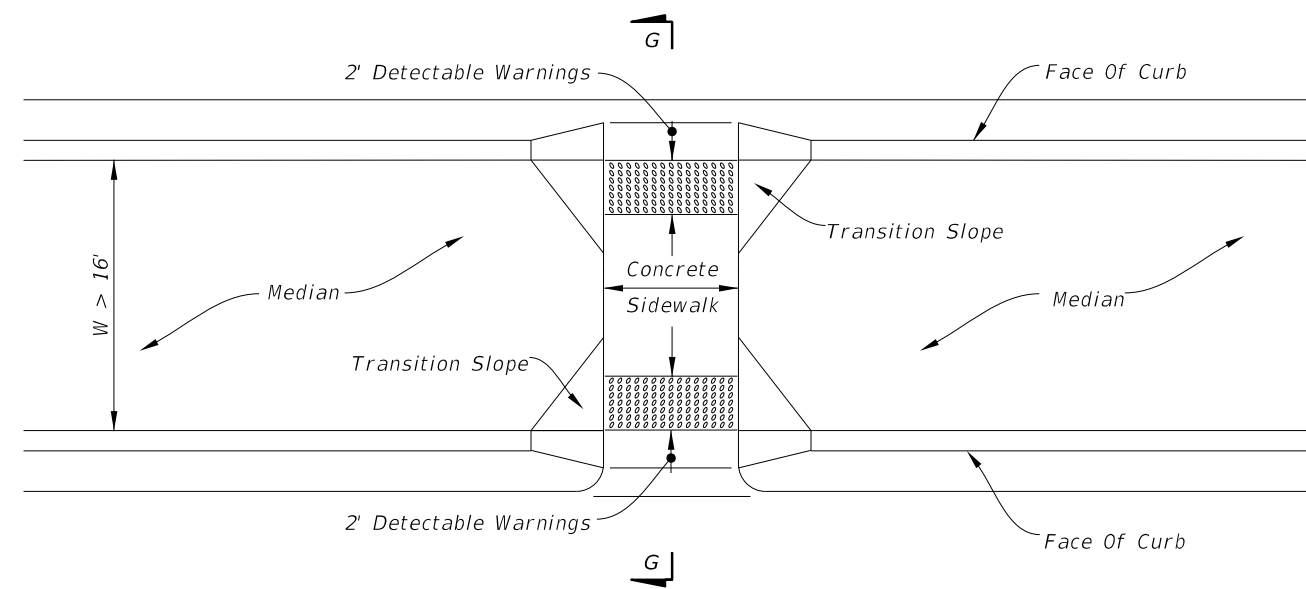

RAISED SIDEWALK

MEDIAN CROSSINGS

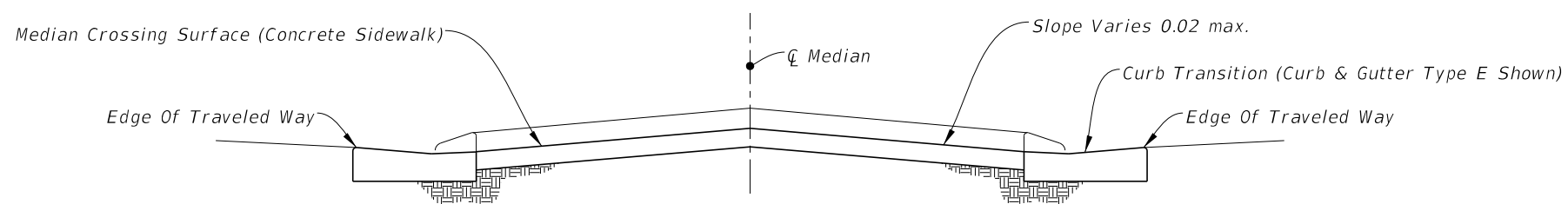

SECTION F-F

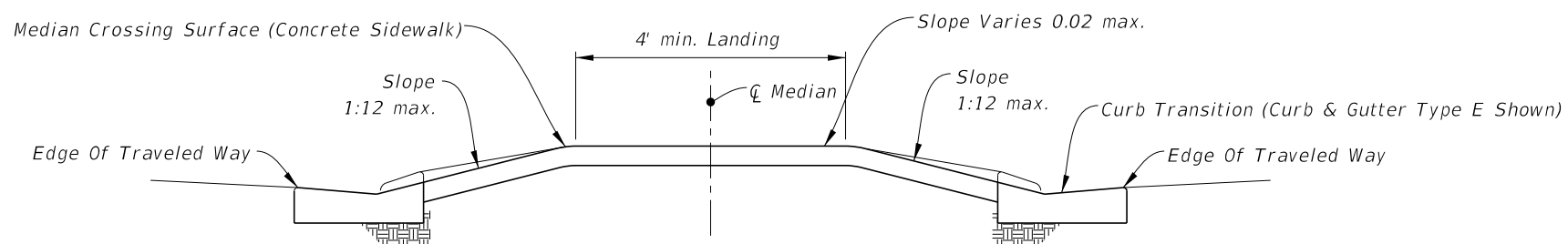

SECTION G-G

NOT TO SCALE

222.2.4 At-Grade Railroad Crossings

Provide an ADA accessible route for pedestrians at railroad crossings by extending proposed or existing sidewalks or shared use paths through the rail crossing. The surface of the crossing must be:

- Firm, stable and slip resistant,
- Level and flush with the top of rail at the outer edges of the rails, and
- Area between the rails aligns with the top of rail.

Place detectable warnings on each side of the railroad crossing as detailed in [Standard Plans](#), *Index 522-002*.

The edge of the detectable warning nearest the rail crossing is to be located between 6 and 15 feet from the centerline of the nearest rail. Where gates are provided, detectable warnings are to be placed a minimum of 4 feet from the side of the gates opposite the rail.

An audible device, such as a bell, is used in conjunction with the traffic control signals, if traffic control signals are in operation at a crossing that is used by pedestrians or bicyclists. Additional information is located in the [MUTCD](#) regarding additional signals, signs, or pedestrian gates and designing crossings for shared use paths.

Flangeway gaps are necessary to allow the passage of train wheel flanges; however, they pose a potential hazard to pedestrians who use wheelchairs because the gaps can entrap the wheelchair casters. A maximum flangeway gap is required for all at-grade pedestrian rail crossings of 2½" for all non-freight rail track and 3" for freight rail track.

222.2.5 Refuge Islands

See *FDM 210.3* for information on refuge islands.

222.2.6 Curb Extensions (Bulb-Outs)

Consider the use of curb extensions (a.k.a., bulb-outs) in conjunction with on-street parking at intersections or midblock locations where there is a crosswalk, provided there is adequate width for existing traffic movements. Curb extensions shorten the crossing

distance, and provide additional space at intersections, allowing pedestrians to see and be seen before entering a crosswalk.

The design of curb extensions must take into consideration the needs of transit, emergency vehicles, commercial trucks, drainage, and bicyclists.

Consult with District drainage staff on drainage accommodations for the curb extension during Phase I of the design. See the ***Drainage Design Guide*** and ***Figure 222.2.1***.

Figure 222.2.1 Curb Extension

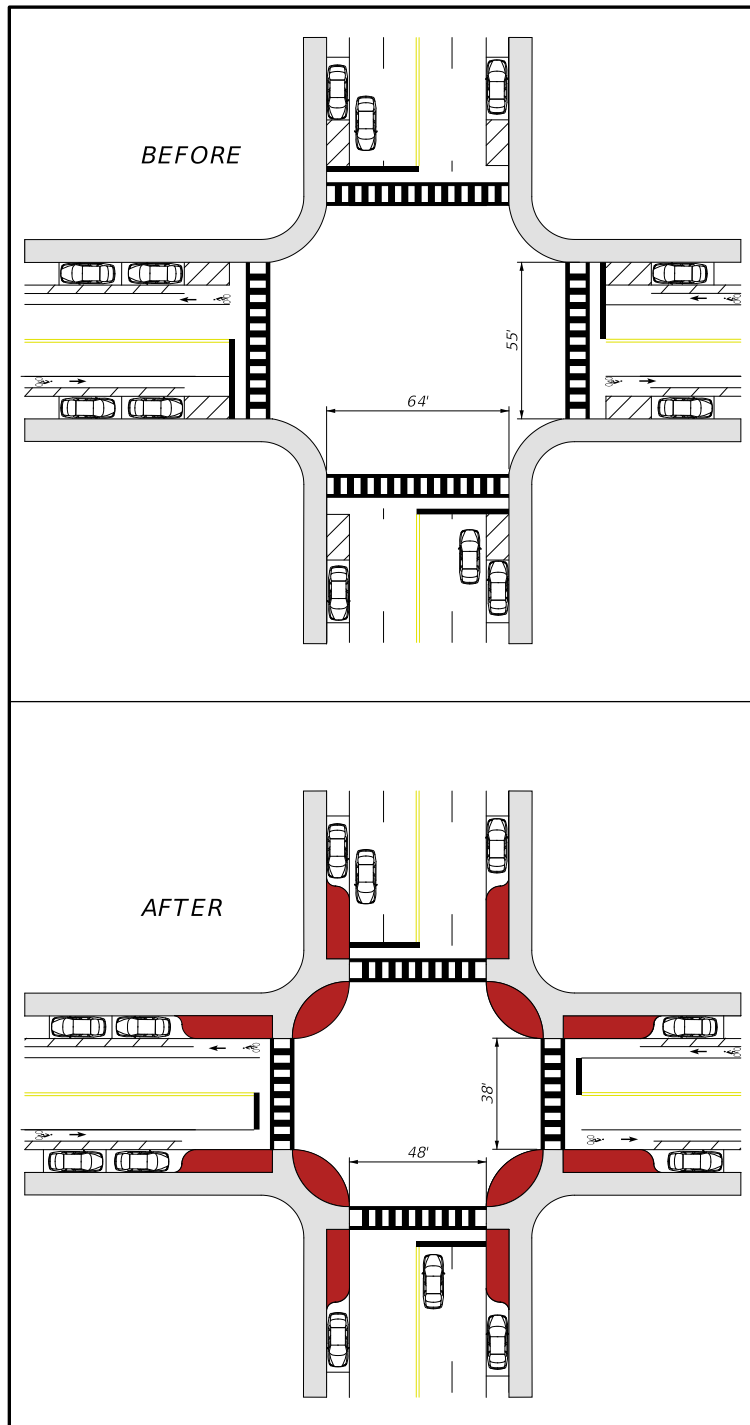

222.2.7 Pedestrian Signals

See **FDM 232.6** for information on pedestrian signals. Pedestrian detector assemblies and pedestrian control signals are detailed in the [Standard Plans](#), **Indexes 653-001** and **665-001**

222.2.8 Public Transit Loading Zones

See **FDM 225** for information on public transit facilities. Provide a minimum 5-foot-wide sidewalk connecting transit stops to sidewalk or shared use paths.

Coordination with the following may be required to determine the optimum location of boarding and alighting areas, transit shelters and bus bays:

- District Pedestrian and Bicycle Coordinator
- District Modal Development Office Coordinator
- District ADA Coordinator
- District Public Transportation staff
- Local public transit provider

222.2.9 Pedestrian Bridges

See **FDM 266** for information on pedestrian bridges.

222.2.10 Shared Use Paths

See **FDM 224** for information on shared use paths.

222.2.11 Street Furniture

Street furniture may include benches, lighting fixtures, transit shelters, and bicycle parking. These items may be placed within the R/W under certain conditions. Ensure items do not obstruct sight distance or visibility of pedestrians at crosswalks. Do not use street furniture on curb extensions.

Refer to **FDM 223.5** for information on bicycle parking amenities, and **FDM 225** for information on public transit facilities. Appropriate types of street furniture may vary based on frequency and density of pedestrian activity. Street furniture must allow for minimum sidewalk width and meet lateral offset requirements identified in **FDM 222.2.1.1** and **222.2.1.2**.

222.3 Detectable Warnings

Detectable warnings are a distinctive surface pattern of domes detectable by cane or underfoot that alert people with vision impairments of their approach to street crossings. Install detectable warnings to cover the full width of the walking surface and 2 feet deep. They are required on sidewalks at the following locations:

- Curb ramps and transition areas at street crossings
- Pedestrian refuge islands where there is one or more of the following:
 - Change in surface texture
 - Change in elevation (e.g., curb ramp)
 - Change in horizontal alignment of the path within the refuge island
 - Two-stage crossings
- Pedestrian at-grade railroad crossings
- Commercial driveways with a stop sign, yield sign, or traffic signal
- Boarding and alighting areas adjacent to the roadway at bus stops where there is an at-grade connection to the roadway
- Edges of railroad boarding platforms not protected by screens or guards

Detectable warnings should not be placed where sidewalk intersects urban flared driveways or on sidewalks that run continuously through residential driveways. Do not place detectable warnings on transition slopes or over grade breaks. Further guidance on detectable warnings is provided in [Standard Plans, Index 522-002](#).

222.4 Pedestrian Drop-off Hazards and Railings

A pedestrian drop-off hazard is a steep or abrupt downward slope that can be hazardous to pedestrians.

There are two pedestrian drop-off hazard conditions defined in **Figure 222.4.1**. Additionally, depending on the height of a slope and the severity of the conditions beyond,

cases other than those shown in **Figure 222.4.1** may also be considered a pedestrian drop-off hazard.

When the pedestrian drop-off hazard cannot be eliminated, consider the following:

- (1) Fencing is typically used in C1 and C2 context classifications, and on shared use paths and trails.
- (2) Railing is typically used in C2T, C3, C4, C5, and C6 context classifications, and at locations attaching to bridge rail or along sidewalks.
 - (a) Pedestrian/Bicycle Railings ([Standard Plans](#), [Index 515-021](#) through [515-062](#)) are adequate for shielding all drop-offs but are generally intended for use on drop-offs greater than 60 inches.
 - (b) Pipe Guiderail ([Standard Plans](#), [Indexes 515-070](#) and [515-080](#)) is adequate for shielding drop-offs which are 60 inches or less.
 - (c) Along continuous sections where the drop-off varies above and below the 60-inch threshold, for uniformity the engineer may consider using only one of the railing types adequate for shielding all drop-offs.
 - (d) Pedestrian/Bicycle Railings and Pipe Guiderail are non-crashworthy and are not to be placed within:
 - i. Lateral offset requirement for curbed roadways, or
 - ii. Clear zone for high-speed curbed and flush-shoulder roadways.
- (3) Maintain driver's line of sight at intersections and driveways.

The standard height for Pedestrian/Bicycle Railing is 42 inches. Provide a 48-inch-tall Pedestrian/Bicycle Railing when all three of the following conditions exist:

- (1) Bicyclists are permitted to travel within 3 feet of the railing.
- (2) The path is on a downward grade steeper than 5%.
- (3) There is a horizontal curve having a radius less than that specified for the design speed of the bicycle facility. Taller railing should not extend more than 20 feet beyond the point of tangency of the horizontal curve.

Pedestrian railings are not required where W-beam guardrail is installed at the back of the sidewalk or shared use path.

Pedestrian/Bicycle railings (42 inches in height) are not required where traffic railings separate the vehicular traffic from the pedestrian or bicycle facility.

Where Pedestrian/Bicycle Railing is used, the Department will cover the cost only for standard galvanized steel or standard aluminum railing. If the Local Agency desires a painted railing, they are required to provide the additional funding and commit to cover the maintenance cost.

The Department will cover the cost of the standard Infill Panel Types shown in the [Standard Plans](#). If the Local Agency desires a railing having Custom Infill Panels which increases the cost over standard infill panels, they are required to provide the additional funding to cover this initial premium cost. In addition, a maintenance agreement will be needed to address the responsibilities associated with maintaining Custom Infill Panels.

Figure 222.4.1 Drop-Off Hazards for Pedestrians

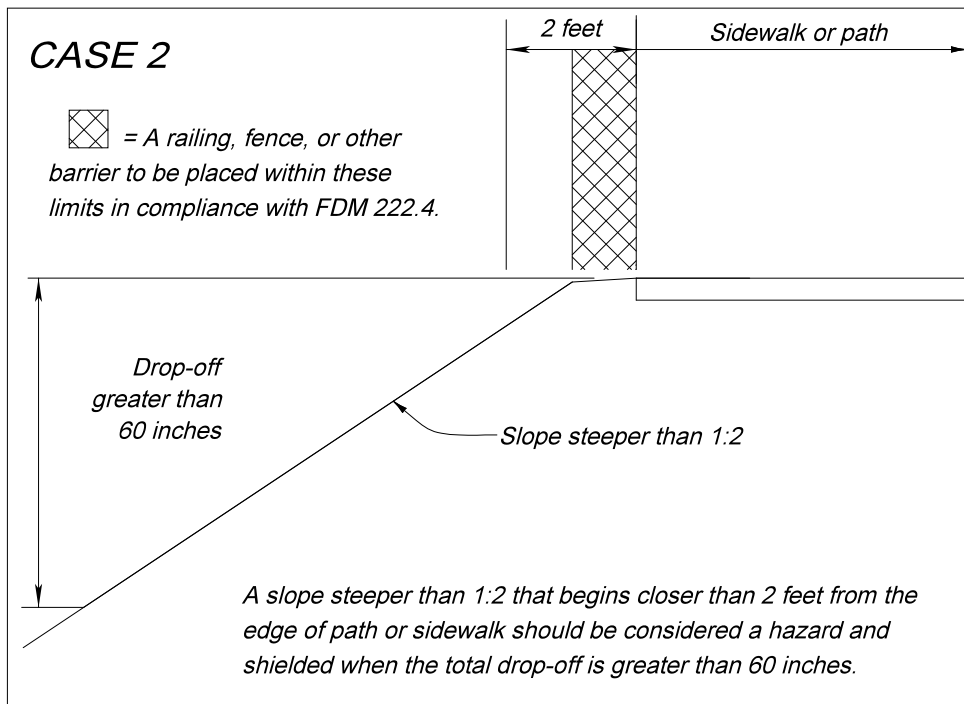
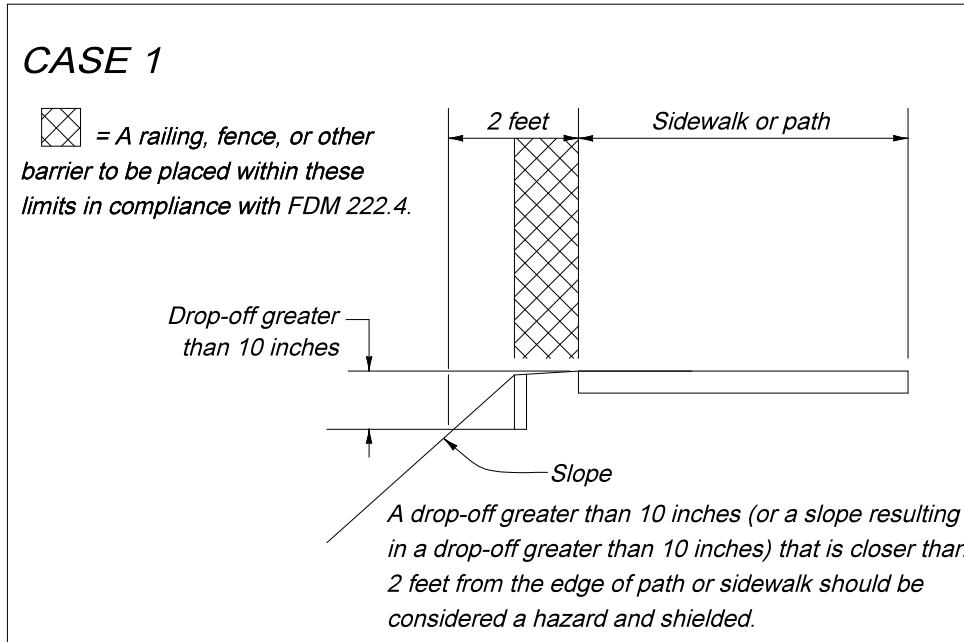

222.4.1 Bridge Pedestrian Railings and Fences

Details and typical applications of various crashworthy pedestrian/bicycle bridge railings and fencing are provided in **Figures 222.4.2 – 222.4.8**. The installation of fencing on traffic railing between sidewalk or shared use paths and travel lanes on LA facilities must be approved by the State Structures Design Engineer.

The Engineer should work with the District to determine when an enclosed fencing option is warranted.

Figure 222.4.2 Bridge Railing – Pedestrian/Bicycle Railing

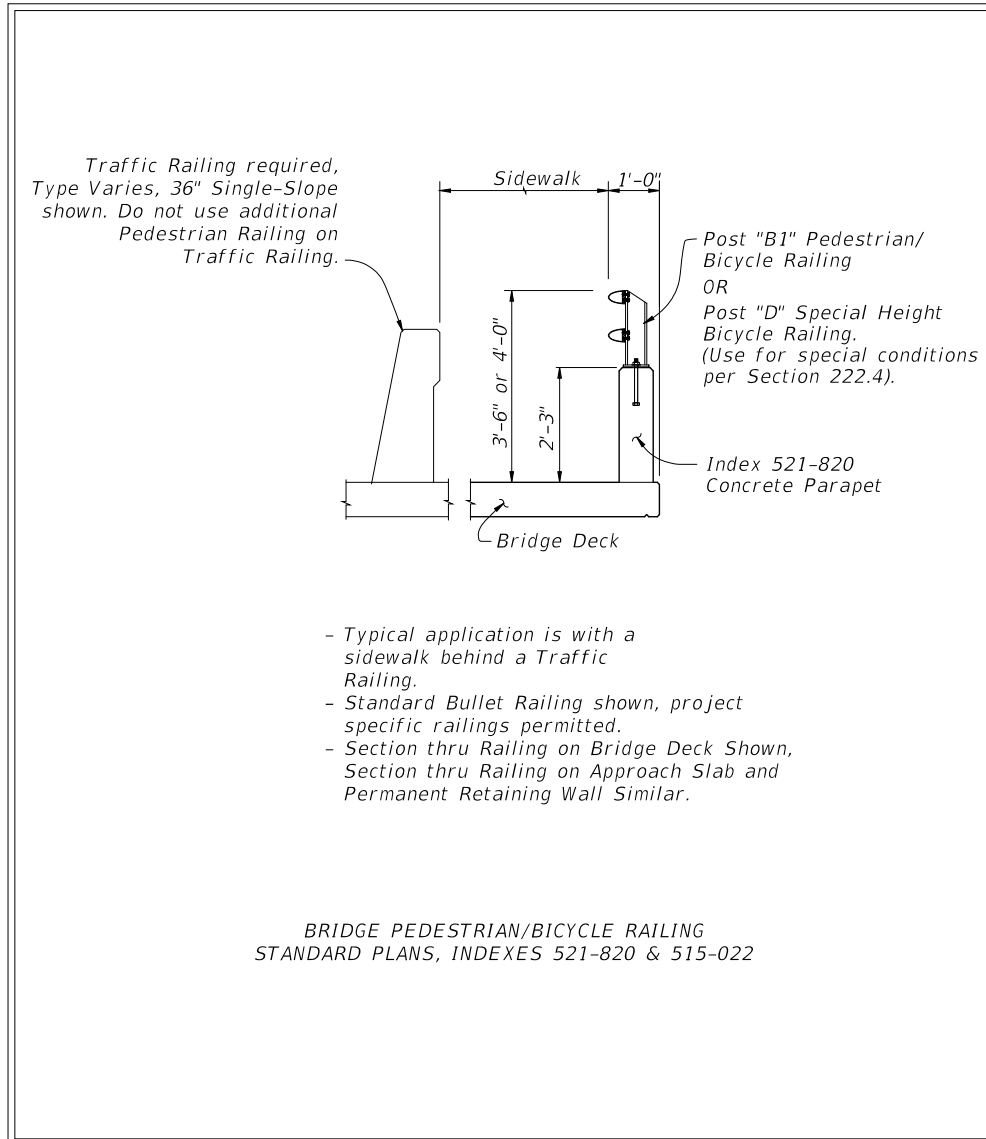

Figure 222.4.3 Bridge Railing – Pedestrian/Bicycle Railing

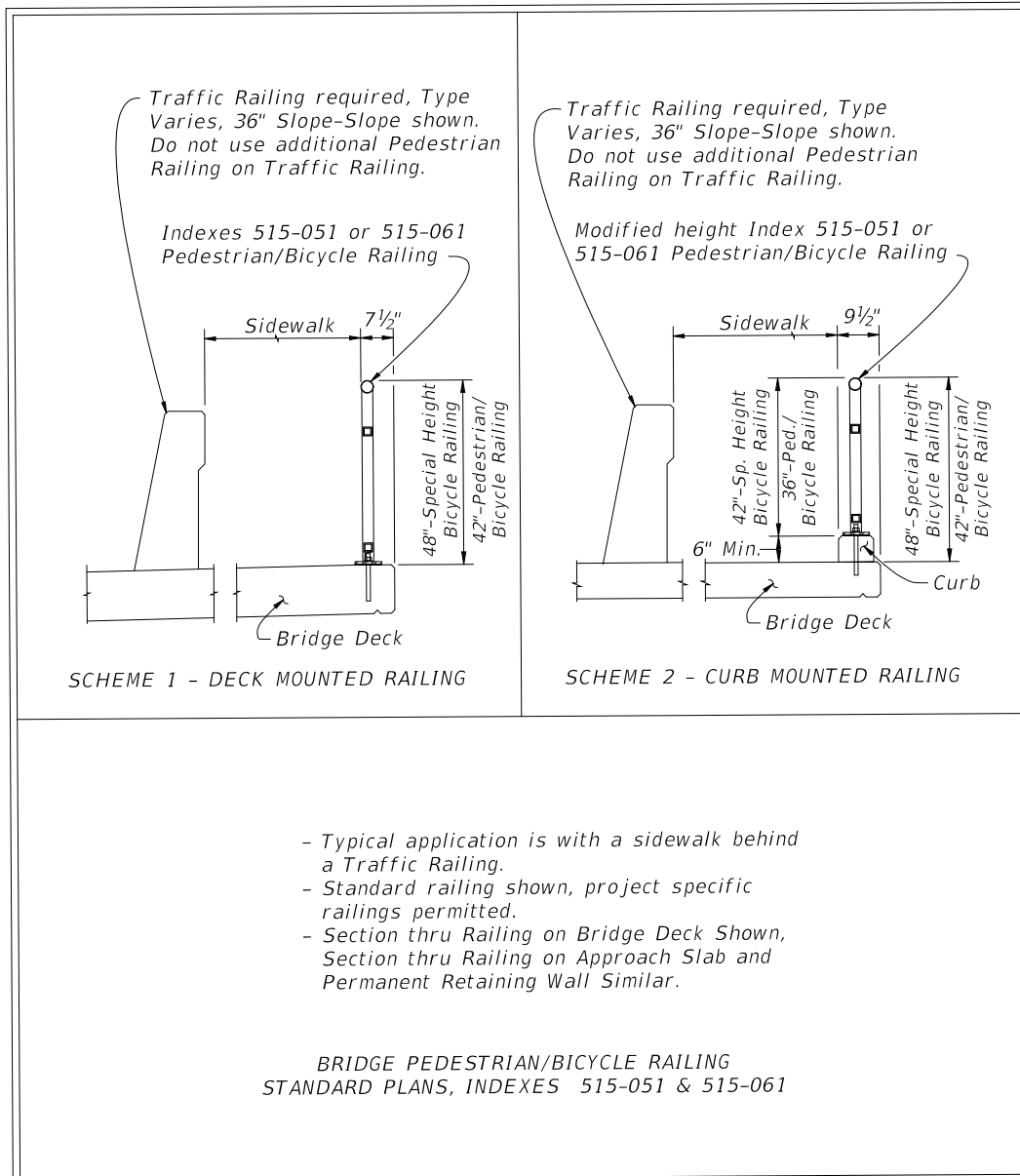

Figure 222.4.4 Bridge Railing – Pedestrian/Bicycle Railing

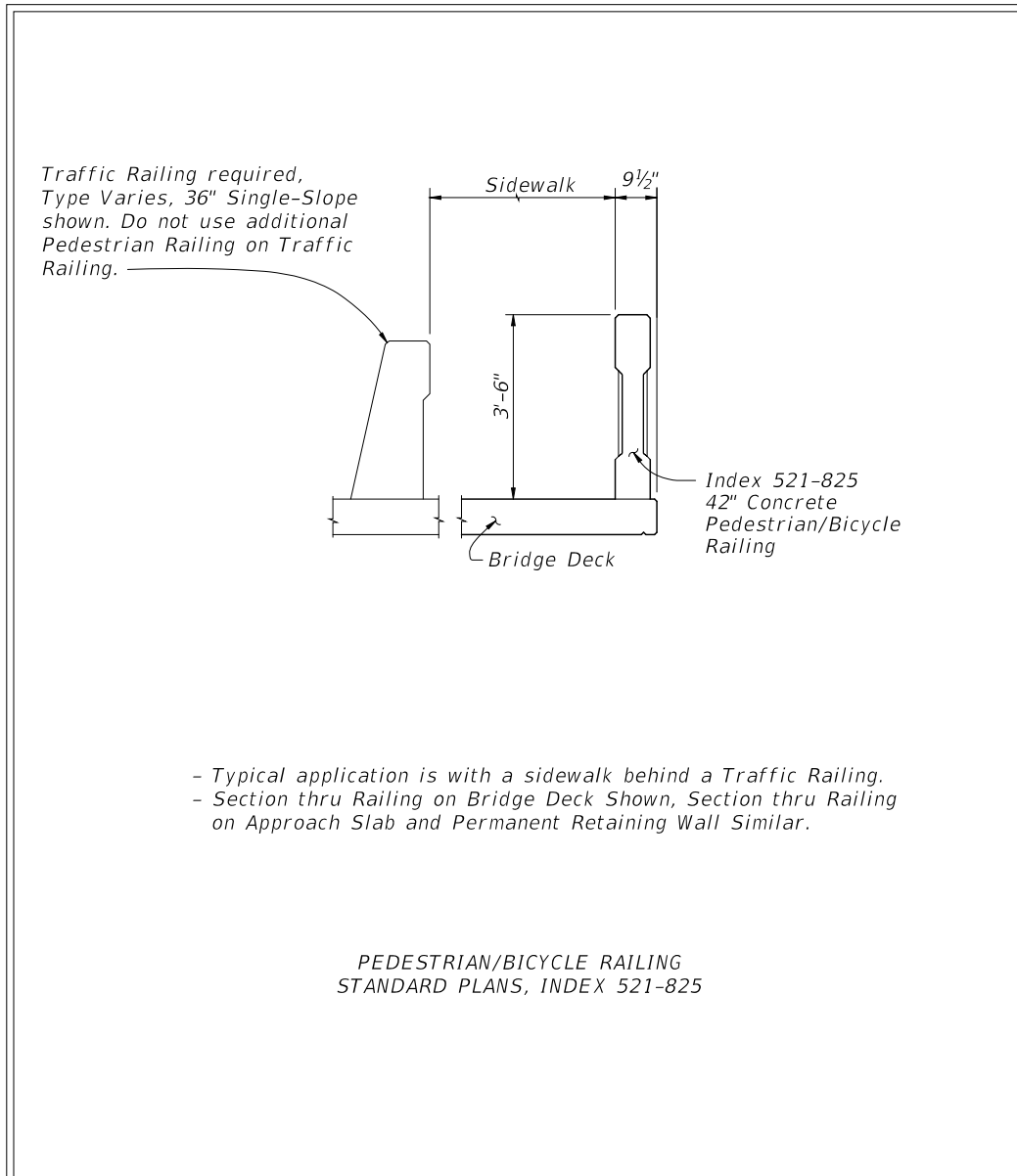

Figure 222.4.5 Bridge Railing and Pedestrian/Bicycle Railing Retrofit

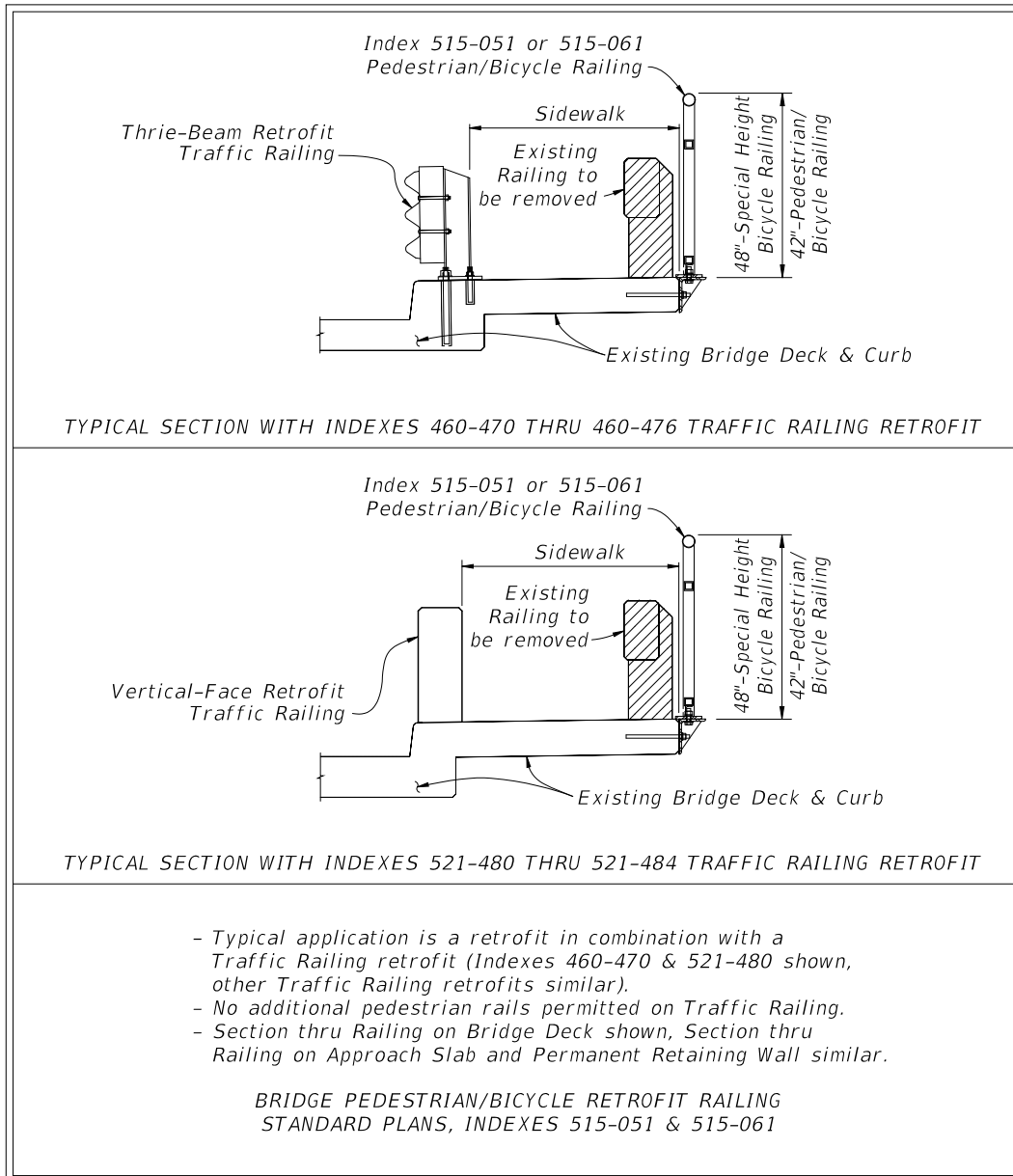

Figure 222.4.6 Bridge Railing and Bridge Parapet Fencing

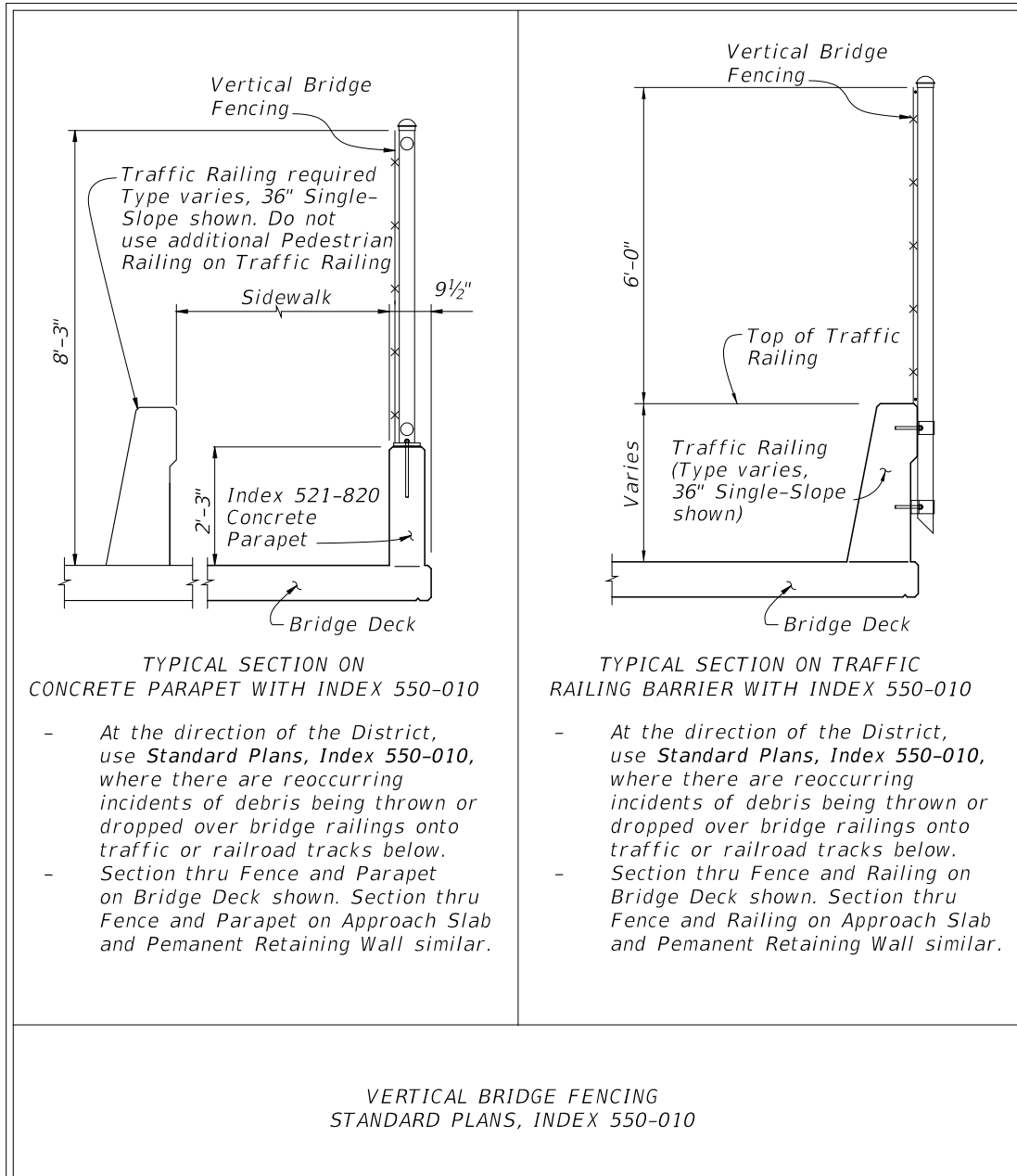

Figure 222.4.7 Curved Bridge Fencing

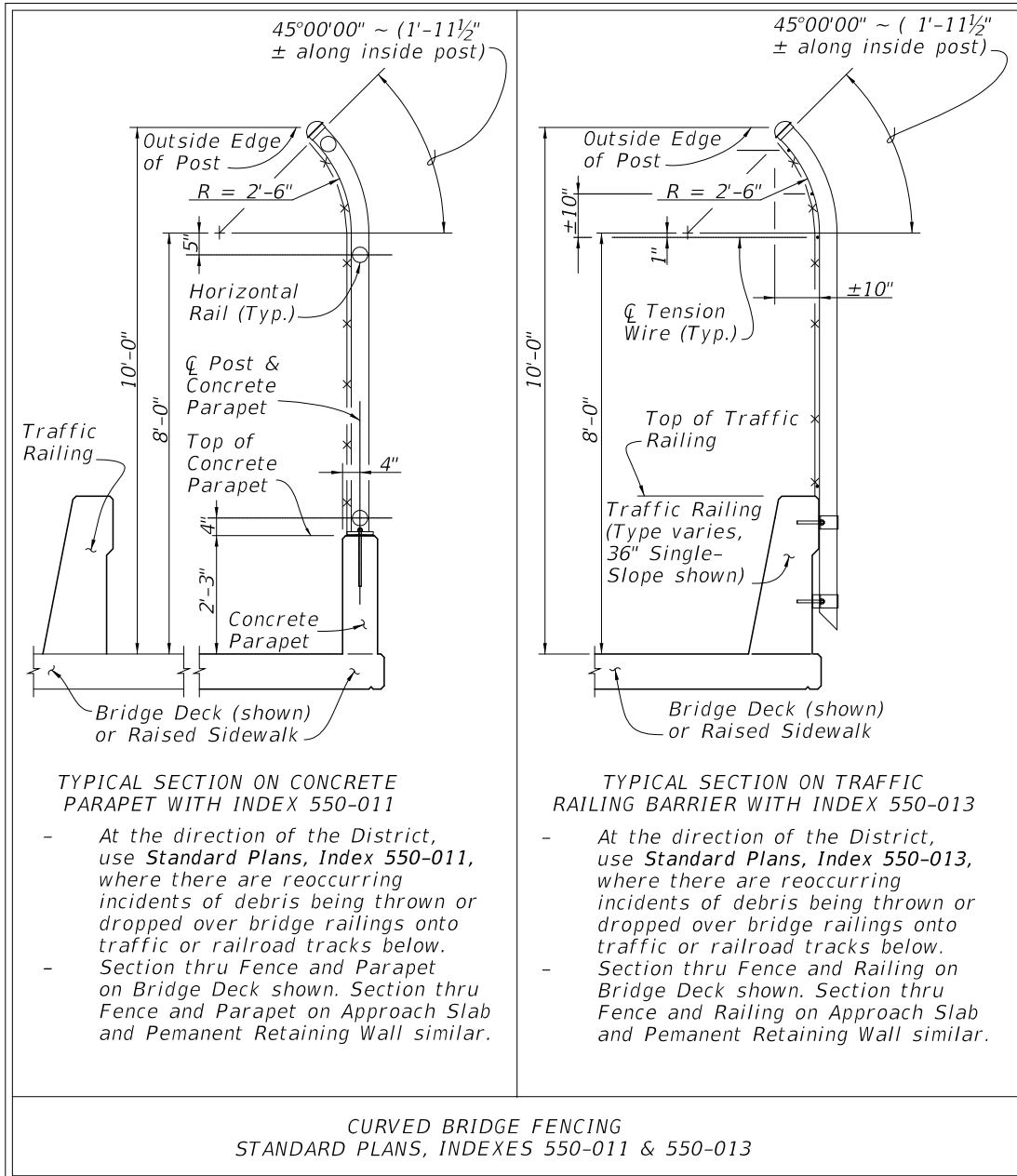
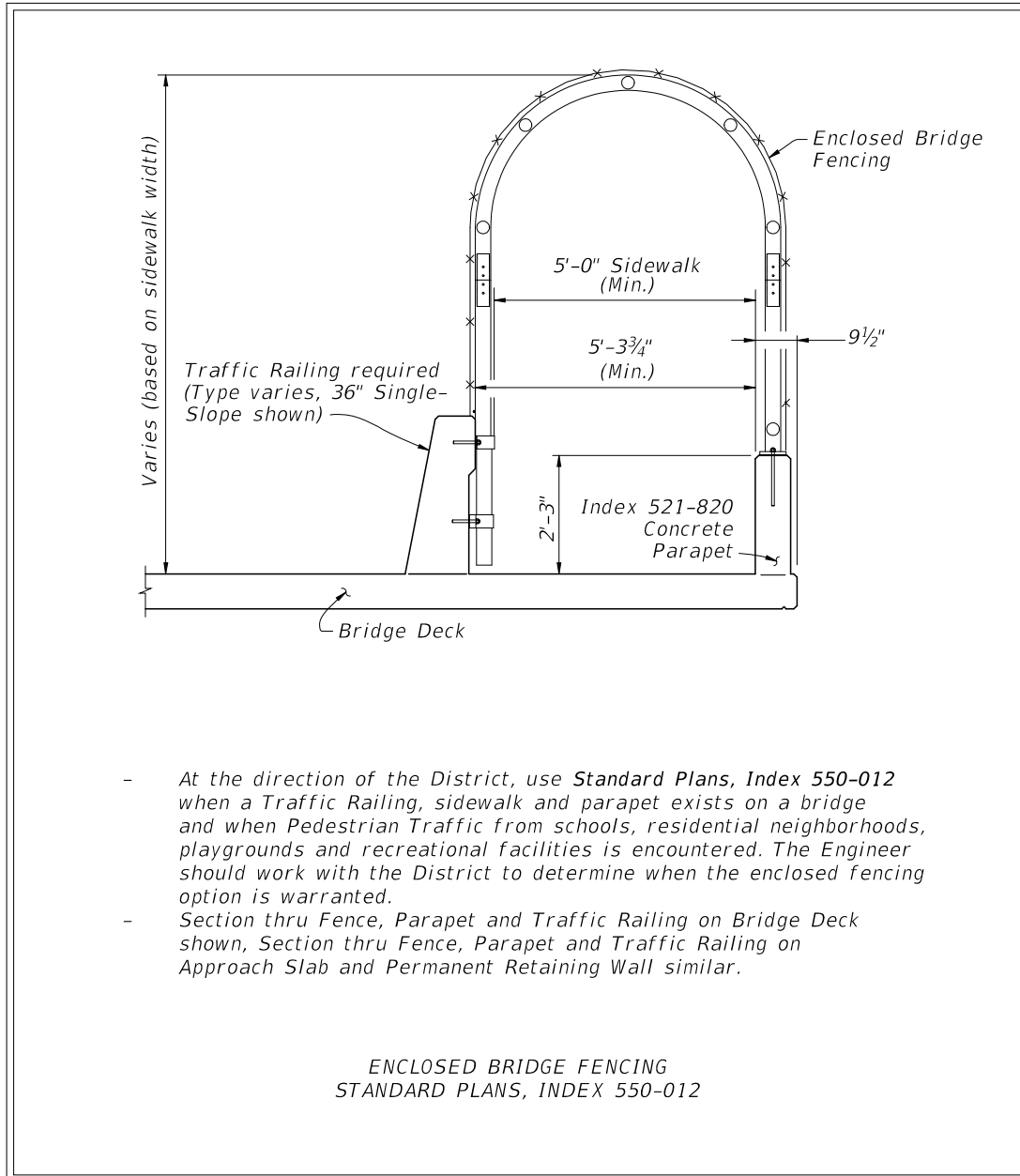

Figure 222.4.8 Bridge Railing – Enclosed Fencing



222.4.2 Pedestrian Railings on RRR Projects

For RRR projects, existing pedestrian railings and pipe guiderail should be removed that are within:

- Required lateral offset for curbed roadways, or
- Inside clear zone for high speed curbed and flush shoulder roadways

If there was a documented issue of traffic incidents involving pedestrians prior to the installation of the existing pedestrian railing or pipe guiderail that would likely reoccur, implement one of the following treatments, in order of priority:

- (1) Eliminate the hazard and remove the pedestrian railings and pipe guiderail, or
- (2) Allow the railing to remain.

222.5 Movable Bridge Pedestrian Gates

Refer to ***Structures Design Guidelines (SDG)***, Chapter 8 for movable bridge pedestrian safety design requirements.

223 Bicycle Facilities

223.1 General

This chapter provides the minimum criteria to be used for the design of bicycle facilities on the State Highway System (SHS).

Provide a bicycle facility on all roadways on the SHS, except where its establishment would be contrary to public safety; e.g., limited access facilities as defined by **FDM 211**. The various methods of providing bicycle facilities are discussed in **FDM 223.2**.

Bicycle safety can be enhanced through the following measures:

- (1) Maintaining a smooth, clean riding surface, free of obstructions. This includes ensuring drainage inlets and utility covers that cannot be moved out of the travel way are flush with grade, well seated, and use bicycle-compatible inlets, grates and covers.
- (2) Responsive and appropriate traffic control devices, consistent with guidance in the **Manual on Uniform Traffic Control Devices (MUTCD)**, including providing bicycle oriented directional signage.
- (3) Providing adequate lighting.
- (4) Developing and maintaining a district bicycle facility plan to assign proposed bicycle facility types through a consistent and efficient process and ensure the following:
 - (a) Integration of FDOT bicycle facilities with local and regional bicycle transportation systems
 - (b) The direct use of more complex facility types in a cost-effective and efficient manner.
- (5) For more design guidance regarding bicycle facilities on arterials and collectors, refer to [**FHWA Separated Bike Lane Planning and Design Guide**](#) and [**AASHTO Guide for the Development of Bicycle Facilities**](#).

Process a Design Variation when a bicycle facility cannot be provided or when criteria contained within this chapter are not met.

223.2 Bicycle Facilities

A bicycle facility accommodates bicycle travel. Bicycle facilities play an important role in supporting bicycle travel.

Bicycle facilities include the following:

- Bicycle lanes
- Keyhole lanes
- Intersection Bicycle Box and Two-Stage Bicycle Turn Box
- Paved shoulders
- Shared use paths
- Separated bicycle lanes
- Bicycle ramps

223.2.1 Bicycle Lanes

Bicycle lanes are a portion of a roadway designated for the exclusive use of bicyclists. Bicycle lanes are designated by a bicycle symbol pavement marking in accordance with [Standard Plans, Index 711-002](#) and the [MUTCD](#), and illustrated in [Exhibits 223-1 through 223-3](#). Bicycle lane signs and plaques may be used in accordance with the [MUTCD](#) when high levels of bicycle traffic exist or are anticipated.

Bicycle lanes can be used on roadways with a design speed ≤ 45 mph. However, it is best practice to consider other types of facilities for design speeds greater than 30 mph, such as a separated bicycle lane or shared use path.

Mark paved shoulders as bicycle lanes when all the following are met:

- (1) Design speed ≤ 45 mph,
- (2) Shoulder width ≥ 5 -foot,
- (3) Within C2T, C4, C5, C6, C3C context classification, or within C3R when demand is demonstrated, and
- (4) Shared use path or separated bicycle lanes are not present along corridor.

Bicycle lanes are one-way facilities and carry bicycle traffic in the same direction as adjacent motor vehicle traffic. On one-way streets, bicycle lanes should typically be placed on the right side of the street. A bicycle lane on the left side of the street can be considered if it will substantially reduce the number of potential conflicts, such as those caused by frequent bus traffic, heavy right-turn movements, high-turnover parking lanes, or if there is a significant number of left-turning bicyclists.

223.2.1.1 Bicycle Lane Width

The width of the bicycle lane is measured from the edge of travel lane to the edge of pavement. For new construction projects when a bicycle lane has been selected as the bicycle facility, a 7-foot buffered bicycle lane is the standard. A buffered bicycle lane has a double-6-inch white edge line separating the bicycle lane and the adjacent travel lane.

Buffered bicycle lanes are depicted in **Exhibit 223-1**. A buffered bicycle lane should not exceed 7 feet in width (including the buffer). Any additional pavement width that results from restricting the buffered bicycle lane to 7 feet should be applied to the outside travel lane.

For projects where a bicycle lane is needed and it is not practical to move the existing curb (e.g., RRR), the width of the bicycle lane depends on the width of the available roadway pavement. For these types of projects, the options in the order of priority are:

- (1) 7-foot buffered bicycle lane
- (2) 6-foot buffered bicycle lane
- (3) 5-foot bicycle lane
- (4) 4-foot bicycle lane

Do not place a bicycle lane with less than 5 feet of width adjacent to a 10-foot traffic lane.

When roadway pavement is continuous to the face of guardrail or barrier, the minimum bicycle lane width is 5 feet. See **FDM 223.2.1.3** when the bicycle lane is adjacent to a right-turn lane or bus bay.

223.2.1.2 Pavement Markings and Signage

Bicycle lane pavement marking symbols are illustrated in **Exhibit 223-1**. Use the following guidance in determining the appropriate placement of bicycle lane markings:

- (1) At an intersection approach, transition the buffer lane striping to a double 6-inch-wide stripe using a 2'- 4' dotted pattern 150 feet in advance of the intersection to provide sufficient distance for an automobile or truck to merge into the bicycle lane before turning right.
- (2) Provide continuous lane striping past low-volume and residential driveways.
- (3) Place a Helmeted Bicyclist Symbol and Bicycle Lane Arrow (per [Standard Plans, Index 711-002](#)) in the following locations:
 - (a) The beginning of a bicycle lane

- (b) The far side of major intersections
 - (c) Prior to and within the keyhole lane
- (4) The maximum spacing of the Helmeted Bicyclist Symbol and Bicycle Lane Arrow is 1,320 feet.

Provide “Bike Lane Ahead” and “Bike Lane End” signage in accordance with the [MUTCD](#).

See **FDM 230.3.1.3** for information on placing markings on concrete surfaces.

223.2.1.3 Keyhole Lanes

A keyhole lane is a bicycle lane that is placed between a through lane and the adjacent right-turn lane, merge lane, bus bay, or parking lane.

To reduce conflicts between motorists and bicyclists, consider transitioning a bicycle lane to an adjacent separated bicycle lane, shared use path, or urban side path prior to and through the conflict area. Keyhole lanes are not required where a separated bicycle lane is provided.

Provide a keyhole lane on curbed roadways that have a bicycle lane approaching a right-turn lane, merge lane, bus bay, or parking lane. On curbed roadways that do not have a bicycle lane approaching an intersection with a right-turn lane, consider providing a 17-foot right-turn lane for development of future bicycle facilities. Provide a keyhole lane on flush shoulder roadways of any design speed where the approaching or departing paved shoulder is of at least 4 feet in width.

Provide a 7-foot buffered keyhole lane on curbed roadways; however, when 7 feet is not obtainable, provide the greatest keyhole lane width possible, but not less than 5 feet. The keyhole lane should match the width of the shoulder on flush shoulder and high-speed curbed roadways, but not less than 5 feet.

See **FDM 223.4** for bicycle lane design criteria when adjacent to on-street parking.

Include Helmeted Bicyclist Symbol and Bicycle Lane Arrow pavement markings in the keyhole lane. Keyhole lanes are illustrated in **Exhibit 223-2**.

For RRR projects, a keyhole lane should be provided except on projects that have inadequate R/W or utility conflicts.

223.2.1.4 Green-Colored Pavement Markings

Green-colored pavement markings may be used when the need to enhance the conspicuity of bicycle-vehicular conflict areas is demonstrated. The Federal Highway Administration (FHWA) has issued an Interim Approval (IA.14) for the use of green-colored pavement in marked bicycle lanes, extensions of bicycle lanes through intersections, and other bicycle-vehicular conflict areas. FDOT has received permission from FHWA for use of green-colored pavement on the SHS. The Interim Approval may be found at the following website:

https://mutcd.fhwa.dot.gov/resources/interim_approval/ia14/index.htm

Bicycle-vehicular conflict areas are illustrated in **Exhibit 223-3**, and include:

- (1) Bicycle lane crosses a vehicular right turn lane
 - (a) Separate right-turn lane
 - (b) Dropped lane transitioning into a right-turn lane
 - (c) Free-flow channelized right-turn lane, such as at an interchange: lane addition or merge lane
- (2) Bicycle lane adjacent to a dedicated bus bay
- (3) Intersection Bicycle Boxes, see **FDM 223.2.1.5**
- (4) Two-Stage Bicycle Turn Boxes, see **FDM 223.2.1.5**

Green-colored pavement markings supplement the required bicycle lane pavement markings and are not to be used as a substitute for such markings.

The use of green-colored pavement markings requires the approval of the District Design Engineer through Project Suite's Design Approval Request Process. The approval must be obtained during Phase I of Design. The addition of green-colored pavement markings to bicycle lanes per these criteria do not require a local agency maintenance agreement. For placement on existing pavement, contact the State Materials Office for additional placement requirements.

Use the following guidance in the placement of green-colored pavement markings for bicycle lanes:

- (1) When it is used in conjunction with white dotted lines, such as when extending a bicycle lane across a right turn lane or access to a bus bay, the transverse-colored marking must match the 2'- 4' white dotted line pattern of the bicycle lane extension.

- (2) Start the green-colored pavement as a solid pattern 50 feet in advance of the dotted striping, match the 2'- 4' dotted through the conflict area, and then resume the solid color for 50 feet after the conflict area, unless such an extent is interrupted by a stop bar, an intersection curb radius or bicycle lane marking.

Include quantities in accordance with the [Basis of Estimates Manual](#). Load these quantities into the Designer Interface in the Signing and Pavement Marking Category.

Projects using green-colored pavement markings, the EOR must submit either a GIS (a.k.a., shapefile or geodatabase) or CADD (e.g., dsgnsp.dgn, dsgnsp.dwg) file(s) depicting the location(s) of these markings. Submit the required files via email to CO-CIMGIS@dot.state.fl.us and copy the State Bicycle Pedestrian Coordinator.

Additional details on the file format can be found in the [CADD Manual](#) and at the following website: <https://www.fdot.gov/gis/bim/green-pavement>.

223.2.1.5 Intersection Bicycle Box and Two-Stage Bicycle Turn Box

The Federal Highway Administration (FHWA) has issued Interim Approvals (IA), for the use of intersection bicycle boxes ([IA.18](#)) and two-stage bicycle turn boxes ([IA.20](#)). FDOT has received permission from FHWA for use of these markings on the SHS.

Intersection bicycle boxes increase the visibility of stopped bicycle traffic at an intersection and help group together bicyclists to clear intersections more quickly. Two-stage bicycle turn boxes provide another option for bicyclists to make a left turn at an intersection.

The use of intersection bicycle boxes or two-stage bicycle turn boxes may be considered only at signalized intersections. Should it be determined there are safety concerns with the IA's device or application and the IA is terminated, the device must be removed and the site restored to its previous condition.

Intersection bicycle boxes are to meet the requirements in [IA.18](#) and comply with all of the following conditions:

- 'Right turn on red' is prohibited
- The left turn signal is protective
- All approaches to the intersection have a posted speed no greater than 35 mph
- Bicycle detection is provided if detection is required to actuate the signal or the signals are not timed
- There is a bicycle lane or bicycle keyhole preceding the bicycle box

- There is no more than one through lane on the approach to the bicycle box
- There is a receiving bicycle facility (bicycle lane or paved shoulder) on the opposite side of the intersection

Two-stage bicycle turn boxes are used only in conjunction with bicycle lanes. They must meet the requirements in [IA.20](#) and comply with all of the following conditions:

- 'Right turn on red' is prohibited
- All approaches to the intersection have a posted speed no greater than 45 mph
- Bicycle detection is provided if detection is required to actuate the signal or the signals are not timed

It is recommended that an educational program be developed to accompany the installation of bicycle boxes or two-stage bicycle turn boxes.

The use of intersection bicycle boxes or two-stage bicycle turn boxes require the approval of the State Roadway Design Engineer.

223.2.2 Paved Shoulders

A paved shoulder is the portion of the roadway contiguous with the traveled way for accommodation of errant vehicles, stopped vehicles, bicycle traffic, and emergency use. A paved shoulder must be a minimum width of 4 feet to serve as a bicycle facility.

See **FDM 223.2.1** for criteria on marking a paved shoulder as a bicycle lane. See **FDM 210.4** for additional information on paved shoulder requirements.

When audible and vibratory treatment is used adjacent to a paved shoulder that serves as a bicycle facility, see **FDM 210.4.6**.

223.2.3 Shared Use Paths

A shared use path may be substituted for a bicycle lane when the roadway design speed is 35 mph or greater and all the following conditions are met:

- Context classification C1, C2, or C3,
- Separation can be maintained between bicycle and motorized traffic through intersections, and

- Conflict points are minimal and mitigated.

An Urban Side Path, which is a category of shared used path, may be substituted for a bicycle lane when the roadway design speed is 35 mph or less and the following conditions are met:

- Context Classification of C2T, C4, C5, and C6
- The adjacent roadway is curbed

As shown in **Figure 223.2.1**, in some cases it may be possible to fit a shared use path into the same space required for a sidewalk and buffered bicycle lane. Process a Design Variation for signs placed within the path horizontal and vertical clearance envelope (see **FDM 224.7** and **224.8**) or roadway lateral offset (see **FDM 215** and **Standard Plans**). In other cases, additional width may be required. It is preferable to plan for shared use paths and separated bicycle lanes ahead of time by reflecting them in a district bicycle facility plan.

See **FDM 224** for shared use path design criteria.

Figure 223.2.1 Bicycle Lane and Shared Use Path Examples

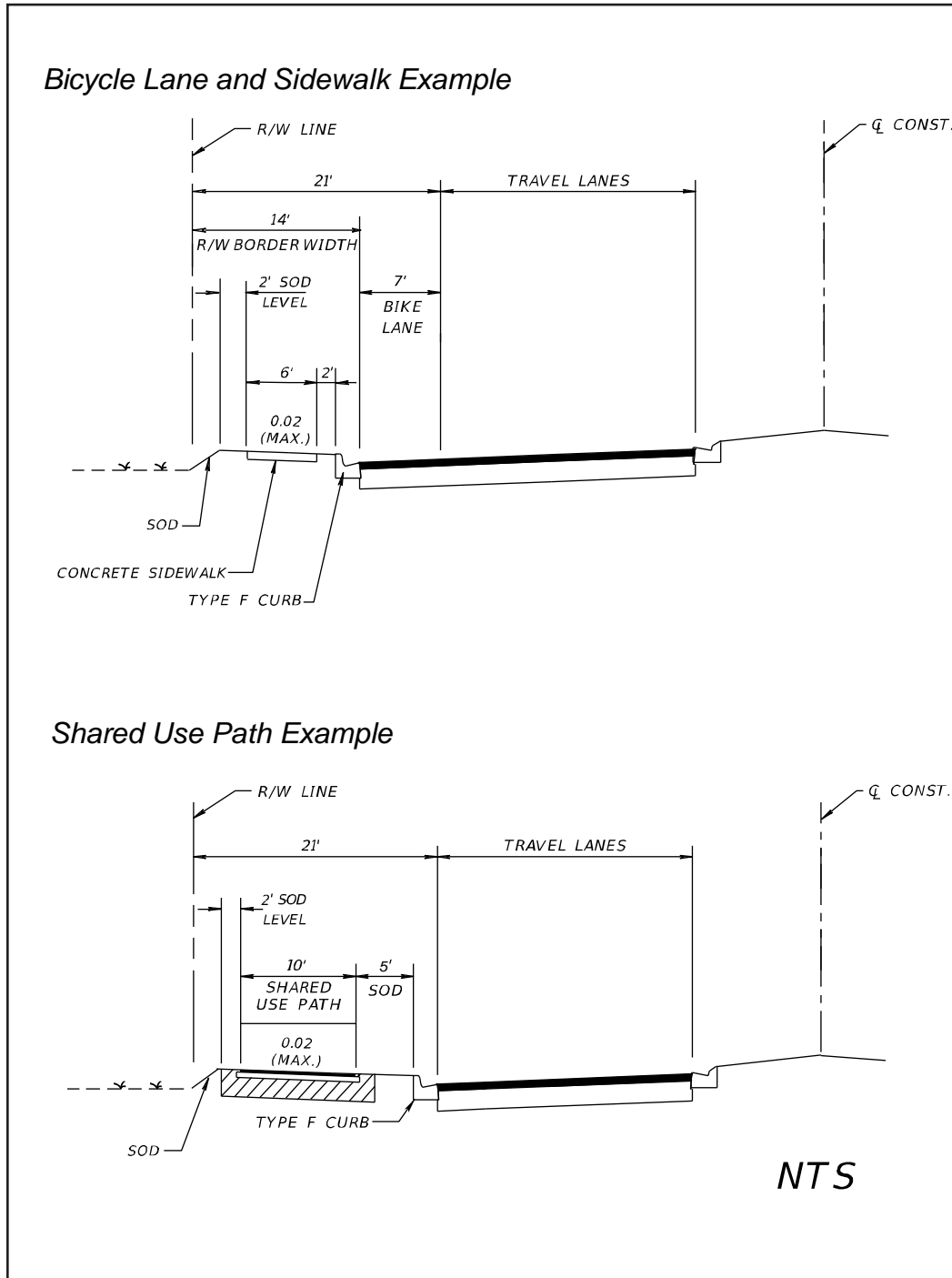

223.2.4 Separated Bicycle Lanes (SBL)

Separated bicycle lanes are one-way or two-way bicycle lanes that are adjacent to and physically separated from the vehicular travel lane. Bicyclists in these facilities are separated from vehicular traffic.

A separated bicycle lane may be used when all the following conditions are met:

- Minimum required combined width of the separator and separated bicycle lane can be obtained,
- Separation can be maintained between bicycle and motorized traffic through intersections, and
- Conflict points are minimal and mitigated. Cyclists should be given priority at the driveway and side street crossings.

A separated bicycle lane should be considered when street level bicycle facility transitions are needed for interchange ramp and intersection approaches. See **FDM 223.2.6** for criteria for transitioning between elevations and **FDM 211.18** for ramp crossing criteria.

Use the criteria contained in **FDM 223.2.4** in conjunction with the [FHWA Separated Bike Lane Planning and Design Guide](#) to plan and design separated bicycle lanes on the State Highway System.

223.2.4.1 Type of Separation

Tubular markers, islands, on-street parking, and rigid barriers may be used as forms of separation for the appropriate design speeds as follows:

- 35 mph or less: Tubular markers, traffic separators, islands, rigid barriers, or on-street parking. For separated bicycle lanes adjacent to on-street parking, use an island (see **Figure 223.2.2**).
- 40-45 mph: Traffic separator, islands, or rigid barriers

Use curb types for separated bicycle lanes as shown in **FDM 223.2.5**. Other forms of separation require approval from the State Roadway Design Engineer.

223.2.4.2 Sidewalk Level Separated Bicycle Lanes

Sidewalk level separated bicycle lanes (sidewalk level SBLs), also known as raised bicycle lanes, are exclusive bicycle facilities located at sidewalk level directly adjacent to the roadway,

Use the following criteria when designing sidewalk level SBLs:

- In C2T, C4, C5, or C6 where design speed is 35 mph or less, use urban side path criteria per FDM 224 for the following elements. In other conditions, use Shared Use Path criteria for these elements.
 - Horizontal Clearance
 - Vertical Clearance
 - Design Speed
 - Horizontal Alignment
 - Separation from Roadway
 - Longitudinal Grades
 - Cross Slopes
- Follow the width criteria in **Table 223.2.1**
- When adjacent to a sidewalk, provide a 2-foot detectable buffer (e.g. grass strip or textured pavement) between the sidewalk and separated bicycle lane. A 1-foot detectable buffer may be used in constrained conditions.

A sidewalk level bike lane does not substitute for a sidewalk, where a sidewalk is required. See **Figure 223.2.2** for an example of a sidewalk level bike lane.

Figure 223.2.2 Example of Sidewalk Level Bicycle Lane

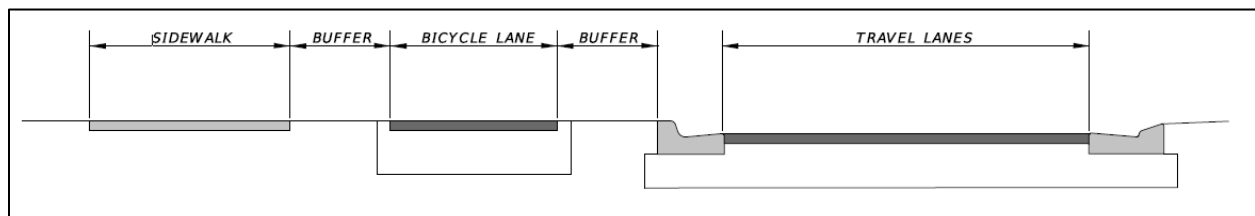

223.2.4.3 Width of Separation

The widths of separation are as follows:

- 3 feet minimum if adjacent to on-street parking. See **Figure 223.2.3** for more information.
- If adjacent to travel lanes:
 - 35 mph or less: 6 feet preferred, 3 feet minimum unless using tubular markers or islands, then 2 feet minimum
 - 40 to 45 mph: 8 feet preferred, 3 feet minimum.

Figure 223.2.3 On-Street Parking Minimal Separation

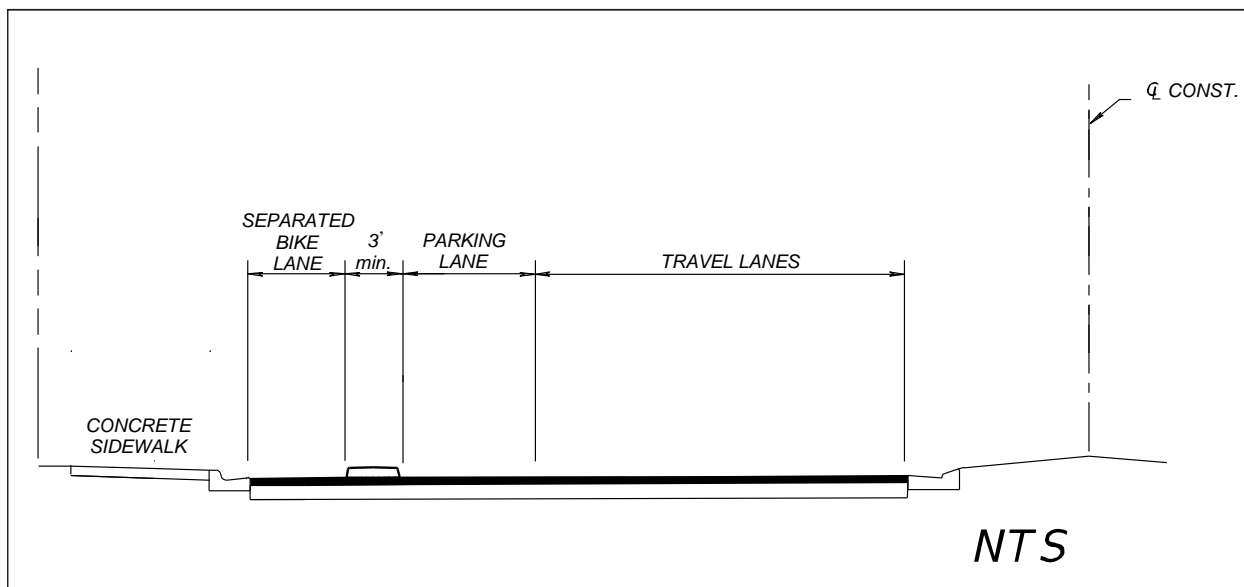

223.2.4.4 Separated Bicycle Lane Widths

Use wider lanes where higher volumes are expected.

The preferred lane width for one-way separated bicycle facilities is 7 feet. For two-way facilities, the preferred lane width is 12 feet.

Use the following minimum separated bicycle lane widths in **Table 223.2.1** along one-way and two-way separated bicycle lane facilities under constrained conditions:

Table 223.2.1 Minimum Separated Bicycle Lane Widths

One-Way Facility	Width (feet)
Between drop curbs, types E or B curbs, at sidewalk level, or adjacent to one type F or D curb	5
Between two type F or D curbs	6
Two-Way Facility	Width (feet)
Between drop curbs, types E or B curbs, or at sidewalk level	8
Adjacent to one type F or D curb	9
Between two type F or D curbs	10
Notes: (1) A continuous barrier is treated the same as a type F or D curb.	

223.2.5 Separated Bicycle Lane (SBL) Curb Types

Selecting the appropriate curb type is important when designing separated bicycle lanes and street buffer zones. Increased risks of bicycle wheel or pedal strikes and crashes can be influenced by the curb type. The curb angle and curb height can have an impact when exiting the bicycle lane, accessing parking, and determining risk of encroachment by motor vehicles. **Figure 223.2.4** illustrates and describes curb types used for separated bicycle lanes.

Figure 223.2.4 SBL Curb Types

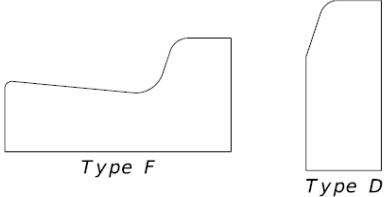
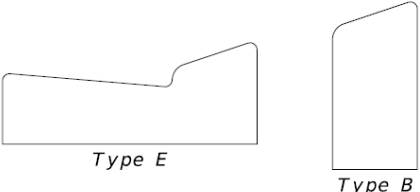
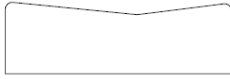
Curb Types	Description
 <p style="text-align: center;">Type F Type D</p>	<p><i>Types F and D Curbs assist in channelizing bicycles, but wheels or pedals could strike the curb.</i></p>
 <p style="text-align: center;">Type E Type B</p>	<p><i>Types E and B curbs also assist in channelizing bicycles, reduces pedal strikes, and provide easier access to the sidewalk for dismounting.</i></p>
 <p style="text-align: center;">Drop Curb</p> <p>See References: FDOT Standard Plan-Index 520-001, 520-002 FDOT Drainage Manual-Table 3.2</p>	<p><i>Drop Curbs are designed with a forgiving angle that minimizes pedal strikes but consumes more cross section width that could be used for the bicycle lane or a buffer. The curbs also allow safer exit from the bicycle lane, without impeding fellow bicyclists. However, the curb can be encroached by motor vehicles and bicycles.</i></p> <p style="text-align: right;">(N.T.S)</p>

223.2.5.1 Pavement Markings

Pavement markings used for separated bicycle facilities must conform to the [MUTCD](#), [Traffic Engineering Manual \(TEM\)](#), or [FDM 230](#). Markings that do not conform to any of these manuals require approval by the State Roadway Design Engineer and State Traffic Operations Engineer.

223.2.5.2 Intersections and Driveways

Chapter 5 of the [FHWA Separated Bike Lane Planning and Design Guide](#) includes typical designs to address the following:

- Facility connections at intersections,
- Side streets and driveways, and
- Traffic operation tools such as bicycle signal faces and signal phasing.

See the [TEM](#) for more information on traffic operation tools.

Maintain separation between bicycle and motorized traffic through intersections (e.g., do not use mixing zones and keyhole lanes).

Minimize turning conflicts through access management. Cyclist should have priority at the driveway and side street crossings that remain.

223.2.6 Bicycle Ramps

Use bicycle ramps when connecting on-street bicycle facilities to sidewalk level SBLs or shared use paths on curbed roadways.

Figure 223.2.5 illustrates the geometrics for a bicycle ramp when a utility strip of at least 5-feet is present. The desired angle between the ramp and the roadway ranges from 20 to 25 degrees; however, the angle is not to exceed 35 degrees.

Figure 223.2.6 illustrates the geometrics for a bicycle ramp when the sidewalk on the approach leg is adjacent to, or near the back of curb.

Place a Directional Tactile Walking Surface Indicator (a.k.a., Directional Indicator) at the top of the bicycle ramp to provide a tactile cue for visually impaired pedestrians to continue down the sidewalk or shared use path. Do not place detectable warning surfaces on the bicycle ramp. See [Developmental Specification Dev528](#) and [Developmental Standard Plans \(DSP\) Index D528-001](#) for additional requirements. Do not include a Directional Indicator when connecting an on-street bicycle facility to a sidewalk level SBL.

Figure 223.2.5 Angled Bicycle Ramp

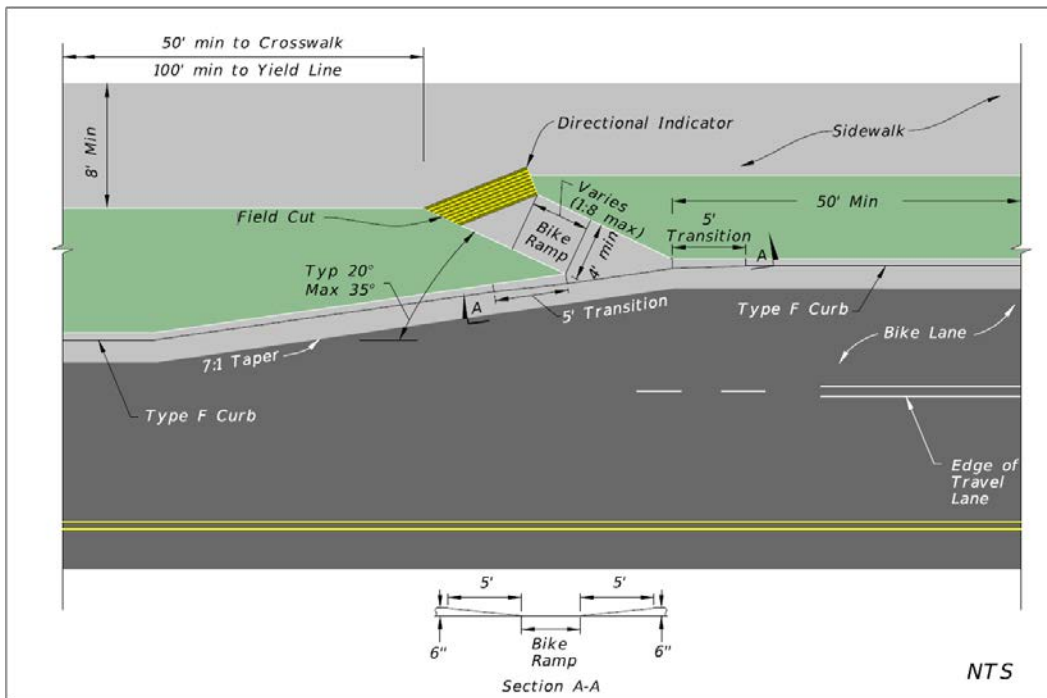
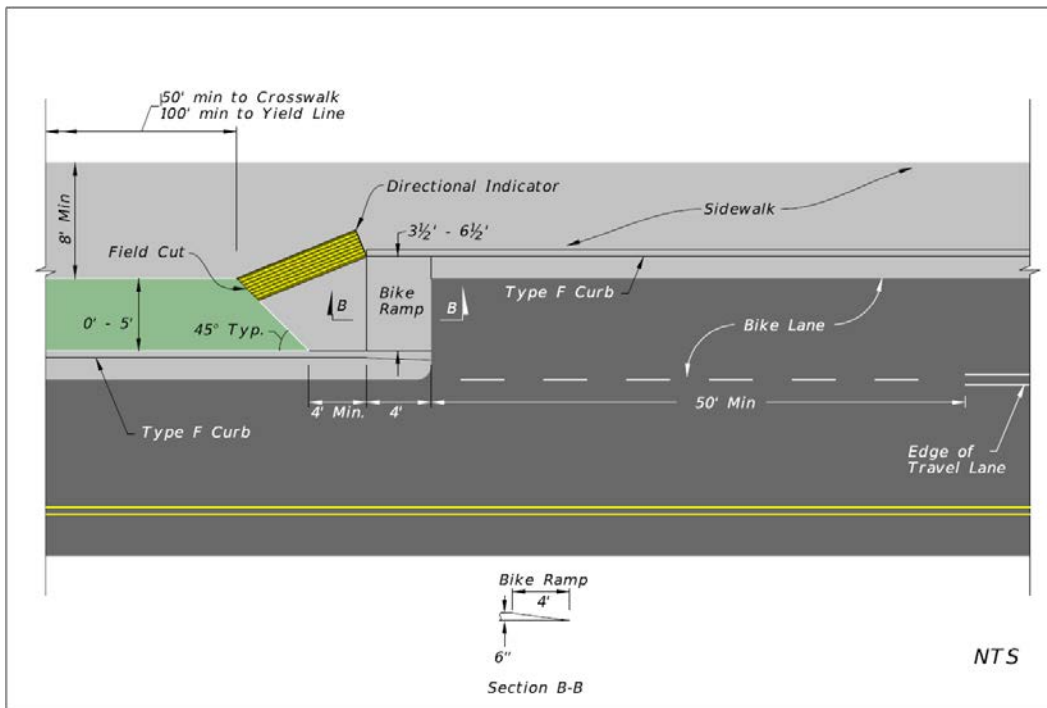
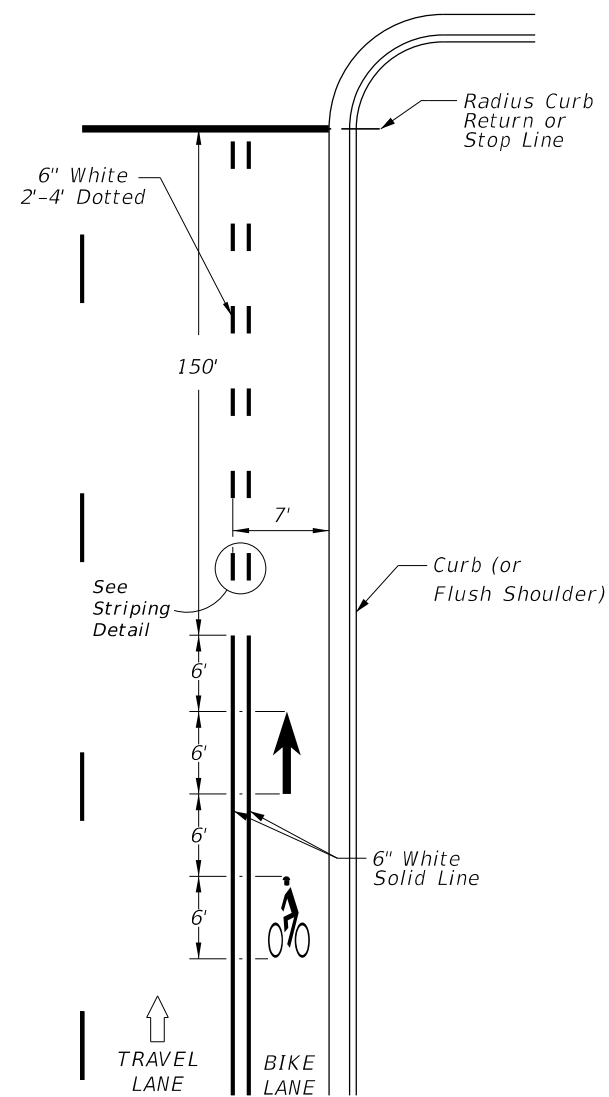
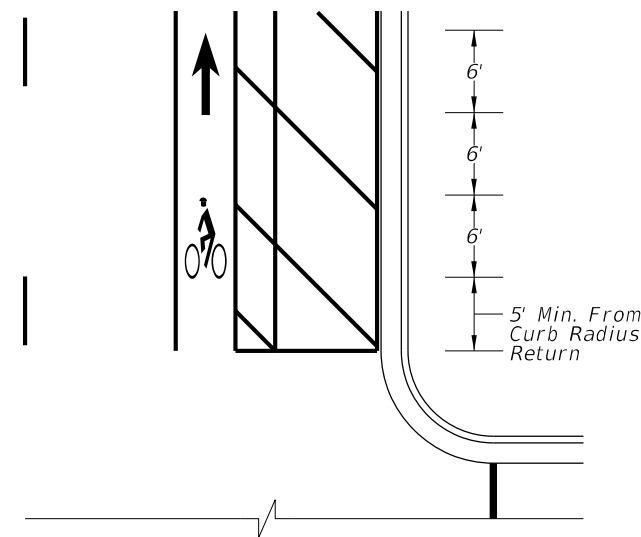
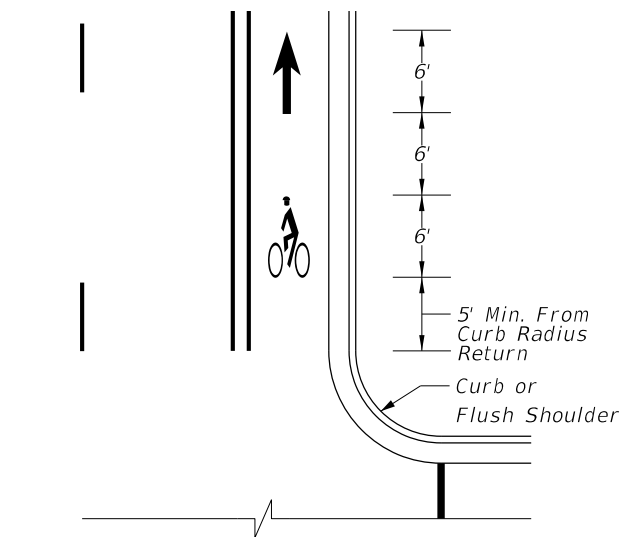

Figure 223.2.6 Straight Bicycle Ramp



BIKE LANE TYPICAL PAVEMENT MARKINGS



BIKE LANE INTERSECTION APPROACH DETAILS

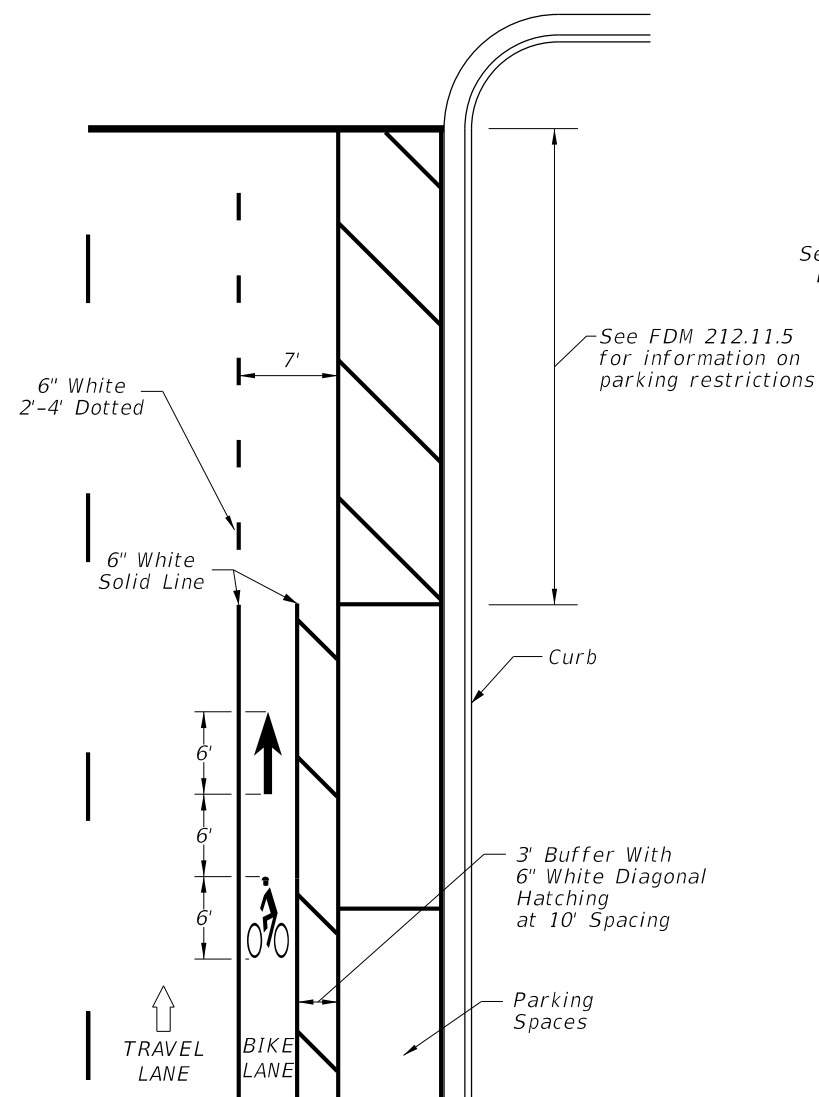

BIKE LANE ADJACENT TO ON-STREET PARKING

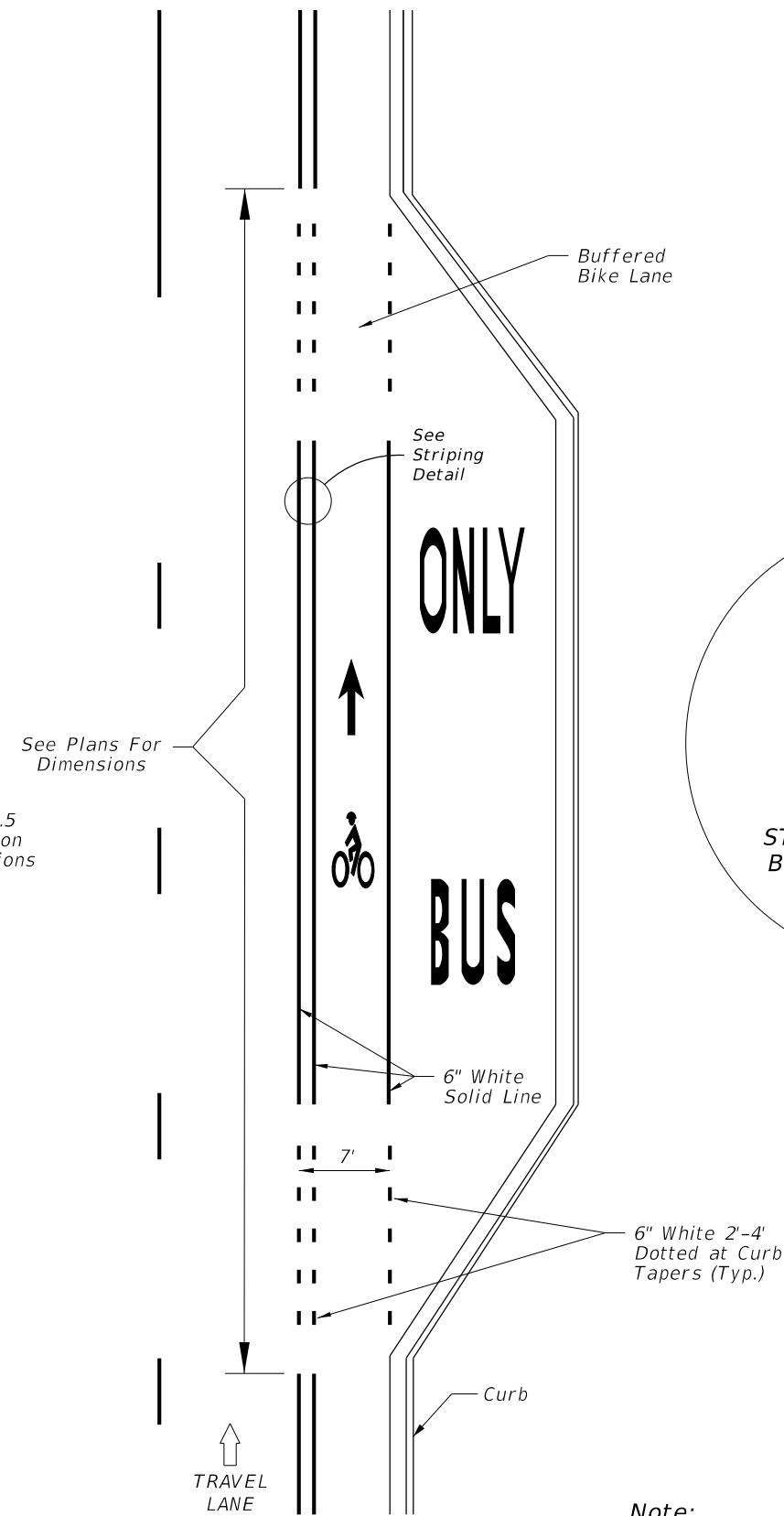

BIKE LANE ADJACENT TO BUS BAY

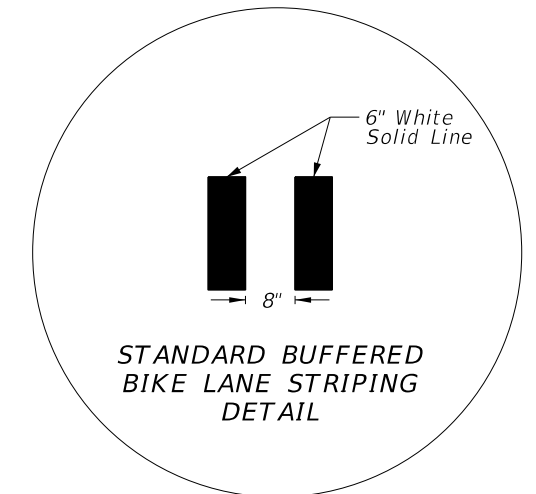

Note:
See Exhibit 230-1 in FDM 230 for bike lane and midblock crossings pavement markings.

NOT TO SCALE

EXHIBIT 223-1
05/14/2019

TYPICAL KEYHOLE LANES

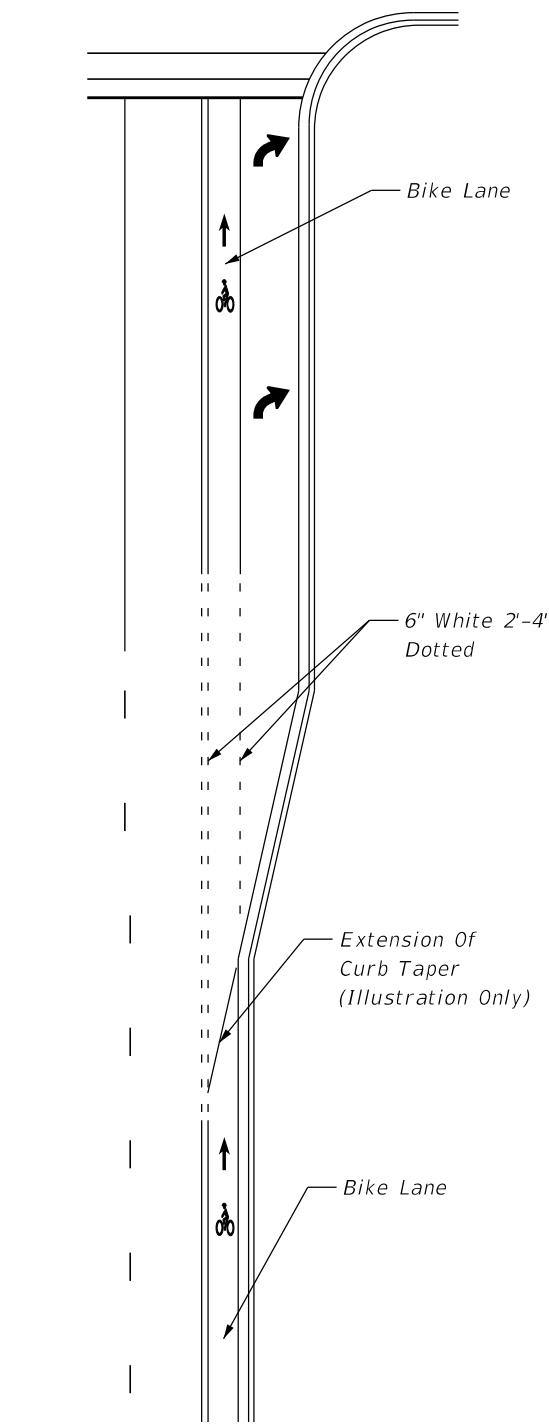

CURBED ROADWAY INTERSECTION WITH SEPARATE RIGHT TURN LANE

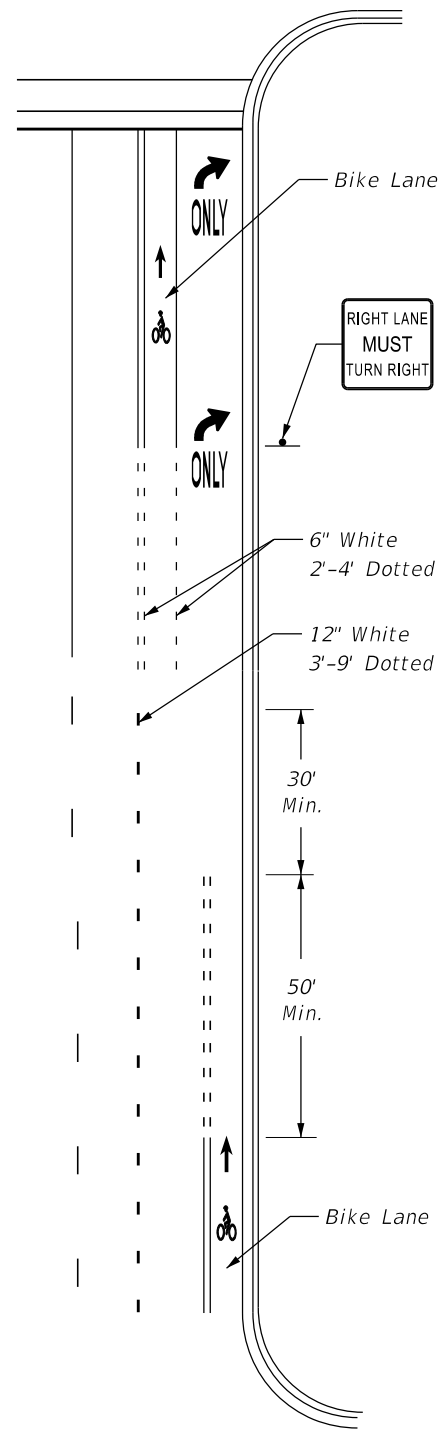

CURBED ROADWAY INTERSECTION WITH RIGHT TURN DROP LANE

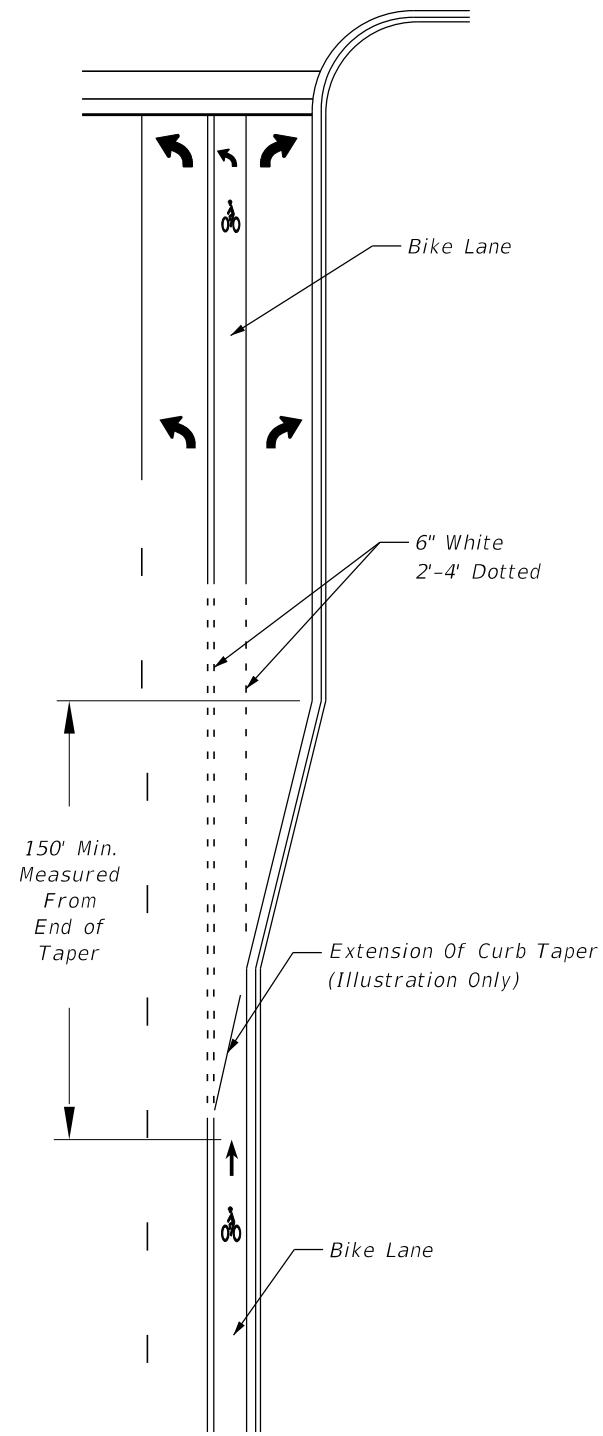

CURBED ROADWAY "TEE" INTERSECTION WITH SEPARATE RIGHT-TURN LANE

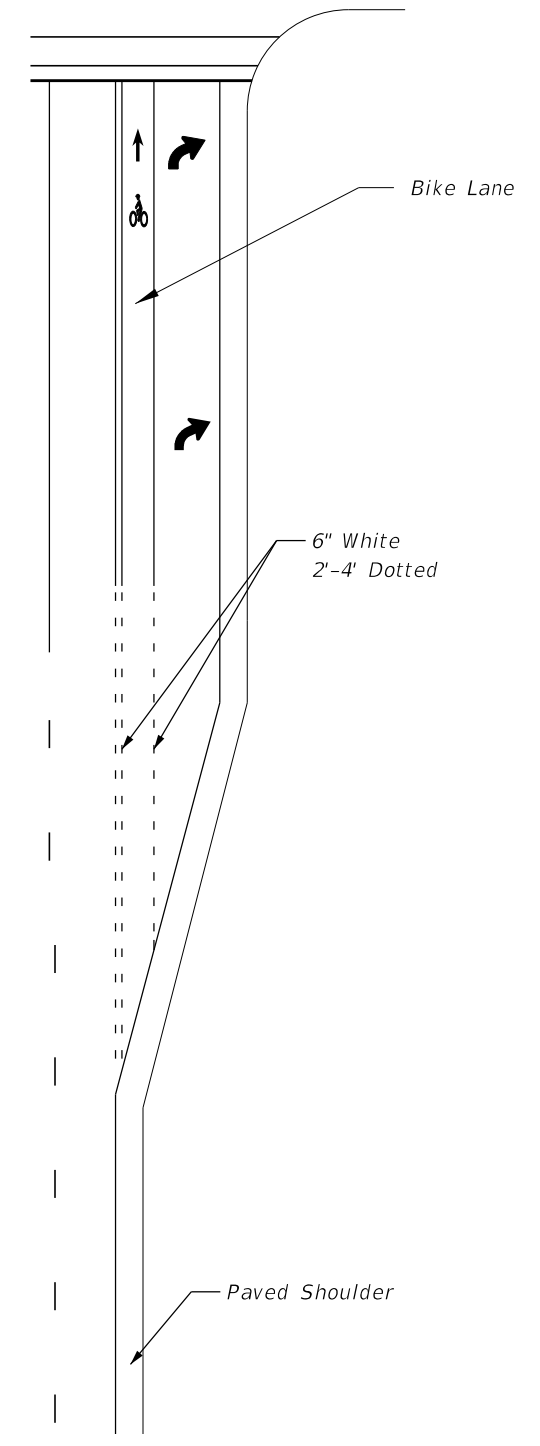

FLUSH SHOULDER ROADWAY INTERSECTION WITH SEPARATE RIGHT-TURN LANE

NOT TO SCALE

GREEN-COLORED BIKE LANES

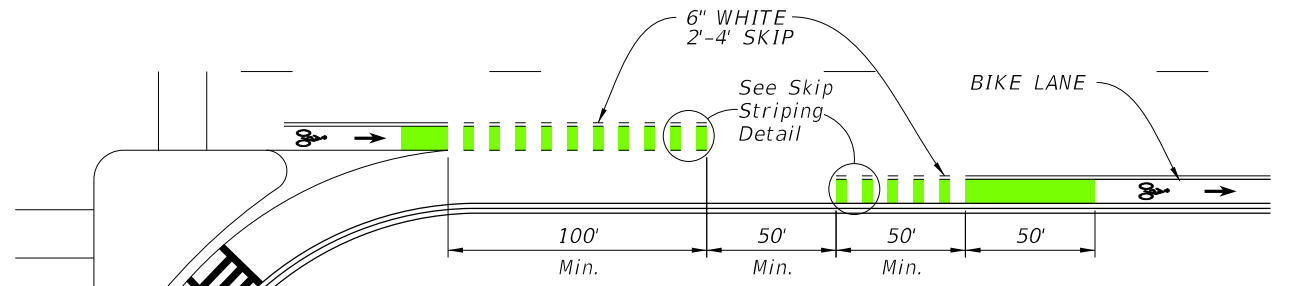
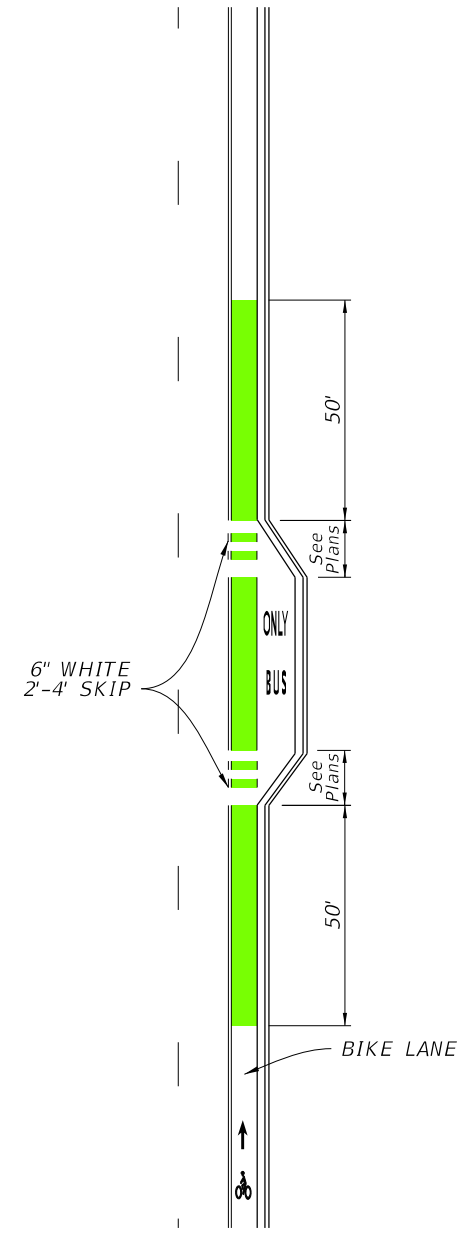
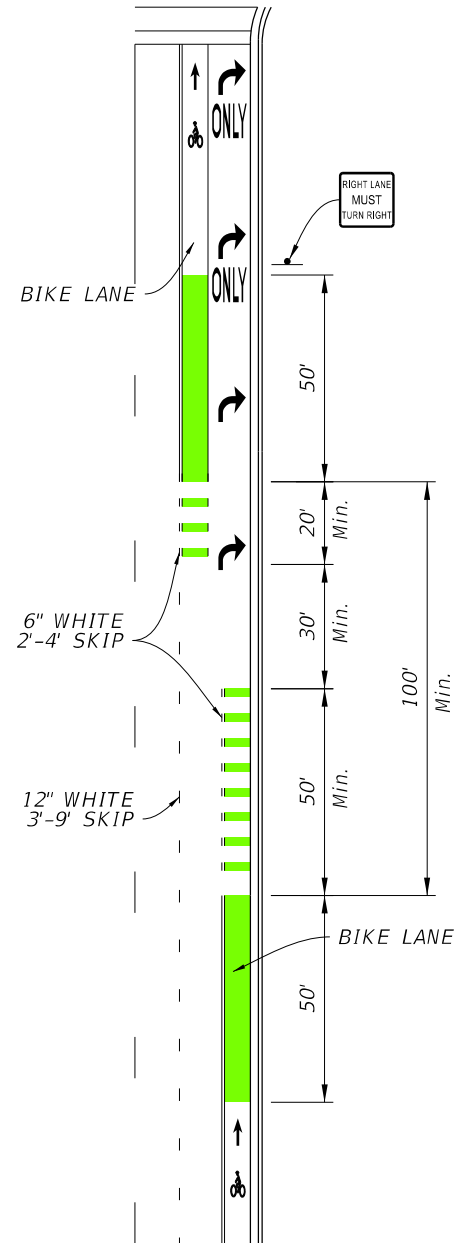
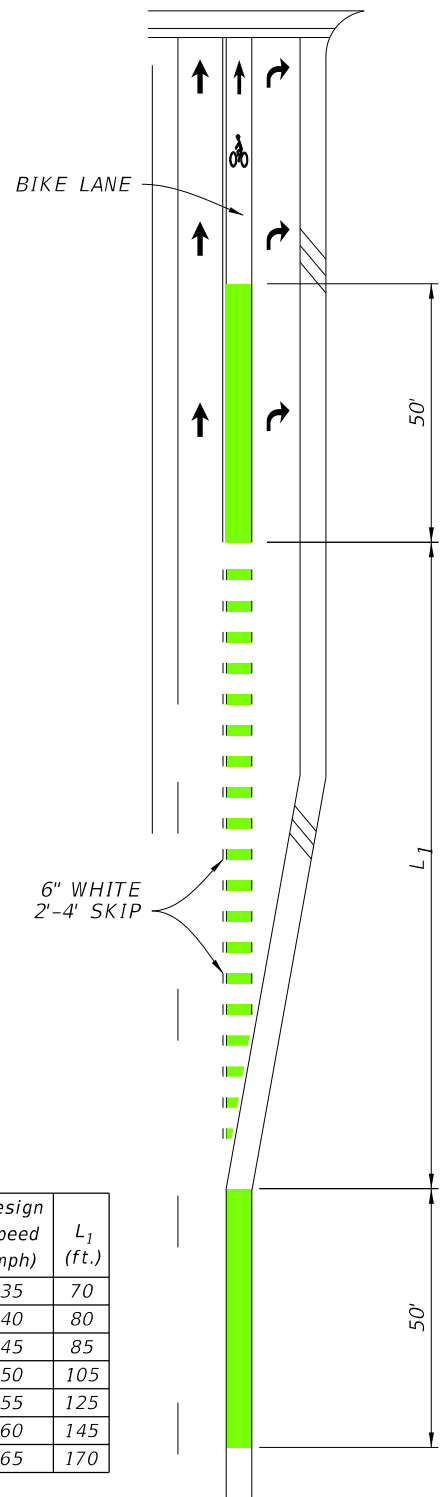

D
BIKE LANE WITH
FREE-FLOW CHANNELIZED
RIGHT-TURN LANE

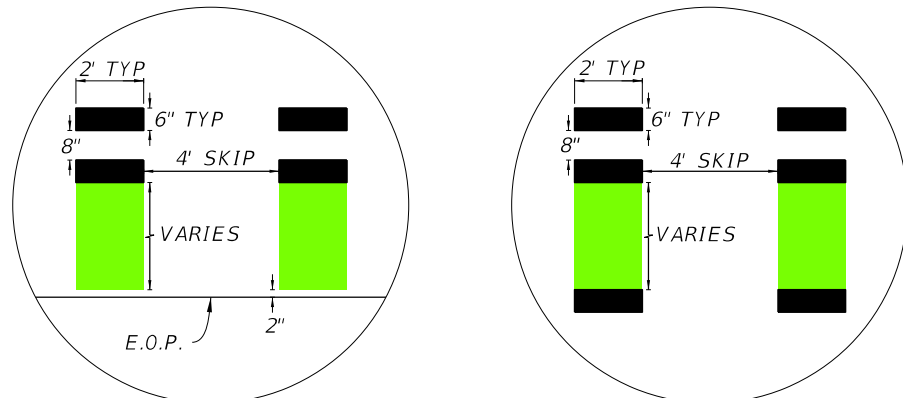

E
CURBED ROADWAY
BIKE LANE
WITH CHANNELIZED
RIGHT-TURN LANE

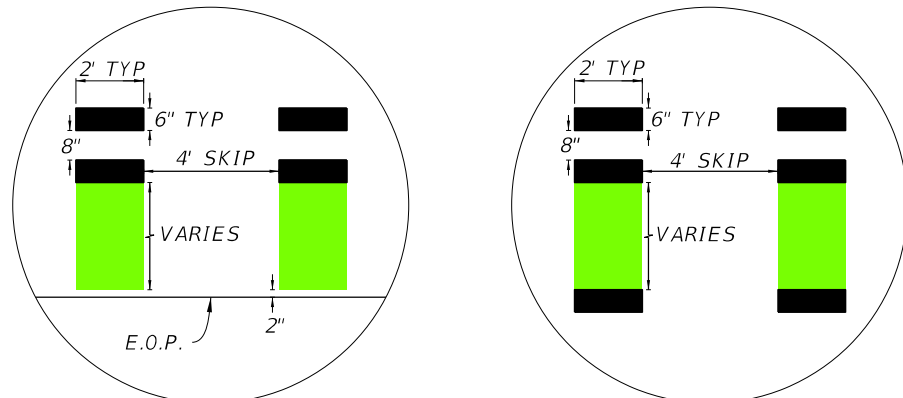

Design Speed (mph)	L ₁ (ft.)
35	70
40	80
45	85
50	105
55	125
60	145
65	170

A
FLUSH SHOULDER ROADWAY
BIKE LANE WITH
SEPARATE RIGHT-TURN LANE

B
CURBED ROADWAY
BIKE LANE WITH
RIGHT-TURN DROP LANE

C
CURBED ROADWAY
BIKE LANE ALONG
BUS BAY

Legend
Green Colored Pavement

NOT TO SCALE

EXHIBIT 223-3
01/01/2019

223.3 Shared Lane Markings (Sharrows)

Shared lane markings, or "Sharrows" are optional pavement markings used to indicate a shared environment for bicycles and motor vehicles. Sharrows are used where it is not practical to provide a bicycle facility, and any of the following conditions exist:

- (1) With on-street parallel parking in order to reduce the chance of a bicyclist's impacting the open door of a parked vehicle.
- (2) To fill a gap in an otherwise continuous bicycle facility, generally for a short distance.
- (3) As part of an approved temporary traffic control plan, see **FDM 240**.

Streets with low traffic volumes and low traffic speeds are better suited to a travel environment where bicycle and motor vehicle traffic are mixed. Do not use Sharrows in the following conditions:

- Roadways with a posted speed greater than 35 mph
- On shared use paths
- Within a right turn lane

Place Sharrows in the center of the travel lane. This placement provides guidance to bicyclists to "command the lane" which discourages motorists from passing too closely. This placement also informs drivers that cyclists are entitled to ride in the center of the lane for their safety. To effectively convey this message, place Sharrows immediately after intersections and at a maximum spacing of 250 feet.

223.4 On-Street Parking

Roadways with on-street parking must provide room to cyclists to minimize impacts related to close proximity of parked vehicles (e.g., door zone avoidance). The following treatments are required for roadways with on-street parking:

- Parallel Parking:
 - Provide a 4-foot bicycle lane adjacent to the travel lane with a 3-foot buffer between the parallel parking lane and bicycle lane, per **Exhibit 223-1**.
 - Provide a shared lane marking in place of a bicycle facility when there is less than 7 feet available for the bicycle lane and buffer.
- Angle Parking:
 - Use a shared lane marking in place of a bicycle facility.

223.5 Bicycle Parking Amenities

Appropriately placed bicycle and micromobility parking supports those who choose to use the bicycle or micromobility devices (devices) as their mode of transportation. Bicycle and micromobility parking facilities are installed and maintained by local agencies and require approval of the District Design Engineer when on FDOT R/W. Locate and design bicycle and micromobility device parking facilities so that:

- Sidewalk-level facilities meet the following lateral offset requirements based on roadway design speed
 - ≤ 35 mph: 1.5 ft
 - ≥ 40 mph: 4 ft
- On-street facilities are no closer than 1.5 feet to the traveled way
- When parked, the device fits completely within the parking area (i.e. not extend into the travel lane) and does not interfere with pedestrian facilities
- Racks provide two points of support to the device

Consider the following:

- Shelters are desirable for long-term device parking and for shielding devices from inclement weather conditions
- Lockers can provide a secure place to store and prevent access when closed

When on-street parking is being used to create bicycle and micromobility device parking as seen in **Figure 223.5.1** and **Figure 223.5.2**:

- Use only where vehicular on-street parking is also allowed per **FDM 210.2.3**
- Parking should be flush with the bicycle lane or accessible by a mountable curb
- Vertical ground-mounted objects (i.e. tubular markers) may also be used for motor vehicle and bicycle parking separation

Figure 223.5.1 illustrates on-street bicycle parking at midblock and **Figure 223.5.2** illustrates on-street bicycle parking at an intersection.

Figure 223.5.1 On-Street Bicycle Parking (Midblock)

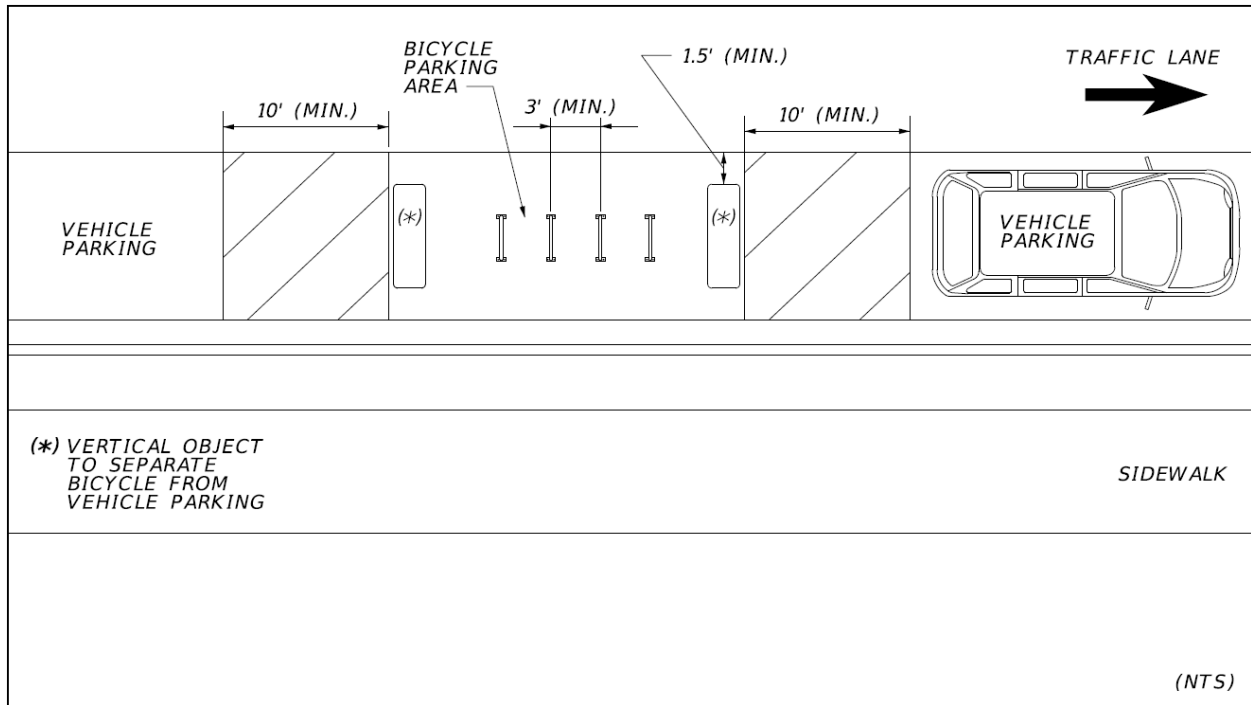
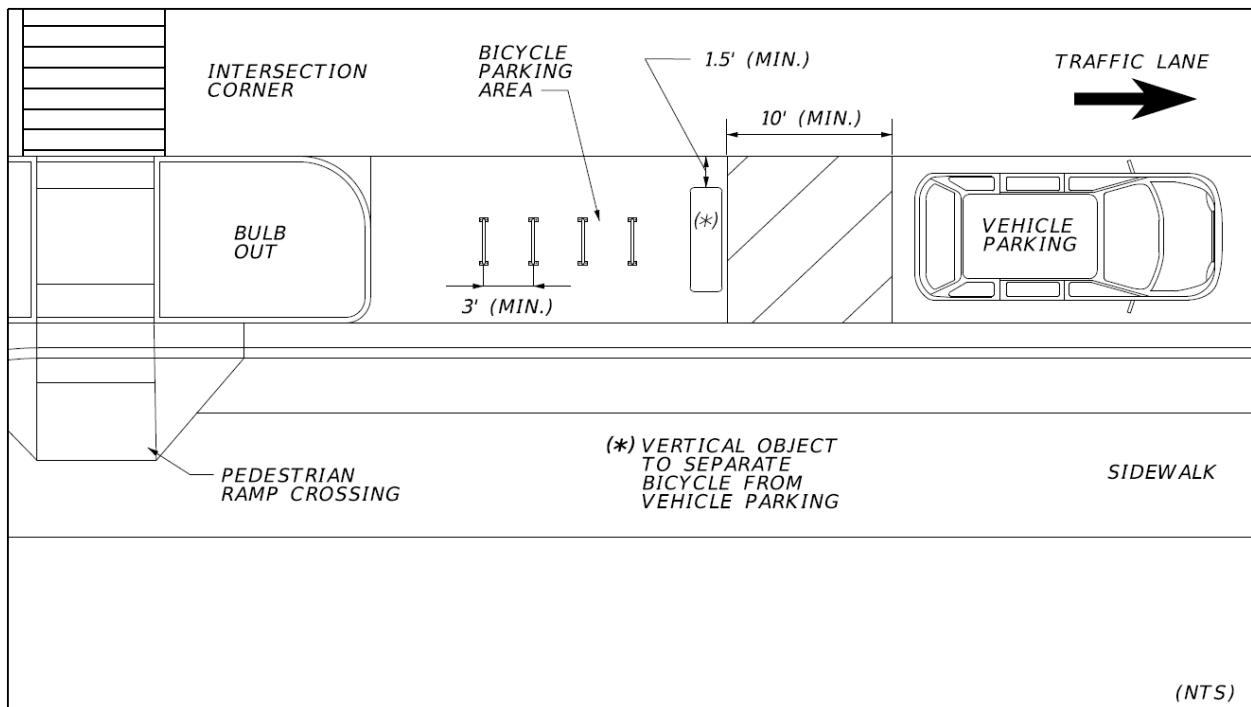

Figure 223.5.2 On-Street Bicycle Parking (Intersection)



See [AASHTO's 2012 Guide for the Development of Bicycle Facilities, Section 6.3.1](#) for site-specific guidance for bicycle racks.

223.6 Bicycle Route System

Bicycle routes include roadways or shared use paths designated through signage, pavement markings or mapping. They provide directional and distance information, and aid bicyclists in wayfinding, especially in complex urban locations or along established long distance bicycle routes.

Follow the signing guidance in the [MUTCD, Part 9](#) when including information directing bicyclists around temporary interruptions in a route. Do not terminate bicycle routes at a barrier.

The decision whether to provide a bicycle route system should be based on the suitability of the particular roadway or shared use path for bicycle travel and the need for wayfinding information. Evaluations of suitability should include roadway width, volume, speed, and types of traffic, parking conditions, grade, sight distance, and connectivity to services, significant destinations, and local transit or regional transportation hubs. Other considerations include location and condition of drainage grates, railroad crossings, pavement surface, signals responsive to bicycles, and maintenance schedules.

223.6.1 U.S. Bicycle Route System

The U.S. Bicycle Route (USBR) System is a network of bicycle routes that span multiple states and are of national or regional significance. These routes are nominated for national designation by State Departments of Transportation (DOTs) and designated and catalogued by the [American Association of State Highway and Transportation Officials \(AASHTO\)](#).

The [National Corridor Plan](#) shows existing and proposed U.S. Bicycle Routes within the United States. Florida has three U.S. Bicycle Routes:

- U.S. Bicycle Route 1
- U.S. Bicycle Route 90
- U.S. Bicycle Route 15

Florida has adopted a policy entitled [U.S. Numbered Bicycle Routes, Topic No. 000-525-060-a](#) in support of the national route system.

223.6.1.1 Determining a U.S. Bicycle Route

The District Bicycle Pedestrian Coordinator(s), with assistance from the State Bicycle Pedestrian Coordinator, will conduct the following:

- Assess and evaluate possible routes and select the most appropriate alternative.
- Acquire written support from federal, state, or local agencies that have jurisdiction over the route or surrounding area, including the following:
 - Road authorities
 - Municipal governments
 - Departments of natural resources
 - Tribes
 - Parks and recreation
 - Federal land agencies; e.g., U.S. Forest Service, Bureau of Land Management, National Park Service
- Secure letter of concurrence from adjacent state (Alabama or Georgia). When these states ask Florida for concurrence of a proposed route, the letter will be signed by the appropriate District Secretary.
- Prepare and submit the AASHTO application. Provide turn-by-turn instructions, map, state letter of concurrence, and written support from road owners. Also include discussion of economic benefits, liability, and signage for the route. The application is to be signed by FDOT Secretary.

Table 223.6.1 provides criteria that can be used to evaluate route options. Route options are scored on a scale from 3 (fulfills selection criteria) to 0 (does not contribute to meeting selection criteria). “N/A” may be used when the criteria does not apply.

Table 223.6.1 U.S. Bicycle Route Criteria

Macro Criteria	3	2	1	0	NA
Within USBR corridor, with an emphasis on intrinsic scenic and cultural qualities of the corridor itself.					
Access to scenic, cultural, historical, and recreational destinations. (May not be directly on route but are nearby.)					
Links major metropolitan areas to connect bicyclists to transportation hubs or major attractions.					
Reasonable direct route in connecting cities or attractions along the corridor.					
Supports natural connections between adjoining states.					
Includes or intersects existing or planned bicycle routes that are suitable for travel by touring bicycles.					
Micro Criteria	3	2	1	0	NA
Meets acceptable design criteria for on-road facilities and shared use paths.					
Utilizes already established and successful routes or paths					
Easy to follow with limited turns; is well marked or has easily identified permanent landmarks to enable navigation.					
Connects to at least one neighboring state's USBR, suitable roadway, bicycle route, or trail system.					
Access to food, water and overnight accommodations (including camping) at appropriate intervals (40-60 miles).					
Access to restaurants, libraries, retail shops and bicycle shops (parts and repair).					
Regularly scheduled ferry service for crossing water bodies. An alternate route should be identified when service may not be available.					
Topography is relatively easy for bicyclists; i.e., avoids extreme climbs.					
Total					

224 Shared Use Paths

224.1 General

Shared use paths are paved facilities physically separated from motorized vehicular traffic by an open space or barrier and are either within the highway right of way or an independent right of way. The term, “shared use path”, as used in this manual is synonymous with trails, multiuse trails, or other similar terms used in other Department manuals.

Shared use paths are used by bicyclists, pedestrians, skaters, runners, and others. Since shared use paths serve as pedestrian facilities, they must comply with Americans with Disabilities Act (ADA) standards. In addition to the requirements of this manual for accessible pedestrian facilities, the bicycle’s operating characteristics govern the design of shared use paths.

It is preferable to plan for shared use paths ahead of time by including them in a district bicycle facility plan. There should be a commitment to provide path continuity with other bikeways throughout the corridor. Ensure adequate access to local streets and other facilities along the path.

A shared use path may substitute for the following:

- Sidewalk in locations where sidewalk is required (See **FDM 222.2.1**)
- Bicycle lanes on roads with a design speed of 35 mph or greater (See **FDM 223.2.1**)

For RRR projects, other than meeting detectable warning and curb ramp requirements, unaltered shared use paths that are not in compliance with **FDM** criteria or ADA standards are not required to be reconstructed.

An Urban Side Path is a category of shared use paths that may be used in C2T, C4, C5 and C6 context classifications where the design speed of the adjacent roadway is 35 mph or less. In C5 or C6 context classifications, Urban Side Paths placed adjacent to the roadway must be provided with a separate sidewalk to accommodate increased pedestrian demand in these context classifications.

The Urban Side Path users and motorists in adjacent travel lanes will be traveling more slowly in C2T, C4, C5, and C6 context classifications, compared to the rural and suburban locations of conventional Shared Use Paths. In addition, because they are associated with curbed roadways, Urban Side Paths will be vertically separated from the roadway, further

distinguishing them from conventional Shared Use Paths. The slower travel speeds and vertical separation allow the use of design criteria differing from a standard Shared Use Path. The slower travel speeds are due to speed management concepts inherent to the urban environment (e.g., enclosure, engagement, and deflection). See **FDM 202** for more information on speed management.

A shared use path may not be the best solution for all conditions. Use a separated bike lane with a sidewalk per **FDM 223** and **FDM 222** in Context Classifications C2T, C4, C5, or C6 when:

- (1) Non-motorist volumes are expected to be high, or
- (2) There may be high numbers of more vulnerable users such as elderly or people with disabilities.

224.1.1 Shared Use Path Within Department Limited Access Right of Way

Exposing vulnerable road users to high-speed traffic is undesirable; therefore, shared use paths located parallel to Limited Access (LA) Facility travel lanes are not permitted within LA right of way (R/W). However, a shared use path on causeways or bridges that span navigable waterways may be considered when the path is shielded from the high-speed traffic using a barrier or traffic railing.

It is the Department's intention to facilitate interconnectivity with other existing or planned shared use paths (trails) as identified by the Florida Greenways and Trails Council in accordance with **Chapter 260, Florida Statutes** "Florida's Greenways and Trail Act". To support Florida's shared use path (trail) network, crossing the Department's LA R/W at an existing roadway, or on a new separated overpass or underpass, will be considered.

Shared use paths that cross LA R/W must meet the following criteria:

- (1) The shared use path is available for public use and includes a fence or wall to prevent access to the LA Facility travel lanes.
- (2) Local Agency Agreements must be obtained to assign ownership, maintenance, and management; responsibilities, including:
 - (a) Lighting
 - (b) Fencing or barriers
 - (c) Security gates
 - (d) Signing
 - (e) Amenities
- (3) At-grade crossings are permitted only at interchange ramp terminals and signalized crosswalks.
- (4) A proposed overpass crossing (i.e., bridge structure spanning LA R/W) must not be within two miles of an existing or proposed shared use path crossing of the same LA Facility. A proposed overpass must:
- (5) Accommodate future widening of the LA Facility,
- (6) Span the LA R/W with minimal piers, and
- (7) Provide abutments outside of clear zone.
- (8) A proposed underpass crossing (i.e., shared use path adjacent to roadway or waterway under LA Facility bridge) must meet minimum vertical clearance as defined in **FDM 224.8**. A proposed underpass must remain free from standing water up to and including the 10-year storm event.

Design Variations for the above criteria must be approved by the Chief Engineer, following a review by the Chief Planner.

224.1.2 Public Transit Loading Zones

See **FDM 225** for information on Public Transportation Facilities. Provide a minimum 5-foot-wide sidewalk connecting transit stops to shared use paths.

Coordination with the following may be required to determine the optimum location of boarding and alighting areas, transit shelters, and bus bays:

- (1) District Pedestrian/Bicycle Coordinator
- (2) District Modal Development Office Coordinator
- (3) District ADA Coordinator
- (4) District Public Transportation staff
- (5) Local public transit provider(s)

224.1.3 At-grade Railroad Crossings

See **FDM 222.2.4** for information on at-grade railroad crossings.

224.1.4 Conflict Points

Special attention should be paid to minimizing and managing conflict points along shared use paths. See **FDM 223.2.4.5** for more information.

224.1.5 Cyclists Enter and Exit Paths

Design Shared Use Path entry and exit points to allow cyclists to enter and exit without riding against traffic. See **FDM 223.2.4.5** for more information.

224.2 Curb Ramps

Provide curb ramps to be the same width as the path. At locations where the path narrows from the typical width, warning signs or pavement markings in conformance with the [**MUTCD**](#) should be used. Refer to **FDM 222.2.2** for specific design criteria for curb ramps.

224.3 Detectable Warnings

Provide detectable warnings in accordance with **FDM 222.3**.

224.4 Widths

The appropriate paved width for a two-directional shared use path is dependent upon context, volume and mix of users. Widths range from a minimum 10 feet to 14 feet, with a standard width of 12-feet. SUN Trail network facilities that are less than 12-feet require approval by the Chief Planner. For shared use paths not in the SUN Trail network:

- (1) 10-foot wide may be used where there is limited R/W.
- (2) Short 8-foot wide sections may be used in constrained conditions.

Consider the accommodation of emergency and maintenance vehicles or management of steep grades when selecting the width of the path.

FHWA's [Shared Use Path Level of Service Calculator](#) may be used as a guide in determining appropriate width.

224.4.1 Tunnel and Bridge Widths

Clear width for tunnels is the width of the shared use path plus four feet. The geometrics and lighting requirements should be discussed with the Department Project Manager and the District Pedestrian/Bicycle Coordinator.

Clear width for standalone pedestrian & bicycle bridges can be found in **FDM 266.3**.

Clear width for shared use paths on vehicular bridges is the width of the approach facility plus four feet (2-foot wide on each side). The minimum clear width is 12 feet under constrained conditions.

224.5 Cross Slopes

To meet ADA requirements, the maximum cross slope on shared use paths is 2%.

Use a 75-foot distance to transition from -2% to 2% or from 2% to -2% when it is desired to change the slope direction of the path. Consider the potential for ponding water when proposing a slope transition.

224.6 Longitudinal Grades

When a shared use path is adjacent to the roadway (i.e., follows the roadway profile), shared use path grades may mirror the roadway profile. When a shared use path is not adjacent to a traveled way, shared use path grades are not to exceed 5%, unless accessible ramps are provided. Maximum ramp slopes are 8.33% and can have a maximum rise of 30 inches, with a level landing at least 60 inches in length.

Grades greater than 5% cause difficulties for many path users including bicyclists. **Table 224.6.1** provides maximum grades and distances for areas in which the terrain makes it necessary to use steeper grades on short sections.

Table 224.6.1 Maximum Grade Lengths

Longitudinal Grade (%)	Maximum Length (feet)
6	800
7	400
8	300
9	200
10	100
11+	50
<p>Notes:</p> <p>(1) When using a longer grade, consider adding 4 to 6 feet of additional width to the path to allow a bicyclist to dismount and walk their bicycle.</p> <p>(2) Clear distances and sight distances should be adjusted to accommodate longer grades.</p>	

Refer to **FDM 224.11** for controls on grade changes.

224.7 Horizontal Clearance

Provide a 4-foot clear area adjacent to both sides of the path, including placement of signs. Maintain a 2-foot-wide graded area with a maximum 1:6 slope adjacent to both sides of the path. For restricted conditions, bridge abutments, sign columns, fencing and railing may be located within 4 feet of the edge of pavement.

For Urban Side Paths, the following criteria reflect the lower design speed. Provide a minimum 2-foot buffer area adjacent to both sides of the path, including placement of signs. Signs, plantings, or other items must be located outside of the 2-foot buffer. Maintain a graded area with a maximum 1:6 slope adjacent to both sides of the path within the 2-foot minimum buffer area.

Horizontal clearance on standalone pedestrian & bicycle bridges, shared use paths alongside or on vehicular bridges, and tunnels is accounted for in the required clear widths as described in **FDM 224.4.1**.

See **FDM 224.15** for information concerning drop-off hazards.

See **Figure 224.8.1** where horizontal clearance is "H".

224.8 Vertical Clearance

Provide a 10-foot vertical clearance from the lowest edge of an overhead obstruction to any portion of the path under the obstruction. An 8-foot clearance is allowed for overhead signs and for other overhead obstructions under constrained conditions.

A 12-foot vertical clearance is desirable for:

- (1) Accommodation of equestrians or maintenance and emergency vehicles.
- (2) Underpasses and tunnels.
- (3) SUN Trail.

Minimum clearances for bridge structures are given in **FDM 260.6**.

Existing elements that provide a minimum 8-foot vertical clearance are not required to be corrected to the clearances listed above.

See **Figure 224.8.1** where vertical clearance is “V”.

Figure 224.8.1 Shared Use Path Horizontal and Vertical Clearance Envelope

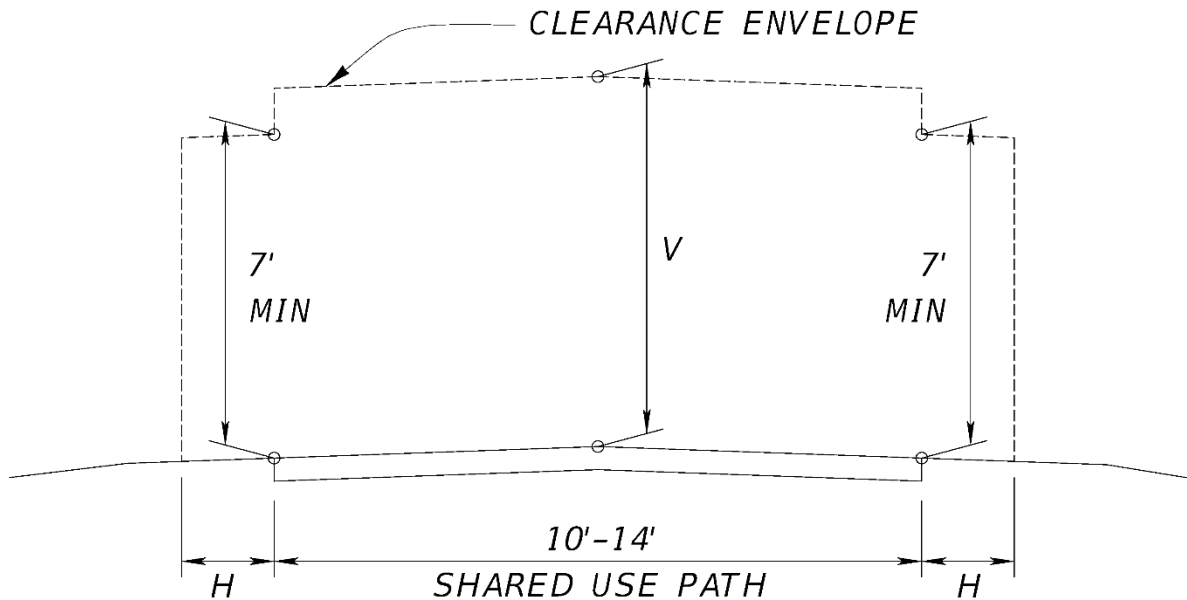

224.9 Design Speed

Use a design speed of 18 mph for paths with longitudinal grades $\leq 4\%$. Use a design speed of 30 mph for paths with downhill longitudinal grades greater than 4%. For Urban Side Paths use a design speed of 10 mph.

224.10 Horizontal Alignment

224.10.1 Minimum Radii

The minimum centerline radius of curvature for a shared use path is provided in **Table 224.10.1**.

Table 224.10.1 Minimum Radius Horizontal Curves on Shared Use Paths

Design Speed (mph)	Maximum Cross Slope (%)	Minimum Radius (feet)
10	2	20
10	-2	22
18	+2	74
18	-2	86
30	+2	261
30	-2	316

Notes:

- (1) For paths with two-way traffic use minimum radius given for cross slope of -2%
- (2) Positive (+) cross slopes represent pavement sloped to the inside of horizontal curves. Negative (-) cross slopes slope toward the outside of horizontal curves.

224.10.2 Stopping Sight Distance

The minimum stopping sight distances for a shared use path are provided in **Table 224.10.2**. Further information on calculating the minimum stopping sight distances may be found in the **AASHTO [Guide for the Development of Bicycle Facilities, 2012](#)**.

- On curbed roadways, the edge of the path is to be at least 5 feet from the face of curb, with consideration of other roadside obstructions (e.g., signs and light poles).

Where the minimum separation cannot be obtained:

- Consider installation of a pedestrian channelization fence at speeds of 45 mph or less to limit incursion of path users onto the roadway.
- Consider installation of a crashworthy barrier at speeds greater than 45 mph to limit incursion of motorists onto the path, although this type of barrier can be used at lower speeds as well.

For Urban Side Paths, place as close to the R/W line as possible, but no closer than 2 feet from the back of curb. Do not place Urban Side Paths adjacent to uncurbed roadways.

Commentary: Criteria provided are minimum values only. As motorist speeds increase, the amount of separation between the traveled way and path should also increase to manage the level of traffic stress for path users.

224.13 Lighting

Lighting for shared use paths is important and should be considered where riding at night is expected, such as paths serving college students or commuters. Lighting should also be considered through underpasses or tunnels. Lighting standards are provided in **Table 231.2.1**.

224.14 Signing, Pavement Marking, and Signalization

The [Standard Plans](#) and the [MUTCD](#) provide guidance and requirements for signage, pavement markings and signals for shared use paths. Signs on shared use paths should follow the dimensions provided in **Table 9B-1 Bicycle Sign and Plaque Sizes, [MUTCD](#)**.

224.15 Drop-off Hazards

Drop-off hazards are steep or abrupt slopes adjacent to the path that can be perilous to pedestrians and cyclists. There are two cases that require shielding as shown in **Figure 224.15.1**. Depending on the depth of the drop-off and severity of the conditions below, shielding may be necessary for conditions other than cases 1 or 2.

Consider the following when determining the feasibility of shielding other drop-off hazards for protecting pedestrians and cyclists:

- (1) The engineer should consult the District Bicycle/Pedestrian Coordinator or Trail Coordinator.
- (2) Installing fencing or railings are two ways to shield the drop-offs. Fencing is generally intended for use in rural areas along paths and trails. Railing is generally intended for urbanized areas, locations attaching to bridge rail or along concrete walkways. Pedestrian/Bicycle Railings ([Standard Plans, Index 515 Series](#)) are adequate for shielding all drop-offs but are generally intended for use on drop-offs greater than 60 inches. Pipe Guiderail ([Standard Plans, Index 515-070](#) and [515-080](#)) is adequate for shielding drop-offs which are 60 inches or less.
- (3) Along continuous sections where the drop-off varies above and below the 60-inch threshold, for uniformity the engineer may consider using only one of the railing types adequate for shielding all drop-offs.
- (4) Railing or fencing near intersections or driveways could obstruct the driver's line of sight. To reduce the need for railings, as a sidewalk or shared use path approaches an intersection, consider extending cross drains and side drains to minimize drop-offs.
- (5) The installation of fencing, railing, or pipe guardrail presents a hazard in and of itself. Evaluate whether or not the installation of these devices present a greater risk than the drop-off or other condition it is intended to shield.

Figure 224.15.1 Drop-Off Hazards for Pedestrians and Bicyclists

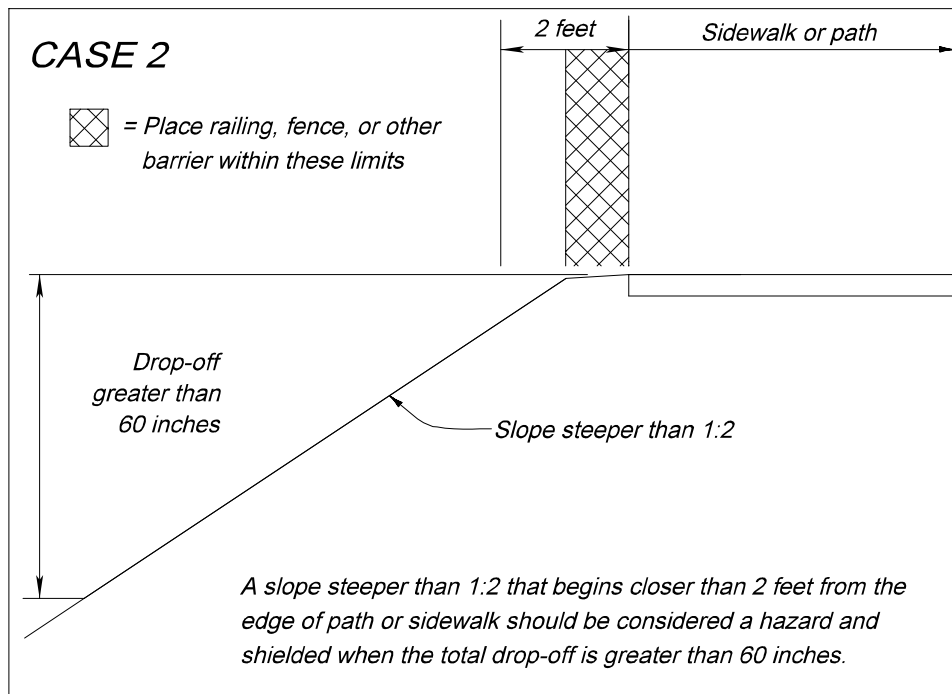
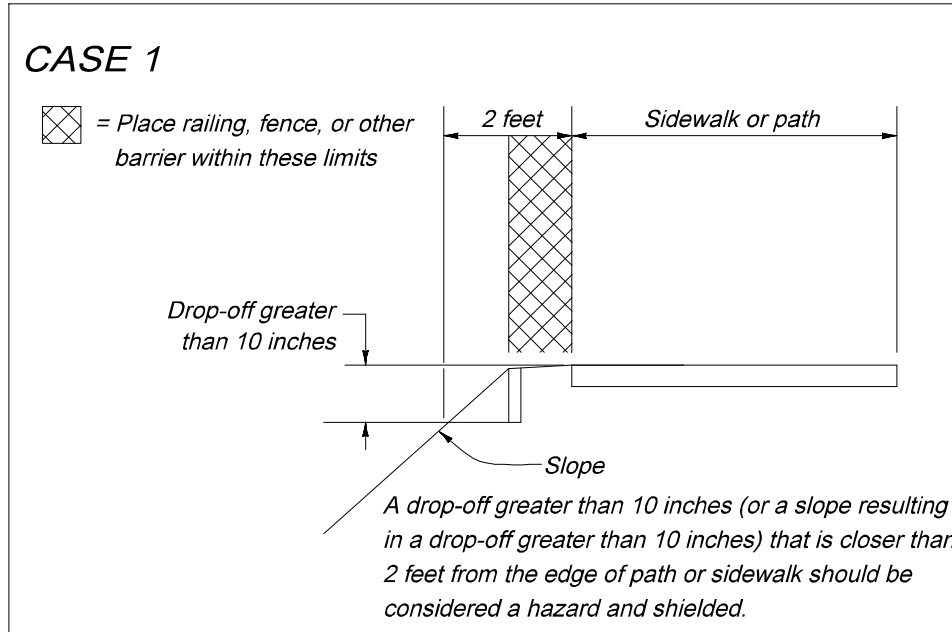

224.16 Path Railings

Requirements for railings and fences are discussed in **FDM 222.4**.

224.17 Typical Sections

Example typical sections are provided in **FDM 913**.

224.17.1 Pavement Design

See the [FDOT Pavement Management website](#) for guidance on pavement requirements.

Provide a pavement design equivalent to standard shoulder pavement:

- (1) 12-inch Stabilized Subgrade
- (2) Base Group 1
- (3) 1.5-inch Structural Course.

224.18 Shade Considerations

Shade along shared use paths is desired. Consider shade from landscaping and shade from architectural sources such as buildings, pavilions, and shade sails.

To maximize shade and minimize costs:

- (1) Begin coordination between the designer, project manager, utilities, district landscape architect, and maintaining agency for the landscaping during Phase I of the design.
- (2) Choose an alignment of the path that can capitalize on shade from existing and proposed trees or architectural sources.

For more information on shade from Landscape Design, refer to **FDM 270**, **FDM 944**, and **Work Program Instructions Part 3, Chapter 16**.

225 Public Transit Facilities

225.1 General

Curbside and street-side transit facilities for bus stops should be considered in the roadway design process when a project includes a public transit route.

The Department's [Accessing Transit: Version III, 2013 Design Handbook for Florida Bus Passenger Facilities](#) provides guidance relating to provisions for curb-side and street-side facilities. Refer to **FDM 215** for criteria on the placement of shelters and benches. Coordination with the District Modal Development Office and local public transit provider(s) is necessary in developing the plans.

Additional guidance on the design of transit facilities is available in the 2014 AASHTO publication, ***A Guide for Geometric Design of Transit Facilities on Highways and Streets, 1st Edition***. This guide provides a comprehensive reference of current practice in the geometric design of transit facilities on streets and highways, including:

- Local buses, express buses, and bus rapid transit operating in mixed traffic
- Dedicated bus lanes, and high-occupancy vehicle lanes
- Bus-only roads within street and freeway environments
- Streetcars and Light Rail Transit running in mixed traffic and transit lanes, and within medians along arterial roadways

The AASHTO guide is intended for use by public agencies, practitioners, and developers in need of basic information about planning, locating, sizing, designing, and implementing transit facilities along roadways.

225.2 Boarding and Alighting Areas

Boarding and alighting areas help to create an accessible bus stop by providing a raised platform that is compatible with a bus that kneels or extends a ramp. A boarding and alighting area must have a firm, stable, and slip-resistant surface with a minimum clear length of 8 feet (measured perpendicular to the curb or roadway edge), and a minimum clear width of 5 feet (measured parallel to the roadway). Firm, stable, and slip resistant boarding and alighting areas are required if amenities such as benches or shelters are added to a bus stop. Boarding and alighting areas are not required at bus stops on flush shoulder roadways where only a bus stop sign is provided. Coordinate with the

appropriate public transit provider(s) to determine compatibility with equipment and transit vehicles.

The slope of the boarding and alighting area parallel to the roadway should be the same as the roadway. For drainage purposes, a maximum slope of 1:50 (2%) (measured perpendicular to the roadway) is allowed.

On flush shoulder roadways, the boarding and alighting area should be constructed at the shoulder break to create an accessible bus stop, as shown in **Figures 225.2.1** and **225.2.2**. The boarding and alighting area may be placed at the edge of shoulder pavement on roadways with a posted speed of 45 mph or less. The raised area provides a landing that is compatible with a bus that kneels or extends a ramp with a slope of 1:6 or less. Bus stops should be located in close proximity to existing intersections, and with sidewalk access. The boarding and alighting area is to:

- (1) Use a Type E curb and gutter (5" curb height)
- (2) Be connected to the sidewalk along the roadway or to the roadway when no sidewalk is present

Provide a sidewalk and/or ramp that is a minimum of 5 feet wide with a maximum slope of 1:12 for the boarding and alighting area. A detectable warning is required where a sidewalk associated with a boarding and alighting area connects to the roadway at grade. Except for the area adjacent to the 5-inch curb, the areas surrounding the boarding and alighting area are to be flush with the adjacent shoulder and side slopes and designed to be traversable by errant vehicles. On the upstream side of the landing, a maximum slope of 1:12 should be provided, and may be grass or a hardened surface. The boarding and alighting area (and ramp and level landing if needed) are to be constructed with 6-inch thick concrete.

Figure 225.2.1 Accessible Boarding and Alighting Area for Flush Shoulder Roadways with Connection to Sidewalk

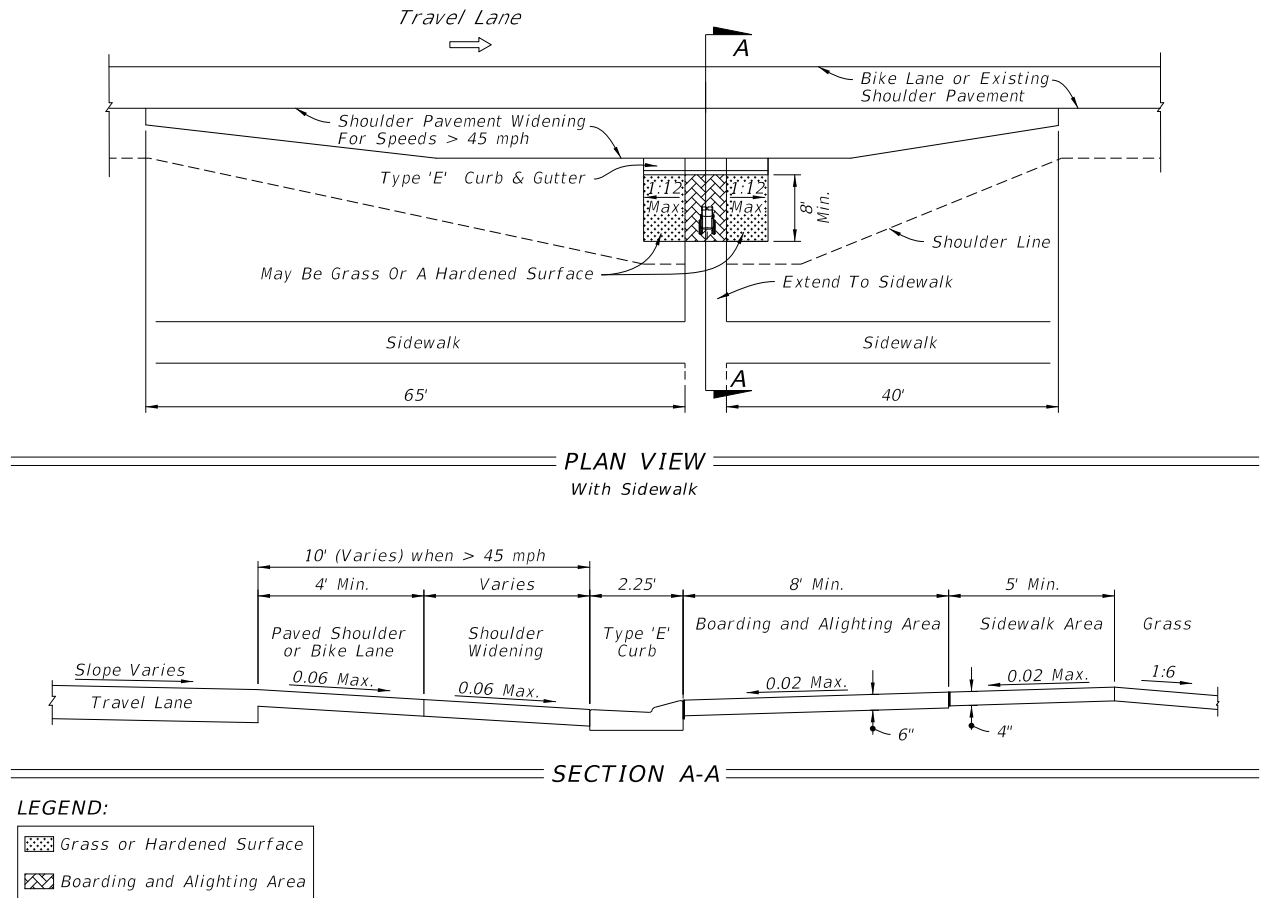
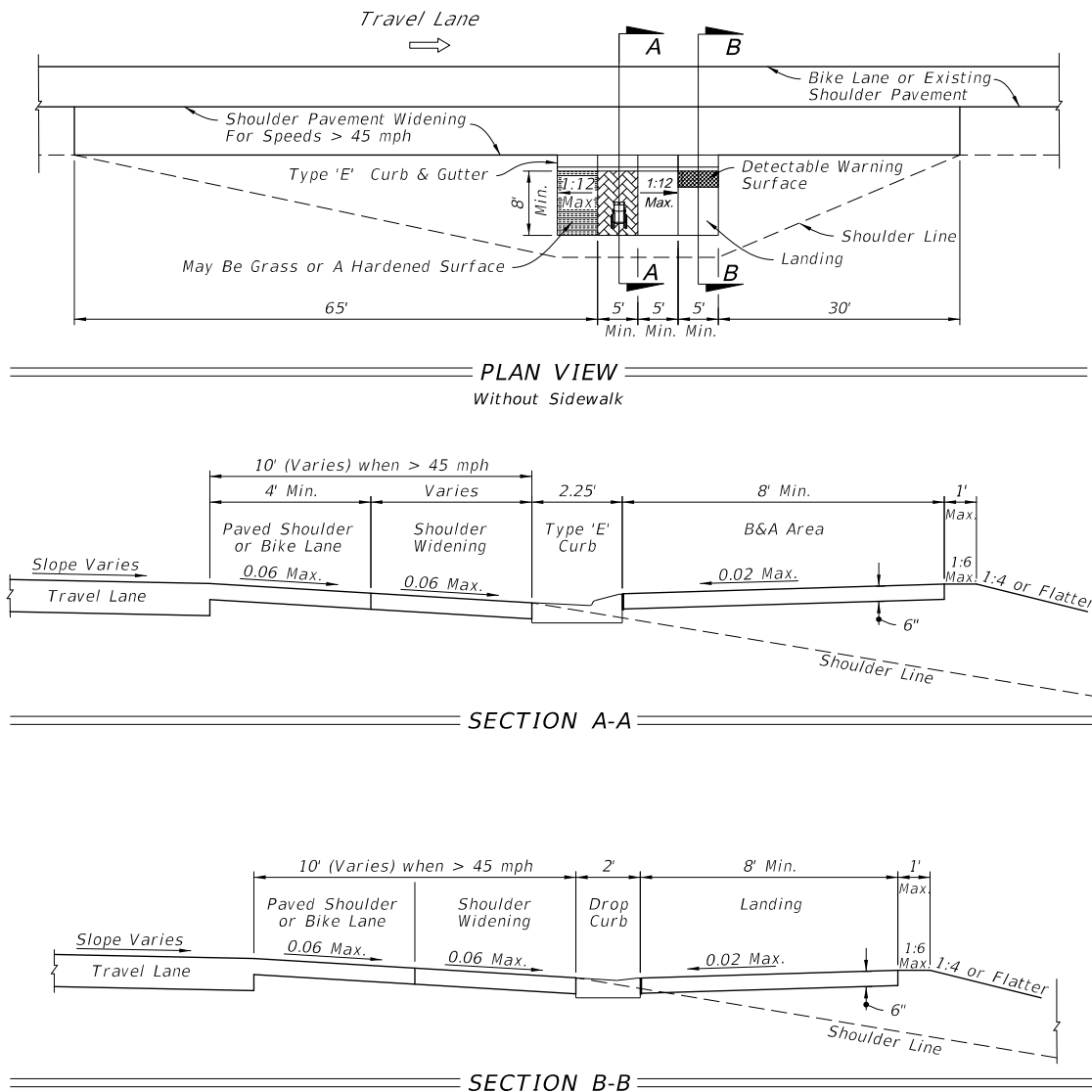

Figure 225.2.2 Accessible Boarding and Alighting Area for Flush Shoulder Roadways with Connection to Roadway



LEGEND:

	Grass or Hardened Surface
	Boarding and Alighting Area
	Detectable Warning Surface

225.3 Street-Side Facilities

Bus stop locations can be categorized as far-side, near-side and midblock stops. Bus stops may be designed with a bus bay or pullout to allow buses to pick up and discharge passengers in an area outside of the travel lane. This design feature allows traffic to flow freely without the obstruction of stopped buses. See **Figure 225.3.1** for typical details for the bus stop and bus bay categories. **Chapter 2** of the [Accessing Transit Handbook](#) provides additional information for each facility. The greater distance placed between waiting passengers and the travel lane increases safety at a stop.

Bus bays are encouraged on roadways with posted speeds 45 MPH and greater. A high frequency of crashes involving buses is a good indicator for the need of a bus bay. Bus bays are classified as closed, open or bulbs. Illustrations for various bus bay configurations are provided in the [Accessing Transit Handbook](#).

Coordinate bus bay designs with applicable transit agencies to determine the site specific needs. In locations where the traffic volumes exceed 1,000 vehicles per hour per lane, it is difficult to maneuver the bus into the bay and back into the travel lane. Incorporating an acceleration distance, signal priority, or a far-side (rather than near-side or midblock) placement, are potential solutions when traffic volumes exceed 1,000 vehicles per hour per lane.

The total length of the bus bay should allow room for an entrance taper, a stopping area, and an exit taper as a minimum. However, in some cases it may be appropriate to consider providing acceleration and deceleration lanes depending on the volume and speed of the through traffic. This decision should be based upon site specific conditions. [Accessing Transit Handbook](#) provides detailed bus bay dimensions for consideration when right of way is unlimited and access points are limited.

Figure 225.3.1 Bus Stop and Bus Bay Categories

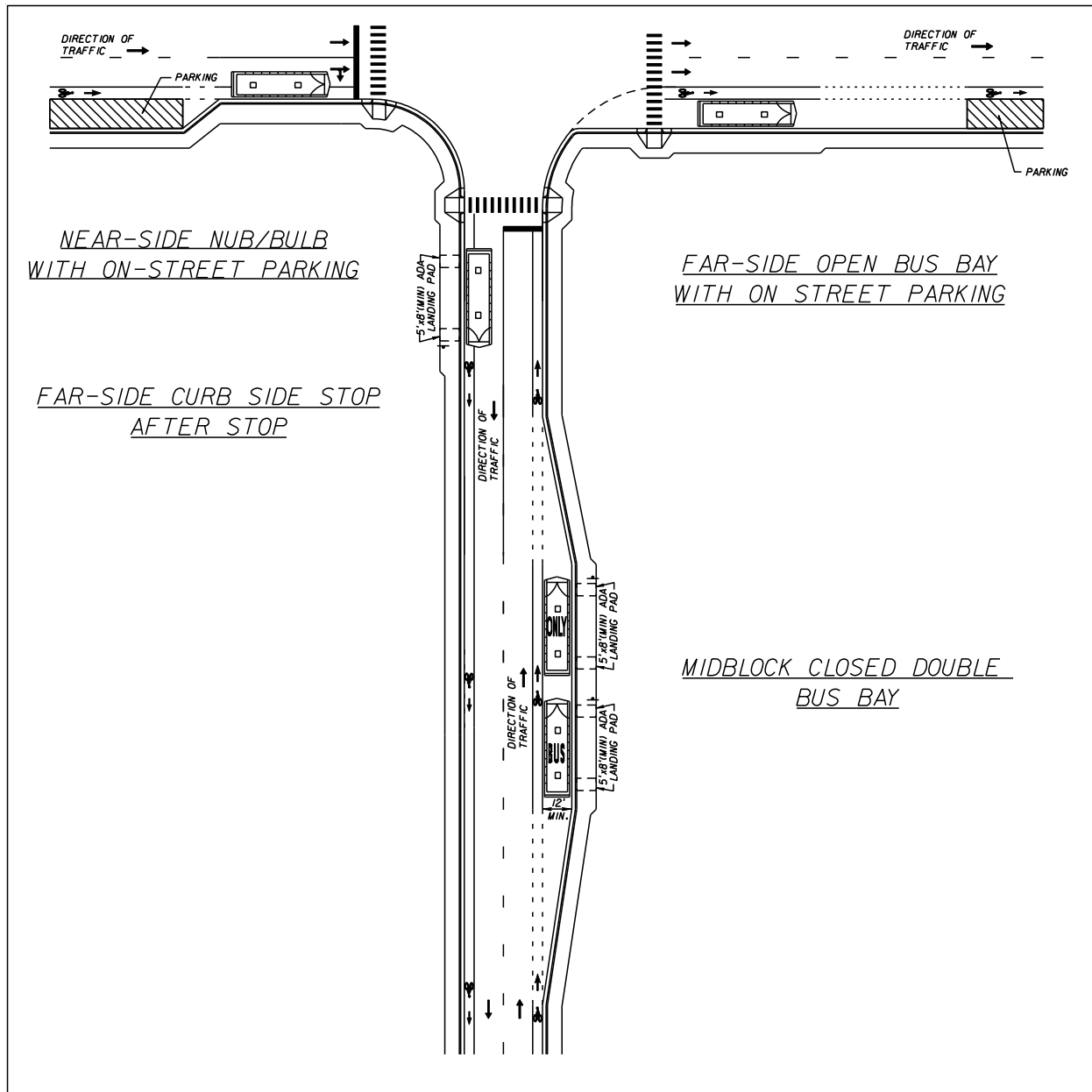

225.4 Exclusive Transit Running Ways

The Department's [Typical Sections for Exclusive Transit Running Ways](#) is a guide which provides a starting point for designing exclusive transit running ways. Case-by-case evaluation of sites and corridors is essential in producing design drawings that are feasible and effective.

This guide presents conceptual typical sections for exclusive transit running ways that may see application in Florida. Typical section elements, general dimensions, analysis considerations, and intersection operations considerations are discussed in the guide for the following scenarios:

- Concurrent flow curb bus lanes
- Concurrent flow median bus lanes
- Contraflow bus lane on a one-way street
- Contraflow bus lane on a two-way street
- At-grade two-way busway on a two-way street
- At-grade reversible one-lane median busway on a two-way street
- At-grade exclusive busway in roadway R/W
- At-grade exclusive busway in separate R/W
- Exclusive bus street
- Shoulder-running bus lanes on an uninterrupted flow highway.

226 Patterned Pavement and Architectural Pavers

226.1 General

Alternative paving treatments, such as patterned pavement and architectural pavers meeting [Standard Specifications](#), may be used for enhancing aesthetics and appearance when requested by a local community, and when the conditions and restrictions provided in this section are met. Patterned pavement treatments are covered under **Section 523** of the [Standard Specifications](#) and are surface markings applied either as an overlay to the pavement surface or imprinted in the pavement surface. Architectural pavers are covered under **Section 526** of the [Standard Specifications](#) and consist of brick pavers or concrete pavers placed on specially prepared bedding material.

These alternative pavement treatments are purely aesthetic treatments and are not considered to be traffic control devices. Use of either of these treatments is highly restricted as stated below. Even when all conditions and restrictions are met, any decision to use these treatments should consider that there may be potential adverse impacts to the traveling public as well as potential long term maintenance problems. Architectural pavers have been found to create significant ride-ability problems even on low-speed roadways. Therefore, architectural pavers are prohibited within the traveled way on the State Highway System. Properly installed patterned pavement treatments do not significantly affect ride-ability; however, their use is also restricted since they are not likely to sustain their friction and wear characteristics for the full life of typical roadway pavement.

These paving treatments involve additional construction and maintenance costs not associated with typical roadway pavement. Therefore, obtain the appropriate agreements with the local maintaining agency. The additional funding for construction and assumption of responsibility for regular inspection and maintenance of the pavement treatment are to be provided by the local maintaining agency. In cases where existing alternative pavement is being removed as part of a Department project, replacement of such pavement is to adhere to the requirements in this chapter regardless of the circumstances of the original installation and maintenance. Maintenance agreements for installations within the traveled way on the State Highway System are to include the provisions outlined in **FDM 226.4.1** for the duration of the installation.

226.2 Design Variations

Design Variations to any of the requirements in this chapter are to be approved by the District Design Engineer.

226.3 Architectural Pavers

When architectural pavers are used, identify the location, type, pattern, shape and color in the plans. In addition, identify the project specific details and requirements for edge restraints, bedding material thickness, and base and sub-base materials and thicknesses, as appropriate in the plans, which are to be signed and sealed by a licensed Florida Professional Engineer. The following restrictions apply to the use of architectural pavers:

- (1) May not be used on the traveled way of the State Highway System.
- (2) May be used on local side streets (with a design speed of 35 mph or less), non-traffic medians and islands, curb extensions, sidewalks, borders, and other areas not subject to vehicle traffic.
- (3) Meet ADA requirements in areas subject to pedestrian traffic. See [Public Rights of Way Accessibility Guidelines \(PROWAG\) R301.5 and R301.7](#) and [Americans with Disabilities Act Accessibility Guidelines \(ADAAG\) 302 and 303](#) for surface requirements.

226.4 Patterned Pavement

When patterned pavement treatments are used, identify the location, patterned type (brick, stone, etc.), and surface color in the plans. Product brands, colors and patterns may be specified in the plans as long as the brand is listed on the [Approved Products List \(APL\)](#) at the time of use if requested by the local agency funding and maintain these treatments. The following restrictions apply to the use of pattern pavement:

- Use on the traveled way of the State Highway System is restricted to areas within marked pedestrian crosswalks where the design speed is 45 mph or less; however, patterned pavement cannot be used on pedestrian crosswalks across limited access roadway ramps. Use on pedestrian crosswalks with heavy truck traffic turning movements ($\geq 10\%$ trucks) should be avoided.
- The pavement to which the treatment is applied is required to be of the same pavement type as, and continuous with, the adjoining pavement. For example, replacing flexible pavement with rigid patterned pavement within the limits of a crosswalk where the abutting pavement is to remain flexible pavement will likely result in pavement joint problems and adverse impacts to rideability. This type treatment is therefore not permitted. Replacing flexible pavement with rigid pavement for an entire intersection including crosswalks may be permitted with a Technical Special Provision submitted to the State Roadway Design Engineer for approval.

- The initial treatment cannot be applied to any State Highway whose asphalt pavement surface is older than 5 years.
- May be used in areas not subject to vehicle traffic such as median islands, curb extensions, sidewalks, and landscaping borders.
- Meet ADA requirements in areas subject to pedestrian traffic. See [PROWAG R301.5 and R301.7](#) and [ADAAG 302 and 303](#) for surface requirements.

226.4.1 Maintenance Memorandum of Agreement

Prior to the installation of patterned pavement crosswalks in intersections on the State Highway System, a Maintenance Memorandum of Agreement is required to be entered into with the local government agency requesting this aesthetic enhancement to the project. This agreement is filed with the District Maintenance Office. This Agreement requires the local government agency to acknowledge that the installation and maintenance of patterned pavement is the total responsibility of the local agency, including contracting for friction testing with a qualified firm.

“Maintenance” of all patterned pavement crosswalks in these Agreements is to be defined, as a minimum, to include its frictional characteristics and integrity as follows:

- Evaluate all lanes of each patterned crosswalk for surface friction within 60 days of project acceptance by the Department. Conduct the friction test using either a locked wheel tester in accordance with **FM 5-592 (Florida Test Method for Friction Measuring Protocol for Patterned Pavements)** or a Dynamic Friction Tester in accordance with **ASTM E1911**. **FM 5-592** can be accessed at the following link:

<https://www.fdot.gov/materials/administration/resources/library/publication/s/fstm/bynumber.shtm>

The initial friction resistance must be at least 35 obtained at 40 mph with a ribbed tire test (FN40R) or equivalent. Failure to achieve this minimum resistance will require all deficient crosswalk areas to be removed to their full extent (lane-by-lane) and replaced with the same product installed initially. If the Department determines that more than 50% of the lanes in the intersection require replacement, the entire intersection installation may be reconstructed with a different product on the [APL](#) or replaced with conventional pavement.

- Approximately one year after project acceptance and every two years thereafter and for the life of the adjacent pavement, only the outside traffic lane areas of each patterned crosswalk must be tested for friction resistance in accordance with

ASTM E274 or **ASTM E1911**. Friction resistance must, at a minimum, have a FN40R value of 35 (or equivalent).

- Send the results of all friction tests to the District's Warranty Coordinator with a cover letter either certifying that the crosswalks comply with the minimum friction criteria or stating what remedial action will be taken to restore the friction.
- Failure to achieve the minimum resistance requires all lanes of the crosswalk to be friction tested to determine the extent of the deficiency. All deficient areas must be removed to their full extent (lane-by-lane) and replaced with the same product installed initially. If the Department determines that more than 50% of the lanes in the intersection require replacement, the entire intersection installation may be reconstructed with a different product on the APL or replaced with conventional pavement.
- When remedial action is required in accordance with the above requirements, the local agency must complete all necessary repairs at its own expense within 90 days of the date when the deficiency was identified. No more than two full depth patterned pavement repairs can be made to an area without first resurfacing the underlying pavement to 1" minimum depth.
- The Department will not be responsible for replacing the treatment following any construction activities in the vicinity of the treatment.
- Should the local agency fail to satisfactorily perform any required remedial work in accordance with this agreement, the Department reserves the right to replace the patterned pavement with conventional pavement (matching the adjacent pavement) and bill the local agency for this cost.

230 Signing and Pavement Marking

230.1 General

Traffic control devices are necessary to help ensure highway safety. Traffic control devices provide for an orderly and predictable movement of motorized and non-motorized traffic throughout the highway transportation system. They also provide guidance and warnings to ensure the safe and informed operation of individual elements of the traffic stream. The design and layout of signs and pavement markings should complement the basic highway design.

FHWA's [Manual on Uniform Traffic Control Devices \(MUTCD\)](#) contains detailed information of all standard highway signs and pavement marking messages. Each sign is identified by a unique designation. Signs and pavement markings not included in the [MUTCD](#) or in the [Standard Plans](#) are to be detailed in the plans. Sign and pavement marking design must comply with [Standard Specifications](#), [Standard Plans](#), [TEM](#), [MUTS](#), and the [MUTCD](#).

Examples of typical signing and pavement marking configurations are included in **FDM 230.6**.

230.1.1 Structural Supports

AASHTO's *LRFD Specifications for Structural Supports for Highway Signs, Luminaires, and Traffic Signals* and [FDOT Modifications to LRFDLTS-1](#) provide structural design criteria.

Refer to **FDM 261** for information regarding structural support requirements. Refer to **FDM 940** for information regarding plan requirements.

230.1.2 School Zones

The Department's *Manual on Speed Zoning for Highways, Roads and Streets in Florida* (a.k.a., [Speed Zoning Manual](#)), **Chapter 15**, provides school zone signing and pavement marking requirements.

Public or private elementary, middle schools (Jr. High), and federally funded facilities providing a full-time educational program are to comply with the pavement markings,

signs, and other traffic control devices referenced in the [Speed Zoning Manual](#). The use of these devices at high schools must be justified by an engineering study.

[Standard Plans](#), *Index 700-120* provides details relating to enhanced highway signing assemblies.

230.1.3 Vertical Clearance

See *FDM 210.10.3* for vertical clearance requirements for sign structures.

230.2 Signing

230.2.1 Sign Placement

Refer to the [MUTCD](#), [Standard Plans](#), and *FDM 215* for acceptable sign locations. Provide a four-foot clear width, not including the width of curb, when a sign is located within a sidewalk.

230.2.1.1 Advance Guide Signs for Limited Access Facilities

Use physical gore as the point of reference to measure distance for advance guide sign messages when the physical gore and theoretical gore are separated by no more than 500 feet.

230.2.2 Overhead Signs on Limited Access Facilities

Section 2A.17 of the [MUTCD](#) lists thirteen optional conditions where overhead signs have value on limited access facilities. Signs are to be ground mounted except at locations required by the [MUTCD](#) or noted below:

Use overhead exit direction signs when any of the following conditions exists:

- (1) Interchange Spacing \leq 3 Miles
- (2) Left Exit
- (3) Three or More Through Lanes

Use overhead advance guide signs when any of the following conditions exists:

- (1) Interchange Spacing \leq 3 Miles
- (2) Left Exit
- (3) Limited access facility to limited access facility Interchange (1/2 mile and 2 mile, 1 mile required by [MUTCD](#))

This criteria is not intended to restrict the use of overhead signs where there is insufficient space for post mounted signs or where there is restricted sight distance.

Place overhead advance guide signs over the shoulder with the edge of the sign aligned with the edge of the traveled way unless otherwise shown in the [MUTCD](#). Place overhead exit signs over the ramp traffic lane(s). If a barrier is present to shield another hazard, place the upright behind the barrier with proper setback for barrier performance.

230.2.3 Local Street Names on Guide Signs

Standard practice is to use route numbers on guide signs to designate roadways. When the local name for a roadway is more familiar than the route number, the local street name may be used as supplemental information to route numbers. The decision to use a local name should be coordinated with the District Traffic Operations Engineer.

230.2.4 External Lighting of Overhead Signs

Provide external lighting of overhead signs only for the following conditions:

- (1) Horizontal curves with radii of 880 feet or less in rural context classifications.
- (2) Horizontal curves with radii of 2,500 feet or less in urban context classifications.
- (3) In sag vertical curves with a K value of 60 or less for all context classifications.

Show sign lighting requirements on the Guide Sign Worksheet when sign lighting is required. Include sign lighting calculations in the Lighting Design Analysis Report.

To eliminate the use of lighting on existing overhead sign structures, confirm all panels on the structure utilize Type XI sheeting. All panels not utilizing Type XI sheeting must be overlaid with Type XI sheeting or replaced with new panels utilizing Type XI sheeting prior to elimination of the lighting.

See **FDM 231.2** for sign lighting criteria.

230.2.5 Signs on Barriers and Traffic Railings

For information regarding attachments to bridge traffic railings, concrete median barrier walls, or concrete shoulder barrier walls, refer to **FDM 215.5**.

Utilize [Standard Plans, Index 700-013](#) when attaching the following permanent sign supports to a median traffic railing:

- (1) No U-Turns (R3-4) w/ Official Use Only
- (2) Left Lane Ends (W9-1)
- (3) Lane Ends Merge Right (W9-2)
- (4) Merge Symbol (W4-2)
- (5) Warning, Regulatory, or Advisory Speed signs used as a countermeasure or mitigation for safety conditions
- (6) Shoulder Use Signs

No other permanent signs are to be attached to median traffic railings. [Standard Plans, Index 700-013](#) may be used for temporary or work zone signs when [Standard Plans, Index 102-600](#) cannot accommodate post mounted signs within existing conditions.

230.2.6 Signing for Temporary Bridges with Steel Decks

Place “Slippery When Wet” signs (W8-5) in advance of temporary bridges with steel decks. Refer to [TEM, Section 2.1](#)

230.2.7 Object Markers and Delineators

An object marker is used to mark obstructions within or adjacent to the roadway. The [MUTCD](#) describes four object markers and how they are to be used. A Type 1 (style OM1-3 only) or Type 3 (all styles) object marker is used to mark obstructions within the roadway. A Type 2 (style OM2-2V only) or Type 3 (all styles) object marker is used to mark obstructions adjacent to the roadway. A Type 4 (style OM4-3 only) object marker (end-of-roadway marker) is used to alert users of the end of the road.

A delineator is a guidance device rather than a warning device. The [MUTCD](#) and [Standard Plans, Index 711-003](#) illustrate the use of delineators along the edge of limited access traffic lanes and interchange ramps. A delineator may be a flexible or a non-

flexible type. District maintenance offices generally have a preference on which should be specified.

Modification for Non-Conventional Projects:

Delete the last sentence of the above paragraph and see RFP for requirements.

230.2.8 Tubular Markers

Tubular markers are the Department's standard device for the purpose of channelization. The color of tubular markers must be the same color as the pavement marking that they emphasize. They are typically used for channelization at the following locations unless signing (e.g., R4-7 or R4-8) is otherwise required:

- (1) Multilane intersections where additional visibility is required for the marking of an island,
- (2) Marking median openings,
- (3) Nose of traffic separators,
- (4) Where the island is obstructed due to crest vertical curves,
- (5) Intersections where the alignment thru the intersection is not straight,
- (6) Hardened center lines,
- (7) To preclude lane changing where it is not practicable to provide a barrier (e.g. managed lanes, separated bicycle lanes, acceleration lanes), and
- (8) To restrict vehicle movements and control turning speeds.

230.2.9 Enhanced Highway Signing Assemblies

Flashing beacons, highlighted signs, and electronic speed feedback signs may be used to increase the conspicuity of warning and regulatory signs.

For school signing requirements, see **Chapter 15** of the [Speed Zoning for Highways, Roads, and Streets in Florida](#).

Typical applications with these enhancements are shown in [Standard Plans, Index 700-120](#).

230.2.10 Internally Illuminated Street Name Signs

Do not exceed nine feet in width for an internally illuminated street name sign. For span wire systems, the sign is to be mounted to the strain poles. On mast arm supports, the sign may be mounted to the support or to the arm. When mounted to the arm, the distance between the upright and the near side edge of the sign is not to exceed ten feet.

Design the street name sign in accordance with the [TEM, Section 2.2](#). Utilize the following text attributes in order of preference:

- (1) 10-inch upper case with 8-inch lower case, Type EM font
- (2) 10-inch upper case with 8-inch lower case, Type E font
- (3) 8-inch upper case with 6-inch lower case, Type EM font
- (4) 8-inch upper case with 6-inch lower case, Type E font

230.2.11 Tourist-Oriented Directional Signs

Tourist-Oriented Directional Signs are guide sign assemblies with individual panels displaying the identity and directional information for a business, service, or activity facilities. These panels are unique in size, content, and have specific criteria for that must comply with [Rule 14-51, Florida Administrative Code](#) and [MUTCD, Chapter 2K](#).

Maximum sign panel dimensions for single and multi-column ground-mounted signs are shown in **Figure 230.2.1**. Place Tourist-Oriented Directional Signs in accordance with [Standard Plans, Index 700-101](#).

Figure 230.2.1 Tourist-Oriented Directional Sign Panel Dimensions

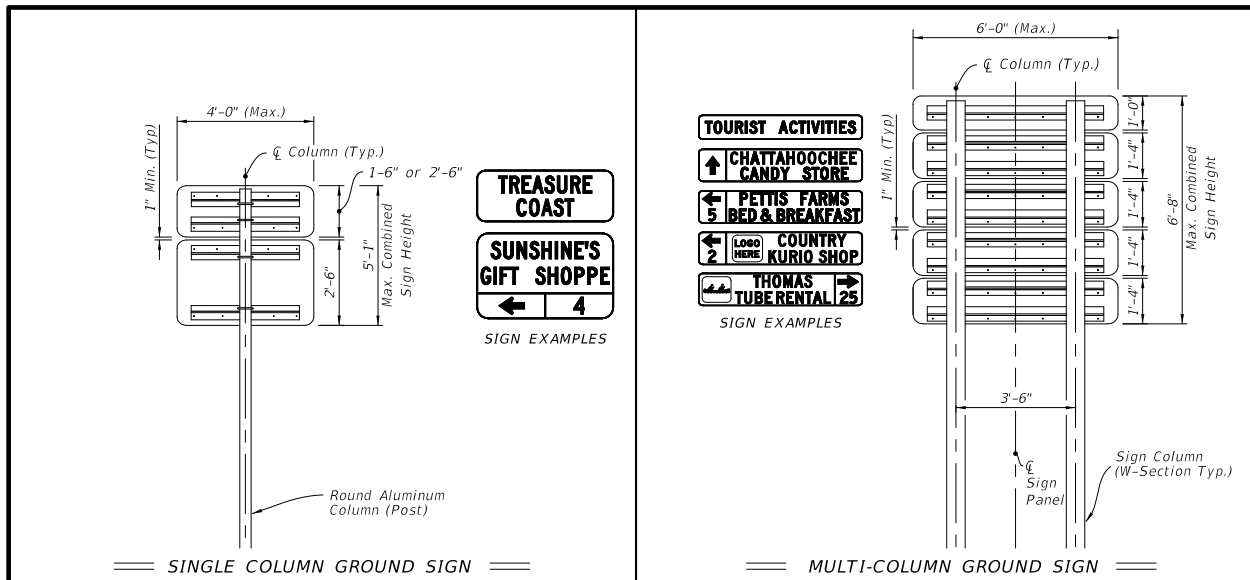

230.2.12 Florida National Scenic Trail Signs

Provide signage and pavement markings as shown in **Exhibit 230-b** at all locations where the Florida National Scenic Trail crosses along the SHS.

Use RS-034 signs to guide the public to designated trailhead parking when available and adjacent to the crossing.

230.3 Pavement Markings

The **MUTCD** was adopted by the Department as the uniform system of traffic control for use on the streets and highways of the State. This action was in compliance with **Chapter 316.0745** of the **Florida Statutes**. The **MUTCD** is the national standard, and its requirements must be met, as a minimum, on all roads in the State. Where Department manuals indicate criteria which is more stringent than the **MUTCD**, Department criteria is to be followed. See **FDM 220** for signing and pavement marking requirements for at-grade railroad crossings.

230.3.1 Selection of Pavement Marking Material

For new pavement markings, use **Table 230.3.1**, as a guide to assist in selecting the appropriate pavement marking material. For any given pavement marking application,

the table indicates allowable materials for three different substrates as follows: asphalt pavement (A), concrete pavement (C), and concrete bridge deck (B). The table also indicates when black contrast is required on new pavement surfaces. For existing asphalt surfaces, contact the District Maintenance Engineer to determine if black contrast is required.

Once the pavement marking material is selected from **Table 230.3.1**, verify the project meets the criteria discussed in **FDM 230.3.1.1** through **230.3.1.5**.

For maintaining existing pavement markings, consider the existing pavement condition and coordinate with the District Maintenance Engineer. Possible options for consideration include:

- Refurbishment Thermoplastic
- Hot Spray Thermoplastic
- Durable Paint

Remove existing pavement markings and apply new pavement marking in accordance with **Table 230.3.1**.

Table 230.3.1 Pavement Marking Material Selection

Pavement Marking Category	Pavement Marking Application	Color	Material Options					Black Contrast**	
			Hot-Applied Standard Thermoplastic	Permanent Tape	Preformed Thermoplastic	Two Reactive Components*	Durable Paint		
Longitudinal Solid Lines	Solid Lines	White	A C	c B		a c		a C B***	
		Yellow	A C	c B		a c			
Longitudinal Skip and Dotted Lines	Skip Lines (10-30 Skip)	White	A	C B		a		a C B	
		Yellow	A	C B		a			
	Dotted Extension Lines (6-10)	White	A	C B		a		a C B	
		Yellow	A	C B		a			
	Dotted Lines (3-9)	White	A	C B		a		a C B	
		Yellow	A	C B		a			
	Dotted Guidelines (2-4)	White	A		C B	a		a C B	
		Yellow	A		C B	a			
Markings Other Than Longitudinal Lines	Diagonal Cross Hatch	White	A C B		a c b				
		Yellow	A C B		a c b				
	Chevrons	White	A C B		a c b				
	Stop Lines		A		a C B			a C B	
	Yield Lines (Shark's Teeth)		A		a C B			a C B	
	Standard and Special Emphasis Crosswalk Transverse Lines-12"		A		a C B			a C B	
	Special Emphasis Crosswalk Longitudinal Bars- 24"				A C B			a C B	
	Railroad Dynamic Envelope				A C B			a C B	
	Messages and Symbols		A		a C B			a C B	
	Lane Use Arrows		A		a C B			a C B	
	Ramp Exit Numbers				A C B			A C B	
	Bicycle Markings (arrows, symbols, messages)				A C B			a C B	
	Shared Use Path Markings (arrows, symbols, messages)				A C B			a C B	
	Wrong Way Arrows		A		a C B			a C B	
	Route Shields		Multi-color			A C B			a C B
	Curb Delineation		Island Nose	Yellow					A C B
Legend:	Options: Preferred (in caps): A = Asphalt Pavement C = Concrete Pavement B = Concrete Bridge Deck Allowed (lowercase): a = Asphalt Pavement c = Concrete Pavement b = Concrete Bridge Deck								
*Two Reactive Components require approval by District Maintenance Engineer and District Construction Engineer. ** For existing asphalt surfaces, contact the District Maintenance Engineer to determine if contrast is required. *** Use black contrast for longitudinal solid white lane lines. Do not use contrast on solid edge lines.									

230.3.1.1 Longitudinal Solid Lines

The following applies to Longitudinal Solid Line material selection:

- For Asphalt Surfaces:
 - Hot-Applied Standard Thermoplastic is the preferred option.
 - Two Reactive Components may be used if approved by the District Maintenance Engineer and District Construction Engineer.
 - For existing asphalt surfaces, contact the District Maintenance Engineer to determine if black contrast is required.
- For Concrete Surfaces:
 - Hot-Applied Standard Thermoplastic is the preferred option.
 - Permanent Tape may be used with the understanding that the cost is significantly higher.
 - Two Reactive Components may be used if approved by the District Maintenance Engineer and District Construction Engineer.
 - Use black contrast consistent with [***Standard Plans Index 711-001***](#) for longitudinal solid white lane lines. Do not use contrast on solid edge lines.
- For Concrete Bridge Deck Surfaces:
 - Use Permanent Tape.
 - Use black contrast consistent with [***Standard Plans Index 711-001***](#) for longitudinal solid white lane lines. Do not use contrast on solid edge lines.

230.3.1.2 Longitudinal Skip and Dotted Lines

The following applies to Longitudinal Skip Line (10-30), Dotted Extension Line (6-10), and Dotted Line (3-9) material selection:

- For Asphalt Surfaces:
 - Hot-Applied Standard Thermoplastic is the preferred option.
 - Two Reactive Components may be used if approved by the District Maintenance Engineer and District Construction Engineer.
 - For existing asphalt surfaces, contact the District Maintenance Engineer to determine if black contrast is required.
- For Concrete and Concrete Bridge Deck Surfaces:
 - Use Permanent Tape
 - Use black contrast consistent with [Standard Plans Index 711-001](#) for longitudinal skip and dotted lines.

The following applies to Dotted Guide Line (2-4) material selection:

- For Asphalt Surfaces:
 - Use Hot-Applied Standard Thermoplastic if black contrast is not required.
 - Use Preformed Thermoplastic if black contrast is required. Use black contrast consistent with [Standard Plans Index 711-001](#) for longitudinal dotted lines.
 - Two Reactive Components may be used if approved by the District Maintenance Engineer and District Construction Engineer.
- For Concrete and Concrete Bridge Deck Surfaces:
 - Use Preformed Thermoplastic with black contrast consistent with [Standard Plans Index 711-001](#) for longitudinal dotted lines.

230.3.1.3 Markings Other Than Longitudinal Lines

The following applies to Diagonal Cross Hatch and Chevron material selection:

- For Asphalt, Concrete, and Concrete Bridge Deck Surfaces:
 - Hot-Applied Standard Thermoplastic is the preferred option.
 - Preformed Thermoplastic may be used with the understanding that the cost is significantly higher.

The following applies to Stop Line, Yield Line, 12-inch Transverse Line at standard and special emphasis crosswalks, Message, Lane Use Arrow, and Wrong Way Arrow material selection:

- For Asphalt Surfaces:
 - Hot-Applied Standard Thermoplastic is the preferred option if black contrast is not required.
 - For existing asphalt surfaces, contact the District Maintenance Engineer to determine if black contrast is required. Use Preformed Thermoplastic with black contrast if black contrast is required.
- For Concrete and Concrete Bridge Deck Surfaces:
 - Use Preformed Thermoplastic with black contrast.

The following applies to 24-inch Longitudinal Bars at special emphasis crosswalks material selection:

- For Asphalt Surfaces
 - Preformed Thermoplastic is the preferred option.
 - For existing asphalt surfaces, contact the District Maintenance Engineer to determine if black contrast is required. Use Preformed Thermoplastic with black contrast if black contrast is required.
- For Concrete and Concrete Bridge Deck Surfaces:
 - Use Preformed Thermoplastic with black contrast.

The following applies to Railroad Dynamic Envelope, Bicycle Markings (includes arrows, symbols, and messages), Shared Use Path Markings (includes arrows, symbols, and messages), and Route shields material selection:

- For Asphalt Surfaces:
 - Use Preformed Thermoplastic.
 - For existing asphalt surfaces, contact the District Maintenance Engineer to determine if black contrast is required. Use Preformed Thermoplastic with black contrast if black contrast is required.
- For Concrete and Concrete Bridge Deck Surfaces
 - Use Preformed Thermoplastic with black contrast.

The following applies to Ramp Exit Number material selection:

- For Asphalt, Concrete, and Bridge Deck Surfaces
 - Use Preformed Thermoplastic with black contrast.

Provide the following black contrast for Markings Other Than Longitudinal Lines and include details in the plans:

- Special Emphasis Crosswalk 24-inch Longitudinal Bars: Provide 4-inch-wide black contrast border on both sides of longitudinal bars.
- Yield Lines (Shark's Teeth): Provide black contrast block with a minimum of 1.5 inches from the yield line perimeter to the edges of the block.
- Stop Lines: Provide 4-inch-wide black contrast border on both sides of stop line.
- Railroad Dynamic Envelope: Provide 4-inch-wide black contrast border on both sides of each 12-inch-wide line.
- Lane Use Arrows, Wrong Way Arrows, Messages, Symbols, and Bicycle Markings (includes arrows, symbols, and messages) with design speed of 45 MPH and less: Provide 1.5-inch minimum black contrast border adjacent to the perimeter of the pavement marking.
- Lane Use Arrows, Wrong Way Arrows, Messages, Symbols, and Bicycle Markings (includes arrows, symbols, and messages) with design speed greater than 45 MPH: Provide black contrast block with a minimum of 1.5 inches from the pavement marking perimeter to the edges of the block.
- Intricate Symbols - For intricate symbols such as the Helmeted Bicyclist Symbol, use black contrast block for all design speeds.

230.3.1.4 Curb Delineation

Use Durable Paint for curb delineation at island noses.

230.3.2 Pavement Marking Maintenance

Two standard methods to extend the life of existing pavement markings are the application of Refurbishment Thermoplastic and Hot Spray Thermoplastic. These applications are often used when existing pavement markings no longer meet specification requirements, and the anticipated service life of the pavement is approximately 3 years or greater. Refurbishment Thermoplastic and Hot Spray Thermoplastic are discussed in the following sub-sections.

Use of Durable Paint is an option for asphalt pavement where the longer service life of Refurbishment Thermoplastic is not required. Durable Paint should not be used in areas opened to traffic due to the prolonged cure time of approximately 20 minutes. Prior to use, contact the District Maintenance Engineer to determine if use of Durable Paint is recommended.

230.3.2.1 Refurbishment Thermoplastic

Refurbishment Thermoplastic is the placement of new hot-applied thermoplastic material on top of existing pavement markings at a minimum thickness of 0.06 inches (60 mils). On concrete riding surfaces (i.e., concrete pavement and bridge deck surfaces) with existing Permanent Tape pavement markings, remove and replace in accordance with **Table 230.3.1**.

Consider the following when contemplating the use of refurbishment markings:

- Remaining service life of the pavement
- Thickness and conditions of existing markings
- Traffic volumes
- Cost of markings
- Other special requirements such as contrast needs or ground-in rumble strip installation

Coordinate with the District Maintenance Engineer to determine if Refurbishment Thermoplastic is appropriate. If Refurbishment Thermoplastic cannot be applied without exceeding the maximum thickness of 0.150 inches (150 mils), use Hot Spray Thermoplastic, or remove the existing markings before placing Hot-Applied Standard Thermoplastic markings. When contemplating use of Refurbishment Thermoplastic, consider an anticipated service life of 3-5 years. Refer to [Standard Specification 711](#) for additional information on Standard and Refurbishment Thermoplastic.

230.3.2.2 Hot Spray Thermoplastic

Hot Spray Thermoplastic is the application of a minimum 0.04-inch (40 mil) application of Hot Spray Thermoplastic material on existing longitudinal pavement markings.

Use of Hot Spray Thermoplastic may be conducive in the following circumstances:

- Existing audible or vibratory pavement markings need to have retroreflectivity restored.
- Resurfacing is scheduled within 2-4 years
- Refurbishment Thermoplastic would result in excessive pavement marking thickness and the removal and replacement with Standard Thermoplastic is cost prohibitive.
- Condition of the existing pavement has deteriorated such that removal and replacement is not an option as it would cause greater damage to the existing pavement.

230.3.3 No-Passing Zones

Follow the procedures contained in the [MUTS](#) for determining the limits of no-passing zones.

Limits of pavement markings for no-passing zones will be established by one of the following methods:

- (1) On projects where existing roadway conditions (vertical and horizontal alignments) are to remain unaltered by construction, the no-passing zones study will be accomplished as part of the design phase. The limits of the no-passing zones will be shown on the plans.

- (2) On projects with new or altered vertical and horizontal alignments, limits for no-passing zones will be established during construction. The required traffic study and field determination of limits will be performed by the designer during post design. Sufficient time must be included to accomplish the required field operations without delaying or interfering with the construction process.

For 2-Lane, 2-way roadways, a no-passing zone study should be conducted if any of the following conditions apply subsequent to the last roadway resurfacing project:

- (1) Newly constructed intersections
- (2) Multiple new residential or commercial driveway connections
- (3) New sight distance obstructions due to vegetation, tree growth or buildings
- (4) History of wrong way/head-on crashes or observations/complaints of near misses

230.3.4 Work Zone Pavement Markings

Use Standard Paint for work zone markings on asphalt and concrete pavement. The performance of Standard Paint has been evaluated by the Department for a period of 6 months.

Consider using Durable Paint or Refurbishment Thermoplastic when a work zone phase is expected to last for more than a year under heavy traffic volumes. The performance of Durable Paint has been evaluated by the Department for a period of 18 months.

Use Removable Tape for transitions on the final structural course or dense-graded friction course. Removable Tape may be used for other markings to avoid the removal of paint and scaring of final surface. Do not use Removable Tape for application durations of more than 6 months. Do not use Removable Tape on open-graded friction course.

Use contrast consistent with [Standard Plans Index 711-001](#) for solid white lane lines. Do not use contrast on solid edge lines.

230.3.5 Raised Pavement Markers (RPMs)

Retroreflective RPMs, Class B, are the standard type of RPM.

Internally illuminated RPMs are similar to retroreflective RPMs but are internally illuminated with LEDs. Internally illuminated RPMs may be used in lieu of retroreflective RPMs to enhance delineation and driver awareness as a mitigation strategy for substandard conditions as defined in the [TEM, Section 4.6](#).

Place all RPMs in accordance with the [Standard Plans, Index 706-001](#) and the [MUTCD](#).

230.4 Wrong-Way Signs and Pavement Markings

Deploy the enhanced signing and pavement markings in this section to improve positive guidance, to minimize driver confusion, and to reduce wrong-way movements. The height of WRONG WAY (R5-1a) signs must be in accordance with [Standard Plans, Index 700-101](#). Include red retroreflective strips on DO NOT ENTER (R5-1) and static WRONG WAY (R5-1a) sign columns in accordance with the [MUTCD 2A.21](#). Include white retroreflective strips on ONE WAY (R6-1) sign columns in [Exhibits 230-5, 230-6, and 230-7](#) in accordance with the [MUTCD 2A.21](#). These wrong-way prohibitive signs and pavement markings are used to enhance driver awareness. They are in addition to other required signs and pavement markings that are not shown in exhibits.

230.4.1 Exit Ramp Intersections

The standard for signing and pavement marking and advanced countermeasure installation at exit ramp intersections are illustrated in [Exhibits 230-1a](#) and [230-1b](#). The description of the layouts are as follows:

- (1) Include MUTCD “optional” signs; second DO NOT ENTER (R5-1), second WRONG WAY (R5-1a), and ONE WAY (R6-1) signs.
- (2) Include NO RIGHT TURN (R3-1) and COMBINATION U-TURN & LEFT TURN PROHIBITION (R3-18) signs.
- (3) Use 42 inches by 30 inches WRONG WAY (R5-1a) signs.
- (4) Modify distances between signs and detectors as appropriate for multi-lane ramps.
- (5) Include yellow 2'-4' dotted guideline striping on left edge line and white dotted guideline striping on right edge or lane line for left turns between ramps entrances/exits and cross-streets.
- (6) Include retroreflective yellow paint on ramp median nose where applicable. Include RPMs on ramp median nose in accordance with [Standard Plans, Index 706-001](#).
- (7) Include a straight arrow and route interstate shield pavement marking in left-turn lanes extending from the far-side ramp intersection through the near-side ramp intersection to prevent premature left turns. Refer to [TEM, Section 4.2.4](#) “Route Shields for Wrong-Way Treatment” for additional information.

- (8) Include a straight arrow and ONLY pavement message in outside lane approaching the ramp exit.
- (9) Coordinate with the District Traffic Operations Engineer (DTOE) to determine if a wrong-way vehicle detection system and a pair Light-emitting Diode (LED) Highlighted WRONG WAY (R5-1a) signs are required. If the DTOE determines they are required, install as illustrated in **Exhibits 230-1a and 230-1b**. The Highlighted Sign assembly may be solar powered or AC powered. If powered by AC, provide a power service assembly, conduits, and power conductors from the Highlighted Sign to the local cabinet. The Highlighted Sign must be integrated back to the District's Traffic Management Center (TMC). Connectivity between the Highlighted Sign and the TMC may be provided by either fiber optic or wireless communications. If fiber optic communications are used, include the fiber optic cable, conduit, and transmission equipment. If wireless communications are used, include the antenna and communication devices.

Modification for Non-Conventional Projects:

Delete item (9) above and see the RFP.

230.4.2 Diverging Diamond Intersections

Signing of Diverging Diamond Intersections is an evolving practice and not explicitly addressed in the MUTCD, however typical signing and pavement markings at diverging diamond crossovers and exit ramp intersections are illustrated in **Exhibit 230-2** and described as follows:

- (1) Include DO NOT ENTER (R5-1), WRONG WAY (R5-1a), and ONE WAY (R6-1) signs.
- (2) Include NO RIGHT TURN (R3-1), NO LEFT TURN (R3-2), and COMBINATION U-TURN & LEFT TURN PROHIBITION (R3-18) signs.
- (3) Include KEEP RIGHT (R4-7), KEEP LEFT (R4-8), and OBJECT MARKER (OM3) signs.
- (4) Use 42 inches by 30 inches WRONG WAY (R5-1a) signs.
- (5) Include white 2'-4' dotted guideline striping for through movements at the crossover location turns as well as at ramp entrances/exits.
- (6) Include retroreflective yellow paint on crossover and ramp median nose where applicable. Include RPMs on ramp median nose in accordance with [Standard Plans, Index 706-001](#).

- (7) Include a straight arrow pavement marking in all through lanes for the crossover maneuver in both directions on the downstream side of the crossover intersections.
- (8) Include Wrong-Way Arrow pavement markings in all through lanes for the crossover maneuver in both directions on the upstream side of crossover intersections.
- (9) Include route interstate shield pavement marking in the left turn lane(s) prior to and after the crossover intersection. Refer to TEM, Section 4.2.4 "Route Shields for Wrong-Way Treatment" for additional information.
- (10) Include a left turn arrow and ONLY pavement message in exclusive left turn lanes approaching ramp entrances.

See **FDM D217** for more information on Diverging Diamond Interchanges.

230.4.3 Divided Arterials and Collectors

Provide Wrong-Way Arrow pavement markings at unsignalized intersections with median widths of 20 feet or greater.

Provide DO NOT ENTER (R5-1) signs and WRONG WAY (R5-1a) signs at unsignalized intersections with median nose widths of 30 feet or greater. Orient each sign face at 45 degrees toward the connection it is intended to regulate. For median nose widths less than 30 feet, the median DO NOT ENTER (R5-1) and WRONG WAY (R5-1a) signs are optional. Place each sign as close to the wrong-way roadway as possible while meeting the placement criteria of [Standard Plans](#), **Index 700-101**.

See **Exhibits 230-3** and **230-4** for recommended configurations of Wrong-Way Arrow pavement markings, DO NOT ENTER (R5-1) signs, and WRONG WAY (R5-1a) signs.

Commentary: For median nose widths less than 30 feet, median DO NOT ENTER (R5-1) and WRONG WAY (R5-1a) signs should only be considered in high-risk locations (as described below). If placed in these narrower medians, ensure details in the plans clearly specify 45-degree rotation of each sign toward the wrong way movements to reduce visibility to those making proper turning movements.

At intersections with positive offset left-turns, use DO NOT ENTER (R5-1) signs with dimensions of 48 inches by 48 inches. See **FDM 212.14.4** for further information on offset left turn lanes.

For Context Classifications C1, C2, C3C, and C4 place Wrong-Way Arrow pavement markings in all lanes prior to unsignalized, stop-controlled connection (i.e., side streets,

commercial driveways, or driveways). Space Wrong-Way Arrow pavement markings no closer than 300 feet. For all other Context Classifications, consider placing Wrong-Way Arrow pavement markings as described above where high-risk locations are present.

Coordinate with the District Traffic Operations Engineer (DTOE) to evaluate high-risk locations using factors such as land-use, presence of lighting, history of impaired driving, crash history, and an over-represented population of licensed drivers 25 or younger and 65 or older. Determination of high-risk locations is at the discretion of the DTOE.

At intermediate ends of medians, consider the use of KEEP RIGHT (R4-7) sign for median nose widths less than 30 feet.

230.4.4 One-Way Pairs and Divided Arterials/Collectors with One-Way Egress

One-Way Egress is a condition where a two-way or one-way side street, commercial driveway, or driveway connects to a one-way arterial/collector or divided arterial/collector without a median opening.

See **Exhibit 230-5** for recommended configurations.

Place a ONE WAY (R6-1) sign at signalized and unsignalized, stop-controlled connection (i.e., side streets, commercial driveways, or driveways) with one-way egress. ONE WAY (R6-1) sign shall be placed on far side median or shoulder depending on facility type.

At driveways controlled by a non-signalized traffic control device with one-way egress, place a RIGHT TURN ARROW (FTP-55R-06) sign or a LEFT TURN ARROW (FTP-55L-06) sign below the STOP (R1-1) sign. Verify this sign has not already been installed by District driveway permit. At side street connections, place a Mandatory Lane Control (R3-5) sign below the STOP (R1-1) sign.

For Context Classifications C1, C2, C3C, and C4 place Wrong-Way Arrow pavement markings in all lanes prior to signalized and unsignalized, stop-controlled connection (i.e., side streets, commercial driveways, or driveways) with one-way egress. Space Wrong-Way Arrow pavement markings no closer than 300 feet. For all other Context Classifications, consider placing Wrong-Way Arrow pavement markings as described above where high-risk locations are present. Coordinate with the District Traffic Operations Engineer (DTOE) to evaluate high-risk locations using factors such as land-use, presence of lighting, history of impaired driving, crash history, and an over-

represented population of licensed drivers 65 and older. Determination of high-risk locations is at the discretion of the DTOE.

230.4.5 Undivided One-Way Streets

For two-way street approaches, place the following signs and pavement markings as illustrated in **Exhibit 230-6**:

- (1) Place the corresponding turn prohibition (R3 Series) symbolic sign on the right-hand side of the approach street.
- (2) Place DO NOT ENTER (R5-1) signs on both sides of the one-way street.
- (3) Place Wrong-Way Arrow pavement markings in all lanes upstream of side street.
- (4) Add turn and through lane-use arrow on approaches to the one-way street.
- (5) For one-way approaches, place the following signs and pavement markings as illustrated in **Exhibit 230-7**:
- (6) Place the corresponding turn prohibition (R3 Series) symbolic sign. Where overhead structures exist, consider placement of a secondary turn prohibition sign over the lane or closest to the direction it is prohibiting.
- (7) Place DO NOT ENTER (R5-1) signs on both sides of the one-way street.
- (8) Place Wrong-Way Arrow pavement markings in all lanes prior to the side street.

230.4.6 Two-Way Signalized Intersections

Provide the following signing and pavement markings as illustrated in **Exhibit 230-8** for intersections serving two-way traffic where the distance from the side street stop bar to the arterial receiving lane meets or exceeds 60 ft:



- (1) Place yellow 2'-4' dotted guide center line for left turn movement onto a two-way state route.
- (2) Where design or conditions deem it appropriate to provide enhanced positive guidance for the driver, include yellow 2'-4' dotted guide center line for left turn movement off the state route.

- (3) For multiple left turn lanes, place white 2'-4' dotted guideline for right edge or lane line. For single left turn lane, white 2'-4' dotted guideline may be provided on right edge line.

If a two-way street crosses a one-way street at a signalized intersection, the criteria of **FDM 230.4.5** applies.

STANDARD SIGNING AND PAVEMENT MARKING AT EXIT RAMP INTERSECTIONS

LEGEND

-  Wrong-Way Arrows
-  Wireless Antenna
-  Lane Assignment Arrows

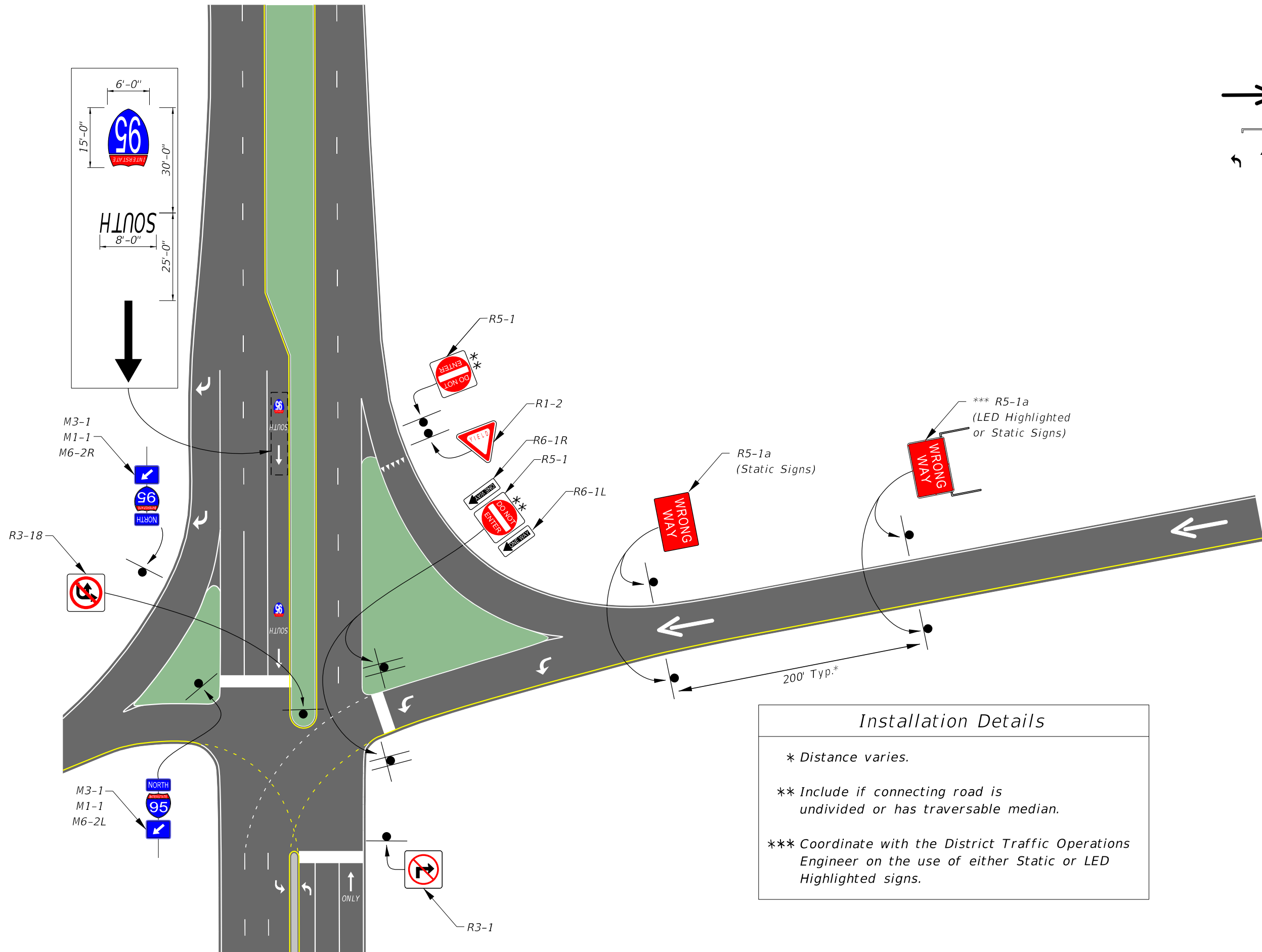

Installation Details

- * Distance varies.
- ** Include if connecting road is undivided or has traversable median.
- *** Coordinate with the District Traffic Operations Engineer on the use of either Static or LED Highlighted signs.

NOT TO SCALE

EXHIBIT 230-1a
01/01/2023

TYPICAL LAYOUT FOR PARTIAL CLOVERLEAF/TRUMPET EXIT RAMP INTERSECTION

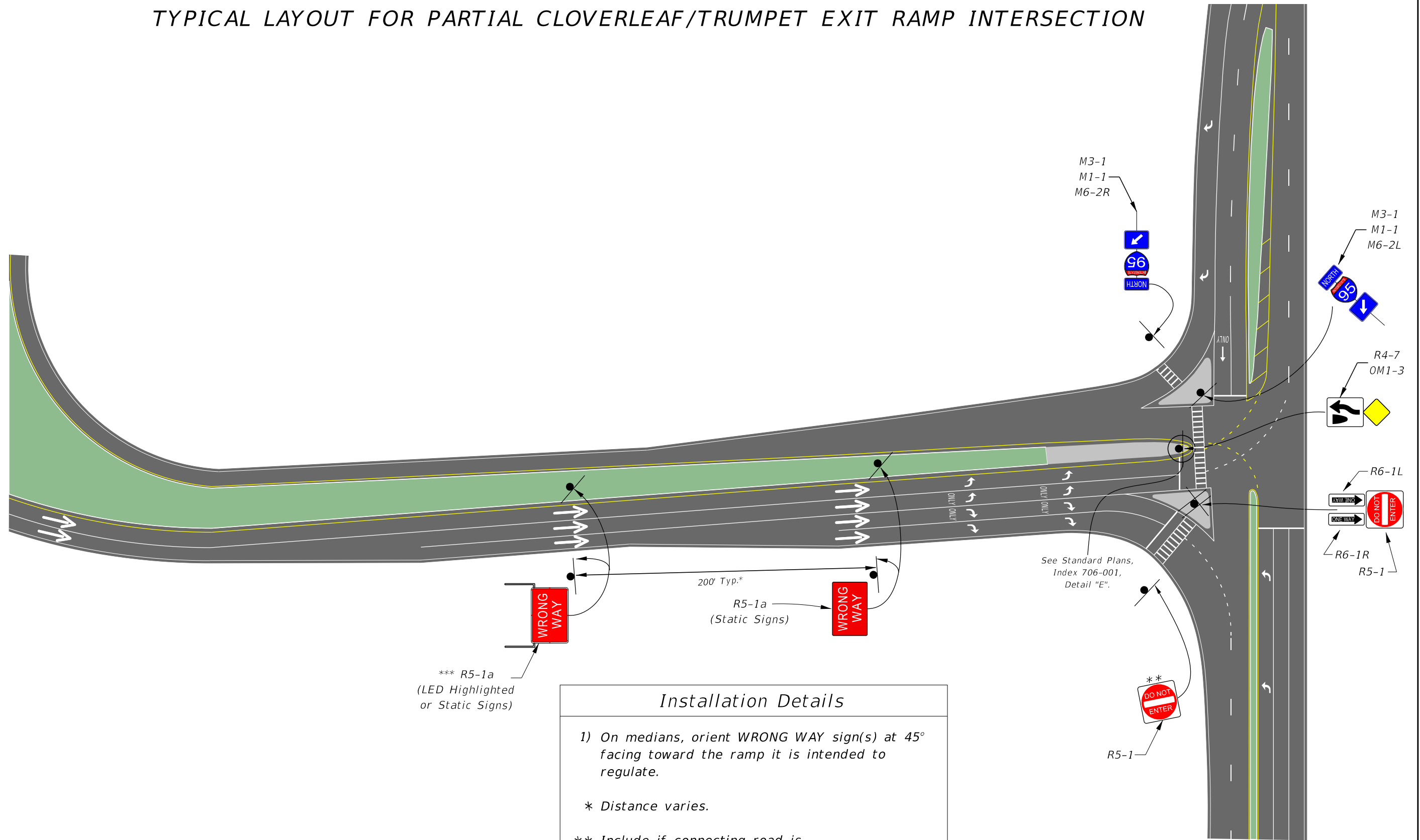

Installation Details

1) On medians, orient WRONG WAY sign(s) at 45° facing toward the ramp it is intended to regulate.

* Distance varies.

** Include if connecting road is undivided or has traversable median.

*** Coordinate with the District Traffic Operations Engineer on the use of either Static or LED Highlighted signs.

- LEGEND**
- Wrong-Way Arrows
 - Wireless Antenna
 - Lane Assignment Arrows

NOT TO SCALE

EXHIBIT 230-1b
01/01/2023

DIVERGING DIAMOND INTERSECTIONS

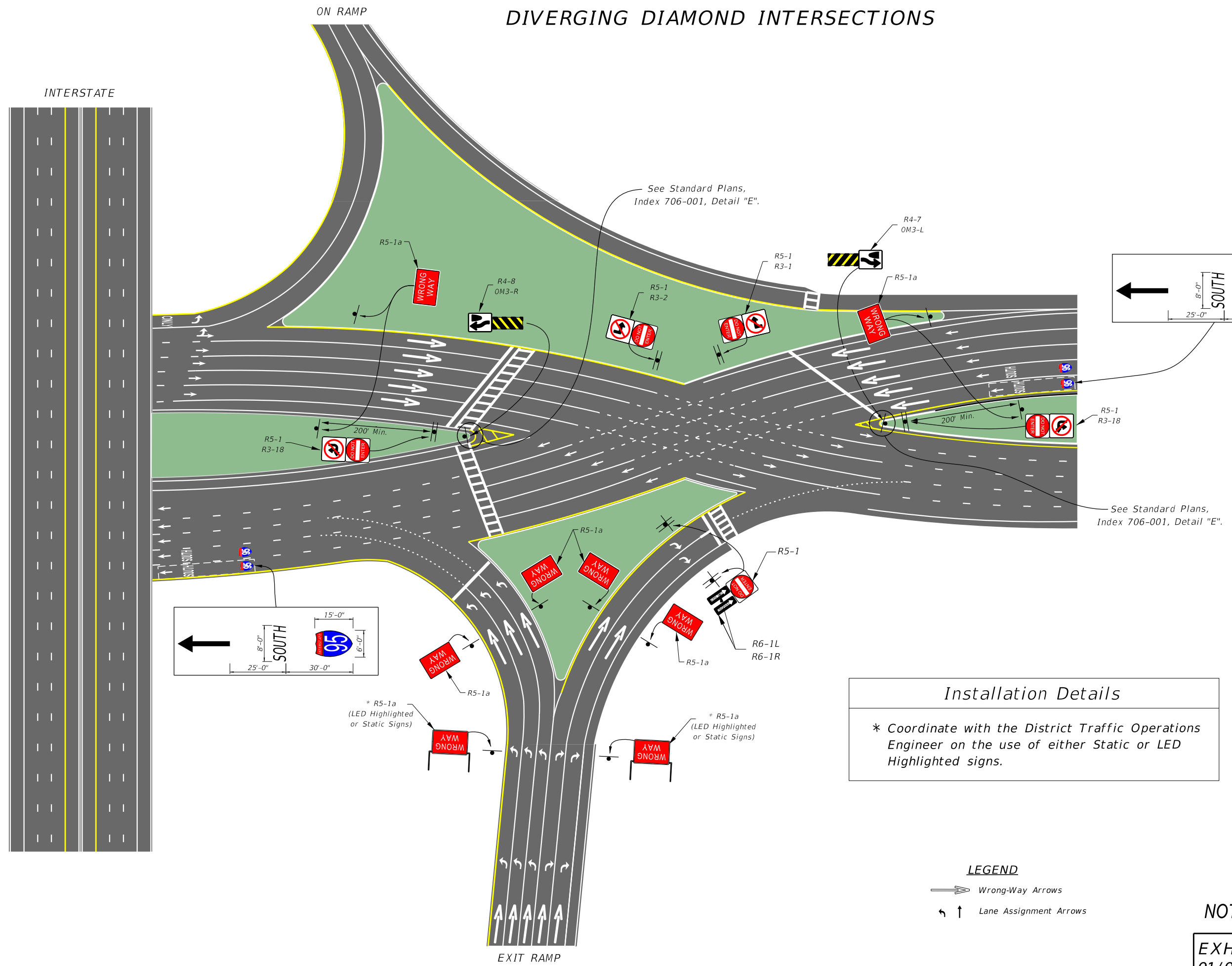

Installation Details

* Coordinate with the District Traffic Operations Engineer on the use of either Static or LED Highlighted signs.

LEGEND

→ Wrong-Way Arrows

↖ ↑ Lane Assignment Arrows

NOT TO SCALE

EXHIBIT 230-2
01/01/2023

WRONG-WAY SIGNING AND PAVEMENT MARKING AT 4-LEG UNSIGNALIZED INTERSECTIONS ALONG DIVIDED ARTERIALS/COLLECTORS

Installation Details

* If median nose width is <30 ft, these R5-1 and R5-1a signs are optional. See FDM 230.4.3

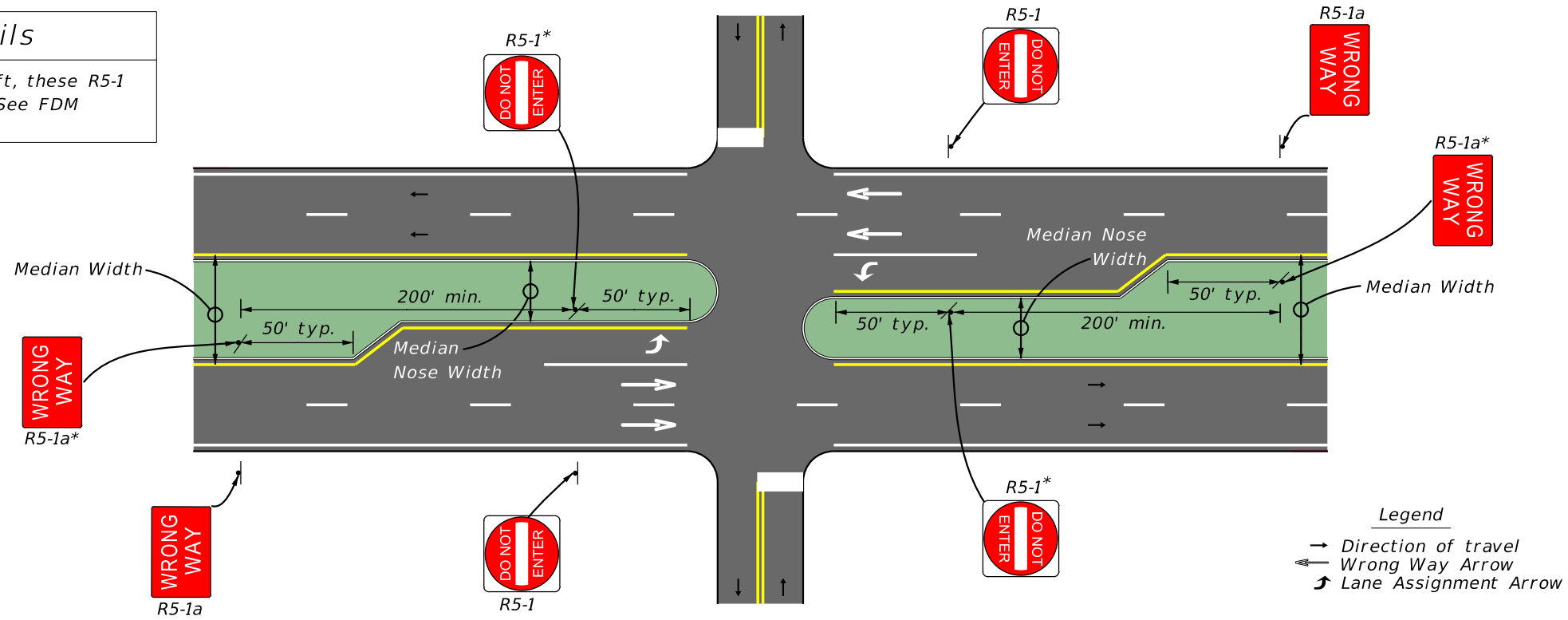

NOT TO SCALE

EXHIBIT 230-3
10/2022

WRONG-WAY SIGNING AND PAVEMENT MARKING AT 3-LEG UNSIGNALIZED INTERSECTIONS ALONG DIVIDED ARTERIALS/COLLECTORS

Installation Details

(1) Median Nose Width is equal to Median Width when auxiliary lanes are not present.

* If median nose width is <30 ft, these R5-1 and R5-1a signs are optional. See FDM 230.4.3.

** Wrong Way Arrows optional when Downstream One-Way Egress is present. See Exhibit 230-5 for signing at these One-Way Egress locations.

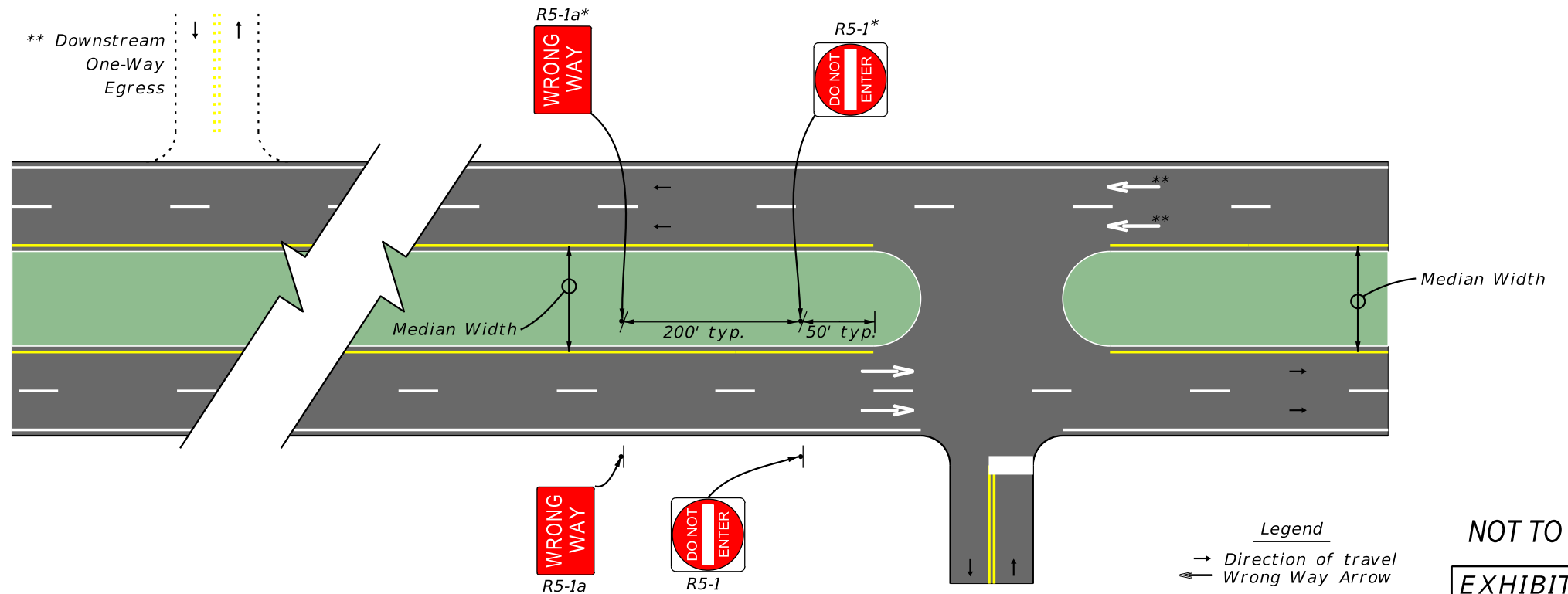

NOT TO SCALE

EXHIBIT 230-4
10/2022

ONE-WAY PAIRS AND DIVIDED ARTERIALS/COLLECTORS WITH UNSIGNALIZED ONE-WAY EGRESS

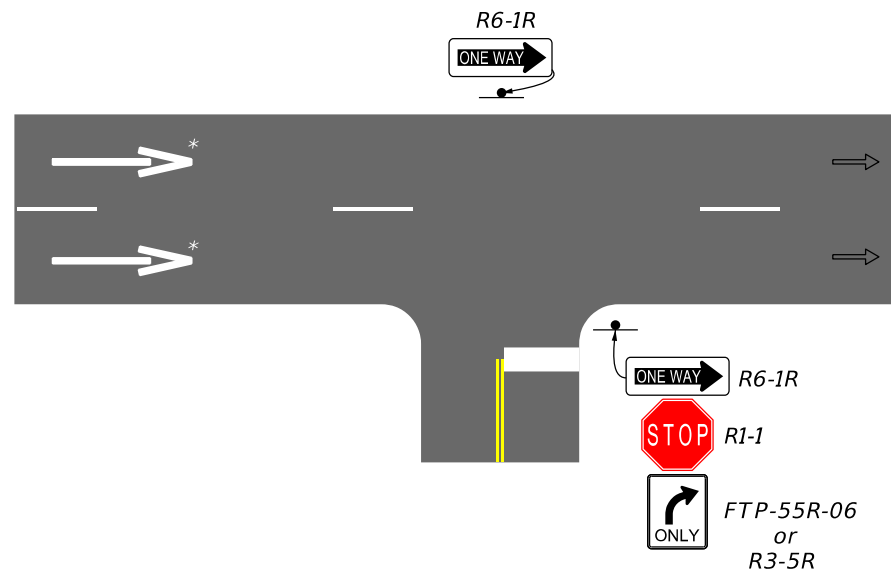

- ### Installation Details
- 1) R6-1 shall be placed on far side median or shoulder depending on facility type.
 - 2) RIGHT TURN ARROW (FTP-55R-06) or LEFT TURN ARROW (FTP-55L-06) typically added by district driveway permit.
 - 3) Mandatory Movement Lane Control (R3-5) sign must be added to side street.
- * See FDM 230.4.4 for how often to place Wrong-Way arrows based on context classification.

Legend
 → Direction of travel
 → Wrong Way Arrow

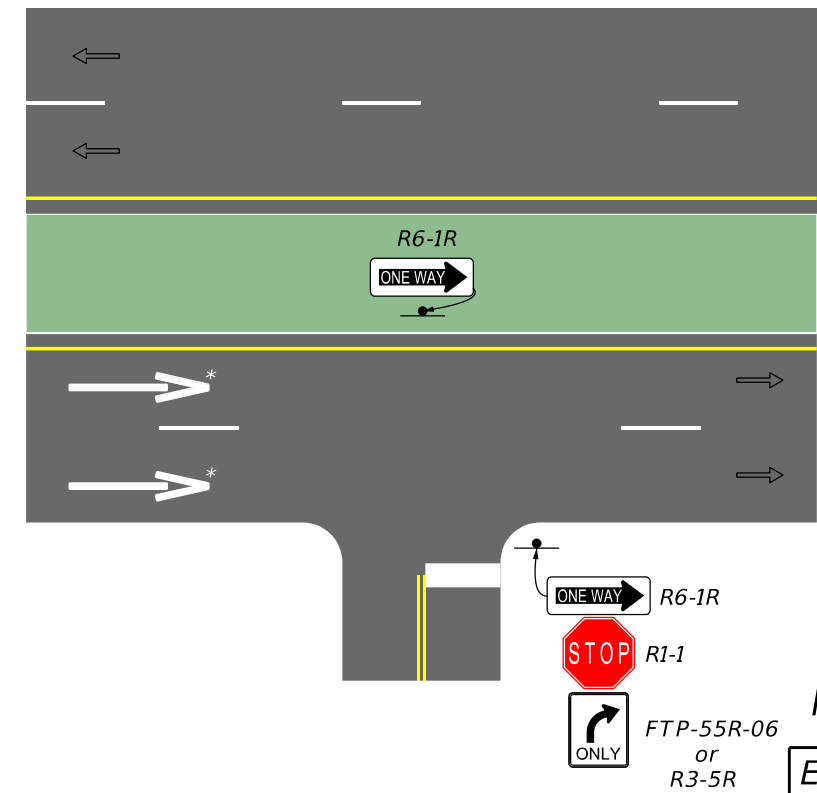

NOT TO SCALE
 EXHIBIT 230-5
 10/2022

TYPICAL TWO-WAY APPROACH TO UNDIVIDED SIGNALIZED AND UNSIGNALIZED ONE-WAY STREET

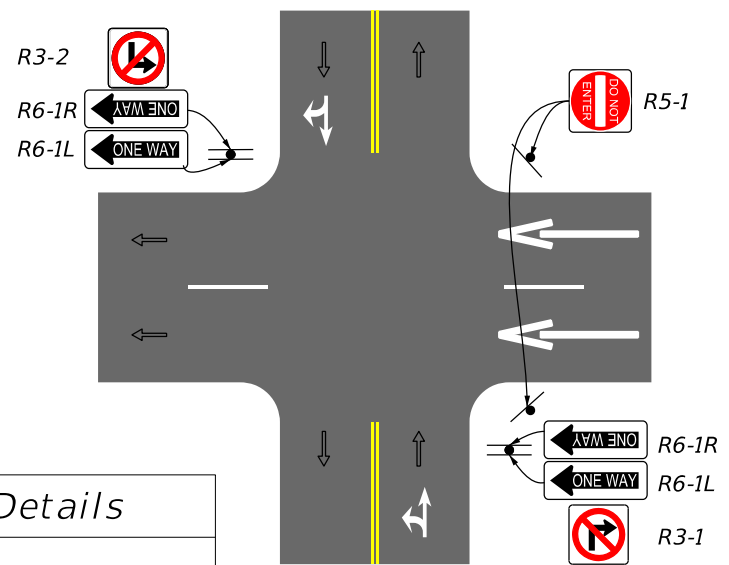

- ### Installation Details
- 1) Wrong-Way signing and pavement markings for signalized and stop control.
 - 2) Place Wrong-Way arrows four feet upstream of stop bar, if present.

Legend
 → Direction of travel
 → Wrong Way Arrow
 → Lane Assignment Arrow

NOT TO SCALE
 EXHIBIT 230-6
 10/2022

TYPICAL ONE-WAY APPROACH TO UNDIVIDED SIGNALIZED AND UNSIGNALIZED ONE-WAY STREET

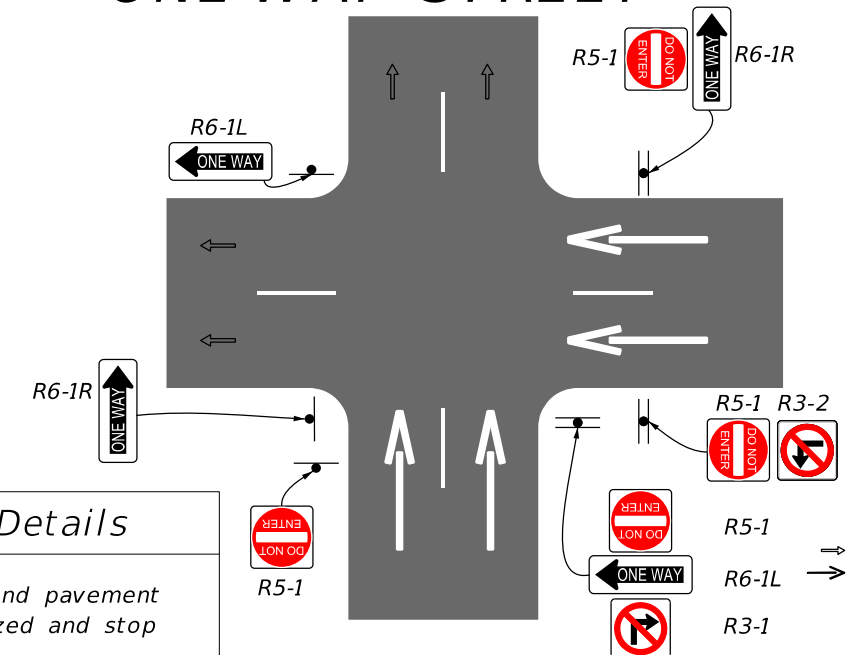

- ### Installation Details
- 1) Wrong-Way signing and pavement markings for signalized and stop control.
 - 2) Place Wrong-Way arrows four feet upstream of stop bar, if present.

Legend
 → Direction of travel
 → Wrong Way Arrow

NOT TO SCALE
 EXHIBIT 230-7
 10/2022

TYPICAL DOTTED LINE MARKINGS TO EXTEND CENTER LINE AND LANE LINE MARKINGS INTO SIGNALIZED INTERSECTION

Installation Details

- 1) Center line extensions in the intersection shall be dotted guide yellow lines.
- 2) $d \geq 60$ ft. The distance of the left turn from the side street stop bar to the arterial receiving lane meets or exceeds 60 ft. See FDM 230.4.6.

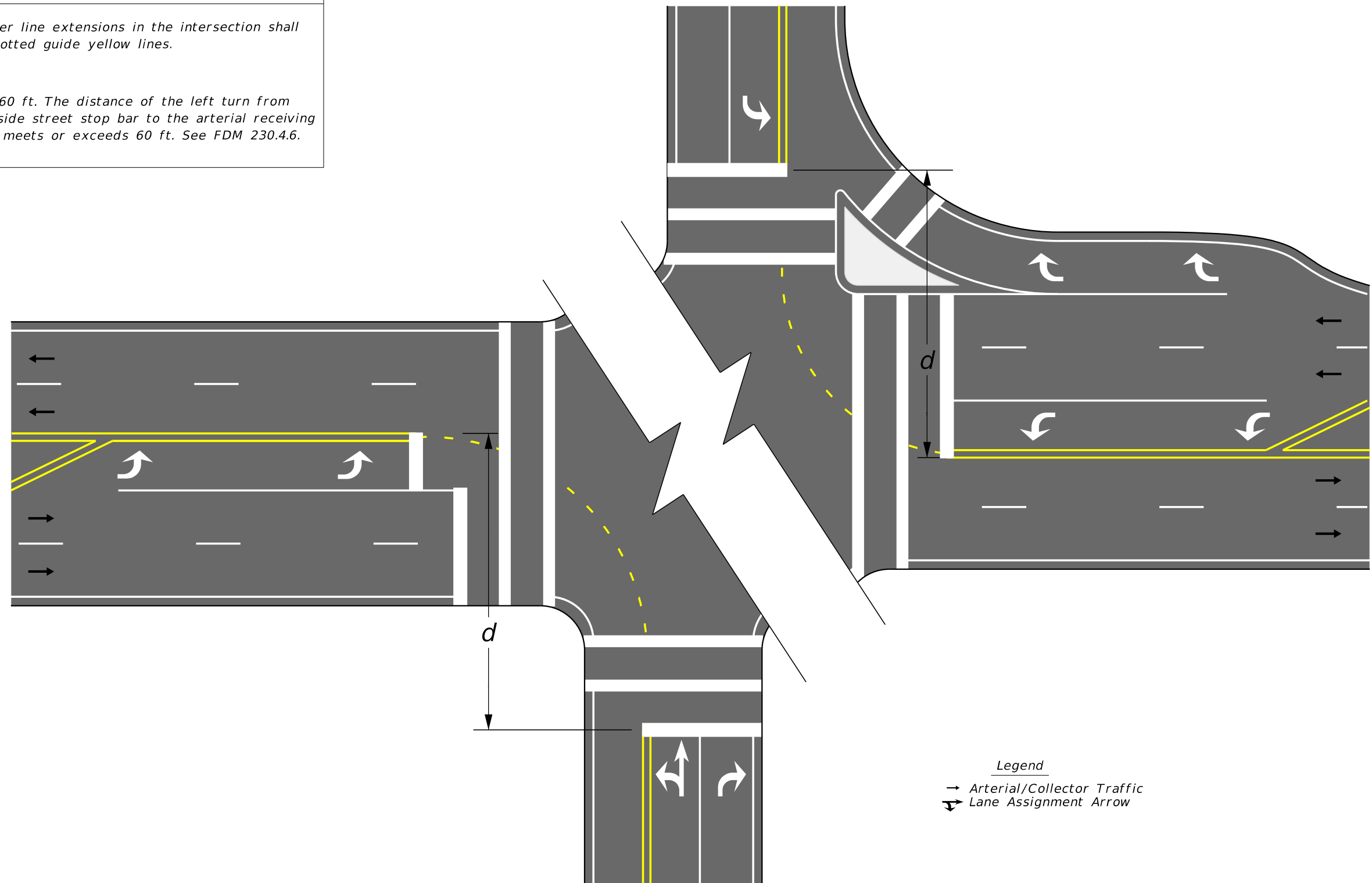

Legend
→ Arterial/Collector Traffic
↪ Lane Assignment Arrow

NOT TO SCALE

EXHIBIT 230-8
06/01/2021

230.5 Signing and Pavement Marking Coordination

Coordination with other offices and agencies is a very important aspect of signing and pavement marking design. The offices discussed in this section are those that are typically involved in developing signing and marking plans; however, there may be other offices or agencies involved.

The District Utilities Engineer provides the coordination between the designer and the various utilities. The Utilities Section may assist in identifying or verifying conflicts with overhead and underground utilities. The District Utilities Engineer should be contacted as early in the design phase as possible.

The Structures EOR provides the design of the sign structure and foundation for overhead cantilever and overhead truss sign assemblies. The Structures EOR should be contacted early in the design phase to allow adequate time for coordination with the Geotechnical Engineer in obtaining the necessary soils information.

Contact the State Outdoor Advertising and Logo Manager on any project affecting business logo structures. Refer to **FDM 110.5.5** for requirements and additional information.

230.6 Typical Signing and Pavement Marking Configurations

The following sub-sections describe standard signing and pavement marking applications for midblock crosswalks, Florida scenic trails, median openings along divided arterials/collectors, roadway transitions, stop controlled intersections along divided arterials/collectors, and residential and minor street terminations.

230.6.1 Midblock Crosswalks

Typical signing and pavement markings for stop controlled and signal controlled midblock crosswalks are illustrated in **Exhibit 230-9** and described as follows:

- (1) Include PEDESTRIAN TRAFFIC (W11-2), DIAGONAL ARROW (W16-7p), AHEAD (W16-9p), and STOP HERE FOR PEDESTRIANS (R1-5p) signs
- (2) Include 24" white stop line placed 40 feet plus or minus 10 feet in advance of the marked crosswalk.
- (3) Include 6" solid white lane lines 100 feet in length upstream of each approach and terminating at the stop line.

- (4) Include special emphasis crosswalk markings consistent with [Standard Plans, Index 711-001](#).

230.6.2 Florida Scenic Trails

Typical signing and pavement markings for Florida Scenic Trails are illustrated in **Exhibit 230-10** and described as follows:

- (1) Include FLORIDA NATIONAL SCENIC TRAIL 1000 FEET, PEDESTRIAN CROSSING (W11-2), DIAGONAL ARROW (W16-7p), and AHEAD (W16-9p) signs.
- (2) Include FLORIDA NATIONAL SCENIC TRAIL, TRAIL MARKER, and HIKING TRAIL (RS-068) signs.
- (3) Include special emphasis crosswalk markings consistent with [Standard Plans, Index 711-001](#).

230.6.3 4-Leg Stop Controlled Intersections Along Divided Arterials/Collectors

Typical signing and pavement markings for stop controlled median openings along divided highways are illustrated in **Exhibit 230-11** and described as follows:

- (1) Include DIVIDED HIGHWAY CROSSING (R6-3), STOP (R1-1), and ONE WAY (R6-1) signs.
- (2) Include YIELD (R1-2) and ONE WAY (R6-1) signs in the median when the median nose width is 30 feet or greater.
- (3) Divided highway signs (R6-3) may be on the same structure with the STOP and ONE WAY signs or on a separate structure.
- (4) See the [MUTCD](#) and [Standard Plans, Index 711-001](#) for additional pavement marking details.
- (5) See **FDM 230.4** for Wrong-Way signs and pavement markings.

230.6.4 3-Leg Stop Controlled Intersections Along Divided Arterials/Collectors

Typical signing and pavement markings for 3-leg stop controlled intersections along divided arterials/collectors are illustrated in **Exhibit 230-12** and described as follows:

- (1) Include DIVIDED HIGHWAY CROSSING (R6-3a), STOP (R1-1), and ONE WAY (R6-1) signs.
- (2) Include YIELD (R1-2) and ONE WAY (R6-1) signs in the median when the median nose width is 30 feet or greater.
- (3) Include OBJECT MARKER (OM1-3) as shown and in accordance with **Specification 705** and [Standard Plans, Index 700-010](#).
- (4) See the [MUTCD](#) and [Standard Plans, Index 711-001](#) for additional pavement marking details.
- (5) Provide sheeting on signs and object markers in accordance with **Specification 993**.
- (6) See **FDM 230.4** for Wrong-Way signs and pavement markings.

230.6.5 Residential and Minor Street Terminations

Typical signing and pavement markings for residential and minor street terminations are illustrated in **Exhibit 230-13** and described as follows:

- (1) For minor street terminations, include STOP (R1-1), LARGE ARROW (W1-6), and TWO DIRECTIONAL LARGE ARROW (W1-7), signs. Include OBJECT MARKER (OM1-3) as shown and in accordance with **Specification 705** and [Standard Plans, Index 700-010](#).
- (2) For residential street terminations, include DEAD END (W14-1) sign. Include OBJECT MARKER (OM4-3) as shown and in accordance with **Specification 705** and [Standard Plans, Index 700-010](#).

230.6.6 Roadway Transitions (2 Lane Undivided to 4 Lane Divided)

Typical signing and pavement markings for roadway transitions from 2-lane undivided to 4-lane divided are illustrated in **Exhibit 230-14** and described as follows:

- (1) Include DIVIDED HIGHWAY (W6-1), DIVIDED HIGHWAY ENDS (W6-2), TWO WAY TRAFFIC (W6-3), DO NOT ENTER (R5-1), KEEP RIGHT (R4-7) and LANE ENDS (W4-2) signs.
- (2) For left roadway centered on existing roadway scheme, include LANE ENDS MERGE LEFT (W9-2L), and RIGHT LANE ENDS (W9-1) signs.
- (3) For right roadway centered on existing roadway scheme, include LANES ENDS MERGE RIGHT (W9-2R), and LEFT LANE ENDS (W9-1L) signs.

230.6.7 Channelized Turn Lanes

Typical signing and pavement markings for channelized turn lanes are illustrated in **Exhibit 230-15** and described as follows:

- (1) Include STOP (R1-1) sign.
- (2) For yielding right turn lanes include YIELD (R1-2) sign.
- (3) Include right or left turn lane arrows as applicable.

230.6.8 Toll Route Markers

Typical signing and pavement markings for toll routes are illustrated in **Exhibit 230-16a** to **16c** and described as follows:

- (4) Use toll route marker sign panel on the toll mainline.
- (5) Use the Toll Auxiliary Sign in combination with the toll route marker on side streets leading to the toll mainline.
- (6) On numbered routes, use the Toll Route Shield without the additional Toll Auxiliary Sign.

The width of cardinal direction sign, directional arrow auxiliary sign, or other auxiliary sign in the route marker assembly must match the width of the parent route marker sign.

The signs and markers can be found in the [Department's Sign Library](#).

230.6.9 Bicycle and Pedestrian Facilities at Interchanges

Typical signing and pavement markings for bicycle and pedestrian facilities through interchange areas are illustrated in **Exhibits 230-17a** and **230-17b**. Use the signs below to alert and direct motorists, pedestrians, and bicycles through the interchange area:

- (1) Place COMBINED BICYCLE/PEDESTRIAN WARNING (W11-15) sign and AHEAD (W16-9P) plaque to alert motorists of the upcoming pedestrian crossing.
- (2) Place STOP HERE FOR PEDESTRIANS (R1-5b) sign at stop line to indicate where motorists must stop for pedestrians.
- (3) Place PEDESTRIAN WARNING (W11-15) sign and DOWN ARROW (W16-7P) plaque to indicate the pedestrian and bicycle crosswalk location.
- (4) Place NO TURN ON RED (R10-11a) sign if a traffic signal controls the intersection.

Use other signs and pavement markings per the **TEM** and **MUTCD** if needed, based on the design of the interchange. Criteria for the design of bicycle and pedestrian facilities through interchanges is found in FDM 211.

The signs and pavement markings can be found in the [**Department's Sign Library**](#).

TYPICAL SIGNING AND PAVEMENT MARKING FOR MIDBLOCK CROSSWALKS

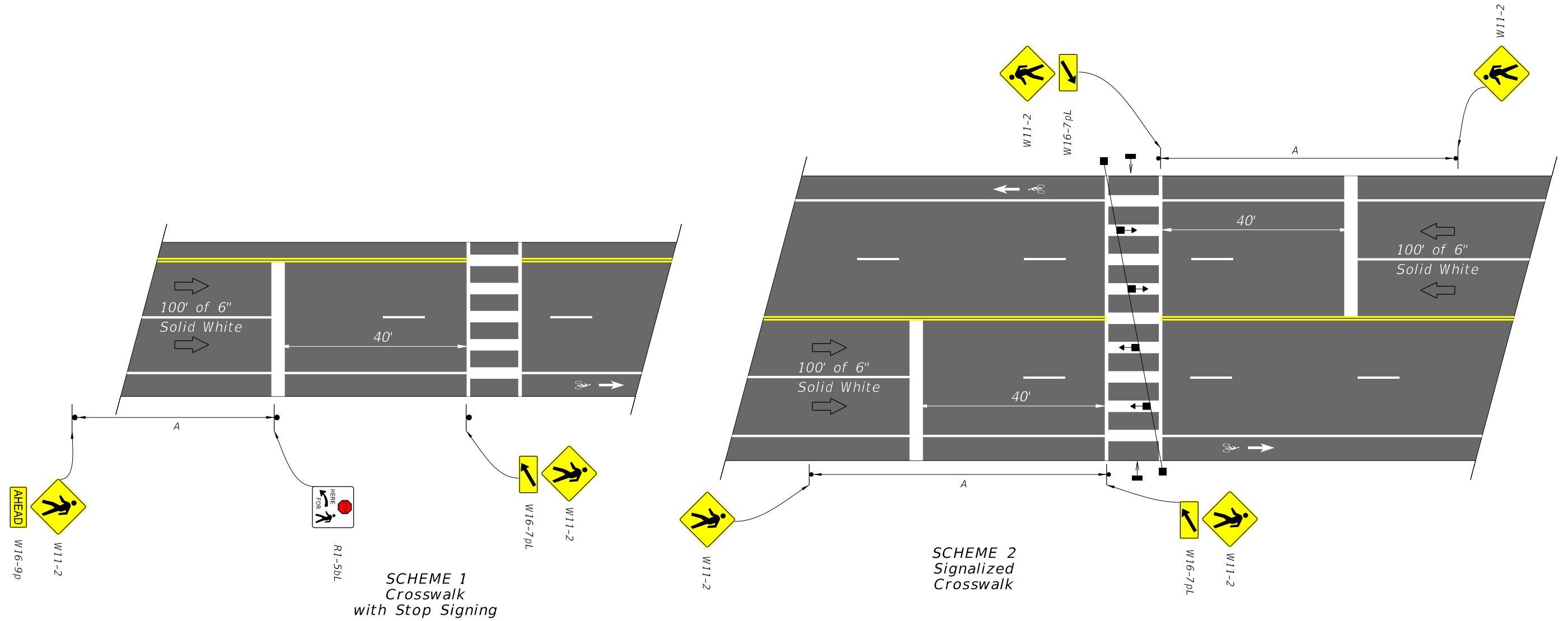

LEGEND

➡ Direction of Traffic

➡ Bike Lane

APPROACH SPEED MPH	A-SUGGESTED DISTANCE (Ft.)
25 Or Less	200
26 To 35	250
36 To 45	300

Note:
The details shown do not depict the signing and markings for multi-lane roadways with divided medians. For these applications, additional signs shall be installed on the median side. Minimum width of Mid-Block Crosswalks is 10'.

NOT TO SCALE

EXHIBIT 230-9
01/01/2024

TYPICAL SIGNING AND PAVEMENT MARKING FOR FLORIDA NATIONAL SCENIC TRAILS

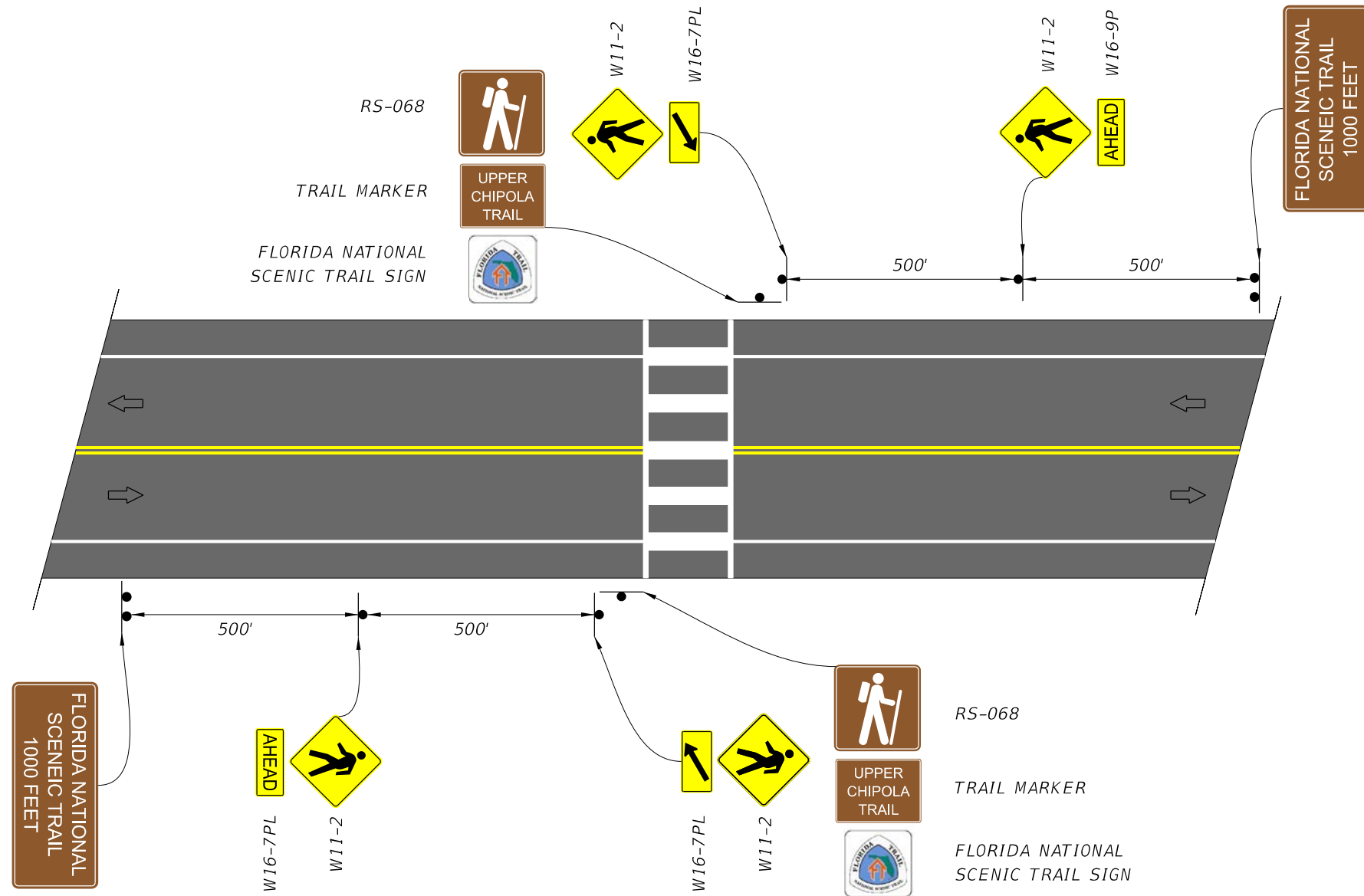

NOTE: The FLORIDA NATIONAL SCENIC TRAIL sign will be provided by the US Forest Service.

LEGEND
 Direction of Traffic



FLORIDA NATIONAL SCENIC TRAIL SIGN

NOT TO SCALE

TYPICAL SIGNING AND PAVEMENT MARKING FOR AT 4-LEG STOP CONTROLLED INTERSECTIONS ALONG DIVIDED ARTERIALS/COLLECTORS

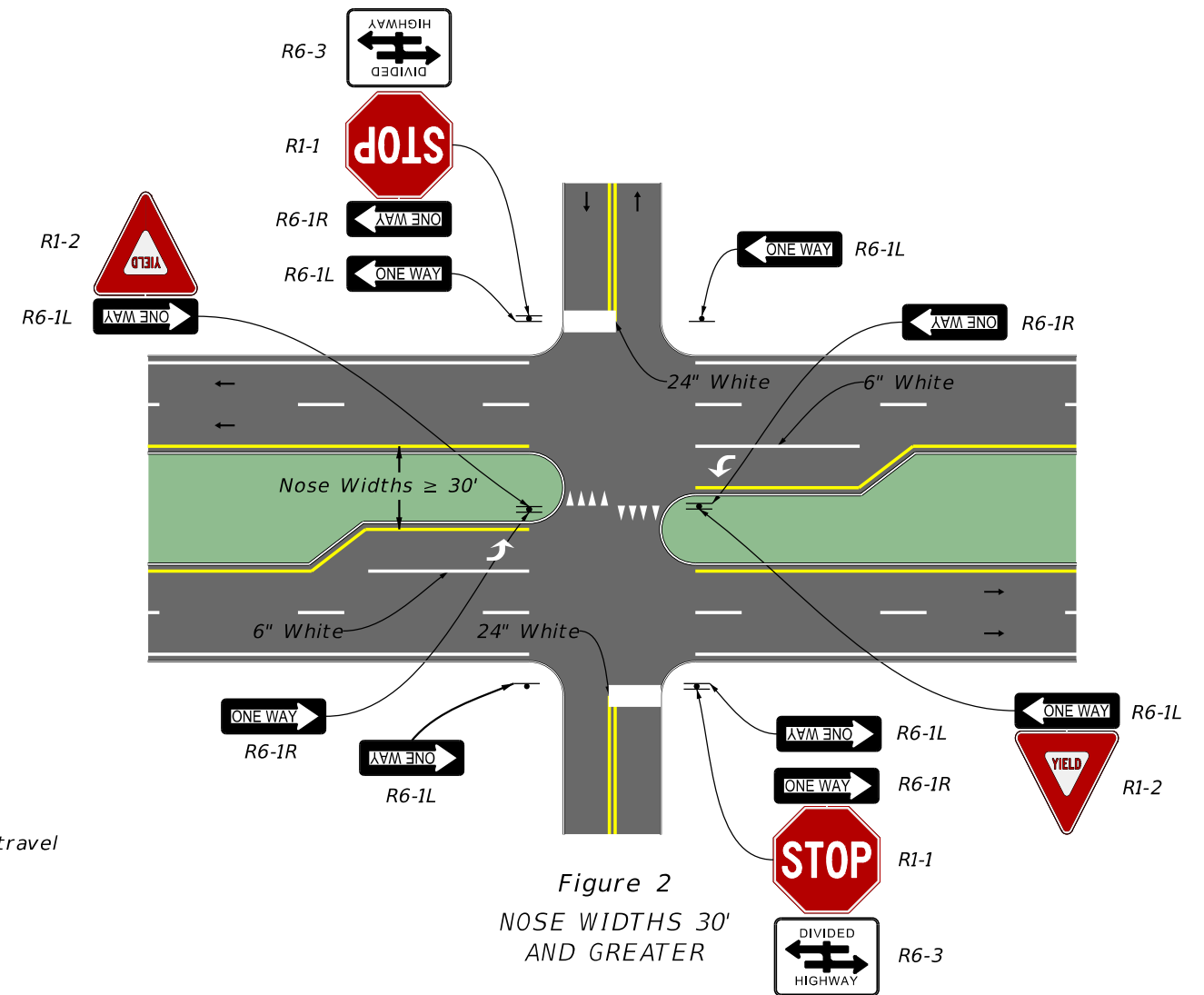
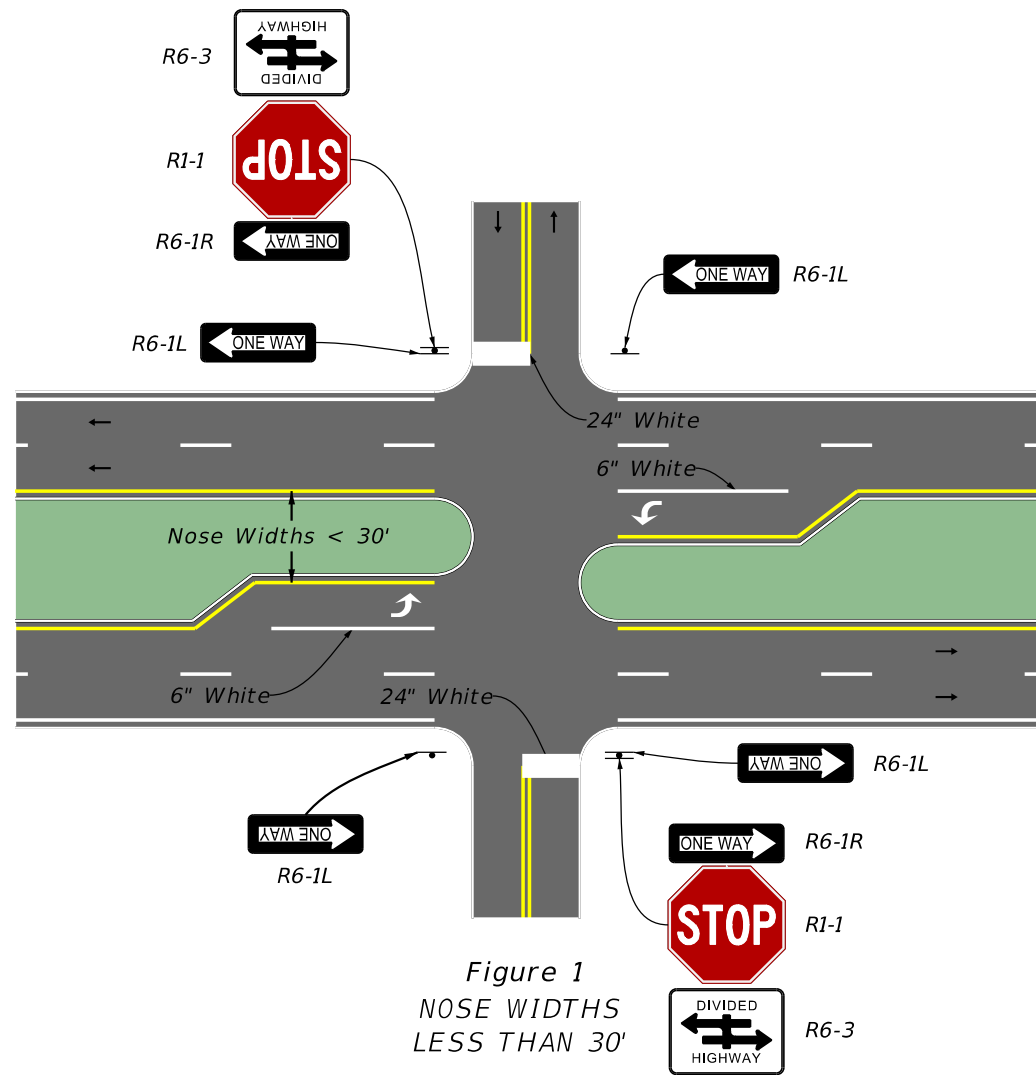

Legend
→ Direction of travel

Installation Details

- 1) Divided Highway signs (R6-3) may be on the same structure with the STOP and ONE WAY signs or on a separate structure.
- 2) See the MUTCD and Standard Plans, Index 711-001, for additional pavement marking details.
- 3) For additional signing and pavement marking details to discourage Wrong-Way Driving, see FDM 230.4.3

NOT TO SCALE

EXHIBIT 230-11
06/01/2021

TYPICAL SIGNING AND PAVEMENT MARKING AT 3-LEG STOP CONTROLLED INTERSECTIONS ALONG DIVIDED HIGHWAYS

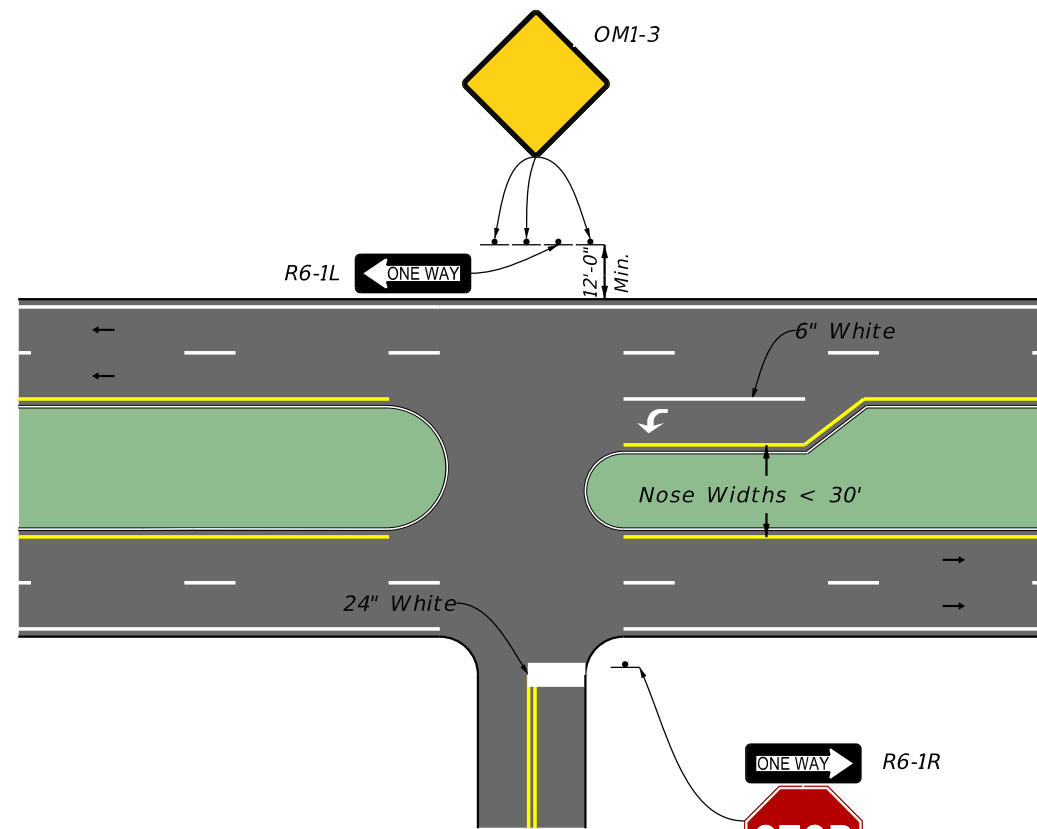

Figure 1
NOSE WIDTHS
LESS THAN 30'

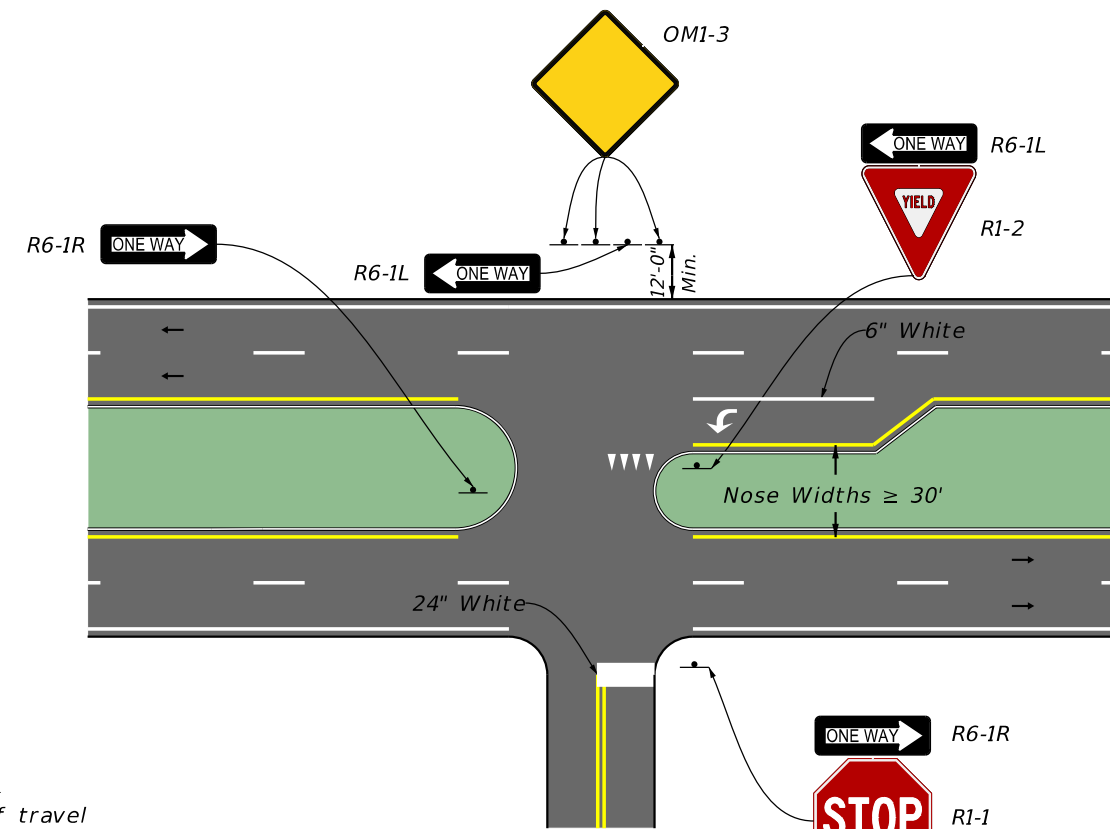

Figure 2
NOSE WIDTHS 30'
AND GREATER

Legend
→ Direction of travel

Installation Details

- 1) Major streets to be evaluated on a case-by-case basis.
- 2) Install Object Markers in accordance with Index 700-010.
- 3) See Index 711-001 for pavement markings.
- 4) Provide sheeting on signs and object markers in accordance with Specification 993.
- 5) For additional signing and pavement marking details to discourage Wrong-Way Driving, see FDM 230.4.3

NOT TO SCALE

EXHIBIT 230-12
10/2022

TYPICAL SIGNING AND PAVEMENT MARKING FOR RESIDENTIAL AND MINOR STREET TERMINATIONS

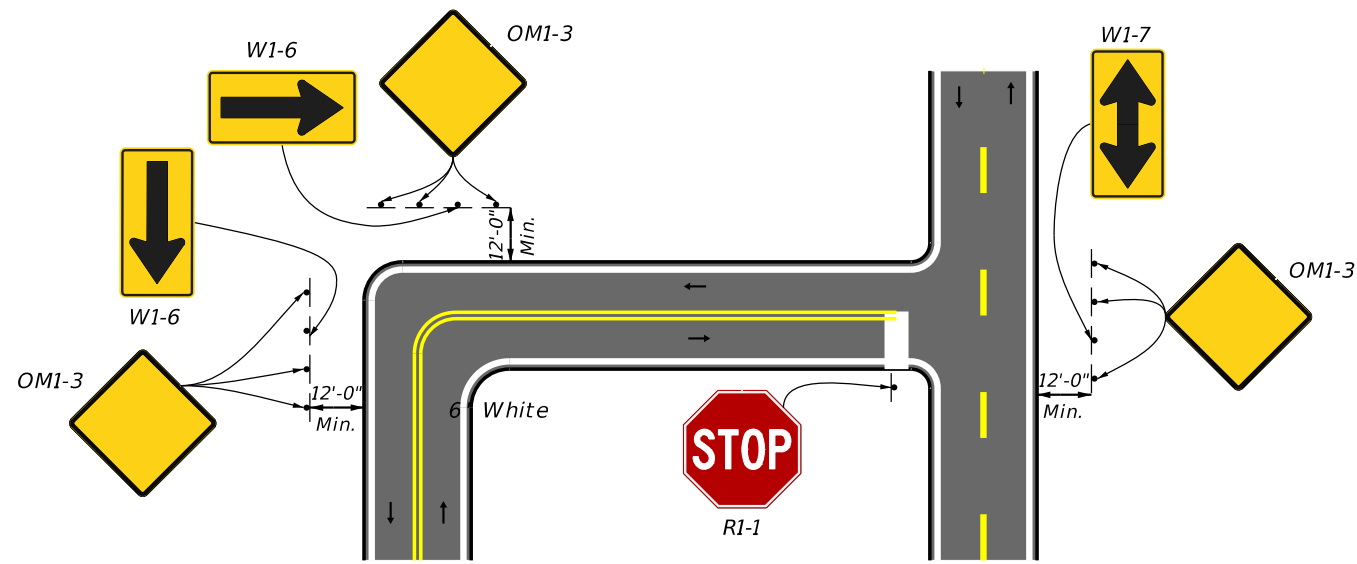

Figure 1
TRAFFIC CONTROLS FOR MINOR
STREET TERMINATION

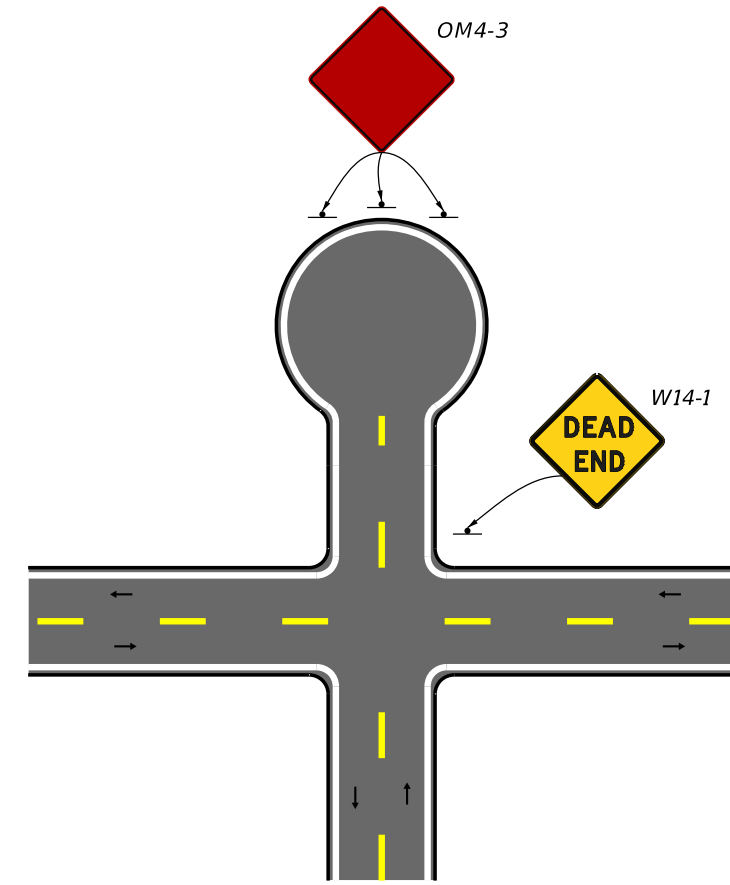
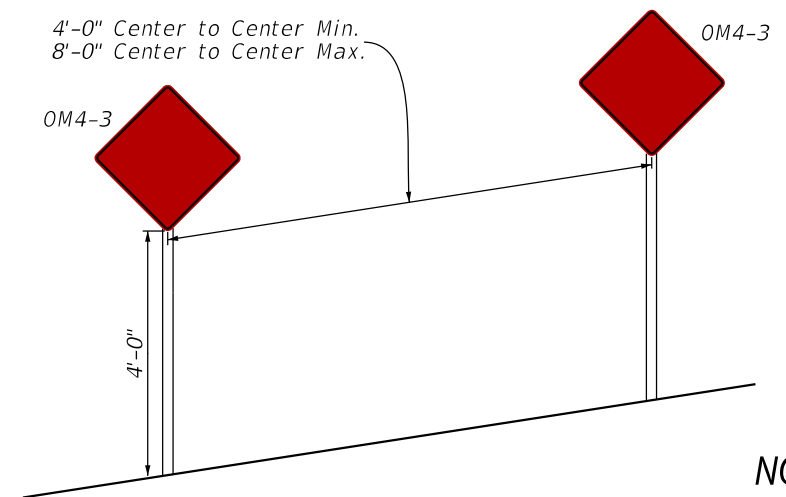

Figure 2
TRAFFIC CONTROLS FOR
CUL-DE-SAC OR DEAD END

Installation Details
1) Major streets to be evaluated on a case-by-case basis..
2) Install Object Markers in accordance with Index 700-010
3) See Index 711-001 for pavement markings.
4) Provide sheeting on signs and object markers in accordance with Specification 993.

Legend
→ Direction of travel



NOT TO SCALE

TYPICAL SIGNING AND PAVEMENT MARKINGS FOR ROADWAY TRANSITIONS

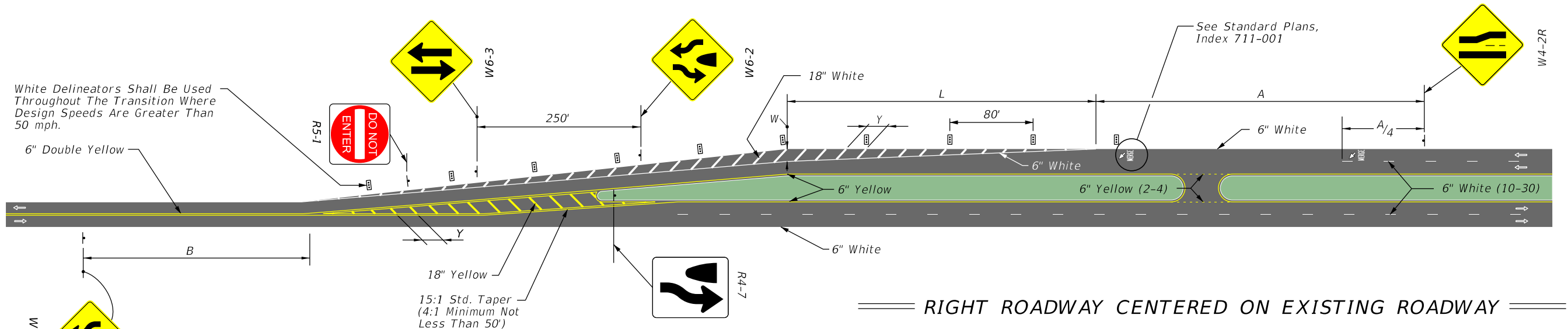
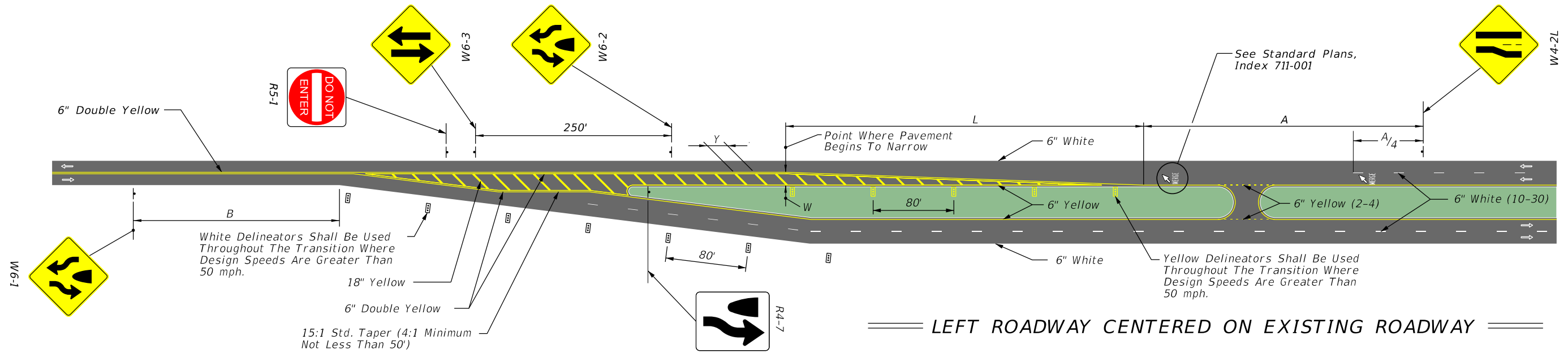

SCHEMES FOR TRANSITION - 2 LANE / 4 LANE ROADWAY

SPEED MPH	"A" (FT.)	"B" * (FT.)
60	---	640
55	950	595
50	850	550
45	750	500
40	650	455
30	450	365

* 50' Minimum

POSTED SPEED MPH	"Y" (FT.)
50 OR MORE	40
45	30
40	20
35	20
30 OR LESS	10

DESIGN SPEED 'S' (MPH)	Length 'L' (FT.)
40 or Less	$L = WS^2/60$
45 or Greater	$L = WS$



→ Direction of Travel

NOTE: W9-1 & W9-2 are supplemental to the W4-2 sign and may be deleted if space is not available. The W9-1 should be used if only one supplemental sign is installed.

NOT TO SCALE

EXHIBIT 230-14
01/01/2024

TYPICAL PAVEMENT MARKINGS FOR CHANNELIZED TURN LANES

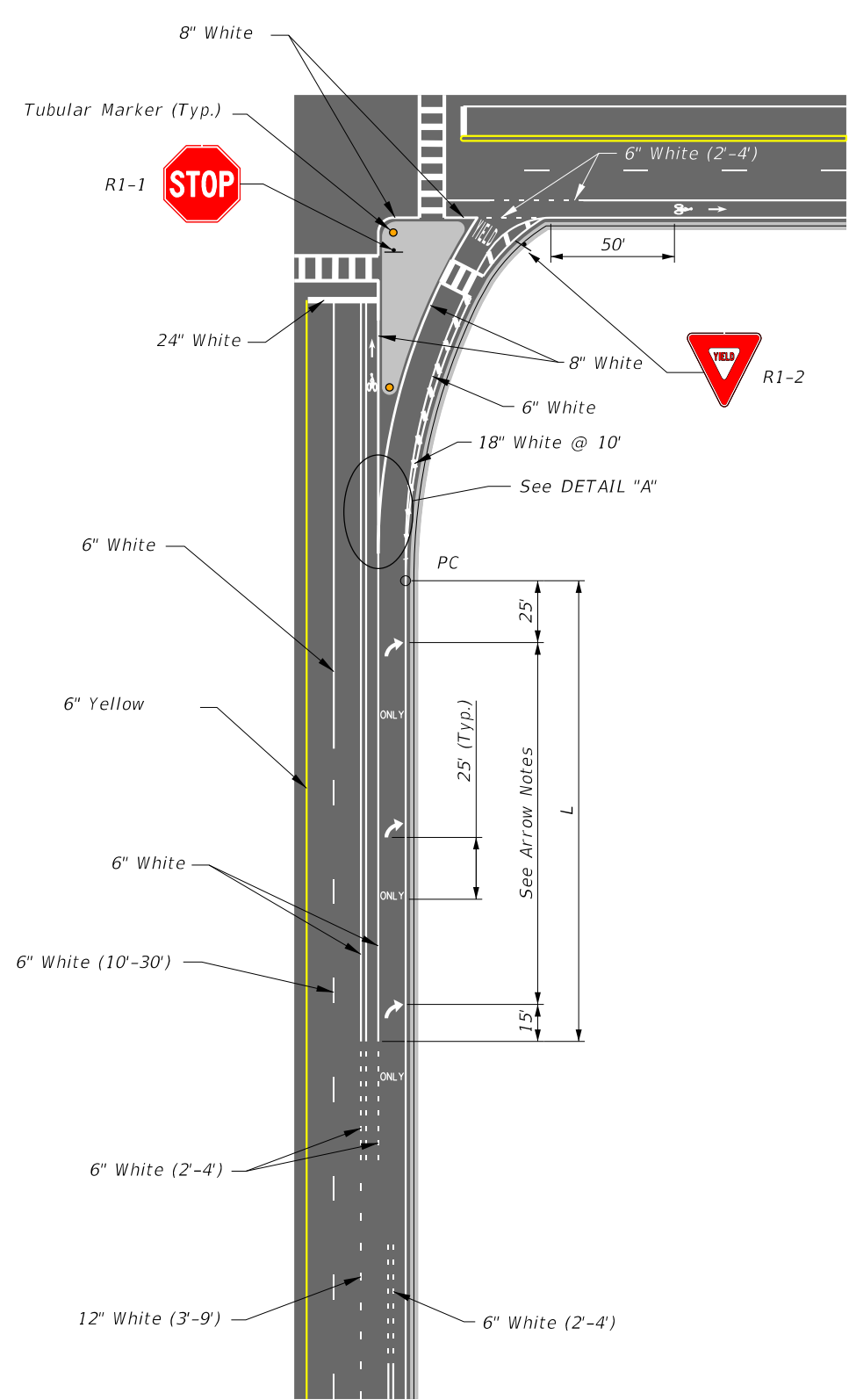

RIGHT TURN LANE DROP AND ISLAND DETAILS
LEFT TURN LANE DROP IS MIRROR IMAGE
(Showing yielding right turn lane)

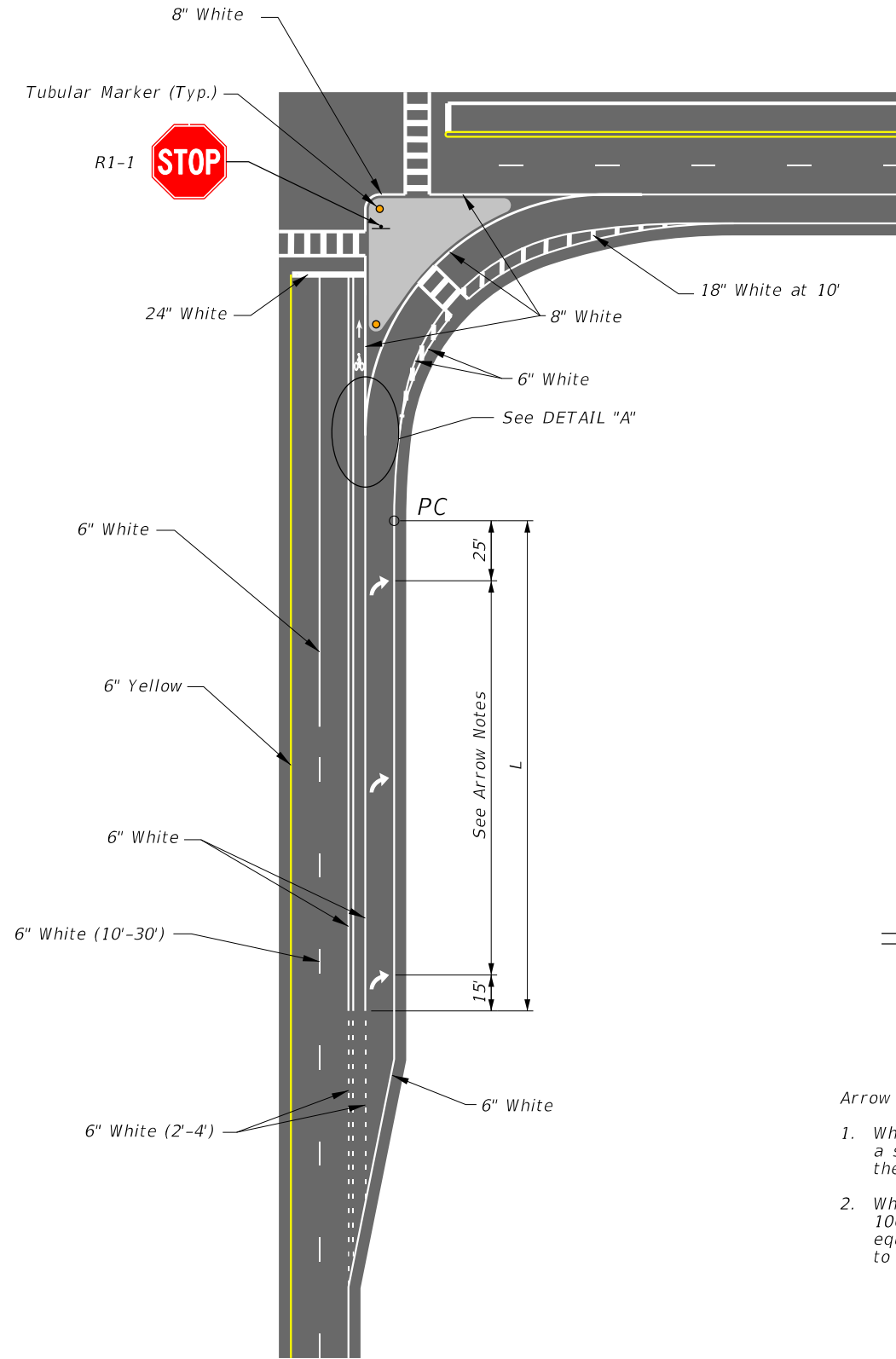

RIGHT TURN LANE AND ISLAND DETAILS
(Showing free flow right turn lane)

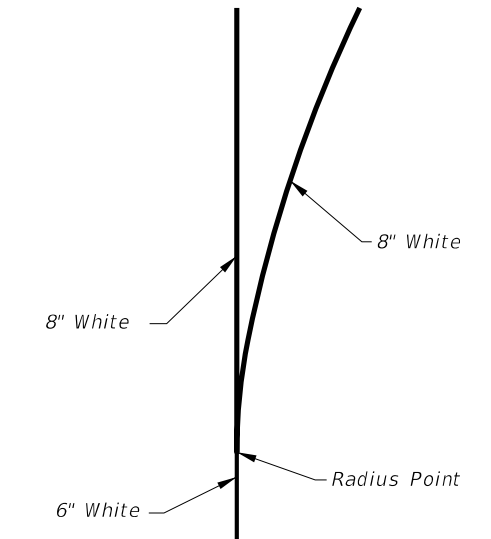

DETAIL "A"

Arrow Notes

1. When L is less than 100': provide a single arrow located 25' from the PC.
2. When L is greater than or equal to 100': provide the smallest number of equally spaced arrows subject to a maximum spacing of 100'.

NOT TO SCALE

EXHIBIT 230-15
01/01/2024

ALL ELECTRONIC TOLLING CONNECTING ROADWAYS TYPICAL SIGNING LAYOUT

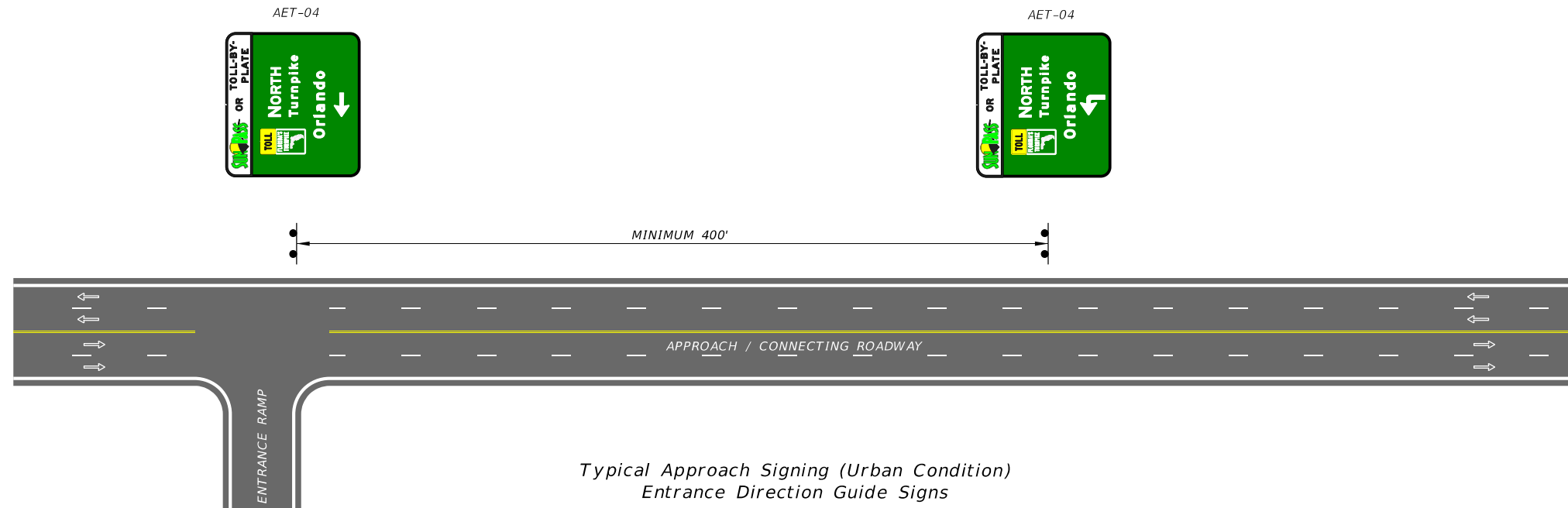

Typical Approach Signing (Urban Condition)
Entrance Direction Guide Signs

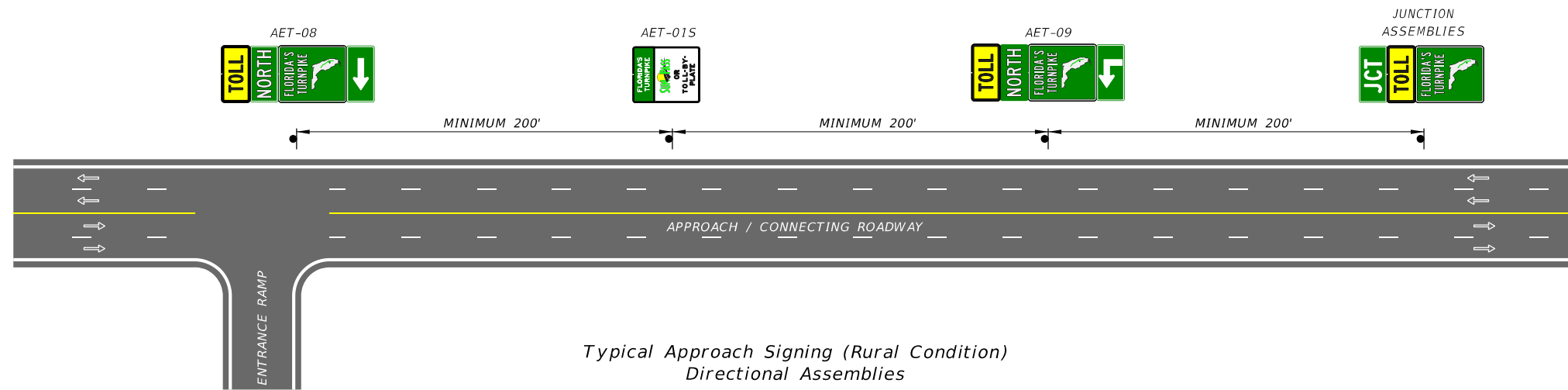

Typical Approach Signing (Rural Condition)
Directional Assemblies

NOTES:

1. MINIMUM SPACING DISTANCES FOR SIGNS TO CONFORM TO THE TRAFFIC ENGINEERING MANUAL, AND F.A.C. RULE CHAPTER 14-51, TABLE 1.
2. LEGENDS/MESSAGES SHOWN ON SIGNS AET-04 ARE PROVIDED AS AN EXAMPLE ONLY. ACTUAL DESIGNS SHALL BE SHOWN IN THE PLANS.

NOT TO SCALE

ALL ELECTRONIC TOLLING ENTRANCE / EXIT RAMP TYPICAL SIGNING LAYOUT

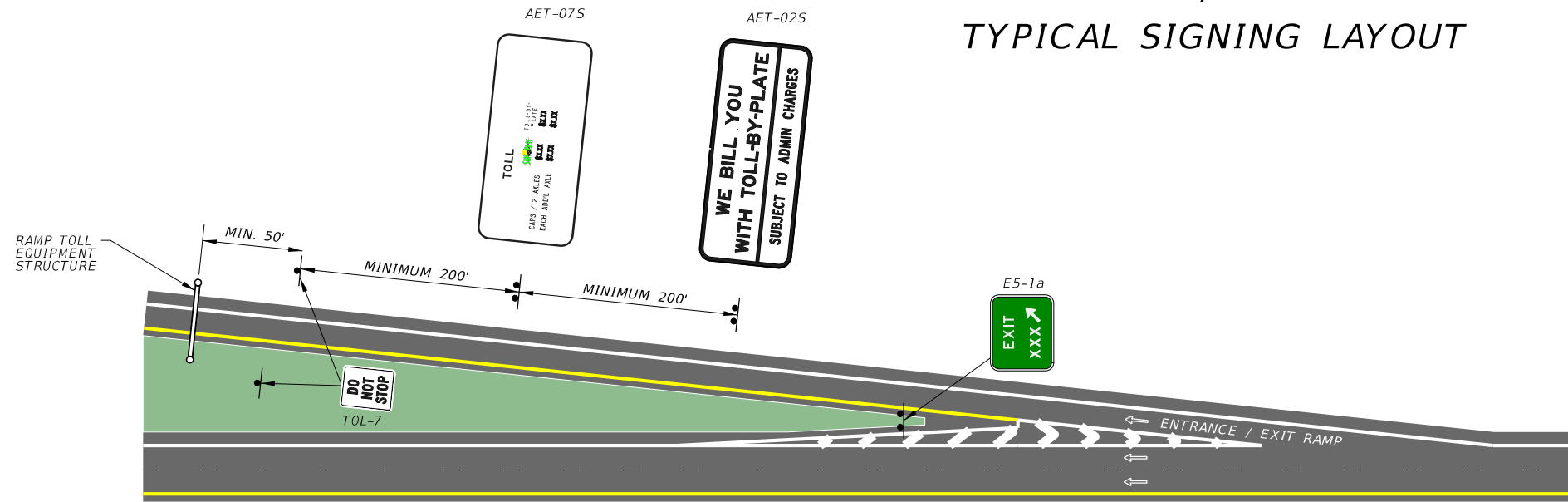

Typical Entrance / Exit Ramp Signing
With Toll Equipment Structure

NOTES:

1. MINIMUM SPACING DISTANCES FOR SIGNS SHALL CONFORM TO THE TRAFFIC ENGINEERING MANUAL AND F.A.C. RULE CHAPTER 14-51, TABLE 1.
2. TWO TOL-7 (DO NOT STOP) SIGNS ARE REQUIRED PER DIRECTION OF TRAVEL.
3. PLACEMENT OF AET-07S AND AET-02S SIGNS MAY BE BEFORE OR AFTER THE GANTRY, IF FIELD CONSTRAINTS WARRANT IT.
4. STRIPING FOR MULTI-LANE RAMP TOLL SITE MUST CONFORM TO STRIPING SHOWN IN EXHIBIT 230-16c.

NOT TO SCALE

EXHIBIT 230-16b
01/01/2024

ALL ELECTRONIC TOLLING MAINLINE TOLL TYPICAL SIGNING LAYOUT

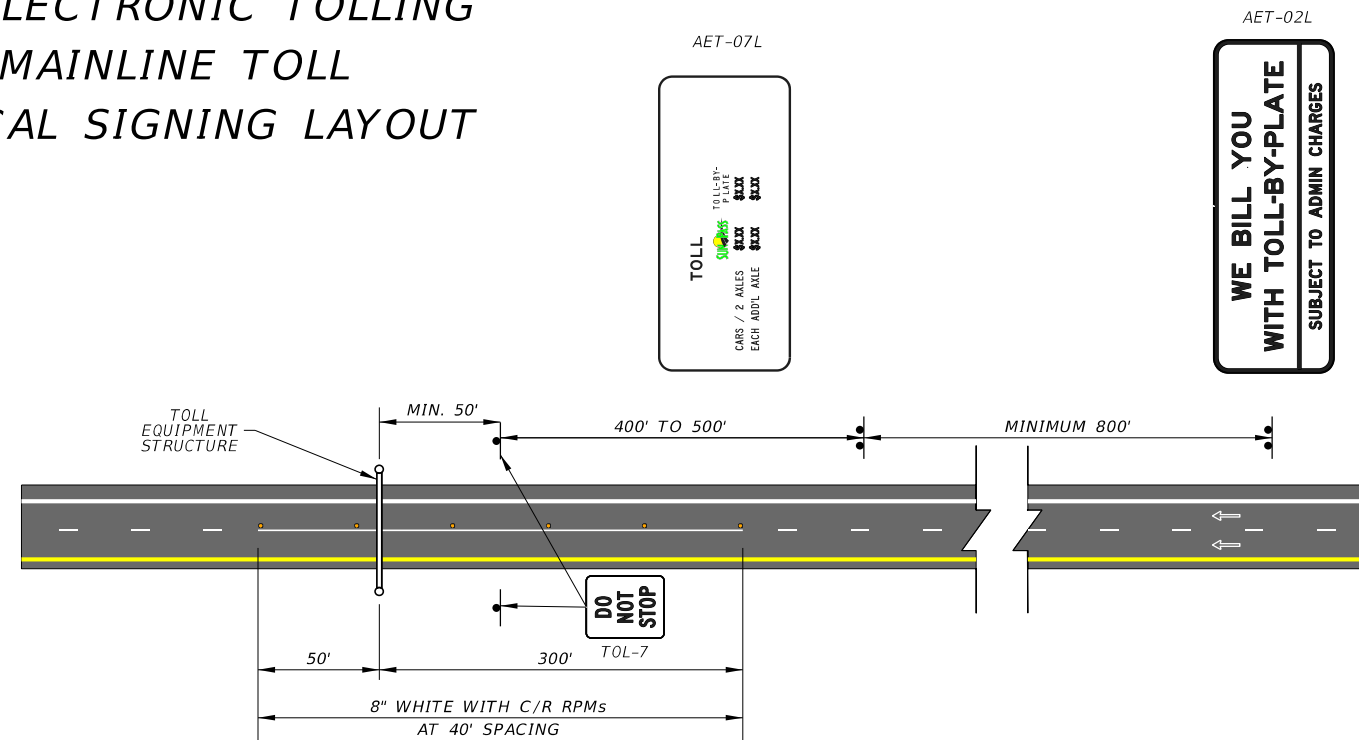

NOTES:

1. MINIMUM SPACING DISTANCES FOR SIGNS SHALL CONFORM TO THE TRAFFIC ENGINEERING MANUAL AND F.A.C. RULE CHAPTER 14-51, TABLE 1.
2. TWO TOL-7 (DO NOT STOP) SIGNS ARE REQUIRED PER DIRECTION OF TRAVEL.
3. PLACEMENT OF AET-07L AND AET-02L SIGNS MAY BE BEFORE OR AFTER THE GANTRY, IF FIELD CONSTRAINTS WARRANT IT.

Mainline Toll Equipment Structure

NOT TO SCALE

EXHIBIT 230-16c
01/01/2024

*BICYCLE AND PEDESTRIAN FACILITIES
THROUGH INTERCHANGE
TYPICAL SIGNING AND MARKING LAYOUT*

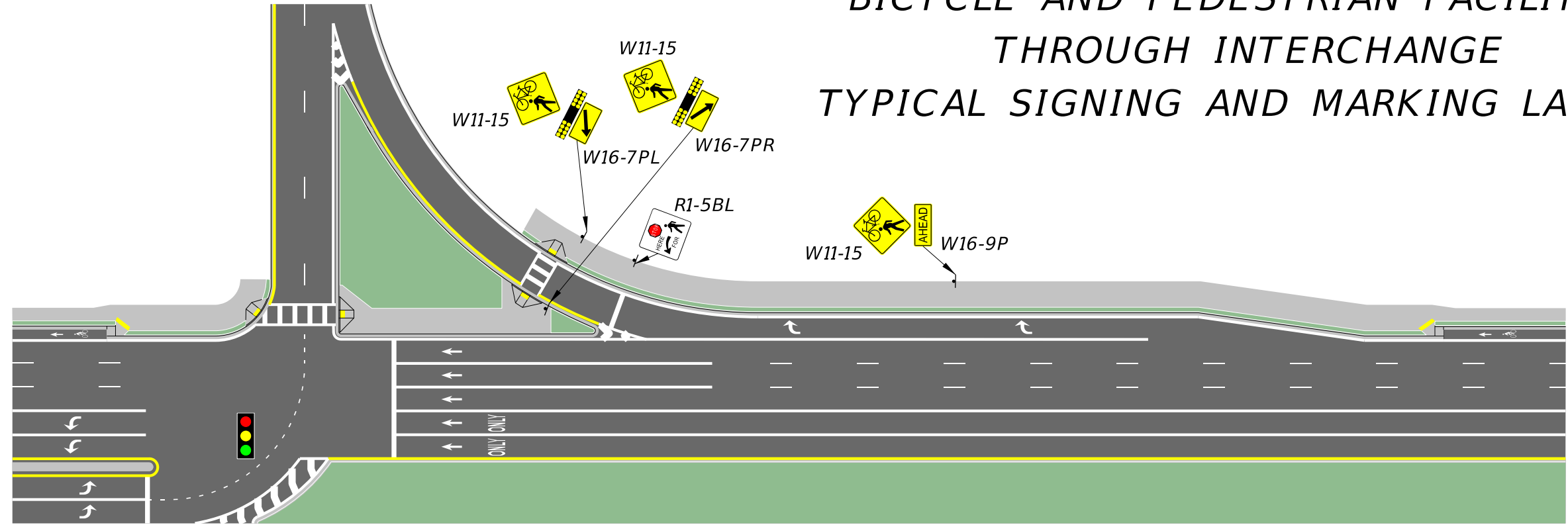

NOT TO SCALE

EXHIBIT 230-17a
01/01/2024

*BICYCLE AND PEDESTRIAN FACILITIES
AT LOW-ANGLE INTERCHANGE RAMP
TYPICAL SIGNING AND MARKING LAYOUT*

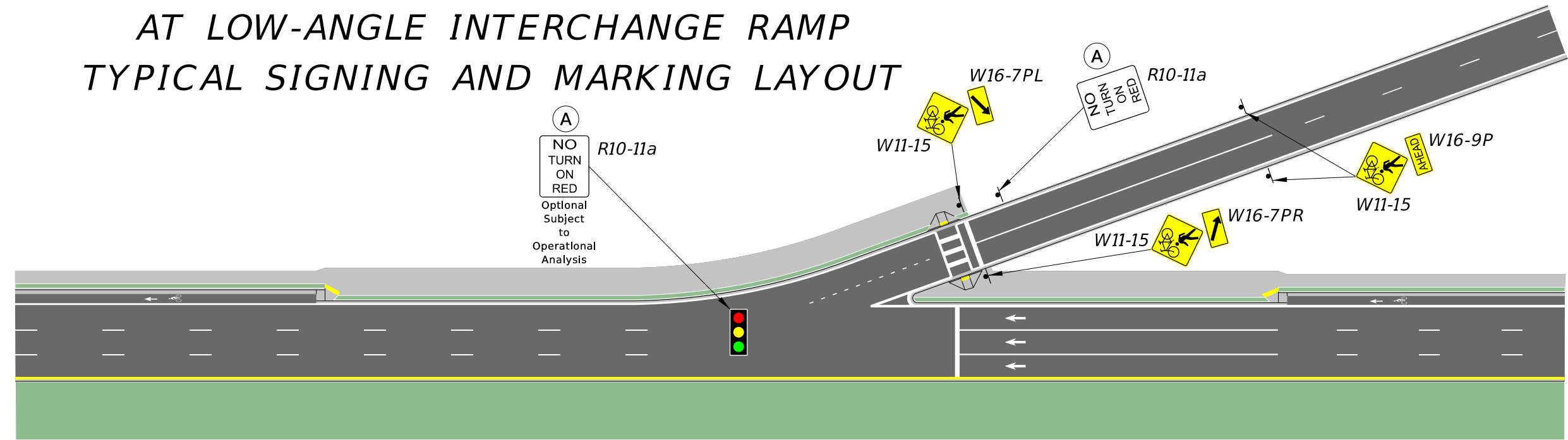

NOT TO SCALE

EXHIBIT 230-17b
01/01/2024

231 Lighting

231.1 General

Roadway lighting benefits the traveling public by improving nighttime visibility of roadway geometry, vehicles, pedestrians, and obstructions. The design and layout of lighting should complement the basic highway design and must comply with the requirements of **FDM 215** for roadside safety.

Locate light poles between the right of way line and the outside edge of curbs or shoulders as applicable. Light poles are permitted in the median only when lighting from the outside cannot meet the criteria shown in **Table 231.2.1** without being supplemented by median lighting. Additionally, light poles placed in medians must be mounted on or behind barriers per the requirements in **FDM 215.2.9** and [Standard Plans, Index 715-002](#).

This chapter provides the process and criteria to be used in the development of lighting designs on the SHS. The design and installation of these lighting systems must comply with the National Electrical Code (NEC) unless otherwise specified by the Department.

231.1.1 Design Luminaires

Use only luminaires listed on the Department's **Approved Products List (APL)** for the corresponding usage cases. Obtain photometric information from manufacturers to use in the lighting design and resulting design luminaire selection. Include the design luminaire information with the Lighting Plans per the requirements of **FDM 943**.

Where practical, use consistent luminaire models with the same input/output properties per new lighting location (e.g., per corridor, intersection, interchange, sidewalk, etc.).

231.1.2 Structural Supports

AASHTO's LRFD Specifications for Structural Supports for Highway Signs, Luminaires, and Traffic Signals and the [FDOT Modifications to LRFDLTS-1](#) provide structural design criteria.

Refer to **FDM 261** for information regarding structural support requirements. Refer to **FDM 943** for information regarding Lighting Plans requirements.

231.1.3 Attachments to Barriers

Refer to **FDM 215** for information regarding proposed attachments to bridge traffic railings, concrete median barrier walls, concrete shoulder barrier walls or the evaluation of existing attachments.

231.1.4 Voltage Drop Criteria

When determining conductor sizes for lighting electrical circuits, the maximum allowable voltage drop, measured from the power company's transformer through the last device on any one circuit, must not exceed 5%.

The NEC's additional voltage drop criteria for the individual evaluation of feeders and circuit branches may be considered at the District's discretion.

231.1.5 Grounding

The grounding requirements for lighting systems, as shown in the [Standard Plans](#) are as follows:

- (1) Install 20' of ground rod at each conventional height light pole and at each pull box.
- (2) Install 40' of ground rod at each electrical service point.
- (3) At each high mast pole, install an array of 6 ground rods 20' in length, as shown in the [Standard Plans, Index 715-010](#).

The above lengths of ground rod will be installed at each pole, pull box and service point, and the cost will be incidental to the unit or assembly being installed.

231.2 Design Criteria

Use the illuminance method for nighttime light level design. The design values for light levels given by the **AASHTO Roadway Lighting Design Guide** are maintained values. These maintained values have been adjusted for Department assigned light loss and maintenance factors, and they are provided in **Table 231.2.1** as required light level criteria.

The **AASHTO Roadway Lighting Design Guide** permits either the illuminance technique or the luminance technique to be used in the design of highway lighting. The luminance technique requires a complex design process and knowledge of the reflective

characteristics of the pavement surface used. These reflective characteristics change as the pavement ages and with variations in weather conditions. It is for these reasons that the luminance technique is not used for nighttime light level design. As a result, direct illumination methods must be used in design software for general roadway lighting. The radiosity or reflectance of surfaces is not required in the analysis.

For the differing daytime bridge underdeck analysis requirements, see **FDM 231.3.6.2**.

Conventional lighting generally includes the basic fixtures for roadside placement that are used for the majority of roadway lighting cases, excluding the specialized fixtures used for high mast, underdeck, sidewalk, shared used path, and sign lighting.

Luminaire tilt is defined in [Standard Plans, Index 715-001](#). Luminaires may be tilted up to the following:

- (1) 5 degrees for limited access facilities, excluding undivided segments and ramps
- (2) 15 degrees for weigh stations, agricultural stations, and rest areas

Light poles installed within the clear zone must be breakaway or shielded by an approved barrier unless they are bridge or barrier mounted. Where practical, avoid placing unshielded light poles at locations where distracted or errant drivers may have a greater tendency for roadway departures (e.g., downstream of lane drops, shoulder narrowing, or gore areas). See **FDM 215** for additional information on roadside safety design.

Pole setback is the horizontal distance from the edge of the travel lane to the pole. Mounting Height is defined below.

Lighting Values:

Meet the requirements of **Table 231.2.1** as directed throughout this chapter. The listed illumination levels must be met or exceeded. Beyond this requirement, use illumination levels that are as low as practical.

For corridor lighting, the average Horizontal Foot Candle (H.F.C.) requirements of **Table 231.2.1** must not be exceeded by more than 10%. Where corridor lighting areas adjoin different areas with higher illumination requirements, the corridor lighting may exceed its illumination requirement only in the portion where light spill from the adjacent brighter area is unavoidable. These short segments may be excluded from the lighting value checks only as necessary to transition between differing requirements.

Table 231.2.1 Lighting Values

Roadway Classification Or Location Type	Illumination Level Average Foot Candle		Illumination Uniformity Ratios		Veiling Luminance Ratio
	Horizontal (H.F.C.)	Vertical (V.F.C.)	Avg./Min.	Max./Min.	$L_{V(MAX)}/L_{AVG}$
Corridor Lighting					
Limited Access Facilities	1.5	N/A	4:1 or Less	10:1 or Less	0.3:1 or Less
Major Arterials	1.5				
Arterial Lighting Retrofit	1.0-1.5				
Other Roadways	1.0				
High Mast Lighting					
All Roadway Classifications	0.8-1.0	N/A	3:1 or Less	10:1 or Less	N/A
Signalized Intersection and Roundabout Lighting					
New or Reconstruction	3.0 Std. 1.5 Min.	1.5 Std. 1.2 Min.	4:1 or Less	10:1 or Less	N/A
Intersection Lighting Retrofit	1.5 Std. 1.0 Min.	1.5 Std. 1.0 Min.			
Isolated Lighting	1.0-1.5	1.0-1.5			
Unsignalized Intersection Lighting					
All Project Types	1.0-1.5	1.0-1.5	4:1 or Less	10:1 or Less	N/A
Midblock Crosswalk Lighting					
Low Ambient Luminance	N/A	1.5	N/A	N/A	N/A
Medium & High Ambient Luminance		2.3			
Sidewalks and Shared Use Paths					
Facilities Separated from the Roadway	2.5	N/A	4:1 or Less	10:1 or Less	N/A
Sign Lighting					
Low Ambient Luminance	5-10	N/A	N/A	6:1	N/A
Medium Ambient Luminance	10-20				
High Ambient Luminance	20-40				

Table 231.2.1 Lighting Values cont.

Roadway Classification Or Location Type	Illumination Level Average Foot Candle		Illumination Uniformity Ratios		Veiling Luminance Ratio
	Horizontal (H.F.C.)	Vertical (V.F.C.)	Avg./Min.	Max./Min.	$L_{V(MAX)}/L_{AVG}$
Rest Area Lighting					
All Roadways and Parking Areas	1.5	N/A	4:1 or Less	10:1 or Less	N/A
Wildlife-Sensitive Conventional Lighting					
Limited Access Facilities	0.8-1.0	N/A	4:1 or Less	10:1 or Less	0.3:1 or Less
Arterials and Collectors	1.0-1.5	N/A			
Signalized Intersection – New	1.5-3.0	1.0	4:1 or Less	10:1 or Less	N/A
Signalized Intersection – Retrofit or Isolated	1.0-1.5	1.0.			
Midblock Crosswalk	N/A	1.0	N/A	N/A	N/A
Notes:					
(1) Illumination Uniformity Ratios do not apply to V.F.C.					
(2) Standard (Std.) values must be met unless doing so raises the accompanying H.F.C. or V.F.C. result in excess of double its required illumination level. For such cases, the Minimum (Min.) value may apply.					
(3) Ambient luminance classifications are defined in the AASHTO Roadway Lighting Design Guide .					

Limited Access Facilities:

If the length of the mainline roadway between any two lighted areas is 0.5 mile or less, then that segment of the mainline must be lighted. These lighted areas may include roadway mainline segments, interchanges, service plazas, and toll facilities.

Interchanges:

For independently lighted interchanges with no connection to adjacent mainline or crossroad lighting, the lighting values for high mast lighting may be used throughout all areas, including bridge underdecks. See **FDM 231.3.1** for the included analysis zones and limits.

Where the mainline or crossroad corridors have a connecting lighting system adjacent to the interchange limits, continue the connecting corridor's lighting values through the interchange for consistency. Conventional and high mast style lights may work in conjunction to achieve these illumination levels. On ramps, either high mast lighting values or the corridor's lighting values may be used at the District's discretion, so long as consistent lighting value requirements are used throughout all ramps in the interchange.

For high mast lighting, the effects of elevated ramps and bridge decks must be accounted for in the design analysis, particularly when light is blocked by other raised objects (e.g., adjacent bridges, railings, signs, or miscellaneous structures). Meet the maximum illumination and uniformity ratio requirements to avoid bright spots.

Mounting Height:

Mounting height (M.H.) for conventional lighting is the vertical distance from the finished grade at the pole's base to the luminaire's light source, regardless of lateral placement of the pole.

Specify mounting heights for conventional lighting as shown in [Standard Plans, Index 715-002](#). In the photometric analysis, adjust the luminaire height to account for the difference between the finish grade elevation at the pole's base and the approximate average roadway surface elevation. In order to assume a simplified level roadway, a surface elevation tolerance of $\pm 18''$ is permitted in the analysis.

The design luminaire must not exceed the maximum candela for the associated minimum mounting height per **Table 231.2.2**.

**Table 231.2.2 Minimum Mounting Heights
 Based on Maximum Candela**

Minimum Mounting Height (ft.)	Maximum Candela of Luminaire		
	Long Distribution	Medium Distribution	Short Distribution
20 or Less	5,000	10,000	15,000
25	10,000	15,000	20,000
30	15,000	20,000	25,000
35	20,000	25,000	30,000
40	25,000	30,000	35,000
45	30,000	35,000	40,000
50	35,000	40,000	45,000

Notes:

- (1) "Distribution" refers to the longitudinal distribution of the luminaire output per the Illuminating Engineering Society of North America (IESNA).
- (2) "Maximum Candela" is generally provided with the manufacturer's luminaire specific "IES" file for AGI32® or similar design software.

Color Temperature:

Apply the Correlated Color Temperature (CCT) requirements of **Table 231.2.3** to lighting projects that are warranted for reasons other than CCT. The requirements of **Table 231.2.3** alone do not warrant replacement of existing luminaire installations.

Where new luminaires are added within the limits of existing lighting systems for maintenance, retrofits, or other purposes, the requirements of **Table 231.2.3** do not apply. Instead, match the CCT of the existing system to maintain color consistency. For new luminaires added within existing high pressure sodium systems, use 3000K or lower CCT.

For roadside facility lighting, use the same CCT as the nearest roadway lighting for consistency. Such facilities include, but are not limited to, sidewalks, shared use paths, toll sites, rest areas, and weigh stations. If roadway lighting is not visible from the roadside facility, then use 3000K or lower CCT for the roadside facility.

Where permitted per **Table 231.2.3**, consider the use of the warmer 2700K CCT for aesthetic locations including residential areas, natural areas, historic areas, downtown

districts, parks, and campuses. Additionally, the requirements of **FDM 231.2.1** for Environmental Lighting supersede the requirements of **Table 231.2.3**.

Daytime underdeck lighting that is installed per the requirements of **FDM 231.3.6.2** must be 4000K CCT. For these locations, either 4000K CCT or the corridor values in **Table 231.2.3** may apply for the nighttime underdeck lighting operation phase at the District’s discretion. If no daytime underdeck lighting is required, then the corridor values in **Table 231.2.3** apply to nighttime underdeck lighting.

Table 231.2.3 Correlated Color Temperature (CCT)

Design Speed	Context Classification	CCT
Arterials and Collectors		
≤ 35 mph	All	2700K ¹ or 3000K
≤ 50mph	All	3000K
≥ 55mph	C1 & C2	3000K
≥ 55mph	C3 ²	4000K
Limited Access Facilities		
All	All	3000K
Notes:		
(1) Consider use of 2700K per the description above		
(2) Higher number context classifications may apply		

231.2.1 Environmental Lighting

Wildlife areas of concern are identified by the District’s environmental managers or permit coordinators on a project-specific basis. For lighting within these areas, follow the requirements for Wildlife-Sensitive Conventional Lighting listed in **Table 231.2.1** along with **FDM 231.3**. Where practical, use only Wildlife-Sensitive Conventional Luminaires listed on the [APL](#), and orient lighting away from the wildlife-sensitive areas per **FDM 231.2.2**.

For consideration of sea turtle nesting beaches, the Office of Environmental Management (OEM) provides additional resources on the [Protected Species and Habitat](#) website or through the **Florida Geographic Data Library (FGDL)** metadata explorer. The *Data Tools for Turtle Lighting* provide GIS shape files and Google Earth™ map layers showing

the areas of concern where lighting may be visible from light-sensitive sea turtle nesting beaches. For projects within these areas, coordinate with the District's environmental managers or permit coordinators to evaluate proposed lighting impacts to sea turtles on nesting beaches. Where the lighting is visible from nesting beaches, the following requirements apply.

For Wildlife-Sensitive Buffer Areas:

- (1) Orient lighting away from nesting beaches to avoid direct lighting and consider light shielding, where practical.
- (2) Follow criteria for Wildlife-Sensitive Conventional Lighting per **Table 231.2.1**. Use only Wildlife-Sensitive Conventional Luminaires as listed on the [APL](#).
- (3) For night-time work zone lighting within the wildlife-sensitive buffer area that will occur during sea turtle nesting season, meet the requirements of **FDOT Standard Specifications Workbook 8-4.1**.

For Dark-Sky Buffer Areas:

- (1) Follow International Dark-Sky Association recommendations where practical, including the topics of light orientation and light shielding.
- (2) Use Luminaires with a 3000K CCT or lower. Use traditional luminaires as listed on the [APL](#); specify CCT in Lighting Plans.

231.2.2 Light Spill

Design lighting systems to minimize light projection beyond the right of way line. Illumination levels outside of the right of way should be as low as practical, with attention given to reducing impacts to the surrounding areas.

If wildlife areas or residential properties are within 100 feet of a luminaire, select a luminaire model that has original manufacturer's shielding options available for a potential future installation. Where residential or commercial structures are directly adjacent to luminaires, determine whether immediate shielding would prevent light from entering nearby windows and living spaces. Call for such shielding in the plans where practical.

Provide a general overview of the light spill status to coordinate mitigation decisions with the District Design Office. Provide a brief summary of these coordination efforts, including the participants and results, in the LDAR per **FDM 231.7**. See **FDM 231.2.1** for additional wildlife area requirements.

231.3 Design Methodology

A lighting design analysis is required where a new system of luminaires is being installed or where luminaire locations are being changed within an existing system. This requirement includes lighting retrofits, the general adding or moving of light poles, and the replacement of more than three consecutive luminaires on existing light pole runs for maintenance or other purposes.

Roadway Lighting:

Provide a photometric software analysis for roadway areas being illuminated throughout the project. Include a printout of the analysis in the LDAR per **FDM 231.7**. Such printouts must be in electronic format (e.g. PDF) using 11" x 17" sheets with photometric data points that are clearly legible. The analysis results must indicate foot-candle values displayed on plan view with 1/100th accuracy (0.XX foot-candles). Where solid objects (e.g. bridges) block luminaire light contributions, a 3D graphic representation must be included that accounts for such objects. Analysis using only typical sections is not permitted.

Use the polygon method for all horizontal area photometric calculations. Establish illumination data points (i.e. calculation points) within the polygon at the following intervals:

- (1) Roadway Segments – General: 15 feet longitudinally and 5 feet transversely along the roadway
- (2) Roadway Segments – Beneath Bridge Underdecks: 5 feet longitudinally and 5 feet transversely along the roadway, including pedestrian ways.
- (3) Signalized Intersections: 5 feet longitudinally and 5 feet transversely along the roadway.

Sign Lighting:

Provide a photometric software analysis for signs being illuminated throughout the project. The analysis must include illumination data points at a maximum 1-foot by 1-foot spacing, covering the entire sign area. Include a printout of the analysis in the LDAR per **FDM 231.7**. Such printouts must be in electronic format (e.g. PDF), and they must have photometric data points that are clearly legible. The analysis results must indicate foot-candle values displayed with 1/100th accuracy (0.XX foot-candles).

Refer to [RCI Features & Characteristics Handbook](#), Urban Classification – Feature 124 for additional information concerning urban designations Urban 1 through Urban 5.

231.3.1 Analysis Zones

Establish independent analysis zones for each signalized intersection segment and for each roadway segment between signalized intersections. Roadway lighting for roadway segments, signalized intersection segments, and pedestrian lighting are to meet the criteria shown in **Table 231.2.1**.

Analyze signalized intersection segments using one analysis zone bounded by the back of sidewalks and the signalized intersection stop bars on each approach. See **FDM 231.3.2** for additional intersection information, including vertical illumination analysis information.

The termini for each roadway segment will be either the lighting project limits, or the signalized intersection stop bars. Continue lighting through bridge underpasses using underdeck lighting per **FDM 231.3.6**. The boundary for each underdeck segment will be the same as the roadway corridor passing through it. The boundary of each roadway segment is described as follows:

Flush Shoulder Roadways:

- (1) Analyze divided roadway segments with grassed medians or bridge supports using two analysis zones (i.e., one for each direction of travel). Each zone will be bounded by the outside and median shoulder breaks (includes full-width shoulders).
- (2) Analyze multi-lane undivided roadway segments using two analysis zones (i.e., one for each direction of travel). Each zone will be bounded by the outside shoulder break and the centerline of the roadway (includes full-width shoulders).
- (3) Analyze two and three lane roadway segments as one analysis zone bounded by the outside shoulder breaks (includes full-width shoulders).

Curbed Roadways:

- (1) Analyze divided roadway segments with grassed medians or bridge supports using two analysis zones (i.e., one for each direction of travel). Each zone will be bounded by the back of sidewalk and the back of the median curb.
- (2) Analyze multi-lane undivided roadway segments, including roadways with two-way left turn lane, using two analysis zones (i.e., one for each direction of travel). Each zone will be bounded by the back of sidewalk and the center of the roadway.

Limited Access Facilities and Interchanges:

Establish independent analysis zones for the mainline roadway segments, ramp segments, underdeck segments, and crossroad segments at interchanges.

The termini for each mainline roadway segment will be the lighting project limits. Logical termini for the other segments will be determined by the designer. The boundary for each underdeck segment will be the same as the ramp or roadway corridor passing through it. The boundary of each segment is described as follows:

- (1) Analyze divided mainline roadway with grassed median or bridge supports using two analysis zones, one for each direction of travel (i.e., one zone for each direction of travel). Each zone will be bounded by the outside and median shoulder breaks (includes full-width shoulders).
- (2) Analyze barrier separated mainline roadway as one analysis zone bounded by the outside shoulder breaks of each direction of travel (includes full-width shoulders).
- (3) Analyze each ramp segment as one analysis zone bounded by the shoulder breaks (includes full-width shoulders). Light ramps where the connecting mainline or interchange is lighted.
- (4) Analyze crossroad segments based on the criteria given above for flush shoulder or curbed roadways. Light crossroads when the connecting interchanges are lighted, following the limits below.
- (5) Analyze interchanges, including the mainline, ramps, crossroads, and underdeck areas per above. For interchanges where there is no connecting crossroad lighting, extend the interchange's crossroad lighting to the limits of the interchange ramps. For interchanges where there is no connecting mainline lighting, place the interchange's mainline lighting within the limits of 200 feet upstream and 200 feet downstream of the exit and entrance ramps, respectively.

Rest Areas:

- (1) Analyze each ramp as defined for limited access facilities above. Light all ramps connecting to rest areas.
- (2) Analyze the mainline roadway as defined for limited access facilities above. Mainline lighting is required adjacent to rest areas. If there is no continuous mainline lighting adjacent to the rest area, place mainline lighting within the limits of 200 feet upstream and 200 feet downstream of the exit and entrance ramps, respectively.
- (3) Analyze all paved areas and parking lots around the rest area facilities. Light these areas within limits defined at the District's discretion.

231.3.2 Intersections

231.3.2.1 Signalized Intersections

For new or reconstructed signalized intersections within context classifications C3 through C6, provide lighting meeting the requirements of **Table 231.2.1**. For all other signalized intersection contexts, lighting may be provided at the District's discretion. Vertical illuminance is the primary design value used to measure driver visibility of pedestrians. Research has determined that visibility of pedestrians in crosswalks at intersections is a function of the following:

- (1) Background illuminance
- (2) Luminaire location in relation to the approach vehicle
- (3) Luminaire mounting height
- (4) Distance from the luminaire to the crosswalk
- (5) Photometrics of the luminaire

The vertical illuminance calculation method to be used at intersections will be the variable light meter aimed toward the driver's location. This calculation will provide the vertical illumination level of a pedestrian which the driver sees approaching the crosswalk. This type of vertical illumination calculation is outlined in the **IESNA Design Guide for Roundabout Lighting (DG-19-08)**. When performing this calculation, the driver's location from the crosswalk must be established. Use the stopping sight distance for the nearside approach based on the posted speed of the near approach roadway. Use the stopping sight distance for the turning movement approaches based on the operating speed for each specific turning radius.

The vertical illuminance must be calculated for three movements for each intersection approach. The first is the thru movement and the near side crosswalk; the second is the right turn movement and crosswalk on the adjacent side street; and the third is the left turn movement and the crosswalk on the side street. **Figures 231.3.1** through **231.3.3** indicate each of these three movements and the corresponding crosswalk area that must be analyzed. The vertical illuminance data points are to be on a line centered in the crosswalk with a horizontal point spacing of 1.65 feet at a height of 5 feet above the pavement. The linear data points are oriented toward the approaching driver, which is different from the data points for sidewalks, where the data points are oriented parallel to the main pedestrian flow.

See **FDM 231.3.2.1.1** for projects where pedestrian lighting improvements are desired, but the existing intersection infrastructure will remain and be supplemented to achieve the desired improvements.

Figure 231.3.1 Vertical Illuminance Calculation for Near Side Movement

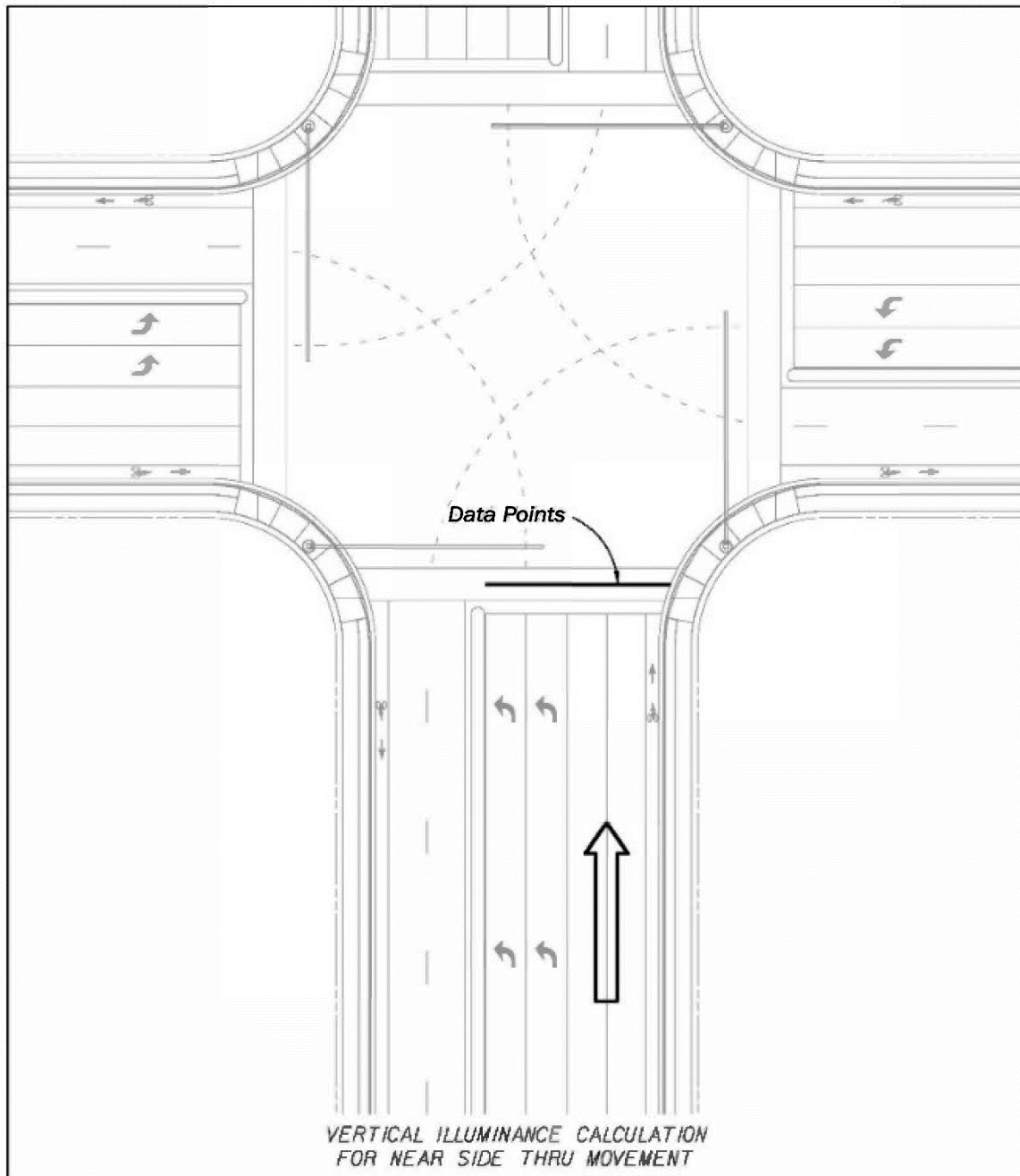

Figure 231.3.2 Vertical Illuminance Calculation for Right Turn Approach

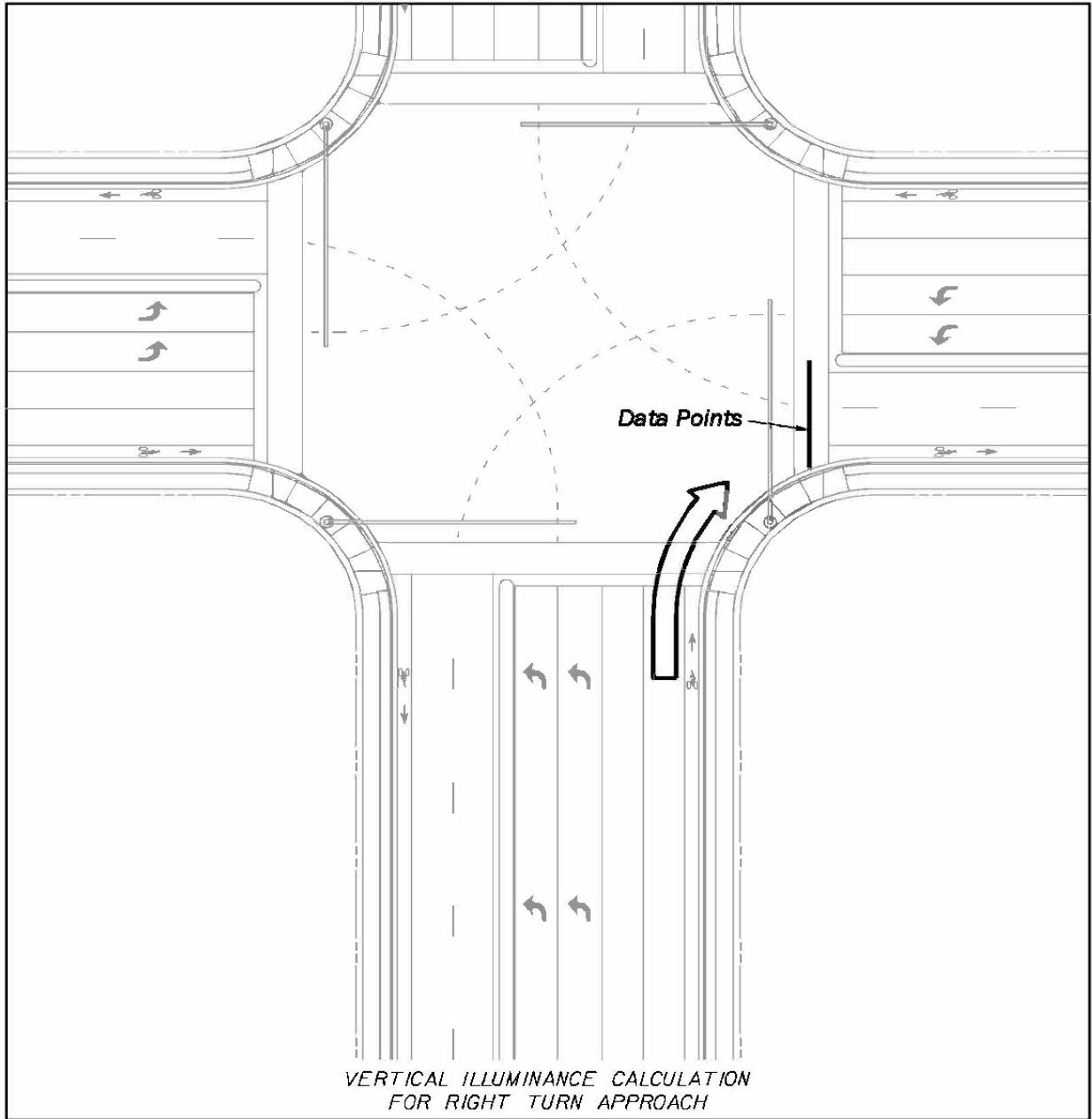

Figure 231.3.3 Vertical Illuminance Calculation for Left Turn Approach

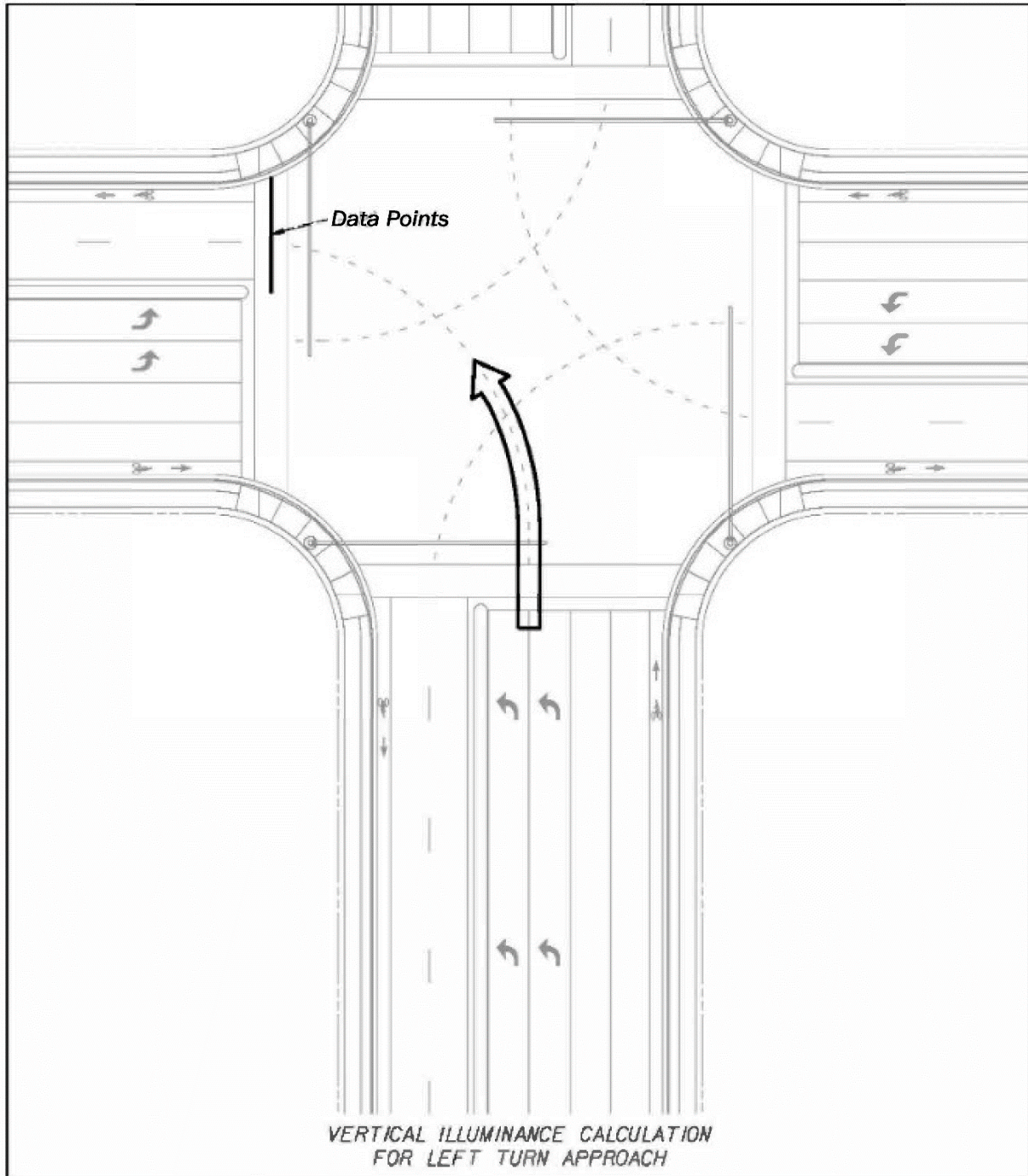
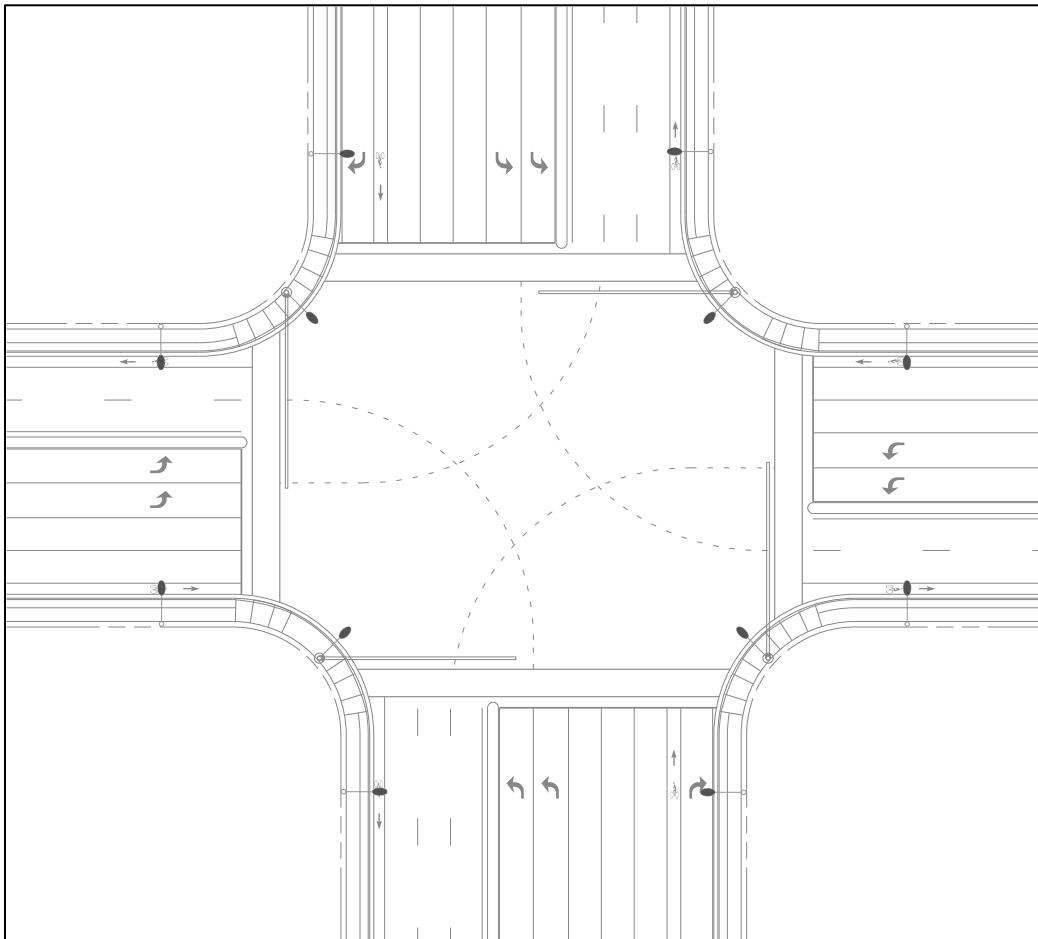

Figure 231.3.4 shows the typical lighting layout for a large intersection. The crosswalk and luminaire locations must be coordinated to optimize the vertical illumination level.

Figure 231.3.4 Typical Lighting Layout for Large Intersection



231.3.2.1.1 Intersection Lighting Retrofit

For existing signalized intersections where a full signal upgrade is not occurring, the existing infrastructure may restrict the placement of additional lighting structures necessary to meet the New and Reconstructed criteria of **Table 231.2.1**. With these challenges considered, **Table 231.2.1** provides reduced illumination requirements for Intersection Lighting Retrofit designs. These retrofits provide safety benefits of improved lighting without the full reconstruction of light and signal structures.

Lighting retrofits should be considered for use at existing signalized intersections that have a history of nighttime pedestrian crashes. Lighting retrofits may be included with RRR and minor intersection improvement projects that do not include full signal reconstruction. An Intersection Lighting Retrofit operation may include replacing older luminaire types with LED luminaires, adding additional light poles, adding luminaire support arms to existing structures, and any other minor modifications needed to meet the Lighting Retrofit requirements of **Table 231.2.1**. Lighting retrofits generally do not include removing or replacing existing structures such as light poles and signal structures.

For Intersection Lighting Retrofit designs, the vertical illuminance requirement of **Table 231.2.1** only applies to the near side movement (see **Figure 231.3.1**).

Existing, low-mounted sidewalk lighting is generally not intended to meet the lighting requirements of **Table 231.2.1**. To prevent increased glare, do not increase light output at existing luminaire locations with mounting heights less than 30 feet.

Independent maintenance operations that update existing fixtures to LED fixtures are not considered Intersection Lighting Retrofits for design and planning purposes.

231.3.2.1.2 Isolated Lighting Intersections

Use the Isolated Lighting requirements of **Table 231.2.1** for signalized intersections with no connecting lighting on approach corridors. The vertical illuminance requirement only applies to the near side movement for these designs (see **Figure 231.3.1**).

231.3.2.2 Unsignalized Intersections

Provide lighting for unsignalized intersections consistent with any connecting corridors that meet warranting requirements of **FDM 231.4**.

Consider adding lighting for unsignalized intersections with a history of nighttime pedestrian crashes, particularly for marked crosswalks on uncontrolled approach legs. For marked crosswalks at such intersections, the vertical illuminance requirement of **Table 231.2.1** is only required for the near side movement (see **Figure 231.3.1**).

231.3.3 Roundabouts

Provide lighting for roundabouts as required per **FDM 213**.

The roundabout lighting criteria for new or reconstruction in **Table 231.2.1** applies where pedestrian features are provided. Calculate the vertical illuminance for crosswalks on each near side approach and for each right turn movement in accordance with the methodology outlined in **FDM 231.3.2**. Use conventional corridor lighting criteria for roundabouts where pedestrian traffic is not anticipated. Use the Isolated Lighting requirements of **Table 231.2.1** for roundabouts with no connecting lighting on approach corridors.

231.3.4 Midblock Crosswalks

Provide lighting for midblock crosswalks as required per **FDM 222**. Where midblock crosswalks are placed to serve a facility that generates pedestrian crossings only during daylight hours, this lighting requirement may be omitted at the District's discretion.

Lighting criteria for midblock crosswalks are provided in **Table 231.2.1**. Calculate the vertical illuminance for the crosswalk on each near side approach in accordance with the methodology outlined in **FDM 231.3.2**. This criteria applies for stand-alone crosswalks at all locations, including entrance or exit ramps.

231.3.5 Sidewalks and Shared Use Paths

Lighting criteria for sidewalks and shared use paths are provided in **Table 231.2.1**. These values are only intended for facilities separate from the roadway.

When sidewalk or shared use path lighting affects an adjacent roadway, then the sidewalk or shared use path illumination requirements are reduced to match those of the adjacent roadway. When such lighting is mounted below a height of 30 feet, use full cutoff luminaires with low output. Include the effects of this sidewalk or shared use path lighting when meeting the roadway's lighting requirements in **Table 231.2.1**, including the veiling luminance check for glare.

231.3.6 Bridge Underdeck Lighting

Luminaires for underdeck lighting are wall-mount fixtures that are mounted to the bridge substructure, including the piers, pier caps, end bents, or wall copings.

231.3.6.1 Nighttime Underdeck Lighting

If the roadway passing under the bridge has lighting immediately adjacent to the bridge, then bridge underdeck lighting is required to maintain continuity of the lighting system. The roadway lighting values for bridge underdeck lighting must be equal to, or an average of, the connecting roadway lighting on either side of the underpass per **Table 231.2.1**.

If there is no adjacent roadway lighting per above, bridge underdeck lighting may still be used at the discretion of the Districts. This lighting is typically provided where frequent pedestrian traffic is expected or where changing roadway geometry and features occur. Follow the lighting value requirements of **Table 231.2.1** for the appropriate roadway classification or location type.

231.3.6.2 Daytime Underdeck Lighting

Daytime underdeck lighting may be required where wide bridge structures block natural sunlight from reaching the roadway below, causing rapid brightness changes that affect driver visibility. The length and geometry of the underpass area are the primary considerations for determining the need for daytime underdeck lighting and any resulting analysis.

The underpass length is the distance that a vehicle would travel underneath the bridge structure, measured along the centerline of the roadway passing under the bridge structure. Parallel bridges must be considered as one continuous structure unless the lateral distance between them is greater than 15 feet and the resulting opening is free of obstructions that would prevent daylight from reaching the roadway below.

For underpasses 80 feet long or less, daytime underdeck lighting is not required and may be used at the District's discretion. For underpasses greater than 80 feet but less than or equal to 150 feet, underdeck lighting designed for nighttime lighting values per **Table 231.2.1** must be installed and run continuously throughout daytime hours. These conditions assume an overpass height of at least 15 feet above the roadway and a width of at least 40 feet.

For underpasses not meeting the above conditions, a daytime underdeck lighting analysis using **ANSI/IES RP-22-11 Tunnel Lighting (ANSI/IES-TL)** guidance is required as described below. At a minimum, the following procedure applies:

- (1) Determine the need for daytime supplemental lighting for the underpass using methodology from the **ANSI/IES-TL Table 2**. If the adjustment factor is zero, then no further daytime lighting underdeck analysis is required.

- (2) Use the **ANSI/IES-TL 6.4.1** Table Method to determine the Threshold Zone Luminance requirements.
- (3) Use the **ANSI/IES-TL 6.4.3** Reduction Curve Method to determine luminance level requirements throughout the Threshold Zone and Transition Zones as applicable. Note that if the Threshold Zone length exceeds the underpass length, then the initial Threshold Zone value may be used throughout the entire underpass.
- (4) Use the **ANSI/IES-TL 6.4.4** methodology and **ANSI/IES-TL Table 7** to determine the luminance requirement for the Interior Zone, if applicable for longer underpasses.
- (5) Consider all other aspects described throughout **ANSI/IES-TL**, including non-roadway surface illumination per **ANSI/IES-TL 6.4.6** and flicker effects per **ANSI/IES-TL 6.5**.
- (6) Perform a daylight study using lighting simulation software capable of 3-D modeling of proposed underpasses. AGi32® or equivalent lighting software is recommended. Some considerations include luminance contributions from the sun per weather station data, material reflectance, and underpass orientation per **ANSI/IES-TL**. Create a design that meets the above established requirements. A process framework is described below:
 - (a) Create an underpass model. The model must include all light-reflecting surfaces, all openings, the roadway layout below the underpass, the bridge structures beneath underpass (e.g. columns), and any other light sources or obstacles to light.
 - (b) Apply surface reflectivity characteristics. The recommended material reflectivity characteristics may be obtained from **Table 231.3.1** below.
 - (c) Create calculation zones for the roadway(s) beneath the proposed underpass per the **ANSI/IES TL Figure 1 and Figure 8**. Data points near the edges of the underpass may artificially inflate the luminance average, so it is recommended that those data points not be considered in the overall average luminance. Per **ANSI/IES Table 2** notes, daytime lighting is not required within 23 feet of the underpass entry and exit.
 - (d) Run daylight models and calculate average luminance values within calculation zones established per above. Site location coordinates are required for weather station data (if available). To establish if supplemental lighting is needed, a daylight module analysis must be run with the orientation of the sun at 9:00am, 12:00pm, and 3:00pm for the summer and

winter solstice as well as the fall and spring equinox (12 analysis times total).

- (e) If average luminance requirements per (2) thru (4) cannot be met using daylight alone per part (d), then provide supplemental wall mount luminaires beneath underpass as needed to meet the average luminance requirements per zone. Use of nighttime luminaires in conjunction with the daytime supplemental luminaires is permitted where practical. The goal is to meet the average luminance requirement using the least number of fixtures while avoiding flicker affects. Adjust and re-run the daylight plus luminaire analysis module as needed to meet the average luminance values per zone as determined above. Design and select luminaires to meet the requirement at the time of least daylight contribution.
 - (f) In the LDAR, provide all assumptions, conclusions, and visual representations of photometric results as produced by the lighting software.
- (7) Based on the completed lighting analysis, develop underdeck lighting plans, including the following:
- (a) Provide the specific locations of required design luminaires in plan, elevation, and isometric views. Show the specific baseline lumen output per location, as required by the analysis. This information must be specified along with all other design luminaire requirements per **FDM231.1.1**, including details for the following:
 - For underpasses 250 feet or less, a photo sensor control may be used to switch from daytime to nighttime operation. The switch may be adjusted to occur at a timeframe after dawn and before dusk at the District's discretion.
 - For underpasses greater than 250 feet, each design luminaire output must be adjustable by remote control, pre-programmed timer, and photo sensor. Each luminaire must be capable of at least 20% higher and 20% lower lumen output than the baseline determined in the analysis.
 - (b) Describe the expected maintenance agreement and required expertise in the Lighting Coordination document per **FDM 231.6**. Provide expected provisions for the lighting's future oversight, maintenance, programming, and remote adjustments as needed.
 - (c) Provide other applicable elements of the lighting plans per **FDM 943**, including the electrical system design as coordinated per **FDM 231.6**

Table 231.3.1 Material Reflectivity

Material of Surface	Recommended Reflectivity
Concrete	0.25
Steel	0.20
Asphalt	0.38

231.3.7 Arterial Lighting Retrofit

Upgrading the luminaires on existing light poles is sometimes beneficial for arterial roadway corridors. This provides advantages of newer lighting technology without the cost of removing or replacing existing pole structures. However, using existing light pole locations also restricts the design placement of new luminaires. As such, reduced lighting values are provided in **Table 231.2.1** for Arterial Lighting Retrofits.

An Arterial Lighting Retrofit operation generally includes replacing older luminaire types with LED luminaires while leaving all of the existing light poles in place. Where practical, a limited number of light poles may be added or removed as needed to meet the design requirements. Do not reduce illumination levels from the existing condition. Any existing sidewalk illumination must be maintained or increased.

Use Arterial Lighting Retrofits at the discretion of the District Traffic Design Engineer. Consider if increased light levels from an all-new light pole system may instead be appropriate based on past safety performance.

231.4 Lighting Justification

The Department follows the warrants for lighting of corridors and interchanges established by **AASHTO**. The warrants are based on benefit-cost ratios determined from the Average Daily Traffic (ADT), the ratio of night to day crashes, initial cost, and maintenance.

Interchanges that are not on the interstate highway system will require a warrant analysis. A benefit-cost ratio of 2.0 or greater is the threshold for lighting usage at these interchanges.

Interchanges that are on the interstate highway system must all be lighted to assure consistency and to meet driver expectations. A warrant analysis is still required for funding evaluation and information, but it will not be used as the determining factor for lighting usage at these interchanges.

A lighting justification must be completed in accordance with [Manual on Uniform Traffic Studies \(MUTS\), Chapter 14.](#)

231.5 Existing Lighting During Construction

The maintenance of existing lighting will be the responsibility of the contractor only if the lighting is affected by the construction. The contractor is not expected to replace lamps and pole knockdowns or to repair wiring if these problems are not caused by the construction work.

The plans are to specify the scope of the contractor's responsibility for the maintenance of existing lighting.

231.6 Lighting Design Coordination

Agency Coordination Document:

Contact applicable local construction, power, and maintaining agencies to confirm roles of lighting stakeholders. Prior to developing the Lighting Plans, create a document entitled "Lighting Agency Coordination", and include the following information:

- (1) Project ID, roadway name, and limits
- (2) Lighting designer or EOR
- (3) Local agencies and personnel contacted
- (4) List of local agency requirements, including structural, electrical, and aesthetic requirements that will substitute for FDOT requirements
- (5) Lighting EOR that will accept the above local agency requirements as an equivalent substitute for FDOT requirements
- (6) A brief summary of expected operating and maintenance agreement, including responsible parties and term lengths

Include "Lighting Agency Coordination" document with the project documentation. All local agency requirements listed must later be included with the details or notes of the Lighting Plans. The "Lighting Agency Coordination" document may be updated as design

work progresses, but the latest version must be saved and included with the project documentation.

General Coordination:

Contact the District Utilities Engineer when the pole locations are set and the electrical load has been determined. The designer should coordinate with the utility company providing power on the preferred location for the electrical service.

Coordinate with the Drainage Section to assure that high water tables, stormwater retention areas, or other water bodies will not be a problem with the proposed location of light poles and the light pole pull boxes.

Coordinate locations of lighting equipment and conduits with other utilities and systems, including ITS, traffic signal, or toll site equipment layouts. In general, check light poles, pull boxes, and lighting circuit equipment to avoid physical conflicts or interference with ITS and toll site functions.

Coordinate locations of lighting equipment and conduits on bridge structures with the bridge structural designer. Include light and conduit locations, and attachment details in the plans. Refer to [Structures Design Guidelines](#), **Section 1.9** for details and restrictions related to bridge attachments.

Typically, the District Maintenance Engineer in conjunction with the District Utilities Engineer obtains the required maintenance agreements. The designer should coordinate with these offices to ensure that this activity is either underway or scheduled.

Any lighting project, especially high mast, adjacent to or in the vicinity of an airport, may present a potential conflict. For poles located within 3 miles of airports, check coordinates of light pole structures with the FAA website tool to determine if further filing and coordination with the FAA is necessary.

Modification for Non-Conventional Projects:

Delete **FDM 231.6** and replace with the following:

231.6 Lighting Project Coordination

The Lighting Engineer of Record is responsible for all necessary coordination.

231.7 Lighting Design Analysis Report

Prepare a Lighting Design Analysis Report (LDAR) that provides a photometric analysis for all lighted areas, including each intersection segment, mainline segment, ramp segment, interchange area, and structure with underdeck lighting. These designs, including horizontal and vertical illumination analyses, should be shown on separate photometric plan sheets. For additional analysis and formatting details, see **FDM 231.2** and **231.3** along with corresponding sections above.

Provide a summary statement on cost-effectiveness of the lighting design. In general, the system with the largest pole spacing that meets design requirements and avoids detrimental light spill will be the most cost-effective design. Also, provide information for at least three luminaire models/manufacturers considered, and explain why the final design luminaire was chosen based on cost-effectiveness.

Provide voltage drop calculations, load analysis calculations for each branch circuit, and lighting calculations for each lighting system.

Include the Lighting Agency Coordination document per **FDM 231.6**. If applicable, include the FAA coordination documents per **FDM 231.6** Include the light spill coordination summary per **FDM 231.2.2**.

For LDAR components, provide sufficient detail in print format (e.g., PDF) so that reviewers do not require compatible design software to check inputs and results of calculations.

232 Signalization

232.1 General

Signalization provides an orderly and predictable movement of motorized and non-motorized traffic throughout the highway transportation system. They also provide guidance and warnings to ensure the safe and informed operation of the traffic stream.

The design and layout of signals should complement the basic highway design and comply with:

- [Standard Specifications](#),
- [Standard Plans](#),
- [Traffic Engineering Manual \(TEM\)](#),
- [Structures Manual \(Volume 3\)](#),
- [Manual on Uniform Traffic Studies \(MUTS\)](#),
- [National Electrical Code \(NEC\)](#), and
- [Manual on Uniform Traffic Control Devices \(MUTCD\)](#).

The criteria presented in the following sections supplement the [MUTCD](#).

232.1.1 Structural Supports

AASHTO's LRFD Specifications for Structural Supports for Highway Signs, Luminaires, and Traffic Signals and the [FDOT Modifications to LRFDLTS-1](#) provide structural design criteria.

Refer to **FDM 261** for information regarding structural support requirements. Refer to **FDM 941** for information regarding plan requirements.

232.1.2 Attachments to Barriers

Refer to **FDM 215** for information regarding proposed attachments to bridge traffic railings, concrete median barrier walls, concrete shoulder barrier walls or the evaluation of existing attachments.

232.1.3 Certification and Specialty Items

Traffic control signals and devices installed in Florida must be certified by the Department. The State Traffic Engineering Research Laboratory (located in Tallahassee) is responsible for certifying all traffic control equipment. If requiring new equipment types or types not typically used, contact the State Traffic Engineering Office to determine the certification status of the equipment. Noncertified equipment cannot be used.

232.1.4 LED Light Sources

The Light Emitting Diode (LED) is the standard light source for all signal indications.

232.1.5 Retroreflective Signal Backplates

Install retroreflective signal backplates on traffic signals for all approaches.

Provide rigid retroreflective backplates for all new signal structures. Flexible retroreflective backplates may be used on existing signal structures in accordance with [TEM, Section 3.9](#).

232.1.6 Signal Heads for Through Lanes

Place a three-section head over the center of each lane for approaches of two or more lanes. When a single left turn lane is provided, a five-section cluster can serve as one of the indications required for the inside through lane.

232.1.7 Vertical Clearance

See *FDM 210.10.3* for vertical clearance requirements.

232.2 Lane Configuration

The engineer responsible for the traffic signal design may be asked to verify the number and configuration of traffic lanes required for an intersection to function properly when signalized. For this calculation use the Design Hourly Volume (DHV) based on the Department's Standard K factor and not a peak to daily (P/D) ratio based on a 24-hour count.

The K, D, and T factors convert the two-way AADT volumes to a one-way DHV. This is appropriate for the total approach movements. The AM and PM peak turning movement counts on each approach should be addressed individually. Current turning movement counts should be taken to determine the percentage of turns for each approach. Apply the percentages to the DHV for each approach volume to determine the turning volumes that should be used for the turn lane design calculations. Compare the turning volumes to the movement counts supplied by Planning. Use the greater of the two values for the design of turn lanes. Contact the District Planning Office to determine if recent counts are available and also if any use changes are planned which would require adjustments to the turn percentages found in the current counts.

Storage lanes for left turns can affect the capacity and safety of intersections. The storage length of a left turn lane is a critical design element. The queue of left turn vehicles in a storage lane of inadequate length may extend into the through lanes. The result is loss of capacity for the through lanes. The queue of through vehicles may also extend beyond the entrance of a short-left turn storage lane, blocking access to the storage lane. Either case results in a less efficient operation of the intersection and may cause last minute lane changes, thereby increasing the possibility of conflicts.

Turn lanes should comply with **FDM 212**. The available queue length provided should be based on a traffic study.

The factors to determine the length of a left turn storage lane are:

- (1) The design year volume for the peak hour (see discussion above).
- (2) An estimate for the number of cycles per hour.

NOTE: If the cycle length increases, the length of the storage for the same traffic also increases.

- (3) The signal phasing and timing.

There are several techniques used to determine necessary storage length. The following are suggested guidelines for left turn lanes:

- (1) Where protected left turn phasing is provided, an exclusive turn lane should be provided.
- (2) Left turn lanes should be provided when turn volumes exceed 100 vehicles per hour (VPH) and may be considered for lesser volumes if space permits.
- (3) For signalized intersections, the following formula may be used, assuming an average vehicle length of 25 feet.

$$Q = \frac{(2.0)(DHV)(25)}{N}$$

Where:

- Q = design length for left turn storage in ft.
- DHV = left turn volume during design peak hour, in VPH.
- N = number of cycles per hour for peak hour, use N = 30 as default.

Note: Computer programs, such as **TRANSYT-7F** and **Synchro** are used to develop signal phasing and timing. One of the outputs of these programs is the queue length. For projects where traffic signal timing is included as a part of the project, the output of these programs should be considered in determining storage length.

Where peak hour truck traffic is 10% or more, use vehicle length of one passenger car and one truck.

- (4) Where left turn volumes exceed 300 vph, a double left turn should be considered.
- (5) When right of way has already been purchased, and the designer has to choose between a long wide grass median or a long left turn lane, the storage length for the left turn should be as long as practical without hindering other access.

Right turn lanes are provided for many of the same reasons as left turn lanes. Right turns are, however, generally made more efficiently than left turns. Right turn storage lanes should be considered when right turn volume exceeds 300 vph and the adjacent through volume also exceeds 300 vehicles per hour per lane (vphpl). The introduction of right turn lanes can impact pedestrian crossing distances at signalized intersections; therefore, additional analysis may be required to weigh the impacts of increased pavement width and signal operations.

232.3 Left Turn Treatments

Follow the guidelines given below when determining signal treatments for left turns. For detailed information, see the [TEM, Section 3.2](#).

(1) Single Turn Lane

(a) Protected/Permissive Phasing

Option #1: A five-section cluster or a separate turn signal head may be used for this location. If a separate turn signal head is used, it should be positioned over the center of the left turn lane. If a five-section cluster is used, it should be installed over the lane line between the left turn lane and through lane. The five-section cluster can serve as one of the two indications required for the through traffic.

Option #2: A flashing yellow arrow signal indication may be used. A study conducted by the National Cooperative Highway Research Program determined that drivers had fewer crashes with flashing yellow left-turn arrows than with traditional yield-on-green signal configurations. A flashing yellow arrow must use a separate four section head positioned over the center of the left turn lane.

(b) Protected Phasing

A separate signal head for the left turn lane with red, yellow and green arrow indications should be positioned over the center of the left turn lane.

(2) Dual Turn Lanes – Use only protected phasing; i.e. permissive movements will not be allowed. A single three-section head with red, yellow, and green arrow indications should be centered over each turn lane. These heads are in addition to the dual indications required for the through movement.

(3) Separated Turn and Through Lanes – Guidance for signal operation of separated left turn and through lanes is found in the [TEM, Section 3.2](#).

(4) Single Lane Approach on Stem of "T" – A minimum of two three-section heads are required.

(5) Two Approach Lanes on Stem of "T"

Option #1: The approach may display two three-section heads with circular indications on all sections.

Option #2: The approach may display a five-section cluster in conjunction with a three-section head. If the lanes are exclusive left and right turn lanes, then the

five-section cluster should be placed over the center of the lane line and the three-section head over the major movement lane. If one of the lanes is a shared left and right lane, then the five-section cluster should be placed over the center of this lane and the three-section head over the center of the other lane.

Option #3: The approach may display two three-section heads for the major movement and a single three-section head for the secondary movement.

(6) Three Approach lanes on Stem of "T"

Option #1: The approach may display two three-section heads for the major movement and one for the secondary movement (Exclusive left and right turn lanes).

Option #2: The approach may display a five-section cluster in conjunction with a three-section head (exclusive left and right turn lanes). The five-section cluster should be placed over the center of the lane line separating the left turn lane(s) from the right turn lane(s). The three-section head should be placed over the other lane line to provide dual indication for the major movement.

Option #3: When the middle lane is a shared left and right turn lane, then a five-section cluster should be placed over the center of this lane and a three-section head placed over each of the other two lanes. Each head must contain green and yellow arrow indications in this situation.

Modification for Non-Conventional Projects:

Add the following sentence:

(7) Coordinate requirements with the local maintaining agency.

NOTE:

- (1) For all cases, the approach must display "dual indications". This means that there will be at least two heads with identical indications on the major approach. For example, if a green arrow is displayed on one head of the major movement or approach then a green arrow must be displayed on the second head.
- (2) The same signal display option should be used throughout an urban area to provide consistency in display to the motorist.
- (3) The use of advance and/or overhead lane use signs should be used as a supplement to pavement arrows on stems of signalized "T" intersections.

232.4 Controller Assemblies

The lateral offset requirements for signal poles and controller cabinets are given in **FDM 215**. Final location of these devices must be based on the safety of the motorist, visibility of the signal heads, ADA requirements, and access by maintenance.

(1) Controller Timings:

The development of controller timings is a basic part of traffic signal design. Signal controller timing plans must be signed and sealed by a licensed Professional Engineer.

Traffic signal timings and settings are developed and designed for a specific intersection location. The settings must respond to all users at the intersection and meet objectives defined by the policies of the responsible Maintaining Agency.

Coordinate with the responsible Maintaining Agency to verify that traffic signal cabinets, controllers, assemblies, and standards are compatible with the agency's needs and are synchronized accordingly. The signal timings for the Yellow change and all red clearance intervals must be in accordance with the [TEM](#), **Section 3.6**.

Traffic signal designs on state and local roadways must include initial timings of all controllers in the plans set. If the responsible agency decides to implement different timings than the ones in the plan set, it must insure they were prepared under the supervision of a licensed Professional Engineer.

(2) Future Intersection Expansion:

Any planned intersection improvements should be considered in the signal design. The controller type, cabinet type, and the number of load switches are examples of design features that may be affected by future intersection improvements. The signal design engineer must determine if the current design should include capabilities for future improvements.

(3) Upgrade of Existing Controller Assemblies:

Replace or expand existing controller assemblies when an upgrade is required. Minor expansions include the addition of load switches, new controller timings, or new controller unit provided the cabinet is properly wired. Major expansions include cabinet rewiring or any work requiring the removal of the cabinet back panel. Contact the District Traffic Operations Engineer before making the decision to expand or replace an existing controller assembly.

232.5 Vehicle Detection

Detection technology types commonly used with signal design include inductive loops installed in pavement and video (camera) or microwave sensors mounted on the pole or mast arm supports. Inductive loop detection is generally used with asphalt pavement, and video detection with concrete pavement or bridge structures. Coordinate with the District Transportation Systems Management and Operations (TSM&O) Engineer to determine the preferred detection technology that will serve the needs of the District and maintaining agency.

(1) Inductive Loop Detection:

The traffic signal design is to identify the placement of loops for each intersection. Vehicle detection loops are detailed in the [Standard Plans, Index 660-001](#) and are suitable for most locations. [Index 600-001](#) allows for minor modifications in size and placement of the loops when required by site conditions.

(2) Video Vehicle Detection System (VVDS):

VVDS uses a camera to detect vehicle presence. The traffic signal design is to identify the placement of cameras for each intersection.

(3) Microwave Vehicle Detection System (MVDS):

MVDS uses an FCC-certified, low-power microwave radar signal (sensors) to detect vehicle presence within a detection zone. These systems establish wired or cellular communication with the agency responsible for system operation and maintenance. This allows for remote configuration and monitoring.

232.6 Pedestrian Detection and Control Signal

The standard for detecting the presence of a pedestrian is the Pedestrian Pushbutton Detector. Pedestrian detector assemblies and pedestrian control signals are detailed in the [Standard Plans, Index 653-001](#) and [Index 665-001](#). Pedestrian detection systems are listed on the Department's Approved Product List ([APL](#)).

Use the countdown pedestrian signal assembly on projects that include pedestrian-controlled signal installations. Refer to the [TEM, Chapter 3](#), for additional information on pedestrian signal installation and operation.

Orient pushbutton with the face parallel to the crosswalk to be used (i.e. parallel to the crossing direction). See [Standard Plans, Index 665-001](#) for additional orientation guidance.

232.6.1 Accessible Pedestrian Signal Feature

Where pedestrian facilities are provided, include provisions (e.g., conduit, conductors, signal cables) needed for future use of Accessible Pedestrian Signal (APS) devices on all new and reconstructed signalized intersections and signalized midblock crossing locations.

See [TEM 3.7](#) for installation and operation criteria of Accessible Pedestrian Signals on the State Highway System.

232.7 Signal Preemption

Determine if there is a requirement for signal preemption; e.g., close proximity to fire station or railroad crossing. Refer to the *FDOT Procedure for Signalization Pre-Emption Design Standards* ([FDOT Procedure 750-030-002](#)) for additional information on the conditions for which preemption is required or should be considered. Coordinate all signal preemption requirements with the local maintaining agency.

232.8 Mast Arm Supports

Utilize an underground communication cable infrastructure for those signals operating as part of an advanced traffic management system on these designated corridors.

Orient mast arm signal structures approximately 90° to approach traffic; i.e., mast arms diagonal to traffic are not allowed.

Signs on mast arms will be restricted to required regulatory and street name signs.

232.8.1 Mast Arm Policy

Provide mast arms in accordance with the following criteria for new signals installed on the State Highway System:

- (1) Intersections within the [Mast Arm Boundary Map](#), as defined by the State Traffic Engineering Office Implementation Guidelines (aka mast arm policy area):

Signals are to be supported by galvanized mast arms, with the signal head(s) rigidly attached to the mast arm. When it is impractical to use a mast arm or overhead rigid structure within the [Mast Arm Boundary Map](#), a two point span wire assembly with adjustable hangers must be used and a Design Variation must

be approved in accordance with **FDM 122**. The Department will install and maintain mast arm installations only with galvanized finish. If the Local Maintaining Agency wants a painted finish, see coating requirements for ancillary structures in **FDM 261.1**.

Modification for Non-Conventional Projects:

Delete the last three sentences of the above paragraph and see RFP for requirements.

- (2) Signalized Intersections outside the [Mast Arm Boundary Map](#):

Signals along all corridors outside the [Mast Arm Boundary Map](#) must be supported by two-point span wire assemblies with adjustable hangers. If the Local Maintaining Agency prefers a mast arm, they must provide funding for the increase in construction cost., and if the requested mast arm is to be painted, see coating requirements for ancillary structures in **FDM 261.1**.

Modification for Non-Conventional Projects:

Delete the last sentence of the above paragraph and see RFP for requirements.

232.9 Span Wire Assemblies

Use either perpendicular spans, box spans or drop box spans for all traffic signal span wire assemblies. Signs on span wires will be restricted to required regulatory signs.

Diagonal span assemblies may be used for flashing beacon installations. A Design Variation is required for any other diagonal installation. The Design Variation must be signed by both the District Design Engineer and the District Traffic Operations Engineer.

232.10 Traffic Signal Project Coordination

Coordination with other offices and agencies is an important aspect of project design. The offices discussed in this section are normally involved in signal projects, however there may be others.

Roadway Design – Typically, the designer of a signal project receives the base sheets for design and any required cross sections from the roadway designer. Base sheets may be created from existing plans when the signal project is not part of an active roadway design project.

Utilities - The District Utilities Engineer provides the coordination between the designer and the various utilities that may be involved in the project. The Utilities Section may assist in identifying or verifying conflicts with overhead and underground utilities. The designer should coordinate with the utility company providing power on the preferred location for the electrical service.

Structures Design - The Structures Engineer of Record provides the design of the traffic signal mast arms and strain poles, including the design of the foundation. The Structures Engineer of Record should be contacted early in the design phase to allow adequate time for coordination with the Geotechnical Engineer in obtaining the necessary soils information.

Coordinate locations and attachments of traffic signals and conduits on bridge structures with the bridge structural designer. Include traffic signal and conduit locations and attachment details in the plans. Refer to [Structures Design Guidelines](#), **Section 1.9** for details and restrictions related to bridge attachments.

Pedestrian and Bicycle Coordinator - The District Bicycle and Pedestrian Coordinator should be consulted to assure that all potential pedestrian and bicyclist concerns have been considered.

232.11 Traffic Signal System Power Design

Traffic signal systems typically operate at 120 volts alternating current (AC) from the commercial utility service provider. Refer to **Section 233.3** for power source design considerations. The following subsections describe the power calculations at the traffic signal intersection.

232.11.1 Power Load Requirements

The total power requirement for any traffic signal system site is the sum of the power of all components within the cabinet as well as all the components outside of the cabinet.

Assume all equipment is in continuous operation.

232.11.2 Voltage Drop

Perform voltage drop calculations for the following conductors.

- (1) Conductors from the utility service provider meter to the traffic signal cabinet:
 - (a) Measure the distance between the meter and the traffic signal cabinet.
 - (b) Determine the conductor size for a maximum of 5% voltage drop.
 - (c) Voltage drop mitigation strategies may include use of larger conductors or higher service voltage.
 - (d) Minimum conductor size is 6 American Wire Gauge (AWG).
- (2) Conductors from the traffic signal cabinet to the traffic signal head:
 - (a) Measure the distance between the traffic signal cabinet and the farthest traffic signal head.
 - (b) Determine the conductor size for a maximum of 5% voltage drop.
 - (c) Voltage drop mitigation strategies may include use of larger conductors.
 - (d) Minimum conductor size is 14 AWG.

Perform traffic signal system electrical design in accordance with the National Electric Code for traffic signal system equipment electrical designs, including voltage drop calculations, load requirements, electrical device sizing and grounding.

233 Intelligent Transportation Systems (ITS)

233.1 General

Intelligent Transportation Systems (ITS) criteria provided in this chapter applies to the placement and installation of ITS devices and systems along Florida's roadways including Limited Access (LA) facilities, arterials, and express lanes.

The design and layout of ITS facilities should complement the basic highway design and comply with current versions of the following:

- [Standard Specifications](#)
- [Standard Plans](#)
- [Traffic Engineering Manual \(TEM\)](#)
- [Structures Manual](#)
- [Highway Beautification Policy](#)
- [Manual on Uniform Traffic Studies \(MUTS\)](#)
- *AASHTO Standard Specifications for Structural Supports for Highway Signs, Luminaires and Traffic Signals*
- [Manual on Uniform Traffic Control Devices \(MUTCD\)](#)
- [Intelligent Transportation System Integration Guide Book](#)
- *National Electric Code (NEC)*
- *National Fire Protection Association (NFPA)*
- [Title 23 Code of Federal Regulation \(CFR\), Part 940](#)
- [Title 47 CFR, Part 90](#)
- [Title 47 CFR, Part 95L](#)

Additional information related to the design of ITS facilities is found in the following locations of the **FDM**:

- **FDM 215** – lateral offset requirements for poles, sign structures, field cabinets, and communication hubs for deployments. Deployment refers to existing and new ITS facilities and infrastructure.
- **FDM 221** – utility coordination
- **FDM 261** – structural support requirements

- **FDM 942** – ITS Plans content and requirements

The Statewide Systems Engineering Management Plan and various systems engineering templates (e.g., Concept of Operations) are found on the following web site:

https://www.fdot.gov/traffic/ITS/Projects_Deploy/SEMP.shtm

233.1.1 Railroad-Highway Grade Crossing Near or Within Project Limits

Federal-aid projects with a railroad-highway grade crossing near or within the project limits should refer to **FDM 220.2.4**.

233.1.2 Attachments to Barriers

Refer to **FDM 215** for information regarding proposed attachments to bridge traffic railings, concrete median barrier walls, concrete shoulder barrier walls or the evaluation of existing attachments.

233.1.3 ITS Device Approval and Compatibility

ITS devices are traffic control devices that follow approval requirements discussed in **FDM 232.1.3**.

Incorporate features and functions that allow interoperability with other ITS deployments throughout the region and state including existing Transportation Management Center (TMC) hardware and software. Examples of design characteristics that promote interoperability include:

- Systems and products based on open architectures and standards.
- Systems and products that are scalable and nonproprietary.
- Compatibility with the Department's SunGuide® Software directly or via support of one or more of its related Interface Control Documents (ICD).
- Compatibility with the local agency central system software, as applicable.
- Systems on the Department's Approved Products List ([APL](#)), Innovative Products List ([IPL](#)), or proprietary products. Refer to **FDM 110.4.1** for more information on proprietary products.
- Compatibility with existing or legacy systems and networks.

- Develop technical special provisions (TSPs) or modified special provisions (MSPs) in accordance with the Department's [Specification Handbook](#).

233.2 ITS Design Criteria

ITS devices and systems gather, analyze, and distribute real-time information to improve the safety, efficiency, mobility, security, and integration of transportation systems. Various ITS technologies have strengths and limitations for collecting, analyzing, and disseminating information. Select ITS devices for the appropriate application.

Many ITS devices require specific placement and configuration requirements for the equipment to perform properly. Consider the following for the design of these devices:

- (1) Life cycle expectancy for continued operations and maintenance.
- (2) Value engineering for installation and maintenance of the design.
- (3) Environmental impacts.
- (4) Technologies for commercial vehicle operations.
- (5) Technologies for connected vehicles.
- (6) Accommodations for future expansion.
- (7) Utility and landscaping impacts.

233.2.1 Title 23 CFR, Part 940

ITS projects must comply with the requirements specified in the [Guidelines for the Implementation of Part 940 in Florida](#) (Topic No. 750-040-003). This is to ensure compliance with **Code of Federal Regulations (CFR) Chapter 23 Part 940 Section 940.11** and Department requirements.

233.2.2 Maintenance Considerations

Consider the following for maintenance access:

- Provide a minimum 4-foot clear area around the ITS pole for maintenance of the camera lowering device.
- Avoid ITS equipment near areas susceptible to vegetation overgrowth, swales, or wetlands.
- Avoid installing equipment in medians.

- Provide a leveling platform and railing system (handrail) to protect from any drop-off hazards and/or slopes steeper than 1:2.
- Place ITS equipment behind existing or proposed guardrails, as required in ***FDM 215.2.4***.
- Provide space to pull over on the shoulder to access the equipment.

233.3 ITS Power Design

ITS systems typically operate on 120 volts alternating current (AC) from the commercial utility service provider. Some systems operate using a low voltage (60 volts or less) direct current (DC) power source, facilitating battery and solar power options. Do not use 600-volt step-up electrical systems. Do not exceed 480 volts for ITS systems. Consider the following for power designs:

- Existing and future loads.
- Expected power consumption duty cycle.
- The time during which the system must operate.

Include a Remote Power Management Unit (RPMU) within each ITS field cabinet.

233.3.1 Power Source Design and Placement

Power service availability is an essential element to ITS design. The power service location is the demarcation point between the Department and the commercial utility service provider. In many cases, the power service is a new power service pole located immediately inside the R/W.

Identify the location of power service and design the power service cable routing from the power service to the field device cabinet. Include the device stations and offsets for proposed power service locations in the plans.

Power service locations are typically located within a half-mile of the ITS devices served. Consult with the commercial utility service provider to select optimal power service locations for power service routing greater than a half-mile.

Identify underground and above-ground obstacles (e.g., buried utilities, structure foundations, retaining walls, guardrail) between proposed ITS devices and the power services. These obstacles may affect the location of proposed ITS devices, the choice of power service points, or the routing for the power service conductors.

233.3.2 Local Backup and Alternative Power Sources

Provide Uninterruptible Power Supply (UPS) to prevent failure of normal operations for mission critical systems. Mission critical systems are systems that are critical to the daily operation of the Transportation Management Center (TMC) (e.g., master hubs, certain local hubs, detectors, cameras, signs, tolling systems, express lanes) as defined by the District ITS/Transportation Systems Management & Operations (TSM&O) Engineer.

Solar or wind power sources may be an option for some ITS applications. Consider the geographical and topographic features that affect sunlight or wind exposure, size of site, and protection from maintenance operations (e.g., mowing).

An electrical distribution system may be necessary in rural areas where commercial electric service is not readily available. Design the electrical distribution system in accordance with **NEC** requirements. Consider voltage and amperage needs of the equipment along the distribution system. Different combinations of voltage, conductor size, step-up, step-down, and isolation transformers may be used to design a system that is cost effective to construct and maintain. Coordinate with the District ITS/TSM&O Engineer to determine additional electrical capacity needs.

233.3.3 Application for Electric Service

Proposed service points for new power service installations require approval by the commercial utility service provider. This approval should be coordinated with the Department and the commercial utility service provider early in the design process.

The approval of proposed service points for new power service installations include the following steps:

- (1) Determine the following:
 - (a) Availability of service at any location.
 - (b) Commercial utility service provider's standard type of service for the load to be served.
 - (c) Designated point of delivery (prior to confirmation with the commercial utility service).
- (2) Request that the proposed service points be verified and approved by the commercial utility service provider.
- (3) (Optional) Hold a coordination meeting in the field with the commercial utility service provider representative.

- (4) (Optional) Designer to obtain a written agreement with the commercial utility service provider for agreed upon service locations.

In most locations, the secondary distribution system provides service(s) at standard voltages.

233.3.4 Power Design Requirements

Key design steps for an ITS device deployment electric power system are:

- (1) Determine the total power requirement based on anticipated peak equipment loads determined in accordance with **FDM 233.3.5**.
- (2) Select a suitable power source based on availability.
- (3) Determine transformer requirements (step-down, step-up, or isolation), where applicable. The need for transformers may be based on voltage and power loss calculations.
- (4) Balance the device electrical loads to achieve a uniform and efficient power distribution design.
- (5) Separate power service meter to be provided for ITS infrastructure

Locate a power disconnect switch within a convenient distance from the device service enclosure. For example, the power to operate a Dynamic Message Sign (DMS) may be fed from a nearby DMS service enclosure, and a power disconnect switch is typically installed outside of the service enclosure. Step-up and step-down transformers must include a minimum of two 2.5% full capacity below normal taps and two 2.5% above normal taps on the primary side.

233.3.5 Power Load Requirements

The total power requirement for any deployed device or deployment site is the sum of the power requirements of the following:

- Heating Ventilation and Air Conditioning (HVAC).
- Cabinet components (lights, fans, UPS).
- Devices not powered through the UPS.
- Convenience outlets.
- Future device loads.

Assume all equipment is in continuous operation. Provide 20% spare load capacity in every ITS field cabinet (excluding DMS loads). In addition, provide for a 15A load at 120V at the end of every circuit.

233.3.6 Voltage Drop

Perform voltage drop calculations for ITS devices with the following considerations:

- Ability of the ITS device to operate above or below the nominal voltage.
- Distance from the power source to the ITS device.

Voltage drop mitigation strategies may include use of larger power conductors or higher service voltage.

Meet **NEC** code for ITS equipment electrical designs, including voltage drop calculations, load requirements, electrical device sizing (e.g., switches, isolators, bus bars, surge protective devices), and grounding.

233.3.7 Installation of Power Cable

Install power cables in separate conduits and pull boxes from communications cables. Design for the maximum duct fill ratio in accordance with **NEC, Chapter 9**.

233.3.8 Grounding and Lightning Protection

Include provisions for grounding and lightning protection. Examples of techniques for grounding and lightning protection include the following:

- Proper bonding and installation of grounding rods and grounding conductors.
- Air terminals.
- Surge Protective Devices (SPDs).

[Standard Plans](#), **Index 700-090** contains additional information on grounding and lightning protection for DMS signs.

Existing geological and other physical characteristics (e.g., rock formations, underground utilities, gravel deposits, soil types, and resistivity, groundwater) affect the design or layout of grounding systems. Include in the plans relevant subsurface data at the proposed installation locations (e.g., soil resistivity measurements).

Place the grounding arrays such that grounding paths from the down cable to the primary electrode are as straight as possible. Provide details in the plans related to grounding and cable routing for each device.

Determine grounding and SPD placement and overall system design based on project-specific needs and the following:

- Follow ***NFPA 780 (Standard for the Installation of Lightning Protection Systems)***, ***Underwriters Laboratories (UL) UL-1449***, and the ***NEC***.
- Place SPD equipment so that grounding connections are as short and straight as possible.
- Avoid bending conductor routes.
- Provide physical separation between low-voltage and high-voltage signal paths.
- Avoid routing unprotected wires or grounding wires parallel or adjacent to the protected wiring.

233.3.9 Emergency Generator Power Systems (Generators)

Generators provide temporary power when commercial AC power is interrupted. Their use is associated with mission critical ITS applications (as described in ***FDM 233.3.2***).

Permanent generators are required for applications that cannot tolerate a short duration outage. Supplement with a UPS or battery system to provide continuous power service during the start-up cycle of the generator.

Include a connection and proper receptacles to accommodate a portable generator for applications that can tolerate a short duration outage of a few hours.

233.3.9.1 Generator Design Requirements

Sizing a generator depends on design load (including future device loading) and power factor. Consider run time requirements and future load expansion in the generator design. Identify and design specific critical load circuits to be powered by the generator when commercial power fails.

Use Liquefied Petroleum Gas (LPG) as the fuel type for permanent generator designs. The preferred storage technique for LPG is in-ground (buried) tank. Obtain approval from the District ITS/TSM&O Engineer to use fuel alternatives. Design permanent generators

to provide a minimum of 48-hours of run time at full (rated) load. Meet the minimum requirements in **NFPA 58 (Liquefied Petroleum Gas Code)** for generator designs.

For permanent generators, provide a generator pad with a minimum clearance of 30 inches around the generator and fuel tank. Provide pad design details with adequate information such as reinforcing, concrete class type/strength, and installation notes.

Install a manual transfer switch for all generator installations and also include an automatic transfer switch for permanent generator installations. The automatic transfer switch must provide emergency power in less than 15 seconds and permit full manual override control for testing and maintenance.

Install a remote monitor and control appliance for permanent generators. Connect to a network management system to monitor the status of permanent generators and allow remote operations and testing capabilities. Coordinate with the District ITS/TSM&O Engineer for connections to a network management system.

233.3.10 DC Power Plant (48 Volt)

DC power plants protect ITS devices from potential disruptions, such as high-switching voltages, transients, lightning strikes, harmonic distortion, and interference from other equipment.

Include DC power plants where ITS applications require isolation from the AC power grid utility service provider. Connect the DC power plant to the facility grounding system.

233.3.10.1 Battery Types

Use Valve Regulated Lead-Acid (VRLA) batteries for mission critical ITS applications (as described in **FDM 233.3.2**).

Consider a large form factor lithium battery (e.g., Lithium Iron Phosphate) if a site has a unique battery size limitation.

Provide proper ventilation for specified battery system.

Do not use flooded type lead-acid batteries.

233.3.10.2 Battery Sizing

Size battery systems to support all the following:

- Present design load plus load expansion safety margin (typically 25%).
- Anticipated future load expansion.
- Minimum run time requirements of the DC power plant load.

Evaluate the present design load for the maximum instantaneous DC current requirements and the average DC current requirements.

Size VRLA battery systems such that the battery cells do not discharge below 50% of their rated capacity.

233.3.10.3 Battery Interconnects

Provide a circuit breaker disconnect and a low voltage disconnect for battery systems.

233.3.10.4 Battery Charging Systems

Match the battery charging system to the battery type and size to avoid unnecessary damage to battery cells. Battery charging systems may include multiple rectifiers for load sharing and redundancy.

233.3.10.5 Battery Monitoring System

Provide a battery monitoring system to monitor the condition of each battery or cell. Specify a monitoring system that identifies a thermal runaway event in the battery system and provides information to the charging system. This allows the charging system to lower the rectifier float voltage to limit the current or shutdown the battery system. Connect the battery monitoring system to the network to permit remote reporting.

233.3.10.6 DC Power Plant Load Distribution

Equip DC power load circuits with circuit breaker panels or fuses. Circuit breakers and fuses may be inherent to the DC power plant or part of a stand-alone fused alarm panel to distribute the DC power to load circuits. The panels may be networked to permit remote monitoring.

233.3.10.7 DC Power Plant Wiring

Specify stranded insulated wire with sufficient gauge to carry the required current in the DC power plant. Specify red insulation for source wiring (e.g., -48 VDC) and black insulation for the return (0 V).

233.3.10.8 Battery Installation

Large DC power plants and battery systems installed on flooring, may require a structural analysis to determine the load bearing capacity. Coordinate with the FDOT Project Manager to determine if structural analysis is required.

Design for the weight of large DC power plants and batteries to be evenly distributed to minimize surface or floor load.

233.4 ITS Support Infrastructure

ITS support infrastructure includes:

- Conduits infrastructure
- Pull, slice, and junction boxes
- Utility designation (e.g., power, communications)
- Fiber optic network cables and connections
- Poles and structures
- Camera lowering devices

Coordinate the grading of all foundations to ensure elevation of cabinet bases are above grade. Consider the following:

- Sight obstructions with landscaping and other structures
- Temporary Traffic Control functionality
- Drainage or flooding concerns
- Constructability
- Access for future maintenance

233.4.1 Conduit Infrastructure

Specify the conduit color, inner duct type, size, and quantity of the conduit system in the Plans. Coordinate with the District ITS/TSM&O Engineer to ensure conduit colors and sizes synchronize with existing conduit subsystem. Obtain approval from the District ITS/TSM&O Engineer and District Structures Engineer to utilize bridge-mounted or barrier-wall-embedded conduit for fiber/electric service wires.

Design the conduit system in accordance with the following:

- Conduit runs are to be as straight as possible
- Joints and bends in the conduit system are to meet minimum bending radius of the fiber optic cable as defined in [Standard Specifications, Section 633](#)
- Place conduit along the edge of R/W as much as possible to avoid future widening conflicts
- Avoid placing conduits:
 - Within terrain steeper than 1:4 slope
 - Near endangered species habitats, chronic wet areas, landscaping, drainage features, and existing or proposed roadside features (e.g., guardrail)
 - Near underground utilities and lighting conductors
 - Behind noise walls
- Provide maintenance access to the conduit and pull or splice boxes
- Minimize the number of directional borings. If there are two directional bore sections, less than 100 feet apart, then consider using a continuous directional bore.
- Minimize road crossings. When road or ramp crossing is necessary, locate and route the conduit crossing in a manner that minimizes the length to cross the road. Place conduit perpendicular (shortest distance) to the roadway or ramp to the greatest extent practicable.
- Include only one fiber cable in each fiber optic backbone conduit. Do not collocate fiber cables inside the same backbone conduit. Obtain approval from the District ITS/TSM&O Engineer to place multiple fiber optic cables in conduits with lateral fiber optic cable drops. Ensure conduits meet NEC conduit fill ratio requirements.

Provide callouts and notes in the plans indicating existing conduit infrastructure that will be removed or abandoned in the project. Note existing underground conduit identified in the plans for removal as incidental to clearing and grubbing.

If existing conduit is to be abandoned and remain in place, include fiber optic cable removal in plans, so that it is apparent that the conduit has been abandoned.

233.4.2 Pull, Splice, and Junction Boxes

Provide access points using pull, splice, or junction boxes. Minimum requirements for placement of access points are as follows:

- Provide at-grade access to fiber optic cables housed within conduit systems.
- Provide assist points to aid in fiber optic cable installation.
- Provide protection for the fiber optic cable.
- Provide space for storing cable slack/coils and splice enclosures.
- Provide space for entry, routing, and slack fiber storage for pull boxes and splice boxes. Fiber optic cable slack requirements are provided in [Standard Specifications, Section 633](#).

Access points are required at the following locations:

- As provided in [Standard Specifications, Section 635](#).
- Planned or future splice locations.
- On each side of:
 - A railroad crossing.
 - A roadway crossing, except for narrow roadways, such as ramps.

Splice boxes must be used for access points on fiber optic cable backbone routes or for device drop. Pull boxes can only be used for access points when the conduit system extends from the backbone to the ITS field devices.

[Standard Plans, Index 634-002](#) includes information for aerial interconnect, and [Index 635-001](#) includes information for pull and splice box details.

The top of pull, splice, and junction boxes should be placed a minimum of 2 feet above the appropriate drainage feature elevation. Coordinate with the Drainage Design Engineer to confirm these structures and their associated components are placed above the appropriate elevation as follows:

- Treatment Swales – Weir Elevation
- Conveyance Ditches – Normal Depth
- Stormwater Ponds – Design Storm Peak Stage

- Floodplain Compensation or Other Systems – Seasonal High-Water Level

Provide the applicable elevation of the top of the pull, splice, and junction in the component-specific cross-sections and typical cross-sections.

233.4.3 Fiber Optic Cable Designating System

The fiber optic cable designating system provides visual indication of the underground fiber optic conduit or cable system. Provide appropriate fiber optic cable locating and marking per [Standard Specifications 633](#).

233.5 Fiber Optics and Network Design

Design network facilities based on specific project needs with the following information:

- General network topology.
- Facility diagrams illustrating conduit routes.
- Network diagrams, including communication hub details.
- External network connections and demarcation points.
- Fiber block diagram to show switches, field devices, and physical network connectivity.

Include Special Provision [SP0071101-Tolls](#) in the contract documents when there are existing power or communication cables that transmit toll system information near areas where work is to be performed. Refer to the [General Tolling Requirements \(GTR\)](#) for specific ITS requirements related to toll facility design.

233.5.1 Fiber Optic Cable

Fiber optic cable is utilized in the Department's statewide network infrastructure to provide data and device control communications between ITS field devices, Transportation Management Centers (TMCs) and other identified stakeholder facilities.

Requirements for fiber optic cable are as follows:

- Design for single mode fiber strands.
- Define fiber optic cable backbone, drop buffer tube, and strand color requirements.

- Use 12 fibers as a minimum when lateral fiber optic cable drops to ITS field cabinets. Use 24 fibers as a minimum when lateral fiber optic cable drops to local ITS hubs with Layer 3 switches.
- Use 144 single-mode fibers as a minimum for fiber optic cable backbone in new systems.

233.5.1.1 Splices, Terminations, and Connection Hardware

Plans must provide the following:

- Splice points and splice diagrams.
- Interconnect fiber strands, origination, and destination points.
- Minimum link loss budget; including line, splice, and termination losses
- Reserve loss budget for future splicing and cable deterioration. Budget for future loss to equal one-half of the total decibels of the circuit or 10 decibels, whichever is greater.
- Splice enclosures to protect all fiber splices within splice trays. Number and size of splice trays and enclosures are based on the number of fibers involved in the splicing diagram at each splice location.
- Existing fiber optic cables and the location of the nearest full splices in the existing cables, including distance in each direction.
- Termination of fiber optic cables using a Fiber Patch Panel (FPP). Terminate single-mode fiber optic cable in the FPP or use pre-terminated FPP connectors.
- When the project work necessitates a break in the fiber cable, include provisions regarding allowable downtime. Provide any temporary splice drawings required during construction.

233.6 ITS Poles and Structures

Consider the following to locate and select ITS poles and structures:

- Existing ITS infrastructure, roadway features, device type (match existing), and environment.
- Road geometry, static signs spacing, lightning protection, underground utilities, and drainage infrastructure.
- Aesthetics, conflict avoidance, and line of sight issues.

- Soil boring information for the foundation design of the structures.
- Co-locating ITS devices to minimize the number of poles and structures.
- Pole type for each ITS device (e.g., pre-stressed concrete, steel) and structure type (e.g., cantilever, full-span, mid-span).

233.6.1 Camera Lowering Device

Provide a lowering device for pole-mounted cameras with mounting heights greater than 45 feet or where height impedes access via maintenance truck.

Design external conduit for housing the cables, mounting box hardware at the top of the structure, and component details required for installation (e.g., air terminal, guide wire) for a lowering device to be attached to an existing pole or similar structure.

Orient the lowering device to prevent an operator from standing directly beneath the equipment while it is being lowered.

233.7 ITS Enclosures

ITS enclosures include ITS field cabinets, small equipment cabinets, and equipment shelters. Each of these cabinets require an analysis for design, usage, and placement.

233.7.1 ITS Cabinets

Placement of ITS cabinets is based on the safety of the motorist, visibility of roadside devices, and safety of maintenance staff. Mount the ITS cabinets on concrete pads, structures, or poles. Do not place cabinets in flood-prone areas or wetlands. Place ground mounted DMS cabinets based on the DMS type. Cabinet mounting details are shown in [***Standard Plans, Index 676-010***](#).

Size the cabinet to accommodate equipment to be installed, ease of access, anticipated future equipment (e.g., connected vehicle roadside unit in-cabinet equipment), and proper ventilation. All cabinets within a project corridor should have a consistent layout for the interior by functionality. Orientate the cabinet such that the maintenance technician is facing oncoming traffic when accessing the cabinet. Show cabinet orientation and door swings in the plans.

Provide one power and one communication entry conduit for each cabinet, at minimum. Include additional conduit entries as required for the equipment to be housed. Include spare conduits in the cabinet for future expansion.

Provide maintenance service slabs in accordance with [Standard Plans, Index 676-010](#).

Consider mitigation strategies to prevent drop-off hazards from maintenance service slabs. Modifications to grading surrounding the maintenance service slab is preferred to the extent practicable. The use of retaining walls and railings should be limited to safety concerns in coordination with district ITS maintenance. If a railing is used, extend maintenance slab to provide a minimum of three feet, six inches of clear space beyond all sides of the ITS pole and cabinet constrained by the railing.

Coordinate with district ITS maintenance for deficiencies and other safety concerns at existing maintenance slab locations. If field reviews and documented safety concerns warrant refurbishment or replacement of any deficient maintenance slabs, seek approval from District ITS/TSM&O Engineer to make provisions in the plans to address the deficiencies.

233.7.2 Small Equipment Enclosures

Small equipment enclosures include structure- or pole-mounted cabinets (e.g., National Electrical Manufacturers Association (NEMA) 3R). These may be used in lieu of ITS field cabinets in locations that require minimal equipment to be housed. Small equipment enclosures may be connected to another ITS site, which houses the Ethernet switch and other ITS components. When locating the small equipment enclosure, consider the allowable power and communication loss per *IEEE 802.3ab* to District network speed requirements.

233.7.3 Equipment Shelter

Co-location of master hub equipment in existing FDOT-owned microwave tower buildings may be used in-lieu of new equipment shelters. Coordinate with the District ITS/TSM&O Engineer and the State Traffic Engineering and Operations Office's ITS Communications division to determine if co-location is possible.

If co-location is not possible, provide the following information in the equipment shelter details:

- (1) Site layout

- (a) Shelter dimensions.
 - (b) Site preparation work, clearing and grubbing, fencing, and landscape.
 - (c) Conduit and pull box installation.
 - (d) Details for grounding.
- (2) Shelter layout
- (a) Details for electrical and lighting.
 - (b) HVAC systems.
 - (c) Back-up power systems (e.g., UPS, generator, fuel tanks).
 - (d) Security features (e.g., cameras, security alarms).
 - (e) Remote monitoring alarms.
- (3) Equipment layout
- (a) Overhead cable trays.
 - (b) Standard EIA/TIA 19-inch racks.
 - (c) Demarcation punch blocks.
 - (d) Patch panels.
 - (e) Equipment placement within each rack.

233.8 Communication and Networking Devices

Network devices include a variety of Internet Protocol (IP)-addressable electronic equipment. This equipment is used for the collection and dissemination of video, traffic data, and other information.

Provide communication and networking devices that conform with the following:

- Network requirements and information for communication network design.
- Compatibility with existing network equipment currently in operation.
- Minimal system downtime to facilitate immediate replacement of defective or damaged units.
- Open architecture.
- Survivability and reliability.
- Redundant path and no single point of failure.

233.8.1 Managed Field Ethernet Switch (MFES) Network

Provide MFES network to avoid the following:

- Distance limitations for common Ethernet media types.
- Interference that may be induced on copper-based interconnects.
- Data size transfer limitations based on Gigabit Interface Converter (GBIC).

In the fiber network layout, provide a leap-frog configuration to support availability and optimal data transfer. Ensure no more than one DMS and no more than six CCTV devices are included on any one leap-frog circuit. Ensure that adjacent CCTV devices are on separate circuits.

233.8.2 Device Server

Include device servers when remote field devices with serial communication interfaces require connection to an Ethernet network.

Equipment that may require the use of device servers include:

- (1) Traffic data and vehicle detection systems.
- (2) Road Weather Information System (RWIS).
- (3) Low-speed data output devices.

233.8.3 Media Converter

Media converters may be used to transition between various types of interfaces.

233.8.4 Wireless Communications System

Determine the proper wireless communications system to fit the ITS application (e.g., point-to-point, point-to-multipoint). Consider reliability, security, capital, and operational expenditures, licensed versus unlicensed radio bands, and regulatory requirements for the wireless communications system selection.

Wireless systems enable data communications through radio links.

Typical applications for point-to-point wireless communications system includes:

- Remote ITS field devices or intersections that can use a wireless connection to the nearest fiber drop point.
- Across rugged terrain and bodies of water.
- The use of fiber optics is temporarily unavailable during construction; this use must be approved by the District ITS/TSM&O Engineer.
- ITS device sites where it is difficult or cost prohibitive to install fiber optic cables.

Typical applications for point-to-multipoint wireless communications system includes:

- Land Mobile Radio push-to-talk.
- Highway Advisory Radio.
- Citizens Band (CB) Radio.

The ITS Communications division maintains the Federal Communications Commission (FCC) licenses associated with ITS wireless communications and manages assignment of new licenses. Districts using wireless communications systems to support an ITS application are encouraged to contact State Traffic Engineering and Operations Office's ITS Communications division.

Specify each component in the wireless communications system including antennas, radios, transmission lines, and connectors. Provide installation details, location, and placement of the system components. Design cable management details. Consider the length between transmit and receive equipment to attain optimum communications signal.

Design line-of-sight, throughput, frequency, availability, power levels, and path calculations for the communications design plans as follows:

- Design the communication path so that two-thirds of the Fresnel Zone is clear of any obstructions (e.g., surrounding terrain, trees, signs, buildings).
- Set throughput capacity for each radio link to transmit two times more data than the maximum data throughput.
- Analyze multipath challenges over large water bodies and within urban street canyons (created by large buildings).
- Analyze spectrum interference in the vicinity.

Wireless communications shall not be used for communication to Express Lane ITS devices.

233.8.5 Layer 3 Switch

Within the ITS network, the Layer 3 switch provides connectivity at transmission rates of 1 or 10 Gigabit per second to and from adjacent Layer 3 switches.

The Layer 3 switch includes Layer 2 capabilities, including Quality of Service (QoS), Internet Group Management Protocol (IGMP), rate limiting, security filtering, and general management. The Layer 3 switch is fully compatible and interoperable with the ITS trunk Ethernet network interface.

The Layer 3 switch is a port based VLAN, supporting VLAN tagging, meeting the requirements of IEEE 802.1Q standard.

The selection of a Layer 3 switch involves variables suited for the proper environment. Items such as dual power supplies, dual supervisor units, Layer 3 protocols, and voltage requirements are considered during the switch selection process. Items such as number and type of ports are design specific. An MSP and custom pay-item are needed for all projects requiring a Layer 3 switch.

See **Form 233-A** (located in **FDM 103**) for desired Layer 3 switches.

233.9 Traffic Data and Vehicle Detection Systems

Include the location and placement of system components and provide installation details for the cables. Design the cabling installation details.

Consider capabilities and functional limitations at each location to attain the required levels of detection accuracy as specified in [Standard Specifications, Section 660](#).

Show detector types and locations on the plans to obtain traffic data such as speed, occupancy, and volume. Detector placement must conform to the following requirements:

- Cover all lanes in both directions (as a group or individually).
- Space one-third to one-half mile in urban areas (context classifications C4, C5 and C6).
- Space one mile in suburban areas (context classifications C3R and C3C).
- Space one to two-mile in rural areas (context classifications C1, C2, and C2T).
- Space one-fourth to one-third mile on express lanes.
- Place at major interchanges exit and entrance ramps.

- Place at intersection to detect vehicle presence at the stop bar, when required.

233.9.1 Loop Detectors

Do not use loop detectors on concrete pavement or on corridors with large traffic volumes of heavy vehicles. Consider using them at locations with low volumes of traffic.

233.9.2 Video Vehicle Detection Systems (VVDS)

Design considerations for VVDS include:

- Upstream versus downstream view orientation.
- Shoulder coverage to detect stalled vehicles.
- Detection zone layout to cover near and far zones.
- Roadway geometry and line of sight.
- Requirement to view VVDS images from the Transportation Management Center (TMC).
- High-contrast or low-light conditions that might interfere with VVDS data reliability.
- Maintenance requirements and impact of high winds on detector alignment and calibration.

233.9.3 Microwave Vehicle Detection Systems (MVDS)

Design considerations for MVDS include:

- Cover all lanes in both directions of travel.
- Provide offset mounting on structures.
- Avoid aiming toward steel structures.
- Align detector perpendicular to the roadway.
- Provide access for maintenance and calibration.
- Use Power over Ethernet when connecting to an ITS Field Cabinet within 330 feet.

On limited-access facilities, place MVDS devices at a maximum of 1-mile intervals for C1 and C2 context classifications and half-mile intervals for other context classifications. Additionally, place MVDS devices at all limited-access facility exit ramp locations or as directed by the District ITS/TSM&O Engineer.

Install MVDS at CCTV camera locations, if possible, to minimize costs. Install MVDS so that it does not interfere with the lowering of CCTV. Do not use roadway lighting poles or sign structures for the installation of CCTV cameras or MVDS.

233.9.4 Wireless Magnetometer Detection Systems (WMDS)

Design considerations for WMDS include:

- Determine the number and spacing of sensors based on detection requirements, e.g., three magnetometers may be required for truck parking.
- Align sensors such that they are placed in the direction of traffic flow or parking space.
- Provide access for installation, maintenance, and calibration.

233.9.5 Automatic Vehicle Identification (AVI) Systems

Design considerations for AVI systems include:

- (1) Follow manufacturer's requirements for AVI sensor placement, mounting height, offset, and line of sight.
- (2) Follow location and spacing based on District objectives for the AVI system. Potential locations include mid-blocks, major intersections, and locations prior to or after interchanges.

233.10 Closed-Circuit Television Systems

Closed-circuit television (CCTV) systems consist of roadside cameras, communication devices, as well as camera control and video display equipment. CCTV is located at one or more remote monitoring locations that allow surveillance of roadway and traffic conditions for traffic and incident management. Cameras are also required for visual confirmation of dynamic message signs and ramp signal operation, as well as security purposes.

Locate and place cameras to provide continuous view of general toll lanes, managed lanes, and limited-access roadways within the project corridor.

Design and placement considerations for CCTV cameras include:

- Continuous view of arterial roadways as directed by the Department.

- Coverage of roadway features including lanes, shoulders, ramps, ramp terminals, and designated emergency stopping, and crash investigation sites beyond the traveled way.
- Coverage of the master hubs, ITS cabinets, generators, and walk-in DMS. Ensure the CCTVs can view corresponding DMS clearly.
- Place cameras at interchanges to view arterial traffic.
- Place cameras for DMS verification no further than 1,000 feet from the face of the DMS with a clear line of sight within the horizontal and vertical viewing cone.
- Dedicated express lane cameras for verification must be capable of pan, tilt, and zoom (PTZ) for every DMS.
- Accommodate service and maintenance access with minimal impact to traffic.
- Utilize crash data analysis to place cameras at high-crash locations.
- Place the camera at a location with minimal vegetation obstruction within half-mile on each side.
- Identify locations for vegetation removal in the plans or propose closer spacing upon approval from the District ITS/TSM&O Engineer and District Landscape Architect.
- Locate the camera in accordance with minimum lateral offset requirements in **FDM 215**, or place behind existing guardrail and barrier walls. Avoid introducing new guardrail and barrier walls.
- Specify camera mounting height in the plans based on specific project needs. Mount cameras a minimum of 45 feet above the highest crown elevation of the mainline roadway on limited-access facilities. Consider the following in determining the mounting height:
 - Required viewing distance.
 - Roadway geometry and lane configuration.
 - Roadway functional classification (e.g., arterial, collector, limited access facility).
 - Environmental factors (e.g., glare from the horizon, headlight glare).
 - Vertical clearance.
 - Co-location with the other ITS devices.
 - Existing and anticipated vegetation.
- Do not place cameras on lighting structures.

- Avoid placing camera poles in the bottom of ditches or in locations that would prevent maintenance.
- Consider camera life-cycle cost, including maintenance costs.
- Consider CCTV performance and bandwidth requirements, control type, use of temporary cameras, and camera housing.

Design camera housings, enclosures, lowering devices, and mounts in accordance with the [Standard Specifications](#).

Refer to [Standard Plans](#), [Index 649-020](#) or [Index 641-020](#) for CCTV camera pole and foundation details. Refer to Department's [Standard Specifications](#), (Division II and III) Section 649 for Steel Pole and Section 641 for Concrete CCTV Pole.

233.11 Motorist Information Systems

Motorist Information Systems include DMS, Highway Advisory Radio (HAR), electronic display signs, and Citizens Band (CB) Radio.

233.11.1 Dynamic Message Sign (DMS)

Select the appropriate DMS type based on specific project needs. Position the DMS to be legible from the roadway based on the display characteristics of DMS technology (e.g., the vertical and horizontal viewing angles of LED displays).

Determine DMS placement based on the following requirements:

- Compatible with the message library proposed for use on the project, including text and graphics.
- Utilize DMS capable of displaying minimum character heights and line spacing per the [MUTCD](#), Section 2L.04.
- Place in advance of high crash locations and traffic bottlenecks.
- Place where sufficient space is available between the edge of travel lanes and the R/W limits, while meeting the minimum lateral offset requirements in **FDM 215**
- Place where no conflict with underground or overhead utilities exists.
- Accommodate access for service and maintenance.
- Place along key commuter or evacuation corridors.

- Place on Interstate and Freeway facilities in advance of interchanges that offer alternate routes, and meet the requirements of [MUTCD](#), Section 2L and the following:
 - Place in advance of 1-mile exit signing.
 - Provide a minimum 800-foot spacing between existing and planned overhead static and other signs, per the [MUTCD](#). Provide increased spacing when conditions allow.
 - Install walk-in DMS on support structures without static signage.
 - In advance of interchanges where interstates meet to allow for advance messaging of traffic conditions on both roadways. Consider locations that are two exits before major interchanges as well as immediately prior to the interchange.
 - Mount embedded DMS over or under the static sign panel or use a static sign cut-out.
- Place on arterials prior to major intersections and interchanges:
 - Approximately 1/4 to 1/2 mile in advance of major intersections or interchanges.
 - At least 600 feet from adjacent signalized intersections.
 - Where the DMS is continuously visible to motorists for 600 to 800 feet, depending on the design speed of the roadway.
 - Where no existing or planned guide signs exist within the 600-foot minimum visibility distance.
 - With minimum interference from lighting, adjacent driveways, side streets, or commercial signage.
 - Where no historical neighborhoods exist.

233.11.1.1 Express Lanes DMS

Express lanes DMS must be full-color or full-matrix DMS and conform to the following application criteria:

Table 233.11.1 DMS Characters

DMS Type		Minimum Character Size (inches)	Minimum Number of Characters Per Line	Maximum Resolution (millimeter pixel pitch)
Lane Status	LA Facility	18	18	20
	Arterial	12		
Toll Amount	LA Facility	18	7	
	Arterial	12		

233.11.2 Highway Advisory Radio (HAR)

A highway advisory radio (HAR) system is an advisory tool that informs the public of traffic- and safety-related issues. HAR systems may be installed or upgraded with the approval from the Chief Engineer. See Engineering and Operations Memorandum [16-03](#).

Include the equipment necessary for the operator to record verbal messages from onsite or remote locations, and to continually broadcast live, prerecorded, or synthesized messages from roadside transmission sites. Also, include highway signs with remotely operated flashing beacons to notify motorists of HAR broadcasts.

Refer to FCC regulations [Title 47 CFR, Part 90.242](#) for additional design requirements on travelers' information stations. Additional information on licensing issues, frequency allocation, and other specifics may be obtained by contacting the State Traffic Engineering and Operations Office's ITS Communications division.

Determine placement of a HAR installation based on specific project needs, as well as the following requirements:

- Transmission of message that can be received by motorists traveling through the broadcast zone.
- Placement on Interstate and Freeway facilities prior to interchanges that offer alternate routes.
- Placement in advance of high crash locations and traffic bottlenecks.
- Placement that accommodates access for service and maintenance.
- Placement along key commuter or evacuation corridors.

- Placement of flashing beacon signs within the HAR coverage area prior to exit signs or DMS associated with an interchange.
- Wood poles are often recommended by HAR manufacturers for antenna mounting to reduce interference that may occur with conductive poles. Install the antenna in accordance with the manufacturer's recommendations and in compliance with FCC requirements.

233.11.3 Electronic Display Signs

Place Variable Speed Limit (VSL) signs and Lane Control Signals (LCS) in accordance with:

- Locations per District requirements.
- Sign spacing per [MUTCD](#) requirements.

Specify field cabinet, support structure, power supply, and communications to support VSL and LCS installation.

233.11.4 Citizens Band (CB) Radio

The Department deploys CB radios to advise motorists (particularly commercial freight vehicles) about travel conditions and emergencies. The CB radio service operations and electronic equipment are regulated by the FCC in [Title 47 CFR, Part 95, Subpart D](#).

Operation of a remotely located CB radio station from a facility (e.g., a Transportation Management Center (TMC) where the operator is not co-located with the CB radio) requires a written waiver of the FCC rules. Contact State Traffic Engineering and Operations Office's ITS Communications division to obtain the required FCC waiver needed to remotely operate a CB radio.

233.12 Additional ITS Devices

This section includes information on other ITS devices that are TSM&O tools.

233.12.1 Road Weather Information System (RWIS)

RWIS consists of Environmental Sensor Station that incorporates multiple or single environmental sensor(s) (e.g., wind speed sensors, visibility sensors, pavement sensors)

that are attached to one pole. Location of Environmental Sensor Stations should consider the following:

- Place in locations where weather observations will be the most representative of the roadway segment of interest.
- Select locations to avoid the following:
 - Effects of passing traffic (e.g., heat, wind, splash).
 - Standing water.
 - Locations where billboards, surrounding trees, or other vegetation would affect the weather measurements.

For more information on appropriate location of ESS and additional design requirements, refer to the [***FHWA's Road Weather Information System \(RWIS\) Environmental Sensor Station Siting Guidelines, Publication No. FHWA-HOP-05-026.***](#)

Identify the appropriate communication platform for the RWIS application (e.g., copper, fiber, wireless).

Licensing for using satellite-based communications is required, and it must be coordinated by the Department with the National Oceanic and Atmospheric Administration (NOAA). Coordinate the use of satellite-based systems with the State Traffic Engineering and Operations Office's ITS Communications division.

233.12.2 Ramp Metering Signals

A ramp metering signal controls the number of vehicles entering a limited-access facility to maintain steady traffic flow. Consider the following when designing ramp metering signals:

- [***MUTCD***](#) signalization requirements for ramp signals (e.g., design of the signal system, number of signal heads, placement beside or over the ramp).
- Distance from the stop bar to the acceleration lane to allow vehicles starting from the signal to reach highway speeds and merge safely.
- Distance from signal stop bar to the cross-street intersection to allow adequate vehicle storage at the signal.
- Add two-lane storage upstream of stop bar from cross street to store additional vehicles and not spill over cross street if ramp meter is proposed on a single lane ramp and traffic analysis warrants the need.
- Placement of stop bar and queue length detection.

- Placement of detectors to support local or central ramp signal control algorithm in use by the District.
- Signing to support signal operation.

233.12.3 Connected Vehicle Infrastructure

Connected Vehicle (CV) is an emerging TSM&O strategy that generally falls into three application categories:

- Vehicle-to-Infrastructure (V2I).
- Vehicle-to-Vehicle (V2V).
- Vehicle-to-Others (V2X).

The V2X components include pedestrians, bicyclists, personal mobile devices, aftermarket safety devices (ASDs), and any other Internet of Things (IoT). The common communications source uses 5.9 GHz Dedicated Short-Range Communication (DSRC) or cellular communications to and from Roadside Units (RSUs) and On-board Units (OBUs).

Use the following national standards when designing CV infrastructure:

- United States Department of Transportation (USDOT) [DSRC RSU Specifications](#).
- Society of Automotive Engineers (SAE) [DSRC Message Set Dictionary](#), including Basic Safety Messages (BSMs) and Traveler Information Messages (TIMs).
- USDOT [Mapping Tool](#) or LiDAR for intersection mapping.
- USDOT Architecture Reference for Cooperative and Intelligent Transportation ([ARC-IT](#)).
- FCC, [Title 47 CFR](#), Parts 90 and 95L.
- USDOT Security Credential Management System ([SCMS](#)).
- Communications requirements for Internet Protocol version 6 ([IPv6](#)).

Consider the following for the RSU device placement:

- Co-location of devices with new or existing ITS or signal infrastructure.
- Availability of inside cabinet space for RSU-associated equipment.
- Antenna placement location.

- Wireless coverage.

Provide the RSU locations to the State Traffic Engineering and Operations Office's ITS Communications division and the District ITS/TSM&O Engineer to file for FCC licenses for all DSRC RSUs. FCC licenses must be granted before a station transmits on any channel.

233.13 Maintenance of ITS Devices and Communications

Coordinate with District ITS/TSM&O Engineer to determine if maintenance of ITS devices and communications during a construction project is required. Considerations for uninterrupted ITS devices and communications include the following:

- Install new ITS communications network before removing the existing network.
- Use of temporary fiber that is placed outside the limits of construction.
- Use of temporary aerial fiber or wireless communications.
- Use of other public or private communications.
- Make every effort to maintain existing ITS devices and field equipment. If ITS device locations are impacted by planned construction, include temporary ITS devices.

The maintenance of ITS devices and communications plan must be approved by the District ITS/TSM&O Engineer.

240 Transportation Management Plan

240.1 General

A Transportation Management Plan (TMP) is required for minimizing activity-related traffic delay and crashes. The goal of a TMP is to reduce congestion during construction by managing traffic through the project area. For TMPs, significant projects are defined as:

- (1) A project that, alone or in combination with other concurrent projects nearby, is anticipated to cause sustained work zone impacts.
- (2) All Interstate system projects within the boundaries of a designated Transportation Management Area (TMA) that occupy a location for more than three days with either intermittent or continuous lane closures.

Significant projects may require a multi-discipline TMP team to plan, coordinate, implement, monitor, and evaluate the details of TMP elements. Depending on the project logistics, the team composition may include FHWA, local government, and business representatives.

Complete the Transportation Management Plan Form, **Form 240** (See **FDM 103**). This form is required for all projects (significant or not) to document compliance with the **CFR 23, Part 630, Subpart J**.

240.1.1 TMP Reference Documents

Comply with the following documents for the development of TMPs:

- (1) **Manual on Uniform Traffic Control Devices for Streets and Highways, ([MUTCD](#)), Part VI**
- (2) **Policy on Geometric Design of Highways and Streets, AASHTO**
- (3) **Roadside Design Guide, AASHTO, Chapter 9**
- (4) **[Standard Plans](#), 102 Series and 711-002**
- (5) **FDOT Standard Specifications for Road and Bridge Construction ([Standard Specifications](#))**
- (6) **[Basis of Estimates Manual](#)**
- (7) **FDOT Accessing Transit Handbook, Chapter 4.6.**

- (8) ***AASHTO Guide for the Development of Bicycle Facilities, 4th Edition, Chapter 7***
- (9) [*Traffic Analysis Handbook*](#)

240.1.2 TMP Components

A TMP consists of strategies to manage the work zone impacts of a project. The scope, content, and degree of detail will vary based upon the expected work zone impacts of the project. A TMP may include the following three components:

- Temporary Traffic Control Plan
- Transportation Operations Plan
- Public Information Plan

240.2 Temporary Traffic Control Plan

A Temporary Traffic Control Plan (TTCP) is required for all work zones within, or adjacent to highways, roads and streets as specified by Florida Statute and Federal regulations. Typical applications of some commonly encountered situations are shown in the MUTCD. Some of these typical applications have been modified by the [*Standard Plans, 102 Series*](#). Most work zones will require further development of the typical applications to address project-specific conditions.

240.2.1 TTCP Details

240.2.1.1 Emergency Shoulder Use

The requirements for Emergency Shoulder Use (ESU) outlined in ***FDM 211.4.6*** must be maintained during all phases of construction. A Design Variation to omit ESU evacuation requirements for any phase of construction must be approved by the Chief Engineer.

240.2.1.2 Work Zone Speed

Work zone speed is used with the [*Standard Plans, 102 Series*](#), and to select geometric elements within the project limits.

Work zone speed should be the existing posted speed. The existing posted speed is defined as the posted speed prior to the start of any work zone activity. A reduction from

the existing posted speed should only be made when geometric constraints make it necessary or when implementing the Motorist Awareness System (MAS) in accordance with **FDM 240.2.2.12** and **[Standard Plans, 102 Series](#)**. Include the justification for reduction in existing posted speed in the project documentation (see **FDM 111.7**). The TTCP and the project documentation will suffice as a traffic and engineering investigation.

A work zone speed more than 10 mph below the existing posted speed requires the approval of the District Traffic Operations Engineer, and the District Director of Transportation Operations.

A work zone speed below the minimum statutory speed for the class of facility is prohibited.

For projects with interspaced work activities (such as interstate resurfacing), locate speed reductions in proximity to those activities which merit a reduced speed, and not “blanketed” for the entire project.

240.2.1.3 Tapers

Transitions and tapers should be obvious to drivers. If sight distance is restricted (e.g., a sharp vertical or horizontal curve), the taper should begin well in advance of the view obstruction.

Temporary Traffic Control (TTC) devices at intersections must provide sight distances for the road user to perceive potential conflicts and to traverse the intersection safely.

See the **[Standard Plans, 102 Series](#)** for taper length requirements.

See **FDM 210** for required sight distance using the work zone speed.

240.2.1.4 Superelevation

The minimum radii where superelevation is not necessary are provided in **Table 240.2.1**.

When superelevation is provided, specify the superelevation in accordance with **FDM 210**.

Table 240.2.1 Minimum Radii for Normal 0.02 Cross Slopes

Minimum Radii for Normal Cross Slopes (Feet)									
Work Zone Speed (mph)									
25	30	35	40	45	50	55	60	65	70
290	430	610	820	1080	1390	1840	2400	3130	4090

For Turnpike Projects, use superelevation criteria described in **FDM 210** and **211**.

240.2.1.5 Lane Widths

See [Standard Plans, 102 Series](#) for lane width requirements.

240.2.1.6 Lane Closure Analysis

Lane closure analysis is a process used to calculate the peak hour traffic volume and the restricted capacity for open road and signalized intersections. The analysis will determine if a lane closure should be allowed and the times during which a lane closure can occur without causing excessive travel delay.

Common uses for lane closures include:

- Reconstruction, rehabilitation, or resurfacing of travel lanes or shoulders
- Provide lateral offset to the work area
- Staging of construction equipment
- Bicycle and pedestrian accommodations

Many roadways have directional peak hour traffic volumes, with inbound morning traffic, and outbound afternoon traffic. A composite lane closure analysis would, in many cases, require night work or create very short allowable lane closure periods. If a lane closure analysis is calculated for inbound and outbound separately, night work may be avoided and longer lane closure periods may be allowed.

On limited access facilities, include a traffic analysis of any ramp affected by the lane closure.

When a closure of one or more lanes is necessary, provide an allowable lane closure duration of at least one ten-hour period per 24-hour work period. Approval by the State Roadway Design Engineer is required when at least one ten-hour-period per 24-hour work period cannot be provided.

A lane closure duration of more than one calendar day on limited access facilities is prohibited. If a lane closure duration of more than one calendar day on limited access facilities is unavoidable, obtain approval from the District Secretary or Turnpike Executive Director.

See **FDM 241** for the lane closure analysis process and worksheet example.

240.2.1.7 Traffic Pacing

Traffic pacing is a temporary traffic control technique that allows short duration work operations by pacing traffic at a slow speed upstream of the work zone. The Department frequently allows this technique for:

- Installing overhead sign structures
- Replacing sign panels
- Placing bridge beams
- Installing utility crossings

See the [Standard Plans](#) for additional traffic pacing information.

Specify traffic pacing restrictions for all multilane roadways with a work zone speed of 50 mph or greater. See **FDM 242** for the procedure for calculating the traffic pacing restrictions.

Obtain District Traffic Operations Engineer approval prior to adding traffic pacing into the TTCP.

For limited access roadways, include a contingency plan in the event that the construction activities last longer than the allowable pacing timeframe. This plan must note that it will only be used at the direction of the Construction Project Manager.

240.2.1.8 Detours, Diversions, and Lane Shifts

Detour: A redirection of motorized and non-motorized traffic onto an alternate route, using state roads or local (county or city) roads, to bypass the work zone.

Diversion: A redirection of motorized and non-motorized traffic onto temporary pavement adjacent to the existing or permanent roadway.

Lane Shift: The redirection of motorized and non-motorized traffic onto a different section of the permanent roadway or shoulder.

Design detours, diversions, and lane shifts in accordance with **FDM 240.2.1.9** and the following:

- Maintain existing shoulder width where practicable, but no less than:
 - 2 feet for limited access roadways or roadways with existing paved shoulders less than 4 feet, or
 - 4 feet (i.e., maintain bicycle facility) for all other roadways.
- For offsets to barriers and special considerations (e.g., refuge areas or emergency vehicle access), see **FDM 215**.
- Special detours from a divided highway to an undivided condition must separate opposing traffic using either temporary barrier or temporary lane separators in accordance with the [Standard Plans](#). The use of striping, RPMs, and complementary signing, either alone or in combination is not considered acceptable for separation purposes.
- Minimize interruption of local transit operations and coordinate with emergency services.
- For diversions on high-speed multilane facilities, place cross-slope break overs on lane lines except when the lane is actively transitioning.
- Meet the requirements in **FDM 211** for lane cross slopes on limited access facilities.
- Pavement drop offs must be no more than 2 inches away from a lane line.
- Check spread to verify that the provided shoulder width complies with the criteria in **Chapter 3.9.1** of the [FDOT Drainage Manual](#).

Ramps that service tandem trucks must entirely accommodate the WB-109D truck turning radius within the longitudinal pavement markings of each lane.

In addition to the requirements above, design detours in accordance with the following:

- Detour signing must convey clear direction allowing users to safely traverse the entire detour and return to the original path of travel.
- When developing a detour, consider the type of motorized traffic being routed (e.g., vertical clearance for large vehicles). Do not route large vehicles through a U-turn.

- Consider the structural capacity of the detour pavement.
- Obtain concurrence from the local agency when detours are to utilize local roadways.
- Include truck turning templates and AutoTurn Analysis in the TTCP design documentation.

240.2.1.9 Bicycle, Pedestrian, and Transit Accommodation

Include accommodations for the following road users of all ages and abilities in the TTCP:

- Pedestrians
- Bicyclists
- Transit users

Provide accommodations on Florida National Scenic Trail and SUN Trail.

ADA requirements apply during TTC. Include provisions at the same level of accessibility as the existing facility or greater. See [Standard Specifications, Section 102](#) and *FDM 222, 225* for more information.

Minimize impacts to existing bicycle, pedestrian, and transit facilities by preserving the following to the extent feasible:

- Safety and accessibility features
- Connectivity of the facilities to and through the project
- Directness of the routes

Incorporate the following requirements into the TTCP:

Design Principles for Temporary Bicycle and Pedestrian Facilities:

- (1) Provide like-for-like bicycle and pedestrian facilities to the maximum extent feasible. When this cannot be accomplished for bicycle facilities, separate motorized traffic from bicycle traffic whenever possible. The higher the volumes of motorized traffic or percentage of truck traffic and the longer the duration of construction, the more substantial the separation should be.

Specify temporary bicycle ways that replicate the geometric characteristics of the existing bicycle way. For example, a separated bicycle facility should remain

separated during construction. See **FDM 223** for more information on separated bicycle facilities.

- (2) Phase the construction plans to ensure bicycle and pedestrian facilities are only closed when necessary. Phasing has the following advantages:
 - Restricts bicycle and pedestrian network disruption to smaller segments of the project at a time
 - Limits the number and use of TTC devices on a project to those areas where the bicycle and pedestrian network is currently being disrupted

See **FDM 921** for more information on phasing.

- (3) See **Standard Plans, Series 102** for additional information and requirements on pedestrian facilities in work zones.
- (4) Provide temporary barrier per **FDM 215** where temporary pedestrian ways divert pedestrian traffic to be immediately adjacent to vehicular traffic (e.g., a paved shoulder) or when a separated bike lane has been moved. This does not apply to temporary pedestrian ways behind curb.
- (5) Ensure work zones adjacent to sidewalks or temporary pedestrian ways provide separation between pedestrians and the work area.

Location of Temporary Routes for Pedestrians and Bicyclists:

- (1) Do not lead pedestrians or bicyclists into direct conflicts with vehicles, equipment, or operations.
- (2) Keep detour lengths and diversions as short as practicable.
 - (a) Detours should not create more than a 30% increase in the length of the non-motorized facility, or not longer than 0.5 miles for bicyclists or 0.25 miles for pedestrians.
 - (b) To minimize the detour length, consider providing a temporary mid-block crosswalk instead of detouring pedestrians to the nearest signalized intersection or existing crosswalk.
- (3) The order of preference for routing:
 - (a) Maintain facility on the same side of the road.
 - i. Narrow the temporary bicycle way or temporary pedestrian way if needed.
 - ii. Consider closing one lane of motorized traffic to accommodate non-motorized traffic of bicycle or pedestrian facilities with high usership.

- Separate motorized traffic from pedestrians by providing a temporary barrier where feasible per **FDM 215**, or by providing LCDs to delineate the temporary pedestrian path.
- iii. If the existing bicycle facility is a shared use path or separated bike lane and separation for bicyclists, such as a temporary bike lane, is not possible, then bicyclists may be directed onto a temporary or permanent pedestrian way of a min. width of 8 feet.
 - iv. When the existing bike facility is a bicycle lane, marked shoulder, or paved outside shoulder 4' or greater in width, and the work zone speed is 35 mph or less, then bicyclists may be directed onto the travel lane. Provide portable changeable message signs (PCMS) letting motorists know bicyclists will be detoured onto the road, per **FDM 243**. For example:
 - Bike Facility Closed, Bicycles on Road
 - Bike Detour Ahead, Bicycles on Road
- (b) Diversion to the opposite side of the road. Return to original side of road as soon as possible. For two-lane two-way work within the traveled way, additional bicycle accommodations are not necessary. Standard flagging procedures allow bicyclists to use the opposite shoulder.
- i. Phase the construction so bicycle or pedestrian facilities will be open on the other side of the road if facilities cannot be provided on the same side of the road.
 - ii. Choose crossing points with adequate stopping sight distance.
 - iii. If using temporary midblock crossings, meet the criteria in the [TEM](#) for permanent midblock crosswalks. Consider the use of temporary traffic signals or RRFBs with temporary midblock crossings. See **FDM 240.2.2.8** and the [TEM](#) for more information.
 - iv. Warn motorized and non-motorized traffic there are extra pedestrian or bicycle crossings through portable changeable message signs (PCMS) per **FDM 243**. For example:
 - Bike Detour Ahead, Ped Detour Ahead
 - Use Caution, People Crossing Ahead
 - Use Caution, Bicycle Crossing Ahead
 - Use Caution, Ped Bike Crossing Ahead
 - Use Caution, New Xwalks Ahead

- Use Caution, New Cross Walks
- Use Caution, New Xwalks 500 Ft
- v. Facilitate left turns for bicyclists. Consider whether accommodations can be made for two-stage left turns where appropriate.
- (c) Detour to another road. Return to original road and side of road as soon as possible.
 - i. Coordinate with the owner of the facility pedestrians or bicyclists will be detoured onto.
 - ii. Notify motorists on the detoured road through portable changeable message signs (PCMS) per **FDM 243** if there are additional crossings or if bicyclists will be detoured to a shared lane condition. Motorists may not be aware of the construction project that has caused the need for re-routing. For example:
 - Bike Facility Closed, Bicycles on Road
 - Bike Detour Ahead, Bicycles on Road
 - Use Caution, People Crossing Ahead
 - Use Caution, Bicycle Crossing Ahead
 - Use Caution, Ped Bike Crossing Ahead
 - Use Caution, New Ped Xing Ahead
 - Use Caution, New Cross Walks
 - Use Caution, New Xwalks 500 Ft
- (d) Where the above options are not feasible or are cost prohibitive, consider the use of a vehicle transport service. Show accessible pickup and drop off locations in the TTCP. Coordinate with District Design Engineer and District Construction Engineer.

Transit Users:

Ensure provision is made to allow transit users to access transit stops, and to board and depart transit vehicles safely. Temporary transit access must include provisions at the same level of accessibility as the existing facility or greater. See FDOT's [Accessing Transit Handbook](#) for guidance on transit stops.

240.2.1.10 Railroads

Ensure that the TTCP does not cause queuing of traffic across railroad tracks. Evaluate the signal timing, tapers, lane closures and distance to intersections as compared to projected peak traffic volumes. Evaluate the effects of the TTCP on interconnected traffic signals and railroad signals to avoid conflicting or ineffective signal controls.

240.2.1.11 Utilities

If contract utility work is anticipated in conjunction with or during the highway construction, the TTCP must account for and adequately protect all work activities. The phasing of construction activities must be compatible with the utility work. Utilities, whose work affects traffic, are required by FHWA to provide a TTCP. This requires early and effective coordination with utilities.

240.2.1.12 Existing Traffic Signals

Adjust signal heads to maintain proper position when lane shifts are necessary and determine the need for temporary vehicle detection. Coordinate required modifications to existing traffic signal operations with the District Traffic Operations Engineer and show signal adjustments in the TTCP.

Provide signal installation plans that specify the preliminary phasing and timing for each phase of construction in the TTCP. Include project specific requirements (e.g., equipment harmonization or operational responsibilities), in the Technical Special Provisions. Signal displays and location must meet [MUTCD](#) requirements.

240.2.1.13 Roadside Hazards

See **FDM 215** and [Standard Plans, 102 Series](#) for information on the shielding of roadside hazards.

240.2.1.14 Drop-offs in Work Zones

See [Standard Plans, 102 Series](#) for requirements related to drop-offs in work zones.

240.2.1.15 Bridge Construction

To facilitate the development of an optimal design minimizing traffic disruption and construction costs, the roadway engineer and structures engineer must collaborate with each other prior to completion of Phase I roadway plans or the Bridge Development Report (BDR), whichever is earlier. For very complex urban projects, this collaboration should begin as early as the PD&E phase of the project.

Modification for Non-Conventional Projects:

Delete **FDM 240.2.1.15** and replace with the following:

240.2.1.15 Bridge Construction

To facilitate the development of an optimal design minimizing traffic disruption and construction costs, collaboration between the roadway engineer and structures engineer is required.

240.2.1.16 Emergency Pull Off Area

For long-term TTC operations on Limited Access roadways, include a paved emergency pull off area when the shoulder width is reduced to less than eight feet for a distance of one mile or more. The preferred location is to the right of the outside travel lane. Coordinate these locations with the District Traffic Operations Engineer to accommodate road users and emergency personnel.

The emergency pull off area must meet the following:

- Minimum of twelve feet wide and 500 feet long
- Located every ½ to 1 mile, but not closer than ½ mile from an interchange
- Maintain the adjacent lane or paved shoulder cross slope
- Include chevron pavement markings at 60-foot spacing
- Do not locate an emergency pull off area near an ingress/egress location for the contractor.

240.2.2 Temporary Traffic Control Devices

The [MUTCD](#) contains detailed instructions on the use of traffic control devices. Special design considerations applicable to Florida are discussed in the following sections.

Temporary traffic control devices should not be placed in locations where they will block or interfere with transit stops, pedestrians, or bicycle traffic.

240.2.2.1 Signs

The following types of signs are encountered in temporary traffic control:

- Work Zone Signs
- Existing Signs

Work Zone Signs:

Work zone signs are typically post mounted in accordance with [Standard Plans, 102 Series](#).

Signing for the control of traffic entering and leaving work zones by way of intersecting roadways must be adequate to inform drivers, cyclists, and pedestrians of work zone conditions. At a minimum, provide a "Road Work Ahead" sign.

If the work zone interrupts the continuity of an existing bicycle or pedestrian way, then provide signs directing non-motorists alongside or around the work zone and back to the bicycle or pedestrian way.

See the [Standard Plans, 102 Series](#) for required work zone signs and placement.

Existing Signs:

Specify covering, removing, or relocating existing regulatory or warning signs that conflict with the TTCP, or to complement the work zone conditions (e.g., if a stop sign on an existing side road is needed, use the existing sign and show the location that it is to be relocated to).

Modify existing guide signs to show changes made necessary by the construction operations. If existing guide signs are to be removed during construction, make provisions for temporary guide signing. The temporary sign should be black on orange

with the legend designed in accordance with [MUTCD](#) requirements for permanent guide signing.

240.2.2.2 Work Zone Pavement Markings

Specify the use of work zone pavement markings in accordance with *FDM 230* and [Standard Specifications, Section 102](#).

240.2.2.3 Temporary Raised Pavement Markers

Temporary Raised Pavement Markers (RPMs) are used to supplement work zone pavement markings in accordance with [Standard Plans, 102 Series](#) and [Standard Specifications, Section 102](#).

240.2.2.4 Channelizing Devices

Channelizing devices direct road users through the work zone. Specify the use of channelizing devices in accordance with the [Standard Plans, 102 Series](#) and [Standard Specifications, Section 102](#).

240.2.2.5 Pedestrian Longitudinal Channelizing Devices

Specify the use of pedestrian Longitudinal Channelizing Devices (LCDs) for the following situations:

- At each closed pedestrian way location, for the full width of the pedestrian way
- In locations where a drop-off hazard exists (see [Standard Plans, 102 Series](#))
- In locations where the active work zone is within 2 feet of the sidewalk or pedestrian walkway
- Along both sides of a temporary pedestrian way
 - Pedestrian LCDs are not required on sides where an existing or temporary barrier delineates the temporary pedestrian way.

240.2.2.6 Arrow Boards

Specify the use of arrow boards to supplement other devices for lane closures on multilane roadways. Refer to the [MUTCD](#) for further information.

240.2.2.7 Portable Changeable Message Signs

Specify the use of Portable Changeable Message Signs (PCMS) as a supplemental device to provide road users with the following information:

- (1) Construction schedules
- (2) Alternate routes
- (3) Expected delays
- (4) Detours, diversions, and lane shifts

A PCMS is not to be used to replace any required sign or other device. See **FDM 243** for requirements in determining the appropriate uses and messages for the PCMS.

240.2.2.8 Temporary Traffic Signals

Design and detail temporary poles and span wire assemblies for temporary traffic signals using the following criteria:

- (1) Design temporary signal supports for a 100-mph wind speed. See [Structures Manual, Volume 3](#) for additional requirements.
- (2) See Lateral Offset Criteria in **FDM 215** for placement of temporary traffic signal supports.

Provide sufficient signal timing for pedestrians where a pedestrian crossing is present.

Include temporary traffic signals in the TTCP in accordance with **FDM 240.2.1.12**.

240.2.2.9 Type III Barricades

Specify the use of type III barricades to close or partially close a roadway or ramp. Two barricades are typically used for a 12-foot-wide lane. One barricade should be used for lanes less than 12 feet in width.

240.2.2.10 Temporary Barrier

See [Standard Plans, 102 Series](#) and *FDM 215* for temporary barrier requirements.

240.2.2.11 Law Enforcement Officers

Law enforcement officers are used to heighten the awareness of passing vehicular traffic and to improve safety through the work zone. The following types of law enforcement officer are used in temporary traffic control:

- Speed and Law Enforcement Officer
- Traffic Control Officer

Speed and Law Enforcement Officer:

Speed and law enforcement officers are used to control the speed of motorists in the work zone. Speed and law enforcement officers should be considered for the following work zone conditions:

- (1) Speed reductions
- (2) Temporary barrier adjacent to through traffic
- (3) Nighttime work
- (4) Workers exposed to high-speed traffic

For limited access facilities, coordinate with District Construction when encountering the above criteria. Speed and law enforcement officer use on arterials and collectors requires approval from the District Director of Transportation Operations.

Traffic Control Officer:

Traffic control officers are used to increase the visibility of the work zone or work operation. Uniformed law enforcement officers are respected by motorists, cyclists, and pedestrians. Utilize traffic control officers as a supplement to traffic control devices to assist in traffic movements and provide a safer work zone.

Specify the use of traffic control officers in accordance with [Standard Specifications, Section 102](#).

240.2.2.12 Motorist Awareness System

A Motorist Awareness System (MAS) is used to alert motorists to the presence of an active work zone and to emphasize reduced speed limits. A MAS consists of the following devices:

- Portable Regulatory Sign
- Radar Speed Display Unit

Specify the use of a MAS in accordance with [Standard Plans 102-613](#).

For a posted speed of 65 mph or greater, reduce the work zone speed by 10 mph. For a posted speed of 60 mph, use a work zone speed of 55 mph.

Portable Regulatory Sign:

A Portable Regulatory Sign (PRS) is used to highlight the work zone speed. A portable regulatory sign consists of a speed limit sign with flashing lights mounted on a portable trailer. The flashing lights are intended to draw attention to the speed limit sign.

Radar Speed Display Unit:

A Radar Speed Display Unit (RSDU) is used to display a motorist's current speed. A radar mounted on the unit detects the speed and relays it to a LED display panel adjacent to a static speed limit sign.

240.2.2.13 Temporary Raised Rumble Strips

Temporary raised rumble strips are used to warn vehicular traffic of the upcoming work zone. Specify the use of temporary raised rumble strips when both of the following conditions occur:

- Lane closure on a two-lane, two-way roadway
- Existing posted speed prior to construction is 55 mph or greater

240.2.2.14 Temporary Lane Separator

Temporary lane separator should be used to separate opposing traffic on previously divided roadways with a work zone speed of 45 mph or less.

See [Standard Plans, 102 Series](#) for temporary lane separator details.

240.2.2.15 Temporary Highway Lighting

When practical, existing highway lighting is to remain in service during all phases of construction or until new lighting is installed and placed in service. Temporary highway lighting is not required where it is necessary to remove existing lighting before new lighting is placed in service.

Use temporary highway lighting at the District's discretion. For example, Districts may determine that temporary highway lighting is warranted for areas such as interchanges or other large roadways with complex vehicle movements. When temporary highway lighting is used, provide plans content per **FDM 943** and comply with the following:

- (1) Meet the lighting criteria in **Table 231.2.1**, except that the illumination levels may be lowered to a range of 0.8 to 1.0 foot-candles at the District's discretion. Leeway may be given for lighting values given the temporary nature.
- (2) Position lights as high as practical, with consideration for avoiding glare.
- (3) Meet minimum lateral offset criteria in **Table 215.2.2**.
- (4) Utilize structural supports that are crashworthy or shielded by a crashworthy barrier that was installed for other purposes.
- (5) Utilize structural supports that are attached to and located behind permanent or temporary concrete barriers (or traffic railings) as follows:
 - (a) Do not install temporary barrier for the sole purpose of supporting or protecting the temporary lighting system.
 - (b) Do not locate structural supports for temporary lighting on the back side of permanent or temporary barriers/traffic railings if the back side of the barriers/traffic railings are within the work zone clear zone (per [Standard Plans, 102 Series](#)) of other traffic lanes.
 - (c) Attach structural supports to the back face of temporary and permanent barriers/traffic railings using brackets that do not protrude above the top of the barrier/traffic railing.
 - (d) Use undercut anchor or screw anchor systems for attaching brackets to barriers/traffic railings. Use stainless steel or mechanically galvanized carbon steel anchors. Position anchors as to avoid the reinforcing steel within the barrier/traffic railing.
 - (e) Design the luminaire pole, support brackets, and anchors for a 100-mph wind speed.

- (f) Do not design luminaire pole, support brackets and anchors for vehicular impact loads.
 - (g) For structural supports attached to and located behind permanent concrete barriers/traffic railings, provide a minimum setback distance from the top edge of the traffic face of the barrier/traffic railing to the traffic face of the luminaire pole in accordance with **FDM 215**.
 - (h) For structural supports attached to and located behind [Standard Plans, 102 Series](#) (Type K Temporary Concrete Barriers), provide a minimum setback distance of 1'-6" from the top edge of the traffic face of the barrier to the traffic face of the luminaire pole. To minimize the potential for damaging reinforcing steel during the installation of the anchors, attach brackets within the middle portion, where there is large spacing between the vertical steel reinforcing bars, of the Type K Barrier Unit.
 - (i) Temporary lighting must only be attached to a continuously anchored Type K Temporary Concrete Barrier System.
 - (j) The supports attached to Type K Temporary Concrete Barrier must not encroach into the required deflection distance when the barrier is shielding an above ground hazard.
- (6) For temporary highway lighting near a wildlife area of concern (as determined by the Environmental Management Office), comply with the Wildlife-Sensitive Lighting criteria in **FDM 231**.

240.2.2.16 Overhead Bridge Related Construction Activities

There are several overhead work activities that must be executed without traffic below. **Table 240.2.2** provides typical work durations for common overhead bridge related work activities. The work activity durations given in the table assume a best-case scenario in which the Contractor has optimized resources and work planning in advance to minimize traffic disruption.

Table 240.2.2 Typical Durations for Overhead Bridge Work

Work Activity	Duration
Bridge Demolition	2 to 3 days per span
Beam Placement Simple Span	30 minutes per beam
Beam Placement Continuous Steel I-Beam	60 minutes per beam
Beam Placement Continuous Steel Box Girder	90 minutes per girder, depending on the complexity of the connections
Form Placement	4 hours per lane
Deck Concrete Placement	3 hours per span
Span Sign Structure Placement	20 to 25 minutes per structure
Segment Placement from Land Based Cranes (Balanced Cantilever)	2.5 hours per segment

240.2.2.17 Temporary Structures

The use of temporary structures is often required to allow for the installation of the permanent structure. Temporary structures commonly used for the construction of highway structures include temporary stability towers and temporary sheet pile walls.

Temporary stability towers are commonly used for the erection of segmental bridges constructed in balanced cantilever, steel plate girders, and steel box girders. Temporary sheet pile walls are commonly used for the construction of pier footings or to facilitate the installation of MSE wall straps. It is important to show the location of all temporary structures in each phase of the TTCP to assure there are no conflicts. See **FDM 215** to determine if temporary structures must be shielded.

240.2.2.18 Temporary ACROW Bridge

When using a temporary ACROW bridge, include “Legal Weight Only” sign in accordance with [Standard Plans, Index 700-102](#) and [Index 700-107](#). Specify “Slippery When Wet” (W8-5) signs in advance of all temporary ACROW bridges when an asphalt overlay is not used. See [Standard Plans, 102 Series](#) and the associated [Standard Plans Instructions \(SPI 102-200 for the 300 Series and 102-201 for the 700 Series\)](#) for more information.

For limited access facilities, the ACROW Series 700 bridging must be used. All temporary bridges require a project-specific foundation design.

Coordinate with the State Maintenance Office in a timely fashion because there is a limited quantity of Department-owned temporary ACROW bridges available.

240.2.2.19 Short-Term Raised Rumble Strip Sets

In locations with existing raised rumble strip sets (e.g., intersections, approaches to horizontal curves, toll plazas), maintain or replace the raised rumble strip sets throughout construction. Provide short-term raised rumble strip sets when existing raised rumble strip sets are removed for construction activities, until the permanent raised rumble strip sets are installed. Short-term raised rumble strip sets must be installed prior to opening the road to traffic; therefore, quantities may include multiple applications due to construction phasing. Refer to [Standard Plans](#), *Index 546-001* and [Standard Specifications](#), *Section 546* for additional requirements and information.

240.2.2.20 Limited Access Exit Ramp Opening

Meet the requirements of the [MUTCD](#), *Part 6* for work near a limited access facility exit ramp and include a minimum ramp opening of 200 feet. See *Figure 240.2.1*.

Figure 240.2.1 Work in the Vicinity of an Exit Ramp

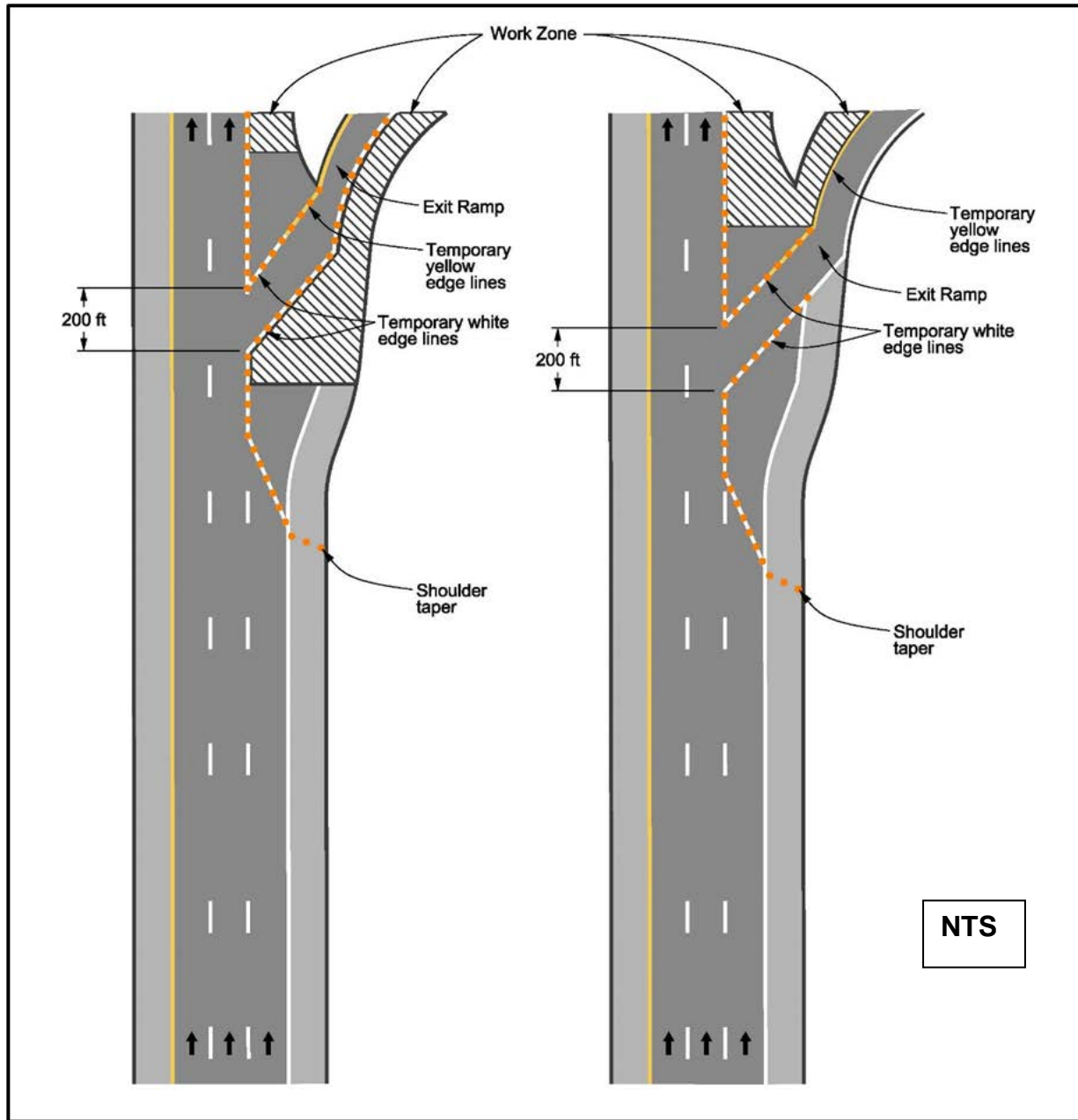

240.2.2.21 Temporary Drainage

Refer to the *FDOT [Drainage Manual](#)* for temporary drainage criteria. Additional guidance can be found in the *[Drainage Design Guide](#)*.

240.3 Transportation Operations Plan

The Transportation Operations Plan (TOP) contains strategies to improve mobility, work zone access, and safety. Strategies will include items such as work zone Intelligent Transportation System (ITS) components and incident management. **Table 240.3.1** provides common TOP items.

A TOP should be considered for significant projects, as defined in **FDM 240.1**.

Table 240.3.1 Transportation Operations Strategies

Category			
Demand Management	Corridor/Network Management	Work Zone Traffic Management	Safety Management and Enforcement
Transit services improvements	Signal timing/ coordination improvements	Speed limits reduction or variable speed limits	ITS for traffic monitoring and management
Transit incentives	Temp. traffic signals	Temp. traffic signal	Transportation Management Center (TMC)
Shuttle services	Intersection improvements	Temp. barrier	Aerial surveillance
Ridesharing/ carpooling incentives	Bus turnouts	Crash Cushions	Milepost markers
Park-and-Ride promotion	Turn restrictions	Automated flagger assistance devices (AFAD)	Service patrol
HOV lanes	Truck restrictions	On-site safety training	Local detour routes
Variable work hours	Dynamic lane close system	TMP inspection team meetings	Contract support for incident management
Telecommuting	Ramp closures		Incident/emergency response plan
	Railroad crossing controls		Law enforcement
			Emergency Access, Emergency Pull Off Areas, Glare Screens

240.4 Public Information Plan

The Public Information Plan (PIP) describes how project information will be communicated to affected parties, traveling public, and project stakeholders prior to and during construction. The PIP will also describe the most efficient method of communicating this information (e.g., local media, business groups, message signs). The PIP should be integrated into the project's Community Awareness Plan (CAP) when the CAP is to include communication strategies.

A PIP should be considered for significant projects, as defined in **FDM 240.1**.

See the following for additional information on public involvement and CAP requirements:

- (1) **FDM 104**
- (2) [Public Involvement Handbook](#)
- (3) [PD&E Manual](#)

240.5 Temporary Traffic Control Training

The Department has prescribed temporary traffic control training requirements outlined in the [Temporary Traffic Control \(Maintenance of Traffic\) Training Handbook](#).

241 Lane Closure Analysis

241.1 General

See **FDM 240** for requirements and criteria concerning lane closures.

241.2 Lane Closure Excel Program

An Excel file is available to assist in the preparation of the Lane Closure Worksheet. The program can be found at the Department's TTC Resources web page: [TTC Resource Download Library](#). The Excel worksheet is based on the methods presented in this chapter; Districts may require alternate methods.

The Excel worksheet also illustrates two examples: a widening project and a resurfacing project.

241.3 Lane Closure Symbols and Definitions

The following symbols and definitions provide detail and guidance on the variables to be entered into the Input Data Sheets. The number provided in the circle corresponds to the circled number found on the Lane Closure Worksheet in **FDM 241.5**.

- ① ATC Actual Traffic Counts. Use current traffic counts. Traffic counts can be obtained from the Office of Planning, or you may need to get traffic counts done. The designer needs hourly traffic volumes with a total traffic volume for a 24-hour period (see **Figure 241.7.1**).
- ② P/D Peak Traffic to Daily Traffic Ratio. Highest hourly volume divided by the total 24-hour volume. Convert the percentage to a decimal on the Lane Closure Worksheet (see **Figure 241.7.1**).
- ③ D Directional Distribution of peak hour traffic on multilane roads. This factor does not apply to a two-lane roadway converted to two-way, one-lane. The directional distribution can be obtained from the Office of Planning.
- ④ PSCF Peak Season Conversion Factor. Many counties in Florida have a significant variance in seasonal traffic. Use the PSCF for the week in which the actual traffic count was conducted. The [Transportation Statistics Office](#) has tables showing Peak Season Conversion Factors for every county in Florida. These tables are found in the [Florida Traffic](#)

[Online](#) mapping application by selecting “Traffic Reports” from the toolbar on the right side of the screen.

- ⑤ RTF Remaining Traffic Factor is the percentage of traffic that will not be diverted onto other facilities during a lane closure. Convert the percentage to a decimal on the Lane Closure Worksheet. This is an estimate that the designer must make on his own, or with help from the Office of Planning. Range: 0% for all traffic diverted to 100% for none diverted.
- ⑥ G/C Ratio of Green to Cycle Time. This factor is to be applied when lane closure is through or within 600 ft. of a signalized intersection. The Office of Traffic Engineering has timing cycles for all traffic signals.
- ⑦ V Peak Hour Traffic Volume. The designer calculates the peak hour traffic volume by multiplying the actual traffic count, times peak to daily traffic ratio, times directional factor, times peak seasonal factor, times remaining traffic factor. This calculation will give the designer the expected traffic volume of a roadway at the anticipated time of a lane closure.
- ⑧ C Capacity of a 2L, 4L 6L, or 8L roadway with one lane closed, and the remaining lane(s) unrestricted by lateral obstructions. The capacity of a 4L, 6L, or 8L roadway is based on lane closure in only one direction.
- ⑨ RC Restricting Capacity of the above facilities by site specific limitations detailed in the Temporary Traffic Control plans which apply to travel lane width, lateral clearance and the work zone factor. The work zone factor only applies to two lane roadways (see the tables in **FDM 241.6** to obtain the Obstruction Factor and Work Zone Factor).
- ⑩ OF Obstruction Factor which reduces the capacity of the remaining travel lane(s) by restricting one or both of the following components: Travel lane width less than 12 ft. and lateral clearance less than 6 ft. (see Obstruction Factor Table in **FDM 241.6**).
- ⑪ WZF Work Zone Factor (WZF) is directly proportional to the work zone length (WZL). The capacity is reduced by restricting traffic movement to a single lane while opposing traffic queues. The WZF and WZL only apply to a two lane roadway converted to two way, one lane (see the Work Zone Factor Table in **FDM 241.6**).
- ⑫ TLW Travel Lane Width is used to determine the obstruction factor (see the Obstruction Factor Table in **FDM 241.6**).

- ⑬ LC Lateral Clearance is the distance from the edge of the travel lane to the obstruction. The lateral clearance is used to determine the obstruction factor (see the Obstruction Factor Table in **FDM 241.6**).

241.4 Lane Closure Worksheet Instructions

General Instructions are as follows:

- (1) **Lane Closure Symbols and Definitions** (see **FDM 241.3**) provide guidance on where to find the necessary information to fill out the lane closure worksheets.
- (2) Fill out the top part of the lane closure worksheet and complete the formulas to calculate the hourly percentage of traffic at which a lane closure will be permitted.
- (3) Transfer the calculated percentages to the graph on the **Lane Closures 24 Hour Counts** (see **Figure 241.7.1**).
- (4) Draw a line across the graph representing the percentage for both open road and signalized intersections (see **Figure 241.7.1**).
- (5) Plot the hourly percentages (hourly volume divided by total volume) on the graph. Any hourly percentage extending above the restricted capacity percentage lines for open road or signalized intersections indicates the potential for excessive delays.
- (6) Lane closures should be prohibited during the time periods shown to have a potential for excessive delays.

241.5 Lane Closure Worksheet

DATE: _____

FINANCIAL PROJECT ID: _____

FEDERAL AID PROJECT NO.: _____

COUNTY: _____

DESIGNER: _____

NO. EXISTING LANES: _____

LOCATION: _____

SCOPE OF WORK: _____

Calculate the peak hour traffic volume (V)

$$V = ATC \text{ (1)} \times P/D \text{ (2)} \times D \text{ (3)} \times PSCF \text{ (4)} \times RTF \text{ (5)} = \text{(7)}$$

Capacity (C) of an Existing 2-Lane – Converted to 2-Way, 1-Lane = 1400 VPH

Capacity (C) of an Existing 4-Lane – Converted to 1-Way, 1-Lane = 1800 VPH

Capacity (C) of an Existing 6-Lane – Converted to 1-Way, 2-Lane = 3600 VPH

Capacity (C) of an Existing 8-Lane – Converted to 1-Way, 3-Lane = 5400 VPH

Factors restricting Capacity:

$$TLW \text{ (12)} \quad LC \text{ (13)} \quad WZL \text{ (11)} \quad G/C \text{ (6)}$$

Calculate the Restricted Capacity (RC) at the Lane Closure Site by multiplying the appropriate 2L, 4L, 6L, or 8L Capacity (C) from the Table above by the Obstruction Factor (OF) and the Work Zone Factor (WZF). If the Lane Closure is through or within 600 ft. of a signalized intersection, multiply the RC by the G/C Ratio.

$$RC \text{ (Open Road)} = C \text{ (8)} \times OF \text{ (10)} \times WZF \text{ (11)} = \text{(9)}$$

$$RC \text{ (Signalized)} = RC \text{ (Open Road)} \text{ (9)} \times G/C \text{ (6)} = \text{(9)}$$

If $V \leq RC$, there is no restriction on Lane Closure

If $V > RC$, calculate the hourly percentage of ADT at which Lane Closure will be permitted

$$\text{Open Road \%} = \frac{RC \text{ (Open Road)} \text{ (9)}}{\text{(ATC (1) } \times D \text{ (3) } \times PSCF \text{ (4) } \times RTF \text{ (5))}} = \text{\%}$$

$$\text{Signalized \%} = \text{Open Road \%} \times G/C \text{ (6)} = \text{\%}$$

Plot 24 hour traffic to determine when Lane Closure permitted. (See **Figure 241.7.1**)

NOTE: For Existing 2-Lane Roadways, $D = 1.00$.

Work Zone Factor (WZF) applies only to 2-Lane Roadways.

For $RTF < 1.00$, briefly describe alternate route _____

241.6 Lane Closure Input Data

Table 241.6.1 Obstruction Factors (OF)

Lateral Clearance (LC) (feet)	Travel Lane Width (TLW) (feet)			
	12	11	10	9
6	1.00	0.96	0.90	0.80
4	0.98	0.94	0.87	0.77
2	0.94	0.90	0.83	0.72
0.0	0.86	0.82	0.75	0.65

Table 241.6.2 Work Zone Factors (WZF)

WZL (ft.)	WZF	WZL (ft.)	WZF	WZL (ft.)	WZF
200	0.99	2200	0.87	4200	0.78
400	0.97	2400	0.86	4400	0.77
600	0.96	2600	0.85	4600	0.77
800	0.95	2800	0.84	4800	0.76
1000	0.93	3000	0.83	5000	0.75
1200	0.92	3200	0.82	5200	0.75
1400	0.91	3400	0.81	5400	0.74
1600	0.90	3600	0.80	5600	0.73
1800	0.89	3800	0.80	5800	0.73
2000	0.88	4000	0.79	6000	0.72

Figure 241.6.1 Work Zone Length (WZL)

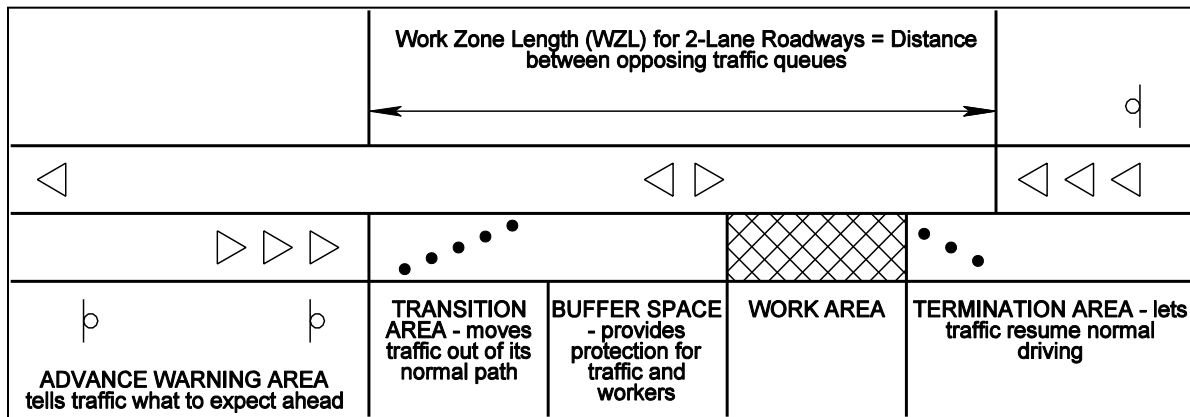

241.7 24-Hour Counts

Figure 241.7.1 24-HR Counts – Example

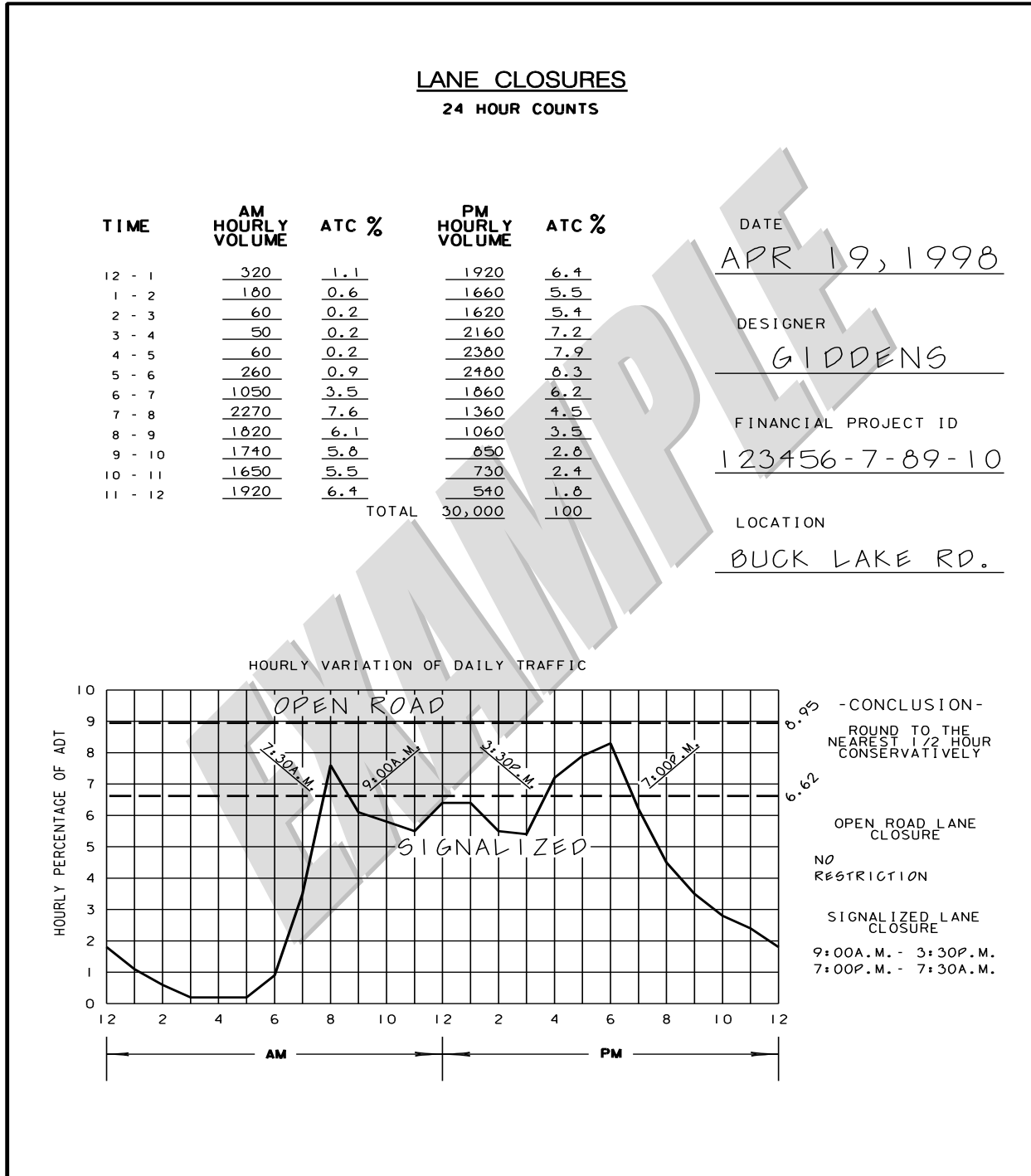

242 Traffic Pacing Design

242.1 General

See *FDM 240.2.1.7* for traffic pacing requirements and criteria.

242.2 Traffic Pacing Excel Program

An Excel file is available to assist in the preparation of the Traffic Pacing Report. The program can be found at the Department's temporary traffic control resources web page: [TTC Resource Download Library](#). The Excel worksheet is based on the methods presented in this chapter; Districts may require alternate methods.

The Excel file also illustrates an example of a bridge beam replacement.

242.3 Traffic Pacing Symbols and Definitions

The following symbols and definitions provide detail and guidance on the variables to be entered into the Input Data Sheets.

AADT Annual Average Daily Traffic. In lieu of actual traffic counts, use AADT provided by the Office of Planning. Adjust the AADT to peak season hourly traffic by applying the model correction factor and the hourly distribution factors.

ATC Actual Traffic Counts. Traffic counts can be obtained from the Office of Planning or collected on the project site. The designer needs hourly traffic volumes for a 24-hour period.

C Capacity. The capacity of the roadway under free flow conditions in passenger cars per hour per lane

$C = 2,400$ pc/h/ln for 70 mph regulatory speed

$C = 2,300$ pc/h/ln for 65 mph regulatory speed

$C = 2,250$ pc/h/ln for 60 mph regulatory speed

$C = 2,220$ pc/h/ln for 55 mph regulatory speed

$C = 2,150$ pc/h/ln for 50 mph regulatory speed

FHV	Heavy-vehicle adjustment factor. This factor is used to convert hourly traffic to equivalent passenger cars. Heavy vehicles include trucks, busses and recreational vehicles.
HDF	Hourly Distribution Factors. Multiply the AADT by the HTD to obtain the traffic volume for a particular hour. The Office of Planning publishes hourly distribution factors for regions of the state.
HTD	Hourly Traffic Demand in vehicles / hour. Hourly traffic volumes will be required for each hour in the analysis period. Hourly traffic volumes may be obtained from the Project Traffic Report, the Office of Planning or from field data collection. Use the most recent values available.
MOCF	Model Correction Factor. The MOCF converts AADT to peak season traffic.
N	Number of Lanes
Pc/h/ln	Passenger cars per hour per lane. Pc/h/ln represents the traffic volume or capacity of one lane adjusted for heavy vehicles.
PSCF	Peak Season Conversion Factor. The Office of Planning publishes tables with the PSCF for each county in Florida. Each county table has a PSCF for the week that the traffic counts were collected. The factor converts the ATC to Peak Season Traffic representing the highest daily traffic for the year.
P_t	Percent Trucks (%).

242.4 Traffic Pacing Calculations Example

STEP 1: Calculate the hourly percentage of peak season traffic for each hour of the day (in pcphpl) and plot the 24-hour traffic percentages.

A. Calculate the Heavy Vehicle Adjustment Factor,

$$F_{HV} = 1 + \left(\frac{P_t}{100}\right) 0.5 = 1 + \left(\frac{6.71}{100}\right) 0.5 = 1.034$$

B. Using actual traffic counts calculate the hourly traffic demand (*Hour 1 shown*)

$$HTD_i = \frac{(ATC_i)(PSCF)(F_{HV})}{N}$$

$$HTD_1 = \frac{(1406)(1.04)(1.034)}{3} = 504 \text{ pcphpl}$$

C. Calculate the percent capacity, $\%C = \frac{HTD_1}{c} \times 100$ where:

$C = 2,300$ pc/h/ln for 65 mph regulatory speed (*Hour 1 shown*)

$$\%C = \frac{HTD_1}{C} \times 100 = \frac{504}{2300} \times 100 = 21.9\%$$

Hour	AM Hourly Traffic Demand	Percent Capacity	Hour	PM Hourly Traffic Demand	Percent Capacity
24 - 1	504	21.90%	12-13	2193	95.40%
1 - 2	277	12.00%	13-14	2290	99.90%
2 - 3	215	9.40%	14-15	2427	105.50%
3 - 4	212	9.20%	15-16	2393	104.00%
4 - 5	338	14.70%	16-17	2368	104.00%
5 - 6	758	33.00%	17-18	2147	93.30%
6 - 7	2031	88.30%	18-19	2083	90.60%
7 - 8	2617	113.80%	19-20	1820	79.10%
8 - 9	2571	111.80%	20-21	1484	64.50%
9 -10	2408	104.70%	21-22	1277	55.50%
10-11	2249	97.80%	22-23	1078	46.90%
11-12	2174	94.60%	23-24	816	35.50%

HOURLY VARIATION OF DAILY TRAFFIC

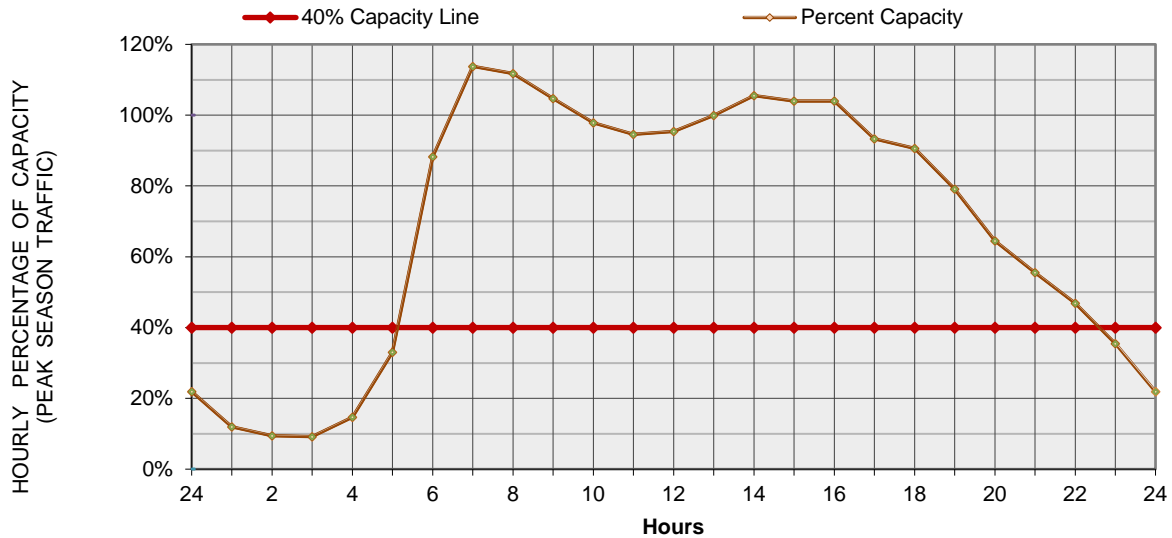

STEP 2: Identify the traffic pacing restrictions. Leave a buffer period of one hour between the end of traffic pacing operations and the beginning of 40% capacity.

HOURLY VARIATION OF DAILY TRAFFIC

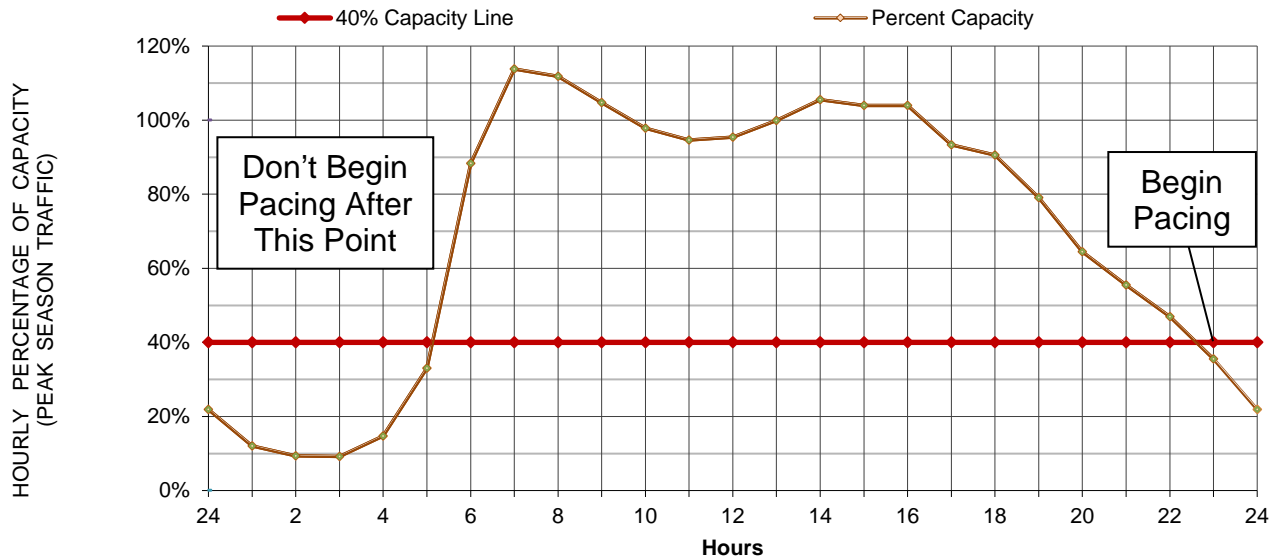

243 Portable Changeable Message Signs

243.1 General

See **FDM 240** for additional information concerning the use of portable changeable message signs (PCMS).

A PCMS is required for nighttime work that takes place within 4 feet of traveled way, and considered for the following conditions:

- (1) Road closures
- (2) Ramp closures
- (3) Delays created by:
 - (a) Congestion
 - (b) Crashes
 - (c) Lane closures
 - (d) Two-way traffic on divided highway
 - (e) Multiple lane closures
 - (f) Unexpected shifts in alignment

243.2 PCMS Placement

The message displayed must be visible and unobstructed to a motorist in accordance with [Standard Specification 102](#). The message displayed must be installed at the following minimum distances:

- (1) 900 feet on approach to construction work areas to allow for two message cycles.
- (2) 500 to 800 feet in advance of potential traffic problems
- (3) 0.5 to 2 miles in advance of complex traffic control schemes that require new or unusual traffic patterns.

243.3 PCMS Messages

Messages must be simple, with a minimum number of words and lines and must include no more than two displays of no more than three lines each with 8 characters per line. Provide the location and messages to be displayed in the Temporary Traffic Control (TTC) plan.

Programmed messages must provide appropriate information for the conditions likely to be encountered. Place the programmed messages in the TTC plan. Consider the following items in the development of a message:

- (1) Message elements
 - (a) Problem statement (where?)
 - (b) Effect statement (what?)
 - (c) Attention statement (who?)
 - (d) Action statement (do?)
- (2) Message format
 - (a) Will vary depending on content
 - (b) "Where" or "what" will generally lead
 - (c) "Who" and "do" follow in that order
 - (d) "Who" often understood from "where"
- (3) Display format
 - (a) Discrete, with entire message displayed at once is most desirable
 - (b) Sequential is OK, 2 parts maximum
 - (c) Run-on moving displays prohibited
 - (d) One abbreviation per panel display desirable, two abbreviations are the maximum. Route designation is considered as one abbreviation and one word. Guidelines for abbreviations are provided on the following pages. Refer to the [*Library of Approved Safety Messages for DMS*](#).

243.3.1 PCMS Worksheet

See **Figure 243.3.1** for an illustration on the development of a PCMS Worksheet.

See **Form 243-A** (located in **FDM 103**) and **FDM 921** for instruction on showing the worksheet information in the plans set.

Figure 243.3.1 PCMS Worksheet

Financial Project No.: 123456-7-89-10

Location of board: Westbound Buck Lake Road – Station 100+00

Used: from 01 - 01 - 01 at 6 : 00 am pm

to 02 - 02 - 02 at 6 : 00 am pm

Message programmed by: W. Giddens

MESSAGE 1

U	S	E					
C	A	U	T	I	O	N	

MESSAGE 2

T	R	U	C	K	S		
E	N	T	E	R	I	N	G
R	O	A	D	W	A	Y	

Timing:

Message 1 will run 10 . 00 seconds.

Message 2 will run 12 . 50 seconds.

STANDARD ABBREVIATIONS FOR USE ON PCMS

Standard abbreviations easily understood are:

<u>WORD</u>	<u>ABBREV.</u>	<u>WORD</u>	<u>ABBREV.</u>
Boulevard	BLVD	Normal	NORM
Center	CNTR	Parking	PKING
Crossing	XING	Pedestrian	PED
Crosswalk	XWALK	Road	RD
Emergency	EMER	Service	SERV
Entrance, Enter	ENT	Shoulder	SHLDR
Expressway	EXPWY	Slippery	SLIP
Freeway	FRWY, FWY	Speed	SPD
Highway	HWY	Traffic	TRAF
Information	INFO	Travelers	TRVLRS
Left	LFT	Warning	WARN
Maintenance	MAINT		

Other abbreviations are easily understood whenever they appear in conjunction with a particular word commonly associated with it. These words and abbreviations are as follows:

<u>WORD</u>	<u>ABBREV.</u>	<u>PROMPT</u>
Access	ACCS	Road
Ahead	AHD	Fog*
Blocked	BLKD	Lane*
Bridge	BRDG	[Name]*
Chemical	CHEM	Spill
Construction	CONST	Ahead
Exit	EX, EXT	Next*
Express	EXP	Lane
Hazardous	HAZ	Driving
Interstate	I	[Number]
Major	MAJ	Accident
Mile	MI	[Number]*
Minor	MNR	Accident
Minute(s)	MIN	[Number]*
Oversized	OVRSZ	Load
Prepare	PREP	To Stop
Pavement	PVMT	Wet*
Quality	QLTY	Air*
Route	RT	Best*
Turnpike	TRNPK	[Name]*
Vehicle	VEH	Stalled*
Cardinal Directions	N, E, S, W	[Number]

Upper, Lower UPR, LWR Level

* = Prompt word given first

The following abbreviations are understood with a prompt word by about 75% of the drivers. These abbreviations may require some public education prior to usage.

<u>WORD</u>	<u>ABBREV.</u>	<u>PROMPT</u>
Condition	COND	Traffic*
Congested	CONG	Traffic
Downtown	DWNTN	Traffic
Frontage	FRNTG	Road
Local	LOC	Traffic
Northbound	N-BND	Traffic
Roadwork	RDWK	Ahead [Distance]
Temporary	TEMP	Route
Township	TWNSHP	Limits

* = Prompt word given first

Certain abbreviations are prone to inviting confusion because another word is abbreviated or could be abbreviated in the same way. Do not use these abbreviations:

<u>ABBREV.</u>	<u>INTENDED WORD</u>	<u>WORD ERRONEOUSLY GIVEN</u>
WRNG	Warning	Wrong
ACC	Accident	Access (Road)
DLY	Delay	Daily
LT	Light (Traffic)	Left
STAD	Stadium	Standard
L	Left	Lane (Merge)
PARK	Parking	Park
RED	Reduce	Red
POLL	Pollution (Index)	Poll
FDR	Feeder	Federal
LOC	Local	Location
TEMP	Temporary	Temperature
CLRS	Clears	Color

250 Hydraulic Data and Agency Permits

250.1 General

A Bridge Hydraulic Report (BHR) includes the following, as applicable:

- Bridge Hydraulics Recommendation Sheet,
- Bridge hydraulic calculations, and
- Scour calculations (prepared as specified in **Chapter 4** of the [Drainage Manual](#), **Topic No. 625-040-002**).

250.1.1 Bridge Hydraulic Recommendation Sheet (BHRS)

Prepare the Bridge Hydraulic Recommendation Sheet (BHRS) for new structures and widenings as specified in **Chapter 4** of the [Drainage Manual](#).

250.2 Scour Calculations

Scour calculations are required for new structures and for major widening of an existing bridge structure. See the [Structures Design Guidelines](#) for classification of major and minor widening.

Scour calculations for the widening of an existing structure will be considered by the Department on an individual basis.

Develop scour estimates using a multi-disciplinary approach involving the Hydraulics Engineer, the Geotechnical Engineer, and the Structures Design Engineer. Design bridges and bridge culverts to withstand the design flood without damage and to withstand the 500-year flood (super flood) without failure. Refer to the [Structures Design Guidelines](#) for specific foundation design steps and the [Drainage Manual](#) for policy on scour computations.

The 100-year and 500-year scour elevations are required for the design of all bridges over watercourses. In addition, the Long-Term Scour Elevation must be established for bridge structures required to meet the extreme event vessel collision load. For more information on these scour elevations see the [Drainage Manual](#).

250.2.1 Scour Design Process

Scour problems should be resolved early in the design process. The Bridge Development Report (BDR), or 30% structures plans submittal when a BDR is not required, is a means of addressing and resolving all major design issues early in the design process. The BDR (or 30% structures plans) should also define the need for scour considerations, establish the scour parameters, and arrive at possible solutions. The eight-step process is illustrated in **Figure 250.2.1** and described as follows:

Modification for Non-Conventional Projects:

Delete the above paragraph and replace with the following:

Submit the scour calculations as part of the 90% foundation component plan submittal.

- (1) The Drainage Design Engineer evaluates stream stability and scour potential based on all available data, assumed soil conditions, structure positioning, and foundation designs. The Drainage Design Engineer's assumptions (hydraulic, geotechnical, and structural) and design parameters should be discussed with both the Geotechnical and Structures Design Engineers. When evaluating stream stability and scour potential, the recommendations developed from FHWA's [*Hydraulic Engineering Circular \(HEC\)*](#) should be followed as well as the design requirements provided in **Chapter 4** of the [*Drainage Manual*](#). This work should be initiated during the PD&E study where changes in the alignment could affect the severity of general scour.
- (2) The Geotechnical Engineer will then consider the possible alignments based on the scour potential and subsoil conditions. It may be necessary to conduct exploratory work if variability of subsoil conditions are suspected but not sufficiently defined. The results of exploratory investigations should be discussed with both the Hydraulics and Structures Design Engineer, and any previous scour assumption verified or modified.
- (3) The Structures Design Engineer should provide approximate span ranges, pier configurations, and pier locations for the different alternates. In addition, possible foundation types and approximate sizes should be developed such that the Drainage Design Engineer can estimate local scour potentials. Conditions to be considered are:
 - (a) The extent and severity of scour along the alignment must be developed. For example, for bridges over a wide body of water, general scour could vary in extent and severity. It may be reasonable, therefore, to consider fewer foundations in the most severe areas (i.e., span the problem), or take

appropriate steps to assure the structural integrity of the foundation in those locations.

- (b) The pile driving resistance, which must be overcome at the time of construction, may be greater than the ultimate pile capacity at a later date due to subsequent scour activity.
 - (c) Likewise, design drilled shaft capacity must account for the possibility that ultimate capacity will be reduced as a result of future scour activity.
- (4) The Drainage, Geotechnical, and Structures Design Engineers must develop the scour potential and rate each location and furnish the results to the District Environmental Management Office for consideration in establishing the recommended alignment(s).
 - (5) The preferred alignment is established by others.
 - (6) The Structures Design Engineer develops more detailed calculations showing possible span arrangements and types and sizes of foundations.
 - (7) The Drainage, Geotechnical, and Structures Design Engineers review the proposed configuration to assure that scour has been properly addressed. The Drainage Design Engineer reviews both the general and local scour potential and recommends continuation or changes.
 - (8) The Structures Design Engineer finalizes the configuration and proceeds with a more detailed analysis of the foundation including the anticipated pile tip elevations. The Drainage, Geotechnical, and Structures Design Engineers must review and concur. The final results are then incorporated into the BDR or 30% structures plans as applicable.

Modification for Non-Conventional Projects:

Delete the third sentence of item 8, above and replace with the following:

Submit the final results as part of the 90% foundation component plan submittal.

Figure 250.2.1 Structural Plans Development
Sheet 1 of 2

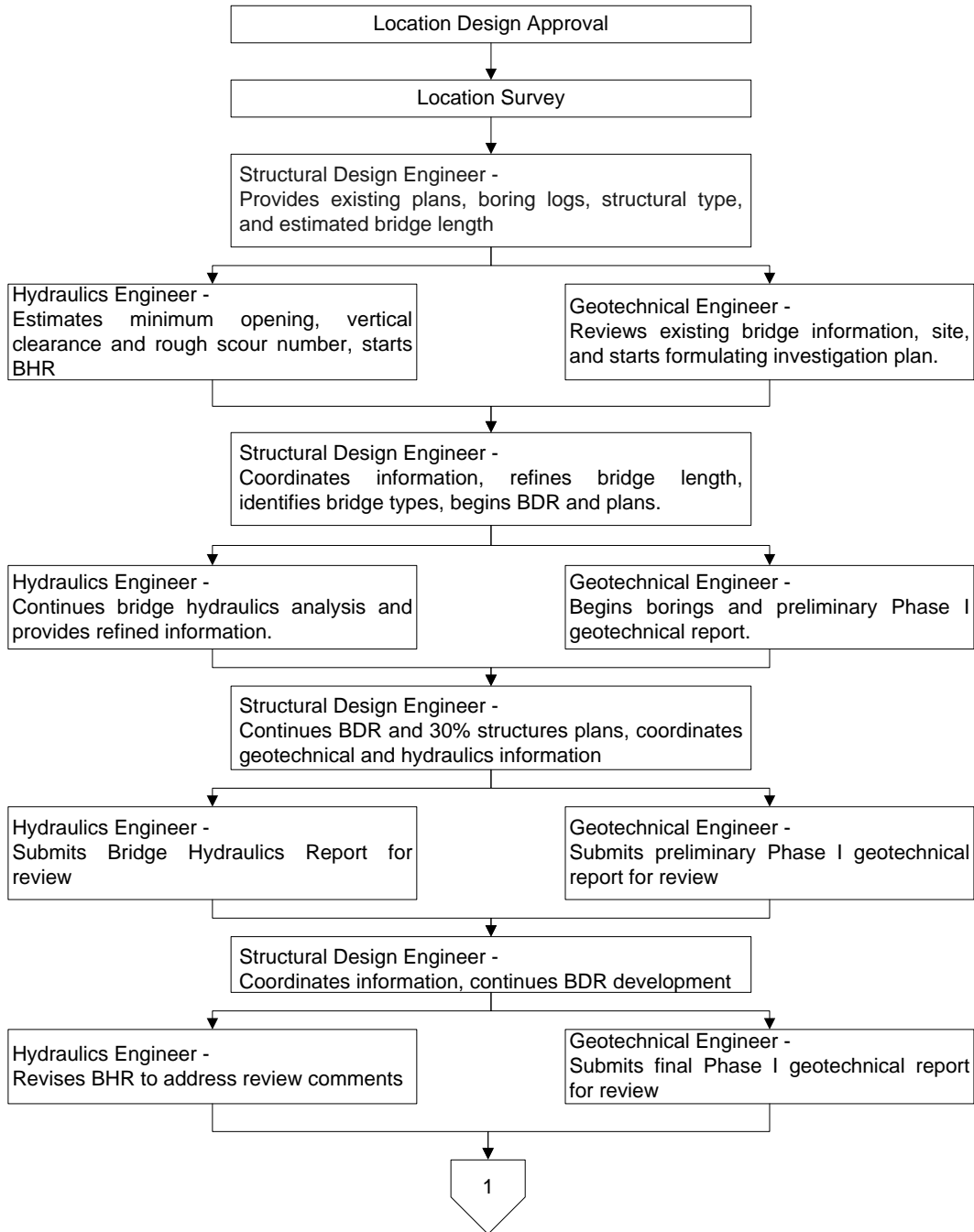
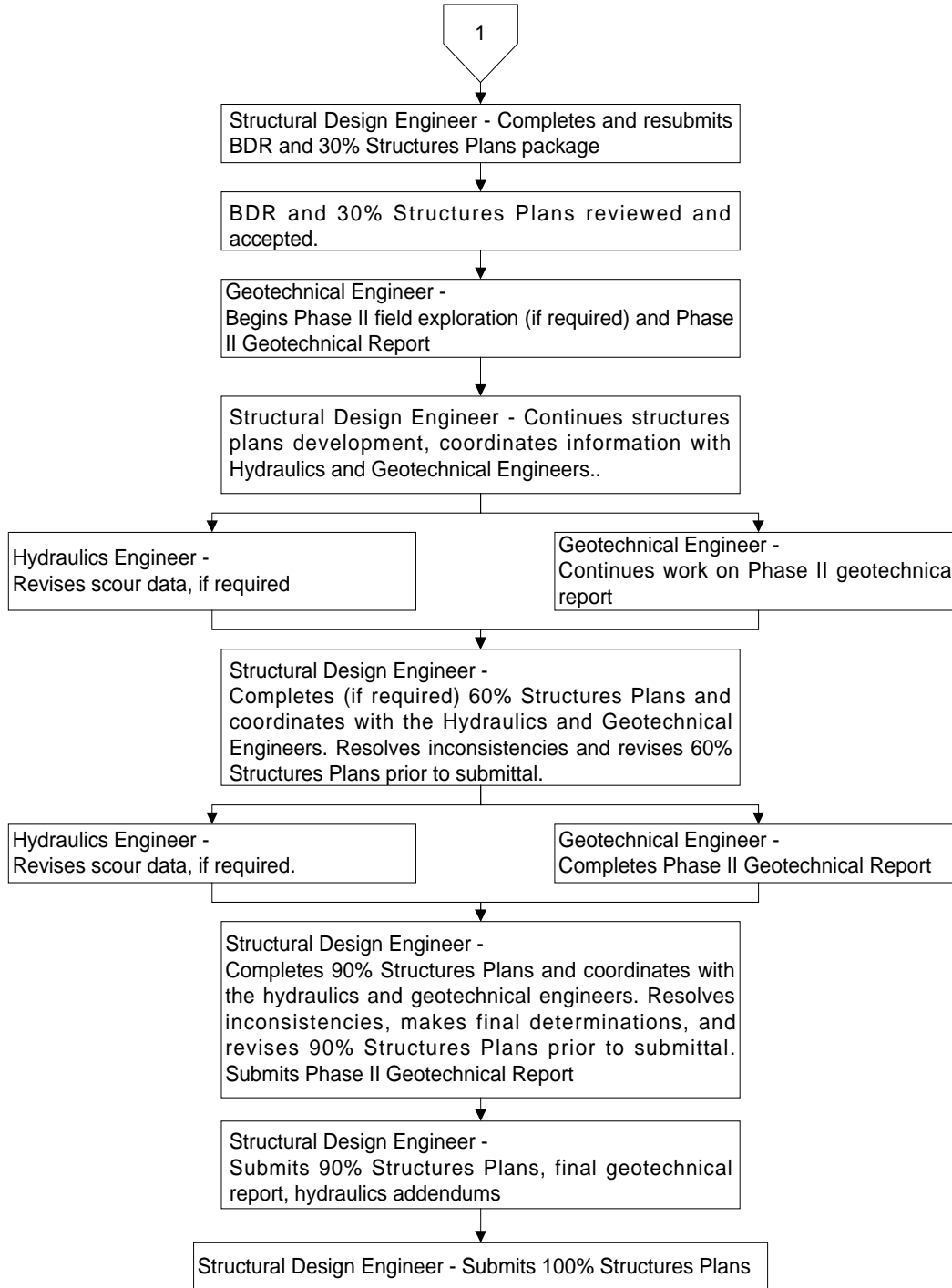

Figure 250.2.1 Structural Plans Development

Sheet 2 of 2



250.2.2 Bridge Foundation Design Process

This is a multi-discipline effort involving Geotechnical, Structures, and Hydraulics/Coastal Engineers. The process described below will often require several iterations. The foundation design must address the various scour conditions and furnish sufficient information for the Contractor to provide adequate equipment and construction procedures. These three engineering disciplines have specific responsibilities in considering scour as a step in the foundation design process.

- (1) The Structures Engineer determines the preliminary design configuration of a bridge structure utilizing geotechnical and hydraulic data. The Structure Engineer also performs lateral stability evaluations for the applicable loadings described in the [Structures Design Guidelines, Section 2.12 \(Substructure Limit States\)](#), (do not impose arbitrary deflection limits except on movable bridges). A preliminary lateral stability analysis generally will occur during the BDR phase of the project, and a final evaluation will occur subsequent to the selection of the final configurations. The Structures Engineer must apply sound engineering judgment in comparing results obtained from scour computations with available hydrological, hydraulic, and geotechnical data to achieve a reasonable and prudent design.

Modification for Non-Conventional Projects:
Delete the third sentence of item 1, above.

- (2) The Hydraulics Engineer provides the predicted scour elevation through a 100-year flood event (100-Year Scour), a 500-year flood event (500-Year Scour), and for "Long-Term Scour". "Long Term Scour" is defined and described in **Chapter 4** of the [Drainage Manual](#).
- (3) The Geotechnical Engineer provides the nominal axial (compression and tension) capacity curves, mechanical properties of the soil, and foundation recommendations based on construction methods, pile availability, similar nearby projects, and site access.

250.2.3 Submittal Requirements

During the 30% and 90% structures plans reviews, the EOR must coordinate the reviews of the design of both the Drainage and Geotechnical Engineers to assure compliance with the results of the scour calculations. The EOR must consult with the District Structures Maintenance Engineer for scour inspection reports on existing bridges.

Modification for Non-Conventional Projects:

Delete the first sentence of the above paragraph and replace with the following:

During the 90% foundation component plans submittal, the EOR must coordinate the reviews of the design of both the Drainage and Geotechnical Engineers to assure compliance with the results of the scour calculations.

250.3 Debris Accumulation

Debris accumulation on the upstream side of substructure units can significantly affect the flow of water and cause significant scour. Evaluate the type of vegetation upstream from the bridge and consider the probability of debris accumulation in establishing types and locations of substructure units. Special consideration must be given to mitigating debris accumulation on substructure units.

Debris clearance criteria are specified in **FDM 260.8.1**.

250.4 Agency Permits

Most projects will require several permits from Federal, State and local agencies. For examples of the types of permits that may be required, see **Part 1, Chapter 12** of the [**Project Development and Environment Manual \(PD&E Manual\)**](#).

Modification for Non-Conventional Projects:

Delete **FDM 250.4** and see RFP for requirements concerning Agency Permits.

251 Stormwater Runoff Control Concept (SRCC) Development

251.1 General

A Stormwater Runoff Control Concept (SRCC) must be developed during design and is a conceptual layout of temporary sediment and erosion control Best Management Practices (BMPs). The intent of the SRCC is to provide sediment and erosion control quantities for cost estimating purposes and to offer reasonable assurances for permits obtained during design. CADD files developed for this concept will not be signed and sealed but will be included in the CADD.zip or BIM.zip. Permanent controls (such as permanent sod/turf, inlets, erosion mats, etc.) must be included in the contract plans. The Contractor is responsible for developing a project specific plan to match field conditions, project approach, and construction phasing. Implementing, installing, inspecting, and maintaining these controls are also the responsibility of the Contractor.

The SRCC should be prepared in consultation with Drainage, Construction and Environmental personnel. This concept must consider project limits, wetland locations, preservation areas, and existing and proposed terrain and drainage features. The [*Sediment and Erosion Control Manual*](#) provides guidance for appropriate application of BMPs. A review of the permitting agency requirements is recommended. Links to the Applicant Handbooks for each Water Management District are provided below:

[*Northwest Florida*](#)

[*Suwannee River*](#)

[*Southwest Florida*](#)

[*St. Johns River*](#)

[*South Florida*](#)

The amount of information provided to adequately address stormwater runoff control varies based on the complexity of a project. A concept sediment and erosion control layout may be only tabular for minor projects.

Include details for controls that are not detailed in the [*State of Florida Erosion and Sediment Control Designer and Reviewer Manual*](#). The details should show the work intended, where and how the control is to be placed, and any other special design details. Include a Technical Special Provision in the project specification package when required by the erosion control items of work.

251.2 Narrative for Environmental Resource Permitting

To assist with environmental resource permit (ERP), a standard narrative erosion and sediment control plan ([Form 251-A](#)) is available for use on FDOT projects.

251.3 Documents for Construction

To facilitate compliance with [Standard Specifications, Section 104](#), the following documents are initiated by the designer and transmitted to the contractor within the CADD.zip file structure.

251.3.1 SRCC Worksheet

See **FDM 908** for SRCC Worksheet requirements.

251.3.2 SWPPP Template

Provide a copy of the NPDES CGP SWPPP Template for FDOT Projects ([Form 251-B](#)) in the “Permits” Project CADD folder. The designer should provide information as indicated within the template.

260 Bridge Structures

260.1 General

The design criteria presented in this chapter apply to bridge structures on arterials, collectors, and Limited Access Facilities. Criteria regarding lanes, medians, and shoulders for bridges are illustrated in **FDM 260.1.1**. Subsequent sections of this chapter contain specific information and criteria regarding these typical section elements, as well as geometric features.

260.1.1 Partial Bridge Sections

Criteria regarding lanes, medians, and shoulders are illustrated in the following partial bridge sections, **Figures 260.1.1 – 260.1.4**. These figures show sections through the bridge deck. Sections through the approach slab and permanent retaining wall should match the lanes, medians, and shoulder widths in the bridge section.

**Figure 260.1.1 Partial Bridge Sections for Limited Access Facilities and Divided Arterials (4 or More Lanes)
 Design Speed 50 mph and Greater**

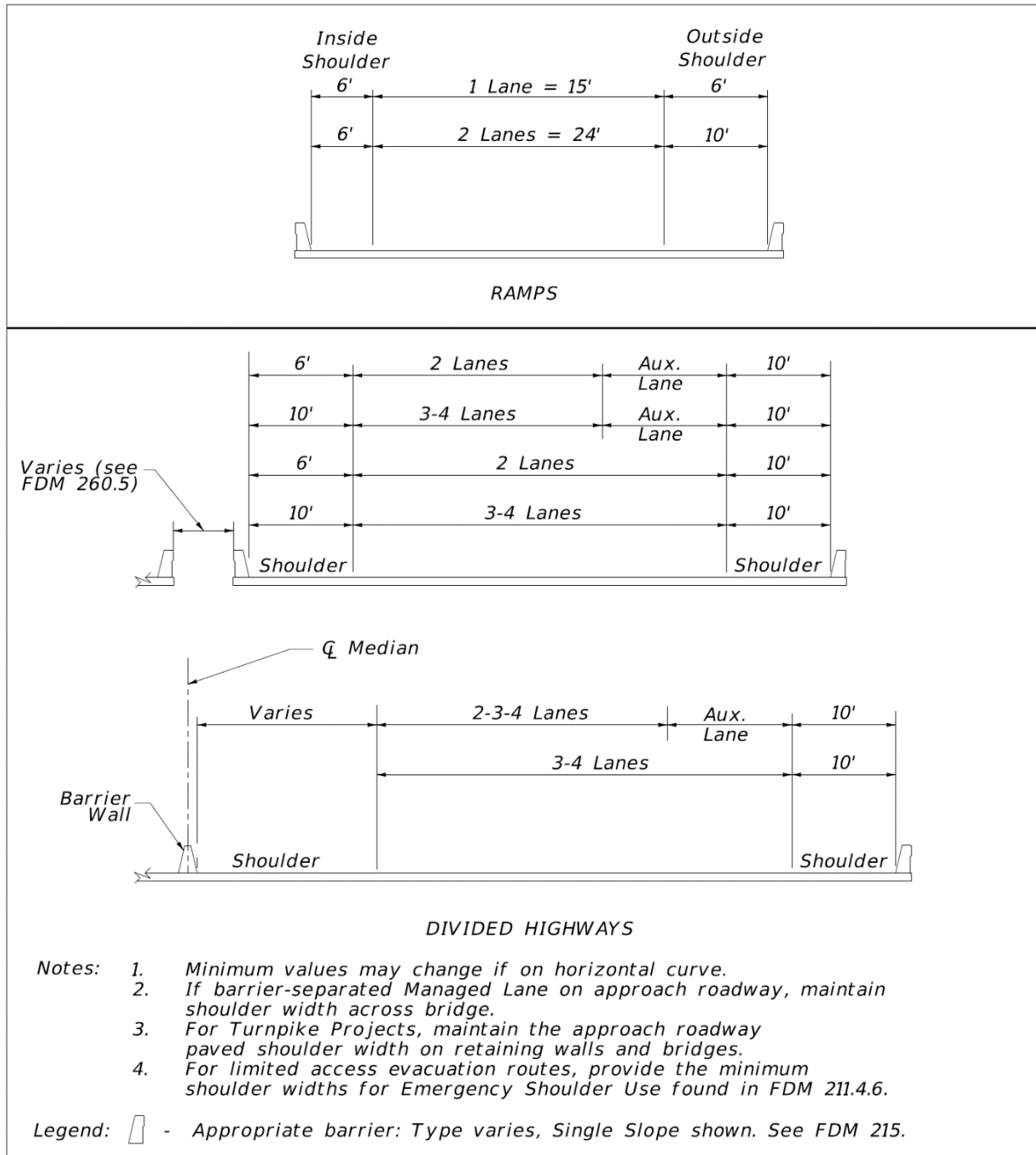
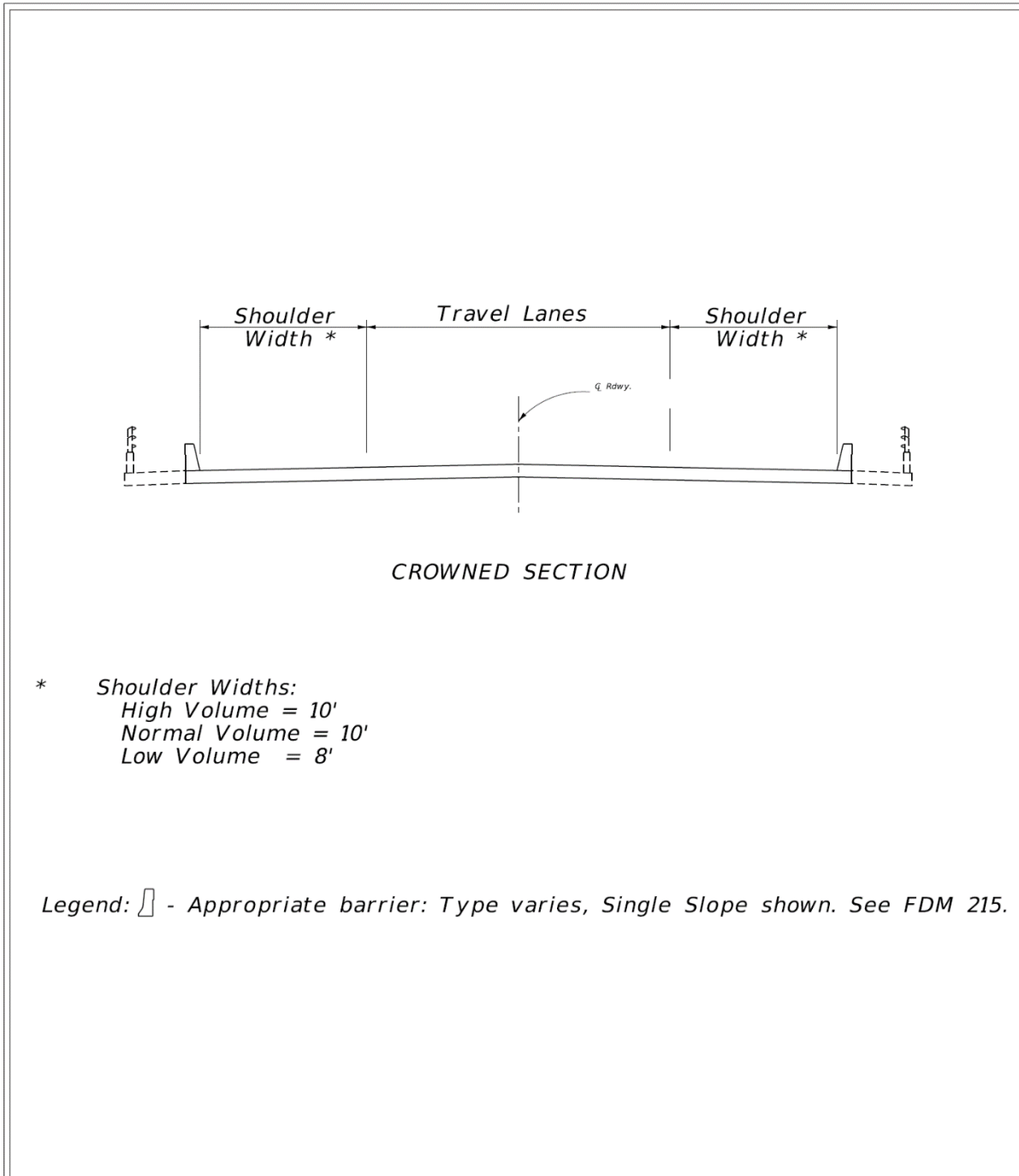

Figure 260.1.2 Bridge Section for Undivided Arterials and Collectors



**Figure 260.1.3 Partial Bridge Sections for Curbed Arterials and Collectors
 Design Speed 45 mph and Less**

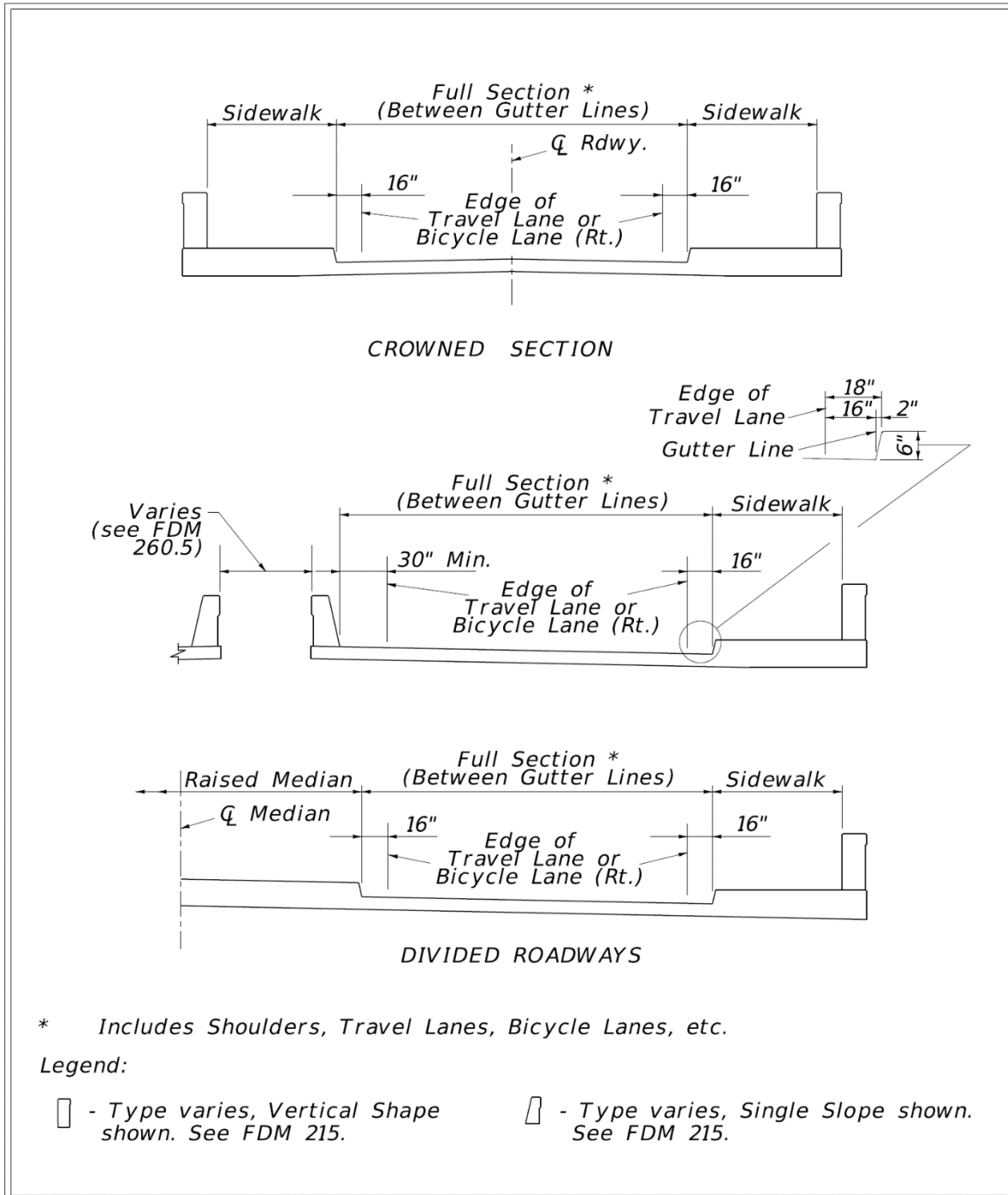
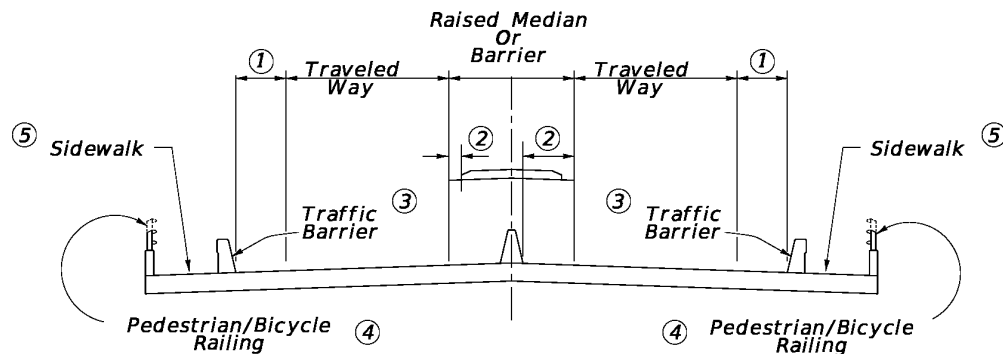

Figure 260.1.4 Bridge Section for Divided Arterials and Collectors



- ① **Outside shoulders:**
 - Curbing on approach roadway:*
Use 2.5' minimum, 8'-4" with bike lane, 8' minimum for bridges 500' or longer or high-level bridges.
 - Flush shoulder on approach roadway:*
Use 10' minimum.
- ② **Median shoulders:**
 - Raised median on bridge:*
Use same offset to median as used on the approach roadway.
 - Median barrier on bridge:*
Raised median on approach roadway:
Use 2.5' minimum, and for bridges 500' or longer or high-level bridges use 6' minimum for 2 lanes and 8' minimum for 3 or more lanes.
 - Flush shoulder on approach roadway:*
Use 6' minimum for 2 lanes and 10' minimum for 3 or more lanes.
- ③ *Use traffic barrier between traveled way and sidewalk and separate pedestrian railing at back of sidewalk if heavy pedestrian traffic is anticipated or facility is near a school, or design speeds on the bridge are 50 mph or greater.*
- ④ *Provide pedestrian/bicycle railing as required per FDM 222.4*
- ⑤ *See FDM 260.2.2 for sidewalk width requirements.*

260.2 Lanes

Lane widths are to match the approach roadway lane widths.

260.2.1 Bicycle Lanes

Continue bicycle lanes on the approach roadway across the structure.

260.2.2 Sidewalk and Shared Use Paths

Continue width of sidewalk or shared use path on the approach roadway across the structure. Bridge sidewalk width may be less than the approach roadway for long bridges (greater than 100 feet), but not less than 5 feet for C1 and C2 context classification or 6 feet for all other context classifications.

Provide sidewalk on new bridges where sidewalk or shared use path is not present along the roadway but may be included with a future project.

Modification for Non-Conventional Projects:

Delete **FDM 260.2.2** and see RFP for requirements.

260.3 Shoulders

Figures 260.1.1 – 260.1.4 provide criteria for shoulder widths on various bridge sections. Where these widths differ from those required for roadways or ramps, decisions about the final values chosen for the project are to be coordinated between the District Roadway Design and Structures Design Offices.

On roadway alignments having 12-foot shoulders with continuous barrier walls and closely spaced bridges, a 12-foot bridge shoulder width may be considered. Bridges are considered to be closely spaced when the required length of shoulder transition (between standard width roadway and bridge shoulders) is greater than the distance between the bridges. The decision to use 12-foot bridge shoulder widths should be coordinated with the District Design Engineer.

Modification for Non-Conventional Projects:

Delete the above paragraph and see RFP for bridge shoulder width requirements.

260.4 Bridge Cross Slopes

Bridge cross slope is typically 0.02 for non-superelevated bridge deck sections. Bridges with one-way traffic have a uniform cross slope applied over all travel lanes and required shoulders. Bridges with two-way traffic may be designed with a crowned bridge deck section. This cross-slope criteria applies to all bridge decks whether of cast-in-place concrete, precast concrete, or open steel decking.

Use transitions to adjust for differences in cross slope between the approach roadway section and the required straight-line slope for bridge decks.

260.5 Bridge Median

For divided highways, the District will determine the desired distance between structures based in the following:

- (1) Provide separate structures if the open space between the bridges would be 20 ft. or more.
- (2) Provide single structure if the open space between the bridges would be less than 10 feet.
- (3) A single structure is recommended when the open space between the bridges would be between 10 and 20 feet.

Consult with the District Structures Maintenance Engineer when the open space between the bridges would be less than 20 feet.

The inspection and maintenance capabilities of each District Office's personnel and equipment will provide the basis for deciding on a single structure deck or twin bridges. If the total width for a single structure exceeds the capacity of district maintenance equipment, typically a 60-foot reach, twin structures may be specified and the open distance between structures determined by the practical capability of the maintenance and inspection equipment. This is particularly important for girder superstructures because those areas that cannot be reached by topside equipment might require catwalks, ladders, or other access features. Such features are to be accounted for in the initial selection of alternates as they will add to the cost of superstructures.

Design bridge railings and separators in accordance with the [Structures Design Guidelines \(SDG\)](#). For more information regarding bridge traffic railings, refer to **FDM 215**.

260.6 Vertical Clearance

For roadway, pedestrian, or railroad bridge over roadway, the minimum vertical clearance is the least distance measured between the lowest bridge superstructure or substructure element and the traveled way or shoulder directly below the element.

For roadway or pedestrian bridge over railroad, the minimum vertical clearance is the least distance measured between the bottom of the superstructure and the top of the highest rail utilized.

For roadway or pedestrian bridge over High-Speed Rail Systems, see the latest version of **American Railway Engineering and Maintenance-of-Way Association (AREMA)** guidelines, or contact the design office of the high-speed rail line of interest.

For roadway or pedestrian bridge over electrified railroad, see FDOT's **South Florida Rail Corridor Clearance Policy for 25 KV service (Topic No. 000-725-003)**. This provision also applies to tracks identified as candidates for future electrification.

FDOT minimum vertical clearances for new construction and RRR projects are given in **Table 260.6.1**. New construction criteria are also illustrated in **Figures 260.6.1** through **260.6.5**.

Table 260.6.1 Minimum Vertical Clearances for Bridges

Type of Crossing	Minimum Vertical Clearance (feet)		
	New Construction		RRR
	New Bridge	Construction Affecting Existing Bridge	
Roadway or Railroad bridge over Limited Access Roadway	16.5	16.0	16.0
Roadway or Railroad bridge over Arterial or Collector Roadway			14.5
Pedestrian bridge over Roadways	17.5	17.0	
Roadway or Pedestrian bridge over Railroad	23.5		
Roadway or Pedestrian bridge over Electrified Railroad	24.25		
Notes:			
(1) For construction affecting an existing bridge (e.g., bridge widenings or resurfacing), if the proposed minimum design vertical clearance is between 16 feet and 16 feet 2 inches or if a Design Variation or Design Exception is required, place a note in the plans as shown in FDM 914 .			
Roadway or Railroad bridge over Arterial or Collector Roadway			
(1) Contact the District Structures Design Engineer for further guidance if any sway bracing members over the bridge deck have a clearance of less than 14 feet.			
(2) An existing bridge with a vertical clearance less than 14.5 feet requires a Design Variation. See Traffic Engineering Manual, Section 2.6 for information on required signing and warning features.			

Figure 260.6.1 Flush Shoulder Roadway

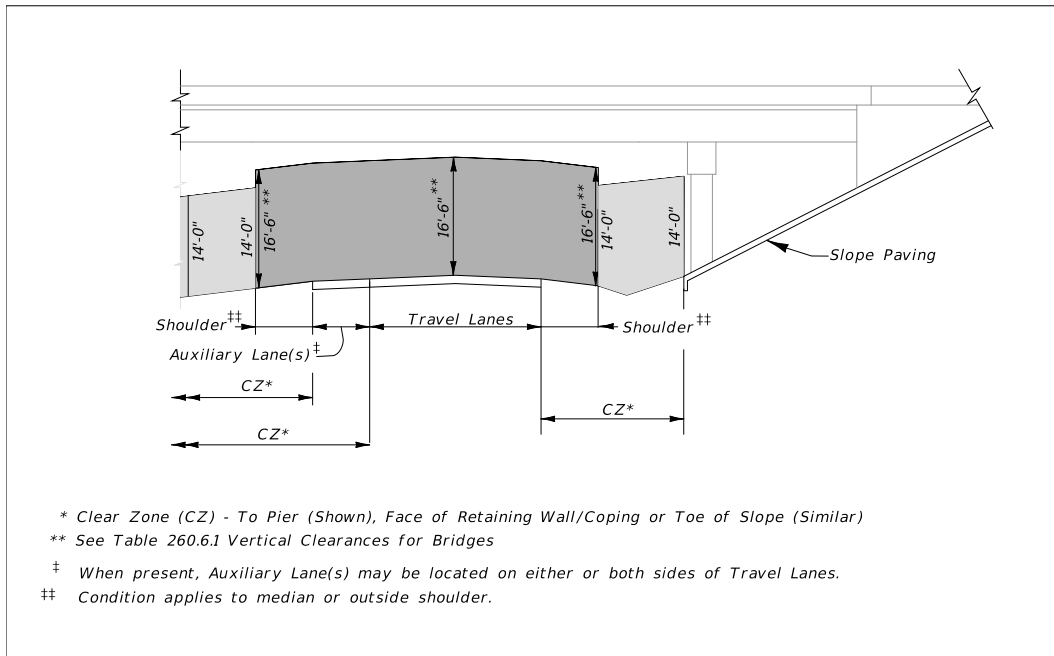

Figure 260.6.2 Flush Shoulder Divided Roadway

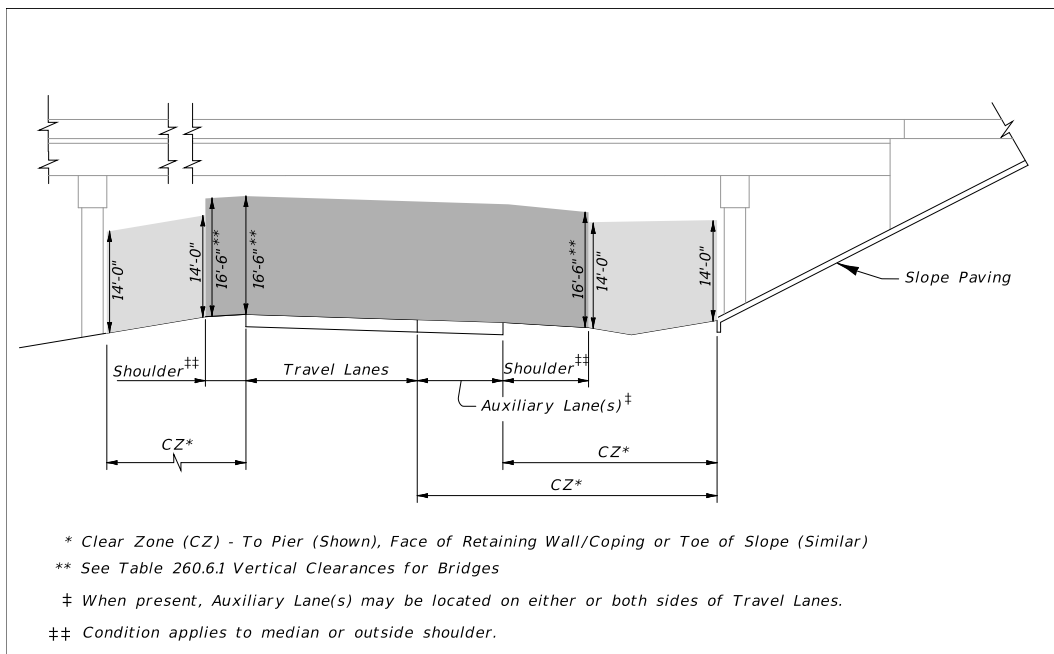

Figure 260.6.3 Curbed Roadway ≤ 45 mph

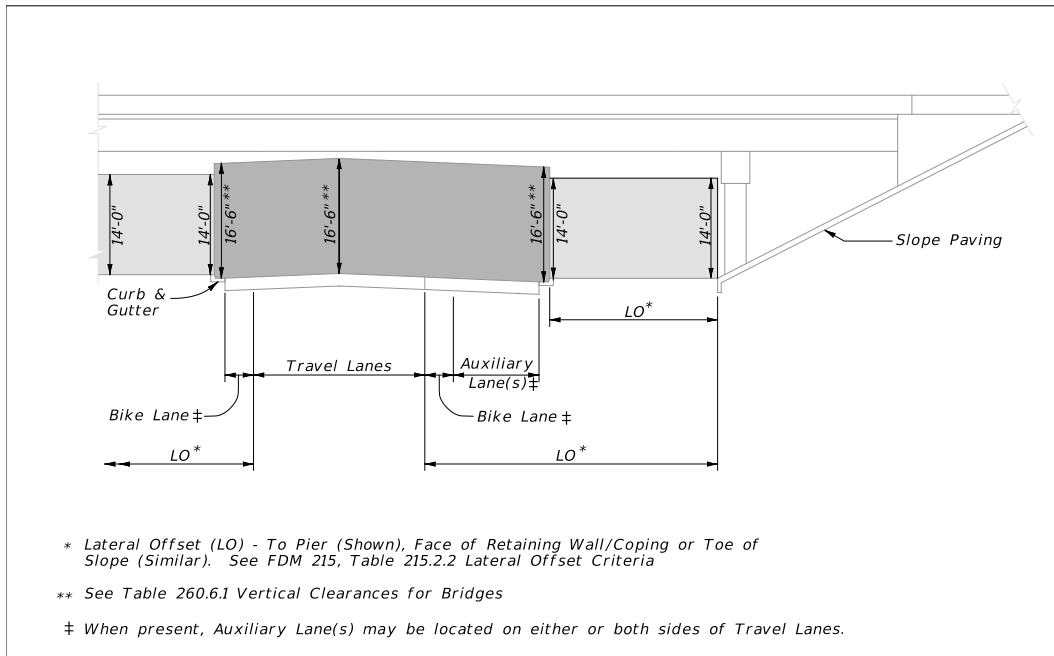

Figure 260.6.4 Curbed Roadway ≤ 45 mph – Section through Bridge

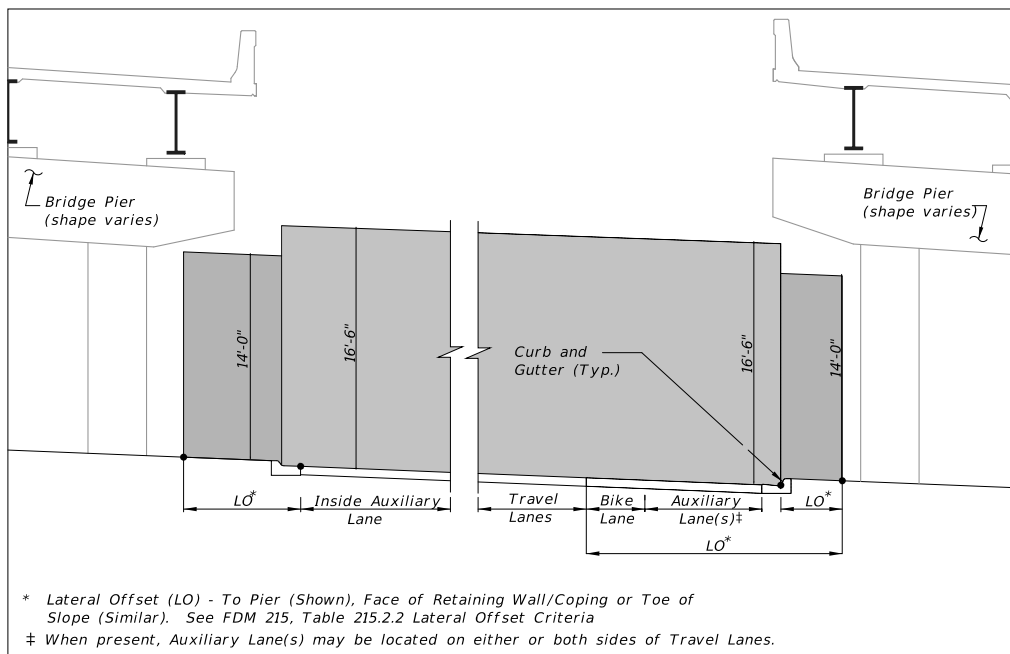
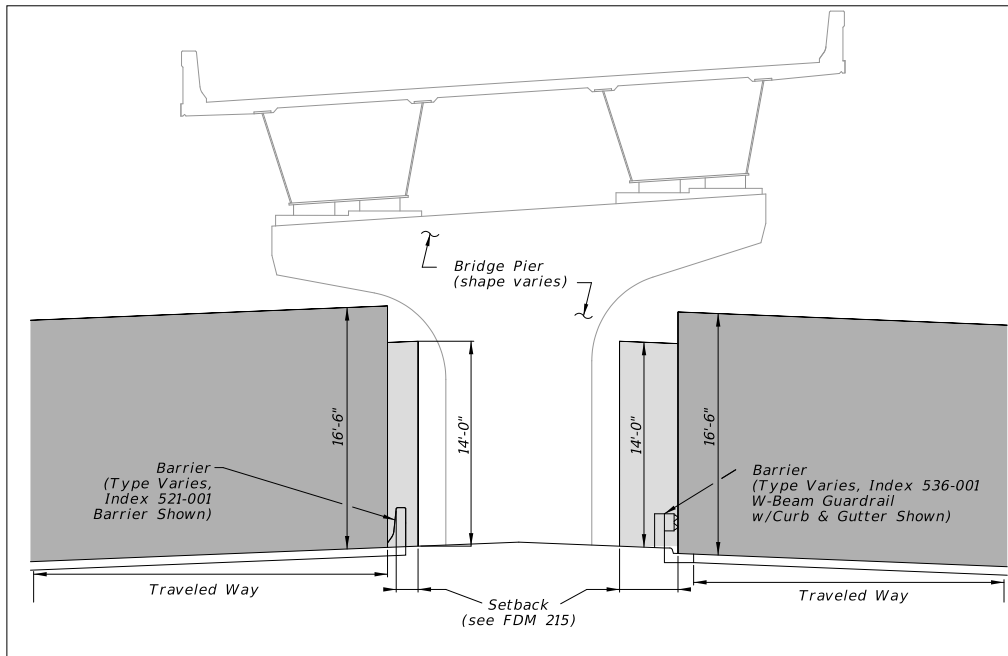

Figure 260.6.5 Curbed Roadway with Traffic Barrier



260.7 Typical Paving Under Bridge

A 10-foot paved outside shoulder under overpass bridges is recommended. In addition, miscellaneous asphalt within the median area and from the paved shoulder to the bridge slope pavement should be placed. This pavement will provide additional safety, enhance drainage, reduce maintenance, and improve appearance. Typical paving under bridges is illustrated in **Figure 260.7.1**.

Figure 260.7.1 Typical Paving Under Bridge

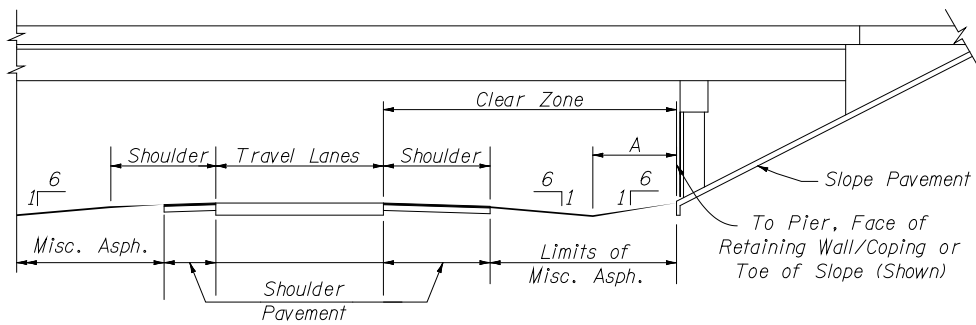
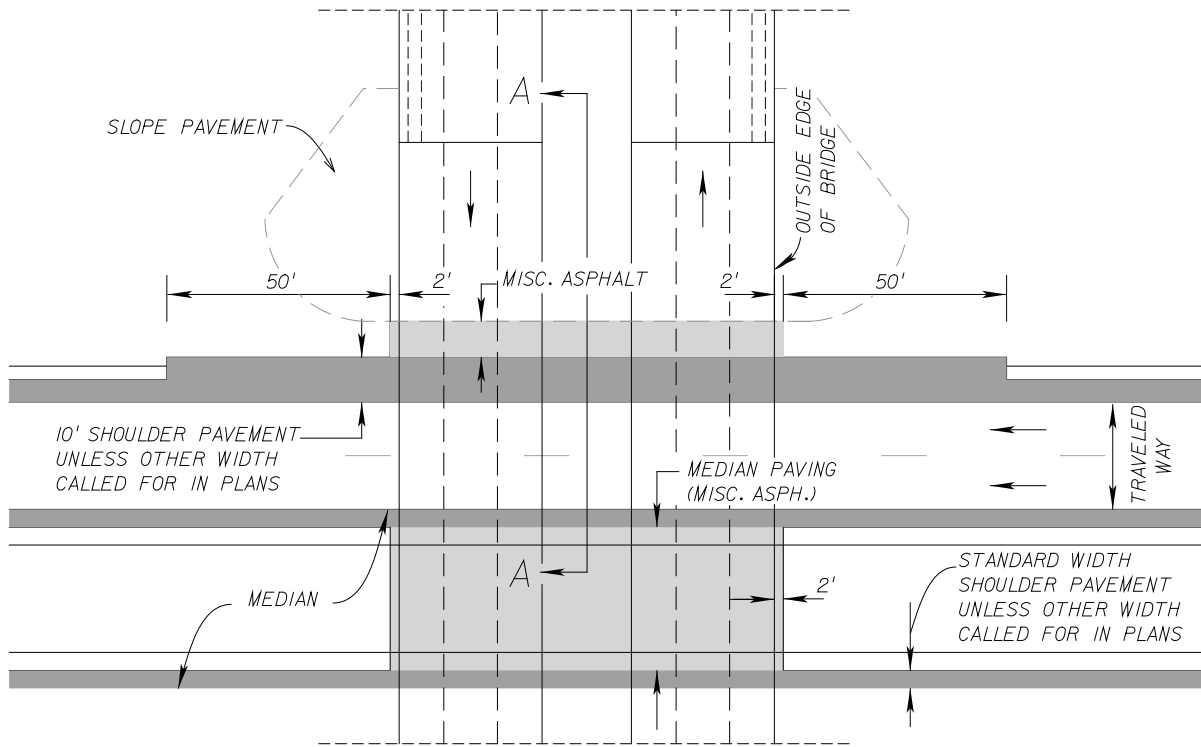

SECTION A-A

FACILITY	A
Limited Access Facilities	12'
Flush Shoulder Arterials & Collectors Design Speed 50 mph or greater	8'
Flush Shoulder Arterials & Collectors Design Speed 45 mph or less	6'

260.8 Bridges Over Waterways

260.8.1 Vertical Clearance

The following criteria applies to the minimum vertical bridge clearance over water:

Environment:

For concrete superstructures classified as Moderately or Extremely Aggressive due to chloride content, material requirements are determined based on location of the superstructure relative to the splash zone. See [SDG 1.3](#), [SDG 1.4](#), and [SDG 4.3](#) for more information.

For steel superstructures, obtain the minimum vertical clearance from the District Bridge Maintenance Engineer. At a minimum, steel superstructures must be located above the splash zone. See [SDG 1.3](#) for more information.

Modification for Non-Conventional Projects:

Delete the above paragraph and replace with the following:

Steel superstructures must be located above the splash zone as defined in [SDG 1.4](#) or as specified in the RFP.

Drainage:

The minimum vertical clearance between the design flood stage and the low member of a bridge is 2 feet. This clearance is necessary to allow the majority of debris to pass without causing damage to the structure. This requirement does not apply to culverts and bridge-culverts.

Navigation:

Provide the following minimum vertical clearance for navigational purposes:

- (1) 6 feet above the Mean High Water for tidewater bays and streams
- (2) 6 feet above the Normal High Water for freshwater rivers, streams, non-regulated/controlled canals, and lakes
- (3) 6 feet above the control elevation for regulated/controlled lakes and canals

For bridges without a designated navigation channel, minimum vertical clearance for navigation purposes is measured from the low point of the superstructure to the water surface anywhere along the length of the bridge over the navigable water. For bridges with a designated navigation channel, minimum vertical clearance for navigation purposes is measured from the low point of the superstructure to the water surface at the edges of the designated navigation channel. Navigation lights are not considered in the vertical clearance.

Coastal Bridges:

A minimum vertical clearance of 1 foot above the 100-year design wave crest elevation including the storm surge elevation and wind setup is required for the superstructure. For bridge designs where this criterion cannot practically be met, refer to the [FDOT Drainage Manual, Section 4.9.5](#).

Information on the Normal High Water, control water elevation, or Mean High Water can be obtained from the appropriate Drainage Design Engineer.

Widening of existing structures which do not meet the minimum vertical clearance criteria stated above (either before or after the widening) may be justified hydraulically or economically. However, encroachment of vertical clearance criteria may be limited and is required to be approved by the agency having jurisdiction over the navigable waterway.

260.8.2 Horizontal Clearance

Provide the following minimum horizontal clearance:

- (1) 10 feet for crossings subject to boat traffic.
- (2) Consistent with debris conveyance needs and structure economy where no boat traffic is anticipated.

Horizontal clearance is defined as the unobstructed clear distance between piers, fender systems, culvert walls, etc. projected by the bridge normal to the flow.

260.8.3 Regulatory Agency Requirements

Vertical and horizontal clearances will also be subject to the requirements of the Coast Guard, Corps of Engineers, Water Management District, and any other regulatory agency having appropriate statutory jurisdiction or authority. Such regulatory agency requirements may exceed Department requirements.

260.9 Evaluation of Existing Bridge Structures

Each project will require a determination on the most appropriate action regarding existing structures; i.e., should bridge remain as is, be rehabilitated, or be replaced. This determination should be made as early as practical due to the potential impact to the work program. Pavement resurfacing funds can only be used for minor bridge improvements such as rail retrofits and ADA improvements. Bridges that require major improvements or replacement must be programmed with appropriate bridge program funds.

The determination of bridge improvement needs is to be supported by an engineering analysis and report. The determination is to be based on an assessment of the bridge's structural and functional adequacy. The engineering report is to include the following:

- (1) Project description
- (2) Operational impact evaluation
- (3) Safety impact evaluation that includes a detailed review of crash history, severity, contributing factors, etc.
- (4) Benefit/cost analysis

If the engineering analysis determines it is not feasible to bring the bridge into full compliance with minimum criteria, a Design Exception or Design Variation addressing the feature(s) not meeting criteria must be processed in accordance with **FDM 122**. The engineering analysis and report should be used to support the Design Exception or Design Variation.

Review the Department's work program to see if a structure is scheduled for replacement, before determining short term improvements. Consider short term improvements that enhance safety, but may not bring the bridge into compliance, such as:

- Upgrading of connecting guardrail systems
- Approach roadway or shoulder widening
- "Narrow Bridge Ahead" signing and shoulder warning (see **FDM 210.4.5**)

If a bridge is functionally obsolete but structurally sound, complete replacement is usually not warranted. For these structures, a full range of possible improvements should be considered to bring the structure into compliance with minimal criteria. Widening of the structure or rail retrofits are primary options. If a roadway is being programmed or considered for improvements or widening (adding lanes), consider the needs of the future structure(s).

When evaluating bridge replacement or widening, the following should be considered:

- (1) Cost of replacing the existing bridge with a wider bridge designed to new bridge criteria.
- (2) Cost of widening the existing bridge (if widening is practical), including life cycle costs of maintaining a widened bridge.
- (3) The number of crashes that would be eliminated by replacement or widening.
- (4) The hydraulic sufficiency and the risk of failure due to scour and/or ship impact as well as the consequences of failure.

260.9.1 Bridge Width

Required bridge widths for new bridge structures are illustrated in the partial bridge sections, **Figures 260.1.1 – 260.1.4**.

Minimum existing bridge widths for arterials and collectors are provided in **Table 260.9.1**.

See **FDM 210.4.5** for information concerning narrow bridge shoulder warning devices.

Bridge widening is to be in accordance with the [Structures Design Guidelines](#) and meet the geometric requirements for new construction.

Table 260.9.1 Minimum Widths for Existing Bridges

Bridge Median Treatment	Minimum Width		
	Traveled Way Width	Shoulder Width (ft)	
		Median	Outside
Undivided (AADT < 750)	Total Width of Approach Lanes	n/a	2.0
Undivided (AADT ≥ 750)	Total Width of Approach Lanes	n/a	4.0
Divided (Median Separator)	Total Width of Approach Lanes	1.5	4.0
Divided (Median Barrier Wall)	Total Width of Approach Lanes	2.5	4.0
One Way Bridges	Total Width of Approach Lanes	2.5	4.0

260.9.1.1 Interstate, Freeways and Expressways

For resurfacing projects, existing 4-lane (2-lanes in one direction) mainline bridges may remain in place without a Design Exception or Variation when all the following requirements are met:

- (1) Minimum 12-foot lane widths, and
- (2) Minimum 3-foot left shoulder, and
- (3) Minimum 10-foot right shoulder on bridges \leq 200 feet in length, or minimum 3-foot right shoulder on bridges $>$ 200 feet in length.

260.9.2 Bridge Loading

See *FDM 121.17* for load rating requirements.

260.9.3 Pier Protection, Bridge Railing and Roadside Safety Hardware

See *FDM 215* for requirements.

260.9.4 Bridge Mounted Support Structures and Signs

See *Structures Manual Volume 3 Chapter 18* for existing bridge mounted support structures and signs.

261 Structural Supports for Signs, Signals, Lighting, ITS, and Tolling

261.1 General

The criteria for the structural design of sign, signal, lighting, ITS, and tolling support structures (aka Ancillary Structures) must be in accordance with AASHTO's **LRFD Specifications for Structural Supports for Highway Signs, Luminaires, and Traffic Signals**, as modified by the [Structures Manual, Volume 3](#). Include structural details in the Plans for all sign, signal, lighting, ITS, and tolling structures. Use the [Standard Plans](#) for sign, signal, lighting, ITS, and tolling support structures, unless site conditions or other considerations require a custom design.

When a custom support structure is required, or otherwise specifically designated in the contract documents, the Engineer of Record (EOR) is responsible for the structural design including foundations and the review of the shop drawings. Details for supports attached to bridge structures must be coordinated with the bridge structural engineer and included in the plans. See [Structures Design Guidelines, Section 1.9](#) and [Structures Manual, Volume 3, Section 2.6](#) for details and restrictions related to making attachments to bridges.

Sign and signal structures are limited to the following dimensions:

- [Standard Plans, Index 700-041](#), Span Sign Structure: Span Length \leq 220 feet
- [Index 700-040](#), Cantilever Sign Structure: Cantilever Length \leq 50 feet
- [Indexes 700-040](#) and [700-041](#), Cantilever & Span Sign Structure: Truss Depth \leq 8 feet
- [Indexes 649-030](#) and [649-031](#), Standard Mast Arm Assemblies: Cantilever Length \leq 78 feet
- [Indexes 649-010](#) or [641-010](#), Steel or Concrete Strain Pole with Signal Cable: Span Length \leq 250 feet

These dimensional limitations are applicable to both the designs contained within the [Standard Plans](#) and project-specific designs. Any sign or signal structure exceeding these dimensions requires a Design Variation approved with concurrence from the District Structures Design Engineer. See the applicable [Standard Plans Instructions \(SPI\)](#) for additional information on sign and signal structures.

Steel ancillary structures (highway signs, luminaires, traffic signals, ITS, and tolling) must use a galvanized coating per the [Standard Plans](#). They must not be painted or otherwise coated without written approval of the District Structures Design Engineer. If the local Maintaining Agency requests a painted or otherwise coated finish, the requesting agency is to provide the funding for the additional construction cost and be responsible for maintenance costs.

Modification for Non-Conventional Projects:

Delete the above paragraph and replace with the following:

Steel ancillary structures (highway signs, luminaires, traffic signals, ITS, and tolling) must use a galvanized coating per the [Standard Plans](#) unless specified otherwise in the RFP.

See *FDOT Modifications to LRFD Specifications For Structural Supports For Highway Signs, Luminaires And Traffic Signals (LRFDLTS-1)*, [Structures Manual Volume 3](#), Section 2.6 for limitations on the use of bridge mounted signs.

261.2 Sign Support Structures

Use the applicable [Standard Plans](#) for the following sign support structures:

- **Index 700-010** Single Column Ground Signs
- **Index 700-011** Single Column Cantilever Ground Mounted Sign
- **Index 700-012** Single Post Bridge Mounted Sign Support
- **Index 700-013** Single Post Median Barrier Mounted Sign Support
- **Index 700-020** Multi-Column Ground Sign
- **Index 700-040** Cantilever Sign Structures (Overhead)
- **Index 700-041** Span Sign Structures (Overhead)

Refer to the corresponding **Standard Plans Instruction (SPI)** for design information.

For [Standard Plans](#), **Index 700-010** Single Column Ground Signs, the contactor selects the appropriate pole size using the sign dimensions given in the plans and the four-step process given the standard.

Where the distance between the curb and the sidewalk restricts the use of [Standard Plans](#), **Index 700-020**, **Index 700-011** may be used.

The EOR is responsible for the design of all multi-column ground signs and overhead sign structures (including bridge mounted signs). This responsibility is for the entire sign structure, including the supports and foundations, as well as all details necessary to fabricate and erect the sign structures. The EOR is also responsible for the shop drawing review in accordance with **FDM 152** when sign structure shop drawings are required by the Contract Documents.

FDOT assigns identification numbers to overhead sign structures. See the [Structures Detailing Manual, Chapter 2](#), for instructions.

Use FDOT standard overhead sign support structures whenever possible. Only use custom (non-standard) overhead sign support structures as a last resort solution. If a custom overhead sign support structure is required:

- Provide a brief written justification for its use.
- Coordinate the proposed design and details early in the plan development process with the District Structures Design Engineer.

Modification for Non-Conventional Projects:

Delete the last sentence above and replace with the following:

Use of a custom (non-standard) overhead sign structure is not permitted unless otherwise shown in the RFP.

261.3 Lighting Support Structures

Use the applicable [Standard Plans](#) for the following lighting support structures:

- **Index 715-010** High Mast Lighting,
- **Index 715-002** Standard Aluminum Lighting.

Refer to the corresponding [SPI](#) for design information.

261.4 Traffic Signal Support Structures

Use the applicable [Standard Plans](#) for the following traffic signal support structures:

- **Index 649-010** Steel Strain Poles,
- **Index 641-010** Concrete Poles,

- **Indexes 649-030** and **649-031** Mast Arm Assemblies.

Refer to the corresponding [SPI](#) for design information.

See **FDM 232** for determining which locations require mast arms.

Design all structures assuming traffic signal assemblies have rigid backplates in accordance with **FDM 232.1.5**

Span wire systems have two strain pole options, rectangular prestressed concrete and round steel. Round steel poles are typically used on longer spans where prestressed concrete poles do not have the required capacity.

For attaching Free-Swinging, Internally Illuminated Street Sign Assemblies, see [Standard Plans Index 700-050](#).

Mast Arm Assemblies may be Standard Mast Arm Signal Structures, Standard Mast Arms for Site-Specific Loadings or Custom Designs. Use the Flowchart in **Figure 261.4.1** to determine which type of Mast Arm design is suitable for the particular application. See [Standard Plans](#), **Indexes 649-030** and **649-031**, and their [SPI](#).

Figure 261.4.1 Flowchart for Designing Mast Arm Assemblies

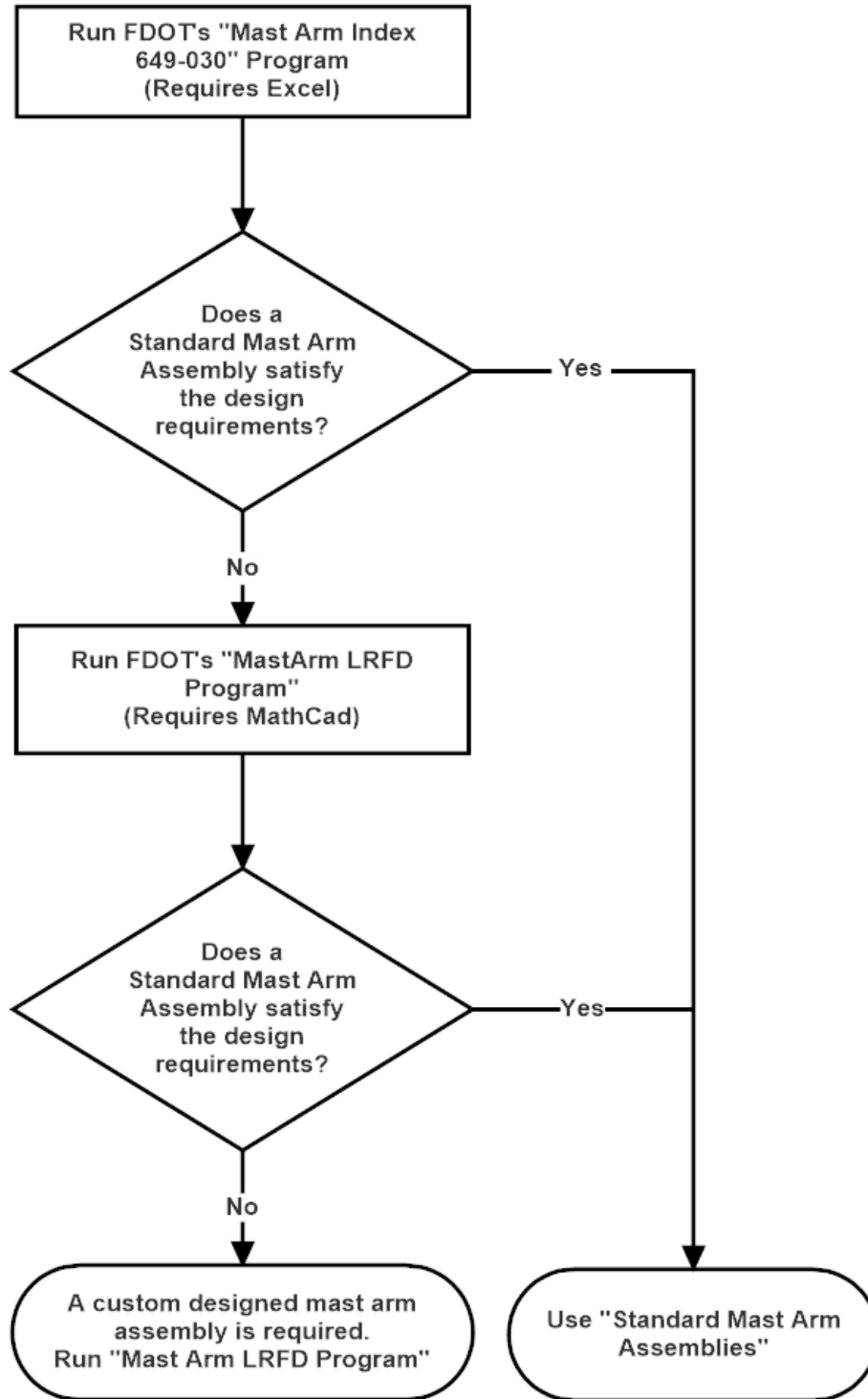

261.5 ITS Support Structures

Use the applicable [Standard Plans](#) for the following ITS support structures:

- **Index 649-020** Steel CCTV Poles,
- **Index 641-020** Concrete CCTV Poles,
- **Indexes 700-040** and **700-041** Cantilever and Span Sign Supports to support Dynamic Message Signs (DMS). For additional DMS details, see [Standard Plans](#), **Index 700-090** Dynamic Message Sign Walk-In.

Refer to the corresponding [SPI](#) for design information.

Refer to the [Structures Manual](#), **Volume 3** for Dynamic Message Sign Structure design requirements.

261.6 Tolling Support Structures

Refer to the [General Tolling Requirements](#) (**GTR**) for the design of tolling support structures.

261.7 Foundations

Unique site circumstances may require the foundation variables to be modified from the foundations shown in the [Standard Plans](#). If custom designs are required, the Geotechnical Engineer must provide the soil information to be used by the EOR during the design phase of the project.

The foundation design and drawings where special foundations are required are the responsibility of the EOR. The Geotechnical Engineer must provide the EOR the following soils information (this information may be derived from the borings of other nearby structures or from roadway borings):

- (1) Soil Type and SPT-N value
- (2) Effective Unit Weight of the Soil
- (3) Design High Water Table Level
- (4) Effective Friction Angle of the Soil (if applicable)
- (5) Cohesion Value (if applicable)
- (6) Coefficient of Horizontal Subgrade Reaction
- (7) Factored Bearing Resistance (if applicable)

Include the above soils information in the plans. Additionally, Soil Boring Data Sheets must be included in the plans, except for strain poles. This will provide the Contractor with the conditions for which the foundations were designed as compared to actual on-site conditions and establish criteria for any future analysis of the foundations.

261.8 Evaluating Existing Ancillary Structures

Evaluate existing ancillary structures within the project limits in accordance with this section to produce the Ancillary Structures Report as described below in **FDM 261.8.4**.

When only retrofitting 'flexible' backplates to existing mast arm or span wire signals, see the [Traffic Engineering Manual \(TEM\)](#), **Section 3.9**.

261.8.1 Condition Evaluation

Perform a Condition Evaluation for ancillary structures that have a proposed change in loading conditions or are proposed for relocation. A Condition Evaluation is a physical and functional assessment that includes inventory of attachments, damage, deterioration, or other potential defects that may cause a reduction in service life or design capacity. Coordinate with the District Structures Design Engineer (DSDE) and District Structures Maintenance Engineer (DSME) prior to performing the Condition Evaluation. Consider the findings of the Condition Evaluation and how the condition may affect the structural capacity of the ancillary structure, paying special attention to items added after initial construction and changes to the structure's section properties. Based on the findings, determine if a detailed structural analysis is required in coordination with the DSDE.

Sources for as-built plans include [ProDo](#) (ProDo is accessible to FDOT staff only), the District Maintenance Office, and District Design Office.

261.8.2 Existing Ancillary Structures to Remain In-Place

When adding new or modifying existing attachments to existing ancillary structures, mitigation strategies should be used to reduce additional structural loading to the extent practicable. For example, some mitigation strategies could include:

- Relocating street name signs, no right turn on red signs, or other attachments to the mast arm upright or closer to the base of the arm.
- Shifting location of existing signals closer to the mast arm upright while maintaining tolerance for lane alignment

- Replacing existing rigid signal backplates with flexible backplates
- Replacing existing attachments with lighter/smaller devices that provide the same/similar function and meet MUTCD minimum requirements

261.8.2.1 Determination of need for Detailed Structural Analysis

A detailed structural analysis of an existing ancillary structure is not required for replacing attachments in-kind (e.g., same or less critical location on the structure; same or less weight or size/EPA) unless warranted by the findings of the Condition Evaluation.

A detailed structural analysis may not be required when adding, modifying, or replacing attachments as described in the following for each ancillary structure type. For these cases, provide a justification in the Ancillary Structures Report. The one-time allowance for additional loads/areas herein are for all attachments in excess of the original design configuration throughout the life of the structure.

Commentary: In some cases, the benefit of adding safety devices to existing structures may outweigh the potential risk of structural failures during the design extreme event limit state. The Department has determined that some level of risk is acceptable to improve safety and replacement of a slightly overstressed ancillary structure based on an extreme high-wind event is not desirable.

- **Lighting Structures:**

Fixtures may be replaced with those having a similar Effective Projected Area (EPA, typically provided by the manufacturer) without detailed structural analysis. The total EPA of all fixtures on the structure must not increase by more than 10% above the documented design EPA (e.g., from Standard Plans Instructions, shop drawings, etc.). If the documented design EPA is not available, use the total existing fixture EPA. Otherwise, perform a detailed structural analysis as described below.

- **Service or CCTV Poles:**

A total area for existing and proposed attachments of less than 6 square feet may be attached to the upright/vertical pole without detailed structural analysis. For standard CCTV camera support structures, see the [Standard Plans Instructions](#) for **Index 641-020** (Concrete CCTV Pole) and **Index 649-020** (Steel CCTV Pole) for additional loading allowed for future operating needs without a detailed structural analysis. Otherwise, perform a detailed structural analysis as described below.

- **Span and Cantilever Overhead Sign Structures:**

Sign panel modifications that comply with the original design (e.g., design has already accounted for future panels) do not require a detailed structural analysis. A total area of less than 6 square feet for existing and proposed attachments (other than sign panels) may be attached without detailed structural analysis. Otherwise, perform a detailed structural analysis as described below.

- **Tolling Structures:**

A total area of less than 6 square feet for proposed attachments (sign panels may not be attached to tolling structures) may be attached without detailed structural analysis. Otherwise, perform a detailed structural analysis as described below.

- **Strain Pole Structures:**

Additional devices attached only to the vertical upright with a total area of less than or equal to 18 square feet and a total weight less than or equal to 145 pounds, no structural capacity analysis is required. Otherwise, perform a detailed structural analysis as described below.

Commentary: The size and weight limits of the additional devices are roughly based on the maximum allowable for internally illuminated street name signs per [Standard Specifications 700](#).

- **Standard Mast Arm Structures:**

A “Standard Mast Arm” support structure is one that has previously been, or is currently, included in the *FDOT [Design Standards](#)* or *FDOT [Standard Plans](#)* regardless of the publication dates. These structures should contain an Identification Tag specifying the Arm Type which can be used to determine the moment capacity of the horizontal support members. The Arm Type or Identification Tag may be noted in the Department’s Bridge Management System (BrM). For structures without an Identification Tag, use the criteria below for Non-Standard Mast Arm Structures.

Commentary: The Identification Tag is typically located under the handhole cover or terminal compartment cover plate. Access to the handhole cover or terminal compartment should be coordinated with the District Maintenance Office.

For Standard Mast Arm support structures with additional devices attached only to the vertical upright with a total area of less than or equal to 18 square feet and a total weight less than or equal to 145 pounds, no analysis is required.

Commentary: The size and weight limits of the additional devices are roughly based on the maximum allowable for internally illuminated street name signs per [Standard Specifications 700](#).

For Standard Mast Arm support structures with additional loading on the horizontal member that produces a flexural demand/capacity ratio less than or equal to 1.10, no further analysis is required. Use the [FDOT Mast Arm Evaluation Program](#) to determine the flexural demand/capacity ratio of the horizontal member.

For Standard Mast Arm support structures with flexural demand/capacity ratios at the base of the horizontal member greater than 1.10, perform a detailed structural analysis.

- **Non-Standard Mast Arm Structures:**

For non-standard Mast Arm structures or those without an Identification Tag, the original as-built plans should be obtained to determine the original configuration of the attachments.

For non-standard Mast Arm support structures with additional devices attached only to the vertical upright with a total area of less than or equal to 18 square feet and a total weight less than or equal to 145 pounds, no analysis is required (see Commentary above).

For non-standard Mast Arm support structures with additional loading (as compared to the configuration of the attachments in the original as-built plans) on the horizontal member that produces an increase in the moment at the base of the horizontal member of less than or equal to 10%, no further analysis is required. Use the [FDOT Mast Arm Evaluation Program](#) to determine percentage increase in moments at the base of the horizontal member.

For non-standard Mast Arm support structures with an increase in moment at the base of the horizontal member greater than 10%, perform a detailed structural analysis.

261.8.2.2 Detailed Structural Analysis

When a detailed structural analysis is required, evaluate the capacity of the structure in accordance with the [Structures Manual, Volume 3, Section 18.1](#). Report the Demand/Capacity (D/C) ratios, Stress Ratios (SRs), and Combined Force Interactions (CFIs). If all D/C ratios, SRs, and CFIs are less than or equal to 1.10, the existing structure may remain without processing a Design Variation or Design Exception. The DSDE must review the detailed structural analysis and provide final direction to either allow the existing structure to remain, strengthen the existing structure, or replace the structure. For projects not in a typical design-bid-build or design-build contract (e.g., permit, push-button, safety), consult the District Traffic Operations Engineer (DTOE) instead of the DSDE. Obtain concurrence from the DSME. The DSME must document the DSDEs or DTOEs decision in BrM.

Contact the DSDE for guidance on a detailed structural analysis for existing ancillary structures without plans, shop drawings, foundation depths, or design calculations.

261.8.3 Existing Ancillary Structures to be Relocated

Perform a Condition Evaluation and detailed structural analysis for all ancillary structures to be relocated.

261.8.4 Ancillary Structures Report

Produce an Ancillary Structures Report including the following:

- Listing of ancillary structures within the project limits including the proposed disposition (e.g., remain in place, relocated, replaced, removed)
- Condition Evaluation (if required)
- Justification for when a detailed structural analysis is not required
- Detailed structural analysis (if required)
- Documentation of any required remedial actions
- Other items as specified by the District

Submit the Ancillary Structures Report to the DSDE and the DSME. The Ancillary Structures Report will be stored in PSEE.

262 Retaining Walls

262.1 General

This chapter describes the procedure to be used in the development of retaining wall plans. This chapter should be used in conjunction with the [Structures Design Guidelines \(SDG\)](#), [Structures Detailing Manual \(SDM\)](#), and the applicable [Standard Plans Instructions \(SPI\)](#).

See **FDM 215** for guidance on roadside barrier requirements and [SDG, Chapter 6](#) for retaining wall mounted traffic railing requirements. See **FDM 222** for pedestrian and bicycle rail requirements. See [SDG, Section 1.4.5](#) for the policy on retaining wall surface finishes.

Precast walls other than Mechanically Stabilized Earth (MSE) walls should be considered as an alternate when sufficient room for soil reinforcement is not available.

[Standard Plans, Index 400 Series, 455 Series, 548 Series](#), and [Indexes 521-600 through 521-640](#), contain general notes and common details for retaining walls. See the applicable [SPI](#) for information on the use of these standards.

Using the site-specific geotechnical information, the structures Engineer of Record (EOR), in cooperation with the Geotechnical Engineer, will determine the appropriate wall type and its requirements. See the [SDG, Section 3.12](#) for the Permanent Retaining Wall Selection Process.

For retaining walls greater than 5 feet in height, provide a 10-foot maintenance area (1:10 or flatter) in front of the wall face with suitable access for maintenance vehicles. See [Structures Design Guidelines \(SDG\), Section 3.12](#) for information regarding partial height walls. See **FDM 210.6** for additional roadside slope information.

The following sections refer to the structures plans submittal procedure. For projects where there are no bridges, the roadway EOR must adjust the procedure as required for the roadway project.

262.2 Retaining Wall Plans Submittal Procedures

On projects with retaining wall types not listed on the APL (C-I-P wall systems, permanent concrete and steel sheet pile walls, soldier pile walls, non-proprietary precast wall systems, complex wall systems, or project specific designs), the complete wall design and details are included in the plans by the EOR.

On projects with proprietary retaining wall systems listed on the [APL](#), the EOR provides the Wall Control Drawings and the appropriate wall systems Data Tables in the plans. The EOR selects which FDOT Wall Type (see the [SDG, Section 3.12](#)) is appropriate for the project and places this information in the notes associated with the Data Tables. The Contractor then selects the [APL](#) listed retaining wall system to build based on the allowable wall types shown in the notes associated with the Data Tables and on the [Standard Plans](#). Proprietary retaining walls require shop drawings in accordance with **FDM 152**.

Proprietary retaining wall design plans are not required in the contract plans for normal wall projects (see **FDM 262.2.2**). If the proprietary walls are two-phased, include generic details for attaching the permanent facing (second phase) to the primary reinforcement in the contract set. If spatial limitations require project specific details, or the wall is subject to unusual geometric or topographic features, include project specific details in the contract set. If the proprietary wall is experimental, it is required to have fully detailed design plans in the contract set (see **FDM 262.2.3**).

Provide an analysis with the 60% Structures Plans Submittal meeting the requirements of [SDG 7.8](#) when an existing MSE wall with metallic soil reinforcement will be widened or modified on a construction project and the existing soil reinforcement provides resistance for the proposed configuration. For wall projects without bridges, provide the analysis with the Phase II Submittal.

Modification for Non-Conventional Projects:

Delete the above paragraph and replace with the following:

Unless otherwise shown in the RFP, provide an analysis with the 90% Submittal meeting the requirements of [SDG 7.8](#) when an existing MSE wall with metallic soil reinforcement will be widened or modified on a construction project and the existing soil reinforcement provides resistance for the proposed configuration.

Prior to construction on projects utilizing proprietary wall systems, the contractor will submit, for approval by the EOR, shop drawings that are based on an [APL](#) listed wall system that is shown in the plans. Site-specific details for the wall construction will be included in these shop drawings.

The success of these methods for producing wall plans is highly dependent on complete, accurate and informative Control Plans. The importance of the Geotechnical Engineer's

role in this scheme cannot be emphasized enough and is detailed in the [Soils and Foundation Handbook, Chapters 3, 8, and 9](#).

The Geotechnical Engineer's wall type recommendation must be presented in a report together with the results of field and laboratory testing and the reasoning for the recommendation. For Proprietary Walls, also include the following: external stability analyses, minimum soil reinforcement length vs. wall height for external stability, recommended soil reinforcement type limitations if any (e.g., synthetic vs. steel), maximum bearing pressure for each wall height and soil reinforcement length for each different wall height (2-foot increments).

The normal failure modes to be investigated are shown in [SDG, Chapter 3](#).

Procedures for developing retaining wall plans follow.

262.2.1 Non-Proprietary Retaining Walls

(1) Bridge Development Report (BDR) / 30% Plans:

The BDR must discuss and justify the use/non-use of non-proprietary retaining walls. If the use of these retaining walls is applicable to the site and economically justified, it may be the only design required or it may be an alternate to a proprietary design. Include Wall Control Drawings (as specified in the [SDM, Chapter 19](#)), cross sections, details and general notes in the 30% Plans submittal. Denote the location of drainage inlets, utilities, sign structures, lights, and barrier joints in the plans. See the [SDM, Chapter 19](#) for more information.

(2) 30% Plans:

The 30% Plans must be submitted for approval and development of the plans continued towards the 90% Plans submittal.

(3) 90% Plans:

The 90% Plans submittal must be further developed to include, in addition to the information required for the 30% Plans, information listed in the [SDM, Chapter 19](#).

Modification for Non-Conventional Projects:

Delete **FDM 262.2.1** and replace with the following:

262.2.1 Non-Proprietary Retaining Walls

See [SDG](#), **Section 3.12** for wall selection requirements. Include Wall Control Drawings (as specified in the [SDM](#), **Chapter 19**), cross sections, complete wall details and general notes in the Component Plans submittal. Denote the location of drainage inlets, utilities, sign structures, lights and barrier joints in the plans. See the [SDM](#), **Chapter 19** for more information.

262.2.2 Proprietary Wall Systems Where Full Design Details Are Not Required In Contract Plans

Preapproved Vendor Drawings for proprietary wall systems are listed on the [APL](#) and are categorized in accordance with the applicable FDOT Wall Type(s). Utilize these drawings with the applicable standard(s) and Data Tables. Do not include the Vendor Drawings in the plans.

Use the following procedure in preparing plans for wall projects.

(1) BDR/30% Plans:

Discuss and justify the use of proprietary retaining walls and FDOT Wall Types (see [SDG](#), **Section 3.12**) in the BDR. Provide documentation of all the site-specific geotechnical information and wall system considerations in the Retaining Wall Justification portion of the BDR. Include the Retaining Wall System Data Tables and Preliminary Wall Control Drawings with the information shown in [SDM](#), **Chapter 19** for the Plan and Elevation Sheets.

(2) 60% Plans/Phase II Roadway Submittal:

For bridge projects requiring project specific details for proprietary wall systems, include the project specific details in the 60% Plans Submittal. For wall projects without bridges, project specific details must be included in the Phase II Submittal.

(3) 90% Plans/Phase II Roadway Submittal:

Include the completed Wall Control Drawings, project specific details and Data Tables in the 90% Plans Submittal.

Modification for Non-Conventional Projects:

Delete **FDM 262.2.2** and replace with the following:

262.2.2 Proprietary Wall Systems Where Full Design Details Are Not Required In Contract Plans

Preapproved Vendor Drawings for proprietary wall systems are listed on the [APL](#) and are categorized in accordance with the applicable FDOT Wall Type(s). Utilize these drawings with the applicable standard(s) and Data Tables. Do not include the Vendor Drawings in the plans.

Using site-specific geotechnical information, the EOR, in cooperation with the geotechnical engineer, will determine all wall system requirements. See [SDG 3.12](#) to determine appropriate FDOT Wall Type. Include Wall Control Drawings, project specific details, and Data Tables in the Component Plans submittal, as specified in the [SDM, Chapter 19](#). Denote the location of drainage inlets, utilities, sign structures, lights and barrier joints in the plans. See the [SDM, Chapter 19](#) for more information.

262.2.3 Proprietary Wall Systems Where Full Design Details Are Required In Contract Plans

The following procedure for plans preparation should be followed if the walls are required to be fully detailed in the contract plans.

(1) BDR/30% Plans:

The BDR must discuss and justify the use of proprietary retaining walls. Include Wall Control Drawings in the 30% Plans. It will not be necessary for these Plans to contain pay items; however, they must include, but not be limited to, the information listed in the [SDM, Chapter 19](#).

(2) Control Plans/Invitation Package:

The Control Plans must be reviewed by the Department and, upon approval, sent to all the appropriate wall companies. Provide a set of control plans, roadway plans and foundation report to the wall companies no later than by the 60% Plans submittal. A copy of the transmittals to the wall companies must be sent to the DSDO or SDO as appropriate. The proprietary companies must acknowledge receipt of the invitation package. If they choose to participate they must provide design plans for the retaining walls and submit the plans for review as prescribed in the invitation letter.

(3) 90% Plans:

Upon receipt of the proprietary design plans, the designer must review the design and incorporate the wall plans into the contract set. The plans from the wall companies, control plans and wall company standard drawings must constitute the 90% Plans.

Modification for Non-Conventional Projects:

Delete **FDM 262.2.3** and replace with the following:

262.2.3 Proprietary Wall Systems Where Full Design Details Are Required In Contract Plans

Using site-specific geotechnical information, the EOR, in cooperation with the geotechnical engineer, will determine wall system requirements. See [SDG 3.12](#) to determine appropriate FDOT Wall Type. The Design-Build EOR must coordinate with one of the vendors with approved wall drawings on the [APL](#) to prepare fully detailed project specific proprietary drawings for inclusion into the Component Plans. Include Wall Control Drawings and Data Tables (in accordance with [SDM, Chapter 19](#)) in the Component Plans submittal. Denote the location of drainage inlets, utilities, sign structures, lights and barrier joints in the plans. See the [SDM, Chapter 19](#) for more information.

262.2.4 Critical Temporary Walls

A critical temporary wall is a temporary wall that is necessary to maintain the safety of the traveling public, or structural integrity of nearby structures or utilities during construction. Traffic lanes located either above or below a grade separation and within the limits shown in [SDM, Chapter 19](#), will require the design of a critical temporary wall.

On bridge projects, discuss the use of, and selected type of, critical temporary walls in the BDR.

Modification for Non-Conventional Projects:

Delete the above sentence.

Typically, critical temporary walls are either proprietary MSE walls or steel sheet pile walls. Concrete sheet piles, soldier pile walls and precast or cast-in-place concrete walls may also be used as critical temporary walls.

Critical temporary proprietary MSE walls must comply with [Standard Plans, Index 548-030](#) (and the applicable [SPI](#)) and require generic design details in the contract plans. The plans format must be in accordance with **FDM 262.2.2** and **FDM262.2.3**. Include control drawings and the completed Temporary Retaining Wall System Data Tables. Submit the final design details in the shop drawings.

If critical temporary steel sheet pile walls are used, complete the associated Data Table and include it in the plans. See the [Structures Detailing Manual](#) for more information including critical temporary wall definitions.

If other types of critical temporary walls are used, prepare the necessary details and include them in the plans.

263 Geosynthetic Design

263.1 General

This chapter provides design guidance for geosynthetic reinforced soil slopes and geosynthetic reinforced foundations over soft soils. “Geosynthetic” is a generic term for all synthetic materials used in Geotechnical engineering applications and includes geotextiles and geogrids.

Reinforced soil slopes should be utilized only when unreinforced slopes are not appropriate and retaining walls are not economical or are undesirable. **FDM 215** contains design criteria for the use of roadside slopes.

Reinforced foundations over soft soils should be utilized when the existing soils are too weak to support the anticipated loading without soil failure, and when excavation and replacement (or other ground modification methods) are not economical solutions.

Approved geosynthetic products are included in the [Approved Products List \(APL\)](#).

263.2 Contract Plans Content

Provide the geosynthetic application type and specific requirements to ensure the geosynthetic selected from the [APL](#) will be suitable. Refer to [Standard Specification 985](#) to determine which test values will be available for selecting the products for each application from the [APL](#).

Control drawings are required which depict the geometrics (plan and elevation view) of the area being reinforced. These designs are generic and are not based upon any one specific product or supplier; the product brand names are not shown on the plans. Design reinforced slopes using the maximum reinforcement spacing allowed. For soft soils, design the reinforcement and provide the minimum total strength required.

Include the following information in the plans:

- Required reinforcement strength based on the maximum allowed vertical spacing of these materials,
- The extent and the number of layers of geosynthetic reinforcement,
- Vertical spacing of geosynthetic reinforcement,
- Orientation of geosynthetic,

- Facing details,
- Details at special structures or obstructions,
- Typical construction sequence,
- Top and bottom elevations of the geosynthetic reinforcement layers,
- Surface treatments, and
- Any other required design parameters or limitations.

263.3 Shop Drawings and Redesigns

The contractor can choose to construct the reinforced soil structures either by: (1) using geosynthetic materials approved for the intended application in the [APL](#) meeting or exceeding the strength required in the plans and placed at or less than the spacing(s) shown in the plans, or (2) submitting an alternate design (redesign) which optimizes the use of a specific material and revises the material spacing within the limits contained in the design methodology in **FDM 263.4**. Redesigns may be optimized for backfill specific material properties verified prior to the redesign or based on generic properties which must be verified prior to backfill placement. All designs must meet the design methodology requirements contained in **FDM 263.4**.

Modification for Non-Conventional Projects:

Delete the first sentence of the above paragraph and replace with the following:

Construct the reinforced soil structures using geosynthetic materials approved for the intended application in the [APL](#) meeting or exceeding the strength required in the plans and placed at or less than the spacing(s) shown on the Plans.

The shop drawing reviewer must be familiar with the requirements, design and detailing of these systems. The review must consist of but not limited to the following items:

- (1) Verify horizontal and vertical geometry with the contract plans.
- (2) The soil reinforcement must be approved for the intended application in the [APL](#).
- (3) The soil reinforcement design values do not exceed the values in the [APL](#).
- (4) Verify that the material strengths and number of layers of the product selected meets or exceeds the design shown in the contract plans.

- (5) Soil properties for the fill material chosen by the contractor must meet or exceed those used in the design shown in the Contract Plans.
- (6) If a redesign is proposed, verify the design meets the requirements of **FDM 263.4** and the Contract Plans, and the soil properties for the fill material chosen by the contractor meets or exceeds those used in the redesign.

See [Standard Specifications Section 145](#) for requirements associated with Contractor initiated redesigns.

263.4 Geosynthetic Reinforcement Design Considerations

Only those geosynthetic products approved for usage on reinforced soil slopes in the [APL](#) are eligible for use on FDOT projects. Design the geosynthetic reinforced systems using comprehensive stability analyses methods that address both internal and external stability considerations by a Florida licensed Professional Engineer who specializes in Geotechnical engineering.

263.5 Geosynthetic Reinforcement Design Requirements

Use the following design guidelines and requirements for the analyses and design of geosynthetic reinforcement:

- (1) **Performance:** The design resistance factors must cover all uncertainties in the assumptions for the design limit state. The resistance factors must not exceed the following:
 - (a) 0.65 against pullout failure.
 - (b) 0.65 against sliding of the reinforced mass.
 - (c) 0.75 against external, deep-seated failure.
 - (d) 0.65 against external, deep-seated failure when supporting a structure.
 - (e) 0.75 against compound failure; i.e., failure through the reinforcement.
 - (f) 0.75 against internal failure.
 - (g) 0.75 against local bearing failure (lateral squeeze).

- (2) **Nominal Tension Resistance of Reinforcement:** The maximum long-term reinforcement tensile resistance of the geosynthetic must be:

$$T_a = \frac{T_{ult}}{RF_c RF_d CRF}$$

Where:

- T_a = The nominal long-term reinforcement tensile resistance.
- T_{ult} = The ultimate strength of a geosynthetic in accordance with [ASTM D 6637](#) for the reinforcement oriented normal to the slope.
- RF_c = Reduction factor for installation damage during construction for the appropriate fill material (sand or lime rock).
- RF_d = Reduction factor for durability (due to Chemical or Biological degradation).
- CRF = Creep reduction factor. (T_{ult}/T_{creep})
- T_{creep} = Serviceability state reinforcement tensile load based on minimum 10,000-hour creep tests.

These reinforcement specific parameters can be found in the [APL](#).

For applications involving reinforcing slopes with geosynthetic, the minimum design life is 75 years.

- (3) **Soil Reinforcement Interaction:** Friction reduction factors are presented as Soil-Geosynthetic Friction values in the [APL](#) for each approved geosynthetic product.

263.6 Geosynthetic Reinforcement Design Guidelines

These design guidelines are excerpted from the FHWA Publications (a) **FHWA GEC 011** ([FHWA-NHI-10-024](#) & [FHWA-NHI-10-025](#)), "**Design and Construction of Mechanically Stabilized Earth Walls and Reinforced Soil Slopes-Volumes 1 & 2**", and (b) **No. FHWA HI-95-038**, "**Geosynthetic Design and Construction Guidelines**". Designers should refer to these publications for further details.

- (1) **Reinforced Slope** - see reference (a) **FHWA GEC 011**.

- Step 1. Establish the geometry and loading - see **Figure 263.6.1**.
- Step 2. Determine the engineering properties of the in-situ soils.

- Step 3. Determine the properties of the reinforced fill and the retained fill.
- Use the following default values for fill soil within the reinforced volume when the fill material source is not known:
- For sand fill: $\phi = 30^\circ$, $\gamma = 105$ pcf, $c = 0$;
- For crushed lime rock fill: $\phi = 34^\circ$, $\gamma = 115$ pcf, $c = 0$.
- Step 4. Evaluate design parameters for the reinforcement.
- Step 5. Check unreinforced slope stability.
- Step 6. Design reinforcement to provide a stable slope.
- Step 7. Check external stability and service limit state deformations.
- Step 8. Evaluate requirements for subsurface and surface water runoff control.

(2) **Reinforced Foundation over Soft Soils** - see reference (b) [*FHWA HI-95-038*](#).

- Step 1. Define embankment dimensions and loading conditions - see **Figure 263.6.2**.
- Step 2. Establish the soil profile and determine the engineering properties of the foundation soil.
- Step 3. Obtain engineering properties of embankment fill materials.
- Step 4. Establish appropriate resistance factors and operational settlement criteria for the embankment.

The resistance factors must not exceed the following:

- (a) 0.65 against bearing failure of subsoil
- (b) 0.65 against pullout failure in select soil
- (c) 0.50 against pullout failure in plastic soil
- (d) 0.65 against lateral spreading (sliding) of the embankment
- (e) 0.75 against external, deep-seated failure at the end of construction

- (f) 0.65 against external, deep-seated failure at the end of construction, when supporting a structure.
- (g) 0.65 against tensile failure of the reinforcement

Settlement criteria: depends upon project requirements

Step 5. Check bearing capacity, global stability (both short and long term), and lateral spreading stability.

Step 6. The geosynthetic reinforcement should be designed for strain compatibility with the weak in-situ soil.

Based on the type of weak in-situ soil, the maximum design strain in the geosynthetic ($\epsilon_{\text{geosynthetic}}$) is as follows:

Cohesionless soil: $\epsilon_{\text{geosynthetic}} = 5\%^*$

Cohesive soils: $\epsilon_{\text{geosynthetic}} = 5\%^*$

Peat: $\epsilon_{\text{geosynthetic}} = 10\%^*$

* For all cases, limit $\epsilon_{\text{geosynthetic}}$ to the strain at failure minus 2.5%

Step 7. Establish geosynthetic strength requirements in the geosynthetic's longitudinal direction.

Step 8. Establish geosynthetic properties.

Step 9. Estimate magnitude and rate of embankment settlement.

Step 10. Establish construction sequence and procedures.

Include all stages of construction. Base the analysis of each stage on the estimated strength of the subsoils at the end of the previous construction stage.

Step 11. Establish construction observation requirements.

Use instrumentation such as settlement plates, piezometers, and/or inclinometers to monitor the performance of the construction. Establish the monitoring criteria, such as the maximum rate of piezometric and/or settlement change that must occur before the next stage of construction can proceed.

Figure 263.6.1 Geosynthetic Reinforced Soil Slopes

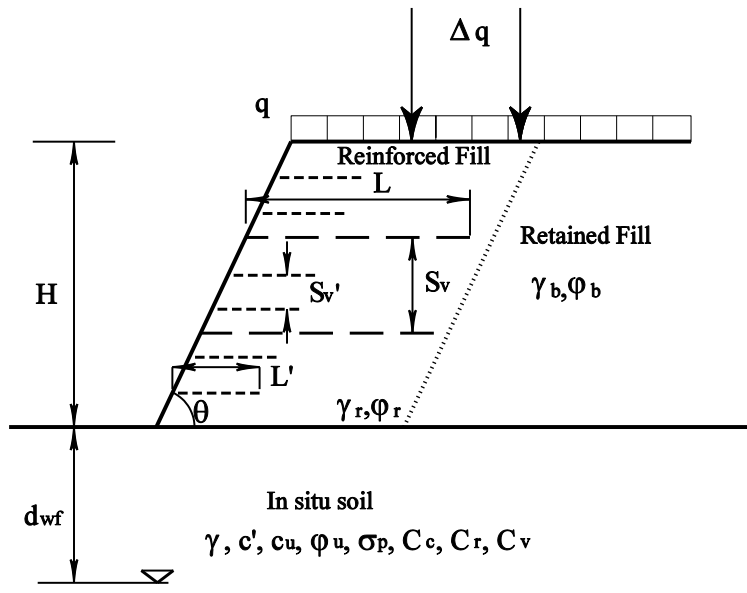

- Notations:**
- H = slope height
 - θ = slope angle
 - L = length of primary reinforcement
 - L' = length of secondary reinforcement, 4' minimum
 - S_v = vertical spacing between primary reinforcements, 4' maximum
 - S_v' = vertical spacing between secondary reinforcements, 1' maximum
 - q = surcharge load
 - Δq = temporary live load
 - d_{wf} = depth to groundwater table in foundation
 - $\gamma_r, \gamma_b, \gamma$ = unit weights of soils in reinforced, retained and foundation, respectively
 - ϕ_r, ϕ_b, ϕ = friction angles of soils in reinforced, retained and foundation, respectively
 - c', c_u = cohesion strength parameters of foundation soil

Figure 263.6.2 Geosynthetic Reinforced Foundations over Soft Soils

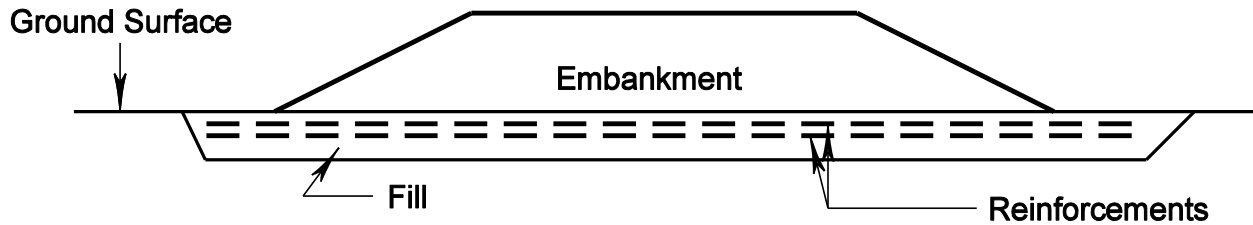

- (1) The spacing between any two reinforcements must be 6 to 12 inches.
- (2) Extend the reinforcement layer(s) below the embankment to 3 feet beyond the toe of slope or the development length required to resist pullout, whichever is longer.
- (3) Additional layers of reinforcement may be added below or within the embankment.

264 Noise Walls and Perimeter Walls

264.1 General

Noise abatement measures identified as reasonable and feasible during the PD&E phase are re-evaluated during final design based on detailed design data and the public involvement process. This chapter contains the process for the final noise wall analysis, reasonableness and feasibility determinations, design and public involvement concerning noise abatement during the development of the contract plans.

This chapter also contains the process for the consideration, design, and incorporation of perimeter walls in the contract plans.

264.2 Noise Walls

Chapter 23 of the **Code of Federal Regulations, Part 772 (23 CFR 772)** entitled **“Procedures for Abatement of Highway Traffic Noise and Construction Noise”** contains the federal regulations for the assessment of traffic noise impacts and abatement on federal aid projects. **Section 335.17** of the **Florida Statutes (F.S.)** requires the use of **23 CFR 772** for traffic noise impact assessment on highway projects, regardless of funding type. The policy for abatement of traffic noise on Department projects and the requirements for assessing the noise impacts and abatement commitments are detailed in FDOT’s Noise Policy (**Part 2, Chapter 18** of the **Project Development and Environment Manual (PD&E Manual) (Topic No. 650-000-001)**). The initial evaluation of noise impacts is made during the PD&E phase of a project. A commitment to perform a detailed noise analysis during final design to support the need for reasonable and feasible noise abatement measures on a project are included in the Noise Study Report (NSR) and summarized in the Environmental Document. Review the Environmental Document and any subsequent re-evaluations to identify all preliminary noise abatement commitments.

Noise abatement commitments made during the PD&E phase are subject to design changes made during final design, such as:

- (1) Roadway profiles and horizontal alignments
- (2) Typical section elements
- (3) Land use changes
- (4) Proposed ground elevation at noise wall locations.

PD&E assumptions are appropriate for preliminary reasonableness and feasibility assessment; however, the final determinations concerning noise abatement are based on the contract plans developed during final design. Coordinate with the District Noise Specialist in the District Environmental Management Office to ensure proper analysis and public involvement occurs. Final top of noise wall elevations should be based on modeled heights and coordinated with the District Noise Specialist.

Modification for Non-Conventional Projects:

Delete the above two paragraphs and replace with the following:

See the RFP for noise wall requirements. If an Alternative Technical Concept proposes changes to the horizontal or vertical alignments depicted in the Concept Plans, any associated required changes to the noise wall locations must also be addressed. Any modifications or additions to noise wall location and height requirements depicted in the RFP must be approved by the Department based on the information from a Noise Study Report Addendum (NSR Addendum) provided by the Design-Build Firm. The Design-Build Firm must coordinate with the noise specialist in the District Environmental Management Office to ensure proper public involvement occurs during final design. Changes will trigger a re-evaluation, which must be approved by the Department.

If no feasible and reasonable noise abatement is identified in the Environmental Document or any subsequent environmental re-evaluations, no further effort is required during final design unless design changes are made that may affect noise impacts. However, it is still necessary to evaluate construction noise and vibration impacts and develop any Special Provisions to be included in the plans.

Modification for Non-Conventional Projects:

Delete the above paragraph and replace with the following:

If noise walls are not specified in the RFP, no further effort is required during final design. If design changes are proposed, a reevaluation of traffic noise and abatement reasonableness and feasibility shall be performed. Evaluate construction noise and vibration impacts and develop the necessary Special Provisions to be included in the plans.

Consider all noise receptors identified in the Environmental Document and NSR in the final design re-evaluation. Noise receptors resulting from development completed after the approval date of the Environmental Document (Date of Public Knowledge) are not to

be considered, as the Department is not responsible for providing noise abatement at these sites.

During final design:

- (1) Re-evaluate noise abatement identified as reasonable and feasible during the PD&E phase based on detailed design data or changes made during the development of final plans.
- (2) Evaluate locations where significant design changes are likely to affect noise impacts and require consideration of additional noise abatement.

Document the final noise abatement measures for the project in a Noise Study Report Addendum (NSR Addendum).

Modification for Non-Conventional Projects:

Delete the above two paragraphs and replace with the following:

If an Alternative Technical Concept is proposed to change the horizontal or vertical alignments depicted in the Concept Plans, any associated required changes to the noise wall locations must also be addressed. Any modifications/additions to noise wall location and height requirements depicted in the RFP must be evaluated for approval by the Department.

See RFP for requirements.

See **Structures Design Guidelines (SDG), Section 1.4.5** for the policy on noise wall surface finishes.

264.2.1 Noise Study Report Addendum

The re-evaluation of preliminary noise abatement commitments during final design is documented in an NSR Addendum. The re-evaluation must be based on the final roadway geometry and the proposed noise abatement design, including noise wall type, location, dimensions, and estimated costs. The final design re-evaluation should be conducted using the latest version of the FHWA's Traffic Noise Model (TNM).

Noise abatement measures are considered when noise levels at a receptor(s) approach or exceed the noise abatement criteria or substantially exceed existing noise levels. The noise abatement criteria are listed in **Table 264.2.1**. Approaching the criteria means within 1 dB(A) of the noise abatement criteria. A predicted increase of 15 dB(A) or more is considered substantial. Noise abatement is considered only for Activity Categories A, B, C, D and E.

The NSR Addendum should contain a description of the methodology for selecting final noise wall dimensions including any evaluation matrix used.

264.2.2 Noise Abatement Criteria

A noise wall should be both reasonable and feasible to be provided on the project.

264.2.2.1 Feasibility

Factors for noise abatement measures include both acoustic (noise reduction) and engineering considerations. The noise wall must attain a minimum acoustic insertion loss of 5 dB(A) to at least two impacted receptors. The insertion loss is defined as the level of noise reduction because of abatement.

Engineering factors to consider is the constructability of the noise wall; e.g., lane closures, sight distance, terrain changes, utilities, bridges, overpasses, access, maintenance, and drainage. Consideration should also be given to whether a noise wall can be constructed using standard construction methods and techniques.

264.2.2.2 Reasonableness

A noise wall is considered reasonable if it provides an insertion loss design goal of 7 dB(A) to at least one benefited receptor at a reasonable cost of \$42,000 per benefited receptor or less. A benefited receptor is a receptor that receives a noise reduction at or above the minimum threshold of 5 dB(A) (whether impacted or not).

The cost reasonableness is calculated by multiplying the statewide average unit cost (per square foot) by the square footage of the noise wall and dividing it by the number of benefited receptors. The statewide average unit cost of noise wall to be used in determining cost reasonableness is established by the Office of Environmental Management. The statewide average unit cost of noise walls to be used in the calculation of the cost/benefited receptor is \$30.00/ft². Refer to the [PD&E Manual](#) for the latest unit cost update.

Additional costs such as required right of way, special drainage features, special bridge support and special foundations associated with the installation of a noise wall should be added to the unit cost. If these additional costs increase the cost per benefited receptor above the \$42,000 limit, a determination to provide noise abatement must be made in consultation with the District Environmental Management Office, and the Office of Environmental Management (OEM), pursuant to **Title 23 United States Code (U.S.C.), Chapter 3, Section 327** and [Memorandum of Understanding \(MOU\)](#) dated December

14, 2016. Any decision to eliminate a noise wall from consideration based on the inclusion of these additional costs will require clear demonstration that the additional costs are associated only with the noise wall and cannot be mitigated by other considerations.

Do not exceed the following heights:

- (1) For ground mounted noise walls use a maximum height of 22 feet. Shield non-crash tested noise walls within the clear zone.
- (2) For noise walls on bridge and retaining wall structures use a maximum height of 8 feet.
- (3) For ground mounted Traffic Railing/Noise Wall combinations use a maximum height of 14 feet.

Refer to the NSR prepared during the PD&E phase for the analytical results used to evaluate noise wall heights necessary to achieve minimum, desired and optimum insertion loss. The optimum noise wall height is the most cost effective in consideration of noise reduction benefits per unit cost of the noise wall. Perform a comparative analysis to evaluate an appropriate range of noise wall configurations (height, length and roadway offset). Determine the number of benefited receptors and calculate the cost per benefited receptor for each configuration evaluated. Select a noise wall configuration that can provide the insertion loss design goal (7 dB(A)) at a reasonable cost (less than \$42,000 per benefited receptor). If this is not achievable, select a noise wall configuration that optimizes insertion loss per impacted receptor and cost per benefited receptor.

The height of the noise wall is measured from the ground elevation to the top of the noise wall. Tall noise walls are seldom necessary at the top of roadway embankments or berms since the elevation of the embankment contributes to the effective height of the noise wall. In addition, changes in the vertical grade of the top of the noise wall should be gradual and abrupt changes in wall heights should be avoided. Natural ground elevations at the base of the noise wall fluctuate, even in flat terrain. Therefore, provide plan details that make clear to the contractor the final top of wall elevations, post spacing and foundation step locations. See the [Standard Plans Instructions, Index 534-200](#), and [Indexes 521-510](#) thru [521-515](#) for additional design requirements. See [LRFD Section 15](#) and [SDG, Sections 3.16](#) and [3.18](#) for the Noise Wall design criteria.

When an otherwise continuous noise wall is broken resulting in a horizontal separation between the wall sections, it is often necessary to overlap the wall sections to reduce insertion loss degradation. Examples of horizontal separation include:

- When the mainline noise wall is located at the right of way line, but is moved to the shoulder break at a bridge location.
- When transitioning from the mainline to a ramp at interchanges.

The overlap distance of noise walls is generally equal to four times the separation; however, an analysis by the Noise Specialist is necessary to determine the optimum overlap. Review the need or effectiveness of a noise wall in the infield area of an interchange during final design. The attenuation of ramp traffic may provide adequate insertion loss when considering the intersecting roadway's noise contribution. When selecting wall termini details, consider maintenance access, clear zone and line of sight.

Ensure the noise wall study station limits, for concrete barrier/noise walls, are extended to account for any tapers, attenuators or guardrail required during final design as required by the [Standard Plans](#). This also applies to overlapping noise wall installations. These changes may require reanalysis in an updated Noise Study Report Addendum document due to site specific geometry.

Show the location and limits (stations and offsets), including any tapers, for the traffic railing/noise walls in the contract plans.

Table 264.2.1 Noise Abatement Criteria

Noise Abatement Criteria [Hourly A-Weighted Sound Level-decibels (dB(A))]				
Activity Category	Activity Leq(h)		Evaluation location	Description of activity category
	FHWA	FDOT		
A	57	56	Exterior	Lands on which serenity and quiet are of extraordinary significance and serve an important public need and where the preservation of those qualities is essential if the area is to continue to serve its intended purpose.
B	67	66	Exterior	Residential
C	67	66	Exterior	Active sports areas, amphitheaters, auditoriums, campgrounds, cemeteries, day care centers, hospitals, libraries, medical facilities, parks, picnic areas, places of worship, playgrounds, public meeting rooms, public or nonprofit institutional structures, radio studios, recording studios, recreational areas, Section 4(f) sites, schools, television studios, trails, and trail crossings.
D	52	51	Interior	Auditoriums, day care centers, hospitals, libraries, medical facilities, places of worship, public meeting rooms, public or nonprofit institutional structures, radio studios, recording studios, schools, and television studios.
E	72	71	Exterior	Hotels, motels, offices, restaurants/bars, and other developed lands, properties or activities not included in A-D or F.
F	-	-	-	Agriculture, airports, bus yards, emergency services, industrial, logging, maintenance facilities, manufacturing, mining, rail yards, retail facilities, shipyards, utilities (water resources, water treatment, electrical), and warehousing.
G	-	-	-	Undeveloped lands that are not permitted.

Notes:

- (1) Based on *Table 1 of [23 CFR Part 772](#)*
- (2) Activity Leq(h) criteria values are for impact determination only, and are not design standards for noise abatement measures.
- (3) Activity Category B, C and E include undeveloped lands permitted for these activities.
- (4) FDOT defines that a substantial noise increase occurs when the existing noise level is predicted to be exceeded by 15 decibels or more as a result of the transportation improvement project. When this occurs, the requirement for abatement consideration will be followed.

264.2.3 Final Noise Abatement Measures

Document the final noise abatement measures in the environmental re-evaluation and the NSR Addendum prior to construction advertisement. Refer to **Part 2, Chapter 18** of the [PD&E Manual](#) for required documentation in the NSR Addendum.

Modification for Non-Conventional Projects:

Replace the above paragraph with the following:

Any modifications to noise abatement locations, noise wall types, lengths and heights must be documented in the NSR Addendum for approval by the Department prior to beginning noise wall construction.

The District Noise Specialist will verify that the noise walls shown in the contract plans comply with the final noise abatement measures included in the NSR Addendum.

The District Environmental Management Office will ensure that the final noise abatement measures are reflected in the re-evaluation of the Environmental Document and will obtain concurrence from OEM, if appropriate.

264.3 Perimeter Walls

Modification for Non-Conventional Projects:

Delete **FDM 264.3** and replace with the following:

See the RFP for perimeter wall requirements. If an Alternative Technical Concept is proposed that changes the horizontal or vertical alignments depicted in the Concept Plans, any associated required changes to the perimeter wall locations must also be addressed. Any modifications/additions to perimeter wall location requirements depicted in the RFP must be assessed by the Department based on the information provided by the Design-Build Firm and are subject to Department approval. The Design-Build Firm must coordinate with the District Environmental Management Office to ensure proper public involvement occurs during final design.

Perimeter walls provide a barrier between a highway and adjacent properties; however, they are not intended to provide any measurable noise reduction. Benefits of perimeter walls include:

- (1) minimizing visual impacts,
- (2) providing a visual screen when existing vegetation is removed,
- (3) providing a physical separation,
- (4) maintaining access control restrictions.

The initial assessment for the use of a perimeter wall would typically be performed during the PD&E phase and documented in a Perimeter Wall Justification Report (PWJR). The final decision for the use of a perimeter wall is made during final design when the conditions and cost are available for consideration. Add decisions made during final design to the PWJR by addendum. See the [Standard Plans Instructions, Index 534-250](#) design requirements. See *LRFD Section 15* and [SDG, Sections 3.16](#) and [3.18](#) for the design criteria

264.3.1 Consideration of Perimeter Walls

Perimeter walls may be considered:

- (1) On new construction and reconstruction projects when requested by a local municipality or group of directly affected property owners. The distance from the edge of the proposed travel lane to the closest portion of the adjacent structure should be less than 150 feet; and when one or more of the following are met:
 - (a) The capacity of an existing highway is expanded by adding lanes to the outside.
 - (b) Horizontal and/or vertical alignment of an existing highway is significantly altered as defined in the [PD&E Manual](#) (Part 2, Chapter 18, Section 18.1.3.1 Type I Projects).
 - (c) The highway project is proposed on a new alignment or location.
 - (d) Existing vegetation or other visual barriers are removed.
- (2) Around Department facilities (e.g., rest areas, weigh stations), to separate the facility from adjacent land uses.

Consider the following factors when determining if a requested perimeter wall would provide a benefit:

- (1) **Functional Classification:** Perimeter walls will not be recommended on arterial roadways where multiple openings would be required to maintain access.

- (2) Context Classification; e.g., dense residential, educational facilities, recreation areas. Land on which the structure is located should be immediately adjacent to the R/W.
- (3) Highway traffic is visible from the adjacent properties.
- (4) No new Right of Way is required to construct the wall (further consideration will be made if Department is granted an easement from adjacent properties).
- (5) Constructability, safety, cost, access, drainage and utility conflicts.
- (6) Cost of perimeter wall must not exceed \$25,000 for each adjacent property, including the cost of utility relocation.

To assure consistent application of these guidelines, partial or complete funding from third party sources will not be accepted and no custom designs are allowed.

See [SDG, Section 3.18](#) for additional limitations on where perimeter walls may be located.

264.3.2 Restrictions on Consideration of Perimeter Walls

Perimeter walls are not considered on the following conditions unless an exception is granted by the Assistant Secretary of Engineering and Operations:

- (1) Retrofitting existing conditions where highway improvements are not proposed
- (2) Mitigation of environmental impacts
- (3) Building(s) that received a building permit after the Date of Public Knowledge

264.3.3 Local Municipality Concurrence

The Department will approach the local government during the design phase of the project to seek concurrence on the inclusion of proposed perimeter wall; including location and aesthetics. The local government will be responsible for obtaining support from the majority (simple majority) of the adjacent residents/property owners prior to construction of a perimeter wall. The local government or landowner assumes responsibility for maintenance and structural repairs of perimeter walls located on non-FDOT owned lands.

The local government or landowner will provide formal concurrence with the recommendation (resolution or letter) and a Maintenance Agreement for the perimeter wall, if applicable. Include these documents in the PWJR Addendum.

264.4 Public Involvement

Public coordination is often necessary to finalize wall locations, length and heights, color, textures, and other aesthetic features. Coordinate required public involvement activities with the District Public Involvement or Community Liaison Coordinator.

264.4.1 Noise Walls

Conduct a written survey to establish that a simple majority of the benefited receptors are in favor of the construction of the noise wall. If the public is not in favor, the Department may elect not to build the wall. The Department will make the final determination on the use of noise walls if consensus cannot be reached by a neighborhood. This survey is typically conducted during final design but may have occurred during the PD&E phase. Coordinate survey issues with the District Environmental Management Office.

Noise walls located on arterial roadways can potentially impact access. The ability to construct an effective noise wall can depend on an individual property owner's willingness to sign a right of way indenture allowing access to be cut off or modified. For these conditions, it is a general practice to obtain a written statement from each affected property owner demonstrating support for the noise wall. If an adjacent property owner declines to sign the indenture, evaluate alternative noise wall layouts to determine the effectiveness of noise abatement on the project segment. Document in the NSR Addendum that the noise wall is not feasible if the insertion loss criteria cannot be met.

264.4.2 Perimeter Walls

Coordination with the local government for the identification and design of perimeter walls may require public involvement. Public involvement may be necessary to finalize wall locations and aesthetic features, especially if there are substantial changes to conditions or previously requested needs. Coordinate required public involvement activities with the District Public Involvement or Community Liaison Coordinator.

Perimeter walls located on arterial roadways can potentially impact access. The ability to construct perimeter wall(s) can depend on an individual property owner's willingness to sign a right of way indenture allowing access to be cut off or modified. For these type projects, it is a general practice to obtain a written statement from each affected property owner demonstrating support for the perimeter wall. If an adjacent property owner(s) declines to sign the indenture the Department may elect not to build the perimeter wall. Document the final determination in the PWJR Addendum if the perimeter wall is not feasible.

264.4.3 Outdoor Advertising Signs

Section 479.25, F.S. *“Erection of noise-attenuation barrier blocking view of sign; procedures; application”*, provides procedures and requirements for allowing permitted, conforming, lawfully erected outdoor advertising signs to be increased in height if visibility is blocked due to construction of noise walls (or “noise attenuation barriers” as referred to in the statute). The statute also provides procedures that address various coordination requirements (e.g., notification requirements, survey requirements, public hearing requirements, and approval requirements) for the involved parties. The involved parties include the Department, the local government or local jurisdiction, and the benefited receptors (or “impacted property owners” as referred to in the statute). Refer to Part 1, Chapter 11 Public Involvement, of the [**PD&E Manual**](#) for additional details about meeting notification requirements.

265 Reinforced Concrete Box and Three-Sided Culverts

265.1 General

The Department recognizes three types of culverts;

- Round and elliptical reinforced concrete pipe,
- Concrete box culverts (four-sided), and
- Three-sided concrete culverts.

This chapter presents the minimum requirements for concrete box culverts and three-sided concrete culverts, both of which are classified as Category 1 structures in accordance with **FDM 121**. It is not possible to provide prescriptive requirements for all conditions, so guidance provided in this chapter is for typical designs. Each location will usually have some unique character (e.g., floods, scour, surroundings, salt water, historic character). Unique environments need to be thoroughly evaluated and all environmental requirements satisfied.

The procedure for the hydraulic analysis of culverts differs based on whether the culvert is located at a riverine or tidal crossing. Refer to **Chapter 4** of the [Drainage Manual](#) for the appropriate hydraulic analysis and documentation requirements.

Definitions of terms used in this chapter include the following:

Culverts are structures under the roadway with an interior width of less than or equal to 20 feet. The interior width is measured along the centerline of the roadway from face-to-face (inside) of the extreme abutments or sidewalls.

[The National Bridge Inspection Standards](#) classify the following culverts as bridge-sized (a.k.a., bridge culverts):

- Box and three-sided culverts with a clear opening measured along the center of the roadway > 20 feet, or between the extreme ends of openings for multiple boxes.
- Also includes multiple pipes where the clear distance between openings is less than $\frac{1}{2}$ of the smaller adjacent opening.

Figure 265.1.1 provides an illustration of a single-span and a multi-span bridge culvert.

Figure 265.1.1 Examples of Bridge Culverts

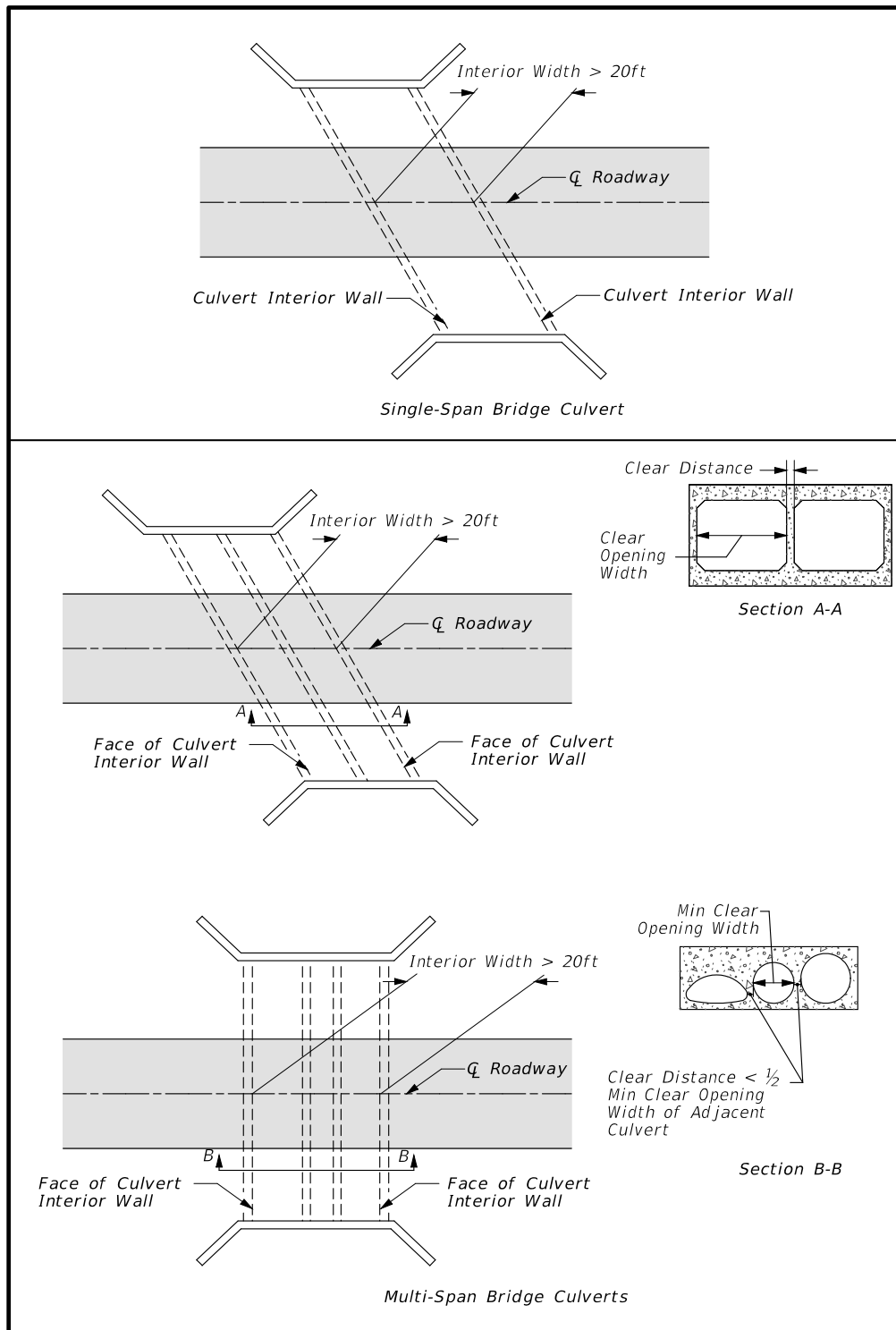

Concrete box culverts (four-sided) typically have rectangular cross sections. An arch or arch-topped culvert is considered a box culvert if the “sidewalls” are built monolithic with the bottom (invert) slab. Two-piece (four-sided) box culverts are permitted with a simply supported top slab, which is keyed into a monolithic three-sided bottom section. Concrete box culverts are typically used where the streambed is earth or granular soil and rock is not close enough to the streambed to directly support the structure.

Three-sided concrete culverts may be rectangular in shape or a frame with varying wall and slab thickness or an arched or arch-topped structure. These structures have separate foundations with spread footings supported by earth, rock or piles. The largest culverts are typically not boxes; rather they are frames or arches. Use of three-sided concrete culverts where rock is not at or near the streambed requires pile support for the footings or some other form of positive scour protection. Three-sided concrete culverts on spread footings may be used for railroads, wildlife crossings, bicycle/pedestrian/equestrian/golf cart paths, and other uses that do not convey water or have scour vulnerability.

Clear span is the perpendicular distance between the inside face of the sidewalls. The maximum clear span recommended for a concrete box culvert is 24 feet.

Design span for non-skewed culverts is the perpendicular distance between the centerline of the sidewalls. For culvert units with skewed ends, the design span of end sections is the distance between the centerlines of the sidewalls measured parallel to the skewed end.

265.2 Structure Type Selection

Determine the most appropriate type of short-span structure. The basic choices are a corrugated metal structure, concrete box culvert, concrete frame or arch, and a short-span bridge. While the site conditions are the primary deciding factor for structure selection, aesthetics, constructability, and economics are also very important.

Proper selection of the feasible structure alternatives is based on site and project-specific parameters, including but not limited to:

- (1) Vertical and horizontal clearance requirements
- (2) Available “beam” (top slab) depth
- (3) Maintenance and protection of traffic requirements (e.g., phase construction)
- (4) Construction constraints (e.g., water diversion requirements)
- (5) Foundation requirements

- (6) Environmental concerns (e.g., natural streambed)
- (7) Desired aesthetic treatments (e.g., arch appearance)
- (8) Geometric limitations (e.g., skew angle, right of way restrictions, utilities)

Concrete culverts are usually more expensive in initial cost than corrugated metal structures. However, concrete culverts are the preferred alternative when considering suitability to the site and life-cycle cost estimates. The advantages of concrete culverts are superior durability for most environmental conditions, greater resistance to corrosion and damage due to debris, greater hydraulic efficiency, and typically longer service life.

Concrete culverts are typically the least expensive option at sites with limited headroom. Smaller corrugated metal structures typically require a minimum height of soil cover of 2 feet and for some structures the soil cover increases to 4 feet or more depending on size and shape. Concrete culverts, frames, and arches can have the least amount of cover by placing a minimum of 3 inches of asphalt pavement directly on the top slab. Corrugated metal structures will also typically require taller structures than concrete box culverts, to provide adequate waterway area below design high water due to their arched shapes. If a corrugated metal structure is a viable option, an engineering evaluation and cost analysis should be performed in consultation with the District Drainage Engineer.

Single-cell and multi-cell concrete box culverts with barrel spans less than 15 feet, are often the most cost-effective structural solution where debris collection and aesthetics are not a major concern. Three-sided culverts may be appropriate for single spans exceeding 20 feet where scour is not a concern.

The use of a short-span bridge should be investigated before a final determination is made to use a large concrete culvert. Possible advantages of a bridge may be minimized work in the stream, speed of erection, minimized interference with the existing structure foundation, and easier phased construction. See **FDM 121** for procedural steps on planning short-span bridges.

265.2.1 Precast Concrete Culverts

Precasting permits efficient mass production of concrete units. The advantages often offset the cost of handling and transporting the units to the site. Precast units are often limited to certain sizes and skews due to forms, transportation, and handling concerns. Skewed units typically need more reinforcement and thicker slabs and/or sidewalls. The use of skewed units will increase the cost of the culvert due to increased fabrication costs.

Skewed end units are sometimes required to satisfy right of way constraints and/or phased construction requirements for skewed alignments. In the event they are necessary, skewed

precast culvert units must be designed for the skewed-end design span. Precast manufacturers should be contacted for information on maximum skews available.

Precast culverts may occasionally need to be placed on moderate or steep grades. No maximum slope is recommended for box culverts because of the need to match the slope of the streambed. Three-sided box culverts and the frames and arches should be limited to a maximum slope of 2%. Precast manufacturers should be contacted for the maximum grade that can be fabricated if a grade larger than 2% is proposed. If matching a steeper slope is necessary, the ends of the precast units must be beveled to create vertical joints and the footings may be stepped or the length of the sidewall varied.

Provide a 2 to 4-inch gap between the walls of adjacent cells when two or more single-cell, precast concrete culverts are placed side-by-side. Fill this gap with Class NS (non-structural) concrete, non-excavatable, flowable fill or non-shrink grout.

All manufacturers must have approved precast drainage product facilities in accordance with **Section 6.3** of the [Materials Manual](#).

265.2.2 Concrete Box Culverts

A cast-in-place culvert must be designed and detailed in the contract plans when a concrete box culvert is selected as the appropriate structure for the site. A precast concrete box culvert alternative is permitted during construction unless specifically excluded in the contract plans. Speed of erection, maintenance of traffic, stream diversion problems, and site constraints can be minimized when utilizing precast culverts.

265.2.3 Three-Sided Concrete Culverts

There are various types of proprietary, precast concrete frames, arch topped units, and arches available. These units are typically used when larger culverts (spans ≥ 20 feet) are required. They can only be considered when scour protection is adequately provided or aesthetics are a consideration. They may be placed on spread footings with an invert slab, footings on rock, or pile-supported footings. The advantages of the precast concrete arches and frames are the same as for the precast concrete box culverts, except that longer spans (up to 48 feet) are possible.

A precast culvert should be the preferred option when a three-sided concrete culvert is selected as the appropriate structure for the site. A cast-in-place reinforced concrete foundation and the channel lining must be designed and detailed in the contract plans. The final design of the precast three-sided culvert structure and any necessary foundation

modifications must be completed by the Contractor's Engineer of Record (usually the manufacturer).

Sizes of precast units that are common to more than one manufacturer should be selected. Dimensions of the sidewalls and top slab, reinforcement size and spacing should not be shown on the plans, unless necessary. If sidewall or top slab dimensions are dictated by site conditions, only show the affected dimensions, and indicate if they are minimums, maximums, or specifically required dimensions. The assumed top slab dimension used to determine fill limits should be shown in the contract plans.

Include a note in the contract plans requiring the Contractor to provide all design details not included in the contract plans. This method should result in the most economical culvert design.

265.2.3.1 Precast Arch and Arch-Topped Units

Consider the following when selecting a precast arch or arch-topped culvert:

- (1) Aesthetics concerns may make the use of arch-shaped units desirable. The use of arch-shaped facade panels is not recommended, especially for hydraulic openings due to snagging of debris.
- (2) The amount of skew that can be fabricated varies. Some manufacturers prefer to produce only 0° skew units. The maximum skew at which a precast unit should be fabricated is 45°. The culvert orientation to the centerline of the highway may be at a skew greater than 45°.
- (3) An arch unit is preferable for a grade separation for highway vehicles or railroads when a dry conveyance environment is necessary. The arch shape eliminates any ponding problems above the culvert without special fabrication or field adjustments that would be required for flat-topped culverts.
- (4) Arch units are preferred in cases where fills above the precast units exceed 20 feet.
- (5) Precast arch-topped units are currently available in spans up to 48 feet.
- (6) Arched units have been used as liners for old masonry or concrete arches in other States. After the construction of a pedestal wall at the base, the units are slid into place. The void between the existing arch and the liner is filled with grout installed through fittings cast into the liner units.
- (7) Large arch units may be shipped in two pieces and assembled on site. Three-piece units are not permitted.

265.2.3.2 Precast Frame Units

Consider the following when selecting a precast frame (rectangular) culvert:

- (1) Many of precast frame-type units can be fabricated with skew angles up to 45°. This characteristic is useful when phased construction is proposed. When used for phased construction with shallow highway pavements, no temporary shoring is needed at the phase construction joint to support the fill or pavement.
- (2) Frame units provide a simpler traffic railing/headwall connection than arch-topped units.
- (3) Frame units provide a hydraulic opening greater than arches of equivalent clear span when flowing full.
- (4) Precast frame units can be fabricated by some manufacturers with any increment of span length up to 40 feet, although typical span length increments are 2 feet.
- (5) Maximum rise of the units is normally limited to 10 feet due to shipping and handling considerations. Investigate the need for a pedestal wall when a larger rise is necessary.

265.3 Foundation Design

All structures discussed in this chapter, regardless of span and height of fill, are considered buried structures in regard to foundation design. There is no requirement for seismic analysis; however, this may change in the future as more research is completed.

For culverts with spans greater than or equal to 20 feet, foundation recommendations are provided in the Bridge Geotechnical Report (Phase I) and included in the Bridge Development Report (BDR). Foundation design parameters for culverts with spans less than 20 feet are provided by the District Geotechnical Engineer or the Department's Geotechnical Engineering consultant. Foundation recommendations and design parameters must include factored bearing resistance, predicted total and differential settlements, and any required excavation and replacement to ensure proper behavior of the foundation.

The District Geotechnical Engineer or the District Structures Design Office should be consulted to determine the proper foundation treatment.

Modification for Non-Conventional Projects:

Delete **FDM 265.3** above and replace with the following:

265.3 Foundation Design

All structures discussed in this chapter, regardless of span and height of fill, are considered buried structures in regard to foundation design. There is no requirement for seismic analysis. The EOR will coordinate the foundation recommendations with the geotechnical engineer for the project. Foundation design parameters must be shown in the contract plan set and will include factored bearing resistance, predicted total and differential settlements, and any required excavation and replacement to ensure proper behavior of the foundation.

265.3.1 Rock Foundations

In the unusual case where sound rock is at or near the surface of a streambed, an invert slab is not required and a three-sided culvert would generally be the appropriate structure selected. Concrete footings are either keyed or doweled into rock based on consultation with an Engineering Geologist and the District Geotechnical Engineer.

The wall height should be constant and the footing height varied when the elevation of the rock surface varies by 2 feet or less. If the variation in rock surface elevation exceeds 2 feet, the height of the culvert wall may be varied at a construction joint or at a precast segment joint. In some cases, it may be necessary to use walls of unequal heights in the same segment, but this should generally be avoided.

265.3.2 Earth or Granular Soil Foundations

In most cases a concrete culvert will not be founded on rock, so a box culvert (four-sided) with an integral invert slab should be the preferred foundation treatment. In areas of compact soil and low stream velocities, three-sided concrete culverts may be used if they have positive scour protection such as piles or channel lining with concrete-filled mattresses, gabions, or riprap rubble, and spread footings founded below the calculated scour depth. Three-sided concrete culverts located in stream beds, with spans equal to or exceeding 20 feet, must have pile supported footings when the structure is not founded on sound rock.

Concrete box culverts should never be founded partially on rock and partially on earth to avoid differential settlement. If rock is encountered in a limited area, it should be removed to a minimum depth of 12 inches below the bottom of the bottom slab and backfilled with

either select granular material or crushed stone. Concrete culverts are rigid frames and do not perform well when subjected to significant differential settlement due to a redistribution of moments. All concrete box culverts should have a designed undercut and backfill. Consult the District Geotechnical Engineer to determine the depth of the undercut and type of backfill material required to prevent excessive differential settlement. Any required undercut and backfill must be shown on the plans.

A concrete box culvert can be considered if settlement is expected and the foundation material is fairly uniform. The culvert should be designed to accommodate additional dead load due to subsequent wearing surface(s) which may be needed to accommodate the settlement of the box. Precast culverts require mechanical connections between units when significant differential settlement is anticipated. [Standard Plans, Index 400-291](#) provides criteria for cast-in-place link slab to satisfy this requirement when joint openings are expected to exceed 1/8 inch. The District Geotechnical Engineer or the Department's Geotechnical Engineering consultant should provide the anticipated differential settlement, which should be included in the contract plans.

If the foundation material is extremely poor and it is desirable to limit settlement, coordinate with the District Geotechnical Engineer to determine the best course of action. A typical remedy might be removal of unsuitable or unstable material and replacement with suitable material. All required remedies must be shown on the plans.

265.3.3 Three-sided Culvert Foundation Design

Provide a cast-in-place footing design in the contract plans when a three-sided structure is selected for a site. There are several types of culverts that may meet the project specifications. Determine which specific type of unit would best fit that particular application and use those vertical and horizontal reactions for design of the foundations. Consider contacting known fabricators for design reactions. If no specific type of unit is determined as most appropriate, a conservative estimate of the design reactions for all types should be used and the reactions included in the contract plans.

Modification for Non-Conventional Projects:

Delete **FDM 265.3.3** and replace with the following:

265.3.3 Three-sided Culvert Foundation Design

When a three-sided structure is selected for a site, the specific culvert details including the cast-in-place footing design must be included in the contract plans.

265.4 Wingwalls

A wingwall is a retaining wall placed adjacent to a culvert to retain fill and to a lesser extent direct water. Wingwalls are preferably cast-in-place, but precast wingwalls may be considered on a project-by-project basis. Wingwalls are generally designed as cantilevered retaining walls. Precast counterfort and binwalls may also be considered for design of wingwalls. Cast-in-place wingwall designs are provided by the Department's standard box culvert computer program.

Wingwall alignment is highly dependent on-site conditions and should be evaluated on a case-by-case basis. The angle(s) of the wall(s) on the upstream end should direct the water into the culvert. It is also desirable to have the top of the wall elevation above the design high water elevation to prevent overtopping of the wall.

Consider potential conflicts with R/W limits and utilities when precast wingwalls are permitted. The footprint of the footing and excavation, especially for bin type walls, can be extensive. Notes should be placed on the plans alerting the Contractor to these requirements when they exist. Due to skew or grade differences between the cast-in-place or precast culvert units and precast wingwalls, it is necessary to provide a cast-in-place closure pour between the culvert end unit and precast wingwalls. A closure pour is not required if cast-in-place wingwalls are used.

When precast wingwalls are permitted, the cost is included in the cost of the culvert barrel. No separate item is required but the estimated concrete and reinforcing steel quantities for a cast-in-place design should be included in the contract plans.

Modification for Non-Conventional Projects:

Delete **FDM 265.4** above and replace with the following:

265.4 Wingwalls

Precast wingwalls will only be permitted when specifically allowed in the RFP. The specific culvert details must be included in the contract plans.

265.5 Headwalls/Edge Beams

Headwalls are normally used on all culverts. In deep fills a headwall helps retain the embankment. In shallow fills the headwall may retain the roadway and provide the anchorage area for the railing system.

Headwalls should be cast-in-place and attached to precast culvert end segments in accordance with [Standard Plans, Index 400-291](#). Headwalls one foot or less in height with no railing attachment for single barrel precast culverts may be precast. If a curb must be placed on a culvert without a sidewalk, the headwall must be cast-in-place to allow for the tie-in of the curb's anchor bar, unless the curb is also cast at the precast facility.

The typical maximum height of headwalls is 3 feet. Greater heights are attainable but are only used in special cases. Headwall heights greater than 2 feet above the top slab require an independent transverse analysis, which is not provided by the FDOT box culvert program.

Concrete culverts with skewed ends may require additional stiffening of the top and bottom slabs by what is most commonly called an "edge beam". An edge beam is similar to a headwall or cutoff wall. The headwall may be used to anchor metal traffic railing posts and traffic railings or retain earth fill, as well as stiffening the top slab of culverts that lose their rigid frame action as a result of having a skewed end.

When additional strength is required in the concrete edge beam, use the following criteria:

- (1) If there is a 1-on-2 slope to the edge beam, it will be more economical to increase the depth of the edge beam in order to meet the required design.
- (2) When the edge beam is at shoulder elevation (anchoring guard rail and traffic railing), the edge beam height should be maintained and the width of the edge beam should be increased.

265.6 Cutoff Walls

A cutoff wall is required in all culverts with invert slabs to prevent water from undermining the culvert. The cutoff wall should be a minimum 24 inches below the bottom of the invert slab or to the top of sound rock if the rock is closer. Investigate the need for deeper cutoff walls when culvert is founded on highly permeable soils or with significant hydraulic gradients. The cutoff wall may also act to stiffen the bottom slab for skewed box culverts.

Cutoff walls must always be specified at each end of the barrel. When a concrete apron is provided, show an additional cutoff wall at the end of the apron. For three-sided culverts, where the apron is made continuous with the barrel invert slab, the cutoff wall is only required at the end of the apron. The wingwall footings should have toe walls extending close to the bottom of the cutoff wall to prevent scour around the edges of the cutoff wall.

When a precast culvert is specified, the cutoff wall must be cast-in-place. The cost of the cutoff wall is included in the cost of the culvert barrel. No separate item is required but

the estimated concrete and reinforcing steel quantities should be included in the contract plans.

265.7 Aprons

Box culverts can significantly increase the stream flow velocity because the concrete has a roughness coefficient significantly lower (i.e., smoother) than the streambed and banks. To dissipate this increase in energy and to prevent scour, a riprap rubble or other type of revetment apron may be required at the ends of some culverts. The District Drainage Engineer should be consulted to determine the appropriate apron requirements.

Modification for Non-Conventional Projects:

Delete the last sentence in above paragraph and see RFP for requirements.

The apron must be cast-in-place when a precast culvert is specified with a concrete apron. The cost of the apron is included in the cost of the culvert barrel. No separate item is required but the estimated concrete and reinforcing steel quantities should be included in the contract plans.

Modification for Non-Conventional Projects:

Delete the above paragraph and replace with the following:

When a precast culvert is specified with a concrete apron, the apron must be cast-in-place.

265.8 Subbase Drainage

In some situations where there is low fill (< 12 inches below the base course) [***Standard Plans, Index 400-289***](#) requires additional friable base or coarse aggregate material above the top and along the sides of the culvert to eliminate maintenance problems.

265.9 Joint Waterproofing

Culverts will occasionally be used to allow the passage of things other than water, including but not limited to pedestrians, bicycles, trains, golf carts, wildlife, or farm animals. In cases where it is desirable to have a dry environment, a waterproof joint wrap

should be used to cover the joints between precast culvert units or to cover the construction joints in cast-in-place culverts.

Even though a joint sealer is always placed between individual precast concrete culvert units and the units are pulled tightly together, water may seep through the joint. The minimum requirement for waterproofing these joints is to provide an external sealing band in accordance with **ASTM C 877**, centered on the joints, covering the top slab, and then extending down the sidewalls to the footing. The purpose of the waterproofing membrane is to restrict seepage of water or migration of backfill material through the joints in the culverts and it is not intended to protect the concrete.

The external sealing band is mandatory for precast three-sided culverts under **Section 407** of the [Standard Specifications](#) but will need to be included as a note in the contract plans when required for box culverts.

265.10 Traffic Railings

For information regarding roadside barriers or traffic railings refer to **FDM 215**.

265.11 Design Requirements for Concrete Culverts

Refer to the **Chapter 3** of the [Structures Design Guidelines](#) for design and analysis requirements.

265.12 Design Details

Provide a complete cast-in-place design in the contract plans when a box concrete culvert is proposed for a site. Standard details for concrete box culverts are provided in the [Standard Plans, Index 400-289](#). The contractor is usually permitted to substitute precast concrete box culverts for cast-in-place box culverts in accordance with **Section 410** of the [Standard Specifications](#). The contractor may select a standard precast box culvert design in accordance with [Standard Plans, Index 400-292](#) or provide a custom design. Design and fabrication details for precast box culverts, including calculations for custom designs, must also comply with the requirements of [Standard Plans, Index 400-291](#) and be submitted to the Engineer of Record for approval.

Provide either a complete cast-in-place design or a conceptual precast barrel design with a complete foundation and wingwall design, in the contract plans when a three-sided concrete culvert is proposed for a site. The contractor is permitted to substitute precast three-sided culverts for cast-in-place three-sided culverts in accordance with **Section 407**

of the [Standard Specifications](#). Design and fabrication details for precast three-sided culverts, including calculations, must be submitted to the Engineer of Record for approval. Do not place wildlife shelves in hydraulic structures.

The bar designations in **Table 265.12.1** should be used for box culvert reinforcement:

Table 265.12.1 Bar Identification Schedule

BAR IDENTIFICATION SCHEDULE		
C.I.P. (LRFD) Index 400-289	Precast (LRFD) Index 400-292	Description / Bar Location
105	As1	Top Corner Bars
106	As1	Bottom Corner Bars
102	As2	Top Slab, inside face transverse bars
103	As3	Bottom Slab, inside face transverse bars
101	As1/As7	Top Slab, outside face transverse bars
104	As1/As8	Bottom Slab, outside face transverse bars
108	As4	Exterior wall, inside face vertical bars
105/106	As1	Exterior wall, outside face vertical bars
107	-	Interior wall, vertical bars both faces
110/111	As6/As9	Top Slab longitudinal bars (temperature reinf.)
109/112	As9	Bottom Slab longitudinal bars (temperature reinf.)
113/114		Exterior wall longitudinal bars (temperature reinf.)
115/ 116...		Interior wall longitudinal bars (temperature reinf.)
111	As5	Top Slab inside face longitudinal bars (design distribution reinforcement)

Additional reinforcing bars and designations must be added as required. No standardized bar designations are provided for three-sided culverts.

Modification for Non-Conventional Projects:

Delete **FDM 265.12** and replace with the following:

265.12 Design Details

Provide complete details for the proposed concrete culvert in the contract plans.

265.13 Computer Design and Analysis Programs

The Department's [LRFD Box Culvert Program](#) (Mathcad) from the Structures Design Office website is available for LRFD designs. This program analyzes monolithic single or multi-barrel box culverts with prismatic members and integral bottom slabs only. The program requires input for all member thicknesses, material properties and reinforcing area utilizing a trial and error design methodology.

Other computer programs are available for design of reinforced concrete culverts such as BOXCAR and CANDE. Generally, these other computer programs should only be used for preliminary designs or independent quality assurance checks. Consult with the State Structures Design Office before using one of these other programs in lieu of the FDOT box culvert program.

265.14 Design and Shop Drawing Approvals

The Engineer of Record for the contract plans has design and shop drawing approval authority for precast concrete box and three-sided culverts. All calculations and shop drawings require a quality assurance review for general compliance of contract requirements and for suitability of the design for the given design conditions.

Standard precast concrete box culvert designs are available in [Standard Plans, Index 400-292](#) for a limited number of box culvert sizes. Modification of FDOT standard box culverts or design of special size box or three-sided culverts is delegated to Contractor's Engineer of Record in accordance with the **Section 407** and **Section 410** of the [Standard Specifications](#). The Contractor is responsible for providing all design computations and details for these units.

Modification for Non-Conventional Projects:

Delete **FDM 265.14** and see RFP for Shop Drawing Approval requirements.

266 Bicycle and Pedestrian Bridges

266.1 General

A separate bicycle and pedestrian bridge may be necessary to provide continuity to sidewalks, bicycle lanes and shared use paths. See **FDM 222, 223, and 224** for information on bicycle and pedestrian facilities.

See **Chapter 10** of the **Structures Design Guidelines (SDG)** for information on pedestrian bridges.

266.2 Designer Qualifications

Engineering firms must be technically pre-qualified with the Department in the appropriate bridge design work type(s), in accordance with **Rule 14-75, Florida Administrative Code**, when designing the following:

- Department owned pedestrian bridges
- Permitted, non-Department owned pedestrian bridges within, under or over State Road right-of-way.

For Department projects only, engineering firms must also be administratively pre-qualified (approved overhead audit) for projects greater than \$500,000 total value per professional services contract. See **Table 266.2.1** for designer qualifications on projects with prefabricated steel truss pedestrian bridges.

Table 266.2.1 Designer Qualifications for Prefabricated Steel Truss Pedestrian Bridges

Project Type	Category 1 per FDM 266.4?	Project EOR Design Firm		Contractor's EOR	
		Role	Prequalification	Role	Prequalification
Department	Yes	Substructure and/or foundation design	[T + A] Work Type 4.1.2 - Minor Bridge Design, or other necessary work group based on substructure design	Steel truss design	T (Work Type 4.2.2 - Major Bridge Design - Steel)
	No	Steel truss, substructure and/or foundation design	[T + A] Work Type 4.2.2 - Major Bridge Design - Steel and other necessary work group based on substructure design	CSIP redesign of steel truss and any associated substructure and/or foundation design	T (Work Type 4.2.2 - Major Bridge Design - Steel)
Non-Department	Yes	Substructure and/or foundation design	T Work Type 4.1.2 - Minor Bridge Design, or other necessary work group based on substructure design	Steel truss design	T (Work Type 4.2.2 - Major Bridge Design - Steel)
	No	Steel truss, substructure and/or foundation design	T Work Type 4.2.2 - Major Bridge Design - Steel and other necessary work group based on substructure design	CSIP redesign of steel truss and any associated substructure and/or foundation design	T (Work Type 4.2.2 - Major Bridge Design - Steel)

Notes:

- (1) See **FDM 266.4.2** for definitions of Project EOR Design Firm and Contractor's EOR.
- (2) "T" = Technical prequalification required in accordance with **Rule 14-75, Florida Administrative Code**.
- (3) "T + A" = Technical and Administrative (approved overhead audit) prequalification for projects greater than \$500,000 total value per professional services contract in accordance with **Rule 14-75, Florida Administrative Code**.
- (4) CSIP = Cost Savings Initiative Proposal

266.3 Design Criteria

Design bicycle and pedestrian bridges in accordance with the following criteria:

- (1) Clear width for bridges is:
 - (a) 8-foot minimum on a pedestrian structure; 12-foot desirable
 - (b) 12-foot minimum on a shared use path structure; 16-foot desirable
 - (c) Minimum clear width is the width of the approach facility when the facility is wider than the minimums above; desirable clear width is the width of the approach facility plus four feet (2-foot-wide clear area on each side).
- (2) Minimum vertical clearance under pedestrian bridges must be in accordance with **FDM 260.6** and **FDM 260.8**.
- (3) Account for future widening of the roadway below when determining required lateral offset (per **FDM 215.2.4**).
- (4) Ramp grades should not exceed 5%, but in no case be more than 8.33% with a maximum 30-inch rise.
 - (a) Provide level landings that are 5-feet long at the top and bottom portions of the ramp.
 - (b) Provide intermediate level landings that are 5-feet long when the ramp length results in a rise that exceeds 30-inches.
- (5) Provide full-length pedestrian ADA handrails on both sides of pedestrian ramps.
- (6) Consider providing stairways in addition to ramps.
- (7) Provide railing and fencing options in accordance with the [SDG, Chapter 10](#).
 - (a) See **FDM 222, Figures 222.4.6** through **222.4.8** for vehicular fencing options.
 - (b) Provide full or partial screening on pedestrian bridges crossing State Road right-of-way in order to reduce the likelihood of objects being dropped or thrown onto the roadway below. See **Figure 266.3.1** for example of full screening.

Coordinate with District Design Engineer and local stakeholders to determine use of full screening on pedestrian bridges crossing FDOT right of way. When fencing is required, make the limits of fencing from the beginning of the approach slab at Begin Bridge to the end of approach slab at End Bridge.
 - (c) Pedestrian bridges on State Road right-of-way but not crossing State Road right-of-way are not required to be screened.

- (d) Check with local authorities for guidance on screening for Department pedestrian bridges crossing local rights of way.
- (e) The use of chain link fence on ramps of the pedestrian bridges will be determined on a project-by-project basis.

Modification for Non-Conventional Projects:

Add the following sentence:

- (f) When fencing is required, the limits of fencing is from the beginning of the approach slab at Begin Bridge to the end of the approach slab at End Bridge, unless otherwise indicated in the RFP.

An Independent Peer Review meeting the requirements of **FDM 121.12** is required for non-Department owned projects in which the pedestrian bridge is constructed within, under or over State Road right-of-way, regardless of the funding source. The Independent Peer Review must be completed, and all comments resolved prior to erecting the structure over or adjacent to traffic. Include the following note in the Plans:

The Independent Peer Review must be completed, and all comments resolved, prior to erecting the structure over or adjacent to traffic. The term adjacent is in accordance with [Standard Plans Index 102-600, Table 5 – Clear Zone Widths for Work Zones](#).

Figure 266.3.1 Pedestrian or Shared Use Path Bridge Typical Section

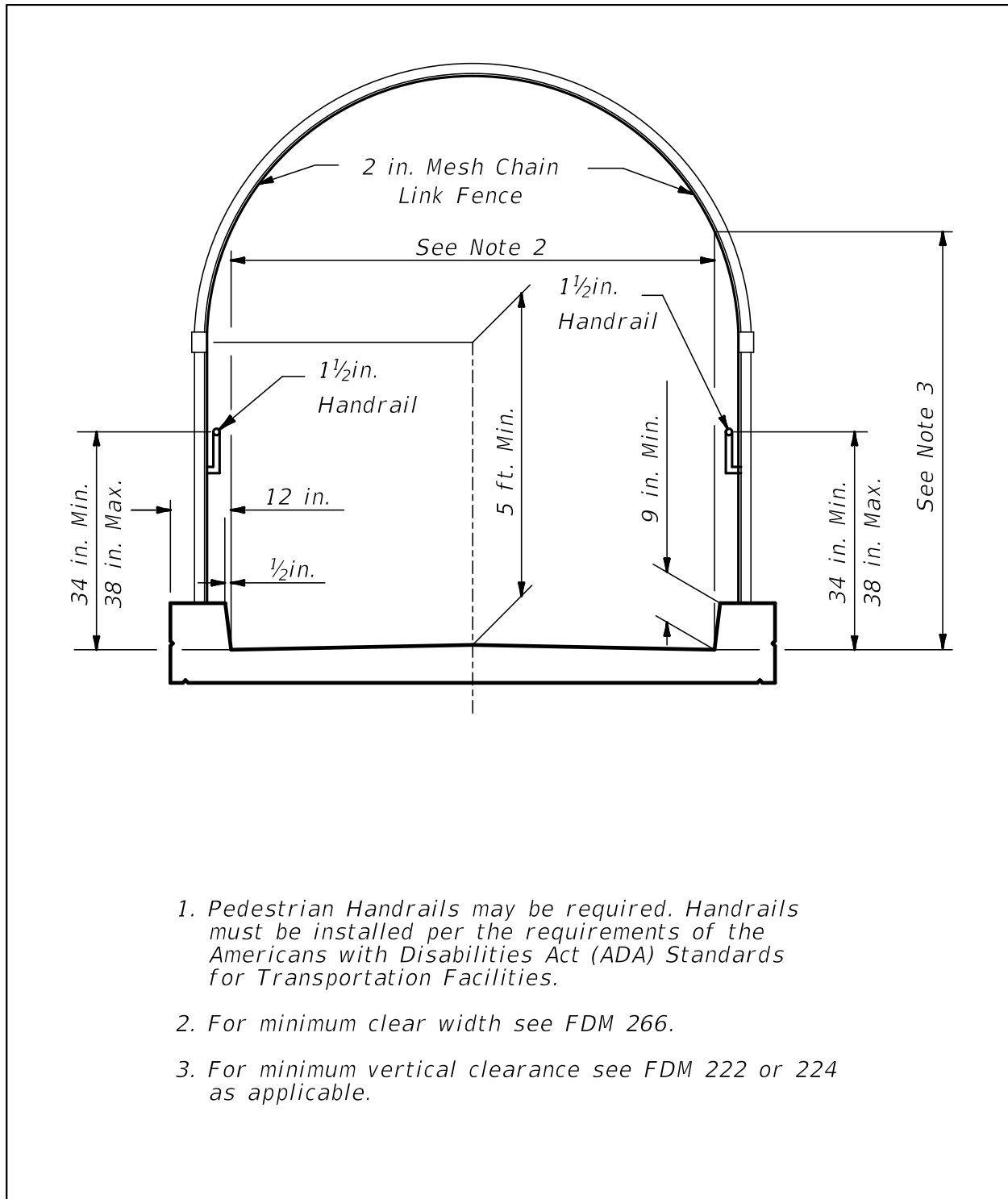

266.4 Prefabricated Steel Truss Bridges

In many situations it makes good engineering and economic sense to utilize prefabricated steel truss bridges for pedestrian crossings. These bridges can be stand-alone structures or a hybrid structure with adjoining spans of other types (FIB, deck slab, steel I-girder, etc.). The provisions of this article apply only to the spans on a bridge that are comprised of prefabricated steel trusses. The term steel truss bridge as applied in this article refers only to stand-alone steel truss structures or to the steel truss spans of a hybrid bridge structure.

The following conditions must be met to use the plans development process described in **FDM 266.4.4** and for the prefabricated steel truss bridge to be classified as a Category 1 structure:

- (1) The bridge lies within a tangent horizontal alignment.
- (2) The maximum span¹ length does not exceed 200 feet measured between the centerline of bearings.
- (3) The bridge width is constant.
- (4) Each span¹ is simply supported (no continuity over supports)
- (5) The supports have a skew angle² of 20° or less.

Notes:

- (1) Span indicates an individual span.
- (2) See the [Structures Detailing Manual \(SDM\) Section 2.14](#) for the definition of skew angle.

When the above conditions are not met, the plans development process described in **FDM 266.4.4** is not permitted, the truss span must be fully detailed in the Structures Plans, and the bridge is classified as a Category 2 structure. This requirement applies to all projects (including permits) involving Department or non-Department owned prefabricated steel truss bridges placed within, under or over State Road right-of-way, as well as Local Authority Projects developed and designed in accordance with Department policies.

Modification for Non-Conventional Projects:

Delete **FDM 266.4** and replace with the following:

266.4 Prefabricated Steel Truss Bridges on Department Projects

Prefabricated steel truss bridges can be stand-alone structures or a hybrid structure with adjoining spans of other types (FIB, deck slab, steel I-girder, etc.). The provisions of this article apply only to the spans on a bridge that are comprised of prefabricated steel trusses. The term steel truss bridge as applied in this article refers only to stand-alone steel truss structures or to the steel truss spans of a hybrid bridge structure.

The following conditions must be met for the prefabricated steel truss bridge to be classified as a Category 1 structure:

- (1) The bridge lies within a tangent horizontal alignment.
- (2) The maximum span¹ length does not exceed 200 feet measured between the centerline of bearings.
- (3) The bridge width is constant.
- (4) Each span¹ is simply supported (no continuity over supports)
- (5) The supports have a skew angle² of 20 degrees or less.

Notes:

- (1) Span indicates an individual span.
- (2) See the [Structures Detailing Manual \(SDM\) Section 2.14](#) for the definition of skew angle.

See the RFP for additional requirements.

266.4.1 Qualification of Prefabricated Steel Truss Pedestrian Bridge Producers

Use prefabricated steel truss pedestrian bridges from providers included on the Department's Production Facility Listing. For information on the facility qualification process see **Articles 11.1.5** and **11.1.6** of the [FDOT Materials Manual](#).

266.4.2 Design and Detailing Responsibilities

The project Engineer of Record (EOR) is responsible for the design and detailing of the steel truss bridge substructure and foundation including end bents, piers, and pile foundations or spread footings. The project EOR is also responsible for the design and detailing of approach structures (non-steel truss bridge spans, walls, ramps, steps, approach slabs, etc.).

The Contractor's EOR is responsible for the design and detailing of the steel truss bridge superstructure including trusses, deck, bridge railing, floor beams, bridge joints, bearing assemblies and anchor bolts.

Modification for Non-Conventional Projects:

Delete **FDM 266.4.2** and replace with the following:

266.4.2 Design and Detailing Responsibilities

The Engineer of Record (EOR) is responsible for the design and detailing of the steel truss bridge foundation, substructure, and superstructure. The EOR is also responsible for design and detailing of approach structures (walls, ramps, steps, approach slabs, etc.). Include the steel truss bridge superstructure including trusses, deck, bridge railing, floor beams, bridge joints, bearing assemblies and anchor bolts as part of the appropriate phase submittal, depending on whether the steel truss bridge is considered Category 1 or Category 2 per **FDM 121**. See the RFP for additional requirements.

266.4.3 Project Processing

Project processing of prefabricated steel truss bridges is summarized in **Figure 266.4.1**.

266.4.4 Plans Development

To allow equal opportunity for all qualified pedestrian bridge producers to participate, the pedestrian bridge plans should have the flexibility to accommodate multiple alternate superstructure designs. When a prefabricated steel truss pedestrian bridge is classified as a Category 1 Structure per **FDM 266.4**, adhere to the following procedure when developing the plans:

- (1) Using **Figures 266.4.2, 266.4.3, and 266.4.4**, coordinate with the District Project Manager to select allowable truss configurations, truss member shapes, and bridge cross sections. A box truss bridge cross-section is required for spans greater than 150 feet.

If project specific aesthetic requirements warrant the use of truss configurations not included in **Figure 266.4.2** the project EOR can specify additional truss configurations. However, a minimum of two steel truss pedestrian bridge producers must be capable of satisfying the aesthetic requirements.

- (2) Develop a Plan and Elevation sheet and Bridge Typical Section to be submitted with the BDR/30% plans.
- (3) After the BDR/30% plans have been approved, send out a Prefabricated Pedestrian Bridge Invitation to Participate (ITP) to all prefabricated pedestrian steel truss bridge producers on the Department's Production Facility Listing. Send the ITP through registered mail with return receipt to confirm delivery. Contact information for all qualified producers can be found at the following web address:

<https://www.fdot.gov/materials/quality/programs/qualitycontrol/materialslistings/postjuly2002.shtm>

The ITP is intended to solicit qualified producers for information required to design the foundation and substructure of the steel truss pedestrian bridge. The ITP cover letter should contain the following elements with links to websites as appropriate and applicable:

- (a) Introduction with brief project description
- (b) Project Requirements
 - i. Design Specifications Requirements
 - ii. Construction Specifications Requirements
 - iii. Design Standards Requirements
 - iv. Bridge Typical Section
 - v. Allowable Truss Options

- vi. Painting Requirements
 - vii. Pedestrian Fence/Railing Requirements
 - viii. Vehicular Loading Requirements
 - ix. Project Specific Aesthetic Requirements
 - x. Project Geometry including Vertical Clearance Requirements for Each Span
- (c) Participation Requirements
- (d) Submittal Requirements

Include the following items in the ITP package:

- (e) Hard copy:
- i. Invitation to Participate Cover Letter
 - ii. Project Location Map
 - iii. Plan and Elevation
 - iv. Bridge Typical Section and Pedestrian Fence Concept
 - v. Pedestrian Bridge Data Sheet
- (f) Electronic files:
- i. PDF file with all of the above
 - ii. Pedestrian Bridge Data Sheet in CADD format

For a sample Prefabricated Pedestrian Bridge ITP complete with all hard copy attachments see **Example 266.4.1**. To aid plan development CADD cells for the Pedestrian Bridge Data Sheet and Plan and Elevation sheet (2 of 2) are available in the FDOT Structures Cell Library. For the current FDOT CADD Software downloads follow the link below:

<https://www.fdot.gov/cadd/downloads/software/software.shtm>

- (4) Upon delivery the pedestrian bridge, producers must acknowledge receipt of the ITP package.
- (5) In order to be eligible to participate in the project the pedestrian bridge producers must provide a completed Pedestrian Bridge Data Sheet as outlined in the ITP on or before the specified due date (prior to 60% plans submittal). The completed Data Sheets must be electronically signed and sealed by the pedestrian bridge producer's EOR for inclusion in the final plan set.

The project EOR assigns a unique sheet number to each data sheet. The sheet numbers will be identified with the prefix BP (e.g., BP-1, BP-2, BP-#) and the data sheets will be placed at the end of the numbered sequence of the bridge plans. This will allow the Pedestrian Bridge Data Sheets to have independent sheet numbers as plan development progresses.

- (6) After all ITP responses are received the project EOR must design and detail the foundation and substructure to accommodate the superstructure designs of all eligible pedestrian bridge producers. The design must envelope the most extreme loading conditions and geometry of all alternates.
- (7) A Public Interest Finding is required for Federal Aid projects when only one Interest for Participation letter is received.

Include the following notes in the plans:

(a) Eligible Steel Truss Pedestrian Bridge Producers

Included in this plan set are Pedestrian Bridge Data Sheets submitted by bridge producers eligible to participate in this project. Producers who failed to submit a data sheet are excluded from participation. No Cost Savings Initiative Proposal will be accepted for the truss superstructure portion of the project. Contact information for the eligible producers is included in the data sheet.

(b) Shop Drawing Submittal

Prior to fabrication the Contractor's EOR must submit signed and sealed superstructure shop drawings, technical specifications, and design calculations to the Engineer for review and approval.

Figure 266.4.2 Prefabricated Pedestrian Bridge Standard Truss Configurations

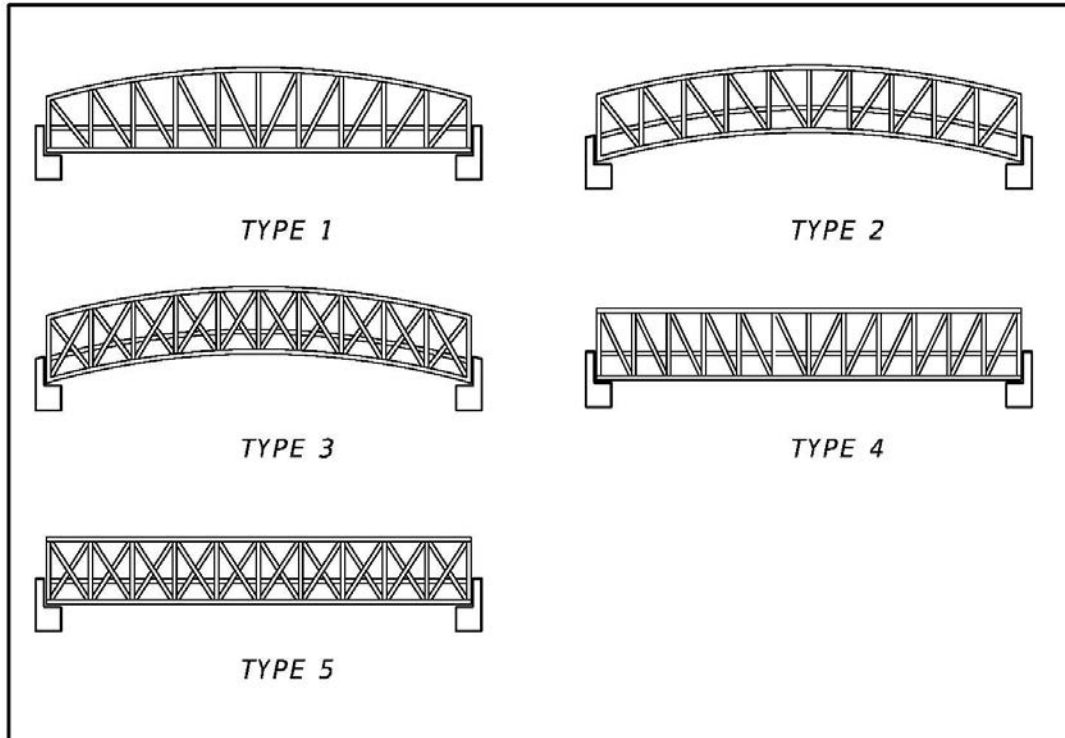

Figure 266.4.3 Prefabricated Pedestrian Bridge Standard Truss Member Shapes

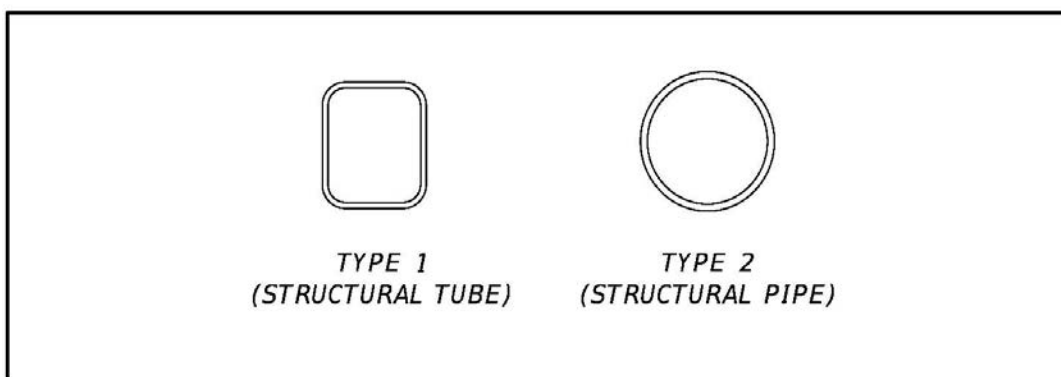
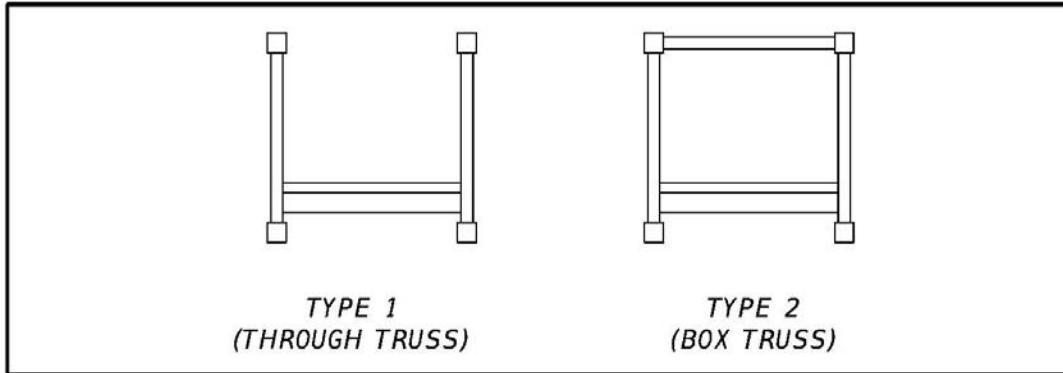

Figure 266.4.4 Prefabricated Pedestrian Standard Bridge Cross-Sections



Modification for Non-Conventional Projects:

Delete **FDM 266.4.4** and see the RFP for requirements.

Example 266.4.1 Sample Steel Truss Pedestrian Bridge Plans

Sheet 1 of 8

(prepare on Department letterhead)

FLORIDA DEPARTMENT OF TRANSPORTATION

DISTRICT 3

PREFABRICATED PEDESTRIAN BRIDGE

INVITATION TO PARTICIPATE

Project: CR 250 over Ruby Creek Pedestrian Bridge

Financial Project Number: 217664-1-52-01

Federal Aid Project Number(s): SF2-349-R

Date: March 15, 2011

Introduction:

The Florida Department of Transportation is currently preparing bid documents for the construction of a steel truss pedestrian bridge adjacent to County Road 250 crossing Ruby Creek in Jefferson County. The superstructure of the proposed bridge is to be provided by a steel truss pedestrian bridge producer who is prequalified to work on Department projects. This invitation to participate is being sent to all prequalified producers to solicit information needed by the project EOR to design the foundation and substructure of the proposed bridge. Enclosed are the following materials:

- (1) Hard Copy
 - (a) Project location map
 - (b) Bridge Typical Section and Pedestrian Fence Concept
 - (c) Plan and Elevation (P&E) (2 sheets)
 - (d) Pedestrian Bridge Data Sheet
- (2) Electronic
 - (a) PDF file with all of the above
 - (b) Pedestrian Bridge Data Sheet in CADD format

Example 266.4.1 Sample Steel Truss Pedestrian Bridge Plans

Sheet 2 of 8

Project Requirements:

- (1) Design Specifications:
FDOT Structures Design Guidelines (SDG) Article 10.4.
https://www.fdot.gov/docs/default-source/structures/structuresmanual/currentrelease_test_old/Vol1SDG.pdf
- (2) Construction Specifications:
FDOT Standard Specifications for Road and Bridge Construction
<https://www.fdot.gov/programmanagement/specs.shtm>
- (3) Standard Plans:
FDOT Standard Plans
<https://www.fdot.gov/design/standardplans>
- (4) Allowable Truss Options: Allowable Truss options shown on P&E sheet 2 of 2 (Attached).
- (5) Paint: Paint structural steel in accordance with **Sections 560** and **975** of the **Standard Specifications**. Paint structural steel with a high performance top coat system. The color of the finish coat to be Federal Standard No. 595, Color No. 36622.
- (6) Pedestrian Fence: Bridge Fence consistent with bridge rail concept and **SDG Article 10.12**.
- (7) Vehicular Loading: Vehicular Loading per **AASHTO LRFD Guide Specifications** for the Design of Pedestrian Bridges is not required.
- (8) Geometry: For project geometry see attached P&E sheets.

Participation:

To be eligible to participate on this project pedestrian bridge producers must:

- Acknowledge receipt of this ITP
- Be on the Department's List of Qualified Fabrication Facilities.
- Submit a response to this ITP on or before June 10, 2011 to the project EOR.

Submittal:

Provide completed pedestrian bridge data sheet as follows:

- Bearing Plate Dimensions Table – for each span provide bearing dimensions as shown to the nearest 1/8th inch.

Example 266.4.1 Sample Steel Truss Pedestrian Bridge Plans

Sheet 3 of 8

- Bearing Plate Locations & Bridge Seat Elevations Table – for each substructure unit provide dimensions as shown to the nearest 1/8th inch and bridge seat elevation to the nearest 0.001 feet.
- Bridge Reactions Table – for each span provide loads as indicated to the nearest 0.1 kip.
- Company Contact Information Table – in the contact information block provide company name, address, contact person, phone number, and e-mail address.
- Florida PE Seal and Signature – provide seal and signature of Florida PE responsible for the work.

Submit response to:

John Doe, PE
XYZ Engineers, Inc.
123 East Main Street
Tampa, Florida 33607

By submitting a response to this invitation to participate the pedestrian bridge producer is agreeing to satisfy all project requirements listed above if selected.

Example 266.4.1 Sample Steel Truss Pedestrian Bridge Plans

Sheet 5 of 8

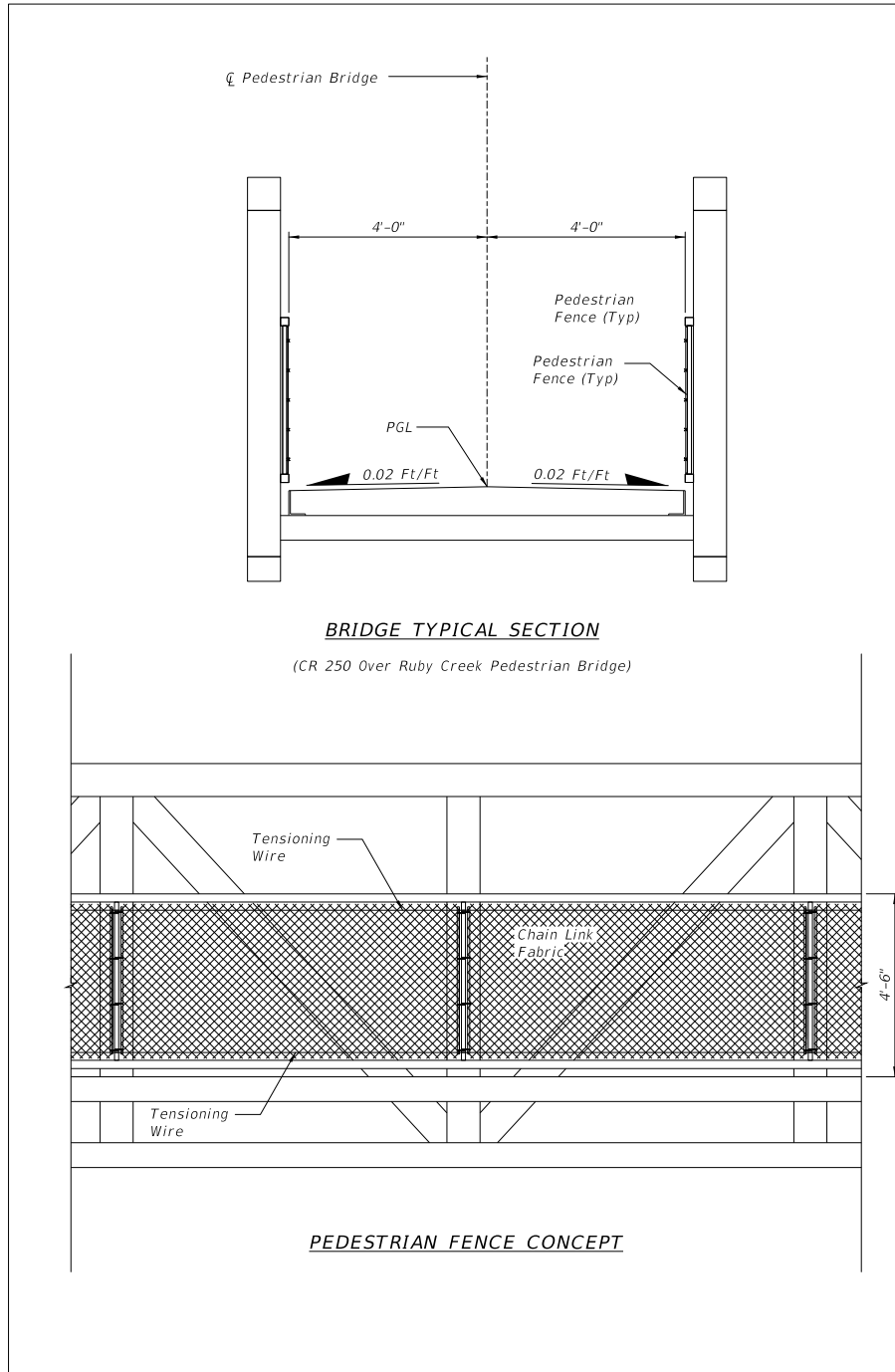

Example 266.4.1 Sample Steel Truss Pedestrian Bridge Plans

Sheet 7 of 8

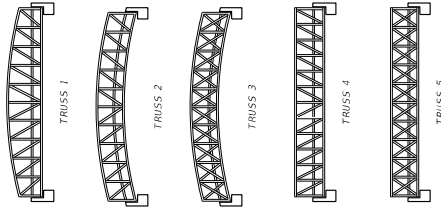

TRUSS CONFIGURATIONS

Permitted (Y/N)	TRUSS 1	TRUSS 2	TRUSS 3	TRUSS 4	TRUSS 5
Y	Y	N	N	Y	N



TRUSS MEMBER SHAPES

Permitted (Y/N)	SHAPE 1 (STRUCTURAL TUBE)	SHAPE 2 (STRUCTURAL PIPE)
Y	Y	Y

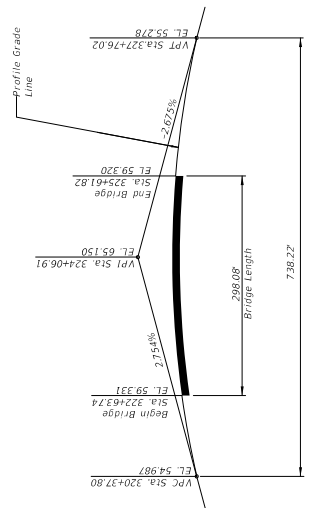

VERTICAL CURVE DATA

Profile Grade
 VPT STA 327+76.02 EL. 55.278
 -2.65%
 End Bridge STA 325+61.82 EL. 50.320
 VPI STA 324+90.91 EL. 65.150
 2.15%
 Begin Bridge STA 322+63.74 EL. 59.331
 VPC STA 320+37.80 EL. 54.987
 Bridge Length 298.08'
 7.38.22'

NOTES:

- Eligible Pedestrian Bridge Producers included in this plan set are Pedestrian Bridge Data Sheets submitted by bridge producers eligible to participate in this project. Producers who have failed to submit a data sheet are not eligible to participate in this project. All data sheets submitted for consideration shall be submitted to the project engineer. A proposal shall be accepted for the truss superstructure portion of the project. Contact information for the eligible producers is included in the data sheets.
- Allowable Superstructure Options
 All allowable superstructure options are indicated by an "X" in the table on this sheet. For multi-span bridges on the same truss bridge options and depth of truss for each span.
 3. Shop Drawing Submittal
 Prior to fabrication the EOR shall submit signed and sealed superstructure shop drawing, technical specifications, and calculations to the Engineer for review and approval.

ALLOWABLE BRIDGE * CROSS-SECTIONS

Permitted (Y/N)	SECTION 1 (THROUGH TRUSS)	SECTION 2 (BOX TRUSS)
Y	Y	N

ALLOWABLE TRUSS CONFIGURATIONS

Permitted (Y/N)	TRUSS 1	TRUSS 2	TRUSS 3	TRUSS 4	TRUSS 5
Y	Y	N	N	Y	N

* Through Truss Bridges are acceptable only for spans less than or equal to 150'. For spans over 150' Box Truss Bridges are required.

DATE	BY	SECTION	REVISIONS	ISSUING	PROJECT

STATE OF FLORIDA DEPARTMENT OF TRANSPORTATION	PROJECT	SHEET NO.	SHEETS
DIVISION	PLAN AND ELEVATION (2 OF 2)		
COUNTY	CR 250		
DISTRICT	JEFFERSON 217664-1-22-01		
PROJECT NUMBER	CR 250 OVER RUBY CREEK PEDESTRIAN BRIDGE		

Example 266.4.1 Sample Steel Truss Pedestrian Bridge Plans

Sheet 8 of 8

TYPICAL END BENT
PARTIAL PLAN

TYPICAL INTERMEDIATE PIER/BENT
PARTIAL PLAN

TYPICAL END BENT
PARTIAL ELEVATION

TYPICAL INTERMEDIATE PIER/BENT
PARTIAL ELEVATION

SPAN	G (in.)			H (in.)			J (in.)			K (in.)		
	1	2	3	1	2	3	1	2	3	1	2	3

COMPANY CONTACT INFORMATION												
COMPANY												
ADDRESS												
CONTACT												
PHONE												
E-MAIL												

LOAD TYPE	SPAN 1			SPAN 2			SPAN 3			SPAN 4		
	P (KIP)	T (KIP)	L (KIP)	P (KIP)	T (KIP)	L (KIP)	P (KIP)	T (KIP)	L (KIP)	P (KIP)	T (KIP)	L (KIP)
DEAD LOAD												
UNIFORM LIVE LOAD												
VEHICLE LOAD												
WIND UPWARD												
WIND LEeward												
WIND TRANSVERSE												
WIND VERTICAL												
THERMAL												

1. P - Unfactored Vertical Load each Bearing Plate (4 per Span)

2. T - Unfactored Transverse Shear and a vertical couple at the top of each pier/ bearing location

3. L - Unfactored Longitudinal Load each Bearing Plate (4 per Span)

4. Downward vertical loads are positive (+), upward vertical loads are negative (-).

5. The horizontal wind load acting at the C.G. of the truss creates a transverse shear and a vertical couple at the top of each pier/ bearing location.

6. Design Specifications

- AASHTO LRFD Bridge Design Specifications
- American Association of State Highway and Transportation Officials (AASHTO) Load and Resistance Factor (LRFD) Bridge Design Specifications
- AASHTO LRFD Guide Specifications for the Design of Pedestrian Bridges, current Edition
- FDOT Plans Preparation Manual, current Edition

BEARING LOCATIONS & BRIDGE SEAT ELEVATIONS												
BENT/PIER	A	B	C	D	E	F						
	(ft.)	(ft.)	(ft.)	(ft.)	(ft.)	(ft.)						
1												
2												
3												
4												
5												

PEDESTRIAN BRIDGE DATA												
STATE OF FLORIDA												
DEPARTMENT OF TRANSPORTATION												
PROJECT	COUNTY	DISTRICT	SECTION	FILE NO.	DATE	DESIGNER	CHECKER	APPROVER	DATE	SCALE	REVISIONS	REVISIONS
CR 250	JEFFERSON	21984-1-52-03										
CR 250 OVER RUBY CREEK PEDESTRIAN BRIDGE												

270 Planting Designs

270.1 General

This chapter provides the criteria and requirements for development of planting designs.

Landscape projects serve ecological, restoration, and conservation functions. Planting designs can effectively:

- Change the characteristics of the roadway corridor to encourage lower vehicle operating speeds.
- Provide shade and comfort for pedestrians.
- Preserve infrastructure from erosion.
- Support economic development.
- Enhance the aesthetic value of transportation facilities.

For Selective Clearing and Grubbing plan content refer to **FDM 924**.

For Planting Plan content and Construction Cost Estimate refer to **FDM 944**.

270.1.1 Maintenance Agreements

A maintenance agreement is often obtained when a local agency or group requests landscape designs that require elevated levels of care beyond the establishment period. When requested, assist the Department Project Manager in the execution of an agreement.

270.2 Planting Design Requirements

Planting designs may include:

- Protection of existing plant material to remain
- Removal or relocated plant material
- New plant material

Plants need quality space above and below ground to thrive. To ensure that quality space is provided, coordinate the Landscape Plan with other component plans.

Planting designs must comply with the following requirements:

- (1) Target a combined value greater than 50% for large plants of the estimated value of all plants specified in the plans. Large plants are defined as:
 - (a) Shrubs, trees, and cycads, 7 gallons or greater
 - (b) Single-trunk palms
 - (c) Clustering Palms, 6-foot height or greater
- (2) Meet clear zone and lateral offset requirements for mature plants with diameter > 4 inches as specified in **FDM 215**.
- (3) Meet district setback requirements for the following:
 - (a) Drainage Structures and Pipes
 - (b) R/W Fence and Retaining Walls
 - (c) Back of Guardrail, or Ditch Pavement
 - (d) Concrete Bridge Embankment
 - (e) Light Poles
 - (f) ITS Poles and Devices
 - (g) Underground Utilities
 - (h) Overhead Electrical Utilities
- (4) Meet sight distance requirements specified in **FDM 210**.
- (5) Meet intersection sight distance requirements specified in **FDM 212**. Do not use plants that will require routine maintenance to preserve sight distance.
- (6) Use plants that are resistant to destructive insects and diseases, and do not rely on inoculation for survival.
- (7) Preserve visibility of community aesthetic features, roadway signing and lighting, and permitted outdoor advertising signs
- (8) Be compatible with above and below ground utilities. Consider plant size at maturity when selecting trees and vegetation.
- (9) Not inhibit the performance and function of stormwater systems.
- (10) Accommodate maintaining agency's preferences, abilities, and resources using primarily native plants that are context appropriate and locally adapted.
- (11) Include a diverse mix of plants when practical.

In addition, planting design should avoid the following:

- (1) The need to amend or replace existing soil.
- (2) Potential damage to pavement from growing roots.
- (3) Accumulation of falling debris (fruit, nuts, large leaves) on sidewalk.

270.2.1 Department-Maintained Landscapes

Coordinate the intended level of maintenance expected with the District Maintenance Office.

Landscape designs for highways that are viewed by high-speed motorists are often low maintenance. Plants selected for these areas typically do not rely on an irrigation system or fertilizer for survival. Avoid planting designs that require irrigation following plant establishment period.

Landscape designs for rest areas, toll facilities, median treatments, or other areas which will be viewed by pedestrians or slow-moving motorists may require a higher standard of care and maintenance.

Arrange trees and palms to allow for efficient mowing paths of tractors, and to maintain design intent in the case of plant mortality. Rigid geometric designs focused on repetition should not be used.

270.2.2 Roundabout Central Island

Provide varying height trees and plants in the central island to enhance driver recognition of the roundabout upon approach. Select tree species 6-foot in height or taller when installed; palm trees 12-foot or taller. Select shrubs that will recover or regenerate naturally after mechanical damage. Select trees and plants with a variety of height, color, form, and texture.

Place trees and palms near the center of the central island, and not less than 6 feet from the face of Type D curb. Place shrubs in a simple arrangement to help increase visual awareness of the roundabout.

The landscape design must be fully integrated into the roundabout design to optimize the performance of the roundabout.

270.3 Soil Enhancements

Highly disturbed soils (i.e., soils located in medians, embankments, and roundabouts) are often densely compacted, rocky, unsuitable pH levels, and infertile. These soil conditions may negatively impact plant establishment by inhibiting root growth, reducing water infiltration, and inhibiting nutrient uptake.

When possible, select plant species that can thrive in the existing or disturbed soil conditions. Soil enhancements become necessary for soil conditions that inhibit plant establishment and growth. Soil enhancements are typically limited to:

- Planting beds
- Tree or palm planting pits (typically 2-times the size of the root ball)

Excavation for amendments or replacement soil cannot occur within two feet from the back of any curb or from any structure.

270.3.1 Soil Analysis

Conduct a preliminary analysis of the existing soil conditions during analysis phase, or early in the design process to determine what plants will thrive. The preliminary analysis should include pH, soil fertility, and percolation tests. The Department may require an advanced soil analysis when preliminary analysis indicates the existing soils are not suitable for plant establishment and growth.

Provide documentation to the District Landscape Architect justifying the need for soil enhancements.

270.3.2 Soil Enhancement Selection

Select the appropriate soil enhancements based on the results of the soil analysis. There are three types of soil enhancements:

- (1) Soil scarification (a.k.a., soil structural improvement) includes mechanically loosening the existing soils.
- (2) Soil amendment includes mixing organic soils, inorganic soils, or minerals with the existing soils.

- (3) Soil replacement with Landscape Soil. Landscape Soil material requirements are included in [**Standard Specification 987-2.4**](#). Soil replacement is used only when either of the following conditions exist:
- (a) Other soil enhancement types will not improve the quality of the existing soil to support establishment and vigorous growth of new or relocated plants.
 - (b) The District Design Engineer approves the use of Landscape Soil on a design project that has raised curbed medians, bulb-outs, sidewalk tree pits, and roundabout central islands to accommodate a subsequent landscape project.

271 Irrigation Designs

271.1 General

This chapter provides the criteria and requirements for designing irrigation systems. For Irrigation Plan content and Construction Cost Estimate refer to **FDM 944**.

Irrigation is the application of water applied evenly on designated areas using a system of pipes and sprinkler heads. Irrigation systems are often included with landscape projects in areas where:

- Rainfall is irregular
- Healthy and robust plantings are desirable
- Plants are observed and enjoyed by pedestrians or slow-moving vehicular traffic (e.g., rest areas, toll plazas, streetscapes, roundabouts)
- Plants serve as a safety enhancement (e.g., roundabout central island, midblock crossings, median treatment)
- Access to planting area during establishment period is not practical

271.2 Irrigation System Requirements

Irrigation system designs must comply with the following requirements:

- (1) Provide reliable points of connection for water and power source with sufficient capacity for system operation. Power source may be electric, solar, or battery. Water sources, in the order of preference are:
 - (a) Re-use or reclaimed water
 - (b) Well water (with acceptable mineral content that will not cause staining of concrete surfaces)
 - (c) Potable water
 - (d) Stormwater pond
- (2) Provide fully automatic controllers, including the following:
 - (a) Connected to a rain sensor
 - (b) Programable irrigation run time based on watering restrictions, temperature, sunshine, and humidity

- (c) Grounded per manufacturers recommendations
 - (d) Communication abilities and flow monitoring when required by district
 - (e) Housed in a secure cabinet (NEMA 3R) located near the power source and generally out of view of the public
- (3) Use durable materials that are traffic rated and ultraviolet light resistant.
- (4) Minimum 12 inches of cover from top of pipe for lateral lines and 18 inches for mainline. Size pipes to maintain a minimum working pressure at each spray head or nozzle as per manufacturer. Water flow rate in pipe not to exceed 5-feet per second without district concurrence.
- (5) Provide sprinkler head-to-head coverage with uniform precipitation rate. Avoid overspray into the roadway, sidewalks, transit stops, and other similar paved areas.
- (6) Compatible with the maintaining agency's preferences, abilities, and resources. Request proprietary product certification when applicable.
- (7) Comply with requirements:
- (a) Florida Building Code
 - (b) Water Management Districts
 - (c) Florida Administrative Code.

271.3 Landscape Irrigation Sleeves

Landscape irrigation sleeves are used in locations where a future landscape project with irrigation is planned, as determined by the District Landscape Architect. Irrigation sleeves are intended to be used on new and reconstruction projects, where there is an opportunity to install the sleeves in an open trench.

Typical installation may include under paved surfaces to connect to raised medians, roundabout central islands, or under driveways.

See [Standard Plans](#), *Index 591-001* for landscape irrigation sleeve installation requirements.

272 Hardscape Designs

272.1 General

This chapter provides the criteria and requirements for hardscape features.

Hardscape is any non-living structure or feature included within a landscape design. Hardscape-only projects are not landscape projects. Examples of hardscape include:

- landscape borders (e.g., stone, bricks, concrete)
- planters, fountains, or other Community Aesthetic Features
- retaining walls or sidewalk
- benches and decks
- wayfinding signage
- transit stops
- pavers for driveways, paths, plazas, or patios

See **FDM 944** for Hardscape Plan content and Construction Cost Estimate.

272.2 Hardscape Design Requirements

Hardscape designs must comply with the following requirements:

- (1) Be compatible with a maintaining agency's preferences, abilities, and resources. Request proprietary product certification when applicable.
- (2) Preserve visibility of Community Aesthetic Features, highway signing, and permitted outdoor advertising signs
- (3) Be compatible with above and below ground utilities.
- (4) Support community efforts for economic development, urban revitalizations, and aesthetic enhancements. See **FDM 127** for hardscape identified as a Community Aesthetic Feature.
- (5) Meet vertical and horizontal clearance requirements for pedestrian and bicycle facilities in **FDM 222, 223, and 224**.
- (6) Meet lateral offset or clear zone requirements in **FDM 215**.

- (7) Meet sight distance requirements in **FDM 210**.
- (8) Meet intersection sight distance in **FDM 212**.
- (9) Use materials that are low maintenance and durable.
- (10) When possible, use recycled or recyclable materials.
- (11) Comply with:
 - (a) Florida Building Code
 - (b) Florida Administrative Code

273 Landscape Maintenance Guide

273.1 General

This chapter provides the criteria and requirements for the Landscape Maintenance Guide. See **FDM 944.7** for development of Landscape Maintenance Guide sheet.

A Landscape Maintenance Guide is required for all landscape projects whether delivered as a standalone or as a component set of plans. This plan sheet describes the long-term design intent, limits of landscape maintenance, and the necessary activities for maintaining the planting and irrigation designs.

273.2 Landscape Maintenance Guide Requirements

The Landscape Maintenance Guide provides guidance to the maintaining agency on anticipated activities necessary to preserve the design intent, assure vitality of the plant material, and optimize the performance of the irrigation system. Coordinate the methods for plant care, and watering frequency for irrigation system with the maintaining agency.

Include a draft Landscape Maintenance Guide with the Phase III submittal, submit final guide with Phase IV submittal. Place the final PDF of the Landscape Maintenance Guide in the:

- Maintenance agreement when maintained by a local agency or group
- Maintenance contract when maintained by the Department.

273.2.1 Design Intent

Convey the design intent of the landscape design is intended to provide.

- (1) Functional characteristics of individual plants or groups of plants may provide:
 - (a) Screen adjoining land use
 - (b) Provide shade to sidewalk or path
 - (c) Reduce stormwater velocity (erosion control)
 - (d) Maintain full foliage, or naturally appearing forest
 - (e) Reestablish natural roadside edge
 - (f) Support economic development, or enhance the esthetic value of rest areas

- (g) Provide a safety enhancement (e.g., roundabout central island, midblock crossings, median treatment)
- (2) Preserve required site distances, such as:
 - (a) Stopping and intersection sight distance
 - (b) Horizontal and vertical clearances near pedestrian facilities
 - (c) Outdoor advertising sign view zone
 - (d) Lateral offset and clear zone

273.2.2 Plant Vitality

Convey the maintenance activities and performance to assure continued plant vitality, such as:

- (1) Plant pruning:
 - (a) Maintain clear trunk to X feet
 - (b) Maintain at height no less than X feet
 - (c) Maintain height no greater than X feet
 - (d) Maintain form and spread
- (2) Fertilizer requirements (type and frequency)
- (3) Watering requirements
- (4) Weeding, mulch replenishment, and planting bed edging
- (5) Pest and disease control
- (6) Hardscape and site amenities preservation

273.2.3 Irrigation System Performance

Convey the maintenance activities for optimal performance of the irrigation system, such as:

- (1) Frequency of scheduled inspections and testing requirements
- (2) Requirements associated with the original design parameters, including manufacturer specifications and user manuals
- (3) Zone run times based on system efficiency, precipitation rate, seasonal adjustments, and local jurisdictional restrictions

- (4) Inspection and maintenance of the following:
 - (a) Backflow preventer and point of connection
 - (b) Water source and pressure requirements
 - (c) Filters and filtration requirements
 - (d) Operation of controller and sensors
 - (e) Valve flow and operation
 - (f) Head adjustment and spray pattern, including necessary adjustments as the landscape matures
- (5) Winterization requirements (if applicable)
- (6) Future audit requirements

273.3 Limits of Landscape Maintenance

Provide an illustration that defines the boundaries of maintenance activities. The illustration is typically not-to-scale and produced on a standard-format sheet (11"x17") oriented west to east, or south to north (increasing stationing or mile post). Illustration should include the following:

- (1) Use the planting plan sheets, "gray screened" and devoid of unnecessary text and labeling, in the background.
- (2) Display and label the limits of maintenance shown as shaded, or hatched areas.
- (3) Provide a north arrow with NTS, typically placed in the top right corner of the sheet.
- (4) Label the following:
 - (a) Begin and end project limits
 - (b) R/W and easements
 - (c) Roadway names
 - (d) Outside edge of sidewalk, pavement, or other elements that define the boundary of maintenance activities

Include the limits of landscape maintenance as an exhibit to the Landscape Maintenance Guide.

273.4 Landscape Maintenance Cost Estimate

Estimate the annual cost for proposed landscape maintenance activities, including irrigation system. Consult with the District Landscape Architect and District Maintenance staff when developing the cost estimate. During design, a preliminary cost estimate allows the maintaining agency to evaluate the landscape plan and determine if revisions are necessary.

Include the cost estimate as an exhibit to the Landscape Maintenance Guide.

274 Selective Clearing and Grubbing

274.1 General

This chapter provides the criteria and requirements for Selective Clearing and Grubbing (C&G) designs. See **FDM 924** for development of Selective C&G Plan sheets

Selective C&G is an alternative to Standard C&G in areas outside the limits of construction (i.e., area that must be cleared for the purpose of constructing the roadway). While Standard C&G requires complete removal of all trees, stumps, roots and other such protruding vegetation, Selective C&G provides instruction for areas where existing trees and vegetation are retained.

Coordinate the determination of desired Select C&G areas with the District Landscape Architect early in the design phase. Verify that the inclusion of Select C&G activities aligns with future landscape projects or available Landscape Opportunity Plan. Also, review Project Commitments made during the PD&E phase to identify possible landscaped areas that would benefit from Select C&G activities.

Selective C&G areas may include one or more of the following activities:

- Preservation and protection of desirable trees and vegetation
- Removal of undesirable trees and vegetation
- Installation of tree protection fencing
- Branch and root pruning
- Tree or palm relocation

Preserve and protect healthy and structurally sound trees, palms, and vegetation along transportation corridors. Removal or relocation of trees and palms should be considered only when preservation is impractical. See **FDM 275** for tree and palm relocation requirements.

Refer to **Figure 274.1.1** for an illustration of the Selective C&G process, including vegetation removal, preservation, relocation, and supplementing with new landscape material.

Figure 274.1.1 Illustration of Selective C&G Process

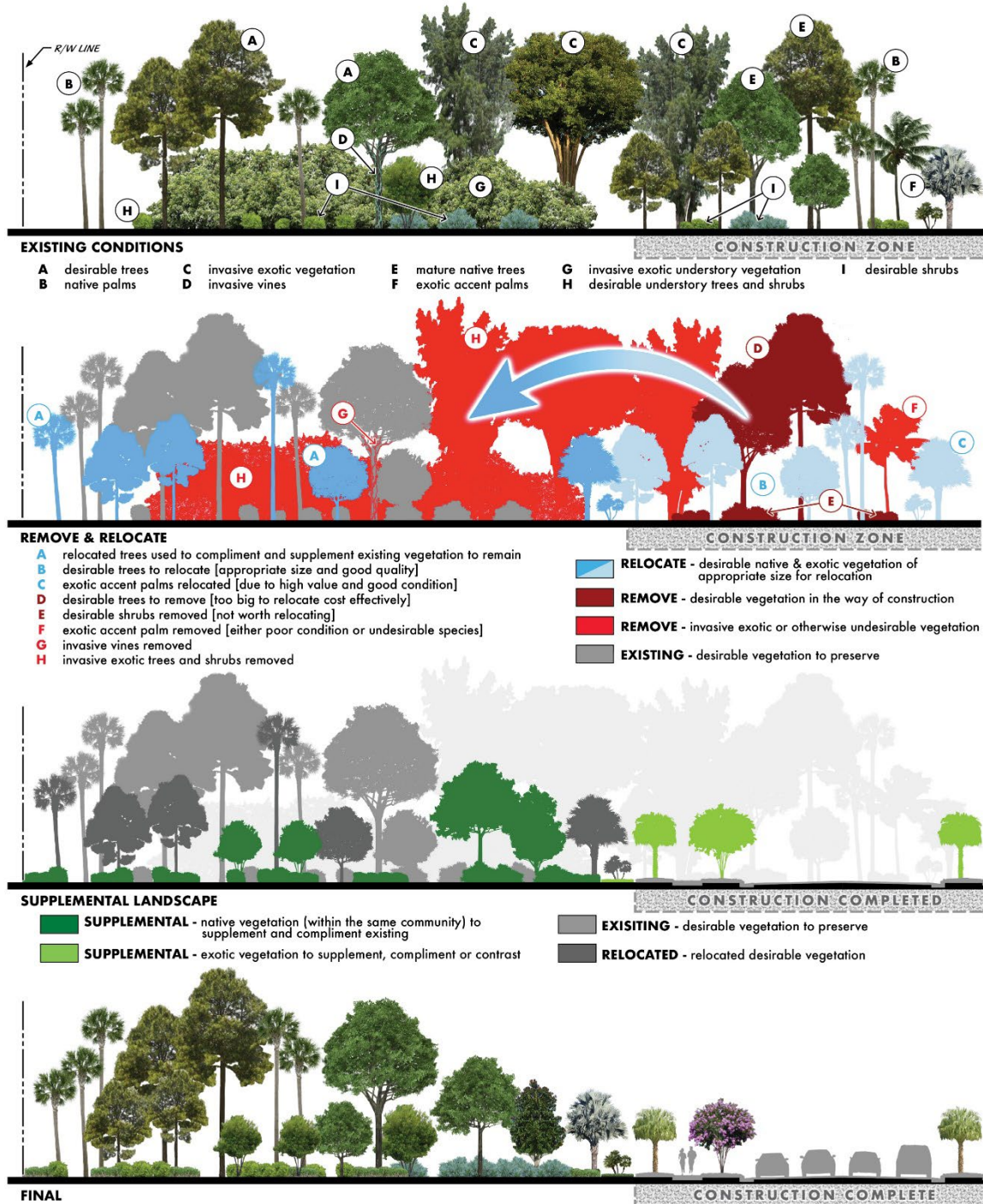

274.1.1 Preservation of Trees and Vegetation

Preserve natural landscapes by identifying Plant Preservation Areas within the Select C&G Plan sheets. Plant Preservation Areas are areas in which no construction activities are to occur, including the staging of materials or equipment.

Trees, palms, shrubs, grasses, wildflowers, and existing soils within Plant Preservation Areas are to be protected from construction activities. Surrounding these areas by silt fence (or other visible delineation) during the construction phase is an effective way of avoiding unintended encroachment.

Verify with the District Landscape Architect that preservation areas align with future highway landscape plans.

274.1.2 Removal of Undesirable Trees and Vegetation

Trees and vegetation that are in poor health, diseased, or listed as invasive are undesirable and should be removed. Within a designated Selective C&G area, undesirable vegetation can be removed while preserving existing desirable vegetation.

Mechanical thinning (removal) of undergrowth to improve the health and appearance of desirable trees and vegetation should also be considered. Avoid thinning dense trees and shrubbery along the R/W when this vegetation is providing a desired buffer between the roadway and adjacent residents.

When removing undesirable trees, determine if stump removal is necessary or may be left in place.

Chemical weed control, or physical removal of invasive trees and vegetation will also improve the health and appearance of remaining landscaped area. When attempting to remove invasive grass, weeds, and vines, consider the effectiveness of this treatment when adjacent properties are overrun as well, or if follow-up treatments will be necessary for complete eradication.

Category 1 plants listed by the [Florida Exotic Pest Plant Council](#) are undesirable and removed when feasible.

274.1.3 Tree Protection Fencing

Tree protection fencing is to protect the tree in its entirety, including the root system, trunk, branches, and surrounding soil from damage, compaction, and contamination. Utilize tree protection fencing for trees “selected” to remain when:

- (1) Individual or groups of trees require preservation, or
- (2) Individual or groups of trees have been relocated within project limits.

Place fencing around the root zone, or at minimum the dripline of trees. See [FDOT Standard Plans](#), Index 110-100 for fencing installation requirements.

274.1.4 Branch and Root Pruning

Branch pruning is the selective removal of unwanted tree branches and provides one or more of the following benefits:

- Reduce risk of damage to people or property
- Manage tree health and direction of growth
- Provide horizontal and vertical clearance for pedestrians, cyclists, or vehicles
- Improve tree structure, restore shape, or improve aesthetics

Root pruning is the process of cutting roots prior to mechanical excavation near a tree. Root pruning is necessary to minimize damage to the tree's critical root system during construction, or in preparation for tree relocation. The roots are typically sliced at the drip line of an established tree.

274.2 Selective C&G Field Assessment

A field assessment should be conducted prior to final determination on extent of Select C&G activities. The field assessment should identify the following:

- (1) Opportunities for preservation, protection and enhancement of existing vegetation, and tree relocation options. Also note:
 - (a) Presence of endangered plant species ([Florida Department of Agriculture Endangered Plant Species](#)), or invasive trees and vegetation.
 - (b) Health and condition of trees and vegetation
 - (c) Historically significant, or large trees or palms

- (d) Completed beautification or landscape projects
- (e) Vegetation buffers between project and adjacent landowners
- (2) Opportunities for vegetation removal to create vistas or allow views into desirable areas such as ponds, forested areas, or other attractive transportation features.
- (3) Anticipated limits of construction and the impacts on surrounding vegetation.
- (4) Location of outdoor advertising signs, community aesthetic features, or other similar structures.
- (5) Corridors traversing through designated Florida Scenic Highways, or conservation lands.
- (6) Possible utility conflicts effecting proposed tree removal or installations.

274.2.1 Tree and Vegetation Survey

The result of the field assessment determines the course of action for Selective C&G and the extent of the Tree and Vegetation Survey.

Prepare a site inventory of all existing trees and vegetation, including species, size, and location. Coordinate with the surveyor to have trees tagged and surveyed.

A site inventory provides a record of what existed prior to construction if mitigation or replacement is warranted due to damage caused by contractor.

274.3 Selective C&G Maintenance Report

A Select C&G Maintenance Report is required when Select C&G sheets are included in the Roadway Plans.

This Select C&G Maintenance Report details the care and maintenance of preservation and Selective C&G areas. This document describes the intent of the Selective S&G activities, and arboricultural best practices.

Deliver the Select C&G Maintenance Report to the District Project Manager.

275 Tree and Palm Relocation

275.1 General

This chapter provides the criteria and requirements for relocation of trees and palms. For Tree and Palm Relocation plan content refer to **FDM 944**.

Relocation of trees and palms require the approval of the District Landscape Architect.

Develop a root pruning and relocation plan tailored to the species being relocated. Time periods required between root pruning and relocation must be in accordance with Industry standards and **Supplemental Specification 581**.

275.2 Relocation Considerations

When deciding to relocate a tree or palm, consider the following:

- (1) Protected tree or palm species ([Florida Department of Agriculture Endangered Plant Species](#)), or local jurisdictional regulations.
- (2) Cost effectiveness of relocation (i.e., cost and benefit of relocating existing trees versus purchasing new nursery material)
- (3) Tree or palm condition (e.g., size, form, health, structure)
- (4) Aesthetic, historical cultural, community, and environmental value
- (5) Functional characteristics and engineering (e.g., safety considerations)
- (6) Negative public perceptions regarding removal of healthy trees
- (7) Overall suitability for relocating:
 - (a) Desirable and disease resistant species
 - (b) Survivability
 - (c) Required establishment period
 - (d) Impact to construction schedule
 - (e) Removal, transport, or installation issues

275.3 Relocation Site Selection

For construction projects, trees or palms must be relocated to a site that is within, or near the project limits which decreases transport costs and increases the survival rate.

For maintenance-let landscape projects an off-site location may be considered when there is not sufficient space to relocate a tree on-site. Off-site relocations must meet the following requirements:

- Relocation site is within the district in which the contract is let
- Acceptable plan for care during establishment period
- A written agreement with the maintaining agency has been obtained

276 Outdoor Advertising Signs

276.1 General

This chapter provides the criteria and requirements for outdoor advertising signs.

Generally, any outdoor advertising sign structure requires a permit from FDOT. A legally erected or permitted sign establishes a protected view zone in which no plantings may encroach on the driver's line of site of the sign. When a landscape project is within or near the limits of a view zone, the landscape architect will notify the sign owner in writing (email correspondence is acceptable).

276.1.1 View Zones

In accordance with [Chapter 479, F.S.](#), the view zone begins at a point on the edge of pavement perpendicular to the nearest edge of the sign facing and continues in the direction of approaching traffic for a distance of:

- 350 feet for posted speed limits of 35 mph or less, or
- 500 feet for posted speed limits over 35 mph.

An alternate view zone is created by shifting the starting point along the edge of roadway and then adding the distances stated above. The alternate view zone can be established via the original permit application, vegetation management permit, or by written agreement (email correspondence is acceptable) between the Department and the sign owner.

Use the [Outdoor Advertising Database](#) located on the [Outdoor Advertising](#) web site to verify the permit status of permitted outdoor advertising signs located within 1,000 feet of the project limits. Search the database by county and roadway section ID to make sure all permitted signs are identified. Some permitted signs may not be erected or visible at the time of design, but still have valid view zones.

The database provides pertinent information for erected signs, including:

- Permit status (active, voided, revoked, canceled, or expired)
- View zone requirements (by statute, or alternate view agreement)
- Approved Vegetation Management Permit

For signs with a permit status of “revoked”, “cancelled”, or “expired”, contact the State Outdoor Advertising Administrator (identified on the [Outdoor Advertising](#) web site) to determine if the view zone is still valid.

276.1.2 Vegetation Management Permit

An approved [Vegetation Management Permit Application](#) allows the owner to alter, remove or install vegetation within the Department's right of way. This application may also establish an alternate view zone. The activities granted to the owner via permit may have a significant bearing on the proposed landscape project.