266 Bicycle and Pedestrian Bridges

266.1 General

A separate bicycle and pedestrian bridge may be necessary to provide continuity to sidewalks, bicycle lanes and shared use paths. See **FDM 222, 223, and 224** for information on bicycle and pedestrian facilities.

See **Chapter 10** of the **Structures Design Guidelines (SDG)** for information on pedestrian bridges.

266.2 Designer Qualifications

Engineering firms must be technically pre-qualified with the Department in the appropriate bridge design work type(s), in accordance with **Rule 14-75, Florida Administrative Code**, when designing the following:

- Department owned pedestrian bridges
- Permitted, non-Department owned pedestrian bridges within, under or over State Road right-of-way.

For Department projects only, engineering firms must also be administratively pre-qualified (approved overhead audit) for projects greater than \$500,000 total value per professional services contract. See **Table 266.2.1** for designer qualifications on projects with prefabricated steel truss pedestrian bridges.

Table 266.2.1 Designer Qualifications for Prefabricated Steel Truss Pedestrian Bridges

Project Type	Category 1 per FDM 266.4?	Project EOR Design Firm		Contractor's EOR	
		Role	Prequalification	Role	Prequalification
Department	Yes	Substructure and/or foundation design	[T + A] Work Type 4.1.2 - Minor Bridge Design, or other necessary work group based on substructure design	Steel truss design	T (Work Type 4.2.2 - Major Bridge Design - Steel)
	No	Steel truss, substructure and/or foundation design	[T + A] Work Type 4.2.2 - Major Bridge Design - Steel and other necessary work group based on substructure design	CSIP redesign of steel truss and any associated substructure and/or foundation design	T (Work Type 4.2.2 - Major Bridge Design - Steel)
Non-Department	Yes	Substructure and/or foundation design	T Work Type 4.1.2 - Minor Bridge Design, or other necessary work group based on substructure design	Steel truss design	T (Work Type 4.2.2 - Major Bridge Design - Steel)
	No	Steel truss, substructure and/or foundation design	T Work Type 4.2.2 - Major Bridge Design - Steel and other necessary work group based on substructure design	CSIP redesign of steel truss and any associated substructure and/or foundation design	T (Work Type 4.2.2 - Major Bridge Design - Steel)

Notes:

- (1) See **FDM 266.4.2** for definitions of Project EOR Design Firm and Contractor's EOR.
- (2) "T" = Technical prequalification required in accordance with **Rule 14-75, Florida Administrative Code**.
- (3) "T + A" = Technical and Administrative (approved overhead audit) prequalification for projects greater than \$500,000 total value per professional services contract in accordance with **Rule 14-75, Florida Administrative Code**.
- (4) CSIP = Cost Savings Initiative Proposal

266.3 Design Criteria

Design bicycle and pedestrian bridges in accordance with the following criteria:

- (1) Clear width for bridges is:
 - (a) 8-foot minimum on a pedestrian structure; 12-foot desirable
 - (b) 12-foot minimum on a shared use path structure; 16-foot desirable
 - (c) Minimum clear width is the width of the approach facility when the facility is wider than the minimums above; desirable clear width is the width of the approach facility plus four feet (2-foot-wide clear area on each side).
- (2) Minimum vertical clearance under pedestrian bridges must be in accordance with **FDM 260.6** and **FDM 260.8**.
- (3) Account for future widening of the roadway below when determining required lateral offset (per **FDM 215.2.4**).
- (4) Ramp grades should not exceed 5%, but in no case be more than 8.33% with a maximum 30-inch rise.
 - (a) Provide level landings that are 5-feet long at the top and bottom portions of the ramp.
 - (b) Provide intermediate level landings that are 5-feet long when the ramp length results in a rise that exceeds 30-inches.
- (5) Provide full-length pedestrian ADA handrails on both sides of pedestrian ramps.
- (6) Consider providing stairways in addition to ramps.
- (7) Provide railing and fencing options in accordance with the **SDG, Chapter 10**.
 - (a) See **FDM 222, Figures 222.4.6** through **222.4.8** for vehicular fencing options.
 - (b) Provide full or partial screening on pedestrian bridges crossing State Road right-of-way in order to reduce the likelihood of objects being dropped or thrown onto the roadway below. See **Figure 266.3.1** for example of full screening.

Coordinate with District Design Engineer and local stakeholders to determine use of full screening on pedestrian bridges crossing FDOT right of way. When fencing is required, make the limits of fencing from the beginning of the approach slab at Begin Bridge to the end of approach slab at End Bridge.
 - (c) Pedestrian bridges on State Road right-of-way but not crossing State Road right-of-way are not required to be screened.

- (d) Check with local authorities for guidance on screening for Department pedestrian bridges crossing local rights of way.
- (e) The use of chain link fence on ramps of the pedestrian bridges will be determined on a project-by-project basis.

Modification for Non-Conventional Projects:

Add the following sentence:

- (f) When fencing is required, the limits of fencing is from the beginning of the approach slab at Begin Bridge to the end of the approach slab at End Bridge, unless otherwise indicated in the RFP.

An Independent Peer Review meeting the requirements of **FDM 121.12** is required for non-Department owned projects in which the pedestrian bridge is constructed within, under or over State Road right-of-way, regardless of the funding source. The Independent Peer Review must be completed, and all comments resolved prior to erecting the structure over or adjacent to traffic. Include the following note in the Plans:

The Independent Peer Review must be completed, and all comments resolved, prior to erecting the structure over or adjacent to traffic. The term adjacent is in accordance with [Standard Plans Index 102-600, Table 5 – Clear Zone Widths for Work Zones](#).

Figure 266.3.1 Pedestrian or Shared Use Path Bridge Typical Section

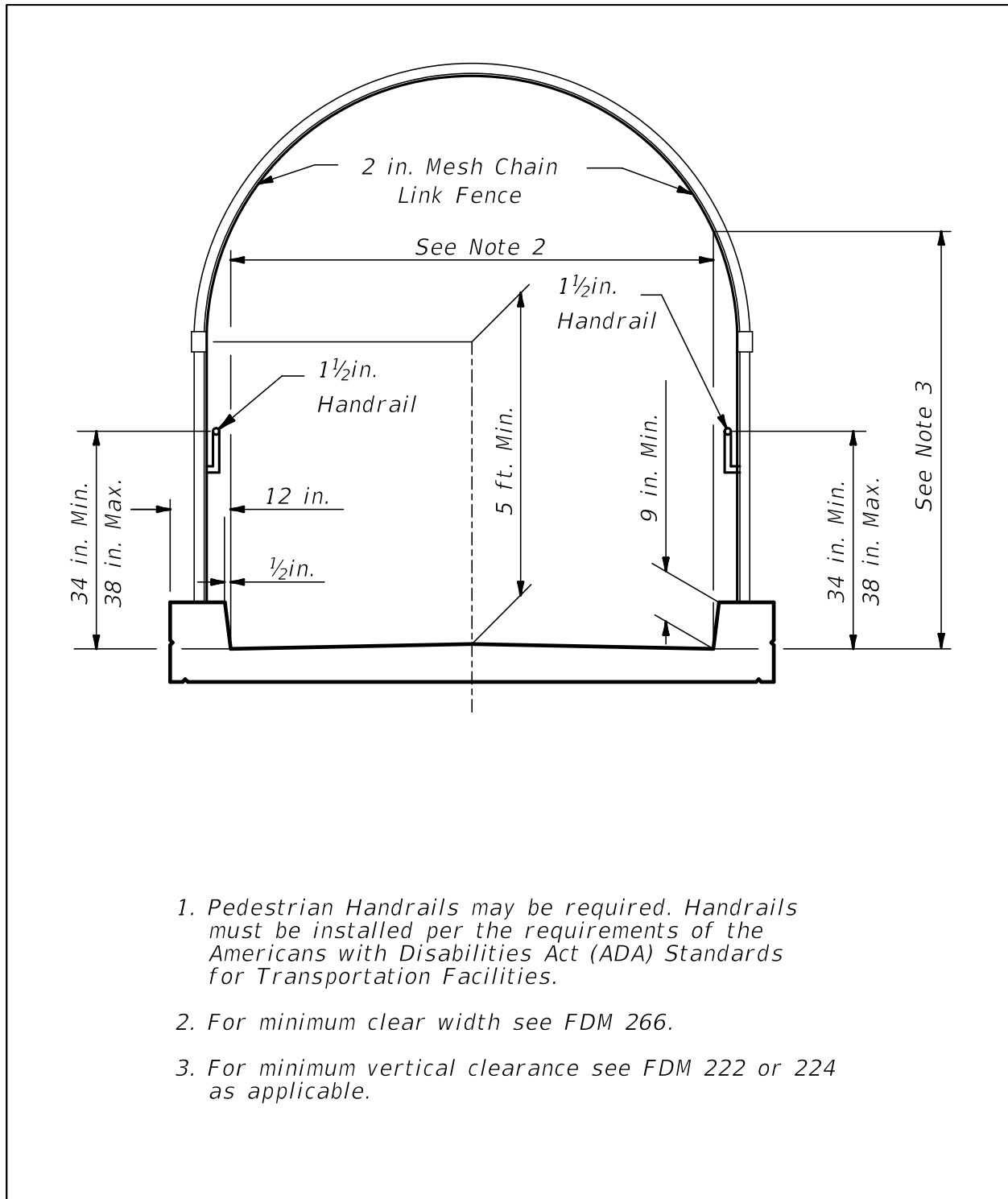

266.4 Prefabricated Steel Truss Bridges

In many situations it makes good engineering and economic sense to utilize prefabricated steel truss bridges for pedestrian crossings. These bridges can be stand-alone structures or a hybrid structure with adjoining spans of other types (FIB, deck slab, steel I-girder, etc.). The provisions of this article apply only to the spans on a bridge that are comprised of prefabricated steel trusses. The term steel truss bridge as applied in this article refers only to stand-alone steel truss structures or to the steel truss spans of a hybrid bridge structure.

The following conditions must be met to use the plans development process described in **FDM 266.4.4** and for the prefabricated steel truss bridge to be classified as a Category 1 structure:

- (1) The bridge lies within a tangent horizontal alignment.
- (2) The maximum span¹ length does not exceed 200 feet measured between the centerline of bearings.
- (3) The bridge width is constant.
- (4) Each span¹ is simply supported (no continuity over supports)
- (5) The supports have a skew angle² of 20° or less.

Notes:

- (1) Span indicates an individual span.
- (2) See the [Structures Detailing Manual \(SDM\) Section 2.14](#) for the definition of skew angle.

When the above conditions are not met, the plans development process described in **FDM 266.4.4** is not permitted, the truss span must be fully detailed in the Structures Plans, and the bridge is classified as a Category 2 structure. This requirement applies to all projects (including permits) involving Department or non-Department owned prefabricated steel truss bridges placed within, under or over State Road right-of-way, as well as Local Authority Projects developed and designed in accordance with Department policies.

Modification for Non-Conventional Projects:

Delete **FDM 266.4** and replace with the following:

266.4 Prefabricated Steel Truss Bridges on Department Projects

Prefabricated steel truss bridges can be stand-alone structures or a hybrid structure with adjoining spans of other types (FIB, deck slab, steel I-girder, etc.). The provisions of this article apply only to the spans on a bridge that are comprised of prefabricated steel trusses. The term steel truss bridge as applied in this article refers only to stand-alone steel truss structures or to the steel truss spans of a hybrid bridge structure.

The following conditions must be met for the prefabricated steel truss bridge to be classified as a Category 1 structure:

- (1) The bridge lies within a tangent horizontal alignment.
- (2) The maximum span¹ length does not exceed 200 feet measured between the centerline of bearings.
- (3) The bridge width is constant.
- (4) Each span¹ is simply supported (no continuity over supports)
- (5) The supports have a skew angle² of 20 degrees or less.

Notes:

- (1) Span indicates an individual span.
- (2) See the [Structures Detailing Manual \(SDM\) Section 2.14](#) for the definition of skew angle.

See the RFP for additional requirements.

266.4.1 Qualification of Prefabricated Steel Truss Pedestrian Bridge Producers

Use prefabricated steel truss pedestrian bridges from providers included on the Department's Production Facility Listing. For information on the facility qualification process see **Articles 11.1.5** and **11.1.6** of the [FDOT Materials Manual](#).

266.4.2 Design and Detailing Responsibilities

The project Engineer of Record (EOR) is responsible for the design and detailing of the steel truss bridge substructure and foundation including end bents, piers, and pile foundations or spread footings. The project EOR is also responsible for the design and detailing of approach structures (non-steel truss bridge spans, walls, ramps, steps, approach slabs, etc.).

The Contractor's EOR is responsible for the design and detailing of the steel truss bridge superstructure including trusses, deck, bridge railing, floor beams, bridge joints, bearing assemblies and anchor bolts.

Modification for Non-Conventional Projects:

Delete **FDM 266.4.2** and replace with the following:

266.4.2 Design and Detailing Responsibilities

The Engineer of Record (EOR) is responsible for the design and detailing of the steel truss bridge foundation, substructure, and superstructure. The EOR is also responsible for design and detailing of approach structures (walls, ramps, steps, approach slabs, etc.). Include the steel truss bridge superstructure including trusses, deck, bridge railing, floor beams, bridge joints, bearing assemblies and anchor bolts as part of the appropriate phase submittal, depending on whether the steel truss bridge is considered Category 1 or Category 2 per **FDM 121**. See the RFP for additional requirements.

266.4.3 Project Processing

Project processing of prefabricated steel truss bridges is summarized in **Figure 266.4.1**.

Figure 266.4.1 Project Processing of Prefabricated Steel Truss Bridges Flowchart

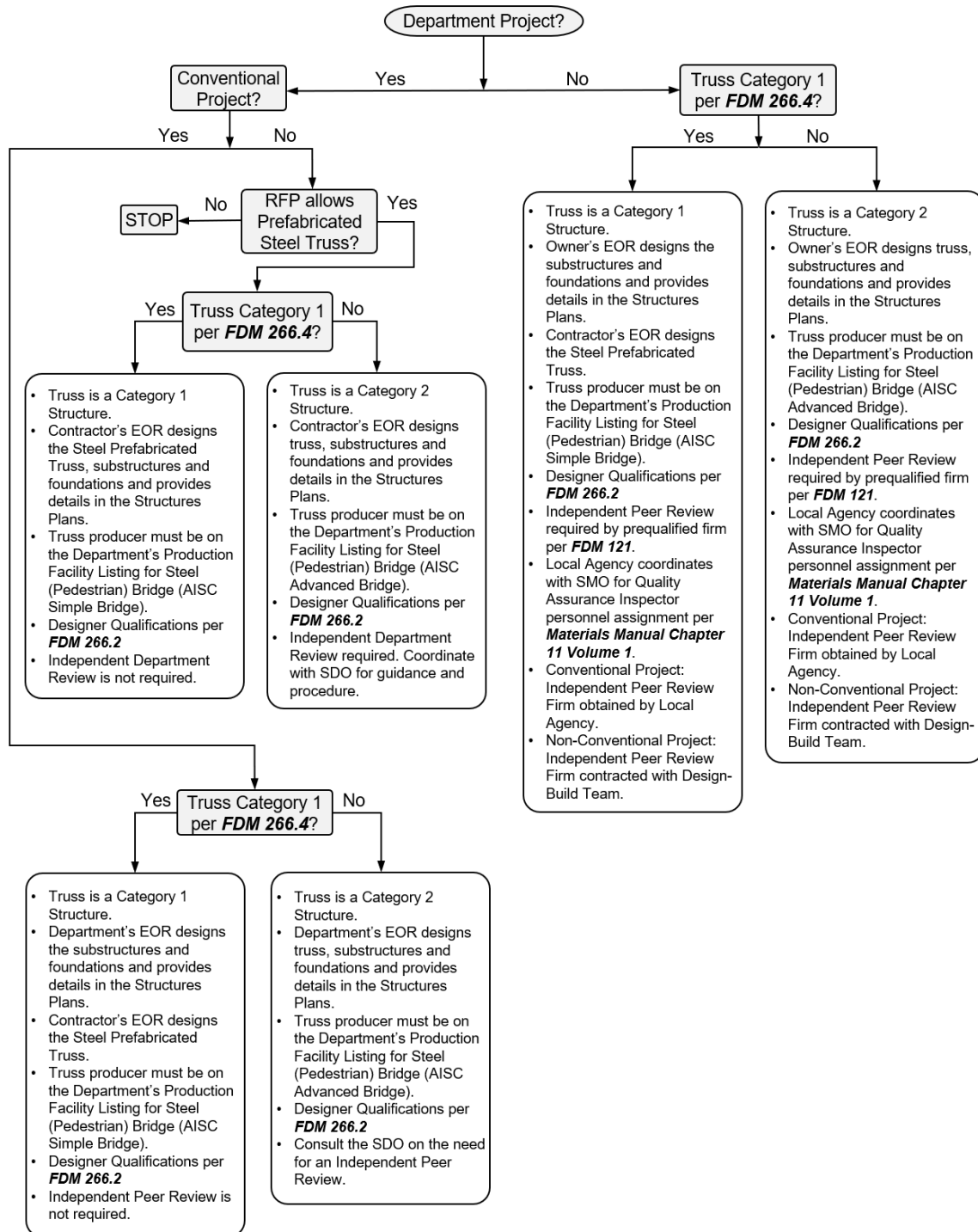

266.4.4 Plans Development

To allow equal opportunity for all qualified pedestrian bridge producers to participate, the pedestrian bridge plans should have the flexibility to accommodate multiple alternate superstructure designs. When a prefabricated steel truss pedestrian bridge is classified as a Category 1 Structure per **FDM 266.4**, adhere to the following procedure when developing the plans:

- (1) Using **Figures 266.4.2, 266.4.3, and 266.4.4**, coordinate with the District Project Manager to select allowable truss configurations, truss member shapes, and bridge cross sections. A box truss bridge cross-section is required for spans greater than 150 feet.

If project specific aesthetic requirements warrant the use of truss configurations not included in **Figure 266.4.2** the project EOR can specify additional truss configurations. However, a minimum of two steel truss pedestrian bridge producers must be capable of satisfying the aesthetic requirements.

- (2) Develop a Plan and Elevation sheet and Bridge Typical Section to be submitted with the BDR/30% plans.
- (3) After the BDR/30% plans have been approved, send out a Prefabricated Pedestrian Bridge Invitation to Participate (ITP) to all prefabricated pedestrian steel truss bridge producers on the Department's Production Facility Listing. Send the ITP through registered mail with return receipt to confirm delivery. Contact information for all qualified producers can be found at the following web address:

<https://www.fdot.gov/materials/quality/programs/qualitycontrol/materialslistings/postjuly2002.shtm>

The ITP is intended to solicit qualified producers for information required to design the foundation and substructure of the steel truss pedestrian bridge. The ITP cover letter should contain the following elements with links to websites as appropriate and applicable:

- (a) Introduction with brief project description
- (b) Project Requirements
 - i. Design Specifications Requirements
 - ii. Construction Specifications Requirements
 - iii. Design Standards Requirements
 - iv. Bridge Typical Section
 - v. Allowable Truss Options

- vi. Painting Requirements
 - vii. Pedestrian Fence/Railing Requirements
 - viii. Vehicular Loading Requirements
 - ix. Project Specific Aesthetic Requirements
 - x. Project Geometry including Vertical Clearance Requirements for Each Span
- (c) Participation Requirements
- (d) Submittal Requirements

Include the following items in the ITP package:

- (e) Hard copy:
- i. Invitation to Participate Cover Letter
 - ii. Project Location Map
 - iii. Plan and Elevation
 - iv. Bridge Typical Section and Pedestrian Fence Concept
 - v. Pedestrian Bridge Data Sheet
- (f) Electronic files:
- i. PDF file with all of the above
 - ii. Pedestrian Bridge Data Sheet in CADD format

For a sample Prefabricated Pedestrian Bridge ITP complete with all hard copy attachments see **Example 266.4.1**. To aid plan development CADD cells for the Pedestrian Bridge Data Sheet and Plan and Elevation sheet (2 of 2) are available in the FDOT Structures Cell Library. For the current FDOT CADD Software downloads follow the link below:

<https://www.fdot.gov/cadd/downloads/software/software.shtm>

- (4) Upon delivery the pedestrian bridge, producers must acknowledge receipt of the ITP package.
- (5) In order to be eligible to participate in the project the pedestrian bridge producers must provide a completed Pedestrian Bridge Data Sheet as outlined in the ITP on or before the specified due date (prior to 60% plans submittal). The completed Data Sheets must be electronically signed and sealed by the pedestrian bridge producer's EOR for inclusion in the final plan set.

The project EOR assigns a unique sheet number to each data sheet. The sheet numbers will be identified with the prefix BP (e.g., BP-1, BP-2, BP-#) and the data sheets will be placed at the end of the numbered sequence of the bridge plans. This will allow the Pedestrian Bridge Data Sheets to have independent sheet numbers as plan development progresses.

- (6) After all ITP responses are received the project EOR must design and detail the foundation and substructure to accommodate the superstructure designs of all eligible pedestrian bridge producers. The design must envelope the most extreme loading conditions and geometry of all alternates.
- (7) A Public Interest Finding is required for Federal Aid projects when only one Interest for Participation letter is received.

Include the following notes in the plans:

(a) Eligible Steel Truss Pedestrian Bridge Producers

Included in this plan set are Pedestrian Bridge Data Sheets submitted by bridge producers eligible to participate in this project. Producers who failed to submit a data sheet are excluded from participation. No Cost Savings Initiative Proposal will be accepted for the truss superstructure portion of the project. Contact information for the eligible producers is included in the data sheet.

(b) Shop Drawing Submittal

Prior to fabrication the Contractor's EOR must submit signed and sealed superstructure shop drawings, technical specifications, and design calculations to the Engineer for review and approval.

Figure 266.4.2 Prefabricated Pedestrian Bridge Standard Truss Configurations

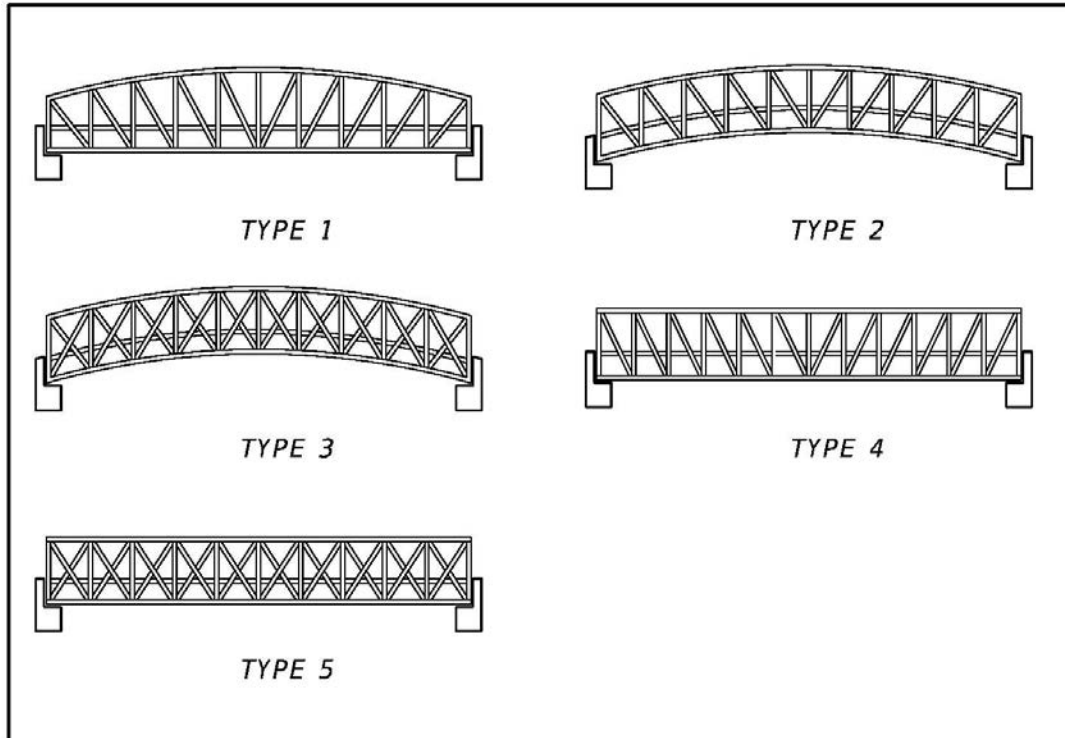

Figure 266.4.3 Prefabricated Pedestrian Bridge Standard Truss Member Shapes

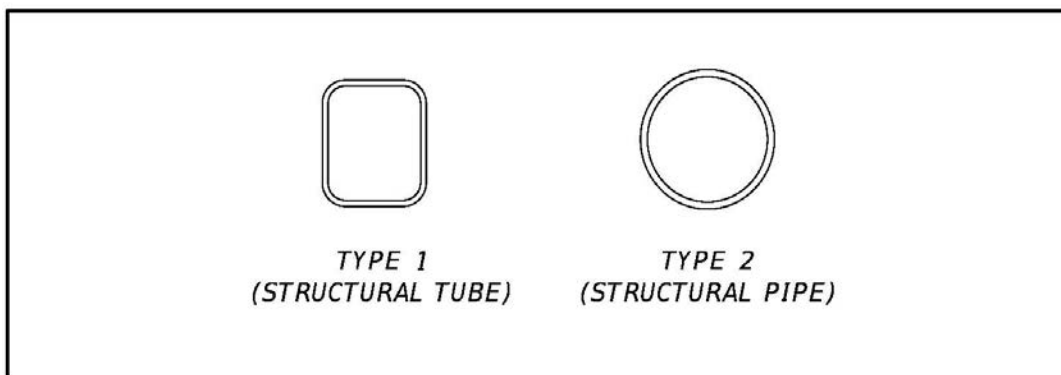
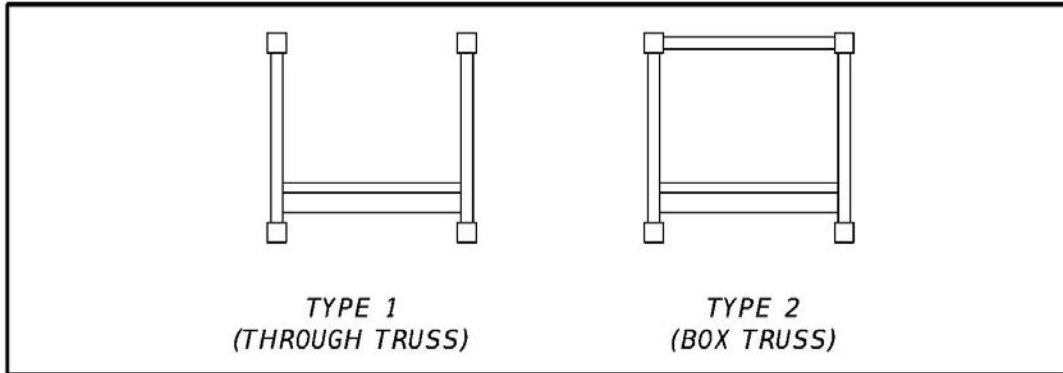

Figure 266.4.4 Prefabricated Pedestrian Standard Bridge Cross-Sections



Modification for Non-Conventional Projects:

Delete **FDM 266.4.4** and see the RFP for requirements.

Example 266.4.1 Sample Steel Truss Pedestrian Bridge Plans

Sheet 1 of 8

(prepare on Department letterhead)

FLORIDA DEPARTMENT OF TRANSPORTATION

DISTRICT 3

PREFABRICATED PEDESTRIAN BRIDGE

INVITATION TO PARTICIPATE

Project: CR 250 over Ruby Creek Pedestrian Bridge

Financial Project Number: 217664-1-52-01

Federal Aid Project Number(s): SF2-349-R

Date: March 15, 2011

Introduction:

The Florida Department of Transportation is currently preparing bid documents for the construction of a steel truss pedestrian bridge adjacent to County Road 250 crossing Ruby Creek in Jefferson County. The superstructure of the proposed bridge is to be provided by a steel truss pedestrian bridge producer who is prequalified to work on Department projects. This invitation to participate is being sent to all prequalified producers to solicit information needed by the project EOR to design the foundation and substructure of the proposed bridge. Enclosed are the following materials:

- (1) Hard Copy
 - (a) Project location map
 - (b) Bridge Typical Section and Pedestrian Fence Concept
 - (c) Plan and Elevation (P&E) (2 sheets)
 - (d) Pedestrian Bridge Data Sheet
- (2) Electronic
 - (a) PDF file with all of the above
 - (b) Pedestrian Bridge Data Sheet in CADD format

Example 266.4.1 Sample Steel Truss Pedestrian Bridge Plans

Sheet 2 of 8

Project Requirements:

- (1) Design Specifications:
FDOT Structures Design Guidelines (SDG) Article 10.4.
https://www.fdot.gov/docs/default-source/structures/structuresmanual/currentrelease_test_old/Vol1SDG.pdf
- (2) Construction Specifications:
FDOT Standard Specifications for Road and Bridge Construction
<https://www.fdot.gov/programmanagement/specs.shtm>
- (3) Standard Plans:
FDOT Standard Plans
<https://www.fdot.gov/design/standardplans>
- (4) Allowable Truss Options: Allowable Truss options shown on P&E sheet 2 of 2 (Attached).
- (5) Paint: Paint structural steel in accordance with **Sections 560** and **975** of the **Standard Specifications**. Paint structural steel with a high performance top coat system. The color of the finish coat to be Federal Standard No. 595, Color No. 36622.
- (6) Pedestrian Fence: Bridge Fence consistent with bridge rail concept and **SDG Article 10.12**.
- (7) Vehicular Loading: Vehicular Loading per **AASHTO LRFD Guide Specifications** for the Design of Pedestrian Bridges is not required.
- (8) Geometry: For project geometry see attached P&E sheets.

Participation:

To be eligible to participate on this project pedestrian bridge producers must:

- Acknowledge receipt of this ITP
- Be on the Department's List of Qualified Fabrication Facilities.
- Submit a response to this ITP on or before June 10, 2011 to the project EOR.

Submittal:

Provide completed pedestrian bridge data sheet as follows:

- Bearing Plate Dimensions Table – for each span provide bearing dimensions as shown to the nearest 1/8th inch.

Example 266.4.1 Sample Steel Truss Pedestrian Bridge Plans

Sheet 3 of 8

- Bearing Plate Locations & Bridge Seat Elevations Table – for each substructure unit provide dimensions as shown to the nearest 1/8th inch and bridge seat elevation to the nearest 0.001 feet.
- Bridge Reactions Table – for each span provide loads as indicated to the nearest 0.1 kip.
- Company Contact Information Table – in the contact information block provide company name, address, contact person, phone number, and e-mail address.
- Florida PE Seal and Signature – provide seal and signature of Florida PE responsible for the work.

Submit response to:

John Doe, PE
XYZ Engineers, Inc.
123 East Main Street
Tampa, Florida 33607

By submitting a response to this invitation to participate the pedestrian bridge producer is agreeing to satisfy all project requirements listed above if selected.

Example 266.4.1 Sample Steel Truss Pedestrian Bridge Plans

Sheet 4 of 8



LOCATION MAP

CR 250 OVER RUBY CREEK PEDESTRIAN BRIDGE
JEFFERSON COUNTY FLORIDA
FPN 217664-1-52-01

Example 266.4.1 Sample Steel Truss Pedestrian Bridge Plans

Sheet 5 of 8

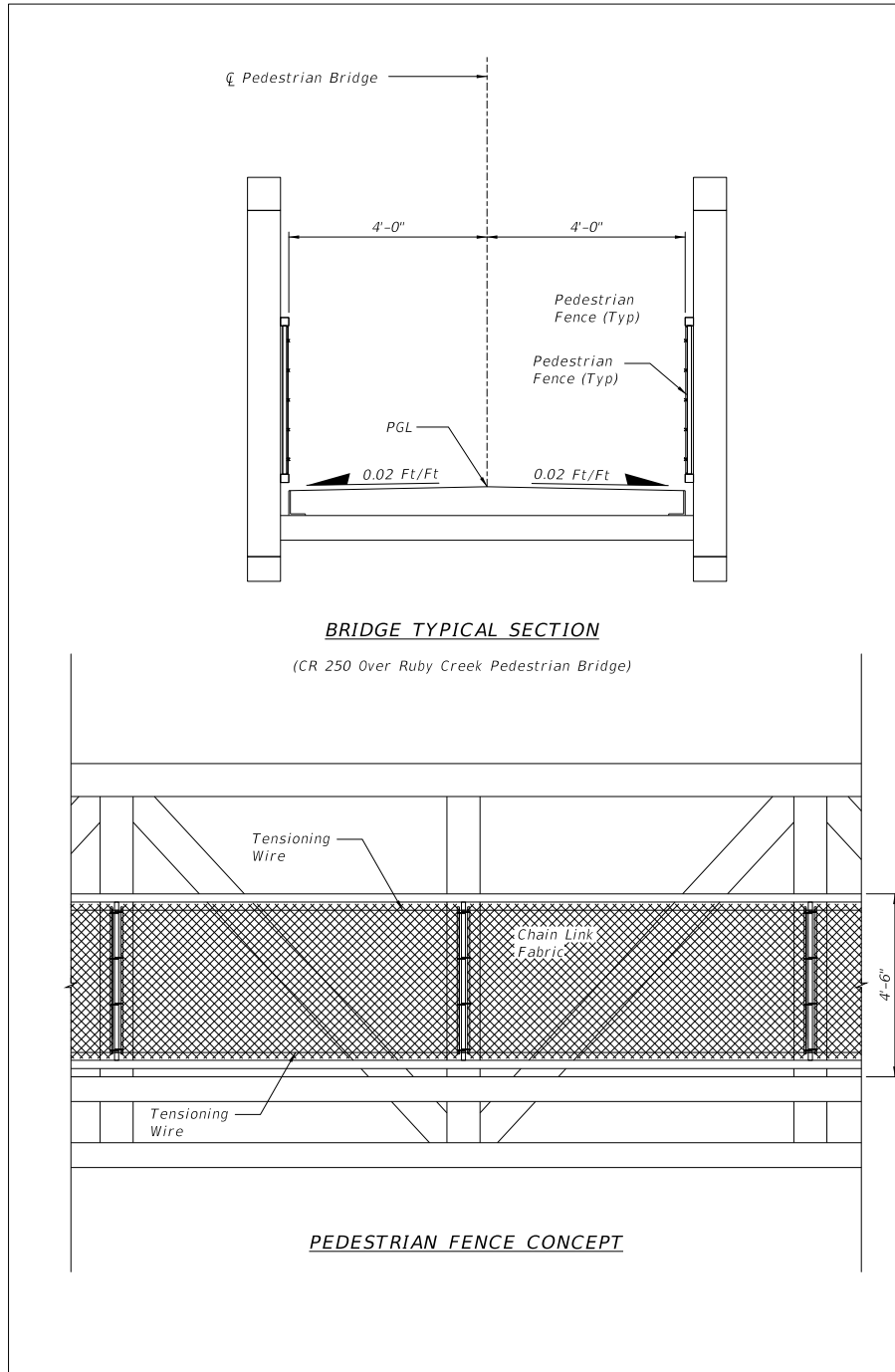

Example 266.4.1 Sample Steel Truss Pedestrian Bridge Plans

Sheet 6 of 8

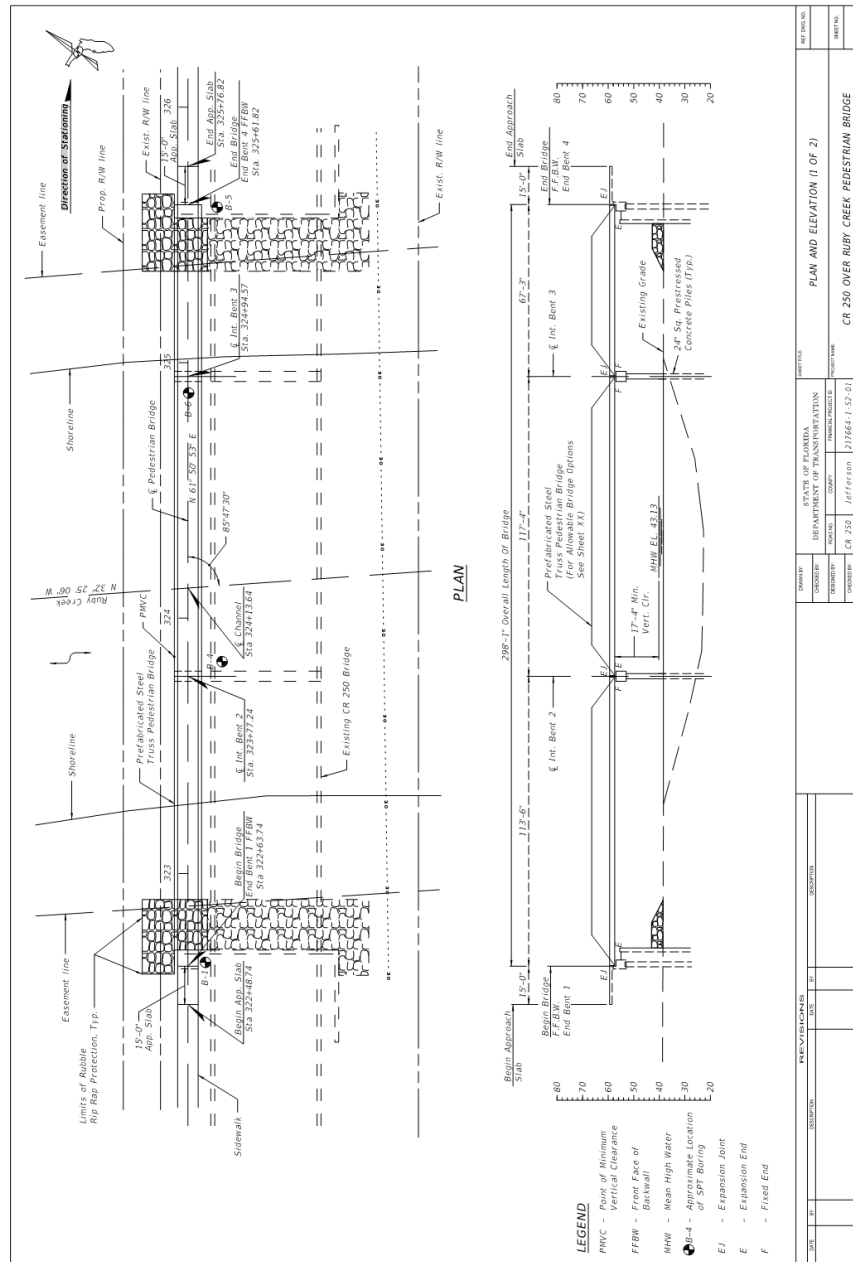

Example 266.4.1 Sample Steel Truss Pedestrian Bridge Plans

Sheet 7 of 8

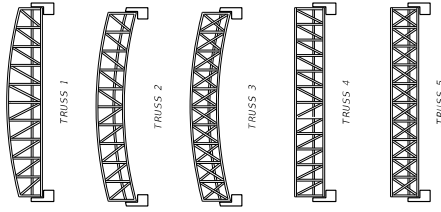

TRUSS CONFIGURATIONS

ALLOWABLE TRUSS CONFIGURATIONS					
TRUSS 1	TRUSS 2	TRUSS 3	TRUSS 4	TRUSS 5	
Y	N	N	Y	N	
Permitted (Y/N)					



TRUSS MEMBER SHAPES

ALLOWABLE TRUSS MEMBER SHAPES		
SHAPE 1	SHAPE 2	
Y	Y	
Permitted (Y/N)		

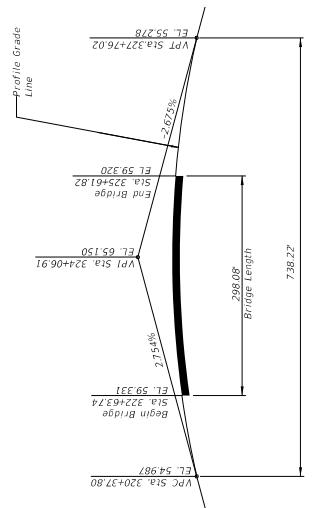

VERTICAL CURVE DATA

Profile Grade
 VPT STA 327+76.02 EL. 55.278
 -2.65%
 End Bridge STA 325+61.82 EL. 50.320
 VPI STA 324+90.91 EL. 65.150
 2.15%
 Begin Bridge STA 322+63.74 EL. 59.331
 VPC STA 320+37.80 EL. 54.987
 Bridge Length 298.08'
 7.38.22'

NOTES:

- Eligible Pedestrian Bridge Producers included in this plan set are Pedestrian Bridge Data Sheets submitted by bridge producers eligible to participate in this project. Producers who have a data sheet on file with the project but are not listed in the data sheets are not eligible. Proposal shall be accepted for the truss superstructure portion of the project. Contact information for the eligible producers is included in the data sheets.
- Allowable Superstructure Options
 All allowable superstructure options are indicated by an "X" in the table on this sheet. For multi-span bridges on the same truss bridge options and depth of truss for each span.
 3. Shop Drawing Submittal
 Prior to fabrication the EOR shall submit signed and sealed superstructure shop drawing, technical specifications, and calculations to the Engineer for review and approval.

ALLOWABLE BRIDGE * CROSS-SECTIONS

ALLOWABLE BRIDGE * CROSS-SECTIONS		
SECTION 1	SECTION 2	
Y	N	
Permitted (Y/N)		

ALLOWABLE BRIDGE * CROSS-SECTIONS

ALLOWABLE BRIDGE * CROSS-SECTIONS		
SECTION 1	SECTION 2	
Y	N	
Permitted (Y/N)		

* Through Truss Bridges are acceptable only for spans less than or equal to 150'. For spans over 150' Box Truss Bridges are required.

DATE	BY	CHECKED	DESIGNED	PROJECT NO.	SHEET NO.

STATE OF FLORIDA DEPARTMENT OF TRANSPORTATION	PROJECT PLAN AND ELEVATION (2 OF 2)	SHEET NO.
COUNTY CR 259	PROJECT NO. 217664-1-22-01	SHEET NO.
DESIGNED BY JEFFERSON	PROJECT NAME CR 250 OVER RUBY CREEK PEDESTRIAN BRIDGE	SHEET NO.

DATE: 08/11/2022 10:03:06 AM PROJECT: 217664-1-22-01 SHEET: 2 OF 2

Example 266.4.1 Sample Steel Truss Pedestrian Bridge Plans

Sheet 8 of 8

TYPICAL END BENT
PARTIAL PLAN

TYPICAL INTERMEDIATE PIER/BENT
PARTIAL PLAN

TYPICAL END BENT
PARTIAL ELEVATION

TYPICAL INTERMEDIATE PIER/BENT
PARTIAL ELEVATION

BEARING PLATE DIMENSIONS	SPAN 1			SPAN 2			SPAN 3			SPAN 4		
	G (in.)	H (in.)	J (in.)	P (KIP)	T (KIP)	L (KIP)	P (KIP)	T (KIP)	L (KIP)	P (KIP)	T (KIP)	L (KIP)
1												
2												
3												
4												

BRIDGE REACTIONS	SPAN 1			SPAN 2			SPAN 3			SPAN 4		
	P (KIP)	T (KIP)	L (KIP)	P (KIP)	T (KIP)	L (KIP)	P (KIP)	T (KIP)	L (KIP)	P (KIP)	T (KIP)	L (KIP)
DEAD LOAD												
UNIFORM LIVE LOAD												
VEHICLE LOAD												
WIND UPWARD												
WIND LEeward												
WIND ¹ TRANSVERSE												
THERMAL												

BEARING PLATE DIMENSIONS

SPAN	G (in.)	H (in.)	J (in.)	K (in.)
1				
2				
3				
4				

COMPANY CONTACT INFORMATION

COMPANY	
ADDRESS	
CONTACT	
PHONE	
E-MAIL	

BEARING PLATE DETAILS

FIXED

EXPANSION

BRIDGE REACTIONS

BRIDGE REACTIONS	SPAN 1			SPAN 2			SPAN 3			SPAN 4		
	P (KIP)	T (KIP)	L (KIP)	P (KIP)	T (KIP)	L (KIP)	P (KIP)	T (KIP)	L (KIP)	P (KIP)	T (KIP)	L (KIP)
DEAD LOAD												
UNIFORM LIVE LOAD												
VEHICLE LOAD												
WIND UPWARD												
WIND LEeward												
WIND ¹ TRANSVERSE												
THERMAL												

BEARING LOCATIONS & BRIDGE SEAT ELEVATIONS

BENT/PIER	A (in.)	B (in.)	C (in.)	D (in.)	E (in.)	F (ft.)
1						
2						
3						
4						
5						

CONSTRUCTION SPECIFICATIONS

1. P - Unfactored Vertical Load each Bearing Plate (4 per Span)
2. L - Unfactored Longitudinal Load each Bearing Plate (4 per Span)
3. The horizontal wind load acting at the C.G. of the truss creates a transverse shear and a vertical couple at the top of each pier/ bearing location.
4. Design Specifications
 - American Institute of Steel Construction, Inc. (AISC) 360-16
 - American Association of State Highway and Transportation Officials (AASHTO) Load and Resistance Factor (LRFD) Bridge Design Specifications, current Edition
 - AASHTO LRFD Guide Specifications for the Design of Pedestrian Bridges, current Edition
 - FDOT Plans Preparation Manual, current Edition
5. Construction Specifications
 - Current Edition and supplements thereto.

STATE OF FLORIDA
 DEPARTMENT OF TRANSPORTATION
 COUNTY: CR 250 JEFFERSON DISTRICT: 211684-1-52-03
 PROJECT: CR 250 OVER RUBY CREEK PEDESTRIAN BRIDGE
 SHEET NO. 266.4.1-52-03