

## 222 Pedestrian Facilities

### 222.1 General

This chapter provides the minimum criteria to be used for the design of pedestrian facilities on the State Highway System. The term “pedestrian” used in this chapter includes any person traveling on foot or in a wheelchair. Pedestrians should be expected on all of Florida’s state roadways except where restricted on Limited Access (LA) facilities.

Process a Design Variation when the design criteria for pedestrian facilities in this manual are not met. Reference the following conditions that support not providing a pedestrian facility in the Design Variation documentation:

- (1) The establishment of pedestrian facilities would be contrary to public safety.
- (2) The cost of providing pedestrian facilities would be excessively disproportionate to the need or probable use.
- (3) The presence of other available means for pedestrian traffic. Other available means should meet the following requirements:
  - (a) Meet the design criteria for pedestrian facilities on state roadways.
  - (b) Provide access to the same services, origination and destination sites, and transit connections as the project corridor.
  - (c) Not result in a significant increase in travel time or trip length, exposure to motorized traffic, or substantial elevation changes.
  - (d) Provide appropriate locations to cross limited access, arterial or collector roadways, or railroad corridors.

#### 222.1.1 Americans with Disabilities Act (ADA)

In addition to the criteria presented in the *FDM* and Department’s [Standard Plans](#), the following documents provide Americans with Disabilities Act (ADA) guidance in the design of pedestrian facilities in public R/W:

- ***United States Department of Justice 2010 Americans with Disabilities Act (ADA) Standards for Accessible Design***
- ***United States Department of Transportation 2006 ADA Standards for Transportation Facilities.***

- **Florida Accessibility Code** contains **ADA** requirements for accessibility to sites, facilities, buildings, and elements by individuals with disabilities.

## 222.2 Pedestrian Facilities

Pedestrian facilities are features or elements used to support pedestrian travel. Pedestrian facilities may include the following:

- Sidewalks
- Curb ramps and blended transitions
- Crosswalks
- At-grade railroad crossings
- Refuge islands
- Curb extensions
- Pedestrian signals
- Public transit loading zones
- Pedestrian bridges
- Shared use paths
- Street furniture

Pedestrian safety can be enhanced through the following measures:

- (1) Maintaining a smooth, clean walking surface, free of obstructions.
- (2) Responsive and appropriate traffic control devices, consistent with guidance in the [Manual on Uniform Traffic Control Devices \(MUTCD\)](#), including providing pedestrian-oriented directional signage.
- (3) Sidewalks and other pedestrian walkways are continuous, and termini connect to existing sidewalk, pedestrian crossing, or access point.
- (4) Providing adequate lighting.

### 222.2.1 Sidewalk

Sidewalk is a continuous concrete pedestrian walkway as depicted in [Standard Plans Index 522-001](#).

Provide sidewalk on all curbed roadways, except where prohibited by [Section 316.130 \(18\), Florida Statute \(F.S.\)](#). The inclusion of sidewalk on short isolated sections of curbed roadway is not required when:

- Within C1 and C2 context classification, and
- There are no pedestrian facilities leading to, or from the location.

Provide sidewalk on high speed curbed and flush shoulder roadways within C2T, C3C, C4, C5 or C6 context classification; and within C1, C2 or C3R where the demand for use is demonstrated.

For high speed curbed and flush shoulder roadways, place sidewalk in the following order of desirability:

- (1) As near the R/W line as possible.
- (2) Outside of the clear zone.
- (3) Five feet beyond the limits of the full width shoulder.
- (4) At the limits of the full width shoulder.

Sidewalk on flush shoulder roadways is not to be constructed directly adjacent to the roadway or shoulder pavement. Nearing intersections, the sidewalk should be transitioned as necessary to provide a more functional crossing location that also meets driver expectation. Further guidance on the placement of stop or yield lines and crosswalks is provided in the [MUTCD, Part 3](#) and [Standard Plans 711-001](#).

Continue sidewalk across bridge structures when sidewalk is provided on the approach roadway. Also provide sidewalk on new bridges where sidewalk or shared use path is not present along the roadway but may be included with a future project.

Sidewalk should be constructed on both sides of the roadway; however, if sidewalk is constructed on only one side, provide reasonable pedestrian access to destinations (e.g., transit stops, homes, places of work, stores, schools, post offices, libraries, parks) on the opposite side.

For RRR Projects, other than meeting detectable warning and curb ramp requirements, unaltered sidewalks that are not in compliance with **FDM** criteria, [Standard Plans](#), or ADA requirements are not required to be reconstructed.

See **FDM 127.2 (15)** for limitations on aesthetic applications on sidewalks.

### **222.2.1.1 Sidewalk Width**

The standard sidewalk width varies by context classification as shown in **Table 222.2.1**.

**Table 222.2.1 Standard Sidewalk Widths**

Context Classification		Sidewalk Width (feet)
C1	Natural	5
C2	Rural	5
C2T	Rural Town	6
C3	Suburban	6
C4	Urban General	6
C5	Urban Center	10
C6	Urban Core	12

**Notes:**

- (1) For C2T, C3 and C4, sidewalk width may be increased up to 8 feet when the demand is demonstrated.
- (2) For C5 and C6, when standard sidewalk width cannot be attained, provide the greatest attainable width possible, but not less than 6 feet.
- (3) For RRR projects, unaltered sidewalk with width 4 feet or greater may be retained within any context classification.
- (4) See **FDM 260.2.2** for sidewalk width requirements on bridges.

See **FDM 214** for information on sidewalks across driveways.

Provide the following minimum unobstructed sidewalk width (excluding the width of the curb) when there is no practical alternative to placing a pole within the sidewalk:

- 36 inches for aboveground utilities. This 36-inch width may be reduced to 32 inches, not exceeding 24 inches in length, when there is no practical alternative available to avoid an obstruction.
- 48 inches for signal, light, sign poles

When used for plantings and street furniture, the area between the back of curb and the sidewalk should be 5 feet or greater in width. Consider providing treewells in areas where on-street parking is provided.

Appropriate types of street furniture may vary based on frequency and density of pedestrian activity. Street furniture must allow for minimum sidewalk width and vertical clearance as required in this section and **FDM 222.2.1.2**.

Refer to **FDM 223.5** for information on bicycle parking amenities and **FDM 225** for information on public transit facilities as related to use of sidewalk space.

### **222.2.1.2 Vertical Clearance**

Provide a minimum 7-foot vertical clearance over the entire walking surface. See **FDM 260.6** for pedestrian bridge vertical clearance requirements.

### **222.2.1.3 Grades and Cross Slope**

When sidewalk is adjacent to the roadway (i.e., located back of curb or consistent separation from curb), sidewalk grades may mirror the roadway profile. When sidewalk is not adjacent to a traveled way, sidewalk grades are not to exceed 5%, unless accessible ramps are provided.

There should be enough sidewalk cross slope to allow for adequate drainage; however, to comply with ADA requirements, the maximum cross slope is 2%. A clear 1-foot wide graded area with a maximum 1:6 slope should be provided adjacent to the sidewalk. Edge drop-offs should be avoided. When drop-offs cannot be avoided and lie within 2 feet of the edge of sidewalk, they should be shielded as discussed in **FDM 222.4**.

## **222.2.2 Curb Ramps and Blended Transitions**

[Standard Plans](#), **Index 522-002** provides requirements and details for curb ramps and landings that are compliant with Americans with Disabilities Act Standards for Transportation Facilities.

A continuous accessible pedestrian route, including curb ramps and blended transitions (e.g., depressed corners, raised street crossings, flush roadway connections) are required along sidewalks and shared use paths. Provide curb ramps to be the same width as the sidewalk where practicable. Additional information, nomenclature, requirements, and details for curb ramps and landings are provided in the [Standard Plans](#), **Index 522-002**.

Alpha-identifications have been provided in Index 522-002 for the various curb ramp options (e.g., CR-A, CR-B, etc.) to facilitate ease of callouts in the Plans. Use the curb ramp options as follows:

- Curb Ramps CR-A, CR-B & CR-C are for use where ramp and landing depths are not restricted.
- Curb Ramps CR-D, CR-E, CR-F, CR-G and CR-H are for linear pedestrian traffic.
- Curb Ramps CR-K and CR-L are for use where ramp and landing depths are restricted.

Include sidewalk curb ramps at the following locations:

- All intersections and driveways with curbed returns. Include a landing at the top of each ramp.
- On curbed roadways between intersections where a crosswalk has been established.

Pull boxes, manholes (and other utility covers), and other types of existing surface features in the location of a proposed curb ramp or detectable warning should be relocated. When relocation is not feasible, adjust the feature to meet the ADA requirements for surfaces (including the provision of a nonslip top surface, and adjustment to be flush with and at the same slope as the adjacent surface).

Curb ramps should be in line with the crossing and must provide a maximum slope of 1:12 (8.3 percent). At intersections where more than one road is crossed, provide curb ramps at both ends of each crossing. Crossings are required to meet the same grade and cross slope requirements as sidewalks. Where criteria for maximum cross slope cannot be met, process a Design Variation and provide the minimum attainable cross slope. When following the profile grade of the roadway, curb ramp slopes should not exceed 15 feet in length.

Provide transition slopes (flared sides) where a pedestrian circulation path crosses the curb ramp. The maximum slope of transition slopes is 1:10, measured parallel with and adjacent to the curb line.

When altering an existing pedestrian facility and conditions preclude the construction of a curb ramp slope of 1:12, provide a slope from 1:12 to 1:10 with a maximum rise of 6 inches.

Provide a landing at all pedestrian pushbutton locations. The landing must provide a clear area of 30 inches by 48 inches directly in front of the pedestrian pushbutton to allow persons using a wheeled mobility device to actuate the button while remaining stationary. Horizontally center the 48-inch dimension on the pushbutton.

When compliance with Department curb ramp requirements is determined to be technically infeasible (i.e., no engineering solution is available), a Design Variation is required. This may occur where existing right of way is inadequate and where conflicts may occur with existing features which cannot be feasibly relocated or adjusted (e.g., drainage inlets, signal poles, pull and junction boxes, etc.).

### **222.2.2.1 Driveways**

See **FDM 214** for additional information on pedestrian accommodations at driveways.

New and reconstructed driveways are to be in compliance with [Standard Plans, Index 330-001 and 522-003](#).

For RRR Projects, unaltered driveways that are not in compliance with [Standard Plans](#) or ADA requirements are not required to be reconstructed.

### **222.2.3 Crosswalks**

Crosswalks are marked paths where pedestrians can safely cross a roadway. Marking of crosswalks helps drivers better identify the intersection and guides pedestrians to the best crossing location.

Use Special Emphasis crosswalk markings for all marked crosswalks except the following. Use standard crosswalk markings at marked stop-controlled intersection approaches.

Coordinate with the District Traffic Operations Office on proposed new marked crosswalks. For new and existing crosswalks, meet criteria and guidelines in [Traffic Engineering Manual \(TEM\), Section 5.2](#).

[TEM 5.2](#) also contains criteria and guidelines on additional treatments including signals, signing, pavement markings and other treatments at midblock and unsignalized intersections.

For crosswalk signing and pavement markings, see **FDM 230**, [MUTCD](#), and [Standard Plans, Index 711-001](#).

The maximum cross slope for crosswalks is 2%. For crosswalks located at signalized intersections, midblock, or driveways, cross slope may exceed 2% but not greater than 5%.

School Zone crosswalks have additional criteria for signing and pavement markings. For requirements for school signs and markings, see [The Manual on Speed Zoning for Highways, Roads and Streets in Florida, Chapter 15](#).

See **FDM 127.2 (15)** for limitations on aesthetic applications on crosswalks.

### 222.2.3.1 Intersections

Provide crosswalk markings for all legs of a signalized intersection unless there is a documented, project-specific justification not to do so (e.g., physical constraints, safety concern).

When separated right-turn lanes are used, place crosswalks so that an approaching motorist has a clear view of the pedestrian, and the crossing distance is minimized. See [TEM 2.44](#) for signing criteria.

Coordinate with the District Traffic Operations Office for new marked crosswalks at unsignalized intersection locations and meet the criteria and guidelines identified in [TEM 5.2](#).

*Commentary: Marked crosswalks at an uncontrolled location may be supplemented with other treatments such as beacons, signals, curb extensions, raised medians, raised traffic islands, and enhanced overhead lighting. See [TEM 5.2](#) for a complete and updated list of these types of treatments.*

Additional countermeasure treatments are recommended at locations where any of the following conditions exist:

- (1) Where posted speeds are greater than 35 mph,
- (2) On a roadway with 4 or more lanes without a raised median or raised traffic island that has an ADT of 12,000 or greater, or
- (3) On a roadway with 4 or more lanes with a raised median or raised traffic island that has or is projected to have (within 5 years) an ADT of 15,000 or greater.

As roadway volumes, speeds, and number of travel lanes increase, marked crosswalks are best used in conjunction with other countermeasure treatments.

For controlled intersections with six-lane divided roadways or crossing distances exceeding 80 feet, consider installing a two-stage pedestrian crossing with median refuge



island. See **FDM 210** for more information on Intersection Refuge Islands and Hardened Centerlines.

### **222.2.3.2 Midblock**

Midblock crosswalks are used to supplement pedestrian crossings in areas between intersections.

Provide illumination for both new and existing midblock crosswalks in accordance with **FDM 231**.

An engineering study is required for all new Midblock Crosswalks. Follow the procedure and guidelines identified in **TEM 5.2**.

Midblock crosswalks are not recommended at locations where any of the following exist:

- (1) The distance from the crosswalk to the nearest intersection (or crossing location) is less than 300 feet.
- (2) The crossing distance exceeds 60 feet (unless a median or a crossing island is provided).
- (3) The sight distance for both the pedestrian and motorist is not adequate.
- (4) The crosswalk cross slope (roadway profile) exceeds 5%.
- (5) The crosswalk grade (roadway cross slope) exceeds normal crown.

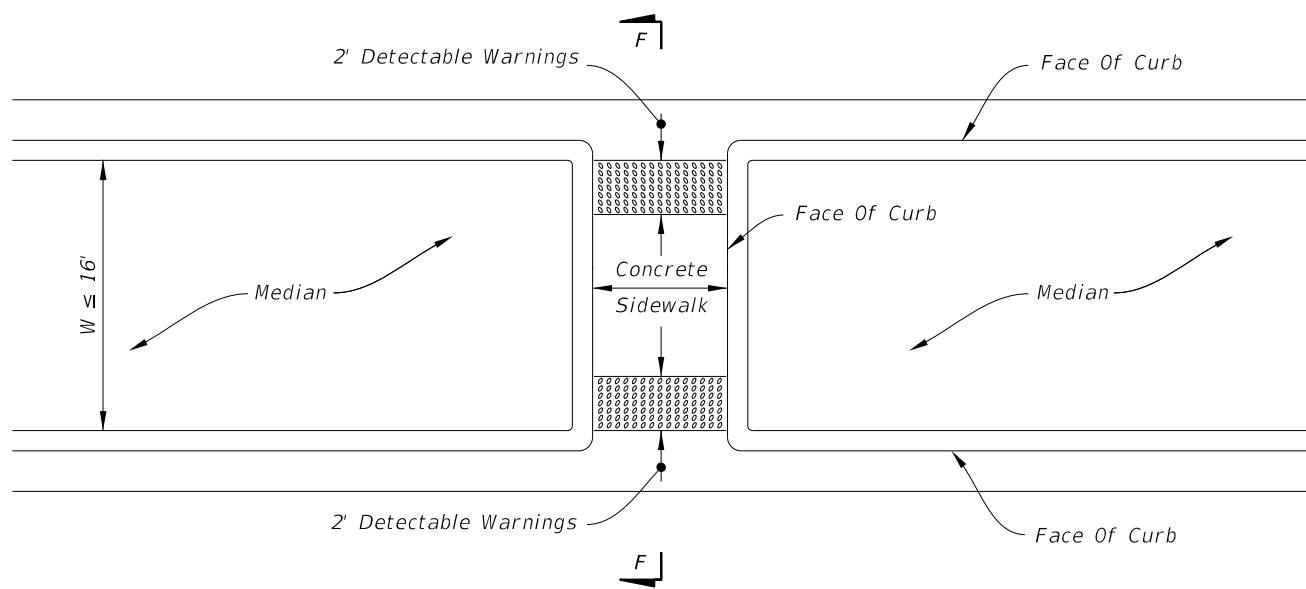
See **Figures 210.3.4** and **210.3.5** for examples of midblock crossings with refuge islands. Refer to **FDM 230.6** for information on pavement markings and midblock crossings.

If site conditions are identified that would obstruct the placement of a midblock crosswalk, include additional features in the design to remedy these conditions. Features like overhead signing can help alert motorists and be used to light the crossing. Curb extensions or bulb-outs can improve sight distance and decrease the crossing distance. Adjustment of the profile on the roadway crossing may be required to improve the cross slope of the crosswalk.

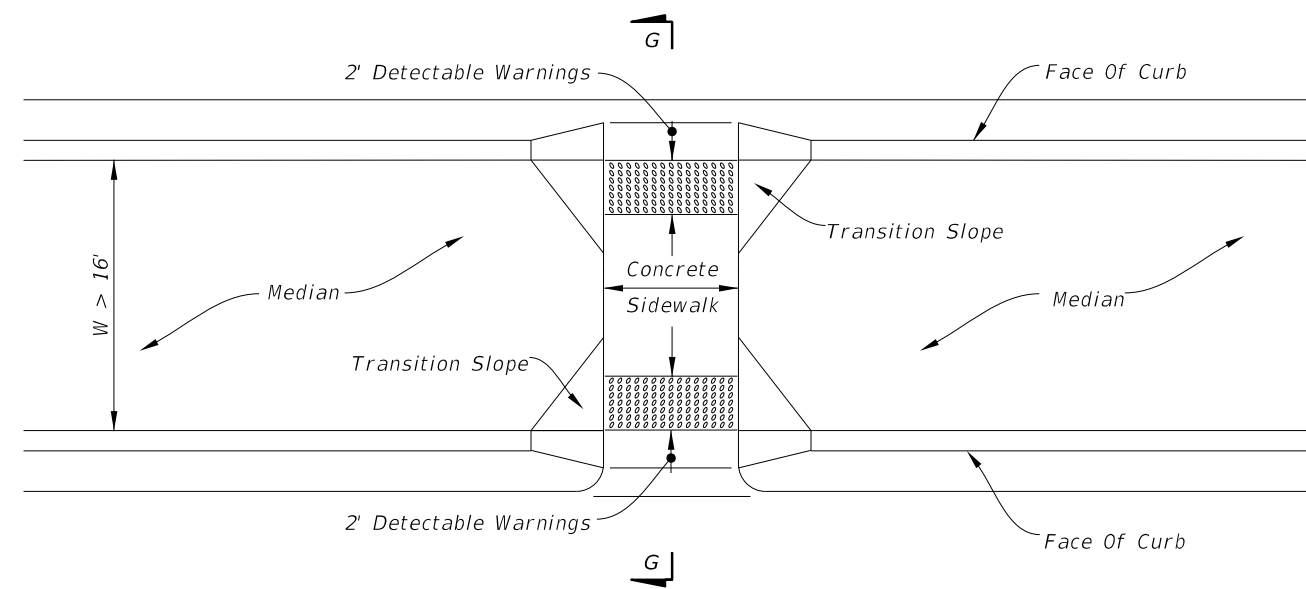
The sidewalk median crossing through a raised median will be either depressed or raised, depending on the median width between the backs of curbs ( $W$ ), as follows:

- (1) Depressed Sidewalk when  $W \leq 16$  feet
- (2) Raised Sidewalk when  $W > 16$  feet

See **Exhibit 222-1** for more information.

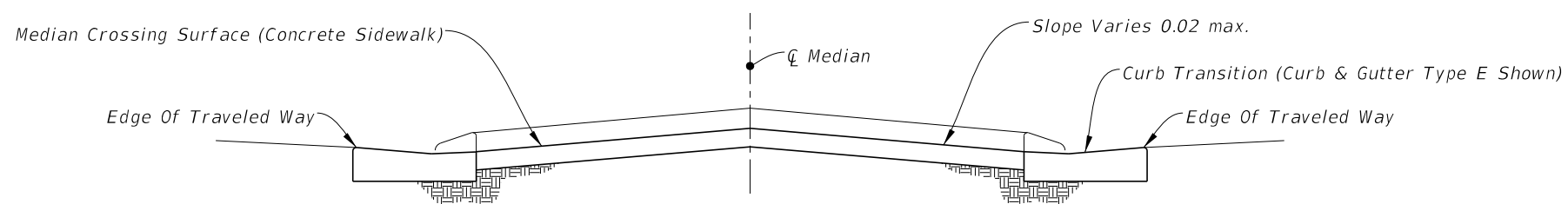


**DEPRESSED SIDEWALK**

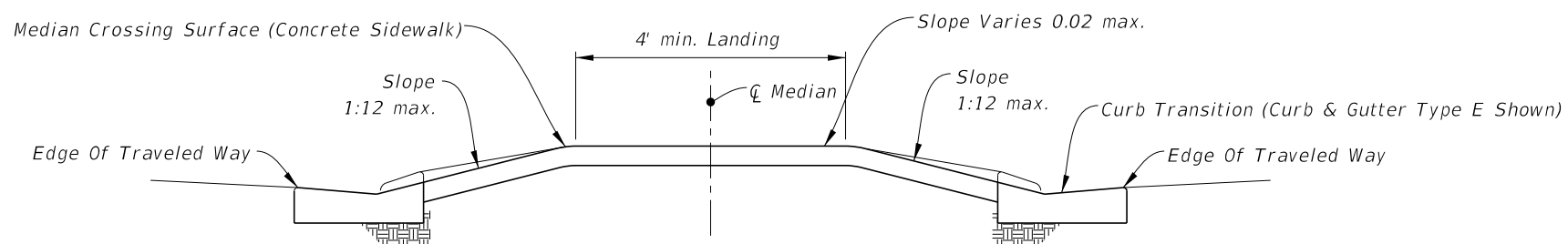


**RAISED SIDEWALK**

**MEDIAN CROSSINGS**



**SECTION F-F**



**SECTION G-G**

NOT TO SCALE

## 222.2.4 At-Grade Railroad Crossings

Provide an ADA accessible route for pedestrians at railroad crossings by extending proposed or existing sidewalks or shared use paths through the rail crossing. The surface of the crossing must be:

- Firm, stable and slip resistant,
- Level and flush with the top of rail at the outer edges of the rails, and
- Area between the rails aligns with the top of rail.

Place detectable warnings on each side of the railroad crossing as detailed in [Standard Plans](#), *Index 522-002*.

The edge of the detectable warning nearest the rail crossing is to be located between 6 and 15 feet from the centerline of the nearest rail. Where gates are provided, detectable warnings are to be placed a minimum of 4 feet from the side of the gates opposite the rail.

An audible device, such as a bell, is used in conjunction with the traffic control signals, if traffic control signals are in operation at a crossing that is used by pedestrians or bicyclists. Additional information is located in the [MUTCD](#) regarding additional signals, signs, or pedestrian gates and designing crossings for shared use paths.

Flangeway gaps are necessary to allow the passage of train wheel flanges; however, they pose a potential hazard to pedestrians who use wheelchairs because the gaps can entrap the wheelchair casters. A maximum flangeway gap is required for all at-grade pedestrian rail crossings of 2½" for all non-freight rail track and 3" for freight rail track.

## 222.2.5 Refuge Islands

See *FDM 210.3* for information on refuge islands.

## 222.2.6 Curb Extensions (Bulb-Outs)

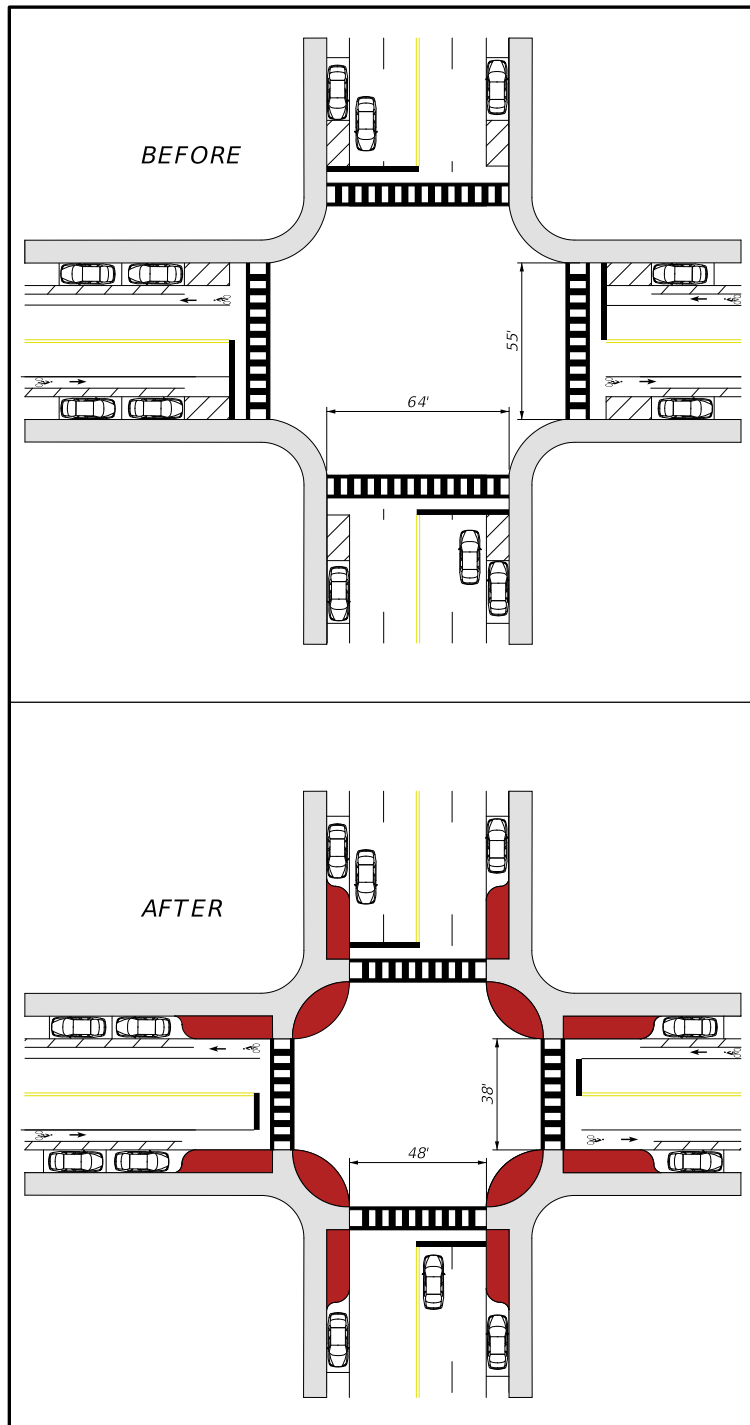
Consider the use of curb extensions (a.k.a., bulb-outs) in conjunction with on-street parking at intersections or midblock locations where there is a crosswalk, provided there is adequate width for existing traffic movements. Curb extensions shorten the crossing

distance, and provide additional space at intersections, allowing pedestrians to see and be seen before entering a crosswalk.

The design of curb extensions must take into consideration the needs of transit, emergency vehicles, commercial trucks, drainage, and bicyclists.

Consult with District drainage staff on drainage accommodations for the curb extension during Phase I of the design. See the ***Drainage Design Guide*** and ***Figure 222.2.1***.

**Figure 222.2.1 Curb Extension**



### **222.2.7 Pedestrian Signals**

See **FDM 232.6** for information on pedestrian signals. Pedestrian detector assemblies and pedestrian control signals are detailed in the [Standard Plans](#), **Indexes 653-001** and **665-001**

### **222.2.8 Public Transit Loading Zones**

See **FDM 225** for information on public transit facilities. Provide a minimum 5-foot-wide sidewalk connecting transit stops to sidewalk or shared use paths.

Coordination with the following may be required to determine the optimum location of boarding and alighting areas, transit shelters and bus bays:

- District Pedestrian and Bicycle Coordinator
- District Modal Development Office Coordinator
- District ADA Coordinator
- District Public Transportation staff
- Local public transit provider

### **222.2.9 Pedestrian Bridges**

See **FDM 266** for information on pedestrian bridges.

### **222.2.10 Shared Use Paths**

See **FDM 224** for information on shared use paths.

### **222.2.11 Street Furniture**

Street furniture may include benches, lighting fixtures, transit shelters, and bicycle parking. These items may be placed within the R/W under certain conditions. Ensure items do not obstruct sight distance or visibility of pedestrians at crosswalks. Do not use street furniture on curb extensions.

Refer to **FDM 223.5** for information on bicycle parking amenities, and **FDM 225** for information on public transit facilities. Appropriate types of street furniture may vary based on frequency and density of pedestrian activity. Street furniture must allow for minimum sidewalk width and meet lateral offset requirements identified in **FDM 222.2.1.1** and **222.2.1.2**.

### **222.3 Detectable Warnings**

Detectable warnings are a distinctive surface pattern of domes detectable by cane or underfoot that alert people with vision impairments of their approach to street crossings. Install detectable warnings to cover the full width of the walking surface and 2 feet deep. They are required on sidewalks at the following locations:

- Curb ramps and transition areas at street crossings
- Pedestrian refuge islands where there is one or more of the following:
  - Change in surface texture
  - Change in elevation (e.g., curb ramp)
  - Change in horizontal alignment of the path within the refuge island
  - Two-stage crossings
- Pedestrian at-grade railroad crossings
- Commercial driveways with a stop sign, yield sign, or traffic signal
- Boarding and alighting areas adjacent to the roadway at bus stops where there is an at-grade connection to the roadway
- Edges of railroad boarding platforms not protected by screens or guards

Detectable warnings should not be placed where sidewalk intersects urban flared driveways or on sidewalks that run continuously through residential driveways. Do not place detectable warnings on transition slopes or over grade breaks. Further guidance on detectable warnings is provided in [Standard Plans, Index 522-002](#).

### **222.4 Pedestrian Drop-off Hazards and Railings**

A pedestrian drop-off hazard is a steep or abrupt downward slope that can be hazardous to pedestrians.

There are two pedestrian drop-off hazard conditions defined in **Figure 222.4.1**. Additionally, depending on the height of a slope and the severity of the conditions beyond,

cases other than those shown in **Figure 222.4.1** may also be considered a pedestrian drop-off hazard.

When the pedestrian drop-off hazard cannot be eliminated, consider the following:

- (1) Fencing is typically used in C1 and C2 context classifications, and on shared use paths and trails.
- (2) Railing is typically used in C2T, C3, C4, C5, and C6 context classifications, and at locations attaching to bridge rail or along sidewalks.
  - (a) Pedestrian/Bicycle Railings ([Standard Plans](#), [Index 515-021](#) through [515-062](#)) are adequate for shielding all drop-offs but are generally intended for use on drop-offs greater than 60 inches.
  - (b) Pipe Guiderail ([Standard Plans](#), [Indexes 515-070](#) and [515-080](#)) is adequate for shielding drop-offs which are 60 inches or less.
  - (c) Along continuous sections where the drop-off varies above and below the 60-inch threshold, for uniformity the engineer may consider using only one of the railing types adequate for shielding all drop-offs.
  - (d) Pedestrian/Bicycle Railings and Pipe Guiderail are non-crashworthy and are not to be placed within:
    - i. Lateral offset requirement for curbed roadways, or
    - ii. Clear zone for high-speed curbed and flush-shoulder roadways.
- (3) Maintain driver's line of sight at intersections and driveways.

The standard height for Pedestrian/Bicycle Railing is 42 inches. Provide a 48-inch-tall Pedestrian/Bicycle Railing when all three of the following conditions exist:

- (1) Bicyclists are permitted to travel within 3 feet of the railing.
- (2) The path is on a downward grade steeper than 5%.
- (3) There is a horizontal curve having a radius less than that specified for the design speed of the bicycle facility. Taller railing should not extend more than 20 feet beyond the point of tangency of the horizontal curve.

Pedestrian railings are not required where W-beam guardrail is installed at the back of the sidewalk or shared use path.

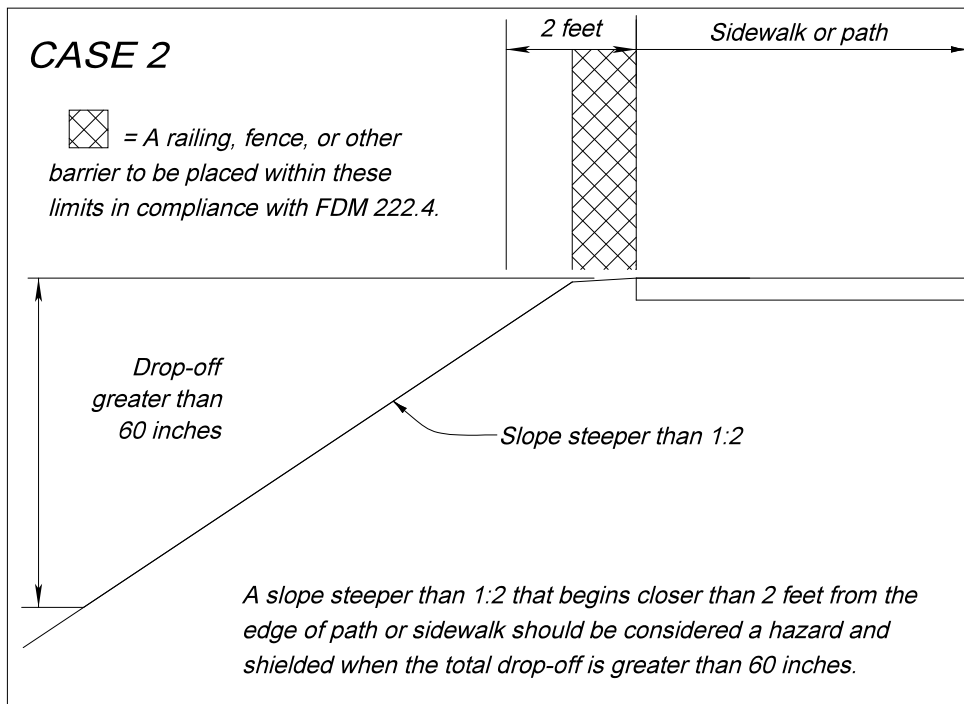
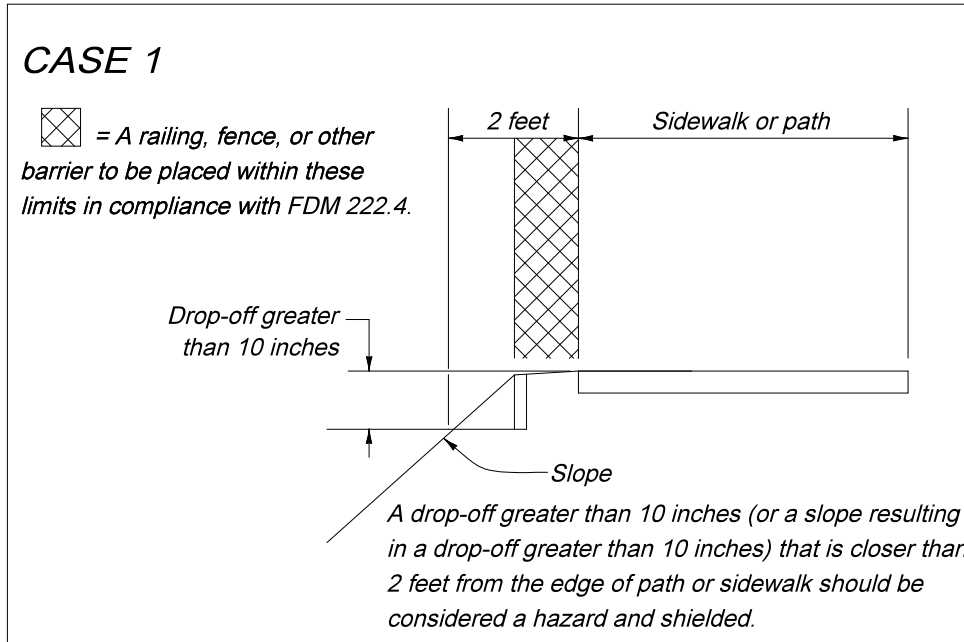
Pedestrian/Bicycle railings (42 inches in height) are not required where traffic railings separate the vehicular traffic from the pedestrian or bicycle facility.



Where Pedestrian/Bicycle Railing is used, the Department will cover the cost only for standard galvanized steel or standard aluminum railing. If the Local Agency desires a painted railing, they are required to provide the additional funding and commit to cover the maintenance cost.

The Department will cover the cost of the standard Infill Panel Types shown in the [Standard Plans](#). If the Local Agency desires a railing having Custom Infill Panels which increases the cost over standard infill panels, they are required to provide the additional funding to cover this initial premium cost. In addition, a maintenance agreement will be needed to address the responsibilities associated with maintaining Custom Infill Panels.

**Figure 222.4.1 Drop-Off Hazards for Pedestrians**

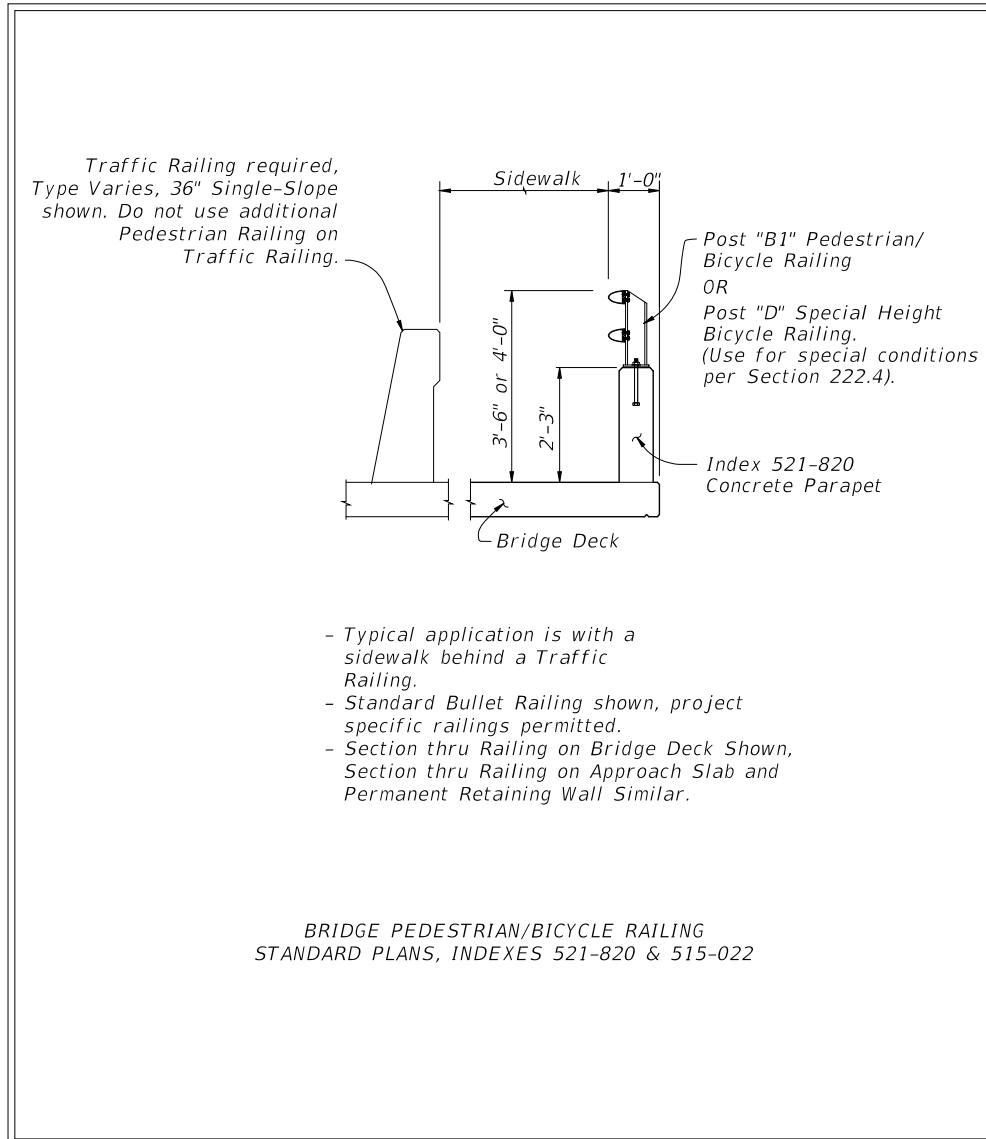


## **222.4.1 Bridge Pedestrian Railings and Fences**

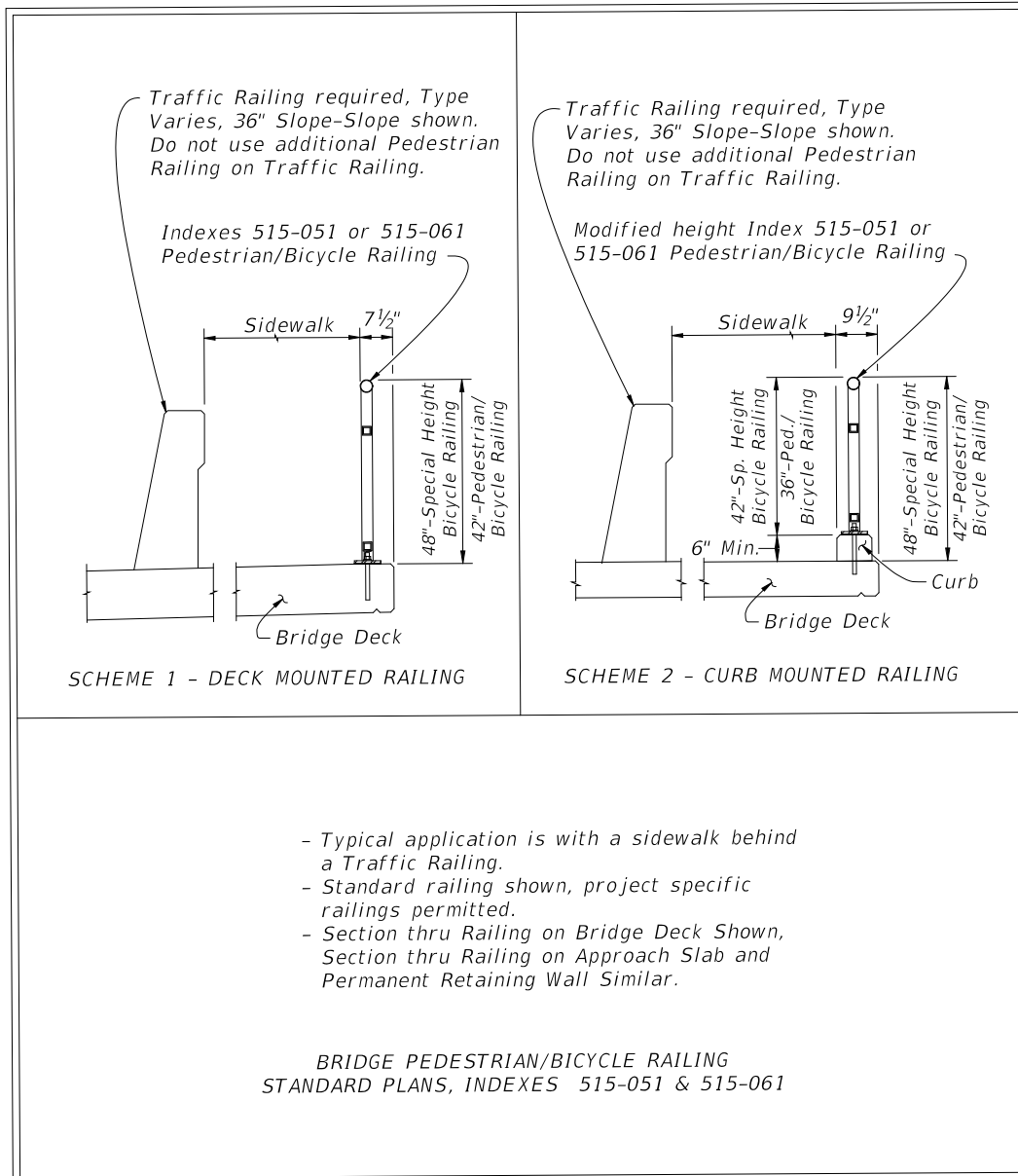
Details and typical applications of various crashworthy pedestrian/bicycle bridge railings and fencing are provided in **Figures 222.4.2 – 222.4.8**. The installation of fencing on traffic railing between sidewalk or shared use paths and travel lanes on LA facilities must be approved by the State Structures Design Engineer.

The Engineer should work with the District to determine when an enclosed fencing option is warranted.

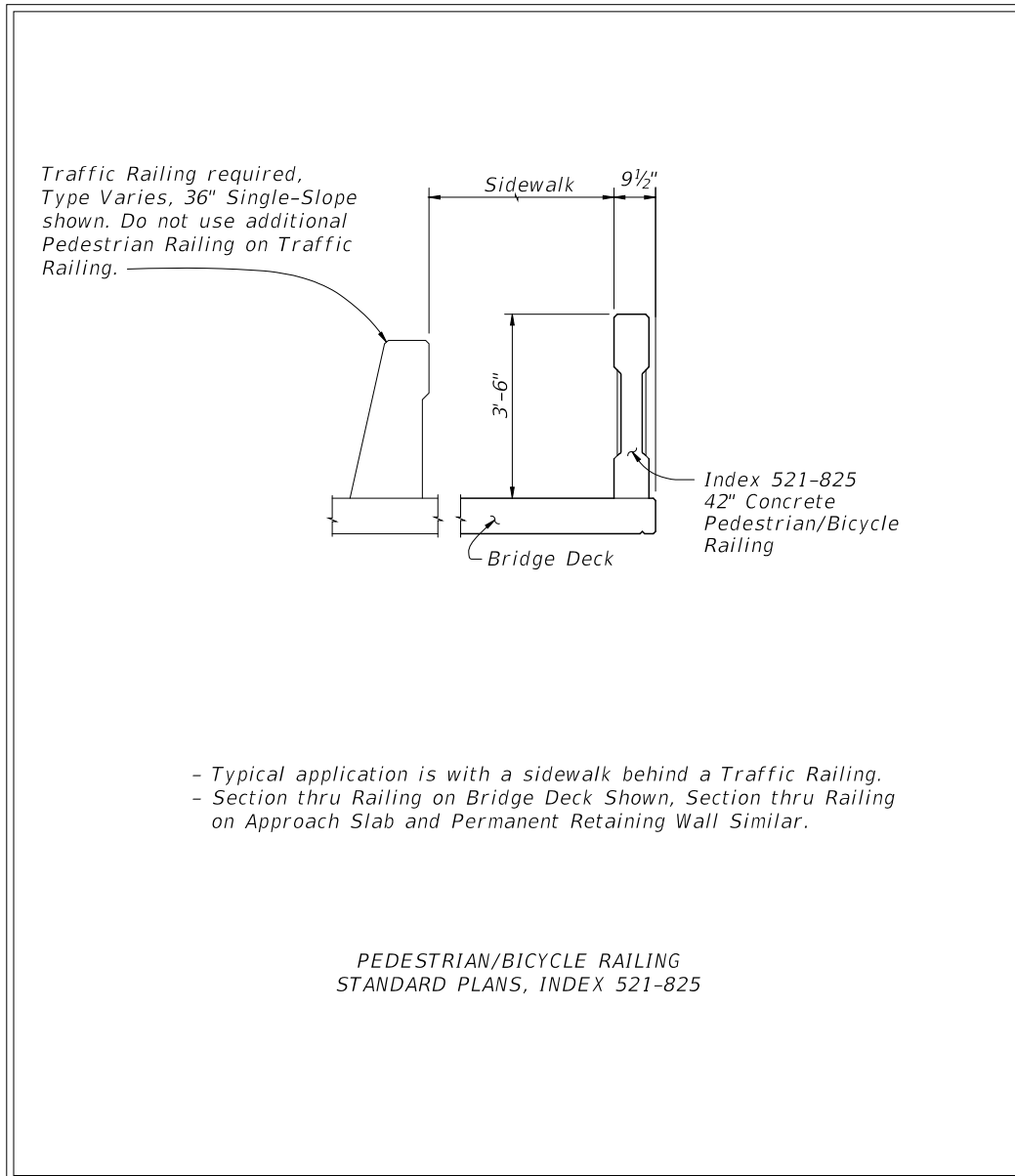
**Figure 222.4.2 Bridge Railing – Pedestrian/Bicycle Railing**



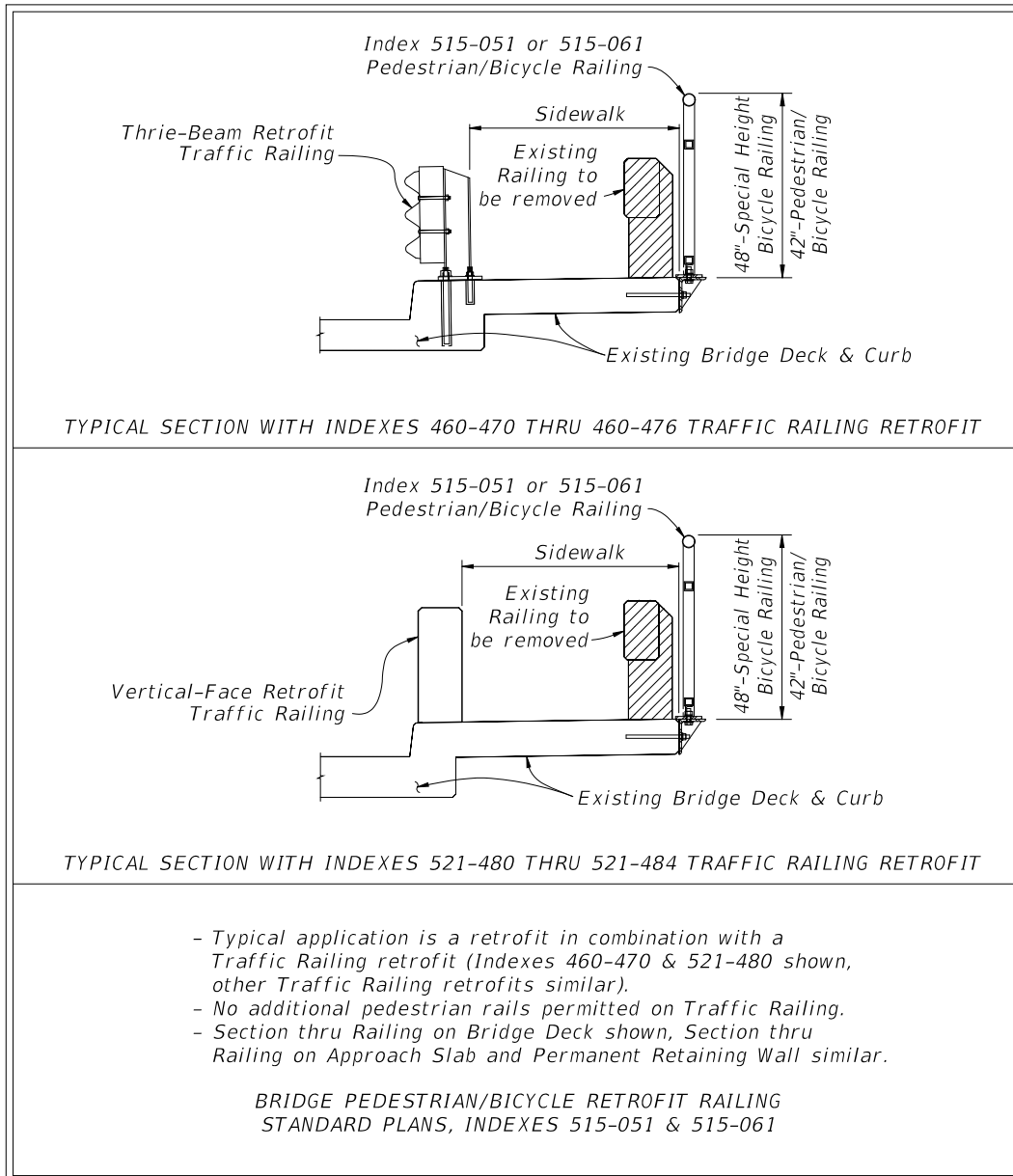
**Figure 222.4.3 Bridge Railing – Pedestrian/Bicycle Railing**



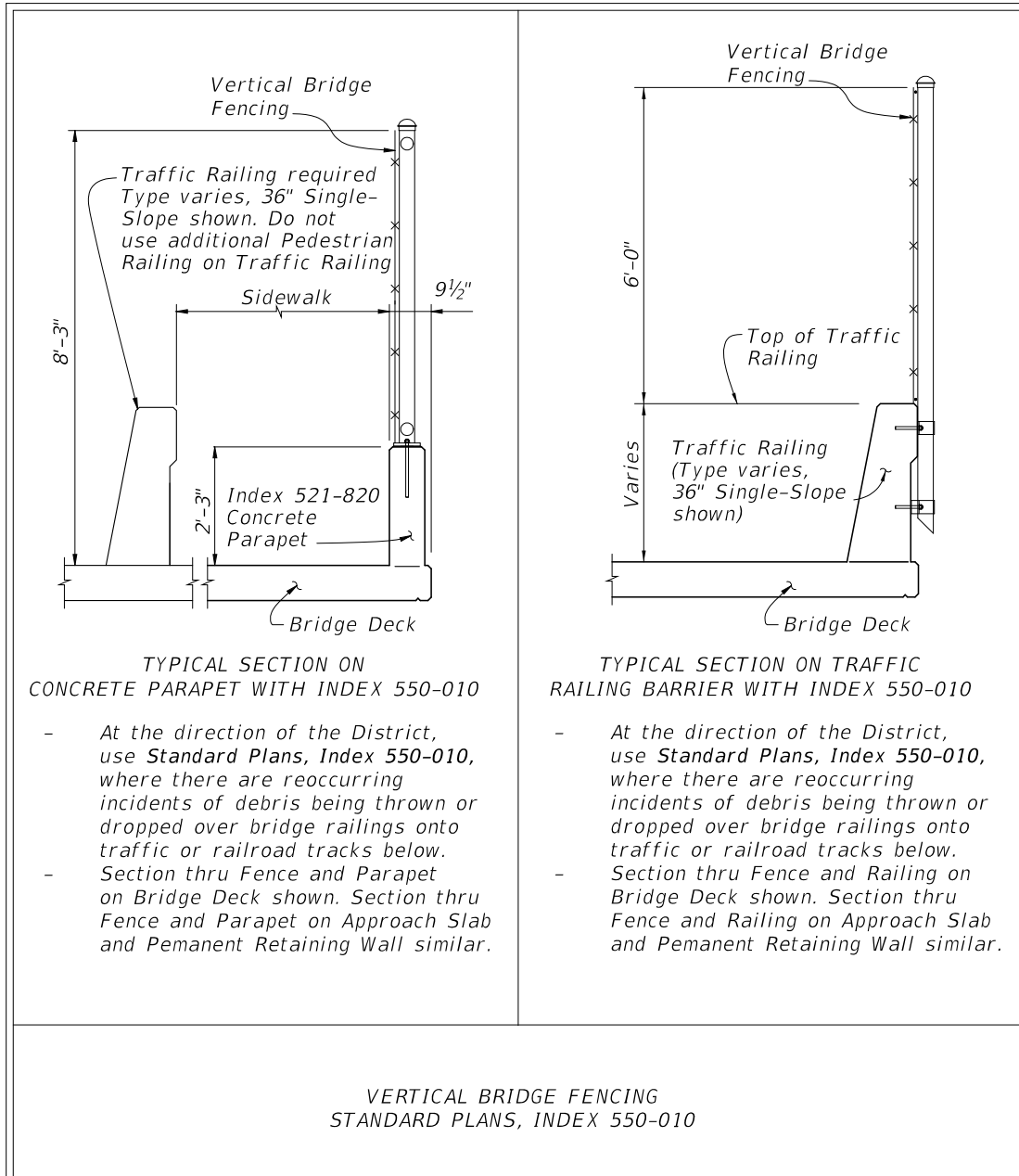
**Figure 222.4.4 Bridge Railing – Pedestrian/Bicycle Railing**



**Figure 222.4.5 Bridge Railing and Pedestrian/Bicycle Railing Retrofit**

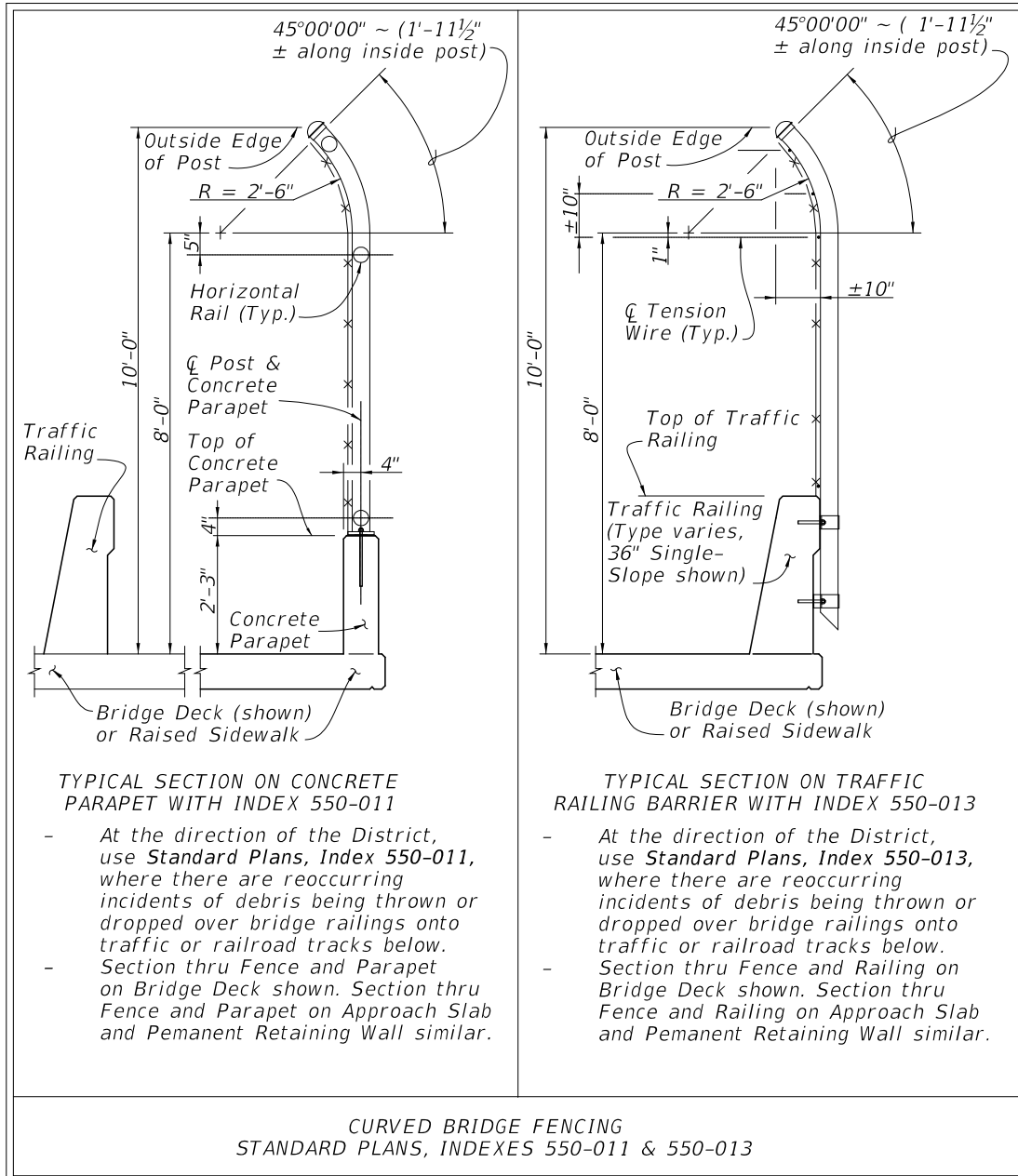


**Figure 222.4.6 Bridge Railing and Bridge Parapet Fencing**

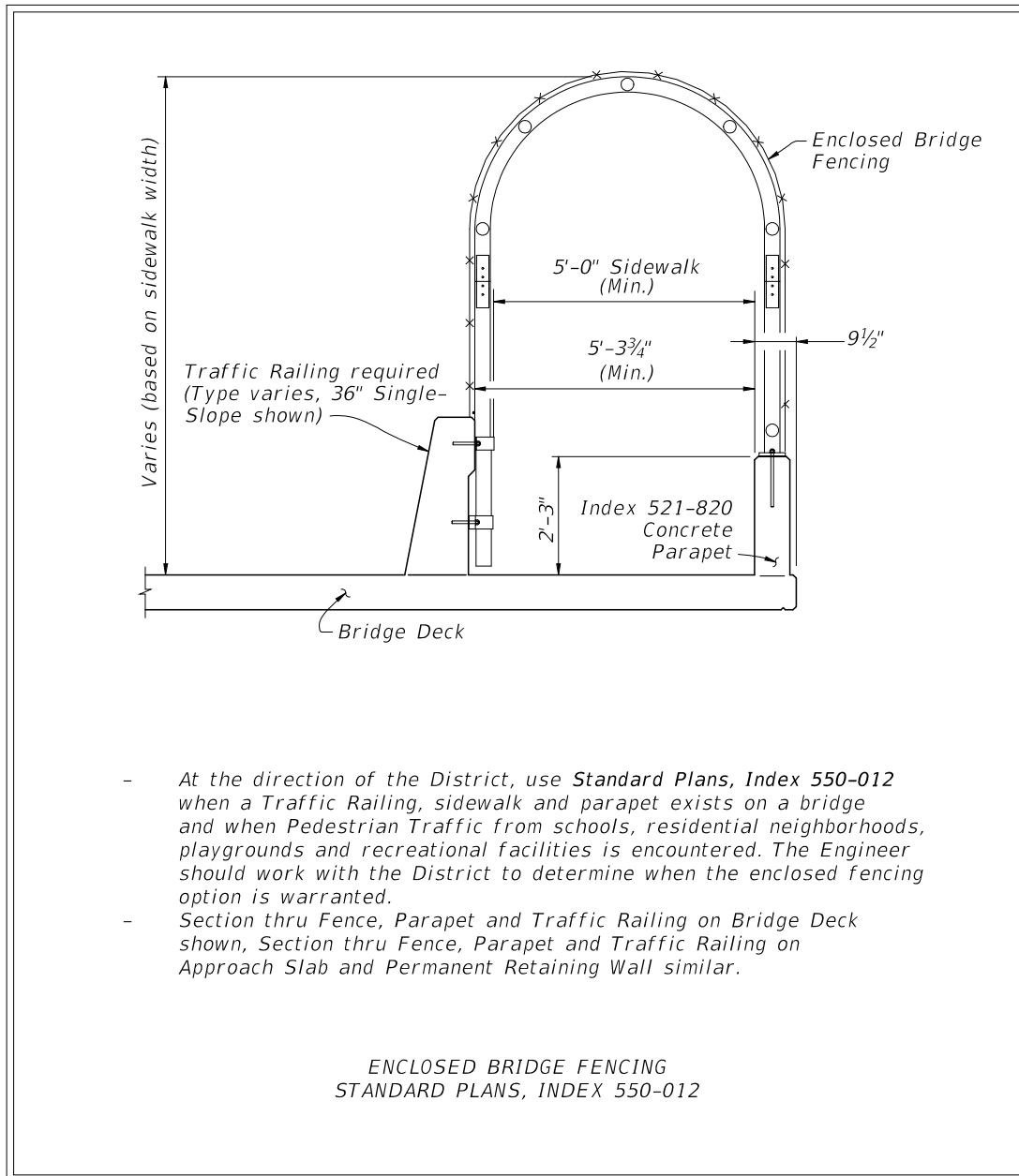




**Figure 222.4.7 Curved Bridge Fencing**



**Figure 222.4.8 Bridge Railing – Enclosed Fencing**



## 222.4.2 Pedestrian Railings on RRR Projects

For RRR projects, existing pedestrian railings and pipe guiderail should be removed that are within:

- Required lateral offset for curbed roadways, or
- Inside clear zone for high speed curbed and flush shoulder roadways

If there was a documented issue of traffic incidents involving pedestrians prior to the installation of the existing pedestrian railing or pipe guiderail that would likely reoccur, implement one of the following treatments, in order of priority:

- (1) Eliminate the hazard and remove the pedestrian railings and pipe guiderail, or
- (2) Allow the railing to remain.

## 222.5 Movable Bridge Pedestrian Gates

Refer to **Structures Design Guidelines (SDG)**, Chapter 8 for movable bridge pedestrian safety design requirements.