



2023 FDOT Design Manual
100 Series: Development and Processes

100 Introduction

FDOT Design Manual

PURPOSE:

This *Florida Department of Transportation (FDOT) Design Manual (FDM)* sets forth geometric and other design criteria, as well as procedures, for all new construction, reconstruction, and resurfacing projects on the State Highway System and the National Highway System. The information contained herein applies to the preparation of contract plans for roadways and structures.

AUTHORITY:

Sections 20.23(3)(a) and 334.048(3), Florida Statutes.

SCOPE:

This procedure impacts anyone preparing roadway and structures construction plans for the Department.

PROCEDURE:

The criteria in this manual represent requirements for the State Highway System which must be met for the design of FDOT projects unless approved Design Exceptions or Design Variations are obtained in accordance with procedures outlined in this manual.

Roadway and structures design is primarily a matter of sound application of acceptable engineering criteria and standards. While the criteria contained in this manual provide a basis for uniform design practice for typical roadway design situations, precise standards which would apply to individual situations must rely on good engineering practice and analyses.

Special requirements for Non-Conventional Projects, e.g., Design-Build Projects and all Non-Design-Bid-Build Public-Private-Partnership Projects, may be shown in a "Modification for Non-Conventional Projects" box as shown in the following example:

Modification for Non-Conventional Projects:

Delete the last three paragraphs above and see the RFP:

These boxes are located at the beginning of the chapter or after a section, paragraph or table which is to be modified. The requirements listed within these boxes are only applicable to Non-Conventional Projects.

The Author of a Request for Proposal (RFP) for a Non-Conventional project must use the standard boilerplate language as a starting point in developing RFPs on all Department Design-Build projects. **Section V** of the **Design-Build Boilerplate** establishes Department, FHWA and AASHTO criteria, procedures, guidelines, and design codes that serve as design constraints to be used in the performance of the work. The governing regulations list in **Section V** cannot be modified without the approval of the State Construction Office. The standard boilerplate language is available at the FDOT Construction Office website:

<https://www.fdot.gov/construction/DesignBuild/DBDocuments/DBDocsMain.shtm>

Pre-scoping questions have been developed to aid in the establishment of project constraints and requirements to be included in the RFP. The Pre-scoping questions can be found at:

<https://www.fdot.gov/construction/DesignBuild/DBRules/DBRulesMain.shtm>

Situations will exist where these criteria will not apply. The inappropriate use of and adherence to these criteria does not exempt the engineer from the professional responsibility of developing an appropriate design. The engineer is responsible for identifying those criteria which may not apply to a particular design, and for obtaining the necessary Design Exception or Design Variation to achieve proper design.

1. ORGANIZATION

The **FDM** is a three-part manual. **Part 1** contains development and processes, **Part 2** contains design criteria, and **Part 9** contains material concerning the preparation and assembly of model-centric plans. Parts 3 through 8 are reserved for future use.

2. DISTRIBUTION

This document is available electronically on the FDM web page:

<https://www.fdot.gov/roadway/fdm/>

FDM users can register to receive notification of updates and **Roadway Design Bulletins** online through the Department's Contact Management Database at:

<https://fdotewp1.dot.state.fl.us/ContactManagement/Utilities/login.aspx>

For information on updates and **Roadway Design Bulletins**, contact:

Roadway Design Office, Mail Station 32

Telephone (850) 414-4310

FAX Number (850) 414-5261

<https://www.fdot.gov/roadway/>

3. REVISIONS AND UPDATES

FDM users are encouraged to submit comments and suggestions for changes to the manual to the State Roadway Design Office. When ideas or suggestions are received, they will be reviewed by appropriate Roadway or Structures Design staff in a timely manner and will be coordinated with other offices affected by the proposed change. Items warranting immediate change will be made with the approval of the State Roadway Design Engineer and/or State Structures Design Engineer in the form of a **Design Bulletin**.

Roadway Design Bulletins are numbered based on the two-digit calendar year and bulletin number (YY- ##). Notices are sent to all users who are registered to receive notifications for **Roadway Design Bulletins** and updates to the **FDM**. Design Bulletins affecting the **FDM** will remain effective until either:

1. An official manual revision is published; or
2. The **Design Bulletin** is made void.

Roadway Design Bulletins are posted online at:

<https://www.fdot.gov/roadway/bulletin/>

Structures design issues, which are subject to modification and revision, will be processed in coordination with the State Structures Design Office. See the **Structures Manual** for more information on this process.

Proposed revisions are distributed in draft form to each District's Roadway Design Engineer or Structures Design Engineer. These experienced engineers provide the necessary technical and practical input on how the revision will potentially affect their District's operations and customers. Periodically, these engineers meet collectively with the State Roadway Design Office or the State Structures Design Office to discuss comments on the proposed revisions. Proposed revisions with comments are then presented to the District Design Engineers (DDE) for review and comment. Once the comments are addressed, the Florida FHWA Division Office is given the opportunity to review the revisions as per the Department's Stewardship Agreement with FHWA.

The State Roadway Design Office will also coordinate proposed revisions or additions with affected offices within the Central Office. Substantive revisions that result in policy change may be coordinated with the Executive Committee for adoption.

Revisions and updates are adopted or rejected by the State Roadway Design Engineer (for Roadway Design issues) or the State Structures Design Engineer (for Structures Design issues). Requirements mandated by FHWA or State Rules will be coordinated with the DDEs and affected offices within the Central Office and are considered compulsory.

Notification of the adopted revisions and addenda will be distributed to registered users of the manual through the Department's Contact Management Database.

4. DEVELOPMENTAL DESIGN CRITERIA

Developmental Design Criteria (DDC) provides a process for the Department to develop future **FDM** criteria for new or innovative design concepts and technologies.

A Design Memorandum will be released to notify the Districts of the initial availability of each **DDC**.

The **DDC** is published separately from the **FDM**; however, they will be listed with hyperlinks to the **DDC** on the **FDM** webpage along with the **FDM** chapters.

A Central Office Monitor (Monitor) is assigned to each **DDC**. The Monitor oversees the development of the criteria, monitors the use of the **DDC** on projects, and makes revisions and updates as needed.

The **DDC** must be used to the extent practicable on projects containing the applicable design elements; however, must not adversely affect the production schedule. Determination of applicability versus project schedule is at the discretion of the District Design Engineer. Include the Monitor as a lead reviewer in the Electronic Review Comments (ERC) system when the **DDC** is used.

The Department's Design Variation process is not applicable to **DDC**. When requesting deviations from **DDC**, designers must contact the assigned Monitor to obtain written approval. Written approvals for deviations will be used by the Monitor to further develop **DDC** language. Designers are not required to submit written documentation when requesting deviations. The sole purpose of this process is to aid the Monitor in understanding the challenges faced by designers in following the **DDC**.

Revisions to **DDC** may be made by the Department at any time and the last revision date will be noted within each chapter. Revisions to **DDC** are not retroactive for projects where the design effort for applicable design elements is substantially complete as determined by the District Design Engineer.

Modification for Non-Conventional Projects:

Delete item 4 above and see the RFP.

TRAINING:

None required.

FORMS:

All forms related to this manual are found in ***FDM 103***.

102 Glossary of Terms

102.1 General

The following definitions used in the FDOT Design Manual (FDM) are assigned for consistency of understanding and interpretation of the processes and criteria contained within. These definitions may not be consistent with AASHTO, MUTCD, NCHRP, or other documents referenced in this manual. When definition of terms conflict with other FDOT manuals, use the definitions provided in this chapter.

102.2 FDM Definitions

Access Classification

A classification of a roadway that determines the standards to apply to the design of medians, median openings, connections, and signal spacing. See **FDM 201** for additional information.

AADT

Annual Average Daily Traffic (AADT) is the total volume of vehicle traffic of a roadway for a year divided by 365 days.

Area Designation (Rural, Urban, Urbanized)

Rural: Places outside the boundaries of concentrated populations that accommodate higher speeds, longer trip lengths and freedom of movement, and are relatively free of street and highway networks.

Urban: A geographic region comprising as a minimum the area inside the United States Bureau of the Census boundary of an urban place with a population of 5,000 or more persons, expanded to include adjacent developed areas as provided for by Federal Highway Administration (FHWA) regulations. The FHWA Urban Boundary maps are available online at:

<https://www.fdot.gov/roadway/BufferMaps/Default.shtm>

Urbanized: A geographic region comprising as a minimum the area inside an urban place of 50,000 or more persons, as designated by the United States Bureau of the Census, expanded to include adjacent developed areas as provided for by Federal Highway Administration regulations. Urban areas with a population of fewer than 50,000 persons which are located within the expanded boundary of an urbanized area are not separately recognized.

As-Built Plans

The Contract Plans after construction is completed, all revisions including those occurring during construction, have been included and with the title on the key sheet changed to Final Plans.

Blended Transitions

Blended transitions are areas where the elevation of a roadway and a sidewalk, or shared use path, are the same along the width of a pedestrian crossing. Blended transitions can vary in geometrics. For flush shoulder roadways, blended transitions are the portion of the sidewalk, or shared use path, that meets the traveled way, bicycle lane, or paved shoulder. For curbed roadways, blended transitions are elevation transitions of the roadway such as a raised crosswalk, raised intersection, or depressed corner. Detectable warnings must be placed in the same locations as that of a curb ramp.

Bicycle Way

Any road, path, or way which by law is open to bicycle travel, regardless of whether such facilities are signed and marked for the preferential use by bicyclists or are to be shared with other transportation modes. Examples include bicycle lanes, paved shoulders, shared use paths, and traffic lanes.

C-D Road

Collector-Distributor Roads are limited access roadways provided within a single interchange, or continuously through two or more interchanges on a freeway segment. They provide access to and from the freeway and reduce and control the number of ingress and egress points on the through freeway. They are similar to continuous frontage roads except that access to abutting property is not permitted.

Context Classification

Description of the land use and transportation context where a roadway is found. Roadways are designed to match the characteristics and demands defined by the appropriate Context Classification criteria. See **FDM 200** for additional information.

Control Vehicle

An infrequent vehicle allowed to encroach into adjacent lanes, curbs, and sidewalks of intersections or driveways when making turning movements. Geometric design of intersections and driveways are based on the design vehicle.

Conventional Project

Projects for which the preparation of the contract documents is a 'stand-alone' effort resulting in Plans, Specifications and Estimates (PS&E) package that is advertised for a Construction Contract. These projects are often referred to as "design-bid-build" projects.

Crash Analyses

Summaries, crash rates, or other formatted reports that are developed using crash data.

Crash Data

Crash data at FDOT is the Florida Traffic Crash Report (FTCR) data received from the Florida Department of Highway Safety and Motor Vehicles (FLHSMV) with additional information from FDOT, such as location coordinates and coding for first point of impact position on the roadway.

Commentary: The State Safety Office (SSO) completes fatal and serious injury (KA) crash location review within days of receipt of the information, and the data is immediately available for use. All available data in the Crash Analysis Reporting (CAR) system within the recommended review period should be incorporated into a project's analysis.

The FDOT SSO adds information during the crash location processing and the crash data is updated continuously as data is received. This includes verified data and completed data sets.

Verified data refers to crash data that has been processed and reviewed by the FDOT staff in the SSO. Data that have been verified is tied to location coordinates on the public roadways and can be reported from the CAR system, the SSOGis Query Tool, or other FDOT crash data portals. Preliminary data for all crashes is available in the SIGNAL FOUR ANALYTICS (SFA) data base. This SFA data should be used to supplement crash analyses and is available in coordination with the District Safety Office.

A completed data set, which may also be called "finalized" data, at FDOT refers to the completion of the location processing and review for a specific calendar year of crash data. The SSO completes the review of crashes on the State Highway System (SHS) for a given year and follows that completion by running the annual crash rate analyses in the CAR system. These annual steps produce the Average Crash Rates and the High Crash listings.

All available data in the CAR system should be incorporated into a project's analysis.

Crash Reports or Crash Report Documents:

Original Florida Traffic Crash Report (FTCR) form documents in .TIFF or .PDF format as received from FLHSMV. These are the documents filed by law enforcement when reporting crashes.

Design Speed

A principal design control that regulates the selection of many of the project standards and criteria used for design. There are three categories of Design Speed:

High Speed: Design Speeds 50 mph and greater.

Low Speed: Design Speeds of 45 mph and less.

Very Low Speed: Design Speeds 35 mph and less.

Design Vehicle

Vehicles with representative weight, dimensions, and operating characteristics used to establish highway design controls for accommodating vehicles of designated classes. The design vehicle is the largest frequent user of a given roadway; see **FDM 201.6**.

Functional Classification

The grouping of streets and highways into classes, or systems, according to the character of service they are intended to provide.

Arterial: Divided or undivided roadways that provide continuous routes which serve through traffic, high-traffic volumes, and long average trip lengths. Arterials include expressways without full control of access, US numbered highways and principal state roads that connect cities and towns. Arterials are further classified by context.

Collector: Divided or undivided roadway which serves to link arterials with local roads or major traffic generators. They serve as transition link between mobility needs and land use needs. Collectors may include minor state roads, major county roads, and major urban and suburban streets. Collectors on the SHS are further classified by context.

Freeway: The terms Freeway, Interstate, Toll Road, and Expressway are often used synonymously when establishing criteria within this manual. A Freeway is a divided highway that provides full control of access (i.e., Limited Access) and is intended for long distance trips. Interstate is a federally-funded network of freeways that must meet national design criteria and operational standards. Toll Road is a general term for any road that requires the user to pay to use all or a portion of the road. Expressways are freeways situated in major metropolitan areas with primary service for commuters; and may or may not be tolled. Movement of traffic, free of interference and conflicts, is of primary importance for these types of facilities. Essential elements include medians, grade separations, interchanges, and, in some cases, collector-distributor roads and frontage roads. Freeways may be further classified as rural, urban, or urbanized.

Grade Separation

A crossing of two roadways, or a roadway with a railroad or pedestrian pathway, at different levels.

Highway

A highway is a high-speed roadway (divided or undivided) intended for travel between destinations like cities and towns.

Intersection

Intersection types can be categorized by intersection basic type, functional classification, control type, area type, or a combination of these classifiers, depending on the element of design.

Lanes

Auxiliary Lane: The designated widths of roadway pavement marked to separate speed change, turning, passing, and weaving maneuvers from through traffic. They may also provide short capacity segments.

Bicycle Lane: A bicycle lane (bike lane) is a portion of a curbed roadway which has been designated by striping and special pavement markings for use by bicyclists.

Express Lane: An express lane is a type of managed travel lane physically separated from general use lanes, or general toll lanes, within a roadway corridor. Express lanes use dynamic pricing through electronic tolling in which toll amounts are set based on traffic conditions.

General Use Lane: Any untolled traffic lane that is not set aside for a specific purpose such as Express lanes.

HOV Lane: Special designated travel lanes reserved for high occupancy vehicles (HOV); e.g. buses and carpool vehicles. They may be adjacent to general use lanes or separated.

Travel Lane: A travel lane is the designated portion of a roadway intended to carry motorized through traffic. Generally, travel lanes equate to the basic number of lanes for a facility; e.g. 4-lane divided highway has 4 travel lanes.

Traffic Lane: The term traffic lane may be used synonymously with traveled way in this manual. See definition for traveled way.

Local Agency Funding Agreement (LFA)

An agreement used when Local Agencies provide funds to the Department for a specific project, often that are not on the State Highway System. The conveyance of funds and work to be accomplished are documented with a signed Local Agency Funding Agreement. The Agreement typically includes provisions for additional funding for contingency. These Agreements must be coordinated through the Comptroller's office and is covered by procedure locally funded agreements (non-PTO) – financial provisions and processing (**Topic Number: 350-020-300-n**).

Local Road

Roadways which provide high access to abutting property, low average traffic volumes, and short average trip lengths. Local roads may include minor county roads, minor urban and suburban subdivision streets, and graded or unimproved roads.

Low Volume and High Volume

Certain operating characteristics and driver expectancy on highways. Standards for these controls are based on area type and are given in **Table 102.1.1**.

Table 102.1.1 AADT Thresholds for Low and High-Volume Roadways

Facility	Urban		Rural	
	Low Volume AADT	High Volume AADT	Low Volume AADT	High Volume AADT
Freeway				
4-Lane Facility	57,000	69,000	46,000	56,000
6-Lane Facility	86,000	103,000	69,000	83,000
8-Lane Facility	114,000	138,000	92,000	111,000
Arterial				
2-Lane Facility	16,000	20,000	9,000	14,000
4-Lane Facility	37,000	43,000	38,000	47,000
6-Lane Facility	55,000	64,000	58,000	71,000
8-Lane Facility	69,000	80,000	--	--
Collector				
2-Lane Facility	11,000	16,000	8,000	13,000
4-Lane Facility	37,000	45,000	30,000	38,000
<p>LOW VOLUME ROADWAYS: Design Year AADT is \leq low volume AADTs shown. HIGH VOLUME ROADWAYS: Design Year AADT is \geq high volume AADTs shown.</p>				

Maintenance Agreement

An agreement with a Local Agency for the maintenance responsibilities of a federally funded project. This agreement is required for construction projects let by FDOT for work not on the State Highway System and must be obtained prior to the authorization for construction of the project.

Match Existing

This term is used when the construction of a proposed element (e.g., roadway, sidewalk, striping) may need to be adjusted at the termini to harmonize with the existing element to which it is connected. For Resurfacing Projects, this term is used when the existing pavement cross slopes are not intentionally modified or changed (i.e., applicable to constant depth milling and resurfacing).

Paratransit

Comparable transportation service required by the American with Disabilities Act (ADA) for individuals with disabilities who are unable to use fixed route transportation systems. The specific requirements and parameters for this service, including eligibility and service requirements, are contained in 49 CFR Part 37, Subpart F.

Pedestrian Access Route

A continuous and unobstructed path of travel provided for individuals with disabilities within or coinciding with a pedestrian way.

Pedestrian Way

A space for pedestrian travel separated from traffic lanes. Sidewalks, shared use paths, footpaths and shoulders are pedestrian ways; however, footpaths and shoulders are not Pedestrian Access Routes, since they lack specific improvements or provisions to accommodate persons using mobility aids.

Projects of Division Interest (PoDI)

PoDIs are projects that have an elevated risk, contain elements of higher risk, or present a meaningful opportunity for FHWA involvement to enhance meeting program or project objectives. Project selection is risk-based. Stewardship and oversight activities will be directed toward addressing identified risks. This may include retaining certain project approvals, where permissible, or directing stewardship or oversight activities to a specific phrase or element of the project. Additional information is included in ***FDM 128***.

Production Date

The committed completion date for final plans (as described in ***FDM 301.2.5***) and Certifications (e.g., utilities, permits, R/W, environmental). Marks the date that the project is ready for the Plans, Specifications, and Estimates (PS&E) Submittal(s).

Ramp

A turning roadway that connects a Freeway to a crossing roadway within an interchange. The components of a ramp are a terminal at each leg and a connecting road. The geometry of the connecting road ramp usually involves some curvature and a grade.

Roadway

Roadways consist of prepared surfaces (asphalt or concrete pavement) for use by vehicles, including shoulders and adjacent bicycle lanes. A divided roadway provides a separation between opposing traffic lanes.

Safe System

The Safe System approach aims to eliminate fatalities and serious injuries of all users of the transportation system through a holistic model of multiple elements working together to safeguard against tragic crash outcomes.

Commentary: There are five elements of the Safe System: Safe Road Users, Safe Vehicles, Safe Speeds, Safe Roads, and Post-Crash Care. Each element is inter-related and weaknesses in one element may be compensated with strengths in another.

*The criteria within the **FDM** have been developed with the Safe System approach in-mind as related to Safe Speeds and Safe Roads. The term “Safe System” may not be specifically mentioned; however, it is inherent within the criteria and important to keep in mind when making engineering decisions to vary from the criteria.*

The Safe System approach begins with a foundational acknowledgement that transportation system users, as humans, will inevitably make mistakes. These mistakes may lead to crashes on our transportation facilities. FDOTs Target Zero goal is to eliminate fatal and serious injuries.

To achieve zero fatalities and serious injuries, crash forces induced on the human body must be kept below the tolerable limits. When designing and operating the transportation system, it is critical to manage crash kinetic energy. Human error is to be expected; therefore, the transportation infrastructure should be designed and operated to eliminate fatalities and serious injuries. This may be achieved by first reducing the risk of error and secondly, when crashes do occur, to maintain collision forces on the human body within tolerable levels by managing speed and crash angles to reduce injury severity.

The following are six foundational principles for understanding and applying the Safe System approach:

- **Fatalities and serious injuries are unacceptable** – *While no crashes are desirable, the Safe System approach emphasizes a focus on crashes resulting in fatal and serious injuries. Regardless of road users’ socio-economic backgrounds, their abilities, and the modes of*

transportation they use, no one should experience fatal or serious injuries when using the transportation system.

- **Humans make mistakes** – Road users will inevitably make mistakes, and those mistakes can lead to crashes. The Safe System approach expects the transportation system be planned, designed, and operated to be forgiving of inevitable human error, so that fatal and serious injury outcomes are unlikely to occur.
- **Humans are vulnerable** – Humans have a limited ability to tolerate the energy involved in crash impacts. Although the exchange of kinetic energy in collisions among vehicles, objects, and road users has multiple determinants, applying the Safe System approach involves managing the kinetic energy of crashes to avoid fatal and serious injury outcomes.
- **Responsibility is shared** – All stakeholders (transportation system users and managers, vehicle manufacturers, emergency responders, etc.) must work collaboratively to ensure that crashes do not lead to fatal or serious injuries.
- **Safety is proactive** – Proactive and data-driven tools should be used to identify and mitigate latent risks in the system, rather than waiting for crashes to occur and reacting afterwards.
- **Redundancy is crucial** – Reducing the risk of severe crash outcomes requires all parts of the system be strengthened so that if one element fails, the others protect transportation system users.

Shoulder Break

Point of intersection of the shoulder slope plane and the embankment or ditch slope plane; i.e., where the full-width shoulder slope of 0.05 or 0.06 “breaks” to a front slope of 1:X.

Strategic Intermodal System (SIS)

A transportation system comprised of facilities and services of statewide and interregional significance, including appropriate components of all modes. The highway component includes all designated SIS Highway Corridors, Emerging SIS Highway Corridors, SIS Intermodal Connectors, and Emerging SIS Highway Intermodal Connectors.

Streets

The local system which provides direct access to residential neighborhoods and business districts, connects these areas to the higher order road systems and offers the highest access

to abutting property; sometimes deliberately discouraging through-traffic movement and high speeds.

Traveled Way

The traveled way is the portion of the roadway for the movement of vehicles, exclusive of shoulders and bicycle lanes. The traveled way includes travel lanes and auxiliary lanes.

Truck Traffic

Truck traffic is sometimes used as a qualifying control. Truck traffic is expressed as a percent of the AADT or daily count (24 hr).

Turnpike Projects

Projects within the Turnpike system as defined by FS 338.221(6), 2021:

“Turnpike system’ means those limited access toll highways and associated feeder roads and other structures, appurtenances, or rights previously designated, acquired, or constructed pursuant to the Florida Turnpike Enterprise Law and such other additional Turnpike projects as may be acquired or constructed as approved by the Legislature.”

103 Standard Forms

103.1 General

This chapter contains fillable portable document format (PDF) of the standard forms found in the FDOT Design Manual (**FDM**). The form number assigned to each form corresponds to the **FDM** chapter in which it is discussed. Refer to the related chapter for instruction on the use of each form.

Bridge Development Report Submittal Checklist

Project Name _____

Financial Project ID _____

FA No. _____ Projects of Division Interest Yes No
 NHS Yes No

Date _____ FDOT Project Manager _____

	ITEMS	STATUS ^(b)
(1)	Typical Sections for Roadway and Bridge ^(a)	Select Status
(2)	Roadway Plans in Vicinity of Bridge ^(a)	Select Status
(3)	Maintenance of Traffic Requirements ^(a)	Select Status
(4)	Bridge Hydraulics Report ^(c)	Select Status
(5)	Geotechnical Report ^(c)	Status Select
(6)	Bridge Corrosion Environmental Report ^(c)	Status Select
(7)	GRS Abutments Feasibility Assessment ^(d)	Select Status
(8)	Precast Feasibility Assessment.....	Select Status
(9)	Existing Bridge Plans.....	Select Status
(10)	Existing Bridge Inspection Report.....	Status Select
(11)	Existing Bridge Load Rating.....	Status Select
(12)	Wildlife Connectivity.....	Select Status
(13)	Utility Requirements.....	Select Status
(14)	Railroad Requirements.....	Select Status
(15)	Retaining Wall and Bulkhead Requirements.....	Select Status
(16)	Lighting Requirements.....	Select Status
(17)	ADA Access Requirements.....	Select Status
(18)	Other.....	Select Status

- (a) Must be approved by District before BDR submittal.
- (b) Select appropriate status: Provided, Not Applicable, Comments Attached
- (c) See approval requirements for these documents in **FDM 121**.
- (d) GRS = Geosynthetic Reinforced Soil

Standard Peer Review Certification Letter

Florida Department of Transportation
District _____

Attn:

Reference: Independent Peer Review Category 2 Structures
Financial Project ID:
Federal Aid Number:
Contract Number:

Submittal: 90% Bridge _____ Plans
Submittal
Bridge Number(s):

Dear

Pursuant to the requirements of the Contract Documents, hereby certifies that an independent peer review of the above-referenced submittal has been conducted in accordance with **FDM 121** and all other governing regulations. Component plans that were included in the peer review are as follows:

Outstanding / Unresolved Comments and Issues:

Certification Statement:

I certify that the component plans listed in this letter have been verified by independent review and are in compliance with all requirements presented in the Contract Documents. Independent Peer Review comments and comment resolutions have been included in this submittal under separate cover.

I have also attached a current copy of the Firm's Independent Peer Review Prequalification Letter issued by the Department with the "Approved Rates" Section redacted.

Please do not hesitate to contact me if you have any questions.

Name of Independent Peer Review Firm _____

Name of Independent Peer Reviewer _____

Title _____

Signature _____

Florida Professional Engineer Lic. No. _____

Certification Letter

Florida Department of Transportation
District _____

Attn: _____

Reference: Independent Peer Review Category 2 Structures
Financial Project ID: _____
Federal Aid Number: _____
Contract Number: _____

Submittal: Final Bridge _____ **Plans**
Submittal _____
Bridge Number(s): _____

Dear _____,

Pursuant to the requirements of the Contract Documents, _____ hereby certifies that an independent peer review of the above-referenced submittal has been conducted in accordance with **FDM 121** and all other governing regulations. Component plans that were included in the peer review are as follows:

Certification Statement:

I certify that the component plans listed in this letter have been verified by independent review, that all review comments have been adequately resolved, and that the plans are in compliance with all Department and FHWA requirements presented in the Contract Documents.

I have been provided with all 90% Department or Department Representative Electronic Review Comments (ERC). I certify that I have reviewed the comments and have considered these concerns in the Independent Peer Review. See attached 90% ERC comments.

I have also attached a current copy of the Firm's Independent Peer Review Prequalification Letter issued by the Department with the "Approval Rates" section redacted.

Please do not hesitate to contact me if you have any questions.

Name of Independent Peer Review Firm _____

Name of Independent Peer Reviewer _____

Title _____

Florida Professional Engineer Lic. No. _____

*[Insert Signature,
Date and Seal
here.]*

Name of IPR Quality Assurance Manager _____

Title _____

Florida Professional Engineer Lic. No. _____

*[Insert Signature,
Date and Seal
here.]*

Submittal/Approval Letter

To: _____
District or Turnpike Design Engineer

Date: _____

Financial Project ID: _____ New Const. RRR Other _____
Federal Aid Number: _____

Project Name: _____

State Road Number: _____ Co./Sec./Sub. _____

Begin Project MP: _____ End Project MP: _____

FHWA Project of Division Interest: Yes No

Request for: Design Exception Design Variation Design Variation Memorandum

Community Aesthetic Feature: Conceptual Final

Re-submittal: Yes No Original Ref# _____ - _____ - _____

Requested for the following element(s):

- Design Speed Lane Width Shoulder Width Cross Slope
- Design Loading Structural Capacity Vertical Clearance Maximum Grade Stopping Sight Distance
- Superelevation Horizontal Curve Radius Other _____

Recommended by:

_____ Date _____

Name:
Responsible Professional Engineer or Landscape Architect (Landscape-Only Projects)

Approvals:

_____ Date _____

Name:
District or Turnpike Design Engineer

_____ Date _____

Name:
District Structures Design Engineer

_____ Date _____

Name:
State Roadway Design Engineer

_____ Date _____

Name:
State Structures Design Engineer

_____ Date _____

Name:
Chief Engineer

_____ Date _____

Name:
FHWA Division Administrator

Project Design Variation Memorandum Form 122-B

To: _____
 District or Turnpike Design Engineer

Date: _____

Financial Project ID: _____ New Const. RRR Other _____

Federal Aid Number: _____

Project Name: _____

State Road Number: _____ Co./Sec./Sub. _____

Begin Project MP: _____ End Project MP: _____

Request for: Design Variation

Design Element	MP: Beg-End	Existing	Proposed	Required	Attr. Crashes	Approved	Denied	Addl. Docum.
----------------	-------------	----------	----------	----------	---------------	----------	--------	--------------

1.	_____	_____	_____	_____	_____ <input type="checkbox"/>	_____ <input type="checkbox"/>	_____ <input type="checkbox"/>	_____ <input type="checkbox"/>
----	-------	-------	-------	-------	--------------------------------	--------------------------------	--------------------------------	--------------------------------

Justification: _____

2.	_____	_____	_____	_____	_____ <input type="checkbox"/>	_____ <input type="checkbox"/>	_____ <input type="checkbox"/>	_____ <input type="checkbox"/>
----	-------	-------	-------	-------	--------------------------------	--------------------------------	--------------------------------	--------------------------------

Justification: _____

3.	_____	_____	_____	_____	_____ <input type="checkbox"/>	_____ <input type="checkbox"/>	_____ <input type="checkbox"/>	_____ <input type="checkbox"/>
----	-------	-------	-------	-------	--------------------------------	--------------------------------	--------------------------------	--------------------------------

Justification: _____

4.	_____	_____	_____	_____	_____ <input type="checkbox"/>	_____ <input type="checkbox"/>	_____ <input type="checkbox"/>	_____ <input type="checkbox"/>
----	-------	-------	-------	-------	--------------------------------	--------------------------------	--------------------------------	--------------------------------

Justification: _____

Design Element MP: Beg-End Existing Proposed Required Attr. Crashes Approved Denied Addl. Docum.

5. _____
 Justification: _____

6. _____
 Justification: _____

Appendices: Yes No

Recommended by:

_____ Date _____
 Name: _____
 Responsible Professional Engineer or Landscape Architect (Landscape-Only Projects) (Seal)

Approvals:

_____ Date _____
 Name: _____
 District or Turnpike Traffic Operations Engineer

_____ Date _____
 Name: _____
 District or Turnpike Design Engineer

Initial Meeting And Methodology Checklist

The Applicant should prepare the following list of items to discuss at the initial meeting. The District Review Team may require the Applicant to address these items in the Concept Report.

Project Information

- | | |
|---|---|
| <input type="checkbox"/> Project Location, Limits, and Length | <input type="checkbox"/> Jurisdiction(s) in which the Project is Located |
| <input type="checkbox"/> Project Purpose | <input type="checkbox"/> Proposed Change in Lane Configuration |
| <input type="checkbox"/> Conceptual plan (including transitions to and from the lane repurposing section) | <input type="checkbox"/> Project Schedule |
| <input type="checkbox"/> Existing and long-range future AADT (the latter based on historical growth and the regional travel demand model) | <input type="checkbox"/> Existing and anticipated context classification |
| <input type="checkbox"/> Environmental and utilities impacts | <input type="checkbox"/> Public Involvement, agency outreach and endorsement |
| <input type="checkbox"/> Consistency of the proposed project with the applicable Long-Range Transportation Plan (LRTP), Transportation Improvement Program (TIP), Transit Development Plan (TDP), comprehensive plan, master plans, visions, and Complete Streets initiatives | <input type="checkbox"/> Existing design and posted speeds |
| <input type="checkbox"/> Status of the roadway as an Evacuation Route, and freight route | <input type="checkbox"/> Existing and future typical section |
| <input type="checkbox"/> Project limits are within or proposed to be part of Strategic Intermodal System (SIS) | <input type="checkbox"/> Target speed with anticipated changes in posted speed limits and design speeds |
| <input type="checkbox"/> Status of the roadway as a major transit corridor per the LRTP or TDP | <input type="checkbox"/> Need for design variations or design exceptions |
| <input type="checkbox"/> Proposed use(s) for the right-of-way after lanes are eliminated (e.g., widened sidewalks, bicycle lanes, landscaping, on-street parking, transit lanes) | <input type="checkbox"/> Plan for obtaining input and review from businesses, residents, and other stakeholders |
| <input type="checkbox"/> Impact on bicycle/pedestrian infrastructure and connectivity | <input type="checkbox"/> Plan for receiving endorsement from elected officials |
| <input type="checkbox"/> Impact on parking | <input type="checkbox"/> Funding source and cost estimates |
| <input type="checkbox"/> Impact on transit routes, stop locations (including appropriateness of turn radii and lane widths), include total number of stops and routes in the area. | <input type="checkbox"/> Size of impact area-parallel and cross streets |
| <input type="checkbox"/> Existing right-of-way width and any proposed changes to the right-of-way width | <input type="checkbox"/> Potential implementation strategy and partner commitments |
| <input type="checkbox"/> Anticipated changes in jurisdictional responsibility for ownership or maintenance of the roadway | <input type="checkbox"/> Impact on School crossing locations and midblock crossing |
| <input type="checkbox"/> Existing and anticipated changes in functional classification | <input type="checkbox"/> Need to add, remove, or modify traffic signals |
| <input type="checkbox"/> Existing and anticipated changes to access management classification | <input type="checkbox"/> Existing or proposed roundabouts |
| | <input type="checkbox"/> Near and long-range multimodal level of service (LOS) and queuing analysis for intersections and segments in the impact area under build and no-build scenario |
| | <input type="checkbox"/> Mitigation to address the significant adverse impact on state roads and regional transportation system |
| | <input type="checkbox"/> Crash data summary and analysis for the segments and intersections within the project limits |
| | <input type="checkbox"/> Case-specific special considerations to be determined (e.g., railroad crossing improvements) |

Lane Repurposing Initial Notice To Central Office

To: _____ From: _____ Date: _____
Systems Management Administrator *District Lane Repurposing Coordinator*

The intent of this notice is to inform Central Office that District _____ has received a request for lane repurposing on the State Highway System.

PROJECT INFORMATION

State Road and Project Location: _____
Roadway ID: _____ Project Limits (MP): from _____ to _____
Roadway ID: _____ Project Limits (MP): from _____ to _____
Context Classification: _____ Access Management Classification: _____
Applicant: _____
Project Description: _____

Proposed Change in Cross Section: From _____ lanes to _____ lanes

SIS NHS

ACTIONS AND OUTCOMES TO DATE

District staff participated in a meeting with _____ on _____ to formally commence the lane repurposing review process. At that meeting, District staff provided an overview of the lane repurposing review process and the Applicant shared initial information about the lane repurposing project. The District determined the specific review process and analysis methodology for the lane repurposing request

NEXT STEPS

The Applicant will submit a Draft Concept Report (containing a proposed typical section) as the lane repurposing review process proceeds. If the District reviewers find the Draft Concept Report acceptable, the Applicant submits a formal Application Package (including the Final Concept Report) to the District. If the Application Package is complete and acceptable, the lane repurposing request will be approved at the District level. The Final Application Package along with signed Form-C will be sent to Central Office for final approval.

Concurrences:

District Planning and Environmental Administrator Date: _____

District Design Engineer Date: _____

District Traffic Operations Engineer Date: _____

Lane Repurposing Final Review And Approval Notice To Central Office

The intent of this notice is to inform Central Office that District _____ has completed the review for the following lane repurposing project on the State Highway System.

PROJECT INFORMATION

State Road and Project Location: _____

Roadway ID: _____ Project Limits (MP): From _____ to _____

Roadway ID: _____ Project Limits (MP): From _____ to _____

Context Classification: _____ Access Management Classification: _____

Existing Posted Speed: _____ Proposed Posted Speed: _____

Design Speed: _____ Target Speed: _____

Transit facilities (stops and routes): Yes No

Applicant: _____

Project Description: _____

Proposed Change in Cross Section: From _____ lanes to _____ lanes

SIS NHS

Attachments: Concept Report Plan views Typical sections

District Concurrences:

District Planning and Environmental Administrator

Date: _____

District Design Engineer

Date: _____

District Traffic Operations Engineer

Date: _____

Central Office Concurrence:

Chief Planner

Date: _____

Final Approval:

Chief Engineer

Date: _____

Design Plans Phase Review

DATE: _____

TO: _____

FROM: ____ COPIES: _____

SUBJECT: Response to _____ Phase Review

REF: Financial Project ID _____
FA Project Number _____
County _____

APPROVED:

CONCURRENCE:

Responsible Professional Eng.
(Name of Consultant Firm)

* District Design Engineer
* District Structures Design Engineer
* District Project Management Engineer

* As appropriate

Design Plans Component Review

DATE: _____

TO: _____

FROM: ____ COPIES: _____

SUBJECT: Response to _____ Component Review

REF: Financial Project ID _____
FA Project Number _____
County _____

APPROVED:

CONCURRENCE:

Responsible Professional Eng.
(Name of Consultant Firm)

* District Design Engineer
* District Structures Design Engineer
* District Project Management Engineer

* As appropriate

Special Provisions

DATE: _____

TO: _____

FROM: ____ COPIES: _____

SUBJECT: Response to _____ Component Review

REF: Financial Project ID _____
FA Project Number _____
County _____

APPROVED:

CONCURRENCE:

Responsible Professional Eng.
(Name of Consultant Firm)

* District Design Engineer
* District Structures Design Engineer
* District Project Management Engineer

* As appropriate

18 KIP Equivalent Single Axle Loads (ESAL)

Financial Project ID _____

State Road No. _____

County _____

I have reviewed the 18 KIP Equivalent Single Axle Loads to be used for pavement design on this project. I hereby attest that these have been developed in accordance with the FDOT ***Project Traffic Forecasting Procedure*** using historical traffic data and other available information.

Name

Signature

Title

Organizational Unit

Date

Project Traffic

Financial Project ID _____

State Road No. _____

County _____

I have reviewed the Project Traffic to be used for design on this project. I hereby attest that it has been developed in accordance with the FDOT ***Project Traffic Forecasting Procedure*** using historical traffic data and other available information.

Name

Signature

Title

Organizational Unit

Date

**Sample Local Agency Maintenance Agreement
For Work Performed by the Department
Sheet 1 of 3**

Financial Project ID: _____

Federal Aid No. _____

Local Agency: _____

Project Description: _____

Bridge No.: _____

MAINTENANCE AGREEMENT

THIS AGREEMENT, made and entered into on this _____ day of _____, 20____, by and between the STATE OF FLORIDA DEPARTMENT OF TRANSPORTATION (hereinafter called "DEPARTMENT"), and _____, Florida (hereinafter called "LOCAL AGENCY");

WITNESSETH:

WHEREAS, the DEPARTMENT is preparing to undertake a project within the LOCAL AGENCY and LOCAL AGENCY identified and known to the parties by Financial Project I.D. _____ which will be of benefit to the LOCAL AGENCY; and

WHEREAS, approval of federal aid necessary to the project requires agreement by the LOCAL AGENCY to maintain the project;

NOW, THEREFORE, in consideration of the premises, the parties hereby agree as follows:

1. The DEPARTMENT will undertake the project and obtain approval of the Federal Highway Administration for federal participation.
2. Upon completion and acceptance, the LOCAL AGENCY will assume responsibility for maintenance of the project and will conduct such maintenance in accordance with approved state standards.
3. To the extent permitted by law, LOCAL AGENCY must indemnify, defend, and hold harmless the DEPARTMENT and all of its officers, agents, and employees from any claim, loss, damage, cost, charge, or expense arising out of any act, error, omission or negligent act by LOCAL AGENCY, its agents, or employees, during the performance of the Agreement, except that neither LOCAL AGENCY, its agents, or its employees will be liable under this paragraph for any claim, loss, damage, cost, charge, or expense arising out of any act, error, omission, or negligent act by the DEPARTMENT or any of its officers, agents, or employees during the performance of the Agreement. Nothing herein must waive the rights of sovereign immunity of either party.

**Sample Local Agency Maintenance Agreement
For Work Performed by the Department**

Sheet 2 of 3

4. In the event there are cost overruns, supplemental agreements (specifically incurred in the areas located off the State Highway System), and or liquidated damages not eligible to be paid for by federal funds due to the Federal Highway Administration determining that said costs are non-participating costs, the LOCAL AGENCY must be responsible for one hundred percent (100%) of the funds required to make up the shortfall not paid by federal funds. The Project is off of the "State Highway System," therefore, in accordance with **Section 339.08(1), Florida Statutes**, State funding cannot be used for payments of non- participating costs on this Project. (Examples of non-participating items could be fishing piers; premium costs due to design or CEI errors or omissions; material or equipment called in for the plans but not used in the construction, as referenced in the Federal Aid Policy Guide 23, **CFR Section 635.120**).
 - a. Should such shortfalls occur, due to a determination that said costs are non-participating, the LOCAL AGENCY agrees to provide, without delay, a deposit within fourteen (14) calendar days of notification from the Department, to ensure that cash on deposit with the Department is sufficient to fully fund the shortfall. The Department must notify the LOCAL AGENCY as soon as it becomes apparent there is a shortfall; however, failure of the Department to so notify the LOCAL AGENCY must not relieve the LOCAL AGENCY its obligation to pay for its full participation of non-participating costs during the Project and on final accounting, as provided herein below. If the LOCAL AGENCY cannot provide the deposit within fourteen (14) days, a letter must be submitted to and approved by the Department's project manager indicating when the deposit will be made. The LOCAL AGENCY understands the request and approval of the additional time could delay the project, and additional non-participating costs may be incurred due to the delay of the project.
5. The DEPARTMENT intends to have its final and complete accounting of all costs incurred in connection with the work performed hereunder within three hundred sixty days (360) of final payment to the Contractor. The Department considers the Project complete when the final payment has been made to the Contractor, not when the construction work is complete. All non-participating Project cost records and accounts must be subject to audit by a representative of the LOCAL AGENCY for a period of three (3) years after final close out of the Project. The LOCAL AGENCY will be notified of the final non-participating cost of the project. Both parties agree that in the event the final accounting of total non-participating costs pursuant to the terms of this Agreement is less than the total deposits to date, a refund of the excess

will be made by the Department to the LOCAL AGENCY. If the final accounting is not performed within three hundred and sixty (360) days, the LOCAL AGENCY is not relieved from its obligation to pay.

- 6. In the event the final accounting of total non-participating costs are greater than the total deposits to date, the LOCAL AGENCY will pay the additional amount within forty (40) calendar days from the date of the invoice from the Department. The LOCAL AGENCY agrees to pay interest at a rate as established pursuant to Section 55.03, Florida Statutes, on any invoice not paid within forty (40) calendar days until the invoice is paid.
- 7. Any payment of funds under this Agreement provision will be made directly to the Department for deposit.

IN WITNESS WHEREOF, the parties hereto have set their hands and seals on the day and year first above written.

_____,
LOCAL AGENCY OFFICIAL

STATE OF FLORIDA
DEPARTMENT OF TRANSPORTATION

By: _____
Title: _____

By: _____
District Secretary

(Type Name)

ATTEST:

Clerk (Seal)

ATTEST:

Executive Secretary (Seal)

LEGAL APPROVAL:

LOCAL AGENCY Attorney

(Type Name)

LEGAL APPROVAL:

Senior Attorney

Items of Work Checklist

DATE: _____

TO: _____, District Specifications

FROM: _____, Project Manager

COPIES TO:

SUBJECT: ITEMS OF WORK

Financial Project ID: _____ (GOES WITH _____)

County (Section): _____

* Project Description: _____

The plans package for the above referenced project includes the following items of work to be performed:

- | | |
|---|--|
| <input type="checkbox"/> Milling & Resurfacing | <input type="checkbox"/> Highway Signing |
| <input type="checkbox"/> Base Work | <input type="checkbox"/> Guardrail |
| <input type="checkbox"/> Shoulder Treatment | <input type="checkbox"/> Landscaping |
| <input type="checkbox"/> Drainage Improvements | <input type="checkbox"/> Box or Three-sided Culverts |
| <input type="checkbox"/> Curb & Gutter | <input type="checkbox"/> Bridges |
| <input type="checkbox"/> Traffic Signals | <input type="checkbox"/> MSE Walls |
| <input type="checkbox"/> Lighting | <input type="checkbox"/> Sidewalks/Shared Use Path |
| <input type="checkbox"/> Other (Please Specify) | |

Please include the county, project description and all items of work that apply in the *Intent and Scope* so they may be added to the advertisement description.

* The project description should only include the road number and the limits or location of the project.

Record Shop Drawing Transmittal

Date _____

TO: _____

FROM: _____

(Final Review Office)

PROJECT NAME _____

FINANCIAL PROJECT ID _____

FEDERAL AID PROJECT NO. _____

CONTRACT ID NUMBER _____

COUNTY (SECTION) _____

STATE ROAD NUMBER _____

BRIDGE NUMBER _____

CONTRACTOR _____

ENGINEER OF RECORD _____

We are transmitting herewith the following Record Shop Drawings for archiving:

- 1. _____
- 2. _____
- 3. _____
- 4. _____
- 5. _____
- 6. _____

For the Final Review Office: _____

(Signature)

(Date)

For the Receiving Office: _____

(Signature)

(Date)

Layer 3 Switch Worksheet

Chassis Based Switches					
Number of Management Blades					
Backplane Capacity					
Number of Copper Ports					
Protocol Requirements					
Number Fiber Ports #1		Fiber Port Speed			
Number Fiber Ports #2		Fiber Port Speed			
Number Fiber Ports #3		Fiber Port Speed			
Number Power Supplies		Voltage (AC/DC)			
Optics Needed					
	Optic #1	Optic #2	Optic #3	Optic #4	Optic #5
# Required					
Speed Requirement					
Distance Required					
Require OEM					

Stack Aggregation Switches					
Number of Fiber Ports					
Number of Copper Ports					
Protocol Requirements					
Number Power Supplies		Voltage (AC/DC)			
Optics Needed					
	Optic #1	Optic #2	Optic #3	Optic #4	Optic #5
# Required					
Speed Requirement					
Distance Required					
Require OEM					

Transportation Management Plan (TMP) Form

Responsible Professional Engineer: _____

FDOT Project Manager: _____

State Road: _____

Project Location: _____

Roadway ID: _____

Project Limits (MP): From _____ to _____

Project Description: _____

Financial Project ID: _____

New Const. RRR

Federal Aid Number. _____

Other FHWA Projects of Division Interest Yes No

In accordance with the requirements of the FDOT Design Manual (FDM) Chapter 240, the following items determine the scope and need of a Transportation Management Plan (TMP). Complete the following checklist and provide brief descriptions of the items included, as appropriate.

Indicate if the project meets one or both of the following qualifying conditions as "significant project":

- A project that, alone or in combination with other concurrent projects nearby, is anticipated to cause sustained work zone impacts.
- All Interstate system projects within the boundaries of a designated Transportation Management Area (TMA) that occupy a location for more than three days with either intermittent or continuous lane closures.

If either or both above qualifying conditions are met, indicate compliance with the following documents in development of a TMP for the Project:

- FDOT Design Manual***
- FDOT Standard Plans***
- FDOT Standard Specifications for Road and Bridge Construction***
- FDOT Basis of Estimates Manual***
- Manual on Uniform Traffic Control Devices for Streets and Highways, (MUTCD), Part VI***

- Policy on Geometric Design of Highways and Streets, AASHTO**
- Roadside Design Guide, AASHTO, Chapter 9**
- FDOT Accessing Transit Handbook, Chapter 4.6.**
- AASHTO Guide for the Development of Bicycle Facilities, 4th Edition, Chapter 7**

TMP Components:

Indicate that the following TMP Components have been addressed on the project:

- Temporary Traffic Control Plan (TTCP)**
 - Work Zone Speed Established**
Speed Reduction Required (Y/N)

If Yes, is the “*Work Zone Speed less than Existing Posted Speed*” documentation completed (Y/N)
 - Lane Closure Analysis**
If included, was the “*Lane Closure Analysis Worksheet*” and any restrictions requiring approval completed (Y/N)
 - Traffic Pacing**
If included, was the “*Traffic Pacing Worksheet*” completed (Y/N)
 - Portable Changeable Message Signs**
If included, was the “*Portable Changeable Message Sign Worksheet*” completed (Y/N)
 - Bicycle, Pedestrian, and Transit Accommodations**
 - Railroads**
Was the District Railroad Coordinator consulted (Y/N)
 - Utilities**
Was the District Utility Coordinator consulted (Y/N)
 - Signals**
Was the District Traffic Operations Engineer consulted (Y/N)
 - Speed and Law Enforcement Officer**
Was the District Construction Office consulted or any usage requiring approval completed (Y/N)

Transportation Operations Plan (TOP):

Briefly describe TOP components included on the project. If a comprehensive plan has been prepared, indicate below, and attach.

TOP Description:

Public Information Plan (PIP):

Briefly describe PIP components included on the project. If a comprehensive plan has been prepared, indicate below, and attach.

PIP Description:

Portable Changeable Message Signs Worksheet

Location of board: _____

Used: from _____ at _____

to _____ at _____

Message programmed by: _____

MESSAGE 1

MESSAGE 2

Timing:

Message 1 will run: _____ seconds.

Message 2 will run: _____ seconds.

Standard Abbreviations For Use On Changeable Message Signs

Standard abbreviations easily understood are:

<u>WORD</u>	<u>ABBREV.</u>	<u>WORD</u>	<u>ABBREV.</u>
Boulevard	BLVD	Normal	NORM
Center	CNTR	Parking	PKING
Crossing	XING	Pedestrian	PED
Crosswalk	XWALK	Road	RD
Emergency	EMER	Service	SERV
Entrance, Enter	ENT	Shoulder	SHLDR
Expressway	EXPWY	Slippery	SLIP
Freeway	FRWY, FWY	Speed	SPD
Highway	HWY	Traffic	TRAF
Information	INFO	Travelers	TRVLRS
Left	LFT	Warning	WARN
Maintenance	MAINT		

Other abbreviations are easily understood whenever they appear in conjunction with a particular word commonly associated with it. These words and abbreviations are as follows:

<u>WORD</u>	<u>ABBREV.</u>	<u>PROMPT</u>
Access	ACCS	Road
Ahead	AHD	Fog*
Blocked	BLKD	Lane*
Bridge	BRDG	[Name]*
Chemical	CHEM	Spill
Construction	CONST	Ahead
Exit	EX, EXT	Next*
Express	EXP	Lane
Hazardous	HAZ	Driving
Interstate	I	[Number]
Major	MAJ	Accident
Mile	MI	[Number]*
Minor	MNR	Accident
Minute(s)	MIN	[Number]*
Oversized	OVRSZ	Load
Prepare	PREP	To Stop
Pavement	PVMT	Wet*
Quality	QLTY	Air*
Route	RT	Best*
Turnpike	TRNPK	[Name]*
Vehicle	VEH	Stalled*
Cardinal Directions	N, E, S, W	[Number]
Upper, Lower	UPR, LWR	Level

* = Prompt word given first

The following abbreviations are understood with a **prompt** word by about 75% of the drivers. These abbreviations may require some public education prior to usage.

<u>WORD</u>	<u>ABBREV.</u>	<u>PROMPT</u>
Condition	COND	Traffic*
Congested	CONG	Traffic
Downtown	DWNTN	Traffic
Frontage	FRNTG	Road
Local	LOC	Traffic
Northbound	N-BND	Traffic
Roadwork	RDWK	Ahead [Distance]
Temporary	TEMP	Route
Township	TWNNSHP	Limits

* = Prompt word given first

Certain abbreviations are prone to inviting confusion because another word is abbreviated or could be abbreviated in the same way. **DO NOT USE THESE ABBREVIATIONS:**

<u>ABBREV.</u>	<u>INTENDED WORD</u>	<u>WORD ERRONEOUSLY GIVEN</u>
WRNG	Warning	Wrong
ACC	Accident	Access (Road)
DLY	Delay	Daily
LT	Light (Traffic)	Left
STAD	Stadium	Standard
L	Left	Lane (Merge)
PARK	Parking	Park
RED	Reduce	Red
POLL	Pollution (Index)	Poll
FDR	Feeder	Federal
LOC	Local	Location
TEMP	Temporary	Temperature
CLRS	Clears	Color

104 Public Involvement

104.1 General

FDOT's policy on ***Public Involvement, Topic No. 000-525-050*** states:

"It is the policy of the Florida Department of Transportation (Department) to use every possible opportunity to engage with and involve the public that leads to community-based decisions when planning, designing, constructing, and maintaining transportation facilities and services to meet the State's transportation needs. The participation of the public is an integral part of the transportation process and results in

- Early and continuous opportunities for public input
- Consideration of public needs and preferences
- Informed decisions through collaborative efforts
- Mutual understanding and trust between the Department and its partners

The Department will promote public involvement, engagement opportunities and information exchange activities in all functional areas using various techniques adapted to the audience, local area conditions, and project requirements."

Detailed information on Public Involvement activities and requirements can be found in the [Metropolitan Planning Organization \(MPO\) Program Management Handbook, Chapter 6](#); the [Project Development and Environment Manual \(PD&E Manual\) Part 1, Chapter 11](#) and the [Public Involvement Handbook](#).

Typically, when a project reaches the design phase, many of the project commitments and community issues have already been identified. However, there are times when design alternatives need to be reevaluated to determine their community impacts. Any commitments made in previous phases are communicated to designers, who are responsible for carrying them out. If constraints arise that require design changes that affect FDOT's ability to meet commitments, then the process would require follow-up with the affected community. In such cases, additional public involvement and community impact assessment may be necessary to address public concerns.

Projects may have the following potential community impacts that are not identified until the design phase:

- (1) Impacts on public safety, including people with disabilities
- (2) School crossings or other areas of high pedestrian activity
- (3) Aesthetic features such as landscaping or tree replacement
- (4) Medians or access changes
- (5) Intersections and driveways, including audible signalized intersections
- (6) Accessibility of corridor businesses and neighborhoods
- (7) Significant improvements to bicycle, pedestrian, and transit facilities
- (8) Lighting
- (9) Maintenance of Traffic
- (10) Railroad crossings
- (11) Location and extent of storm water management facilities

104.2 Public Information and Outreach

Start developing and implementing a public information and outreach campaign when the design phase begins. Ongoing monitoring throughout the life of the project will be necessary. The following steps should be used when planning and implementing a public information and outreach campaign.

- (1) **Determine appropriate size and nature.** The size and nature of a public information and outreach effort is determined by the characteristics of a project, its location, and the anticipated impacts. Address the size and duration of the project, the amount of delay anticipated, special traffic and safety conditions such as heavy truck traffic, changes to bicycle and pedestrian routes and facilities, and disruptions to other modes and key facilities such as airports, stadiums, and hospitals.
- (2) **Identify resources.** Typically, public information and outreach spending is included in the project budget. In addition, the Department may need to tap existing resources, such as an operating 511 system and the Lane Closure Information System (LCIS) and leverage external resources such as free media coverage.
- (3) **Identify partners.** Working with a range of partners to design and implement an information and outreach campaign will strengthen the strategies employed and may reduce the costs and resources. Partners may include state and local

agencies, law enforcement, major employers, business and neighborhood associations, and local clubs and advocacy groups.

- (4) **Identify target audiences.** Identifying target audiences is a key in developing an effective communication strategy. This determines the types of messages that should be conveyed and the best method of communicating those messages.
- (5) **Develop the message(s).** The messages communicated should provide project information to maintain safety and minimize delay and should indicate that the agency cares about the traveling public, including transit riders, pedestrians, cyclists, and motorists. More specific messages might include details of the work zone, travel times through the work zone, alerts regarding the need for cyclists to share or control a travel lane and alternate routes and modes of transportation.
- (6) **Determine communication strategies.** How information is communicated will depend on the audiences, the messages to be conveyed, and the campaign budget. The [*Public Involvement Handbook*](#) discusses a wide range of strategies for communicating information about a project.
- (7) **Determine communication timing.** Begin public information and outreach before work commences to develop partnerships and inform the public about the project, its anticipated impacts, and additional sources of ongoing project information. Early contact and coordination with bicycle groups (such as Metropolitan Planning Organization Bicycle/Pedestrian Advisory Committees or bike clubs) helps mitigate friction.

104.3 Community Awareness Plan (CAP)

The CAP identifies and documents the notification method to project stakeholders of potential impacts of a proposed construction project. Project stakeholders typically include local governments, law enforcement, affected property owners, tenants, and the public. The CAP establishes and maintains a strategy for early, meaningful, and continuous public involvement during the design and construction phases. Specifically, the intent of the CAP is to develop an approach to achieve the following objectives:

- (1) Resolve controversial issues during the design phase.
- (2) Develop and maintain stakeholder support for the project.

At a minimum, the CAP should include the following elements:

- (1) **Project Description:** Identify the project background, existing conditions, and proposed project scope. Include special features or amenities to be included in the project when describing the scope of work.

- (2) **Description of the Community:** Describe the area surrounding the project limits and properties that might be affected. Include special demographic data that would assist in determining the need for translation services or bilingual staff at a public meeting.
- (3) **Potential Controversial Issues:** Identify community issues or concerns. Some level of controversy can be expected from the following: access changes, driveway modifications, parking removal, right-of-way acquisition, new signalized intersections, landscaping changes or removal, loss of aesthetic feature, safety issues identified by law enforcement, or temporary construction impacts (e.g., lane closures, detours).
- (4) **Special Commitments:** List commitments made prior to or during the design phase.
- (5) **Traffic Control and Access Impacts:**
 - (a) Temporary Traffic Control Plan – Describe the temporary traffic control plan, including lane closures, night work, or detours. Identify special community events that must be considered.
 - (b) Access Impacts – Describe temporary or permanent access changes, including driveway modifications.
 - (c) Construction Schedule – Identify when construction activities are expected to begin.
 - (d) Preliminary Contract Time – Include an estimate of the contract duration.
- (6) **CAP Level:** Identify the public involvement level and justify the level selected.
- (7) **Identification of Project Stakeholders:** List the property owners, tenants, elected and appointed officials, local, state, and federal agency representatives, law enforcement, and interested organizations.
- (8) **Proposed Public Involvement Notification Methods and Activities During Design:** Describe the outreach efforts to conduct during the design phase, the anticipated schedule, and how the public will be notified.
- (9) **Proposed Public Involvement Notification Methods and Activities During Construction:** Provide a timeline of public involvement activities for the construction phase.

104.3.1 CAP Levels

FDOT CAP Guidelines for all design and construction projects identify four levels of public involvement based on the type of project:

- Level 1:** Project is noncontroversial, causes negligible accessibility impacts, and causes minimal traffic disruption.
- Level 2:** Project has general public acceptance, little impact on accessibility or traffic, and a moderate degree of traffic disruption. Examples include urban resurfacing, bridge repair projects, and other construction activities that may require lane closures.
- Level 3:** Project may be controversial, will significantly impact traffic flow, or will significantly affect accessibility to properties (temporary or permanent). Examples are parking removal, median openings or closures, access management issues, traffic signal removal, roadway widening, major reconstruction, and projects including detours.
- Level 4:** Project involves road widening or major reconstruction, bridge widening or replacement, new interchange, or closures (temporary or permanent) of the roadway, ramps, bridges, or railroad crossings.

104.4 Recommended Activities

A public information and outreach campaign involves communicating with road users, the general public, area residences and businesses, and appropriate public entities about a road project and its implications for safety and mobility.

104.4.1 Design Activities

The District Public Information Officer (PIO) should also have final approval of informational documents intended for public distribution.

Typical activities corresponding to the CAP level are provided as follows:

CAP Level 1

- (1) Provide Phase II plans to city, county officials, and staff to solicit comments and concurrence.

CAP Level 2, 3, 4

- (1) When requested, provide presentation(s) to city, MPO, County Commission, legislators and community groups regarding design, impact, and construction status.
- (2) Provide plans for all phase reviews to city, county officials, and staff to solicit comments and concurrence.
- (3) Provide plans for all phase reviews to maintenance, construction, and appropriate Operations Center.
- (4) Following Phase II review:
 - (a) Send Notice of Access Impact (driveway closures/modifications) to affected property owners. If done by mass mailing, all proposed access revisions must be clearly stated in the mailing.
 - (b) Project Information Workshop(s) with city and county staff, law enforcement, elected officials, property owners, and interested public to solicit comments. Mass mailing of invitation or project flyers are typically coordinated by the Department Project Manager and the District PIO.

104.4.2 Construction Activities

Typical activities corresponding to the level type are provided as follows:

CAP Level 1, 2, 3, 4

- (1) Two to four weeks prior to beginning construction activities, conduct a mass mailing of project information with construction dates and specific traffic impact information. Project flyers are typically coordinated by the Construction Project Manager and the District PIO.
- (2) One week prior to beginning construction activities, include information regarding the project start date, pertinent project information and specific traffic impacts in the District PIO's Weekly Traffic Report (news release).
- (3) Throughout the construction phase, include specific traffic impacts in the District PIO's Weekly Traffic Report (news release). It is the Construction Project Manager's responsibility to provide the District PIO with this information in a timely manner to meet media deadlines.

CAP Level 2, 3, 4

- (1) After Letting, conduct a 'Hand Off' meeting including representatives from Design, Construction, Utilities, Traffic Operations and Maintenance. This meeting is typically scheduled by the Design Project Manager.
- (2) When requested, provide presentations to city and county officials, legislators, community groups and property owners regarding project status, as needed or requested.

CAP Level 3, 4

- (1) During the development of Scope of Services for C.E.I., determine if a consultant PIO is required for the project. This decision will be made by the Design Project Manager, Construction Project Manager, and the District PIO. The District PIO should be involved in writing Requests for Proposals and Scopes of Services language that pertain to contracting with community involvement and public information consultants.
- (2) For project websites, Construction staff typically maintains the website in accordance with the Project Website Guidelines.

104.5 Combined PD&E and Design Projects

For projects that overlap the PD&E and Design phases, prepare a Public Involvement Plan (PIP) in accordance with **Part 1, Chapter 11** of the [PD&E Manual](#). At the conclusion of the PD&E phase, update the PIP to include the following:

- (1) Summary of community concerns and issues
- (2) List of special commitments
- (3) Summary of the Temporary Traffic Control Plan
- (4) Description of access impacts
- (5) Construction schedule
- (6) Estimated construction duration
- (7) Proposed public involvement activities during construction

104.6 Noise and Perimeter Walls

See **FDM 264.4** for Public Involvement requirements for noise and perimeter walls.

105 Aesthetic Design

105.1 General

Merriam-Webster defines aesthetic as “*pleasing in appearance; beautiful.*” Aesthetics has to do with human perception of whether places or objects are beautiful or ugly; elegant or tasteless; elaborate or plain. It is difficult to define aesthetics because it is a subjective topic. However, humans can generally arrive at a consensus of what is “pleasing in appearance.”

Successful implementation of aesthetics can be summarized in a quote by Alvar Aalto: “Beauty is the harmony of function and form.” In the design of transportation facilities, the roadway should blend with its physical and social environment.

Aesthetic design should achieve a balance between form, function, color, texture, durability, and cost. It is important that designers be sensitive to the aesthetic implications of their work and also to their personal aesthetic capabilities and limitations.

Florida’s beauty is a combination of the natural and built environment; credited with attracting millions to visit, invest, live, and work here. Transportation facilities are the largest, most visited, and most visible land use in Florida; the largest public spaces in most communities. Quality transportation design should not diminish the visual quality of a place and the experience of being there.

105.2 Aesthetic Design

Aesthetics is an integral part of the transportation design process and should not require additional tasks. Aesthetic designs are not an afterthought to embellish or provide adornments, frills, decorations, or add-ons to cover ugly parts. Affordable, biddable, constructible, and maintainable designs can artfully respond to the Department’s and communities’ safety, mobility, and aesthetic ideals. Even when there are no known aesthetic issues or when a project is minor, transportation facilities must not be ugly and detract from Florida’s beauty.

It is important to achieve a balance between form, function, color, texture, durability, and cost in the design of transportation facilities. Implementation of aesthetic principals in transportation design involves the balanced combination and implementation of the following elements:

- Form
- Scale
- Proportion
- Location
- Materials
- Lightness, darkness, shade, shadow, and reflection
- Color
- Perspective
- Context
- Viewsheds
- Durability
- Orientation
- Aspect
- Exposure

The placement of transportation elements (e.g., signs, signal control boxes, handrails) should be carefully considered during design. It may be possible to strategically place these items to avoid disturbing a scenic view.

105.3 Policies

[Constitution of the State of Florida, Article II, Section 7\(A\):](#)

“It shall be the policy of the state to conserve and protect its natural resources and scenic beauty.”

[Section 334.044 \(26\) Florida Statutes:](#)

"The department shall have the powers and duties to...conserve the natural roadside growth and scenery; and to provide for the implementation and maintenance of roadside conservation, enhancement, and stabilization programs.”

Aesthetic effects and roadway design considerations are discussed in the [PD&E Manual \(Topic No. 650-000-001\), Part 2, Chapter 5 and the FDOT Drainage Manual section 5.4.4.2 Detention and Retention Ponds.](#)

105.4 Guidelines

Integrating aesthetics into transportation projects accomplish the following:

- (1) Support safety, mobility, and enjoyment of all users, and can be integrated with functional elements.
- (2) Provide facilities that are compatible with the surrounding natural and built environment, based on the context of the roadway; e.g., the urban scale, surrounding architecture, forests, farms, parks, neighborhoods, landscape, community features, water bodies, views, and vistas.

- (3) Avoid, minimize, and mitigate insensitive solutions that detract from Florida's beauty.
- (4) Coordinated to provide a clear sense of order, clarity, and continuity.
- (5) Use materials and design solutions sensitive to scale, form, materials, color, pattern, texture, and architectural style of existing and proposed elements.
- (6) Address maintenance needs and responsibilities.

Roadways should blend into the landscape, avoiding large cuts and fills into the existing terrain. Horizontal and vertical alignment should be coordinated so that a driver has an opportunity to gain a sense of the local environment. Combinations of horizontal and crest vertical curves and broken-back curves should be avoided. Excessively long tangent sections become monotonous. Curvature or other features should be added to maintain drivers' interest and awareness.

Vistas of exceptional beauty should be accentuated by the roadway geometrics. Ideally, such vistas should be on the outside of horizontal curves, without excessive roadside appurtenances and signs to clutter the view. Consider the view from, and the view of the transportation facility.

Preferred design solutions may require additional right of way (R/W). Aesthetics is an acceptable design objective. The Department has a wide discretion to select the amount and location of the property to be acquired. Courts can inquire whether the Department has adequately considered alternatives, costs, environmental factors, long-range planning, and safety. As long as these factors are adequately considered, courts generally are not authorized to substitute their design judgment for that of Department unless the Department acts illegally in bad faith or abuses its discretion.

Often, the most attractive and elegant design solution can be low cost or no cost and add little or no time to the project schedule.

105.5 Process

Although beauty is subjective, two or more people can usually find consensus on what is attractive or beautiful and what is not. Seek and use the opinions of others to inform the final design.

Consideration of aesthetics begins early and is as integral to the design process as safety and mobility. Within the time and budget available, identify and build on opportunities to improve the project aesthetics.

Visualize and evaluate each design element as it will appear from the road, the sidewalk, the bike lane, and from adjacent properties; day and night. Visualize how the element will appear after ten or more years of weather, minimal care, and typical use.

105.6 Safety and Scenic Beauty

General principles of aesthetic design include form, scale, order, and proportion. Due to the need for uniformity in roadway design, there is often a lack of contrast and variety. This can contribute to driver monotony, a real safety concern. By integrating aesthetic design principles throughout the design process, the need for uniformity can be balanced with the need for variety and interest.

106 Exempt Public Documents

106.1 General

This chapter describes the Department's policy concerning the distribution of sensitive documents used in the design and construction of structures.

106.2 Exempt Documents

In an effort to protect Florida's transportation infrastructure, the 2002 Legislature enacted **Section 119.071(3)(b), Florida Statute (F.S.)**, which provides that building plans, blueprints, schematic drawings, and diagrams, including draft, preliminary, and final formats, which depict the internal layout and structural elements of a building, arena, stadium, water treatment facility, or other structure owned or operated by an agency are exempt from the requirements of Florida's Public Records Law.

Therefore, plans, blueprints, schematic drawings and diagrams of structures owned by the Department are exempt from the public records provisions of **Chapter 119, F.S.** This exemption includes draft, preliminary and final documents and includes paper, electronic, and other formats.

106.3 Distribution of Exempt Documents

[Procedure 050-020-026](#) (*Distribution of Exempt Documents Concerning Department Structures and Confidential and Exempt Security System Plans*) describes the process for the distribution of documents deemed as Exempt Documents.

For the purpose of [Procedure 050-020-026](#), the term "structure" includes bridges and culverts with an opening of more than 20 feet between undercopings of abutments or spring lines of arches or extreme ends of openings for multiple boxes, and those other bridges subject to safety inspection under **Section 335.074, F.S.** A roadway is not otherwise a structure.

Entities or persons outside the Department requesting or receiving copies of any portion of plans or other documents considered Exempt Documents must complete a request form ([Form No. 050-020-26](#)). The entity or person receiving the Exempt Documents must maintain the exempt status of the Exempt Documents. This procedure applies to all Department internal or contracted staff who have access to such Exempt Documents in their Department work.

110 Initial Engineering Design Process

110.1 General

This chapter discusses the engineering design process which begins with the approval of the Project Location and Design Concept Acceptance and ends with the construction letting. It may include an update process when the construction plans and specifications are ready and on hold in the district and require revising to make them contract ready. Throughout this design process, quality control will be performed by those responsible for the engineering design and plans preparation activities.

The engineering and design activities and the schedules depend on the type of project and the required effort to accomplish the desired objectives. There are three basic types of projects:

- (1) **New Construction** - A highway or bridge project along a new corridor on new horizontal and vertical alignments.
- (2) **Add Lanes and Reconstruction** - A highway project along an existing facility to add lanes, widen or replace bridges, or improve intersections to improve capacity, safety, or operation.
- (3) **Other Projects** - May include Resurfacing, Restoration and Rehabilitation (RRR), operational improvements, safety enhancements, or improvements to extend the service life of an existing highway or bridge. These projects generally do not require a PD&E phase. The scopes are so varied that it is difficult to define them, except project by project. They can vary in magnitude from installing highway lighting for enhanced safety or resurfacing pavement to extend the service life, to minor lane and shoulder widening, bridge rail modification or intersection improvements. These projects may also include transit facilities, bike paths, sidewalks, and landscaping.

Figure 110.1.1 shows the major activities included in the initial engineering design process.

Figure 110.1.1 Major Activities – Initial Engineering Process

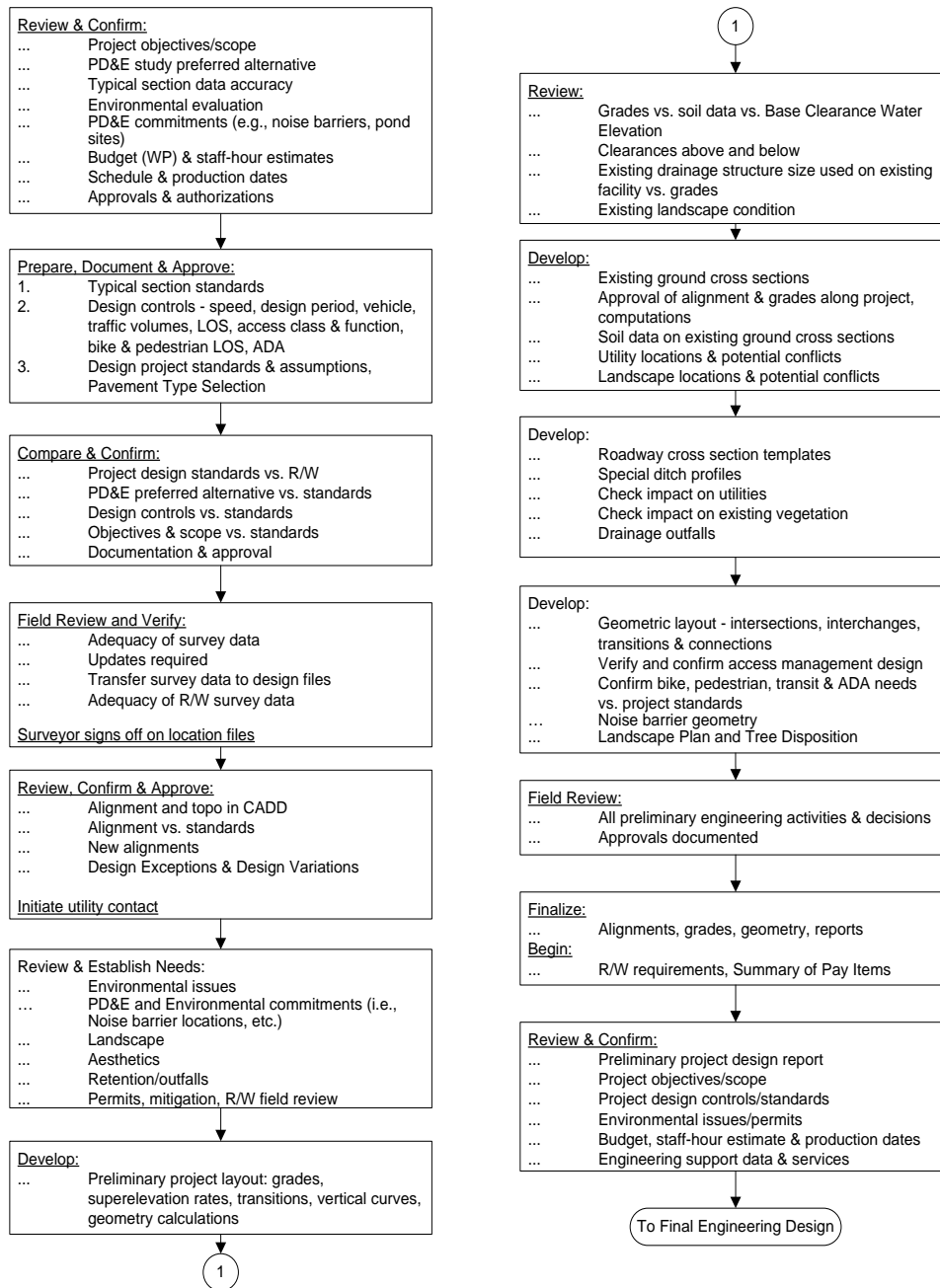

110.2 Initial Engineering Design

Generally, the initial engineering process should accomplish or complete the following activities:

- (1) Completely and fully define and document the objectives of the project and the scope of activities to accomplish them. This will almost always require an on-site review.
- (2) Document the surrounding context as it relates to aesthetics and accommodating trees (existing and proposed) and other long-lived plants.
- (3) Develop and document a realistic staff-hour estimate and production schedule to accomplish the scope of activities identified.
- (4) Coordinate with the District Interchange Review Coordinator to determine if a re-evaluation of the approved Interchange Access Request (IAR) is necessary. The Interchange Access Request Users Guide ([IARUG](#)) provides the requirements for performing a re-evaluation of the Interchange Access Request (IAR).
- (5) Establish and document the design controls, criteria, assumptions, project design standards, Design Exceptions, and Design Variations. Significant changes to previously approved PD&E concept may result in a re-evaluation of the Environmental Document. Discuss with the District Environmental Management Office.
- (6) Review Project Commitment Record (PCR) that was completed during PD&E and identify all prior PD&E commitments that will be addressed during design; e.g., the need to design and locate noise barriers (with insertion loss calculations), special pond site requirements, landscape or aesthetic considerations, pedestrian and bicycle commitments, access commitments, wildlife management commitments, wetland issues, transit issues.
- (7) Identify and document additional engineering, data gathering, and support services.
- (8) Determine and document the structural design requirements.
- (9) Determine and document if R/W is required.
- (10) Establish and document the review procedure and number of submittals, if different from guidelines provided in this manual.
- (11) Establish preliminary geometry, grades, and cross sections.
- (12) Identify and implement needed public involvement activities. See **FDM 104**.
- (13) Develop Pavement Type Selection Report based on FDOT [Pavement Type Selection Manual](#) (**Topic No. 625-010-005**).

- (14) Identify seasonal high water and base clearance water elevations and determine base clearance.
- (15) Identify locations of potential hydroplaning risk and develop mitigation strategies to reduce risk and aid in the development of the Typical Section Package.

If a PD&E phase has been completed, some of the activities listed above may have been performed to varying levels during that phase. The information contained in the preliminary engineering report should be considered as the starting point for the initial engineering phase. When there was no PD&E phase, the initial engineering design activities must establish the project scope, controls, criteria, and standards, data gathering requirements, right of way (R/W) needs, and major design elements necessary to determine that the project is viable and R/W can be cleared.

110.3 Scope, Objectives, Schedule, and Budget

The Department's project manager is responsible for the development, review and approval of the project objectives, scope of work, and schedule in accordance with the [Project Management Guide](#). They must also verify that required funds are in the work program.

The project objectives and scope are best confirmed and completed by:

- (1) Reviewing the PD&E study recommendations, conclusions, and commitments including any safety needs.
- (2) Review, select, and prioritize any of the overlapping safety projects identified in the Department's Safety Needs Dashboard with coordination and approval of the District Traffic Operations Engineer and/or District Safety Administrator.
- (3) Performing a field review of the project with the project manager and personnel from appropriate FDOT offices, such as Roadway Design, Traffic Operations, Safety, Right of Way, Utilities, Landscape, Survey, Maintenance, and Construction.
- (4) Requesting a review of the draft scope of services activities by FDOT offices, such as Maintenance, Construction, Design, Traffic Operations, Access Management, Public Transportation, Pedestrian and Bicycle, and Environmental Management.
- (5) Developing the scope of services sufficient to advertise for professional services. After the scope of services is completed and approved, the schedule and budget may be confirmed and updated by the engineer/project manager and approved by the appropriate district manager. The scope of services should anticipate and include:

- (a) The most cost-effective methods that may be used in Subsurface Utility Engineering (SUE) for locating subsurface anomalies, structures, buried fiber optic cable, and utilities.
- (b) Opportunities to accommodate existing trees, proposed trees, and other long-lived plants.

After consultant selection or in-house assignment, the designer or consultant should review and confirm the scope of services.

110.4 Project Design Controls and Standards

Selection of appropriate project design controls and standards ensure that the facility will function safely at the level desired and expected by motorists, pedestrians, and cyclists. The Engineer of Record (EOR) is responsible for establishing project design controls and standards to be used in the development of the construction plans. Place documentation for the selected project design controls and standards in Project Documentation (see **FDM 111.7**).

The design controls as addressed in this manual include:

- design speed
- design vehicle
- design period
- traffic volumes
- level of service
- functional classification
- access classification
- context classification

Other factors that control the selection of project design controls and standards include right of way constraints, utility conflicts, and preservation of large trees.

The Preliminary Engineering Report (PER) or project concept report may include some of the project design controls and standards to be used on the project. These design parameters should be reviewed, confirmed as valid and consistent with the overall corridor or system, and documented.

See **FDM 201.5** for information on selecting the appropriate design speed for the project.

Either a Design Exception or Design Variation, as described in **FDM 122**, must be obtained when selected project design controls and standards do not meet Department's criteria.

110.4.1 Sole Sourced Products or Processes

Sole sourcing products or processes occurs when the EOR specifies a proprietary product or process within the construction contract documents which results in the exclusion of other products or processes that may perform the same or similar function. Sole sourcing must be justified by the EOR, reviewed by District and Central Office Technical Experts, and approved by the District Design Engineer. Identify these features as early in the design process as possible and provide the approved justification prior to the Phase III submittal.

Provide justifications that factually and technically support the sole sourcing of the proprietary product or process. Address why sole sourcing is reasonable and necessary to fulfill the project's needs. Complete the Sole Sourcing Approval along with supporting documents and justification as needed in the PSEE module. The State Product Evaluation Administrator will verify the Approved Product List (APL) number, and/or invite the manufacturer to apply for listing on the APL.

110.5 Support Services

Review information or support services that have been provided to determine the completeness and currency of data used in previous studies/reports.

Technical data required for the design of a roadway project can be available from various sources, such as:

- (1) Surveys - design, topographical, aerial, drainage, right of way location, soil, utilities
- (2) Traffic Data
- (3) Pavement Design
- (4) Environmental Documents (including Noise Study Report and wildlife connectivity recommendations)
- (5) Original Plans
- (6) Crash Data
- (7) Roadway Characteristics Inventory (RCI)
- (8) As-Built Drawings
- (9) Intelligent Transportation Systems Facility Management (ITSFM) Documentation

During the design process, the project will require coordination with different sections or offices. When engineering decisions, information, or other support services are required

from FDOT functional areas, it is the project manager's responsibility to coordinate and facilitate the request and expedite a timely response. The functional areas include but are not limited to:

- | | |
|----------------------------------|---|
| (1) Planning and Programs | (16) Structures |
| (2) Surveying and Mapping | (17) Safety |
| (3) Traffic Design | (18) Plans Review |
| (4) Geotechnical | (19) Public Transportation |
| (5) Drainage | (20) Landscape Architecture |
| (6) Maintenance | (21) Tolls Design |
| (7) Construction | (22) Intelligent Transportation Systems |
| (8) Utilities | (23) Lighting / Electrical |
| (9) Estimates and Specifications | (24) Architecture |
| (10) Right of Way | (25) Materials |
| (11) FHWA | (26) Turnpike Concepts |
| (12) Value Engineering | (27) Central Office |
| (13) Traffic Operations | (28) Program Management |
| (14) Environmental Management | |
| (15) Access Management | |

110.5.1 Project Aviation Requirements

Federal regulations exist to protect the national airspace system and must be considered when planning, designing and constructing a Department project. The Department must comply with the requirements of [**Title 14 Code of Federal Regulations \(CFR\), Part 77 \(14 CFR, Part 77\)**](#) regarding the construction or alteration of existing or proposed permanent and temporary structures.

Place the FAA Determination in accordance with **FDM 111.7.2.12**.

110.5.1.1 Required Coordination

Responsibility for complying with **14 CFR, Part 77** ultimately rests with the Department. However, the responsibility for filing FAA notifications rests with the Engineer of Record. The FAA notification process is a complex and lengthy process; therefore, coordinate with both of the following as early as possible in the initial phases of the project for assistance:

District Aviation Coordinator and Airspace and Land Use Manger
Aviation and Spaceports Office
<https://www.fdot.gov/aviation/>

110.5.1.2 FAA Notification Guidelines

The FAA provides a [Notice Criteria Tool](https://oeaaa.faa.gov/) via the Obstruction Evaluation/Airport Airspace Analysis (OE/AAA) website (<https://oeaaa.faa.gov/>). Unless exempt from filing notice per **14 CFR, Part 77**, this tool must be used to determine if the construction activity or alteration requires notice to the FAA.

If notice is required, use [FAA Form 7460-1, "Notice of Proposed Construction or Alteration"](#). **Form 7460-1** should be submitted electronically through the FAA's Obstruction Evaluation/Airport Airspace Analysis (OE/AAA) website:

<https://oeaaa.faa.gov/>

The website allows filing multiple "points" in a matrix on a single **Form 7460-1**. Early submission is recommended to avoid required design changes or delays in letting or construction.

Submission of **Form 7460-1** will result in the FAA issuing a Determination whether the obstruction constitutes a hazard to air navigation in accordance with **14 CFR, Part 77**. Construction may not commence until the FAA issues a Determination. If the obstruction is determined to be a hazard, the construction may not proceed according to **Chapter 333, F.S.**

FAA Emergency Notification:

Emergency notifications are rarely granted. In such a case, the required notification may be sent by telephone or any expeditious means to the nearest FAA Flight Service Station, and within 5 days thereafter, a completed copy of the **FAA Form 7460-1**, must be submitted to the FAA Southern Regional Office in Atlanta.

110.5.2 Projects Involving Existing Bridges

Coordinate with appropriate offices and functional areas on projects that involve existing bridges as described below.

110.5.2.1 Projects Involving Steel Bridges

For all projects that involve the repair, repainting or replacement of a steel bridge, the Design Project Manager must contact the State Corrosion Engineer in the State Materials Office and the District Contamination Impact Coordinator (DCIC) to determine if the bridge contains lead or other hazardous elements. The State Corrosion Engineer and DCIC will furnish a Modified Special Provision for disposition of the lead based paint waste for that particular project.

The Design Project Manager must provide the Modified Special Provision to the Engineer of Record who is preparing the contract plans and specifications. The Engineer of Record must ensure that the project specifications include Modified Special Provision and that they prohibit the use of lead based paint. A mandatory pre-bid conference is not required unless special conditions exist and the district determines one is needed.

110.5.2.2 Projects Involving Bridges with Asbestos-Containing Materials

There may be asbestos-containing materials (ACM) used in bridges. Projects involving bridges that are to be either partially or fully demolished or renovated require an asbestos survey to be conducted by a licensed Asbestos Consultant. This should be completed as early in the project as possible to determine the nature and extent of ACM and if abatement is required. Some bridge elements potentially containing asbestos include (but are not limited to) the following:

- (1) Tender House Roof Materials (e.g., felts, flashings, mastics)
- (2) Tender House Floor Materials (e.g., tiles, sheet flooring, mastics)
- (3) Tender House Wall Materials (e.g., drywall muds, joint compounds)
- (4) Tender House Window Materials (e.g., caulks, gaskets)
- (5) Bridge Equipment Materials (e.g., gaskets, packings, linings, insulation)
- (6) MSE Wall Gaskets
- (7) Beam/Deck Bearing Pads

- (8) Asbestos-cement pipes (e.g., scuppers)
- (9) Bascule Bridge Machinery Brake Pads
- (10) Troweled-on or Sprayed-on Decorative Coatings

110.5.2.3 Projects Involving Bridge Demolition

At or before the 30% plans phase, the Department will determine if it has a need for the debris resulting from the demolition of a bridge. If no such need exists, and in response to **Section 1805, SAFETEA-LU Legislation**, the Department is then required to notify local, State and Federal government agencies of the availability of the bridge debris for their beneficial use (use as shore erosion control or stabilization, ecosystem restoration, and marine habitat restoration). For any projects that involve the complete demolition of a bridge, the Design Project Manager is required to notify these agencies of the availability of the resulting debris. The Bridge Development Report (BDR)/30% Structure Plans (see **FDM 121**) will include the approximate volume of debris and the estimated timeframe in which the material will be available.

The Design Project Manager must coordinate with the receiving agency and the District Construction Engineer to develop a Joint Project Agreement. The receiving agency will be responsible for all additional costs associated with the processing, delivery, placement, and use of the material. The following items must be determined in order for the Joint Project Agreement to be developed:

- (1) The volume of raw (unprocessed) debris (a more detailed quantity than original estimate).
- (2) The estimated timeframe for the debris availability.
- (3) The location of the receiving agency's staging/storage site to which the raw debris is to be delivered. Any further work involving processing and final placement of the material is expected to be the responsibility of the receiving agency and not part of the FDOT's contract for bridge demolition.
- (4) An estimated cost to transport the debris to that site. This estimate will be the amount the receiving agency must pay the FDOT.

Once this information is determined, the contract plans will include the instructions for the delivery of the debris.

If no agency expresses interest in the debris material, then the material will be disposed of in accordance with FDOT Specifications.

Requirements for the original notification to agencies (including a sample Notification Letter) and the resulting Joint Project Agreement are found on the [Project Management](#) website.

The demolition of bridges with ACM requires that Asbestos Abatement Plans be developed by a licensed Asbestos Consultant. **FDM 110.5.2.2** and the [Construction Project Administration Manual \(CPAM\)](#), **Section 10.4** contain additional requirements for projects involving demolition of bridges with ACM.

110.5.2.4 Local Roadways on Department-owned Bridges

Evaluate Department-owned bridges that carry local roadways over Department Right-of-Way to ensure compliance with the requirements of the **FDM** and **Structures Design Guidelines (SDG)**. Include needed retrofits or other improvements (e.g., traffic railings, guardrail transitions, pier protection) in the project scope.

110.5.3 Projects Involving Bridges Over Navigable Water

For projects involving bridges over navigable water, the Design Project Manager must provide the District Structures Maintenance Engineer (DSME) sufficient notification prior to engaging in any action in, on, or around the bridge(s). This includes any field reviews involving persons conducting activities that may be perceived as suspicious (e.g., parking on the bridge, repeated viewing from a boat or other vehicle, carrying cameras and other electronic equipment like a GPS, etc.). This will allow the DSME to notify the U.S. Coast Guard prior to such activities taking place.

110.5.4 Wildlife Connectivity

Wildlife connectivity features include new or modified structures; e.g. bridges, bridges with shelves, specially designed culverts, enlarged culverts, or drainage culverts. Exclusionary devices such as fencing, walls or other barriers may be included to funnel wildlife to a crossing. Disciplines that may be involved in this effort include Structures, Roadway, Drainage, Environmental Management, Permitting, Right of Way, and Utilities.

Wildlife connectivity needs are usually identified during the PD&E study. However, coordinate with the District Environmental Management Office and District Permit Office early in the design phase for determination of the type, size and other parameters for the wildlife crossing feature. For further guidance on wildlife connectivity refer to the [FDOT Wildlife Crossing Guidelines](#), commitments section of the Environmental Document, and any other documentation regarding the wildlife connectivity related to the project.

In the event that wildlife connectivity needs are not identified until after the design process has begun, immediately start the coordination process with the District Environmental Management Office and District Permit Office.

110.5.5 Interstate Projects Affecting Logo Structures

Determine if the construction activities on Interstate mainline or ramp projects may impact logo sign structures. Any affected logo structures must be identified so those logo structures can be properly addressed in the plans. Once the affected logo structures are identified, the designer must coordinate with the State Outdoor Advertising and Logo Manager, the Logo Program Contractor, and the District Traffic Operations Office to determine if the logo structures need to be relocated or redesigned during construction. Through this coordination, the following questions must be answered:

- (1) Will the construction activities require the relocation of any logo structures during construction?
- (2) Where will the logo structures be reinstalled?
- (3) Will an upgrade of the sign panel, support or foundation of the affected logo structure be required?

The disposition (e.g., relocate, furnish & install) of affected logo structures must be addressed in the plans and paid for as specified in the [*Basis of Estimates Manual*](#).

Refer to the Logo Sign Program web page for additional information:

<https://www.fdot.gov/rightofway/LogoSignProgram.shtm>

110.5.6 Products and Source of Supply

The Buy America provisions are included in the Build America, Buy America Act (BABA). All projects must comply with the BABA provisions, established in **Public Law No. 117-58, §§ 70901-52 and 23 CFR 635.410**. BABA requirements are covered in **FDOT Standard Specifications, Section 6**. The allowable levels of foreign steel or iron, and contractor certification requirements are identified in **Specification 6-5.2**.

For BABA requirements, the term “Federal funds” is not limited to Federal Highway Administration (FHWA) funds or construction projects with a federal project number. Some state or local funds may have originated with other federal funding programs. Therefore, all FDOT projects will be subject to the same BABA requirements regardless of funding sources.

BABA includes items on construction projects that will remain in place as part of the permanent installation. Exceptions exist for temporary products and manufactured products, as identified on the APL.

While **Specification 6-5.2** applies to contractors, designers also have a responsibility to ensure BABA is met. When BABA is not met, project funding may be affected. The design engineer of record must perform sufficient research to ensure these requirements are met.

This research is necessary when the plans include the following:

- (1) Non-standard or special grade steel components and shapes.
- (2) Proprietary products not on the APL.
- (3) Sole sourced products not on the APL.
- (4) Special machinery with steel or iron components.
- (5) Heavy sections of steel sheet pile wall.

It is not necessary to conduct such research for the following:

- (1) Standard domestic steel beams and shapes of standard grades as shown on the National Steel Bridge Alliance (NSBA) website.
- (2) Standard concrete reinforcing steel sizes and grades.
- (3) Standard steel drainage pipe sizes and gages.
- (4) Items included on the APL that are domestically sourced.
- (5) Items covered in the [Standard Plans](#) including:
 - (a) Standard mast arm assemblies.
 - (b) Standard steel guardrail, posts, and end treatments.
 - (c) Standard drainage grates.
 - (d) Standard steel fences.
 - (e) Standard steel sign supports and structures.

For iron or steel products, if it is determined that the product being proposed is not manufactured in the United States, then the Designer must determine if the estimated costs of such foreign steel or iron is within the thresholds stated in the specification. If the costs exceed such threshold, the Designer must explore alternatives that utilize domestic steel or iron, or seek a waiver from FHWA. Generally, it is preferred to select a different engineering solution utilizing domestic products.

For all other products, if it is determined that the product being proposed is not manufactured in the United States, then the Designer must explore alternatives that utilize domestic products, or seek a waiver. Contact the State Product Evaluation Administrator for assistance. Generally, it is preferred to select a different engineering solution utilizing domestic products.

Product Evaluation will assist Designers with inviting manufacturers to submit documentation for APL listing.

Should a waiver become necessary, it must be obtained before the contract letting to ensure federal funding is not jeopardized. Submit BABA waiver requests to the Central Office for concurrence by the Directors of Design and Construction and notify the Office of Work Program of the requests. Upon concurrence, requests will then be forwarded to the FHWA Florida Division Office for approval and coordinated with the FHWA headquarters in Washington, D.C. for further concurrence. Originals will be returned to the District by the Central Office. These issues must be identified early in the plans preparation process.

110.5.7 Traffic Monitoring Sites

One or more traffic monitoring sites should be considered for addition to each construction project which has a type of work consistent with the construction of such sites. Examples of compatible work types include traffic signals, resurfacing, reconstruction, and other work that involves either pavement surfaces or electrical systems. Inquiries about monitoring sites should be addressed to the Traffic Data Section Manager of the Traffic Data & Analytics Office, Office of Planning.

110.5.8 Fire Suppression Systems

The Department has determined that the details for standpipes, valves and hydrants that have been used on past projects for fire suppression systems located within traffic railings and roadway barriers present significant snag hazards for errant vehicles and thus are not crashworthy. The Department has also determined that there is insufficient justification for incorporating fire suppression systems into, on or attached to traffic railings and roadway barriers in an attempt to improve safety during an extreme event, (e.g. a vehicle fire).

FDOT owned fire suppression systems are not allowed on bridges, retaining walls or limited access facilities unless they are approved by the Chief Engineer due to special circumstances. Commonly occurring traffic related incidents will not be considered as special circumstances or as justification for the installation of any fire suppression system.

If an FDOT fire suppression system is approved, agreements must be executed with a local agency to bear all installation costs, repair costs and maintenance functions.

Any fire suppression system that is not owned by FDOT is defined by **Section 337.401, (F.S.)** as a utility and is not to be issued a utility permit unless approved by the Chief Engineer in accordance with **Rule 14-46.001, Florida Administrative Code** and the Utility Accommodation Manual.

110.5.9 Trees, Landscape, and Landscape Irrigation Systems

Consistent with Department policy, determine how the project can be designed to accommodate existing desirable trees and proposed trees. Determine if commitments have been made to preserve or provide trees, landscape, or landscape irrigation systems. Determine if a landscape project is programmed or proposed as a component or standalone by the Department or a local agency.

The District Landscape Architect will determine the level of preservation, tree relocation, or invasive species eradication involved. Projects that impact desirable trees typically require Selective Clearing and Grubbing plans (see **FDM 229** and **924**).

Coordinate with the District Landscape Architect to determine the following:

- Whether design alternatives could reduce impacts to existing vegetation.
- Whether existing trees will be saved or relocated (if avoidance is not an option). This will determine the prioritization of the level of required funding.

110.5.10 Projects Involving Trails

For projects involving trails (e.g., Florida National Scenic Trail, SUN Trail, bike routes, etc.) intersecting or along the right-of-way, coordinate with the trail owner to ensure the use of the trail is not interrupted during construction.

110.6 Preliminary Geometry

To establish geometry, the following activities should be accomplished or near completion:

- (1) Supporting data such as surveys, traffic, and pavement evaluation data.
- (2) Typical sections and pavement design.
- (3) Standards, Design Variations, and Design Exceptions.
- (4) PD&E commitments addressed.
- (5) Need for R/W phase addressed.
- (6) Utility initial contact and survey data.
- (7) Transit initial contact and facility location.

The initial engineering design activities to establish the preliminary project plans are:

- (1) Set and calculate the horizontal alignment.
- (2) Set the proposed profile grade lines.
- (3) Develop preliminary cross sections at selected intervals or control locations.
- (4) Develop preliminary layout of roadway, intersections, interchanges, transitions, and connections.
- (5) Field review all proposed preliminary engineering layout and decisions for conflicts, R/W needs, connections, updates, and additional needs.

The initial engineering review is used to obtain confirmation and approval of the objectives, scope, standards, decisions, and assumptions to be used as the basis for the engineering and design.

The above activities should result in the following:

- (1) Structures can now be given the horizontal and vertical alignment and clearance requirements for bridges.
- (2) R/W Engineering can be furnished with mainline R/W requirements for the project.
- (3) Plan-profile sheets can be clipped.
- (4) Traffic plans development can be initiated.
- (5) Cross sections, grades, and alignments, as required, can be provided to the drainage section.
- (6) Work sheets, as needed, can be provided to the permits section for initial evaluation.

- (7) Utility/Agency Owners (UAOs) can be provided plans, profiles and cross sections as required to identify/verify and designate their existing utilities as well as indicate proposed installations.
- (8) The list of pay items can be loaded into Designer Interface by identifying the items of work involved at this stage of design.
- (9) The need for noise barriers has been confirmed and locations established.
- (10) Subsurface work can be performed free of conflicts with underground FDOT infrastructure.

111 Final Engineering Design Process

111.1 General

The final engineering design process follows the initial engineering design process and review. The primary objective of the final engineering design phase is to prepare contract plans and specifications that can be used to bid and construct the project with a minimum number of field changes, delays, and cost overruns.

Modification for Non-Conventional Projects:

Delete the above paragraph and replace with the following:

The primary objective of the final engineering design phase is to prepare contract plans and specifications sufficient to meet the contract requirements.

On projects requiring Federal authorization where the Design Phase and the PD&E Phase overlap, the Department must receive Location Design Concept Acceptance (LDCA), prior to acceptance of the Phase II submittal (prior to advancing into Final Design). To advance past Phase II coordinate with the Environmental Management Office who will work with FHWA (see **Part 1, Chapter 4** of the [PD&E Manual](#)). The Design Project Manager must coordinate with the PD&E Project Manager, and the District Environmental Management Office to ensure that that the Department has received LDCA for the project. The Design Project Manager will need to convey this information to the district federal aid staff in the District Work Program Office. **Figure 111.1.1** shows the major activities included in the final engineering design process.

Modification for Non-Conventional Projects:

Delete the first two sentences of the above paragraph and replace with the following:

On projects requiring Federal authorization where the Design Phase and the PD&E Phase overlap, the Department must receive Location Design Concept Acceptance (LDCA), prior to release of the final RFP.

Figure 111.1.1 Major Activities – Final Engineering Design Process

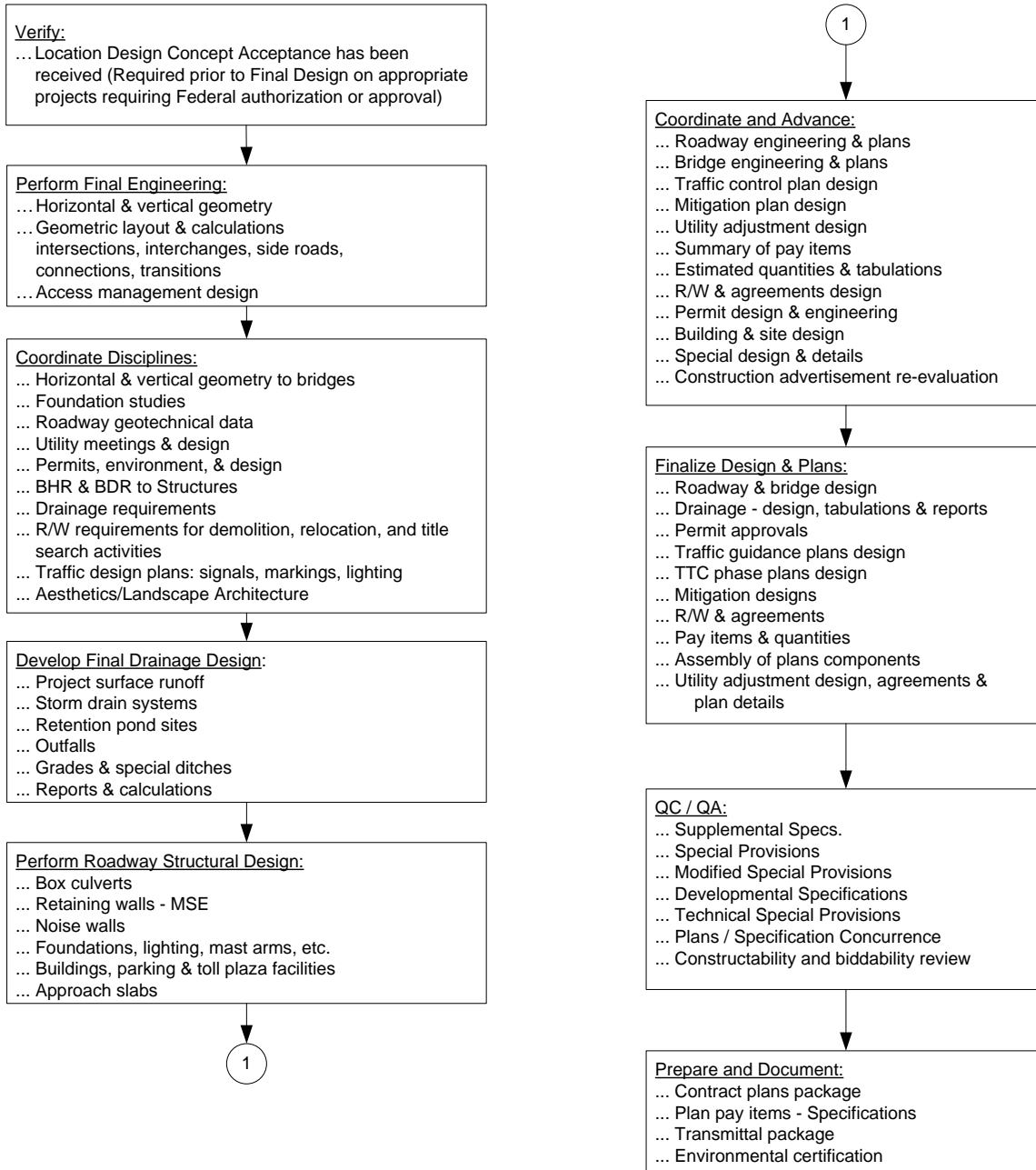

111.2 Final Engineering Design

The Engineer of Record (EOR) and Design Project Manager must coordinate activities to ensure that the quality, accuracy, and appropriate decisions go into the performance of each step. The project quality control should include a plan-do-check routine for each set of activities or operations.

The major design activities include, but are not limited to, the following:

- (1) Pavement design
- (2) Drainage design
- (3) Structural (bridge) design
- (4) Structural (roadway) design
- (5) Roadway design including access management, earthwork, selective clearing and grubbing, geometrics, ADA
- (6) Traffic plans design including signing, marking, signals, lighting
- (7) Utility adjustment design
- (8) Permit preparation design including ponds, mitigation
- (9) Temporary Traffic control plans (work zone) design
- (10) R/W requirements design
- (11) Building and site design including landscaping, ADA, transit
- (12) Estimates and Quantities preparation
- (13) Specifications and special provisions
- (14) Landscape design including accommodating existing and proposed vegetation.
- (15) Noise barrier design

Modification for Non-Conventional Projects:
Delete item 12 above.

111.2.1 Work Program Administration (WPA) System

Project stationing information is to be checked and entered into the Work Program Administration (WPA) system during final engineering design. This information is important for tying construction records, such as material coring, sampling and testing to other databases. The information is entered by stations, which are related to roadway mile post for later information retrieval.

The begin and end stations, and station equations are entered into the WP50 computer screen under FM on the FDOT CL/SUPERSESSION Main Menu for each WPA location. After logging onto SUPERSESS, the WP50 designees enter on FM (Financial Management System). On the FM Main Menu, press ENTER: 3 for WPA (Work Program Administration). On WPA Main Menu, press ENTER: 25 for WP50 (Station Definition).

Update access to WP50 screen is granted through the Work Program Development Office in Tallahassee. Listed below are the important edit and browse features:

- (1) Only enter FM Item Segment number on the top line.
- (2) The RDWYLOC sequence number displays on the top line of the screen and on the first line of the header information. It's entered on the top line to retrieve a particular location.
- (3) The transaction type "00" is entered on the top line to browse station equation information for that RDWYLOC. The transaction type "02" is entered on the top line to update station equation information for that RDWYLOC. The transaction type "99" is entered on the top line to erase station equation information for that RDWYLOC.
- (4) Press the F8 key will forward from one RDWYLOC to the next RDWYLOC on the same Item Segment number. Press ENTER key to update or delete data on the screen depending on the transaction type but will not page forward.
- (5) Press F3 key will take the user to the FM main menu while press F15 key will take the user back to the SUPERSESS main menu.

After entering the station information, it is important to verify the milepost limits in WPA are still accurate. This can be accomplished by reviewing the WP50 computer screen.

If the project length has changed, the District Work Program Office should be advised to correct the mileposts.

111.3 Contract Plans and BIM Files

The products of the engineering design activities are component sets of contract plans. The major component sets may include:

- (1) Roadway
- (2) Signing and Pavement Marking
- (3) Signalization
- (4) Intelligent Transportation Systems (ITS)
- (5) Lighting
- (6) Landscape
- (7) Architectural Plans
- (8) Structures Plans
- (9) Toll Facilities

Each Utility Work by Highway Contractor Agreement may have a separate phase for each Financial Project Identification Number (FPID). The plan set for each agreement is placed in the back of the contract plans set under the associated FPID.

Modification for Non-Conventional Projects:

Delete the two sentences above and see the RFP.

These component sets, the specifications package, and the pay items list with calculated quantities are assembled and packaged as the construction contract letting documents.

Modification for Non-Conventional Projects:

Delete the sentence above and replace with the following:

These component sets and the specifications package are assembled and packaged as the construction contract documents.

BIM files are signed and sealed 2D or 3D CADD files that are included with the contract plans. See [FDOT CADD Manual](#), **Section 5.16** for instruction on the development of BIM files.

111.4 Standard Specifications and Special Provisions

The EOR must develop engineering designs that can be constructed, controlled, measured and paid for under the current [Standard Specifications](#).

In the event the work required is not covered by the Standard Specifications or the supplements and special provisions thereto, the EOR must develop a Modified Special Provision (MSP) or Technical Special Provision (TSP) to be made part of the Specifications Package for the project.

See **FDM 901.3** for phase submittal requirements.

The approval process for MSPs and TSPs are different, described as follows:

111.4.1 Modified Special Provision

MSPs are used to modify Standard Specifications language to reflect specific project needs not addressed in the applicable Standard Specifications eBook. These should be submitted to the District Specification Engineer as early as practical, but not later than Phase III submittal. After the District Specification Engineer concurs with the changes, the MSP will be forwarded to the State Specifications Engineer for their approval. There is often collaboration between District, Central Office, and the designer prior to approval by the State Specifications Engineer.

111.4.2 Technical Special Provision

TSPs are used for specific elements of construction not covered within the **Standard Specifications eBook**.

TSPs describe:

- The work to be performed,
- requisite materials,
- construction or installation requirements, and
- measurement and pay item information.

TSPs should be developed and entered into Electronic Review Comments (ERC) as early as practical, but not later than Phase III submittal. TSPs are not to be loaded into ERC with phase submittal documents (i.e., keep these reviews separate).

District Specifications and Estimates Office reviewers, and appropriate technical discipline reviewers will provide comments through ERC. The State Program Management Office may assist the district with the review of a TSP, when requested. After the TSP ERC comments have been reconciled, the District Specifications Office will coordinate the required legal review with the (District/Department) General Counsel. After receiving concurrence from the General Council, District Specifications Office will approve the TSP.

In the event the need for a TSP is identified later than Phase III, coordinate with the District Specifications Office to expediate the approvals and concurrence by (District/Department) General Counsel.

Instruction on the preparation of Specification Packages can be found in the [Specifications Handbook](#).

111.5 Pay Items and Summaries of Quantities

Pay Items and Summaries of Quantities are provided in the Estimated Quantities Report (see **FDM 902**).

Modification for Non-Conventional Projects:

Delete FDM 111.5 .

111.6 PS&E Submittal Package

A Plans, Specifications, and Estimates (PS&E) submittal package consists of the final Plans, Specifications, and Estimates, along with any other contract and transmittal documents. **FDM 131** provides further guidance on the contents of the transmittal.

Modification for Non-Conventional Projects:

Delete FDM 111.6 .

111.7 Project Documentation

The submittal of project documentation is required for all projects. Place required project documents in Project Suite Enterprise Edition (PSEE) within the Design Development Documentation (DDD) Module concurrent with the second PS&E submittal. Place only final documents in this folder structure; do not submit working files or draft documents. Standard file format is PDF; however, an Excel spreadsheet may be placed in the folder structure if protected to prohibit changes.

When the PSEE module is fully populated and no additional plan changes are expected, the Department will lock the Design Development Documentation Module, typically not later than the project advertisement date. Project managers do not inherit the ability to modify the status of the DDD module within the project. This permission is controlled by the district wide permission “Manage Design Documentation Module Status,” and each district should have a policy of how this permission is assigned.

Place PD&E documents in the Office of Environmental Management’s SWEPT (Statewide Environmental Project Tracker) application.

111.7.1 File Naming Convention

Although the filename is limited to 240 characters, the number of characters used should not exceed 48. Filename is not to contain spaces or special characters (!@#%&^*+). Filenames are not case sensitive; however, the use of uppercase letters to begin each word in the filename is encouraged. Recommended filenames for submitted documents are provided in **Table 111.7.1**.

Additional document description may be provided using a hyphen before the identifying information, for example:

- TempRetainingWallDesignCalculations-TempRetWall2
- DesignVariation-Sidewalk
- StructuresGeotechReport-MSERetWall
- RoadwayGeotechReport-PondSoilSurvey

111.7.2 Documents

Include the list of documents contained in **Table 111.7.1** when the document must be produced to support the development of the contract plans. Include other final supporting documents, reports, or calculations not listed in this table if applicable.

Include any correspondence (e.g., memorandums, meeting minutes, emails) when design decisions are expressed. Assemble a single PDF that contains all applicable documents pertaining to the subject in chronological order. Include document subject in the name using a hyphen (e.g., Correspondence-GreenBikeLanes.pdf).

Table 111.7.1 – Document Summary Table

PSEE Folder	Document Type	Document	File Name
APPROVALS	ICE Report	ICE Report	ICEReport
	Variations-Exceptions	Design Variation Package	DesignVariation
		Design Exception Package	DesignException
		Design Memorandum	DesignMemo
		Project Design Variation Memorandum	ProjectDesignVariationMemo
	Approval Docs	Project Correspondance	Correspondance
		Lane Repurposing Approval	LaneRepurposingApproval
		Federal Aviation Administration (FAA) Determination	FAADetermination
		Intersection Number Request Form	IntersectionNumberRequestForm
		Contract Time Memorandum	ContractTimeMemo
		Permit Exemption Letter	PermitExemptionLetter
		Structure Number Request Form	StructureNumberRequestForm
		Value Engineering Report	ValueEngineeringReport
	ROADWAY	Typical Section Package	Typical Section Package
Pavement Design Report		Pavement Design Report	PavementDesignReport
Roadway Docs		AutoTurn Analysis	AutoTurnAnalysis
		Superelevation Analysis	SuperelevationAnalysis
		Cross Slope Evaluation	CrossSlopeEvaluation
		Barrier Length of Need Analysis	LengthofNeedAnalysis
		Sight Distance Analysis	SightDistanceAnalysis
		Lane Closure Analysis	LaneClosureAnalysis

Table 111.7.1 – Document Summary Table Cont.

PSEE Folder	Document Type	Document	File Name
ROADWAY	Roadway Docs	Work Zone Speed Study	WorkZoneSpeedStudy
		Summary of Pay Items Report	SummaryPayItemsReport
		Cross Section Sheet	CrossSectionSheet
		Transportation Management Plan	TransportationManagementPlan
		Project KMZ File	ProjectKMZFile
		ADA Assessment Report	ADA-AssessmentReport
		Roadway Safety Assessment Report	RoadwaySafetyAssessmentReport
		Roadway Operational Assessment Report	RoadwayOperationalAssessmentReport
		Existing Roadway Characteristics Assessment Report	ERCAR
		Community Awareness Plan	CommunityAwarenessPlan
		Express Lanes Separation Treatment Selection Memo	ELSeparationTreatmentSelectionMemo
DRAINAGE	Drainage Docs	Location Hydraulics Report	LocationHydraulicsReport
		Bridge Hydraulics Report	BridgeHydraulicsReport
		Pond Siting Report	PondSitingReport
		Drainage Report	DrainageReport
		Base Clearance Water Evaluation Report	BaseClearanceWaterEvaluation
		Pipe Inspection Report	PipeInspectionReport

Table 111.7.1 – Document Summary Table Cont.

PSEE Folder	Document Type	Document	File Name
SandPM	SandPM Docs	Attachment to Barrier Calculations	AttachmentToBarrierCalculations
		Multi-Post Sign Report	MultiPostSignReport
		Concept Signing Plan	ConceptSigningPlan
SIGNALS	Signals Docs	Sub-Surface Utility Location Form (mast arm location)	SubSurfaceUtilityLocationForm
SIGNALS ITS	Signals Docs ITS Docs	Signal Warrant Report	SignalWarrantReport
		Signal Analysis Report	SignalAnalysisReport
		ITS Concept of Operations	ITSConceptOfOperations
ITS	ITS Docs	ITS Power Design Analysis Report	ITSPowerDesignAnalysis
		Express Lanes Systems Engineering Management Plan	ELSystemEngineeringManagementPlan
		Express Lanes Concept of Operations	ELConceptOfOperations
LIGHTING	Lighting Docs	Voltage Drop Calculations	VoltageDropCalculations
		Lighting Justification Report	LightingJustificationReport
		Lighting Design Analysis Report	LightingDesignAnalysisReport
		Intersection Lighting Retrofit Report	IntersectionLightingRetrofitReport
		Lighting Agency Coordination	LightingAgencyCoordination

Table 111.7.1 – Document Summary Table Cont.

PSEE Folder	Document Type	Document	File Name
LANDSCAPE	Landscape Docs	Landscape Maintenance Plan	LandscapeMaintenancePlan
		Landscape Maintenance Cost Estimate	LandscapeMaintenanceCostEstimate
		Irrigation Feasibility Report	IrrigationFeasibilityReport
		Landscape Opportunity Plan	LandscapeOpportunityPlan

Table 111.7.1 – Document Summary Table Cont.

PSEE Folder	Document Type	Document	File Name
STRUCTURES	Structures Docs	Bridge Structure Design Calculations	BridgeStructureDesignCalculations
		Temporary Detour Bridge Calculations	TempDetourBridgeCalculations
		Bridge Load Rating Report	BridgeLoadRatingReport
		Temporary Retaining Wall Design Calculations	TempRetainingWallDesignCalculations
		Temporary Shoring Design Calculations	TempShoringDesignCalculations
		Retaining Wall Design Calculations	RetainingWallDesignCalculations
		Overhead Sign Structure	OverheadSignStructureDesignCalculations
		Mast Arm Design Calculations	MastArmDesignCalculations
		Box Culvert Design Calculations	BoxCulvertDesignCalculations
		High Mast Lighting Design Calculations	HighMastLightingDesignCalculations
		Ancillary Structures Report	AncillaryStructuresReport
Bridge Development Report	BridgeDevelopmentReport		

Table 111.7.1 – Document Summary Table Cont.

PSEE Folder	Document Type	Document	File Name
TOLLS	Tolls Docs	Toll Siting Technical Memorandum	TollSitingTechMemo
		Express Lanes Diagrams and Concept Plans	ELDiagramsAndConceptPlans
		Tolls Mechanical Design Analysis	TollMechanicalDAR (required for Toll Equipment Buildings Only)
		Tolls Structural Design Analysis Report	TollStructuralDAR
		Tolls Gantry Design Analysis Report	TollGantryDAR
		Tolls Power Design Analysis Report	TollPowerDAR
		GTR Deviations	GRTDev_XX
ARCHTECTURAL	Architect Docs	Electrical Calculations	ElectricalCalculations
		Mechanical Calculations	MechanicalCalculations

Table 111.7.1 – Document Summary Table Cont.

PSEE Folder	Document Type	Document	File Name
ARCHTECTURAL	Architect Docs	Plumbing Calculations	PlumbingCalculations
		Structural Calculations	StructuralCalculations
		Water Feature Hydraulic Calculations	WaterFeatureHydraulicCalculations
		Civil Site Design Documentation	CivilSiteDesignDocumentation
		Electrical Design Analysis Report	ElectricalDesignAnalysisReport
		Mechanical Design Analysis Report	MechanicalDesignAnalysisReport
GEOTECH	Geotech Docs	Roadway Geotechnical Report	RoadwayGeotechReport
		Sign Structure Geotechnical Report	SignStructureGeotechReport
		Signal Structure Geotechnical Report	SignalStructureGeotechReport
		ITS Geotechnical Report	ITSGeotechReport
		Lighting Geotechnical Report	LightingGeotechReport
		Structures Geotechnical Report	StructuresGeotechReport
		Architectural Geotechnical Investigation Report	ArchitecturalGeotechInvestigationReport

112 Update Engineering Design Process

112.1 General

An update engineering design process is required when nine months or more has elapsed since final contract Plans, Specifications, and Estimates (PS&E) package was completed. The requirements of the update process depend on:

- (1) Type of project
- (2) Adequacy and appropriateness of the original design controls and standards
- (3) Original scope and objectives.

Determining the extent of the update process, as shown in **Figure 112.1.1**, requires input from both engineering and management.

Figure 112.1.1 Major Activities - Update Engineering Design Process

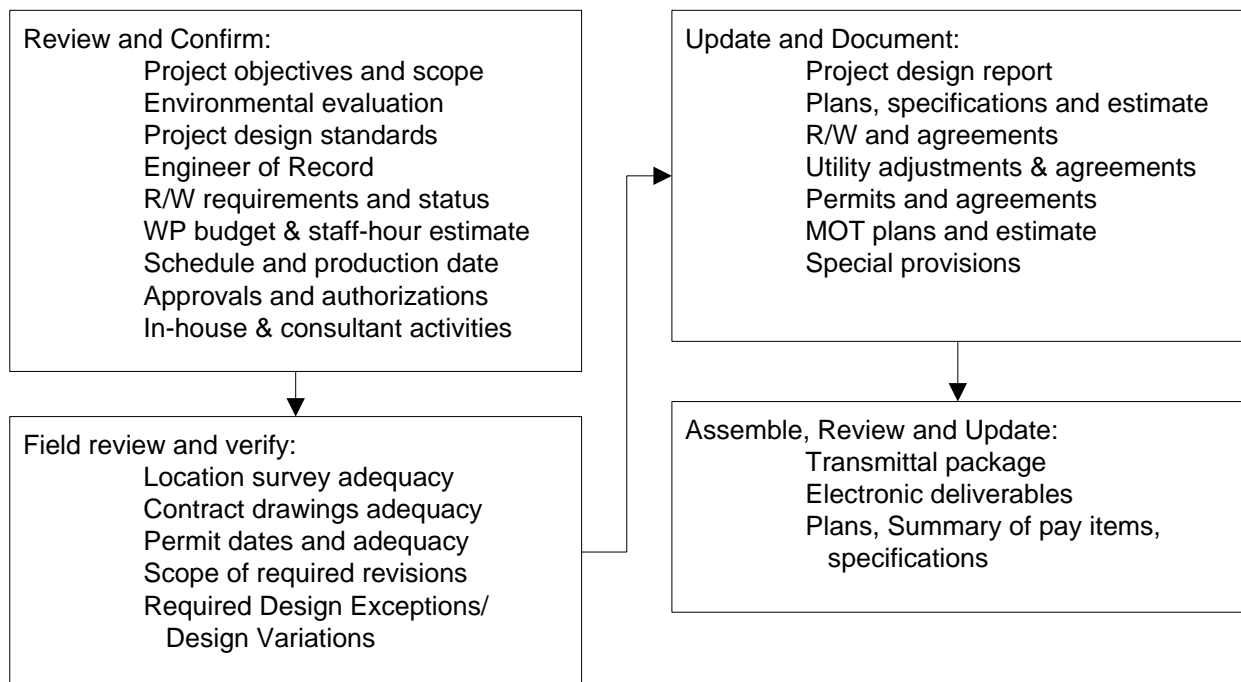

112.2 Design Update Review and Decision Process

Conduct an engineering review of the PS&E package and supporting documents to determine the activities required to update the package and get it ready for letting.

- (1) Review and compare the original project objectives, scope, and standards with current corridor conditions, as well as growth rate and patterns, to determine if the project design is still valid.
- (2) Review and compare the original environmental evaluations and commitments against current requirements.
- (3) Review and compare the permit date and terms against current requirements.
- (4) Review R/W certifications and agreements and confirm the status of documents.
- (5) Compare the component plans and BIM files against current requirements, including [Standard Plans](#), [Standard Specifications](#), [Basis of Estimates](#), and design criteria.
- (6) Review agreements with outside entities such as Utility Agency/Owners (UAOs), maintaining agencies and local agencies to determine if the agreements are still valid.
- (7) Resubmit Design Exceptions and Design Variations with updated documentation based on current data and conditions.

If it is determined that engineering updates are required, the scope, staff-hour estimate, schedule, cost estimate, and other activities described in **FDM 110** should be followed to the extent necessary to define the scope and schedule for the update process.

112.3 Updating Engineering Design and Documents

The actual engineering design activities necessary to update the PS&E package will vary from project to project. Develop a fully defined scope of work to determine resources and schedule needed for the update. Fully describe the required activities in the professional services contract if one is to be used.

All reports, calculations, assumptions, and engineering decisions that support changes to the component plans, BIM files, specifications, or other documents must be sealed by the Engineer of Record (EOR) updating the PS&E package. Changes to the component plans and BIM files are approved by the EOR, and require concurrence by the District Design Engineer, District Structures Design Engineer, or District Consultant Project Management Engineer, as appropriate for the type of change. Updated documentation of approvals and concurrences must be in the project file.

112.4 Revised PS&E Package

In addition to the required engineering changes, the contract transmittal package must be reviewed and updated to current status.

- (1) All component plans and BIM files are made current and sealed.
- (2) Specifications and special provisions are made current and sealed.
- (3) The CADD.zip or BIM.zip file is made current.
- (4) The Estimated Quantities Report is made current and sealed.
- (5) The contract file is made current.

113 Right of Way Requirements

113.1 General

To assist the roadway designer's understanding of Right of Way (R/W) requirements, which must be addressed during the project development and design phases of projects, the following terms are briefly defined as an introduction.

Right of Way is real property or an interest therein, donated or acquired by purchase or condemnation, to accommodate transportation improvements. Fee simple is the strongest interest available to the Department and is sought for most permanent highway facilities. When improvements are designed which will fall outside of the existing R/W boundaries, additional lands must be identified and acquired. All necessary Right of Way and easements must be in Department ownership prior to advertisement of the project for letting.

Limited Access R/W is purchased for facilities such as Interstate and Expressways. This limits public access to interchange connection-points designed with entrance and exit ramps and limits access to motorized vehicular traffic. Pedestrians and bicycles are restricted in the interest of traffic capacity and safety.

Controlled Access R/W is acquired for the remaining State Highway System. This allows the general public and landowners along the corridors reasonable access, but in a controlled pattern that will facilitate the movement of through traffic.

Perpetual Easements grant a right of use over, under or through the property of another. They are used when permanent structures or improvements are to be constructed and maintained on parcels where acquisition of fee title would be impractical; e.g., sight triangles or drainage facilities. Condemnation powers may be utilized to acquire Perpetual Easements.

Temporary Easements (a temporary right of use over, under or through the property of another) are used when it is necessary to temporarily occupy a parcel for a specific purpose such as construction of improvements requisite of the project, construction of temporary detours, stock piling materials or parking equipment. A Temporary Easement may also be necessary when it is determined that reestablishing access causes a compensable impact to the use of the abutting land or causes a safety issue due to a change in grade. No improvement which requires maintenance by the Department beyond the term of the easement can be constructed on a temporary easement.

License Agreements are used to gain access to adjoining properties for sloping, grading, tying in, harmonizing, and reconnecting existing features of the licensor's property with

the highway improvements to be constructed. This work is for the benefit of the property owner. The Department does not compensate for license agreements. If the owner refuses to execute the agreement, the Department will not perform the work outside of Department Right of Way.

Licenses are included here as real property interests for convenience, but they are not real property interests. A license, with respect to real property, is a privilege to go on the premises for a certain purpose but does not vest any title in the licensee.

The most economical means of constructing the project should always be the objective. The designer must design the highway facility within the existing R/W, obtain a license agreement, or request acquisition of R/W to accommodate project elements.

113.2 Procedures for Establishing Right of Way Requirements

The procedures for addressing R/W requirements require engineering analyses, economic comparisons, and professional judgments. Consultation with the District R/W Surveyor and District R/W Manager is required. One excellent method of providing the consultation is the "R/W Partnering" concept with all parties that have a vested interest participating in the decision-making process.

Alternate design studies will be required in many locations to determine if additional R/W should be purchased, a retaining wall constructed, or modified slopes and barrier system should be considered. A reasonable estimate of R/W costs or damages expected must be obtained from the R/W Office in order to make such a design study. Alternate construction methods may be shown on the plans as preferred and alternate methods.

113.2.1 Open Cut and Fill Roadway Sections

R/W requirements along the project boundaries are dictated by the actual construction limits plus a reasonable maintenance buffer. The roadway cut and fill slopes, drainage ditch slopes and other construction elements are used to define the construction limits, which are generally shown on the roadway cross sections. R/W requirements are determined by reviewing the plotted cross sections after the roadway and drainage design elements have been established and major revisions are highly unlikely.

A joint field review of the proposed R/W is strongly encouraged and should be conducted at this point. The design details and the property information must be reviewed by the designer, personnel from the R/W Office and the R/W Mapping Office. This review should be scheduled during the Phase II design process as defined in this manual and should address such issues as:

- (1) Will additional R/W be required for project access, maintenance of the facility, or transit facility needs? Check pond sites, high embankment slopes, bridges, outfalls, canals, and similar sites.
- (2) Can acquisitions be avoided or design modified to avoid substantial damages to remainder property or businesses? Examples include designing retaining walls or by adjusting slopes or grades to reduce the difference in elevation between the remainder and the project grade at the R/W line.
- (3) Can the roadway grades be revised or connections relocated so access to the remainders can be constructed without damaging the use of the remainder, thereby minimizing or avoiding severance and business damages caused by altering the access?
- (4) Can drainage facilities (e.g., outfalls, ponds, ditches) be maintained without additional R/W space? Can uneconomic remainders be used for stormwater treatment?
- (5) Has consideration been given to joint use ponds (including golf course ponds) and/or regional treatment facilities?
- (6) Check the suitability and cost effectiveness of storm water treatment facilities and the status of permit approval.
- (7) What types of legal instruments are likely to be required to secure the appropriate property rights for the project?
- (8) Review the status of R/W activities by others in the project area. Avoid multiple acquisitions from the same owner at ramp terminals, intersections and by future FDOT projects.
- (9) Check for potentials of hazardous materials, "4F" parcels, utility easements, landlocked remainders, and parcels, which could be eliminated.
- (10) Check for acquisitions involving existing treatment systems which could be mitigated within the FDOT system.
- (11) Discuss the possibility of advance acquisition of any parcel where development is imminent.
- (12) Check for incidental work which will fall outside of R/W such as trenching, wall forms, or equipment maneuvering space.
- (13) Check for availability of offsite property owned by FDOT which could be used for mitigation sites.
- (14) Discuss status of any R/W being claimed by maintenance pursuant to **Section 95.361, F.S.** (Maintenance Statute).

113.2.2 Curbed Roadway Sections

Establishing R/W requirements for curbed roadway sections will generally follow very similar procedures as the open roadway section projects. The analysis and decision making is complicated by more property owners, generally higher property values, businesses, and more complex access management problems.

The roadway and drainage design must be developed to a point where all major elements of the project (including transit facilities, signalization poles, lighting poles and overhead sign foundations) are firmly fixed. On projects with sidewalks and driveway connections, the design elements can be accurately established only if proper survey data has been obtained for the designer's use. Profile elevations along the proposed R/W line and back of sidewalk and half-sections or profiles at each driveway location should be obtained as a minimum standard practice.

The design engineer must perform the design work required to establish the project profile grades and the back of sidewalk grades to minimize the grade differences at the R/W line. Areas of superelevation must be analyzed very carefully. Split profile grades or other design strategies may be required to accommodate the proposed construction of the facility within minimum R/W limits.

The developed drainage and roadway design elements should be plotted on the plan sheets and the cross sections, which will establish the preliminary R/W requirements along the project boundaries as indicated by the construction limits. A good quality control review and a joint review with R/W appraisers and R/W Mapping personnel at this time will assist in determining the final R/W requirements. The same issues listed earlier in these procedures should be addressed.

113.2.3 Access Management

Access to the Department's facilities is an important element of the design and R/W determination procedures. Follow the Access Management Rules (14-96 and 14-97) and the procedures and directives adopted (**Topic Numbers 625-010-020** and **625-010-021**) to implement the objectives of those rules. Identification of access and median opening location in relation to individual parcels should be completed before appraisal.

The following activities should be accomplished by the Designer:

- (1) The access classification of the roadway segment and the connection category of the driveways must be determined. The designer must be aware of the nature, type, frequency of trips and number of vehicles utilizing the driveway.

- (2) The designer must make a determination as to which driveways are in conformance, which are to be maintained, which are to be closed and which are to be modified to bring them into compliance.
- (3) The designer must obtain sufficient field survey data to establish the highway grades, horizontal alignment, and the existing ground elevations in the vicinity of the driveway location. The data necessary to accurately design the driveway connection and determine an acceptable tie-in with the existing surface should be obtained as a minimum.
- (4) The designer should develop the most economical driveway design which will conform to the standards and the requirements of the access management objectives. Alternate designs and locations may be required to meet the property needs. Generally, the best option can be reached by negotiating with the property owner and/or tenant in a give and take atmosphere; however, Right of Way must take the lead in such negotiations.

Driveway connections must be addressed in consultation with R/W personnel. This fact should not be overlooked on projects, such as resurfacing, on which there may not be any other R/W requirements. R/W related decisions to be made about driveway connections, probably on a case-by-case basis, include:

- (1) License Agreements (LA) are used where restoration of the driveway connection is not necessary to project construction or maintenance of the finished facility. The LA allows the Department entry to the property at no cost in order to harmonize and reestablish the driveway connection. Refusal of the property owner to execute the LA does not unduly affect construction of the project. If refusal would adversely affect the construction of the project, then a Temporary Construction Easement should be used and the engineer should be prepared to testify in court as to necessity.
- (2) In the situation where a team consisting of the engineer, the R/W Mapper, the District Right of Way Manager (DRWM), and Legal (or their designees) decides that (1) harmonization and restoration of the driveway connection is likely to cause a diminution in the use of the property, and (2) no taking for the benefit of the project is necessary, then the DRWM must decide on the appropriate method of compensating the property owner, whether by a TCE or some other means.
- (3) The Office of R/W will see that the proper instruments are executed to enter onto the property for purposes of construction and to compensate the owner for damages, if any are due. If other acquisition of that property is proposed, these instruments should include the entry and compensation, if any, for the driveway.

- (4) If there is no acquisition from a property, yet the property owner feels their property has been negatively affected by a project, the property owner can negotiate or claim damages through the inverse condemnation process.
- (5) Design should always, in their consultation with R/W personnel, make a determination if a fee taking or permanent easement is in the public interest to protect the facility. If a permanent easement will protect the facility and still give the owner some utility in the easement area, this may reduce the severance and business damages incurred.

113.2.4 Procedures for Decision Making

To assist in the decision process related to R/W requirements and instruments to be used, the following guidelines from the Office of Right of Way may be used during the joint review process. Close coordination with the District Right of Way Office and the Office of General Counsel is required during this decision-making process.

A License Agreement is the default method for driveway harmonization; use of a Temporary Construction Easement must be justified in terms of project integrity, cost or potential impact of the project on the property.

- (1) License agreements should be used only if the following conditions can be met:
 - (a) The improvements or changes contemplated have no compensable impact to the use of the property, and are for the sole benefit of the property owner; and
 - (b) None of the improvements are required for the construction, operation and maintenance of the transportation facility and removal of or change to the improvements will not be detrimental to the facility.
- (2) Temporary Easements should be used under the following conditions:
 - (a) When it is necessary to temporarily occupy a parcel for a specific purpose such as construction of improvements requisite of the project, construction of temporary detours, stockpiling materials or parking equipment;
 - (b) When it is determined that reestablishing access creates a compensable impact to the use of the abutting land;
 - (c) Where grading, tying-in, harmonizing, and/or connecting an access point is required to maintain the safety and design of the facility;
 - (d) The contemplated improvements or uses of the property owner's land are required only during the period of construction of the transportation facility;
 - (e) Removal or alteration of the improvements to the property owner's land subsequent to construction would not be detrimental to the facility; and,

- (f) After construction is complete, there will be no need for periodic re-entry onto the property by the Department for maintenance or other purposes.
- (3) Fee Simple R/W purchase should be used when the following conditions exist:
 - (a) The planned improvements to the property owner's land are required as a part of construction of the transportation facility;
 - (b) The improvement on that land must remain in place as a part of the facility; and,
 - (c) Periodic re-entry to the property is required for maintenance or repair.

Perpetual Easements may be considered as an alternative to fee simple purchase in the R/W process if the owner may continue to enjoy some benefits of the property without impairing the Department's use and the total acquisition costs to the Department are less than the cost of acquiring fee.

113.2.5 Transmittal of Right of Way Requirements

R/W requirements should be finalized before transmitting them to the R/W Mapping Office for preparation of R/W maps. All R/W requirement transmittals should be in writing and clearly indicate in the memo and on the plans which parcels have been finalized and which parcels are still pending. An effort should be made to transmit final R/W requirements in usable segments. Priority should be given to the major, expensive, or complex acquisitions that are going to require more time to acquire and complete the relocation of the occupants. Advanced design effort and final R/W requirement determination may expedite meeting production ready dates. It is desirable to transmit requirements as early as possible in the plans development.

All R/W requirements that are firm (primarily mainline construction limits) should be transmitted by Phase II. All other requirements that generally involve more detailed design completion (e.g., outfalls, pond locations, corner clips, access needs) must be submitted by the Phase III stage completion of the roadway design plans.

All R/W requirements must be transmitted by the completion of the Phase III roadway design plans.

113.3 Process for Establishing Right of Way Requirements

Establishing Right of Way requirements is a design process but requires close coordination with other functions that have input to the project development and design of the project.

The Engineer of Record is responsible and must ensure that representatives from the appropriate functional areas are involved in the determination process. They must also ensure that a review of the final R/W requirements is performed. The "R/W Partnering" concept is an excellent method of ensuring that the proper consultation and input is received.

Generally, the R/W needs-determination will involve Roadway, Bridge and Drainage Design, Permits, Utilities, R/W appraisers, R/W Mapping and Legal functions. On consultant designed projects, the Department project manager's role as lead coordinator is especially critical.

113.3.1 New or Major Reconstruction Projects

These projects generally have Project Development and Environmental (PD&E) activities and Right of Way activities identified in the Work Program.

The project development process must address R/W requirements and perform sufficient preliminary engineering design to obtain preliminary cost estimates from the R/W Office. This may require that the PD&E consultant or in-house scope of services include work such as:

- (1) Preliminary roadway grades & geometric design.
- (2) Conceptual Drainage design and layout.
- (3) Analysis of major access management issues.
- (4) R/W Survey, property lines and limited topography.
- (5) R/W Mapping and property research activities.
- (6) Preliminary R/W cost estimates work.
- (7) Analysis of the transit, pedestrian/bicycle R/W needs.

This early identification of potential R/W requirements, approximate costs and work effort to complete R/W activities will greatly improve both cost estimates and schedules of projects. Also, involving R/W mapping and appraisers will assist in developing better project alternatives.

R/W requirements identified during the project development phase should not be considered firmly set. The R/W Office cannot be requested to begin R/W mapping or appraisal activities based on these requirements, without extraordinary efforts by the designer to support the acquisition process as in advance acquisition.

113.3.2 Reconstruction Projects with Anticipated Right of Way Requirements

These projects may not have a formal PD& E study, but they were determined during Work Program development to require some R/W acquisition. Most projects will require some environmental re-evaluation effort and all projects should have some preliminary engineering to better define objectives, scope, and R/W requirements. The following general process, as it relates to R/W requirements should be established by design:

PHASE I

- (1) R/W Mapping will provide preliminary maps showing properties and all existing R/W lines for the project. These should be requested by the designer or by the Department project manager, on consultant projects.
- (2) The roadway designer will define project horizontal and vertical alignment and relate the existing R/W lines to the project as necessary to set R/W limits.

PHASE II

- (1) The roadway designer will identify proposed R/W requirements as indicated by the completed design details such as the following:
 - (a) Limits of construction slopes for roadway and bridges
 - (b) Cross section elements, transit facilities, ditches, curb returns and sidewalks
 - (c) Driveway and street connections
- (2) The drainage designer will identify proposed R/W requirements as indicated by the completed drainage features, which may include:
 - (a) Retention or Detention Ponds
 - (b) Mitigation of environmental issues
 - (c) Drainage outfalls, sediment basins

The designer will review all proposed R/W requirements with the R/W Mapping Office. This should be performed during the Phase II design activities in order to make decisions on how each parcel of proposed R/W will be acquired. These decisions will impact which design approach is taken. The issues to be discussed and decisions to be considered are detailed in **FDM 113.2**.

- (3) As R/W requirements are determined, the information is furnished to the R/W Mapping Office by memo documenting clearly which R/W is final and which is pending. The R/W Mapping Office will use only the final requirements transmitted to prepare R/W maps. See **FDM 113.2.5**.

PHASE III

- (1) By the completion of Phase III design, all R/W requirements will be identified and transmitted to the R/W Mapping Office.
- (2) After transmittal of final R/W requirements to the R/W Mapping Office, design changes that affect R/W must be coordinated with the R/W Mapping Office, in a timely manner.

The R/W shown on the roadway plans must be in exact agreement with the R/W Maps.

It is essential that close coordination be maintained with R/W personnel in order to ensure that design changes affecting R/W are transmitted promptly.

113.3.3 Projects without an Identified Right of Way Phase

Many improvements to highway projects are intended to be accomplished within the existing R/W. The widening or widening and resurfacing projects are examples. Such projects must be evaluated very carefully and very early in the roadway design process.

The addition of R/W requirements can have a tremendous impact on the schedule and on the anticipated costs of a highway improvement project. R/W Mapping should be consulted on all projects to ensure that the proposed construction lies completely within the existing R/W and no Trustees of the Internal Improvement Trust Fund parcels or maintenance surveys are required.

For all projects determined to be completely within existing R/W the Department project manager or District R/W Surveyor as appropriate, must notify the District R/W Manager, in writing, that no R/W is required. This notification will serve as the basis for the District R/W Manager's certification that all necessary R/W is available for construction.

If unanticipated R/W requirements are identified during design, the production management staff, and the R/W Mapping Office should be notified as soon as the requirements are determined. The production management staff will then give direction as to continuing with the design and acquisition. If acquisition continues, it will follow the previously discussed procedures.

Figure 113.3.1 Right of Way Requirements Generalized Process Flow Diagram

(Each function must have well defined written procedures for the development, quality control, coordination, and regular exchange of product evaluation.)

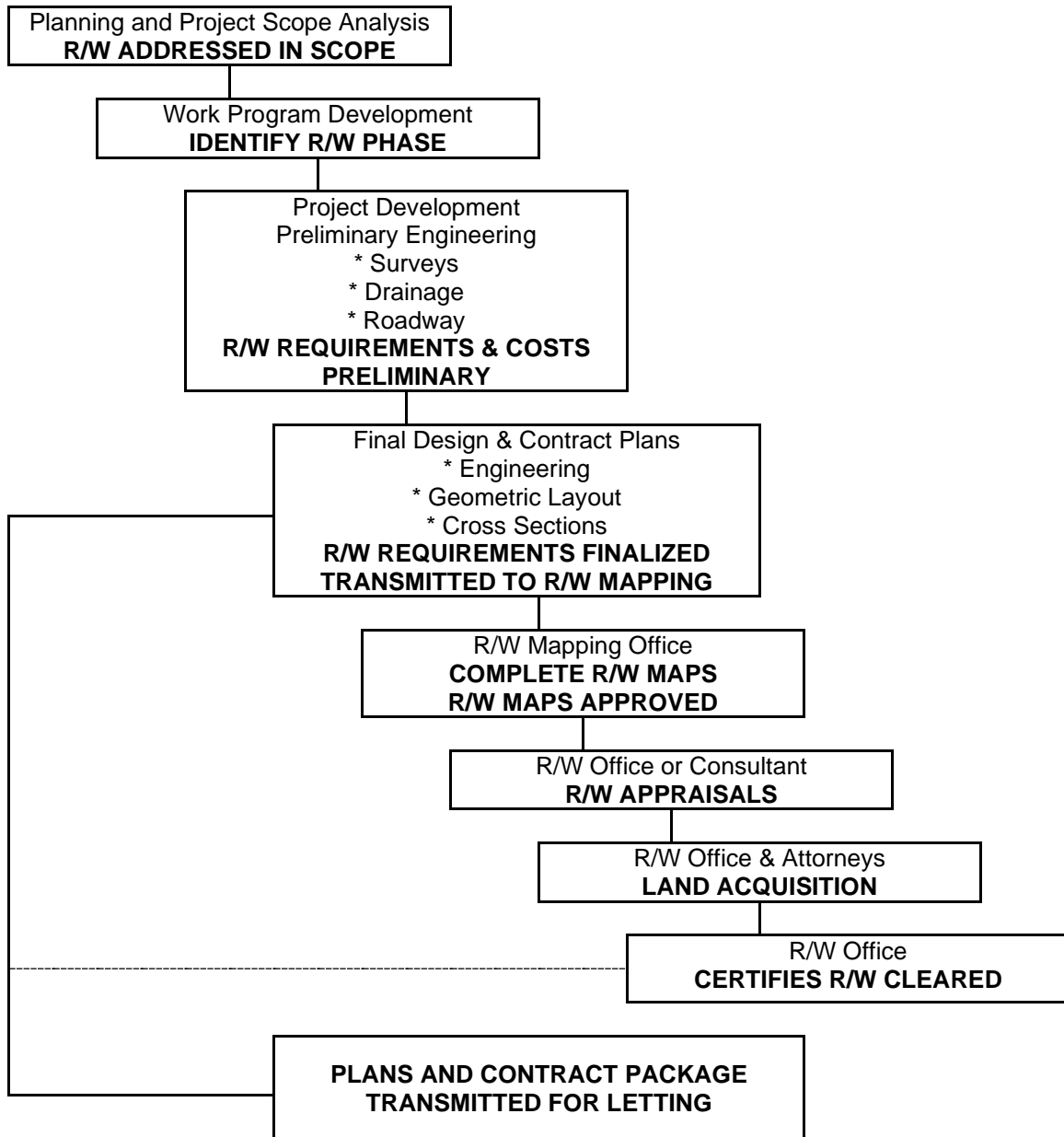

114 Resurfacing, Restoration, and Rehabilitation (RRR)

114.1 General

Resurfacing, restoration, and rehabilitation (RRR) work is defined as work undertaken to extend the service life of an existing highway and enhance highway safety for all modes of travel. This includes the placement of additional surface materials and other work necessary to return an existing roadway to a condition of structural and functional adequacy. This chapter contains processes and requirements specific to RRR projects necessary to evaluate existing roadways for safety and performance.

The District Safety Engineer and District Safety Administrator must be involved in determining safety needs. Target Speed must be established early in the design process to assist with meeting safety objectives.

114.1.1 Improvements in RRR Projects

RRR projects must meet **FDM Part 2** criteria and requirements. In addition, the following must be included in the scope for each RRR project:

- (1) Provide improvements recommended by the Safety Assessment described in FDM 114.3.2.2.
- (2) Pavement Resurfacing/Rehabilitation.
- (3) Modifications necessary to comply with the **FDM** requirements associated with the Americans with Disabilities Act (ADA).
- (4) Provide paved shoulders.
- (5) Improvements to roadside barriers and guardrail necessary to meet minimum standards.
- (6) Improvements to bridge rails necessary to meet minimum standards.
- (7) Provide Traffic Signal Mast Arms within the mast arm policy area (see **FDM 232.8**) where existing strain poles require replacement/relocation.

114.1.2 SIS Facilities

Projects on controlled access SIS Corridor and Connector facilities should be designed using new construction criteria. RRR criteria may be applied on a project to the extent permitted by the Action Plan for that corridor, consistent with the schedule for phased

improvements to bring the facility up to new construction criteria. For controlled SIS Corridors and Connectors with no Action Plan, RRR criteria may be applied if minimum design speed criteria shown in **FDM 201** are met, or a Design Variation or Design Exception for design speed is approved.

114.1.3 Interstate, Expressway, and Freeway Resurfacing

The processes and requirements contained in this chapter are applicable for Interstate, Expressway, and Freeway (i.e., LA Facility) resurfacing projects.

114.1.4 Pavement Only Projects and Ride Only Projects

Pavement Only Projects (POPs) are also known as “Maintenance Resurfacing Projects.” They include milling and resurfacing to restore the functional condition of the pavement but are not intended to increase the structural capacity. For POP pavement design requirements, refer to Chapter 7 of the [**Flexible Pavement Design Manual**](#).

Ride Only Projects are those where the existing pavement is in good structural condition but is deficient in ride due to the presence of irregularities such as manholes, utility valves, or utility tie-in patches in the wheel path. These projects may entail either an entire resurfacing of the project limits, or spot resurfacing of damaged areas. The intent of Ride Only Projects is to correct the ride deficiency rating.

This chapter does not apply to projects programmed as POPs or Ride Only Projects other than meeting ADA curb ramp and detectable warning requirements. Work Program Instructions, Chapter 27, states that POP projects cannot be on the “high crash list.”

114.2 Planning and Programming RRR Projects

The principal objectives of a RRR project are intended to extend the service life and provide for the needs of the roadway through the next resurfacing cycle, which include:

- (1) To preserve or extend the service life of the existing pavement.
- (2) To improve multi-modal capacity (without adding continuous through lanes).
- (3) To improve multi-modal operating characteristics.
- (4) To provide safety modifications that support the Safe System approach (see ***FDM 102*** for definition.)
- (5) To provide, to the extent practicable, for expected transportation needs in the corridor based on context classification changes over time.

RRR projects are typically identified and programmed based on projections of deficient pavement condition and are funded under the Department's Pavement Resurfacing program. Districts are tasked with meeting assigned lane mile resurfacing targets. Resurfacing funds are allocated annually to each District based on an estimated cost per lane mile. The amount allocated includes funds necessary for pavement resurfacing, rehabilitation, minor reconstruction, and pavement milling and recycling. Refer to ***Part III, Chapter 27, Resurfacing***, of the [Work Program Instructions](#) for funding resurfacing projects.

Due to limitations on resurfacing funds, improvements other than those necessary to address a safety need or to meet design criteria must be carefully considered before inclusion in the project scope. To ensure that the safety needs of the project are addressed, to the extent feasible, coordination with the District Safety Engineer and District Safety Administrator should be done at the time of scoping. Coordinate early with the DSE and DSA to balance the safety needs, available time and resources to accomplish the RRR and safety needs objectives.

Identify potential modifications to meet anticipated future conditions during the context classification review as part of scoping. This will typically include reviewing local and District plans (e.g., bicycle facilities plan, corridor studies, sector plans, etc.) for desired pedestrian, bicycle, and transit facilities along the project corridor to identify opportunities for improvement as part of the RRR project.

114.2.1 Right of Way (R/W) Acquisition

RRR projects do not typically involve R/W acquisition; however, review RRR projects to determine if additional R/W is required to meet project needs. Conditions that may warrant R/W acquisition include:

- (1) Providing pedestrian, bicycle, or transit facilities
- (2) Speed management countermeasures
- (3) Correcting substandard roadway elements
- (4) Meeting access management requirements
- (5) Providing new or improved drainage conveyance or treatment facilities
- (6) Making intersection improvements (see **FDM 212** for conventional intersection criteria and guidance, and **FDM 213** for roundabout criteria and guidance)

When R/W acquisition is warranted, the design should be expedited to determine actual R/W requirements. Coordinate the requirements with the District Right of Way Office.

114.2.2 Survey Guidelines

Types of survey work typically included in RRR Projects are as follows:

- (1) Mill and resurface only, EOP to EOP, no other improvements [Level 1].
- (2) Resurface with trench widening (Roadway only) [Level 1 if lump sum excavation].
- (3) Resurface adding turn lanes (spot improvements) [Level 2].
- (4) Resurface adding shoulder pavement [Level 2].
- (5) Combination of numbers 2-4 [Level 2].
- (6) Resurface with access management [Level 2]
- (7) Resurface with pedestrian, bicycle, and transit facility improvements [Level 2].
- (8) Resurface with cross slope or superelevation correction [Level 2].
- (9) Add shoulder pavement only [Level 2 or 3].
- (10) (E) Extend drainage structures [Level 3].
- (11) (E) Guardrail, end treatments, (safety) [Level 2].
- (12) (E) Side drain closure; mitered ends [Level 3].
- (13) Intersection improvements [Minor = Level 2; Major = Level 3].

- (14) (E) Correct horizontal or vertical alignment [Level 3].
- (15) (E) ADA compliance [Level 2].
- (16) Approaches to structures [Level 4].
- (17) RRR with R/W acquisition [Level 3].

(E) = Element of an item

114.2.2.1 Minimum Levels of Survey Effort

(1) LEVEL 1

Review by District Surveyor to check for Public Land Corners. Check sections for cross slope at 1000 feet in tangents. For curves, check 50 feet before PC, at PC, 50 and 100 feet after PC and at middle of curve or 300-foot intervals. (Reverse at PT). May use assumed datum if approved by the District Location Surveyor and the Project Manager/Designer. The cross sections will have a common benchmark elevation throughout the curve. In other words, do not assume an elevation at the centerline of the highway for each cross section. A minimum of two (2) benchmarks should be set off of the highway near the R/W Line and may be on assumed elevations or NAVD 88 datum. If the surveyor elects to use temporary assumed benchmarks, they must last throughout the life of construction and cannot be set in trees, power poles or concrete monuments. Establish begin and end points of project and reference.

(2) LEVEL 2

Minor spot improvements such as turn lane at existing crossover or turn lane on 2-lane. No additional R/W required. Where R/W is adequate, establish horizontal and vertical control in the improvement area. May use assumed vertical datum if approved by the District Location Surveyor and the Project Manager/Designer. The cross sections will have a common benchmark elevation throughout the curve. In other words, do not assume an elevation at the centerline of the highway for each cross section. A minimum of two (2) benchmarks should be set off of the highway near the R/W Line and may be based on assumed elevations or NAVD 88 datum. If the surveyor elects to use temporary assumed benchmarks, they must last throughout the life of construction and cannot be set in trees, power poles or concrete monuments. If R/W is constrained, re-establish existing R/W line. Level 1 required throughout other portions of project. Cross section level to be determined by Project Manager/Designer with input from the District Location Surveyor and Resident Engineer. TOPO with supplemental cross sections or

elevations in area(s) of deficient criteria or proposed improvement(s). Reference control points outside R/W. Subsurface utility locates if required.

(3) **LEVEL 3**

Continuous improvements through length of project such as widening or paved shoulder; or major spot improvements (structure replacement; major intersection improvement). May require R/W purchase. Horizontal Control baseline, centerline, or network. Vertical Control on NAVD 88. TOPO with supplemental elevations (limits to be determined). Digital Terrain Model (DTM) at specified locations. R/W Control Survey and Maps (if R/W purchased). Subsurface utility locates.

(4) **LEVEL 4**

Full Digital Terrain Model (DTM) and TOPO for entire project.

114.2.3 Public Involvement

Contact the District Public Information Office for information regarding public involvement on RRR projects.

114.3 RRR Design Process

The RRR design process is a team effort that requires familiarity with processes, guidance, criteria, and standards for planning, design, safety, traffic engineering, traffic operations, and maintenance. To ensure all needs are addressed, perform the assessments described in **FDM 114.3.1** through **114.3.11** below.

114.3.1 Assessment of Design Controls

Set design controls in accordance with **FDM 201**. Target Speed must be established early in the project development to set the design controls.

114.3.2 Assessment of Existing Conditions

Before beginning design of the project, perform office and field reviews to assess current conditions. The assessment includes both physical conditions, operating conditions, and related local plans and projects.

114.3.2.1 Office Reviews

Review old plan sets, as-built drawings, Straight Line Diagrams, and other historical records to assess many of the existing conditions. Review and identify the project-level Context Classification for any related plans or conditions that could affect the goals of the project.

The existing conditions assessment should include:

- (1) Horizontal and vertical geometrics, including intersections.
- (2) Existing Typical Section elements.
- (3) Radius, length, and superelevation of curves.
- (4) Shoulder treatments and side slopes.
- (5) Drainage features, including cross drains and drainage structures. Evaluate District Drainage and Maintenance reported drainage issues.
- (6) Clear zone or lateral offset, and shielding devices
- (7) Location and design of intersections including opportunities for alternative intersection designs where they may improve bicycle and pedestrian safety.
- (8) Pavement cross slope and superelevation data.
- (9) Pedestrian, bicycle, and transit facilities.
- (10) ADA compliant features.
- (11) Operating Conditions, including:
 - (a) A summary of posted speeds on the project.
 - (b) Conditions attributable to current control of access.
 - (c) Operational issues along the corridor (e.g., signal timing, detection failure, red light running, queue build-up, speeding, and split failures).
- (12) Planning Office review of district and local plans, major permits or projects relating to the project area.

114.3.2.2 Safety Assessment

Perform a safety assessment, resulting in written recommendations. The safety assessment should include:

- (1) Evaluation of safety needs identified and documented through the [Safety Assessment Dashboard](#). The Safety Assessment Dashboard is an internal FDOT application accessible only to specific FDOT positions. Coordinate with the District Traffic Safety Engineer to obtain information from the dashboard.
- (2) Evaluation of proactive safety countermeasures supporting the Safe System approach.
- (3) Identification of significant crash locations, with:
 - (a) Determination of possible causes, and
 - (b) Recommended modifications, mitigation measures, implementation of speed management techniques, or other safety countermeasures.
- (4) Review of correspondence files for letters of public concern.
- (5) Review of historic crash and travel statistics.
- (6) Identification of safety and mobility measures such as filling pedestrian facility gaps, providing adequate crossing opportunities, correcting deficiencies of bicycle facilities, and improving connectivity of bicycle facilities.

The safety assessment along with written recommendations must be submitted to the District Safety Engineer and District Safety Administrator.

114.3.2.3 Field Reviews

Perform a field review to observe and verify physical, operational and safety conditions including those identified during the office review and safety assessment.

The field review must:

- (1) Verify geometric and physical conditions by observing the following:
 - (a) Pavement condition including distressed pavement or depressions that may indicate pavement or base failure
 - (b) Alignment
 - (c) Cross slope and superelevation
 - (d) Lane width

- (e) Traffic control markings and signs
 - (f) Side slopes and clear zones
 - (g) Shoulder type and width
 - (h) Intersection and bridge elements
 - (i) Sight distances
 - (j) Drainage (including erosion or siltation issues)
 - (k) Highway appurtenances
 - (l) ADA features
 - (m) Transit stops
 - (n) Pedestrian facility connectivity and identification of pedestrian facility gaps and substandard conditions.
 - (o) Pedestrian and bicycle crossing locations
 - (p) Bicycle facility connectivity and identification of bicycle facility gaps and substandard conditions.
 - (q) Nighttime review to observe lighting along corridor, intersections, and mid-block crosswalks.
 - (r) Signalization
 - (s) No-passing zone (see **FDM 230**)
- (2) Verify the following operating conditions:
- (a) Verify posted regulatory speeds and posted advisory speeds.
 - (b) Observe reported and suspected problem areas (e.g., signal timing, pedestrian detection, signal head placement).
 - (c) Evaluate access features.
- (3) Verify safety conditions by observing the following:
- (a) Known crash locations.
 - (b) Indicators of lane departure or other unsafe operations (e.g., tire marks on walls or curb, tire tracks on front slope, tire marks encroaching on pedestrian areas, damaged drainage inlet top within curb return, guardrail repairs).
 - (c) Evidence of informal pedestrian movement paths or improper crossing.

114.3.2.4 Identified Improvements

Coordinate with the District Project Manager, District Design Engineer, District Safety Engineer, and District Safety Administrator for safety related issues with identified improvements necessary to correct deficiencies. Crash analysis should include an examination of needs identified through the [Safety Assessment Dashboard](#) and the identification of proactive countermeasures in support of the Safe System approach.

Identified improvements may include:

- (1) Remove, relocate, or make crashworthy roadside obstacles.
- (2) Remove unwarranted guardrail.
- (3) Upgrade or replace nonstandard guardrail, end treatments and crash cushions.
- (4) Replace or retrofit obsolete bridge rails.
- (5) Improve side slopes; slope flattening/stabilizing.
- (6) Correct shoulder drop-off.
- (7) Provide or widen paved shoulders.
- (8) Correct pavement cross slope and superelevation.
- (9) Provide side drain safety modifications.
- (10) Increase sight distance at intersections.
- (11) Improve pavement markings.
- (12) Improve pavement drainage.
- (13) Provide new or replace deficient sidewalks.
- (14) Provide transit stops.
- (15) Provide new or upgrade existing pedestrian crossings (e.g., midblock crossings, bulb-outs, raised crosswalks, refuge islands).
- (16) Provide new or upgrade existing bicycle facilities (e.g., keyholes, conflict markings).
- (17) Upgrade railroad crossing approaches.
- (18) Provide or upgrade signalization (e.g., leading pedestrian intervals, pedestrian signals, automatic recall, push-button locations, midblock pedestrian signals).
- (19) Provide or upgrade lighting.
- (20) Upgrade signing and other traffic control devices (e.g., Rapid Rectangular Flashing Beacons, Pedestrian Hybrid Beacons).

- (21) Provide or upgrade curb cuts, ramps, and other ADA features.
- (22) Reconstruct or close driveways to comply with Access Management standards.
- (23) Adjusting corridor speeds to reflect changing development conditions or safety needs (see **FDM 201.5.1** for Target Speed on RRR projects).

114.3.2.5 Design Exceptions and Design Variations

Existing features not meeting RRR criteria require processing of a Design Exception or Design Variation for the feature to remain. Refer to **FDM 122** for the Design Exception and Design Variation procedures. See also, **FDM 114.1.1**.

114.3.2.6 Design Documentation

Include in the design file all documentation that substantiates the design process and decisions made. Documentation may include the following information:

- (1) A short paragraph which states the overall project purpose. Factors such as principal reason for the project, anticipated project cost, principal work type, general R/W needs or provisions, and any special project priorities are appropriately addressed here.
- (2) Documents that detail the existing conditions on the project. Findings of office reviews, field reviews and surveys are assembled here, to document existing geometric and roadside features, operating conditions, traffic volumes, posted speeds, existing pavement markings, signing, and safety. A brief overall summary of findings is recommended.
- (3) Document the selected standards based on project intent and conditions.
- (4) A summary of safety issues that have been identified for the project and recommended solutions.
- (5) Reviews of the project design for safety improvements, documenting what was finally accomplished or ruled out of the project subsequent to the scope of work having been completed.
- (6) Those items in the original scope of work for the project which cannot be reasonably accomplished and must be removed or delayed.

114.3.3 Intersections

Evaluate intersections to determine if a traffic engineering study is needed. The following items should be considered:

- (1) Traffic Signal Mast Arms or single point attachment span wires within the mast arm policy area where existing strain poles require replacement/relocation. See **FDM 232.8** for information on mast arm policy.
- (2) Addition of right and left turning lanes.
- (3) Realignment of intersection.
- (4) Adequate turning radii for left and right turning lanes.
- (5) Use of channelization to reduce excessive areas of conflict at large intersections.
- (6) Placement of crosswalks as related to sidewalks and stop bars.
- (7) Locations of pedestrian, bicycle, and transit facilities.
- (8) Need and potential for protected intersection.
- (9) Locations of utilities, signal poles, controller cabinets, lighting poles and drainage structures as related to sidewalks and curb ramps.
- (10) Warrants for traffic control systems.
- (11) Addition of signal backplates where it would not require structural modifications to mast arms or span wire systems. See [Traffic Engineering Manual \(TEM\)](#), **Section 3.9** for use of flexible backplates where needed.
- (12) History of angle crashes or observed red-light running.
- (13) Addition of auxiliary heads where it would not require structural modifications to mast arms or span wire systems.
- (14) Installation of buried conduit for future traffic control systems.
- (15) Lighting for intersection illumination.
- (16) Adequate line of sight.
- (17) ADA needs.

Include corrective measures in projects having T-intersections with overrepresented crash histories or other evidence of safety or operational problems.

When there are proposed changes in intersection control, a roundabout alternative must be considered. See **FDM 213** for additional information.

The additional cost associated with improvements requested by local governments that exceed the Department's criteria should be paid for by the local government making the request (e.g., installation of mast arm signal supports in areas beyond the mast arm policy area).

114.3.4 Drainage

Conduct a site visit to evaluate the physical condition of the existing drainage system and to determine if hydraulic and/or safety improvements are needed. In addition to the site visit, contact the local maintenance office to coordinate these findings and to discuss the drainage history along the section of roadway to be resurfaced. If drainage improvements are warranted, perform the required hydraulic analysis to determine the most cost-effective repair strategy to restore the design intent of the existing drainage system. When siltation is noted during site review, follow the pipe inspection criteria in the [Drainage Manual](#), Chapter 3. The [Drainage Manual \(Topic No. 625-040-002\)](#) contains design criteria and methods which provide guidance in formulating suitable drainage features, either through modification or replacement.

See **FDM 215** for roadside safety requirements of drainage features.

Consult with drainage and environmental permit specialists when the roadway modifications impact existing ditch cross sectional area, storage and infiltration or increase discharge rates and volumes. Stormwater management, using retention or detention storage, may be required to mitigate for water quality, rate, and volume changes associated with the proposed roadway improvements. The drainage specialist must perform the drainage analysis to determine if improvements are required and must provide the necessary drainage design, flood data information, and all information required to obtain the necessary environmental permits.

114.3.5 Pedestrian, Bicyclist, and Transit

Coordinate with the District Pedestrian/Bicycle Coordinator, the District Modal Development Office, and, as needed, the District Safety Engineer and/or District Safety Administrator when deficiencies in bicycle, pedestrian, or transit facilities are identified during the field review or project development.

114.3.6 At-grade Railroad Crossing

Federal-aid projects must be reviewed to determine if a railroad-highway grade crossing is in or near the limits of the project. If such railroad-highway grade crossing exists, see **FDM 220** for requirements.

Review physical and operational characteristics of at-grade railroad crossings for compliance with minimum standards. Discuss identified deficiencies with the District Railroad Coordinator. Resurfacing funds must not be used where the primary purpose is to improve an at-grade railroad crossing.

114.3.7 Lighting

Lighting features must meet the requirements of **FDM 231**.

Lighting may be installed at specific locations to reduce the effects of ambient light conditions or to improve safety at the following locations:

- (1) Busy or high crash intersections or areas
- (2) Transit stops.
- (3) Channelized intersections.
- (4) Carpool parking lots.
- (5) Pedestrian and bicycle crossings.
- (6) Ramp terminals.
- (7) Roundabouts
- (8) Midblock Crossings

Coordinate project needs with the District Lighting Engineer.

114.3.8 Signals, Signing, and Pavement Markings

Signal features must meet the requirements of **FDM 212** and **FDM 232**.

Signing and Pavement Marking features must meet the requirements contained in **FDM 230**. Review and adjust no-passing zone locations as needed on 2-lane roadways in accordance with [Manual on Uniform Traffic Studies \(MUTS\)](#), Chapter 11.

Coordinate project needs with the District Traffic Operations Engineer.

114.3.9 Bridge Structures

See **FDM 260.9** for information on evaluating existing bridge structures.

Review bridges in sufficient detail to clearly establish cost effective and appropriate improvements to be included in the project. RRR program funds can be used only for minor bridge improvements; e.g., rail retrofits, ADA improvements.

Bridges that require substantial improvements, or replacement, should be programmed with the appropriate bridge program funds.

114.3.9.1 Pier Protection

The requirements for Pier Protection are outlined in **FDM 215**.

114.3.10 Roadside Safety Hardware

See **FDM 215** for RRR requirements of Roadside Safety Hardware.

114.3.11 Sign, Signal, Lighting, and ITS Support Structures

See **FDM 261.7** for information on evaluating ancillary structures.

115 Standard Plans and Standard Specifications

115.1 General

This chapter describes the relationship between the plans development process, the **Standard Plans for Road and Bridge Construction** ([Standard Plans](#)), and the **Standard Specifications for Road and Bridge Construction** ([Standard Specifications](#)).

115.1.1 Effective Dates

The [Standard Plans](#) are published annually and are effective based on construction letting dates. The effective dates for each version are provided on the [Standard Plans](#) website. Identify the governing version for each project in accordance with **FDM 910**. See the **Structures Detailing Manual** for additional requirements for bridges.

The [Standard Specifications](#) are published annually and are effective based on construction letting dates.

Modification for Non-Conventional Projects:

Delete **FDM 115.1.1** and see the RFP for the governing [Standard Plans](#) and [Standard Specifications](#).

115.2 Standard Plans

The [Standard Plans](#) (formerly referred to as the [Design Standards](#)) are standard construction details that are published as sets of Indexes. The [Standard Plans](#) provide consistent designs and details for the preparation of construction contract documents.

[Standard Plans](#) are developed with consideration for durability, maintainability, and broad applicability. However, they may not be suitable for use on all projects or site conditions. The Engineer of Record (EOR) must determine the appropriate application of Standard Plans for each project.

The [Standard Plans](#) comprise the latest and best practices of the Department as follows:

- (1) Are in compliance with:
 - (a) Department criteria, policy, preferences, and specifications,
 - (b) **AASHTO** publications.
 - (c) Federal laws and regulations.
 - (d) Basis of Estimates, Approved Products List, and Construction Specification consistency and coordination.
- (2) Provide detail clarity and are based on proven designs with considerations for constructability and long-term maintenance.
- (3) Reserve structural capacity; redundancy of design.
- (4) Clarify material usage.
- (5) Promote contractor familiarity.
- (6) Standardize formwork for concrete components.

Incorporate the [Standard Plans](#) as appropriate unless a need to develop project-specific designs is documented. Place documentation in the Project Documentation folder; see **FDM 111.7**.

The [Standard Plans](#) may be supplemented or amended by one or more of the following:

- **Standard Plans Errata**
- **Standard Plans Revisions**
- **Standard Plans Interim Revisions**
- **Developmental Standard Plans**
- **Modifications to Standard Plans**
- **Standard Plans Instructions**
- **Data Tables**

115.2.1 Standard Plans Errata

The Errata process implements minor changes to the [Standard Plans](#) before the next regularly scheduled version is published (i.e., out-of-cycle). These changes do not affect

cost or implementation of the Index (e.g., correcting editorial or typographical errors). Errata are published on the [Standard Plans](#) website next to the Index.

115.2.2 Standard Plans Revisions

[Standard Plans](#) revisions are implemented with the regularly scheduled annual version (i.e., in-cycle). These revisions may include additions, updates, corrections, clarifications, or deletions to the [Standard Plans](#). Documentation of [Standard Plans](#) revisions is posted in Revision History sheets on the [Standard Plans](#) website.

115.2.3 Standard Plans Interim Revisions

Standard Plans Interim Revisions (SPIR) are changes requiring implementation before the regularly scheduled version of the [Standard Plans](#) is published (i.e., out-of-cycle). The **SPIR** is posted on the website with the version of the [Standard Plans](#) that is specifically affected. Interim revisions are typically incorporated into the proceeding annual publication.

SPIRs are made effective through the release of a **Design Bulletin**, which includes the revised Index and implementation requirements. When a **SPIR** is applicable to a project, it must be referenced in accordance with **FDM 910**.

115.2.4 Developmental Standard Plans

Developmental Standard Plans integrate new or innovative concepts into the [Standard Plans](#). A Central Office Monitor is assigned to each **Developmental Standard Plan**. The Central Office Monitor oversees the development of the Index, monitors the usage process, and makes changes as needed. The use of a **Developmental Standard Plan** requires the approval of the Central Office Monitor.

Developmental Standard Plans are typically released with a **Design Bulletin** or as part of criteria included within the **FDM**.

Follow the process illustrated in **Figure 115.2.1** when seeking approval to use a Developmental Index. When a project-specific use has been approved by the Central Office Monitor, the project's FPID number is listed on the **Developmental Standard Plans** website with the appropriate Developmental Index. Include the Developmental Index in the project plans in accordance with **FDM 910**.

Figure 115.2.1 Developmental Standard Plans Usage Process

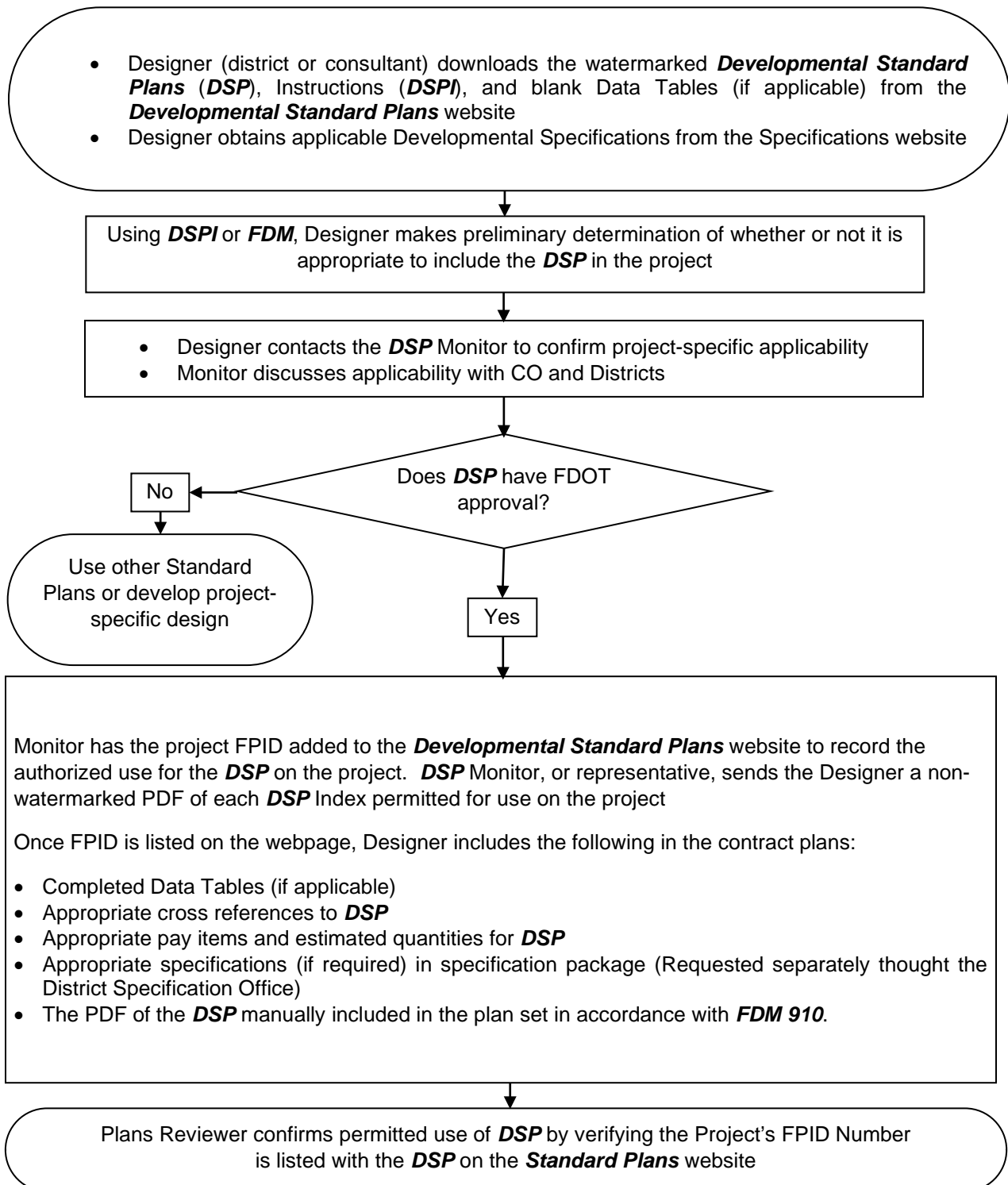

115.2.5 Modifications to Standard Plans

Modifications to Standard Plans may be needed if the [Standard Plans](#) do not meet a project specific need. When this occurs, modifications of a [Standard Plan](#) requires the approval of the District Design Engineer. To facilitate the process, CADD files are available on the [Standard Plans](#) website. When **Modifications to Standard Plans** are needed, the modifications must be performed under the direct supervision of a Florida Licensed Professional Engineer and one of the following methods must be used:

- (1) **Method 1:** Produce a new project-specific drawing using the details within the CADD files as a guide or template. No reference to the related [Standard Plan](#) is called out in the plans. The details in the plans which were created from the CADD files cease to be a Standard and the engineer responsible for the modifications to the drawings becomes the EOR for the application of the entire design.
- (2) **Method 2:** Modify the details and notes within the CADD files for the project-specific requirements. No reference to the related [Standard Plan](#) is called out in the plans. The plans must clearly depict evidence that modifications have been made to the original [Standard Plan](#) to avoid any confusion. It may be appropriate to place a plan note indicating that the details are based on modifications to the original [Standard Plan](#). The details in the plans which were created from the CADD file cease to be a Standard and the engineer responsible for the modifications to the drawings becomes the EOR for the application of the entire design, including the applicability and correctness of the unaltered portions of the CADD file.
- (3) **Method 3:** If the required modifications are minor (e.g., modifications to reinforcing, changes to specific sectional details, or accommodations for unique design elements), use the CADD file to create details showing the modifications to the [Standard Plans](#) on a separate sheet in the plans. Include a reference to the related [Standard Plans](#) in the Index of Sheets. Place the modified details in the plans on a sheet entitled, "*Modifications to Standard Plans, Index ### - ###*". The engineer responsible for the modifications to the [Standard Plan](#) becomes the EOR for the details on this sheet and for effects the modification has on other components within the [Standard Plans](#).

115.2.6 Standard Plans Instructions

The ***Standard Plans Instructions (SPIs)*** provides instructions for incorporating the ***Standard Plans*** into the Contract Plans. ***SPIs*** include design criteria, usage limitations, plan content requirements, and pay item information. ***SPIs*** may also provide examples and sample drawings.

Instructions are organized by ***Standard Plans*** Index number and included on the ***Standard Plans*** website adjacent to the associated Index. Some instructions apply to an entire series of Indexes. Instructions for the Indexes in each respective series are included in the instructions for the lead Index of the series.

It is the responsibility of the EOR using these instructions to determine the applicability of an Index in the design of a project. The inappropriate use of and adherence to these instructions does not exempt the engineer from the responsibility of developing an appropriate design.

115.2.7 Data Tables

Many ***Standard Plans*** require Data Tables that must be completed and included in the plans. The Data Tables provide information that supplements or completes individual ***Standard Plans***. The Data Tables are presented as CADD Cells and are included with the FDOT CADD Software. Modifications of these tables are discouraged.

Current Data Tables can be found on the ***Standard Plans website*** (under “Supporting Documents”) when they are not available in the FDOT CADD Software.

Data Tables include a “Table Date” in the upper right corner of each table, and they may include a “Notes Date” for each set of corresponding notes. “Table Date” or “Notes Date” reflect the latest modification of the CADD cell and are not to be changed or deleted. Compare the “Table Date” or “Notes Date” with the ***SPI*** to confirm that the current Data Table is being used.

115.2.8 Local Agency Standards and Details

Local agency standards are permitted on off-system projects for items requested by the local maintaining agencies that differ from the Department’s ***Standard Plans***. Use only local agency standards developed by a Florida Licensed Professional Engineer. Usage of local agency standards requires approval of the District Design Engineer.

Use one of the following methods to incorporate local agency standards and details into the Contract Plans:

- A. Include as **Modifications to Standard Plans**, as described above.
- B. Add project-specific details and notes based on the local agencies standard into the Contract Plans. The engineer responsible for including these details and notes in the Contract Plans becomes the EOR for the application of the entire design. This option should only be used for items completely independent of the Department's Standard Plans.
- C. Attach the local agencies standard(s) (without modification) in the Contract Plans. Only include the standard(s) specific to the project. Insert the local agency standard(s) into the Contract Plans in accordance with the requirements for **Developmental Standard Plans** provided in **FDM 910**. Reference the agency standards where required using plan notes or callouts.

Consider the need for a Modified Special Provision or Technical Special Provision where the local agency standards conflict with, or are not addressed by, the FDOT Standard Specifications. Coordinate the need for project-specific pay items with the District Specifications Office.

115.3 Standard Specifications

The governing Specifications for a project include the Standard Specifications and any revisions thereto. These revisions typically take the form of Special Provisions, Supplemental Specifications, Modified Special Provisions (MSPs), Technical Special Provisions (TSPs), and Developmental Specifications. Revisions to the Standard Specifications are compiled into the **Specifications Package**, which is part of the contract documents.

The process of compiling and formatting the **Specifications Package** is described in the Department's **Specification Package Preparation Procedure (Topic No.: 630-010-005)** and the Specifications Handbook. These documents also include the definitions of the various components and an explanation of the roles and responsibilities of the different individuals involved (e.g., EOR, District, Central Office).

The governing Standard Specifications for every project must be identified in the plans in accordance with **FDM 910**.

These publications are available on the State Specification Office website at: <https://www.fdot.gov/programmanagement/PackagePreparation/Default.shtm>

116 Alternative Intersection and Interchange Review

116.1 General

Alternative Intersection evaluations are governed by the Intersection Control Evaluation process. See the ***Intersection Control Evaluation (ICE) Manual*** for requirements at the following web address:

https://www.fdot.gov/traffic/TrafficServices/Intersection_Operations.shtm

See ***FDM 901*** for Alternative Intersection and Interchange phase submittal requirements.

Alternative intersections and interchanges provide a fresh approach to addressing congestion and safety concerns on the State Highway System. They are typically more complex than conventional designs and there is little guidance available to designers. For these reasons, all proposed Alternative Intersection and Interchange designs require a detailed review early and throughout the design process.

Configurations subject to this detailed review are listed as follows:

- Roundabout
- Median U-Turn (MUT)
- Restricted Crossing U-Turn (RCUT)
- Jug Handle
- Displaced Left Turn
- Continuous Green-T
- Quadrant Roadway
- Diverging Diamond Interchange (DDI)

Include Alternative Intersection and Interchange Review Packages in the Phase I Submittal. Designate a representative of the State Roadway Design Office as a Lead Reviewer for all phases in ERC.

117 Monitor Existing Structures

117.1 General

Monitor Existing Structures includes settlement, vibration, and groundwater monitoring of existing structures during construction as described in [Standard Specifications, Section 108](#). Monitor Existing Structures pay item numbers are lump sum; see the [Basis of Estimates Manual](#) for additional information.

For Department (in-house) design projects, the Department PM should work with appropriate district staff to identify and determine the structures that are to be monitored.

For Consultant design projects, the Consultant PM is to provide to the Department PM a list of structures that warrant consideration for monitoring. The Department PM will work with appropriate district staff to make a final determination of the structures that are to be included.

117.2 Inspection and Settlement Monitoring

Inspection and settlement monitoring (pay item 108-1) is primarily used to mitigate the risk for damage occurring to an existing structure due to settlement of the foundation. Structures considered for settlement monitoring typically include buildings, bridges, retaining walls, and other facilities such as historic features or swimming pools. This pay item is typically not used for Department owned structures, but should be considered for existing bridges for bridge widening projects.

If a determination is made to monitor an existing structure, include pay item 108-1 in the Estimated Quantities (EQ) Report in the Summary of Lump Sum Items table.

117.2.1 Miscellaneous Structures

Activities that may cause harm to existing structures include the construction of foundations for mast arm signal poles, strain poles, cantilever signs, overhead truss signs, high mast lighting, and ITS poles.

Because **108-2.1** of the [Standard Specifications, Section 108](#), does not provide prescribed distances for Miscellaneous Structures, all structures that are to be monitored must be listed in a pay item note on the General Notes sheet; see **FDM 117.5**.

117.2.2 Structures Other Than Miscellaneous Structures

Activities that may cause harm to existing structures include the excavation of deep foundations, extraction of existing piles, sheet piling and temporary casing installations, and pile driving operations associated with bridge or retaining wall construction.

MSE walls and bridges founded on short piles, shallow foundations, or timber pile foundations are vulnerable to these operations.

Structures that are to be monitored that are beyond the distances specified in the [Standard Specifications, Section 108](#), must be listed in a pay item note on the General Notes sheet; see *FDM 117.5*.

117.2.3 Roadway Compaction Operations

Activities that may cause harm to existing structures include embankment and asphalt vibratory compaction.

Do not include inspection and settlement monitoring (pay item 108-1) for roadway compaction operations when a note is included in the plans requiring non-vibratory compaction mode near any structure recommended for monitoring.

Structures that are to be monitored that are beyond the distances specified in the [Standard Specifications, Section 108](#), must be listed in a pay item note on the General Notes sheet; see *FDM 117.5*. It is typically not necessary to monitor structures beyond the distances specified in the [Standard Specifications, Section 108](#).

117.3 Vibration Monitoring

Vibration monitoring (pay item 108-2) is primarily used to mitigate the risk for interfering with the intended use of an existing structure. Structures considered for vibration monitoring typically include buildings in which sensitive business operations are conducted: e.g., eye surgery, medical treatments, rehabilitation operations, recording and broadcasting operations, places of worship, antique shops, or museums.

This pay item is not typically used for residential properties, storage facilities, retail and grocery stores, warehouse and distribution centers, or other similar structures where sensitive business operations are not conducted. This pay item should not typically be used for Department owned structures.

Activities that may warrant vibration monitoring include pile driving, sheet pile and casing installation, and embankment and asphalt vibratory compaction.

Do not include vibration monitoring (pay item 108-2) for embankment and asphalt compaction operations when the risk of interfering with the intended use of a structure is mitigated by including a note in the plans that:

- (1) Restricts hours of construction activities (to non-business hours).
- (2) Requires non-vibratory compaction mode.

If a determination is made to monitor an existing structure, include pay item 108-2 in the EQ Report in the Summary of Lump Sum Items table. Because [Standard Specifications, Section 108](#), does not provide prescribed distances for Vibration Monitoring, all structures that are to be monitored must be listed in a pay item note on the General Notes sheet; see **FDM 117.5**.

117.4 Groundwater Monitoring

Dewatering operations has the potential for lowering the groundwater elevation in or above compressible soils supporting a structure which can cause that structure to settle. Groundwater monitoring for this purpose is not common and is to be used only when concurred with by the District Geotechnical Engineer.

If a determination is made to monitor an existing structure, include pay item 108-3 in the EQ Report in the Summary of Lump Sum Items table. Because [Standard Specifications, Section 108](#), does not provide prescribed distances for Groundwater Monitoring, structures that are to be monitored must be listed in a pay item note on the General Notes sheet; see **FDM 117.5**.

117.5 Pay Item Notes

The following are examples of pay item notes. Notes are included in the plans only when [Standard Specifications, Section 108](#), does not provide prescribed distances, or when a structure is beyond the prescribed distances.

- 108-1 In addition to the requirements of [Standard Specifications, Section 108](#), provide Inspection and Settlement Monitoring for the following structures:
- Church located at 3750 County Road 220 during pile driving operations.
 - Historic cemetery stone archway entrance located at Sta. 1327+60 Lt. during foundation construction for mast arm signal pole.
 - Existing I-95 Bridge over NW 6th Ave, piers 1 through 6, during pile driving operations for bridge widening.
- 108-2 Provide Vibration Monitoring for the Walk-in Medical Clinic located at 3326 Byron Road during pile driving operations.
- 108-3 Provide Groundwater Monitoring for the commercial building located at Sta. 840+25 Rt. during dewatering operations.

120 Design Submittals

120.1 General

The design process will require various submittals to transfer technical information and decisions between the Engineer of Record (EOR), Department personnel, and functional areas. The Department Project Manager is responsible for the adequacy of the submittals or requests and for the coordination of reviews between the Department and the EOR. Each district office head (including Construction and Maintenance) should assume direct responsibility for assigning reviewers and meeting the review schedules. The contract scope of work should list the information to be furnished by FDOT functional areas and submittals (number and type) required of the EOR.

During the design process, various items of information may be required from different sections or departments. **Figure 120.1.1**, shown on the following page, is a partial list of functional areas with typical submittals and requests. Plans phase submittals include component plans and BIM files.

**Figure 120.1.1 List of Requests and Contacts
Sheet 1 of 2**

A) Planning

Request pavement design (18 Kip ESAL)
Request project traffic data
Request turning movements for intersections
Request updates of project traffic data (as needed)
Request Context Classification
Railroad contact (Phase I and III)
Plans transmittal letter data (railroad)
Notification that projects is in vicinity of a traffic monitoring site

B) Traffic Plans/Traffic Operations

Request turns and counts for intersection design
Notification that projects include milling
Signing & pavement marking plans (Phase I, II, III)
Traffic signal plans (Phase I, II, III) & signal warrant
Lighting plans (Phase I, II) & justification report
Pedestrian and bicycle project traffic
Safety/crash analysis and recommendations
Operational and capacity review of design plans

C) Geotechnical

Request pavement design soil information
Request roadway soil survey
Soils data
Request foundation investigations
Request dynaflect testing
Phase III review if unsuitable soils exist.
Soils and foundation recommendations
PH and soils resistivity for culvert material selection
Request pavement composition and milling recommendations
Review if any changes are made in alignment, grade, or typical section.
Bridge Geotechnical Report

D) Surveying and Mapping

Request survey

E) Drainage

Request grade and high-water review
Conceptual drainage plan & assumptions
Bridge Hydraulics Report
Request drainage design
Request final drainage review
Permit review
Stormwater Runoff Control Concept

F) Maintenance

Pavement design comments
Phase I Plans review & response
Phase II Plans review & response
Phase III Plans review & response

G) Construction

Pavement design comments
Phase I Plans review & response
Phase II Plans review (constructability) & response
Phase III Plans review (biddability) & response
Submit traffic control plan request
Contract time

H) R/W Surveying and Mapping

Submit title search request
Request existing Right of Way maps
Transmit Right of Way requirements
Final Right of Way check
Plans transmittal letter data

I) Utilities

Preliminary (First) contact (Phase I)
Pre-Design conference and contact (Phase II)
Final contact (Phase III)
Horizontal and vertical verification of utilities
Plans transmittal letter data (utilities)
Number of sets of final prints for utility companies

**Figure 120.1.1 List of Requests and Contacts
Sheet 2 of 2**

J) Estimates and Specifications

- Preliminary estimate (LRE)
- Preliminary estimate (Phase I)
- Preliminary estimate (Phase II)
- Preliminary estimate (Phase III)
- Complete estimate (Phase IV)

K) Right of Way Department

- Project schedule updates as needed
- R/W estimates as needed
- Pre-Proposal appraisal conference
- Field questions from R/W agents as needed
- Plans transmittal letter data
- Phase I Plans Review (by Appraiser)
- Phase II Plans Review (by Appraiser)
- Phase III Plans Review (by Appraiser)

Phase IV Plans Review (by Appraiser)

L) FHWA (if Project of Division Interest (PoDI))

- Phase I Plans review & response
- Phase II Plans review & response
- Phase III Plans review & response
- Phase IV Plans review & response
- Submit for typical section approval
- Submit for pavement design approval
- Submit Design Exception request letters
- R/W review

M) Value Engineering (\$25,000,000+)

- Phase I & II reviews

120.2 Design Documentation Submittals

Certain engineering processes require the submittal of information to specific Department personnel for the purpose of making timely decisions and confirming project objectives. Submittals will take place as these activities are completed so that issues do not go unresolved before subsequent activities begin. The following are submittals that should take place during initial engineering. Ideally these engineering type submittals are done in lieu of traditional phase plans reviews.

120.2.1 Field Survey Data

Evaluate the following typical field survey data for sufficient breadth and accuracy to complete the proposed design. Bring deficiencies to the attention of the Department.

- (1) Design location survey data including horizontal and vertical control, alignments, reference points, utilities, natural and manmade features, and topography or general shape of the terrain.
- (2) Digitized aerial survey data, especially for large areas such as drainage maps. Drainage design survey data from site inspection and historical records.
- (3) Right of Way and related property (land) survey data, including property owners and acreage.

- (4) Geotechnical studies and foundation and soils report, including physical properties and classifications of soils, together with recommendations related to foundations, pavement, and drainage design.
- (5) Bridge data sheet surveys, channel alignment survey data, and bathymetric data.

120.2.2 Traffic Data

In the development of roadway plans, traffic data is used to justify:

- Number of through lanes,
- Geometric improvements to intersections,
- Traffic signal timings, and
- Pavement design.

The number of through lanes is usually determined during the project development phase, based on Annual Average Daily Traffic (AADT) and factors included in the typical section. Vehicular traffic data shown on the plans Typical Section sheet includes:

- AADT for the following:
 - Current Year (refers to when the traffic data is collected),
 - Opening Year (as defined in the FDOT Project Traffic Forecasting Handbook), and
 - Design Year (as defined in the FDOT Project Traffic Forecasting Handbook)
- Design hour factor (K is the Department's Standard "K" factor as defined in the FDOT Traffic Forecasting Handbook),
- Directional distribution (D is the percent of two-way peak-hour traffic that occurs in the peak direction), and
- Truck factors (T is the percent that trucks constitute of vehicular traffic) for the peak hour and a 24-hour period.

The source and methods used to produce this data must be documented.

120.2.2.1 Traffic Counts

Intersection improvements and signal timings require additional information on turning volumes. The [***FDOT Project Traffic Forecasting Procedure \(Topic No.: 525-030-120\)***](#) describes the input data required, explains the procedure to forecast turning volumes,

and provides examples. A Project Traffic Report will be required. Traffic counts provide input on the number of motor vehicles, bicycles and pedestrians using an intersection. At proposed (non-existing) major intersections, turning volumes are estimated using transportation planning models or other means. Forecasts provide designers the information required to determine the need for turning lanes, turning bay length, signal timings, and pedestrian crossings. Also, the designer establishes Right of Way requirements based on documented needs to satisfy design year volumes.

120.2.2.2 18-kip Equivalent Single Axle Loads (ESAL)

In pavement design, the designer requires AADT forecasts for the year a project opens to traffic and for the design year. AADT, together with percent trucks (24-hour period) and other factors used by the Department, provides information on the pavement loadings (18kip ESAL) used in pavement design. The FDOT Project Traffic Forecasting Procedure provides additional information.

120.2.3 Typical Section Package

The purpose of the typical section package is to establish and document the following:

- (1) Project Controls
- (2) Typical Section Elements
 - Lanes (width and cross slope)
 - Curbs (for curbed roadways)
 - Median (for divided roadways)
 - Shoulders (paved and unpaved)
 - Front and back side slopes, including roadside ditches
 - Border and clear zone
 - Bicycle and pedestrian facilities.
- (3) Traffic Data
- (4) Potential Design Variations and Design Exceptions related to the typical section.

Prepare a typical section package for projects that alter cross section elements and for resurfacing projects. The typical section package must be prepared and sealed by the EOR. The 11" x 17" report format is available in the FDOT CADD Software for the development of typical section packages.

The Typical Section Package consists of a cover sheet and proposed typical section sheet(s). See **Exhibit 120-1** for an example of a cover sheet and **Exhibits 120-2** through **120-4** for examples of typical section sheets.

120.2.3.1 Approval Process

The completed Typical Section Package is signed and sealed by the Engineer of Record (EOR). Concurrence signatures must be obtained prior to sealing (typically obtained using DocuSign), including:

- District Design Engineer: design, posted, and target speeds and typical section
- District Traffic Operations Engineer: design, posted, and target speeds
- FHWA Transportation Engineer: typical section
- District Structures Engineer: bridge typical section elements
- District ISD Manager: Context Classification and target speed

Projects with PD&E Phase:

The typical section package is prepared by the PD&E EOR as part of the Project Development & Environment (PD&E) process. The Typical Section Package is processed after the preferred alternative is selected. Include a copy of the approved Typical Section Package as part of the PD&E Final Preliminary Engineering Report.

Projects without PD&E Phase:

For projects that do not contain a PD&E phase, or if significant changes occurred during the design process, a Typical Section Package is prepared by the Design EOR. The Typical Section Package should be approved by the Department prior to the Phase II plans submittal.

120.2.3.2 Cover Sheet

The Cover Sheet contains the following:

- (1) **Project Identification:** Place the Financial Project ID number(s) immediately under the heading "TYPICAL SECTION PACKAGE" at the top of the sheet. When the project involves Federal funds, place the words "(Federal Funds)" under the Financial Project ID. Place the county name and roadway section number associated with the Straight-Line Diagrams under the Financial Project ID or "(Federal Funds)". Include a description of work type under the state road number.

- (2) Project Work Limits and Features as explained in **FDM 910.2.2**.
- (3) Project Location: Show a small-scale state map at the upper right portion of the Cover Sheet and indicate with leader line the general location of the project within the state.
- (4) PD&E or Design EOR Signature Block: See **FDM 130** for requirements.
- (5) Sheet Index: Provide an index of sheets listing all sheets contained in the package that the EOR is responsible for.
- (6) Typical Section Concurrence: Concurrence from the District Design Engineer for all typical sections is required. Other concurrence signatures may be included:
 - (a) District Structures Design Engineer for bridge typical sections
 - (b) County or City Engineer for local roadway typical sections.
 - (c) Concurrence of the typical section elements by the FHWA Transportation Engineer is required on Projects of Division Interest (PoDI). Refer to **FDM 128** for additional information concerning PoDIs.
- (7) Design Speed and Posted Speed Concurrence: The District Design Engineer and District Traffic Operations Engineer will discuss and agree to the posted speed. The selected design speed will be jointly approved by the District Design Engineer and the District Traffic Operations Engineer with a declaration that the posted speed is not expected to exceed the selected design speed.
- (8) Context Classification Concurrence: Context classification is determined by FDOT district staff on all projects. Coordinate with the FDOT Project Manager to obtain context classification(s). Concurrence from the District Intermodal Systems Development (ISD) Manager or Planning and Environmental Management Administrator for the context classification assigned to each typical section is required.
- (9) Target Speed Concurrence: The District Design Engineer, District Traffic Operations Engineer, and District Intermodal Systems Development Manager will discuss and agree to the Target Speed.

120.2.3.3 Typical Section Sheet

The Typical Section sheet contains a data box that provides the Project Controls, and the cross-section view showing the proposed typical section. Provide a Typical Section sheet for each proposed typical section. The only gaps between the begin and end Project Limits should be Project Exceptions. Other than the primary State Road typical section, additional typical sections may be required for the following conditions:

- A change in the number of through lanes, or a change in Project Controls
- Change in facility type (e.g., flush shoulder roadway to curbed roadway)
- Intersecting roadways when significant work length is required
- Toll sites (ramp and mainline) representing the required 100 feet of loop pavement underneath the toll gantry.
- New, widened, or modified bridges.

Project Controls:

Indicate Project Controls that apply to the typical section being shown as follows:

- (1) Context Classification: Indicate the applicable context classification.
- (2) Functional Classification: Indicate the type of facility.
- (3) Highway System: Indicate the applicable highway system(s) for the roadway.
- (4) Access Classification: Indicate the degree of access for the roadway.
- (5) Criteria: Indicate the type of construction.
- (6) Potential Exceptions and Variations: List non-compliant typical section elements related to the typical section.

When the typical section limits contain one or more applicable project control, list each project control with the limits to which it applies. This is an acceptable practice only when changes in project control do not affect the typical section elements being shown.

Typical Section:

Display the proposed typical section in the center of the cross-section view panel. The FDOT CADD Software provides typical section templates that can be modified to reflect the conditions of a particular project. Typical sections are not created to scale, but the horizontal dimensions should be proportionate.

Show all required typical section information contained in **FDM 913.2**, except:

- (1) Show and label Border Width (required only for new construction and reconstruction projects) and Clear Zone (required only for flush shoulder roadway).
- (2) Do not include Typical Section Notes and Details.
- (3) Do not include Partial Sections.

Place below each typical section the name of roadway and station or Mile Post (MP) Limits. Assumed beginning MP or station (e.g., MP 0.000 at point of intersection) may be used for local roads.

Provide the following Traffic Data on the lower left portion of the plan view panel:

- (a) Current Year and AADT
- (b) Estimated Opening Year and AADT
- (c) Estimated Design Year and AADT
- (d) K, D, T (24-hour) factors.
- (e) Design Hour T factor
- (f) Design Speed, Posted Speed, Target Speed

STATE OF FLORIDA
DEPARTMENT OF TRANSPORTATION

TYPICAL SECTION PACKAGE

FINANCIAL PROJECT ID 123456-1-52-01
(FEDERAL FUNDS)

BAY COUNTY (46080)

STATE ROAD NO. 22 (WEWA HWY)

ADD LANES AND RECONSTRUCT FROM CRIM BLVD. TO KURT ST.

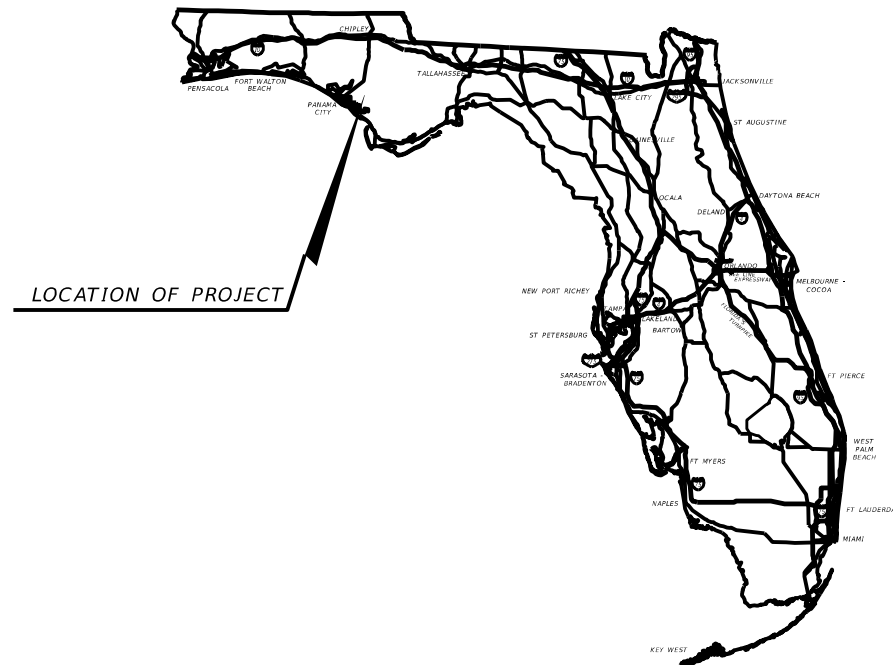

FDOT DISTRICT DESIGN ENGINEER

Lan B. Solo
2017.10.11 08:12:33 - 4'00'

CONCURRING WITH:
TYPICAL SECTION ELEMENTS
TARGET SPEED
DESIGN & POSTED SPEEDS

FDOT DISTRICT TRAFFIC OPERATIONS ENGINEER

Garth Paul
2017.10.10 14:10:15 - 4'00'

CONCURRING WITH:
TARGET SPEED
DESIGN & POSTED SPEEDS

FDOT DISTRICT INTERMODAL SYSTEMS DEVELOPMENT MANAGER

Rey-Rey Olay
2017.10.10 12:01:30 - 4'00'

CONCURRING WITH:
CONTEXT CLASSIFICATION
TARGET SPEED

FDOT DISTRICT STRUCTURES DESIGN ENGINEER

J.T. Hutt
2017.10.10 15:11:45 - 4'00'

CONCURRING WITH:
TYPICAL SECTION ELEMENTS

PROJECT LOCATION URL: <https://tinyurl.com/367v2589>
PROJECT LIMITS: BEGIN MP 1.560 - END MP 7.560
EXCEPTIONS: NONE
BRIDGE LIMITS: BR#469998 MP 3.422 - MP 3.471
RAILROAD CROSSING: NONE

APPROVED BY:

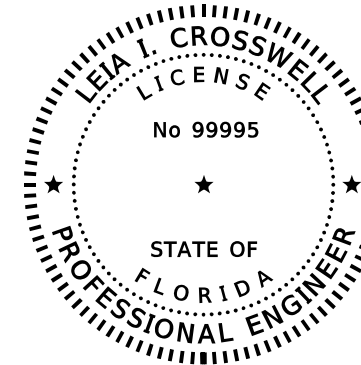

THIS ITEM HAS BEEN DIGITALLY SIGNED AND SEALED BY

Leia I. Crosswell
2017.10.09 16:40:48 - 4'00'

ON THE DATE ADJACENT TO THE SEAL

PRINTED COPIES OF THIS DOCUMENT ARE NOT CONSIDERED SIGNED AND SEALED AND THE SIGNATURE MUST BE VERIFIED ON ANY ELECTRONIC COPIES.

ROADWAY ENGINEERS, INC.
123 MAIN STREET
TALLAHASSEE, FL 32301
CERTIFICATE OF AUTHORIZATION: 12345
LEIA I. CROSSWELL, P.E. NO. 99995

THE ABOVE NAMED PROFESSIONAL ENGINEER SHALL BE RESPONSIBLE FOR THE FOLLOWING SHEETS IN ACCORDANCE WITH RULE 61G15-23.004, F.A.C.

INDEX OF SHEETS

SHEET NO	SHEET DESCRIPTION
1	COVER SHEET
2	TYPICAL SECTION NO. 1
3	TYPICAL SECTION NO. 2
4	TYPICAL SECTION NO. 3
5	TYPICAL SECTION NO. 4

Exhibit 120-1
Date: 1/1/22

FHWA TRANSPORTATION ENGINEER

NOT USED

CONCURRING WITH:

LOCAL TRANSPORTATION ENGINEER

NOT USED

CONCURRING WITH:

SHEET NO.

1

PROJECT CONTROLS

CONTEXT CLASSIFICATION

- () C1 : NATURAL () C3C : SUBURBAN COMM.
- () C2 : RURAL () C4 : URBAN GENERAL
- () C2T : RURAL TOWN () C5 : URBAN CENTER
- (X) C3R : SUBURBAN RES. () C6 : URBAN CORE
- () N/A : L.A. FACILITY () N/A : FL GREENBOOK

FUNCTIONAL CLASSIFICATION

- () INTERSTATE () MAJOR COLLECTOR
- () FREEWAY/EXPWY. () MINOR COLLECTOR
- (X) PRINCIPAL ARTERIAL () LOCAL
- () MINOR ARTERIAL

HIGHWAY SYSTEM

- () NATIONAL HIGHWAY SYSTEM
- () STRATEGIC INTERMODAL SYSTEM
- (X) STATE HIGHWAY SYSTEM
- () OFF-STATE HIGHWAY SYSTEM

ACCESS CLASSIFICATION

- () 1 - FREEWAY
- () 2 - RESTRICTIVE w/Service Roads
- () 3 - RESTRICTIVE w/660 ft. Connection Spacing
- (X) 4 - NON-RESTRICTIVE w/2640 ft. Signal Spacing
- () 5 - RESTRICTIVE w/440 ft. Connection Spacing
- () 6 - NON-RESTRICTIVE w/1320 ft. Signal Spacing
- () 7 - BOTH MEDIAN TYPES

CRITERIA

- (X) NEW CONSTRUCTION / RECONSTRUCTION
- () RESURFACING (LA FACILITIES)
- () RRR (ARTERIALS & COLLECTORS)

POTENTIAL EXCEPTIONS AND VARIATIONS RELATED TO TYPICAL SECTION:

- DESIGN VARIATIONS
1. LATERAL OFFSET

TYPICAL SECTION No. 1

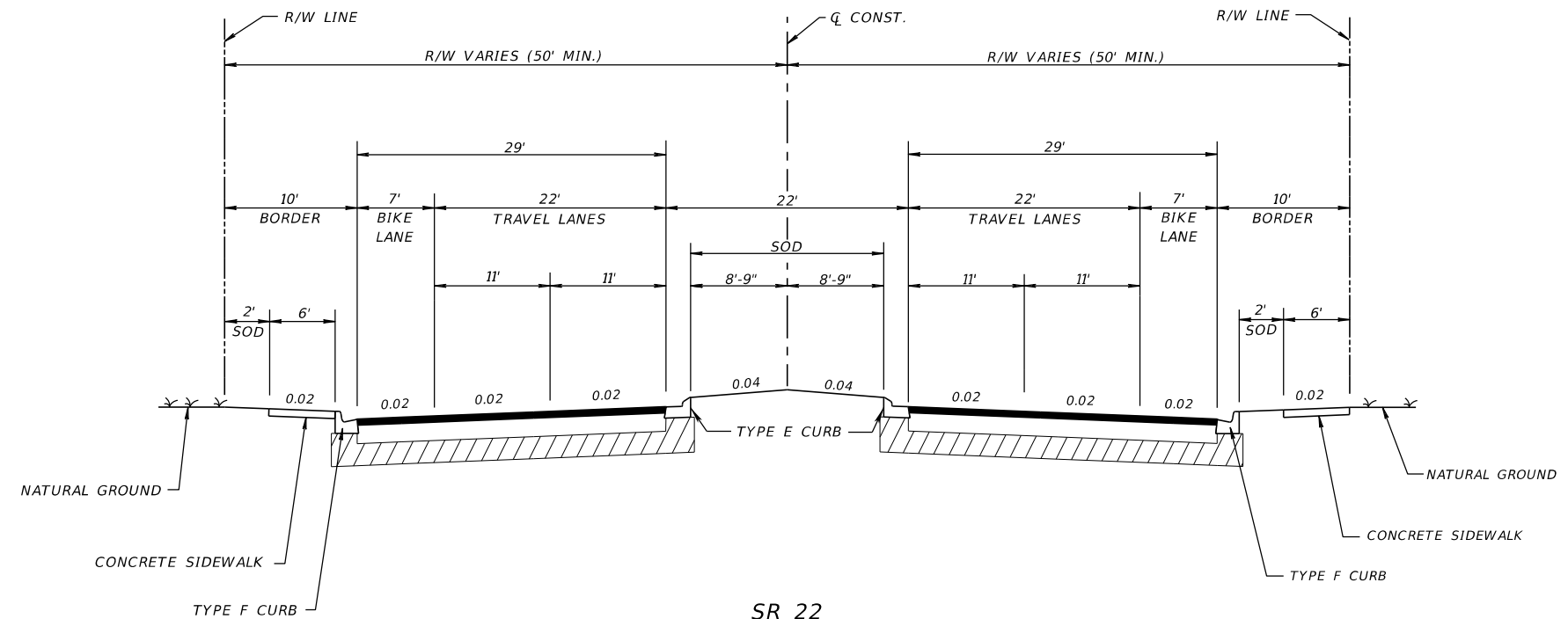

SR 22
MP 1.560 TO MP 3.422
MP 3.471 TO MP 3.725

TRAFFIC DATA

CURRENT YEAR = 2018 AADT = 22800
 ESTIMATED OPENING YEAR = 2020 AADT = 25800
 ESTIMATED DESIGN YEAR = 2040 AADT = 30600
 K = 6% D = 55% T = 2% (24 HOUR)
 DESIGN HOUR T = 1%
 TARGET SPEED = 35 MPH
 DESIGN SPEED = 35 MPH
 POSTED SPEED = 35 MPH

NOT TO SCALE

Exhibit 120-2
Date: 1/1/22

FINANCIAL PROJECT ID	SHEET NO.
123456-1-52-01	2

PROJECT CONTROLS

CONTEXT CLASSIFICATION

- () C1 : NATURAL () C3C : SUBURBAN COMM.
- () C2 : RURAL () C4 : URBAN GENERAL
- () C2T : RURAL TOWN () C5 : URBAN CENTER
- (X) C3R : SUBURBAN RES. () C6 : URBAN CORE
- () N/A : L.A. FACILITY () N/A : FL GREENBOOK

FUNCTIONAL CLASSIFICATION

- () INTERSTATE () MAJOR COLLECTOR
- () FREEWAY/EXPWY. () MINOR COLLECTOR
- (X) PRINCIPAL ARTERIAL () LOCAL
- () MINOR ARTERIAL

HIGHWAY SYSTEM

- () NATIONAL HIGHWAY SYSTEM
- () STRATEGIC INTERMODAL SYSTEM
- (X) STATE HIGHWAY SYSTEM
- () OFF-STATE HIGHWAY SYSTEM

ACCESS CLASSIFICATION

- () 1 - FREEWAY
- () 2 - RESTRICTIVE w/Service Roads
- () 3 - RESTRICTIVE w/660 ft. Connection Spacing
- (X) 4 - NON-RESTRICTIVE w/2640 ft. Signal Spacing
- () 5 - RESTRICTIVE w/440 ft. Connection Spacing
- () 6 - NON-RESTRICTIVE w/1320 ft. Signal Spacing
- () 7 - BOTH MEDIAN TYPES

CRITERIA

- (X) NEW CONSTRUCTION / RECONSTRUCTION
- () RESURFACING (LA FACILITIES)
- () RRR (ARTERIALS & COLLECTORS)

POTENTIAL EXCEPTIONS AND VARIATIONS RELATED TO TYPICAL SECTION:

TYPICAL SECTION No. 2

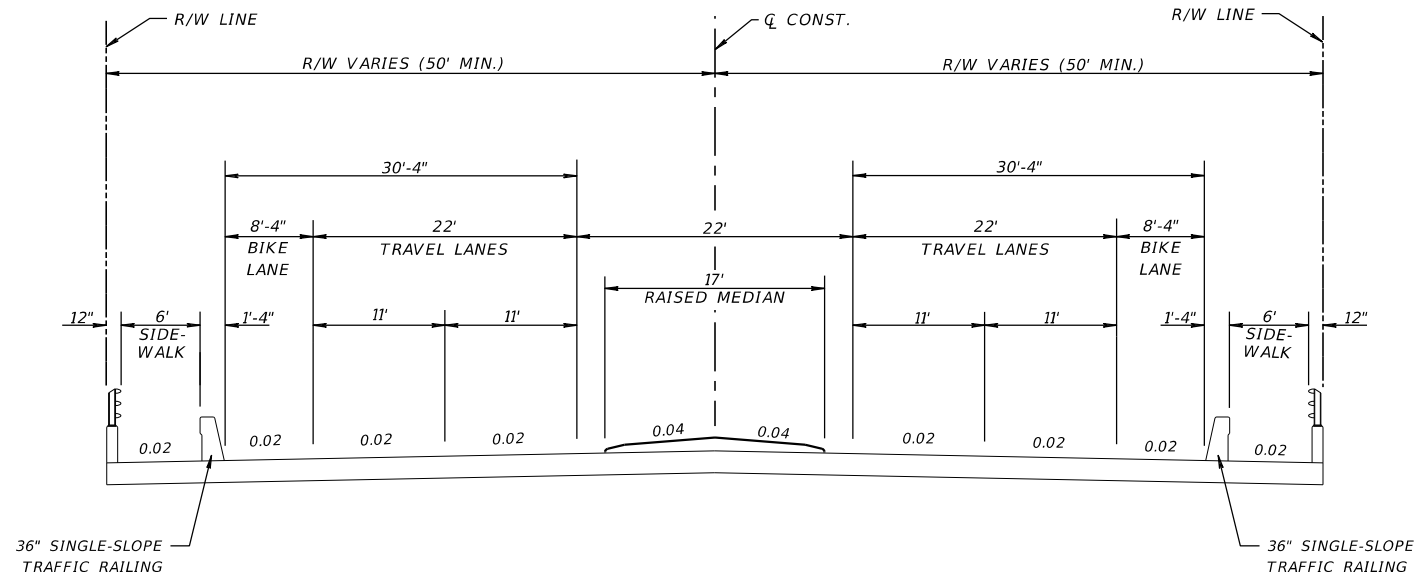

SR 22 OVER CALLAWAY BAYOU
MP 3.422 TO MP 3.471

NOT TO SCALE

TRAFFIC DATA

CURRENT YEAR = 2018 AADT = 22800
 ESTIMATED OPENING YEAR = 2020 AADT = 25800
 ESTIMATED DESIGN YEAR = 2040 AADT = 30600
 K = 6% D = 55% T = 2% (24 HOUR)
 DESIGN HOUR T = 1%
 TARGET SPEED = 35 MPH
 DESIGN SPEED = 35 MPH
 POSTED SPEED = 35 MPH

Exhibit 120-3
Date: 1/1/22

FINANCIAL PROJECT ID	SHEET NO.
123456-1-52-01	3

PROJECT CONTROLS

CONTEXT CLASSIFICATION

- () C1 : NATURAL
- (X) C2 : RURAL
- () C2T : RURAL TOWN
- () C3R : SUBURBAN RES.
- () N/A : L.A. FACILITY
- () C3C : SUBURBAN COMM.
- () C4 : URBAN GENERAL
- () C5 : URBAN CENTER
- () C6 : URBAN CORE
- () N/A : FL GREENBOOK

FUNCTIONAL CLASSIFICATION

- () INTERSTATE
- () FREEWAY/EXPWY.
- (X) PRINCIPAL ARTERIAL
- () MINOR ARTERIAL
- () MAJOR COLLECTOR
- () MINOR COLLECTOR
- () LOCAL

HIGHWAY SYSTEM

- () NATIONAL HIGHWAY SYSTEM
- () STRATEGIC INTERMODAL SYSTEM
- (X) STATE HIGHWAY SYSTEM
- () OFF-STATE HIGHWAY SYSTEM

ACCESS CLASSIFICATION

- () 1 - FREEWAY
- () 2 - RESTRICTIVE w/Service Roads
- (X) 3 - RESTRICTIVE w/660 ft. Connection Spacing
- () 4 - NON-RESTRICTIVE w/2640 ft. Signal Spacing
- () 5 - RESTRICTIVE w/440 ft. Connection Spacing
- () 6 - NON-RESTRICTIVE w/1320 ft. Signal Spacing
- () 7 - BOTH MEDIAN TYPES

CRITERIA

- (X) NEW CONSTRUCTION / RECONSTRUCTION
- () RESURFACING (LA FACILITIES)
- () RRR (ARTERIALS & COLLECTORS)

POTENTIAL EXCEPTIONS AND VARIATIONS RELATED TO TYPICAL SECTION:

TYPICAL SECTION No. 3

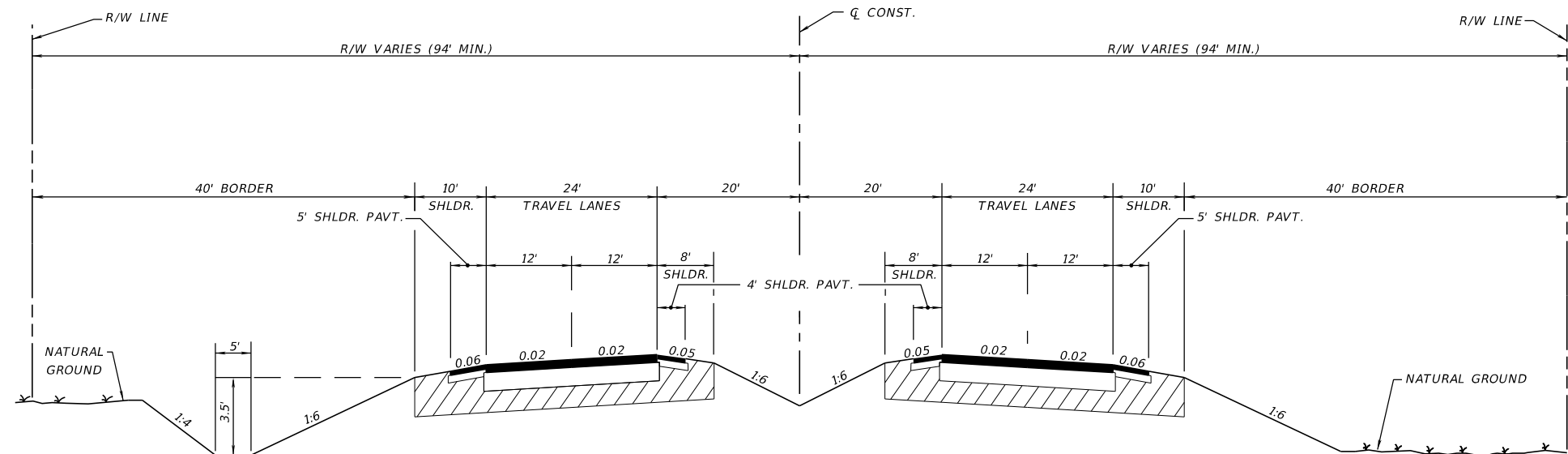

SR 22
MP 3.725 TO MP 7.560

TRAFFIC DATA

CURRENT YEAR = 2018 AADT = 22800
 ESTIMATED OPENING YEAR = 2020 AADT = 25800
 ESTIMATED DESIGN YEAR = 2040 AADT = 30600
 K = 6% D = 55% T = 2% (24 HOUR)
 DESIGN HOUR T = 1%
 TARGET SPEED = 60 MPH
 DESIGN SPEED = 60 MPH
 POSTED SPEED = 60 MPH

NOT TO SCALE

Exhibit 120-4
Date: 1/1/22

FINANCIAL PROJECT ID	SHEET NO.
123456-1-52-01	4

THE OFFICIAL RECORD OF THIS SHEET IS THE ELECTRONIC FILE DIGITALLY SIGNED AND SEALED UNDER RULE 61G15-23.004, F.A.C.

120.2.4 Preliminary Drainage Design

On projects where the drainage design is a critical element the following items should require a preliminary submittal:

- (1) Determination of water elevations affecting the roadway grade. These include base clearance water elevations and design flood elevations.
- (2) Pond Siting Report.
- (3) Documentation of preliminary drainage coordination with permitting agencies
- (4) Information that is essential to proper evaluation of drainage design concepts such as seasonal high ground water, soil types, existing cross drain peak design stages, historical pavement failure, floodplain elevation, present water elevations, and drainage areas.
- (5) Documentation of coordination with the Landscape Architect and District Maintenance Engineer regarding aesthetics, including the accommodation of existing and proposed trees, particularly where additional R/W or Design Exceptions or Design Variations may be required.

120.2.5 Preliminary Geometry and Grades

On projects where connections to the facility make grades a critical element, back of sidewalk profiles, project profile grades, determination of water elevations affecting the roadway grade, and driveway and side street geometry should require a preliminary submittal. The Department may require the designer to present the project geometry and grade to a geometry and grade technical review team to encourage productive dialogue and proper communication regarding these design issues. If a bridge exists within the project limits, the early input of the structural designer as to approach grades and clearance needs should be coordinated to ensure proper bridge design.

120.2.6 Preliminary Traffic Control Plan

On projects where the traffic control plan is a critical element the following items should require a preliminary submittal.

- (1) Typical sections of each construction phase with information that is essential to proper evaluation of each construction phase; e.g., location and nature of proper construction drainage; regulatory speed; location of work zone; proposed traffic control devices; number, width and location of maintained traffic; maximum drop-off; maintenance of existing lighting.

- (2) Documentation addressing possible innovative construction techniques; e.g., need for temporary detours, hazardous material excavation, temporary structures.
- (3) Documentation of coordination with the local community; e.g., city and county transportation engineers, businesses, police, hospitals, civic centers or arena operations, fire department, schools, mass transit.
- (4) When a temporary bridge is used, the designer must coordinate with the State Bridge Evaluation Engineer in Tallahassee (Office of Maintenance) to ensure that a detour route for overweight vehicles is included in the plans. If no detour route is available, the temporary bridge may have to be designed to support multi-trip overweight vehicles.

120.2.7 Pavement Selection and Design

The pavement selection and design should be completed as early in the process as possible. The Rigid and Flexible Pavement Design Manuals are available through [Pavement Management Publications](#).

The final version (non-signed and sealed) of the Pavement Design Package should be submitted and reviewed prior to submitting the Phase II plans. The Phase II plans submittal should incorporate the resolution of comments from the final version Pavement Design Package review. The signed and sealed Pavement Design Package should be approved by the Department prior to the Phase III plans submittal.

120.2.8 Preliminary Utilities

On projects where utility coordination is a critical element, the following early involvement activities should be required.

- (1) Prior to Phase I plans submittal, early involvement can be obtained by coordinating a review of the utility information in the topographic survey. This review may be accomplished by distribution of the topographic survey to all Utility Agency/Owners (UAOs) through the District Utility Office for mark-ups and confirmation of existing facilities.
- (2) Once the designer has reviewed the early topographic survey mark-ups a meeting should be held with the UAOs, District Utility Office and the designer to discuss errors, omissions, and future plans of the utilities already identified within the corridor. This will allow the designer the ability to prioritize which utilities will ultimately impact the design.

120.3 Structures Submittals

Structures design elements go through decision-making reviews at various stages of the design as listed below:

120.3.1 Coordination of Structural Design - (Bridges and Retaining Walls)

Requests for structural design should include roadway plan and profile sheets showing horizontal and vertical alignment and cross sections within 500 feet of each end of the bridge or ends of retaining walls. Horizontal curvature that is on or near the end of the bridge or retaining wall must be shown. Nonstandard superelevation transition details or other special profiles must be included if any part or all of the transition is on the bridge or wall. The approved proposed typical section is required.

Provisions for access to property near the end of bridges and adjustments to avoid costly Right of Way takings should be resolved.

120.3.2 Bridges

Bridge design begins when the Phase I bridge geotechnical report is complete and proceeds on a schedule which allows simultaneous review of the final (90%) bridge plans and the Phase III roadway plans. All structures design work is coordinated through the District Structures Design Engineer or the State Structures Design Office in the Central Office, depending on the category or complexity of the structure. Determine the typical section of the facility crossing, the horizontal and vertical clearance requirements, and the profile grades prior to beginning structures design. For complete details and requirements for structural designs and plans preparation, the reader is referred to **FDM 121** and the Structures Detailing Manual issued by the State Structures Design Office.

Generally, the completion and review of bridge designs are accomplished in the following phases:

- (1) BDR/30% Structures Plans
- (2) 60% Substructure Submittal / 60% Structures Plans
- (3) 90% Structures Plans
- (4) 100% Structures Plans

These reviews should be coordinated with the phase reviews of the roadway plans. Submit the latest set of structural plans with the Phase II roadway plans submittal. This joint submittal at Phase II roadway plans review is to ensure that roadway and bridge structures plans are consistent; i.e., widths, superelevation transitions, vertical and horizontal alignment, and work zone traffic control agree. The precise number and type of plans submittals depends on the complexity of the design and the sensitivity of the project. Each submittal must include written responses to the comments received on the previous submittal.

Modification for Non-Conventional Projects:

Delete **FDM 120.3.2** above and replace with the following:

120.3.2 Bridges

For bridge submittal requirements see RFP and **FDM 121**.

120.3.3 Other Structural Submittals and Reviews

In addition to bridge plans, structures plans may include retaining walls, sheet piling, noise barriers, box or three-sided culverts, pedestrian overpasses, temporary bridges, and special structural appurtenances. Special structural appurtenances that include transit related furnishings and amenities would require review by the local transit agency.

For projects where bridges and other structures plans are involved, preliminary and final plan submittals (usually along with bridge plans) should be handled according to the instructions for structures plans submittals covered in **FDM 121** and **FDM 262**.

For projects where retaining walls are required along with roadway plans (no bridge in the project), follow the procedure outlined in **FDM 262**. The submittal of detailed control plans should occur as early in the design process as possible.

120.4 Plans Phase Reviews

The number of submittals and phase reviews is determined on a project-by-project basis and defined in the scope. Submittals allow functional areas to review the development of the project as contained in the scope.

Formal plans phase review requirements are covered in the District Quality Control Plan. Reviews should include Department personnel that can assist in making timely decisions and confirm that the requirements have been met for their discipline. Reviews are driven

by the engineering process and occur when input or a decision is needed. Some of these activities are discussed in **FDM 120.2**. Reviews are complete when the comments from all the various offices have been resolved and have been documented as required in **FDM 128**.

Constructability and biddability reviews by the District Construction Office will be included at appropriate stages of the phase review process. Procedures for these reviews are provided in the [Construction Project Administration Manual](#).

Minor projects, such as resurfacing, typically have two plans phase reviews. The two reviews consist of a decision-making phase review on the scope and intent of the project and a final plans phase review for constructability and biddability. One of these will be an on-site review.

On complex projects plans phase reviews may be required at the Phase I, II and III stages and a final check at Phase IV. Two on-site reviews are typically required with one of these held early in the initial engineering phase.

FDM 901.3 outlines, in detail, the sequence for contract plans preparation and assembly required by the several design phase submittals. Also included in the chapter is information required to be presented on various plan sheets included with each submittal.

When the plans are in compliance with all phase review requirements and are considered final, they are to be submitted in accordance with the process described in **FDM 131**.

Modification for Non-Conventional Projects:

Delete **FDM 120.4** above and replace with the following:

120.4 Plans Phase Reviews

FDM 901.3.1 outlines, in detail, the sequence for contract plans preparation and assembly required by the design phase submittals.

120.4.1 Review of Non-Department-Owned Projects

Perform a Department review of those portions of non-Department-owned projects located on Department-owned Right of Way, regardless of funding source or owner. Perform the review to the same extent as reviews for Department projects to assure compliance with the Department's design criteria. See **FDM 121.18** and **FDM 121.12** for review requirements of non-Department-owned projects containing a structure located on, under or over Department-owned Right of Way.

121 Bridge Project Development

121.1 General

Structural designs for new construction are developed under the direction of the Structures Design Office (SDO) and the District Structures Design Offices (DSDO).

Designs are to be developed in accordance with:

- This manual
- The [Structures Manual](#) (Topic No. 625-020-018)
- The [Standard Plans](#) (Topic No. 625-010-003)
- The *AASHTO-LRFD Bridge Design Specifications* as referenced in the [Structures Manual](#)
- Applicable FHWA Directives
- Other criteria as specified by the Department

Structural designs for repair or rehabilitation of bridges are generally developed under the direction of the District Structures Maintenance Engineer (DSME) and may not include all the submittal types discussed in this chapter.

Modification for Non-Conventional Projects:

Delete the above paragraph.

Structure designs for other agencies or authorities such as the Jacksonville Transportation Authority or various Expressway Authorities may meet the Department's criteria or additional criteria as specified by the authority.

For projects involving bridges over navigable water, notify the DSME a minimum of 90 days prior to engaging in any action in, on, or around the bridge. Refer to **FDM 110.5.3** for further information.

121.2 Organization

The SDO is a subdivision of the Office of Design under the direction of the Chief Engineer and the Assistant Secretary for Engineering and Operations. The SDO is under the direction of the State Structures Design Engineer (SSDE). Each District, including the

Turnpike, has a staff of structural design engineers that comprise the DSDO, and which is under the direction of the District Structures Design Engineer (DSDE).

121.3 Definitions

All structures are grouped into the following two categories based upon design difficulty, structural complexity, type of construction materials used and history of use in Florida.

121.3.1 Category 1 Structures

The following structure types are classified as Category 1 Structures:

- (1) Box or three-sided culverts
- (2) Bridges with simple or continuous span reinforced concrete slab superstructures
- (3) Bridges with prestressed concrete slab superstructures
- (4) Bridges with simple span non-post-tensioned concrete beam or concrete girder superstructures with cast in place decks
- (5) Widening for the structure types listed above
- (6) Prefabricated steel truss pedestrian bridges meeting the Category 1 conditions of **FDM 266.4**
- (7) Retaining walls
- (8) Roadway signing, signalization, and lighting supports
- (9) Overhead sign structures and toll gantries
- (10) Noise walls and perimeter walls

121.3.2 Category 2 Structures

All structure types not listed above are classified as Category 2 Structures unless exempted by the SDO. In addition to, or in lieu of, the criteria listed above, a structure is classified as a Category 2 Structure when any of the following are present:

- (1) Bridge substructures containing any of the following:
 - (a) Post-tensioned components
 - (b) Straddle piers
 - (c) Integral caps
 - (d) Mildly reinforced pier column with net sustained tension on the extreme fiber under permanent service loads in the final condition
- (2) Bridges designed for vessel collision or bridges with superstructures subject to application of wave loads
- (3) Bridges with non-redundant foundations, micropiles, or auger cast piles
- (4) Any component designed using Fiber Reinforced Polymer (FRP) composite materials except components in the [Standard Plans](#) that include FRP composite materials
- (5) Braided underpass structures where the beams or flat slab superstructure element is not oriented parallel to traffic of the overlying roadway and a portion of the superstructure and substructure extends beyond the limits of the overlying traffic barriers
- (6) Design concepts, components, elements, details, or construction techniques not normally used by Florida DOT including but not limited to:
 - (a) New bridge types
 - (b) New materials used to construct bridge components
 - (c) New bridge construction methods
 - (d) Non-standard or unusual bridge component-to-component configurations and connection details
 - (e) Department issued [Developmental Standard Plans](#) or modified versions of Developmental Design Standards
 - (f) Items not covered by the Department's [Standard Specifications](#)
 - (g) All atypical precast structural elements (The following are not considered to be atypical: AASHTO Beams, and precast elements included in the [Standard Plans](#).)

- (h) Prefabricated Bridge Elements and Systems (PBES) not meeting all requirements of Chapter 25 of the [Structures Detailing Manual](#)

The Department supports the use of accelerated project construction techniques including the expanded use of precast/prefabricated bridge elements and systems as a way to reduce costs, construction time, and user impacts; however, the use of precast/prefabricated bridge elements can create long term durability and quality issues depending on the details utilized. Therefore, the designs and details for these elements must be approved by the Department prior to use.

Modification for Non-Conventional Projects:

Items listed in numbers 4 through 6 above are not allowed unless they are specifically permitted in the RFP or unless they are submitted and approved during the Alternative Technical Concept (ATC) process.

121.4 Abbreviations and Acronyms Used in Structures Design

Terminology used in the area of Structures Design is often written in the form of abbreviations or acronyms. Following is a list of acronyms frequently encountered in this manual and in other references used in structures design and include those commonly used for offices, organizations, materials, systems, features, equipment, conditions, and expertise:

AASHTO	<i>American Association of State Highway and Transportation Officials</i>
ACI	<i>American Concrete Institute</i>
ACIA	<i>Assigned Commercial Inspection Agency</i>
ADA	<i>Americans with Disabilities Act</i>
AISC	<i>American Institute of Steel Construction</i>
ANSI	<i>American National Standards Institute</i>
APL	<i>Approved Products List</i>
AREMA	<i>American Railway Engineering and Maintenance Association</i>
ASTM	<i>American Society for Testing and Materials</i>
AWS	<i>American Welding Society</i>
BBS	<i>Bulletin Board System</i>
BDR	<i>Bridge Development Report</i>
BHR	<i>Bridge Hydraulics Report</i>
BHRS	<i>Bridge Hydraulics Recommendation Sheet</i>
CADD	<i>Computer Aided Design and Drafting</i>
CEI	<i>Construction Engineering and Inspection</i>

<i>C.I.P. (C-I-P)</i>	<i>Cast-in-Place (Concrete)</i>
<i>CSIP</i>	<i>Cost Savings Initiative Proposal</i>
<i>CPAM</i>	<i>Construction Project Administration Manual</i>
<i>CVN</i>	<i>Charpy V-Notch (Impact Testing)</i>
<i>DSDE</i>	<i>District Structures Design Engineer</i>
<i>DSDO</i>	<i>District Structures Design Office</i>
<i>DSME</i>	<i>District Structures Maintenance Engineer</i>
<i>EOR</i>	<i>Engineer of Record</i>
<i>FDOT</i>	<i>Florida Department of Transportation</i>
<i>FHWA</i>	<i>Federal Highway Administration</i>
<i>GRS</i>	<i>Geosynthetic Reinforced Soil</i>
<i>LRS</i>	<i>Low-relaxation Strands</i>
<i>LRFD</i>	<i>Load and Resistance Factor Design</i>
<i>MHW</i>	<i>Mean High Water</i>
<i>MSE</i>	<i>Mechanically Stabilized Earth (Walls)</i>
<i>MUTCD</i>	<i>Manual on Uniform Traffic Control Devices</i>
<i>NBR</i>	<i>Nominal Bearing Resistance</i>
<i>NHS</i>	<i>National Highway System</i>
<i>NHW</i>	<i>Normal High Water</i>
<i>NOAA</i>	<i>National Oceanic and Atmospheric Administration</i>
<i>OEM</i>	<i>Office of Environmental Management</i>
<i>OIS</i>	<i>Office of Information Systems</i>
<i>OSHA</i>	<i>Occupational Safety and Health Administration</i>
<i>PDA</i>	<i>Pile Driving Analyzer</i>
<i>PD&E</i>	<i>Project Development and Environment</i>
<i>PPD</i>	<i>Plans Production Date</i>
<i>RDR</i>	<i>Required Driving Resistance</i>
<i>RFP</i>	<i>Request For Proposal</i>
<i>SDO</i>	<i>Structures Design Office</i>
<i>SIP (S-I-P)</i>	<i>Stay-in-Place (Forms)</i>
<i>SRS</i>	<i>Stress-relieved Strands</i>
<i>SSDE</i>	<i>State Structures Design Engineer</i>
<i>TAG</i>	<i>Technical Advisory Group (SDO and DSDEs)</i>
<i>TFE (PTFE)</i>	<i>Polytetrafluoroethylene (Teflon)</i>
<i>TRB</i>	<i>Transportation Research Board</i>
<i>TTCP</i>	<i>Temporary Traffic Control Plans</i>
<i>UBC</i>	<i>Ultimate Bearing Capacity</i>
<i>UV</i>	<i>Ultraviolet</i>

121.5 Responsibility

The DSDO has total project development and review responsibility for projects involving Category 1 Structures. The SDO has total project development and review responsibility for projects involving Category 2 Structures. This responsibility for Category 2 Structures extends to widening and rehabilitation projects and repairs of bridge components that qualify the structure as a Category 2 Structure. For large projects with multiple bridges, review responsibilities will be coordinated between the DSDO and the SDO based on the category of the individual bridge, workload demands and project make-up.

The District Project Manager must coordinate with the DSDE who will review and concur with the bridge aspect of all projects during the PD&E process in accordance with **Part 2, Chapter 3** of the [PD&E Manual](#).

The DSDE or the SSDE, as appropriate, must concur/approve all bridge related work after location design approval is granted.

To assure a uniform approach to a project, the Engineer of Record must coordinate with the appropriate structures design office (i.e., DSDO or SDO) to discuss structures related phase review comments and get concurrence on how to proceed.

Modification for Non-Conventional Projects:

Delete **FDM 121.5** and replace with the following:

121.5 Responsibility

Submit RFP's on those projects where it is anticipated that Category 2 bridges will be designed and constructed to the SSDE for review and approval. Submit RFP's on those projects where it is anticipated that Category 1 bridges will be designed and constructed to the DSDE for review and approval.

The DSDO has total component structure plan review responsibility for projects involving Category 1 Structures. The SDO has total component structure plan review responsibility for projects involving Category 2 Structures. This responsibility for Category 2 Structures extends to widening and rehabilitation projects and repairs of bridge components that qualify the structure as a Category 2 Structure. The DSDE or the SSDE, as appropriate, determine when structure component plans should be "Released for Construction."

The District Project Manager must coordinate with the DSDE who will review and concur with the bridge aspect of all projects during the PD&E process in accordance with **Part 2, Chapter 3** of the [PD&E Manual](#).

121.6 Projects of Division Interest

See **FDM 128** for FHWA requirements.

121.7 Bridge Project Development

The following sections will define, clarify, and list the information necessary to produce an acceptable and reproducible set of contract documents (special provisions, bridge contract drawings) ready for advertisement and construction.

Bridge project development normally includes five phases of development. The first phase of development, bridge analysis, occurs during the Project Development and Environment (PD&E) process. After location design approval is granted, the second phase, Bridge Development Report/30% Structures Plans, is initiated. After approval of the BDR, the final phases of work will begin. The third phase is the 60% Structures Plans that consists of the substructure foundation submittal for all projects and 60% Structures Plans for most Category 2 Structures. The fourth phase includes the 90% Structures Plans and specifications. The fifth phase includes the 100% Structures Plans and specifications. For efficiency, one engineering firm (one design team) should be responsible for the BDR and the final plans and specifications.

For Category 2 bridges and some Category 1 bridges, step negotiations are suggested. Step negotiations are desirable because the final bridge type cannot be determined until the BDR is complete. Utilizing this scenario, the first step of the negotiations would include the BDR/30% Structures Plans. After submittal of the BDR/30% Structures Plans, negotiations for final three phases of work (60% Structures Plans, 90% Structures Plans and 100% Structures Plans) would begin. Negotiations should not be finalized until the BDR/30% Structures Plans are approved by the DSDO or the SDO as appropriate.

Modification for Non-Conventional Projects:

Delete **FDM 121.7** and replace with the following:

121.7 Bridge Project Development

Bridge project development normally includes four phases of development. The first phase of development, bridge analysis, occurs during the Project Development and Environment (PD&E) process. The second phase includes the development of the bridge related project constraints based on project specific requirements and development of the bridge concept plans for inclusion into the RFP. A series of pre-scoping questions has been compiled and are available on the Office of Construction website to aid in the development of project specific constraints. Depending on the complexity of the project and at the discretion of the Department, this second phase may include a Bridge Feasibility Assessment for the purpose of developing the structures concept plans. The third phase involves the project procurement process. See [Procurement and Administration Procedure \(Topic No. 625-020-010\)](#) for specific requirements. The fourth phase includes component structure plan reviews in accordance with the requirements of the RFP.

121.8 Bridge Analysis

121.8.1 General

The Bridge Analysis is performed during the PD&E phase by qualified bridge engineers. The findings of the bridge analysis must be approved by the District Structures Design Office or the State Structures Design Office, as applicable, in accordance with the responsible review authority specified in **FDM 121.5**. The function of the bridge analysis is to determine the general attributes for the recommended bridge. The specific attributes of the bridge will be defined in the BDR.

For bridges over water, a location Hydraulics Report will be prepared in conjunction with the bridge analysis. General site geotechnical knowledge is also required (usually from existing bridge plans) or, in some cases, it may be desirable to obtain borings.

121.8.2 Contents

The bridge analysis provides conceptual guidance for the bridge design consultant. Conceptual guidance on how the bridge should fit into the uniqueness of the site should be provided. Bridge design and structure type should be left to the design team in the later phases of work. Include the following in the bridge analysis:

- (1) Environmental and site considerations, including the need for wildlife connectivity (see **FDM 110.5.4**).
- (2) Vertical and horizontal clearances (existing and proposed).
- (3) Load Rating of existing bridge if any portion is retained.
- (4) Disposition of existing structure. (Final disposition of demolished bridge debris will depend on whether or not a local, State or Federal agency has agreed to receive the debris. See **FDM 110.5.2.3**).
- (5) Vertical and horizontal geometry.
- (6) Typical section.
- (7) Conceptual ship/barge impact data (sample of recreational and commercial traffic).
- (8) Identification of historical significance of bridge and surrounding structures.
- (9) Aesthetic level for bridge and bridge approaches.
- (10) Location Hydraulics Report.
- (11) Bridge deck drainage considerations.
- (12) Stream bottom profile.
- (13) Conceptual geotechnical data.
- (14) For sites with movable bridge options, a life cycle cost comparison will be prepared and compared to fixed bridge options (Ref: **AASHTO Movable Bridge Inspection, Evaluation, and Maintenance Manual, 2nd Edition**).
- (15) Phase Construction Impacts.
- (16) Construction time.

121.9 Bridge Development Report (BDR)/30% Structures Plans

The BDR is intended to be a tool in selecting the optimal bridge type and to establish all the basic parameters that will affect the work done in the Design and Plans Preparation phase. Initiate the BDR after location design approval (For those sites not requiring location design approval, a categorical exclusion will be required before initiation of the BDR). Include the Phase I Geotechnical Report and the Bridge Hydraulic Report with the submittal containing the BDR. For some projects, the 30% Structures Plans will be included as an appendix to the BDR. See **FDM 121.9.9**.

The work necessary to prepare the BDR is determined on a case-by-case basis and depends upon the bridge's complexity and other factors as described below:

- (1) Considering the site constraints of the crossing (vertical and horizontal clearance requirements, etc.), the optimal bridge type may be evident for some simple Category 1 Structures without comparing various bridge types and an abbreviated BDR that requires less effort may be appropriate. In certain cases, the BDR may simply document the reasons for the bridge type selected.
- (2) An abbreviated BDR will usually be appropriate for widenings; however, in some cases a thorough evaluation of viable structural possibilities and economical options may be required to determine if replacement of the bridge would be more appropriate than widening. Factors to consider when determining the BDR effort for widenings include, but are not limited to, the following:
 - (a) Load rating,
 - (b) Condition of the existing bridge,
 - (c) History of structural problems,
 - (d) Clearance limitations in the widened configuration,
 - (e) Historical significance (see **FDM 121.9.5**), and
 - (f) Sites where there has been a record of serious flooding or scouring.

See **Section 7.1.1** of the [Structures Design Guidelines](#) for load rating considerations to be included in the BDR recommendations.

- (3) For all other situations, including all new Category 2 Structures and major widenings of Category 2 Structures, the BDR will consider all viable bridge types and alternatives. See **Section 7.2** of the [Structures Design Guidelines](#) for definitions of minor and major widenings.

The District Structures Design Engineer will make the final determination on the scope of work necessary to prepare a BDR.

Once approved, the BDR will define the continuing work by the Engineer of Record (EOR). It is mandatory that the EOR obtain and coordinate the information and requirements of the offices and engineering disciplines whose input is essential to the preparation of an effective BDR. Changes to the parameters after the BDR is approved could result in schedule delays and supplemental agreements; therefore, it is critical that District Offices, FHWA (if involved), the SDO and other involved agencies recognize the purpose and importance of the BDR. The BDR phase of work will contain sufficient detail for the justification of the proposed bridge type. The BDR is developed from information outlined on the Bridge Development Report Submittal Checklist shown in **FDM 103, Form 121-A**. This information is often provided by others; however, the EOR is responsible for ensuring that all of the information is adequate and appropriate. If the data is not sufficient, the EOR must obtain the required information before the BDR can be completed and submitted.

When alternate designs are considered, consistency between the alternates is essential in ensuring equitable competition and optimum cost-effectiveness. This consistency includes uniformity of design criteria, material requirements and development of unit costs.

The BDR should contain only supportable and defensible statements. Subjective opinions or unsubstantiated statements are not acceptable. All arguments are to be clearly and logically defensible with calculations, sketches, or other technical data.

121.9.1 Contents

The major items to be considered in the BDR are:

- (1) General: The bridge length, height and pier locations are subject to vertical and horizontal design clearance requirements such as those for clear zone, navigation, wildlife connectivity, and hydrology. After these considerations are met, span lengths are governed by economics and aesthetic considerations. Superstructure depths (grade separation structures in particular) are to be kept to the minimum that is consistent with good engineering practice. Recommended span/depth ratios for steel superstructures are shown in AASHTO.

The length of the bridge will be affected by:

- (a) Opening required by the Bridge Hydraulic Report.
 - (b) Environmental Considerations, including wildlife connectivity (see ***FDM 110.5.4***).
 - (c) Railroad clearances and cross sections.
 - (d) Width of waterway or width of cross section of roadway being spanned including the use of retaining walls, or fender systems.
- (2) Statical System: Address the economic and engineering advantages of both simple span and continuous spans.
 - (3) Superstructure: Some superstructure types that could be considered are prestressed concrete girders, inverted-tee sections, reinforced or prestressed concrete slabs, steel rolled sections or plate girders, steel or concrete box girders, and post tensioned slabs, bulb-tees, or boxes.
 - (4) Substructures: Some substructure types that could be considered are pile bents and multi-column or hammerhead piers. Variations of column shapes may be appropriate for aesthetic or economical requirements.
 - (5) Foundations: Some foundation types that could be considered are steel and concrete piles, drilled shafts, geosynthetic reinforced soil (GRS) abutments and spread footings. Assess GRS abutments to determine feasibility for all new bridges. If GRS abutments are determined not to be the most suitable alternative for the project, provide a statement in the BDR indicating so and the reasons why (e.g., sinkhole-prone area or differential settlement limit exceeded).
 - (6) Vessel Collision: Vessel collision forces will often have a major effect on the structural configuration and overall economics. See vessel collision requirements in the [**Structures Design Guidelines**](#).

- (7) Scour: The 100 year and 500 year predicted scour elevations will often have a major effect on the foundation design. See the foundations and geotechnical requirements in the [Structures Design Guidelines](#).
- (8) Temporary Traffic Control: Show how traffic will be maintained during construction for each of the bridge alternates considered. Assess the impacts of the traffic carried on the structures as well as under the structures being constructed. Consider all major overhead work items such as bridge demolition and girder placement. Show stability towers locations, phased construction sequences, girder splice locations, for each alternate being considered. Compare traffic user impacts for each of the alternates.

(See **FDM 240.4** for additional requirements)
- (9) Precast Feasibility Assessment: Investigate the use of either partial or full precast bridge alternate(s) with the specific purpose of accelerating bridge construction and reducing user impacts. As part of this investigation:
 - (a) Conduct a feasibility assessment responding to questions similar to those listed in **FDM 121.19**.
 - (b) Based on responses to the feasibility questions, explain whether a precast alternate should be considered an advantage on the project or what site constraints, economic impacts, or other factors (e.g., haul distance from precast yard, project variability) precluded or limited its application. If precasting is determined not to be applicable for the project, provide a statement in the BDR indicating so and the reasons why. This statement fulfills the requirements of this section.
 - (c) Only if precasting is found to be viable, evaluate preliminary precast alternates and associated MOT schemes against conventional methods using the assessment matrix and referenced links given in **FDM 121.19**. Provide enough detail in the preliminary evaluation in order to estimate total direct and indirect costs. Indirect costs, typically referred to as road user costs, include fuel use and man-hour losses resulting from detours, anticipated traffic flow reduction, and reduced speed limits. Determine indirect costs using the Department's software at the following link:
 - (d) <http://infonet.dot.state.fl.us/tlconstruction/SchedulingEng/AddSoftwareScheduling.htm>
 - (e) At this stage, a meeting with the District Structures Design Engineer is recommended to discuss the preliminary evaluation and cost estimates before finalizing the alternates for inclusion in the BDR.

- (f) See **Chapter 25** of the [Structures Detailing Manual](#) for design considerations as it relates to Prefabricated Bridge Elements and Systems (PBES).
- (g) Report the estimated total direct costs and estimated total indirect costs, as well as the sum of both, for *each* alternate as three separate dollar amounts in a summary table in the same section as the completed assessment matrix (see **Table 121.19.2**).

Providing both the direct and indirect costs of the project in the BDR enables Department management to make informed decisions to maximize construction dollars while at the same time minimizing construction time and economic impacts to Florida's traveling public.

Also, demonstrate in the BDR text that consideration was given to identify and employ other innovative techniques aimed at reducing costs, shortening project delivery time, enhancing safety during construction, and protecting the environment.

- (10) Quantity estimates: For minor bridges rough quantities (such as reinforcing steel based on weight per volume of concrete) may be sufficient. For major and complex bridges, the degree of accuracy may require more exact calculations keeping in mind that the intent is to establish relative and equitable costs between alternates and not necessarily to require the accuracy of the Final Estimate. For major and complex structures, it may be necessary to develop unit costs from an analysis of fabrication, storage, delivery, and erection costs of the different components. Provide calculated debris volume quantities for projects involving the demolition of bridges.
- (11) Unit costs: Data available from the Department or contractors and suppliers should be used to arrive at unit costs. Record the sources of all price data for later reference. Base cost should be obtained from the **BDR Estimating Section** of the [Structures Manual](#).
- (12) Develop cost curves: For each alternative establish the most economical span arrangement, i.e., minimum combined superstructure and substructure cost.
- (13) Retaining Wall Study: If retaining walls are present, include a retaining wall study in the BDR. This study will conform to the work as specified in **FDM 262** and the [Structures Manual](#).
- (14) Movable Bridges: Include information in the BDR on the type of equipment for the machinery and electrical drive systems, together with a general description of the control system to be utilized. Include a written description and preliminary layouts of system components. Utilize acronyms and terminology as defined in **AASHTO Movable Bridge Inspection, Evaluation, and Maintenance Manual, 2nd Edition**.

- (15) **Bicycle and Pedestrian Facilities:** Describe in the BDR the facilities to be provided and the means to be used to comply with ADA requirements. Describe the pedestrian railing and fencing to be provided. See **FDM 222, 223, and 224.**

For rehabilitation project plans, include the BDR stage in the plans and written descriptions of those system components to be modified from the existing configuration, along with plans of the existing configuration. Submittal of information described in the previous paragraph is not required unless the electrical and mechanical configuration is modified from the existing configuration.

121.9.2 Format

The report is to use standard, letter-size pages with any larger sheets or drawings folded to fit the report size. The report is to be neatly written and the contents presented in a logical sequence with narrative, as required, to explain the section contents. Provide an Executive Summary to compare the relative features and costs of the alternates considered and recommend alternate(s) to be carried forward into the Final Structures Plans Preparation phase.

The BDR is to be as self-contained as possible by including all arguments that establish, justify, support, or prove the conclusions. It is acceptable to refer to other documents that will be included in the final submittal package; however, include any documentation that will help emphasize a point, support a statement, or clarify a conclusion. Such documentation may include drawings, clear and concise views, or other such illustrated information.

Address construction time requirements in the BDR and the effect that components, systems, site constraints and conditions, or other site characteristics or criteria have upon the construction time, whether additive or deductive.

121.9.3 Aesthetics

- (1) General: Integrate three basic elements in any bridge design: efficiency, economy, and elegance. Regardless of size and location, the quality of the structure, its aesthetic attributes and the resulting impact on its surroundings is to be carefully considered. Achieving the desired results involves:
 - (a) Full integration of the three basic elements listed previously.
 - (b) The EOR's willingness to accept the challenge and opportunity presented. A successful bridge design will then be elegant or aesthetically pleasing in and of itself and will be compatible with the site by proper attention to form, shapes, and proportions. Attention to details is of primary importance in achieving a continuity of line and form. Use the rule of "form following function."

Consider the totality of the structure as well as its individual components and the environment of its surroundings. A disregard for continuity or lack of attention to detail can negate the best intent. Formulas cannot be established; however, ACI's ***Aesthetic Considerations for Concrete Bridges*** and TRB's ***Bridge Aesthetics Around the World***, as well as authors such as David P. Billington can guide the designer. A book developed by the Maryland Department of Transportation entitled ***Aesthetic Bridges*** provides excellent guidance. In bridge aesthetics the designer is dealing with the basic structure itself; not with enhancement, additions, or other superficial touches. The EOR is expected to be well read on the subject of bridge aesthetics and committed to fulfilling both the structural and aesthetic needs of the site.

The challenge differs for major and minor structures. Indeed, the challenge may be greater the smaller the project. Major structures, because of their longer spans, taller piers, or curving geometry often offer inherent opportunities not available for minor bridges.

Some basic guidelines where aesthetics may play a more important role are:

- (a) Bridges highly visible to large numbers of users (maritime and motorists).
- (b) Bridges located in or adjacent to parks, recreational areas, or other major public gathering points.
- (c) Pedestrian bridges.
- (d) Bridges in urban areas in or adjacent to commercial and residential areas.
- (e) Multi-bridge projects, such as interchanges, or corridors should attain conformity of theme and unifying appearance. Avoid abrupt changes in structural features.

Considering these guidelines, the District will determine the level of aesthetic effort warranted on a project early in its development. When significant aesthetic expense is proposed, such as is the case with Level Three (Level of Aesthetics), Federally funded projects require legitimate written justification.

(2) Levels of Aesthetics:

Normally the District will establish one of the following three general levels of aesthetic consideration and effort at each structure's site:

- (a) **Level One:** Consists of cosmetic improvements to conventional Department bridge types, such as the use of color pigments in the concrete, texturing the surfaces, modifications to fascia walls, beams, and surfaces, or more pleasing shapes for columns and caps.
- (b) **Level Two:** The emphasis is on full integration of efficiency, economy and elegance in all bridge components and the structure as a whole. Consideration should be given to structural systems that are inherently more pleasing, such as hammerhead or "T" shaped piers, oval or polygonal shaped columns, integral caps, piers in lieu of bents, smooth transitions at superstructure depth change locations, box-type superstructures, concealed drainpipes, conduits, and utilities.
- (c) **Level Three:** The emphasis in this level applies more to the overall aesthetics when passing through or under an interchange or at other sites such as historic or highly urbanized areas where landscaping or unique neighborhood features are to be considered. The bridge itself must comply with Level Two requirements. This level of work may require, at the District's option, a sub-consultant (architect to consider adjacent building styles, and landscape themes) with the necessary expertise and credentials to perform the desired work.

These aesthetic levels are not exclusive. For example, where the EOR believes a specific landscape feature might significantly enhance bridge site elegance, even on a Level 1 design, the recommendation should be offered for the Department's consideration. For aesthetic Levels 2 and 3, public input into this issue may be appropriate. The EOR may recommend particular public involvement to the Department for consideration, or the district might specify such efforts at specific times during the BDR and final plan development phase of the project.

Include a summary of aesthetic considerations for the structure and the site in the BDR. The summary consists of sketches or drawings of recommended treatment as well as the options considered in the aesthetic study but not recommended as appropriate. Also include an estimate of cost to implement the recommended aesthetic treatment in the summary.

The default condition for new steel bridges is uncoated weathering steel where site conditions permit (See **SDG 1.3.2**). Use an Inorganic Zinc Coating System where site conditions preclude uncoated weathering steel and may be used elsewhere with approval of the Chief Engineer. Use of a High-Performance Coating System to any extent for Steel bridges requires written approval from the Chief Engineer.

121.9.4 Construction and Maintenance Considerations

Evaluate all viable structure concepts for constructability. Consider items such as member sizes, handling, fabricating, and transporting members as well as maintenance of traffic, construction staging, equipment access, equipment requirements. Perform a special evaluation to insure against potential problems that may occur in obtaining permits and equipment to transport long and heavy members from point of manufacture to the project site. Contact the Department's Road Use Permits Office for questions concerning the feasibility of transporting long and heavy structural components. Also, take into account considerations for future maintenance inspection in the structure's design. Include those considerations described in **FDM 121.15** and the requirements of the [Structures Manual](#). All special construction and maintenance requirements should be identified and appropriately considered in any concepts recommended for design. A design is able to be inspected properly when it permits safe inspector access to all portions of the structure using equipment available to District Structures Maintenance personnel.

121.9.5 Historical Significance Considerations

When an older bridge is considered for rehabilitation or replacement, the Environmental Management Office will evaluate the historical significance of the structure. A structure may be historically significant due to some of the following characteristics:

- (1) The structure may be an historic example in the development of engineering.
- (2) The crossing may be historically significant.
- (3) The bridge may be associated with an historical property or area.
- (4) The bridge might be associated with significant events or circumstances.
- (5) National Register of Historic Places or on a state or local historical register. If it is determined that the structure is historically significant, then the project should be developed to preserve the historic character of the structure.

121.9.6 Bridge Security

Perform a refined evaluation of all new Category 2 bridges identified in a PD&E study as critical, landmark or signature bridges to determine if anti-terrorist countermeasures are to be included as part of the design. Contact the SDO and the State Maintenance Office for guidance and assistance. Minimize the bridge vulnerability through alternative designs developed in the BDR. Design countermeasures to minimize the effectiveness of explosives. Minimize vulnerability to shape charges and vehicle bombs. Maximize the use of structural redundancy and continuity to limit structural damage.

Countermeasures designed into the bridge alternatives must meet one or more of the following objectives:

- (1) Protect structure from blast effects,
- (2) Maximizing explosive standoff distance,
- (3) Denial of access,
- (4) Minimizing time-on-target,
- (5) Selective protection of the structural integrity of key members, or
- (6) Structural redundancy.

Use one or more of the following countermeasure strategies in the design:

- (1) Deter attacks by the possibility of exposure, capture or failure of the attacker due to visible countermeasures,
- (2) Detect potential attacks before they occur and provide the appropriate response force,
- (3) Defend the bridge by delaying and distancing the attacker from the bridge and protecting the bridge from the effects of weapons, fire and vehicle and vessel impacts, or
- (4) Design the bridge to minimize the potential effects of Weapons of Mass Destruction (WMDs) and conventional explosives, fire and vehicle and vessel impacts.

Structural members that are fracture critical or are cable stays, cable stay pylons, hollow boxes, single columns, twin wall columns and thin wall columns require design modification to reduce the potential impact of explosions. Access into cable stay pylons, box superstructures and movable bridge machinery require heavy doors with secure lock systems. Bridges with essential communication utilities and or gas lines require the design to minimize risk to the utility.

121.9.7 Alternative Designs

The use of alternative designs for some larger or complex projects may result in more competitive bids and lower costs. Accordingly, the EOR is to evaluate benefits from alternatives for the particular structure being developed and provide a recommendation for or against preparing alternative designs. Support the alternative designs recommended by the evaluations included in the BDR. As a guide, consider the following in evaluating justification for alternative designs:

- (1) Alternative designs are to be considered for all structures that cost more than \$25 Million and a difference in alternate material (steel versus concrete) construction costs that are within twice the cost of producing the alternate plans. For example, alternative designs would be warranted if the additional preliminary engineering cost for final plans preparation is \$1.5 million per alternate and the difference between the construction cost estimates utilizing the Department estimating practices in the BDR was less than \$3 million.
- (2) For bridges that cost less than \$25 million consider alternative designs when project issues reflect possible advantages (i.e., TTCP, A+B) from competitive bids.
- (3) For bridges estimated to cost more than \$10 million consider evaluation of alternative designs whenever a unique design concept is proposed until such time that a bid history is established for the unique design.
- (4) Projects containing multiple bridges with a reasonable mixture of concrete and steel designs do not require alternate designs.

Steel box structures and steel plate girders should be evaluated including the differences in corrosion potential. Box Girders are preferred over plate girders when located in extremely aggressive environments.

121.9.8 Conclusions and Recommendations

With due consideration for all applicable data, the engineer is required to recommend the final bridge design system for the site. Thorough justification for the selection will be presented which examines each element of data, and the total estimated construction cost of the recommended design must be indicated in the BDR.

The following sections will define, clarify, and list the information necessary to produce an acceptable and reproducible set of contract documents (special provisions, bridge contract drawings) ready for advertisement and construction. The production of a bridge project commences with the Bridge Development Report (BDR) and ends with complete Contract Documents.

121.9.9 30% Structures Plans

The consultant's scope of services should clearly state at what point the 30% plans are to be submitted. The 30% Structures Plans may be submitted with the Bridge Development Report. If the 30% Structures Plans are submitted separately, the BDR is required to contain enough information and drawings to depict the information needed to properly determine the type, size and location of the bridge.

The 30% Structures Plans should show the following applicable information, as a minimum:

- (1) General Notes Sheet: As many general notes as possible should be included on this sheet at this stage. Add subsequent notes, when necessary, as the design progresses (for example of General Notes, see **Chapter 5** of the [Structures Detailing Manual](#)).
- (2) Plan and Elevation Sheet: provide contents as required by the Structures Detailing Manual.
- (3) Substructures: For end bents, piers, or intermediate bents, show substructure elements and sizes including all deviations from the typical dimensions, foundation type including element spacing and the arrangement of piles or drilled shafts.
- (4) Superstructure: Include cross section showing lanes, shoulders, railings, slab thickness, beam type and spacing and web depth for steel girders. If applicable, show geometric changes in shapes of various components. Also show construction phases and maintenance of traffic data, outline of the existing structure and portions to be removed, and utilities (existing and proposed as available).
- (5) Retaining Walls: Submit preliminary control drawings when proprietary or standard cast-in-place walls are proposed. Include control drawings for all critical temporary walls.
- (6) Bridge Hydraulics Recommendation Sheet.
- (7) Report of core borings.
- (8) Proposed construction sequence and methods indicate construction easements and methods of construction access.
- (9) Preliminary aesthetic details.
- (10) Preliminary post-tensioning layouts.
- (11) Preliminary foundation layouts and pile/shaft data table.
- (12) Sidewalks: If provided, show preliminary accessible elements.

- (13) Any other special details required by the Engineer or details which are not normally used on Department projects.

In addition to these requirements, the following items will be included for moveable bridges: preliminary electrical and mechanical equipment layouts in plan and elevation, submarine cable routing, and single line electrical diagrams including service voltage. Rough size all equipment and submit the supporting calculations.

Include requests for Design Exceptions and Design Variations for structural design criteria in the 30% Structures Plans Submittal. Design Exceptions and Design Variations are required to be approved in accordance with **FDM 122** with concurrence of the DSDO or SDO as appropriate.

Modification for Non-Conventional Projects:

Delete **FDM 121.9** and replace with the following.

121.9 Bridge Feasibility Assessment/Structures Concept Plans

At the discretion of the Department, a Bridge Feasibility Assessment may be necessary during the RFP development phase for the purpose of developing the structures concept plans. When required, the assessment must target specific critical bridge components to ensure that the preliminary information presented in the concept plans can meet all of the project constraints depicted in the RFP.

For aesthetic and wildlife connectivity requirements, see RFP.

121.10 Bridge Development Report (BDR) Submittal Checklist

The Bridge Development Report (BDR) Submittal Checklist (**FDM 103, Form 121-A**) contains a list of the key supporting elements that are required for the preparation, submittal, and review of a BDR. Include this Checklist with the BDR when submitted for review. The BDR Checklist consists of the following items:

- (1) Typical Sections for Roadway and Bridge:
The approved typical sections for both the bridge and roadway are required.
- (2) Roadway Plans:
Preliminary roadway plans covering the bridge vicinity are required.
- (3) Maintenance of Traffic Requirements:

- Show the number of required lanes and the lane widths of all affected roadways in the Maintenance of Traffic Plan.
- (4) Bridge Hydraulics Report and Bridge Hydraulics Recommendation Sheet:
Prepare the Bridge Hydraulics Report (BHR) and Bridge Hydraulics Recommendation Sheet (BHRS) in accordance with the [Drainage Manual](#). Concurrence of the BHR by the District Drainage Engineer with the District Structures Design Engineer for Category 1 Structures and State Structures Design Engineer for Category 2 Structures is required.
 - (5) Geotechnical Report:
Prepare the Bridge Geotechnical Report (Phase I) in accordance with Chapter 3 of the [Structures Design Guidelines](#) and the Department's [Soils and Foundation Handbook](#). Document a thorough investigation of all viable foundation types for the bridge and retaining walls. Concurrence of the District Geotechnical Engineer is required for Category 1 Structures and of both the State and District Geotechnical Engineers for Category 2 Structures.
 - (6) Bridge Corrosion Environment Report:
Prepare a Bridge Corrosion Report to determine the environmental classifications for the structure in accordance with the [Structures Design Guidelines](#) and receive approval from the District Materials Office.
 - (7) Geosynthetic Reinforced Soil (GRS) Feasibility Assessment:
Assess GRS abutments to determine feasibility for all new bridges.
 - (8) Precast Feasibility Assessment:
Investigate the use of either partial or full precast prefabricated bridge alternate(s) with the specific purpose of accelerating bridge construction and reducing user impacts.
 - (9) Existing Bridge Plans:
A set of prints of the existing (preferably as-built) bridge plans should be included for replacement structures and widenings. This is of particular importance for widenings and phase construction. These plans are not usually necessary for completely separate alignments or new interchanges unless the existing structures either will be used for new construction activities or will infringe upon the Contractor's allowed work zone.
 - (10) Existing Bridge Inspection Report:
A copy of the latest existing Bridge Inspection Report and Structures Inventory and Appraisal Form is required for all widenings and rehabilitations and may be required for new structures. Identify the existing paint system(s) on all significant

metal elements of existing structures. Clearly delineate the presence of lead-based paint and asbestos.

(11) Existing Bridge Load Rating:

A copy of the latest existing Bridge Load Rating is required for all widenings and rehabilitations.

(12) Wildlife Connectivity:

Describe the decision to include or exclude wildlife connectivity features into the design. The discussion for excluding a wildlife connectivity feature should summarize coordination with the Environmental Management or Permit office (or may be an attached summary memo from one of these offices). The discussion for including wildlife connectivity should refer to the [Wildlife Crossing Guidelines](#), commitments made during PD&E and any other documentation regarding the wildlife connectivity related to the bridge (or may be an attached summary memo from the Environmental Management or Permit office).

(13) Utility Requirements:

Identify proposed utility attachments to the structure as well as all existing and proposed utilities in the vicinity of the structure. Follow the requirements of the Department's [Utility Accommodation Manual](#) regarding attachments to the structure.

(14) Railroad Requirements:

Identify existing and future railroad requirements. This will include all clearances and crash wall or other construction parameters. Include copies of correspondence with the Railroad Agency.

(15) Retaining Wall and Bulkhead Requirement:

Identify permanent and temporary retaining wall requirements and show the proposed type of wall. Also identify the type, location, and extent of temporary walls to accommodate phased construction and maintenance of traffic.

For water crossings where erosion and wave action are anticipated, identify the type, location, and extent of bulkhead production. Include the proposed tie-back and anchor system in the submittal.

(16) Lighting Requirements:

Identify proposed lighting on or under the structure.

(17) ADA Access Requirements:

Identify ADA access requirements that affect the structure.

(18) Other:

Modification for Non-Conventional Projects:
Delete <i>FDM 121.10.</i>

121.11 Final Plans and Specifications Preparation

121.11.1 General

Within this phase of work, for both Category 1 and 2 Structures, there are three phases of work; viz., 60% Substructure submittal or 60% Structure Plans, 90% Structure Plans and 100% Structures Plans and Specifications. For projects where preapproved proprietary wall systems cannot be used and fully designed proprietary wall plans are required, submit approved control drawings to the appropriate proprietary wall companies as soon as possible and no later than the 60% substructure submittal. Send a copy of this submission to the DSDO or SDO as appropriate.

At any time during the project development, the reviewer may require submittal of design calculations. All Electronic Review Comments (ERC) must be resolved to the Department's satisfaction.

121.11.2 60% Substructure Submittal / 60% Structures Plans

This submittal phase is divided into two distinct parts; viz., the 60% Substructure Submittal (required for all projects) and the 60% Structures Plans for Category 2 Structures and some Category 1 Structures.

(1) 60% Substructure Submittal:

This submittal is required for every project and should be made a part of the 60% Structures Plans phase when that phase is part of the project. The submission is only a partial plans set. The purpose of this submittal is to communicate essential project information to the Geotechnical and Hydraulic Engineers so that all remaining calculations can be performed using actual structural shapes, loads, and dimensions. Plan sheets required for this submittal include: Plan & Elevation, Bridge Hydraulics Recommendation Sheet, Boring Logs, Foundation layout, Substructure Plans, and draft technical specifications.

60% Substructure Submittal Contents:

- (a) Foundation Layouts
- (b) Foundation Installation Notes
- (c) Pile/Drilled Shaft Installation Table
- (d) Footing Concrete Outlines (All Variations)
- (e) Pier Concrete Outline (All Variations)
- (f) Wall Plans - Control Drawings
- (g) Pile Details
- (h) Lateral Stability Analysis Completed
- (i) Phase II Geotechnical Report
- (j) Draft Technical Specifications
- (k) Reinforcement of Footing and Column
- (l) Post-Tensioning Details
- (m) Plan and Elevation Sheet
- (n) Bridge Hydraulics Recommendation Sheet
- (o) Boring Logs

(2) 60% Structures Plans:

When a 60% Structures Plans submittal is required, all comments from earlier reviews will have been resolved. At this phase, the design should be 90% complete and the plans, 60% complete. In addition to the documents required for the 60% Substructure Submittal, the 60% Structures include the following details as applicable in the plans: final concrete outlines of all individual components, major reinforcing steel, final post-tensioning layouts, steel box/I-girder details, segmental concrete box details, bearing details, seismic details, details of congested areas, details of unique features, accessible pedestrian facilities details, and other details as required. For moveable bridges the following additional information is required: electrical calculations (for generator size, service voltage drop, short circuit, service size, automatic transfer switch), single line diagram showing equipment sizes and utilities, conduit and wire sizes, panelboard schedules, and light fixture schedules.

121.11.3 90% Structures Plans

Upon approval of the BDR/30% Structures Plans or 60% Structures Plans, as applicable, 90% Structures Plans begin. At this stage of plans development, the EOR will have resolved the 30% and 60% Structures Plans review comments and developed the plans for completion. The design and plan production is required to be 100% complete. This submittal will include prints of the completed plans, Estimated Quantities Report, design calculations, Final Phase II Geotechnical Report, Addendums to Hydraulic Report and, if appropriate, Technical Special Provisions. No sheet or detail should be missing at this stage.

121.11.4 100% Structures Plans and Specifications

After resolution of the 90% Structures Plan comments, the EOR will make all authorized changes necessary to complete the plans and Technical Special Provisions. The EOR will provide a list of all changes made to the Plans or Specifications that were not directly related to the 90% Structures Plans review comments. The intent is to help minimize the Department's review time and to help the Department's review office to focus on only those new items or details proposed by the EOR. This will, in turn, help to expedite the project's authorization.

The 100% Structures Plans submittal is divided into two distinct phases. First, plans and technical special provisions are submitted 30 days prior to the District's Plans Production Date. Second, once notified by the Department, the plans and all other documents are submitted to the District.

Within the 30-day period allotted, the EOR will receive notification either of additional changes/corrections to be made or to submit the Final Plans as they are. If at any time during the 30-day period the EOR finds additional changes/corrections that should be made, the structures design office responsible for plans approval (either the DSDO) or the SDO as appropriate) is required to be notified for discussion and resolution.

Once all changes/corrections are made, or if no changes/corrections are necessary, the EOR will submit all work to the District prior to or on the Plans Production Date. Submittal of this stage of the work will include the plans, sealed in accordance with **FDM 130**, sealed Technical Special Provisions (if required), and Estimated Quantities Report.

Modification for Non-Conventional Projects:

Delete **FDM 121.11**. See the RFP for plans submittal requirements.

121.12 Independent Peer Review of Bridges

An Independent Peer Review (IPR) is used to validate the design of structures or portions thereof as defined below. The designated IPR firm will have no involvement with the project other than conducting the IPR and is required to be pre-qualified in accordance with [Rule 14-75 of the Florida Administrative Code](#). The responsible independent peer review engineer or the IPR Quality Assurance Manager must be on the Department's list of consultant qualifying engineer personnel (as a P.E. Qualifier) for the specific Group 4 work type.

- (1) The Department may require an IPR for conventional projects. Consult with the SDO when determining the need for such reviews. Consideration of when to require an IPR include, but is not limited to, the following:
 - (a) The introduction of new complex details or structure types.
 - (b) Work being performed that is outside the normal structure type designed by the selected consultant.
 - (c) Structures using complex details within standard bridge types (e.g., integral piers, straddle piers, skewed superstructures).

Modification for Non-Conventional Projects:

Delete item (1) above and replace with the following:

- (1) An Independent Department Review (IDR) is required for all Category 2 Structures. When a firm is designated by the Department to conduct the IDR, the firm will not be a party to the contract with, or perform work for, the Design-Build Firm/Joint Venture.

- (2) An IPR is required for Cost Savings Initiatives involving Category 2 Structures. The IPR function must be performed by a single independent engineering firm other than the engineer responsible for the design. The IPR must include:
 - (a) The superstructure and substructure for bridges consisting of Category 2 superstructures.
 - (b) Only the substructure for bridges where the superstructure is Category 1, but the substructure is Category 2.
 - (c) The superstructure and substructure for bridges designed for vessel collision. The IPR must include all spans or continuous units subject to vessel collision.

- (d) The superstructure and substructure on bridges for which the superstructure is subject to application of wave loads. The IPR must include all spans or continuous units for which the superstructure is subject to application of wave loads.
- (3) An IPR is required for the following structures and components of non-Department-owned projects constructed within, under or over State Road right-of-way, regardless of funding source:
 - (a) Category 1 (excluding miscellaneous structures) or Category 2 Structures
 - (b) Existing bridge retrofits and modifications regardless of bridge category
 - (c) Bridge cladding components and attachments

The peer review is intended to be a comprehensive, thorough independent verification of the original work. An independent peer review is not simply a check of the EOR's plans and calculations; it is an independent verification of the complete design, including but not limited to an evaluation of all nodal forces, using different programs and independent processes than what was used by the EOR. In addition, all independent peer reviews must include but are not limited to the independent confirmation of the following when applicable:

- (1) Compatibility of bridge geometry with roadway geometrics including typical sections, horizontal alignment, and vertical alignment. Minimum lateral offsets and vertical clearance requirements.
- (2) Compatibility of construction phasing with Traffic Control Plans.
- (3) Conflicts with underground and overhead utilities.
- (4) Compliance with AASHTO, Department and FHWA design requirements.
- (5) Conformity to Department Standard Plans.
- (6) Structural Analysis Methodology, design assumptions, and independent confirmation of design results including verification of the design thru all phases of construction.*
- (7) Global and local analyses including nodal forces, considering all structural members, connections/nodes and boundary conditions consistent with the structure type.*
- (8) Design results/recommendations (independent verification of the design).*
- (9) Completeness and accuracy of bridge plans.
- (10) Technical Special Provisions and Modified Special Provisions where necessary.
- (11) Constructability assessment limited to looking at fatal flaws in design approach.

- * When Category 2 elements are designed with software using refined analyses (e.g., Grid, Finite Element Method), the peer review consultant is required to verify the design results by a different program/method.

In addition to the requirements of **FDM 121.11.3** and **121.11.4**, include the following documents with plan submittals requiring an independent peer review:

(1) 90% Plan Submittals

- (a) A tabulated list of all review comments from the independent review engineer and responses from the originator of the design.
- (b) A standard peer review certification letter following the format presented in **Form 121-B** (see **FDM 103**) signed by the independent review engineer. All outstanding/unresolved comments and issues presented in this letter are required to be resolved and implemented prior to the 100% plan submittal.
- (c) A copy of the Department-issued Professional Services Qualification Letter, Part 1, containing the Work Types in which the independent PEER review firm has been qualified to work. The DSDE, for Category 1 bridge projects, or the SSDE, for Category 2 bridge projects, will confirm with the Procurement Office the independent PEER review firm's prequalification status of the appropriate Work Type.
- (d) Independent peer review calculations conforming to the requirements of **FDM 121.13.2**.

(2) 100% Plan Submittals

- (a) A certification letter following the format presented in **Form 121-C** (see **FDM 103**) signed and sealed by the independent review engineer stating that all review comments have been adequately addressed and that the design is in compliance with all Department and FHWA requirements.
- (b) A copy of the Department-issued Professional Services Qualification Letter, Part 1, containing the Work Types in which the independent PEER review firm has been qualified to work. The DSDE, for Category 1 bridge projects, or the SSDE, for Category 2 bridge projects, will confirm with the Procurement Office the independent PEER review firm's prequalification status of the appropriate Work Type.
- (c) Independent peer review calculations conforming to the requirements of **FDM 121.13.2**.

Modification for Non-Conventional Projects:

Delete items (1) and (2) above.

121.13 Assembly of Plans and Calculations

121.13.1 Plans Assembly

Consult the [Structures Detailing Manual](#) for plans assembly, materials, content of plans, and other drafting information.

121.13.2 Calculations Assembly

The requirements herein are applicable to calculations submitted to the Department. All calculation submittals must be complete, understandable, and organized. Submit calculations as a high-quality PDF report, wherein any scanned pages have a minimum 300 dpi and 75% quality compression, with all major chapters delineated with bookmark links, and include the following:

- (1) Cover page listing project information and Engineer of Record
- (2) Table of contents listing all design sections and sub-sections with page numbering
- (3) Comment Tracking Log listing all current and previous comments from the Department (including all Department Representatives) with responses to date, at the time of submission.
- (4) Detailed narrative of the design methodology, including a summary of all applicable design criteria (e.g., specifications and references, loads and load combinations, software and versions used for each component design, geotechnical considerations, modeling considerations for elastic/inelastic behavior, how results from one program were utilized in another, etc.).
- (5) Supporting design assumptions and associated commentary
- (6) Relevant software input and output
- (7) Member or component governing force effect and section capacity
- (8) Refined analyses shall include visual graphics of the structural model(s), loading diagrams, and results

Category 2 Structures require extensive analysis and design documentation due to their inherent complexity. The following are typical requirements for concrete and steel Category 2 Structures to be addressed in the calculations submittal and modified as necessary for each structure type. Other types of bridge structures such as cable stay,

suspension, arch, truss, moveable, FRP, bridges using Prefabricated Bridge Element Systems, etc. shall include similar information.

(1) General

- (a) General project overview and description
- (b) Describe purpose of submittal
- (c) Document all unique or non-standard details pertinent to the calculations submittal
- (d) Design Specifications. List all relevant design specifications and References used during the design, including the date and edition for each.
- (e) Redundancy and Operational Importance
- (f) Bridge target service life
- (g) Analysis Software. Name, version number and provide a description of the programs.
- (h) Properties for each material considered in the analysis and design, including but not limited to yield strength, tensile strength, compression strength, modulus of elasticity, thermal coefficient, Poisson's ratio, etc.

(2) Geometry

- (a) Horizontal alignment
- (b) Vertical alignment
- (c) Horizontal and vertical clearances
- (d) Finish Grade Elevations
- (e) Substructure elevations

(3) Loads and Load Combinations

- (a) Document all loads and load combinations considered in the analysis and design.

(4) Structural Analysis Models

At a minimum, provide the following sections for any structural model to document the assumptions:

- (a) Overview of Model
 - i. Diagram of what components are included in the model stiffness
 - ii. Element and node numbering
 - iii. Tendon/Cable Layouts

- iv. Tendon/Cable Stressing Forces
- (b) Boundary condition assumptions for all structural components
 - i. Connection between superstructure and substructure
 - ii. Connection between substructure and foundation
 - iii. Connection between foundation and soil
- (c) Basic model assumptions
 - i. Cross-sectional information
 - ii. Effective Flange Width
 - iii. FEM element types used
- (d) Construction stages with sequence and descriptions
- (e) Loading diagrams or sketches to clearly document magnitude and direction of loading.
- (f) Non-linear analysis assumptions
 - i. Geometric non-linearity
 - ii. Material non-linearity
- (5) Structural Analysis Software Results

Structural analysis software outputs should be limited to pertinent results and document the following minimum requirements:

 - (a) Force effects for each element
 - (b) Envelope of Forces and Stresses for applicable Load Combinations
- (6) Component Design Calculations

The calculations shall provide the governing loading combinations and section capacities for the structural elements and connections for critical stages during construction and the design life of the bridge listed as follows:

 - (a) Superstructure
 - (b) Substructure
 - (c) Foundation
 - (d) Miscellaneous (bearings, expansion joints, etc.)

(7) Appendices

Provide additional documentation used as a basis of design assumptions for the submittal. Examples include wind-tunnel testing reports, pertinent design related correspondence, side studies, sensitivity analyses, etc.

121.14 Plans Submittal

121.14.1 Schedule

The District Project Manager is responsible for establishing the schedule of submittals with input from the EOR and either the DSDE for Category 1 or Structures Design Office for Category 2 projects.

121.14.2 Submittal Schedule

- (1) BDR/30% Structures Plans
- (2) 60% Substructure Submittal/60% Structures Plans
- (3) 90% Structures Plans
- (4) 100% Structures Plans

Modification for Non-Conventional Projects:

Delete **FDM 121.14.1** and **121.14.2**. See the RFP for requirements.

121.14.3 Summary of Phase Submittals

Submittals made at various stages of project development are required to conform to a uniform standard of completeness for each phase. Use **Table 121.14.1** to prepare deliverables for each stage of project development for fixed bridges. Use **Table 121.14.1** and **Table 121.14.2** to prepare deliverables for each stage of project development for moveable bridges.

Table 121.14.1 and **Table 121.14.2** give a listing of specific structure plan sheets to be submitted at Bridge Development Report, 30%, 60%, 90% and 100% Plans stage. For specific sheet content requirements, see **Structures Detailing Manual Examples for Design-Bid-Build Projects**. For sheets not covered by specific example, see general description below for required level of completion.

- (1) **Preliminary (P):** Basic shapes, geometry and layout of specified members are shown. Rebar and elevations are not required for Preliminary submittals. For example, the outline drawing of an end bent with complete dimensions including stationing, beam, and pedestal layout but without pile layout dimensions or rebar.
- (2) **Substantially Complete (S):** Shapes, geometry and layout have been finalized. Design is 90% complete with most rebar, plate sizes, bolt patterns, concrete strengths finalized and incorporated into the plans. For example, an end bent drawing with rebar, complete dimensions, pile, and beam layout but without elevations.
- (3) **Complete but Subject to Change (C):** The design, drawings and details are complete for the specified component. Only reviewer-initiated changes should be expected at this level. For example, an end bent drawing would be complete, including all rebar callouts, elevations, dimensions.
- (4) **Final (F):** All drawings and designs are complete. No changes are expected at this level. Plans are ready to be signed and sealed by the EOR.

Modification for Non-Conventional Projects:

Delete **FDM 121.14.3** and replace with the following:

121.14.3 Design-Build Technical Proposal and Component Plan Submittals

Component Plan Submittals are required to conform to a uniform standard of completeness for each submittal. Use **Table 121.14.3** to prepare deliverables for each component submittals for fixed bridges. Use **Table 121.14.3** and **Table 121.14.4** to prepare deliverables for component submittals for moveable bridges. Unless otherwise shown in the RFP, Technical Proposals are required to include the requirements of **Table 121.14.3** and **Table 121.14.4**.

Submit component submittals per **Table 121.14.3** and **Table 121.14.4** (e.g., foundation, substructure, and superstructure) for each bridge. Partial submittals of individual elements within a bridge (e.g., End Bent 1, Pier 3, I-girder details) are not permitted.

Table 121.14.3 and **Table 121.14.4** give a listing of specific structure plan sheets to be submitted at Technical Proposal, 90% and Final Plans stage. For specific sheet content requirements, see [Structures Detailing Manual Examples for Non-Conventional Projects](#). For sheets not covered by specific example, see general description below for required level of completion.

- (1) **Preliminary (P):** Basic shapes, geometry and layout of specified members are shown. Rebar and elevations are not required for Preliminary submittals. For example, the outline drawing of an end bent with complete dimensions including stationing, beam and pedestal layout but without pile layout dimensions or rebar.
- (2) **Substantially Complete (S):** Shapes, geometry and layout have been finalized. Design is 90% complete with most rebar, plate sizes, bolt patterns, concrete strengths finalized and incorporated into the plans. For example, an end bent drawing with rebar, complete dimensions, pile and beam layout but without elevations.
- (3) **Complete but Subject to Change (C):** The design, drawings and details are complete for the specified component. Only reviewer-initiated changes should be expected at this level. For example, an end bent drawing would be complete, including all rebar callouts, elevations, and dimensions.
- (4) **Final (F):** All drawings and designs are complete. No changes are expected at this level. Plans are ready to be signed and sealed by the EOR.

Table 121.14.1 Summary of Phase Submittals

Provide the sheets listed as applicable based on structure type.

ITEM	BDR	30%	60% Substr. Submittal	60% Structures Plans*	90%	100%
Cover Sheet		P	S	S	C	F
Key Sheet		P	S	S	C	F
Sheet Index		P	S	S	C	F
General Notes		P	S	S	C	F
Standard Plans Index Sheets					F	F
Surface Finish Details			S	S	C	F
Riprap Details			S	S	C	F
Slope Protection Details			S	S	C	F
Plan and Elevation	S	S	C	C	C	F
Typical Section	S	S	C	C	C	F
Hydraulics Recommendation	P	P	S	S	C	F
Construction Sequence	S	S		C	C	F
Borings		C	C	C	C	F
Foundation Layout		S	S	S	C	F
Pile/Shaft Data Table		P	S	S	C	F
End Bent		P	S	S	C	F
End Bent Details			S	S	C	F
Wing Wall Details			S	S	C	F
Pier	P	P	S	S	C	F
Pier Details		P	S	S	C	F
Footing		P	S	S	C	F
Intermediate Bent	P	P	S	S	C	F
Intermediate Bent Details			S	S	C	F
Drilled Shaft Details		P	S	S	C	F
Finish Grade Elevations				C	C	F
Camber/Build-up/Deflection Diagrams				C	C	F
Framing Plan		P		S	C	F
Superstructure Plan				S	C	F
Superstructure Details				S	C	F
Erection Sequence	P	P	S	S	C	F
P/S Beam Data Tables				S	C	F
Cross Frames/Diaphragm Details				S	C	F
Steel Girder Details		P		S	C	F
P/T Systems		P		S	C	F
Bearing Details				S	C	F
Expansion Joint Details				S	C	F
Approach Slab Details				S	C	F
Reinforcing Bar List					C	F
Conduit and Inspection Lighting Details				P	C	F
Vermin Guard				S	C	F
Wall Control Drawings		P***	S	S	C	F
Wall Details		P	S	S	C	F
Temporary Critical Wall Drawings	P	P	S	S	C	F
Wall Data Tables			S	S	C	F
Temp. Bridge Plan and Elevation			P	P	C	F
Temp. Bridge Foundation Layout			P	P	C	F

Table 121.14.1 Summary of Phase Submittals (continued)

Provide the sheets listed as applicable based on structure type.

ITEM	BDR	30%	60% Substr. Submittal	60% Structures Plans*	90%	100%
Segment Joint Coordinates/Deck Elev.				S	C	F
Segment Layout		P		S	C	F
Typical Segment Dimensions	P	P		C	C	F
Typical Segment Reinforcing				S	C	F
Pier Segment Dimensions	P	P		C	C	F
Pier Segment Reinforcing **				S	C	F
Abutment Segment Dimensions	P	P		C	C	F
Abutment Segment Reinforcing **				S	C	F
Expansion Joint Segment Dimensions		P		S	C	F
Expansion Joint Segment Reinforcing **				S	C	F
Deviation Segment Dimensions		P		C	C	F
Deviation Segment Reinforcing **				S	C	F
Post Tensioning Layout		P		C	C	F
P/T Details	P	P		S	C	F
Transverse P/T Details		P		C	C	F
Bulkhead Details		P		S	C	F
Drainage Layout		P		S	C	F
Drainage Details		P		S	C	F
Load Rating Summary Sheet					C	F
Developmental Standard Plans		C	C	C	F	F
Existing Bridge Plans		F ††	F ††	F ††	F	F

Status Key:

P – Preliminary

S – Substantially Complete

C – Complete but subject to change

F – Final

* – 60% Structures Plan submittals are required for all Category 2 and some Category 1 bridges. See **FDM 121.11.2** for additional information

** – May require integrated drawings

*** – Control Plans only showing geometry, stationing, and offsets

‡ – Where required for project

†† – Widening and projects with phased construction

Table 121.14.2 Summary of Phase Submittals - Movable Bridges

For approach span requirements, see **Table 121.14.1**.

Provide the sheets listed as applicable based on machinery and electrical components utilized.

ITEM	BDR	30%	60% Structures Plans*	90%	100%
Bascule Pier Notes		P	S	C	F
Bascule Span Elevation	P	S	S	C	F
Leaf Clearance Diagrams		P	S	C	F
Bridge Railing Clearance Diagrams		P	S	C	F
Bascule Pier North Elevation View	P	S	S	C	F
Bascule Pier South Elevation View	P	S	S	C	F
Bascule Pier East Elevation View	P	S	S	C	F
Bascule Pier West Elevation View	P	S	S	C	F
Bascule Pier Deck Plan	P	S	S	C	F
Bascule Pier Deck Elevations	P	S	S	C	F
Bascule Pier Trunnion Level Plan	P	S	S	C	F
Bascule Pier Machinery Level Plan	P	S	S	C	F
Bascule Pier Pit Plan	P	S	S	C	F
Bascule Pier Footing Plan	P	S	S	C	F
Bascule Pier Longitudinal Sections	P	S	S	C	F
Bascule Pier Transverse Sections	P	S	S	C	F
Bascule Pier Railing Details			P	C	F
Bascule Pier Stair Details			P	C	F
Bascule Pier Trunnion Access Platform Details	‡	‡	S	C	F
Bascule Pier Finger Joints			P	C	F
Bascule Pier Deck Level Reinforcing			P	C	F
Bascule Pier Trunnion Level Reinforcing			P	C	F
Bascule Pier Machinery Level Reinforcing			P	C	F
Bascule Pier Pit Reinforcing			P	C	F
Bascule Pier Footing Reinforcing			P	C	F
Bascule Pier North Elevation Reinforcing			P	C	F
Bascule Pier South Elevation Reinforcing			P	C	F
Bascule Pier East Elevation Reinforcing			P	C	F
Bascule Pier West Elevation Reinforcing			P	C	F

Table 121.14.2 Summary of Phase Submittals - Movable Bridges (Continued)

Provide the sheets listed as applicable based on machinery and electrical components utilized.

ITEM	BDR	30%	60% Structures Plans*	90%	100%
Bascule Pier Longitudinal Section Reinforcing			P	C	F
Bascule Pier Transverse Section Reinforcing			P	C	F
Bascule Pier Reinforcing Bar List			P	C	F
Control House General Notes			P	C	F
Control house Reflected Ceiling Plan			P	C	F
Control House Access Bridge Dimensions	‡	‡	S	C	F
Control House Access Bridge Reinforcing	‡	‡	S	C	F
Control House Access Bridge Bar List	‡	‡	S	C	F
Control Tower Floor Plans	P	S	S	C	F
Control Tower Sections	P	S	S	C	F
Control Tower Reinforcing Plans			P	C	F
Control Tower Reinforcing Elevations			P	C	F
Control Tower Section Reinforcing			P	C	F
Control Tower Bar List			P	C	F
Control Tower Schedules			P	C	F
Control Tower Elevations	P	S	S	C	F
Control Tower Building Sections			P	C	F
Control Tower Details			P	C	F
Control Tower Stair Plans			P	C	F
Control Tower Stair Sections			P	C	F
Control Tower Roof			P	C	F
Control Tower Door and Window Types and Details			P	C	F
Control Tower Architectural Details			P	C	F
Control Tower HVAC Notes			P	C	F
Control Tower HVAC and Plumbing Floor Plans			P	C	F
Control Tower HVAC and Plumbing Elevations			P	C	F
Bascule Leaf Notes			S	C	F
Bascule Leaf Framing Plan and Longitudinal Section	P	S	S	C	F
Bascule Leaf Transverse Sections at Floorbeams	P	S	S	C	F
Bascule Leaf Transverse Sections at Trunnion	P	S	S	C	F

Table 121.14.2 Summary of Phase Submittals - Movable Bridges (Continued)
 Provide the sheets listed as applicable based on machinery and electrical components utilized.

ITEM	BDR	30%	60% Structures Plans*	90%	100%
Bascule Leaf Transverse Sections at Counterweight Girders	P	S	S	C	F
Main Girder Elevation	P	S	S	C	F
Main Girder Details			P	C	F
Main Girder Web Geometry and Camber Details			P	C	F
Main Girder Force Diagrams			P	C	F
Main Girder Reaction Influence Lines			P	C	F
Main Girder Moment Influence Lines			P	C	F
Floorbeam Details			P	C	F
Counterweight Girder Details			P	C	F
Stringer Details			P	C	F
Lateral Bracing Details			P	C	F
Counterweight Bracing Plan and Details			P	C	F
Counterweight Bracing Sections and Details			P	C	F
Counterweight Plan			P	C	F
Counterweight Longitudinal Sections			P	C	F
Counterweight Transverse Sections			P	C	F
Counterweight Details and Reinforcing Bar List			P	C	F
Bridge Deck Panel Layout			P	C	F
Bridge Deck Panel Sections			P	C	F
Bridge Deck Panel Details			P	C	F
Armored Joint Details			P	C	F
Span Lock Housing Details			P	C	F
Bascule Leaf Jacking Details and Notes			P	C	F
Mechanical General Notes		P	S	C	F
Mechanical Equipment Schedules		P	S	C	F
Drive Machinery Layout		P	S	C	F
Machinery Support Details			S	C	F
Trunnion Assembly Details		P	S	C	F
Open Gearing Details		P	S	C	F

Table 121.14.2 Summary of Phase Submittals - Movable Bridges (Continued)
 Provide the sheets listed as applicable based on machinery and electrical components utilized.

ITEM	BDR	30%	60% Structures Plans*	90%	100%
Rack/Rack Frames and Rack Pinion Details		P	S	C	F
Mechanical Bearing Details		P	S	C	F
Drive Hydraulic Cylinders Details		P	S	C	F
Hydraulic System Layout/Piping Details		P	S	C	F
Hydraulic Cylinder Support Assemblies		P	S	C	F
Hydraulic System Details		P	S	C	F
Live Load Shoe Details		P	S	C	F
Centering Device Details			S	C	F
Span Lock Assembly Details		P	S	C	F
Control Tower – Control Console and Operator's Visualization Geometry Analysis Including CCTV Locations		P	S	C	F
Electrical General Notes		P	S	C	F
Electrical Site Plan		P	S	C	F
Conduit Riser Diagram		P	S	C	F
Single Line Diagram		P	S	C	F
Electrical Symbol Legend		P	S	C	F
Lighting and Equipment Plan (Including Control Tower Lighting, Fire Detection and Lighting Panel Schedules)		P	S	C	F
Lightning Protection, Bonding, and Grounding Plan		P	S	C	F
Navigation Lighting Plan		P	S	C	F
Communication Equipment Plan		P	S	C	F
Control Panel Details		P	S	C	F
Control Console Details		P	S	C	F
Block Diagram of Operating Sequence		P	S	C	F
Control System Architecture Diagram		P	S	C	F
Schematic Diagrams of all Control Systems and Interlocks		P	S	C	F
Control System I/O Points		P	S	C	F
Ladder Logic for PLC			P	C	F
Submarine Cable/Submarine Cable Termination Cabinet Details		P	S	C	F

Table 121.14.2 Summary of Phase Submittals - Movable Bridges (Continued)
 Provide the sheets listed as applicable based on machinery and electrical components utilized.

ITEM	BDR	30%	60% Structures Plans*	90%	100%
Fire and Security Panel Schematic Diagram		P	C	C	F
CCTV Plan and Elevation		P	C	C	F
Limit Switch Development		P	C	C	F
Conduit and Cable Schedule		P	C	C	F
Electrical Equipment Layout - Including but not limited to Generators, Motors, Control Console, Control Panels, and Motor Control Center.		P	C	C	F
CCTV Layout			P	S	F

Status Key:

P – Preliminary

S – Substantially Complete

C – Complete but subject to change

F – Final

* – 60% Structures Plan submittals are required for all movable bridges. See **FDM 121.11.2** for additional information

‡ – Where required for project

Table 121.14.3 Summary of Design-Build Technical Proposal and Component Plan Submittals

Provide the sheets listed as applicable based structure type.

Foundation Submittal

ITEM	Technical Proposal	90%	Final
Cover Sheet		C	F
Key Sheet		C	F
Sheet Index		C	F
General Notes	S	C	F
Standard Plans Index Sheets		F	F
Surface Finish Details		C	F
Riprap Details		C	F
Slope Protection Details		C	F
Plan and Elevation	P	C	F
Typical Section	P	C	F
Hydraulics Recommendation	P	C	F
Construction Sequence	P	C	F
Borings		C	F
Foundation Layout	P	C	F
Pile/Shaft Data Table		C	F
Drilled Shaft Details		C	F
Temp. Bridge Foundation Layout	P	C	F
Existing Bridge Plans		F##	F
Foundation Related Temporary Critical Wall Drawings	P	C	F
Include in all submittals additional details and backup information necessary to substantiate the loading on the foundations. Include a copy of the Geotechnical Report in all submittals. ## – Widening and projects with phased construction 90% and Final submittals for category 2 bridges require an Independent Department Review.			

Table 121.14.3 Summary of Design-Build Technical Proposal and Component Plan Submittals (Continued)

Provide the sheets listed as applicable based structure type.

Substructure Submittal

ITEM	Technical Proposal	90%	Final
End Bent	P	C	F
End Bent Details		C	F
Wing Wall Details		C	F
Pier	P	C	F
Pier Details		C	F
Footing	P	C	F
Intermediate Bent	P	C	F
Intermediate Bent Details		C	F
Reinforcing Bar List		C	F
90% and Final submittals for category 2 bridges require an Independent Department Review.			

Table 121.14.3 Summary of Design-Build Technical Proposal and Component Plan Submittals (Continued)

Provide the sheets listed as applicable based structure type.

Superstructure Submittal

ITEM	Technical Proposal	90%	Final
Finish Grade Elevations		C	F
Camber/Build-up/Deflection Diagrams		C	F
Framing Plan		C	F
Superstructure Plan		C	F
Superstructure Details		C	F
Erection Sequence	P‡	C	F
P/S Beam Data Tables		C	F
Cross Frames/Diaphragm Details		C	F
Steel Girder Details	P	C	F
P/T Systems	P	C	F
Bearing Details		C	F
Expansion Joint Details		C	F
Approach Slab Details		C	F
Reinforcing Bar List		C	F
Conduit and Inspection Lighting Details		C	F
Vermin Guard		C	F
Wall Control Drawings	P	C	F
Wall Details		C	F
Non-Foundation Related Temporary Critical Wall Drawings	P	C	F
Wall Data Tables		C	F
Temp. Bridge Plan and Elevation	P	C	F
Segment Joint Coordinates/Deck Elev.		C	F
Segment Layout	P	C	F
Typical Segment Dimensions	P	C	F
Typical Segment Reinforcing		C	F
Pier Segment Dimensions	P	C	F
Pier Segment Reinforcing **		C	F
Abutment Segment Dimensions	P	C	F
Abutment Segment Reinforcing **		C	F
Expansion Joint Segment Dimensions	P	C	F
Expansion Joint Segment Reinforcing **		C	F
Deviation Segment Dimensions	P	C	F
Deviation Segment Reinforcing **		C	F
Post Tensioning Layout	P	C	F

Table 121.14.3 Summary of Design-Build Technical Proposal and Component Plan Submittals (Continued)

Provide the sheets listed as applicable based structure type.

Superstructure Submittal (Continued)

ITEM	Technical Proposal	90%	Final
P/T Details	P	C	F
Transverse P/T Details		C	F
Bulkhead Details		C	F
Drainage Layout		C	F
Drainage Details		C	F
Load Rating Summary Sheet		C	F
Developmental Standard Plans		F	F
Existing Bridge Plans		F‡	F
90% and Final submittals for category 2 bridges require an Independent Department Review.			

Status Key:

- P** – Preliminary
- S** – Substantially Complete
- C** – Complete but subject to change
- F** – Final
- **** – May require integrated drawings
- ‡** – For geometrically constrained sites, show temporary stability towers in the vicinity of the underlying roadways consistent with the Traffic Control Plans. Also show temporary stability towers within navigable waterways.
- ‡‡** – Widening and projects with phased construction

Table 121.14.4 Summary of Design-Build Technical Proposal and Component Plan Submittals – Movable Bridges

For approach span and foundation submittal requirements see *Table 121.14.3*.
 Provide the sheets listed as applicable based on machinery and electrical components utilized.
Substructure Submittal

ITEM	Technical Proposal	90%	Final
Bascule Pier Notes		C	F
Bascule Span Elevation	P	C	F
Leaf Clearance Diagrams		C	F
Bridge Railing Clearance Diagrams		C	F
Bascule Pier North Elevation View	P	C	F
Bascule Pier South Elevation View	P	C	F
Bascule Pier East Elevation View	P	C	F
Bascule Pier West Elevation View	P	C	F
Bascule Pier Deck Plan	P	C	F
Bascule Pier Deck Elevations	P	C	F
Bascule Pier Trunnion Level Plan	P	C	F
Bascule Pier Machinery Level Plan	P	C	F
Bascule Pier Pit Plan	P	C	F
Bascule Pier Footing Plan	P	C	F
Bascule Pier Longitudinal Sections	P	C	F
Bascule Pier Transverse Sections	P	C	F
Bascule Pier Railing Details		C	F
Bascule Pier Stair Details		C	F
Bascule Pier Trunnion Access Platform Details	‡	C	F
Bascule Pier Finger Joints		C	F
Bascule Pier Deck Level Reinforcing		C	F
Bascule Pier Trunnion Level Reinforcing		C	F
Bascule Pier Machinery Level Reinforcing		C	F
Bascule Pier Pit Reinforcing		C	F
Bascule Pier Footing Reinforcing		C	F
Bascule Pier North Elevation Reinforcing		C	F
Bascule Pier South Elevation Reinforcing		C	F
Bascule Pier East Elevation Reinforcing		C	F
Bascule Pier West Elevation Reinforcing		C	F
Bascule Pier Longitudinal Section Reinforcing		C	F
Bascule Pier Transverse Section Reinforcing		C	F
Bascule Pier Reinforcing Bar List		C	F
90% and Final submittals for category 2 bridges require an Independent Department Review.			

Table 121.14.4 Summary of Design-Build Technical Proposal and Component Plan Submittals – Movable Bridges (Continued)

Provide the sheets listed as applicable based on machinery and electrical components utilized.

Superstructure Submittal

ITEM	Technical Proposal	90%	Final
Control House General Notes		C	F
Control house Reflected Ceiling Plan		C	F
Control House Access Bridge Dimensions	‡	C	F
Control House Access Bridge Reinforcing		C	F
Control House Access Bridge Bar List		C	F
Control Tower Floor Plans	P	C	F
Control Tower Sections	P	C	F
Control Tower Reinforcing Plans		C	F
Control Tower Reinforcing Elevations		C	F
Control Tower Section Reinforcing		C	F
Control Tower Bar List		C	F
Control Tower Schedules		C	F
Control Tower Elevations	P	C	F
Control Tower Building Sections		C	F
Control Tower Details		C	F
Control Tower Stair Plans		C	F
Control Tower Stair Sections		C	F
Control Tower Roof		C	F
Control Tower Door and Window Types and Details		C	F
Control Tower Architectural Details		C	F
Control Tower HVAC Notes		C	F
Control Tower HVAC and Plumbing Floor Plans		C	F
Control Tower HVAC and Plumbing Elevations		C	F
Bascule Leaf Notes		C	F
Bascule Leaf Framing Plan and Longitudinal Section	P	C	F

Table 121.14.4 Summary of Design-Build Technical Proposal and Component Plan Submittals – Movable Bridges (Continued)

Provide the sheets listed as applicable based on machinery and electrical components utilized.

Superstructure Submittal (Continued)

ITEM	Technical Proposal	90%	Final
Bascule Leaf Transverse Sections at Floorbeams	P	C	F
Bascule Leaf Transverse Sections at Trunnion	P	C	F
Bascule Leaf Transverse Sections at Counterweight Girders	P	C	F
Main Girder Elevation	P	C	F
Main Girder Details		C	F
Main Girder Web Geometry and Camber Details		C	F
Main Girder Force Diagrams		C	F
Main Girder Reaction Influence Lines		C	F
Main Girder Moment Influence Lines		C	F
Floorbeam Details		C	F
Counterweight Girder Details		C	F
Stringer Details		C	F
Lateral Bracing Details		C	F
Counterweight Bracing Plan and Details		C	F
Counterweight Bracing Sections and Details		C	F
Counterweight Plan		C	F
Counterweight Longitudinal Sections		C	F
Counterweight Transverse Sections		C	F
Counterweight Details and Reinforcing Bar List		C	F
Bridge Deck Panel Layout		C	F
Bridge Deck Panel Sections		C	F
Bridge Deck Panel Details		C	F
Armored Joint Details		C	F
Span Lock Housing Details		C	F
Bascule Leaf Jacking Details and Notes		C	F
Mechanical General Notes	P	C	F
Mechanical Equipment Schedules	P	C	F
Drive Machinery Layout	P	C	F
Machinery Support Details		C	F

Table 121.14.4 Summary of Design-Build Technical Proposal and Component Plan Submittals – Movable Bridges (Continued)

Provide the sheets listed as applicable based on machinery and electrical components utilized.

Superstructure Submittal (Continued)

ITEM	Technical Proposal	90%	Final
Trunnion Assembly Details	P	C	F
Open Gearing Details	P	C	F
Rack/Rack Frames and Rack Pinion Details	P	C	F
Mechanical Bearing Details	P	C	F
Drive Hydraulic Cylinders Details	P	C	F
Hydraulic System Layout/Piping Details	P	C	F
Hydraulic Cylinder Support Assemblies	P	C	F
Hydraulic System Details	P	C	F
Live Load Shoe Details	P	C	F
Centering Device Details		C	F
Span Lock Assembly Details	P	C	F
Control Tower – Control Console and Operator's Visualization Geometry Analysis Including CCTV Locations	P	C	F
Electrical General Notes	P	C	F
Electrical Site Plan	P	C	F
Conduit Riser Diagram	P	C	F
Single Line Diagram	P	C	F
Electrical Symbol Legend	P	C	F
Lighting and Equipment Plan (Including Control Tower Lighting, Fire Detection and Lighting Panel Schedules)	P	C	F
Lightning Protection, Bonding, and Grounding Plan	P	C	F
Navigation Lighting Plan	P	C	F
Communication Equipment Plan	P	C	F
Control Panel Details	P	C	F
Control Console Details	P	C	F
Block Diagram of Operating Sequence	P	C	F
Control System Architecture Diagram	P	C	F
Schematic Diagrams of all Control Systems and Interlocks	P	C	F

Table 121.14.4 Summary of Design-Build Technical Proposal and Component Plan Submittals – Movable Bridges (Continued)

Provide the sheets listed as applicable based on machinery and electrical components utilized.

Superstructure Submittal (Continued)

ITEM	Technical Proposal	90%	Final
Control System I/O Points	P	C	F
Ladder Logic for PLC		C	F
Submarine Cable/Submarine Cable Termination Cabinet Details	P	C	F
Fire and Security Panel Schematic Diagram	P	C	F
CCTV Plan and Elevation	P	C	F
Limit Switch Development	P	C	F
Conduit and Cable Schedule	P	C	F
Electrical Equipment Layout - Including but not limited to Generators, Motors, Control Console, Control Panels, and Motor Control Center.	P	C	F
CCTV Layout		S	F

Status Key:

- P – Preliminary
- S – Substantially Complete
- C – Complete but subject to change
- F – Final
- ‡ – Where required for project.

121.15 Review for Constructability and Maintainability

121.15.1 Purpose

The purpose of this review is to provide reasonable and practical use of fabrication and construction techniques and equipment without overloading and overstressing components, provide for proper material handling and transportation, provide safe maintenance of traffic, and provide an appropriate construction sequence. Additionally, provide features which will retard bridge deterioration, permit reasonable access to all parts of the bridge for inspection and performance evaluation and provide features to facilitate replacement of damaged and deteriorated bridge components.

121.15.2 Responsibility

For Category 1 and 2 Structures, it will be the responsibility of the District Project Manager, or his/her designee, to coordinate a review of both the 30% and 90% Structures Plans submittals by the appropriate District Construction and Maintenance personnel for constructability and maintainability. For Category 1 Structures, technical issues will be resolved to the satisfaction of the appropriate DSDE. For Category 2 Structures, technical issues will be resolved to the satisfaction of the SDO.

The Construction and Maintenance Offices should be given adequate time to perform these reviews. All comments from these reviews will be addressed prior to the next submittal and its subsequent review.

Modification for Non-Conventional Projects:

Delete **FDM 121.15** and see the RFP for requirements.

121.16 Review for Biddability

121.16.1 Purpose

To prevent construction problems, the District Construction Office will review the plans to make certain the plans are clearly understandable and contain all pertinent notes. During the biddability review, the Construction Office will check for the interface with the roadway segment of the project, utility agreements and environmental permits.

121.16.2 Responsibility

For Category 1 and 2 Structures, it will be the responsibility of the District Project Manager to coordinate a review of the 90% Structures Plan submittal. This review should occur at the same time as the Phase III Plans submittal for the roadway segments of the project.

Additionally, for Category 2 Structures, it will be the responsibility of the SDO to coordinate a review of the 90% Structures Plans submittal.

The Construction Offices should be given adequate time to perform these reviews. All comments from these reviews are required to be addressed prior to the 100% Structures Plans Stage submittal.

Modification for Non-Conventional Projects:

Delete **FDM 121.16**.

121.17 Bridge Load Rating

For new bridges the Engineer of Record is required to load rate the bridge(s) and submit the calculations with the 90% plan submittal.

Prior to developing the scope-of-work for bridge widening or rehabilitation projects, the Department or their consultant will determine the suitability of the bridge project using the load rating. If the existing load rating is inaccurate or was performed using older methods (e.g., load factor), perform a new load rating using the procedures outlined in the [***Structures Manual, Volume 1 - Structures Design Guidelines, Chapter 7***](#). Submit load rating calculations for the entire structure (existing and new) with the 90% plan submittal for the project.

Modification for Non-Conventional Projects:

Delete **FDM 121.17** and see the RFP for requirements.

121.18 Review of Non-Department-Owned Projects (New Construction)

Portions of transportation projects on, under or over a Department-owned right-of-way, regardless of funding source or owner, will be subject to review by the Department. FHWA review will be required whenever a privately funded or LAP structure crosses over an interstate route, or when such work otherwise affects such a route; i.e., lane closures, access, R/W changes. The extent of the Department and FHWA review is that:

- (1) Plans will meet all current clearance requirements (vertical and horizontal).
- (2) Review and approve the maintenance of traffic scheme for construction.
- (3) Securely fasten all attachments to the structure over the highway.
- (4) Design will be sealed by a licensed professional engineer employed by a Department prequalified engineering firm.
- (5) Designs will be in accordance with applicable Department publications.
- (6) Plans will meet all District permit requirements and procedures.

- (7) Submit to FHWA for approval only projects over or affecting a NHS facility.
- (8) Department review for these structures will be performed by the DSDO for Category 1 and the SDO for Category 2 Structures. Structural reviews will be performed to the same extent as reviews performed on Department projects to assure compliance with the Department's design criteria.

121.19 Precast Alternate Development

Modification for Non-Conventional Projects:

Delete **FDM 121.19**.

121.19.1 Precast Feasibility Assessment Questions:

Several negative responses to the following questions may indicate precasting is not feasible for the project. In this case, provide a statement in the BDR stating that precasting is not feasible and indicate the reasons why in order to satisfy the requirements of **FDM 121.9.1, #9**.

- (1) Will precasting reduce traffic impacts? Factors may include: average traffic volumes being affected, detour lengths and durations, lane reductions and duration.
- (2) Is this structure likely to be on the critical path for construction of the project or is this structure on a hurricane evacuation route which requires accelerated delivery?
- (3) Is the size of the project large enough to benefit from economy of scale, assembly line construction processes, and is it large enough to capitalize on a construction learning curve?
- (4) Is precasting practical given the project aesthetics when component lifting weights are considered?
- (5) Is precasting practical given project variability? Factors may include: formwork reuse, multiple construction methods and steps, and variable equipment requirements.
- (6) Does the project site have space within FDOT R/W to use as a near-site casting yard and can precast elements be hauled from likely near-site casting yard locations to the site?
- (7) Can precast elements be hauled from likely off-site prestressed yard locations to the site?

- (8) Are the lifting weights practical given the assumed equipment, construction access, and construction methods?
- (9) Can connection details be developed with the following characteristics:
 - (a) Durable?
 - (b) Easily inspected during construction?
 - (c) Accommodates shaft/pile placement tolerances?
 - (d) Accommodates fit up?
 - (e) Accommodates differential camber (full-depth deck panels)?

121.19.2 Assessment Matrix

Table 121.19.1 is a tool that may be used in documenting the decision-making process for evaluation of precast construction versus conventional cast-in-place construction. **Table 121.19.2** is a sample Alternate Cost Summary Table indicating how to summarize the component cost estimates and their sum.

Table 121.19.1 Sample Assessment Matrix

- *example values in italics* -

Selection Factor	Factor Weight (%)	PRECAST		CONVENTIONAL	
		Score (0 to 5)	Weighted Score*	Score (0 to 5)	Weighted Score*
Total Direct Costs	<i>40</i>	<i>4</i>	<i>160</i>	<i>5</i>	<i>200</i>
Total Indirect Costs	<i>10</i>	<i>5</i>	<i>50</i>	<i>4</i>	<i>40</i>
Factor 3 - <i>Constructability</i>	<i>25</i>	<i>3</i>	<i>75</i>	<i>4</i>	<i>100</i>
Factor 4 – <i>Traffic Impacts</i>	<i>0</i>				
Factor 5 - <i>Construction Duration</i>	<i>0</i>				
Factor 6 - <i>Durability</i>	<i>0</i>				
Factor 7 – <i>Environmental Impacts</i>	<i>10</i>	<i>5</i>	<i>50</i>	<i>2</i>	<i>20</i>
Factor 8– <i>Aesthetics</i>	<i>15</i>	<i>5</i>	<i>75</i>	<i>3</i>	<i>45</i>
Factor 9 – <i>Other</i>	<i>0</i>				
Factor 10 – <i>Other</i>	<i>0</i>				
TOTAL (Σ Factor Weights = 100%)	<i>100</i>		<i>410</i>		<i>405</i>
TOTAL (Excluding Indirect Cost Factor)**	<i>90</i>		<i>360</i>		<i>365</i>

*Weighted Score = Factor Weight x Score **See following explanation, Instructions “6.”

121.19.3 Assessment Matrix Instructions

- (1) **List Selection Factors** to be used to evaluate the applicability of alternates to meet the goals of the project. Factors are project specific and always include Total Direct Costs and Total Indirect Costs (road user costs) and may include some of the following: Constructability, Traffic Impacts (e.g., Maintenance of Traffic, Detours, Traffic Delays), Construction Duration, Durability, Environmental Impacts, and Aesthetics. Include other Factors as required to capture any unique project characteristics that are not otherwise addressed. Note that as many or as few criteria may be used in the assessment matrix as deemed appropriate by the designer; though, a sufficient number of Selection Factors (i.e., criteria) are required to provide a thorough evaluation of the alternates being considered to meet the objectives of the project. When choosing selection factors and applying factor weights avoid double counting benefits. For instance, indirect costs and traffic impacts may be related selection factors.

Costs of precast versus conventional may be affected by:

- (a) Savings associated with labor rates and insurance costs for reduced time working from a barge on a large water project.
 - (b) Savings associated with structural efficiencies resulting from precasting (e.g., composite dead loads in the case of shored deck casting).
 - (c) Savings associated with simultaneous substructure and superstructure component construction.
 - (d) Savings associated with increased productivity rates of precasting.
- (2) **Construct** a two-dimensional table allowing one row for each Selection Factor and two columns for each alternate, one for Score and one for Weighted Score.
 - (3) **Factor Weights** to distinguish the level of importance of each criterion relative to the other criteria in achieving the project objectives. Weighting the various factors will usually require Department/District input. Distribute the Factor Weights such that their sum is equal to 100%.
 - (4) **Score** the relative difference between alternates. Range of scores can vary for a given project (e.g., 0 to 5 or 0 to 10). Scoring may be accomplished by a committee and then the average score for each Selection Factor entered into the matrix.
 - (5) **Calculate** the Weighted Score by multiplying the Factor Weight by Score for each alternate.
 - (6) **Total** the Weighted Score columns: (1) Provide the absolute total of each column, which includes the Indirect Costs Score and, (2) Provide the column total excluding the contribution from the "Total Indirect Costs." It is useful for management to

compare the impacts, both relative and in hard dollar amounts, of indirect costs on bridge construction projects when making their decisions. *The column with the largest total weighted score theoretically indicates the alternate which most closely meets the project objectives as implicated by the matrix construct.*

Table 121.19.2 Sample Alternate Cost Summary

Alternate	Direct Costs* (\$)	Indirect Costs**							Sum: Direct + ΣIndirect (\$)
		Lane Closures		Detour Time		Facility Closure		ΣIndirect (\$)	
		Days (#)	\$/Day	Days (#)	\$/Day	Days (#)	\$/Day		
Precast 1									
Precast 2									
Conventional 1									
Conventional 2									

* In calculation of Direct Costs, give specific consideration to factors that will:

- (1) Increase the cost of the bridge, as necessary to accommodate:
 - (a) Self-propelled modular transporters (SPMTs)
 - (b) Large capacity cranes
 - (c) Special erection equipment
 - (d) Casting yard setup
- (2) Decrease the cost of the bridge, as necessary to accommodate:
 - (a) Reduced labor rates (e.g., work from barges)
 - (b) Reduced maintenance of traffic (MOT) work restrictions
 - (c) Reduced worker compensation insurance rates (e.g., work from barges)
 - (d) Increased production rates due to assembly line processes.
 - (e) Increased production rates due to multiple crews working simultaneously

** Use engineering judgment and knowledge of construction processes to estimate the number of days required for each lane closure, detour, or facility closure for each

alternate. Coordinate this estimate with the preliminary construction schedule and MOT scheme.

121.19.4 Referenced Links

- (1) Connection Details for Prefabricated Bridge Elements and Systems
<https://www.fhwa.dot.gov/bridge/prefab/if09010/>
- (2) Manual on Use of Self-Propelled Modular Transporters to Remove and Replace Bridges
<https://www.fhwa.dot.gov/bridge/pubs/07022/>
- (3) Framework for Decision-Making
<https://www.fhwa.dot.gov/bridge/prefab/framework.cfm>
- (4) Prefabricated Bridge Elements and Systems Cost Study: Accelerated Bridge Construction Success Stories
<https://www.fhwa.dot.gov/bridge/prefab/successstories/091104/index.cfm>
- (5) FDOT RUC (Road User Cost) software (*only available through infonet*)
<http://infonet.dot.state.fl.us/tlconstruction/SchedulingEng/AddSoftwareScheduling.htm>

122 Design Exceptions and Design Variations

122.1 General

The Department's design criteria and standards contained in the FDOT Design Manual are usually within the desirable ranges established by AASHTO. The values given have been accepted by the Federal Highway Administration (FHWA) and govern the design process. When it becomes necessary to deviate from the Department's criteria, early documentation and approval are required. There are two approval processes used by designers: Design Exceptions and Design Variations.

A Design Exception or Design Variation is required when the Department's criteria are not met. This requirement applies to all entities affecting planning, design, construction, and maintenance.

For RRR projects, see also *FDM 114.1.1*.

122.1.1 Safety Projects

For projects using safety funds and developed to improve specific safety problems, only the elements identified under the scope of work for the safety improvement project are subject to these approval processes. Existing non-compliant features, within the limits of a safety improvement project do not require approval to remain, if the project does not create a non-compliant condition. The Safety Study must identify all applicable Variations and Exceptions required based on the proposed scope. For these projects, all applicable Design Variations and Design Exceptions must be approved prior to the beginning of the design phase.

122.1.2 Drainage Projects

For drainage projects, only elements identified in the scope of services for the drainage project are subject to these approval processes. The existing features, within the limits of the drainage project that do not meet design criteria, do not require approval to remain (if the project does not create a nonconforming condition).

122.1.3 Maintenance Projects

Maintenance Resurfacing, Ride Only (a.k.a., Ride Rehabilitation) and Skid Hazard Projects do not require Design Exceptions or Design Variations other than for ADA curb ramp requirements. If compliance with ADA curb ramp requirements is determined to be technically infeasible, documentation as a Design Variation is required. Maintenance Resurfacing Projects can only be programmed on routes that meet the requirements identified in **Chapter 27** of the [Work Program Instructions](#).

122.1.4 Landscape Projects

For Landscape-only projects, intersection sight distance Design Variations may be processed by the Responsible Landscape Architect of Record. For design projects with landscaping, intersection sight distance Design Variations must be processed by a Professional Engineer. In cases where intersection sight distance falls below stopping sight distance, a Design Exception for stopping sight distance must be processed by the respective professional according to the above guidelines.

122.2 Identification

Identify the proper approval process as early as possible in the Planning and Design phases to allow time to research alternatives and begin the analysis and documentation activities. Identification should be done during the PD&E process for major projects and the scope development process for minor projects. Approval must be obtained no later than Phase I design submittal.

122.2.1 Design Exceptions

Design Exceptions are required when existing or proposed design elements do not meet both the Department's governing criteria and AASHTO's new construction criteria for the Controlling Design Elements.

The 10 Controlling Design Elements for high-speed (Design Speed \geq 50 mph) roadways and limited access ramps (all design speeds) are:

- | | |
|-----------------------------|---|
| (1) Design Speed | (6) Stopping Sight Distance |
| (2) Lane Width | (7) Maximum Grade |
| (3) Shoulder Width | (8) Cross Slope |
| (4) Horizontal Curve Radius | (9) Vertical Clearance |
| (5) Superelevation Rate | (10) Design Loading Structural Capacity |

The two Controlling Design Elements for low speed (Design Speed $<$ 50 mph) roadways are:

- (1) Design Speed
- (2) Design Loading Structural Capacity

FDM 122.5 provides AASHTO's minimum requirements for the above elements.

122.2.2 Design Variations

Design Variations are required when existing or proposed design elements do not meet the Department's criteria.

There are 2 methods to document Design Variations:

- Formal Design Variation
- Project Design Variation Memorandum

A **Formal Design Variation** is used for any of the following design elements:

- (1) Controlling Design Elements
- (2) American with Disabilities Act (ADA)
- (3) Design elements requiring signature by individual or office noted in **FDM 122.7.4**.

A **Project Design Variation Memorandum (Form 122-B)** is used to document all Non-Controlling Design elements for projects that do not meet Department criteria and for design elements that are not included in the above list for Formal Design Variations. This document is a stand-alone document prepared by the Engineer of Record and approved by the District Design Engineer and the District Traffic Operations Engineer (as needed).

This form should be submitted early in the design process, as certain items may require more extensive review.

When additional documentation is requested on a **Project Design Variation Memorandum (Form 122-B)**, a Formal Design Variation is required for re-submittal of those elements.

When additional design elements arise on a project following approval of the initial Project Design Variation Memorandum, the Memorandum can be appended for approval of the additional elements. An alternative option would be to submit the Design Variation in an additional Project Memorandum.

122.3 Justification for Approval

Sufficient detail and explanation must be provided to those reviewing the request to justify approval. Develop a detailed justification showing good engineering judgement when allowing a design element to remain that does not meet these requirements. At some point, this justification may be used to defend design decisions made by the Department and the designer. All deviations from Department criteria and standards must be uniquely identified, located, and justified; no blanket approvals are given.

Examples of valid justifications are as follows:

- (1) The required criteria are not applicable to the site-specific conditions.
- (2) The project can be as safe by not following the criteria.
- (3) The environmental or community needs prohibit meeting criteria.

In some instances, the required criteria may be impractical, and the proposed design wisely balances all design impacts. The impacts that may be associated with this level of justification are:

- (1) Safety and Operational performance
- (2) Level of Service
- (3) Right of Way impacts
- (4) Community impacts
- (5) Environmental impacts
- (6) Costs
- (7) Usability by all modes of transportation
- (8) Long term and cumulative effects on adjacent sections of roadway

The justification should not be developed solely on the basis that:

- (1) The Department can save money,
- (2) The Department can save time, or
- (3) The proposed design is similar to other designs.

122.3.1 Approval Process

Project Design Variation Memorandums, Formal Design Variations, and Design Exceptions should be approved by the Department prior to the Phase II plans submittal.

122.4 Documentation for Approval

Supporting documentation that is generated during the approval process is to accompany each submittal. The level of detail for Design Exceptions and Design Variations should be commensurate with the complexity of the design element and the relevance of information to engineering decisions.

Design Exceptions and **Formal Design Variations** should include the following documentation:

- (1) Submittal/Approval Letter (**Form 122-A**, see **FDM 103**)
- (2) Project Description: general project information, location map, context classification, existing roadway characteristics, project limits (mileposts), county section number, work mix, objectives, and obstacles. Include any associated or future limitations that exist as a result of public or legal commitments.
- (3) Project Schedule and Lifespan: Provide (1) the Plans Production date, and (2) the Letting date for the project. Explain why the proposed Design Exception/Variation is either a temporary or permanent condition. Include any future work planned or programmed to address the condition.
- (4) Exception/Variation Description:
 - (a) Specific design criteria that will not be met (provide criteria values from both AASHTO and FDOT). Detailed explanation of why the criteria or standard cannot be complied with or is not applicable. Description of the proposed value and why it is appropriate.
 - (b) A plan view, plan sheet, or aerial photo of the location, showing the design speed, posted speed, target speed, right of way lines, and property lines of adjacent property. A photo of the area of the deficiency.

- (c) Typical section or cross-section of the location.
- (d) The milepost and station location (including left/right side).
- (5) Alternative Designs Considered: meeting Department criteria, meeting AASHTO criteria, partial correction, and the no-build (existing) condition.
- (6) Impacts of the Exception/Variation to:
 - (a) Safety Performance:
 - i. Review and evaluation of the most recent 5 years of crash data from the current date of analysis.
 - ii. Description of the anticipated impact on safety, long and short-term effects. Description of any anticipated cumulative effects.
 - iii. For non-existing or proposed conditions, a comparison of the predicted or expected crash frequency should be included along with a discussion of the 5-year crash history. Some resources that are available for this comparison include:
 - 1. Highway Safety Manual (HSM)
 - 2. Interactive Highway Safety Design Model (IHSDM)
 - 3. Enhanced Interchange Safety Analysis Tool (iSATe)
 - 4. Roadside Safety Analysis Program (RSAP)
 - (b) Operational Performance:
 - i. Description of the anticipated impact on operations, long and short-term effects. Description of any anticipated cumulative effects.
 - ii. Traffic information: Design Year AADT and 24-hour truck volume.
 - iii. Compatibility of the design with adjacent sections of roadway.
 - iv. Effects on capacity (proposed criteria vs. AASHTO) using an acceptable capacity analysis procedure and calculate reduction for design year, level of service.
 - (c) Right of Way
 - (d) Community
 - (e) Environment
 - (f) Usability by all modes of transportation
- (7) Costs: Description of the anticipated costs associated with the Design Exception or Variation. Provide a Benefit-Cost (B/C) ratio, where applicable.

- (8) Mitigation Measures: Description and explanation of practical mitigation measures or alternatives that were considered and selected treatments implemented on the project.
- (9) Summary and Conclusions

A **Project Design Variation Memorandum** should include the following documentation, which may be presented in the format of succinct bullets:

- (1) Submittal/Approval Memo (**Form 122-B**, see **FDM 103**).
- (2) Design criteria versus proposed criteria.
- (3) Review of crash history on the project related to the design element.
- (4) Abbreviated justification for the proposed criteria.

For Lateral Offset Design Variations, provide a tabulation of stations (or mileposts) and lateral offsets for aboveground fixed objects.

Additional information can be found on the [Crash Location Verification Status Dashboard](#).

122.5 AASHTO Controlling Elements

AASHTO criteria, required documentation, and mitigation strategies for the controlling elements is provided in the following sections. Detailed discussions on criteria and mitigation are provided in the **AASHTO Green Book: A Policy on Geometric Design of Highways and Streets, 2018**, and the **FHWA Guide: [Mitigation Strategies for Design Exceptions, July 2007](#)**. The AASHTO criteria provided are in no way intended to replace Department design criteria.

The criteria used for determining Design Exceptions on Interstate projects must be based on AASHTO's **A Policy on Design Standards Interstate System 2016**.

122.5.1 Design Speed

122.5.1.1 AASHTO Criteria

Table 122.5.1 AASHTO Design Speed (Minimum)

Type Facility	Other Factors	Design Speed (mph)	AASHTO	
Interstate	Urban	50	DSIS pg. 3 ⁽¹⁾	
	Rural	70		
Freeways	Urban	50	pg. 8-2	
	Rural	50		
Urban Arterials	Major	20	pg. 2-26 pg. 2-27	
	Other	15		
Rural Arterials	Rolling terrain	50	pg. 7-3	
	Level terrain	50		
	Rural Town	20		
Urban Collectors	Suburban	35	pg. 6-13	
	Urban	30		
	Urban-core	25		
Rural Collectors	Level ADT < 400	40	pg. 6-3, Table 6-1	
	ADT 400 - 2000	50		
	ADT > 2000	60		
	Rolling ADT < 400	30		
	ADT 400 - 2000	40		
	ADT > 2000	50		
Ramps	Highway Design Speeds (mph)		pg. 10-105, Table 10-1	
		30		15
		35		20
		40		20
		45		25
		50		25
		55		30
		60		30
	65	30		
	70	35		
Loop Ramps	Minimum	20	pg. 10-106	
Connections	Direct	40	pg. 10-106	
	Semi-Direct	30		
Notes:				
(1) DSIS = AASHTO's <i>A Policy on Design Standards Interstate System</i> (January 2016).				

122.5.1.2 Documentation

Provide the length of section with reduced design speed compared to the overall length of the project. Include any existing or proposed measures used within the transitions to adjacent roadway sections having higher or lower design (or operating) speeds.

122.5.1.3 Mitigation

A potential mitigation strategy is to use cross-sectional elements to reduce operating speeds to the design speed.

122.5.2 Lane Width

122.5.2.1 AASHTO Criteria

Table 122.5.2 AASHTO Lane Width (Minimum)

Type Facility	Lane Width (feet)	AASHTO
Freeway (including Auxiliary)	12	pg. 8-3, 10-90, DSIS pg.4 ⁽¹⁾
Rural Arterial	11	pg. 7-7, Table 7-3
Rural Town	10	Pg. 7-15
Urban Arterial	10	pg. 7-39
Urban Collector	10	pg. 6-16
Rural Collector	10	pg. 6-6, Table 6-5
Low Speed	10	pg. 4-9
Residential	9	pg. 4-10
Auxiliary (Non-Freeway)	10	pp. 4-9
Continuous TWLTL	10	pg. 4-10
Notes:		
(1) DSIS = AASHTO's <i>A Policy on Design Standards Interstate System</i> (January 2016).		

122.5.2.2 Documentation

Provide locations of alternative routes that meet criteria and a proposal for handling drainage. Include a typical section or plan of the proposed signing and pavement markings associated with the lane width exception.

122.5.2.3 Mitigation

Potential mitigation strategies for lane width are:

- (1) Select optimal combination of lane and shoulder widths based on site characteristics to optimize safety and operations by distributing available cross-sectional width
- (2) Signing to provide advanced warning of lane width reduction
- (3) To improve the ability to stay within the lane:
 - (a) Wide, recessed, or raised pavement markings
 - (b) Delineators
 - (c) Object Markers
 - (d) Tubular Markers
 - (e) Lighting
 - (f) Audible and vibratory treatment, (See **FDM 210.4.6** for arterials and collectors. See **FDM 211.4.4** for LA Facilities.)
- (4) To improve the ability to recover if the driver leaves the lane:
 - (a) Paved or partially paved shoulders
 - (b) Safety edge treatment
- (5) To reduce crash severity if the driver leaves the roadway (See **FDM 215**):
 - (a) Remove or relocate fixed objects
 - (b) Traversable slopes
 - (c) Breakaway safety hardware
 - (d) Shield fixed objects and steep slopes

122.5.3 Shoulder Width

122.5.3.1 AASHTO Criteria

Table 122.5.3 AASHTO Shoulder Widths (Minimum)

Type Facility	Other Factors	Median or Left (feet)	Right (feet)	AASHTO
Freeway	4 lanes	4 paved	10 paved	pg. 8-3
	≥ 6 lanes	10 paved	10 paved	pg. 8-3
Rural Arterial	ADT > 2000		8	pg. 7-7, Table 7-3
	ADT 400-2000		6	
	ADT < 400		4	
	4 lane Divided	4 paved	8	pg. 7-16
	6+ lane Divided	8	8	
Urban Arterial	Low Type (Gravel, Other)		2	pg. 4-12
	High Type (Asphalt, Conc.)		10	
	Heavily Traveled/High Speed/High Trucks		10	
Rural & Urban Collector	ADT > 2000		6	pg. 6-6, Table 6-5
	ADT 400-2000		4	
	ADT < 400		2	

Table 122.5.4 AASHTO Bridge Widths (Minimum)

Type Facility	Other Factors	Bridge Widths		AASHTO
Freeway	New Bridges	Approach Roadway Width		pg. 8-5
Rural Arterial	New Bridges (Short)	Approach Roadway Width		pg. 7-9
	New Bridges (Long) (> 200 ft.)	Travel Lanes + 4 ft. each side		
Urban Arterial	New and Existing Bridges (Short)	Curb to curb width of street		pg. 7-50
	New and Existing Bridges (Long) without shoulders or parking on arterial	Curb to curb width of street		
	New and Existing Bridges (Long) with shoulders or parking on arterial	Travel Lanes + 4 ft. each side		pg. 7-51
Type Facility	Other Factors	Bridge Widths		AASHTO
		New or Reconstruction	To Remain	
Rural and Urban Collector	ADT Under 400	Traveled Way + 2 ft. each side ⁽¹⁾	22 ft. ⁽²⁾	pg. 6-8 Table 6-6,
	ADT 400-2000	Traveled Way + 4 ft. each side ^{(1),(3)}	24 ft. ⁽²⁾	
	ADT > 2000	Approach Roadway Width ^{(1),(3)}	28 ft. ⁽²⁾	
Notes: (1) If the approach roadway has paved shoulders, then the surfaced width must be carried across the bridge. (2) Bridges longer than 100 ft. are to be analyzed individually. (3) For bridges > 100 ft. in length, the minimum bridge width of traveled way plus 3 ft. on each side is acceptable.				

122.5.3.2 Documentation

Provide a proposal to address stalled vehicles, enforcement activities, emergency operations, and drainage in the documentation for the exception.

122.5.3.3 Mitigation

Potential mitigation strategies for shoulder width are:

- (1) Select optimal combination of lane and shoulder width based on site characteristics to optimize safety and operations by distributing available cross-sectional width
- (2) Signing to provide advanced warning of lane width reduction
- (3) To improve the ability to stay within the lane:
 - (a) Wide, recessed or raised pavement markings
 - (b) Delineators
 - (c) Object Markers
 - (d) Lighting
 - (e) Audible and vibratory treatment, (See **FDM 210.4.6** for arterials and collectors. See **FDM 211.4.4** for LA Facilities.)
- (4) To improve the ability to recover if the driver leaves the lane:
 - (a) Paved or partially paved shoulders
 - (b) Safety edge treatment
- (5) To reduce crash severity if driver leaves the roadway (See **FDM 215**):
 - (a) Remove or relocate fixed objects
 - (b) Traversable slopes
 - (c) Breakaway safety hardware
 - (d) Shield fixed objects and steep slopes

122.5.4 Horizontal Curve Radius

122.5.4.1 AASHTO Criteria

Table 122.5.5 AASHTO Horizontal Alignment
 Minimum Radius (feet) with Superelevation (page 3-34, 3-35, Table 3-7)

Type Facility	Super-elevation e-max	Minimum Curve Radius (feet) for Design Speed (mph)											
		15	20	25	30	35	40	45	50	55	60	65	70
Rural Highway and High-Speed Urban Street	0.04	42	86	154	250	371	533	711	926	1190	1500	---	---
	0.06	39	81	144	231	340	485	643	833	1060	1330	1660	2040
	0.08	38	76	134	214	314	444	587	758	960	1200	1480	1810
	0.10	36	72	126	200	292	410	540	694	877	1090	1340	1630
	0.12	34	68	119	188	272	381	500	641	807	1000	1220	1480

Minimum Radius (feet) for Section with Normal Cross Slope (page 3-47, Table 3-11)

Type Facility	Minimum Curve Radius (feet) for Design Speed (mph)											
	15	20	25	30	35	40	45	50	55	60	65	70
Freeway, Arterial, and Collector	947	1680	2420	3320	4350	5520	6830	8280	9890	11700	13100	14700

Minimum Radius (feet) for Intersection Curves (2001 AASHTO, page 201, Exh. 3-43)

Design Speed (mph)	10	15	20	25	30	35	40	45
Minimum Radius (feet)	25	50	90	150	230	310	430	540
Assumed Minimum Superelevation Rate	0.02	0.02	0.02	0.04	0.06	0.08	0.09	0.10

122.5.4.2 Documentation

No additional documentation beyond what is covered in **FDM 122.4** is required.

122.5.4.3 Mitigation

Potential mitigation strategies for horizontal curve radius are:

- (1) To provide advanced warning:
 - (a) Signing
 - (b) Pavement marking messages
 - (c) Dynamic curve warning systems
- (2) To provide delineation:
 - (a) Chevrons
 - (b) Delineators
 - (c) Tubular Markers
 - (d) Linear Barrier Delineators
- (3) To improve the ability to stay within the lane:
 - (a) Widen the roadway
 - (b) Skid-resistant pavement
 - (c) Enhanced pavement markings
 - (d) Lighting
 - (e) Audible and vibratory treatment, (See **FDM 210.4.6** for arterials and collectors. See **FDM 211.4.4** for LA Facilities.)
- (4) To improve the ability to recover if driver leaves the lane:
 - (a) Paved or partially paved shoulders
 - (b) Safety edge
- (5) To reduce the crash severity if driver leaves the roadway (See **FDM 215**):
 - (a) Remove or relocate fixed objects
 - (b) Traversable slopes
 - (c) Breakaway safety hardware
 - (d) Shield fixed objects and steep slopes

122.5.5 Superelevation Rate

122.5.5.1 AASHTO Criteria

Table 122.5.6 AASHTO Superelevation (Maximum)

Type Facility	Superelevation Rate	AASHTO
Highways (Rural)	12%	pg. 3-32
Urban	6%	pg. 3-32
Urban: Low Speed w/severe constraints	None	pg. 3-31
Ramps and Turning Roadways at Intersections	10%	pg. 9-83
Note: (1) Maximum Superelevation is pro-rated value (based upon radius) from rate tables cited above.		

122.5.5.2 Documentation

Provide side friction factors for each curve at the PC, Midpoint, and PT of the curve, and at the location of maximum provided superelevation. For multi-lane facilities, provide values for each lane. Use the following equation:

$$f = \frac{V^2 - 15Re}{V^2e + 15R}$$

where:

- f = Side Friction Factor
- V = Design Speed (mph)
- R = Radius (feet)
- e = Superelevation (ft/ft) at the station evaluated

122.5.5.3 Mitigation

Potential mitigation strategies for superelevation rate exceptions are:

- (1) To provide advanced warning:
 - (a) Signing
 - (b) Pavement marking messages
 - (c) Dynamic curve warning systems
- (2) To provide delineation:
 - (a) Chevrons
 - (b) Linear Barrier Delineators
 - (c) Tubular Markers
- (3) To improve the ability to stay within the lane:
 - (a) Widen the roadway
 - (b) Skid-resistant pavement
 - (c) Enhanced pavement markings
 - (d) Lighting
 - (e) Audible and vibratory treatment, (See **FDM 210.4.6** for arterials and collectors. See **FDM 211.4.4** for LA Facilities.)
- (4) To improve the ability to recover if driver leaves the lane:
 - (a) Paved or partially paved shoulders
 - (b) Safety edge
- (5) To reduce the crash severity if driver leaves the roadway: (See **FDM 215**)
 - (a) Remove or relocate fixed objects
 - (b) Traversable slopes
 - (c) Breakaway safety hardware
 - (d) Shield fixed objects and steep slopes

122.5.6 Stopping Sight Distance

122.5.6.1 AASHTO Criteria

Table 122.5.7 AASHTO Stopping Sight Distance (Minimum)
 (AASHTO page 3-4, Table 3-1)

Design Speed (mph)												
	15	20	25	30	35	40	45	50	55	60	65	70
Stopping Sight Distance (feet) Computed for Design	80	115	155	200	250	305	360	425	495	570	645	730

Table 122.5.8 AASHTO Vertical Alignment
 (AASHTO Table 3-35, Table 3-37, and Table 6-3, and based on a 2' object height)

Design Speed (mph)	Minimum K Value for Vertical Curves	
	Crest	Sag
15	3	10
20	7	17
25	12	26
30	19	37
35	29	49
40	44	64
45	61	79
50	84	96
55	114	115
60	151	136
65	193	157
70	247	181

Note:
 (1) Rate of vertical curvature, K, is the length of curve per percent algebraic difference of the intersecting grades. ($K = L/A$)

**Table 122.5.9 AASHTO Minimum Passing Sight Distance
 (AASHTO page 3-11, Table 3-4)**

Design Speed (mph)											
	20	25	30	35	40	45	50	55	60	65	70
Passing Sight Distance (feet)	400	450	500	550	600	700	800	900	1000	1100	1200

122.5.6.2 Documentation

Provide profiles in the area of vertical alignment related Design Exception or Design Variations for stopping sight distance. Provide plan views with sight triangles for horizontal stopping sight distance evaluations.

122.5.6.3 Mitigation

Potential mitigation strategies for stopping sight distance are:

- (1) To mitigate sight distance restrictions
 - (a) Signing and speed advisory plaques (crest vertical curves)
 - (b) Lighting
 - (c) Adjust placement of lane within the roadway cross section (horizontal)
 - (d) Cross-sectional elements to manage speed
- (2) To improve the ability to avoid crashes:
 - (a) Cross-sectional elements
 - (b) Wider clear recovery area
- (3) To improve driver awareness on approach to intersections:
 - (a) Advance warning signs
 - (b) Dynamic warning signs
 - (c) Larger or additional STOP/YIELD signs
 - (d) Intersection lighting

122.5.7 Maximum Grade

122.5.7.1 AASHTO Criteria

Table 122.5.10 AASHTO Grades (Maximum)

Type Facility	Type Terrain	Grades (%) for Design Speed (mph)											AASHTO
		20	25	30	35	40	45	50	55	60	65	70	
Freeway ⁽¹⁾	Level	---	---	---	---	---	---	4	4	3	3	3	pg. 8-5, Table 8-1
	Rolling	---	---	---	---	---	---	5	5	4	4	4	
Rural Arterial	Level	5	5	5	5	5	5	4	4	3	3	3	pg. 7-6, Table 7-2
	Rolling	8	8	7	7	6	6	5	5	4	4	4	
Urban Arterial:	Level	8	7	7	7	7	6	6	5	5	---	---	pg. 7-38, Table 7-4a
	Rolling	10	10	9	8	8	7	7	6	6	---	---	
Rural Collector ⁽²⁾	Level	7	7	7	7	7	7	6	6	5	---	---	pg. 6-4, Table 6-2
	Rolling	10	10	9	9	8	8	7	7	6	---	---	
Urban Collector ⁽²⁾	Level	9	9	9	9	9	8	7	7	6	---	---	pg. 6-15, Table 6-7
	Rolling	12	12	11	10	10	9	8	8	7	---	---	

Notes:

(1) Grades one percent steeper than the values shown may be used in urban areas.

(2) Short lengths of grade in rural and urban areas, such as grades less than 500 ft. in length, one-way downgrades, and grades on low-volume rural and urban collectors may be up to 2 percent steeper than the grades shown above.

122.5.7.2 Documentation

No additional documentation beyond what is in **FDM 122.4** is required.

122.5.7.3 Mitigation

Potential mitigation strategies for maximum grade are:

- (1) Signing to provide advanced warning
- (2) To improve ability to stay within the lane:
 - (a) Enhanced pavement markings
 - (b) Delineators
 - (c) Tubular Markers
 - (d) Audible and vibratory treatment, (See **FDM 210.4.6** for arterials and collectors. See **FDM 211.4.4** for LA Facilities.)
- (3) To improve ability to recover if driver leaves the roadway (See **FDM 215**):
 - (a) Paved or partially paved shoulders
 - (b) Safety edge
 - (c) Remove or relocate fixed objects
 - (d) Traversable slopes
 - (e) Breakaway safety hardware
 - (f) Shield fixed objects

122.5.8 Cross Slope

122.5.8.1 AASHTO Criteria

Table 122.5.11 AASHTO Cross Slope

Type Facility	Other Factors	Minimum	Maximum	AASHTO
Freeways	---	0.015	0.025 ⁽¹⁾	pg. 8-3
Arterials	Rural	0.015	0.02	pg. 7-6
	Urban	0.015	0.03	pg. 7-38
Divided Highways	---	0.015	0.02 ⁽¹⁾	pg. 7-15
Collectors	Rural	0.015	0.02	pg. 6-4
	Urban	0.015	0.03	pg. 6-15
Shoulders	Paved	0.02	0.06	pg. 4-13
	Gravel	0.04	0.06	pg. 4-13
	Turf	0.06	0.08	pg. 4-13

Note:
 (1) Values given are for up to two lanes in one direction. Additional outside lanes may have cross slopes of 0.03.

122.5.8.2 Documentation

Provide a proposal for handling drainage and details on how the cross-slope impacts intersections.

122.5.8.3 Mitigation

Potential mitigation strategies for deficient cross slope are:

- (1) Signing to provide warning of slick pavement
- (2) To improve surface friction:
 - (a) Pavement grooving (PCC Pavement)
 - (b) Open-graded friction courses (HMA pavement)
- (3) To improve drainage:
 - (a) Transverse pavement grooving (PCC Pavement)

- (b) Open-graded friction courses (HMA pavement)
- (c) Pavement edge drains
- (d) Modified shoulder cross slope to mitigate cross-slope break on the high side of superelevated curves.

122.5.9 Vertical Clearance

122.5.9.1 AASHTO Criteria

Table 122.5.12 AASHTO Vertical Clearance (Minimum)

Type Facility		Vertical Clearance (feet) ⁽²⁾	AASHTO
Freeways		16 ^{(1),(4)}	pg. 8-5, 10-24
Arterials (New Structures):	Rural	16 ⁽¹⁾	pg. 7-9, 10-24
	Urban	16 ⁽¹⁾	pg. 7-51, 10-24
Arterials (Existing Structures):	Rural	14	pg. 7-9, 10-24
	Urban	14	pg. 7-51, 10-24
Other Highways		14	pg. 5-9, 8-5
Sign Trusses		17	pg. 7-9,51, 8-5
Pedestrian Overpass		17	pg. 7-9,51, 8-5
Tunnels:	Freeways	16	pg. 4-62
	Other Highways	14	pg. 4-62
Railroads		23 ⁽³⁾	pg. 10-25
Notes: (1) 14 feet allowed in highly developed urban areas if alternate route has 16 feet. (2) An allowance of 6 inches should be added to vertical clearance to accommodate future resurfacing. (3) See FDM 220.3.4 and the latest version of American Railway Engineering and Maintenance-of-Way Association (AREMA) guidelines, or the design office of the high-speed rail line of interest for specific high-speed guidelines and specifications. Over Electrified Railroad, the minimum vertical clearance is 24 feet 3 inches. (See Topic No. 000-725-003: South Florida Rail Corridor Clearance .) (4) Design Exceptions to the 16-ft vertical clearance standard on rural Interstate routes or on a single Interstate route through urban areas must be coordinated with Surface Deployment and Distribution Command Transportation Engineering Agency (SDDCTEA) as described in FDM 122.5.9.2 .			

122.5.9.2 Documentation

A written evaluation of the vertical clearance deficiency and recommendation by the State Office of Maintenance is required and should be attached to all Vertical Clearance Variations and Exceptions.

Provide locations of alternative routes that meet criteria.

For Interstate Projects, the District is responsible for completing an [Interstate Vertical Clearance Exception Coordination](#) form, for Design Exceptions to vertical clearance requirements above interstate facilities (mainlines and ramps). The District will submit the form to the Surface Deployment and Distribution Command Transportation Engineering Agency (SDDCTEA) via e-mail for approval, copying the FHWA Florida Division. Allow for 10 working days after SDDCTEA receipt for action before requesting notification of disposition (via email or fax). A copy of the approval must be provided with the Design Exception. A request for coordination must take place before the District Design Engineer can recommend the Design Exception.

122.5.9.3 Mitigation

Potential mitigation strategies for vertical clearance are:

- (1) Signing to provide advance warning
- (2) To prevent impacts with low structures:
 - (a) Alternate routes
 - (b) Large vehicle restrictions.
 - (c) Bridge Jacking may be a consideration to address bridges with minor deficiencies.

122.5.10 Design Loading Structural Capacity

122.5.10.1 AASHTO Criteria

Table 122.5.13 AASHTO Structural Capacity (Minimum Loadings)

Type Facility	AASHTO
Freeways, Arterials, and Collectors	See <i>AASHTO LRFD</i> for minimum loadings.

122.5.10.2 Documentation

- (1) Load rating calculations for the affected structure.
- (2) Verification of safe load-carrying capacity (load rating) for State unrestricted legal loads or routine permit loads.
- (3) Verification of Federal legal loads for bridges and tunnels on the Interstate.
- (4) A written evaluation and recommendation by the Office of Maintenance.

122.5.10.3 Mitigation

Potential mitigation strategies for design loading structural capacity are determined on a case-by-case basis.

122.6 Crash Analysis

For areas with crash histories or when a benefit to cost analysis is required, provide a time value analysis between the benefit to society (quantified in dollars) and the costs to society (quantified in dollars) over the life of the Design Exception. The benefit to society is quantified by the savings associated with the projected reduction in crashes. The cost to society is a summary of the construction, operation, maintenance, and other costs anticipated over the life of the project. The Discount (interest) rate to be utilized in benefit/cost analysis is 4%.

Both Historical (HCM) and Predictive (RSAP and HSM) methods are acceptable for performance of a benefit/cost analysis. Perform the analysis early in the design process.

In accordance with the Department's ***Highway Safety Manual Implementation Policy (Topic No. 000-500-001)***, "the transportation analyst is encouraged to use the Highway Safety Manual (HSM) methods, where applicable, to measure safety benefits from proposed improvements."

122.6.1 Historical Crash Method (HCM)

This method can be used for sites with a crash history. The historical crash analysis for Design Exceptions and Design Variations includes a review of crashes from within the FDOT Crash Analysis Reporting (CAR) system database and the SIGNAL FOUR ANALYTICS (SFA) system database. Department approval is required for access to the data within these systems and can be obtained through the district offices.

The FDOT CAR system database includes verified crash data for all fatal and serious injury (KA) crashes typically up to the current date and for all crash types (KABCO) up to 2018 (latest completed data set). These crashes should be included in all HCM analyses. The Signal Four database includes all crash types (KABCO) up to the current date and should be used to supplement the crashes reported from the FDOT CAR system database to establish a complete dataset of crashes over the analysis period. Due to the overlap of crash data within the two systems, proper vetting of the dataset is required to ensure that crashes are not duplicated within the analysis.

The B/C (benefit/cost) ratio is the ratio of the estimated annual reduction in crash costs to the estimated annual increase in combined construction and maintenance costs. The annualized conversion will show whether the projected expenditure of funds for the crash benefit will exceed the direct cost for the improvement.

The HCM uses the **Highway Safety Improvement Program Guideline (HSIPG)** cost per crash by facility type in **Table 122.6.1** to estimate benefit to society, while the cost to society is estimated by the expected cost of right of way, construction, and maintenance.

Table 122.6.1 FDOT Average Crash Costs by Facility Type

Type Facility	Divided Roadway			Undivided Roadway		
	Urban	Suburban	Rural	Urban	Suburban	Rural
2-3 Lanes	\$107,732	\$201,527	\$355,183	\$124,618	\$267,397	\$523,727
4-5 Lanes	\$123,406	\$225,315	\$473,637	\$112,896	\$190,276	n/a
6+ Lanes	\$123,598	\$166,258	\$451,492	\$41,650	n/a	n/a
Interstate	\$153,130	n/a	\$327,385	n/a	n/a	n/a
Turnpike	\$139,221	n/a	\$304,397	n/a	n/a	n/a

Notes:

- (1) Average Cost/Crash: **\$159,093**
- (2) The above values were derived from 2015 through 2019 traffic crash and injury severity data for crashes on state roads in Florida using the formulation described in *FHWA Technical Advisory "Motor Vehicle Accident Costs", T7570.2, dated October 31, 1994. Base costs derived from a memorandum from USDOT: "Guidance on Treatment of the Economic Value of a Statistical Life (VSL) in the U.S. Department of Transportation Analyses", dated August 8, 2016 updating the value of life saved from \$9.4 million to \$9.6 million for 2015 data with a growth factor applied to increase the base cost to \$9.7 million in the current analyses. Costs are computed for the actively state-maintained State Highway System (SHS) only.*
- (3) Link to [Revised Departmental Guidance 2013](#)

When utilizing predictive methods or crash severity distributions for analysis, the following crash severity level costs should be used:

Table 122.6.2 FDOT KABCO Crash Costs

Crash Severity	Comprehensive Crash Cost
Fatal (K)	\$10,890,000
Severe Injury (A)	\$888,030
Moderate Injury (B)	\$180,180
Minor Injury (C)	\$103,950
Property Damage Only (O)	\$7,700
Note: (1) Source: Florida Department of Transportation State Safety Office's Crash Analysis Reporting (CAR) System, analysis years 2015 through 2019. Published by FDOT State Safety Office on 2/23/2022.	

122.6.2 Roadside Safety Analysis Program (RSAP)

This method complements the *AASHTO Roadside Design Guide*, dated June 2011. When hazards cannot be removed or relocated, designers need to determine if a safety device, such as a guardrail or a crash cushion, is warranted to protect motorists from the roadside obstacle. This method can be used to perform a benefit/cost analysis comparing a potential safety treatment with the existing or baseline conditions (i.e., the do-nothing option) or alternative safety treatments. Based on the input of information available to the user (e.g., offsets, traffic, slopes, crash history, traffic accident severity levels), the program will offer results which can be used in comparing design alternatives.

122.6.3 Highway Safety Manual

The *AASHTO Highway Safety Manual (HSM)* provides analytical tools and techniques for quantifying the potential effects on crashes as a result of decisions made in planning, design, operations, and maintenance. The new techniques and knowledge in the HSM reflect the evolution in safety analysis from descriptive (historical) methods to quantitative, predictive analyses. In the *HSM*, crash frequency is the fundamental basis for safety analysis and is used to reduce crashes and severities through the selection of alternative treatments.

The **HSM** includes Safety Performance Functions (SPFs) for many roadway segment and intersection applications. SPFs are equations used to estimate or predict the expected average crash frequency per year at a location as a function of traffic volume and roadway characteristics. Adjust SPFs to local conditions by applying calibration factors shown in **Table 122.6.3**. The use of HSMSPF and Crash Modification Factors (CMF), with an Empirical Bayes (EB) adjustment, provides research-based solutions for use in Benefit/Cost comparisons. Crash distributions presented in **Table 122.6.4** and KABCO costs as specified in **Table 122.6.2** should be used in determining benefits from an **HSM** analysis.

Table 122.6.3 HSM Calibration Factors for Florida

Type Facility		Abbreviation	Calibration Factor (Cx)
FDOT Roadway Calibration Factors			
Rural	2-lane Undivided	R2U	1.00
	4-lane Divided	R4D	0.68
Urban	2-lane Undivided	U2U	1.02
	3-lane with a Center Two-Way Left Turn Lane	U32LT	1.04
	4-lane Undivided	U4U	0.73
	4-lane Divided	U4D	1.63
	5-lane with a Center Two-Way Left Turn Lane	U52LT	0.70
FDOT Intersection Calibration Factors			
Rural	2-lane 3-Leg Stop-Controlled	RTL3ST	1.27
	2-lane 4-Leg Stop-Controlled	RTL4ST	0.74
	2-lane 4-Leg Signalized	RTL4SG	0.92
	Multilane 3-Leg Stop-Controlled	RML3ST	2.20
	Multilane 4-Leg Stop-Controlled	RML4ST	1.64
	Multilane 4-Leg Signalized	RML4SG	0.45
Urban	3-Leg Stop-Controlled Intersection	USA3ST	1.14
	4-Leg Stop-Controlled Intersection	USA4ST	1.87
	3-Leg Signalized w/o Ped. CMFs	USA3SG w/o Ped.	2.58
	3-Leg Signalized w/ Ped. CMFs	USA3SG w/ Ped.	2.50
	4-Leg Signalized	USA4SG	2.27

Table 122.6.4 HSM Crash Distribution for Florida

Type Facility		Abbreviation	K	A	B	C	O	
Rural Roadways	2-lane Undivided	R2U	0.028	0.094	0.181	0.187	0.509	
	4-lane Undivided	R4U	0.033	0.093	0.164	0.186	0.524	
	4-lane Divided	R4D	0.028	0.090	0.187	0.196	0.499	
Urban & Suburban Arterials	2-lane Undivided	U2U	0.009	0.050	0.150	0.224	0.567	
	3-lane TWLTL	U32LT	N/A					
	4-lane Undivided	U4U	0.004	0.031	0.110	0.204	0.650	
	4-lane Divided	U4D	0.008	0.046	0.142	0.234	0.571	
	5-lane TWLTL	U52LT	N/A					
Freeways	Rural		0.017	0.065	0.143	0.163	0.612	
	Urban		0.006	0.035	0.113	0.206	0.641	
	Ramps		0.004	0.032	0.107	0.210	0.647	
All	All Roadways and Ramps		0.007	0.041	0.124	0.217	0.611	
<p>Notes: A - Incapacitating Injury C - Possible (or minor) Injury K – Fatality B - Non-incapacitating Injury O - Property Damage Only</p> <p>Data Source: Florida Department of Transportation, State Safety Office's Crash Analysis Reporting (CAR) database, analysis years 2015 through 2019. Publishing by FDOT State Safety Office on 2/23/2022.</p>								

Tools and spreadsheets for use with these analytical methods have been developed and are available on the following websites:

<https://safety.fhwa.dot.gov/rsdp/hsm.aspx>

<https://www.fdot.gov/roadway/QA/Tools.shtm>

122.7 Design Approval Request

122.7.1 Submittal Package

The submittal package for a Design Exception or a Design Variation will include the same items. However, the required documentation and necessary level of detail will vary depending on the design element being evaluated (as described in **FDM 122.4**). The Design Exception or Design Variation submittal package is to include the following items:

- (1) Submittal/Approval Letter (cover letter): **Form 122-A** (see **FDM 103**).
- (2) Signed and Sealed Report: The signed and sealed documents including all required documentation and justification (see **FDM 122.4** for documentation requirements). Multiple design elements and signed and sealed reports may be included in one submittal package.
- (3) Appendices (as needed): Include any support documentation to facilitate an understanding of the report. Supplemental documents do not alter the sealed analysis or design.

Sign and seal the report in accordance with **FDM 130**. A Submittal/Approval Letter (**Form 122-A**, see **FDM 103**) is to be attached to the Signed and Sealed Report and submitted to the District or Turnpike Design Engineer. The District or Turnpike Design Engineer then approves or denies the request and notifies the Responsible Engineer. When further approvals are required, the District or Turnpike Design Engineer will forward the Submittal/Approval Letter and Sealed Report to the State Roadway Design Office.

122.7.2 Design Exception Approval

The request will be reviewed by the State Roadway Design Engineer and may be forwarded for approval to the Chief Engineer, the State Structures Design Engineer, the Planning Office, and FHWA, as appropriate.

Each request will be reviewed on a case-by-case basis and approved on its merits. When approval is obtained, the State Roadway Design Office will email the disposition to the District or Turnpike Design Engineer along with the signed Submittal/Approval Letter. The State Roadway Design Office will keep an electronic copy filed under the assigned reference number.

When a request is denied, the State Roadway Design Office will notify the District or Turnpike Design Engineer of the disposition. Denied requests can be resubmitted when all deficiencies, noted in the denial notification, have been addressed. This may require

only a new Submittal/Approval Letter if the Sealed Report does not need to be amended; however, if the Sealed Report requires revision, a new Sealed Report and attached Submittal/Approval Letter must be submitted.

Documentation requirements for Design Exceptions are in **FDM 122.4**.

122.7.3 Design Variation Approval

Design Variations are typically approved at the District level; however, there are specific elements requiring Central Office approval noted in **FDM 122.7.4** (see **Table 122.7.1**). Design Variations requiring Central Office approval must follow the processes in **FDM 122.7.2**.

Design Variations approved at the District level may be submitted as either a Formal Design Variation or a Design Variation Memorandum for approval by the District or Turnpike Design Engineer.

Documentation requirements for Design Variations (both Formal and Memorandums) are in **FDM 122.4**.

122.7.4 Signature Requirements

Obtain all required approvals as described in this section. Approvals from multiple individuals may be required for certain issues. The Director of Design must resolve any approval authority issues if conflicting objectives arise. Approval signatures are required by the following Department and FHWA personnel as specified:

Chief Engineer:

- (1) Design Exceptions for Design Speed on SIS facilities, following review by the Chief Planner.
- (2) Design Variations for Design Speed on SIS facilities, following review by the Chief Planner.
- (3) Design Variations for omission of Emergency Shoulder Use (ESU) evacuation requirements for any phase of construction.
- (4) Design Variation for Shared Use Paths in LA R/W not meeting the criteria in **FDM 224.1.1**, following review by the Chief Planner.
- (5) Design Exceptions or Variations involving lateral offsets or vertical clearances for railroads not meeting the requirements of **Rule 14-57 F.A.C.** or the clearance

criteria for the South Florida Rail Corridor (**Topic No. 000-725-003 - South Florida Rail Corridor Clearance Policy for 25 KV service**).

- (6) Design Variations for Non-Standard Use of Shoulders. (e.g., Bus on Shoulder Projects, Part-Time Shoulder Use, Hard Shoulder Running, etc.)
- (7) Design Exceptions for Paved Shoulder Width on Interstate and Turnpike Facilities.
- (8) Design Variations to not install a Railroad Dynamic Envelope (RDE).

FHWA Division Administrator:

- (1) Design Exceptions on Projects of Division Interest (PoDIs).

District (or Turnpike) Design Engineer:

- (1) Design Exceptions
- (2) Design Variations

State Roadway Design Engineer:

- (1) Design Exceptions for elements other than Design Loading Structural Capacity.
- (2) Design Variations involving the use of fencing around stormwater management facilities.
- (3) Design Exceptions or Variations involving lateral offsets or vertical clearances for railroads not meeting the requirements of **Rule 14-57 F.A.C.** or the clearance criteria for the South Florida Rail Corridor (**Topic No. 000-725-003 - South Florida Rail Corridor Clearance Policy for 25 KV service**).

State Structures Design Engineer:

- (1) Design Exceptions for Design Loading Structural Capacity of bridges and Vertical Clearance impacting Category 1 and 2 bridge structures.
- (2) Design Variations for Design Loading Structural Capacity of bridges and Vertical Clearance impacting Category 2 structures.
- (3) Design Variations for Design Loading Structural Capacity due to deficient load ratings impacting both Category 1 and 2 bridge structures.
- (4) Design Variations for Traffic Railing impacting Category 1 and 2 bridge structures.
- (5) Design Exceptions or Variations involving lateral offsets or vertical clearances for railroads not meeting the requirements of **Rule 14-57 F.A.C.** or the clearance criteria for the South Florida Rail Corridor (**Topic No. 000-725-003 - South Florida Rail Corridor Clearance Policy for 25 KV service**).
- (6) Design Variations for noise walls on bridges and retaining walls.

District (or Turnpike) Structures Design Engineer:

- (1) Design Exceptions for Design Loading Structural Capacity of all structural items and Vertical Clearance impacting Category 1 and 2 bridge structures.
- (2) Design Variations for Design Loading Structural Capacity of all structural items and Vertical Clearance impacting Category 1 bridge structures.

Table 122.7.1 Central Office Approvals

Design Element	State Roadway Design Engineer	State Structures Design Engineer	Chief Planner	Chief Engineer
	Approval	Approval	Review	Approval
Design Speed Exception	X			
Design Speed Exception-SIS	X		X	X
Design Speed Variation-SIS			X	X
Design Variation: ESU Omission during Construction				X
Design Variation: Shared Use Path in LA R/W			X	X
Design Variation: Non-Standard Shoulder Use				X
Design Variations to not install an RDE				X
Lane Width Exception	X			
Shoulder Width Exception	X			
Paved Shoulder Width Exception (Interstate and Turnpike)	X			X
Maximum Grade Exception	X			
Cross Slope Exception	X			
Superelevation Rate Exception	X			
Horizontal Curve Radius Exception	X			
Stopping Sight Distance Exception	X			
Design Variation: Traffic Railing (Category 1 and 2 Structures)		X		
Design Variation: Fencing on Traffic Railing between pedestrians and travel lanes on LA Facilities		X		
Design Variation: Crossovers on Limited Access Facilities	X			
Design Variation: Patterned Pavement Technical Special Provisions	X			
Design Variation: Use of fencing around stormwater management facilities	X			

Table 122.7.1 Central Office Approvals (Cont.)

Design Element	State Roadway Design Engineer	State Structures Design Engineer	Chief Planner	Chief Engineer
	Approval	Approval	Review	Approval
Design Loading Structural Capacity				
-Design Exception for Bridges		X		
-Design Variation: Category 2 Structures		X		
-Design Variation: Deficient Load Ratings (Category 1 and 2 Structures)		X		
-Design Variation: Noise walls on bridges and retaining walls		X		
Vertical Clearance Exception				
- Non-Bridge Items	X			
- Bridge Structures (Category 1 and 2)	X	X		
-RR-South Fla Rail Corridor	X	X		X
Vertical Clearance Variation				
-Category 2 Structures		X		
-RR-South Fla Rail Corridor	X	X		X
Lateral Offset Variation				
-Category 1 and 2 Structures	X			
-RR-South Fla Rail Corridor	X	X		X

123 Engineering Design Estimate Process

123.1 General

The construction cost estimate (Authorization Estimate) is one of the last activities performed during the design phase. Use the following items to develop a construction cost estimate:

- (1) The contract plans set, including all component sets; e.g., structures, architectural.
- (2) The specifications, including the supplemental specifications and technical special provisions.
- (3) The Standard Plans referenced on the key sheet of the contract plans.
- (4) The current [Basis of Estimates Manual](#).
- (5) Estimated Quantities Report

Modification for Non-Conventional Projects:

Delete **FDM 123.1** and replace with the following:

123.1 General

The construction cost estimate (Authorization Estimate) is one of the last activities performed on design projects prior to beginning the procurement process. Use the following items to develop a construction cost estimate:

- (1) The Concept Plans including a Estimated Quantities Report, if available;
- (2) The Request for Proposal.

123.2 Basis of Estimates

The [Standard Specifications](#) establish the method of measurement, basis of payment, and pay items for work specified for road and bridge construction. The [Basis of Estimates Manual](#) contains design aids, notes, the pay item structure, a list of currently open pay items, and computation information to aid the engineer in preparing the cost estimate.

Pay items for the various categories of construction work should be identified as those components are completed. For example, pay items for base and pavement work may

be identified as the pavement design is completed; signal pay items may be identified as the signal design is completed. The engineer doing the design and specifications should be knowledgeable about what work is to be done and which pay items are needed.

Use the [Basis of Estimates Manual](#) to identify pay items on all types of projects, e.g., resurfacing, widening, safety, bridge. If any work on a project is not covered by existing specifications, then a technical special provision and possibly a new pay item description, unit of measure, and basis of payment may be required. If a desired pay item is not available, contact the FDOT Project Manager or District Estimates Office for assistance. Additional details for requesting pay items are available in **Chapter 6** of the [Basis of Estimates Manual](#).

Modification for Non-Conventional Projects:

Delete **FDM 123.2**.

123.3 Designer Interface for AASHTOWare Project Preconstruction™ (formerly Trns•port)

The Designer Interface, available through the Program Management Office webpage via the Webgate login, is used to build categories and to add pay items and quantities to categories. Contact the District Estimates Office for more information.

Modification for Non-Conventional Projects:

Delete **FDM 123.3** and replace with the following:

123.3 Designer Interface for AASHTOWare Project Preconstruction™ (formerly Trns•port)

Use the [Basis of Estimates Manual](#) to select the design-build pay items.

123.4 Estimated Quantities

123.4.1 Compiling and Reporting Quantities

See *FDM 902* for information on compiling and reporting quantities. See the [Basis of Estimates Manual](#) for further details. Place detailed documentation on calculations in the project's Calculations folder and included in the CADD_[FPID].ZIP file with the Final Plans Submittal. See the [CADD Manual](#) for details.

123.4.1.1 Plan Quantity

The Department's current practice is to provide for final payment under the plan quantity concept for a large number of commonly used items. Refer to the [Standard Specifications](#) to determine if an item is paid by plan quantity. This concept requires that the estimated quantities be calculated and documented as accurately as possible. Do not include contingencies in the quantity calculation for plan quantity pay items. The designer is responsible for the final pay quantity for all plan quantity items.

123.4.1.2 Final Measurement Concept

The designer is responsible to estimate a quantity for all final measure items. Because there are many variables associated with these items, the final pay quantity will be determined by measurements performed in the field when the item is being used or constructed.

123.4.2 Breakdown of Quantities

Pay item quantities are loaded into the Designer Interface system by category, to reflect the work shown in each design group. When incidental work from one design group is included in the component plans for another group, the pay items must continue to be loaded in the appropriate category for the work to be completed. When a contract contains more than one Financial Project ID, pay item quantities for each project are loaded separately. The Estimated Quantities Report must show separate quantities for each project. Only the Summary of Pay Items run from the Department's WebGate Reporting menu will show the project totals, as well as the combined proposal/contract total. Additional information is available in *Chapter 9* of the [Basis of Estimates Manual](#).

123.5 Contract Time

Contract duration is the time required for the complete construction of the contract. Pay items measured per day need an accurate estimate of construction duration. Before completion of the design project, the plans package is submitted to the District Construction Office scheduling engineer for establishing the contract duration. Large complex projects should have the desired contract duration established earlier in the design process.

Modification for Non-Conventional Projects:

Delete **FDM 123.5**.

123.6 Alternative Contracting Practices

The Construction Office web page defines various contracting techniques used by the Department (<https://www.fdot.gov/construction/AltContract/AltContract.shtm>). When alternative contracting is called for by the Department, coordinate the PS&E preparation with the FDOT Project Manager.

Modification for Non-Conventional Projects:

Delete the previous paragraph and replace with the following:

The Construction Office web page defines various contracting techniques used by the Department (<https://www.fdot.gov/construction/AltContract/AltContract.shtm>). When design-build contracting method is called for by the Department, coordinate the estimate preparation with the FDOT Project Manager.

124 QA/QC Management Plan

124.1 General

Quality Assurance (QA) and Quality Control (QC) are two processes used by Consultants and Department (in-house) designers to ensure that deliverables are complete, orderly, correct, and appropriate for the intended purposes. The quality of the deliverable must meet or exceed industry standards; i.e., "Due Diligence" ("Due or Ordinary Care").

Quality Control (QC) is the process of checking, reviewing, and revising deliverables to comply with Department requirements. Quality Assurance (QA) is enforcing and verifying that quality control procedures have been established and performed.

This chapter describes the Department's QA/QC Management Plan for the development of deliverables. A deliverable is any professional service document (e.g., Plans, Specifications, Reports, Building Information Modeling (BIM) files) where the final version of the product is signed and sealed.

124.2 Quality Control Plan

A Quality Control Plan establishes the review procedures that are to be performed on each deliverable. The Quality Control Plan includes the following elements:

- QA/QC Staffing Plan
- Review procedures for each deliverable type (e.g., reports, plans, BIM files)
- Certificate of Compliance

A project-specific Quality Control Plan is not required for Department (in-house) design projects; however, these projects must follow the procedures outlined in this chapter.

Consultant design projects must either:

- (1) Develop a project-specific Quality Control Plan acceptable to the Department. The Quality Control Plan is completed and accepted before any design efforts begin; typically, within 20 days after Notice to Proceed.
- (2) Adopt the Quality Control Plan requirements outlined in **FDM 124** by submitting a declaration email to the Department PM. Attach the proposed QA/QC Staffing Plan to the declaration email for approval. With this option, the prime consultant is responsible for ensuring that subconsultants also adhere to the procedures outlined in this chapter.

124.2.1 QA/QC Staffing Plan

The QA/QC Staffing Plan contains a list of required deliverables and associated discipline area. The plan must identify the following staff:

- Engineer of Record (EOR) (professional that will sign and seal the document)
- Lead Technical Professional
- Quality Control (QC) Reviewer
- Quality Assurance (QA) Manager
- BIM Manager

Include the above information for the entire design team; i.e., include information for Geotechnical, Landscaping, Survey and Mapping, Environmental, and Utility staff.

The Lead Technical Professional is the professional responsible for the development of the deliverable, which is often the Engineer of Record.

The QC Reviewer must have equal or higher level of qualification as the Lead Technical Professional and must not be involved in the development of the deliverable.

The BIM Manager is responsible for coordinating and conducting Interdisciplinary Reviews of consolidated BIM content. The BIM Manager should be familiar with developing and delivering BIM content.

Whenever staffing changes are necessary on consultant design projects, provide the Department PM an updated staffing plan for approval prior to making staff changes. Include resumes for the replacement staff and the staff being replaced.

An example of a QA/QC Staffing Plan is shown in **Table 124.2.1**.

124.2.2 BIM Review Technology

List the software that will be used for conducting BIM Reviews in the Quality Control Plan. When determining the Digital Review Process to be followed, consider the entire project team's needs and capabilities. More than one solution may be necessary to conduct and document a comprehensive BIM Review.

Examples of BIM Review technologies to consider:

- Cloud collaboration technology: Many forward-thinking technologies are available for collaborative BIM Reviews (e.g., iTwin Design Review, BIM 360, Revizto, PlanGrid, etc.).
- Native design software technology: The software used to develop the model is also acceptable for conducting BIM Reviews (e.g., OpenRoads Designer, Civil 3D, etc.).
- Augmented Reality/Virtual Reality/Mixed Reality (AR/VR/MR) technology: May be considered when an immersive experience is warranted when conducting BIM Reviews (e.g., HoloLens, Google Glass, Oculus, etc...).

Table 124.2.1 Example QA/QC Staffing Plan

Element/Task	Deliverable	Lead Tech. Professional	QC Reviewer
General (PM: Luke S. Walker, PE) (QA Mgr.: Dew Wright, PE) (BIM Mgr.: Tye Down, PE)			
Project Schedule	Schedule	Luke S. Walker, PE	Dep Abillaba, PE
Quality Assurance	Quality Control Plan	Luke S. Walker, PE	Dep Abillaba, PE
Roadway (Rdwy EOR: Luke S. Walker, PE) (Drg EOR: Flow Fast, PE) (TTCP EOR: Lan Solo, PE)			
Variations/Exceptions	Sidewalk Variation	Luke S. Walker, PE	Dep Abillaba, PE
Typical Section	Typical Section Package	Luke S. Walker, PE	Dep Abillaba, PE
Pavement Design	Pavement Design Package	Luke S. Walker, PE	Dep Abillaba, PE
Project Control	Roadway Plans	Chad Bane, PE	Anna King, PSM
Roadway Design	Roadway Plans	Chad Bane, PE	Dep Abillaba, PE
	BIM files	Mora d' Minbas, E.I.	Sabrina Ren, PE
Temp Traffic Control	Roadway Plans	Lan Solo, PE	Luke S. Walker, PE
Drainage Design	Roadway Plans	Flow Fast, PE	Dep Abillaba, PE
Quantity Computations	QTDSRD files	Mora d' Minbas, E.I.	Sabrina Ren, PE
	EQ Report / AASHTOWare	Luke S. Walker, PE	Dep Abillaba, PE
Specifications, TSP	Specifications Package	Luke S. Walker, PE	Dep Abillaba, PE
Signing & Pavement Marking (EOR: Tara Full, PE)			
Signing Design	S&PM Plans	Tara Full, PE	Luke S. Walker, PE
Pavt Marking Design	S&PM Plans	Tara Full, PE	Luke S. Walker, PE
Quantity Computations	EQ Report	Chad Bane, PE	Luke S. Walker, PE
Survey and Mapping (SOR: Anna King, PSM)			
Design Survey	Survey Files	Anna King, PSM	Bob Afett, PSM
Terr Mobile LiDAR	SURVRD01.dgn file	Anna King, PSM	Bob Afett, PSM

124.3 QC Review Procedures for Plans and Documents

This check and back check review process is performed by the applicable design group (in-house design units or consultants) before the deliverable is submitted for the Department's ERC Review. The Quality Control Review may be conducted on either a printed paper copy or a PDF of the deliverable.

A formal and documented Quality Control Review is to be performed on all draft and final Reports, Documents and Plans where the final deliverable is signed and sealed. The project schedule must allocate time to complete this review prior to submittal date; typically, one to three weeks (depending upon complexity of the deliverable).

The plan set or document that has completed the Quality Control Review is referred to as the "QC Document". Documents that contain multidisciplinary information must show documentation of all applicable discipline reviews. For a paper review, scan the QC Document to PDF.

For consultant design projects, the QC Document must be included with the submittal of any deliverable in which the final PDF document is to be signed and sealed; e.g., Typical Section Package, Pavement Design Package, Specifications Package, Plans (all phase submittals), Lighting Justification Report.

For all projects, the Department PM must place the QC Document in the project file.

124.3.1 5-Step Review Process

The 5-step review described in this section pertains to a review of a paper print of the QC Document. It is expected that minor differences to the 5-step review process described will occur based on office or business adopted practices; however, each of the five steps must be carried out.

A color scheme other than the one described in this section may be used. Specify the colors used within the QC stamp.

Step 1 – Origination

The Lead Technical Professional assembles the review document and applies a QC Stamp to the cover of a bound set of documents or to individual sheets, if unbound. The QC Stamp may be digitally generated. An example of a QC Stamp is shown in **Figure 124.3.1**.

The Lead Technical Professional enters a description for the QC Document in the block provided (e.g., Phase II Plans, Draft Typical Section Package). By initialing and dating the Origination block, The Lead Technical Professional affirms that the documents are ready for checking.

Figure 124.3.1 Example QC Stamp

QC Stamp		
Submittal:		
Step	By	Date
Origination		
Checked Correct - Yellow Highlight Change - Red Comments		
Concurrence Agree - Green Check No change - Green 'X'		
Changes Made Green Highlight		
Changes Verified Blue Check		

Step 2 – Checking

The QC Reviewer checks the QC Document:

- Yellow highlight is used to identify the elements of the document that are deemed to be acceptable. Items not checked are not to be highlighted.
- Red mark is used to identify the elements of the document that are deemed to be in error or are questionable (i.e., provide comments).

Black pen (or similar) is used to perform interim manual calculations or make notes for reference on the document.

By initialing and dating the Checked block, the QC Reviewer affirms the completion of the checking process.

Step 3 – Concurrence

The Lead Technical Professional indicates agreement with the suggested change by placing a green check mark by the QC comment. This affirms that this change is to be made. The Lead Professional indicates disagreement with the suggested change by placing a green “X” mark over the QC comment. This affirms that this change is not to be made. This is done only after the Lead Professional has discussed the comment with the QC Reviewer and they reach this conclusion together. Clarification of comment resolution may be provided near the QC comment using blue ink.

By initialing and dating the Concurrence block, the Lead Professional affirms completion of this Concurrence step.

Step 4 – Changes Made

The Lead Professional makes the agreed-upon changes and uses green highlight to identify that the change has been made.

By initialing and dating the Changes Made block, the Lead Professional affirms that all agreed-upon changes have been made.

Step 5 – Changes Verified

The QC Reviewer verifies that comments have been appropriately interpreted and addressed by placing a blue check by the QC comment. The QC Reviewer will coordinate any unresolved issues with the Lead Professional for final resolution, and Step 4 will be repeated when necessary.

By initialing and dating the Changes Verified block, the QC Reviewer affirms that all agreed-upon changes have been verified.

124.3.2 Electronic Review Process

When conducting a Quality Control Review within a PDF document, use an electronic comment review, resolution, and documentation process mimicking the 5-Step Review Process. Place the QC Stamp only on the first sheet of the QC Document. **Bluebeam®** offers a collaborative approach to performing digital QC reviews and is recommended for multidiscipline reviews; other software applications may be used that provide similar workflow.

124.4 QC Review Procedures for BIM Files

A formal Quality Control Review, as outlined in this chapter, must be conducted on project BIM files that are signed and sealed. It is recommended that other CADD files provided to the Department follow these requirements as well.

Conduct and document BIM Reviews using a digital review process. For more information regarding BIM development and BIM.zip deliverable expectations, refer to the ***FDOT [CADD Manual](#); Sections 5.16 Modeling Standards and 8.4.7 BIM ZIP File.***

QC comments made during the phase submittal BIM Reviews must be documented in a QC Summary Report and submitted with each phase submittal. Spreadsheet tables are an acceptable format.

The Department categorizes BIM Reviews as:

- Developmental Reviews
- Design Analysis Reviews
- Interdisciplinary Reviews.

124.4.1 Developmental Reviews

Developmental Reviews are typically conducted by the QC Reviewer for each discipline, and have three focus areas:

- (1) Conformance: BIM adheres to CADD standards
- (2) Completeness: BIM meets the project scoped expectations
- (3) Consistency: BIM files are accurate relative to each other.

124.4.1.1 Conformance

Development Reviews are conducted to check the BIM for conformance, verifying that the BIM elements adhere to the standards defined in the ***FDOT CADD Manual***.

Checking conformance at developmental milestones minimizes the impact of deficiencies (i.e., when the roadway geometries are initially created, when the drainage network is initially developed).

Example of Conformance checks include the following:

- Do the files adhere to CADD standard compliance using the QC Project Inspector and Project Validator tools?
- Are the files based on the correct seed files?
- Are the files and folders named properly?
- Are elements assigned the correct level/layer, color, line-style, and weight?
- Are elements assigned the correct feature definitions/styles, material types and data attributions?
- Do the files have the correct geographic coordinate system defined?
- Is the corridor frequency interval appropriate to account for context classification, tangent/curves, intersections, and critical station expectations?

124.4.1.2 Completeness

Development Reviews are conducted to check the BIM for completeness, verifying that all required existing and proposed elements are developed to the minimum Level of Development (LOD). The Completeness check is conducted prior to each phased delivery. The Completeness check conducted on completed files should verify that “work” elements (aka., scratch elements) have been removed from the BIM files.

Level of Development (LOD) is the degree to which the elements contained in the BIM file are detailed. See [FDOT CADD Manual](#); **Section 5.16.6** for LOD definitions.

124.4.1.3 Consistency

Development Reviews are conducted to check the BIM for consistency, verifying that the project elements are consistent across the various types of data formats (e.g., dwg/dgn, xml, i-model). Disparities between equivalent data indicates that one of the files is inaccurate.

Example of Consistency checks include the following:

- Is the alignment data provided in xml format consistent with the 2D planimetric design in pdf format?
- Are 3D proposed breaklines in dwg/dgn format consistent with the 2D planimetric design in pdf format?

- Are 3D proposed breaklines in dwg/dgn format consistent with the 3D final graded surface provided in xml format?
- Are summary of quantity design files (QTDSRD file) consistent with 2D representation of the planimetric design in pdf format?

124.4.2 Design Analysis Reviews

Design Analysis Reviews are conducted to check that the BIM adheres to design criteria, is void of design flaws, and comply with Department requirements. These reviews are conducted by the discipline QC Reviewers prior to each phase delivery.

Many design flaws are identified in the review of the Plans, however, reviews within the BIM further enhance the reviewer's ability to identify unsuitable conditions, such as:

- Trapped stormwater runoff
- Vertical or horizontal clearance issues
- Undesirable intersection, side road or driveway geometrics or profile
- Constructability issues associated with deep excavations
- Adherence to ADA requirements

The Design Analysis Review should also include checks to ensure that the BIM reflects the data contained in project reports (e.g., Typical Section Package, Pavement Design Package, No Passing Zone Study, Drainage Report, Bridge Hydraulics Report, Geotechnical Report)

124.4.3 Interdisciplinary Reviews

Interdisciplinary Review are conducted to check the interaction between the BIM content developed by each discipline. These reviews are typically coordinated by the BIM Manager prior to each phase submittal.

The primary purpose of the Interdisciplinary Reviews is to identify conflicts or inconsistencies between the various discipline designs, such as:

- Are drainage inlet elevations set properly relative to curbs, ditches, and ponds?
- Are Clearing and Grubbing limits appropriate for all disciplines?
- Are multiple elements occupying the same physical space?

- Are high mast lighting, mast arm, and overhead sign locations clear from obstructions and standing water (final and TTC phases).
- Are minimum pipe cover expectations met?
- Does landscaping provide required sight distance for sideroads and driveways?
- Does the roadway pavement cross slope match the bridge deck cross slope?

124.4.4 Digital Review Process

This section describes a Digital Review Process used to conduct reviews of the BIM content. This process follows the basic QC steps shown in **Figure 124.4.1**. It is expected the process used by the designer will have minor differences from the Digital Review Process described here; however, each of the steps (Origination, Checking, Backchecking, Updating and Verifying) must be carried out.

Figure 124.4.1 QC Review Steps

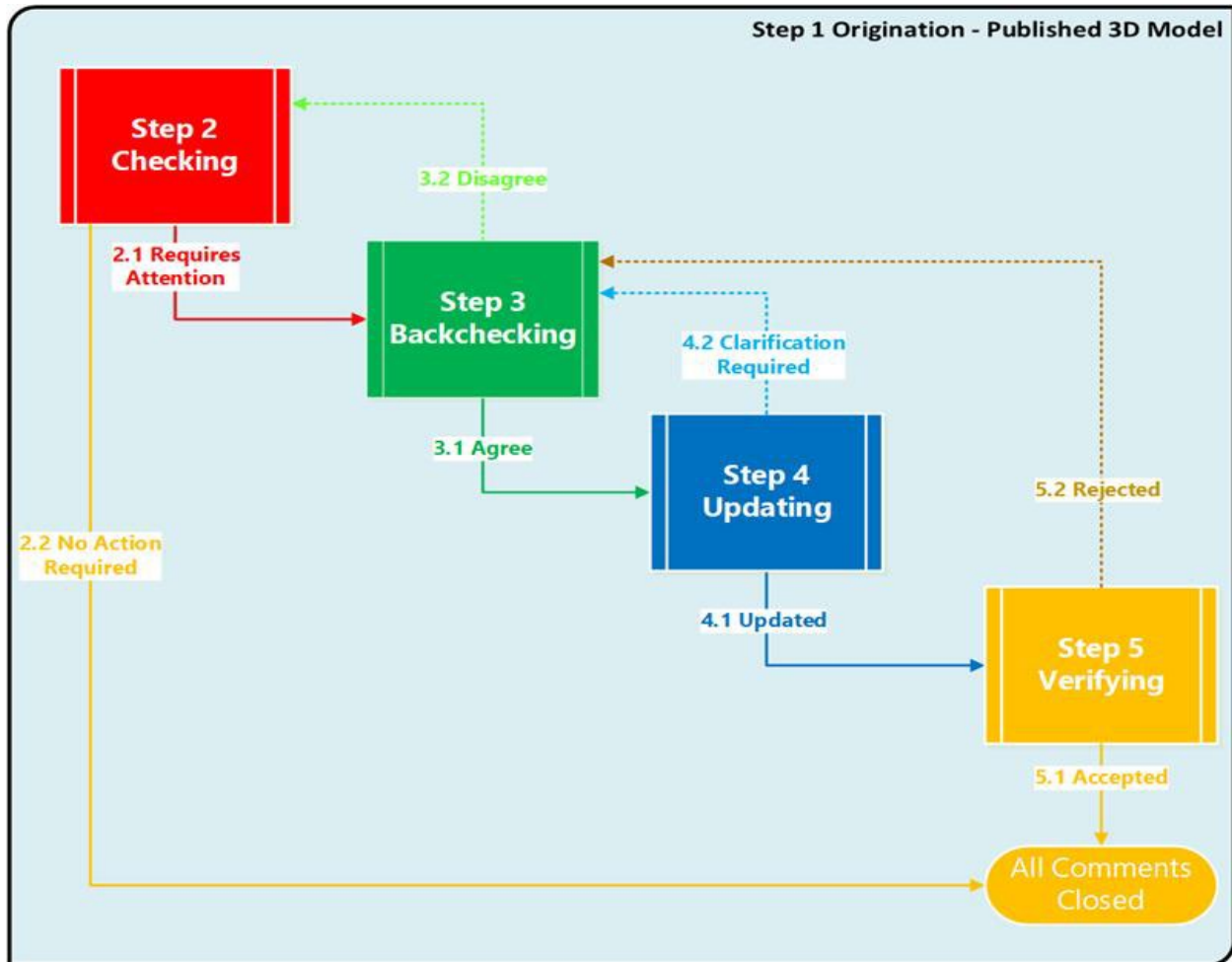

To manage the Digital Reviews expected during design development, develop a BIM Review Log. The review log should be submitted with each phase submittal of the BIM files. An example of a BIM Review Log is shown in **Table 124.4.1**.

Table 124.4.1 Example BIM Review Log

Review Description	Reviewer	Developmental Review			Design Analysis Review	Inter-disciplinary Review
		Conform.	Complete.	Consist.		
Initial Geometrics	Sabrina Ren, PE	12/10/2020			12/12/2020	
Existing Utilities	Sabrina Ren, PE	2/14/2021			2/15/2020	
Phase I BIM	Tye Down, PE	3/25/2021	3/27/2021	3/28/2021	3/28/2021	3/29/2021
Initial Drainage	Dep Abillaba, PE	4/20/2021			4/21/2021	
Final Geometrics	Sabrina Ren, PE	4/26/2021			4/28/2021	
Phase II BIM	Tye Down, PE	8/9/2021	8/10/2021	8/12/2021	8/13/2021	8/15/2021
QTDSRD files	Sabrina Ren, PE					
Final Drainage	Dep Abillaba, PE					
Phase III BIM	Tye Down, PE					
Phase IV BIM	Tye Down, PE					
Final BIM	Tye Down, PE					

Use a status scheme common to many review applications to track each comment through the review process. A status scheme other than the one described in this section may be used; however, it must mimic the intent of the Digital Review Process.

QC Summary Report should include the following information for each comment:

- Unique ID Number
- Name and Role of Originator
- Name and Role of Reviewer
- Date and Review Type (Developmental, Design Analysis, or Interdisciplinary)
- Comment Status
- Comment Response
- Communication Log (e.g., discussion, decisions, directions)

Step 1 – Origination

Each BIM review conducted, as documented by the BIM Review Log, begins with the Originator notifying the Reviewer that the BIM is locked down and ready for review. The BIM Manager often assists with the coordination of this step.

Step 2 – Checking

The Reviewer will check the BIM and create comments with the comment status of:

- (a) “Requires Attention” (associated color is red) – Indicates that the QC Comment is ready for Backchecking.
- (b) “No Action Required” (associated color is yellow) – Indicates that the QC Comment is informational note in the model that does not require further action.

When the review is completed, the Reviewer should request necessary clarification and discuss the QC Comments with the Originator.

Step 3 – Backchecking

The Originator responds to the QC Comments and changes the comment status of “Requires Attention” to:

- (a) “Agree” (associated color is green) – Indicates that revisions will be made to resolve the QC Comment.
- (b) “Disagree” (associated color is red) – Indicates that the Reviewer and Originator have determined that no change is required (STET).

Step 4 – Updating

The Original oversees revisions for QC Comments with the “Agree” and changes the comment status to:

- (a) “Updated” (associated color is Blue) – Indicates that the BIM has been revised.
- (b) “Clarification Required” (associated color is Light Blue) – Indicates that additional information or discussion with the Reviewer is required.

Step 5 – Verifying

The Reviewer determines that the QC Comment has been appropriately interpreted and addressed, and changes the “Updated” comment status to:

- (a) “Accepted” (associated color is yellow) – Indicates that the QC Comment has been resolved and no further action is required.
- (b) “Rejected (associated color is red) – Indicates that the QC Comment requires further action to fully resolve.

124.5 Certificate of Compliance

For consultant produced deliverables, the firm’s designated person for overseeing quality control activities (e.g., Quality Control Officer, Quality Assurance Manager) must review and certify that established quality control procedures have been performed. The purpose of the Certificate of Compliance is to attest that the level of effort used to complete the quality control review adheres to industry standards.

Coordinate requirements for the Certificate of Compliance with the Department PM.

124.6 Independent Peer Review

An independent peer review is supplemental to the Quality Control Review and is performed on selected consultant projects. This review is conducted by an independent team of qualified reviewers on specific design elements or portions of a project. Members of the independent peer review team are not assigned to the same organizational unit that managed and produced the project.

124.7 Field Review

A field review (A.K.A. Plans-in-Hand Review) is supplemental to the Quality Control Review. The review is held at the project site for the purpose of verifying the compatibility of the design with the field conditions encountered during construction. A record of the field review includes the following:

- Date and time.
- List of attendees.
- Documented site conditions and observations; may include marked up plan sheets, photographs or any other method deemed appropriate.

For consultant projects, provide the Department PM with a copy of the review record.

125 Quality Assurance

125.1 General

This chapter describes the planned and coordinated evaluation procedures conducted by FDOT Districts and the Central Office for the purpose of verifying and enforcing that established requirements are being met. Evaluation procedures ensure compliant and consistent performance by the districts and central office units that implement transportation programs.

Section 20.23(3)(a), Florida Statutes (F.S.), requires the establishment of departmental policies, rules, procedures, and standards.

Section 334.048, F.S. states the Legislative intent with respect to the Central Office role in the Department's management accountability and monitoring systems, including corrective actions when appropriate.

125.2 District Quality Assurance Activities

Districts must conduct Quality Assurance (QA) Audits on consultant prepared plans and documents to verify that a Quality Control (QC) review was performed for each deliverable (see **FDM 124**). To complete the requirements of the QA Audit, districts must verify that the completed QC document demonstrates that the review procedures were completed, e.g., QC check prints, Bluebeam, or Adobe QC PDF file, 3D-CADD file check list and notes.

Districts must also verify that the Certificate of Compliance was provided (see **FDM 124.2.3**).

125.2.1 Electronic Review Comment (ERC) Reviews

ERC Reviews are conducted by the Department utilizing the ERC system in accordance with [FDOT Electronic Review Comments \(ERC\) System User Manual](#). The ERC system is an application used to track the review process (comments and responses) for project submittals in a database. The purpose of an ERC Review is to assure that the submitted documents meet Department requirements.

Documents are uploaded into the ERC system only after the required quality control procedures have been performed. It is expected that comments associated with poor

quality work are minimal; the focus of the ERC Review is to validate that the designs and reports are acceptable to the Department.

Discipline experts (reviewers of the document) are assigned through the ERC system, along with the required due date for providing comments. All comments must be adequately addressed before closing out the ERC Review.

125.3 Central Office Quality Assurance Review (QAR) Program

The Office of Design (Central Office) has a formal Quality Assurance Review (QAR) Program which is led by the Office of Design QAR Program Manager. The Office of Design evaluates the District Design Offices for compliance with Department policies, procedures, and manuals through this program.

The Office of Design QAR Program is conducted by Central Office staff; typically, by Roadway Design, Structures Design, and Production Support offices, but may include other offices as necessary. The overall goal of the QAR Program is to achieve an objective assessment on the Department's performance in following established requirements.

The Office of Design QAR Program consists of:

- (1) Development and adoption of an annual QAR Plan
- (2) Conducting QARs on various topics (which cover specific requirements contained within Policies, Procedures, and Manuals) and reporting the findings to the districts and other stakeholders, accomplished through the development and distribution of a QAR Memorandum
- (3) Annual QAR Plan Summary Report

125.3.1 QAR Plan Development

Annual QAR Plans are developed based on Fiscal Year, i.e., the FY 19/20 QAR Plan begins July 1, 2019 and completed by June 30, 2020. An example of a QAR Plan is shown in ***Exhibit 125-1***.

The development and adoption of a QAR Plan occurs between February and April preceding the fiscal year that the plan will cover.

125.3.1.1 FY QAR Plan Development Meeting

For planning the upcoming fiscal year's QAR activities, the Office of Design QAR Plan Development Meeting is held in early February and is led by the Office of Design QAR Program Manager. Representatives from the Roadway Design, Structures Design and Production Support offices attend the QAR Plan Development Meeting; staff from other FDOT offices and FHWA may also be in attendance. Agenda topics discussed at this meeting include:

- (1) Status of current fiscal year QAR Plan
- (2) QAR Topics to be considered for the upcoming fiscal year QAR Plan, based on the following priorities:
 - (a) Safety concerns
 - (b) Construction issues
 - (c) Conformance with new, changed, or existing departmental policies, rules, procedures, and standards
 - (d) Non-compliance or needed improvement identified on previous QARs
 - (e) Opportunities to streamline processes and apply innovation
- (3) Cycle period to complete QARs for all districts. The following general practice applies, based on complexity of QAR and available resources:
 - (a) For each QAR topic identified, the established practice is to complete the reviews for all districts in a single fiscal year; however, a two or three-year cycle may be appropriate for topics requiring extensive evaluations, or on-going Department programs; e.g., ADA, Pavement Design.
 - (b) Typically, QARs are conducted on contract documents, or design processes that were completed in the fiscal year preceding the fiscal year of the QAR Plan. Each project will be evaluated for compliance based on the manuals, policies, and procedures in place at the time the document or design was completed.
 - (c) QAR evaluations should be conducted in the 1st (July-September), 2nd (October-December), and 3rd (January-March) quarters of each fiscal year QAR Plan.
 - (d) The Final QAR Memorandum is to be completed and distributed by the end of the quarter following the quarter in which the QAR evaluation was performed; e.g., Final QAR Memorandum is distributed by December 31st for a QAR conducted in the 1st quarter.

- (4) Assess QAR topics for future fiscal year plans; typically, a one to two-year look ahead.

125.3.1.2 DRAFT FY QAR Plan

QAR representatives from the Roadway Design, Structures Design, and Production Support offices reconvene in early March to complete the DRAFT FY QAR Plan. The focus of this meeting is to select the proposed QAR Topics to be included in the plan.

To complete the DRAFT FY QAR Plan, the following information is identified:

- (1) **Office Unit** – Unit responsible for conducting the QAR.
- (2) **QAR Leader** – Individual who will take the lead in conducting the QAR.
- (3) **Authority** – Department policy, rule, procedure, or standard governing the QAR Topic.
- (4) **QAR Topic/Purpose**
 - (a) **Topic:** The area or subject of the planned QAR evaluation.
 - (b) **Purpose:** The QAR objective and specific requirements being evaluated.
- (5) **QAR Cycle** – The fiscal year quarter in which the QAR will begin. The FY QAR Plan should not subject any district to excessive reviews within the planned year, or within a single quarter.

125.3.1.3 FY QAR Plan Adoption

The DRAFT FY QAR Plan is presented to the District Design Engineers (DDE), District Consultant Project Management Engineers (DCPME), and FHWA in early April. Following the presentation, districts have two weeks to request additional information as to the intent of the QAR Topic or suggest changes to the QAR Cycle.

The FY QAR Plan is formally adopted in early May.

125.3.2 Conducting a QAR

Conducting a QAR involves the following activities:

- (1) Conducting a QAR Kick-off Meeting
- (2) Evaluation of projects for compliance with the QAR purpose statement
- (3) Documenting the findings in a Draft QAR Memorandum
- (4) Resolution of Findings
- (5) Distribution of Final QAR Memorandum

Depending on complexity, a QAR may be conducted by remote review, district visit, or a combination of the two methods. Conducting a QAR involves Central Office and district staff working together to complete the review activities.

125.3.2.1 QAR Kick-off Meeting

The QAR Leader should contact the appropriate district staff at the beginning of the quarter in which the QAR is to be conducted to schedule the QAR kick-off meeting. The QAR Kick-off meeting agenda should include the following:

- (1) QAR topic and purpose
- (2) Identification of Central Office and district staff that will participate in the QAR
- (3) Proposed schedule
- (4) Selected projects to be evaluated and the best method for obtaining the data.
- (5) Agree-upon date to complete the gathering of the required information.

125.3.2.2 Evaluation of Projects

Central Office staff will evaluate district documentation in accordance with the QAR purpose statement. Evaluation of provided documents is typically conducted through office reviews; however, a field review or district visit may be appropriate.

The findings should be tabulated with a clear indication that the project was in full compliance, compliant with opportunity for improvement, partial compliance, or non-compliance. An explanation as to what triggered any partially or non-compliance determination is to be provided.

Project evaluations should be completed by the end of the quarter in which the QAR is to be conducted. The findings of the QAR are documented within a draft QAR Memorandum which is shared with the district.

125.3.2.3 QAR Memorandum

A district-specific QAR Memorandum is to be developed for each QAR Topic. The memorandum contains the following sections:

- (1) Executive Summary
- (2) Projects Selected for Review
- (3) Evaluation Method (Optional)
- (4) Findings
- (5) Observations (Optional)
- (6) Recommendations

Executive Summary

This section should be succinct (1-3 paragraphs) and should not extend to a 2nd page.

- (1) First paragraph should state which design office conducted the review (include other offices if it was a joint review) and the quarter in which the review took place. Include the names of the Central Office and district key staff that participated in the review.
- (2) Second paragraph should provide the stated purpose of the review; e.g., "The specific purpose of this QAR was to verify inclusion of applicable documents in the required E&O file."

- (3) Last paragraph should provide the results of the evaluation by indicating that the district was in full compliance, compliant with opportunity for improvement, partial compliance, or non-compliance.

Projects Selected for Review

This section should provide a description of how the projects were selected to be included in the QAR.

- (1) First paragraph should describe the general project attributes that qualified it for inclusion of the QAR evaluation, e.g., “This QAR included projects with a letting date between July 1, 2017 and June 30, 2018 and proposed a new or extended bridge culvert. Eight projects were identified that met these parameters”.
- (2) Subsequent paragraphs should include discussion on why projects were added or subtracted from the list to be evaluated.
- (3) Last paragraph should state the number of projects that were selected for evaluation.

Evaluation Method (Optional)

This optional section is used to provide a description of the process used to evaluate the compliance of selected projects.

Findings

This section should indicate how the district performed overall and whether the projects met the stated requirements. At a minimum, this section should include:

- (1) First paragraph should begin with “The following table provides a summary of the findings for each project evaluated as part of this QAR.” The table may be omitted if there were only one or two projects identified.
- (2) Flexibility in content and format of tabulated findings should be exercised to clearly convey the information. Only include information that is the basis for why the district did or did not comply with requirements along with statements about what was missing or incomplete. Do not include comments concerning the quality of the document or submittal.
- (3) Subsequent paragraphs should include discussion concerning the assessment of specific projects if additional information would help to clarify findings.

Observations (Optional)

This optional section is used to provide comments concerning faults or best practices in district processes, quality of project deliverables, or any other topic that may have contributed to the findings. It may include discussion on benefits of compliance (improved safety and operational performance or cost savings) and missed opportunities identified through the QAR.

Recommendations

This section should list actions the district should consider for improving compliance with the stated requirements. Include suggested participation in training opportunities directly related to the QAR Purpose. This section may also include recommendations for Central Office improvements (e.g., new, improved or additional training, clarification to departmental policies, rules, procedures and standards).

125.3.2.4 Resolution of Findings

The Draft QAR Memorandum is shared with district staff involved in the QAR, followed by a discussion of findings and recommendations. The resolution of findings is typically face-to-face to assure open dialog between Central Office and district staff. Video conference or teleconference may be used in lieu of face-to-face meeting when deemed appropriate.

125.3.2.5 Distribution of Final QAR Memorandum

The memorandum is finalized after agreed-upon edits from the resolution of findings have been made. The Final QAR Memorandum is typically sent from the manager of the Roadway Design, Structures Design, or Production Support office, as appropriate.

The memorandum is addressed to the District Secretary, with the following recipients copied:

- (1) Director, Office of Design
- (2) District Director of Transportation Development
- (3) District Design Engineer
- (4) Office of Design QAR Program Manager
- (5) FHWA Design Program Manager
- (6) FHWA Quality Assurance Manager

125.3.2.6 Quality Management Dashboard

Quality Management Dashboard (QMD) is a Department enterprise application that is used to store QAR information. The QAR Leader will upload QAR findings and recommendations into the QMD after the Final QAR Memorandum is distributed.

125.3.3 QAR Summary Report

When all the district QAR Memorandums have been completed on a QAR topic, the QAR Leader will summarize findings for that QAR topic in a QAR Summary Report. This report should be no more than one page and is not intended to repeat the individual district QAR Memorandums. This report will summarize recommendations, action items, lessons learned, and best practices identified through that year's QARs for that QAR topic. The QAR Leader will submit this QAR Summary Report to the Office of Design QAR Program Manager prior to June 30th.

The Office of Design QAR Program Manager will compile the individual QAR Summary Reports into a Summary of Recommendations and Action Items Report that should be provided to FHWA no later than August 31st of each year.

The Office of Design QAR Program Manager maintains a library of the Annual QAR Plans, QAR Memorandums, QAR Summary Reports, and a QAR Findings Log.

Office of Design FY 2019/2020 QAR Plan

Office Unit	Leader	Authority	Topic / Purpose	QAR Cycle by District		
				Q1	Q2	Q3
Production Support Office						
Value Engineering	Kurt Lieblong	Topic No. 625-030-002	Topic : Value Engineering (VE) Procedures Purpose: Assess the determination of eligible projects, work plan submission, team member criteria and the 6 phases of the VE job plan.	1,4,5,6	2,3,7,T	
Landscape Architecture	Jeff Caster	Work Program Instructions	Topic: Part III - Ch 16: Landscape Installation Purpose: Evaluate compliancy with requirements for the inclusion of landscape plans in a construction contract.		1,6	4,T
Roadway Design Office						
Standard Plans	Derwood Sheppard	Topic No. 625-010-003	Topic: Longitudinal Barriers Purpose: Determine if new standards and associated policies are being implemented	5	2	4,T
Pavement Management	Rhonda Taylor	Work Program Instructions	Topic: Pavement Resurfacing Purpose: Evaluate compliancy and consistency in selecting and programming projects in the resurfacing program.		ALL	
		Topic No. 625-010-002 Topic No. 625-010-005 Topic No. 625-010-006	Topic: Pavement Design Policy Purpose: Evaluate compliancy and consistency with state standards in developing pavement designs.		4	7
Drainage	Carlton Spirio	Topic No. 625-040-002	Topic: Bridge Hydraulic Reports Purpose: Evaluate consistency in format and content.		3, T	1,5
Quality Assurance	Jeremy Fletcher	Topic No. 625-020-016	Topic: Americans with Disabilities Act (ADA) Purpose: Evaluate design content in Architectural Plans and accessibility issues with existing facilities.	5	2	3
Structures Design Office						
Structures	Scott Arnold	Topic No. 625-000-002	Topic: FDM 121 Bridge Project Development Purpose: Follow-up from the 2015 QAR			2,3,6,7

126 Lane Repurposing Projects

Modification for Non-Conventional Projects:

Delete **FDM 126**.

126.1 General

Lane repurposing projects (a.k.a., “road diets”, “lane elimination”, or “lane reduction”) are intended to reduce the number of travel lanes to achieve systemic improvements. Generally, the purpose of these projects is to reconfigure the existing cross section to enhance other uses and travel modes. Lane repurposing projects typically contribute to the economic development, livability, and vitality of a community. The recovered travelled way can be used to accommodate other uses such as separated bicycle lanes, buffered bicycle lanes, improving existing sidewalks, adding sidewalks, landscaping, on-street parking, bulb-outs, traffic calming, transit, and pedestrian refuge islands marked with crosswalks. Guidance on the development and review processes for repurposing lanes on the State Highway System (SHS) is provided in the Department’s **FDOT Lane Repurposing Guidebook**.

A local government entity (e.g., municipality, county, Metropolitan Planning Organization (MPO), Transportation Planning Organization (TPO)) or the Department can submit a request for the repurposing of travel lanes on the SHS. A private entity may only submit a request through a local government entity. Proposed lane repurposing projects may be part of a larger community vision. With sufficient advanced planning, lane repurposing projects are often done in conjunction with Resurfacing, Restoration and Rehabilitation (RRR) projects. It is preferred that lane repurposing projects be identified ahead of time through a planning exercise such as a district area wide multimodal mobility plan, community vision plan, or downtown redevelopment plan.

If the project has a PD&E phase, the requirements of this chapter are followed during the PD&E study prior to the selection of a preferred alternative. See **Part 1, Chapter 2** of the [PD&E Manual](#) for additional information.

126.2 Requirements

Lane repurposing projects must comply with AASHTO and Department design criteria. A Design Exception or Design Variation is required when an existing or proposed design

element does not comply with the governing criteria. See **FDM 122** for information on Design Exceptions and Design Variations.

Lane repurposing projects should be consistent with the Long-Range Transportation Plan (LRTP), Transportation Improvement Program (TIP), and Transit Development Plan (TDP).

Analyze impacts of a lane repurposing project with consideration for the following:

- Utilities
- Access management
- Businesses
- Traffic operations
- Safety
- Pedestrian and bicyclist activities
- Transit and freight routes
- Environmental impacts
- Evacuation routes
- Emergency responders
- Functional classification
- Context classification
- Landscaping (shade or architectural)
- Speed (target, design and posted)
- Traffic impact due to diversion to parallel routes

Four-lane undivided roadways with AADT \leq 20,000 are typically good candidates for a lane repurposing (e.g., converting to a two-lane, two-way road with a center-left-turn-lane). However, projects are evaluated for lane repurposing feasibility on a case-by-case basis.

If exclusive bus lanes/business access & transit (BAT) lanes are proposed in the lane repurposing project, coordinate with Office of Modal Development/Public Transit and local transit agency.

In addition to impacts of lane repurposing projects, conduct public involvement activities in accordance with the [Public Involvement Handbook](#).

126.2.1 Federal-Aid Projects

Follow the National Environmental Policy Act (NEPA) for lane repurposing projects that use federal funding.

126.2.2 Roadway Functional Reclassification

A lane repurposing project can potentially change the functional classification of a roadway, which could affect planning, funding eligibility, traffic analyses, project prioritization, and state and federal reporting requirements.

A request for a change in functional classification requires review and approval by the Department and FHWA. Approval is typically requested during the preliminary review process. More information is provided in the Department's [Urban Boundary and Functional Classification](#) Handbook. This handbook can be found at the FDOT Transportation Data and Analytics website:

<https://www.fdot.gov/statistics/tsopubs.shtm>.

A proposed change in functional classification of a roadway on the National Highway System (NHS) requires coordination between the Department, local officials, and FHWA.

126.3 Application Process

The application process consists of three main steps: coordination between Applicant and the District, a preliminary review and approval by District, and the final review and approval by Central Office (CO). **FDM 103** includes the **Forms 126-A, B, and C** that are utilized during this process. **Form 126-A** is used as guidance for project meetings, reports and methodology, **Form 126-B** establishes the initial notification to CO Systems Implementation Office (SIO) and **Form 126-C** confirms the final review and approval from CO.

126.3.1 Project Initiation

- (1) The applicant submits the lane repurposing request to the District Lane Repurposing Coordinator.
- (2) The applicant submits required information in the Initial Meeting and Methodology Checklist (**Form 126-A**) to the district prior to the initial meeting.
- (3) The District Lane Repurposing Coordinator schedules the initial meeting to discuss the proposed lane repurposing project with the District Review Team, which includes the following district offices:
 - (a) Planning
 - (b) Environmental Management

- (c) Modal Development
 - (d) Design
 - (e) Safety
 - (f) Traffic Operations
- (4) The applicant attends this initial meeting to discuss the process and requirements of the lane repurposing request.
- (5) The District Lane Repurposing Coordinator submits the initial notification to Central Office Systems Implementation Office (SIO). This will include:
- (a) Initial Meeting and Methodology Checklist (**Form 126-A**)
 - (b) Meeting Minutes
 - (c) Initial Notice to Central Office (**Form 126-B**), with concurrence from the District Planning and Environmental Administrator, District Design Engineer and District Traffic Operations Engineer.

126.3.2 District Preliminary Review

The District Preliminary Review is as follows:

- (1) The applicant will submit a draft concept report containing a proposed typical section to the District Lane Repurposing Coordinator for review.
- (2) The District Lane Repurposing Coordinator will coordinate the review of the project and concept report with the District Review Team.

After District reviewer's acceptance, a Final Concept Report must be submitted along with **Form 126-C** and signed at the District level to CO for review. The District Lane Repurposing Coordinator will work closely with CO staff during this review phase.

126.3.3 Central Office Final Review and Approval

The Final Review and Approval process is as follows:

- (1) The District Lane Repurposing Coordinator submits the Final Review and Approval Notice to Central Office Systems Implementation Office (**Form 126-C**), signed by the District Planning and Environmental Administrator, the District Design Engineer, and the District Traffic Operations Engineer, along with the Final Concept Report.

- (2) The Systems Implementation Office coordinates the review of the lane repurposing request with the different offices in Central Office (e.g., Design, Traffic Engineering and Operations) and obtains concurrence from the Chief Planner.
- (3) The Systems Implementation Office submits the lane repurposing request for obtaining the final approval or denial to the Chief Engineer. The Chief Engineer has the final authority to approve, deny or object (with comments) to the lane repurposing request.
- (4) The Systems Implementation Office submits notification to the District Lane Repurposing Coordinator of the Chief Engineer's decision.
 - (a) Approved: application process is complete.
 - (b) Denied: includes an explanation for the denial.
 - (c) Objection with comments: the applicant may resubmit the lane repurposing proposal to the District once the comments have been addressed. The resubmittal must include an updated concept report and signed **Form 126-C** (included in **FDM 103**).

127 Community Aesthetic Features

127.1 General

A Community Aesthetic Feature (CAF) is an enhancement installed within the Department's right of way to represent or reflect the surrounding community's identity, culture, and values. A CAF may also enhance the sense of place through which a highway passes.

A CAF placed within FDOT Right of Way (R/W) or attached to an FDOT structure or facility must be approved by the Department. These features are designed, maintained, and paid for by a local governmental agency. A CAF is typically constructed by the sponsoring entity but may be included as part of a Department project.

The [Community Aesthetic Feature Agreement](#) (**Form Number 625-010-10**) must be executed by the local governmental entity and the Department prior to any construction within the Department's R/W. This agreement provides for the removal and/or relocation of the CAF at the local governmental entity's expense should it not be maintained by the local governmental entity, or if the Department needs the R/W for transportation purposes. A Deposit, Performance Bond, or Letter of Credit is required as part of the [Community Aesthetic Feature Agreement](#). A waiver of the Deposit, Performance Bond or Letter of Credit is allowed for certain minor installations as indicated within the CAF agreement.

See **F.S. 334.187** for Bond and Letter of Credit requirements.

Final plans for placing a CAF within the Department's R/W must be accompanied by a resolution of the local governmental entity indicating their full financial responsibility for the feature's design, construction, and maintenance during its lifespan. The resolution must indicate the office or position title (e.g., Mayor, City Manager) within the local agency with approval authority to execute the CAF agreement.

127.2 Requirements

A CAF must meet the Department's requirements governing safety, access, and maintenance of the highway. A CAF is classified in the following categories:

- (1) Public Art (Stand Alone or Affixed)
- (2) Local ID Markers (Stand Alone or Affixed)

While there are some criteria unique to each category, all CAFs must meet the following requirements:

- (1) Except where parking is available, select a site and lay out the site plan to deter drivers from stopping within the roadway. If drivers are expected to stop or park, provide for parking in the plan. If public access is available, Department Standards and Specifications must be met, including ADA requirements. Prohibit public access to the CAF when located within limited access R/W.
- (2) The feature must not contain any signs as defined in the **2009 Manual on Uniform Traffic Control Devices (MUTCD), Part 1, Chapter 1A.13**, traffic control features, auditory devices, reflective surfaces, flashing lights, moving parts or moving illumination.
- (3) The feature must not contain any advertising per the **MUTCD** and **23 C.F.R., 1.23** which prohibits advertising on, or commercial use of the R/W. Commercial advertising on state R/W is also prohibited by **Chapter 479, Florida Statutes**, including charitable, fraternal, religious, or political signs, symbols, logos, banners, web links, or any other such devices. Governmental seals or logos are permitted as part of a Local ID Marker.
- (4) Lighting of the feature must not be directed at motorists, bicyclists or pedestrians. For roadway and intersection lighting criteria see **FDM 231**. When located near an airport, the feature must not create a hazard as defined by **Section 333.01(3), F.S.**
- (5) In absence of feature lighting, messages or text included on Local ID Markers must be retroreflective. Decorative or accent lighting must not include any strobe effects, flashing lights, moving parts, or moving illumination.
- (6) CAF installations that are visible from the Interstate mainline, require FHWA approval.
- (7) Do not install Public Art or Local ID Markers in both the median and roadside at a given location. Median placements are allowed on roadways with restricted right of way or restricted roadside conditions.
- (8) CAFs within the median of a limited access facility are prohibited.
- (9) One Stand-Alone feature will be allowed per mainline interchange approach (for a maximum of two installations). The local governmental entity must select one site from amongst the ramp and the mainline, along the outside of a ramp, or the area inside a loop ramp.
- (10) The feature must meet applicable building codes and design criteria for similar structures or landscaping placed adjacent to the highway's R/W, including wind loading commensurate with highway signs in the area.

- (11) The feature must not cause adverse impacts or create public controversy related to any of the following:
 - (a) Property access
 - (b) Air quality
 - (c) Noise
 - (d) Water quality
 - (e) Wetlands
 - (f) Floodplain encroachments
 - (g) Imperiled, endangered, or threatened species or their critical habitat
 - (h) Historical resources
- (12) The CAF, including amenities like landscape or fencing, must not obstruct signs or interfere with a sight distance, sight triangle, or permitted view zone (billboards).
- (13) The CAF final design must be signed and sealed by a responsible professional licensed in Florida, excluding art wraps.
- (14) Attachments to fencing on structures is not permitted.

127.2.1 Public Art (Stand-Alone)

Additional requirements for Public Art (Stand-Alone) are as follows:

- (1) All roadways
 - (a) The location must be outside the appropriate lateral offset or clear zone as defined in **FDM Table 215.2.3** and **215.2.4**, and should be as close to the right of way line as practical.
 - (b) The structure may not display messages with text or contain any words or alpha-numeric characters.
 - (c) The artist's insignia may be inscribed or etched on a small plaque affixed to the artwork or placed on the artwork itself. The insignia must not be visible from the roadway so as to avoid distraction to drivers or bicyclists.
 - (d) The object's highest point must not be greater in elevation than 25 feet above the nearest point of the traveled way.

(2) Curbed roadways

The feature may be placed within the median of curbed roadways, where:

- (a) The Design Speed is less than or equal to 45 mph, and
- (b) The R/W or roadside is restricted, and
- (c) A minimum 4-foot offset from the face of curb is provided.

127.2.2 Public Art (Affixed)

Additional requirements for Public Art (Affixed) are as follows:

- (1) The feature may not display any messages with text or contain any words or alpha-numeric characters.
- (2) The artist's insignia may be inscribed or etched on a small plaque affixed to the artwork or placed on the artwork itself. The insignia must not be visible from the roadway so as to avoid distraction to drivers or bicyclists.
- (3) For bridges, the feature must not reduce the vertical clearance over the roadway.
- (4) For art wraps affixed to roadside features:
 - (a) Do not obstruct traffic control cabinet vents or access panels with the art wrap.
 - (b) Art wrap themes can be approved for general use by a local government entity.
 - (c) A CAF Agreement will be required for these features.
 - (d) Any maintaining agency, other than a local government, must coordinate approvals and maintenance through the appropriate local government entity.
 - (e) Official seals or logos representing the local governmental entity are permitted. Alpha-numeric characters are allowed if they are part of official seals or logos. Seals or logos must be less than 200 square inches each. Only one seal or logo per face is permitted.
 - (f) Maps on traffic control cabinet wraps are not permitted to face the roadway.
 - (g) A Deposit, Bond, or Letter of Credit is not required for art wraps on traffic control cabinets.
 - (h) The DDE should coordinate with the District Traffic Operations Office during the review process for traffic control cabinet wraps.

127.2.3 Local ID Marker (Stand-Alone)

Additional requirements for a Local ID Marker (Stand-Alone) are as follows:

- (1) All roadways:
 - (a) Local ID Markers are intended to represent the geographic boundary for a county, municipality, sovereign nation, or unincorporated area. The Markers should be located in close proximity to the actual geographic boundary of that area. Remove existing standard geographic boundary guide signs, and unofficial signs or structures, at or near the location.
 - (b) Local ID Markers for an unincorporated or community area must provide a map, or sufficient enough description to clearly designate the geographic boundary of the area. Also provide documentation of approval of such boundary by the local governing authority.
 - (c) The location must be outside the appropriate clear zone and lateral offset as defined in **FDM 215.2.3** and **215.2.4** and should be as close to the R/W line as practical.
 - (d) The structure may contain text such as the name of the municipality, county, or community area (as defined in **Chapter 14-51.041, F.A.C.**) with a short phrase or message. Text such as “Exiting” or “Leaving” are prohibited.
 - (e) The object’s highest point must not be greater in elevation than 25 feet above the nearest point of the roadway.
- (2) Curbed roadways:

The feature may be placed within the median of curbed roadways, where:

 - (a) The Design Speed is less than or equal to 45 mph, and
 - (b) The R/W or roadside is restricted, and
 - (c) A minimum 4-foot offset from the face of curb is provided.
- (3) Limited Access Facilities:
 - (a) Provide a minimum 50-foot offset (100-foot preferred) from the edge of the traveled way, whether guardrail is present or not. The 50-foot to 100-foot lateral offset will help to minimize driver distraction and reduce the likelihood that vertical structures will become storm debris blown across the roadway.
 - (b) Letter height must not exceed four feet.
 - (c) Short phrases or messages are prohibited.

127.2.4 Local ID Marker (Affixed)

Additional requirements for a Local ID Marker (Affixed) are as follows:

- (1) All roadways:
 - (a) The feature may contain text such as the name of the municipality, county, or community area (as defined in **Chapter 14-51.041(2)(c), F.A.C.**) with a short phrase. Text such as “Exiting” or “Leaving” are prohibited.
 - (b) For bridges, the feature must not reduce the vertical clearance over the roadway.
- (2) Limited Access Facilities:
 - (a) Letter height must not exceed four feet.
 - (b) Short phrases or messages are prohibited.

127.3 Approval Process

The application process is conducted in two phases, the Concept Phase and the Final Phase.

When any of the requirements in **FDM 127.2** are not met, a Design Variation must be approved by the District Secretary.

127.3.1 Concept Phase

The Concept Phase includes District coordination with the applicant to ensure:

- (1) The appropriate Community Aesthetic Feature category is selected,
- (2) The corresponding requirements are achievable and acceptable, and
- (3) The conditions of the [Community Aesthetic Feature Agreement](#) are acceptable.

The local agency will submit a concept drawing and documentation to the District Office. The concept submittal must include a **Submittal/Approval Letter**, which can be found in **FDM 103, Form 122-A**. The **Submittal/Approval Letter** is to be signed by a representative of the requesting entity, the District Design Engineer (or Turnpike Design Engineer), and the District Secretary.

Upon review by the District Design Engineer and the District Secretary, conceptual approval may be granted. If the concept and proposed Design Variations are deemed

acceptable, the signed **Submittal/Approval Letter**, indicating conceptual approval, will be returned to the local agency.

For applications involving the Interstate System, the District should coordinate with the FHWA District Transportation Engineer.

The package submitted to the District Office for conceptual approval must include the following:

- (1) The designation of the feature category.
- (2) A conceptual drawing/rendering showing the top, front, and side views of the feature with labeled dimensions, material designations including connections, proposed lighting configuration, and any alpha-numeric characters.
- (3) A draft site plan and cross section view dimensioning the location of the feature in relationship to the edge of traveled way and the R/W.
- (4) The design speed of all adjacent roadways.
- (5) A citation of the Governing Design Standards (or Governing Standard Plans), criteria, and building code to which the feature will be designed.
- (6) If the feature is to be affixed to a bridge:
 - (a) Identify the bridge owner.
 - (b) Declare what the impact is to the bridge loading.
- (7) For Local ID Markers, include a site map or provide a dimension from the jurisdictional boundary associated with the marker.
- (8) The Signature/Approval Letter signed by the applicant.

127.3.2 Final Phase

The Final Phase includes the preparation and review of all final documents. The local agency will submit the **Submittal/Approval Letter** and final documents for approval to the District Design Office. The District Secretary will review the application and either grant approval to place the feature or deny the submittal with comments.

The package submitted to the District Design Office for final approval must include the following:

- (1) Site Plans, including a Traffic Control Plan if temporary maintenance of traffic will be required to place and/ or maintain the feature.
- (2) Structural Plans including a wind load analysis.

- (3) Local Governmental Entity Resolution.
- (4) Design Variations for any requirements in **FDM 127.2** that are not met.
- (5) [Community Aesthetic Feature Agreement](#) signed by the local governmental entity.
- (6) **Signature/Approval Letter** signed by the applicant.

Upon receiving final approval by the District Design Engineer (or Turnpike Design Engineer), the District Secretary, and, if applicable, FHWA, the District will notify the local governmental entity that placement of the feature may proceed. The final approval is valid for one year, at which time the local governmental entity may request an extension from the District.

127.4 Place Name Signs

Customized Place Name Signs are considered Local ID Markers which are addressed in **FDM 127.2.3** and **127.2.4**.

The placement of Place Name Signs within FDOT R/W is regulated by the Department. Requirements for Place Name Signs within FDOT R/W are located in **Rule Chapter 14-51, F.A.C., Part IV Place Name Signs**.

All signs placed within the Department's R/W must meet the requirements contained in the [MUTCD, Part 2](#). Signs for general information, services, tourist destinations, and recreational/cultural interest areas all have specific chapters in the [MUTCD](#), which specify color, size and lettering requirements. Destination signs are classified in the [MUTCD](#) as Guide Signs.

127.5 Blue Star Memorial Markers and Flag Poles

Blue Star Memorial Markers and Flag Poles are not considered Community Aesthetic Features and are not covered by this chapter. These markers are managed through the Local FDOT Maintenance and Traffic Operations offices.

128 Federal-Aid Project Certification

128.1 General

The Florida Department of Transportation (FDOT) has a Stewardship and Oversight Agreement with the Federal Highway Administration (FHWA) setting forth the respective roles, responsibilities, and accountability of FDOT and FHWA in the administration of Federal-aid highway funds. See [FHWA-FDOT Stewardship and Oversight Agreement, Topic No. 700-000-005](#) and [Title 23 United States Code 106 \(23 USC 106\)](#). Under this agreement, FHWA grants to FDOT general responsibilities and approvals for design, plans, specifications, estimates, contract awards, contract administration, and project inspections on Federal-aid highway projects except for those projects FHWA and FDOT used the risk-based approach to select as projects of Division Interest” (PoDI), and as discussed in **FDM 128.2**. For those projects that FDOT has oversight responsibility, FDOT will act on FHWA’s behalf by complying with all applicable FHWA policies, regulations, **Title 23 USC**, and **non-Title 23 USC** requirements. Notwithstanding this, FHWA may become involved with any Federal-aid project and retains overall responsibility for all aspects of Federal-aid programs. As such, FHWA has full access to and the legal authority to review any aspect or record of any Federal-aid project at any time. In accordance with **Title 2 Code of Federal Regulations Part 200 (2 CFR Part 200)**, records will be retained for a minimum of three years or until litigation, claims or audit findings initiated before the three-year period have been resolved.

Modification for Non-Conventional Projects:

Delete the second sentence of the above paragraph and replace with the following:

See [FHWA-FDOT Stewardship and Oversight Agreement, Topic No. 700-000-005](#), [Title 23 United States Code 106 \(23 USC 106\)](#), and [Title 23 Code of Federal Regulations 636 \(23 CFR 636\)](#).

128.2 Selection of Federal-Aid Projects

In accordance with the Stewardship and Oversight Agreement, annually in July, FHWA and FDOT will use risk-based approach to negotiate which new projects will be selected as Projects of Division Interest (PoDI). The FHWA Transportation Engineer will coordinate the project selection with their assigned FDOT District Office. Ideally, the projects will be selected from projects listed in the Statewide Transportation Improvement Program (STIP) to be approved by FHWA the following October 1st, and will include projects selected from all four years of the STIP. The projects selected should be on the Federal-aid system to primarily include the Interstate and National Highway System (NHS) routes, but non-NHS projects can be selected. The projects should be selected considering the factors below:

- (1) All major projects as defined by FHWA's major project criteria (cost \geq \$500 million)
- (2) Controversial and Congressional interest Projects
- (3) Demonstration (demo) and pilot projects
- (4) Interstate projects:
 - (a) With Design Exceptions to the 10 controlling criteria
 - (b) For new or modified access points
 - (c) For major reconstruction and widening
- (5) Projects utilizing innovative contracting methods (e.g., design build, public-private partnerships)
- (6) Special Experimental Projects (SEP):
 - (a) Projects requiring SEP-14 approval for alternative contracting methods
 - (b) Projects requiring SEP-15 approval for public-private partnerships
- (7) Unusually complex or controversial projects
- (8) Major unique and/or unusual structures
- (9) A priority focus for projects on the NHS
- (10) A desire to have a mix in project size and scope

All federally funded projects must comply with applicable ***non-Title 23 U.S.C.*** requirements which include, but are not limited to:

- (1) National Environmental Policy Act (NEPA) of 1969 pursuant to 40 C.F.R. Parts 1500 - 1508, 23 C.F.R. Section 771 and Section 6002 of SAFETEA-LU
- (2) Section 4 (f) of the DOT Act of 1966
- (3) Clean Air Act Amendments of 1990
- (4) Civil Rights Act of 1964
- (5) Civil Rights approvals
- (6) Disadvantaged Business Enterprise Program (DBE)
- (7) Uniform Relocation Assistance and Real Properties Acquisition Policies Act of 1970
- (8) Hardship acquisition and protecting buying
- (9) Americans with Disabilities Act/Section 504 Rehabilitation Act of 1973
- (10) Davis-Bacon wage rates
- (11) Waiver for Buy America requirements
- (12) SEP-14/SEP15 contracting methods
- (13) Executive Orders
- (14) FHWA Guidance and technical advisories
- (15) Addition/modification of access points to the Interstate (Interchange, locked gate access points, median crossovers for construction)
- (16) Project by project obligation of federal funds
- (17) Modifications to Federal-aid project agreements
- (18) Final Vouchers

128.3 FDOT Responsibilities

The final design documents, reports and plans for projects not selected as PoDI will be developed in accordance with all applicable Department manuals, guidelines and procedures, and in compliance with all applicable Federal Statutes, Regulations, Executive Orders, and FHWA Directives and Standards. The Department is responsible for assuring that all appropriate criteria have been adhered to, and for documenting its findings in lieu of FHWA reviews. Several of the major areas and the method to be used by the Department to document the acceptability of various final design activities in place of an FHWA review and approval are:

(1) Typical Section Package:

The typical section package should be prepared as described in **FDM 120.2.3** and **120.3.2**. Concurrence by the District Design Engineer documents the acceptability of the package. Concurrence from the District Structures Design Engineer may also be required on unusual bridge typical sections.

(2) Pavement Design Package:

The pavement design is developed and approved by the responsible professional engineer in accordance with Department pavement design procedures. Concurrence from the District Design Engineer is required to document the acceptability of the package in lieu of FHWA review and concurrence.

(3) Bridge Hydraulics Report:

The hydraulics report is developed and approved by the responsible professional engineer in accordance with appropriate design standards. Concurrence from the District Drainage Engineer is required to document the acceptability of the package in lieu of FHWA review and concurrence.

(4) Bridge Development Report:

The bridge development report is developed and approved by the responsible professional engineer in accordance with appropriate design standards. Concurrence from the District Design, Structures Design, or Project Management Engineer is required to document the acceptability of the report in lieu of FHWA review and concurrence.

Modification for Non-Conventional Projects:

Delete item (4).

(5) Design Plans Phase Reviews:

Plan reviews should be conducted as described in **FDM 120**. Concurrence in the resolution of phase review comments from the District Design, Structures Design, or Project Management Engineer is required to document the acceptability of the reviews in lieu of FHWA review and concurrence. (See **Form 128-A, in FDM 103**)

Modification for Non-Conventional Projects:

Delete the above paragraph and replace with the following:

Plan reviews will be conducted as described in **FDM 901**. (See **Form 128-B, in FDM 103**)

(6) Design Exceptions:

Design Exceptions on projects not selected as PoDI require approval and concurrence as described in **FDM 122**.

(7) Special Provisions:

Special provisions, which include project specific and technical special provisions, will be developed and approved by the responsible professional engineer. Concurrence from the District Specifications Engineer is required to document the acceptability of the special provisions in lieu of FHWA review and concurrence. (See **Form 128-C, in FDM 103**)

(8) Plans, Specifications, and Estimates:

The Plans, Specifications, and Estimates (PS&E) Package and contract file will be emailed to Central Office Final Plans section as described in **FDM 131**. The District Director of Transportation Development will certify that the design and PS&E Package has been prepared according to the appropriate certification procedures. The date of this certification will be noted on the Transmittal of PS&E Package. The Transmittal will also identify the individuals that reviewed the Plans Package, Specification Package, and Authorization Estimate, and the dates of their respective reviews. The Department's official estimate will be prepared by the District Estimates Office.

Modification for Non-Conventional Projects:

Delete Item 8.

(9) Authorization to Advertise:

The PS&E Package must be approved by the Specifications and Estimates Office prior to requesting FHWA authorization for construction to advertise. The Contract File Package (consisting of the documents listed on the Contract File Index completed by the district), FHWA Summary Sheet, Cost Estimate, Right of Way Certification, Utility Certification, Environmental Certification and Railroad Certification Agreement (if applicable), along with confirmation of the PS&E approval will be reviewed by the appropriate district and central offices and by the Federal Aid Management Office prior to submittal of the federal authorization request.

Modification for Non-Conventional Projects:

Delete Item 9 and replace with the following:

(9) Use of Federal Funds on Design-Build Projects

The District Design-Build team approves the Design Criteria Package before the release of the **Final Request for Proposal** to the Design-Build Firms. The Design-Build authorization request should be processed immediately upon notice of receipt of package approval. Upon receipt of the approved FHWA authorization, District Federal-Aid Coordinators should notify the District Design-Build firm so that the RFPs and Design Criteria packages can be distributed. See **Chapter 7.1** of the [Procurement and Administration Procedure \(Topic No. 625-020-010\)](#) procedure.

(10) Revisions:

Revisions to the PS&E Package will be processed as described in **FDM 132**. Concurrence from the District Design, Structures Design, or Project Management Engineer is required to document the acceptability of the revision in lieu of FHWA review and concurrence.

Modification for Non-Conventional Projects:

Delete Item 10.

In special cases where programs or projects are developed in the Central Office, an appropriate Central Office Manager will provide any necessary concurrences in lieu of a District Manager.

Modification for Non-Conventional Projects:

Delete the above paragraph.

(11) Environmental Review:

Pursuant to ***Title 23 U.S.C., Chapter 3, Section 327 and the Memorandum of Understanding (MOU)*** executed on December 14, 2016, the Department had assumed FHWA's responsibilities under the National Environmental Policy Act (NEPA) for highway projects on the State Highway System (SHS) and Local Agency Program (LAP) projects off the SHS. Based on this MOU, the Department responsibilities include environmental review, interagency consultation, and other activities pertaining to the review or approval of NEPA actions. The Department is the Lead Federal Agency for highway projects, and approval authority is held by the State Office of Environmental Management. (OEM).

128.4 Certification Documentation and Reviews

FHWA will perform periodic reviews of projects developed under the Stewardship and Oversight Agreement and may have access to review project phases and records at any time. Adequate documentation throughout the design phase is critical. All approvals and concurrences outlined in the previous section must be sufficiently documented. A complete, well-organized design project file should be able to support a compliance review. All correspondence and documents must include the Federal-aid project number. The Quality Assurance procedures described in ***FDM 125*** will be used by the Central Office to monitor district compliance with the certification requirements.

128.5 Certification Statement

A Federal-aid project certification statement by the District Director of Transportation Development for each project is no longer required; however, Districts are responsible for ensuring that all Federal-aid requirements are met as described in this chapter.

130 Signing and Sealing Documents

130.1 General

The act of signing, dating, and sealing contract component plans, BIM files, specifications, reports, or other documents is collectively referred to as signing and sealing.

This chapter provides the Department's requirements for signing and sealing plans and documents in conformance with **Florida Statutes (F.S.)** and **Florida Administrative Code (F.A.C.)**. The Laws and Rules referenced in this chapter are primarily those governing Professional Engineers. Other licensed professionals that are required to sign and seal plans or documents are to follow the Laws and Rules applicable to their profession.

It is the licensee's responsibility to comply with the signing and sealing requirements applicable to their profession's Laws and Rules. It is the District's responsibility to verify that documents are signed, sealed and transmitted in accordance with this chapter.

130.2 Signing and Sealing Contract Plans

The transmitted contract plans signed and sealed by the responsible professional(s) become the Record Set. Every sheet of the Record Set must be signed and sealed, except for the following sheets that may be appended to the contract plans set:

- Existing Bridge Plans,
- [Developmental Standard Plans](#), and
- Plans that are prepared by an employee of a Utility or other employees exempted under [Section 471.003, F.S.](#), except as follows.
 - Utility plans that modify or detail attachments to a bridge or other structure belonging to the Department must sign and seal the sheets affecting such bridge or structure.
 - Plans prepared by nonexempt parties for a Utility must be signed and sealed.

Every sheet of the Record Set must include a title block that contains information for the professional engineer that will sign and seal the sheet, showing:

- (1) The name, address, and license number of the engineer, or
- (2) If practicing through a duly authorized engineering business, the name and license number of the engineer, and the name and address of the engineering business, or
- (3) If employed by a local, State or Federal agency, the name and license number of the engineer, and the name and address of the agency.

A non-engineering licensed professional that will sign and seal the sheet must show similar information in the title block related to their profession.

130.2.1 Digital Signing and Sealing

Digital Delivery is the standard method of electronically transmitting contract documents to the Department. This includes the creation of Portable Document Format (PDF) files of contract plans and specifications, which are signed and sealed with a Digital Signature. The [CADD Manual](#) defines the type of digital certificate to be used for Digital Signature. A representation of the professional's seal next to the Digital Signature Appearance is required for Contract Plans.

Place the following OFFICIAL RECORD note on each plan sheet that is digitally signed and sealed:

"THE OFFICIAL RECORD OF THIS SHEET IS THE ELECTRONIC FILE
DIGITALLY SIGNED AND SEALED UNDER RULE 61G15-23.004, F.A.C."

For standard size (11"x17") plan sheets, the OFFICIAL RECORD note appears along the right edge of the plan sheet just outside the border. For large format (24"x36", 36"x48" or 36"x72") plan sheets, the OFFICIAL RECORD note appears in the information block located in the bottom right portion of the sheet.

The rule number referenced in the note above applies to the engineering professional that is signing and sealing the sheet. A non-engineering licensed professional should use the rule number that applies to their profession:

- Surveyors, Rule 5J-17.062, F.A.C.
- Geologists, Rule 61G16-2.005, F.A.C.
- Landscape Architects, Rule 61G10-11.011, F.A.C.
- Architects, Rule 61G1-16.005, F.A.C.

Electronically transmit the Contract Plans as individual signed and sealed PDFs of component plans. The list of component plans for Digital Delivery is comprised of the following:

- (1) Roadway Plans
- (2) Signing and Pavement Marking Plans
- (3) Signalization Plans
- (4) Intelligent Transportation System (ITS) Plans
- (5) Lighting Plans
- (6) Landscape Plans
- (7) Architectural Plans
- (8) Structures Plans
- (9) Toll Facilities Plans

The component plans listed above may require insertion of sheets that were prepared early in, or prior to the design process (“early works”). The following early plan sheets may be contained in a separate signed and sealed PDF that is to be included as part of the Contract Plans:

- GR-# Soil Survey and Report of Core Borings
- TR-# Tree Survey
- UTV-# Verified Utility Locate

No other plans sheets than those listed above are to be submitted separate from the component plans, except for manually signed and sealed documents as discussed in **FDM 130.2.2**.

See **FDM 910** for instruction on how to show early plan sheets on the Key Sheet.

130.2.1.1 Single Digital Signature

Component plans that will be signed and sealed by a single professional (signatory) may place a signature block, as shown in **Figure 130.2.1**, on the component Key Sheet in lieu of using a Signature Sheet. Listing the sheets contained in the PDF to be signed and sealed is not required.

Figure 130.2.1 Signature Block

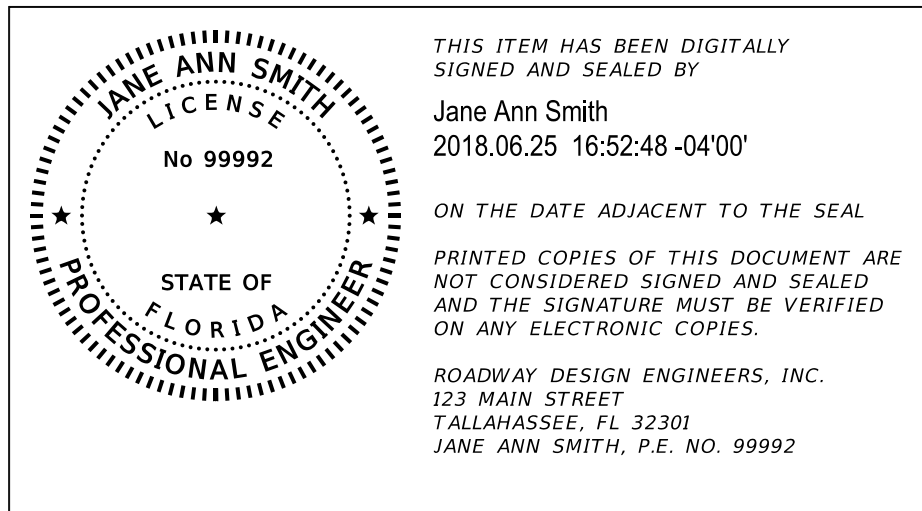

130.2.1.2 Multiple Digital Signatures

A Signature Sheet is required for component plans that will be signed and sealed by more than one professional. See **FDM 910** for Signature Sheet requirements.

130.2.2 Manual Signing and Sealing

Digital Delivery is the standard practice for signing and sealing, and transmittal of contract documents. Transmittal of contract documents that have been manually signed and sealed is only accepted when Digital Delivery is not possible. The following approval is required for acceptance of manually signed and sealed documents:

- (1) District Plans, Specifications, and Estimates (PS&E) Engineer for District Lettings.
- (2) State Final Plans Engineer for Central Office Lettings.

The district is to receive one set of manually signed and sealed contract documents to be retained as the record set. Place a note on the first sheet of the documents and scan into a pdf file. The note is to read: "This is a scanned copy of the original signed and sealed document". Use the scanned pdf file for the Letting process.

If the scanned pdf are sheets that are to be included with a component of the Contract Plans, follow the process for "early works", see **FDM 130.2.1**.

The requirements for manually signing and sealing are covered in the Laws and Rules for each licensee's profession. Do not include the note along the right edge of plan sheets that is used when documents are digitally signed and sealed.

130.3 Signing and Sealing Other Documents

Other documents to be signed and sealed include reports, calculations, specifications, and criteria packages, used in the development of design plans. Sign and seal Specifications Packages in accordance with the [Specifications Handbook](#).

130.3.1 Digital Signing and Sealing

Signing and sealing PDF documents with a Digital Signature is the standard practice. Place a signature block on the first sheet of the PDF document. A representation of the professional's seal next to the Digital Signature Appearance is optional for other documents.

When including a representation of the professional's seal, use the signature block as shown in **Figure 130.2.1**.

When omitting a representation of the professional's seal, use the following signature block:

[NAME], State of Florida, Professional Engineer, License No. [NUMBER]

This item has been digitally signed and sealed by [NAME] on the date indicated here.

Printed copies of this document are not considered signed and sealed and the signature must be verified on any electronic copies.

130.4 Signing and Sealing BIM Files

BIM files are signed and sealed 2D or 3D CADD files that are included with the contract plans. BIM files are listed in a manifest that is placed on the Signature Sheet within the component plans to which the files apply. Each listed file has a unique hash code that identifies the CADD file being signed and sealed. See **FDM Exhibit 910.4** for an example of a BIM file manifest.

FDOT [CADD Manual](#), Section 8.4 Project Deliverables, outlines the steps to complete this process. A training webinar can be found at the following link: [BIM S&S Procedure](#).

130.5 Signing and Sealing Revisions

Modification for Non-Conventional Projects

Delete the first sentence of the above paragraph and replace with the following:

Design revisions are modifications to the plans submittal after it has been stamped Released for Construction.

Design revisions are modifications to the PS&E Submittal after it has been accepted by Central Office Final Plans. Revisions made after the award of the contract are referred to as post-let revisions. Revisions should be prepared by the same professional that Signed and Sealed the plan sheet contained in the Record Set or the original document. When it is necessary to have revisions signed and sealed by a different professional, provide exculpatory language defining the professional's limits of responsibility.

130.5.1 Contract Plans Set

Prepare design revisions as outlined in **FDM 132**. Sign and seal the revision package PDF in accordance with **FDM 130.2**.

Prepare post-let revisions as outlined in **FDM 132** and **Chapter 5** of the [Construction Project Administration Manual \(CPAM\)](#). Sign and seal the revision package PDF in accordance with **FDM 130.2**.

130.5.2 Specifications

Prepare a Supplemental Specifications Package when it becomes necessary to revise either the Specifications Package or a previous Supplemental Specifications Package. Sign and seal the Supplemental Specifications Package in accordance with the [Specifications Handbook](#).

130.5.3 Other Design Documents

Sign and seal each revised sheet and place immediately behind the cover sheet of the original signed and sealed document.

130.6 Support Documents

Engineering decisions are often made on the basis of support documents furnished by non-engineering staff or offices. Two support documents that require certification that they were prepared in accordance with Department procedures are shown in **Form 130-A** and **Form 130-B**; see **FDM 103** for forms.

131 Plans Processing

131.1 General

This chapter describes the critical activities required to process the contract plans, specifications and estimate for letting. It identifies the transmittal forms, certifications and other documents prepared by the District and the various offices involved in processing a Plans, Specifications & Estimates (PS&E) submittal package.

This chapter also outlines the steps to resubmit a project that has been withdrawn from letting.

Projects must be electronically delivered in Digital Delivery format in accordance with **FDM 130** and the [CADD Manual](#).

Other specific requirements for processing the electronic delivery, including information on the Electronic Delivery software, can be found in the [CADD Manual](#).

131.1.1 Definitions

- (1) **Contract Documents:** Contract Documents are treated as one instrument which includes all the following:
 - (a) Advertisement for Proposal, Proposal, Certification as to Publication and Notice of Advertisement for Proposal,
 - (b) Appointment of Agent by Non-resident Contractors,
 - (c) Non-collusion Affidavit,
 - (d) Warranty Concerning Solicitation of the Contract by Others,
 - (e) Resolution of Award of Contract,
 - (f) Executed Form of Contract,
 - (g) Contract Bond,
 - (h) Standard Specifications and Plans (including revisions thereto issued during advertisement),
 - (i) Supplemental Specifications Package,
 - (j) Required Insurance(s) and,

- (k) Addenda, or other information mailed or otherwise transmitted to the prospective bidders prior to the receipt of bids, work orders, and supplemental agreements.

Modification for Non-Conventional Projects:

Delete **FDM 131.1.1** item (1) and replace with the following:

- (1) **Contract Documents:** Contract Documents are treated as one instrument which includes all the following:

- (a) Advertisement, Request for Proposal (RFP),
- (b) Technical and Price Proposal,
- (c) Certification as to Publication and Notice of Advertisement for Proposal, Appointment of Agent by Nonresident Contractors,
- (d) Non-collusion Affidavit,
- (e) Warranty Concerning Solicitation of the Contract by Others,
- (f) Resolution of Award of Contract,
- (g) Executed Form of Contract,
- (h) Contract Bond,
- (i) Design Liability Insurance,
- (j) Standard Specifications and Plans (including revisions thereto issued during construction),
- (k) Addenda, written statements or transcripts or minutes of oral representation by Design-Build Firm made at oral presentations, or other information mailed or otherwise transmitted to the prospective bidders prior to the receipt of bids, work orders and supplemental agreements, whether or not set forth at length in the form of contract.

- (2) **Plans:** Plans include 2D Contract Plans Set(s) and 3D Build Information Model (BIM) files. Plans show the location, character, dimensions, and details of the work.
- (3) **Final Plans:** Plans are considered final after changes noted during the Phase IV submittal review are completed and verified.
- (4) **Mandatory Specification Revision:** A required change to the Specifications, Design Standards, or other contract documents, caused by changes in Federal Regulations, State Statutes, Rules, safety improvements, technological changes,

or omissions and implemented on a time-critical schedule, effective with a specific letting month and year.

- (5) **Plans, Specifications, and Estimates (PS&E) Submittal Package:** For Contract Class 1 (Central Office Letting) this package is transmitted by the District Final Plans Office to State Program Management Office, Final Plans section, or to District Contracts Office for letting. For Contract Class 7 (District Letting) this package is transmitted by the District Plans, Specifications, and Estimates office(s) to District Contracts Office for letting. The package consists of signed and sealed Final Plans and BIM.zip, Specification Package, the Estimated Quantities Report, and other contract and transmittal documents. PS&E Submittals are numbered consecutively, and re-submittals are required until the project is accepted by the District Program Management Office.
- (6) **Authorization Estimate:** The Authorization Estimate is a report generated by the Design Quantities and Estimates (DQE) that is automatically saved to a server for access by authorized users. The Authorization Estimate must be posted to the server no later than the PS&E Transmittal Date.
- (7) **Production Date:** The committed completion date for Final Plans, Specifications Package, and certifications (e.g., utilities, permits, R/W, environmental); these documents must be ready for compilation into the Contract File Index.
- (8) **PS&E Phase:** The plans processing period between Phase IV plans and delivery of PS&E Package to State Program Management Office, Final Plans section, or to District Contracts Office.
- (9) **PS&E Review(s):** Review(s) consisting of the Final Plans, Specifications and Estimate along with any other contract and transmittal documents.
- (10) **PS&E Transmittal Date:** The committed date for the transmittal of the PS&E Submittal Package to State Program Management Office, Final Plans section, or to District Contracts Office.
- (11) **Supplemental Specifications Package:** A signed and sealed document modifying the Specifications Package after construction contract advertisement.

131.2 District Plans Processing

There are plans processing activities that occur in the Districts prior to submitting the PS&E Submittal Package to State Program Management Office, Final Plans section, or to District Contracts Office. The schedule for these activities vary by District; contact the District Final Plans Office for specific requirements.

Review of contract documents during the PS&E Phase often require modifications to the plans, specifications, or quantities. It is considered a Plan Change when modifications

are made prior to the District Estimates Office changing the AASHTOWare Project Preconstruction (PrP) Workflow/Phase or Central Office acceptance of the PS&E Submittal Package.

Plan Changes include modifications, deletions, or addition of data on individual sheets, or adding and deleting entire sheets. Plan Changes also include modifications, deletions, or addition of data to BIM files. Plan Changes are not Plan Revisions (as described **FDM 132**); therefore, do not note Plan Changes in the Revision Block on the sheets.

131.2.1 Authorization Estimate

The Authorization Estimate (used for budgeting construction dollars in the Work Program) is one of the last activities performed during the design phase. Using the final quantities loaded into AASHTOWare Project Preconstruction™ by the EOR, District Estimates Office will adjust unit prices (when appropriate). The District Estimator typically considers the following items when adjusting costs:

- Order of magnitude of the quantity (exceeding high or low)
- Availability of materials
- Accessibility to project location
- Complexity of work, or Traffic Control Plan
- Specialty work or materials
- Contract time restrictions

When finalized, post the Authorization Estimate to the server. Posting must be no later than PS&E Transmittal Date.

131.2.2 Processing the PS&E Submittal Package

District Final Plans Office initiates the collection and processing of PS&E Submittal documents using the PS&E Module within Project Suite Enterprise Edition (PSEE). When the PS&E Submittal package is complete and ready for submission, control of the PSEE model will be transferred to the appropriate office. Transfer control of the PS&E Module no later than the PS&E Transmittal Date to:

- State Program Management Office, Final Plans section, or
- District Contracts Office for district-let projects

Upon receiving control of the PS&E Module, the appropriate office (indicated above) will check the package for completeness. If incomplete, the District Final Plans Office is notified to provide a corrected submittal.

Transfer control of the AASHTOWare Project Preconstruction™ (PrP) project files to the State Program Management Office, Final Plans section when transferring control of the PS&E Module.

131.2.2.1 Transmittal Memo

The Transmittal Memo provides project information to assist with plans processing, and to certify that required approvals have been received. The Transmittal Memo is populated within the PS&E Module. Update the Transmittal Memo whenever information changes due to project updates.

131.2.2.2 Revisions to PS&E Submittal Package

Revisions are modifications to the PS&E Submittal Package after it has been accepted by State Program Management Office, Final Plans section, or District Contracts Office. See **FDM 132** for information on revisions to the PS&E Submittal Package.

131.2.2.3 Re-submittal of Withdrawn Projects

Modification for Non-Conventional Projects:

Delete FDM 131.2.2.3 .

When a District withdraws the PS&E Submittal Package for major revisions before the letting, the project must be resubmitted as a new PS&E Submittal Package with all required components. Show the new Proposal/Contract ID number on the Key Sheet(s).

Project documents in Central Office from the previous submittal will be deleted. A project withdrawn for a period of nine months or longer will be updated according to the process outlined in **FDM 112**.

Districts must coordinate with Central Office Production Management or District Contract Administration to reschedule a letting.

131.3 Central Office Plans Processing

Figure 131.3.1 illustrates the Central Office activities for processing the contract documents for Letting.

Figure 131.3.1 Plans Processing for Central Office Letting

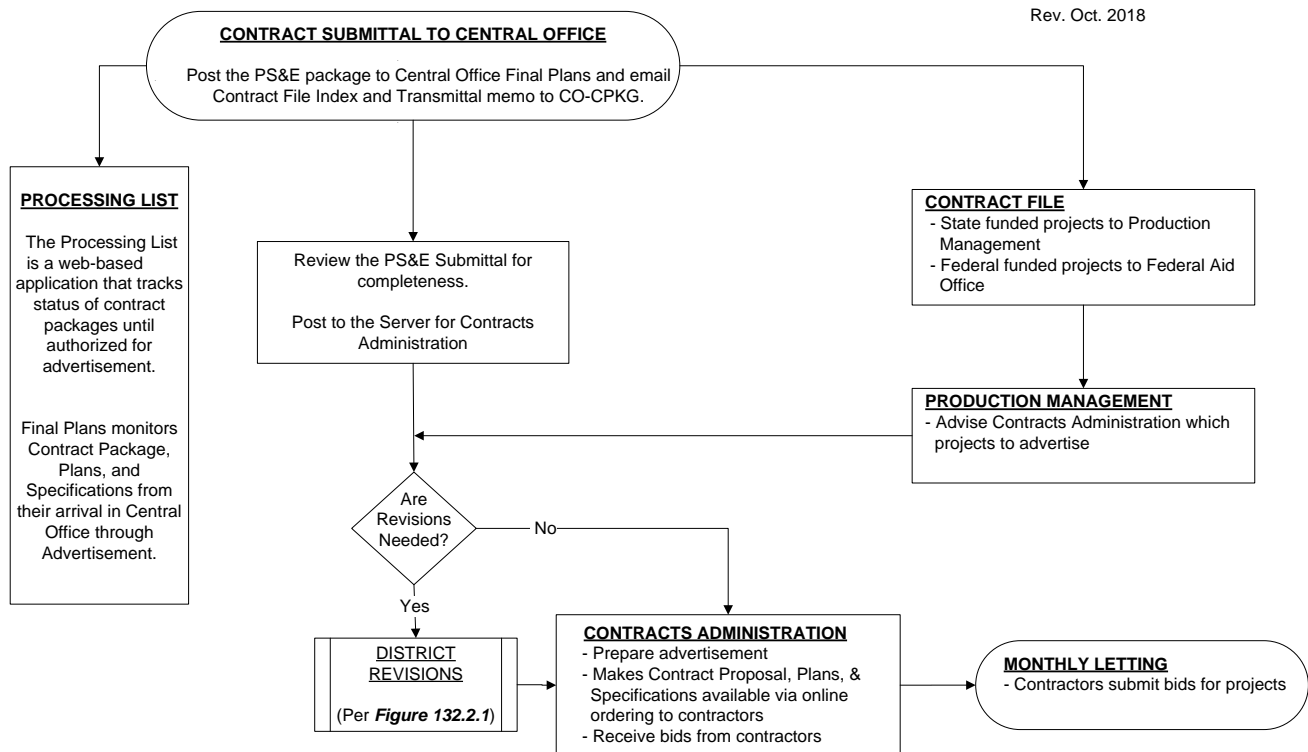

131.4 Re-advertised and Reissued Process

A re-advertised and reissued PS&E Package occurs when a PS&E Package has been advertised/withdrawn or moved beyond advertisement. For a re-advertised and reissued PS&E Package, the Specification Package is to be revised to the current Specifications workbook. The word "REISSUED" precedes the Specifications Package date, as applicable throughout the document.

131.5 Letting Date Changes

The process for changing letting dates depends on the advertisement status of the project.

131.5.1 Before Advertisement

Districts send an email notification of the letting date change to CO-CPKG. Request access to AASHTOWare if the AASHTOWare transfer has occurred. The Project deliverables then become a new submittal with the new letting date.

131.5.2 After Advertisement

For letting date changes from the district, the letting date in the embedded transmittal form will update automatically when Work Program changes the letting date in PSEE.

For letting date changes under a new Specification Workbook and new Standard Plans publication, the Project deliverables must be brought up to date with these new standards. This will require a Plans Revision and an updated Specifications Package. The updated Specifications Package must be listed on the revision memo. Pay items should be checked and updated as necessary for validity with the new date.

132 PS&E Submittal Package Revisions

132.1 General

A PS&E Revision Package is required when modifications to plans, specifications, or estimates are made after the PS&E Submittal Package has been accepted by the State Program Management Office, Final Plans section or District Contracts Office. **Figure 132.1.1** illustrates the flow for processing a Revision Package.

The responsible professional Signs and Seals each revised document in accordance with the requirements of **FDM 130**. If the original professional engineer is not available to prepare a revision and is replaced by a new one, an additional signature sheet should be created listing the sheets containing the revisions they are responsible for.

Other specific requirements for processing the electronic delivery, including information on the Electronic Delivery software, can be found in the [CADD Manual](#).

Figure 132.1.1 Processing Revision Packages

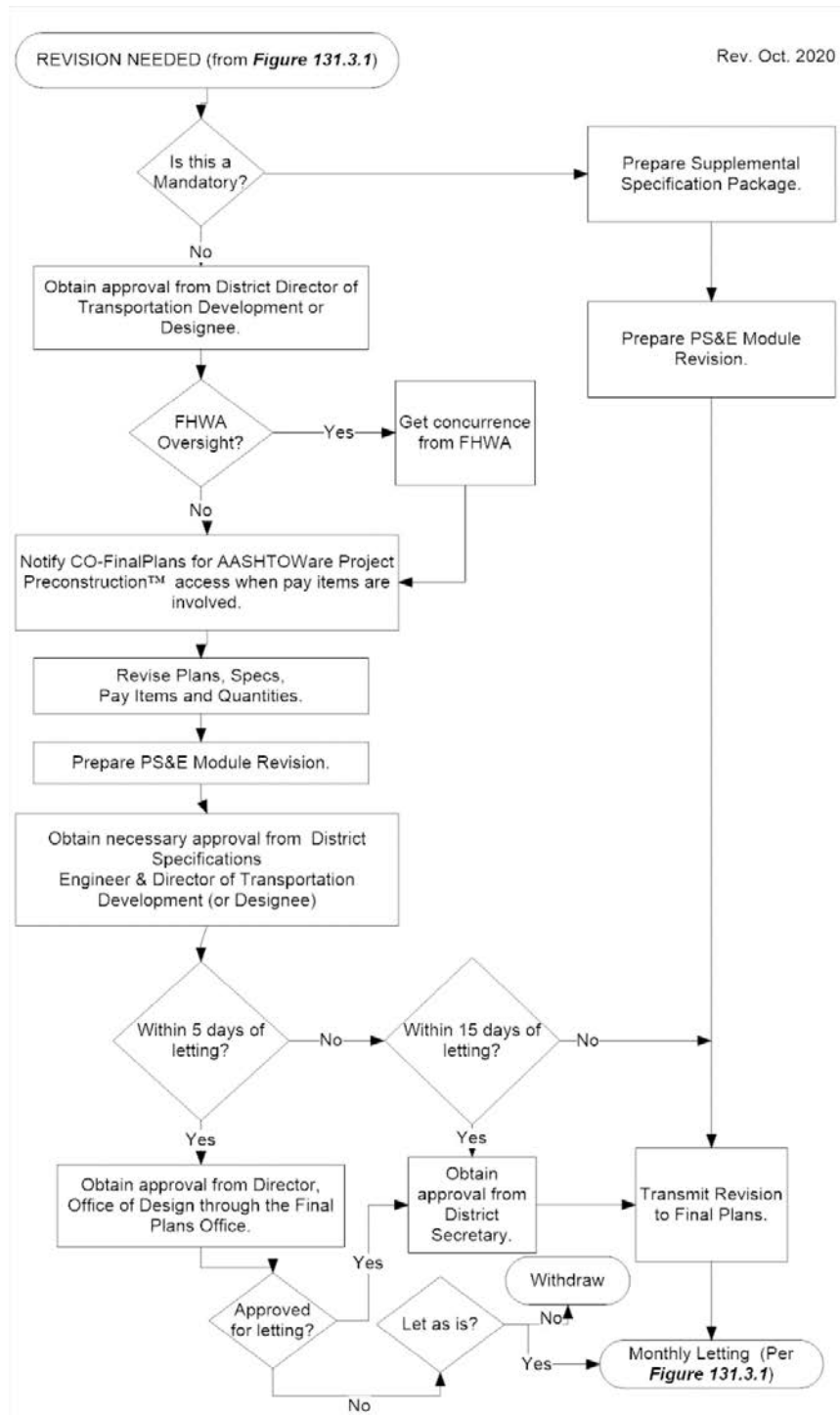

132.2 Plans Revisions

Assign a unique numbered symbol (e.g., a numbered triangle) to each revision made to the Contract Plans. Begin the revision numbering with “1” and number subsequent revisions sequentially. Place the numbered symbol next to the revision on the sheet. Provide the date, numbered symbol, and a brief description of the revision in the Revision Block on each modified plan sheet.

When adding a sheet, the new sheet may be numbered with alphabetic suffix (e.g., 22A, 22B, 22C). Place the revision date, numbered symbol for the revision, and the description “Added Sheet” in the Revision Block of the new plan sheet. Revise the Index of Plan Sheets on the Key Sheet to include the new sheet.

When deleting a sheet, the sheet numbers for the following sheets remain unchanged. Place the revision date, numbered symbol for the revision, and the description “Deleted Sheet” in the Revision Block of the deleted plan sheet. Revise the Index of Plan Sheets on the Key Sheet to indicate the deleted sheet.

See **FDM 910** for instructions on recording a revision on the Key Sheet. Submit each revised component of the Contract Plans as an individual PDF with an appendix REV and the revision number, for example:

- 43177035201-PLANS-01-ROADWAY-REV01
- 43177035201-PLANS-02-SIGNINGMARKING-REV01
- 43177035201-PLANS-03-SIGNALIZATION-REV01

Submit a BIM.zip or CADD.zip file that contains CADD files that have been modified to create the plans PDFs. Use the same appendix (e.g., 43177035201-CADD-REV01) when naming the zip file.

132.3 Supplemental Specifications Package

District Specifications Engineer (or designee) must review the Contract Plans revisions for any effect on the specifications. When changes to the Specifications Package are necessary, prepare a Supplemental Specifications Package in accordance with the requirements of the [Specifications Handbook](#). The completed Supplemental Specifications Package must be submitted with an appendix SUPP and the revision number (e.g., 43177035201-SPECS-SUPP01).

132.3.1 Mandatory Specification Revisions

Mandatory Specification Revisions issued from Central Office will be processed as a Supplemental Specifications Package. Revision Memo approvals are not required for Mandatory Specification Revisions, unless additional revisions are included in the package.

132.4 EQ Report Revisions

Any revision to the Estimated Quantities (EQ) Report will require the report to be generated in its entirety, including quantities for components that did not require a change. Use the same appendix (e.g., 43177035201-ESTIMATES-QUANTITIES-REV01) when naming the EQ Report pdf file.

To create the modified EQ Report, the Calculations Folder within the CADD folder structure must be updated to include only the latest summary tables. Include the updated Calculations Folder in submitted BIM.zip or CADD.zip file.

Place a revision block (see **Figure 132.4.1**) on the EQ Report signature page and indicate pay item numbers and quantities that were revised. Each subsequent resubmittal of the EQ Report will add to the previous revision block so that a complete history of changes is provided. When numerous changes are necessary, the revision block made be placed on its own sheets directly behind the cover sheet.

Figure 132.4.1 Example Revision Block

Revisions		Pay Item		Quantity	
Number	Date	Number	Add/Del/Rev	Old	New
REV01	2/9/21	425-5-1	Add		16.000
		425-6	Add		34.000
		1644-800	Add		1.000
REV02	2/19/21	102-71-16	REV	288.000	329.000
		102-89-1	REV	2.000	4.000

When access to AASHTOWare Project Preconstruction™ is required to make pay item number or quantity revisions, send a request for access to the State Program Management Office, Final Plans section (CO-FINALPLANS). The district will then be granted access for a period not to exceed 2 business days. Access will not be given within 10 days of advertisement.

132.5 Revision Memo

Process revision packages using the PS&E Module within Project Suite Enterprise Edition (PSEE). All revisions to the PS&E Package require a completed Revision Memo providing a Revision Number and describing modifications. Record the revision date for each revised sheet, using the date shown in the revision block on the sheet.

When the revision package is complete and ready for submission, control of the PS&E Module will be transferred to the appropriate office (see **FDM 131.2.1**). The receiving office will check the revisions for completeness.

If information on the Transmittal Memo changes due to Project updates, the Transmittal Memo must be updated within the PS&E Module whether it is a formal Revision or not.

132.5.1 Required Approvals

Several approvals are required to process a revision:

- (1) Obtain concurrence from the District Director of Transportation Development (or designee). Concurrence may be in the form of an email that includes a summary of the revision or a signed Revision Memo.
- (2) In accordance with the Stewardship and Oversight Agreement or the project-specific Project of Division Interest (PoDI), obtain an email concurrence from FHWA prior to making revisions or requesting access to the AASHTOWare Project Preconstruction™. Include the name of the FHWA contact and the concurrence date on the Revision Memo. Major changes to plans or specifications on PoDI Projects made during the advertising period will require the FHWA Division Administrator's approval prior to issuing addenda. Major changes increase the project cost (>\$50,000), alter project termini, change the character of the project, or modify scope of the work.
- (3) Approval from the District Secretary is required on the Revision Memo if the revision is submitted within 15 working days of the letting. Approval can be documented by uploading an email approval to PS&E Module "Supporting Documentation Section".

- (4) Approval from the Director of the Office of Design is required if the revision is submitted within five working days of the letting. Since there is no assurance that all prospective contractors will get these documents on time to be considered in their bids, approval for a revision within five working days of the letting is uncommon. If approval is not granted, the project will either be let as is, or be withdrawn from letting. Withdrawing or moving the project to a later letting after advertisement requires approval by the District Secretary and the Chief Engineer.

133 Retention of Electronic Documents

133.1 General

The documents and files created throughout the life of a project must be retained in electronic format. There are several different storage systems used for retaining these records. See **Figure 133.1.1**. As-built documents that are to be scanned for electronic storage should meet both requirements of the **Construction Project Administration Manual (CPAM), Section 5.12** and the [Transportation Technology User's Manual \(FDOT Procedure No. 325-000-002\)](#).

Figure 133.1.1 Storage of Electronic Documents

Active VAULT	Archive VAULT	Electronic Data Management System (EDMS) Legal Records for Department of State Requirements – Image files (PDF Version 1.7 or TIF) only. For information on Specific Document Types stored in each Group contact the Responsible Office			
		DESIGN EDMS	CONTRACT EDMS	CONSTRUCTION EDMS	STRUCTURES MANAGEMENT EDMS
<p>File management system for in-house CADD file check in/out.</p> <p>Allows for multiple users to work on same files.</p> <p>Working files only.</p> <p>Can be used during Construction Phase to prepare As-Built Plans.</p>	<p>Electronic Vault for Storage of electronically signed, or digital delivery files</p> <p>For Storage of: - Project CD - Plans and Specs CD - Revisions CD - Cat II Bridge As-Built Files</p> <p>Files stored in the PEDDS Database cannot be written.</p>	<p><u>Design Records</u></p> <p><u>Groups</u> Architectural Community Involvement Drainage Environmental Permits Estimates FDOT Publications</p> <p>Geotechnical/Materials Landscaping Lighting Product Evaluation Project Management Rdwy Design Documentation Does not include Plans</p> <p>Roadway Resource Library Specifications Structures Structures Resource Library Tolls Facilities Traffic Design Utility Agreements</p> <p>NOTE: Contract Plans are not stored in the Design EDMS.</p>	<p><u>Contract Records</u></p> <p><u>Groups</u> Construction Contracts: - Amendments - Bid Blank - Certificate of Insurance - Contract - Federal Aid Contract - Provisions - Permits - Pertinent Pages - Proposal - Special Provisions - Specifications - Supplemental Specifications - Utility Work Schedule - Wage Rate</p> <p>Supporting Construction Contract Documents: - Award Letter - Correspondence - Daily Diaries - Execution Letter - Final Estimates Package Work Progress</p> <p>NOTE: Contract Plans are not stored in the Contracts EDMS.</p>	<p><u>Construction Records</u></p> <p><u>Groups</u> Claims Compliance Contract Changes Includes Design Errors and Omissions, Field SA/Work Orders, and SA/Change Orders Contract Documents As-Built Plans Daily Diary Estimates Final Estimates General Correspondence Job Correspondence Material Sampling and Reporting Pre-Letting Includes Design Correspondence Quality Assurance/Quality Control Service Contracts Working Drawing Transmittals Structure Sublet Work Time Correspondence Unpaid Bills Utility</p>	<p><u>Maintenance Records</u></p> <p><u>Groups</u> Bridge Plans and Specifications Bridge Record Bridge Working Drawings Correspondence Geotechnical High Mast Record Sign Record Structural Calculations - As-Bid Plans - As-Built Plans - Repair As-Bid Plans - Repair As-Built Plans - Widening As-Bid Plans - Widening As-Built Plans</p>

140 Lump Sum Projects

Modification for Non-Conventional Projects:

Delete ***FDM 140***.

140.1 General

The purpose of Lump Sum projects is to reduce the costs of contract administration associated with quantity, verification, and measurement. This contracting technique requires the Contractor to submit a lump sum price to complete a project as opposed to bidding on individual pay items. The Contractor will be provided a set of bid documents (plans, specifications) and will develop a Lump Sum bid for all work specified in the contract drawings.

The decision to use the Lump Sum Contracting Technique on a project should be made by the District Design Engineer in consultation with the District Construction Engineer. Lump Sum Projects should be identified during the scope development process, rather than during or after the design process. Conversion of partially complete plans and completed “plans on the shelf” that were originally developed as conventional bid item type projects to the Lump Sum Technique may require significant rework and is generally not recommended.

The contingency pay item is recommended on a Lump Sum project. This tool is used to compensate the Contractor for any additional work requested, which is not covered in the contract documents. District Construction should be consulted for the contingency amount.

140.2 Project Selection

Lump Sum contracting should be used on simple projects. “Simple” is defined by the work activity, not by the project cost. “Simple” projects are:

- (1) Projects with a well-defined scope for all parties (Design and Construction)
- (2) Projects with low risk of unforeseen conditions (i.e., projects that do not involve such things as significant underground utilities, earthwork variations, underground drainage pipes, bricks under pavement in urban areas)
- (3) Projects with low possibility for change during all phases of work – Design and Construction (i.e., limited possibilities for added driveways, median modifications due to developments, or changes due to political involvement)

Examples of projects that may be good Lump Sum contracting candidates:

- (1) Bridge painting
- (2) Bridge projects
- (3) Fencing
- (4) Guardrail
- (5) Minor Intersection improvements (with known utilities)
- (6) Landscaping
- (7) Lighting
- (8) Mill/Resurface (including Interstate) without complex overbuild requirements
- (9) Minor road widening
- (10) Sidewalks
- (11) Signing
- (12) Signalization

Examples of projects that may not be good Lump Sum contracting candidates are listed below. Use of Lump Sum contracting on these type projects requires written approval by the State Roadway Design Engineer:

- (1) Urban construction/reconstruction
- (2) Rehabilitation of movable bridges
- (3) Projects with subsoil earthwork
- (4) Concrete pavement rehabilitation projects
- (5) Major bridge rehabilitation/repair projects where there are many unknown quantities
- (6) JPA Projects with local agency funds

140.3 Plans Preparation

Plan content should conform to the requirements of **Part 3 or Part 9**, subject to the guidance provided herein. Designers should detail plans, either by detailed drawings or plan notes, to clearly describe the work to be performed by the contractor. Notes and requirements must provide specific direction and details that can be properly bid on by the Contractor; avoid notes containing “as directed by the Engineer”.

The following are some of the desired elements in a set of Lump Sum plans:

- (1) Typical Sections.
- (2) Milling, resurfacing and overbuild details to show any cross-slope corrections, including existing pavement cross slope information.
- (3) Document quantities for all work to be performed on the project by location in the Estimated Quantities Report.
- (4) Plan sheets to accurately depict existing conditions and detail all work to be performed by contractor. (i.e., show all limits of milling and resurfacing, pipe installations, limits of sod when different from typical section, all concrete work, guardrail removal/installation).
- (5) Details of work not covered by typical section or the [Standard Plans](#) (e.g., curb and gutter installation, traffic separator limits, special curb ramps, modifications to storm inlets).
- (6) Cross sections when shoulder break is moved. When cross sections are provided, earthwork columns should not be used.
- (7) Anticipated pile tip/drilled shaft elevations on bridge projects. Note: This is the predicted elevation to achieve axial capacity and satisfy all other design requirements and is usually deeper than the minimum tip elevation shown for piles.

140.4 Preliminary Estimate

For a single project (one FPID number), load the pay item for Lump Sum (Alternative Bidding, 999-2) and the Initial Contingency Amount (Do Not Bid) Pay item (999-25) into Designer Interface for AASHTOWare Project™ Preconstruction under the project's FPID number. Load the detailed pay items and quantities that make up the Lump Sum Project scope of work into the Designer Interface system under a duplicate project number created using the FPID number appended with the designation, "LS" (Ex. 12345678901LS). The pay items and quantities are loaded by category to reflect the work shown in each design group.

For a strung project (multiple FPID numbers), load the Lump Sum and Initial Contingency Amount pay item into the Designer Interface system for each FPID number. Load the detailed pay items and quantities for each FPID number into the Designer Interface system under the respective duplicate project number (i.e., Do not load all pay item and quantity information into one FPID number).

Detailed pay items and quantities that make up the Lump Sum Project scope of work will be loaded into a duplicate project from the one to be advertised. Pay items and quantities

are loaded into the Designer Interface system by category to reflect the work shown in each design group. Contact the Project Manager for specific requirements.

140.5 Specifications

The Design Project Manager will provide an “Items of Work” checklist to the District Specifications Office. This checklist is **Form 140-A**, which is found in **FDM 103**. The Specifications Office will include the work items identified on the checklist in the “Intent and Scope” in the Specifications Package. The checklist must include, as a minimum, the major work items shown in the sample included with these guidelines.

Lump Sum Projects require Special Provisions that modify the first nine articles of the Standard Specifications. These Special Provisions are in the Specifications Workbook and must be included as part of the Specifications package.

Article 9-2 of the Special Provisions for Lump Sum Projects must be completed with predetermined unit prices for asphalt materials, concrete, and base when applicable. These unit prices will serve as a basis for calculating pay reductions for deficiencies accepted by the Project Engineer. In the case of asphalt overbuild, the predetermined unit price for the material used for overbuild will serve as a basis for pay adjustments for thicknesses that differ from the thickness shown in the plans. All predetermined unit prices should be based on an analysis of similar type projects let in the District and the District wide average of projects let within the six months prior to the letting date of the project.

For projects including bridges, Article 9-2 of the Special Provisions for Lump Sum Projects must be completed with predetermined unit prices for piling and drilled shafts as applicable. These unit prices will serve as a basis for pay adjustments for the actual quantities installed as additions or deletions from the individual element lengths shown in the plans. All predetermined unit prices should be based on an analysis of similar type projects let in the District and the Districtwide average of projects let within the six months prior to the letting date of the project.

140.6 Contracts Administration

Contracts Administration will include the information provided in the Specifications Package “Intent and Scope” in the job advertisement. This information can be used by the contractors/subcontractors to determine what type of work is contained in the project, in lieu of a list of pay items.

140.7 Construction Contract Administration

Monthly payments will be made based on a payout schedule mutually agreed upon by the Department and the Contractor. The payout schedule will include only major tasks similar to what has been used on design-build projects.

Lump Sum contracts are not fixed price. Changed conditions, extra work and unforeseen work must be negotiated and resolved with the Contractor utilizing Supplemental Agreements and Work Orders on Contingency Supplemental Agreements.

Construction inspection personnel should not be required to document quantities except for asphalt and other items subject to pay adjustments (items with predetermined unit prices). Measurement and completion of "Final" Estimated Quantities Report is not required. Focus should be on inspection and achieving a quality final product. For example, the Project Engineer will not be concerned with how many square yards of sod it takes or the number of miles of final striping. The Project Engineer will be charged with ensuring that the sod, striping, embankment, and pipe meets the lines and grades of the plans and specifications.

140.8 Materials Sampling and Testing

The Laboratory Information Management System (LIMS), relies on the pay items identified in AASHTOWare Project Preconstruction™ (formerly TRNS*PORT), which are populated via the Designer Interface, to generate a Job Guide Schedule based on the ***Sampling, Testing and Reporting Guide (STRG)***. On Lump Sum projects, since there is no detailed pay item list to identify the various types of work, LIMS will output a generic Job Guide Schedule. Some materials will not actually be used depending on the project scope. Personnel should use the Job Guide Schedule entries applicable to their project and input sample data and field test results into LIMS system in accordance with standard procedures. Materials not included on the Job Guide Schedule will be accepted in accordance with **Section 6** of the [Standard Specifications](#) and other pertinent contract documents.

150 Consultant Priority Matrices

150.1 General

Following the completion of the project design phase, the EOR will continue to be available to assist the CEI through the completion of construction of the project. The ***Construction Project Administration Manual (CPAM)*** defines the terms, methods, and processes that the Department and Construction Consultant personnel use to administer construction contracts, including engaging the EOR for various reasons. Specifically, ***CPAM, Section 8.11*** includes a Request For Information (RFI) Priority Matrix and Escalation Matrix. The RFI Priority Matrix is used to determine the required RFI response time for CEI and Design, and the Escalation Matrix will expedite decisions by escalating issues to the next level when not resolved within the RFI response time.

151 Revision Packages

151.1 General

This chapter outlines the process for the development and delivery of revision packages. A revision package is created when the engineering design is changed, and associated documents are modified. There are two types of revision packages:

- (1) Post-let revisions for Design-Bid-Build
- (2) Post-stamped revisions for Design-Build Projects

151.2 Post-Let Revisions

Post-let revisions occur after the project has been awarded for construction. It is the responsibility of the Department's Design Project Manager (PM) to process the required revision package, including any necessary reviews (typically conducted using ERC). The process used to develop and deliver a plans revision package to Construction is as follows:

- (1) The Department identifies the need for a modification and notifies the EOR.
- (2) The EOR develops the draft revision package and delivers it to the Design PM.
- (3) The Design PM is responsible for ensuring that appropriate Department review is conducted.
- (4) When all comments and issues are resolved, the EOR will submit a final signed and sealed revision package to the Design PM. Include a Revision Memo that summarizes the changes made to the contract document in the revision package.
- (5) The Design PM uploads the revision package into the PSEE Design Documentation module.
- (6) The Design PM notifies the Construction PM that the revision is available.
- (7) The Design PM delivers the modified CADD files to the District CADD Manager to be included in the Vault Archive.

151.2.1 Post-Let Revision Package

For revision files contained within the revision package, use the original file name with a suffix “-REV##” (see [CADD Manual](#), Chapter 8). For example, the third revision to a Roadway component is named:

fpid-PLANS -03-ROADWAY-REV03.PDF

Begin the revision package numbering with “1” and number subsequent packages sequentially. For projects which have been revised pre-award, begin the numbering where the pre-award numbering left off. For large complex projects, when requested by the Department, number revision packages by addendum issuance to easily differentiate changes for work order/supplemental agreement processing. In this case, a shape other than a triangle may be utilized.

A revision package is a ZIP file that contains the following documents, as applicable:

- Revision Memo
- Signed and sealed pdf plan sheets
- CADD.zip or BIM.zip
- Specifications (TSPs, MSPs)
- Estimated Quantities

151.2.1.1 PDF Plan Sheets

Revised plan sheets are placed in a single pdf file for each component affected by the change(s). Each component pdf file contains only those sheets that have been modified.

For naming the component pdf file(s), use the original file name with a suffix “-REV##”. For example, the pdf file name for a third revision to the Roadway component is named:

fpid-PLANS -03-ROADWAY-REV01.PDF

Revise pdf plan sheets as follows:

- (1) Revise CADD and BIM files to reflect the required changes or modifications. Add new files or sheets as required.
- (2) “Cloud” revisions in a conspicuous manner within the CADD sheet files. “Cloud” only the latest revisions, i.e., don’t “cloud” previous revisions to the sheet.
- (3) Place the revision number within a unique symbol (e.g., a numbered triangle) beside the “clouded” revision.

- (4) Place the revision date, corresponding numbered symbol for the revision, and a brief description of the revision in the sheet Revision Block.
- (5) If an entire sheet is being deleted, place a circle and strike (Ⓝ) through the entire drawing area and include the deleted sheet in the component pdf file as a revised sheet. Note the deleted sheet on the Key Sheet Index of Sheets.

Create component pdf file(s) containing all affected plan sheets. Forward updated CADD.zip or BIM.zip to District CADD Manager for inclusion in Vault Archive.

151.2.1.2 CADD Files

Provide a CADD.zip or BIM.zip that includes all CADD files that were modified due to the revision. Include the BIM file manifest on the Signature Sheet when signing and sealing a revised BIM file. Indicate in the manifest the BIM file being submitted, the revision package number, and a thorough description of the modifications made to the file.

151.2.1.3 Specifications

When a MSP or TSP must be included in the revision package, develop the special provision in accordance with the Specifications Handbook.

151.2.1.4 Estimated Quantities

Include only updated estimated quantities Summary Tables (Excel files) associated with the design modifications in the revision package. Provide a summary of changes for revised pay item numbers and quantities. The Estimated Quantities (EQ) Report will not be regenerated during the construction phase.

151.3 Post-Stamped Revisions

Post-stamped revisions occur after “Released for Construction” stamping has been completed and are typically initiated by the Design Build Firm. The revision package consists of signed and sealed pdf plan sheets and BIM files for the affected plans component(s).

See ***FDM 151.2.1.1*** and ***FDM 151.2.1.2*** for the procedures to modify these documents.

Department’s Project Manager enters the draft package into ERC for review by the appropriate discipline reviewers and recommendation for stamping. When all ERC comments/issues are resolved, the Department’s Project Manager will initial, date, and stamp each revised sheet as “Released for Construction.

152 Shop Drawing Submittals

152.1 Introduction

While the Contract Plans and Specifications (including Supplemental and Special Provisions) define the overall nature of the project, Shop Drawing submittal is the accepted method of approving a specific element of the work while allowing flexibility in the Contractor's means and methods. The Contract Plans and Special Provisions for the project are to identify the requirements for submittal of Shop Drawings.

Shop Drawing submittals must meet or exceed the quality level of previously approved submittals of a similar nature and be complete enough to allow for fabrication of an item without referencing any other document.

A Shop Drawing submittal for structural bridge components (e.g., steel girders, non-standard precast/prestressed beams) typically include plan and elevation views denoting the placement of a component in the structure.

Unless explicitly stated, definitions shown referencing the Standard Specifications are the same for the Design-Build Division I Specifications:

- (1) **Shop Drawings:** See Specifications.
- (2) **Engineer:** See Specifications.
- (3) **Engineer of Record (EOR):** See Specifications.

Modification for Non-Conventional Projects:

Delete **Engineer of Record (EOR)** definition and replace with the following:

- (3) **Engineer of Record (EOR):** See Design-Build Specifications.

- (4) **Contractor's Engineer of Record:** See Specifications.
- (5) **Specialty Engineer:** See Specifications.
- (6) **Consultant:** The Professional Engineer or Engineering Firm, or the Architect or Architectural Firm, licensed in the State of Florida and under contract to the Department to perform professional services. The consultant may be the Engineer or Architect of Record or may provide services through and be subcontracted to the Engineer or Architect of Record.

- (7) **Architect of Record:** The Architect or Architectural Firm registered in the State of Florida that performs services for the Department in connection with the design and construction of buildings.

Modification for Non-Conventional Projects:

Delete **Architect of Record** definition and replace with the following:

- (7) **Architect of Record:** The Architect or Architectural Firm registered in the State of Florida that performs services for the Design-Build Firm in connection with the design and construction of buildings.

- (8) **“Ballooning”:** The Contractor’s use of minimum 1/16 inch wide lines to "balloon" or "cloud" (encircle) notes or details on drawings, and design calculations, in order to explicitly and prominently call out any deviations from the Contract Plans or Specifications. The EOR may also use "ballooning" to make note of any limitations to their submittal review and disposition of Shop Drawings.
- (9) **Record Shop Drawings:** The Department's official record copy of all Shop Drawings, correspondence/ transmittal files and submittal activity record (logbook).
- (10) **FDOT Shop Drawing Review Office:** The office or other Department entity responsible for performing the Department's review, record keeping, disposition and distribution of Shop Drawings to other disciplines within the district for review as well as distribution back to the project personnel. This office is normally the District Structures Design Office.
- (11) **Final Review Office:** FDOT Shop Drawing Review Office or the EOR performing the final review and making final distribution of shop drawings which have been reviewed.
- (12) **Demolition of Bridges with Continuous Beams or Girders Affecting Public Safety:** See Specifications.
- (13) **Construction Works Affecting Public Safety:** See Specifications.

Modification for Non-Conventional Projects:

Expand the list above with the following:

- (14) **Design-Build Firm:** See Design-Build Specifications.

152.2 Shop Drawing Submittals Not Required

Material certifications, welding procedures, paint procedures and concrete mix designs are typically submitted by the Contractor to the Engineer (CEI) who forwards the certifications to the State Materials Engineer in Gainesville. These items do not need to be submitted to the FDOT Shop Drawing Review Office for review and approval. For non-standard items, the Engineer (CEI) will typically request approval by the EOR regarding applicability. Material certification for items on the Approved Product List (APL) is typically submitted by the Contractor to the Engineer (CEI).

152.3 Contractor Information Required

A Shop Drawing submittal that omits any of the minimum requirements listed in [Standard Specifications, Section 5-1](#) must be returned for resubmittal.

Modification for Non-Conventional Projects:

Delete FDM 152.3 and see RFP for Shop Drawing requirements.
--

152.4 Submittals Requiring a Specialty Engineer or Contractor's Engineer of Record

When required, the Specialty Engineer or Contractor's Engineer of Record must provide a signed and sealed Shop Drawing submittal. The signed and sealed Shop Drawings will be retained by the Department as the official, Record Shop Drawing.

Signed and sealed Shop Drawing submittals by a Specialty Engineer or Contractor's Engineer of Record typically include signed and sealed drawings and calculations.

152.5 Transmittal of Submittals

Submittal of Shop Drawings must be made by the project Contractor to the designated parties, as applicable. Submittals will not be accepted from a subcontractor or fabricator. Subcontractors and fabricators are encouraged to contact the appropriate FDOT Shop Drawing Review Office for guidance.

Figures 152.11.1 thru **152.11.3** shown in **FDM 152.11** illustrate the flow of submittals during the review process. Use electronic delivery to transmit submittals between parties.

Modification for Non-Conventional Projects:

Delete the above paragraph and replace with the following:

Figure 152.11.4 shows the flow of critical temporary works shop drawings affecting public safety including erection manuals and erection plans. **Figure 152.11.4** also shows the flow of demolition plans of a bridge with continuous beams or girders where one span within the unit is over traffic. Use electronic delivery to transmit submittals between parties.

Figure 152.11.5 shows the flow of all other shop drawing submittals. Use electronic delivery to transmit submittals between parties.

See RFP for transmittal and submittal review requirements.

The Special Provisions for the project may denote the number of drawings to be submitted and the procedure to be followed. Furthermore, the office to which the Contractor must transmit his submittal and the procedure to be followed may also be defined during the preconstruction conference for the project.

152.5.1 Requirements for Department EOR

On projects where the EOR is Department in-house staff, transmit submittals to the FDOT Shop Drawing Review Office or as directed at the project's preconstruction conference. The FDOT Shop Drawing Review Office is the principal contact group and "clearing house" for all construction submittals and information desired by the Contractor regarding structural, mechanical, or electrical items.

The EOR must perform a thorough review of the shop drawings, implement a QA/QC Plan, provide a QA/QC check print to the Department, and ensure that all components depicted in the shop drawings are being constructed/fabricated in accordance with the RFC Plans and other Contract Documents. The shop drawing stamp (e.g., "APPROVED" or "APPROVED AS NOTED") must include language that states that the shop drawing was reviewed in accordance with **FDM 152** and with the Contract.

Modification for Non-Conventional Projects:

Delete **FDM 152.5.1** and replace with the following:

152.5.1 Review Requirements for EOR

The EOR must perform a thorough review of the shop drawings, implement a QA/QC Plan, provide a QA/QC check print to the Department, and ensure that all components depicted in the shop drawings are being constructed/fabricated in accordance with the RFC Plans and other Contract Documents. The shop drawing stamp (e.g. "APPROVED" or "APPROVED AS NOTED") must include language that states that the shop drawing was reviewed in accordance with **FDM 152** and with the Contract.

152.5.2 Requirements for Consultant EOR (Full Services)

152.5.2.1 Review by Engineer of Record Only

On projects where the EOR is a Consultant to the Department and has been retained by the Department to review construction items without follow-up review by the Department, the Consultant will assume the responsibility of the owner's agent. The reviewing consultant is encouraged to communicate with fabricators, contractors, specialty engineers and the FDOT Shop Drawing Review Office to clarify concerns before returning the submittal to the Contractor. The reviewing consultant must also contact the Department's Structures Office if unsure of the Department's position on certain issues during the review. Where possible, mark all necessary requirements on the shop drawing sheet and stamp "APPROVED AS NOTED" instead of requiring a resubmittal. The Contractor will transmit the submittals directly to the Consultant (unless otherwise noted below). Upon receipt of the submittal, the Consultant must perform the review, note any comments on the sheets, indicate his disposition by stamping the sheets as described hereinafter and make distribution as described hereinafter. The original submittal forms the official Record Shop Drawing submittal and must be sent by the EOR to the Department at the end of the project.

152.5.2.2 Review by Engineer of Record and the Department

On projects where the EOR is a Consultant to the Department and has been retained by the Department to review construction items, submittals (unless otherwise noted below) must be transmitted by the Contractor directly to the Consultant. Upon receipt of the submittal, the Consultant must perform the review, note any comments on the sheets, indicate his disposition by stamping the sheets as described hereinafter, and transmit the sheets to the FDOT Shop Drawing Review Office for review and distribution. When submittals require a Specialty Engineer, the original submittal forms the official, Record Shop Drawing submittal and must be retained by the Department. Upon completion of his review, the Consultant must transfer his comments to the sealed sheets, indicate his disposition and transmit them to the Department as described above.

Modification for Non-Conventional Projects:

Delete **FDM 152.5.2** and replace with the following:

152.5.2 Review Requirements for Shop Drawings Affecting Public Safety

The EOR must perform a thorough review of the shop drawings, implement a QA/QC Plan, provide a QA/QC check print to the Department, and ensure that all components depicted in the shop drawing are being constructed, fabricated, or demolished in accordance with the RFC Plans and other Contract Documents.

An Independent Peer Review must be performed for all critical temporary works shop drawings, erection manuals, and erection plans affecting public safety. This includes demolition plans of a bridge with continuous beams or girders where one span within the unit is over traffic. This review is a comprehensive independent verification of the design of the structural elements depicted in the shop drawing. The Independent Peer Review cannot be performed by the originator of the shop drawing and must be completed by either the EOR or by an Independent Peer Reviewer. The Independent Peer Review must follow one of the processes below (depending on who performs the Review):

- The EOR performs the Independent Peer Review: The EOR will apply the shop drawing stamp (e.g., "APPROVED" or "APPROVED AS NOTED") and must include a signed and sealed certification letter stating that an Independent Peer Review was performed in accordance with **FDM 152** and with the Contract. The certification letter must clearly state which components (e.g., temporary works) were reviewed.
- An Independent Peer Reviewer performs the Independent Peer Review: The EOR will apply the shop drawing stamp (e.g., "APPROVED" or "APPROVED AS NOTED") and include a statement that the shop drawing was reviewed in accordance with **FDM 152** and with the Contract, but an Independent Peer Review was not performed. Then, an Independent Peer Reviewer qualified under **Florida Administrative Code, Rule 14-75** (in the Work Group for the structure being constructed, fabricated, or demolished) must perform the Independent Peer Review. The Independent Peer Reviewer must sign and seal a certification letter stating that an Independent Peer Review was performed in accordance with **FDM 152** and with the Contract. The certification letter must clearly state which components (e.g., temporary works) were reviewed.

152.5.3 Requirements for Consultant EOR (Design Services Only)

On projects where the EOR is a Consultant to the Department but has not been retained by the Department to review construction items, the contractor will transmit submittals (unless otherwise noted below) directly to the FDOT Shop Drawing Review Office or as directed at the project's preconstruction conference.

Modification for Non-Conventional Projects:

Delete <i>FDM 152.5.3.</i>

152.5.4 Requirements for Architectural or Building Structures

Submittals related to Architectural or Building Structures, such as Rest Areas, Picnic Pavilions, Offices and Warehouses, must be made according to the requirements of the Architectural Services Group, Production Support Office, Florida Department of Transportation, 605 Suwannee Street, MS 40, Tallahassee, FL 32399-0450, Phone (850) 414-4378.

152.5.5 Requirements for Roadway Submittal Items

Distribute all submittals related to roadway plans such as attenuators and non-standard drainage structures (except bridge items such as poles and bracket arms, or as noted below) in accordance with the [Construction Project Administration Manual](#) for the component involved or as otherwise directed at the project's preconstruction conference. Submittals related to bridge items must be transmitted to the Department as previously described in this section.

152.5.6 Requirements for Overhead Sign Structures and Nonstandard Miscellaneous Structures

Transmit submittals concerning overhead sign structures and non-standard miscellaneous structures as previously described in this section.

152.5.7 Miscellaneous Requirements and Assistance

Items not specified above or for which questions may arise regarding submittal requirements, the Contractor should be advised to contact the appropriate FDOT Shop

Drawing Review Office. Regardless of submittal type, a letter of transmittal must always accompany a submittal.

152.6 Disposition of Submittals

The approval or disapproval of submittals by the Reviewer must be indicated by one of the following designations: "APPROVED" (no further action required), "APPROVED AS NOTED" (make corrections noted - no further submittal required), "RESUBMIT" (make corrections noted and resubmit for approval; or insufficient data submitted in order to perform a complete review), or "NOT APPROVED" (rejected - do not resubmit the concept or component as submitted).

Modification for Non-Conventional Projects:

Delete the above paragraph and replace with the following:

The approval or disapproval of submittals by the EOR must be indicated by one of the following designations: "APPROVED" (no further action required), "APPROVED AS NOTED" (make corrections noted - no further submittal required), "RESUBMIT" (make corrections noted and resubmit for approval; or insufficient data submitted in order to perform a complete review), or "NOT APPROVED" (rejected - do not resubmit the concept or component as submitted). Only shop drawings that have been "APPROVED", or "APPROVED AS NOTED" must be submitted to the Department for review. Submit copies of QA/QC shop drawing check prints to the CEI along with the shop drawing.

The Department must stamp the drawings "RELEASE FOR CONSTRUCTION", "RELEASE FOR CONSTRUCTION AS NOTED", OR "RESUBMIT". Where possible, mark all necessary requirements on the shop drawing sheet and stamp "RELEASE FOR CONSTRUCTION AS NOTED" instead of requiring a resubmittal.

Indicate the disposition designation on each and every drawing sheet, or on the cover sheet of calculations, by the use of an electronic, red-colored stamp. The electronic stamp size must not exceed 3" high by 3" wide, but 1 ½" high by 3" wide stamp is preferred. Stamps must identify the approving groups, such as the EOR-Consultant, the Department's Verification Inspection Consultant and Department personnel, and the date. All notations or corrections made on the approval prints must be consistently marked on all drawings.

All Consultants reviewing submittals must red ink stamp and initial each item as noted above with the firm's appropriate stamp. When the EOR is a Consultant, and when a

Sub-consultant is retained to assist in the submittal review, the EOR must signify disposition of the submittal as noted above with the EOR's firm's appropriate stamp prior to distribution or prior to transmitting it to the Department. In this event it is the EOR's prerogative to also require a disposition stamp by the Sub-consultant.

When the EOR receives a submittal that is not in accordance with the requirements of this chapter, the Contractor will be advised to resubmit with the corrections or additions necessary.

Disposition of Shop Drawing submittals by the EOR for construction and erection equipment including beams and winches, launch gantry, erection trusses, forms, falsework, midspan and longitudinal closures, lifting devices, temporary bearing fixity devices, cranes, form travelers, segment carrying equipment and stability devices must be either "NOT APPROVED" if deemed to be unacceptable or, if acceptable, must be "APPROVED AS NOTED" with the following note included on the submittal drawings:

"Drawings are acceptable for coordination with, relationship to, and effects upon the permanent bridge; but have not been reviewed for self-adequacy. Adequacy and intended function remain the sole responsibility of the Contractor."

Unless considered as Construction Affecting Public Safety, the EOR is not responsible for accepting or reviewing calculations or drawings pertaining to construction formwork. These documents should normally be submitted to the Engineer (CEI) or, in the event they are erroneously transmitted to the EOR, should be immediately rerouted to the Engineer (CEI).

On projects when the EOR is a Consultant to the Department and the Department will also be reviewing shop drawings, the Department will perform a second confirmation review of the submittal. Upon receipt of the Consultant's reviewed submittal, the Department will stamp the submittal with the disposition as noted above. The primary purposes of the Department's review include: conformance with FDOT policy and standards; uniformity of disposition with similar submittals; accuracy and completeness of the Consultant's review; and attention to specific details or areas of work that have experienced recurring problems during fabrication or construction.

When the Specialty Engineer or Contractor's Engineer of Record is required by the Contract Plans and specifications to perform a portion of the design of the project, the EOR must confirm that:

- (1) The Specialty Engineer or Contractor's Engineer of Record is prequalified with the Department as such to design and prepare the submittal.
- (2) The Shop Drawings are correctly signed and sealed by the Specialty Engineer or Contractor's Engineer of Record.

- (3) The Specialty Engineer or Contractor’s Engineer of Record understands the intent of the design and utilizes the correct specified criteria.
- (4) The configuration set forth in the submittal is consistent with that of the Contract Documents.
- (5) The Specialty Engineer or Contractor’s Engineer of Record’s methods, assumptions and approach to the design are in keeping with accepted engineering practices.
- (6) The Specialty Engineer or Contractor’s Engineer of Record’s design does not contain any gross inadequacies that would jeopardize or threaten public safety.

Figures 152.11.1 through **152.11.3** shown in **FDM 152.11** illustrate the submittal and distributional flow of a shop drawing transmittal. When the Department concurs with the Consultant’s review and disposition of the submittal, the Department will stamp and distribute the submittal including a record copy for the Consultant.

Modification for Non-Conventional Projects:

Delete the above paragraph and replace with the following:

Figures 152.11.4 and **152.11.5** show the submittal and distributional flow of a shop drawing transmittal. When the Department concurs with the Design-Build Firm’s EOR review and disposition of the submittal, the Department will stamp and distribute the submittal.

152.6.1 Minor Modifications

The submittal will be processed when notations not involving design decisions are added, modified, or deleted and when the disposition of the submittal remains unchanged or changed only in accordance with **Table 152.6.1**:

Table 152.6.1 FDOT Changes to Minor Modifications

From	To
Approved	Approved as Noted
Approved as Noted	Approved
Resubmit	Not Approved
Not Approved	Resubmit

In this event, the Department will notify the Consultant of the modifications, document the notification in the project's shop drawing file, process and distribute the submittal and furnish the Consultant with a copy.

Modification for Non-Conventional Projects:

Delete **FDM 152.6.1** and replace with the following:

152.6.1 Minor Modifications

The submittal will be processed when notations not involving design decisions are added, modified, or deleted and when the disposition of the submittal remains unchanged or changed only in accordance with the following **Table 152.6.1**:

Table 152.6.1 FDOT Changes to Minor Modifications

From	To
Approved	Released for Construction as Noted
Approved as Noted	Released for Construction

In this event, the Department will notify the Design-Build Firm of the modifications, document the notification in the project's shop drawing file, process and furnish the Design-Build Firm with a copy.

152.6.2 Major Modifications

The submittal will be returned to the Consultant for re-review when notations involving significant design decisions must be added, deleted, or modified, when the submittal's review is deemed by the Department to be incomplete or require significantly more work. The Department will notify the Consultant and document the notification in accordance with **Table 152.6.2**. The submittal will be returned to the Consultant for re-review and return to the Department.

Table 152.6.2 FDOT Changes to Major Modifications

From	To
Approved or Approved as Noted	Not Approved or Resubmit
Not Approved or Resubmit	Approved or Approved as Noted

Modification for Non-Conventional Projects:

Delete **FDM 152.6.2** and replace with the following:

152.6.2 Major Modifications

The submittal will be returned to the Design-Build Firm for re-review when notations involving significant design decisions must be added, deleted or modified, when the submittal's review is deemed by the Department to be incomplete or require significantly more work. The Department will notify the Design-Build Firm and document the notification in accordance with **Table 152.6.2**. The submittal will be returned to the Design-Build Firm for re-review and return to the Department.

Table 152.6.2 FDOT Changes to Major Modifications

From	To
Approved or Approved as Noted	Resubmit

152.7 Distribution of Submittals

Figures 152.11.1 thru **152.11.3** shown in **FDM 152.11** illustrate the submittal and distributional flow of shop drawings for reviews performed by Consultant EORs without FDOT review, reviews performed by Consultant EOR with FDOT review, and reviews performed by FDOT only. In the case of reviews performed by Consultant EORs and FDOT, the Consultant must transmit Shop Drawings to the appropriate FDOT Shop Drawing Review Office.

When precast/prestressed concrete components are involved, copies of the Shop Drawings are to be submitted to the Department's District Prestress Engineer and the State Materials Office (Gainesville). When structural steel components are involved, copies of the Shop Drawings are to be submitted to the Department's Verification Inspection Consultant.

When the Department is reviewing shop drawings and a submittal is denied ("RESUBMIT" or "NOT APPROVED"), distribution of the submittal must be made to the FDOT Shop Drawing Review Office's File and the Contractor only, with a copy of the transmittal letter to the Engineer (CEI).

Modification for Non-Conventional Projects:

Delete **FDM 152.7** and replace with the following.

152.7 Distribution of Submittals

Figure 152.11.4 shows the submittal and shop drawing flow diagram for design-build projects. The Contractor submits Shop Drawings to the Engineer (CEI). When precast/prestressed concrete components are involved, copies of the Shop Drawings are submitted to the Department's District Prestress Engineer and the State Materials Office (Gainesville). When structural steel components are involved, copies of the Shop Drawings are submitted to the Department's Verification Inspection Consultant.

152.8 Review of Prequalified Joint Welding Procedures

In accordance with **Section 11.2** of the [Materials Manual](#), the approval of all joint welding procedures specification (WPS) will be the responsibility of the Department's Verification Inspection Consultant. The State Materials Office maintains the list of the approved WPS which may be used on all future projects by the fabricator who developed them, until their expiration. A list of the approved WPSs will be provided with the submittal of the Shop Drawings. The EOR may elect to review these documents. Shop drawings depicting plate sizes, types of welds, weld designations, weld sizes and grades of materials will continue to be reviewed by the EOR.

152.9 Submittal Activity Record (Logbook)

The Final Review Office is responsible for maintaining a Submittal Activity Record (Logbook) on each project reviewed by the office. Update the logbook each day that any Shop Drawing submittal activity occurs. Enter the following minimum data in the logbook for each submittal:

- (1) Financial Project ID and State Project Number (if assigned).
- (2) Submittal Number.
- (3) Description of Submittal.
- (4) Number of Sheets in the Submittal.
- (5) Number of Pages of Calculations, in Reports, in Manuals.

- (6) Date Transmitted by Contractor to the EOR.
- (7) Date Transmitted by EOR (when EOR is not the final reviewer) to the Final Review Office.
- (8) Date Distributed by the Final Review Office to the Contractor.
- (9) Disposition as either "A" (Approved), "AN" (Approved as Noted), "R" (Resubmit) or "NA" (Not Approved).

The Logbook is an historical record of the activity devoted to an individual submittal as well as that for the project as a whole. It can serve as a verification of review time, to respond to inquiries of a particular submittal's status and as a record of manpower effort to aid in estimating and allocating future workload.

152.10 Archiving Record Shop Drawings

Upon completion and acceptance of a construction project by the Department (usually by receipt of a written Notice of Acceptance), the Final Review Office, within thirty (30) days, will transmit the Record Shop Drawings to the appropriate offices, as dictated by practice in the District in which the project is located. The Record Shop Drawings may include some or all of the following documents:

- (1) Shop Drawings (including all relevant data as set forth in the Specifications)
- (2) Project Files of Shop Drawing transmittal letters.
- (3) Submittal Activity Record

The Final Review Office must complete the Record Shop Drawing Transmittal (see **Form 152-A**, located in **FDM 103**), and transmit copies, along with the Record Shop Drawings described above, to the appropriate office. The Record Shop Drawing Transmittal describes all the Record Shop Drawing documents being transmitted.

The Submittal Activity Record (logbook) is intended to serve as the listing of all Shop Drawings transmitted. Other transmitted material such as project files and samples should be listed individually on the Transmittal shown in **Form 152-A**.

Upon receipt of the Record Shop Drawings, the offices receiving the transmittal will verify the documents and material transmitted, sign and date the Record Shop Drawing Transmittal, and return a copy to the Final Review Office.

The Final Review Office will maintain a file of Record Shop Drawing Transmittals (**Form 152-A**) for future reference and use. Once the signed copy of the Record Shop Drawing

Transmittal is received, the Final Review Office's initially retained Record Shop Drawing Transmittal may be discarded.

152.11 Shop Drawing Flow Diagrams

Figures 152.11.1 through *152.11.5* show the submittal and distributional flow of shop drawings for reviews.

Figure 152.11.1 Shop Drawing Flow Diagram for Reviews with Consultant EORs without FDOT Review

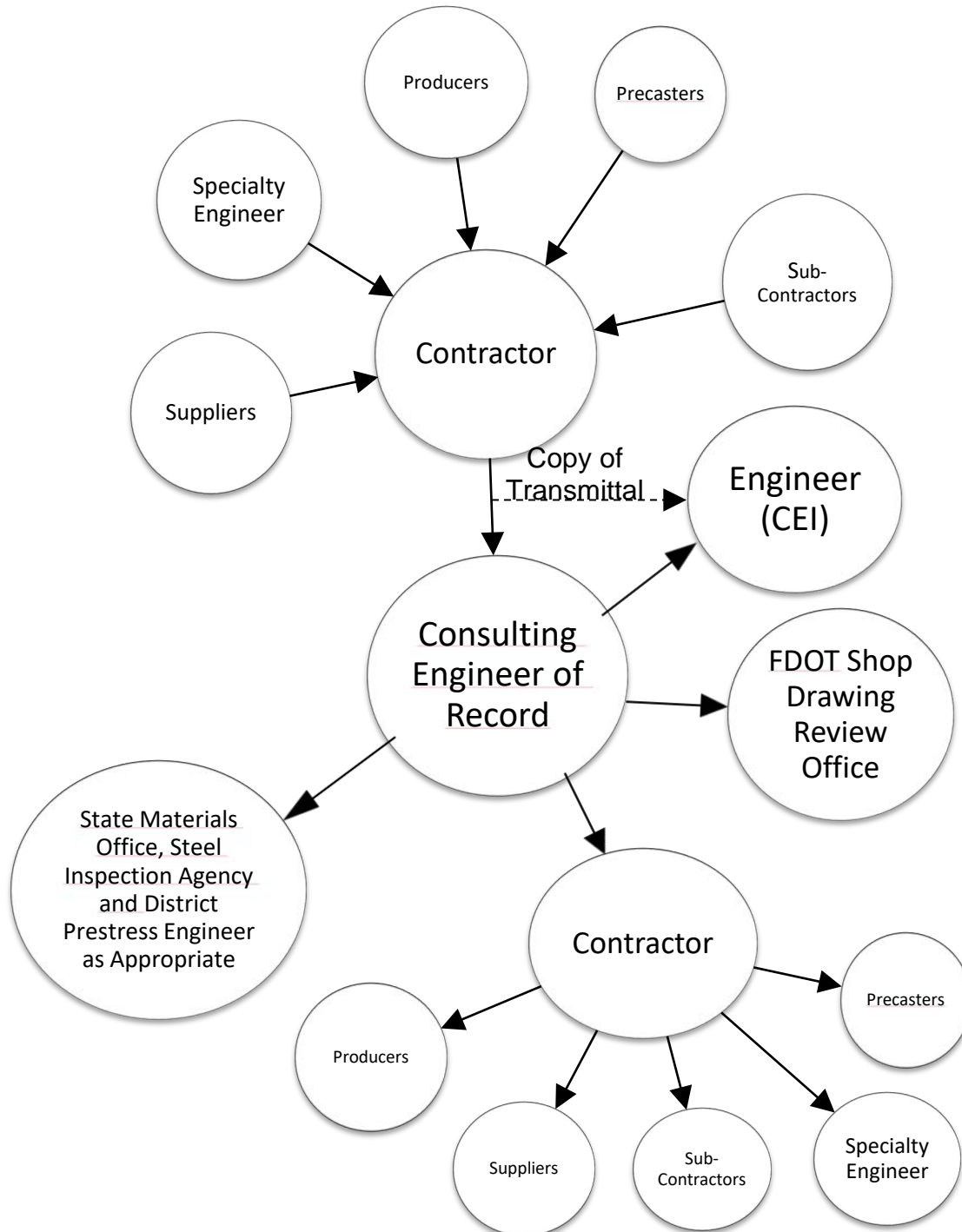

Figure 152.11.2 Shop Drawing Flow Diagram for Performed by Consultant EOR with FDOT Review

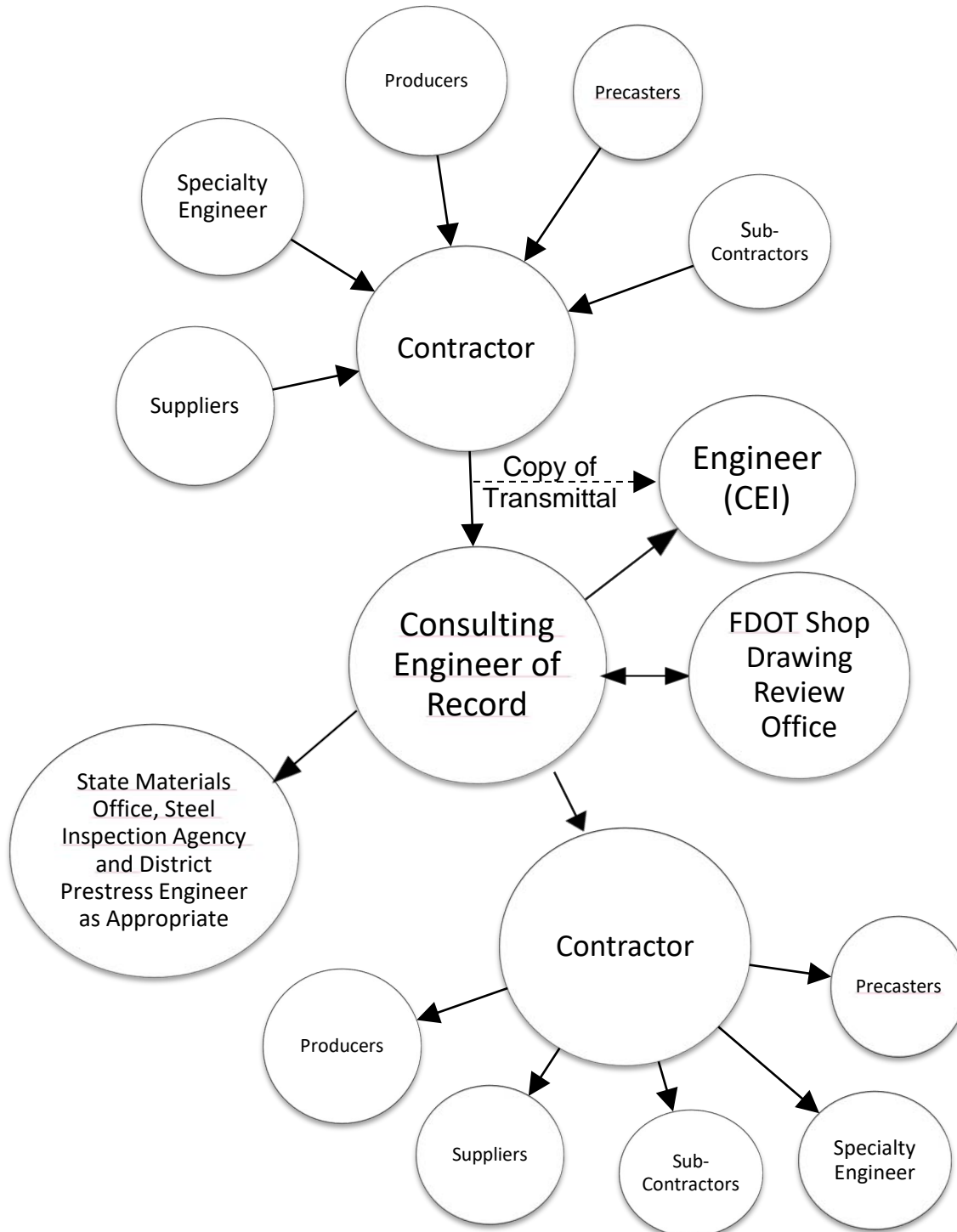

Figure 152.11.3 Shop Drawing Flow Diagram for Reviews Performed by FDOT Only

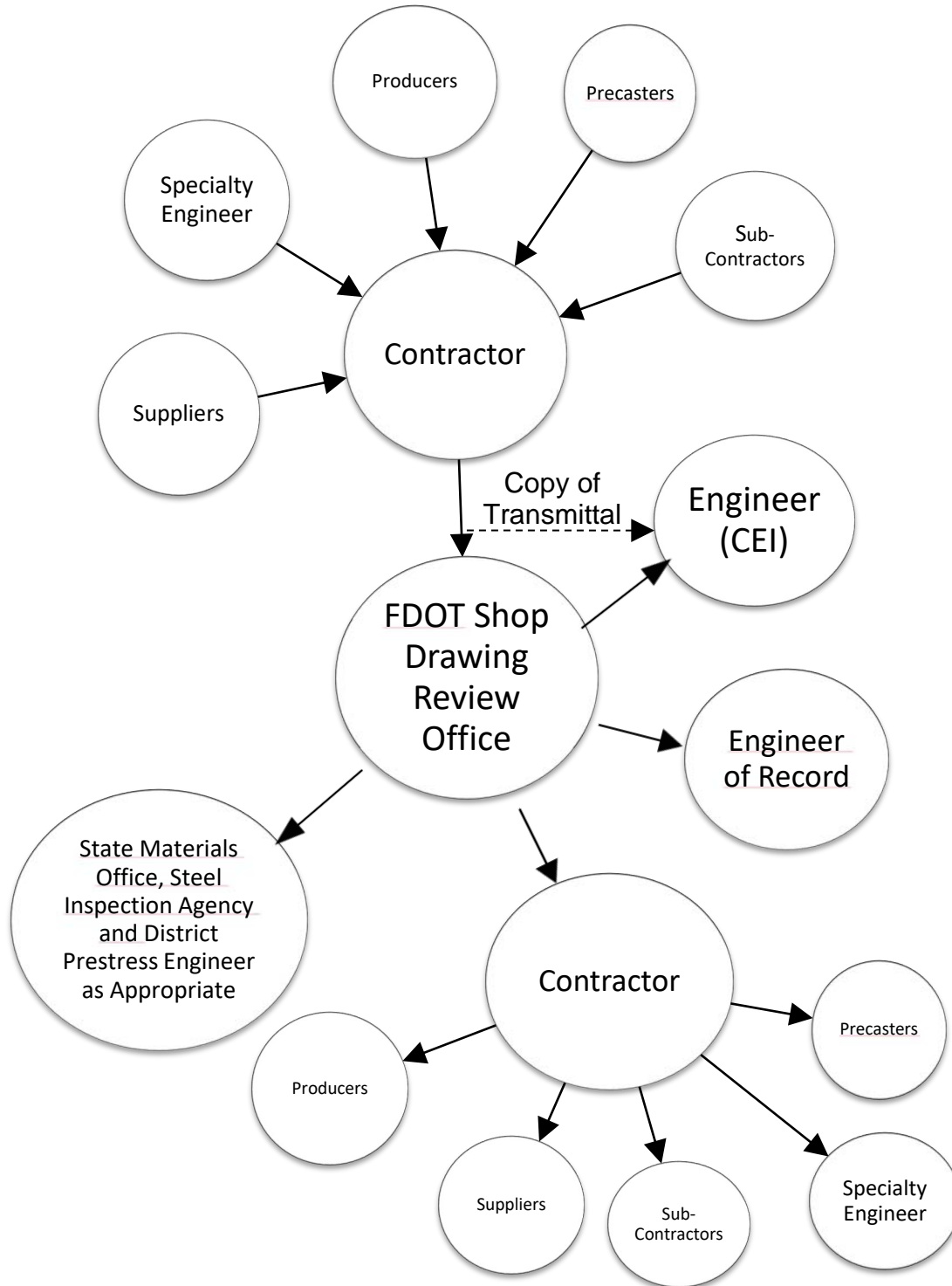

Figure 152.11.4 Shop Drawing Flow Diagram for Design-Build Project- Shop Drawings Affecting Public Safety

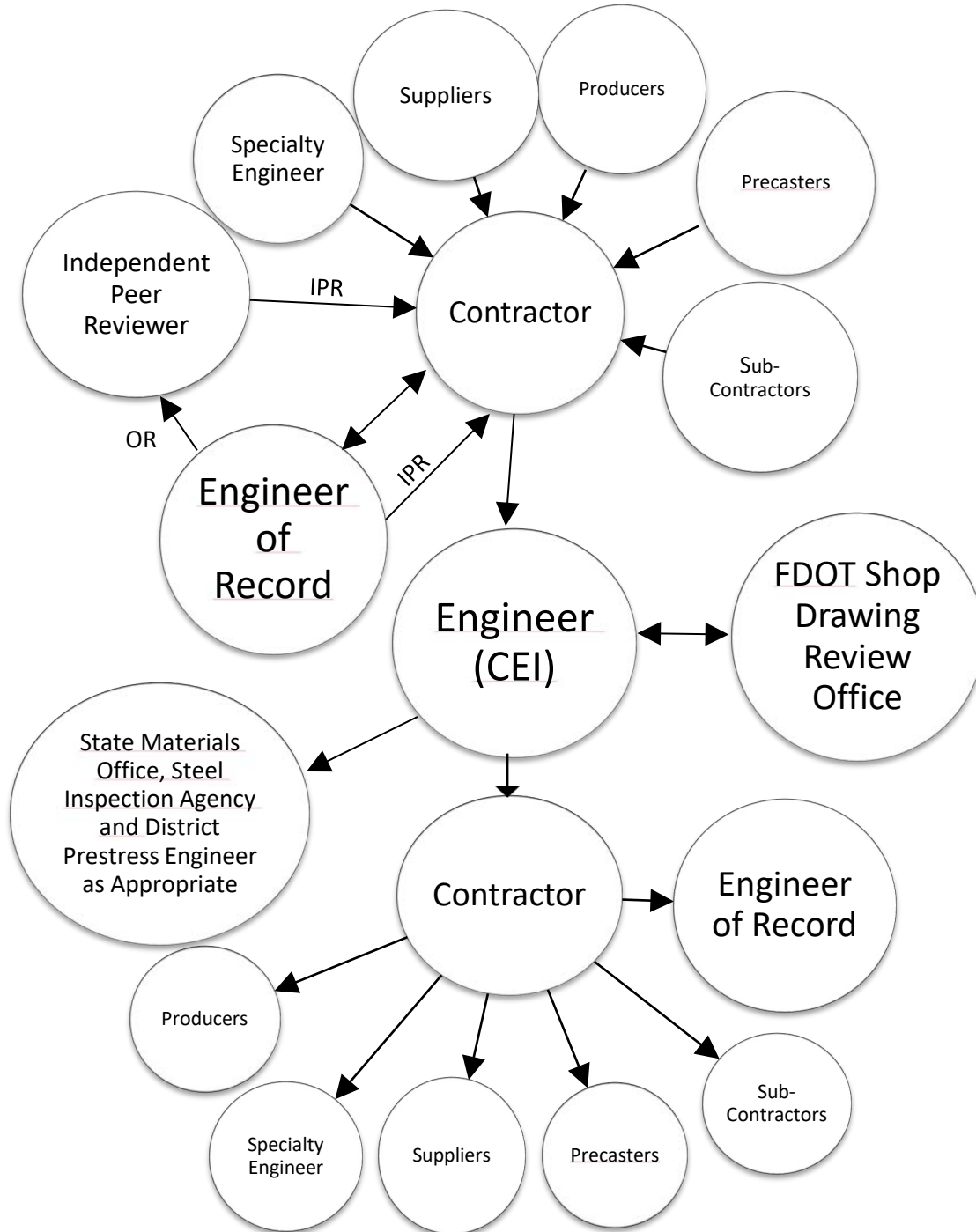

Figure 152.11.5 Shop Drawing Flow Diagram for Design-Build Projects-Shop Drawings Not Affecting Public Safety

