

## 260 Bridge Structures

### 260.1 General

The design criteria presented in this chapter apply to bridge structures on arterials, collectors, and Limited Access Facilities. Criteria regarding lanes, medians, and shoulders for bridges are illustrated in **FDM 260.1.1**. Subsequent sections of this chapter contain specific information and criteria regarding these typical section elements, as well as geometric features.

#### 260.1.1 Partial Bridge Sections

Criteria regarding lanes, medians, and shoulders are illustrated in the following partial bridge sections, **Figures 260.1.1 – 260.1.4**. These figures show sections through the bridge deck. Sections through the approach slab and permanent retaining wall should match the lanes, medians, and shoulder widths in the bridge section.

**Figure 260.1.1 Partial Bridge Sections for Limited Access Facilities and Divided Arterials (4 or More Lanes)  
 Design Speed 50 mph and Greater**

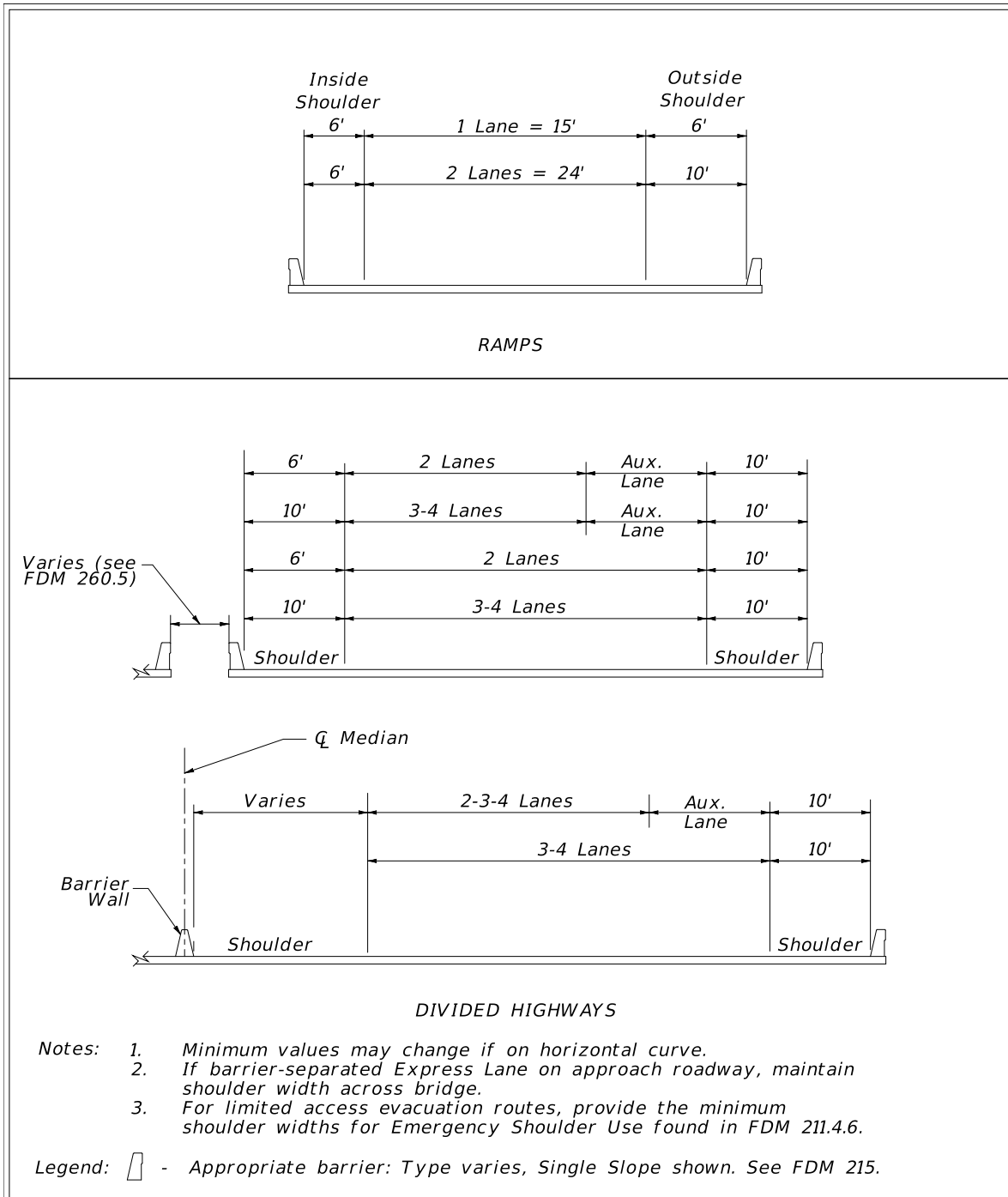

**Figure 260.1.2 Bridge Section for Undivided Arterials and Collectors**

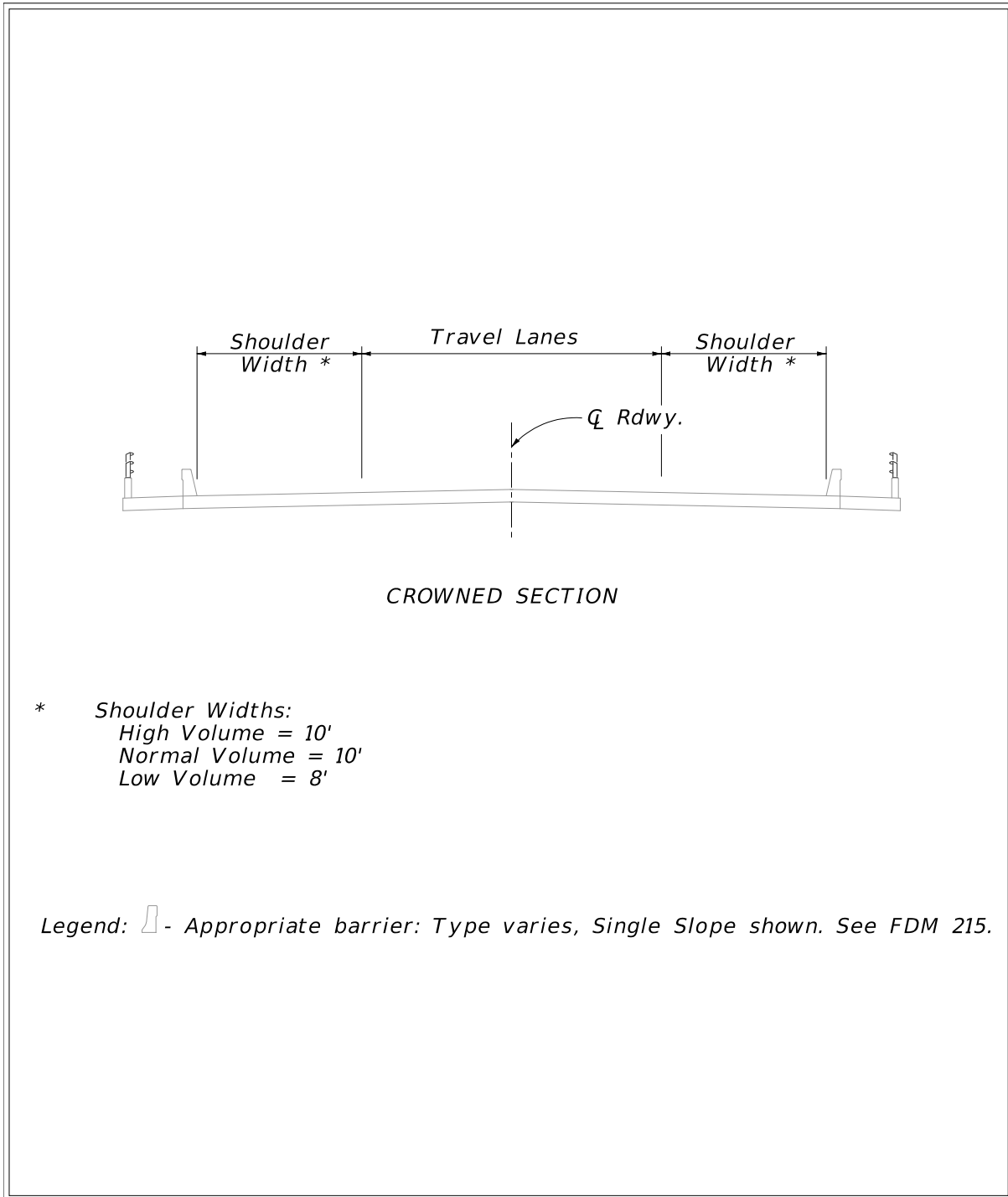

**Figure 260.1.3 Partial Bridge Sections for Curbed Arterials and Collectors  
 Design Speed 45 mph and Less**

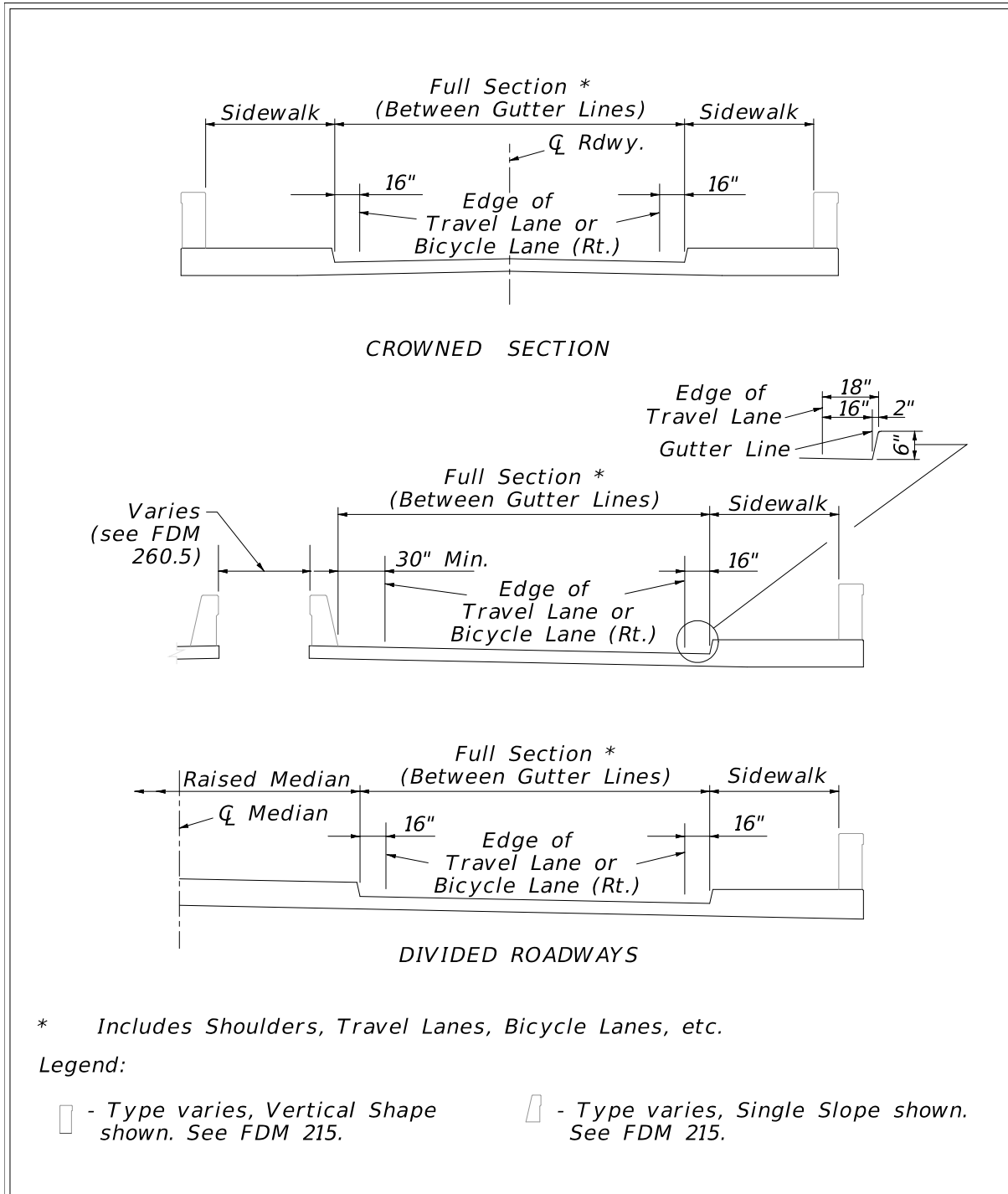

**Figure 260.1.4 Bridge Section for Divided Arterials and Collectors**

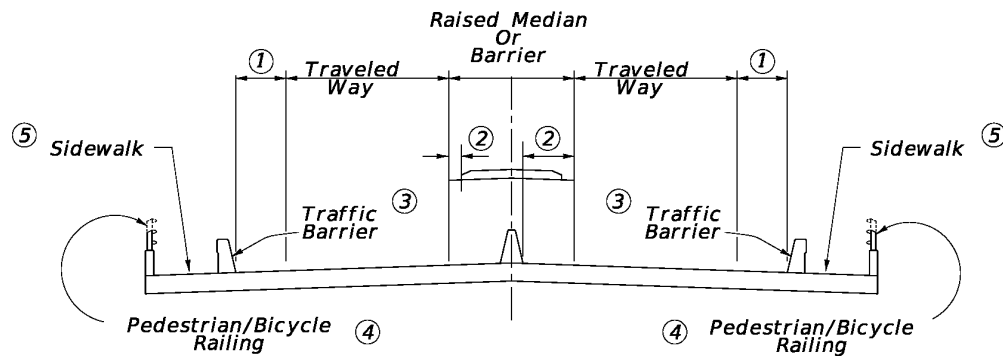

- ① **Outside shoulders:**
  - Curbing on approach roadway:*  
Use 2.5' minimum, 8'-4" with bike lane, 8' minimum for bridges 500' or longer or high-level bridges.
  - Flush shoulder on approach roadway:*  
Use 10' minimum.
- ② **Median shoulders:**
  - Raised median on bridge:*  
Use same offset to median as used on the approach roadway.
  - Median barrier on bridge:*  
*Raised median on approach roadway:*  
Use 2.5' minimum, and for bridges 500' or longer or high-level bridges use 6' minimum for 2 lanes and 8' minimum for 3 or more lanes.
  - Flush shoulder on approach roadway:*  
Use 6' minimum for 2 lanes and 10' minimum for 3 or more lanes.
- ③ *Use traffic barrier between traveled way and sidewalk and separate pedestrian railing at back of sidewalk if heavy pedestrian traffic is anticipated or facility is near a school, or design speeds on the bridge are 50 mph or greater.*
- ④ *Provide pedestrian/bicycle railing as required per FDM 222.4*
- ⑤ *See FDM 260.2.2 for sidewalk width requirements.*

## 260.2 Lanes

Lane widths are to match the approach roadway lane widths.

### 260.2.1 Bicycle Lanes

Continue bicycle lanes on the approach roadway across the structure.

### 260.2.2 Sidewalk and Shared Use Paths

Continue width of sidewalk or shared use path on the approach roadway across the structure. Bridge sidewalk width may be less than the approach roadway for long bridges (greater than 100 feet), but not less than 5 feet for C1 and C2 context classification or 6 feet for all other context classifications.

Provide sidewalk on new bridges where sidewalk or shared use path is not present along the roadway, but may be included with a future project.

Modification for Non-Conventional Projects:
Delete <b>FDM 260.2.2</b> and see RFP for requirements.

## 260.3 Shoulders

**Figures 260.1.1 – 260.1.4** provide criteria for shoulder widths on various bridge sections. Where these widths differ from those required for roadways or ramps, decisions about the final values chosen for the project are to be coordinated between the District Roadway Design and Structures Design Offices.

On roadway alignments having 12-foot shoulders with continuous barrier walls and closely spaced bridges, a 12-foot bridge shoulder width may be considered. Bridges are considered to be closely spaced when the required length of shoulder transition (between standard width roadway and bridge shoulders) is greater than the distance between the bridges. The decision to use 12-foot bridge shoulder widths should be coordinated with the District Design Engineer.

Modification for Non-Conventional Projects:

Delete the above paragraph and see RFP for bridge shoulder width requirements.

## 260.4 Bridge Cross Slopes

Bridge cross slope is typically 0.02 for non-superelevated bridge deck sections. Bridges with one-way traffic have a uniform cross slope applied over all travel lanes and required shoulders. Bridges with two-way traffic may be designed with a crowned bridge deck section. This cross slope criteria applies to all bridge decks whether of cast-in-place concrete, precast concrete, or open steel decking.

Use transitions to adjust for differences in cross slope between the approach roadway section and the required straight-line slope for bridge decks.

## 260.5 Bridge Median

For divided highways, the District will determine the desired distance between structures based in the following:

- (1) Provide separate structures if the open space between the bridges would be 20 ft. or more.
- (2) Provide single structure if the open space between the bridges would be less than 10 feet.
- (3) A single structure is recommended when the open space between the bridges would be between 10 and 20 feet.

Consult with the District Structures Maintenance Engineer when the open space between the bridges would be less than 20 feet.

The inspection and maintenance capabilities of each District Office's personnel and equipment will provide the basis for deciding on a single structure deck or twin bridges. If the total width for a single structure exceeds the capacity of district maintenance equipment, typically a 60-foot reach, twin structures may be specified and the open distance between structures determined by the practical capability of the maintenance and inspection equipment. This is particularly important for girder superstructures because those areas that cannot be reached by topside equipment might require catwalks, ladders, or other access features. Such features are to be accounted for in the initial selection of alternates as they will add to the cost of superstructures.

Design bridge railings and separators in accordance with the **Structures Design Guidelines**. For more information regarding bridge traffic railings, refer to **FDM 215**.

## **260.6 Vertical Clearance**

For roadway, pedestrian, or railroad bridge over roadway, the minimum vertical clearance is the least distance measured between the lowest bridge superstructure or substructure element and the traveled way or shoulder directly below the element.

For roadway or pedestrian bridge over railroad, the minimum vertical clearance is the least distance measured between the bottom of the superstructure and the top of the highest rail utilized.

For roadway or pedestrian bridge over High Speed Rail Systems, see the latest version of **American Railway Engineering and Maintenance-of-Way Association** (AREMA) guidelines, or contact the design office of the high speed rail line of interest.

For roadway or pedestrian bridge over electrified railroad, see FDOT's **South Florida Rail Corridor Clearance Policy for 25 KV service (Topic No. 000-725-003)**. This provision also applies to tracks identified as candidates for future electrification.

FDOT minimum vertical clearances for new construction and RRR projects are given in **Table 260.6.1**. New construction criteria are also illustrated in **Figures 260.6.1** through **260.6.5**.



**Table 260.6.1 Minimum Vertical Clearances for Bridges**

Type of Crossing	Minimum Vertical Clearance (feet)		
	New Construction		RRR
	New Bridge	Construction Affecting Existing Bridge	
Roadway or Railroad bridge over Limited Access Roadway	16.5	16.0	16.0
Roadway or Railroad bridge over Arterial or Collector Roadway			14.5
Pedestrian bridge over Roadways	17.5	17.0	
Roadway or Pedestrian bridge over Railroad	23.5		
Roadway or Pedestrian bridge over Electrified Railroad	24.25		

**Notes:**

(1) For construction affecting an existing bridge (e.g., bridge widenings or resurfacing), if the proposed minimum design vertical clearance is between 16 feet and 16 feet 2 inches or if a Design Variation or Design Exception is required, place a note in the plans as shown in **FDM 311**.

**Roadway or Railroad bridge over Arterial or Collector Roadway**

- (1) Contact the District Structures Design Engineer for further guidance if any sway bracing members over the bridge deck have a clearance of less than 14 feet.
- (2) Contact the District Structures Design Engineer for further guidance when vertical clearance of an existing bridge is less than 14.5 feet. See **Traffic Engineering Manual, Section 2.6** for information on required signing and warning features.

**Figure 260.6.1 Flush Shoulder Roadway**

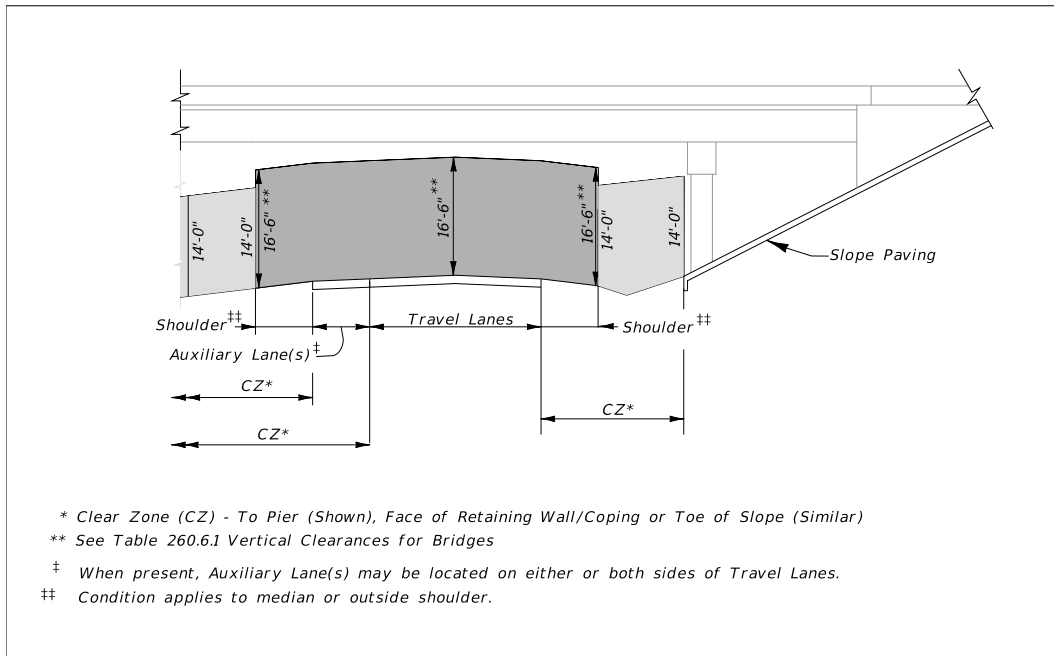

**Figure 260.6.2 Flush Shoulder Divided Roadway**

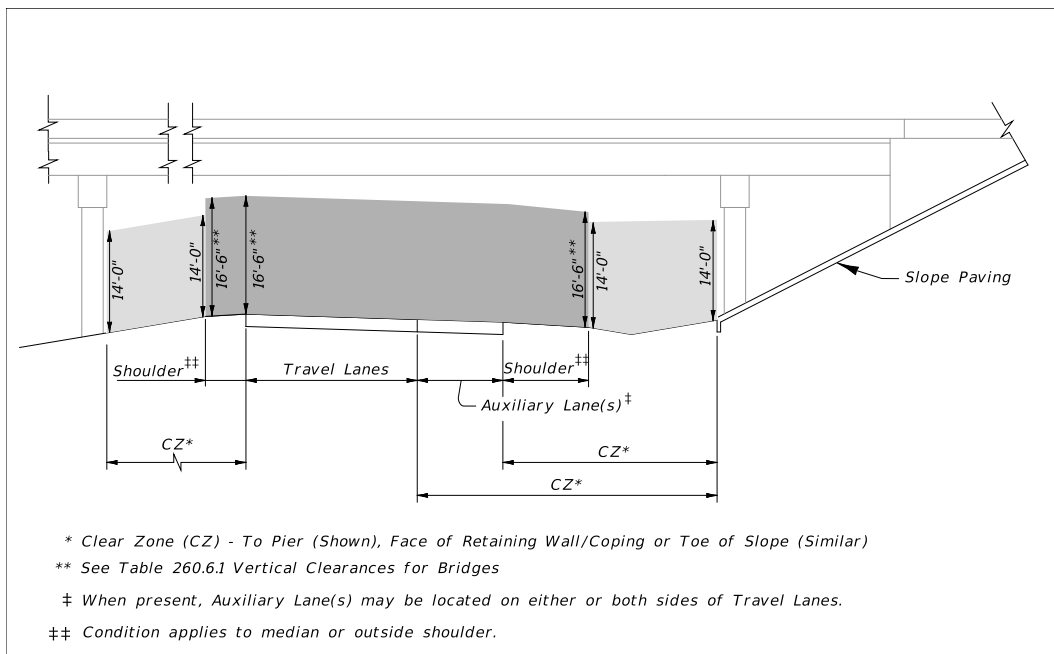

**Figure 260.6.3 Curbed Roadway  $\leq 45$  mph**

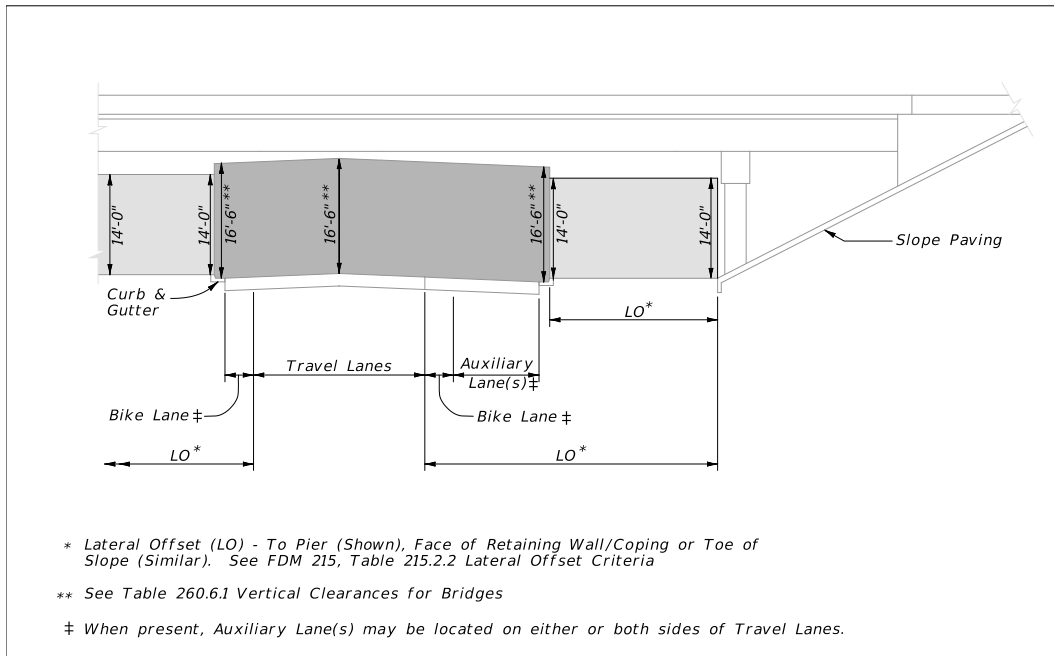

**Figure 260.6.4 Curbed Roadway  $\leq 45$  mph – Section through Bridge**

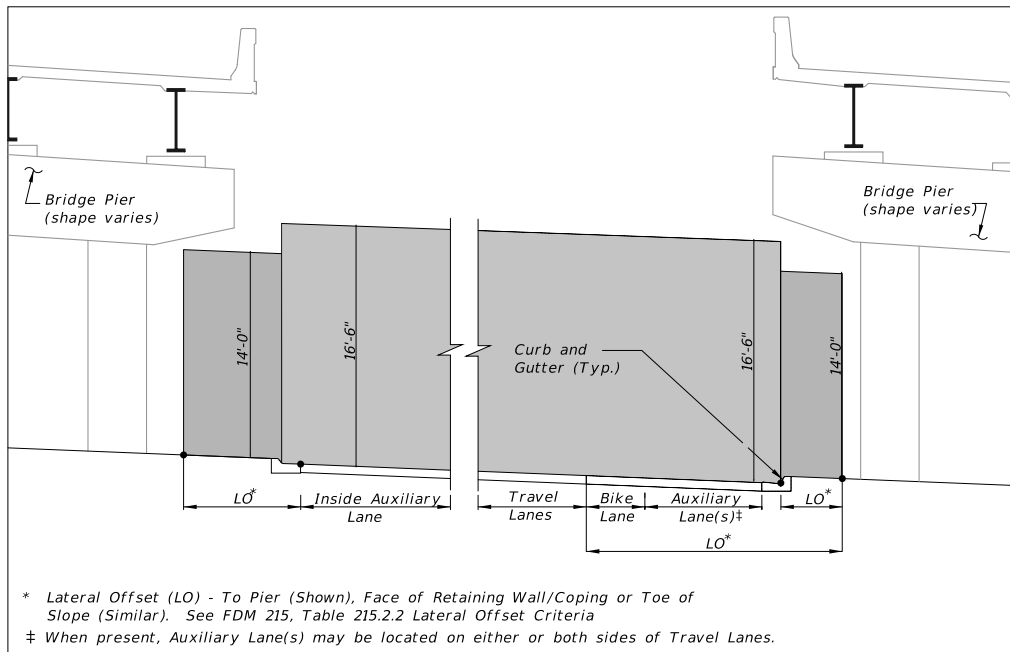

**Figure 260.6.5 Curbed Roadway with Traffic Barrier**

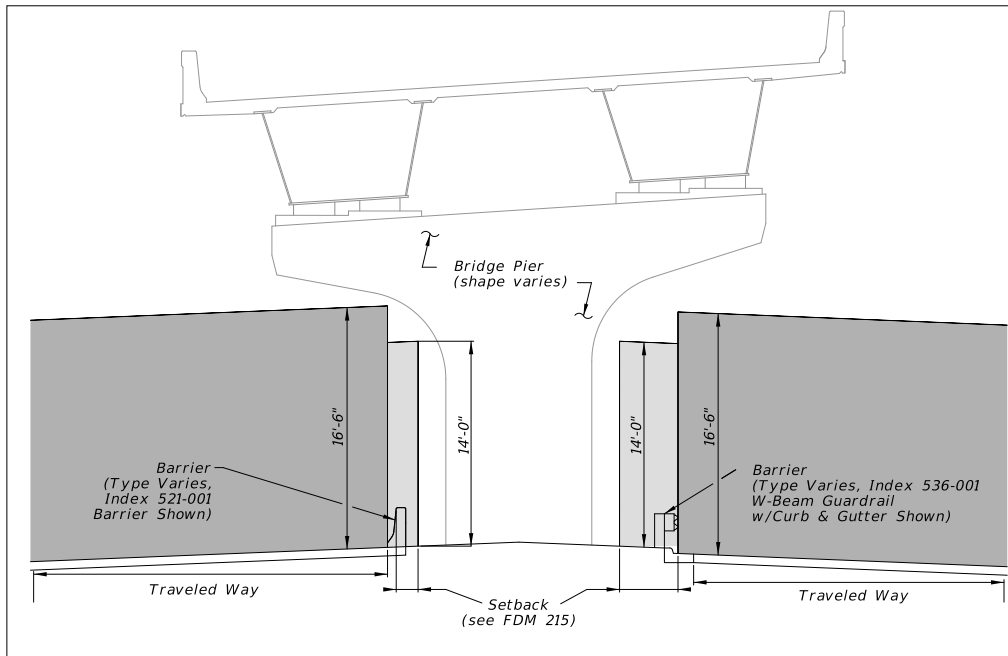

## 260.7 Typical Paving Under Bridge

A 10-foot paved outside shoulder under overpass bridges is recommended. In addition, miscellaneous asphalt within the median area and from the paved shoulder to the bridge slope pavement should be placed. This pavement will provide additional safety, enhance drainage, reduce maintenance, and improve appearance. Typical paving under bridges is illustrated in **Figure 260.7.1**.

**Figure 260.7.1 Typical Paving Under Bridge**

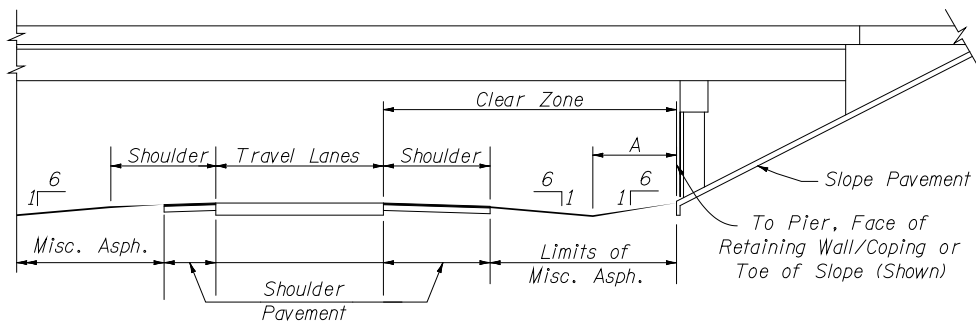
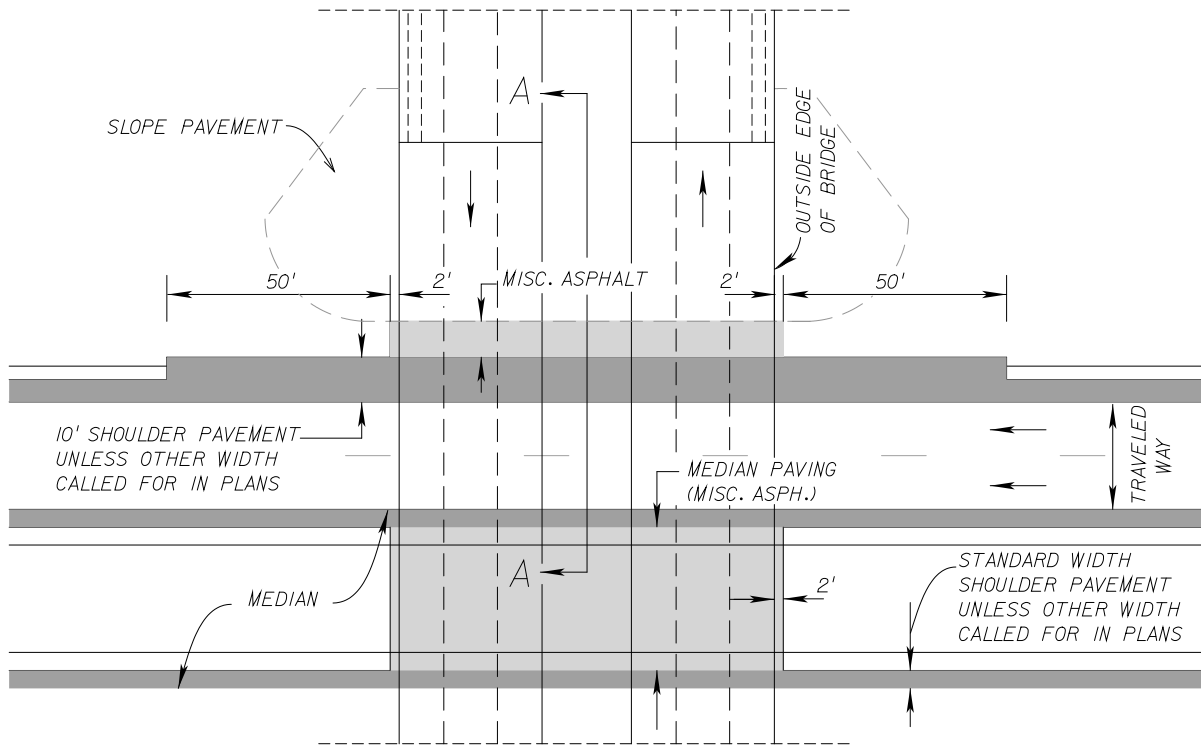

SECTION A-A

FACILITY	A
Limited Access Facilities	12'
Flush Shoulder Arterials & Collectors Design Speed 50 mph or greater	8'
Flush Shoulder Arterials & Collectors Design Speed 45 mph or less	6'

## **260.8 Bridges Over Waterways**

### **260.8.1 Vertical Clearance**

The following criteria applies to the minimum vertical bridge clearance over water:

#### **Environment:**

Minimum vertical clearance is 12 feet above Mean High Water (MHW) for concrete superstructures classified as moderately aggressive or extremely aggressive due to chloride content.

Minimum vertical clearance is obtained from the District Bridge Maintenance Engineer for steel superstructures, but is not to be less than those specified above for the concrete superstructures.

#### **Modification for Non-Conventional Projects:**

Delete the above paragraph and replace with the following:

For steel superstructures, the minimum vertical clearance is not to be less than those specified above for the concrete superstructures or as specified in the RFP.

#### **Drainage:**

The minimum vertical clearance between the design flood stage and the low member of a bridge is 2 feet. This clearance is necessary to allow the majority of debris to pass without causing damage to the structure. This requirement does not apply to culverts and bridge-culverts.

#### **Navigation:**

Provide the following minimum vertical clearance for navigational purposes:

- (1) 6 feet above the Mean High Water for tidewater bays and streams
- (2) 6 feet above the Normal High Water for freshwater rivers, streams, non-regulated/controlled canals, and lakes
- (3) 6 feet above the control elevation for regulated/controlled lakes and canals

For bridges without a designated navigation channel, minimum vertical clearance for navigation purposes is measured from the low point of the superstructure to the water

surface anywhere along the length of the bridge over the navigable water. For bridges with a designated navigation channel, minimum vertical clearance for navigation purposes is measured from the low point of the superstructure to the water surface at the edges of the designated navigation channel. Navigation lights are not considered in the vertical clearance.

### **Coastal Bridges:**

A minimum vertical clearance of 1 foot above the 100-year design wave crest elevation including the storm surge elevation and wind setup is required for the superstructure. For bridge designs where this criterion cannot practically be met, refer to the *FDOT Drainage Manual, Section 4.9.5*.

Information on the Normal High Water, control water elevation, or Mean High Water can be obtained from the appropriate Drainage Design Engineer.

Widening of existing structures which do not meet the minimum vertical clearance criteria stated above (either before or after the widening) may be justified hydraulically or economically. However, encroachment of vertical clearance criteria may be limited and is required to be approved by the agency having jurisdiction over the navigable waterway.

## **260.8.2 Horizontal Clearance**

Provide the following minimum horizontal clearance:

- (1) 10 feet for crossings subject to boat traffic.
- (2) Consistent with debris conveyance needs and structure economy where no boat traffic is anticipated.

Horizontal clearance is defined as the unobstructed clear distance between piers, fender systems, culvert walls, etc. projected by the bridge normal to the flow.

## **260.8.3 Regulatory Agency Requirements**

Vertical and horizontal clearances will also be subject to the requirements of the Coast Guard, Corps of Engineers, Water Management District, and any other regulatory agency having appropriate statutory jurisdiction or authority. Such regulatory agency requirements may exceed Department requirements.

## 260.9 Evaluation of Existing Bridge Structures

Each project will require a determination on the most appropriate action regarding existing structures; i.e., should bridge remain as is, be rehabilitated, or be replaced. This determination should be made as early as practical due to the potential impact to the work program. Pavement resurfacing funds can only be used for minor bridge improvements such as rail retrofits and ADA improvements. Bridges that require major improvements or replacement must be programmed with appropriate bridge program funds.

The determination of bridge improvement needs is to be supported by an engineering analysis and report. The determination is to be based on an assessment of the bridge's structural and functional adequacy. The engineering report is to include the following:

- (1) Project description
- (2) Operational impact evaluation
- (3) Safety impact evaluation that includes a detailed review of crash history, severity, contributing factors, etc.
- (4) Benefit/cost analysis

If the engineering analysis determines it is not feasible to bring the bridge into full compliance with minimum criteria, a Design Exception or Design Variation addressing the feature(s) not meeting criteria must be processed in accordance with **FDM 122**. The engineering analysis and report should be used to support the Design Exception or Design Variation.

Review the Department's work program to see if a structure is scheduled for replacement, before determining short term improvements. Consider short term improvements that enhance safety, but may not bring the bridge into compliance, such as:

- Upgrading of connecting guardrail systems
- Approach roadway or shoulder widening
- "Narrow Bridge Ahead" signing and shoulder warning (see **FDM 210.4.5**)

If a bridge is functionally obsolete but structurally sound, complete replacement is usually not warranted. For these structures, a full range of possible improvements should be considered to bring the structure into compliance with minimal criteria. Widening of the structure or rail retrofits are primary options. If a roadway is being programmed or considered for improvements or widening (adding lanes), consider the needs of the future structure(s).



When evaluating bridge replacement or widening, the following should be considered:

- (1) Cost of replacing the existing bridge with a wider bridge designed to new bridge criteria.
- (2) Cost of widening the existing bridge (if widening is practical), including life cycle costs of maintaining a widened bridge.
- (3) The number of crashes that would be eliminated by replacement or widening.
- (4) The hydraulic sufficiency and the risk of failure due to scour and/or ship impact as well as the consequences of failure.

### 260.9.1 Bridge Width

Required bridge widths for new bridge structures are illustrated in the partial bridge sections, **Figures 260.1.1 – 260.1.4**.

Minimum existing bridge widths for arterials and collectors are provided in **Table 260.9.1**.

See **FDM 210.4.5** for information concerning narrow bridge shoulder warning devices.

Bridge widening is to be in accordance with the **Structures Design Guidelines** and meet the geometric requirements for new construction.

**Table 260.9.1 Minimum Widths for Existing Bridges**

Bridge Median Treatment	Minimum Width		
	Traveled Way Width	Shoulder Width (ft)	
		Median	Outside
<b>Undivided (AADT &lt; 750)</b>	Total Width of Approach Lanes	n/a	2.0
<b>Undivided (AADT ≥ 750)</b>	Total Width of Approach Lanes	n/a	4.0
<b>Divided (Median Separator)</b>	Total Width of Approach Lanes	1.5	4.0
<b>Divided (Median Barrier Wall)</b>	Total Width of Approach Lanes	2.5	4.0
<b>One Way Bridges</b>	Total Width of Approach Lanes	2.5	4.0

### **260.9.1.1 Interstate, Freeways and Expressways**

For resurfacing projects, existing 4-lane (2-lanes in one direction) mainline bridges may remain in place without a Design Exception or Variation when all the following requirements are met:

- (1) Minimum 12-foot lane widths, and
- (2) Minimum 3-foot left shoulder, and
- (3) Minimum 10-foot right shoulder on bridges  $\leq$  200 feet in length, or minimum 3-foot right shoulder on bridges  $>$  200 feet in length.

### **260.9.2 Bridge Loading**

See *FDM 121.17* for load rating requirements.

### **260.9.3 Pier Protection, Bridge Railing and Roadside Safety Hardware**

See *FDM 215* for requirements.