





SYMBOLS:

-  Work Area
-  Channelizing Device (See Index No. 600)
-  Work Zone Sign
-  Flagger
-  Lane Identification + Direction of Traffic

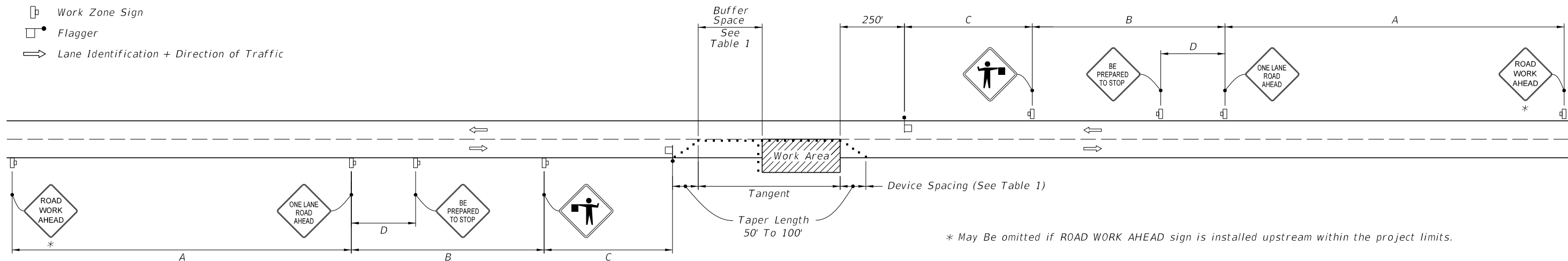

* May Be omitted if ROAD WORK AHEAD sign is installed upstream within the project limits.

WITHOUT TEMPORARY RAISED RUMBLE STRIPS

GENERAL NOTES:

1. Special Conditions may be required in accordance with these notes and the following sheets:
 - A. Railroad Crossings:
 - a. If an active railroad crossing is located closer to the Work Area than the queue length plus 300 feet, extend the Buffer Space as shown on Sheet 3.
 - b. If the queuing of vehicles across an active railroad crossing cannot be avoided, provide a uniformed traffic control officer or flagger at the highway-rail grade crossing to prevent vehicles from stopping within the highway-rail grade crossing, even if automatic train warning devices are in place.
 - B. If the Work Area encroaches on the Centerline, use the Layout for Temporary Lane Shift to Shoulder on Sheet 3 only if the Existing Paved Shoulder width is sufficient to provide for an 11' lane between the Work Area and the Edge of Existing Paved Shoulder. Reduce the posted speed when appropriate.
2. Temporary Raised Rumble Strips:
 - A. Use when both of the following conditions are met concurrently:
 - a. Existing Posted Speed is 55 mph or greater;
 - b. Work duration is greater than 60 minutes.
 - B. Use a consistent Strip color throughout the work zone.
 - C. Place each Rumble Strip Set transversely across the lane at locations shown.
 - D. Use Option 1 or Option 2 as shown on Sheet 2. Use only one option throughout work zone.
3. Additional one-way control may be provided by the following means:
 - A. Flag-carrying vehicle;
 - B. Official vehicle;
 - C. Pilot vehicles;
 - D. Traffic signals.

When flaggers are the sole means of one-way control, the flaggers must be in sight of each other or in direct communication at all times.
4. When a side road intersects the highway within the TTC zone, place additional TTC devices in accordance with other applicable TCZ Indexes.
5. The two channelizing devices directly in front of the work area may be omitted provided vehicles in the work area have high-intensity rotating, flashing, oscillating, or strobe lights operating.
6. When Buffer Space cannot be attained due to geometric constraints, use the greatest attainable length, not less than 200 ft, for posted speeds greater than 25 mph.
7. ROAD WORK AHEAD and the BE PREPARED TO STOP signs may be omitted if all of the following conditions are met:
 - A. Work operations are 60 minutes or less.
 - B. Speed limit is 45 mph or less.
 - C. There are no sight obstructions to vehicles approaching the work area for a distance equal to the Buffer Space shown in Table 1.
 - D. Vehicles in the work area have high-intensity, rotating, flashing, oscillating, or strobe lights operating.
 - E. Volume and complexity of the roadway has been considered.
 - F. If a railroad crossing is present, vehicles will not queue across rail tracks.
 - G. AFADs are not in use.
8. See Index 600 for general TCZ requirements and additional information.
9. Automated Flagger Assistance Devices (AFADs) may be used in accordance with Specifications Section 102, 990 and the APL vendor drawings.

TABLE 1									
Posted Speed	DEVICE SPACING				Distance Between Signs				Buffer Space
	Maximum Spacing of Cones or Tubular Markers		Maximum Spacing of Type I or Type II Barricades/Panels/Drums		A	B	C	D	
	On a Taper	On a Tangent	On a Taper	On a Tangent					
25	20'	50'	20'	50'	200'	200'	200'	100'	155'
30	20'	50'	20'	50'	200'	200'	200'	100'	200'
35	20'	50'	20'	50'	200'	200'	200'	100'	250'
40	20'	50'	20'	50'	200'	200'	200'	100'	305'
45	20'	50'	20'	50'	350'	350'	350'	175'	360'
50	20'	50'	20'	100'	500'	500'	500'	250'	425'
55	20'	50'	20'	100'	2640'	1500'	1000'	500'	495'
60	20'	50'	20'	100'	2640'	1500'	1000'	500'	570'
65	20'	50'	20'	100'	2640'	1500'	1000'	500'	645'
70	20'	50'	20'	100'	2640'	1500'	1000'	500'	730'





CONDITIONS

WHERE ANY VEHICLE, EQUIPMENT, WORKERS OR THEIR ACTIVITIES ENCROACH THE AREA BETWEEN THE CENTERLINE AND A LINE 2' OUTSIDE THE EDGE OF TRAVEL WAY.

12/31/2015 9:03:10 AM

LAST REVISION 01/01/16	REVISION	DESCRIPTION:	 FY 2016-17 DESIGN STANDARDS	TWO-LANE, TWO-WAY, WORK WITHIN THE TRAVEL WAY	INDEX NO. 603	SHEET NO. 1 of 3
---------------------------	----------	--------------	---	--	-------------------------	----------------------------

SYMBOLS:

-  Work Area
-  Channelizing Device (See Index No. 600)
-  Work Zone Sign
-  Flagger
-  Lane Identification + Direction of Traffic

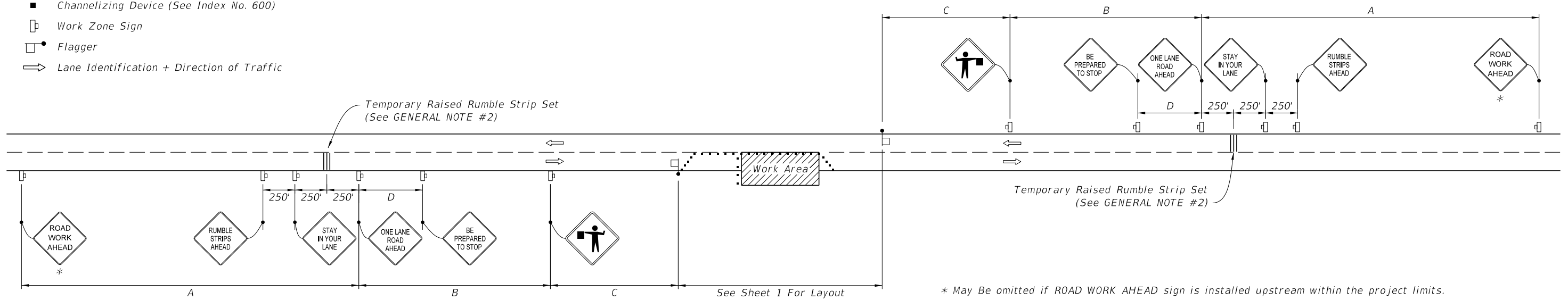

WITH TEMPORARY RAISED RUMBLE STRIPS
(When Required See GENERAL NOTE #2)

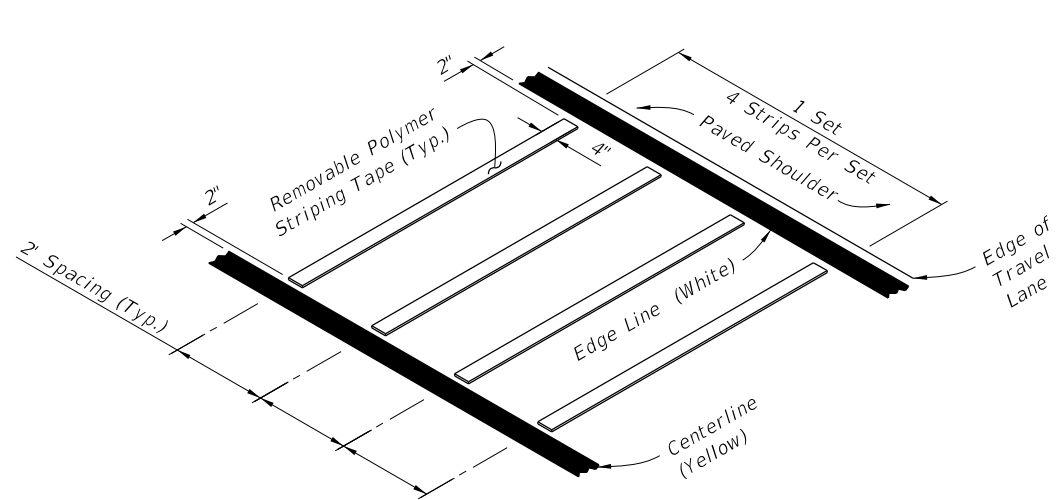

REMOVABLE POLYMER STRIPING TAPE

RUMBLE STRIP SET
OPTION - 1

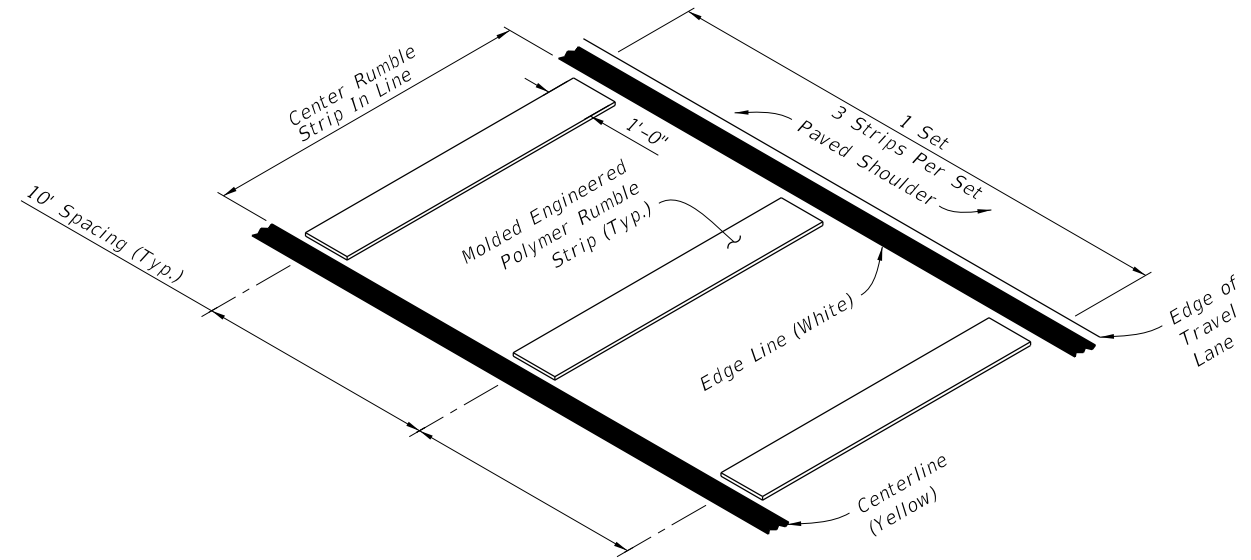

MOLDED ENGINEERED POLYMER SET





RUMBLE STRIP SET
OPTION - 2

TEMPORARY RAISED RUMBLE STRIPS

6/6/2016 10:31:27 AM

LAST REVISION 02/04/16	REVISION	DESCRIPTION:	 FY 2016-17 DESIGN STANDARDS	TWO-LANE, TWO-WAY, WORK WITHIN THE TRAVEL WAY	INDEX NO. 603	SHEET NO. 2 of 3
---------------------------	----------	--------------	---	--	------------------	---------------------

SYMBOLS:

-  Work Area
-  Channelizing Device (See Index No. 600)
-  Work Zone Sign
-  Flagger
-  Lane Identification + Direction of Traffic

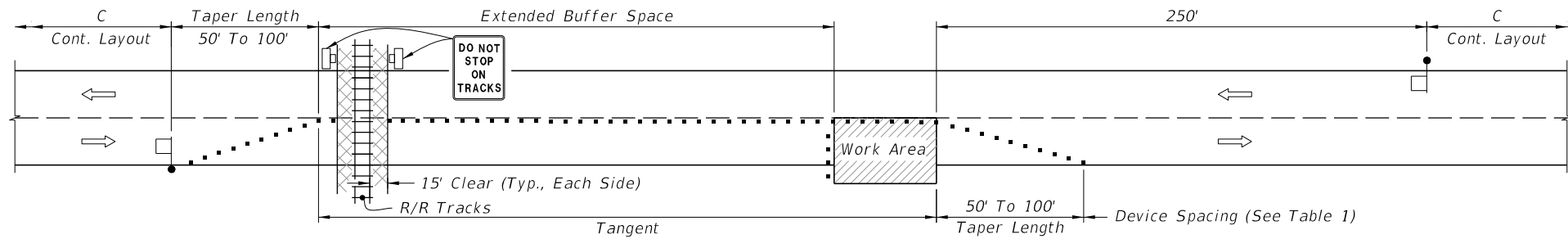

TEMPORARY RAILROAD CROSSING BUFFER SPACE EXTENSION

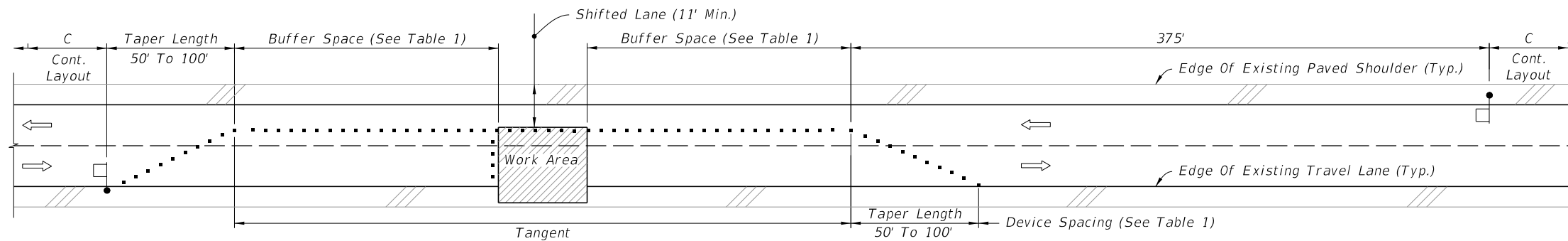

TEMPORARY LANE SHIFT TO SHOULDER WHEN WORK AREA ENCROACHES ON THE CENTERLINE

SPECIAL CONDITIONS

Cross Reference:
1. See General Note #1, Sheet 1 for more information.

12/3/2015 9:03:12 AM

LAST REVISION 01/01/16	REVISION	DESCRIPTION:	 FY 2016-17 DESIGN STANDARDS	TWO-LANE, TWO-WAY, WORK WITHIN THE TRAVEL WAY	INDEX NO. 603	SHEET NO. 3 of 3
---------------------------	----------	--------------	--	--	------------------	---------------------

SPECIAL CONDITIONS