

| SHEET NO. | CONTENTS |
|-----------|--|
| 1 | Preface Manual On Uniform Traffic Control Devices Abbreviations Symbols |
| 2 | Definitions Temporary Traffic Control Devices Pedestrian and Bicyclist Overhead Work Railroads Sight Distance Above Ground Hazard |
| 3 | Clear Zone Widths For Work Zones Superelevation Length Of Lane Closures Overweight/Oversize Vehicles Lane Widths High-Visibility Safety Apparel Regulatory Speeds In Work Zones |
| 4 | Flagger Control Survey Work Zones Signs |
| 5 | Work Zone Sign Supports |
| 6 | Project Information Sign |
| 7 | Commonly Used Warning and Regulatory Signs In Work Zones |
| 8 | Manholes/Crosswalks/Joints Truck Mounted Attenuators Removing Pavement Markings Signals Channelizing Devices Channelizing Devices Consistency Portable Changeable (Variable) Message Signs (PCMS) Advanced Warning Arrow Boards |
| 9 | Drop-Offs In Work Zones |
| 10 | Business Entrance Temporary Asphalt Separator |
| 11 | Identifications-Channelizing Devices |
| 12 | Pavement Markings |

PREFACE

All projects and works on highways, roads and streets shall have a traffic control plan. All work shall be executed under the established plan and Department-approved procedures. This index contains information specific to the Federal and State guidelines and standards for the preparation of traffic control plans and for the execution of traffic control in work zones, for construction and maintenance operations and utility work on highways, roads and streets on the State Highway System. Certain requirements in this Index are based on the high volume nature of State Highways. For highways, roads and streets off the State Highway System, the local agency (City/County) having jurisdiction may adopt requirements based on the minimum requirements provided in the MUTCD.

Index No. 600 provides Department policy and standards. Changes are only to be made thru Department-approved procedures. Index Nos. 601 thru 670 provide typical applications for various situations. Modification can be made to these Indexes as long as the changes comply with the MUTCD and Department Design Standards.

The sign spacing shown on the Indexes are typical (recommended) distances. These distances may be increased or decreased based on field conditions, in order to avoid conflicts or to improve site specific traffic controls.





















Except for emergencies, any road closure on State Highway System shall comply with Section 335.15, F.S.

MANUAL ON UNIFORM TRAFFIC CONTROL DEVICES

The Florida Department of Transportation has adopted the "Manual On Uniform Traffic Control Devices For Streets And Highways" (MUTCD) and subsequent revisions and addendums, as published by the U.S. Department of Transportation, Federal Highway Administration, for mandatory use on the State Maintained Highway System whenever there exists the need for construction, maintenance operations or utility work.

SYMBOLS

The symbols shown are found in the FDOT site menu under Traffic Control cell library on the CADD system. Symbols assigned to the 600 series Design Standards and applicable to traffic control plans, unless otherwise identified in the plans, are as follows:

-  Work Area, Hazard Or Work Phase (Any pattern within a boundary)
-  Channelizing Device
-  Pedestrian Longitudinal Channelizing Device (LCD)
-  Type III Barricade
-  Work Zone Sign
-  Flagger
-  Automated Flagger Assistance Device (AFAD)
-  Traffic Signal
-  Advance Warning Arrow Board
-  Portable Signal
-  Crash Cushion
-  Stop Bar
-  Work Vehicle With Flashing Beacon
-  Shadow (S) Or Advance Warning (AW) Vehicle With Advance Warning Arrow Board And Warning Sign
-  Truck/Trailer Mounted Attenuator (TMA)
-  Law Enforcement Officer
-  Portable Regulatory Sign
-  Radar Speed Display Unit
-  Portable Changeable (Variable) Message Sign
-  Lane Identification + Direction Of Traffic
-  Traffic Control Officer

12/3/2015 9:01:50 AM

| | | | | | | |
|---------------------------|----------|--------------|---|---|-------------------------|-----------------------------|
| LAST REVISION 07/01/15 | REVISION | DESCRIPTION: |  FY 2016-17 DESIGN STANDARDS | GENERAL INFORMATION FOR TRAFFIC CONTROL THROUGH WORK ZONES | INDEX NO. 600 | SHEET NO. 1 of 12 |
|---------------------------|----------|--------------|---|---|-------------------------|-----------------------------|

DEFINITIONS

Regulatory Speed (In Work Zones)

The maximum permitted travel speed posted for the work zone is indicated by the regulatory speed limit signs. The work zone speed must be shown or noted in the plans. This speed should be used as the minimum design speed to determine runoff lengths, departure rates, flare rates, lengths of need, clear zone widths, taper lengths, crash cushion requirements, marker spacings, superelevation and other similar features.

Advisory Speed

The maximum recommended travel speed through a curve or a hazardous area.

Travel Way

The portion of the roadway for the movement of vehicles. For traffic control through work zones, travel way may include the temporary use of shoulders and any other permanent or temporary surface intended for use as a lane for the movement of vehicular traffic.

- a. **Travel Lane:** The designated widths of roadway pavement marked to carry through traffic and to separate it from opposing traffic or traffic occupying other traffic lanes.
- b. **Auxiliary Lane:** The designated widths of roadway pavement marked to separate speed change, turning, passing and climbing maneuvers from through traffic.

Detour, Lane Shift, and Diversion

A detour is the redirection of traffic onto another roadway to bypass the temporary traffic control zone. A lane shift is the redirection of traffic onto a different section of the permanent pavement. A diversion is the redirection of traffic onto a temporary roadway, usually adjacent to the permanent roadway and within the limits of the right of way.

Aboveground Hazard

An aboveground hazard is any object, material or equipment other than traffic control devices that encroaches upon the travel way or that is located within the clear zone which does not meet the Department's safety criteria, i.e., anything that is greater than 4" in height and is firm and unyielding or doesn't meet breakaway requirements.

TEMPORARY TRAFFIC CONTROL DEVICES

All temporary traffic control devices shall be ON the Department's Approved Products List (APL). Ensure the appropriate APL number is permanently marked on the device in a readily visible location.

All temporary traffic control devices shall be removed as soon as practical when they are no longer needed. When work is suspended for short periods of time, temporary traffic control devices that are no longer appropriate shall be removed or covered.

Arrow Boards, Portable Changeable Message Signs, Radar Speed Display Trailer, Portable Regulatory Signs, and any other trailer mounted device shall be delineated with a temporary traffic control device placed at each corner when in use and shall be moved outside the travel way and clear zone or be shielded by a barrier or crash cushion when not in use.

PEDESTRIAN AND BICYCLIST

When an existing pedestrian way or bicycle way is located within a traffic control work zone, accommodation must be maintained and provision for the disabled must be provided.

Only approved pedestrian longitudinal channelizing devices may be used to delineate a temporary traffic control zone pedestrian walkway.

Advanced notification of sidewalk closures and marked detours shall be provided by appropriate signs.

OVERHEAD WORK

Work is only allowed over a traffic lane when one of the following options is used:

OPTION 1 (OVERHEAD WORK USING A MODIFIED LANE CLOSURE)

Overhead work using a modified lane closure is allowed if all of the following conditions are met:

- a. Work operation is located in a signalized intersection and limited to signals, signs, lighting and utilities.
- b. Work operations are 60 minutes or less.
- c. Speed limit is 45 mph or less.
- d. Aerial lift equipment in the work area has high-intensity, rotating, flashing, oscillating, or strobe lights operating.
- e. Aerial lift equipment is placed directly below the work area to close the lane.
- f. Traffic control devices are placed in advance of the vehicle/equipment closing the lane using a minimum 100 foot taper.
- g. Volume or complexity of the roadway may dictate additional devices, signs, flagmen and/or a traffic control officer.

OPTION 2 (OVERHEAD WORK ABOVE AN OPEN TRAFFIC LANE)

Overhead work above a open traffic lane is allowed if all of the following conditions are met:

- a. Work operation is located on a utility pole, light pole, signal pole, or their appurtenances.
- b. Work operations are 60 minutes or less.
- c. Speed limit is 45 mph or less.
- d. No encroachment by any part of the work activities and equipment within an area bounded by 2 feet outside the edge of travel way and 18 feet high.
- e. Aerial lift equipment in the work area has high-intensity, rotating, flashing, oscillating, or strobe lights operating.
- f. Volume or complexity of the roadway may dictate additional devices, signs, flagmen and/or a traffic control officer.
- g. Adequate precautions are taken to prevent parts, tools, equipment and other objects from falling into open lanes of traffic.
- h. Other Governmental Agencies, Rail facilities, or Codes may require a greater clearance. The greater clearance required prevails as the rule.

OPTION 3 (OVERHEAD WORK ADJACENT TO AN OPEN TRAFFIC LANE)

Overhead work adjacent to an open traffic lane is allowed if all of the following conditions are met:

- a. Work operation is located on a utility pole, light pole, signal pole, or their appurtenances.
- b. Work operations are 1 day or less.
- c. Speed limit is 45 mph or less.
- d. No encroachment by any part of the work activities and equipment within 2 foot from the edge of travel way up to 18' height.
 - Above 18' in height, no encroachment by any part of the work activities and equipment over the open traffic lane (except as allowed in Option 2 for work operations of 60 minutes or less).
- e. Aerial lift equipment in the work area has high-intensity, rotating, flashing, oscillating, or strobe lights operating.
- f. Volume or complexity of the roadway may dictate additional devices, signs, flagmen and/or a traffic control officer.
- g. Adequate precautions are taken to prevent parts, tools, equipment and other objects from falling into open lanes of traffic.
- h. Other Governmental Agencies, Rail facilities, or Codes may require a greater clearance. The greater clearance required prevails as the rule.

OPTION 4 (OVERHEAD WORK MAINTAINING TRAFFIC WITH NO ENCROACHMENT BELOW THE OVERHEAD WORK AREA)

Traffic shall be detoured, shifted, diverted or paced as to not encroach in the area directly below the overhead work operations in accordance with the appropriate standard index drawing or detailed in the plans. This option applies to, but not limited to, the following construction activities:

- a. Beam, girder, segment, and bent/pier cap placement.
- b. Form and falsework placement and removal.
- c. Concrete placement.
- d. Railing construction located at edge of deck.
- e. Structure demolition.

OPTION 5 (CONDUCTOR/CABLE PULLING ABOVE AN OPEN TRAFFIC LANE)

Overhead cable and/or de-energized conductor installations initial pull to proper tension shall be done in accordance with the appropriate Standard Index or temporary traffic control plan.

Continuous pulling operations of secured cable and/or conductors are allowed over open lane(s) of traffic with no encroachment by any part of the work activities, materials or equipment within the minimal vertical clearance above the travel way. The utility shall take precautions to ensure that pull ropes and conductors/cables at no time fall below the minimum vertical clearance.

On Limited Access facilities, a site specific temporary traffic control plan is required. The temporary traffic control plan shall include:

- a. The temporary traffic control set up for the initial pulling of the pull rope across the roadway.
- b. During pulling operations, advance warning consisting of no less than a Changeable Message Sign upstream of the work area with alternating messages, "Overhead Work Ahead" and "Be Prepared to Stop" followed by a traffic control officer and police vehicle with blue lights flashing during the pulling operation.

RAILROADS

Railroad crossings affected by a construction project should be evaluated for traffic controls to reduce queuing on the tracks. The evaluation should include as a minimum: traffic volumes, distance from the tracks to the intersections, lane closure or taper locations, signal timing, etc.

SIGHT DISTANCE

Tapers: Transition tapers should be obvious to drivers. If restricted sight distance is a problem (e.g., a sharp vertical or horizontal curve), the taper should begin well in advance of the view obstruction. The beginning of tapers should not be hidden behind curves.

Intersections: Traffic control devices at intersections must provide sight distances for the road user to perceive potential conflicts and to traverse the intersection safely. Construction equipment and materials shall not restrict intersection sight distance.

ABOVEGROUND HAZARD

Aboveground hazards (see definitions) are to be considered work areas during working hours and treated with appropriate work zone traffic control procedures. During nonworking hours, all objects, materials and equipment that constitute an aboveground hazard must be stored/placed outside the travel way and clear zone or be shielded by a barrier or crash cushion.

For aboveground hazards within a work zone the clear zone required should be based on the regulatory speed posted during construction.

12/31/2015 9:01:51 AM

| | | | | | | |
|---------------------------|----------|--------------|--|---|-------------------------|-----------------------------|
| LAST REVISION 07/01/15 | REVISION | DESCRIPTION: |  FY 2016-17 DESIGN STANDARDS | GENERAL INFORMATION FOR TRAFFIC CONTROL THROUGH WORK ZONES | INDEX NO. 600 | SHEET NO. 2 of 12 |
|---------------------------|----------|--------------|--|---|-------------------------|-----------------------------|

CLEAR ZONE WIDTHS FOR WORK ZONES

The term 'clear zone' describes the unobstructed relatively flat area, impacted by construction, extending outward from the edge of the traffic lane. The table below gives clear zone widths in work zones for medians and roadside conditions other than for roadside canals; where roadside canals are present, clear zone widths are to conform with the distances to canals as described in the PPM, Volume I, Chapter 4.

| CLEAR ZONE WIDTHS FOR WORK ZONES | | |
|----------------------------------|---------------------------------------|--|
| WORK ZONE SPEED (MPH) | TRAVEL LANES & MULTILANE RAMPS (feet) | AUXILIARY LANES & SINGLE LANE RAMPS (feet) |
| 60-70 | 30 | 18 |
| 55 | 24 | 14 |
| 45-50 | 18 | 10 |
| 30-40 | 14 | 10 |
| ALL SPEEDS CURB & GUTTER | 4' BEHIND FACE OF CURB | 4' BEHIND FACE OF CURB |

SUPERELEVATION

Horizontal curves constructed in conjunction with work zone traffic control should have the required superelevation applied to the design radii. Under conditions where normal crown controls curvature, the minimum radii that can be applied are listed in the table below.

| MINIMUM RADII FOR NORMAL CROWN | |
|---|----------------|
| WORK ZONE POSTED SPEED | MINIMUM RADIUS |
| MPH | feet |
| 65 | 3130 |
| 60 | 2400 |
| 55 | 1840 |
| 50 | 1390 |
| 45 | 1080 |
| 40 | 820 |
| 35 | 610 |
| 30 | 430 |
| Superelevate When Smaller Radii is Used | |

LENGTH OF LANE CLOSURES

Lane closures shall not exceed 2 miles in total length (taper, buffer space and work space) in any given direction on the Interstate or on state highways with a posted speed of 55 MPH or greater.

OVERWEIGHT/OVERSIZE VEHICLES

Restrictions to Lane Widths, Heights or Load Capacity can greatly impact the movement of over dimensioned loads. The Contractor shall notify the Engineer who in turn shall notify the State Permits Office, phone no. (850) 410-5777, at least seven calendar days in advance of implementing a maintenance of traffic plan which will impact the flow of overweight/oversized vehicles. Information provided shall include location, type of restriction (height, width or weight) and restriction time frames. When the roadway is restored to normal service the State Permits Office shall be notified immediately.

LANE WIDTHS

Lane widths of through roadways should be maintained through work zone travel ways wherever practical. The minimum widths for work zone travel lanes shall be as follows: 11' for Interstate with at least one 12' lane provided in each direction, unless formally excepted by the Federal Highway Administration; 11' for freeways; and 10' for all other facilities.

HIGH-VISIBILITY SAFETY APPAREL

All high-visibility safety apparel shall meet the requirements of the International Safety Equipment Association (ISEA) and the American National Standards Institute (ANSI) for "High-Visibility Safety Apparel", and labeled as ANSI/ISEA 107-2004 or 107-2010. The apparel background (outer) material color shall be either fluorescent orange-red or fluorescent yellow-green as defined by the standard. The retroreflective material shall be orange, yellow, white, silver, yellow-green, or a fluorescent version of these colors, and shall be visible at a minimum distance of 1,000 feet. Class 3 apparel may be substituted for Class 2 apparel. Replace apparel that is not visible at 1,000 feet.

WORKERS: All workers within the right-of-way shall wear ANSI/ISEA Class 2 apparel. Workers operating machinery or equipment in which loose clothing could become entangled during operation shall wear fitted high-visibility safety apparel. Workers inside the bucket of a bucket truck are not required to wear high-visibility safety apparel.

UTILITIES: When other industry apparel safety standards require utility workers to wear apparel that is inconsistent with FDOT requirements such as NFPA, OSHA, ANSI, etc., the other standards for apparel may prevail.

FLAGGERS: For daytime activities, Flaggers shall wear ANSI/ISEA Class 2 apparel. For nighttime activities, Flaggers shall wear ANSI/ISEA Class 3 apparel.

REGULATORY SPEEDS IN WORK ZONES

Traffic Control Plans (TCP's) for all projects must include specific regulatory speeds for each phase of work. This can either be the posted speed or a reduced speed. The speed shall be noted in the TCPs; this includes indicating the existing speed if no reduction is to be made. Regulatory speeds are to be uniformly established through each phase.

In general, the regulatory speed should be established to route vehicles safely through the work zone as close as to normal highway speed as possible. The regulatory speed should not be reduced more than 10 mph below the posted speed and never below the minimum statutory speed for the class of facility. When a speed reduction greater than 10 mph is imposed, the reduction is to be done in 10 mph per 500' increments.

Temporary regulatory speed signs shall be removed as soon as the conditions requiring the reduced speed no longer exist. Once the work zone regulatory speeds are removed, the regulatory speed existing prior to construction will automatically go back into effect unless new speed limit signing is provided for in the plans.

On projects with interspaced work activities, speed reductions should be located in proximity to those activities which merit a reduced speed, and not "blanketed" for the entire project. At the departure of such activities, the normal highway speed should be posted to give the motorist notice that normal speed can be resumed.

If the existing regulatory speed is to be used, consideration should be given to supplementing the existing signs when the construction work zone is between existing regulatory speed signs. For projects where the reduced speed conditions exist for greater than 1 mile in rural areas (non-interstate) and on rural or urban interstate, additional regulatory speed signs are to be placed at no more than 1 mile intervals. Engineering judgement should be used in placement of the additional signs. Locating these signs beyond ramp entrances and beyond major intersections are examples of proper placement. For urban situations (non-interstate), additional speed signs are to be placed at a maximum of 1000' apart.

When field conditions warrant speed reductions different from those shown in the TCP the contractor may submit to the project engineer for approval by the Department, a signed and sealed study to justify the need for further reducing the posted speed, or, the engineer may request the District Traffic Operations Engineer (DTOE) to investigate the need. It will not be necessary for the DTOE to issue regulations for regulatory speeds in work zones due to the revised provisions of F.S. 316.07451(2) (b). Advisory Speed plates will be used at the option of the field engineer for temporary use while processing a request to change the regulatory speed specified in the plans when deemed necessary. Advisory speed plates cannot be used alone but must be placed below the construction warning sign for which the advisory speed is required.

For additional information, refer to the Plans Preparation Manual, Volume I, Chapter 10.

12/31/2015 9:01:53 AM

| | | | | | |
|---------------------------|--------------|--|---|-------------------------|-----------------------------|
| LAST REVISION 01/01/16 | DESCRIPTION: |  FY 2016-17 DESIGN STANDARDS | GENERAL INFORMATION FOR TRAFFIC CONTROL THROUGH WORK ZONES | INDEX NO. 600 | SHEET NO. 3 of 12 |
|---------------------------|--------------|--|---|-------------------------|-----------------------------|

FLAGGER CONTROL

Where flaggers are used, a FLAGGER symbol or legend sign must replace the WORKERS symbol or legend sign.

The flagger must be clearly visible to approaching traffic for a distance sufficient to permit proper response by the motorist to the flagging instructions, and to permit traffic to reduce speed or to stop as required before entering the work site. Flaggers shall be positioned to maintain maximum color contrast between the flagger's high-visibility safety apparel and equipment and the work area background.

Hand-Signaling Devices

STOP/SLOW paddles are the primary hand-signaling device. The STOP/SLOW paddle shall have an octagonal shape on a rigid handle. If the STOP/SLOW paddle is placed on a rigid staff, the minimum length of the staff, measured from the bottom of the paddle to the end of the staff that rests on the ground, must not be less than 6 ft. STOP/SLOW paddles shall be at least 24 inches wide with letters at least 6 inches high and should be fabricated from light semirigid material. The background of the STOP face shall be red with white letters and border. The background of the SLOW face shall be orange with black letters and border. When used at night-time, the STOP/SLOW paddle shall be retroreflectorized.

Flag use is limited to immediate emergencies, intersections, and when working on the centerline or shared left turn lanes where two (2) flaggers are required and there is opposing traffic in the adjacent lanes. Flags, when used, shall be a minimum of 24 inches square, made of a good grade of red material, and securely fastened to a staff that is approximately 36 inches in length. When used at nighttime, flags shall be retroreflectorized red.

Flashlight, lantern or other lighted signal that will display a red warning light shall be used at night.

Flagger Stations

Flagger stations shall be located far enough in advance of the work space so that approaching road users will have sufficient distance to stop before entering the work space. When used at nighttime, the flagger station shall be illuminated.

SURVEY WORK ZONES

The SURVEY CREW AHEAD symbol or legend sign shall be the principal Advance Warning Sign used for Traffic Control Through Survey Work Zones and may replace the ROAD WORK AHEAD sign when lane closures occur, at the discretion of the Party Chief.

When Traffic Control Through Work Zones is being used for survey purposes only, the END ROAD WORK sign as called for on certain 600 Series Indexes should be omitted.

Survey Between Active Traffic Lanes or Shared Left Turn Lanes

The following provisions apply to Main Roadway Traffic Control Work Zones. These provisions must be adjusted by the Party Chief to fit roadway and traffic conditions when the Survey Work Zone includes intersections.

- (A) A STAY IN YOUR LANE (MOT-1-06) sign shall be added to the Advance Warning Sign sequence as the second most immediate sign from the work area.
- (B) Elevation Surveys-Cones may be used at the discretion of the Party Chief to protect prism holder and flagger(s). Cones, if used, may be placed at up to 50' intervals along the break line throughout the work zone.
- (C) Horizontal Control-With traffic flow in the same direction, cones shall be used to protect the backsight tripod and/or instrument. Cones shall be placed at the equipment, and up to 50' intervals for at least 200' towards the flow of traffic.
- (D) Horizontal Control-With traffic flow in opposite directions, cones shall be used to protect the backsight tripod and/or instrument. Cones shall be placed at the equipment, and up to 50' intervals for at least 200' in both directions towards the flow of traffic.

SIGNS

SIGN MATERIALS

Mesh signs may be used only for Daylight Operations.

Vinyl signs may be used for Day or Night Operations not to exceed 1 day except as noted in the standards.

Rigid or Lightweight sign panels may be used in accordance with the vendor APL drawing for the sign stand to which they are attached.

INTERSECTING ROAD SIGNING

Signing for the control of traffic entering and leaving work zones by way of intersecting crossroads shall be adequate to make drivers aware of work zone conditions. When Work operations exceed 60 minutes, place the ROAD WORK AHEAD sign on the side street entering the work zone.

ADJOINING AND/OR OVERLAPPING WORK ZONE SIGNING

Adjoining work zones may not have sufficient spacing for standard placement of signs and other traffic control devices in their advance warning areas or in some cases other areas within their traffic control zones. Where such restraints or conflicts occur or are likely to occur, one of the following methods will be employed to avoid conflicts and prevent conditions that could lead to misunderstanding on the part of the traveling public as to the intended travel way by the traffic control procedure applied:

- (A) For scheduled projects the engineer in responsible charge of project design will resolve anticipated work zone conflicts during the development of the project traffic control plan. This may entail revision of plans on preceding projects and coordination of plans on concurrent projects.
- (B) Unanticipated conflicts arising between adjoining in progress highway construction projects will be resolved by the Resident Engineer for projects under his residency, and, by the District Construction Engineer for in progress projects under adjoining residencies.
- (C) The District Maintenance Engineer will resolve anticipated and occurring conflicts within scheduled maintenance operations.
- (D) The Unit Maintenance Engineer will resolve conflicts that occur within routine maintenance works; between routine maintenance work, unscheduled work and/or permitted work; and, between unit controlled maintenance works and highway construction projects.

SIGN COVERING AND INTERMITTENT WORK STOPPAGE SIGNING

Existing or temporary traffic control signs that are no longer applicable or are inconsistent with intended travel paths shall be removed or fully covered.

Sign blanks or other available coverings must completely cover the existing sign. Rigid sign coverings shall be the same size as the sign it is covering, and bolted in a manner to prevent movement.

Sign covers are incidental to work operations and are not paid for separately.

SIGNING FOR DETOURS, LANE SHIFTS AND DIVERSIONS

Detours should be signed clearly over their entire length so that motorists can easily determine how to return to the original roadway. The reverse curve (W1-4) warning sign should be used for the advanced warning for a lane shift. A diversion should be signed as a lane shift.

EXTENDED DISTANCE ADVANCE WARNING SIGN

Advance Warning Signs shall be used at extended distance of one-half mile or more when limited sight distance or the nature of the obstruction may require a motorist to bring their vehicle to a stop. Extended distance Advanced Warning Signs may be required on any type roadway, but particularly be considered on multilane divided highways where vehicle speed is generally in the higher range (45 MPH or more).

UTILITY WORK AHEAD SIGN

The UTILITY WORK AHEAD (W21-7) sign may be used as an alternate to the ROAD WORK AHEAD or the ROAD WORK XX FT (W20-1) sign for utility operations on or adjacent to a highway.

LENGTH OF ROAD WORK SIGN

The length of road work sign (G20-1) bearing the legend ROAD WORK NEXT _____ MILES is required for all projects of more than 2 miles in length. The number of miles entered should be rounded up to the nearest mile. The sign shall be located at begin construction points.

SPEEDING FINES DOUBLED WHEN WORKERS PRESENT SIGN

The SPEEDING FINES DOUBLED WHEN WORKERS PRESENT sign should be installed on all projects, but may be omitted if the work operation is less than 1 day. The placement should be 500 feet beyond the ROAD WORK AHEAD sign or midway to the next sign whichever is less.

GROOVED PAVEMENT AHEAD SIGN

The GROOVED PAVEMENT AHEAD sign is required 500 feet in advance of a milled or grooved surface open to traffic. The W8-15P placard shall be used in conjunction with the GROOVED PAVEMENT AHEAD sign.

END ROAD WORK SIGN

The END ROAD WORK sign (G20-2) should be installed on all projects, but may be omitted where the work operation is less than 1 day. The sign should be placed approximately 500 feet beyond the end of a construction or maintenance project unless other distance is called for in the plans. When other Construction or Maintenance Operations occur within 1 mile this sign should be omitted and signing coordinated in accordance with Index No. 600, ADJOINING AND/OR OVERLAPPING WORK ZONE SIGNING.

PROJECT INFORMATION SIGN

The Project information sign shall be installed when called for in the plans.

12/3/2015 9:01:54 AM

| | | | | | | |
|---------------------------|----------|--------------|---|---|-------------------------|-----------------------------|
| LAST REVISION 07/01/15 | REVISION | DESCRIPTION: |  FY 2016-17 DESIGN STANDARDS | GENERAL INFORMATION FOR TRAFFIC CONTROL THROUGH WORK ZONES | INDEX NO. 600 | SHEET NO. 4 of 12 |
|---------------------------|----------|--------------|---|---|-------------------------|-----------------------------|

GENERAL NOTES:

- All signs shall be post mounted when work operations exceed one day except for:
 - Road closure signs mounted in accordance with the vendor drawing for the Type III Barricade shown on the APL.
 - Pedestrian advanced warning or regulatory signs mounted on sign supports in accordance with the vendor drawing shown on the APL.
 - Median barrier mounted signs per Index 11871.

TEMPORARY SIGN SUPPORT NOTE:

- Unless shielded with 5'-0" deflection space or outside of the Clear Zone, signs mounted on temporary supports or barricades, and barricade/sign combination must be crashworthy in accordance with NCHRP 350 requirements and included on the Approved Products List (APL).

POST MOUNTED SIGN NOTES:

- Use only approved systems listed on the Department's Approved Products List (APL).
- Manufacturers seeking approval of U-Channel and steel square tube sign support assemblies for inclusion on the Approved Products List (APL) must submit a APL application, design calculations (for square tube only), and detailed drawings showing the product meets all the requirements of this Index.
- Provide 3 lb/ft Steel U-Channel Posts with a minimum section modulus of 0.43 in³ for 60 ksi steel, a minimum section modulus of 0.37 in³ for 70 ksi steel, or a minimum section modulus of 0.34 in³ for 80 ksi steel.
- Provide 4 lb/ft Steel U-Channel Posts with a minimum section modulus of 0.56 in³ for 60 ksi steel, or a minimum section modulus of 0.47 in³ for 70 ksi or 80 ksi steel.
- U-channel posts shall conform with ASTM A 499, Grade 60, or ASTM A 576, Grade 1080 (with a minimum yield strength of 60 ksi). Square tube posts shall conform with ASTM A 653, Grade 50, or ASTM A 1011, Grade 50.
- Sign attachment bolts, washers, nuts, and spacers shall conform with ASTM A307 or A 36.
- For diamond warning signs with supplement plaque (up to 5 ft² in area), use 4 lb/ft posts for up to 10 ft Clear Height (measure to the bottom of diamond warning sign).
- Install 4 lb/ft Steel U-Channel Posts with approved breakaway splice in accordance with the manufacturer's detail shown on the APL.
- The contractor may install 3 lb/ft Steel U-Channel Posts with approved breakaway splice in accordance with the manufacturer's detail shown on the APL.
- Install all posts plumb.
- The contractor may set posts in preformed holes to the specified depth with suitable backfill tamped securely on all sides, or drive 3 lb/ft sign posts and any size base post in accordance with the manufacturer's detail shown on the APL.

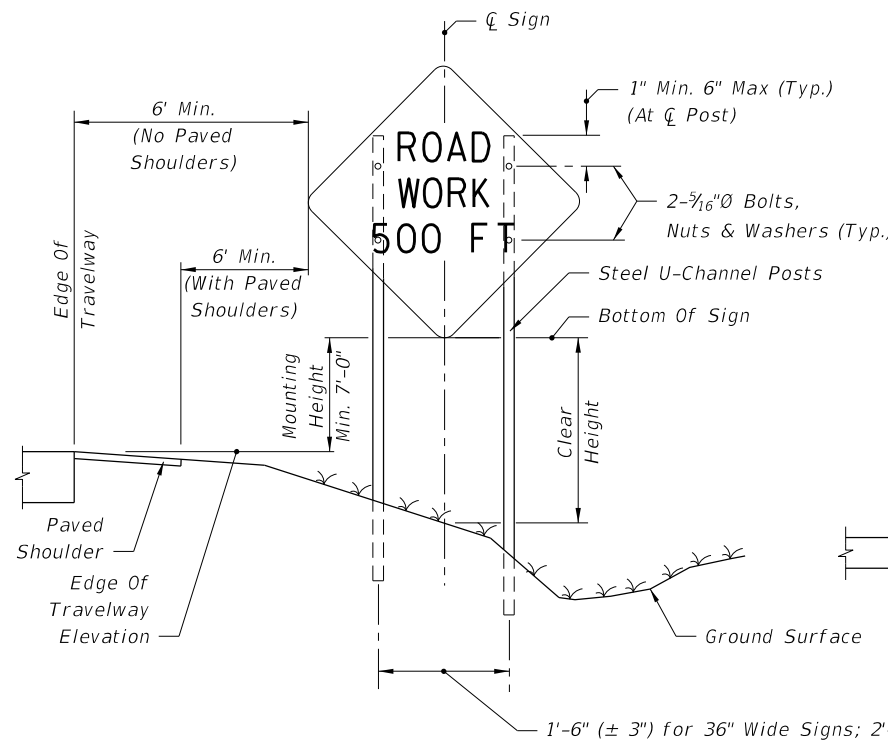

2 POST SIGN SUPPORT MOUNTING DETAILS (SINGLE POST SIMILAR) RURAL

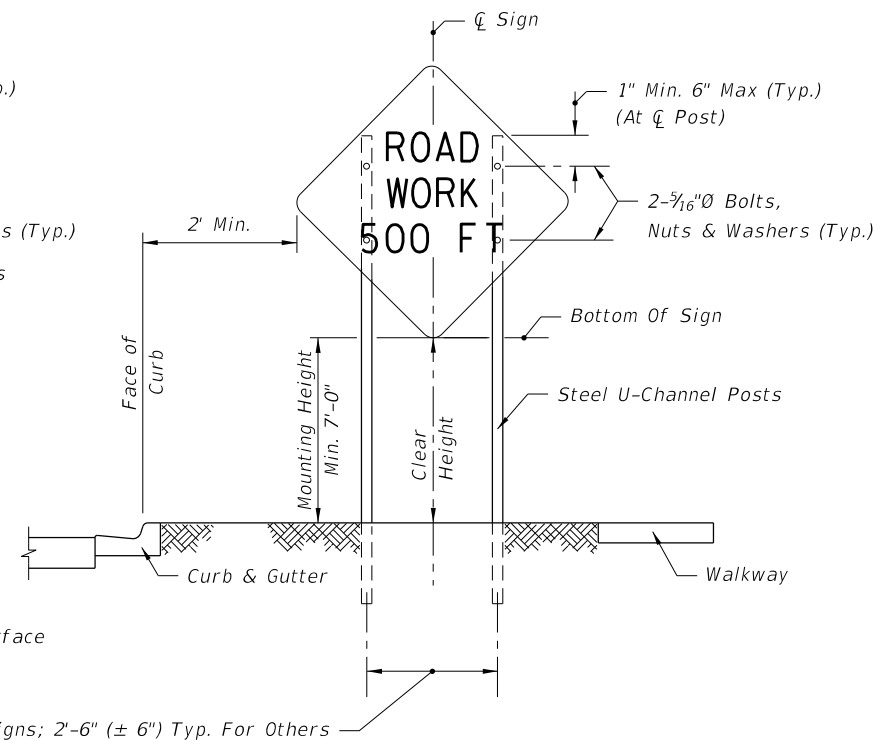

2 POST SIGN SUPPORT MOUNTING DETAILS (SINGLE POST SIMILAR) URBAN

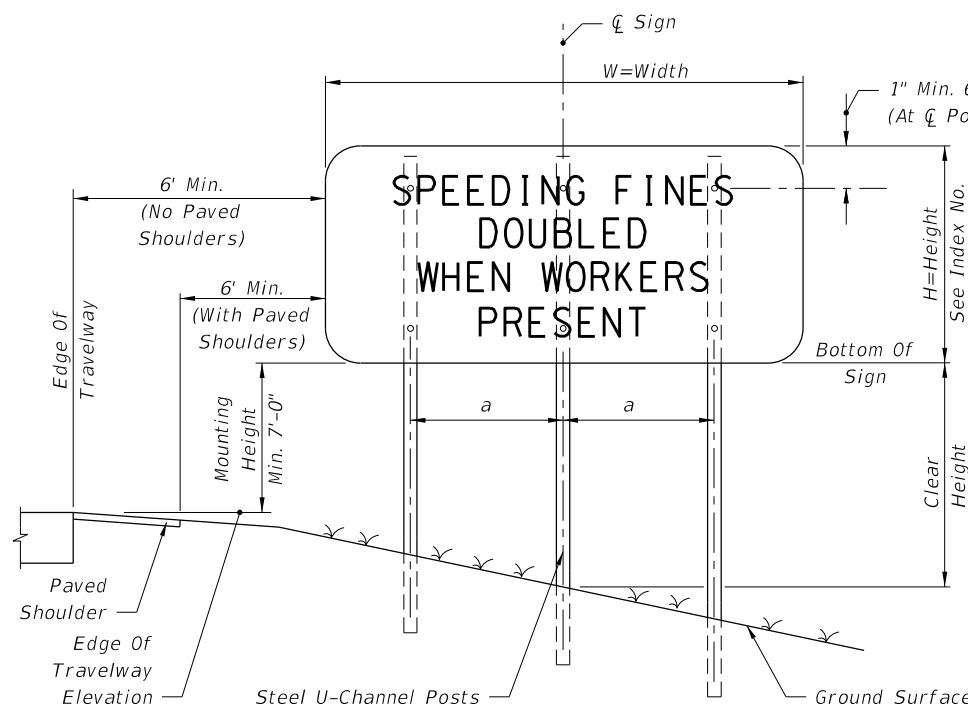

3 POST SIGN SUPPORT MOUNTING DETAILS

Where $W = 48": a = 1' - 4\frac{1}{2}" (\pm 1")$
 $W = 60": a = 1' - 9" (\pm 1")$
 $W = 72": a = 2' - 1" (\pm 1")$

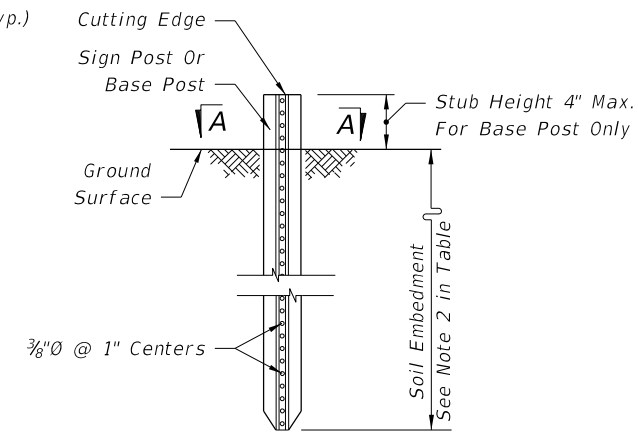

TYPICAL FOUNDATION DETAIL

See APL for post, splice and connection details. No bolts installed closer than 1" to cutting edge.

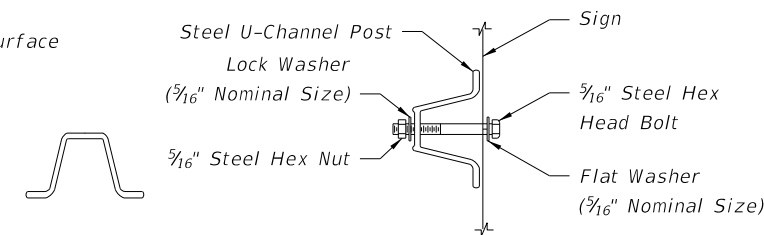

SECTION A-A (SCHEMATIC)

SIGN ATTACHMENT DETAIL (WITHOUT Z-BRACKET)

| POST AND FOUNDATION TABLE FOR WORK ZONE SIGNS | | |
|---|--------------------|---------------------------------|
| SIGN SHAPE | SIGN SIZE (inches) | NUMBER OF STEEL U CHANNEL POSTS |
| Octagon | 30x30 | 1 |
| | 36x36x36 | 1 |
| | 48x48x48 | 1 |
| Triangle | 60x60x60 | 2 |
| | 24x18 | 1 |
| | 24x30 | 1 |
| Rectangle (W x H) | 30x24 | 1 |
| | 36x18 | 1 |
| | 36x24 | 1 |
| | 48x18 | 1 |
| | 48x24 | 1 |
| | 36x48 | 2 |
| | 48x30 | 2 |
| | 48x36 | 2 |
| | 54x36 | 2 |
| | 48x60 | 3 |
| | 60x54 | 3 |
| | 72x48 | 3 |
| | 120x60* | 4* |
| Square | 30x30 | 1 |
| | 36x36 | 2 |
| | 48x48 | 2 |
| Diamond (See Note 7) | 48x48 | 2 |
| Circle | 36Ø | 2 |

Notes For Table:

- Use 3 lb/ft posts for Clear Height up to 10' and 4 lb/ft posts for Clear Height up to 12'.
- * Use 4 lb/ft U-channel sign post with a mounting height of 7' min. and 8' max. Attach sign panel using Z-bracket detail on Sheet 6.
- Minimum foundation depth is 4.0' for 3 lb/ft posts and 4.5' for 4 lb/ft posts.
- For both 3 lb/ft and 4 lb/ft base or sign posts installed in rock, a minimum cumulative depth of 2' of rock layer is required.
- The soil plate as shown on the APL vendor drawing is not required for base posts or sign posts installed in existing rock (as defined in Note 3), asphalt roadway, shoulder pavement or soil under sidewalk.

WORK ZONE SIGN SUPPORTS

12/3/2015 9:01:55 AM

| | | | | | | |
|---------------------------|----------|--------------|---|--|-------------------------|-----------------------------|
| LAST REVISION 01/01/16 | REVISION | DESCRIPTION: | <p>FY 2016-17 DESIGN STANDARDS</p> | <p>GENERAL INFORMATION FOR TRAFFIC CONTROL THROUGH WORK ZONES</p> | INDEX NO. 600 | SHEET NO. 5 of 12 |
|---------------------------|----------|--------------|---|--|-------------------------|-----------------------------|

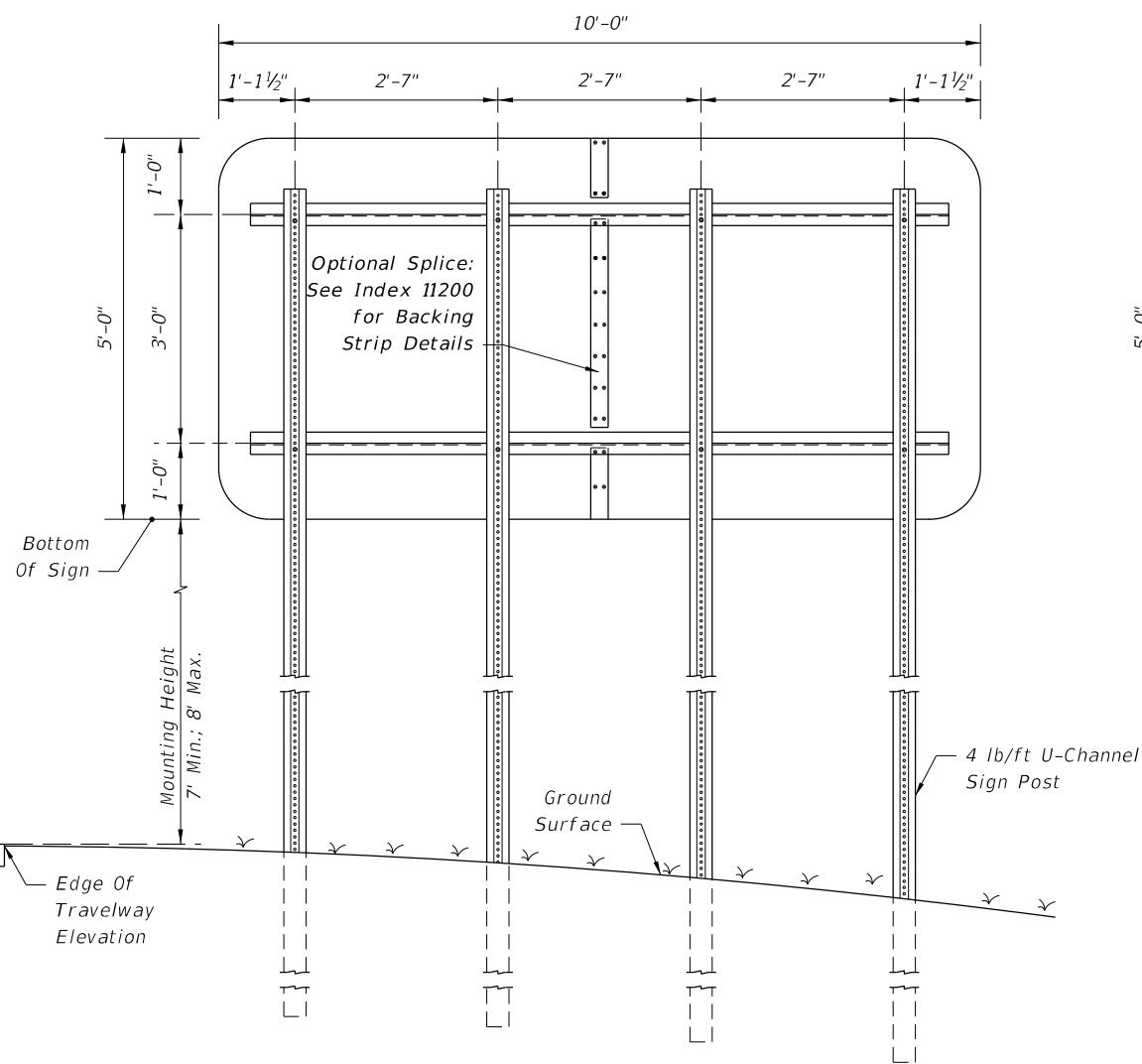

4 POST SIGN SUPPORT MOUNTING DETAIL

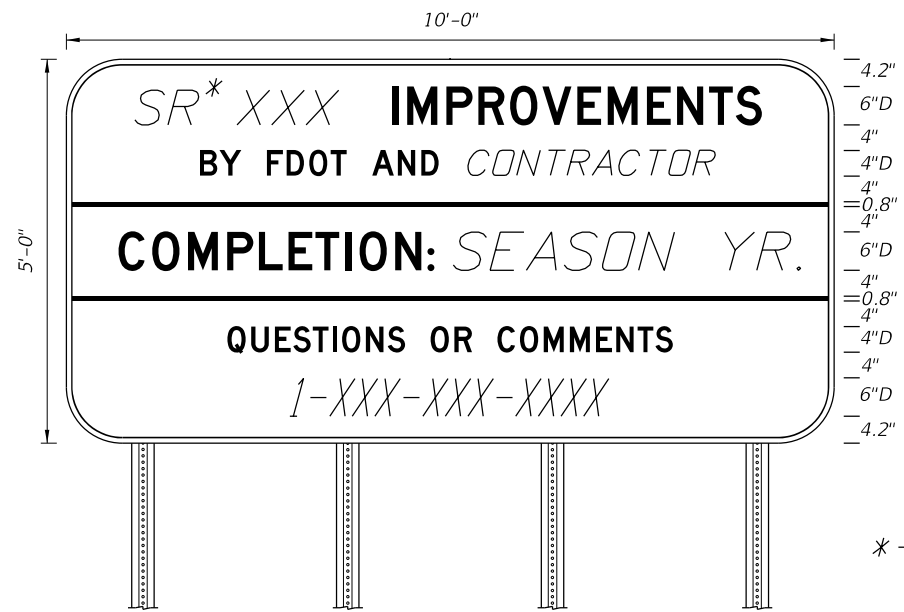

BORDER 10'-0" x 5'-0"
 R=8" 8" Radii
 TH=0.25" 4" and 6" series D Legend
 IN=0.75" Blue Background
 White Legend and Border

PROJECT INFORMATION SIGN DETAIL
 50 MPH OR GREATER
 Use SIGN ATTACHMENT DETAIL
 (WITH Z-BRACKET).

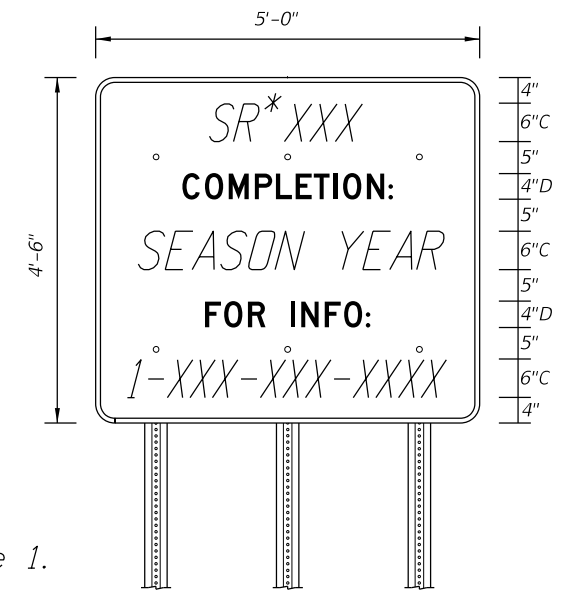

BORDER 5'-0" x 4'-6"
 R=3" 3" Radii
 TH=0.25" 4" series D Legend and
 6" series C Legend
 IN=0.75" Blue Background
 White Legend and Border

PROJECT INFORMATION SIGN DETAIL
 45 MPH OR LESS
 Use SIGN ATTACHMENT DETAIL
 (WITHOUT Z-BRACKET)
 On Sheet 6.

* - See Note 1.

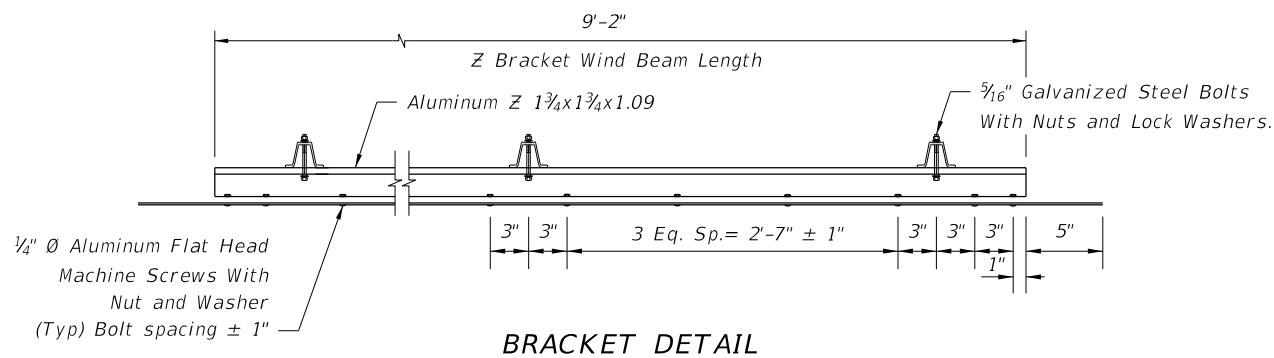

BRACKET DETAIL

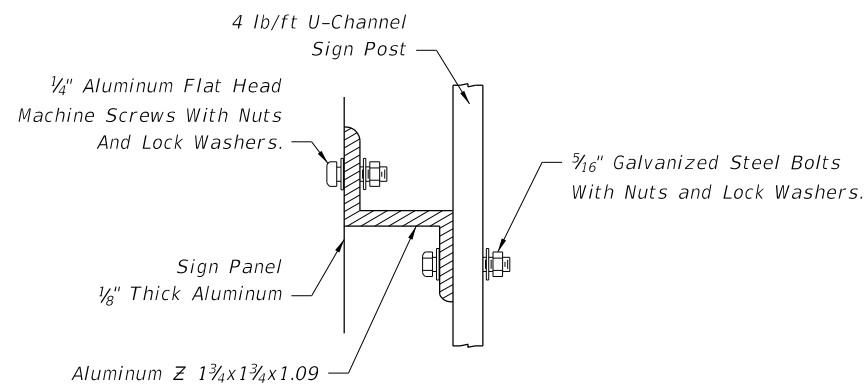

SIGN ATTACHMENT DETAIL
 (WITH Z-BRACKET)

PROJECT INFORMATION SIGN NOTES:

1. Road designation should be the most common designation (ie. I-Interstate, SR-State Road or US.)
2. Italic text on signs indicate variable information specific to the project.
3. See Sheet 5 for POST AND FOUNDATIONS TABLE FOR WORK ZONE SIGNS.
4. See Sheet 5 for TYPICAL FOUNDATION DETAIL.

PROJECT INFORMATION SIGN

12/3/2015 9:01:56 AM

| | | | | | | |
|---------------------------|----------|--------------|------------------------------------|---|---------------------|-------------------------|
| LAST REVISION 07/01/15 | REVISION | DESCRIPTION: | FY 2016-17 DESIGN STANDARDS | GENERAL INFORMATION FOR TRAFFIC CONTROL THROUGH WORK ZONES | INDEX NO. 600 | SHEET NO. 6 of 12 |
|---------------------------|----------|--------------|------------------------------------|---|---------------------|-------------------------|

12/31/2015 9:01:57 AM

| | | | | | | | | | | | | | | | | | | | | |
|---|--------------|--------------|--------------|--------------|--------------|---------------|------------------|----------------|----------------|---------------------------------------|----------------------------------|---------------|---------------|---------------|---------------|------------|------------|------------|------------|------------|
| E5-2 B/O | E5-2a B/O | G20-1 B/O | G20-2 B/O | G20-4 B/O | M4-8 B/O | M4-8A B/O | M4-9L B/O | M4-9R B/O | M4-10L O/B | M4-10R O/B | OM-3R B/Y | R1-1 W/R | R1-2 RW/R | R2-1 B/W | R4-1 B/W | R4-2 B/W | R4-5 B/W | R4-7 B/W | R4-8 B/W | R4-7AL B/W |
| R4-7AR B/W | R4-7BL B/W | R4-7BR B/W | R5-1 WR/W | R9-8 B/W | R9-9 B/W | R9-10 B/W | R9-11 B/W | R9-11a B/W | R11-2 B/W | W1-1R B/O | W1-2R B/O | W1-3R B/O | W1-4R B/O | W1-4b B/O | W1-4c B/O | W1-6 B/O | W1-7 B/O | W1-8 B/O | W3-1 RB/O | W3-2 RB/O |
| W3-3 B(RYG)/O | W3-4 B/O | W3-5 B/O | W4-1 B/O | W4-2 B/O | W5-1 B/O | W5-2 B/O | W5-3 B/O | W6-1 B/O | W6-2 B/O | W6-3 B/O | W8-1 B/O | W8-2 B/O | W8-3 B/O | W8-4 B/O | W8-5 B/O | W8-6 B/O | W8-7 B/O | W8-8 B/O | W8-9 B/O | W8-9a B/O |
| W8-11 B/O | W9-1L B/O | W9-1R B/O | W9-2L B/O | W9-2R B/O | W10-1 B/Y | W11-2 B/O | W12-1 B/O | W12-2 B/O | W13-1 B/O | W20-1A B/O | W20-1B B/O | W20-1C B/O | W20-1D B/O | W20-1E B/O | W20-1F B/O | W20-2A B/O | W20-2B B/O | W20-2C B/O | W20-2D B/O | W20-2E B/O |
| W20-3 B/O | W20-4 B/O | W20-5a B/O | W20-5L B/O | W20-5R B/O | W20-5C B/O | W20-7A B/O | W20-7 B/O | W21-1A B/O | W21-1 B/O | W21-5 B/O | W21-5a B/O | W21-6 B/O | W21-7 B/O | W8-15P B/O | | | | | | |
| W22-1 B/O | W22-2 B/O | W22-3 B/O | | | | | | | | | | | | | | | | | | |
| <p>Notes:</p> <ol style="list-style-type: none"> The size of diamond shaped Temporary Traffic Control (TTC) warning signs shall be a minimum of 48" X 48". Fluorescent orange shall be used for all orange colored work zone signs. The sign shields, symbols and messages contained on this sheet are provided for ready reference to those signs used in the development of the 600 series Design Standards and are commonly used in the development of traffic control plans. For additional signs and sign detail information refer to the STANDARD HIGHWAY SIGNS MANUAL as specified in the MUTCD. Special signs for traffic control plans will be as approved by the State Traffic Plans Engineer. <p>The sign codes shown on this sheet are for the purpose of identifying cell names found in the Traffic Control Cell Library (TCZ.Cel).</p> <p>The STANDARD HIGHWAY SIGNS MANUAL should be referenced for the official sign codes for use in the development of traffic control plans.</p> <p>See Index No. 17355 for MOT sign details.</p> | | | | | | | | | | | | | | | | | | | | |
| <p>COLOR CODES Legend and/or Symbol Background</p> <p>O-Orange (Reflectorized) R-Red (Reflectorized) B-Black (Non-Reflectorized) Y-Yellow (Reflectorized) W-White (Reflectorized) G-Green (Reflectorized)</p> | | | | | | | | | | | | | | | | | | | | |
| MOT-1-06 B/O | MOT-4-06 B/O | MOT-5-06 B/O | MOT-7-06 B/O | MOT-8-06 B/O | MOT-9-06 B/O | MOT-10-06 B/O | MOT-11-06 BLUE/W | MOT-12-06R B/W | MOT-12-06L B/W | MOT-13-06 (Limited access facilities) | MOT-14-06 (All other facilities) | MOT-15-06 B/O | MOT-16-06 B/O | MOT-17-06 B/O | MOT-18-10 B/O | W8-15P B/O | | | | |

COMMONLY USED WARNING AND REGULATORY SIGNS IN WORK ZONES

| | | | | | | | |
|---------------------------|----------|--------------|--|--------------------------------|--|------------------|----------------------|
| LAST REVISION 12/15/14 | REVISION | DESCRIPTION: | | FY 2016-17 DESIGN STANDARDS | GENERAL INFORMATION FOR TRAFFIC CONTROL THROUGH WORK ZONES | INDEX NO. 600 | SHEET NO. 7 of 12 |
|---------------------------|----------|--------------|--|--------------------------------|--|------------------|----------------------|

MANHOLES/CROSSWALKS/JOINTS

Manholes extending 1" or more above the travel lane and crosswalks having an uneven surface greater than 1/4" shall have a temporary asphalt apron constructed as shown in the diagram below.

All transverse joints that have a difference in elevation of 1" or more shall have a temporary asphalt apron constructed as shown in the diagram below.

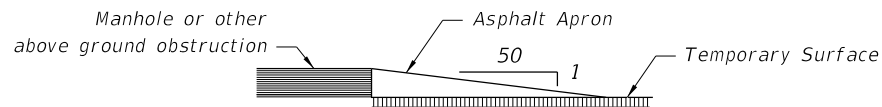

The apron is to be removed prior to constructing the next lift of asphalt. The cost of the temporary asphalt shall be included in the contract unit price for Maintenance of Traffic, LS.

REMOVING PAVEMENT MARKINGS

Existing pavement markings that conflict with temporary work zone delineation shall be removed by any method approved by the Engineer, where operations exceed one daylight period. Painting over existing pavement markings with black paint or spraying with asphalt shall not be accepted as a substitute for removal or obliteration. Full pavement width overlays of either a structural or friction course are a positive means to achieve obliteration.

SIGNALS

Existing traffic signal operations that require modification in order to carry out work zone traffic control shall be included in the TCP and be approved by the District Traffic Operations Engineer.

Maintain all existing actuated or traffic responsive mode signal operations for main and side street movements for the duration of the Contract and require restoration of any loss of detection within 12 hours. The contractor shall select only detection technology listed on the Department's Approved Products List (APL) and approved by the Engineer to restore detection capabilities.

ADVANCE WARNING ARROW BOARDS

An arrow board in the arrow or chevron mode shall be used only for stationary or moving lane closures on multilane roadways.

For shoulder work, blocking the shoulder, for roadside work near the shoulder, or for temporarily closing one lane on a two-lane, two-way roadway, an arrow board shall be used only in the caution mode.

A single arrow board shall not be used to merge traffic laterally more than one lane. When arrow boards are used to close multiple lanes, a single board shall be used at the merging taper for each closed lane.

When Advance Warning Arrow Boards are used at night, the intensity of the flashers shall be reduced during darkness when lower intensities are desirable.

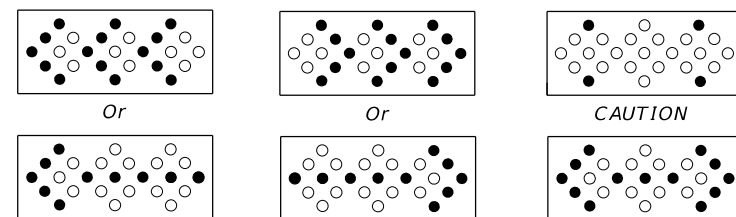

MOVE/MERGE LEFT

MOVE/MERGE RIGHT

MOVE/MERGE RIGHT OR LEFT

- Minimum Required Lamps
- Additional Lamps Allowed

MODES

PORTABLE CHANGEABLE MESSAGE SIGNS (PCMS)

The PCMS can be used to:

1. Supplement standard signing in construction or maintenance work zones.
2. Reinforce static advance warning messages.
3. Provide motorists with updated guidance information.

PCMS should be placed approx. 500 to 800 feet in advance of the work zone conflicts or 0.5 to 2 miles in advance of complex traffic control schemes which require new and/or unusual traffic maneuvers.

If PCMS are to be used at night, the intensity of the flashers shall be reduced during darkness when lower intensities are desirable.

For additional information refer to the FDOT Plans Preparation Manual, Volume I, Chapter 10.

TRUCK/TRAILER-MOUNTED ATTENUATORS

Truck/Trailer-mounted attenuators (TMA) can be used for moving operations and short-term stationary operations. For moving operations, see Index Nos. 607 and 619. For short-term, stationary operations, see Part VI of the MUTCD.

CHANNELIZING DEVICES

Channelizing devices for work zone traffic control shall be as prescribed in Part VI of the MUTCD, subject to supplemental revisions provided in the contract documents and Index 600 requirements. Lighting Devices must not be used to supplement channelization.

CHANNELIZING DEVICE CONSISTENCY

Barricades, vertical panels, cones, tubular markers and drums shall not be intermixed within either the lateral transition or within the tangent alignment.

| | | | | | | |
|---------------------------|----------|--------------|---|---|------------------|----------------------|
| LAST REVISION 07/01/15 | REVISION | DESCRIPTION: |  FY 2016-17 DESIGN STANDARDS | GENERAL INFORMATION FOR TRAFFIC CONTROL THROUGH WORK ZONES | INDEX NO. 600 | SHEET NO. 8 of 12 |
|---------------------------|----------|--------------|---|---|------------------|----------------------|

DROP-OFF CONDITION NOTES

1. These conditions and treatments can be applied only in work areas that fall within a properly signed work zone.
2. A drop-off is defined as a drop in elevation, parallel to the adjacent travel lanes, greater than 3" with slope (A:B) steeper than 1:4 and an algebraic difference in slopes greater than 0.25 (See Drop-off Condition Detail). When drop-offs occur within the clear zone due to construction or maintenance activities, protection devices are required (See Table 1).
3. Drop-offs may be mitigated by placement of slopes with optional base material per Specifications Section 285. Slopes shallower than 1:4 may be required to avoid algebraic difference in slopes greater than 0.25. Include the cost for the placement and removal of the material in Maintenance of Traffic, LSD. Use of this treatment in lieu of a barrier is not eligible for CSIP consideration. Conduct daily inspections for deficiencies related to erosion, excessive slopes, rutting or other adverse conditions. Repair any deficiencies immediately.
4. Distance X is to be the maximum practical under project conditions.
5. For Clear Zone widths, see Index No. 600, Sheet 3.
6. For Setback Distance, refer to the Standard Index drawing of the selected barrier for the required deflection space.
7. Distance from the travel lane to the barrier or warning device should be maximum practical for project conditions.
8. For Conditions 1 and 3 provided in Table 1, any drop-off condition that is created and restored within the same work period will not be subject to the use of barriers; however, warning devices will be required.
9. When permanent curb heights are $\geq 6"$, no warning device will be required. For curb heights $< 6"$, see Table 1.
10. Where a barrier is specified, any of the types below may be used in accordance with the applicable Index:

| Index No. | Description |
|-----------|--|
| 400 | Guardrail |
| 412 | Low Profile Barrier |
| 414 | Type K Temporary Concrete Barrier System |
| 415 | Temporary Concrete Barrier |

For other types of temporary barriers see the APL.
11. Drop-off condition and protection requirements apply to all speeds.

| Condition | X (ft) | D (in.) | Device Required |
|-----------|---|-----------------|----------------------|
| 1 | 0-12 | > 3 | Barrier (See Note 8) |
| 2 | 12-CZ | > 3 to ≤ 5 | Warning Device |
| 3 | 0-CZ | > 5 | Barrier (See Note 8) |
| 4 | Removal of Bridge or Retaining Wall Barrier | | Barrier |
| 5 | Removal of portions of Bridge Deck | | Barrier |

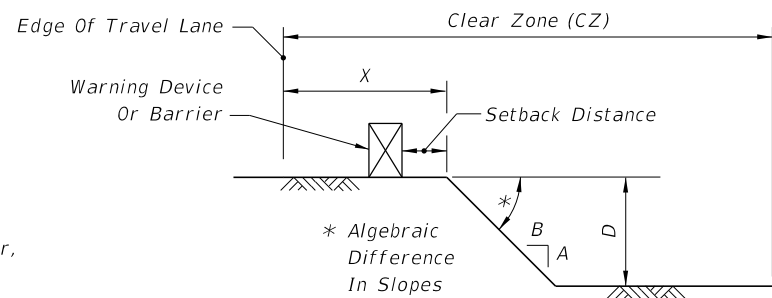

DROP-OFF CONDITION DETAIL

TRAVEL LANE TREATMENT FOR MILLING OR RESURFACING NOTES

1. This treatment applies to resurfacing or milling operations between adjacent travel lanes.
2. Whenever there is a difference in elevation between adjacent travel lanes, the W8-11 sign with "UNEVEN LANES" is required at intervals of 1/2 mile maximum.
3. If D is 1 1/2" or less, no treatment is required.
4. Treatment allowed only when D is 3" or less.
5. If the slope is steeper than 1:4 (not to be steeper than 1:1), the R4-1 and MOT-1-06 signs shall be used as a supplement to the W8-11; this condition should never exceed 3 miles in length.

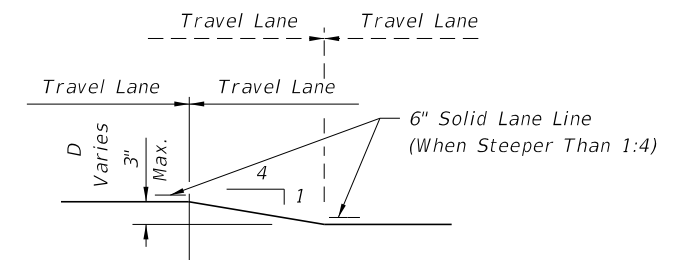

TRAVEL LANE TREATMENT FOR MILLING OR RESURFACING DETAIL

PEDESTRIAN AND/OR BICYCLIST WAY DROP-OFF CONDITION NOTES

1. A pedestrian and/or bicyclist way drop-off is defined as:
 - a. a drop in elevation greater than 10" that is closer than 2' from the edge of the pedestrian or bicyclist way
 - b. a slope steeper than 1:2 that begins closer than 2' from the edge of the pedestrian or bicyclist way when the total drop-off is greater than 60"
2. Protect any drop-off adjacent to a pedestrian or bicyclist way with warning devices, temporary barrier wall, or approved handrail.

WARNING DEVICE NOTES

1. The following are defined as acceptable warning devices:
 - a. Vertical panel
 - b. Type I Or Type II barricades
 - c. Drum
 - d. Cone (where allowed)
 - e. Tubular marker (where allowed)
2. Use the warning device spacing shown in Table 2.

| Speed (mph) | Max. Distance Between Devices (ft) | | | |
|-------------|------------------------------------|---------|--|---------|
| | Cones or Tubular Markers | | Type I or Type II Barricades or Vertical Panels or Drums | |
| | Taper | Tangent | Taper | Tangent |
| 25 | 25 | 50 | 25 | 50 |
| 30 to 45 | 25 | 50 | 30 | 50 |
| 50 to 70 | 25 | 50 | 50 | 100 |

DROP-OFFS IN WORK ZONES

12/31/2015 9:01:59 AM

| Speed (mph) | Max. Distance Between Devices (ft.) | | | |
|----------------|-------------------------------------|---------|--|---------|
| | Tubular Markers | | Vertical Panels or Opposing Traffic Lane Divider | |
| | Taper | Tangent | Taper | Tangent |
| 25 | 25 | 50 | 25 | 50 |
| 30 to 45 | 25 | 50 | 30 | 50 |
| 50 to 70 | 25 | 50 | 50 | 100 |

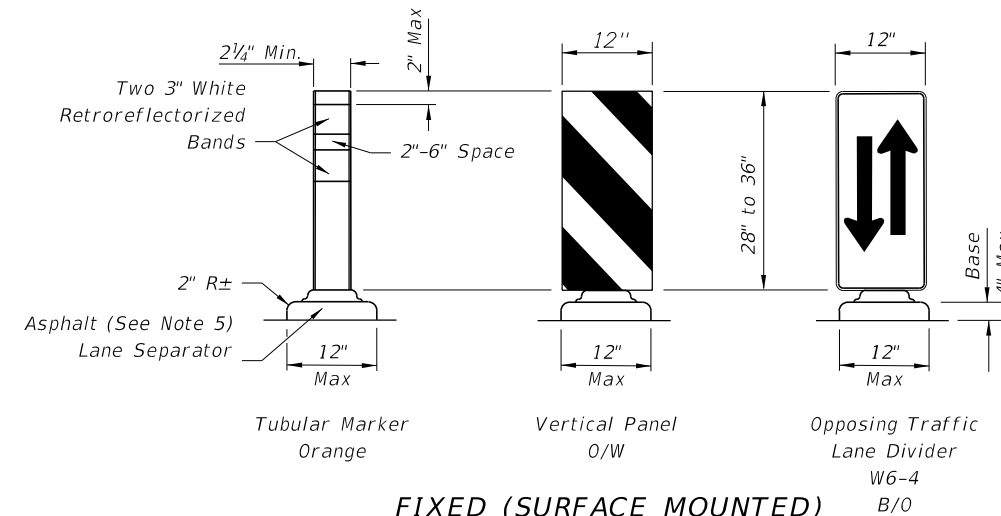
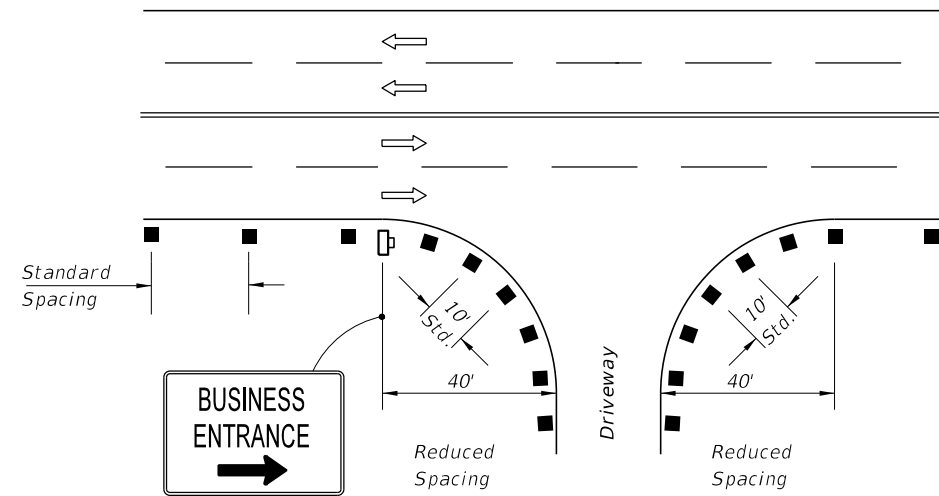
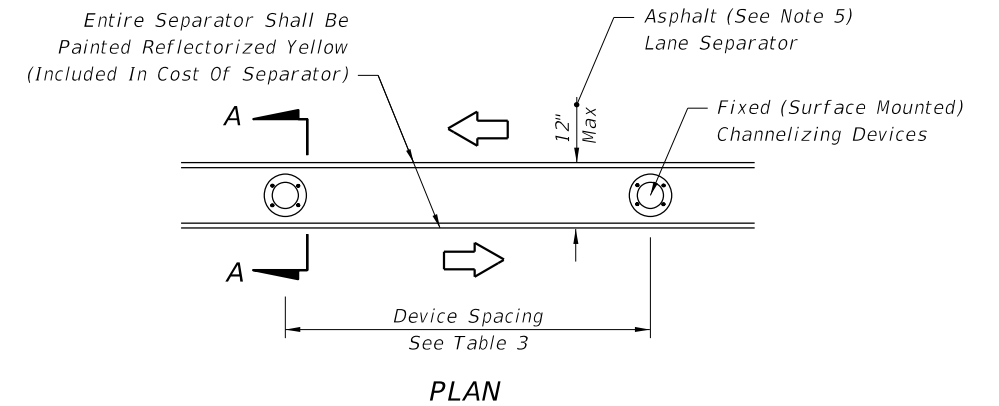

FIXED (SURFACE MOUNTED)
CHANNELIZING DEVICES

SECTION AA

1. For single business entrances, place one 24" x 36" business sign for each driveway entrance affected. Signs shall show specific business names. Logos may be provided by business owners. Standard BUSINESS ENTRANCE sign in Index 17355 may be used when approved by the Engineer.
2. When several businesses share a common driveway entrance, place one 24" x 36" standard BUSINESS ENTRANCE sign in accordance with Index 17355 at the common driveway entrance.
3. Channelizing devices shall be placed at a reduced spacing on each side of the driveway entrance, but shall not restrict sight distance for the driveway users.
4. Business entrance signs are intended to guide motorist to business entrances moved/modified or disturbed during construction projects. Business entrance signs are not required where there is minimal disruption to business driveways which is often the case with resurfacing type projects.

PLACEMENT OF BUSINESS ENTRANCE SIGNS AND
CHANNELIZING DEVICES AT BUSINESS ENTRANCE

1. Temporary lane separators shall be supplemented with any of the following approved fixed (surface mounted) channelizing devices: tubular markers, vertical panels, or opposing traffic lane divider panels. Opposing traffic lane divider panels (W6-4) shall only be used as center lane dividers to separate opposing vehicular traffic on a two-lane, two-way operation. Tubular Markers, Vertical Panels and Opposing Traffic Lane Divider panels shall not be intermixed within the limits where the temporary lane separator is used. The connection between the channelizing device and the temporary lane separator curb shall hold the channelizing device in a vertical position.
2. Reflectorized materials shall have a smooth sealed outer surface which will display the same approximate color day and night. Furnish channelizing devices having retroreflective sheeting meeting the requirements of Section 990.
3. 12" openings for drainage shall be constructed in the asphalt and portable temporary lane separator at a maximum spacing of 25' in areas with grades of 1% or less or 50' in areas with grades over 1% as directed by the Engineer.
4. Tapered ends shall be used at the beginning and end of each run of the temporary lane separator to form a gradual increase in height from the pavement level to the top of the temporary lane separator.
5. The Contractor has the option of using portable temporary lane separators containing fixed channelizing devices in lieu of the temporary asphalt separator and channelizing devices detailed on this sheet. The portable temporary lane separator shall come in portable sections that can be connected to maintain continuous alignment between the separate curb sections. Each temporary lane separator section shall be 36 inches to 48 inches in total length. Portable temporary lane separators shall duplicate the color of the pavement marking. Portable temporary lane separators shall be one of those listed on the Approved Products List.
6. Any damage to existing pavement caused by the removal of temporary lane separator shall be satisfactorily repaired and the cost of such repairs are to be included in the cost of Maintenance of Traffic, LS.

TEMPORARY LANE SEPARATOR

12/31/2015 9:02:00 AM

| | | | | | | |
|---------------------------|--------------|--|--------------------------------|---|------------------|-----------------------|
| LAST REVISION 07/01/15 | DESCRIPTION: | | FY 2016-17 DESIGN STANDARDS | GENERAL INFORMATION FOR TRAFFIC CONTROL THROUGH WORK ZONES | INDEX NO. 600 | SHEET NO. 10 of 12 |
| REVISION | | | | | | |

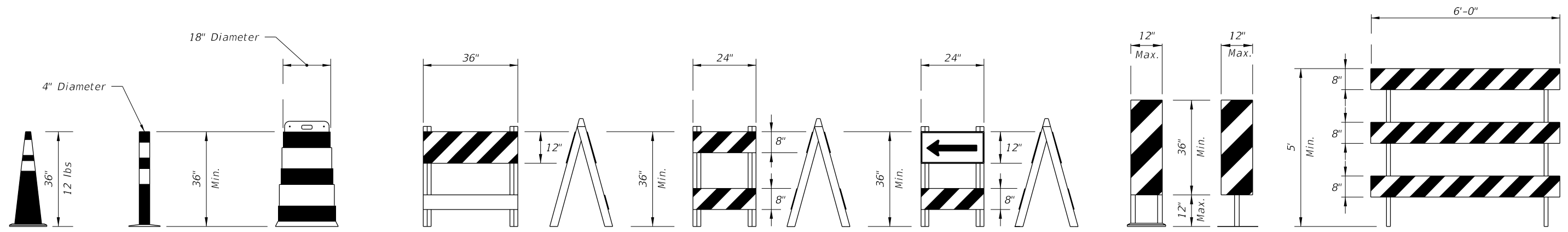

CONES TUBULAR MARKER PLASTIC DRUMS

TUBULAR NON-FIXED
MARKER TO BE USED
DURING DAYLIGHT ONLY

TYPE I BARRICADE

TYPE II BARRICADE

**DIRECTION INDICATOR
BARRICADE**

VERTICAL PANEL
A-FRAME POST MOUNT

TYPE III BARRICADE

CHANNELIZING DEVICE NOTES

- The details shown on this sheet are for the following purposes:
 - For ease of identification and
 - To provide information that supplements or supersedes that provided by the MUTCD.
- The Type III Barricade shall have a unit length of 6'-0" only. When barricades of greater lengths are required those lengths shall be in multiples of the 6'-0" unit.
- No sign panel should be mounted on any channelizing device unless the channelizing device/sign combination was found to be crashworthy and the sign panel is mounted in accordance with the vendor drawing for the channelizing device shown on the APL.
- Ballast shall not be placed on top rails or any striped rails or higher than 13" above the driving surface.
- The direction indicator barricade may be used in tapers and transitions where specific directional guidance to drivers is necessary. If used, direction indicator barricades shall be used in series to direct the driver through the transition and into the intended travel lane.
- The splicing of sheeting is not permitted on either channelizing devices or MOT signs.
- For rails less than 3'-0" long, 4" stripes shall be used.
- Cones shall:
 - Be used only in active work zones where workers are present.
 - Not exceed 2 miles in length of use at any one time.
 - Be reflectorized as per the MUTCD with Department-approved reflective collars when used at night.

- Spacing for longitudinal channelizing devices when placed singly shall be the same as Type I or Type II barricades or drums.
- Vehicular longitudinal channelizing devices shall not exceed 36" in height. For vehicular longitudinal channelizing devices (LCDs) less than 32" in height, the LCD shall be supplemented with approved fixed (surface mounted) channelizing devices (tubular markers, vertical panels, etc.) along the run of the LCD, at the ends, at 50' centers on tangents, and 25' centers on radii. The cost of the fixed supplemented channelizing devices shall be included in the cost of the LCD. LCDs less than 32" in height shall not be used for speeds greater than 45 mph.
- For pedestrian longitudinal channelizing devices, the device shall have a minimum of 8" continuous detectable edging above the walkway. A gap not exceeding a height of 2" is allowed to facilitate drainage. The top surface of the device shall be a minimum height of 32" and have smooth connection points between the devices to facilitate hand trailing. The bottom and the top surface of the device shall be in the same vertical plane. If pedestrian drop-off protection is required, the device shall have a footprint or offset of at least 2', otherwise the device must be at least 42" in height above the walkway and be anchored or ballasted to withstand a 200 lb lateral point load at the top of the device.
- For vehicular longitudinal channelizing devices, use Barrier Delineators meeting Specifications Section 993. Place on top of unit so that retroreflective sheeting faces vehicular traffic. Spacing must be a maximum of 50' centers in transitions, 100' centers on curves and 200' centers on tangents. Color must match adjacent longitudinal pavement marking.

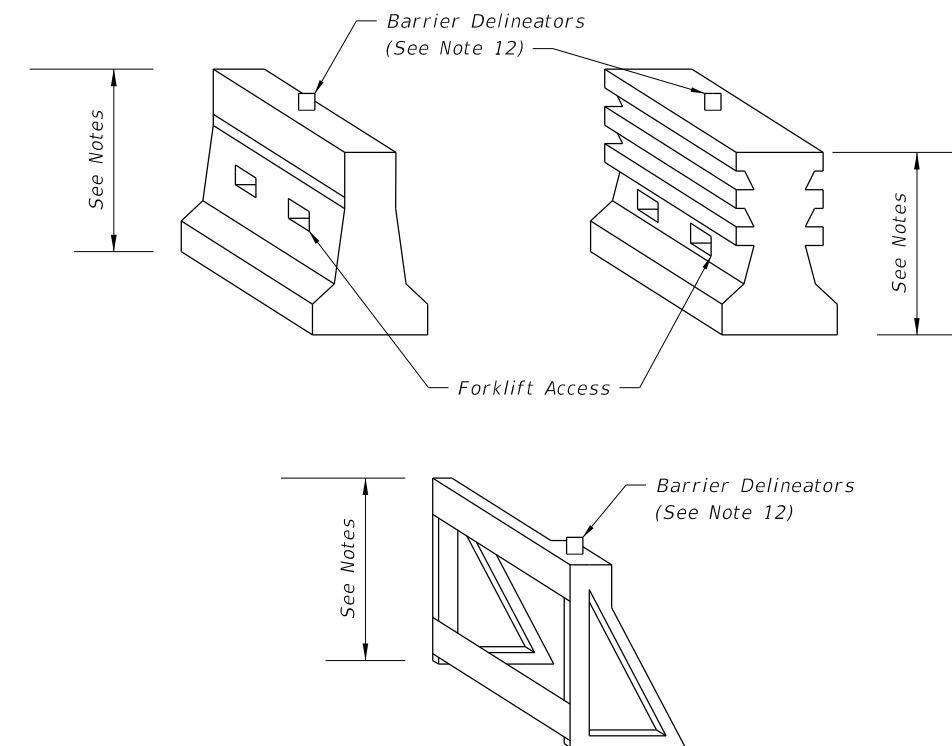

LONGITUDINAL CHANNELIZING DEVICE

IDENTIFICATIONS - CHANNELIZING DEVICES

12/3/2015 9:02:01 AM

| | | | | | | |
|---------------------------|----------|--------------|--|---|-------------------------|------------------------------|
| LAST REVISION 07/01/15 | REVISION | DESCRIPTION: |  FY 2016-17 DESIGN STANDARDS | GENERAL INFORMATION FOR TRAFFIC CONTROL THROUGH WORK ZONES | INDEX NO. 600 | SHEET NO. 11 of 12 |
|---------------------------|----------|--------------|--|---|-------------------------|------------------------------|

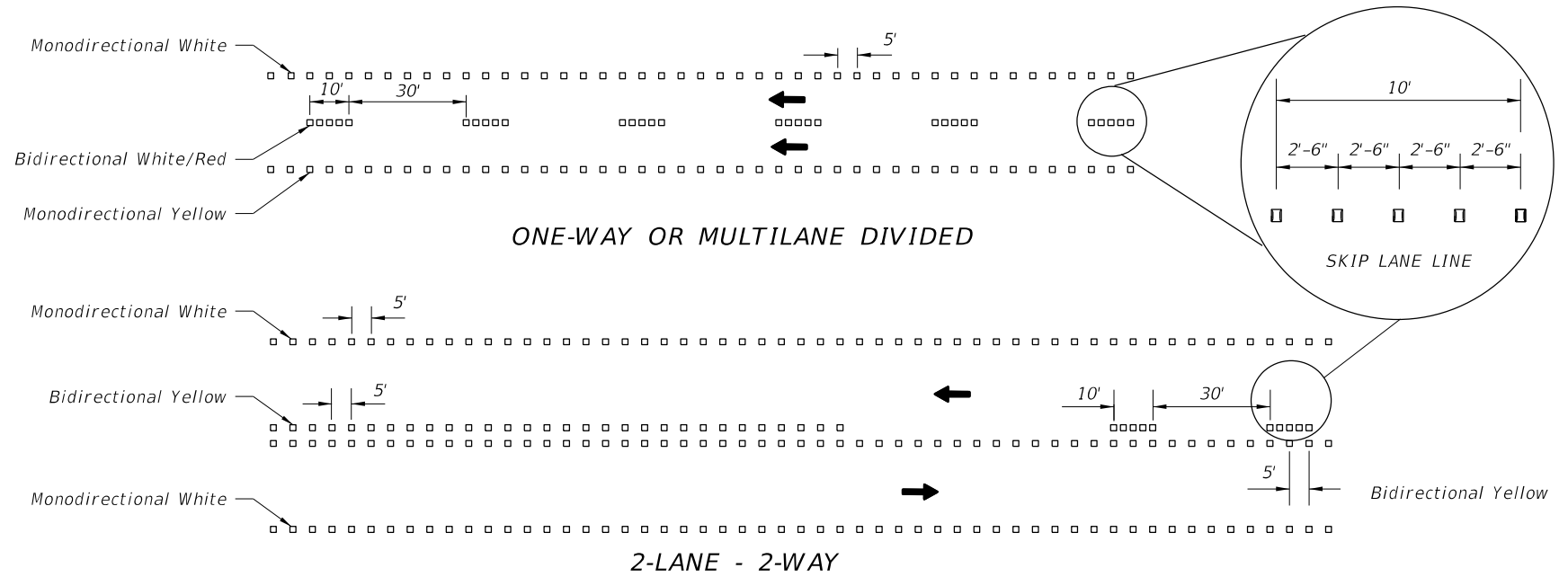

TEMPORARY SUBSTITUTION OF RPM'S FOR PAINT OR REMOVABLE TAPE

1. Paint or removable tape are the required work zone markings and shall be placed in accordance with the plans and specifications. If these work zone markings can not be placed due to weather restrictions identified in the appropriate specification, temporary substitution of RPM's for work zone markings will be allowed until the weather condition permits the placement of appropriate work zone marking. Temporary substitution of RPM's for work zone markings will be allowed for equipment malfunction, placement of the appropriate work zone marking shall be made within 3 days, or sooner if possible. When RPM's are used as a temporary substitution for work zone markings the following shall apply:
 - a. Lane widths identified in the plans must be maintained. Placement of RPM's should consider where work zone markings will be placed as soon as conditions allow. If the RPM's can not be placed so that the lane width is maintained after the placement of the work zone markings, the conflicting RPM's must be removed.
 - b. The color of the RPM body and the reflective face shall conform to the color of the marking for which they substitute.
 - c. In work zones, B RPM's must be used to form lane lines, edge lines and temporary gore areas as a temporary substitute for paint or removable tape at the spacing shown above.

NOTES FOR REFLECTIVE PAVEMENT MARKERS

1. The color of the raised pavement marker under both day and night conditions shall conform to the color of the marking for which they serve as a positioning guide, or for which they supplement or substitute.
2. To provide contrast on concrete pavement, or light asphalt, the five (5) white RPM's shall be followed by five black RPM's. The spacing between RPM's shall be 2'-6". Black RPM's will not be required for contrast with yellow RPM's.
3. RPM's used to supplement lane lines are to be paid for as Reflective Pavement Marker (Temporary), EA. RPM's used as a temporary substitute for paint or removable tape due to weather restrictions are to be paid for as Reflective Pavement Marker (Temporary), EA. RPM's used as a temporary substitute for paint or removable tape due to equipment malfunction are to be placed at the Contractor's expense.

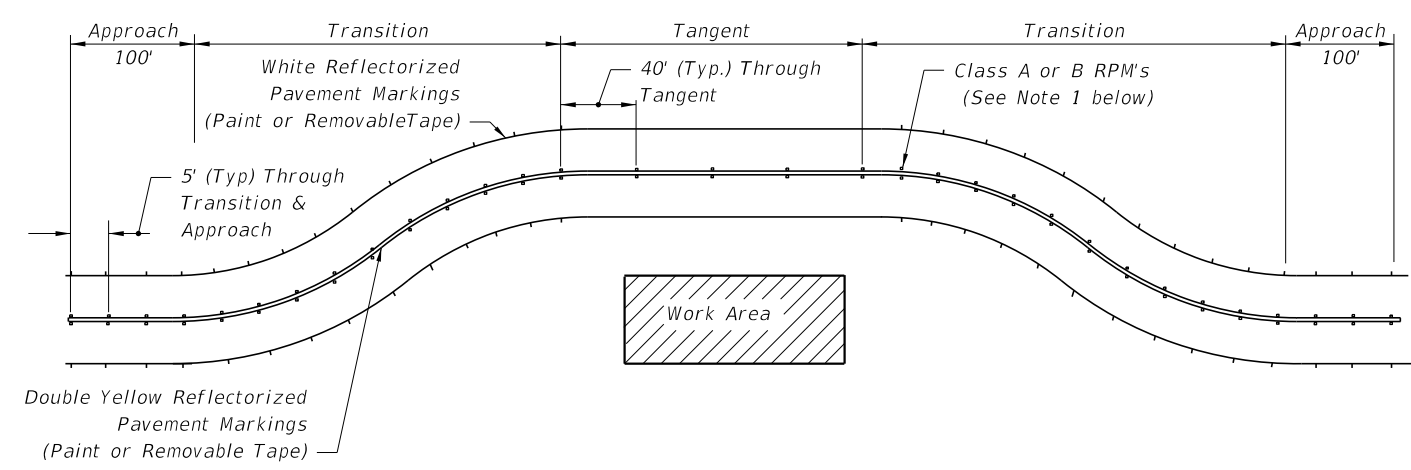

USE OF RPM'S TO SUPPLEMENT PAINT OR REMOVABLE TAPE IN WORK ZONES

1. RPM's shall be installed as a supplement to:
 - a. All lane lines.
 - b. Edge lines in transition & approach areas.
 - c. Edge lines of gore areas.
2. Placement of RPM's should be as shown in Index No. 17352 with the following exceptions:
 - RPM's shall be placed at 5 feet center to center in approach and transition areas.

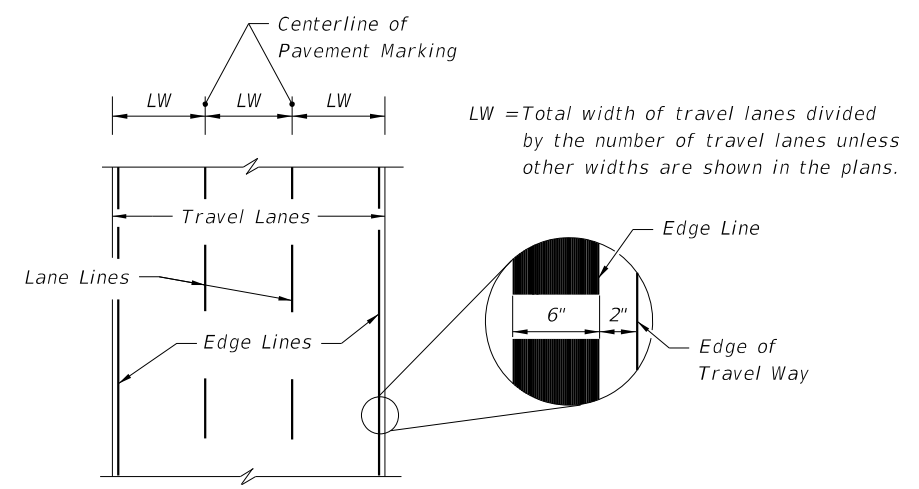

PLACEMENT OF PAVEMENT MARKINGS

PAVEMENT MARKINGS

12/31/2015 9:02:02 AM

| | | | | | | |
|---------------------------|----------|--------------|------------------------------------|---|------------------|-----------------------|
| LAST REVISION 01/01/16 | REVISION | DESCRIPTION: | FY 2016-17 DESIGN STANDARDS | GENERAL INFORMATION FOR TRAFFIC CONTROL THROUGH WORK ZONES | INDEX NO. 600 | SHEET NO. 12 of 12 |
|---------------------------|----------|--------------|------------------------------------|---|------------------|-----------------------|