

## Index 480 Series Traffic Railing - (Vertical Face Retrofit)

### Design Criteria

**NCHRP Report 350**, Test Level 4; **AASHTO LRFD Bridge Design Specifications**, 6th Edition, Section 13; **Structures Design Guidelines (SDG)**

### Design Assumptions and Limitations

Index 480 is the lead standard for the Traffic Railing (Vertical Face Retrofit) standard series which includes Indexes 480 through 484. Use this standard with Indexes 402, 410, 481, 482, 483 and 484.

The Traffic Railing (Vertical Face Retrofit), Indexes 480 through 483, are applicable for retrofitting specific types of existing bridge mounted traffic railings (a.k.a. concrete handrails) that are not based on crash tested designs.

Index 484 should only be used when space is limited, which precludes the use of a guardrail end treatment or crash cushion. Determine the Length of Advancement for the Tapered End Transition using the criteria shown on Index 484, Sheet 1. Indexes 480 through 484 are not acceptable as alternatives for new construction.

These Standards are to be used in conjunction with Indexes 402 and 410. The appropriate Index 402 approach transition retrofit for Index 480 Series bridge railing retrofits or Index 484 Tapered End Transition must be selected and specified in the plans based on the shapes and designs of the existing bridge traffic railings, approach slabs and end bent wing walls. See the Instructions for [Index 402](#) and **SDG 6.7** for more information.

The applicability of the Vertical Face Retrofit to a particular bridge shall be determined based on a review of the Load Rating of the existing bridge, a comparison of the existing bridge geometry to that shown for the Vertical Face Retrofit and an evaluation of the structural adequacy of the existing bridge deck and wing walls in accordance with the requirements of the **SDG**. See **SDG 2.2** for average weight per linear foot of the retrofit.

The Traffic Railing (Vertical Face Retrofit) has been structurally evaluated to be equivalent or greater in strength to a design which has been successfully crash tested previously and approved for a **NCHRP Report 350** Test Level 4 rating. The Standards all utilize a cast in place, vertical face, reinforced concrete block that is installed adjacent to the face of the existing curb and in front of, or in place of, all or part of the existing traffic railing. The Standards work with existing traffic railings that incorporate either solid concrete parapet type or concrete post and beam type railings with or without top mounted metal railings. These existing traffic railings are typically mounted on top of concrete curbs of varying widths and heights. The individual Standards address both narrow and wide curbs (a.k.a. "safety curbs"), and skewed and non-skewed bridges with parallel, perpendicular, angled or flared end bent wing walls. Each Standard includes several schemes that address the given wing wall configurations. Examples depicting existing curb and end bent wing wall configurations are shown in the Existing Curb Schematic and the Partial Plan Views of Existing Bridges herein.

Generally, the Roadway Plans shall include all of the sheets necessary to define and detail the retrofit of the existing traffic railings. Index 480, Traffic Railing (Vertical Face Retrofit) General Notes and Details, shall be referenced in the Roadway Plans or a similar project specific drawing depicting general notes and details, shall be included in the Roadway Plans. In addition, one or more of the appropriate Indexes 481 through 484, that most closely matches the configuration of the existing traffic railing and curb is to be referenced in the Roadway Plans for each bridge as required. Generally, these Standards can be used without any modifications being made to them. More than one of the Indexes 481 through 484, may be required for a single bridge due to the curbs or sidewalks on the two sides of the bridge possibly having different widths.

The need to remove all or part of the existing traffic railing down to the top of the curb in order to provide room for the construction of the retrofit is addressed in the individual retrofit indexes. Payment for the removal of all or part of the existing traffic railing shall be included in Removal of Existing Structures, Pay Item 110-3. As part of the overall retrofit concept for a bridge, the existing traffic railing may be removed, even though it is not specifically required to be, in order to reduce the dead load carried by the bridge. In these cases, the potential drop off hazard for pedestrians that will be created behind the retrofit shall be addressed in the Plans.

The treatment of the approach end of the retrofit shall consist of Index 402, 484 or another appropriate site specific treatment. The appropriate treatment of the trailing end of the retrofit shall be determined by the Roadway Engineer. On approach ends, a Transition Block or Curb is required if the existing Approach Slab does not have a curb. A Transition Block is not required on trailing ends with no opposing traffic, however, a Curb may be required due to drainage needs. An Index 300, Type D Concrete Curb is generally suitable for this application. The appropriate site specific approach and trailing end treatments shall be shown in the Plans.

If an Index 402 Roadway Guardrail Transition is used, the defining station of the end of the transition must be shown in the Plans. The attachment point for the Thrie-Beam Terminal Connector shall be determined based on the shape, length, structural adequacy and direct means of support of the end most section of the Vertical Face Retrofit, the existing wing wall and/or approach slab as follows:

Perpendicular or Angled Wing Walls -

Attach the Thrie-Beam Terminal Connector to the Vertical Face Retrofit on the bridge.

Parallel Wing Walls -

1. If the Vertical Face Retrofit is supported by the wing wall, attach the Thrie-Beam Terminal Connector to the Vertical Face Retrofit along the wing wall if the wing wall is a minimum of 5'-0" long, directly pile supported and structurally adequate. If the Vertical Face Retrofit is supported by the approach slab, attach the Thrie-Beam Terminal Connector along the approach slab section of the retrofit if that section is a minimum of 5'-0" long.
2. Attach Thrie-Beam Terminal Connector to the Vertical Face Retrofit on the bridge if the any of the appropriate preceding criteria for parallel wing walls or approach slabs are not met.

Flared Wing Walls with parallel portions -

1. If the Vertical Face Retrofit is supported by the wing wall, attach the Thrie-Beam Terminal Connector to the Vertical Face Retrofit along the parallel portion of the Vertical Face Retrofit if the wing wall is a minimum of 5'-0" long, directly pile supported, structurally adequate and if the parallel portion of Vertical Face Retrofit is a minimum of 2'-0" long. If the Vertical Face Retrofit is supported by the approach slab, attach the Thrie-Beam Terminal Connector along the approach slab section of the retrofit if that section is a minimum of 5'-0" long and has a parallel portion that is a minimum of 2'-0" long.
2. Attach Thrie-Beam Terminal Connector to the Vertical Face Retrofit on the bridge if any of the preceding criteria for flared wing walls with parallel portions are not met.

Flared Wing Walls without parallel portions -

Attach Thrie-Beam Terminal Connector to the Vertical Face Retrofit on the bridge.

Indexes 402 and 480 through 484 shall be supplemented as required with project specific details that may be deemed necessary to complete the installation of the retrofit railing. These details may include locations and details of any existing utilities, conduits, drainage structures, sign structures and luminaire supports, or designs and details of traffic railing sliding plate assemblies for large expansion joints and any other needed information not included in these Standards. In the event that the details and indexes presented in these Standards do not closely match the existing conditions, the Structures and/or Roadway Engineer(s) shall prepare a customized project specific retrofit design using the crash tested bridge railing and guardrail transition designs presented in Indexes 402 and 480 through 484 as guides. Contact the Structures Design Office and Roadway Design Office for guidance in this event.

The Utility Adjustment Plans, if required, shall contain all necessary utility adjustment information required for the retrofit of the existing traffic railings. Utilities and/or conduits may exist in or adjacent to the existing traffic railings and will vary in size, number and location. The presence, size, number and locations of existing utilities and/or conduits shall be determined by a review of existing Plans and confirmed by field verification. It should be noted that utility and/or conduit installations may vary by location on a single bridge. Thus, a field verification shall be conducted for each individual installation of the retrofit. Existing utilities and/or conduits that conflict with the retrofit shall be relocated if possible or placed out of service. The required field verification work should be completed as early in the evaluation phase as possible.

The Traffic Control Plans for the construction of the retrofit shall be prepared in accordance with Index 600 Series. The Plans shall address all aspects of the full or partial removal of the existing traffic railing (when required) and construction of the retrofit. Generally, the use of Indexes 481 and 483 will require the removal of the existing traffic railing and will require traffic control consisting of shifting, narrowing and/or closing of travel lanes and/or shoulders. In this case, the use of crash tested Precast Concrete Temporary Barriers will also be required to protect the drop-off exposed by the removal of the existing traffic railing.

Indexes 480 through 484 do not address retrofitting of the existing traffic railings, curbs or sidewalks for pedestrian use. The potential need to retrofit the existing bridge for pedestrian use shall be evaluated on a project by project basis and the necessary Plans developed accordingly. Generally, the potential effects on pedestrian use of the bridge will be confined to bridges with sidewalks or wide curbs. The use of the Side Mounted Bridge Pedestrian/Bicycle Retrofit Railing shown in Indexes 851 and 861 shall be evaluated and noted in the Plans where appropriate. See the IDS for Indexes 851 and 861 for more information. The potential reduction in clear width of the curb or sidewalk caused by the installation of the retrofit shall be considered.

It should be noted that the existing traffic railings and/or guardrail end transitions may have been previously retrofitted utilizing a scheme presented in Roadway and Traffic **Design Standards** Index 401 (2000 and earlier Editions). In this event, the requirements for removal, modification or replacement of the prior retrofit shall be evaluated and addressed in the Plans as required. Of the retrofit schemes presented in Roadway and Traffic **Design Standards** Index 401, only Schemes 1 and 19 can be left in place and utilized as a component of the crash tested designs presented in Indexes 402 and 480 through 484. The removal of the prior retrofit, if required, may be considered as incidental work with no separate payment made.

The applicability of the individual retrofit schemes to different wing wall configurations is shown in the following views.

The applicability of the individual Standards to different curb widths is described as follows:

- Index 481 - Applicable for existing narrow curbs as shown below. This index requires removal of the existing traffic railing to the top of the existing curb along the entire length of the bridge and wing walls.
- Index 482 - Applicable for existing wide curbs or sidewalks as shown below. This index generally allows the entire existing traffic railing to remain in place.
- Index 483 - Applicable for existing intermediate width curbs as shown below. This index requires removal of the existing traffic railing to the top of the existing curb along the entire length of the bridge and wing walls.

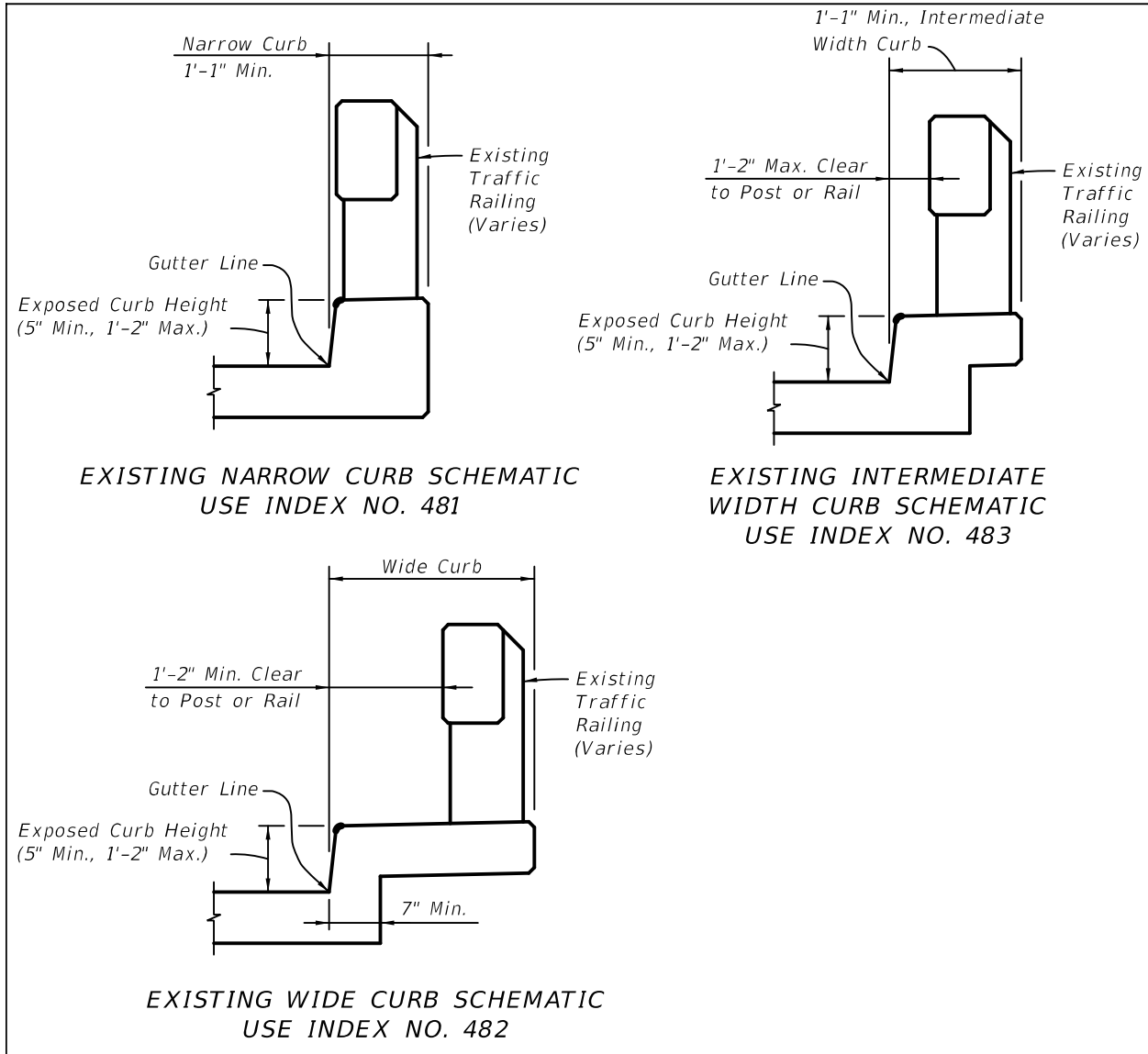

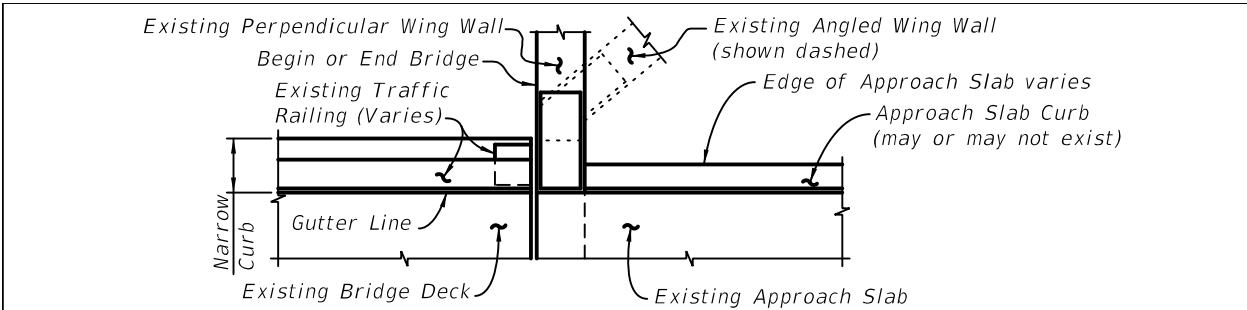

**PARTIAL PLAN VIEW OF EXISTING BRIDGE WITH NARROW CURBS AND PERPENDICULAR OR ANGLED WING WALLS - USE INDEX NO. 481, SCHEME 1**

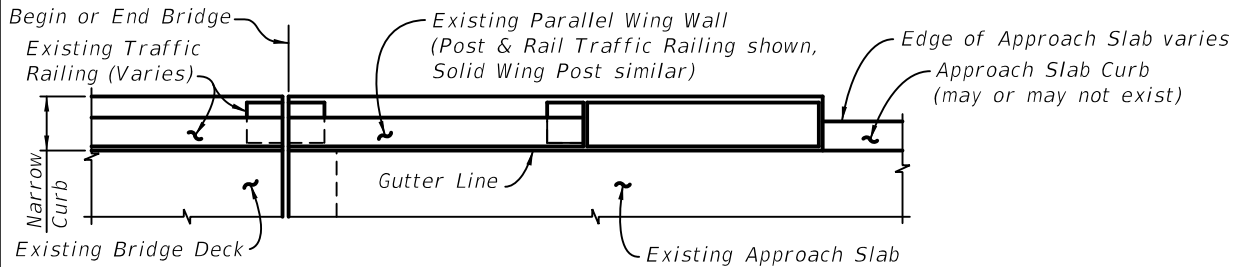

**PARTIAL PLAN VIEW OF EXISTING BRIDGE WITH NARROW CURBS AND PARALLEL WING WALLS - USE INDEX NO. 481, SCHEME 2**

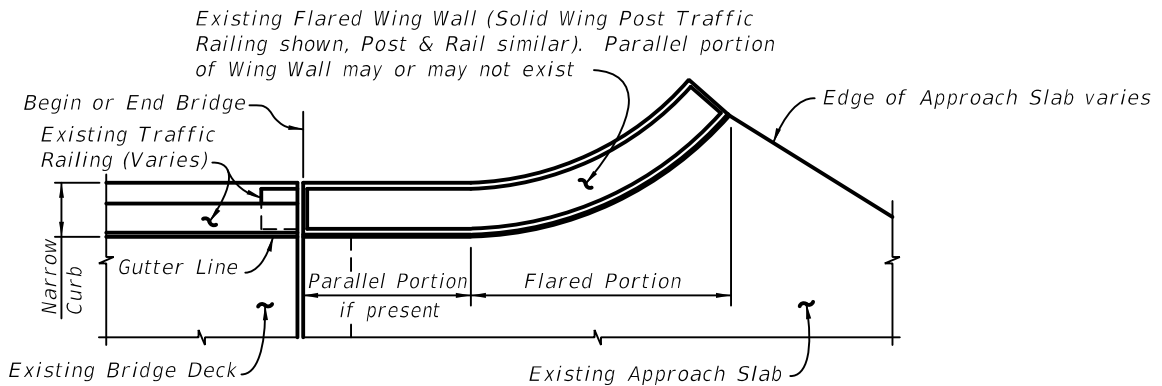

**PARTIAL PLAN VIEW OF EXISTING BRIDGE WITH NARROW CURBS AND FLARED WING WALLS - USE INDEX NO. 481, SCHEME 3**

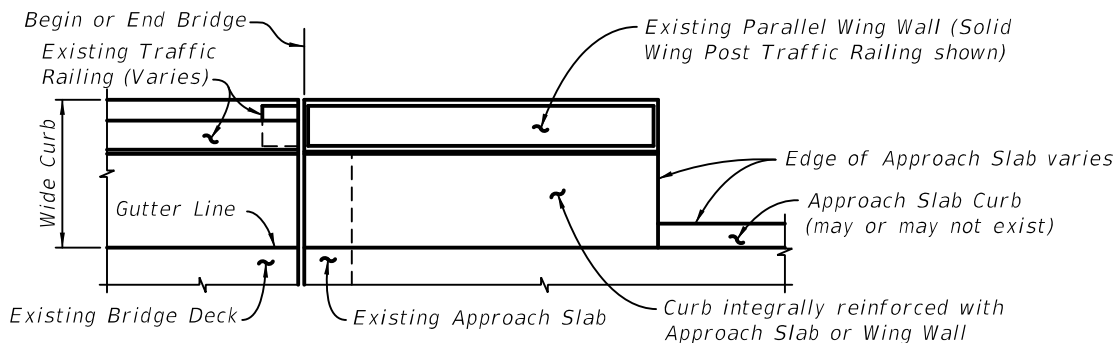

**PARTIAL PLAN VIEW OF EXISTING BRIDGE WITH WIDE CURBS, PARALLEL WING WALLS AND INTEGRALLY REINFORCED APPROACH SLAB CURBS - USE INDEX NO. 482, SCHEME 2**

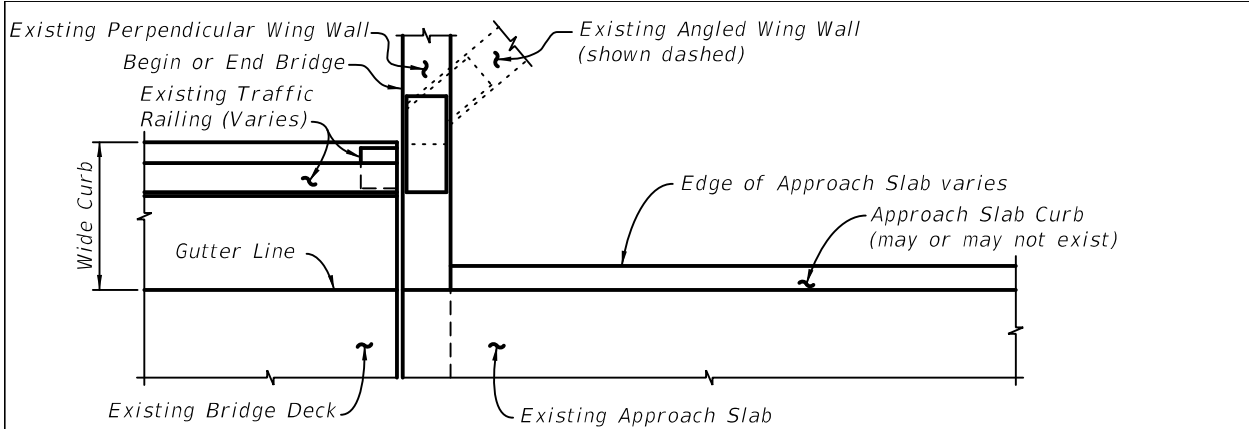

**PARTIAL PLAN VIEW OF EXISTING BRIDGE WITH WIDE CURBS AND PERPENDICULAR OR ANGLED WING WALLS - USE INDEX NO. 482, SCHEME 1**

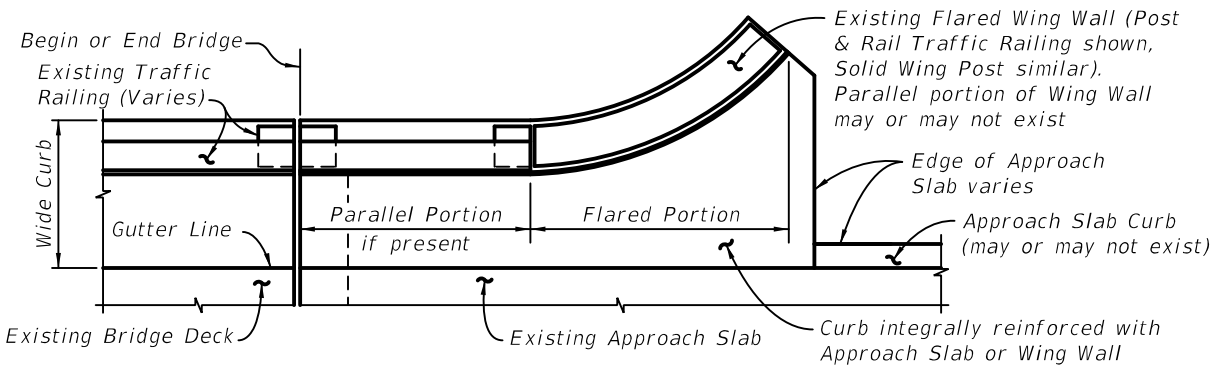

**PARTIAL PLAN VIEW OF EXISTING BRIDGE WITH WIDE CURBS, FLARED WING WALLS AND PARALLEL INTEGRALLY REINFORCED APPROACH SLAB CURBS - USE INDEX NO. 482, SCHEME 2**

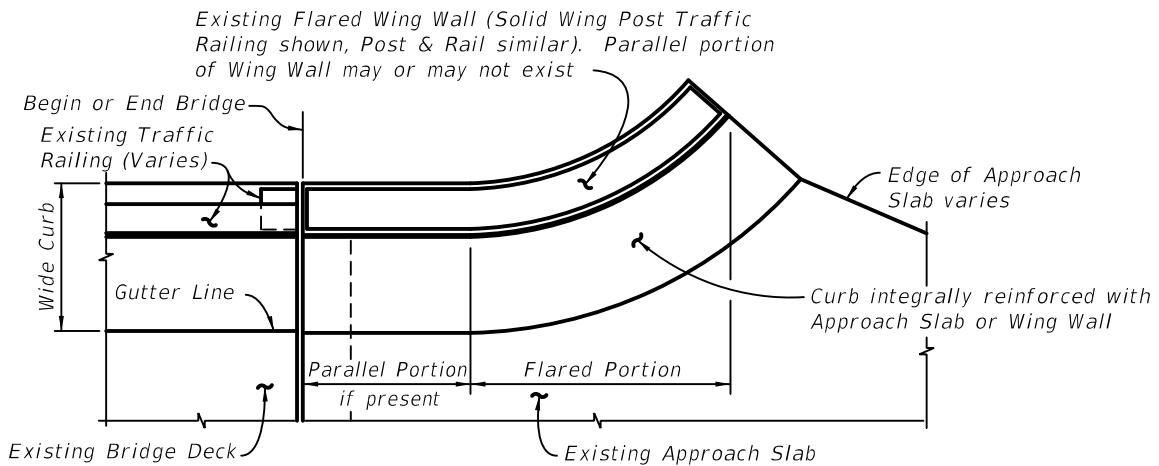

**PARTIAL PLAN VIEW OF EXISTING BRIDGE WITH WIDE CURBS, FLARED WING WALLS AND FLARED INTEGRALLY REINFORCED APPROACH SLAB CURBS - USE INDEX NO. 482, SCHEME 3**

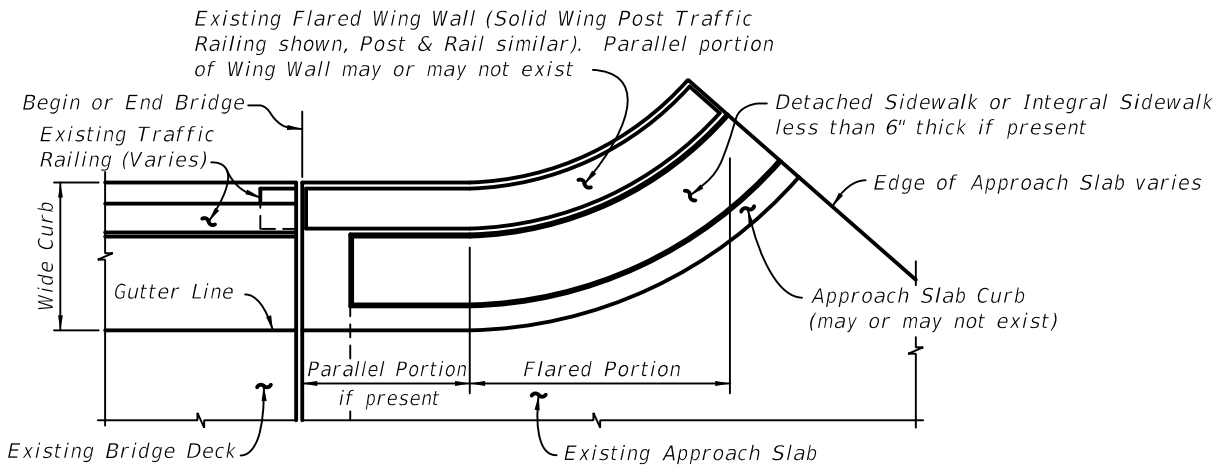

**PARTIAL PLAN VIEW OF EXISTING BRIDGE WITH WIDE CURBS, FLARED WING WALLS AND APPROACH SLABS WITH DETACHED SIDEWALKS OR SIDEWALKS LESS THAN 6" THICK - USE INDEX NO. 482, SCHEME 4**

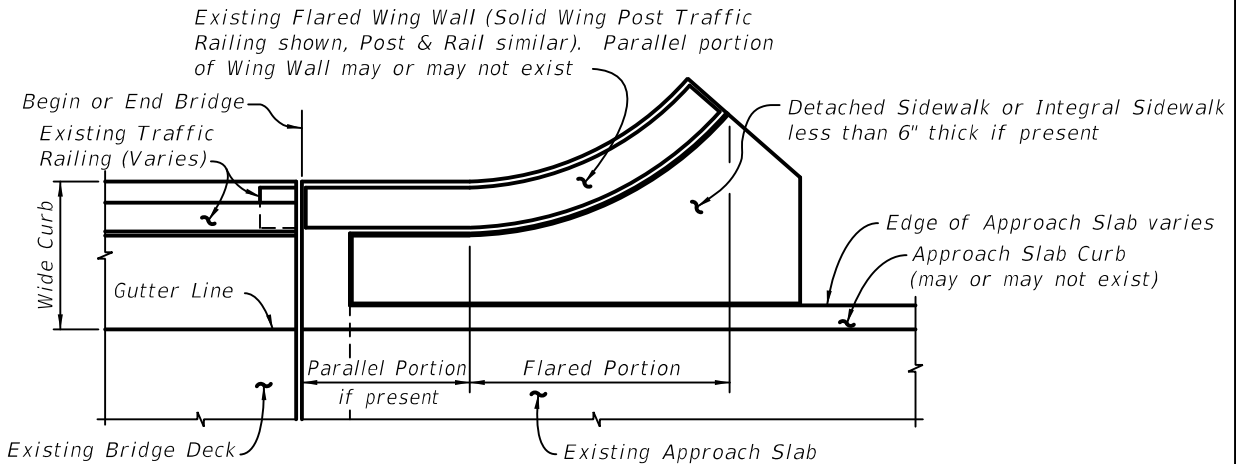

**PARTIAL PLAN VIEW OF EXISTING BRIDGE WITH WIDE CURBS, FLARED WING WALLS AND APPROACH SLABS WITH DETACHED SIDEWALKS OR SIDEWALKS LESS THAN 6" THICK - USE INDEX NO. 482, SCHEME 5**

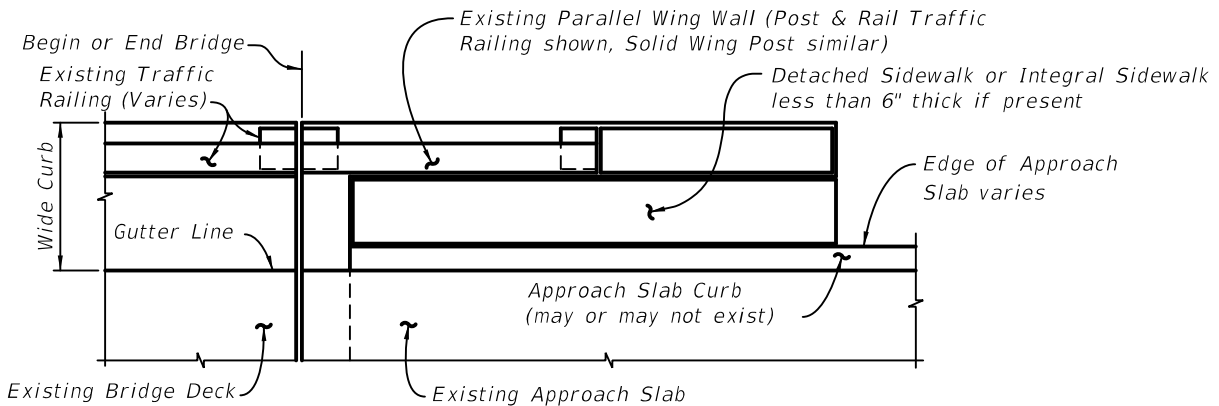

**PARTIAL PLAN VIEW OF EXISTING BRIDGE WITH WIDE CURBS, PARALLEL WING WALLS AND APPROACH SLABS WITH DETACHED SIDEWALKS OR SIDEWALKS LESS THAN 6" THICK - USE INDEX NO. 482, SCHEME 5**



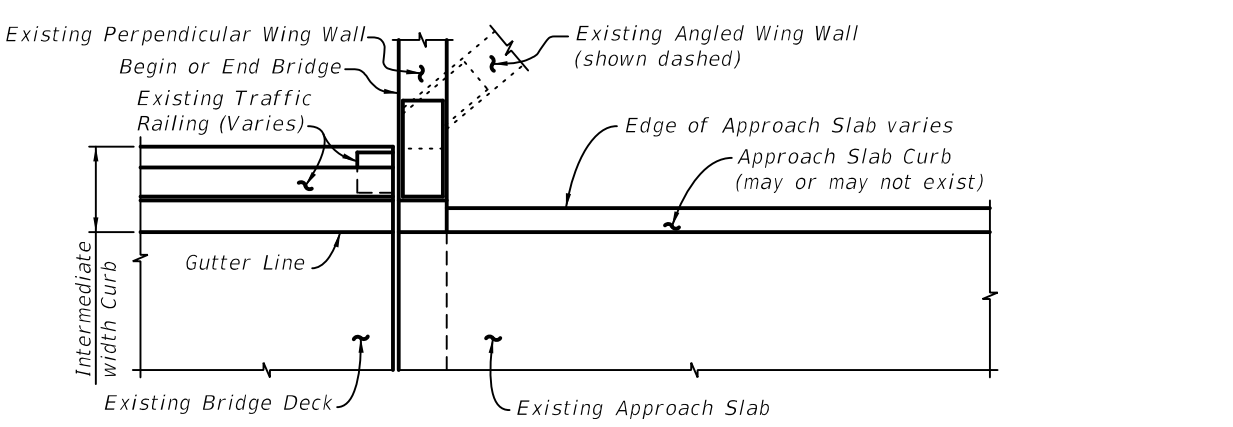

**PARTIAL PLAN VIEW OF EXISTING BRIDGE WITH INTERMEDIATE WIDTH CURBS AND PERPENDICULAR OR ANGLED WING WALLS - USE INDEX NO. 483, SCHEME 1**

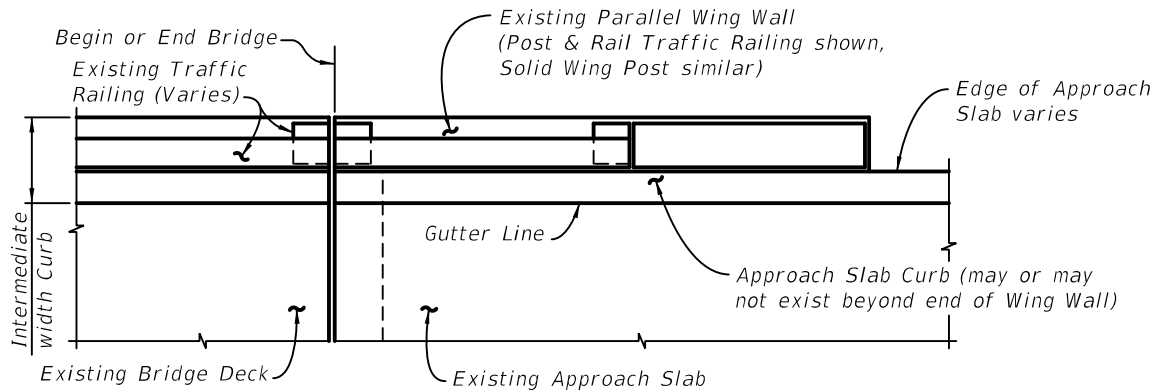

**PARTIAL PLAN VIEW OF EXISTING BRIDGE WITH INTERMEDIATE WIDTH CURBS, PARALLEL WING WALLS AND PARALLEL INTEGRAL APPROACH SLAB CURBS - USE INDEX NO. 483, SCHEME 2**

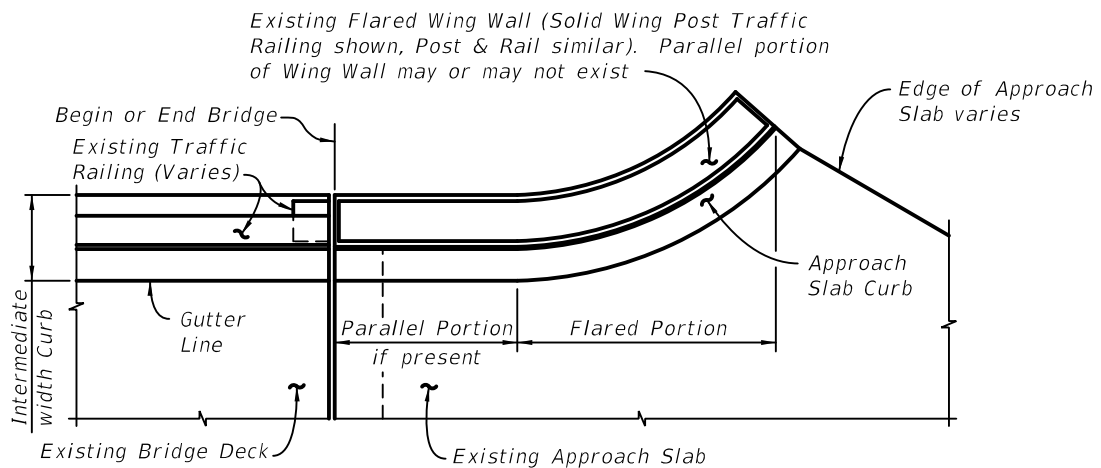

**PARTIAL PLAN VIEW OF EXISTING BRIDGE WITH INTERMEDIATE WIDTH CURBS, FLARED WING WALLS AND FLARED INTEGRAL APPROACH SLAB CURBS - USE INDEX NO. 483, SCHEME 3**

## Plan Content Requirements

The appropriate **Design Standards** Index number and Scheme number shall be shown in the Roadway Plans for each bridge along with the limiting stations of the retrofit. Examples of notes containing the required information as they would appear on a Plan or Plan-Profile sheet are as follows:

"Construct Traffic Railing (Vertical Face Retrofit), Index 48X, Scheme X, from Sta. XX+XX.XX (at or near Begin Bridge) to Sta. XX+XX.XX (at or near End Bridge)."

"Construct Traffic Railing (Vertical Face Retrofit) Spread Footing Approach, Index 484, Scheme X, from Sta. XX+XX.XX (at beginning of Length of Advancement, or at or near End Bridge) to Sta. XX+XX.XX (at or near Begin Bridge, or end of Length of Advancement)."

For projects with multiple bridges, a tabular format may be used to convey the necessary information.

A separate Plan and Elevation sheet of the type used in Structures Plans is generally not required.

## Payment

Item number	Item description	Unit Measure
521-5-8	Concrete Traffic Railing, Bridge, Retrofit-Vertical Face	LF