

Index 405 Guardrail Transitions - Existing Post & Beam Bridge Railings (Wide Curbs) (Rev. 07/13)

Design Criteria

NCHRP Report 350; Plans Preparation Manual, Volume 1, Chapter 25

Design Assumptions and Limitations

This index is applicable for retrofitting existing approach and trailing end guardrail treatments that are adjacent to existing bridge mounted structurally continuous Post and Beam Concrete Handrails (traffic railings) as shown on the following and other similar obsolete Indexes:

- [Index 3199](#) Handrail for 20 ft. Span (1954)
- [Index 3274](#) Concrete Handrail (1954)
- [Index 3276](#) Handrail - 76 ft. Span (1954)
- [Index 3489](#) Handrail - 76 ft. Span (1955)
- [Index 3959](#) Concrete Handrail (1961)
- [Index 4058](#) Concrete Handrail (1957)
- [Index 4727](#) Concrete Handrail (1960 with 1962 Revisions)
- [Index 7678](#) Concrete Handrail (1963)
- [Index 8572](#) Concrete Handrail (1964 with 1967 Revisions)

Index 405 is applicable for use with the obsolete railings listed above that are constructed on curbs as shown below on roadways with a Design Speed of 45 mph or less:

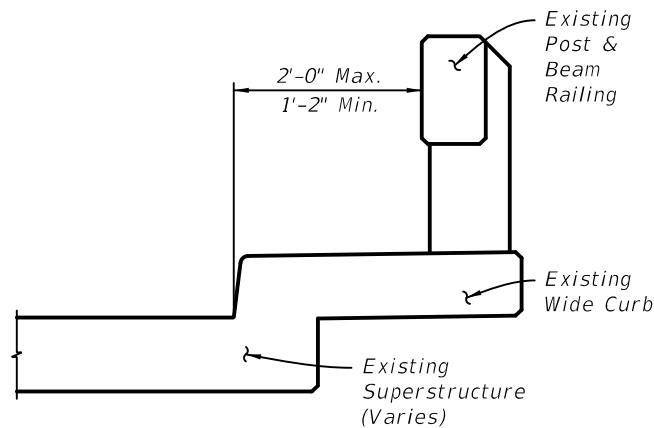

EXISTING WIDE CURB SCHEMATIC
SEE OBSOLETE INDEXES LISTED ABOVE

Neither a new load rating nor an evaluation of the structural adequacy of the existing bridge deck, approach slab or wingwalls are required to use this index.

Index 405 depicts five different retrofit schemes for installing the approach or trailing end guardrail transitions. In each of the retrofit schemes, a section of Vertical Face Retrofit railing is constructed to facilitate connection of the new guardrail transition. The applicability of the individual retrofit schemes to different wingwall configurations is shown in the following views.

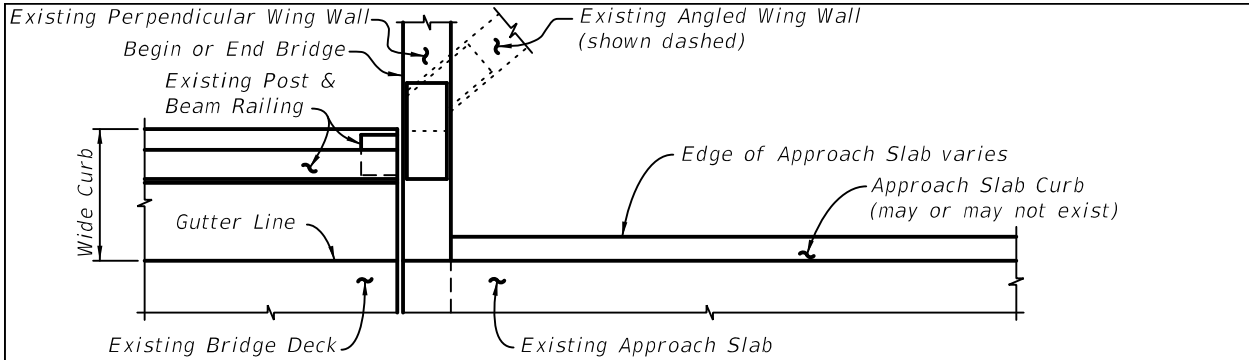

PARTIAL PLAN VIEW OF EXISTING BRIDGE WITH WIDE CURBS AND PERPENDICULAR OR ANGLED WING WALLS - USE SCHEME 1

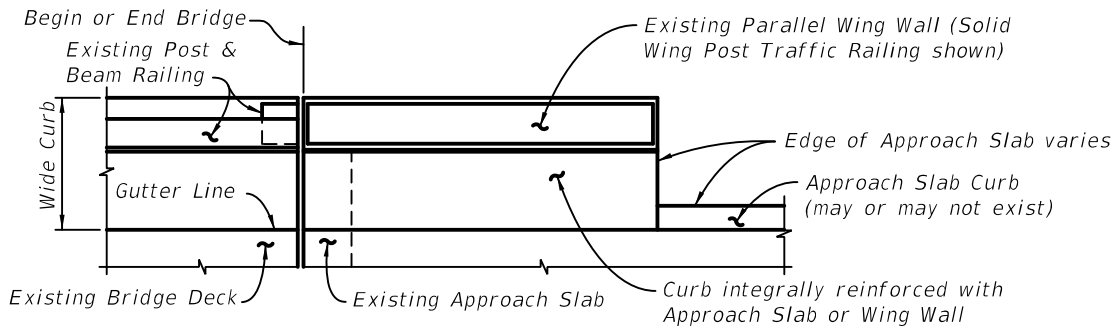

PARTIAL PLAN VIEW OF EXISTING BRIDGE WITH WIDE CURBS, PARALLEL WING WALLS AND INTEGRALLY REINFORCED APPROACH SLAB CURBS - USE SCHEME 2

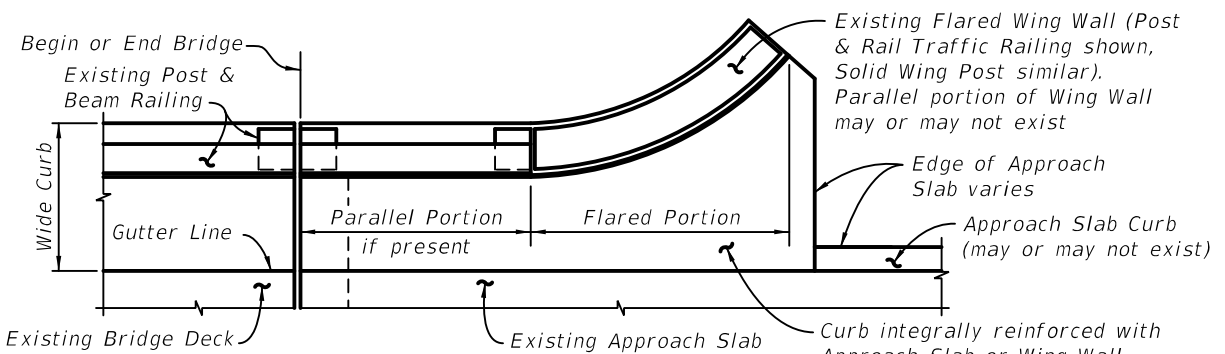

PARTIAL PLAN VIEW OF EXISTING BRIDGE WITH WIDE CURBS, FLARED WING WALLS AND PARALLEL INTEGRALLY REINFORCED APPROACH SLAB CURBS - USE SCHEME 2

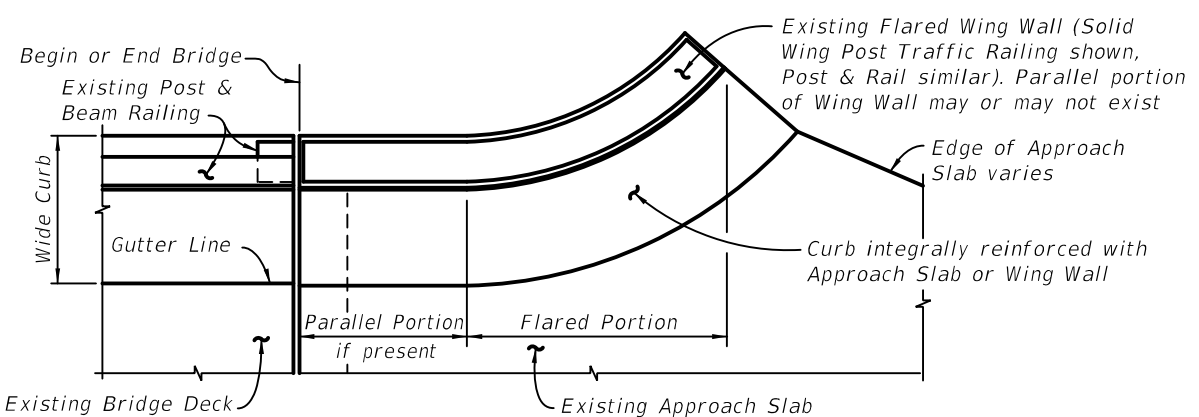

PARTIAL PLAN VIEW OF EXISTING BRIDGE WITH WIDE CURBS, FLARED WING WALLS AND FLARED INTEGRALLY REINFORCED APPROACH SLAB CURBS - USE SCHEME 3

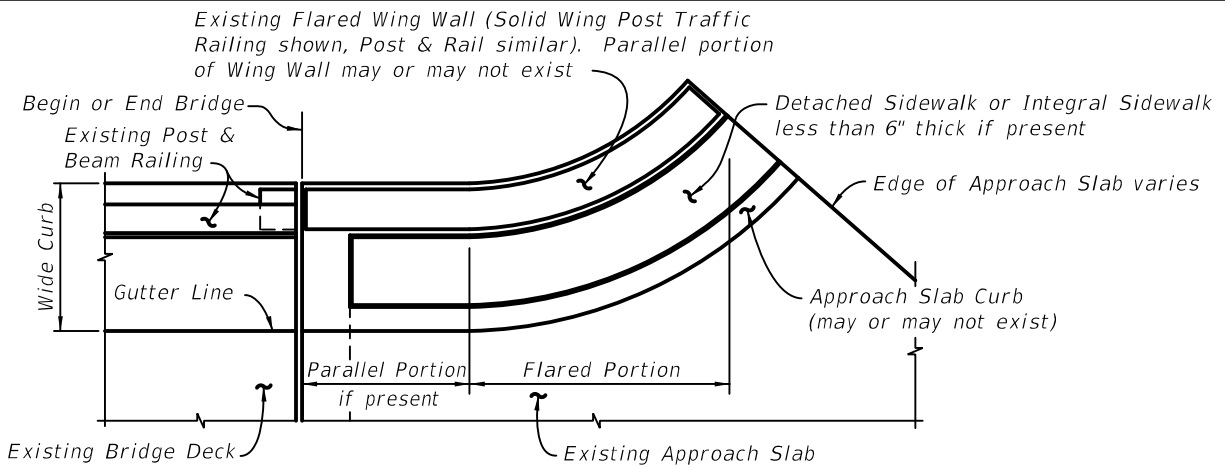

PARTIAL PLAN VIEW OF EXISTING BRIDGE WITH WIDE CURBS, FLARED WING WALLS AND APPROACH SLABS WITH DETACHED SIDEWALKS OR SIDEWALKS LESS THAN 6" THICK - USE SCHEME 4

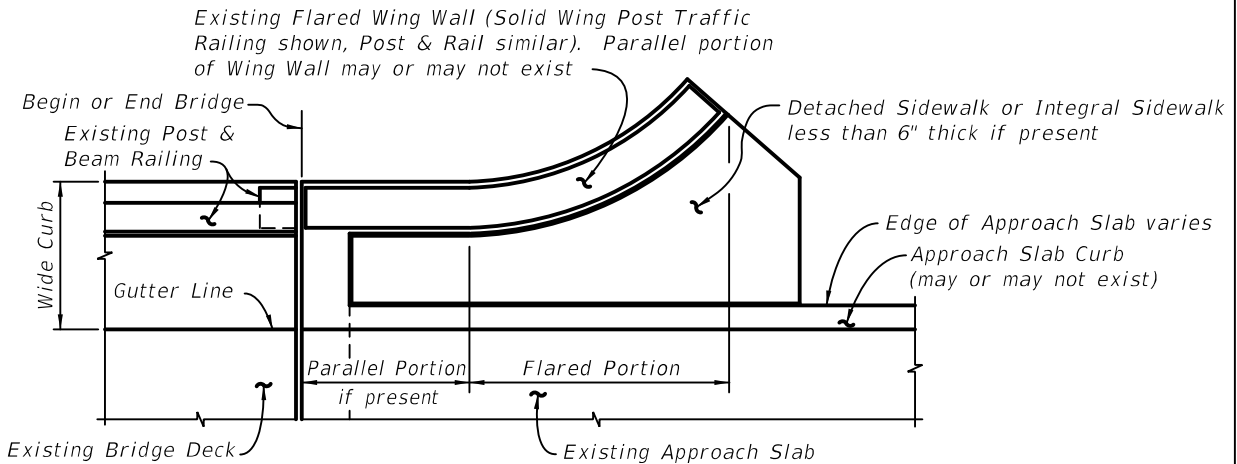

PARTIAL PLAN VIEW OF EXISTING BRIDGE WITH WIDE CURBS, FLARED WING WALLS AND APPROACH SLABS WITH DETACHED SIDEWALKS OR SIDEWALKS LESS THAN 6" THICK - USE SCHEME 5

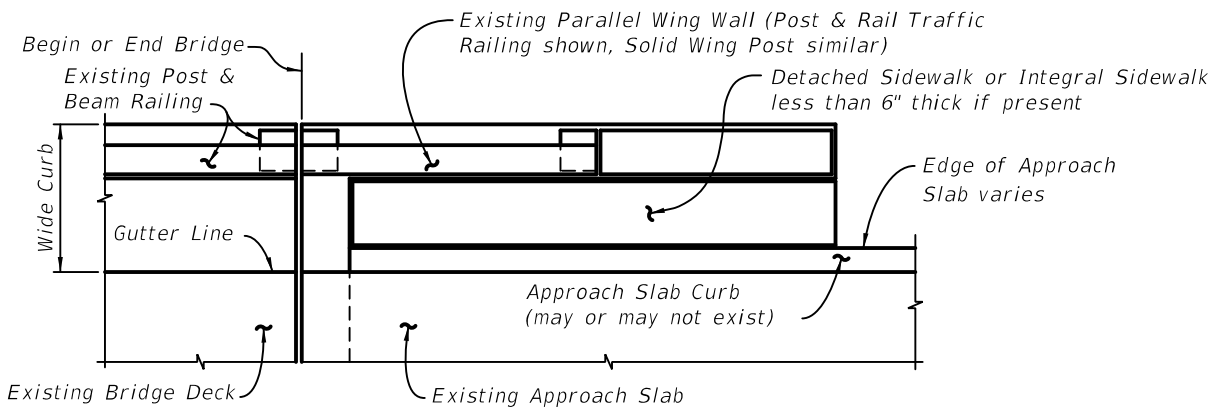

PARTIAL PLAN VIEW OF EXISTING BRIDGE WITH WIDE CURBS, PARALLEL WING WALLS AND APPROACH SLABS WITH DETACHED SIDEWALKS OR SIDEWALKS LESS THAN 6" THICK - USE SCHEME 5

Index 405 is to be used in conjunction with Index 402. The appropriate Index 402 approach guardrail transition retrofit and its limiting station must be selected and specified in the plans based on the shapes and designs of the existing post and beam railing, approach slabs and end bent wingwalls. Determine the attachment point for the Thrie-Beam Terminal Connector based on the shape, length and direct means of support of the end most section of the Vertical Face Retrofit, the existing wingwall and/or approach slab as follows:

Perpendicular or Angled Wingwalls -

Attach the Thrie-Beam Terminal Connector to the Vertical Face Retrofit on the bridge.

Parallel Wingwalls -

1. If the Vertical Face Retrofit is supported by the wingwall, attach the Thrie-Beam Terminal Connector to the Vertical Face Retrofit along the wingwall if the wingwall is a minimum of 5'-0" long and directly pile supported. If the Vertical Face Retrofit is supported by the approach slab, attach the Thrie-Beam Terminal Connector along the approach slab section of the retrofit if that section is a minimum of 5'-0" long.
2. Attach Thrie-Beam Terminal Connector to the Vertical Face Retrofit on the bridge if the any of the appropriate preceding criteria for parallel wingwalls or approach slabs are not met.

Flared Wingwalls with parallel portions -

1. If the Vertical Face Retrofit is supported by the wingwall, attach the Thrie-Beam Terminal Connector to the Vertical Face Retrofit along the parallel portion of the Vertical Face Retrofit if the wingwall is a minimum of 5'-0" long, directly pile supported, and if the parallel portion of Vertical Face Retrofit is a minimum of 2'-0" long. If the Vertical Face Retrofit is supported by the approach slab, attach the Thrie-Beam Terminal Connector along the approach slab section of the retrofit if that section is a minimum of 5'-0" long and has a parallel portion that is a minimum of 2'-0" long.
2. Attach Thrie-Beam Terminal Connector to the Vertical Face Retrofit on the bridge if any of the preceding criteria for flared wingwalls with parallel portions are not met.

Flared Wingwalls without parallel portions -

Attach Thrie-Beam Terminal Connector to the Vertical Face Retrofit on the bridge.

On approach ends, a Transition Block or Curb is required if the existing Approach Slab does not have a curb. The appropriate treatment on trailing ends shall be determined by the Roadway Engineer. A Transition Block is not required on trailing ends with no opposing traffic, however, a Curb may be required due to drainage needs. An Index 300, Type D Concrete Curb is generally suitable for this application. Show the appropriate site specific approach and trailing end treatments in the Plans.

The Utility Adjustment Plans, if required, shall contain all necessary utility adjustment information required for the construction of the retrofit. Utilities and/or conduits may exist in or adjacent to the existing post and beam railings and will vary in size, number and location. The presence, size, number and locations of existing utilities and/or conduits shall be determined by a review of existing Plans and confirmed by field verification. Utility and/or conduit installations may vary by location on a single bridge. Thus, a field verification shall be conducted for each individual installation of the retrofit. Existing utilities and/or conduits that conflict with the retrofit shall be relocated if possible or placed out of service. The required field verification work should be completed as early in the evaluation phase as possible.

The Traffic Control Plans for the construction of the retrofit shall be prepared in accordance with Index 600 Series. The Plans shall address all aspects of the construction of the retrofit. Generally, the use of this index will require traffic control consisting of temporary shifting, narrowing and/or closing of travel lanes and/or shoulders.

This index does not address retrofitting of the existing post and beam railings or sidewalks for pedestrian use. The potential need to retrofit the existing bridge for pedestrian use shall be evaluated on a project by project basis and the necessary Plans developed accordingly. Generally, the potential effects on pedestrian use of the bridge will be confined to bridges with sidewalks. The potential reduction in clear width of the sidewalk caused by the installation of the retrofit shall be considered.

The existing post and beam railing and/or guardrail end transitions may have been previously retrofitted utilizing a scheme presented in Roadway and Traffic Design Standards Indexes 400 or 401 (2000 and earlier Editions) or other retrofit schemes. In this event, the requirements for removal, modification or replacement of the prior retrofit shall be evaluated and addressed in the Plans as required. Payment for the removal of the prior retrofit, if required, must be evaluated on a case by case basis depending on the type of retrofit that is present.

In the event that the details presented in this index do not closely match the existing conditions, the Structures and/or Roadway Engineer(s) shall prepare a customized project specific retrofit design using this index as a guide. Contact the Structures Design Office and Roadway Design Office for guidance in this event.

Plan Content Requirements

In the Roadway Plans:

The Roadway Plans shall include all of the sheets necessary to define and detail the retrofit of the existing guardrail transitions. Generally, this index can be used without any modifications being made to it. If project specific details are required, use this index as a guide for developing general notes and details to be included in the plans. Examples of such details may include locations and details of any existing utilities, conduits, drainage structures, sign structures, luminaire supports, details for new traffic railing sliding plate assemblies for large expansion joints and any other needed information not included in this index.

Show the Design Standards Index number, Scheme number, Limiting Station of Guardrail and whether or not a Transition Block is required for each retrofit location on each bridge. An example of a plan note containing the required information as it would appear on a Plan or Plan-Profile sheet is as follows:

"Construct Guardrail Approach Transition Retrofit, Index 405, Scheme 1 with Transition Block. Limiting Station of Guardrail Transition is XX+XX.XX"

For projects with multiple bridges, a tabular format may be used to convey the necessary information. A separate Plan and Elevation sheet of the type used in Structures Plans is generally not required.

The Utility Adjustment Plans, if required, shall contain all necessary utility adjustment information required for the construction of the retrofit.

The Traffic Control Plans for the construction of the retrofit shall address all aspects of the construction of the retrofit.

Payment

Item number	Item description	Unit Measure
521-5-11	Concrete Traffic Railing - Bridge, Retrofit - Post & Beam Railing	EA
536-8-1 and 536-8-3 or 536-8-6 where appropriate	Guardrail Bridge Anchorage Assembly	EA