

STATE OF FLORIDA DEPARTMENT OF TRANSPORTATION



DRAINAGE MANUAL

OFFICE OF DESIGN, DRAINAGE SECTION, JANUARY 2023

This page left blank intentionally.

TABLE OF CONTENTS

Chapter 1	Introduction
Chapter 2	Open Channel
Chapter 3	Storm Drain Hydrology and Hydraulics
Chapter 4	Cross Drain Hydraulics
Chapter 5	Stormwater Management
Chapter 6	Optional Culvert Materials

APPENDICES

Appendix A	Drainage Law
Appendix B	Acquisition of Real Property Rights
Appendix C	Cover Height Tables
Appendix D	Pipes within Walled Embankment Sections
Appendix E	Intensity-Duration-Frequency Curves and FDOT Rainfall Distributions

CHAPTER 1

INTRODUCTION

1.1	Purpose	1-1
1.2	Authority	1-1
1.3	Scope	1-1
1.4	General.....	1-1
1.5	Resiliency Considerations	1-2
1.6	Documentation of Drainage Design	1-3
1.7	Appendices.....	1-3
1.8	Distribution	1-4
1.9	Procedure for Revisions and Updates.....	1-4
1.10	Training	1-4
1.11	Forms Access.....	1-4

1.1 PURPOSE

The **Drainage Manual** sets forth drainage design standards for Florida Department of Transportation (FDOT) projects.

1.2 AUTHORITY

This **Manual** derives authority from Chapter 334, **Florida Statute (F.S.)**, Sections 20.23(4)(a) and 334.048(3).

1.3 SCOPE

The principal users of this **Manual** are consultants and FDOT personnel who prepare FDOT construction plans.

1.4 GENERAL

Chapter 334, F.S., known as the **Florida Transportation Code**, establishes the responsibilities of the state, counties, and municipalities for the planning and development of the transportation systems serving the people of Florida, with the objective of assuring development of an integrated, balanced statewide system. The **Code's** purpose is to protect the safety and general welfare of the people of the state and to preserve and improve all transportation facilities in Florida. Under **Section 334.044, F.S.**, the **Code** sets forth the powers and duties of the Department of Transportation to develop and adopt uniform minimum standards and criteria for the design, construction, maintenance, and operation of public roads.

The standards in this **Manual** provide a basis for uniform design practice for typical roadway drainage design situations. Realizing that drainage design is primarily a matter of sound application of good engineering judgment, it is impossible to give precise rules that would apply to all possible situations which may arise. Thus, for proper drainage design, we must preserve flexibility to account for varying site conditions, permitting, and sustainable design solutions. Situations will exist where these standards will not apply. THE INAPPROPRIATE USE OF AND/OR ADHERENCE TO THESE STANDARDS DOES NOT EXEMPT THE ENGINEER FROM THE PROFESSIONAL RESPONSIBILITY OF DEVELOPING AN APPROPRIATE DESIGN. The engineer is responsible for identifying those standards that do not apply to a particular design, and for obtaining approval to deviate from those standards. Authority for project-specific changes from this **Manual** rests with the District Drainage Engineer, and deviation from a standard in this **Manual** must be approved by the District Drainage Engineer. The request for deviation must include the engineering justification.

The Federal Highway Administration (FHWA) policies and procedures for the location and hydraulic design of highway encroachments on floodplains are prescribed in **23 Code of Federal Regulations (CFR) 650A** (<http://www.fhwa.dot.gov/legsregs/directives/fapg/cfr0650a.htm>). While the standards presented in the FDOT *Drainage Manual* conform to federal requirements, drainage designers should become familiar with **23 CFR 650A** to develop a basic understanding of some of the design standards for cross drains and bridges.

Use statistical rainfall depth data for Florida in the National Oceanic and Atmospheric Administration (NOAA) Atlas 14 Rainfall Data. This data is available at http://hdsc.nws.noaa.gov/hdsc/pfds/pfds_map_cont.html?bkmrk=fl. Users will find FDOT rainfall distributions and intensity-duration-frequency curves in **Appendix E**.

Various Department publications play an integral role supporting and supplementing the content of this *Manual*. These publications include, but are not limited to, the **FDOT Design Manual (FDM)**, **Structures Design Guidelines (SDG)**, **Standard Plans for Road and Bridge Construction (Standard Plans)**, and **Standard Specifications for Road and Bridge Construction (Standard Specifications)**.

The shaded boxes labeled “**Modification for Non-Conventional Projects**” throughout this *Manual* are intended for design-build projects.

1.5 RESILIENCY CONSIDERATIONS

FDOT’s policy on Resiliency of State Transportation Infrastructure (Topic No. 000-525-053) states that resiliency includes the ability of the transportation system to adapt to changing conditions and prepare for, withstand, and recover from disruption. This policy is incorporated throughout this *Manual*. FDOT drainage systems are engineered to convey the design event without damage to facilities. Other resiliency considerations include:

- Use of NOAA Atlas 14 Rainfall Data, **Section 1.4**
- Open channel design frequency, **Section 2.2**
- Adjustment of Manning’s “n” values for increased vegetation growth between maintenance cycles, **Section 2.4**
- Freeboard for open channels design, **Section 2.4.5**
- Design tailwater determination, including sea level rise, **Section 3.4**
- Sea level rise analysis for vulnerability assessments, **Section 3.4.1**
- Minimum storm sewer pipe diameter, **Section 3.10.1**
- Cross drain design capacity analysis, **Section 4.2.1**
- Scour considerations for foundation design, **Section 4.2.2**
- Hydrologic analysis data, **Section 4.7**

- Minimum cross drain size considerations, **Section 4.10.4.1**

Additional guidance can be found in the following publications:

- **FDOT *Drainage Design Guide Appendix G - Risk Evaluations***
- ***Hydraulic Engineering Circular (HEC) 17, Highways in the Riverine Environment – Floodplains, Extreme Events, Risk and Resilience, 2nd Edition***
- ***HEC 25 – Highways in the Coastal Environment: Assessing Extreme Events – Volume 2, 1st Edition.***
- ***Nature-Based Solutions for Coastal Highway Resilience: An Implementation Guide***

1.6 DOCUMENTATION OF DRAINAGE DESIGN

Include approvals of deviation from this *Manual* in the project drainage design documentation, along with supporting justifications. The hydraulic designer will provide a Drainage Design Report to accompany all phase submittals (signed and sealed for the Final Phase submittal) that addresses the entire project design. This is a record set of all drainage computations, both hydrologic and hydraulic, and includes all necessary support data. All phase submittals must include hydrologic and hydraulic models. The Drainage Design Report must include, at a minimum, pond routing, with justifications for the utilization of all tailwater stages, a clear description of the overall stormwater management system, storm drain tabulations, pond recovery calculations, hydraulic spread calculations, special gutter grade calculations, drainage structure and liner flotation calculations, ditch conveyance calculations, a node-reach diagram superimposed on Department drainage maps, skimmer calculations, cross drain calculations, and other calculations relative to drainage. Include resiliency and adaptation considerations, corresponding economic analysis, and any additional decision-making considerations as an appendix to the Drainage Design Report.

1.7 APPENDICES

This *Manual* includes five appendices:

Appendix A contains a general overview of drainage law, with a discussion of case histories in Florida. It appears as an appendix rather than a chapter since it is primarily informational and does not constitute a standard.

Appendix B contains guidance on general FDOT practice pertaining to acquiring drainage easements, flood rights, etc.

Appendix C contains minimum and maximum cover heights for design.

Appendix D contains policy on the selection of pipes in proximity to structural walls.

Appendix E contains the Intensity-Duration-Frequency Curves and FDOT Rainfall Distributions.

1.8 DISTRIBUTION

This **Manual** is available for downloading from the website link: [Manuals and Handbooks \(fdot.gov\)](https://www.fdot.gov/manuals).

1.9 PROCEDURE FOR REVISIONS AND UPDATES

FDOT invites comments and suggestions for changes to the **Manual**. Submit comments and suggestions by e-mailing the State Drainage Engineer. Appropriate Roadway Design or Drainage Design staff will review each idea or suggestion received in a timely manner.

Statewide meetings of the District Drainage Engineers and the State Drainage Engineer are held at least annually, and teleconferences are held monthly. A major agenda item at these meetings will be the review of planned revisions, and suggestions and comments that may warrant revisions. Based on input from these meetings, FDOT compiles official proposed revisions.

The State Drainage Engineer will coordinate the proposed revisions with all the affected offices and with FHWA. The State Drainage Engineer officially adopts the proposed revisions, with input from the District Drainage Engineers.

Prior to release, the Forms and Procedures Office coordinates all revisions to ensure conformance with and incorporation into the Department's **Standard Operating System**.

1.10 TRAINING

There is no mandatory training required.

1.11 FORMS ACCESS

There are no forms related to this **Manual**.

CHAPTER 2

OPEN CHANNEL

2.1	Introduction	2-1
2.2	Design Frequency	2-1
2.3	Hydrologic Analysis	2-1
2.4	Hydraulic Analysis	2-2
	2.4.1 Manning's "n" Values	2-2
	2.4.2 Slope	2-2
	2.4.3 Channel Linings and Velocity	2-2
	2.4.3.1 Limitations on Use of Linings	2-3
	2.4.4 Channel Bottom	2-3
	2.4.5 Channel Freeboard	2-4
2.5	Construction and Maintenance Considerations	2-4
2.6	Safety	2-5
	2.6.1 Protective Treatment	2-5
	2.6.2 Roadside Safety	2-5
2.7	Documentation	2-5

2.1 INTRODUCTION

This chapter presents standards for the design of artificial or manmade open channels, including roadside ditches, median ditches, interceptor ditches, outfall ditches, and canals.

2.2 DESIGN FREQUENCY

Design open channels to collect and convey without damage, and to confine within the ditch, stormwater flow with standard design frequencies as follows:

Table 2.1: Design Storm Frequencies of Open Channels

TYPE CHANNEL	FREQUENCY
Roadside, Median, and Interceptor Ditches or Swales	10-year
Outfalls	25-year
Canals	25-year
Temporary Roadside and Median Ditches or Swales	2-year
Temporary Outfalls and Canals	5-year

Site-specific factors may warrant the use of an atypical design frequency. Acquire flood rights where offsite stages increase and impact land use values.

Design sidewalks adjacent to channels (ditches) to be above the design stage.

2.3 HYDROLOGIC ANALYSIS

As appropriate for the site, base hydrologic data used for the design of open channels on one of the following methods:

1. A frequency analysis of observed (gage) data, when available. If insufficient or no observed data are available, use one of the procedures below, as appropriate. However, calibrate the procedures below to the extent practicable with available observed data for the drainage basin, or nearby similar drainage basins.
 - a. Regional or Local Regression Equations developed by the USGS
 - b. Rational Equation for drainage areas up to 600 acres
 - c. For outfalls from stormwater management facilities, use the method for the design of the stormwater management facility; see **Chapter 5** for hydrologic methods to design stormwater management facilities
2. For regulated or controlled canals, request hydrologic data from the controlling entity; prior to use for design, verify these data to the greatest extent practical

2.4 HYDRAULIC ANALYSIS

Use Manning's Equation for the design of open channels. Provide ditch computations for all changes in ditch slope, cross section, lining type, or quantity of flow. The flow shown as contributing to the point of interest include all contributions upstream of that point of interest.

2.4.1 Manning's "n" Values

Manning's n values for channels with bare soil and vegetative linings are presented in **Table 2.2**. Manning's n values for rigid linings are presented in **Table 2.3**.

In selecting a Manning's n value, consider the probable condition of the channel during the design event may occur. To account for increased vegetation growth between extended maintenance periods, use higher "n" values for ditches with bottoms at or near the seasonal high groundwater level.

2.4.2 Slope

Provide a minimum physical slope of 0.0005 feet/feet for all conveyance ditches.

2.4.3 Channel Linings and Velocity

Standard Plans, Index 524-001 and **Standard Specification 985** provide standard lining types. **Tables 2.4 and 2.5** present maximum velocities for the various forms of soils and channel linings. When design flow velocities do not exceed the maximum permissible for bare earth as given in **Table 2.4**, standard treatment of ditches consists of grassing and mulching. For higher design velocities, provide sodding, ditch paving, or other forms of lining consistent with **Tables 2.4 and 2.5**.

Check shear stress at locations of steep slopes (>1 percent), such as ditch flow down a pond slope, gore drainage, and offsite flow entering the right-of-way via the back slope of a roadside swale.

The ***Drainage Design Guide (DDG)*** provides additional guidance on types of lining materials, as well as the proper application of various types of linings.

2.4.3.1 Limitations on Use of Linings

2.4.3.1.1 Grassing and Sodding

Do not use grassing or sodding under the following conditions:

1. Continuous standing or flowing water
2. Areas that do not receive the regular maintenance necessary to prevent domination by taller vegetation
3. Non cohesive sandy soils with excessive soil drainage
4. Excessively shady areas

2.4.3.1.2 Concrete Lining

To prevent cracking or failure, place concrete lining on a firm, well-drained foundation. Avoid concrete linings where expansive clays are present.

When using concrete linings where soils may become saturated, design for the potential for buoyancy. Acceptable countermeasures include:

1. Increasing the thickness of the lining to add additional weight
2. For sub-critical flow conditions, specifying weep holes at appropriate intervals in the channel bottom to relieve the upward pressure on the channel
3. For super-critical flow conditions, using subdrains in lieu of weep holes

2.4.3.1.3 Turf Reinforcement Mat (TRM)

Do not use turf reinforcement mats where you expect high siltation. During desilting operations, damage can occur to the TRM.

2.4.4 Channel Bottom

The minimum channel bottom width is five feet to accommodate mitered end sections

and maintenance mowers. Do not use V-bottom ditches unless both front and back slopes are 1:6 or flatter.

The minimum ditch bottom elevation is one foot above the estimated seasonal high groundwater elevation for maintainability. To enable mowing, fine-grained soils may require more than one foot of clearance from the seasonal high groundwater.

2.4.5 Channel Freeboard

Provide a minimum of one foot of channel freeboard above the design stage within the channel if in a fill slope and 0.5 foot if the channel is in a cut slope. Freeboard is measured to the ditch top of bank or low edge of shoulder, whichever is lower. If a channel connects hydraulically to or is part of the stormwater management facility, provide no less than one foot of channel freeboard above the peak design stage of the downstream, hydraulically connected pond. Apply downstream tailwater in freeboard calculations.

- Install inlets, flumes, or embankment protection when pavement runoff is sufficient to cause erosion of the shoulder. (See **Section 3.7** for inlet placement criteria)
- Install inlets to properly collect stormwater runoff for curbed roadway driveways.

2.5 CONSTRUCTION AND MAINTENANCE CONSIDERATIONS

Design open channels consistent with the standard construction and maintenance practices of the Department. The **Standard Plans** and **Standard Specifications** present details on standard ditch linings. In the event the **Standard Plans** and **Standard Specifications** are not suitable for a specific project need, develop a detailed design. Specify this information in the design documents.

Provide berms and other physical access devices that facilitate maintenance activities in ditches, outfall ditches, retention/detention areas, and other drainage-related features. Consider future expansion of the facilities and possible increased maintenance requirements. Use absolute minimum values only in extremely stable areas, in areas requiring infrequent maintenance, or in areas where existing physical constraints require their use. Base berms at the narrowest point; keep right-of-way reasonably uniform. If the design specifies double ditches, the minimum berm width between the two ditches for maintenance access is 10 feet if the ditches are dry or 15 feet if the ditches are wet. Contact the local maintenance office for minimum access requirements when the minimum berm width is not feasible.

2.6 SAFETY

2.6.1 Protective Treatment

Review drainage designs to determine requirements regarding some form of protective treatment to prevent entry to facilities that present a hazard to children and, to a lesser extent, all persons. **Section 3.7** provides general criteria. Provide protective treatment for open channels in the form of fencing when a potential hazard exists.

2.6.2 Roadside Safety

The design and location of open channels will comply with roadside safety and clear zone requirements. See the **FDM** for clear zone requirements, including special clearance criteria for canals.

2.7 DOCUMENTATION

Design documentation for open channels will include hydrologic and hydraulic analyses, calculated freeboard and channel lining requirements. For roadside ditches, **Figure 2-1** provides the required standard format for documentation.

Table 2.2: Manning's "n" Values for Artificial Channels with Bare Soil and Vegetative Linings

<u>Channel Lining</u>	<u>Description</u>	<u>Design "n"</u>
Bare Earth, Fairly Uniform	Clean, recently completed	0.02
Bare Earth, Fairly Uniform	Short grass and some weeds	0.03
Dragline Excavated	No Vegetation	0.03
Dragline Excavated	Light Brush	0.04
Maintained Grass or Sodded Ditches	Good stand, well maintained 2 to 6 inches	0.06*
Channels not Maintained	Clear bottom, brush sides	0.08
Channels not Maintained	Dense weeds to flow depth	0.10
Maintained Grass or Sodded Ditches	Fair stand, length 12 to 24 inches	0.20*

* Decrease 30 percent for flows > 0.7 ft depth (max flow depth 1.5 ft)

Table 2.3: Manning's "n" Values for Artificial Channels with Rigid Linings

<u>Channel Lining</u>	<u>Description</u>	<u>Design "n"</u>
Concrete Paved	Broomed*	0.016
Concrete Paved	"Roughened" - Standard	0.020
Concrete Paved	Gunite	0.020
Concrete Paved	Over Rubble	0.023
Rubble Riprap	Ditch Lining	0.035

* Broomed is not the standard finish and must be specified when used (see **Standard Specification 524-7**)

Table 2.4: Maximum Shear Stress Values and Allowable Velocities for Different Soils

<u>Soil Type</u>	<u>Shear Stress (psf⁺)</u>	<u>*Allowable Velocity (fps[#])</u>
Silt or Fine Sand	0.027	1.50
Sandy Loam	0.037	1.75
Silt Loam	0.048	2.00
Firm Loam	0.075	2.50
Stiff Clay	0.260	3.75
Hardpans	0.670	6.00

* For a flow depth of approximately 3 ft

+ psf is pounds per square foot

fps is feet per second

Reference: University of Florida (1972)

Table 2.5: Maximum Velocities for Various Lining Types

<u>Lining Type</u>	<u>Maximum Velocity (fps)</u>
Grass with Mulch	Bare Soil (Table 2.4)
Sod	4 ^{***}
Lapped Sod	5.5
Erosion Control Blanket	6.5
(Biodegradable, Standard Specification 104-6)	
Plastic Erosion Mat	
(Permanent, Standard Specifications 571 and 985)	
- Type 1	10
- Type 2	14
- Type 3	18
Riprap (Rubble) (Ditch Lining)	6
Other flexible	FHWA HEC-15
Geotextile Grid	4 - 8*
Rigid	10**

* Varies with grid

** Higher velocities acceptable with provisions for energy dissipation

*** If long term turf density is expected to be poor, use 3 fps maximum velocity

FLORIDA DEPARTMENT OF TRANSPORTATION

HYDRAULIC WORKSHEET FOR ROADSIDE DITCHES

Sheet _____ of _____

Road: _____

Prepared by: _____ Date: _____

Project Number: _____

Checked by: _____ Date: _____

STATION TO STATION	SIDE	% Slope	Drain Area (acres)	"C"	t _c (minutes)	i ₁₀ (iph)	Q (cfs)	Ditch Section			"n"	"d" (ft)	"d _{allowed} " (ft)	Calculated Freeboard (ft)	Velocity (fps)	Ditch Lining	Side Drain Pipe Dia. (inches)	Remarks
								F.S. (1:_)	B.W. (ft)	B.S. (1:_)								

Note: F.S. = Front Slope B.W. = Bottom Width B.S. = Back Slope

Figure 2-1: Hydraulic Worksheet for Roadside Ditches

CHAPTER 3

STORM DRAIN HYDROLOGY AND HYDRAULICS

3.1	Introduction	3-1
3.2	Pipe Materials	3-1
3.3	Design Frequency	3-1
3.4	Design Tailwater	3-2
	3.4.1 Sea Level Rise	3-3
3.5	Hydrologic Analysis	3-4
	3.5.1 Time of Concentration	3-4
3.6	Hydraulic Analysis	3-4
	3.6.1 Pipe Slopes	3-4
	3.6.2 Hydraulic Gradient.....	3-4
	3.6.3 Outlet Velocity	3-5
	3.6.4 Manning's Roughness Coefficients	3-5
3.7	Hydraulic Openings and Protective Treatment.....	3-6
	3.7.1 Entrance Location and Spacing.....	3-8
	3.7.1.1 Inlets.....	3-8
	3.7.2 Manholes.....	3-9
	3.7.3 Shoulder Gutter Inlets	3-9
	3.7.4 Inlet Placement.....	3-9
3.8	Grades	3-13
	3.8.1 Longitudinal Gutter Grade	3-13
3.9	Pavement Hydraulics	3-13

3.9.1	Spread Criteria	3-13
3.9.2	Trench Drain.....	3-14
3.9.3	Evaluation of Hydroplaning Potential.....	3-15
3.10	Construction and Maintenance Considerations.....	3-15
3.10.1	Pipe Size and Length	3-16
3.10.2	Minimum Pipe Cover and Clearances	3-17
3.10.3	Pipe Joint Designs Greater than 5 psi	3-18
3.10.4	Existing Pipe Inspection and Siltation.....	3-18
3.11	Pipes Within or Adjacent to Retained Earth Embankment Sections.....	3-19
3.12	Additional Design Considerations	3-19
3.12.1	Noise Walls	3-19
3.12.2	French Drains.....	3-20
3.12.3	Resilient Connectors	3-21
3.12.4	Flotation.....	3-22
3.13	Documentation	3-22
3.13.1	Tabulation Form	3-22
3.13.2	Other Documentation	3-22

3.1 INTRODUCTION

This chapter presents minimum standards for the design of FDOT storm drain systems.

3.2 PIPE MATERIALS

Pipe material selection must follow **Chapter 6** of this **Manual**.

3.3 DESIGN FREQUENCY

Table 3.1 presents standard design storm frequencies for the design of storm drain systems.

Table 3.1: Design Storm Frequencies of Storm Drain Systems

TYPE STORM DRAIN	FREQUENCY
General design	3-year
<ul style="list-style-type: none"> • General design work that involves replacement of a roadside ditch with a pipe system by extending side drain pipes • General design on work to Interstate Facilities 	10-year
<ul style="list-style-type: none"> • Outfalls 	25-year
<ul style="list-style-type: none"> • Interstate Facilities for which roadway runoff would have no outlet other than a storm drain system, such as in a sag inlet or cut section • Outlets of systems requiring pumping stations 	50-year

Acquire flood rights where offsite stages increase and impact land use values.

If a system has both curb inlets and ditch bottom inlets (DBIs), check the hydraulic grade line (HGL) for the DBIs for a 10-year design frequency. All structures in these mixed systems must meet the three-year design frequency.

3.4 DESIGN TAILWATER

For the determination of hydraulic gradient and the sizing of storm drain conduits, use a tailwater elevation coincident with the design storm event and that can be reasonably expected to occur. Standard design tailwater conditions for the design of storm drain systems are as follows:

Crown of pipe at the outlet, or if higher:

Lakes -----	Normal High Water
Rivers and Streams --	Normal High Water
Stormwater Ponds ----	Peak stage in the pond during the storm drain design event; see Chapter 5 for routing requirements; assume all orifices and v-notches to be clogged for the purposes of establishing the design tailwater for storm drain systems connected to ponds
Tidal Bays -----	Mean High Tide
Ditches, Free Flowing --	Normal depth flow in the ditch at the storm drain outlet for the storm drain design storm event; may differ from ditch design storm event
Downstream Control --	The higher of: (1) the stage due to free-flow conditions (described above) or, (2) the maximum stage at the storm drain outlet due to backwater from the downstream control using flows from the storm drain design storm event
Existing Systems -----	Elevation of hydraulic grade line of the system at the connection for the design storm event

French Drains -----	Design head over the outlet control structure
Closed Basin -----	Varies, depending on site-specific conditions
Regulated Canals -----	Agency regulated control elevation

3.4.1 Sea Level Rise

The design of coastal projects (including new construction, reconstruction, and projects rebuilding drainage systems) must incorporate sea level rise analysis to assess the vulnerability of flooding over the design life of the facility. Use the relative sea level trend data from historical tidal records gathered by the National Water Level Observation Network (NWLON) and managed by NOAA:

https://tidesandcurrents.noaa.gov/sltrends/sltrends_states.html?gid=1238

NOAA manages tidal gage stations located around the state of Florida. Use the station nearest the site for analysis. Analysis must consist of straight-line extrapolation based on the design service life of the project. Consider existing system criticality/vulnerability and project costs when implementing this best practice analysis.

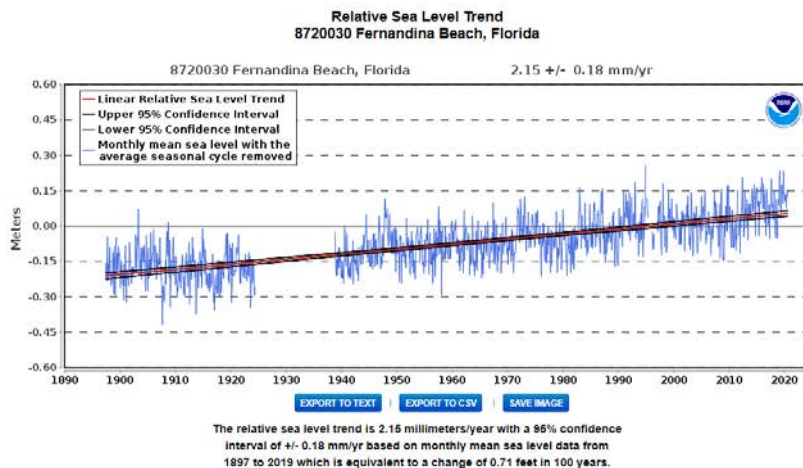

The plot shows the monthly mean sea level without the regular seasonal fluctuations due to coastal ocean temperatures, salinities, winds, atmospheric pressures, and ocean currents. The long-term linear trend is also shown, including its 95% confidence interval. The plotted values are relative to the most recent Mean Sea Level datum established by CO-OPS. The calculated trends for all stations are available as a table in millimeters/year and in feet/century (0.3 meters = 1 foot). If present, solid vertical lines indicate times of any major earthquakes in the vicinity of the station and dashed vertical lines bracket any periods of questionable data or datum shift.

Figure 3-1: Relative Sea Level Trend Data Example

3.5 HYDROLOGIC ANALYSIS

The Department requires use of the Rational Method for performing hydrologic calculations for storm drains. When storm drain systems are integrated with French drain systems or ditch storage systems, perform calculations using hydrographs to account for storage.

3.5.1 Time of Concentration

The minimum allowable time of concentration is 10 minutes.

3.6 HYDRAULIC ANALYSIS

Base hydraulic calculations for determining storm drain conduit sizes on open channel and pressure flow, as appropriate, using Manning's equation.

3.6.1 Pipe Slopes

Use a physical slope that will produce a velocity of at least 2.5 fps and no greater than 15 fps when the storm drain is flowing full.

For pressure flow storm drain systems, the minimum physical slope is 0.1 percent.

3.6.2 Hydraulic Gradient

Include friction losses in computing the design hydraulic gradient for all storm drain systems. Also include energy losses associated with special pollution control structures (weirs, baffles, etc.) and those caused by utility conflict structures.

When hydraulic calculations include only the major losses, such as those described above, and do not include all minor energy losses, provide a minimum of 1 foot of clearance between the elevations of the hydraulic gradient for design storm conditions and the theoretical gutter elevation (i.e., 1.13 feet below the edge of pavement for Type E or F Curb). This does not apply to ditch bottom inlets and other similar conditions where temporary ponding or overload is acceptable.

If design includes all major and minor energy losses, it is acceptable for the hydraulic gradient to reach the theoretical gutter elevation. Minor losses include entrance, exit, junction and manhole, expansion, contraction, and bend.

Include minor losses in hydraulic calculations when the velocity is greater than 7.5 fps. Check total minor losses for systems longer than 2,000 feet to ensure that the minor losses do not exceed the one-foot allowance. If greater than one foot, use calculated minor losses to design the system.

If hydraulic calculations show that intermediate manholes are under pressure, specify that the manhole lids are bolted down.

3.6.3 Outlet Velocity

When the outlet velocity for the design storm discharge exceeds 4 fps, evaluate the need for special channel lining (revetment or armoring) and/or energy dissipation to protect against undesirable scour. To compute the outlet velocity, assume the lowest anticipated tailwater condition that can reasonably be expected to occur during a storm event.

In areas where turf sustainability may be an issue, coordinate with maintenance to determine appropriate channel lining material.

3.6.4 Manning's Roughness Coefficients

Values for Manning's roughness coefficient are as follows:

Concrete Box Culverts	n = 0.012
-----------------------	-----------

Concrete Pipes	n = 0.012
----------------	-----------

Metal Pipes:

Pipe and Pipe Arch—Helical Fabrication

Re-corrugated Ends—All Flow Conditions*

12" to 24"	n = 0.020
------------	-----------

30" to 54"	n = 0.022
------------	-----------

60" and larger	n = 0.024
----------------	-----------

Pipe and Pipe Arch—Spiral Rib Fabrication

Re-corrugated Ends—All Flow Conditions*

All Sizes	n = 0.012
-----------	-----------

Plastic Pipes:

Polyvinyl Chloride-PVC (external rib/smooth interior)

All Sizes n = 0.012

Polyethylene (All Sizes)

Single Wall n = 0.024

Double Wall (Smooth) n = 0.012

Polypropylene (All Sizes)

Single Wall n = 0.024

Double & Triple Wall (Smooth) n = 0.012

* "Spiral" flow will not occur for most design situations. Therefore, the Department has not established "spiral" flow design values. Values for spiral flow, as recommended by the Southeast Corrugated Steel Pipe Association, are contained in the ***AISI Handbook of Steel Drainage & Highway Construction Products***.

3.7 HYDRAULIC OPENINGS AND PROTECTIVE TREATMENT

Select/design inlets and other hydraulic structures to satisfy hydraulic capacity, structural capacity, safety (vehicular, pedestrian, cyclist), and durability requirements.

Use alternate "G" (hot dipped galvanized) grates and frames when the structure is located on any barrier island, the Florida Keys, or within a half-mile of any brackish waterbody containing chlorides > 2,000 ppm.

Review drainage designs to determine if some form of protective treatment is necessary to prevent entry into long or submerged storm drain systems, steep ditches, or water control facilities. Also evaluate protection in systems that are partially submerged at the entrance and fully submerged at locations farther along in the system. If other modifications, such as landscaping or providing flat slopes, can eliminate the potential hazard and thus the need for protective treatment, evaluate them first. Because vehicular and pedestrian safety are achieved by differing protective treatments, this often requires the designer to make a compromise in which one type of protection is more completely realized than the other. In such cases, evaluate the relative risks and dangers involved to provide the design that gives the best balance. Remember that the function of the drainage feature will be essentially in conflict with total safety, and that only a reduction

rather than elimination of all risk is possible.

The three basic types of protective treatment used by the Department are:

<u>Feature</u>	<u>Typical Use</u>
Grates	To prevent persons from being swept into long or submerged drainage systems.
Guards	To prevent entry into long sewer systems under no-storm conditions, to prevent persons from being trapped.
Fences	To prevent entry into areas of unexpected deep standing water or high-velocity water flow, or into areas where grates or guards are warranted but are unsuitable for other reasons.

Review the following when determining the type and extent of protective treatment:

- Establish the nature and frequency of the presence of children in the area, e.g., the proximity to schools, school routes, and parks.
- Consider drainage facilities located outside a limited access area or adjacent to a limited access highway to be unlimited access facilities; a limited-access highway typically does not warrant protective treatment.
- Require adequate debris and access control on all inlet points if guards or grates are used at outlet ends.
- Check the hydraulic function of the drainage facility and adjust it so the protective treatment will not cause a reduction in function.
- Design grates for major structures in a manner that allows items to be carried up by increasing flood stages to avoid debris or persons being trapped against the hydraulic opening.
- Use of a guard may result in a person being pinned against it. A guard is usually used on outlet ends.

- Locate and build fences to reflect the effect of debris-induced force; a fence may capture excessive amounts of debris, which could possibly result in its destruction and subsequent obstruction of the culvert.
- Design protective treatments to prevent entry of certain wildlife, such as manatees.

3.7.1 Entrance Location and Spacing

3.7.1.1 Inlets

The following items determine inlet type, location, and spacing:

1. Inlet capacity and width of spread
2. Movement of vehicles to and from adjacent property on driveways
3. Pedestrian and bicycle safety
4. Maximum pipe length without maintenance access (**Section 3.10.1**)
5. Roadway geometry (e.g., super-elevation transitions, roadway profile, etc.)
6. Hydraulic efficiency of the system
7. Potential for flooding of off-site property
8. Potential for ponding at turn lanes, bus bays and driveways
9. Maintenance accessibility
10. Potential for concentrated flow to cause erosion when it leaves the pavement (including driveways)

Utilize curb inlet types 1-4 to the maximum extent practicable to accommodate maintenance. Curb inlet types 5-10 should only be used when types 1-4 cannot be accommodated. Inlet types 5, 6, 9 and 10 are not permitted in concrete pavement sections.

Locate inlets at all low points in the gutter grade and/or ditch, and as appropriate at intersections, median breaks, driveways and on side streets where drainage would adversely flow onto the highway pavement. Base inlet spacing on spread standards and maximum allowable pipe lengths provided below in **Section 3.9 and Section 3.10**.

Position inlets 10 feet prior to the level section in super-elevation transitions to avoid concentrated flows across the pavement.

Do not locate curb inlets, including inlet transitions, within handicap drop curb locations or on curb returns.

Do not place inlets in bridge approach slabs.

When an inlet is located behind a guardrail post, offset the inlet structure a minimum of 15 inches from the post. For the additional option of mounting special guardrail posts on top of inlet structures, see ***Standard Plans, Index 536-001***.

Inlets in sag vertical curves that have no overflow outlet other than the storm drain system (i.e., barrier wall, bridge abutment, cut sections) must have flanking inlets on one or both sides. Locate the flanking inlets to satisfy spread criteria when the sag inlet is blocked.

Consider the following items pertaining to parking lot drainage:

1. Do not use curb inlets in areas of heavy pedestrian traffic; specifically, service plaza parking lots. Alternately, use ditch bottom inlets with pedestrian-rated grates.
2. Consider positioning ditch bottom inlets in the center of the travel lanes and not in hidden locations, such as parking spaces.
3. Grade parking lots away from the heaviest pedestrian areas to remote locations for better safety. Alternately, use cuts in the curb to allow pavement to drain into grassed swales prior to entering ditch bottom inlets.

3.7.2 Manholes

Place manholes outside of the wheel path of vehicles. Manholes are not allowed in the travel lanes of interstate facilities.

3.7.3 Shoulder Gutter Inlets

Do not place shoulder gutter inlets within the alignment curb or curb transition to shoulder gutter, see ***Standard Plans, Index 536-001***.

3.7.4 Inlet Placement

Table 3.2: Curb and Gutter Inlet Application Guidelines

STANDARD PLANS INDEX	INLET TYPE	TYPE CURB/ GUTTER	GRADE CONSIDERATION	BICYCLE COMPATIBLE	ACCEPTABLE IN AREAS OF OCCASIONAL PEDESTRIAN TRAFFIC [6]	Notes
425-020	1	E & F	Continuous	Yes	Yes	
	2 [1]	E & F	Sag	Yes	Yes	
	3	E & F	Continuous	Yes	Yes	
	4 [1]	E & F	Sag	Yes	Yes	
425-021	5	E & F	Continuous	Yes	Yes	
	6 [1]	E & F	Sag	Yes	Yes	
425-022	7	Separator I & II	Continuous or Sag	Yes	Yes	
425-023	8	Separator IV & V	Continuous or Sag	Yes	Yes	
425-024	9 [2]	D & F	Continuous or Sag	Yes	Yes	
425-025	10 [2]	D & F	Continuous or Sag	Yes	Yes	
425-030	1	Median Barrier Wall	Continuous or Sag	No	Yes [4]	
	2 [3]	Median Barrier Wall	Continuous or Sag	No	Yes [4]	
425-031	-	Barrier Wall	Continuous or Sag	No [5]	Yes	See Index 425-031 Detail "A"
425-032	-	Barrier Wall (Rigid, C & G)	Continuous or Sag	No [5]	Yes	See Index 425-032 Grate Details
425-040	S [7]	Shoulder	Continuous	No [5]	Yes	See Index 425-040 Bar Stub Detail "C"
425-041	V	Valley	Continuous or Sag	No [5]	Yes	

- [1] Double-throated inlets usually are not warranted unless the minor gutter flow exceeds 50 ft in length or 0.5 cfs.
- [2] Use curb inlets 9 and 10 only where flows are light and right-of-way does not permit the use of throated curb inlets.
- [3] These are double inlets; one on each side of the barrier wall.
- [4] Specify the reticuline grate.
- [5] Bicycle compatible as long as a minimum 4-foot riding surface is provided around the inlet, with a preferred 1-foot offset from the inlet. Consider use of pavement markings shown in the 2009 MUTCD to alert cyclists to the inlet in the bicycle lane or shoulder pavement.
- [6] Do not place these inlets in pedestrian ways, but may be used in areas subject to occasional pedestrian traffic near pavement, grassed, or landscaped areas where pedestrians are not directed over the inlet and can walk around the inlet.
- [7] Intended for use in shoulder gutter on facilities subject to heavy wheel loads.

Table 3.3: Ditch Inlet Application Guidelines

STANDARD PLANS INDEX	INLET TYPE [1], [2]	TRAFFIC	BICYCLE COMPATIBLE	ACCEPTABLE IN AREAS OF OCCASIONAL PEDESTRIAN TRAFFIC [5]
425-050	A	Heavy Wheel Loads	No	No
425-051	B	Heavy Wheel Loads	No	Yes
425-052	C [3]	Infrequent Traffic	Yes [6]	Yes [4]
	D	Infrequent Traffic	Yes [6]	Yes [4]
	E	Infrequent Traffic	Yes [6]	Yes [4]
	H	Infrequent Traffic	Yes	Yes
425-053	F	Heavy Wheel Loads	Yes	Yes
	G	Heavy Wheel Loads	Yes	Yes
425-054	J	Heavy Wheel Loads	No	Yes
425-055	K	N/A	N/A	N/A

[1] Specify alternate G grates when in salt-water environment.

[2] Inlets with slots are more debris tolerant than inlets without slots. Debris may buildup on Type B fence of Type K inlet.

[3] For back of sidewalk location, see **Standard Plans, Index 425-060**.

[4] Slotted inlets located in areas accessible to pedestrians must have traversable slots.

[5] Do not place these inlets in pedestrian ways but may be used in areas subject to occasional pedestrian traffic near pavement, grassed, or landscaped areas where pedestrians are not directed over the inlet and can walk around the inlet.

[6] Do not use inlets with traversable slots in areas subject to bicycle traffic.

Table 3.4: Drainage End Treatment - Lateral Offset Criteria

INDEX	STRUCTURE DESCRIPTION	LATERAL OFFSET CRITERIA ^[1]
400-289 to 400-292	Concrete Box Culvert - End Treatments	Outside Clear Zone
425-020 to 425-041	Curb, Barrier & Gutter Inlets	Permitted within Clear Zone
425-050 to 425-051	Ditch Bottom Inlets – (Types A ^[2] and B) ^[3]	
425-052	Ditch Bottom Inlets – (Types C, D, E and H) ^[3] ^[4]	Permitted within Clear Zone
	Ditch Bottom Inlet - Type H w/Slot	Outside Clear Zone
425-053 & 425-054	Ditch Bottom Inlets – (Types F, G and J) ^[3]	Permitted within Clear Zone
425-055	Ditch Bottom Inlet - Type K	Outside Clear Zone
425-060	Back of Sidewalk Drain	Permitted within Clear Zone for Urban Curb & Gutter Sections Only with Design Speed ≤ 45 mph
430-010	U-Type Concrete Endwalls With Grates - 15" to 30" Pipe	Permitted within Clear Zone for Low Design Velocities & Negligible Debris
430-011	U-Type Concrete Endwalls Baffles and Grate Optional - 15" to 30" Pipe	Permitted within Clear Zone w/Grate
430-012	U-Type Concrete Endwalls Energy Dissipator - 30" to 72" Pipe	Outside Clear Zone See Index for "Location Reference"
430-020	Flared End Section	≤ 15" Diameter Inside Clear Zone > 15" Diameter Outside Clear Zone
430-021	Cross Drain Mitered End Section ^[6]	≤ 24" Diameter Inside Clear Zone ^[5] > 24" Diameter Outside Clear Zone
430-022	Side Drain Mitered End Section	Permitted within Clear Zone
430-030 to 430-034	Straight Concrete Endwalls	Outside Clear Zone See Indexes for "Location Reference"
430-040	Winged Concrete Endwalls - Single Round Pipe	
430-090	Safety Modifications for Endwalls	Permitted within Clear Zone w/Grate

[1] Lateral offset criteria for vehicular traffic only. Additional considerations may be needed for pedestrian or bicycle traffic. See Indexes for additional information.

[2] Designed for use on limited-access facilities where debris may be a problem.

[3] When slots are required due to debris considerations, the inlet must contain a traversable slot design to be located within a clear zone. See Indexes for traversable slot designs.

[4] Designs intended for areas of infrequent traffic loading.

[5] Equivalent size pipe arch or elliptical pipes are permitted within clear zone. Recommended MES slope is 1:4, otherwise steeper slopes require DDrE approval.

[6] Include slope and ditch transitions when the roadway slope must be flattened to place end section outside clear zone. See **Standard Plans, Index 430-021** for detail.

3.8 GRADES

3.8.1 Longitudinal Gutter Grade

The minimum longitudinal gutter grade is 0.3 percent.

3.9 PAVEMENT HYDRAULICS

3.9.1 Spread Criteria

The spread criteria listed is for permanent design and temporary construction conditions. Limit the spread resulting from a rainfall intensity of 4.0 inches per hour as follows.

Table 3.5: Spread Criteria

Typical Section Condition	Design Speed (mph)	Spread Criteria*
Parking Lane or Full Width Shoulders	All	No encroachment into the lane
Left Turn Lanes	Design Speed > 45	Keep 8' of lane clear
Right Turn Lanes	All	Keep ½ of lane clear
All Other	Design speed ≤ 45	Keep ½ of lane clear
	45 < Design Speed ≤ 55	Keep 8' of lane clear
	Design Speed > 55	No encroachment into the lane

* The criteria in this column apply to travel, turn, or auxiliary lanes adjacent to barrier wall or curb, in normal or super-elevated sections.

In addition to the above standards, for sections with a shoulder gutter, the spread resulting from a 10-year frequency storm will not exceed one foot, three inches outside the gutter in the direction toward the front slope. This distance limits the spread width to 6 ft, to provide clearance to the face of guardrail posts. See ***Standard Plans, Index 536-001***.

Design temporary drainage, for traffic diversions and construction phases, to provide drainage where construction activities may divert or trap water, compromising the safety and efficiency of the travel lanes. Give additional attention to expected spread for areas that are: (1) flood sensitive, (2) high-speed facilities (> 55 mph posted speed), or (3) using a low side barrier wall. Bridge deck spread must be evaluated for all bridges including MOT phases.

The Bridge Development Report (BDR) must include preliminary spread calculations for the bridge deck in order to determine whether additional drainage conveyance is required. Typical drainage conveyance costs may include, but are not limited to, additional shoulder width during construction, bridge deck drains, and conveyance systems. Costs for the bridge deck drainage must be considered when comparing alternative bridge designs.

3.9.2 Trench Drain

Consider trench drains only when traditional inlets are not feasible. Do not place the trench drains in pedestrian paths unless ADA compliant grates are used. If placed adjacent to reinforced concrete barrier, provide the detail in plans showing the position of the drain relative to the barrier to avoid conflicts with the foundation.

Identify in the plans the type, the design flow of the drain, begin and end locations of the drain and the location of the outlet pipe (if the drain is not stubbed directly into a drainage structure).

Slope outlet pipes and preformed channel inverts at 0.6% or steeper toward the outlet regardless of the surface slope.

Modification for Non-Conventional Projects:

Trench drains are not allowed for the final constructed condition unless approved by the District Drainage Engineer. Trench drains are only allowed for temporary drainage.

3.9.3 Evaluation of Hydroplaning Potential

The **FDM, Section 210.2.4.2 and 211.2.3, Hydroplaning Risk Analysis**, addresses policy for the analysis of hydroplaning potential when required for typical section approval.

Capture accumulated runoff from driveways, side streets and ramps to limit runoff into the mainline travel lanes or other areas where the additional sheet flow could contribute to potential hydroplaning. Design the inlet to capture 100 percent of the flow.

Use the hydroplaning web-based tool and the Design Guidance: Hydroplaning Risk Analysis to perform risk analysis to evaluate hydroplaning potential of typical section options. The hydroplaning tool is available online at : <https://www.fdot.gov/roadway/drainage/hydroplaning>.

3.10 CONSTRUCTION AND MAINTENANCE CONSIDERATIONS

Design storm drain systems consistent with the standard construction and maintenance practices of the Department. The **Standard Plans** provide standard details for inlets, manholes, junction boxes, end treatments, and other miscellaneous drainage details. Specifications are provided in the **Standard Specifications**. In the event the **Standard Plans** are not suitable for a specific project need, develop a detailed design and include it in the plans; and, as appropriate, provide special provisions for inclusion with the project specifications. Consider maintenance concerns of adequate physical access for cleaning and repair in the design.

Except for gutter drain bends, provide topside access at all pipe junctions and bends. The use of junction boxes without topside access will require District Drainage Engineer approval. Consider the use of a new inlet in place of a junction box or manhole to capture roadway runoff.

Drainage structures with internal weirs must have manhole access on each side of the weir. For areas of expected frequent entry, ask FDOT Maintenance if a two-piece, three-foot diameter manhole cover is needed for maintenance access.

Modification for Non-Conventional Projects:

Delete the last sentence in the paragraph above and see the RFP for additional requirements.

Provide a four-foot minimum sump in outfall structures and structures with pollution-

retardant baffles or skimmers installed inside the structure. When two or more baffles or skimmers are used in the same structure, provide a minimum horizontal distance of 2.5 feet between baffles for maintenance access. For submerged systems where cleanout velocity is not maintained, use a two-foot sump for all affected inlets.

For urban roadways with significant leaf drop potential and a posted speed limit of 40 mph or less, consider using a curb inlet screen to keep debris out of the storm drain system. If a curb inlet screen is used, use a catch basin pipe connection screen in conjunction with it.

All constructed inlets and manholes, excluding closed French drain systems, must not have storm drain pipe(s) exiting a drainage structure with a flow line higher than any storm drain pipe entering the same structure.

3.10.1 Pipe Size and Length

The minimum pipe size for trunk lines and laterals is 18 inches. The minimum pipe diameter for all proposed exfiltration trench pipes (French drain) is 24 inches.

The 18-inch minimum pipe size does not apply to connections from external, private stormwater management facilities. The pipe size for these connections is the size required to convey the Chapter 14-86, F.A.C. or other authoritative permitted discharge limitations.

The maximum pipe lengths without maintenance access structures are as follows:

Pipes without French drains:

18" pipe	300 feet
24" to 36" pipe	400 feet
42" and larger and all box culverts	500 feet

French drains that have access through only one end:

24" to 30" pipe	150 feet
36" and larger pipe	200 feet

French drains that have access through both ends:

24" to 30" pipe	300 feet
36" and larger pipe	400 feet

3.10.2 Minimum Pipe Cover and Clearances

1. If a material option is listed in the plans, the minimum cover must adhere to the criteria shown in **Appendix C**. If this is not possible, District Drainage Engineer approval will be required.

2. Storm drain systems that cross railroad tracks must meet special below-track clearance requirements and must use special strength pipe. Coordinate early with the District Rail Administrator and the railroad company to determine the specific pipe and clearance requirements.

3. Utility Clearances:
 - a. When a utility crosses a storm drain alignment, the minimum design clearance between the outside of the pipe and the outside of the conflict is 0.5 foot if the utility has been accurately located at the point of conflict. If the utility has been approximately located, the minimum design clearance is one foot. Utility company recommended clearances can vary from these design values, but electrical transmission lines and gas lines must never come into direct contact with the storm drain.

 - b. Locate storm drain lines so they do not disturb existing utilities to the greatest extent practical. If a utility conflict occurs, contact the District Drainage Engineer and the Utilities Section to review potential problems and feasible solutions.

 - c. When a sanitary line or other utility, including other storm drains, must pass through a manhole, provide minimum clearances in accordance

with **Standard Plans, Index 125-001**. Account for the head loss caused by an obstruction in the computation of the design hydraulic grade line. (Note: Gas mains must not pass through inlet and manhole structures.)

- d. Utility conflict structures must provide manhole access on both sides of the conflict when the conflicting utility is large (≥ 12 inches) or the conflict is close to the top of the structure. Maintenance vacuum trucks have a rigid suction pipe that cannot bend around obstructions. If the degree of access is uncertain, contact the local FDOT maintenance office for direction.

- e. The distance between the bottom of the utility and the conflict structure bottom must be no less than the internal diameter of the outlet pipe. Use a two-foot or four-foot sump in areas where sedimentation is expected. Use of a sump will require that the system be designed to account for the head loss generated if the sump is completely blocked.

3.10.3 Pipe Joint Designs Greater than 5 psi

When the pipe joints are expected to withstand design conditions greater than 5 psi but no more than 10 psi, include a plan note requiring the pipe supplier to test the proposed pipe joint to 10 psi using the methodology described in the **Standard Specifications**. If a pressure rating greater than 10 psi is required, call for a pressure pipe in the plans, including the needed ASTM(s) to clearly identify the pipe requirements.

3.10.4 Existing Pipe Inspection and Siltation

Contact the local maintenance office to obtain historic flooding information, pipe or culvert inspection reports and drainage related pavement structural deficiencies. Field reviews are required to assess the condition for all existing piped storm sewer systems and culverts that are being considered to “Remain in Service.” Pipe inspections may include video inspection depending on access and complexity of the system. In most cases, pipe desilting is necessary to properly inspect pipe joints and other locations where pavement structural deficiencies have occurred. Develop and submit a summary report of the inspection findings to the District Drainage and Maintenance offices.

Based on the coordination and field review findings, coordinate with the District Drainage and local maintenance office to determine what actions are needed to maintain the required function of the existing piped and culverted systems. Coordinate and obtain approval from both the District Drainage and local maintenance offices prior to any

desilting and/or dewatering activities.

Prior to extending any existing pipe that exhibits signs of corrosion and/or structural cracking, further evaluation is required to determine whether pipe repair or replacement is warranted to extend the service life of the rehabilitated system.

3.11 PIPES WITHIN OR ADJACENT TO RETAINED EARTH (WALLED) EMBANKMENT SECTIONS

The design requirements of this section pertain to all pipes that are within or adjacent to embankments confined by retaining walls. Avoid placing drainage pipes through retaining walls and similar structures when possible. If pipes must be placed within or adjacent to retaining walls, coordinate the design of the drainage system with the geotechnical and structural engineers.

The drawings in **Appendix D** detail three categories of pipes within retained earth (walled) embankments. Pipes proposed for installation within these embankments are defined as Wall Zone Pipes. For Wall Zone Pipes, provide verification of wall zones in design calculations.

The Optional Materials Tabulation Sheet must note those pipes that are deemed Wall Zone Pipes. When steel pipes are listed as an option for Wall Zone Pipes also show the minimum pipe wall thickness, meeting the requirements of **Appendix D** on the Optional Materials Tabulation Sheet.

Pipes used as vertical drains passing under or through retaining walls must satisfy the structural requirements of the latest edition of the American Association of State Highway and Transportation Officials (**AASHTO**) **Load and Resistance Factor Design Bridge Design Specifications, (LRFD – BDS), Chapter 12**.

When incorporating existing pipes within or adjacent to retained earth embankment sections, assess the condition of the pipe—both water tightness and structural adequacy under the proposed loading—and confer with the geotechnical and structural engineers.

3.12 ADDITIONAL DESIGN CONSIDERATIONS

3.12.1 Noise Walls

Evaluate the capacity of drainage openings in noise walls and locate them horizontally and vertically to ensure that offsite stormwater inflows are accommodated without increasing offsite stormwater stages for the appropriate regulatory design events. Document the existing drainage patterns, including taking photographs along the location

of the proposed sound barrier. If the capacity and/or location of noise wall drainage openings are insufficient and cannot be amended to handle offsite inflows, design a drainage system to maintain historic flows and to minimize the maintenance required behind the wall, especially for locations with limited right-of-way behind the wall.

3.12.2 French Drains

Design exfiltration systems (French drains) using ***Standard Plans, Index 443-001***. Designs must include provisions for overflow resulting from floods exceeding the design storm condition.

Provide French drain details with dimensional changes or otherwise different from the standard cross-sections represented in ***Standard Plans, Index 443-001***. Generally, pipe invert is placed above water table.

Provide baffles, skimmers, and four-foot minimum sumps at inlet points to minimize the entrance of oil and sediments into the French drain system. Use skimmers in French drain catch basins and in other locations where there is a need to prevent oil, debris or other floating contaminants from exiting the catch basins through outlet pipes. Provide detailed geometry for the skimmers per ***Standard Plans, Index 443-002***.

Do not locate exfiltration trenches where there are contaminated soils and in well field protection zones with less than 30 days' travel time to potable water supply wells. French drains are not allowed in embankments/fill conditions (not natural or compacted soil material).

Provide a minimum of 10 feet between French drains and overhead sign foundations, drill shafts, light pole foundations, or retaining walls. If this minimum distance cannot be met, the segment of perforated pipe and trench within the 10 feet of influence of the drill shaft or foundation must be replaced with a solid segment of pipe.

Install stormwater exfiltration systems at least two feet from parallel underground utilities and 20 feet from existing large trees that will remain in place.

Establish the depth and location of the French drain trench based on prudent benefit/cost analysis, considering the following factors:

1. Depth of transmissive strata that satisfy design needs.
2. Safety, feasibility, and expected frequency of required French drain maintenance activities.

3. Loss of functionality of the French drain due to its being under impervious surfaces.
4. Location of trees, utilities, and other features that may compromise the integrity of the trench envelope.
5. The cost of providing other stormwater management infrastructure in lieu of the French drain.
6. Cost of replacing the French drain in the future.
7. Potential geotechnical failures in Karst areas.

3.12.3 Resilient Connectors

All storm drain manholes and inlets may utilize resilient connectors, as specified in ***Standard Specifications 430***.

Resilient connectors are required for:

- All structures within walled embankments or connected to wall zone pipe.
- All vertical pipes.
- To accommodate movement of the bridge collection piping.

Do not specify or require resilient connectors for the following conditions:

- The interface angle of connection between the structure and pipe is greater than 15 degrees in either the horizontal or vertical direction.
- The structure and all connections fall outside the 1:2 roadway template control line, as per ***Standard Plans, Index 120-001***.
- The remaining beam height of the single precast unit, from the top of that segment to the existing crown of pipe chosen, is less than eight inches.
- In projects where elliptical pipes are specified on the plans.

3.12.4 Flotation

Design structures larger than 10 feet by 10 feet, and greater than 14 feet below the anticipated groundwater table to prevent flotation under design conditions. Recognize that in sandy soils, the groundwater table may increase briefly but significantly during a large rainfall event.

3.13 DOCUMENTATION

3.13.1 Tabulation Form

FDOT-Conduit-StormTab presents the required format for tabulating the results of hydrologic and hydraulic calculations for storm drain systems. File a copy of the completed table for permanent record as a part of the signed and sealed design documentation. You will find descriptions and examples of the form content in the ***DDG***.

Projects utilizing ***FDM 900 Series*** are required to provide the FDOT-Conduit-StormTab Flex table.

3.13.2 Other Documentation

File other supporting calculations and design documentation, including:

1. For complex systems, a narrative describing how the storm drain system will function.
2. Hydrologic computations:
 - a. Time of concentration
 - b. Runoff coefficients
3. Spread and inlet capacity analysis
4. Determination of design tailwater
 - a. NOAA sea level rise trend supporting documentation
5. Optional materials evaluation
 - a. Wall zone pipe identification
 - b. LRFD calculations, if applicable

6. Computation of minor energy losses and design resource for the loss coefficient assigned
7. Completed drainage map with drainage areas to each inlet identified, and structures numbered consistent with drainage computations and tabs
8. Outlet scour protection analysis, if applicable
9. Existing Pipe Inspection and Siltation Report

CHAPTER 4

CROSS DRAIN HYDRAULICS

4.1	Introduction	4-1
4.2	General	4-1
4.3	Design Frequency	4-2
	4.3.1 Permanent Facilities	4-2
	4.3.2 Temporary Facilities	4-2
4.4	Backwater	4-3
4.5	Tailwater.....	4-3
4.6	Clearances	4-3
4.7	Hydrologic Analysis.....	4-3
	4.7.1 Freshwater Flow.....	4-3
	4.7.2 Tidal Flow	4-4
4.8	Hydraulic Analysis.....	4-4
	4.8.1 Riverine Crossings	4-4
	4.8.1.1 Bridges.....	4-4
	4.8.1.2 Bridge-Culverts and Culverts	4-4
	4.8.2 Tidal Crossings.....	4-4
	4.8.2.1 Ocean Boundary Hydrographs.....	4-5
	4.8.2.2 Use of Qualified Coastal Engineers	4-5
4.9	Specific Standards Relating to Bridges	4-5
	4.9.1 Berms for Spill-Through Abutment Bridges	4-5
	4.9.2 Scour Estimates	4-6

4.9.2.1	Coordination.....	4-6
4.9.2.2	Scour Estimates.....	4-6
4.9.2.3	Scour Components.....	4-7
4.9.3	Scour Protection Considerations.....	4-9
4.9.3.1	General.....	4-9
4.9.3.2	Minimum Abutment & Retaining/Sea Wall Protection ...	4-9
4.9.3.3	Pier Protection.....	4-10
4.9.3.4	Use of Bedding Stone with Revetments.....	4-10
4.9.4	Bridge Deck Drainage.....	4-11
4.9.4.1	Spread Standards.....	4-11
4.9.4.2	Scupper Drains.....	4-11
4.9.4.3	Bridge Sidewalk Drainage.....	4-11
4.9.5	Wave and Current Forces on Coastal Bridges.....	4-11
4.9.5.1	Required Level of Analysis.....	4-11
4.10	Specific Standards Relating to all Cross Drains except Bridges.....	4-12
4.10.1	Culvert Materials.....	4-12
4.10.2	Manning’s Roughness Coefficients.....	4-12
4.10.3	End Treatment.....	4-13
4.10.3.1	Protective Treatment.....	4-13
4.10.3.2	Roadside Safety.....	4-13
4.10.4	Construction and Maintenance Considerations.....	4-13
4.10.4.1	Minimum Culvert Sizes.....	4-14
4.11	Documentation.....	4-14
4.11.1	Culverts (all culverts less than a 20-foot bridge culvert).....	4-14

4.11.1.1	Extensions of Culverts with No Known Historical Problems.....	4-14
4.11.1.2	New or Replacement Culverts and Extensions of Culverts with Known Historical Problems.....	4-15
4.11.2	Bridges	4-15
4.11.2.1	Bridges on Controlled Canals	4-15
4.11.2.2	Bridge or Bridge Culvert Widening.....	4-15
4.11.2.3	Bridge Culverts	4-16
4.11.2.4	Category 1 and 2 Bridges	4-16
4.11.3	Document Processing	4-18

4.1 INTRODUCTION

This chapter presents standards and procedures for the hydraulic design of cross drains, including culverts, bridge-culverts¹, and bridges. The ***FDOT Project Development and Environmental Manual*** addresses preliminary planning and location studies for cross drains.

4.2 GENERAL

Prepare the hydraulic design of cross drains in accordance with good engineering practice and comply with **23 CFR 650A** and the ***National Flood Insurance Program (NFIP)***. Specifically:

1. Design all cross drains to have sufficient hydraulic capacity to convey the selected design frequency flood without damage to the structure and approach embankments, with due consideration to the effects of greater floods.
2. Perform scour calculations with normal safety factors to withstand the design flood condition listed in Section 4.9.2.2 and provide to the structural engineer for foundation design. Ensure that the design has a minimum factor of safety of one against failure due to the scour design check flood condition listed in Section 4.9.2.2.
3. Analyze the design of all cross drain structures for the Design Flood, Base Flood (100-year frequency flood), and the Greatest Flood (overtopping flood or the 500-year frequency flood where overtopping is not practicable) that you expect to flow to the structure. Include a summary of this analysis, showing the peak stages and discharges for these events on the final project plans.
4. For projects that encroach into a Regulatory Floodway, coordinate the design with the appropriate local government flood insurance program official.
5. Designers shall reference the latest edition of the ***AASHTO LRFD Bridge Design Specifications (LRFD – BDS), Section 2.6***.

¹ A culvert qualifies as a bridge if it meets the requirements of Item 112 in the FDOT [Bridge Management System Coding Guide](#).

4.3 DESIGN FREQUENCY

4.3.1 Permanent Facilities

Standard design frequencies for permanent culverts, bridge-culverts, and bridges are as follows:

Table 4.1: Design Storm Frequencies of Permanent Facilities

FACILITY	FREQUENCY
Mainline Interstate	50 years
High Use or Essential: Projected 20-year AADT* > 1,500	50 years
Other: Projected 20-year AADT* < 1,500	25 years
<ul style="list-style-type: none"> • Roadside ditch culverts • Pedestrian and trail bridges 	10 years

* AADT is preferred. If it is not available, use ADT.

Note: The flood frequencies used for scour analysis differ. See **Section 4.9.2**.

4.3.2 Temporary Facilities

The 10-year design storm event is the minimum frequency for evaluation of temporary culverts, bridge-culverts, and bridges. The design storm event will cause no more than a one-foot increase in the flood elevation immediately upstream and no more than one tenth of a foot increase 500 feet upstream. If the existing structure has flooding or scour concerns, coordinate with the District Drainage Engineer for site specific considerations.

4.4 BACKWATER

Hydraulically design cross drains to meet the following backwater conditions:

1. Backwater created by the structure will be consistent with Flood Insurance Study requirements adopted by the local community in accordance with the **NFIP** and **Federal Emergency Management Agency (FEMA)** guidelines in addition to other relevant sources.
2. Acquire flood rights where offsite stages increase and impact land use values.
3. Keep the backwater for design frequency conditions at or below the travel lanes.

4.5 TAILWATER

For the sizing of cross drains and the determination of headwater and backwater elevations, use the highest tailwater elevation coincident with the design storm event.

For culverts with tidally influenced tailwaters, adjust the **Mean High Water** elevation for sea level rise using the methodology in **Section 3.4.1**.

4.6 CLEARANCES

Refer to the **FDM, Section 260** for the minimum vertical, horizontal, and regulatory clearance requirements for bridges.

4.7 HYDROLOGIC ANALYSIS

4.7.1 Freshwater Flow

Acquire or generate hydrologic data using one of the following methods, as appropriate for the site:

1. Use a frequency analysis of observed (gage) data when available. If insufficient or no observed data is available, use one of the procedures below as appropriate. To the extent practical, calibrate the procedures below with available observed data for the drainage basin or nearby similar drainage basins.
 - a. Regional or local regression equation developed by the USGS
 - b. Rational Equation for drainage areas up to 600 acres

2. For regulated or controlled canals, request hydrologic data from the controlling entity. Prior to use for design, verify these data to the greatest extent practical.

4.7.2 Tidal Flow

When analyzing creeks and small rivers flowing into tidal water bodies, consider hurricane rainfall runoff in conjunction with surge-driven tailwater. In such cases, since hurricane rainfall is largely independent of peak surge stage, use the U.S. Army Corps of Engineers (USACE) tropical storm rainfall runoff procedure from the **1986 Engineering and Design Storm Surge Analysis Manual (EM1110-2-1412)**, Chapter 4, to estimate runoff from any design surge regardless of the surge return frequency being analyzed. For procedure details, refer to the following manual.

https://fdotwww.blob.core.windows.net/sitefinity/docs/default-source/roadway/drainage/fchc/hurricanerainfall.pdf?sfvrsn=9eaa99df_0

Alternatively, you may use a steady discharge equal to the peak flow from a 10-year storm in lieu of the above **USACE procedure**.

4.8 HYDRAULIC ANALYSIS

4.8.1 Riverine Crossings

4.8.1.1 Bridges

FHWA's Finite Element Surface Water Modeling System (FESWMS), **USACE's HEC-RAS, ICPR Version 4**, and **RMA-2** are acceptable computer programs to analyze the hydraulic performance of bridges over riverine waterways.

4.8.1.2 Bridge-Culverts and Culverts

Analyze the hydraulic performance of bridge-culverts and culverts at riverine waterways based on the techniques provided in **FHWA Hydraulic Design Series (HDS) #5**.

4.8.2 Tidal Crossings

Use coastal engineering analysis, as typified by the USACE and consistent with current coastal engineering practice, in the analysis of astronomical tides and hurricane storm surges. The computer programs acceptable for hydraulic analyses at tidal crossing are **HEC-RAS, RMA-2, ADCIRC**, and **FESWMS**.

4.8.2.1 Ocean Boundary Hydrographs

When ocean coast hurricane hydrographs are used for driving surge models inland, use stage/time hydrographs from the following website:

<https://www.fdot.gov/roadway/Drainage/DHSH.shtm>

Adjust the hurricane hydrograph for sea level rise using the methodology in **Section 3.4.1**.

4.8.2.2 Use of Qualified Coastal Engineers

If coastal hydraulics is significant to the bridge or culvert design, a qualified coastal engineer should review the complexity of the tidal conditions to determine the appropriate level of coastal engineering expertise needed in the design. Ideally, this assessment should be performed during the PD&E phase as specified in the **FDOT PD&E Manual**, Chapter 4. Conditions that typically require direct attention by a coastal engineer during the final design phase include:

- Hydraulic analysis of interconnected inlet systems
- Analysis of inlet or channel instability, either vertically or horizontally
- Determination of design wave parameters
- Prediction of overwash and channel cutting
- Design of countermeasures for inlet instability, wave attack, or channel cutting
- Prediction of sediment transport or design of countermeasures to control sediment transport
- Assessment of wave loading on bridges and other structures

Modification for Non-Conventional Projects:
Delete Section 4.8.2.2 and see the RFP for requirements.

4.9 SPECIFIC STANDARDS RELATING TO BRIDGES

4.9.1 Berms for Spill-Through Abutment Bridges

To facilitate construction, reduce scour potential, and provide for abutment stability, provide a minimum berm width of 10 feet between the top edge of the main channel and the toe of spill-through at bridge abutments. See **Section 4.9.3.2**. For manmade canals, the berm may be omitted at the direction of the maintaining agency.

4.9.2 Scour Estimates

4.9.2.1 Coordination

Develop scour estimates for bridges using a multi-disciplinary approach (See **FDM Section 250**) involving the hydraulics engineer, the geotechnical engineer, the coastal engineer (if needed per **Section 4.8.2**, above), and the structures engineer.

4.9.2.2 Scour Estimates

Develop scour elevation estimates for each bent as follows:

Table 4.2: Scour Estimates

Hydraulic Design Flood Frequency	Scour Design Flood Frequency	Scour Design Check Flood Frequency
Q ₁₀	Q ₂₅	Q ₅₀
Q ₂₅	Q ₅₀	Q ₁₀₀
Q ₅₀	Q ₁₀₀	Q ₅₀₀

- "Long-term scour" for structures required to meet the extreme event vessel collision load.

Estimate scour depths using the procedures of **FHWA's Hydraulic Engineering Circulars (HEC) 18 and 20**, except for the following:

- Follow **Section 4.8.2** for tidal hydraulics analysis methodology.
- Use **Sheppard's Pier Scour Equation** rather than the **CSU Pier Scour Equation** when the total scour (general scour, contraction scour, and local scour) is greater than six feet.
- Use the **Florida Complex Pier Scour Procedure** in lieu of the complex pier scour procedure in **HEC 18**.
- Use the Florida Rock/Clay Scour Procedure to evaluate scour in scour-resistant soils.
- Use SED-2D to evaluate contraction scour in the absence of a clearly defined upstream tidal floodplain.

You can find guidance on the above Florida procedure at the website:
<https://www.fdot.gov/roadway/Drainage/Bridge-Scour-Policy-Guidance.shtm>

4.9.2.3 Scour Components

Scour estimates consist of the total scour resulting from the following:

1. Natural channel aggradation and degradation anticipated during the life of the structure
2. Channel migration anticipated during the life of the structure
3. Contraction scour
4. Local scour, including pier scour and abutment scour from currents and waves
(Note: Abutment scour estimates are not required when the minimum abutment protection is provided.)

The "long-term scour" is the total design scour for structures subject to clear water scour. For structures subject to live bed scour, the "long-term scour" is the normal, everyday scour at the piers combined with the degradation scour anticipated during the life of the structure. The following inset provides criteria for determining normal, everyday scour at the piers.

Normal, Everyday Scour at the Piers

Bridge inspection reports and the design survey are the primary basis for determining normal everyday scour for bridge replacements, parallel bridges, major widenings, etc.

If the proposed piers are the same as the existing, the normal, everyday scour elevation is that which is reflected in the inspection reports and the design survey. Slight differences in scour will likely exist between inspection reports and between the reports and the design survey. In these cases, an average scour elevation will be a reasonable estimate of normal, everyday scour. If there is a large difference, it may be due to an extreme storm event that occurred just before the inspection or survey was made. Investigate this and address these situations on a case by case basis.

For structures in which the proposed piers will be a different size or shape than the existing, adjust the pier scour depth. Using the inspection reports and the survey as discussed above, determine a normal, everyday scour depth at the pier. Adjust this depth using the following formula. The formula was derived by assuming only the pier width and shape change. Flow, velocity, and depth remain unchanged from existing to proposed.

$$y_{sp} = \frac{k_{1p}}{k_{1e}} \left[\frac{a_p}{a_e} \right]^{0.65} y_{se}$$

where:

y_{sp} & y_{se} = Scour depth for proposed pier and existing pier, respectively

k_{1p} & k_{1e} = Pier nose shape correction factor for proposed and existing pier, respectively

a_p & a_e = Pier width for proposed and existing pier, respectively

For new bridges/new alignments where there are no historical records available, the drainage engineer should look for hydraulically similar bridges in the area (preferably on the same water body) and estimate scour using the above guidelines. If there are no similar structures to use for comparison, contact the District Drainage Engineer for guidance on other methods for estimating normal everyday scour.

4.9.3 Scour Protection Considerations

4.9.3.1 General

Design pier spacing and orientation, along with abutment protection, in coordination with other bridge design concerns to minimize flow disruption and potential scour, subject to navigation requirements.

Design abutment and pier protection as follows:

1. For protection against the effects of scour conditions consistent with design requirements stated above
2. For the effects of wind-generated waves and boat wake

Document revetment options deemed to be inappropriate for the site in the Bridge Hydraulics Report (BHR). Write a Technical Specification, if a **Standard Specification** does not exist, based on the use of the most desirable revetment material, with the option to substitute the other allowable materials at no additional expense to the Department.

Specify the environmental classification for gabions based on the criteria found in the **Structures Manual, Volume 1: Structures Design Guidelines, Section 1.3**.

Follow the **USACE Shore Protection Manual** for design of coastal revetment.

4.9.3.2 Minimum Abutment and Retaining/Sea Wall Protection

For wave heights greater than 2.4 feet (typically in coastal applications), use Specific Gravity (S.G.) = 2.65 or greater rubble. In such cases, extend abutment protection beyond the bridge along embankments and retaining/sea walls that may be vulnerable to wave attack during a hurricane. Design for both wave attack above the peak design surge elevation and wave rebound scour at the toe of bulkheads. In such cases, obtain the size and coverage of the revetment from a qualified coastal engineer

4.9.3.2.1 Spill-through Abutments

For spill-through abutments, minimum protection consists of one of the following placed on a slope no steeper than 1(vertical) to 2 (horizontal):

- Rubble riprap (bank and shore), bedding stone, and filter fabric: Rubble riprap (bank and shore) as defined in the **Standard Specification 530** where (1) design flow velocities do not exceed 7.7 fps, (2) Froude numbers are ≤ 0.80 , and (3) wave heights do not exceed 2.4 feet

- Articulated concrete block (cabled and anchored), as defined in **Standard Specification 530**

The **Structures Detailing Manual** provides typical details for standard revetment protection of abutments and extent of coverage. Determine the horizontal limits of protection using **HEC 23**. Provide a minimum distance of 10 feet if **HEC 23** calculations show less than 10 feet.

Prepare site-specific details as stated in **Standard Specification 530** when using articulating concrete block abutment protection.

4.9.3.2 Bulkhead Abutments

When bulkhead abutments are protected by a structural wall, consult with the structural engineer to determine the need for toe protection below the wall and revetment protection above the wall. When the design velocity in the contracted section is less than or equal to 7.2 fps, use bank and shore rubble riprap. When the design velocity is above 7.2 fps, design the size and density of the rubble for site conditions. In all cases, design the spatial extent of the rubble protection for individual site conditions.

4.9.3.3 Pier Protection

Where revetment is deemed necessary to protect piers from scour, and upstream design flow velocities do not exceed 7.2 fps for rectangular piles or bascule piers, and 8.2 fps for round piling or drilled shafts, use one of the following for pier scour protection:

- Rubble riprap (bank and shore), bedding stone, and filter fabric: Rubble riprap (bank and shore) is defined in the **Standard Specification 530**
- Articulated concrete block (cabled)
- Gabions (rock-filled baskets)

4.9.3.4 Use of Bedding Stone with Revetments

Geotextile type and material referenced below is based on **Standard Specification 985**.

Use bedding stone to cushion the underlying filter fabric during installation of rubble and to keep the filter fabric flat against the parent soil to avoid the piping of sheet flow cascading from the top side of the rubble.

4.9.4 Bridge Deck Drainage

4.9.4.1 Spread Standards

The spread standards in **Section 3.9** apply to bridge decks and bridge approaches.

4.9.4.2 Scupper Drains

The standard scupper drain is four inches in diameter and spaced on 10-foot centers, unless spread calculations indicate closer spacing is required. Design using a factor of safety of 2. Scuppers will not be directly discharging onto railroads, roadway travel lanes, shared-use paths, or sidewalks. Provide erosion protection, which could include splash pads or rubble, for scuppers discharging onto erodible surfaces.

4.9.4.3 Bridge Sidewalk Drainage

Where bridge sidewalks are sloped away from the travel lanes, no measures to capture runoff from the sidewalks are required, except at bridge ends. If bridge sidewalk drainage is installed, scuppers must satisfy Americans with Disabilities Act (ADA) requirements to have no more than a one-half inch hole in the walking surface.

4.9.5 Wave and Current Forces on Coastal Bridges

Where coastal bridges are not elevated at least one foot above the design wave crest elevation, a qualified coastal engineer with experience in wave mechanics must address the requirements of the ***AASHTO Guide Specifications for Bridges Vulnerable to Coastal Storms***.

4.9.5.1 Required Level of Analysis

Use a qualified coastal engineer as part of the PD&E scoping effort, especially with structures exposed to severe wave attack. Make determinations, including the appropriate level of analysis, as outlined in the ***SDG, Section 2.5***.

4.10 SPECIFIC STANDARDS RELATING TO ALL CROSS DRAINS EXCEPT BRIDGES

4.10.1 Culvert Materials

Select culvert material in accordance with *Chapter 6* of this *Manual*.

4.10.2 Manning's Roughness Coefficients

Standard values for Manning's roughness coefficient are as follows:

Concrete Box Culverts	n = 0.012
Concrete Pipes	n = 0.012

Metal Pipes:

Pipe and Pipe Arch - Helical Fabrication Re-corrugated Ends - All Flow Conditions*	
12" – 24"	n = 0.020
30" – 54"	n = 0.022
60" and larger	n = 0.024

Pipe and Pipe Arch - Spiral Rib Fabrication Re-Corrugated Ends - All Flow Conditions*	
All sizes	n = 0.012

Structural Plate - Pipe and Pipe Arch Annular Fabrication - All Flow Conditions*	
All - 6" x 2"	n = 0.033
All - 9" x 2-1/2"	n = 0.034

Plastic Pipes:

Polyvinyl Chloride-PVC (external rib/smooth interior) All Sizes	n = 0.012
--	-----------

Polyethylene	
Single Wall	n = 0.024
Double Wall (Smooth)	n = 0.012

Polypropylene (All Sizes)

Single Wall	n = 0.024
Double & Triple Wall (Smooth)	n = 0.012

* "Spiral" flow will not occur for most design situations. Therefore "spiral" flow design values have not been established. Values recommended by the Southeast Corrugated Steel Pipe Association are contained in the ***AISI Handbook of Steel Drainage & Highway Construction Products***.

4.10.3 End Treatment

Select/design the choice of end treatment and other hydraulic structures to satisfy hydraulic capacity, structural capacity, and safety (vehicular, pedestrian, cyclist) requirements.

Treatments are presented in the ***Standard Plans***. Criteria on end treatment selection is in ***Table 3.4***.

4.10.3.1 Protective Treatment

Review drainage designs to determine if some form of protective treatment will be required to prevent entry to facilities that present a hazard to children and, to a lesser extent, all persons or certain wildlife. ***Section 3.7*** presents direction on protective treatment. When grates are used, consider the effect of the grate and potential debris on the hydraulic capacity of the cross drain.

4.10.3.2 Roadside Safety

The type and location of end treatments must consider roadside safety and clear zone requirements. See the ***FDM*** for clear zone requirements and ***Table 3.4*** for end treatment safety guidance.

4.10.4 Construction and Maintenance Considerations

Design culverts to be consistent with the standard construction and maintenance practices of the Department. Standard details for inlets, manholes, junction boxes, end treatments, and other miscellaneous drainage details are provided in the ***Standard Plans***. Specifications are provided in the ***Standard Specifications***. In the event the ***Standard Plans*** are not suitable for a specific project need, develop a detailed design and include it in the plans; and, as appropriate, provide special provisions for inclusion with the project specifications. Proper design also considers maintenance concerns of adequate physical access for cleaning and repair. Refer to the criteria in ***Section 3.10.1***

for the recommended maximum pipe lengths without maintenance access. Refer to Section **3.10.4** for criteria on existing pipe inspection.

4.10.4.1 Minimum Culvert Sizes

Minimum culvert sizes are as follows:

<u>Culvert Type</u>	<u>Minimum Size</u>
Cross Drain	18"
Median Drain	15" * **
Side Drain	15" *
Box Culvert (Precast)	3' x 3'
Box Culvert (Cast in Place)	4' x 4'
Drains from inlets on high fills (e.g., gutter drains)	15" **

* Some locations require 18" minimum. Consider future improvements, hydraulic requirements, debris control, and maintenance access.

** When debris control is not provided by grates, use 18" minimum.

For culverts requiring more than a double line of pipe, investigate other alternatives.

4.11 DOCUMENTATION

4.11.1 Culverts (all culverts less than a 20-foot bridge culvert)

4.11.1.1 Extensions of Culverts with No Known Historical Problems

For extensions of culverts that have no signs of undesirable scour at inlet and outlet ends, no excessive sedimentation, and no history of problems, include in the documentation, at a minimum, the following:

1. Evidence of contact with Maintenance Office
2. Evidence of Field Review
3. Discharge computations
4. Hydraulic computations (**HDS 5**), including any design assumptions

4.11.1.2 New or Replacement Culverts and Extensions of Culverts with Known Historical Problems

At a minimum, include in the documentation:

1. Evidence of contact with a maintenance office
2. Evidence of Field Review
3. Drainage map
4. Hydrologic computations
5. Hydraulic computations (**HDS 5**), including any design assumptions
6. Assessment of the problem (for culverts with known problems)
7. Alternative analysis
8. Optional materials evaluation

4.11.2 Bridges

Document bridge hydraulic design computations and analyses in a permanent record file. The permanent record file will address all design standards provided herein. Provide documentation in detail commensurate with the complexity of the project. Documentation must be sufficient enough that an independent engineer with expertise in bridge hydraulics, but not involved with the design, can fully interpret, follow, and understand the logic, methods, computations, analysis, and considerations used to develop the final design.

4.11.2.1 Bridges on Controlled Canals

Bridges on controlled canals not affected by hurricane surge may utilize the short-format BHR located in **DDG Chapter 5**.

4.11.2.2 Bridge or Bridge Culvert Widening

At a minimum, include in the documentation:

1. Bridges require a completed Bridge Hydraulics Recommendations Sheet (BHRS), including complete design recommendations. Bridge-culverts require

- a completed Flood Data Summary Table. **FDM** provides the format for the BHRS and the Flood Data Summary Table.
2. Evidence of Field Review
 3. Hydrologic analysis, including sources of data and methodology
 4. Hydraulic computations, including any design assumptions; provide an electronic copy with the input and output file(s) for the final computer run
 5. Scour analysis:
 - a) Scour computations
 - b) Scour protection needs
 6. Applicable regulatory agency documents that affect the final design; this may include documents from the Corps of Engineers, Coast Guard, Water Management District, DEP, etc.
 7. Deck drainage analysis and computations

4.11.2.3 Bridge Culverts

At a minimum, include in the documentation:

1. Evidence of Field Review
2. Hydrologic analysis, including sources of data and methodology
3. Hydraulic computations, including any design assumptions; provide an electronic copy with the input and output file(s) for the final computer run
4. Scour analysis addressing the need for inlet and/or outlet protection
5. A summary of the alternatives considered, including cost estimates and reasons for selecting the recommended structure, and a clear explanation as to why it is the most economical structure for the site in question
6. Applicable regulatory agency documents that affect the final design; this may include documents from the Corps of Engineers, Coast Guard, Water Management District, DEP, etc.
7. For interstate system bridges over floodplains where a regulatory floodway has not been established, the documentation must include the evaluation required in **Section 4.4** of this Chapter.

4.11.2.4 Category 1 and 2 Bridges

At a minimum, include in the documentation:

1. A completed BHRS. **FDM** provides the format for the BHRS.
2. BHR:
 - A. A summary of all design recommendations, including:
 - 1) Bridge length, including locations (stations) of abutments

-
- 2) Channel excavation requirements
 - 3) Minimum vertical clearance
 - 4) Minimum horizontal clearance
 - 5) Abutment type and orientation
 - 6) Pier orientation
 - 7) Scour depths
 - a. Scour design event
 - b. Scour check event
 - 8) Scour protection requirements for abutments, piers, and channel; for spill-through abutments, recommendations include:
 - a. Abutment slope
 - b. Type of protection (rubble riprap is standard)
 - c. Horizontal and vertical extent of protection
 - d. Consideration of wildlife connectivity
 - 9) Deck drainage requirements
 - 10) Wave and surge parameters and force determination (or calculation) and analysis (for coastal bridges not elevated one foot above the design wave crest elevation)
- B. Evidence of field review
- C. Hydrologic analysis, including sources of data and methodology
- D. Alternative analysis or evaluation of structure sizes (length and vertical height/clearance) performed consistent with Department policy for bridge hydraulic design and including:
- 1) Cost
 - 2) Design standards
 - 3) Structure hydraulic performance, including backwater, velocity, and scour
 - 4) Impacts of the structure on adjacent property
 - 5) Environmental impacts
- E. The alternative analysis will address the reasons for selecting the recommended structure, and a clear explanation as to why it is the most economical structure for the site in question; at a minimum, the following structure sizes will be evaluated:
- 1) The minimum structure size required to meet hydraulic standards for vertical and horizontal clearance, scour, and backwater
 - 2) Existing structure size if applicable
 - 3) The recommended structure size if different from (1) or (2)
- F. Deck drainage analysis

- G. Supporting hydraulic computations, including:
 - 1) Computer analysis, if appropriate, including a plan view of cross section locations and an electronic copy with the input and output file(s) for the final computer run
 - 2) Scour computations
 - 3) Deck drainage computations
 - 4) Design assumptions
 - 5) Wave and surge parameters and force determinations and analysis (for coastal bridges not elevated one foot above the design wave crest elevation)
- H. Applicable regulatory agency documents that affect the final design, which may include documents from the Corps of Engineers, Coast Guard, Water Management Districts (WMD), DEP, etc.

4.11.3 Document Processing

Process the BHR/BHRS and other supporting design documents in accordance with the ***FDM***.

CHAPTER 5

STORMWATER MANAGEMENT

5.1	Introduction	5-1
5.2	Regulatory Requirements.....	5-1
	5.2.1 Chapter 14-86, Florida Administrative Code.....	5-1
	5.2.2 Section 373.4596, Florida Statutes	5-1
	5.2.3 Chapter 62-330, Florida Administrative Code.....	5-1
	5.2.4 Chapter 62-40, Florida Administrative Code.....	5-1
	5.2.5 Rule 62-302.530, Florida Administrative Code	5-1
	5.2.6 National Pollutant Discharge Elimination System.....	5-2
5.3	Environmental Look Arouds (ELA).....	5-2
5.4	Design Standards.....	5-3
	5.4.1 Design of Systems	5-3
	5.4.1.1 General	5-3
	5.4.1.2 Watersheds with Positive Outlets.....	5-4
	5.4.1.3 Watersheds without Positive Outlets.....	5-4
	5.4.1.4 Exceptions.....	5-5
	5.4.1.5 Aviation	5-5
	5.4.2 Hydrologic Methods.....	5-5
	5.4.3 Protective Treatment	5-6
	5.4.4 Construction and Maintenance Considerations	5-6
	5.4.4.1 General	5-6
	5.4.4.2 Detention and Retention Ponds	5-6
5.5	Documentation	5-8

5.1 INTRODUCTION

This chapter presents standards for the design of stormwater management systems for Department projects. Guidance for drainage connection permits is provided in the ***FDOT Drainage Connection Permit Handbook***.

5.2 REGULATORY REQUIREMENTS

5.2.1 Chapter 14-86, Florida Administrative Code

The design of stormwater management systems for Department projects will comply with the water quality, rate, and quantity requirements of ***Section 334.044(15), Florida Statutes (F.S.), Chapter 14-86, Florida Administrative Code (F.A.C.)***, Rules of the Department of Transportation, only in basins closed during storms up to and including the 100-year storm event, or areas subject to historical flooding.

5.2.2 Section 373.4596, Florida Statutes

Section 373.4596, F.S., requires the Department of Transportation to fully comply with state, Water Management District (WMD), and—when delegated by the state—local government stormwater management programs.

5.2.3 Chapter 62-330, Florida Administrative Code

Chapter 62-330, F.A.C., of the Florida Department of Environmental Protection (DEP) specifies minimum water quantity and water quality treatment standards required by the Environmental Resource Permit program for new development.

5.2.4 Chapter 62-40, Florida Administrative Code

Chapter 62-40, F.A.C., of the Florida DEP outlines basic goals and requirements for surface water protection and management to be implemented and enforced by the Florida DEP and Water Management Districts.

5.2.5 Rule 62-302.530, Florida Administrative Code

The surface water quality numeric criteria are identified in the table within ***Rule 62-302.530, F.A.C.*** When a proposed project is located within the basin of an impaired water body, coordinate with the District NPDES/ MS4 Permits Coordinator. A mapping tool to help identify the presence of impaired water bodies is found at the following webpage:

<https://ca.dep.state.fl.us/mapdirect/?webmap=3047d3c29d0e4feeade418bf85c420c2>

5.2.6 National Pollutant Discharge Elimination System

The **National Pollutant Discharge Elimination System (NPDES) permit program** is administered by the U. S. Environmental Protection Agency and delegated to Florida DEP. This program requires permits for stormwater discharges into waters of the United States from industrial activities, and from large and medium municipal separate stormwater systems.

5.3 ENVIRONMENTAL LOOK AROUNDS (ELA)

After determining project stormwater management requirements and before planning stormwater management design decisions, convene a meeting with regional stakeholders to explore watershed wide stormwater needs and alternative permitting approaches. Evaluate the following opportunities for application on the project:

The Office of Environmental Management (OEM) published the **WATERSS Process Guidebook** September 2021. Review project scope and specifics, coordinate with OEM and consult the PD&E Manual to determine the stormwater management approach for each individual project.

1. WMDs/DEP issues: wetland rehydration, water supply needs, minimum flows and levels, flooding, Total Maximum Daily Load (TMDL) needs, acquisition of fill from DEP/WMDs lands, etc.
2. City/County issues: stormwater re-use, flooding, discharge to golf courses or parks, NPDES needs, water supply needs
3. FDOT project permitting: regional treatment, stormwater re-use, joint use facilities

Appropriate personnel are as follows:

WMDs/DEP (Regional): ERP, water quality, water supply, wetland, and Minimum Flows & Levels personnel, BMAP coordinator(s)

FDOT: DDrE, PD&E Planning, or Design PMs, permit coordinator, NPDES representative

City/County: (as decided by the city/county) City Engineer, Public Works Director, Stormwater Engineer

Document areas of potential cooperation in the project reports for future follow up as the design moves forward.

Hold these ELA meetings before identification of right-of-way acquisition in the PD&E phase. If no right-of-way acquisition or PD&E phase is scheduled, then target as early as

feasible within the design phase.

5.4 DESIGN STANDARDS

5.4.1 Design of Systems

5.4.1.1 General

Design stormwater management facilities to provide the necessary quantity, rate, and quality control based on the presumption that the upstream discharge meets stormwater quantity, rate, and quality criteria prior to reaching the FDOT right-of-way.

For facilities designed to be dry, or using underdrains or exfiltration systems, provide geotechnical analysis certified by the project Geotechnical Engineer.

Accommodate all offsite runoff in accordance with the Department's criteria and all regulatory agency criteria. Maintain all historical flow patterns for offsite flows. If economically prudent, the Department's wet detention facilities may accept (co-mingle) offsite discharges into them without increasing the required water quality treatment design; in such cases, avoid hydraulic impacts on upstream property owners. For co-mingling offsite discharges into the Department's dry retention facilities, consult with the District Drainage Engineer for direction on whether to co-mingle or bypass offsite inflows.

Modification for Non-Conventional Projects:
Delete the previous paragraph and see the RFP for requirements.

Stormwater pond control structures consist of ditch bottom inlets in conjunction with outfall pipes. Do not use trapezoidal weirs, shaped into the pond berm, as primary control structures except where inlets and pipes are not feasible.

Start initial pond routing at the control elevation unless otherwise required by the Water Management District permit.

No pump or any other mechanical means may control any component of a permanent stormwater system.

With facilities designed to be wet, provide a minimum permanent pool depth of six feet to minimize aquatic growth.

Adjust the tailwater elevation for coastal pond outfalls to account for sea level rise using the methodology in **Section 3.4.1**.

While the Department does not encourage the use of pond liners, unique project conditions may necessitate their use. Consult the District Drainage Office prior to beginning design. The **DDG Section 9.3.4.2** provides additional pond liner design considerations.

For treatment swales, base clearance to the base clearance water elevation (BCWE) should be considered when establishing roadway grades. The BCWE for roadside treatment swales should be set at the weir elevation. A lower elevation may be used if all of the following apply:

- In-situ soils are classified as Hydrologic Soil Group A,
- Geotechnical investigation reveals there is no confining layer to impede drawdown, and
- Construction activities are limited within the treatment swale to avoid compaction and tracking of silt and muck.

For ponds, set the BCWE at the 24-hour design high water elevation. In the absence of ponds and treatment swales, set the BCWE at the Seasonal High Water Table elevation.

5.4.1.2 Watersheds with Positive Outlets

Projects discharging to offsite areas subject to reported historical flooding, up to the 100-year, 24-hour storm event, must assess the discharge requirements of **Chapter 14-86, F.A.C.** Additionally, any Department projects discharging into drainage systems with heightened public safety risks, such as roadway drainage systems, must comply with **Chapter 14-86, F.A.C.**

5.4.1.3 Watersheds without Positive Outlets

For projects that are located within a watershed that contributes to a depressed low area, or a lake that does not have a positive outlet such as a river or stream to provide relief (i.e., closed basin or isolated depression), a detention/retention system is required.

Design the detention/retention systems to meet the discharge requirements of **Chapter 14-86, F.A.C.** The retention volume must recover at a rate such that one-half of the volume is available in seven days, with the total volume available in 30 days. A sufficient amount must be recovered within the time necessary to satisfy applicable water quality treatment requirements.

5.4.1.4 Exceptions

5.4.1.4.1 Tidal Areas

Water quantity and rate control criteria are not applicable for projects that discharge directly into tidal areas. This is subject to permission of the appropriate permitting authority.

5.4.1.4.2 Downstream Improvement

Water quantity and rate control criteria are not applicable where it can be demonstrated that downstream conveyance and storage systems have adequate capacity or will be improved to have adequate capacity increased quantity and rate of runoff created by the project.

5.4.1.4.3 Compensatory Treatment

For projects where proper treatment (volume, rate, quality) cannot be feasibly obtained, treatment of existing untreated areas that discharge to the same receiving water body may be substituted in lieu of treating the project.

5.4.1.4.4 Permission from the Downstream Property Owner

Water quantity and rate control criteria can be waived when the downstream property owner(s) agrees to accept the increased quantity and rate of runoff created by the project.

5.4.1.5 Aviation

When designing stormwater facilities within five miles of airports, coordinate with the District Aviation Administrator to determine if stormwater facilities are within Federal Aviation Administration (FAA) oversight. If ponds are within FAA oversight and cannot be prudently moved, these facilities must be designed using FAA guidelines, found primarily in the FAA Advisory Circular titled ***Hazardous Wildlife Attractants on or near Airports***. These FAA design guidelines are intended to reduce plane/bird strikes by making stormwater facilities less attractive to birds.

5.4.2 Hydrologic Methods

The hydrologic method used will consider one of the following:

1. Natural Resources Conservation Service (NRCS) Unit Hydrograph Method

2. Modified Rational Method for basins having a time of concentration of 15 minutes or less

5.4.3 Protective Treatment

Design stormwater management facilities with due consideration of the need for protective treatment to prevent hazards to persons. General guidance on protective treatment is provided in **Section 3.7**. Use flat slopes when practical. Only fence retention areas in accordance with **Section 5.4.4.2 (4)**.

5.4.4 Construction and Maintenance Considerations

5.4.4.1 General

Design stormwater management systems consistent with the standard construction and maintenance practices of the Department. Standard details for inlets, manholes, junction boxes, end treatments, and other miscellaneous drainage details are provided in the **Standard Plans**. Specifications are provided in the **Standard Specifications**. In the event the **Standard Plans** are not suitable for a specific project need, develop a detailed design and include it in the plans; and, as appropriate, provide special provisions for inclusion with the project specifications. Proper maintenance access for cleaning and repair will be addressed.

5.4.4.2 Detention and Retention Ponds

Design stormwater management facilities consistent with the Highway Beautification Policy and Context Sensitive Solutions Policy. Integrate facilities with existing and proposed landscaping and adjoining land uses. Depending on the availability of time, space, and funding, consider attractive pond shapes, tree plantings, selective clearing, and other strategies to preserve or improve aesthetics. Rely on an interdisciplinary team consisting of the Landscape Architect, Drainage Engineer, and local maintenance office. Collaborate with the Landscape Architect to address an aesthetic design approach early enough within the project production schedule to include it in the determination of pond right-of-way acquisition needs.

Standard design features for detention and retention ponds are shown in **Figure 5.1** and are as follows:

1. Maintenance Berm:

Design ponds to provide a minimum 20 feet of horizontal clearance between the top edge of the control elevation and the right-of-way line. Provide at least 15 feet adjacent to the pond at a slope of 1:8 or flatter. Create the inside edge of the maintenance berm to have a minimum radius of 30 feet toward the pond and be a minimum of one foot above the maximum design stage elevation. Sod the berm

area. Discuss maintenance needs with the Department before acquiring additional right-of-way to construct maintenance access around the full perimeter.

2. Slopes:

For facilities designed to be wet, sod pond slopes to the control elevation of the pond. For facilities designed to be dry, sod pond slopes to the bottom of the slope.

3. Freeboard:

As a safety factor for hydrologic inaccuracies, grading irregularities, control structure clogging, and downstream stage uncertainties, at least one foot of freeboard is required above the maximum design stage of the pond. The freeboard is the vertical distance between the maximum design stage elevation of the pond and the inside edge of the berm, as illustrated in **Figure 5-1**.

For linear treatment swales, the minimum freeboard is 0.5 foot.

4. Fencing:

Install fences around ponds only when a documented maintenance need for restricted access has been demonstrated. The installation of fencing around stormwater ponds requires a Design Variation approved by the State Roadway Design Engineer. Where approved, make sure fences are context sensitive and do not detract from the appearance of the ponds or adjoining property.

When requesting the approval of a Design Variation to install fence around stormwater management facilities, the conditions below, when properly documented, typically are acceptable justifications for ponds designed to be permanently wet (permanent design water depth of two feet or greater):

- Above-water pond slopes steeper than 1:4 are unavoidable. Note: Stormwater permits typically require wet ponds to be fenced when the above-water slopes of the pond are steeper than 1:4. Ponds that enjoy the benefit of fence at the right-of-way line need no additional fencing around them.
- A hidden hazard occurs within five feet of the water's edge. Examples of a hidden hazard are a sharp drop off, such as a 1:2 slope, sharp objects, or otherwise potentially injurious, hidden, underwater hazards.
- The site is likely to experience significant exposure to children or the elderly. Examples of such locations are ponds immediately adjacent to schools, daycares, assisted living facilities, nursing homes, public playgrounds, public basketball courts, etc.

In addition, when requesting the approval of a Design Variation to install fence around ponds of any water depth, the conditions below, when properly documented, are typically acceptable justifications:

- Livestock are expected to wander into the stormwater management facility
- Illicit dumping has historically occurred or is expected to occur

5. Access Easements:

When pond areas are not accessible directly from the road right-of-way, provide an access easement.

6. Seepage:

When diking or berming a stormwater pond above surrounding grade, evaluate seeping and piping and consult geotechnical expertise for the stability of the earthwork berm. Avoid planting woody species with developed root structures on embankment berms, as this can cause piping and geotechnical failures.

7. Traversable Pond Overflow:

Design and construct all berm-style weirs in pond or swale berms to be traversable. Berm-style weirs require a structural and geotechnical design to support the loading of maintenance vehicles without failure.

Modification for Non-Conventional Projects:

Do not use any proposed berm-style weirs, trapezoidal or otherwise, unless explicitly allowed in the RFP.

5.5 DOCUMENTATION

The documentation for stormwater management facilities must justify the facility and describe the design and operation. At a minimum, the documentation will include:

1. Pond siting evaluation (required only if additional right-of-way is obtained for the pond) consisting of:
 - a. Identification of alternate sites
 - b. For each alternate, include preliminary information about:
 - i. Right-of-way costs
 - ii. Water quality and quantity volumes
 - iii. Soil and groundwater conditions
 - iv. Potential hazardous waste contaminations
 - v. Potential impacts to endangered species

-
- vi. Potential impacts to cultural resources
 - vii. Potential impacts to utilities
 - viii. Potential impacts to existing landscapes and adjoining land uses
 - ix. Aesthetic effects
 - x. Construction costs including earthwork
2. Drainage Map
 3. Evidence of Field Review
 4. Description of applicable regulatory requirements
 5. Description of pre-developed runoff characteristics, such as basin boundaries, outfall locations, peak runoff rates, and methods of conveyance.
 6. Description of post-developed runoff characteristics, such as those listed in item 5, above
 7. Schematic of interconnected ponds (if applicable)
 8. Description of the operation of the facility; this will be used by design reviewers, but is intended for maintenance personnel who may have to certify that the facility is operating as designed
 9. Soils and groundwater information
 10. Stage versus storage values
 11. Electronic file of routing calculations
 12. Any special maintenance requirements
 13. Justification for any proposed fencing
 14. Documentation of ELA/WATERSS efforts and results
 15. Description of how pond aesthetics are addressed
 16. Additional information as requested by the District Drainage Engineer

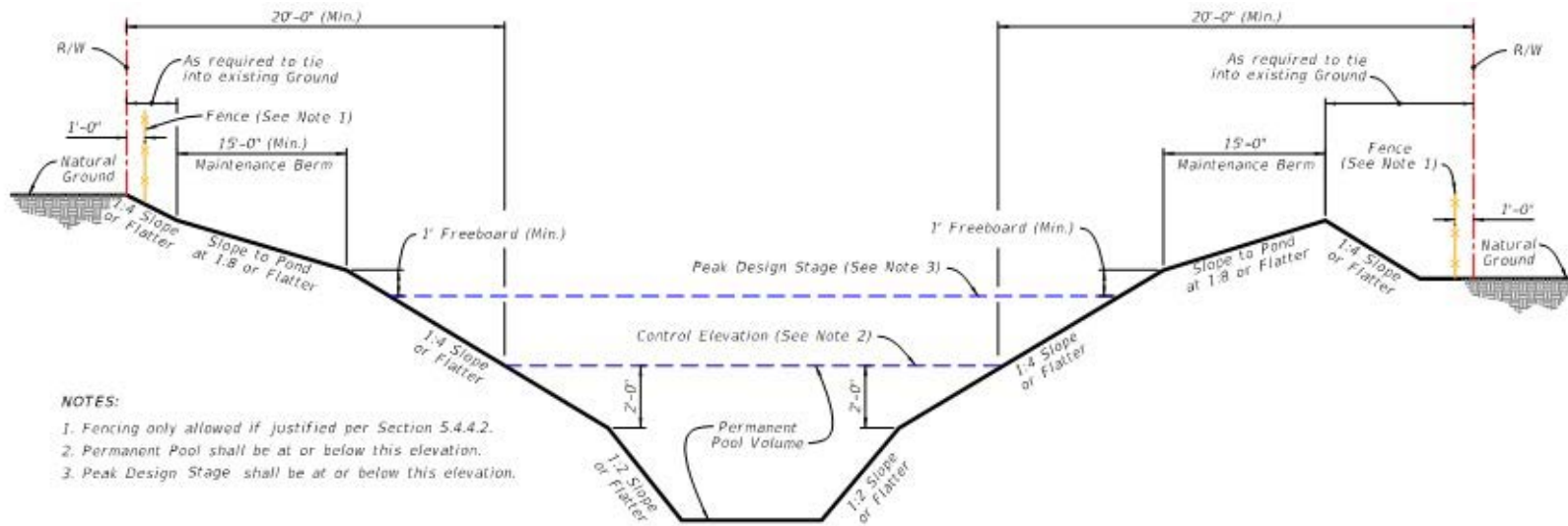

Figure 5-1: Minimum Clearance for Retention-Detention Pond

CHAPTER 6

OPTIONAL CULVERT MATERIALS

6.1	Introduction.....	6-1
6.2	Durability	6-1
	6.2.1 Culvert Service Life Estimation.....	6-1
6.3	Structural Evaluation	6-2
6.4	Hydraulic Evaluations.....	6-2
6.5	Pipes within Walled Embankment Sections	6-3
6.6	Culvert Material Types	6-3
6.7	Jack and Bore	6-5
6.8	Documentation	6-5

6.1 INTRODUCTION

Analyze optional culvert materials for all culvert applications including, but not limited to, storm drains, cross drains, side drains, gutter drains, vertical drains, and French drains. Evaluate all culvert materials shown in **Table 6-1** for the application being designed. Evaluate the functionally equivalent performance in three areas: durability, structural capacity, and hydraulic capacity.

6.2 DURABILITY

Design culverts for a design service life (DSL) appropriate for the culvert function and highway type. Department requirements for DSL are provided in **Table 6-1**. The projected service life of pipe material options called for in the plans will satisfy, as a minimum, the DSL. Do not reduce pipe material standards when projected service life exceeds DSL.

In estimating the projected service life of a material, evaluate the actual performance of the material in nearby similar environmental conditions, its theoretical corrosion rate, the potential for abrasion, and other appropriate site factors. Base theoretical corrosion rates on the environmental conditions of both the soil and water. At a minimum, evaluate the following corrosion indicators:

1. pH
2. Resistivity
3. Sulfates
4. Chlorides

Base all tests for the above characteristics on FDOT-approved test procedures. For projects with a small amount of pipe, to avoid unnecessary site-specific testing, generalized soil maps may be used to delete unsuitable materials from consideration. When known, also evaluate the potential for future land use changes that may change soil and water corrosion indicators.

6.2.1 Culvert Service Life Estimation

Use the latest web-based version of the Culvert Service Life Estimator (CSLE) Program, tables, and figures (found in **Chapter 8** and **Appendix M** of the **Drainage Design Guide, DDG**), and criteria stated below to evaluate the estimated service life for the following culvert materials:

Galvanized Steel:	<i>DDG Figure M-1 and DDG Table M-1</i>
Aluminized Steel:	<i>DDG Figure M-2 and DDG Table M-2</i>
Aluminum:	<i>DDG Figure M-3 and DDG Table M-3</i>
Reinforced Concrete:	<i>DDG Figure M-4 and DDG Table M-4</i>
Non-reinforced Concrete:	100 Years (pH \geq 4.0)
HDPE Class-II:	100 Years
HDPE Class-I:	50 Years
Polypropylene (PP) Class-II:	100 Years
PP Class-I:	50 Years
Steel Reinforced Polyethylene (SRPE)-Ribbed	100 Years
SRPE-Corrugated	50 Years
F949 PVC	100 Years
Other Polyvinyl Chloride:	50 Years

Note: Estimated Service Life for metal pipe may be increased by 10 years if it is coated with a bituminous coating.

The Culvert Service Life Estimator Program is available here: [FDOT Culvert Service Life Estimator Application](#)

6.3 STRUCTURAL EVALUATION

Appendix C provides minimum and maximum cover requirements. The Appendix C cover requirements do not include loadings from structural walls. **Section 6.5** addresses the structural adequacy of pipes in proximity to structural walls. Evaluate the minimum thickness established to meet durability requirements to assure structural adequacy and increase it if necessary. Evaluate materials and sizes not listed in **Appendix C** using the guidelines found within the latest edition of the **AASHTO LRFD – BDS**, and industry recommendations and modified as necessary to be consistent with **Appendix C** and any applicable specifications and installation procedures.

6.4 HYDRAULIC EVALUATIONS

The hydraulic evaluation is intended to establish the hydraulic size in accordance with the design standards provided in the **Drainage Manual** for specific culvert application. For storm drains and cross drains, use the Manning's roughness coefficient associated with

concrete pipe, spiral rib pipe, polyethylene pipe, and polyvinyl chloride pipe.

For side drains, the hydraulic design considers a one-size design. If a material type is inappropriate, eliminate it as an option in the plans.

In addition, **Standard Specification 430-4.1** requires hydraulic evaluation to verify that the standard joint performance, is sufficient. For situations where the minimum joint performance as required by the **Standard Specifications** is not sufficient, provide special provisions to specify the proper joint in the plans. For example, a pump station with a small-diameter pressurized storm drain should use a high-pressure joint. (Note: Joints are tested and rated by the State Materials Office.)

6.5 PIPES WITHIN WALLED EMBANKMENT SECTIONS

Wall Zone pipes are defined as pipes, existing or proposed, that are: (1) within or adjacent to embankment retaining walls, (2) connected to inlets that are within embankment retaining walls, or (3) beneath a bridge substructure element, such as an end bent or pier. Increase the pipe diameter to accommodate future lining. Identify wall zone pipes on the optional materials sheet. Refer to Appendix D for wall types and criteria.

6.6 CULVERT MATERIAL TYPES

Consider the types of culvert materials for the various culvert applications from the list below.

Extend existing culverts (side drains, storm drains, and cross drains) with the existing pipe material. If the existing pipe material is no longer produced, use the most similar material available, i.e., extend fiber reinforced concrete pipe with concrete pipe (RCP or NRCP).

Application	Materials to be Considered
Cross Drain French Drain Side Drain Storm Drain	Aluminized Steel Aluminum Concrete (all approved types) Corrugated Polyethylene (60" maximum) Steel Reinforced Polyethylene (120" Maximum) Polyvinyl Chloride (42" maximum) Polypropylene (60" maximum) Galvanized Steel
Gutter Drain	Corrugated Aluminized Steel ($n > 0.020$) Corrugated Aluminum ($n > 0.020$) Corrugated Steel ($n > 0.020$)
Vertical Drain	Ductile Iron (In saline environments, consider fiberglass reinforced pipe with welded joints, F949 PVC, and steel pipe)
Wall Zone Pipes	Polyvinyl Chloride (42" maximum) Polypropylene (60" maximum) Steel

Present the acceptable pipe materials for side drains, storm drains, and cross drains in the plans. The **FDM** illustrates a method of presenting the acceptable pipe materials in the plan.

6.7 JACK AND BORE

When installing drainage structures using jack and bore, use the casing as the carrier pipe except under railroads or in high-pressure designs. You can find information on calculating pipe thickness for corrosion resistance in the **CSLE** (latest web-based version) and in the ***Drainage Design Guide***.

6.8 DOCUMENTATION

The documentation for optional pipe materials will justify eliminating material types. Include, at a minimum, the following:

1. DSL required
2. Soil and water corrosion indicators used in estimating service life
3. Estimates of service life at cross drains and at various locations of storm drain systems
4. Structural evaluation
 - a. comparison of maximum and minimum cover heights to actual cover height.
 - b. LRFD calculations for wall zone pipes, if applicable.

Modification for Non-Conventional Projects:
The above documentation in Section 6.8 will be required only for the pipe materials selected for use. Document the selected materials on one of the following: Summary of Drainage Structures Sheets, Optional Materials Sheet, or the plan sheets during design.

Table 6-1: Culvert Material Applications and Design Service Life

Application	Storm Drain		Cross Drain		Side Drain ⁴	Gutter Drain	Vertical Drain ¹⁰	Wall Zone Pipe ¹¹	French Drain			
Highway Facility (see notes)	Minor	Major	Minor	Major	All	All	All	All	Replacement will		Other	
									Impact the Roadway ⁵			
Design Service Life →	50	100	50	100	25	25 ⁶	100	100	50	100	50	
Culvert Material	An * indicates suitable for further evaluation											
P I P E	Corrugated Aluminum Pipe	*	*	*	*	*	*			*	*	*
	Corrugated Steel Pipe	*	*	*	*	*	*			*	*	*
	Corrugated Aluminized Steel	*	*	*	*	*	*			*	*	*
	Spiral Rib Aluminum Pipe	*	*	*	*	*				*	*	*
	Spiral Rib Steel Pipe	*	*	*	*	*				*	*	*
	Spiral Rib Aluminized Steel	*	*	*	*	*				*	*	*
	Steel Reinforced Concrete Pipe	*	*	*	*	*				*	*	*
	Non-reinforced Concrete Pipe	*	*	*	*	*				*	*	*
	Polyethylene Pipe – Class I	*		*		*				*		*
	Polyethylene Pipe – Class II ⁸	*	*	*	*	*				*		*
	Polypropylene Pipe -Class I	*		*		*				*		*
	Polypropylene Pipe -Class II	*	*	*	*	*			*	*	*	*
	Steel Reinforced Polyethylene Pipe -Ribbed	*	*	*	*	*						
	Steel Reinforced Polyethylene Pipe -Corrugated	*		*		*						
	Polyvinyl-Chloride Pipe ⁷	*	F949	*	F949	*		F949	*	*	F949	*
	Fiberglass Pipe							*				
	Steel pipe (per Spec 556-2.1)							*	*			
	Ductile Iron Pipe (per Spec 556-2)							*				
S T R P L	Structural Plate Aluminum Pipe	*	*	*	*	*						
	Structural Plate Alum. Pipe-Arc	*	*	*	*	*						
	Structural Plate Steel Pipe	*	*	*	*	*						
	Structural Plate Steel Pipe-Arch	*	*	*	*	*						
B O X	Aluminum Box Culvert	*	*	*	*	*						
	Concrete Box Culvert CBC	*	*	*	*	*		*				
	Steel Box Culvert	*	*	*	*	*						

Table notes are on the following page.

Notes for Table 6-1

1. A minor facility is permanent construction such as minor collectors, local streets and highways, and driveways, provided culvert cover is less than 10 feet. Additionally, this category may be called for at the discretion of the District Drainage Engineer where pipe replacement is expected within 50 years or where future replacement of the pipe is not expected to impact traffic or require extraordinary measures such as sheet piling.
2. A major facility is any permanent construction of urban and suburban typical sections and limited-access facilities. Urban facilities include any typical section with a fixed roadside traffic barrier such as curb or barrier wall. Additionally, rural typical sections with greater than 1,600 AADT also are included in this category.
3. Temporary construction normally requires a much shorter design service life than permanent does. However, treat temporary measures that will be incorporated as permanent facilities as though they are permanent construction with regard to design service life determination.
4. Although culverts under intersecting streets (crossroads) function as side drains for the project under consideration, design these culverts using applicable cross drain service life criteria, not the shorter side drain service life criteria. Use **Standard Plans, Index 430-022** for end treatment.
5. Replacing this pipe would require removal and replacement of the project's pavement or curb.
6. Use a 100-year DSL for gutter drains under retaining or through walls.
7. F949 PVC pipe service life is 100 years. Other PVC pipe has a 50-year service life. Do not use PVC pipe in direct sunlight unless it meets the requirements of **Standard Specification 948-1.1**.
8. Class II HDPE pipe may not be used in the Florida Keys.
9. For any pipes under or adjacent to permanent structures such as retaining walls, MSE walls, buildings, etc., use a 100-year DSL.
10. Resilient connectors are required for all vertical pipes and wall zone pipes.
11. Due to the expected high cost of steel pipe, only list steel pipe as an option if no other pipe material is allowed. For wall zone pipe, concrete box culvert is only an option if cast in place with no joints.

APPENDIX A

DRAINAGE LAW

A.1 OVERVIEW

Current drainage law has evolved from case law in the courts, administrative hearing rulings, and the requirements that have been placed on the Department by other regulatory agencies. The discussion presented in this appendix about the Department's legal rights and responsibilities to the public as they relate to highway drainage is not intended as a substitute for legal counsel, but rather to familiarize engineers with basic drainage law, terminology, rules, and applications as they relate to state road design and maintenance.

A.2 TERMINOLOGY

Applicable Standards or Applicable Water Quality Standards or Minimum Design and Performance Standards: Those discharge standards of the appropriate regulatory entity that apply to the facility under consideration.

Approved Stormwater Management Plan or Master Drainage Plan: A regional plan adopted or approved by a city, county, Water Management District, or other agency with specific drainage or stormwater management authority; provided that (a) such plan is actively being implemented; (b) any required construction is substantially complete; (c) downstream mitigative measures have been provided for in the plan; and (d) the use of any Department facilities either existing or planned, which are part of such plan, have been agreed to by the Department.

Artesian Waters: Percolating waters confined below impermeable formations with sufficient pressure to spring or well up to the surface.

Backwater: An unnaturally high stage in a stream caused by obstruction or confinement of flow, as by a dam, a bridge, or a levee. Its measure is the excess of unnatural over natural stage, not the difference in stage upstream and downstream from its cause.

Concentration: The unnatural collection or convergence of waters, discharging in a narrower width and at a greater depth or velocity.

Critical Duration: The length of time of a specific storm frequency that creates the largest volume or highest rate of net stormwater runoff (post-improvement runoff less pre-improvement runoff) for typical durations up through and including the 10-day duration for closed basins and up through the three-day duration for basins with positive outlets. The critical duration for a given storm frequency is determined by calculating the peak rate

and volume of stormwater runoff for various storm durations and then comparing the pre-improvement and post-improvement conditions for each of the storm durations. The duration resulting in the highest peak rate or largest net total stormwater volume is the “critical duration” storm (volume is not applicable for basins with positive outlets).

Discharge of Dredged Material - Any addition of dredged material into, including redeposit of dredged material other than incidental fallback within, the waters of the United States. See **33 CFR § 323.2(d)**.

Discharge of Fill Material - The addition of fill material into waters of the United States. See **33 CFR § 323.2(f)**

Dredging - Excavation, by any means, in surface waters or wetlands. It also means the excavation, or creation, of a water body which is, or is to be, connected to surface waters or wetlands, as delineated in **Section 373.421(1), F.S.**, directly or via an excavated water body or series of water bodies. See **Section 373.403(13), F.S.**

Diversion: (1) The taking of water from a stream for a beneficial purpose (irrigation, water supply, power, etc.) even though a portion may return to the same stream. (2) The deflection of surface waters or stream waters so that they discharge into a watercourse to which they are not naturally tributary. Deflection of flood water is not diversion.

Drainage Connection: Any structure, pipe, culvert, device, paved or unpaved area, swale, ditch, canal, or any other appurtenance or feature, whether naturally occurring or created, that is used or functions as a link to convey stormwater.

Easement: The right to use the land of others. It may derive from the common law or be acquired, usually by purchase or condemnation, but occasionally by prescription or inverse condemnation. The right is not exclusive, but subject to rights of others in the same land, the lesser right being servient to a prior dominant right. Easements for drainage may give rights to impound, divert, discharge, concentrate, extend pipelines, deposit silt, erode, scour, or to perform any other necessary activity of a highway development.

Use of land of others without right usually leads to right in the future. If use is adverse and notorious for a statutory period, an easement is acquired by prescription with compensation, but, at any earlier time, the owner of the other land may sue for compensation by inverse condemnation.

Erosion and Accretion: Loss and gain of land, respectively, by the gradual action of a stream in shifting its channel by cutting one bank while it builds on the opposite bank. Property is lost by erosion and gained by accretion, but not by avulsion, when the shift

from one channel to another is sudden. Property is gained by reliction when the water in an ocean, lake, river, or stream recedes.

Engineer: A Professional Engineer registered in Florida pursuant to the provisions of **Chapter 471, Florida Statutes**, who as appropriate is competent in the fields of hydraulics, hydrology, stormwater management, or stormwater pollution control.

Erosion and Scour: The cutting or wearing away by the force of water of the banks and bed of a channel in horizontal and vertical directions, respectively.

Facility: Anything built, installed, or maintained by the Department within the Department's right-of-way.

Fill - Material placed in waters of the United States where the material has the effect of: (i) Replacing any portion of a water of the United States with dry land; or (ii) Changing the bottom elevation of any portion of a water of the United States. Examples of such fill material include, but are not limited to rock, sand, soil, clay, plastics, construction debris, wood chips, overburden from mining or other excavation activities, and materials used to create any structure or infrastructure in the waters of the United States. The term fill material does not include trash or garbage. See **33 CFR § 323.2(e)**.

Filling - The deposition, by any means, of materials in wetlands or other surface waters, as delineated in **Section 373.421(1), F.S.** See **Section 373.403(14), F.S.**

Flood Waters: Former stream waters that have escaped from a watercourse (and its overflow channel) and flow or stand over adjoining lands. Flood waters remain as such until they disappear by infiltration, evaporation, or return to a natural watercourse; they do not become surface waters by mingling with such waters or stream waters by eroding a temporary channel.

Groundwater: Water situated below the surface of the land, irrespective of its source and transient status. Subterranean streams are flows of groundwater parallel to and adjoining stream waters, and usually are determined to be integral parts of the visible streams.

Impervious Areas: Surfaces that do not allow, or minimally allow, the penetration of water. Examples of impervious areas are building roofs; all concrete and asphalt pavements; compacted traffic-bearing areas, such as lime rock roadways; lakes, wet ponds, pond liners, and other standing water areas, including some retention/detention areas.

Improvement: Any manmade change to property from previously existing conditions.

Incidental Fallback - The redeposit of small volumes of dredged material that is incidental to excavation activity in waters of the United States when such material falls back to substantially the same place as the initial removal. Examples of incidental fallback include soil that is disturbed when dirt is shoveled and the back-spill that comes off a bucket when

such small volume of soil or dirt falls into substantially the same place from which it was initially removed. See **33 CFR § 323.2(d)(2)(ii)**.

Marshes: Lands saturated by waters flowing over the surface in excess of infiltration capacity, such as sloughs or rivers and tidal channels.

Navigable Waters: Those stream waters lawfully declared or actually used as such.

Navigable Waters of the United States - Those waters of the United States that are subject to the ebb and flow of the tide shoreward to the mean high-water line and/or those waters that are presently used or have been used in the past or may be susceptible to use for interstate or foreign commerce. These are waters that are navigable in the traditional sense. Permits are required in these waters pursuant to **Section 10 of the Rivers and Harbors Act of 1899**. See **33 CFR § 329.4**.

Non-tidal wetland: a wetland that is not subject to the ebb and flow of tidal waters. Nontidal wetlands contiguous to tidal waters are located landward of the high tide line (i.e., spring high tide line). See **86 Federal Register 2744**.

Ordinary High-Water Line (state definition) - For the regulatory purposes of **Chapter 62-330, F.A.C.**, means that point on the slope or bank where the surface water from the water body ceases to exert a dominant influence on the character of the surrounding vegetation and soils. The ordinary high-water line frequently encompasses areas dominated by non-listed vegetation and non-hydric (i.e., upland) soils. See the **Environmental Resource Permit (ERP) Applicant's Handbook, Volume I**.

Ordinary High-Water Mark (with respect to non-tidal waters) - The line on the shore established by the fluctuations of water and indicated by physical characteristics such as a clear, natural line impressed upon the bank, shelving, changes in the character of soil, destruction of terrestrial vegetation, the presence of litter and debris, or other appropriate means that consider the characteristics of the surrounding areas. See **33 CFR § 328.3(e)**.

Owner: Any owner of land, usually specified in relation to another owner. Of two owners affected by the flow of water, the one upland is the upper owner and the other the lower owner. The highway has an owner with the same rights in common law as private owners.

Peak Discharge: The maximum flow of water passing the point of interest during or after a rainfall event.

Perched Waters: Percolating waters detained or retained above an impermeable formation, standing above, and detached from the main body of groundwater.

Percolating Waters: Those waters that have infiltrated the surface of the land and moved

slowly downward and outward through devious channels (aquifers) unrelated to stream waters, until they either reach an underground lake or regain and spring from the land surface at a lower point.

Positive Outlet: A point of stormwater runoff into surface waters that, under normal conditions, would drain by gravity through surface waters ultimately to the Gulf of Mexico, or the Atlantic Ocean, or into sinks, closed lakes, or recharge wells provided the receiving waterbody has been identified by the appropriate Water Management District as functioning as if it recovered from runoff by means other than transpiration, evaporation, percolation, or infiltration.

Pre-Improvement: The condition of property before an improvement is made or, in regard to **Chapter 14-86, F.A.C.**, the condition of property: (a) before November 12, 1986; or (b) on or after November 12, 1986, with connections which have been permitted under **Chapter 14-86, F.A.C.** or permitted by another governmental entity based on stormwater management requirements equal to or more stringent than those in **Chapter 14-86, F.A.C.**

Retained Waters [with respect to the Florida Department of Environmental Protection's (FDEP's) assumption of the **Clean Water Act (CWA) 404 Permit Program**] - those waters over which the United States Army Corps of Engineers (USACE) retains jurisdiction that are presently used, or are susceptible to use in their natural condition or by reasonable improvement as a means to transport interstate or foreign commerce shoreward to their ordinary high water mark, including all waters which are subject to the ebb and flow of the tide shoreward to their mean high water mark, including wetlands adjacent thereto. The USACE will retain responsibility for permitting for the discharge of dredged or fill material in those waters identified in the Retained Waters List, as well as all waters subject to the ebb and flow of the tide shoreward to their mean high-water mark that are not specifically listed in the Retained Waters List, including wetlands adjacent thereto landward to the administrative boundary. The administrative boundary demarcating the adjacent wetlands over which jurisdiction is retained by the USACE is a 300-foot guideline established from the ordinary high-water mark or mean high tide line of the retained water. In the case of a project that involves discharges of dredged or fill material both waterward and landward of the 300-foot guideline, the USACE will retain jurisdiction to the landward boundary of the project for the purposes of that project only. See the **State 404 Program Applicant's Handbook**.

Sovereignty Submerged Lands - Those lands by which the State of Florida acquired title on March 3, 1845, by virtue of statehood. Sovereignty submerged lands include all submerged lands, title to which is held by the Board of Trustees (Governor and Cabinet) of the Internal Improvement Trust Fund (TIITF). Sovereignty submerged lands include, but are not limited to, tidal lands, islands, sandbars, shallow banks, and lands waterward of the ordinary or mean high water line, beneath navigable fresh water or beneath tidally-influenced waters.

State Assumed Waters - "or "Assumed Waters" means those waters of the United States

that that are not “retained waters” as defined above that the state assumed permitting authority over pursuant **to Section 404 of the CWA, Pub. L. No. 92-500**, as amended, **33 U.S.C. § 1251 et seq.**, and rules promulgated thereunder, for the purposes of permitting the discharge of dredge or fill material. See the **State 404 Program Applicant’s Handbook**.

Stormwater: The flow of water that results from and occurs immediately following a rainfall event.

Stormwater Management System - A surface water management system that is designed and constructed or implemented to control discharges which are necessitated by rainfall events, incorporating methods to collect, convey, store, absorb, inhibit, treat, use, or reuse water to prevent or reduce flooding, over drainage, environmental degradation, and water pollution or otherwise affect the quantity and quality of discharges from the system [**Sections 373.403(10) and 403.031(16), F.S.**].

Stream Waters: Former surface waters that have entered and now flow in a well-defined natural watercourse together with other waters reaching the stream by direct precipitation or from springs in the bed or banks of a watercourse. They continue as stream waters as long as they flow in the watercourse, including in overflow and multiple channels as well as the ordinary or low water channel.

Surface Water (state definition) - Means water upon the surface of the earth, whether contained in naturally or artificially created boundaries or diffused. Water from natural springs shall be classified as surface water when it exits from the spring onto the earth’s surface [**Section 373.019(21), F.S.**]. **Rule 62-340.600, F.A.C.**, further defines surface waters as waters on the surface of the earth, contained in bounds created naturally or artificially, including, the Atlantic Ocean, the Gulf of Mexico, bays, bayous, sounds, estuaries, lagoons, lakes, ponds, impoundments, rivers, streams, springs, creeks, branches, sloughs, tributaries, and other watercourses.

Swamps: Lands saturated by groundwater standing at or near the surface.

Tidal wetland: A tidal wetland is a jurisdictional wetland that is inundated by tidal waters. Tidal waters rise and fall in a predictable and measurable rhythm or cycle due to the gravitational pulls of the moon and sun. Tidal waters end where the rise and fall of the water surface can no longer be practically measured in a predictable rhythm due to masking by other waters, wind, or other effects. Tidal wetlands are located channelward of the high tide line. See **86 FR 2744**.

Volume: The total amount of water coming to a point of interest. It may be from surface water, watercourses, groundwater, or direct precipitation.

Watercourse: A definite channel with bed and banks within which water flows, either continuously or in season. A watercourse is continuous in the direction of flow and may

extend laterally beyond the definite banks to include overflow channels contiguous to the ordinary channel. The term does not include artificial channels such as canals and drains, except as natural channels are lawfully trained or restrained by the works of man. It also does not include depressions or swales through which surface or errant waters pass.

Waters of the United States - Waters of the United States is defined in **33 CFR Part 328** and **40 CFR § 122.2** and is the jurisdictional boundary of a water that is regulated by the USACE or the United States Environmental Protection Agency (EPA) under the **CWA**.

Watershed: The region draining or contributing water to a common outlet, such as a stream, lake, or other receiving area.

Wetlands (federal definition) - Those areas that are inundated or saturated by surface or ground water at a frequency and duration sufficient to support, and that under normal circumstances do support, a prevalence of vegetation typically adapted for life in saturated soil conditions. Wetlands generally include swamps, marshes, bogs, and similar areas. (**40 CFR § 232.2**)

Wetlands (state definition) - Those areas that are inundated or saturated by surface water or ground water at a frequency and duration sufficient to support, and under normal circumstances do support, a prevalence of vegetation typically adapted for life in saturated soils. See **Section 373.019(27), F.S.**

A.3 SURFACE WATER LAW

A.3.1 Upland Owner

Generally, an upland owner has an easement over the land of the lower landowner for surface waters that flow over the lower land. In exchange for this privilege, the upland owner has the duty not to divert surface waters, change the velocity of flow, add to the pollution, or increase the amount of waters from other directions to the extent that damage occurs on the lower-lying property of the other landowner. Ideally, the surface-water flow should imitate the conditions in existence when the lands were in a natural state. Realistically, changes made in the development of real property are reviewed by the courts on a case-by-case basis to determine whether the changes that occur are substantial and whether the development has been reasonable. A major factor, if the courts find that a nuisance has been created by the upland owner on the lower land, is whether the lower landowner came to the nuisance.

A.3.2 Lower Landowner

Generally, the lower landowner has the duty to the upland owner not to prevent or obstruct the flow of surface waters onto his land from that of the upland owner. The lower landowner cannot exclude these surface waters, nor can he cause the water to flow back to his upland neighbor. One exception to this rule is when such a backflow is a natural condition that could be anticipated from the natural configurations of the land. An example of this exception would be a land-locked storage basin that overflows in an intense storm of long duration. Even if it is foreseeable, the overflow onto the neighboring land when caused by natural conditions is not a trespass by the lower landowner. However, if the lower landowner diverted additional waters into the land-locked basin and took the chance that such a natural event could occur, the lower landowner may be responsible for the surface-water overflow onto the neighboring property.

You will find another exception to the responsibilities owed to the lower landowner in the low-lying areas in South Florida where indiscriminate rim ditching was allowed. If the lower landowner came to this condition, he cannot assert a trespass or nuisance claim.

If the Department is involved in any way, on any side of the mentioned situations, contact with the legal department is required.

If a lower landowner accepts surface water from the upland owner over and above the natural surface water, and the upland owner developed property in reliance on that acceptance, the lower landowner may be prevented from refusing to accept that water volume in the future. An example of this would be an owner of a cow pasture who accepts Department highway drainage into a pond on his land for use as a drinking area for his herd of cows. If he or a subsequent owner later decided to build a shopping center by the state roadway, he would continue to be responsible for the storage of the water placed on his property by the Department.

A.3.3 Status Quo and Reasonably Foreseeable Development

Two important items in highway drainage design for the Department to review from a legal perspective are the current natural state of the adjoining property to the highway and the reasonably foreseeable development that will occur in the area. Address the first concern by creating current and/or reviewing historical drainage maps of the area. Evaluate the second concern by reviewing local comprehensive zoning and stormwater management plans for the area in question. When feasible, integrate the highway system design with the local plans.

A.3.4 Summaries of Current Florida Case Law

The following summaries of the leading Florida cases on surface-water management should assist the drainage engineer in his review of problematic drainage areas:

In Westland Skating Center, Inc. v. Gus Machado Buick, Inc., 542 So.2d 959 (1989), an adjacent property owner constructed and operated a skating rink adjacent to an auto dealership property. The parties agreed that the natural drainage flow was generally and gradually toward the southwest from the skating rink property onto and toward the rear of the auto dealership property. When the auto dealership was built in 1970, a miniature-golf course occupied the skating rink property and neither owner had problems with rainwater.

After the construction of the skating rink building, and during heavy rainfalls, the auto dealership property experienced extensive flooding which damaged several cars. Discussions to alleviate the flooding were unavailing, so the auto dealership constructed an 8-foot high by 2-foot deep 900-foot-long wall on its property.

During the next heavy downpour, the water backed up on the skating rink property and inflicted heavy damage to the rink's floor. This continued and Westland sued the auto dealership for damages and a mandatory injunction to remove the wall.

Before trial, Westland obtained a partial summary judgment to the effect that as long as the skating rink was constructed in accordance with the South Florida Building Code, the auto dealership's lower elevation lot remained the servient tenement for all surface water flowing from the skating center. The case preceded to trial where the jury was instructed with the language of the partial summary judgment above and found in favor of the skating rink.

That decision was appealed to the Third District Court of Appeals which reversed the judgment holding that the trial judge had applied an incorrect rule of law in granting the partial summary judgment and that the jury instruction based on the summary judgment also was error and reversed and remanded the case back for another trial. The Florida Supreme Court accepted review based on direct conflict of decisions. The Court analyzed the two doctrines that were normally used to resolve disputes involving the interference of surface waters which are the common enemy rule or the civil law rule.

However, the Court found that neither of these two doctrines was perfect, especially in view of more and more development in Florida. Therefore, the Court adopted a third rule, known as the reasonable use rule, that would now govern cases involving the interference with surface waters flowing from improved property. Stating that under the **reasonable use rule**:

“ . . . a possessor of land is not unqualifiedly entitled to deal with surface waters as he pleases nor is he absolutely prohibited from increasing or interfering with the natural flow of surface waters to the detriment of other. Each possessor is legally privileged to make reasonable use of his land even though the flow of surface waters is altered thereby and causes some harm to others. He incurs liability only when his harmful interference with the flow of surface waters is unreasonable.

Westland, 542 So.2d 959, 961 (1989)

The Court affirmed the Third District Court of Appeals decision and reversed the judgment and remanded the case back for a new trial.

In Leon County v. Smith, 397 So.2d 362 (Fla. 1st DCA 1980), a developer of a subdivision designed a drainage system that would collect surface water and transport it east to west to a central ditch and then southerly through a ditch to the plaintiff/landowner's property. The outfall point for this water was along the northern boundary line of the landowner's property and no provisions were made for transporting the water across his land.

Later, the County accepted ownership of and responsibility for the drainage system. As homes were built in the subdivision, increasing amounts of stormwater entered the drainage system and discharged onto the plaintiff's property. The County then enclosed portions of the drainage system with pipes, and other drainage systems were connected to it. The velocity of the water flow was so increased by these actions that the drainage carved gullies four- to six-feet deep into the plaintiff's land. In addition, water continued flowing from the subdivision for days after the rain stopped and the area in and around the ditches remained a muddy ooze. Eventually, the flooding rendered the plaintiff's land useless.

The court held that, as a result of the County's action, the County had taken the plaintiff's property and was required to pay him just compensation for that property.

In Hanes v. Silgain, 448 So.2d 1130 (Fla. 1st DCA 1984), the plaintiff Hanes alleged that the manner in which Silgain Motel Corporation and Gulf Oil Corporation developed their property unreasonably diverted the natural flow of surface water to the detriment of the Hanes' property. Hanes further alleged that Silgain was negligent in designing and constructing an inadequate retention basin. Silgain then brought a third-party action against the Department of Transportation alleging, among other things, that the Department negligently maintained a storm drainage system in such a manner as to

wrongfully divert and disperse large volumes of surface waters onto Silgain's land in a concentrated stream.

The Department in turn brought a third-party action seeking contribution against various landowners and users, asserting that the defendants developed their property in a manner that diverted and cast unreasonable quantities of surface water into the Department storm drainage system. The Department also alleged that such diversion overtaxed its drainage system, thereby rendering the defendants proportionately responsible for such damage as may have resulted to Silgain and Hanes from any excess drainage system discharge.

The Department's complaint was dismissed with prejudice. The appellate court upheld this dismissal, ruling that the Department was solely responsible for the maintenance of its drainage system and that commercial developments draining into this system did not jointly share in this responsibility.

In Department of Transportation v. Burnette, 384 So.2d 916 (Fla. 1st DCA 1980), the Department was enjoined from collecting water in pipes and ditches, and from diverting the water from its natural course and sending it onto Burnette's property.

The court found that the natural drainage path for land immediately surrounding U.S. 90 within a half mile west of Madison was northward under the highway and across property later occupied by North Florida Junior College. A culvert system was installed on the highway. Subsequently, those northward drainage courses were plugged, apparently to protect North Florida Junior College. This action caused ponding immediately south of the highway.

Then, in 1969, the Department allegedly changed the drainage by constructing and buying a ditch on an easement from the highway 500 feet south toward the northern boundary of the subject property. During the same project, the Department added more drainage to this system through a culvert along the south side of State Road 10, adding the runoff from 103 acres of improved land in municipal Madison. Burnette's engineer testified that an estimated 14 million gallons (43 acre-ft) of water from the City of Madison would be included in the drainage system and that under such conditions, 50 low acres of Burnette's land would be flooded, and access would be limited on the remaining 50 acres.

The court concluded, however, that an action for inverse condemnation did not lie, because all beneficial uses to the property were not deprived and because the property had always been subject to intermittent flooding.

Stoer v. Ocala Mfg. Ice and Packing Co., 24 So.2d 579 (Fla. 1946), created an exception to upland owner liability in Florida in situations where the upland owner drains water into a natural watercourse. In such cases, an upland owner can increase the volume and velocity of the water flow into a natural watercourse without incurring any liability as long

as the natural flow of water is not diverted, or the watercourse is not overtaxed to the injury of the lower landowners.

A.4 POLLUTION CONTROL

Pollution control is becoming increasingly important in drainage law. The engineer faces a potential legal problem with environmental consequences at practically every point on a highway. There are three primary areas of highway drainage in which the Department must be especially concerned with regulation and liability:

1. Dredge and fill
2. Stormwater runoff
3. Underground injection wells
4. Resiliency

The following is a general discussion of regulated activities that require permits from various agencies. It is not intended to be project specific. Obtain design permit assistance for a particular project from the Office of Environmental Management and the permit coordinator for the project.

Environmental permits are required from one or more regulatory agencies for most land alterations, including the addition of impervious surfaces; construction, alteration, or abandonment of stormwater management facilities; impacts to wetland or surface waters (including navigable waters); and actions that could adversely affect protected wildlife species and/or their habitat. Both the state and federal permitting programs have established various permit types based on specific impact thresholds and/or activity types.

Permit applications are reviewed by the regulatory agencies for their consistency with regulatory criteria and/or the effect of the project on the environmental resources (e.g., wetlands, water quality, protected species, and their habitats). Through the application process, the regulatory agencies may request other agencies, such as the Florida Fish and Wildlife Conservation Commission, Florida Division of Historical Resources (FDHR), Bureau of Archaeological Research (BAR), to review transportation projects to ensure that they are not adversely impacting the resources (i.e., wildlife, habitat, cultural) under their purview. Certain protected species impacts may also require a specific species permit.

A.4.1 ENVIRONMENTAL RESOURCE PERMITS

State Agencies

The Florida Department of Environmental Protection (FDEP) is the State's primary environmental regulatory agency. Its jurisdiction over water pollution control extends to "waters of the state" as defined in Section 403.031, **Florida Statutes**:

"Rivers, lakes, streams, springs, impoundments, and all waters or bodies of water including fresh, brackish, saline, tidal surface, or underground."

It is not necessary for the area included in the waters of the state to be perpetually submerged in water; the DEP includes in its jurisdiction landward areas which are only covered by water some of the time. Guidance for the legal determination of this boundary is provided in Rule 62-340.600, FAC.

State permits are required for proposed impacts to jurisdictional wetlands and other surface waters as well as for flood protection and water quality, and to ensure compliance with coastal zone management criteria. The FDEP and Florida Water Management Districts (WMDs) are the primary state wetland permitting agencies.

Stormwater Runoff

Stormwater impacts associated with transportation projects are addressed through permitting of stormwater management systems. FDOT transportation projects involving the construction, alteration, operation, maintenance, repair, abandonment and removal of stormwater management systems, dams, impoundments, reservoirs, appurtenant works, and works including structures, dredging, and filling located in, on or over wetlands or other surface waters as defined in **Chapter 62-340, F.A.C.**, are governed by the Environmental Resource Permit (ERP) Program under **Chapter 62-330, F.A.C.** Under the authority of **Section 373.4131, F.S.**, FDEP and Florida's five WMDs implement the ERP program under **Chapter 62-330, F.A.C.** and Part IV of Chapter 373, F.S. The ERP program was adopted to provide consistent permitting thresholds, requirements, and processes throughout the state.

ERP requirements govern stormwater management design and vary among WMDs. Stormwater pond design criteria for slopes, berms, and clearances, in the **Drainage Manual, Topic Number 625-040-002**, are set so as to satisfy similar WMD pond design criteria. Generally, ERP requirements regulate stormwater discharge leaving FDOT ROW. Typically, maximum post-development discharge is limited to no greater than pre-development discharge for the specified design storm events required by the WMD. However, in certain basins with historical flooding or limited stormwater conveyance infrastructure, WMDs require onsite development reductions from pre-development discharge. On FDOT transportation projects, ERPs are obtained prior to construction, typically when the drainage design is substantially complete (i.e., after Phase II design plans).

ERP permitting is performed under the guidance of **Chapter 62-330, F.A.C.** and the **ERP Applicant's Handbook, Volume I**. The **ERP Applicant's Handbook** is incorporated by reference as part of **subsection 62-330.010(4), F.A.C.**, and carries the same authority as the rule itself. **Chapter 62-330, F.A.C.**, and the **ERP Applicant's Handbook, Volume I** apply statewide.

The ***ERP Applicant's Handbook, Volume I*** provides general background information on the ERP program, including agency contact information, a summary of the statutes and rules used to authorize and implement the ERP program, and the forms used to notice or apply to the agencies for an ERP authorization. This volume of the ***ERP Applicant's Handbook*** also provides discussion on:

1. Activities regulated under ***Chapter 62-330, F.A.C.***, and ***Part IV of Chapter 373, F.S.***;
2. Types of permits, permit thresholds, and exemptions;
3. Procedures used to review exemptions and permits;
4. Conditions for issuance of an ERP, including the environmental criteria used for activities located in wetlands and other surface waters;
5. Erosion and sediment control practices to prevent water quality violations; and,
6. Operation and maintenance requirements.

FDEP has delegated much of the permitting responsibility for Environmental Resource Permits (ERPs) found in ***Chapter 62-330, F.A.C.*** to four of the five Water Management Districts (WMDs) and specified local governments. The Northwest Florida Water Management District (NFWWMD) does not have full ERP authority from FDEP. The permitting responsibility of each agency is detailed in the FDEP and WMD agency operating agreements.

The five WMDs are: NFWWMD, Suwannee River (SRWMD), St. Johns River (SJRWMD), South Florida (SFWMD), and Southwest Florida (SWFWMD). WMDs have been delegated permitting authority by FDEP for discharges, including stormwater discharges; dredge and fill activities in, on, or over waters of the State; construction activities which discharge to waters of the State; and, state-owned submerged lands which include all tidal lands and submerged lands under navigable waters owned by the State of Florida. The NFWWMD does not have full permitting authority from FDEP; the FDEP processes permit applications for projects with submerged lands and actions on military bases within the geographic area of the NFWWMD.

Implementation of the ERP program by the WMDs is governed not only by Chapter 62-330, F.A.C. but also by ***ERP Applicant's Handbook, Volume I*** and ***ERP Applicant's Handbook, Volume II***- for each of the WMDs which address regional differences. ***Volume II*** primarily applies to activities that require the services of a registered professional engineer to design a stormwater management system.

Each WMD incorporates a provision in the ***ERP Applicant's Handbook, Volume II*** referencing ***Section 373.413(6), F.S.***, which provides the WMDs with additional flexibility

in the permitting of stormwater management systems associated with the construction or alteration of state transportation projects and facilities, such as regional treatment facilities. This statutory language also provides that FDOT is only required to treat stormwater generated by its transportation projects, not water entering its treatment systems from offsite areas, unless it is cost-effective to do so.

Depending on the size, location and nature of proposed project, a project may be exempt from permitting, or may require either a General or Individual Permit. General Permits as provided under **Rule 62-330.401, F.A.C.**, are required for activities which can be conducted with minimal environmental impact, provided the applicant adheres to certain conditions which are described under **Rule 62-330.405, F.A.C.**, and requires notice to the permitting agency under **Rule 62-330.402, F.A.C.** These certain conditions for all General Permits do not apply to the general permit for stormwater management systems under **Section 403.814(2), F.S.**, nor is there a notice requirement. General permits are specifically listed in **Rules 62-330.407 – 62-330.635, F.A.C.** and of specific importance to FDOT is the General Permit under Rule 62-330.447 for minor activities within existing rights-of-way or easements.

An Individual Permit is required for projects which do not fall under permitting size and impact thresholds as described under **Rule 62-330.020, F.A.C.** and is not covered by a General Permit. See Rule 62-330.054, F.A.C.

A conceptual approval permit is also available under **Rule 62-330.056, F.A.C.**, but not required, for activities occurring in phases or over a large land area. A conceptual approval permit does not authorize construction, maintenance, removal, or alteration (a separate individual permit is required for those activities). However, the first phase of construction can be authorized at the same time the conceptual approval permit is issued. This type of permit is not typically applicable to FDOT projects, but may prove useful for complicated, controversial, and/or long-term projects where FDOT wants to establish its expectations in the way the ERP will be administered during future phases of a given project. It also has the potential to save time with agency reviews when applying for construction permits for individual phases especially if the elimination and reduction of impacts criteria has been addressed at the conceptual stage.

Exempt activities do not typically require notice be given to the FDEP or WMDs. If agency notice is required, it will be stipulated in the rule for the specific exemption. If verification that the activity is exempt, an on-line self-certification can be obtained, or the appropriate regulatory agency can perform the certification for a fee. An agency determination that an activity qualifies for an exemption is subject to **Chapter 120, F.S., notice of rights to potential third-party challengers.** Although some projects may be exempt from the need to obtain an ERP, the project may still require coordination with wildlife agencies. For example, a project may have a bridge or culvert inhabited by bat species. This may require coordination with the FWC or USFWS.

A list of exempt activities is contained in **Rule 62-330.051, F.A.C.** Two exemptions of interest to FDOT include:

1. **Subsection 62-330.051(4), F.A.C., Bridge, Driveways, and Roadways** - Exempts work in other Surface Waters (water conveyances that are not wetlands as defined by **Chapter 62-340, F.A.C.** (such as some roadside ditches) for road shoulder and turn lane improvements or paving of dirt roads owned by county or local governments. Subsection (c) Minor roadway safety construction, alteration, or maintenance and operation can be applicable for FDOT sidewalk and milling and resurfacing projects.
2. **Subsection 62-330.051(9), F.A.C., Pipes or Culverts** - Exempts up to 0.03 acres of work in wetlands as delineated under **Chapter 62-340, F.A.C.**, including Outstanding Florida Waters (OFW) for culvert outfall and headwall construction.

Consumptive Water Use Permits

Consumptive use of water is broadly defined as any use of water which reduces the supply from which it is withdrawn or diverted. The consumptive use of water is managed by the WMDs as prescribed in **Part II of Chapter 373, F.S.** Each WMD regulates the use of water within its jurisdictional boundaries to ensure that permitted water uses are reasonable-beneficial, will not interfere with any presently existing legal uses of water, and are consistent with the public interest, as required by **Section 373.223, F.S.** This authority applies to public water supplies, agricultural and landscape irrigation, contamination clean-up, commercial/industrial uses, and dewatering/mining activities. The WMDs issues general and individual consumptive water use permits. FDOT should coordinate with the appropriate WMD to determine whether a water use permit will be required for a project.

Right of Way Occupancy Permits

Right of Way (ROW) Occupancy permits may be required for projects impacting WMD property. A ROW Occupancy Permit is issued by a WMD or local water control district, if applicable, allowing for a compatible public or private use while protecting the WMD's ability to use the canal and levee rights of way of the USACE's Central and Southern Florida Flood Control Project, the related water conservation areas, and certain other canals and works or lands of a WMD. A ROW Occupancy Permit is a proprietary revocable license and does not convey property rights to the permittee.

State 404 Dredge and Fill Permits

FDEP has been delegated permitting authority under *Section 404(g) of the Clean Water Act (CWA)* to authorize dredge and fill impacts to those waters of the United States that the state assumed permitting authority over (**assumed waters**). FDEP administers the

State 404 Program under Part IV of **Chapter 373, F.S.**, The State 404 Program is a separate program from the existing ERP program, and projects within state-assumed waters will require both an ERP and a State 404 Program authorization. **Chapter 62-331, F.A.C.**, and the **State 404 Applicant's Handbook** provide rules and guidance on how the state program is administered. Determination of whether a water is under FDEP's permitting jurisdiction can be established by contacting FDEP or using the Retained Waters Screening Tool found on **FDEP's 404 Assumption Website**.

The United States Army Corps of Engineers (USACE) has **Section 404** permitting responsibility for “**retained waters**” as defined in the **State 404 Program Applicant's Handbook**. FDEP considers a State 404 authorization as a state permit.

State-owned Submerged Lands Authorizations

Activities located on sovereignty submerged lands also referred to as “state-owned submerged lands” as described in A.2 Terminology require a proprietary authorization from the Board of Trustees of the Internal Improvement Trust Fund (Board of Trustees) to use such lands according to **Chapter 18-21, F.A.C.** Proprietary authorization is required for essentially all FDOT activities on state-owned submerged lands. FDOT fee simple ownership of an area does not preclude the determination of state owned sovereign submerged lands by FDEP.

FDEP and the WMDs act as staff to the Board of Trustees and, in accordance with the Operating Agreement between their agencies, will process all applications involving proposed work on state-owned submerged lands. These agencies have delegated authority from the Board to approve or deny most projects, but for some types of projects (such as submerged land leases), the final decision to approve or deny the authorization rests with the Governor and Cabinet of the state of Florida, who serve as the Board of Trustees. Leases are typically required for revenue-generating uses and are, therefore, not required for FDOT projects. FDOT projects proposed on state-owned submerged lands typically need a letter of consent or an easement. The determination for the proprietary authorization is part of the ERP permitting process. However, the final easement or letter of consent is provided by the FDEP after issuance of the ERP.

Additionally, for FDOT projects requiring the use of state-owned upland conservation lands which are managed for conservation, outdoor resource-based recreation, for example the Withlacoochee Forest, or archaeological or historic preservation requires the approval of the Acquisition and Restoration Council (ARC). These lands are held by the Board of Trustees who is responsible for the acquisition, administration, management, control, supervision, conservation, protection, and disposition of all land owned by the state or any of its agencies, departments, boards, or commissions with specific exclusions provided in **Section 253.03, F.S.**, such as land held for transportation facilities, transportation corridors, and canal rights of ways.

Administratively supported by the FDEP, ARC administers the review and approval of

management plans and land uses for all state-owned conservation lands, which includes overseeing the process of review of acquisition of interests (i.e., easements) on these lands and recommending approvals to the BOT. This includes acting on FDOT's applications for easements across such lands.

The Board of Trustees has delegated some of its authority to FDEP staff to handle other forms of authorization to allow local, state, and federal governmental agencies to use state-owned uplands provided that the requested action does not prevent the intended use of the property. To acquire an upland interest in state-owned conservation lands, or request authorization to use state-owned uplands temporarily for construction, maintenance, or other purposes, the District will need to contact FDOT's OEM.

National Pollutant Discharge Elimination Permits

FDEP implements the National Pollution Discharge Elimination System (NPDES) and the Coastal Construction Control Line (CCCL) permitting programs throughout the State.

As authorized by the Clean Water Act (**CWA**), the NPDES permit program controls water pollution by regulating point sources that discharge pollutants into waters of the United States. The EPA delegated to the FDEP the authority to implement the NPDES stormwater permitting program in the State of Florida (in all areas except Indian Country lands) under federally approved Florida rules. The state NPDES permit shall be the sole permit issued regulating the discharge of pollutants or wastes into surface waters within the state for discharges covered by the U. S. Environmental Protection Agency approved state NPDES program. FDEP's authority to administer the NPDES program is contained in **Section 403.0885, F.S.** If a project will disturb one acre or more of soil, and if the stormwater run-off from the site will discharge to waters of the state (even if the discharge is conveyed through the municipal storm sewer system), a NPDES Construction Generic Permit (CGP) under **Chapter 62-621, F.A.C.**, will be required prior to commencement of construction as a means of protecting down-stream water quality. A **Notice of Intent (NOI)** (application) is filed with FDEP at least two days prior to the commencement of construction.

Part of the NPDES permit program is the Municipal Separate Storm Sewer System (MS4). An MS4 is a publicly-owned conveyance or system of conveyances (i.e., ditches, curbs, catch basins, underground pipes, etc.) designed or used for collecting or conveying stormwater that discharges to surface waters of the State. An MS4 can be operated by entities such as municipalities, counties, drainage districts, colleges, military bases, or prisons. FDOT is a regulated MS4 operator under federal and state rules. Regulated MS4 operators must obtain an NPDES stormwater permit and implement a comprehensive **Stormwater Management Program (SWMP)** to reduce the contamination of stormwater runoff and eliminate illicit discharges to the MS4.

As implemented by **Chapter 62-624, F.A.C.**, Phase I of the MS4 program addresses discharges of stormwater runoff from "medium" and "large" MS4s (i.e., those MS4s located in areas with populations of 100,000 or greater). A Phase I MS4 is defined in **subsection 62-624.200(10), F.A.C.**, as "a municipal separate storm sewer system identified under **Section 402(p)(2)** of the **CWA** and subject to regulation under **Section 402(p)(3)(B)** of the **CWA** as implemented as part of FDEP's federally approved NPDES stormwater program pursuant to **Section 403.0885, F.S.**" Generally, Phase I MS4s are covered by individual permits and are effective for no more than five years. There are individual MS4 permits issued to several counties in Florida, and FDOT is a co-permittee in each of those permits.

FDOT has an approved [Statewide Stormwater Management Plan \(SSWMP\)](#) that describes the activities to be conducted, methods to be used, and procedures to be followed by FDOT to reduce the discharge of pollutants to and from the Phase I MS4s throughout the State of Florida. This plan supports FDOT's documentation and procedures for annual reporting as a co-permittee under the MS4 Phase 1 permits. As stated in Section II of the Phase 1 permit, the **SSWMP** is incorporated into the permit by reference once approved by FDEP and serves as the guiding document for FDOT compliance as a co-permittee under Florida's Phase 1 MS4 program. More information can be found in the [FDOT SSWMP](#).

Phase II of the program regulates discharges from certain MS4s not regulated under Phase I, that meet designation criteria set forth in **Chapter 62-624, F.A.C.** A Phase II MS4 is defined in **subsection 62-624.200(11), F.A.C.**, as "a municipal separate storm sewer system subject to regulation under **Section 402(p)(6)** of the **CWA**, as implemented as part of FDEP's federally approved NPDES stormwater program pursuant to **Section 403.0885, F.S.**, this chapter (**Chapter 62-624, F.A.C.**), and **paragraph 62-621.300(7)(a), F.A.C.**, which incorporates by reference FDEP's Generic Permit for Discharge of Stormwater from Phase II MS4, and includes MS4 facilities owned or operated by the United States and MS4 facilities operated by the FDOT that are not covered by an existing Phase I MS4 permit." Phase II MS4s are covered by a general permit. There are numerous general permits issued to FDOT for various Phase II designated areas.

Each regulated MS4 is required to develop and implement a **SSWMP** to reduce the contamination of stormwater runoff and prohibit illicit discharges.

Coastal Construction Control Line

FDEP manages a CCCL Program to protect the coastal system from improperly sited and designed structures which can destabilize or destroy the beach and dune system. As defined in **subsection 62B-33.002(6), F.A.C.**, the CCCL is "the line established pursuant to the provisions of **Section 161.053, F.S.**, and recorded in the official records of the county, which defines that portion of the beach-dune system subject to severe fluctuations based on a 100-year storm surge, storm waves, or other predictable weather conditions." A CCCL permit is required for construction activities seaward of the CCCL and fifty-foot

setback. For projects within the CCCL, FDOT must coordinate with FDEP to ensure FDOT projects adhere to the special siting and design criteria established to eliminate or reduce impacts to the beach dune system, adjacent properties, native salt resistant vegetation, and marine turtles. Rules and procedures for obtaining this permit can be found in **Chapter 62B-33, F.A.C.**

Drainage Wells

Certain local situations may dictate the use of drainage wells. Typically, this would occur on barrier islands and coastal locations, where the stormwater would be introduced into saltwater and could be effective in maintaining the existing fresh/saline water interface. Groundwater withdrawal typically is not permitted in these areas. However, due to the nature of drainage wells, specific design approval for the construction of drainage wells must be granted by the State Drainage Engineer on an individual project basis.

Drainage wells are considered by the DEP to be Class V, Group 5 wells, regulated under **Chapter 62-528, FAC**. The program implements the Underground Injection Control regulations and is dedicated to preventing degradation of the quality of other aquifers adjacent to the injection zone. Drainage well use and treatment of the surface water prior to discharge must be consistent with these regulations. Class V injection wells are used for storage or disposal of fluids into or above an underground source of drinking water. In locations where the available area for pond siting(s) is limited (e.g., urbanized coastal areas), FDOT may direct stormwater into shallow wells. These wells are considered non-major Class V wells that are permitted through FDEP District offices. Recognize that some existing wells and all future wells drilled into potable or potentially potable aquifers may require pretreatment of the surface water prior to discharge.

Sea Level Impact Projection (SLIP) Studies for State-Financed Coastal Construction

Presently, there is on-going rulemaking on **Rule 62S-7: Sea Level Impact Project (SLIP) Studies** for any state-financed coastal construction. Beginning one year after effective date of this rule which should be in early 2022 a state-financed constructor, as defined in s. 161.551, F.S., must conduct a SLIP study that meets the standards and criteria in **Rule 62S-7.012, F.A.C.**, prior to construction of a new coastal structure. The timing of construction and the applicability of the Rule to coastal structures is defined in **Rule 62S-7.010, F.A.C., Definitions**.

A state-financed constructor may comply with this requirement by using the FDEP's web-based tool, which was designed to meet the criteria in **Rule 62S-7.012, F.A.C.**, for performing and submitting a SLIP study or conduct and submit a SLIP study by their own method that otherwise meets the standards and criteria established in **Rule 62S-**

7.012, F.A.C. The state-financed constructor must submit the SLIP study to the FDEP for publication on its website. The state-financed constructor may not commence construction of a new coastal structure until a SLIP study meeting the criteria in Rule 62S-7.012, F.A.C., has been submitted to FDEP and has received notification from the FDEP via the web-based tool or email that the SLIP study has been published on the FDEP's website for 30 days. The FDEP encourages submission of the SLIP study during planning and design phases of the project.

A SLIP study required under s. 161.551, F.S., shall meet the standards and criteria under the rule which includes, but is not exclusive, the following:

1. Show the amount of sea level rise expected over 50 years or the expected life of the structure, whichever is less. When there are multiple project features that function as one combined project, as contemplated by s. 161.551(3), F.S., one SLIP study may be submitted, but the expected life shall be that of the highest Risk Category for all project features contemplated.
2. Show the amount of flooding, inundation, and wave action damage risk expected over 50 years or the expected life of the structure, whichever is less. The amount of flooding and wave damage expected must be calculated using the criteria in the rule.:

FDEP's web-based tool has been designed to meet these standards and criteria.

FDEP's intent in this rule is to inform and raise awareness with the state-financed constructor of the potential impacts of sea level rise and increased storm risk on coastal infrastructure. **Implementation of the findings of the SLIP studies is at the discretion of the state-financed constructor.**

Failure to comply with the SLIP study requirements may result in compliance or enforcement action by FDEP, including but not limited to:

1. Pursuit of injunctive relief to cease construction until the constructor comes into full compliance with the requirement;
2. Recovery of all or a portion of state funds expended on the construction activity.

Federal Agencies

Federal permits are issued by multiple federal agencies under various regulatory authorities. Permits are typically required for proposed impacts to jurisdictional wetlands and other surface waters, impacts to civil works projects, and for bridge or causeway construction over navigable waters of the United States. For these types of impacts, the United States Army Corps of Engineers (USACE) and the United States Coast Guard (USCG) are the primary federal permitting agencies for FDOT projects. Impacts to

protected federal species may need to be permitted by either the United States Fish and Wildlife Service (USFWS) or the National Marine Fisheries Service (NMFS).

The USACE issues dredge and fill permits in Waters of the United States in accordance with **Section 404** of the **CWA** and **Section 10** and **Section 14** of the **Rivers and Harbors Act of 1899**. With EPA's approval of the State 404 Program, USACE's authority under **Section 404** of the **CWA** is limited to waters that are defined as retained waters by the USACE.

Additionally, **Section 10** of the **Rivers and Harbors Act of 1899** grants the USACE the permitting authority for "structures or works in or affecting a navigable water of the United States." Such structures or works include boat ramps, piers, breakwaters, jetties, docks, bridge abutments, and aids to navigation. **Section 14** of the **Rivers and Harbors Act** allows the USACE to grant permission to alter civil works projects.

If a project involves a bridge over navigable waters of the United States, the USCG issues bridge permits under the **Rivers and Harbors Act of 1899** and the **General Bridge Act of 1946**. These **Acts** placed the navigable waters of the United States under the exclusive control of the USCG to prevent any interference with their navigability by bridges or other obstructions except by express permission of the United States Government.

Regardless of whether the USACE and/or USCG function as the permitting agency or serve as lead or cooperating agencies for a given federal action, the issuance of federal permits requires coordination with resource agencies. The USFWS and the NMFS serve as the federal wildlife commenting agencies during the USACE's or USCG's federal permitting process. Which agency provides comment depends upon which protected species (terrestrial and/or marine) or critical habitat are potentially affected.

Federal 404 Clean Water Act Permits

Activities in waters of the United States regulated under **Section 404** of the **CWA** include (but are not limited to) fill for development, water resource projects (such as dams and levees), infrastructure development (such as highways and airports), and mining projects. **Section 404** requires issuance of a permit before dredged or fill material may be discharged into jurisdictional waters of the US, including wetlands, unless the activity is exempt from **Section 404** regulation (e.g., certain farming and forestry activities). The USACE's authority under **Section 404** of the **CWA** is limited to those waters identified as retained waters.

As described by the EPA (**EPA, 2015**), the basic premise of the **Section 404** program is that no discharge of dredged or fill material may be permitted if:

1. A practicable alternative exists that is less damaging to the aquatic environment; or

2. The nation's waters would be significantly degraded.

Therefore, a proposed activity must first show that steps have been taken to:

- a. Avoid impacts to wetlands, streams, and other aquatic resources;
- b. Minimize adverse effects on the resource if impacts are unavoidable; and
- c. Compensate for all remaining unavoidable impacts (i.e., wetland or listed wildlife mitigation) such that there is no net loss of wetland function from the proposed project.

There are several federal dredge and fill permit types that are distinguished by their limits of impact. In increasing magnitude/complexity, they include Nationwide Permits, General Permits, State Programmatic General Permits, Letter of Permission, and Standard Permits. Additionally, it is possible to obtain a determination from the USACE of "no permit required" if a project is anticipated to have no impact on wetlands or surface waters under the jurisdiction of USACE. This determination by the USACE does not supersede the requirement to obtain any other federal or state permits which may be necessary for a project, nor does it constitute a federal evaluation of possible impacts to species protected under the Endangered Species Act (**ESA**) or impacts to historic resources protected under **Section 106** of the National Historic Preservation Act (**NHPA**).

1. **General Permit** - This refers to a USACE authorization that is issued on a nationwide or regional basis (District-wide or more limited geographic scope) for a category of activities when those activities are substantially similar in nature and cause only minimal individual and cumulative impacts (**USACE, 2014**). (See **40 CFR § 230.7**) They are reviewed every five years and may be renewed, modified, or suspended. The USACE's **Source Book**, located on USACE offices websites, should be reviewed for an entire listing of thresholds for a project to qualify under a general permit. Coordination with the USACE will ensure the project impacts meet the requirements for general permit authorizations. It is important to note that "consideration of alternatives in **40 CFR § 230.10(a)** are not directly applicable to General Permits".
 - a. **Nationwide Permits (NWP)** - There are more than 50 established NWPs. Nationwide Permits are a type of general permit for certain activities having minimal environmental impacts. (See **33 CFR Part 330**) These are essentially automatic permits for qualifying activities. Each NWP includes a series of impact thresholds, such that if a project's anticipated impacts fall below the specified thresholds, the project would qualify for the NWP without review by or approval of the USACE. However, it is recommended to submit an application package to the USACE and request that the USACE concur with the determination that the project is consistent with the thresholds associated with a given NWP. With concurrence from USACE, the applicant will have a level of comfort that their project is consistent with the federal intent of the NWP. Without USACE concurrence, an applicant may run the risk of being in violation of the **CWA** during construction if there is a disagreement with a USACE representative as to whether their project is consistent with NWP

intent.

There are certain NWP's that require Pre-Construction Notification (PCN) prior to project construction due to variability in the degree of potential impacts for a given type of work. In accordance with **33 CFR § 330.1** for NWP's requiring advance notification, the notification must be provided in writing as early as possible prior to commencing the proposed activity but must be received no less than 45 days prior to commencing construction. The permittee may presume that the project qualifies for the NWP unless the permittee is otherwise notified by the USACE within a 45-day period. The 45-day period starts on the date of receipt of the notification in the USACE district office and ends 45 calendar days later. If the USACE notifies the prospective permittee that the notification is incomplete, a new 45-day period will commence upon receipt of the revised notification. The prospective permittee may not proceed with the proposed activity before expiration of the 45-day period unless otherwise notified by the USACE. If the USACE fails to act within the 45-day period, the USACE must use the procedures of **33 CFR § 330.5** to modify, suspend, or revoke the NWP authorization.

Both the NWP's, and the General Conditions required in PCN, are itemized on the USACE web site. It is important to be aware of general conditions associated with NWP. For example, general condition 18 requires consultation with the NMFS or USFWS if the project activity may affect a listed species or critical habitat protected under the **ESA**.

NWP's are reviewed and generally renewed every five years, so it is important to keep abreast of current NWP listings. Coordination with the USACE will ensure the applicant meets the requirements under NWP authorizations. NWP that are typically relevant to FDOT projects include: NWP No. 3 Maintenance, No. 14 Linear Transportation Projects, No. 15 USCG Approved Bridges, and No. 23 Approved Categorical Exclusions.

b. **Regional General Permits** that may apply to FDOT projects.

Regional General Permit **SAJ-92** is applicable for projects with identified impact thresholds [i.e., where dredge and fill impacts do not result in the loss of greater than a total of 0.5 acre of tidal impacts to waters of the United States (wetlands, surface waters and navigable waters) for the entire project, and 5.0 acres of non-tidal impacts to waters of the United States (wetlands, surface waters and navigable waters) for any 1-mile segment of roadway length as measured from the beginning of the project, up to a maximum loss of 50 acres of waters of the United States per project]. This regional general permit is limited to projects that have been reviewed through the FDOT's ETDM and/or PD&E processes. To be current, the Environmental Documents must have been evaluated, re-evaluated, or confirmed within 5 years of submitting an application.

This regional general permit may not authorize construction of a new alignment (non-existing roadway).

Regional General Permit **SAJ-46**, Shoreline Stabilization Activities in Florida, may also be applicable to FDOT projects. This permit authorizes new work and maintenance associated with shoreline stabilization activities including bulkheads and seawalls with backfill, seawall footers, and shoreline stabilization materials.

- c. **State Programmatic General Permits (SPGP)** - The purpose of the SPGP is to avoid duplication of permitting between the USACE and the FDEP for minor work located in waters of the United States, including navigable waters. These agencies have a coordination agreement detailing the procedures and process on how to avoid duplication of regulatory review.
2. **Letter of Permission (LOP)** - **LOPs** are used when project impacts are minor or would not have significant individual or cumulative effect. The process required to obtain a **LOP** approval is more detailed than the NWP process; however, it is typically less rigorous than that for a Standard Permit. The USACE is not required to publish an individual public notice, but they must coordinate with federal and state wildlife agencies and complete a public interest evaluation as outlined in **33 CFR § 325.2 (e)(1)**. A determination as to whether a **LOP** is the appropriate instrument for a given action is at the discretion of the USACE.
3. **Standard Permit** - This permit is also referred to as an Individual Permit and is required for larger, more complex projects when a proposed project does not meet the criteria to qualify for a General Permit, Nationwide Permit, or **LOP**. See **33 CFR § 325.5** for more information on the Standard Permit requirements.

There are exemptions for very narrowly-defined activities that result in incidental impacts to wetlands or surface waters in accordance with **Section 404(f)(1)** of the **CWA**. For instance, one exemption for FDOT is for the maintenance of transportation structures, so long as the structures are in non-tidal waters and the character, slope, and size of the original fill design is not proposed to change. See <https://www.epa.gov/cwa-404/exemptions-permit-requirements>.

Section 408 Permit

FDOT is required to obtain USACE authorization when an FDOT project is proposed to alter existing federal flood control projects (i.e., levees, dams, and canals). The USACE provides guidance for this process in **Section 408 – Interim Changes for Immediate and Future Policy Revisions (2018)**. **Section 14** of the **Rivers and Harbors Act of 1899** and codified in **33 U.S.C. § 408** (commonly referred to as “**Section 408**”) authorizes the Secretary of the Army, on the recommendation of the Chief of Engineers of the USACE, to grant permission for the alteration or occupation or use of a USACE civil works project if the Department of the Army’s Secretary determines that the activity will not be

injurious to the public interest and will not impair the usefulness of the project. The granting or denial of permission pursuant to **Section 408** is made formal through a **Section 408** Decision Letter.

A decision on a **Section 408** request is a federal action, and therefore subject to **NEPA** and other environmental requirements. While ensuring compliance is the responsibility of USACE, the requester is responsible for providing all information that the District identifies as necessary to satisfy all applicable federal laws, executive orders, regulations, policies, and ordinances guidance. Like traditional federal **Section 10/404** permitting, insufficient supporting documentation may result in requests for additional information until the file is deemed complete by USACE. The **NEPA** process is set forth in **40 CFR §§ 1500-1508** and the USACE civil works **NEPA** implementing regulations are found in **33 CFR Part 230**. Because proposed alterations vary in size, level of complexity, and potential impacts, the procedures and required information to make such a determination are intended to be scalable. Early coordination with USACE is suggested in order to determine the appropriate level of required support to navigate the **Section 408** review process.

Typically, when a ROW Occupancy Permit application is submitted to a WMD, the WMD reviews it and determines if the WMD needs to send it to USACE. If sent to USACE, they will evaluate whether **Section 408** applies. If it is determined that **Section 408** applies, the USACE will decide whether the **Section 408** review can be conducted at the District level in Jacksonville or the review will need to be elevated to USACE Regional Headquarters in Atlanta, Georgia. In general, review at the District level would be for projects that adjust features around a canal, dam, or levee that would not result in changes to authorized structural geometry or hydraulic capacity. These reviews take approximately 30 to 90 days for decisions to be rendered. For more complicated projects that may propose changes to structural geometry or hydraulic capacity of an existing facility, the review may be elevated to USACE Headquarters. These reviews can take between 18 to 24 months. Generally, proposed alterations that would result in substantial adverse changes in water surface profiles will not be approved. There are no statutory time limits on **Section 408** review.

In situations where USACE is also evaluating a **Section 10/404** permit application, the USACE may forward the **Section 408** decision letter with the **Section 10/404** permit decision once it is made. Under no circumstances will **Section 10/404** actions be rendered in advance of a decision on a **Section 408** request. For cases involving a categorical permission, the written approval will be validation that the categorical permission is applicable.

Section 9 Bridge Permits

The USCG approves the location and plans of bridges and causeways and imposes conditions relating to the construction, maintenance, and operation of these bridges in the interest of public navigation. The USCG is also required by law to ensure environmental

considerations are given careful attention and importance in each bridge permitting decision.

Bridge permits and permit amendments are the USCG documents approving the location and design plans of bridges. A USCG bridge permit is commonly referred to as a **Section 9** permit because permitting authority historically relied on **Section 9 of the Rivers and Harbors Appropriation Act of 1899**. Currently, the authority primarily relies upon the **General Bridge Act of 1946**. Consistent with the **Rivers and Harbors Appropriation Act**, the **General Bridge Act** requires USCG approval to construct a new bridge or reconstruct/modify an existing bridge over navigable waters.

The USCG has jurisdiction over “navigable waters” of the United States, as defined in **33 CFR § 2.36** as well as by specific congressional and judicial designations. There are two USCG Districts with jurisdiction in Florida. The USCG Seventh District, located in Miami, issues bridge permits for projects in FDOT Districts 1, 2, 4, 5, 6 and 7. The USCG Eighth District, located in New Orleans, issues bridge permits for projects in FDOT District 3. For Turnpike projects, the applicable USCG District is based upon the location of the project within the USCG District boundaries.

In USCG Seventh District the USCG may request a **Bridge Project Questionnaire** to help them determine whether a bridge permit is required. In USCG Eighth District 3 documents any coordination with FHWA and the USCG by uploading coordination letters to the EST and may add a summary in the Navigation section of the planning or programming screen summary report. If available, the letter from the USCG should include the USCG’s determination of jurisdiction, determination that a permit is or is not needed, and/or if a lighting plan is required.

All bridges across waterways that support nighttime navigation are required to display navigational lights in accordance with **33 CFR Part 118**. The approval of navigational lights and other required signals must be obtained prior to any construction from the USCG District Commander (Bridge Office). The USCG may exempt bridges over waterways with no significant nighttime navigation from the lighting or other signal requirements. Design plans for navigational lighting should be separate from the design plans for the bridge when submitting a USCG bridge permit application. The bridge navigational lighting plan requires a separate application from the bridge permit application.

USCG bridge permits are required for construction of a new bridge or modification of an existing bridge over navigable waters. A USCG bridge permit is necessary if a bridge project includes any of the following:

1. The construction of a new bridge over navigable waters;
2. The modification of an existing bridge that increases the travel capacity of the bridge (i.e., adding a travel lane); or,
3. The modification of an existing bridge that would result in changes to navigation (i.e., changes to the horizontal or vertical clearances, fender systems)

Unless specifically declared otherwise by Congress, navigable waters are defined in **33 CFR § 2.36** to include the following:

- a. Territorial seas of the United States;
- b. Internal waters of the United States subject to tidal influence; and;
- c. Internal waters of the United States not subject to tidal influence:
 - 1) which are or have been used, or are or have been susceptible for use, by themselves or in connection with others, as highways for substantial interstate or foreign commerce, notwithstanding obstructions that require portages; or
 - 2) which a governmental or non-governmental body with expertise in waterway improvement determines, or has determined to be, capable of improvement at a reasonable cost (a favorable balance between cost and need) to provide, by themselves or in connection with others, highways for substantial interstate or foreign commerce.

During permitting, the District's role is as an applicant, regardless of the lead agency for preparation of the **NEPA** document. Coordination with USCG during permitting takes place to determine the requirements for a complete bridge permit application. FDOT submits the application for the USCG bridge permit as early as practicable and ensures that the documentation submitted to USCG with the permit application is complete with respect to documenting navigational impacts as well as compliance with **NEPA** and other required federal environmental statutes, regulations, and executive orders. This is to assist USCG in processing the permit application as quickly as possible. This should include coordination/concurrence letters from federal and state resource agencies, as appropriate.

Bridge Permit Exceptions and Exemptions

Several types of projects involving bridges do not require a USCG permit but may still require USCG authorization or notification. This may include 1) bridge removal (USCG notification required), 2) retaining all or part of a bridge over navigable water for purposes other than transportation (USACE notification required), and 3) repairing or replacing worn or obsolete parts on an existing bridge where the modification would not result in changes to navigation (e.g., projects involving bridge maintenance, painting, pile jackets, spall repairs).

The **Coast Guard Bridge Permitting** document states that most infrastructure repairs do not require a USCG permit as long as they do not affect navigation clearances or bridge configuration. In addition, emergency repairs or replacement of severely deteriorated or damaged bridges or construction of new temporary bridges to meet emergency land transportation requirements may be authorized by the USCG without formal permit action. Authorization under these circumstances is limited to the minimum period required to return the bridge to normal operation.

There are three types of exemptions from a USCG bridge permit, these include **1982 Coast Guard Authorization Act (CGAA) (PL 97-322, Title 1, Oct. 15, 1982, 96 Stat. 1581)**, Advance Approval Waterways, and **Title 23 U.S.C. 144(c)**.

1982 Coast Guard Authorization Act

Section 107 of the CGAA of 1982, 33 U.S.C. § 525(b), exempts bridge projects from bridge permits when the bridge project crosses non-tidal waters which are not used, and susceptible to use in their natural condition, or susceptible to use by reasonable improvement as a means to transport interstate or foreign commerce.

Advance Approval Waterways

There may be instances where bridges are proposed to be built across waterways which are deemed navigable in law but not traversed by any vessel larger than small motorboats (e.g., logs, log rafts, kayaks, canoes, rowboats, and outboard johnboats). The term “small motorboats” does not include sailing or cabin cruiser crafts. In these cases, the clearances provided for high water stages will be considered adequate to meet the reasonable needs of navigation.

In these circumstances, the USCG can issue an Advance Approval Authorization in accordance with **33 CFR § 115.70**. Each potential candidate bridge/waterway crossing is evaluated by the USCG on a case-by-case basis to determine if an Advance Approval may be appropriate.

Title 23 U.S.C. § 144(c)

The **Surface Transportation Assistance (STA) Act of 1978** amended **Section 144 of Title 23, U.S.C.** and was enacted to reduce paperwork and related costs in the execution of the USCGs bridge permit programs. For FHWA funded or eligible projects, FHWA has the responsibility under **23 U.S.C § 144** and **23 CFR § 650.805** to determine whether a bridge project receiving federal assistance under **Title 23, U.S.C.**, meets the exemption criteria for USCG Administration purposes. Though FHWA maintains authority for **23 U.S.C § 144(c)**, such waterways fall under USCG jurisdiction and are covered in the **2014 Memorandum of Agreement (MOA) between USCG and FHWA**. FHWA agreed that USCG will have an informative and effectual role in the determination process. The FHWA determination is preliminary and USCG input on navigability and commerce is influential to FHWA’s determination. Therefore, before such FHWA determinations are made, FHWA consults with the USCG to obtain concurrence with the determination. Upon consultation by the FHWA, the USCG will timely concur or not concur so as to not delay project advancement.

A USCG permit is not required if FHWA determines that the proposed construction, reconstruction, rehabilitation, or replacement of the federally aided or assisted bridge is over waters:

- 1) Which are not used or are not susceptible to use in their natural condition or by reasonable improvement as a means to transport interstate or foreign commerce and
- 2) Which are
(if) not tidal, or

(ii) if tidal, used only by recreational boating, fishing, and other small vessels less than 21 feet in length.

FDOT assesses the need for a USCG permit, or navigation lights or signals for proposed bridges. If uncertain whether the waterway is susceptible to improvement for navigation, is tidal, or is considered navigable, or if the types of vessels using the waterway are unknown, FDOT consults with the appropriate USCG or FHWA depending on project location. Early coordination takes place between FDOT and the USCG (without FHWA) for federal projects under jurisdiction of the USCG Seventh District, with USCG making the decision through the Efficient Transportation Decision Making (ETDM) Environmental Screening Tool (EST) for projects that qualify for screening. For federal projects in the USCG Eighth District, FHWA makes this preliminary determination in coordination with USCG.

For bridge crossings of waterways with navigational traffic where FDOT believes that a USCG permit may not be required, the FDOT provides supporting information early to enable the USCG/FHWA to make a determination that a permit is not required and that proposed navigational clearances are reasonable.

Since construction in waters exempt from a USCG permit may be subject to other USCG authorizations, such as approval of navigation lights and signals and timely notice to local mariners of waterway changes, the USCG should be notified whenever the proposed action may substantially affect local navigation.

The ***Title 23 U.S.C. § 144(c)*** exemption is only applicable to FHWA funded or eligible projects in which FDOT is the lead agency (***NEPA*** Assignment).

A.5 WATER MANAGEMENT DISTRICTS

A.5.1 General

Prior to 1972, water management legislation in Florida had developed on a piecemeal basis. In that year, a comprehensive law was enacted to provide extensive protection and management of water resources throughout the state.

The ***Florida 1972 Water Resources Act***, Chapter 373, ***Florida Statutes***, provides a two-tiered administrative structure headed at the state level by the DEP. The DEP supervises five regional Water Management Districts designed to provide the diverse types of regulation needed in different areas of the state. These include the previously existing Central and Southern Florida Flood Control District, renamed the South Florida and the Southwest Florida Water Management Districts. Since these two districts had already been established and were authorized to levy *ad valorem* taxes to pay for their regulatory functions, they were promptly delegated full regulatory and permitting powers by the Department of Natural Resources (DNR), at that time the state-level regulatory agency. The three new districts established under the Act were the Suwannee River, St. Johns

River, and Northwest Florida Water Management Districts.

A.5.2 Basin Boards

Basin boards in the Water Management Districts handle administrative and planning functions in the particular basin, such as developing plans for secondary water control facilities and for water supply and transmission facilities for counties, municipalities, or regional water authorities. Basin boards do not exercise regulatory or permitting authority but help to relieve the Water Management Districts of some of their administrative chores.

A.5.3 Governing Boards

The governing boards of the Water Management Districts exercise broad statutory powers under Chapter 373, *Florida Statutes*. In regard to water works, they are authorized to:

"Clean out, straighten, enlarge, or change the course of any waterway, natural or artificial, within or without the district; to provide such canals, levees, dikes, dams, sluiceways, reservoirs, holding basins, floodways, pumping stations, bridges, highways, and other works and facilities which the board may deem necessary; establish, maintain, and regulate water levels in all canals, lakes, rivers, channels, reservoirs, streams, or other bodies of water owned or maintained by the district; cross any highway or railway with works of the district and to hold, control, and acquire by donation, lease, or purchase, or to condemn any land, public or private, needed for rights-of-way or other purposes; any way remove any building or other obstruction necessary for the construction, maintenance, and operation of the works; and to hold and have full control over the works and rights-of-way of the district."

These boards also establish rules and regulations related to water use, adopted after public hearing and subject to review by the Governor and Cabinet sitting as the Land and Water Adjudicatory Commission.

A.5.4 Permitting Authority

Permitting authority has been conferred on the Water Management Districts for artificial recharge projects or the intentional introduction of water into any underground formation; the construction, repair, and abandonment of water wells; the construction or alteration of dams, impoundments, reservoirs, and other water storage projects; the licensing and registration of water well contractors; and the hookup of local water works to the district's works. Such broad regulatory powers are consistent with the declared policy of the Florida Water Resources Act for the DEP "to the greatest extent practicable," to delegate

conservation, protection, management, and control authority over state waters to the Water Management Districts.

A.5.5 Interagency Cooperation

The DEP has been concerned most directly with water quality control while the Water Management Districts have been primarily involved with water quantity control. This has inevitably resulted in regulatory overlap and confusion since water quality and water quantity considerations are seldom mutually exclusive. This regulatory overlap has made it necessary for the DEP and the Water Management Districts to work out an effective policy to avoid confusion and redundancy in the state's regulatory scheme.

Permitting criteria overlap between the DEP and the Districts often requires permit applicants to approach both agencies for action on a single proposed activity. The extent of this overlap depends largely on the extent to which a Water Management District has implemented its own permitting authority and established a broad range of rules and regulations for water resource management within its jurisdiction. Because they were in existence prior to enactment of the Water Resources Act, the two southern districts have experienced the major share of problems with overlapping responsibilities. Negotiations between the DEP and the Water Management Districts have led to increased regulatory efficiency and greater convenience for the environmental permit applicant.

One cooperative approach has been the designation of a "primary" and "secondary" agency for specific permitting areas. Applicants would apply for a permit from the primary agency only; the secondary agency would provide input and guidance according to the terms of an interagency agreement. The DEP's Bureau of Water Resources has assigned a coordinator to attend District board meetings and act as a direct link between the agencies for the resolution of overlap problems. Also, joint quarterly meetings and the development of standardized rules have been helpful in promoting cooperation.

In dealing with highway drainage problems and issues, the Department engineer must be aware of the rules and regulations of the Water Management District in which the project is located. Since the Department issues permits for connections to the highway drainage system, it has become even more essential from the agency's standpoint to coordinate water storage plans and state resources, and to continue to preserve comprehensive water management plans.

A.6 WATER CONTROL DISTRICTS

Prior to July 1, 1980, the DEP, or a majority of the owners, or the owners of the majority of the acreage of any contiguous body of wet or overflowed lands or lands subject to overflow situated in one or more counties were empowered pursuant to **Chapter 298, Florida Statutes**, to form water control or drainage districts for agricultural purposes, or when conclusive to the public health, convenience, and welfare, or of public utility or

benefit. On July 1, 1980, Chapter 298 was amended to provide that water control districts could only be created by special act of the legislature. The drainage districts in existence prior to that time were grandfathered in.

Drainage districts are governed by a board of supervisors who are elected by the landowners in the district. The DEP's voting rights in the elections are proportional to the extent of the acreage owned by the state in the districts. Presumably, that acreage would include Department of Transportation right-of-way existing in the district.

The board of supervisors is empowered to hire a chief engineer, who is responsible for the drainage works in the area, to adopt and carry out the plan of reclamation.

The Department of Community Affairs recently has been actively charged with the responsibility of coordinating growth management in the State, which will reflect on drainage facilities and projected area growth.

A.7 LOCAL GOVERNMENT PROGRAMS THAT DEAL WITH SURFACE WATER RUNOFF

Under present law, municipalities have authority to provide for drainage of city streets and reclamation of wet, low, or overflowed lands within their jurisdiction. They may construct sewers and drains and may levy special assessments on benefited property owners to pay all or part of the costs of such works. Additionally, municipalities have the power of eminent domain to condemn property for these purposes. Thus, they have the means to deal directly with storm- and surface-water runoff problems.

The general zoning power that municipalities may exercise pursuant to **Chapter 166, Florida Statutes**, enables them to enact floodplain zoning ordinances. Such ordinances may simply require compliance with special building regulations or may exclude certain types of development in a designated floodplain. Enactment of such ordinances is another method by which municipalities can address runoff problems.

Most counties and municipalities have a drainage plan ordinance that requires submittal of a drainage plan for proposed developments. In addition, they commonly require that a drainage impact assessment be prepared and submitted if there is to be a change in the development site. Several local governments have ordinances restricting the amount of surface-water runoff that may be carried by a particular drainage system, or the amount of sediment transported by the runoff.

Many local ordinances also incorporate a floodplain regulation element or minimum elevations for old and new buildings to comply with the Federal National Flood Insurance Act of 1968 and the various current Flood Disaster Protection Acts. The virtues of flood control ordinances are multiple. As one study concluded:

"While such regulations are primarily designed to avoid direct flood damage to life and property, they yield clear benefits in the context of water quality maintenance as well. Overflows from septic tanks and combined sewers, for example, may be closely linked with improperly designed sewage and drainage systems within the floodplain. By preventing excessive encroachment of developments upon the floodplain, these special zoning laws also seem to retard rates of runoff and consequent water pollution from stream bank erosion and adjacent land surfaces."

Subdivision regulations relating to surface-water runoff control tend to be more detailed than local government ordinances, and often require submittal of a comprehensive drainage plan, approval of which is often a prerequisite for plat approval. Some regulations include runoff and rainfall criteria to which the proposed drainage system must conform, while others indicate permitted or preferred surface-water runoff control structures and techniques. Other provisions found in subdivision regulations include: a requirement that runoff from paved areas meet certain water quality standards; the encouragement or requirement of onsite retention of runoff; the regulation of grading and erosion control methods; and a monitoring requirement for the discharge of surface-water runoff into lakes, streams, and canals.

Whether the Department must comply with these local rules and programs is a question that generates confusion. **Section 335.02(4), F.S.**, provides that FDOT is not subject to county, municipal, or special district regulations for projects on the SHS and therefore is not required to obtain local permits unless a FDEP permitting program was delegated to a county government. Notwithstanding, if an FDOT project has a direct impact on property or water control district structures, FDOT shall coordinate with the District legal counsel and may need to coordinate with the appropriate county, municipality, or special district based on counsel direction.

APPENDIX B

ACQUISITION OF REAL PROPERTY RIGHTS

B.1 PROPERTY PURCHASES

The Department currently purchases three types of real property interests:

1. Drainage easements (permanent easements)
2. Flooding and water storage easements (temporary easements)
3. Fee simple title

By dividing the property needs into these categories, the Department is able to conform to requirements that empower it to take and make use of only as much real property as is necessary and best suited to a project.

Drainage Easements

The Department acquires a permanent easement on property needed to ensure permanent maintenance of drainage facilities. Purchase of fee simple title is avoided, since the only public purpose for which the land is intended is drainage and drainage maintenance.

Under the drainage easement, the Department is empowered to remove any artificial or natural barriers that interfere with the use for which the easement was purchased. This includes fences, trees, shrubs, large root systems, or other obstacles to proper drainage or maintenance. The Department cannot be held legally accountable if actions taken to prevent hindrances to usage damage or destroy natural growth.

In many developed areas of the state, parking facilities have been built over drainage easements, with approval contingent on installation of piping that continues to satisfy the Department's objectives. The following conditions also apply:

- The design must be for ground-level parking facilities.
- The Department will not be responsible for the cost of piping needed to maintain Department standards for the easement.
- The costs borne by the fee simple owner include design, construction, and the Department's inspection activities.

Since maintenance or roadway reconstruction activities may require removal of some or all of the parking facility, the Department should make sure that any agreement specifically releases it from any liability for physical damage to or loss of use of the facility.

Flooding and Water Storage Easements

On occasion, water from heavy rainfall events or non-permitted drainage hookups will exceed the design limits of the highway drainage system, leaving the closed system and flowing onto land the Department does not own. When you can identify areas where this may occur in advance, and when such flooding occurs under a limited set of conditions and is temporary in nature, the Department may acquire a temporary flooding easement. This gives the Department flood rights, allowing temporary use of private property to ease flooding. The flood easement may or may not define conditions under which flooding may occur and the elevation water would be expected to reach under those conditions. Emphasis on public safety and cost is paramount when negotiating for the easement.

Flood rights usually are purchased on land in a natural state, which already floods under certain weather conditions from non-highway sources. An example of this type of land is a land-locked natural basin, such as those found in northern Florida.

To provide a retention or detention storage area for discharging water from the closed highway drainage system, the Department may purchase either a temporary or permanent water storage easement. This storage area may allow the water to be transported to waterways of the state or to evaporate or percolate into the soil over time, and may be in response to certain temporary conditions or can become part of the drainage system design.

Many current comprehensive county zoning plans require that developers provide storage for runoff that occurs from land development. Since these storage areas generally are available to public and private entities, the Department should consider their use whenever possible and only purchase storage rights needed for roadway drainage when no other alternative is available.

Fee Simple Title

Make the decision to purchase fee simple title rather than an easement to real property on a case-by-case basis that evaluates the benefits in terms of public safety and convenience against the additional cost. A typical example would be property containing open drainage ditches with sufficient depth or velocity to pose a clear and present hazard to the public. Possession of fee simple title would allow the Department to fence the property and otherwise minimize potential dangers in accordance with state safety standards.

B.2 PROPERTY EXCHANGES

As a general rule, either rights of way or easements can be exchanged in-kind between the Department and a property owner when the property owner requests the exchange and no additional costs or inconveniences will be borne by the Department as a result of

the exchange. All costs of necessary reconstruction, legal services, documentation, or recording the exchange will be borne by the property owner. Before approving the exchange, the Department must evaluate the potential for use, liabilities, and increased maintenance engendered by the exchange.

B.3 CRITERIA FOR ESTABLISHING PROPERTY INTERESTS

This *Manual* establishes the minimum criteria for establishing property interests for drainage purposes, including width and alignments. Allow a sufficient additional allowance for construction and maintenance requirements.

APPENDIX C

COVER HEIGHT TABLES

The following tables have been calculated for FDOT based on FDOT **Standard Specification 125**. If the design of the pipe requires unique installation requirements varying from the standard specification, the Engineer of Record (EOR) will compute pipe cover in accordance with the latest edition of the **AASHTO LRFD – BDS**.

Notable Abbreviations

NA - Not Available

NS - Not Suitable (for Highway LRFD HL-93 Live Loadings)

General Notes

1. The tabulated values are recommended minimum dimensions to withstand anticipated highway traffic loads. Additional cover may be required to support construction equipment loads or highway traffic loads before pavement is completed. Some size thickness combinations may require minimum cover greater than those listed within this appendix.
2. Tabulated values are based on the guidelines found in the **AASHTO LRFD – BDS, 6th Edition, Chapter 12** and other general site design assumptions. Alternative values may be used in lieu of the values tabulated within this appendix based on site-specific calculations developed by suitable methods and detailed in the plans. The assumptions made for use in the development of the tabulated values include:
 - a. 120 lb/cubic feet soil density
 - b. The pipes will be installed at or above the established water table (The depth of the water table is below the springline of the pipe $H_w=0$ ft)
 - c. Pipe trench excavation per FDOT Specification 125-4.4
 - d. Pipe trench backfill allowable soils, bedding, and compaction per FDOT Specification 125-8
 - e. Pipes maximum deflection = 5 percent per FDOT Specification 430-8
 - f. Pipes maximum strains per AASHTO
3. Calculate minimum cover as shown in the figures for each pipe type. If the minimum cover provided is not sufficient to avoid placement of the pipe within the base course, then increase the minimum cover to a minimum of the bottom of base course.
4. Measure maximum cover from top of finished grade to the outside crown of pipe for all pipe shapes and types.
5. Unless otherwise noted, the minimum cover in unpaved areas is the same as with flexible pavement.

6. Allowable cover heights as specified in this Appendix do not account for loadings from structural walls in proximity to pipes.

Concrete Pipe – Round and Elliptical

Minimum Cover

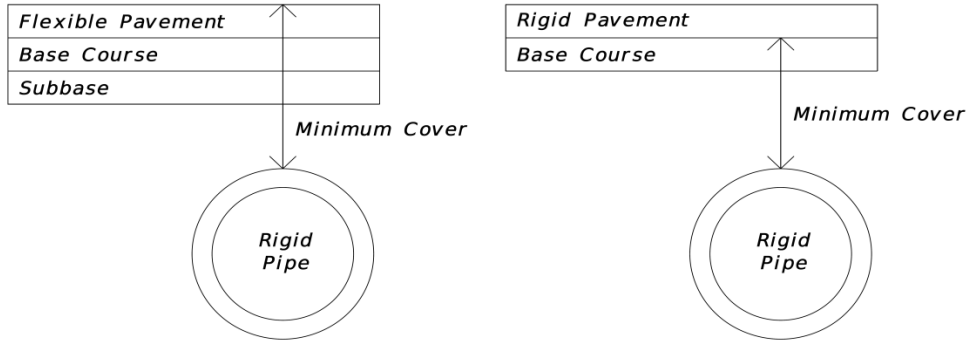

Concrete Pipe Minimum Cover

Unpaved or Flexible
Pavement
12 in.

Rigid
Pavement
9 in.

Concrete Pipe – Round

Maximum Cover

Round Pipe (B Wall)—Type I Installation					
Pipe Diameter	Maximum Cover (ft)				
	Class I	Class II	Class III	Class IV	Class V
12"	11	16	22	34	45
15"	12	16	23	34	45
18"	12	16	23	35	45
24"	11	16	22	34	45
30"	11	15	22	34	45
36"	11	15	21	33	45
42"	10	15	21	33	45
48"	10	14	21	32	45
54"	10	14	21	32	45
60"	9	14	20	32	45
66"	9	13	20	31	45
72"	7	12	18	29	45
78"	7	12	18	29	45
84"	7	12	18	29	45
90"	6	11	18	29	45
96"	5	11	18	29	45
102"	-	11	17	28	45
108"	-	11	17	28	45
114"	-	11	17	28	45
120"	-	10	17	28	44

- Pipe Class I D-Load = 800 lbs./ft./ft. (0.01" crack)
 D-Load = 1,200 lbs./ft./ft. (ultimate)

- Pipe Class II D-Load = 1,000 lbs./ft./ft. (0.01" crack)
 D-Load = 1,500 lbs./ft./ft. (ultimate)

- Pipe Class III D-Load = 1,350 lbs./ft./ft. (0.01" crack)
 D-Load = 2,000 lbs./ft./ft. (ultimate)

- Pipe Class IV D-Load = 2,000 lbs./ft./ft. (0.01" crack)
 D-Load = 3,000 lbs./ft./ft. (ultimate)

- Pipe Class V D-Load = 3,000 lbs./ft./ft. (0.01" crack)
 D-Load = 3,750 lbs./ft./ft. (ultimate)

Concrete Pipe—Round Dimensions		
Equiv. Dia. (in)	Area (Sq. Ft.)	Wall Thickness (in.)* Classes II, III, IV, V B Wall
12	0.8	2
15	1.2	2 1/4
18	1.8	2 1/2
24	3.1	3
30	4.9	3 1/2
36	7.1	4
42	9.6	4 1/2
48	12.6	5
54	15.9	5 1/2
60	19.6	6
66	23.8	6 1/2
72	28.3	7
78	33.2	7 1/2
84	38.5	8
90	44.4	8 1/2
96	50.3	9
102	56.7	9 1/2
108	63.7	10
114	70.9	-
120	78.5	-
<p>* For Informational Purposes Only.</p> <p>Do Not Specify Wall Thickness.</p> <p>Option B Wall is Industry Standard.</p>		

Concrete Pipe – Elliptical

Maximum Cover

Elliptical Pipe—Installation Type II						
Pipe Equiv. ID	Span	Rise	Maximum Cover (ft)			
			Class HE-I	Class HE-II	Class HE-III	Class HE-IV
18"	23"	14"	8	12	17	25
24"	30"	19"	8	11	16	25
30"	38"	24"	8	11	16	25
36"	45"	29"	8	11	16	25
42"	53"	34"	7	11	16	25
48"	60"	38"	7	11	16	25
54"	68"	43"	7	11	16	25
60"	76"	48"	7	10	15	24
66"	83"	53"	7	10	15	24
72"	91"	58"	6	10	15	24
78"	98"	63"	6	10	15	24
84"	106"	68"	6	10	15	24
90"	113"	72"	6	10	15	24
96"	121"	77"	5	9	15	24
102"	128"	82"	5	9	14	23
108"	136"	87"	5	9	14	23
114"	143"	92"	5	9	14	23
120"	151"	97"	5	9	14	23

Pipe Class HE II D-Load = 1,000 lbs./ft./ft. (0.01" crack)
 And VE II D-Load = 1,500 lbs./ft./ft. (ultimate)

Pipe Class HE III D-Load = 1,350 lbs./ft./ft. (0.01" crack)
 And VE III D-Load = 2,000 lbs./ft./ft. (ultimate)

Pipe Class HE IV D-Load = 2,000 lbs./ft./ft. (0.01" crack)
 And VE IV D-Load = 3,000 lbs./ft./ft. (ultimate)

Concrete Pipe—Elliptical Dimensions						
Nominal Dimensions				Equiv. Dia. (in)	Area (Sq. Ft.)	Wall Thickness (in.)
Horiz.		Vert.				Classes HE II, III, IV VE II, III, IV
Rise (in.)	Span (in.)	Rise (in.)	Span (in.)			
12	18	18	12	15	1.3	2 1/2
14	23	23	14	18	1.8	2 3/4
19	30	30	19	24	3.3	3 1/4
24	38	38	24	30	5.1	3 3/4
29	45	45	29	36	7.4	4 1/2
34	53	53	34	42	10.2	5
38	60	60	38	48	12.9	5 1/2
43	68	68	43	54	16.6	6
48	76	76	48	60	20.5	6 1/2
53	83	83	53	66	24.8	7
58	91	91	58	72	29.5	7 1/2
63	98	98	63	78	34.6	8
68	106	106	68	84	40.1	8 1/2
72	113	113	72	90	46.1	9
77	121	121	77	96	52.4	9 1/2
82	128	128	82	102	59.2	10
87	136	136	87	108	66.4	10 1/2
92	143	143	92	114	74	11
97	151	151	97	120	82	11 1/2
* For Informational Purposes Only.						

Plastic Pipe

Minimum Cover

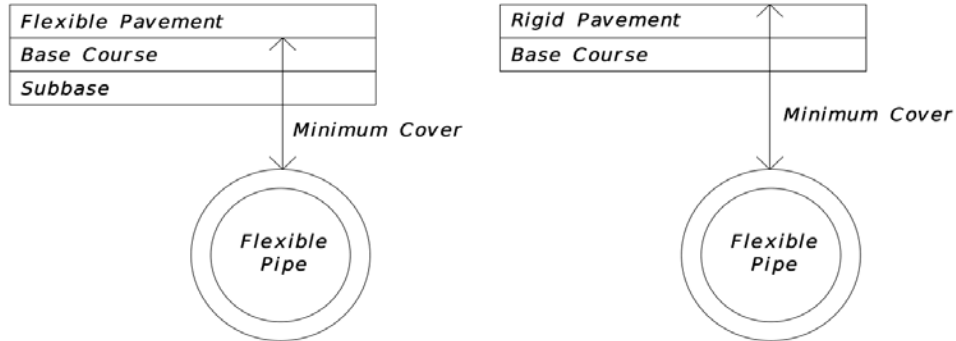

Note: Unpaved areas have a minimum cover of 12 inches

Pipe Type & Size	Minimum Cover (in)
Corrugated Polyethylene	
12" - 48"	24
60"	30
Corrugated Polypropylene	
12" - 48"	24
60"	30
Corrugated Polyvinylchloride	24

Pipe Type & Size	Minimum Cover (in)
Steel Reinforced Polyethylene	
30" - 60"	12
66" - 72"	18
84" - 96"	24
108"	30
120"	36

Maximum Cover

Corrugated Polyethylene Pipe	
Diameter	Max Cover (ft)
12"	19
15"	20
18"	17
24"	13
30"	13
36"	14
42"	13
48"	12
60"	13

Corrugated Polypropylene Pipe	
Diameter	Max Cover (ft)
12"	21
15"	22
18"	19
24"	16
30"	19
36"	16
42"	15
48"	15
60"	16

Corrugated Polyvinylchloride Pipe	
Diameter	Max Cover (ft)
12"	42
15"	45
18"	42
21"	41
24"	41
30"	40
36"	40

Steel Reinforced Polyethylene Pipe	
Diameter	Max Cover (ft)
30"-42"	50
48"-96"	30
108"-120"	25

Corrugated Aluminum Pipe

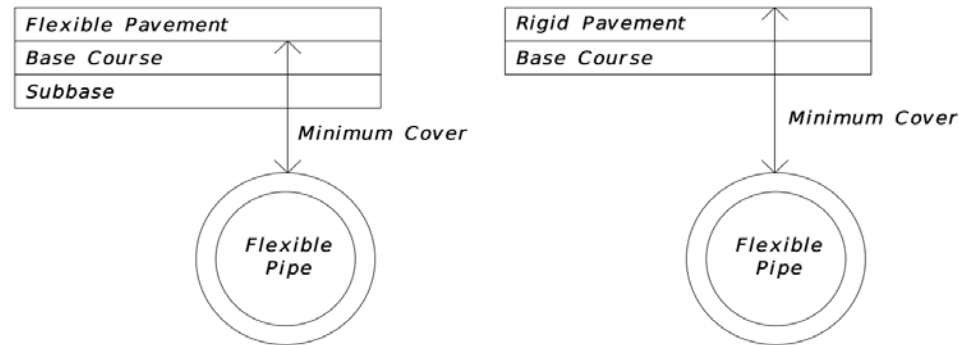

Aluminum—Round Pipe—2 2/3" x 1/2" Corrugation											
D (in.)	Area (sq. ft.)	Minimum Cover (in.)					Maximum Cover (ft.)				
		Sheet thickness in Inches (Gage)					Sheet thickness in Inches (Gage)				
		0.06 (16)	0.075 (14)	0.105 (12)	0.135 (10)	0.164 (8)	0.06 (16)	0.075 (14)	0.105 (12)	0.135 (10)	0.164 (8)
12	0.8	12	12	NA	NA	NA	100+	100+	NA	NA	NA
15	1.2	12	12	NA	NA	NA	100+	100+	NA	NA	NA
18	1.8	12	12	12	NA	NA	83	100+	100+	NA	NA
21	2.4	12	12	12	NA	NA	71	89	100+	NA	NA
24	3.1	12	12	12	NA	NA	62	78	100+	NA	NA
30	4.9	12	12	12	NA	NA	50	62	87	NA	NA
36	7.1	NS	12	12	12	NA	NS	52	73	94	NA
42	9.6	NS	NS	12	12	NA	NS	NS	62	80	NA
48	12.6	NS	NS	12	12	12	NS	NS	54	70	86
54	15.9	NS	NS	NS	12	12	NS	NS	NS	62	76
60	19.6	NS	NS	NS	NS	NS	NS	NS	NS	NS	NS
66	23.8	NS	NS	NS	NS	NS	NS	NS	NS	NS	NS
72	28.3	NS	NS	NS	NS	NS	NS	NS	NS	NS	NS

Aluminum—Round Pipe—3" x 1" Corrugation											
D (in.)	Area (sq. ft.)	Minimum Cover (in.)					Maximum Cover (ft.)				
		Sheet thickness in Inches (Gage)					Sheet thickness in Inches (Gage)				
		0.06 (16)	0.075 (14)	0.105 (12)	0.135 (10)	0.164 (8)	0.06 (16)	0.075 (14)	0.105 (12)	0.135 (10)	0.164 (8)
36	7.1	12	12	12	NA	NA	47	60	84	NA	NA
42	9.6	12	12	12	NA	NA	40	51	72	NA	NA
48	12.6	12	12	12	12	NA	35	44	62	84	NA
54	15.9	12	12	12	12	NA	31	39	55	74	NA
60	19.6	12	12	12	12	NA	28	35	50	67	NA
66	23.8	12	12	12	12	12	25	32	45	61	72
72	28.3	NS	12	12	12	12	NS	29	41	55	65
78	33.2	NS	12	12	12	12	NS	26	38	51	60
84	38.5	NS	NS	12	12	12	NS	NS	35	47	56
90	44.2	NS	NS	12	12	12	NS	NS	32	44	52
96	50.3	NS	NS	12	12	12	NS	NS	30	41	48
102	56.7	NS	NS	NS	13	13	NS	NS	NS	38	45
108	63.6	NS	NS	NS	NS	NS	NS	NS	NS	NS	NS
114	70.9	NS	NS	NS	NS	NS	NS	NS	NS	NS	NS
120	78.5	NS	NS	NS	NS	NS	NS	NS	NS	NS	NS

Aluminum—Round Pipe—Spiral Rib									
Rib Spacing (3/4" x 3/4" x 7 1/2")									
D (in.)	Area (sq. ft.)	Minimum Height of Fill (in.)				Maximum Height of Fill (ft.)			
		Sheet thickness in Inches (Gage)				Sheet thickness in Inches (Gage)			
		0.06 (16)	0.075 (14)	0.105 (12)	0.135 (10)	0.06 (16)	0.075 (14)	0.105 (12)	0.135 (10)
12	0.79	NA	NA	NA	NA	NA	NA	NA	NA
15	1.23	12	12	NA	NA	53	73	NA	NA
18	1.77	12	12	NA	NA	44	61	NA	NA
21	2.4	12	12	NA	NA	38	52	NA	NA
24	3.14	12	12	NA	NA	33	45	NA	NA
30	4.91	15	15	15	NA	26	36	59	NA
36	7.1	24	18	18	NA	*21	30	49	NA
42	9.6	NS	21	21	NA	NS	*25	41	NA
48	12.6	NS	NS	24	24	NS	NS	36	51
54	16	NS	NS	24	24	NS	NS	32	45
60	19.6	NS	NS	24	24	NS	NS	*28	41
66	23.8	NS	NS	NS	24	NS	NS	NS	37

* Special installation required. Refer to AASHTO Standard Specifications for Highway Bridges or ASTM B788-88 and manufacturer's recommendations.

Corrugated Steel Round

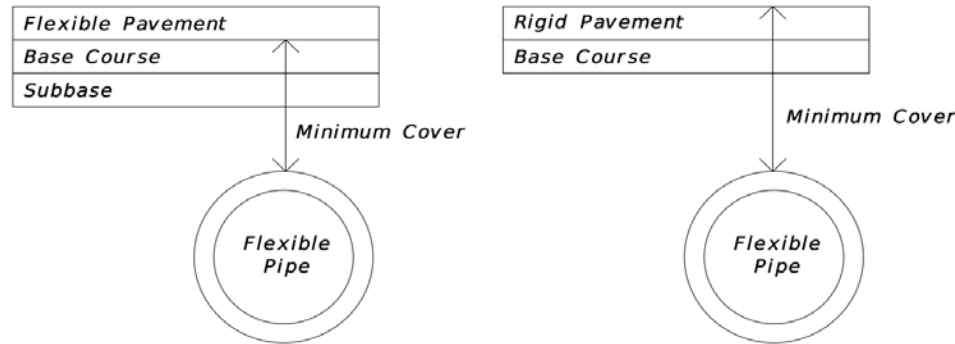

Steel—Round Pipe—2 2/3" x 1/2" Corrugation											
D (in.)	Area (sq. ft.)	Minimum Cover (in.)					Maximum Cover (ft.)				
		Sheet thickness in Inches (Gage)					Sheet thickness in Inches (Gage)				
		0.064 (16)	0.079 (14)	0.109 (12)	0.138 (10)	0.168 (8)	0.064 (16)	0.079 (14)	0.109 (12)	0.138 (10)	0.168 (8)
12	0.79	12	12	NA	NA	NA	100+	100+	NA	NA	NA
15	1.23	12	12	NA	NA	NA	100+	100+	NA	NA	NA
18	1.77	12	12	12	NA	NA	100+	100+	100+	NA	NA
21	2.4	12	12	12	NA	NA	100+	100+	100+	NA	NA
24	3.14	12	12	12	NA	NA	100+	100+	100+	NA	NA
30	4.91	12	12	12	NA	NA	82	100+	100+	NA	NA
36	7.1	12	12	12	12	NA	68	86	100+	100+	NA
42	9.6	12	12	12	12	NA	51	73	100+	100+	NA
48	12.6	12	12	12	12	12	40	64	90	100+	100+
54	16	12	12	12	12	12	NS	57	80	100+	100+
60	19.6	NS	NS	12	12	12	NS	NS	72	93	100+
66	23.8	NS	NS	12	12	12	NS	NS	NS	84	100+
72	28.3	NS	NS	NS	12	12	NS	NS	NS	77	94
78	33.2	NS	NS	NS	NS	12	NS	NS	NS	NS	87
84	38.5	NS	NS	NS	NS	12	NS	NS	NS	NS	80

Steel—Round Pipe—3" x 1" Corrugation											
D (in.)	Area (sq. ft.)	Minimum Cover (in.)					Maximum Cover (ft.)				
		Sheet thickness in Inches (Gage)					Sheet thickness in Inches (Gage)				
		0.064 (16)	0.079 (14)	0.109 (12)	0.138 (10)	0.168 (8)	0.064 (16)	0.079 (14)	0.109 (12)	0.138 (10)	0.168 (8)
36	7.1	12	12	12	NA	NA	79	99	100+	NA	NA
42	9.6	12	12	12	NA	NA	67	84	100+	NA	NA
48	12.6	12	12	12	12	NA	59	74	100+	100+	NA
54	16	12	12	12	12	NA	52	65	92	100+	NA
60	19.6	12	12	12	12	NA	47	59	83	100+	NA
66	23.8	12	12	12	12	12	42	53	75	97	100
72	28.3	12	12	12	12	12	38	48	69	89	100
78	33.2	12	12	12	12	12	35	45	63	82	100
84	38.5	12	12	12	12	12	33	41	58	76	93
90	44.2	12	12	12	12	12	30	38	54	70	87
96	50.3	NS	12	12	12	12	NS	36	51	66	81
102	56.7	NS	13	13	13	13	NS	33	48	62	76
108	63.6	NS	NS	14	14	14	NS	NS	45	58	72
114	70.9	NS	NS	15	15	15	NS	NS	42	55	68
120	78.5	NS	NS	15	15	15	NS	NS	40	52	64
132	95	NS	NS	NS	17	17	NS	NS	NS	47	58

Steel—Round Pipe—Spiral Rib Rib Spacing 3/4" x 3/4" x 7 1/2"									
D (in.)	Area (sq. ft.)	Minimum Cover (in.)				Maximum Cover (ft.)			
		Sheet thickness in Inches (Gage)				Sheet thickness in Inches (Gage)			
		0.064 (16)	0.079 (14)	0.109 (12)	0.138 (10)	0.064 (16)	0.079 (14)	0.109 (12)	0.138 (10)
12	0.79	NA	NA	NA	NA	NA	NA	NA	NA
15	1.23	NA	NA	NA	NA	NA	NA	NA	NA
18	1.77	12	12	NA	NA	90	100+	NA	NA
21	2.4	12	12	12	NA	77	100+	100+	NA
24	3.14	12	12	12	12	68	95	100+	100+
30	4.91	12	12	12	12	54	76	100+	100+
36	7.1	12	12	12	12	45	63	100+	100+
42	9.6	12	12	12	12	38	54	90	100+
48	12.6	12	12	12	12	33	47	78	100+
54	16	14	14	14	14	29	41	70	100+
60	19.6	NS	15	15	15	NS	37	62	91
66	23.8	NS	17	17	17	NS	33	57	83
72	28.3	NS	NS	18	18	NS	NS	52	76
78	33.5	NS	NS	20	20	NS	NS	48	70
84	38.5	NS	NS	21	21	NS	NS	44	64
90	44.2	NS	NS	NS	23	NS	NS	NS	60
96	50.3	NS	NS	NS	NS	NS	NS	NS	NS
102	56.7	NS	NS	NS	NS	NS	NS	NS	NS
108	63.6	NS	NS	NS	NS	NS	NS	NS	NS

Corrugated Aluminum Pipe Arch

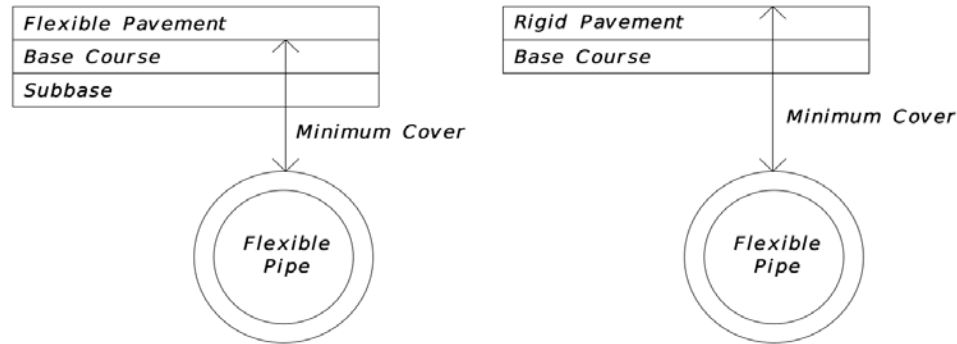

Aluminum—Pipe Arch—2 2/3" x 1/2" Corrugation												
Equivalent Diameter D (in.)	Span in.	Rise in.	Minimum Cover (in.)					Maximum Cover (ft)				
			Sheet thickness in Inches (Gage)					Sheet thickness in Inches (Gage)				
			0.06 (16)	0.075 (14)	0.105 (12)	0.135 (10)	0.164 (8)	0.06 (16)	0.075 (14)	0.105 (12)	0.135 (10)	0.164 (8)
15	17	13	33	28	28	28	28	12	12	12	12	12
18	21	15	30	30	30	30	30	11	11	11	11	11
21	24	18	27	27	27	27	27	12	12	12	12	12
24	28	20	29	29	29	29	29	11	11	11	11	11
30	35	24	NS	29	29	29	29	NS	11	11	11	11
36	42	29	NS	30	30	30	30	NS	11	11	11	11
42	49	33	NS	NS	30	30	30	NS	NS	11	11	11
48	57	38	NS	NS	NS	NS	NS	NS	NS	NS	NS	NS
54	64	43	NS	NS	NS	NS	NS	NS	NS	NS	NS	NS
60	71	47	NS	NS	NS	NS	NS	NS	NS	NS	NS	NS

Aluminum—Pipe Arch—3" x 1" Corrugation												
Equivalent Diameter D (in.)	Span in.	Rise in.	Minimum Cover (in.)					Maximum Cover (ft)				
			Sheet thickness in Inches (Gage)					Sheet thickness in Inches (Gage)				
			0.06 (16)	0.075 (14)	0.105 (12)	0.135 (10)	0.164 (8)	0.06 (16)	0.075 (14)	0.105 (12)	0.135 (10)	0.164 (8)
48	53	41	12	12	12	12	12	20	20	20	20	20
54	60	46	12	12	12	12	12	20	20	20	20	20
60	66	51	12	12	12	12	12	20	20	20	20	20
66	73	55	NS	12	12	12	12	NS	20	20	20	20
72	81	59	NS	NS	12	12	12	NS	NS	16	16	16
78	87	63	NS	NS	12	12	12	NS	NS	16	16	16
84	95	67	NS	NS	12	12	12	NS	NS	16	16	16
90	103	71	NS	NS	NS	13	13	NS	NS	NS	15	15
96	112	75	NS	NS	NS	NS	NS	NS	NS	NS	NS	NS
102	117	79	NS	NS	NS	NS	NS	NS	NS	NS	NS	NS

Aluminum—Pipe Arch—Spiral Rib Rib Spacing (3/4" x 3/4" x 7 1/2")										
Equivalent Diameter D (in.)	Span in.	Rise in.	Minimum Cover (in.)				Maximum Cover (ft)			
			Sheet thickness in Inches (Gage)				Sheet thickness in Inches (Gage)			
			0.06 (16)	0.075 (14)	0.105 (12)	0.135 (10)	0.06 (16)	0.075 (14)	0.105 (12)	0.135 (10)
18	20	16	23	23	23	23	15	15	15	15
21	23	19	24	24	24	24	14	14	14	14
24	27	21	26	26	26	26	12	12	12	12
30	33	26	26	26	26	26	12	12	12	12
36	40	31	27	27	27	27	12	12	12	12
42	46	36	24	24	24	24	12	12	12	12
48	53	41	NS	24	24	24	NS	14	14	14
54	60	46	NS	24	24	24	NS	17	20	20
60	66	51	NS	24	24	24	NS	17	20	20
66	73	55	NS	NS	27	27	NS	NS	20	20

Corrugated Steel Pipe Arch

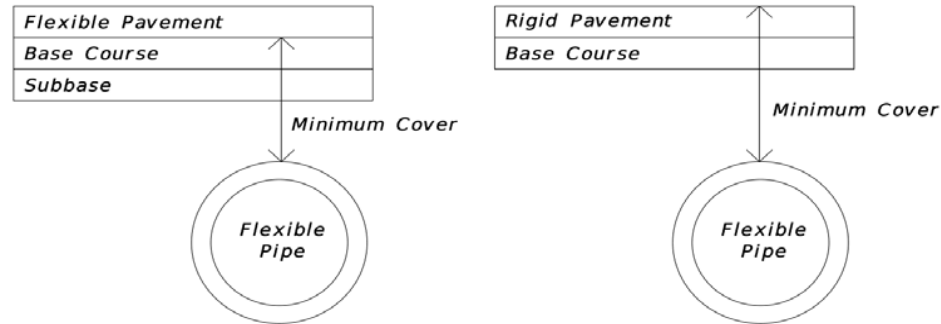

Steel—Pipe Arch—2 2/3" x 1/2" Corrugation												
Equivalent Diameter D (in.)	Span in.	Rise in.	Minimum Cover (in.)					Maximum Cover (ft)				
			Sheet thickness in Inches (Gage)					Sheet thickness in Inches (Gage)				
			0.064 (16)	0.079 (14)	0.109 (12)	0.138 (10)	0.168 (8)	0.064 (16)	0.079 (14)	0.109 (12)	0.138 (10)	0.168 (8)
15	17	13	28	28	28	28	28	12	12	12	12	12
18	21	15	30	30	30	30	30	11	11	11	11	11
21	24	18	27	27	27	27	27	12	12	12	12	12
24	28	20	29	29	29	29	29	11	11	11	11	11
30	35	24	29	29	29	29	29	11	11	11	11	11
36	42	29	30	30	30	30	30	11	11	11	11	11
42	49	33	NS	30	30	30	30	NS	11	11	11	11
48	57	38	NS	NS	23	25	23	NS	NS	11	11	11
54	64	43	NS	NS	20	20	20	NS	NS	11	11	11
60	71	47	NS	NS	NS	22	22	NS	NS	NS	10	10
66	77	52	NS	NS	NS	NS	NS	NS	NS	NS	NS	NS
72	83	57	NS	NS	NS	NS	NS	NS	NS	NS	NS	NS

Steel—Pipe Arch—3" x 1" Corrugation												
Equivalent Diameter D (in.)	Span in.	Rise in.	Minimum Cover (in.)					Maximum Cover (ft)				
			Sheet thickness in Inches (Gage)					Sheet thickness in Inches (Gage)				
			0.064 (16)	0.079 (14)	0.109 (12)	0.138 (10)	0.168 (8)	0.064 (16)	0.079 (14)	0.109 (12)	0.138 (10)	0.168 (8)
48	53	41	12	12	12	12	12	20	20	20	20	20
54	60	46	12	12	12	12	12	20	20	20	20	20
60	66	51	12	12	12	12	12	20	20	20	20	20
66	73	55	12	12	12	12	12	20	20	20	20	20
72	81	59	12	12	12	12	12	16	16	16	16	16
78	87	63	12	12	12	12	12	16	16	16	16	16
84	95	67	NS	12	12	12	12	NS	16	16	16	16
90	103	71	NS	NS	13	13	13	NS	NS	15	15	15
96	112	75	NS	NS	14	14	14	NS	NS	15	15	15
102	117	79	NS	NS	15	15	15	NS	NS	15	15	15
108	128	83	NS	NS	NS	16	16	NS	NS	NS	15	15
114	137	87	NS	NS	NS	18	18	NS	NS	NS	15	15
120	142	91	NS	NS	NS	NS	18	NS	NS	NS	NS	15

Steel—Pipe Arch—Spiral Rib										
Rib Spacing (3/4" x 3/4" x 7 1/2")										
Equivalent Diameter D (in.)	Span in.	Rise in.	Minimum Cover (in.)				Maximum Cover (ft)			
			Sheet thickness in Inches (Gage)				Sheet thickness in Inches (Gage)			
			0.064 (16)	0.079 (14)	0.109 (12)	0.138 (10)	0.064 (16)	0.079 (14)	0.109 (12)	0.138 (10)
18	20	16	23	23	23	23	15	15	15	15
21	23	19	24	24	24	24	14	14	14	14
24	27	21	26	26	26	26	12	12	12	12
30	33	26	26	26	26	26	12	12	12	12
36	40	31	27	27	27	27	12	12	12	12
42	46	36	24	24	24	24	12	12	12	12
48	53	41	NS	18	18	18	NS	12	12	12
54	60	46	NS	15	15	15	NS	20	20	20
60	66	51	NS	NS	17	17	NS	NS	20	20

APPENDIX D

PIPES WITHIN WALLED EMBANKMENT SECTIONS

Wall Zone Criteria

Wall Zone	Requirements	Comments
A	Wall Zone Pipe (see <i>Drainage Manual</i> , Table 6-1)	Not likely to leak and used when probable first indicator of leak is topside settlement or soil loss
B	Wall Zone Pipe. No longitudinal conveyances ² allowed. Transverse conveyances must meet AASHTO LRFD criteria ³	First indicator of leak is wall damage: pipe must endure unique loading with no chance of leakage
C	No pipes allowed	First indicator of leak is bridge/wall damage

Notes

1. Requirements apply to all retaining walls, including those shown in the following sketches. Wall types not shown or project-specific wall designs will incorporate the same restrictions.
2. For the purposes of this table and these figures, a longitudinal conveyance is defined as a pipe run that is aligned with the wall stationing and deviating no more than 45 degrees from the wall alignment. For skewed walls and in the cases where the criteria for longitudinal and transverse directions overlap, e.g., at wall corners, the more stringent criteria must apply.
3. Design pipes in Zone B to provide adequate structural integrity after the expected section loss due to corrosion over the design service life of the pipe. Assume the following:
 - a. 120 lb/cubic feet soil density (moist)
 - b. Pipe trench excavation per Subarticle 125-4.4 of the **Standard Specifications**
 - c. Pipe trench backfill allowable soils, bedding, and compaction per Article 125-8 of the **Standard Specifications**
4. Implement site specific design when a pressurized pipe is placed within, through, under, or immediately adjacent to a retaining wall. This is to assure the design of structural elements takes into consideration support limitations that may be created by the presence of utilities and potential damage or failure of the structure if a pressurized pipe leaks.

5. French Drains are not permitted within any retained earth (walled) embankment sections or wall zones.
6. Hydraulically size drainage pipes to allow for future internal lining.
7. Use two-phased MSE walls, per **SDG 3.12.1.D**, when expecting significant settlement. For two-phased MSE walls, install transverse piping after as much of the settlement as practical has occurred. Coordinate this effort with the Geotechnical Engineer.

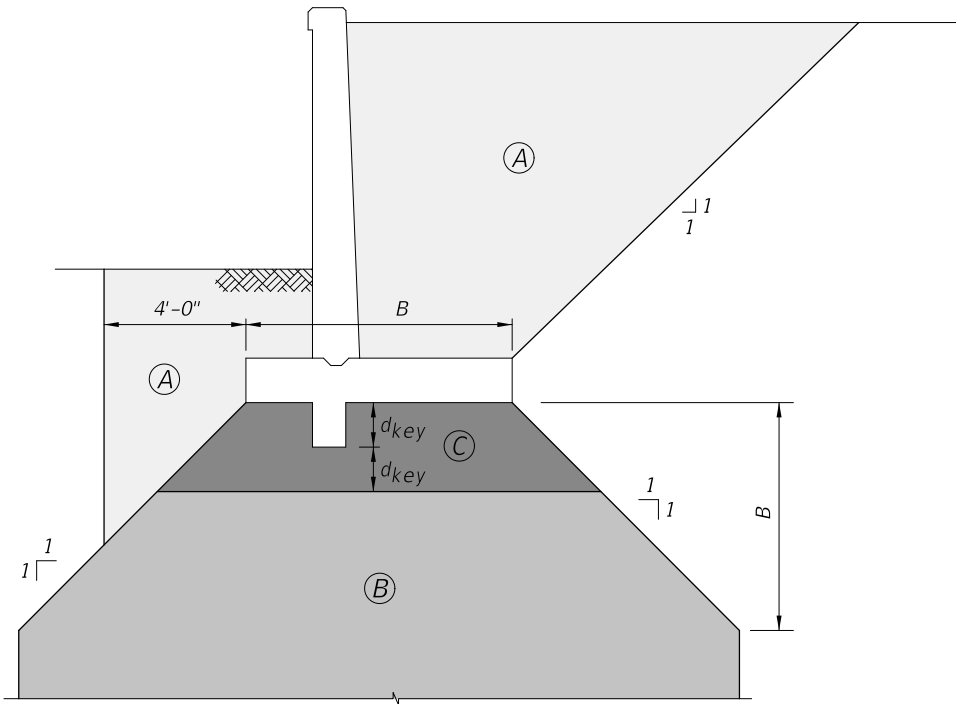

SECTION THRU CAST IN PLACE CANTILEVER RETAINING WALL (INDEX 400-010)

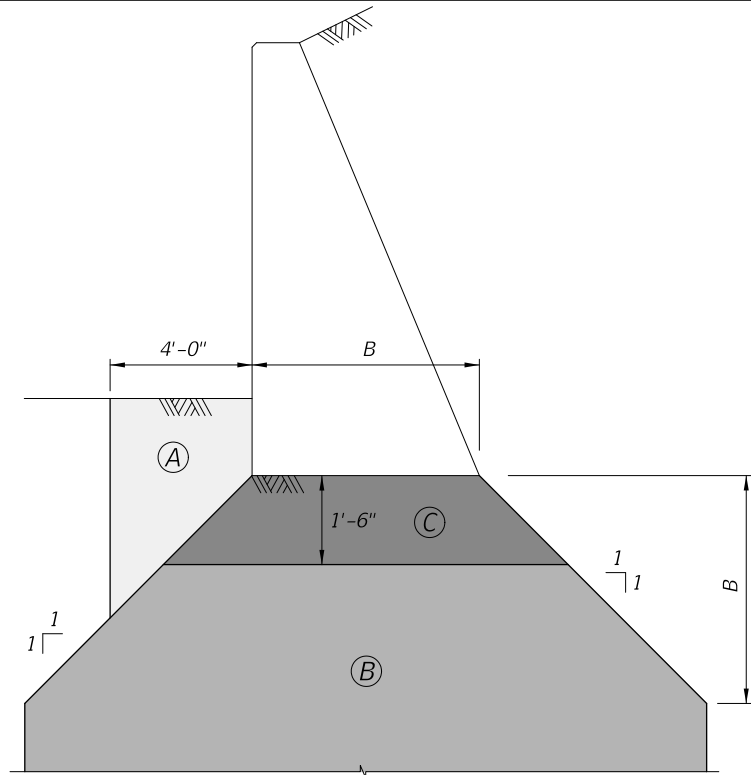

SECTION THRU CAST IN PLACE GRAVITY WALL (INDEX 400-011)

Figure D-1

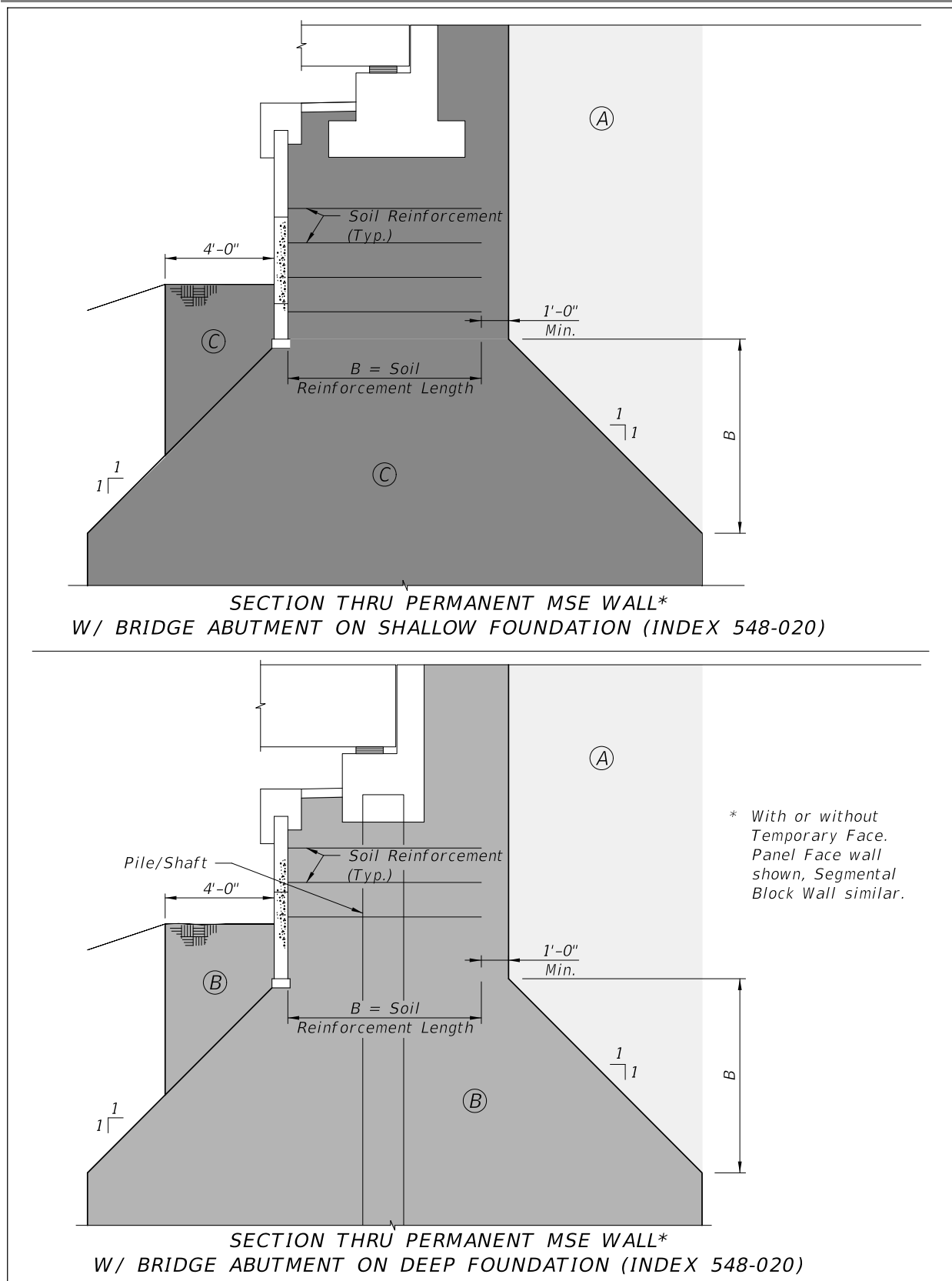

Figure D-2

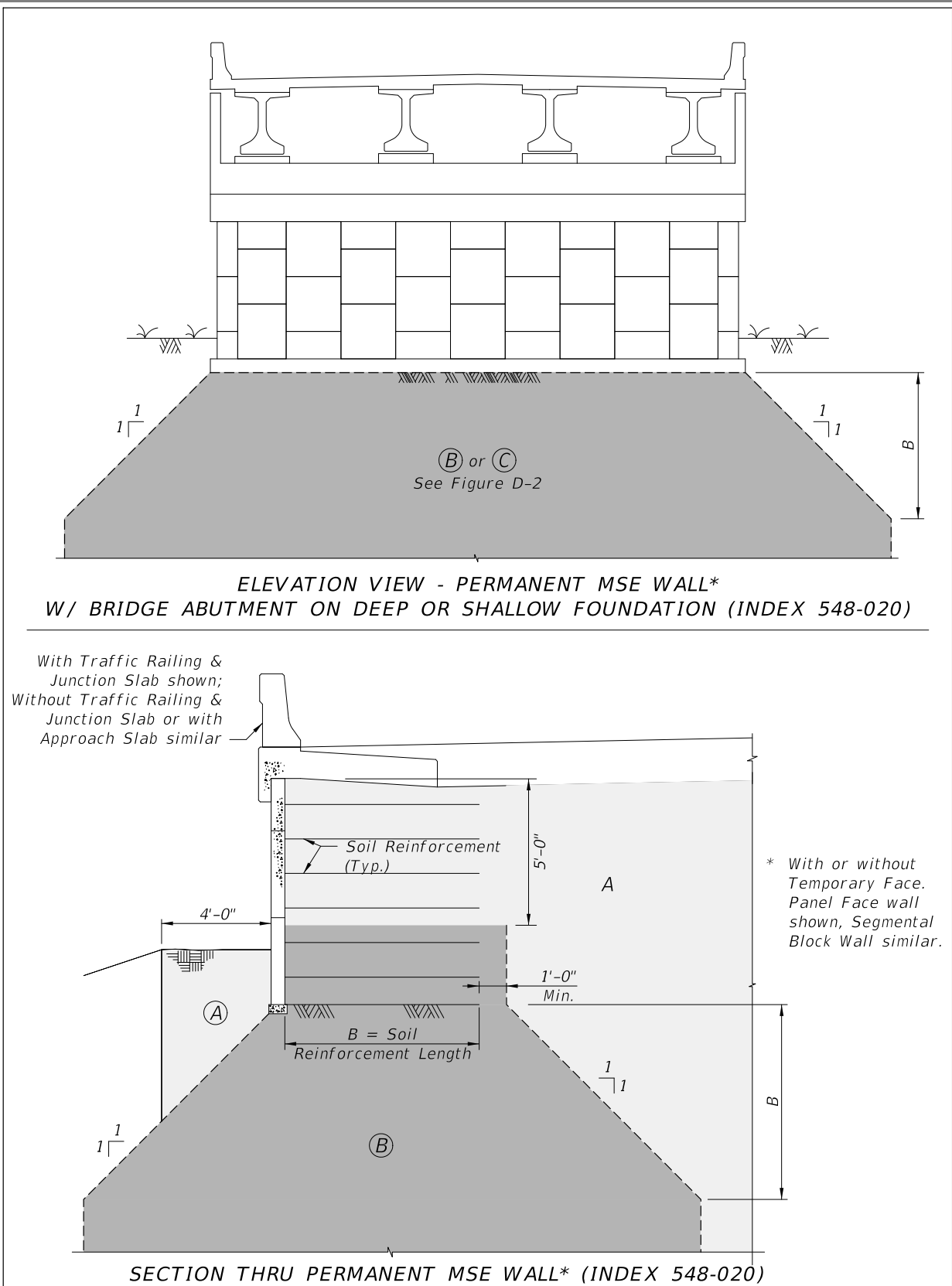

Figure D-3

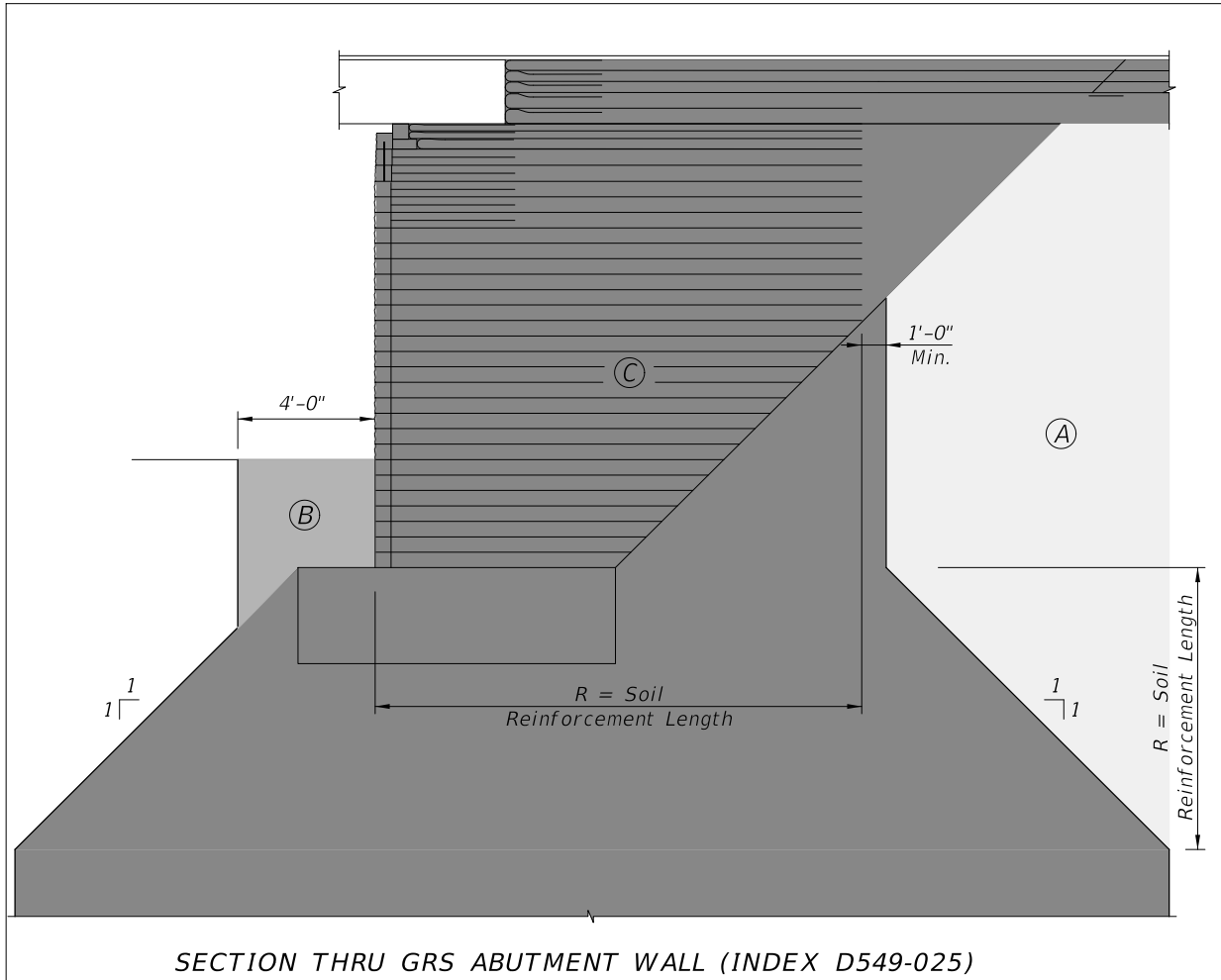

Figure D-4

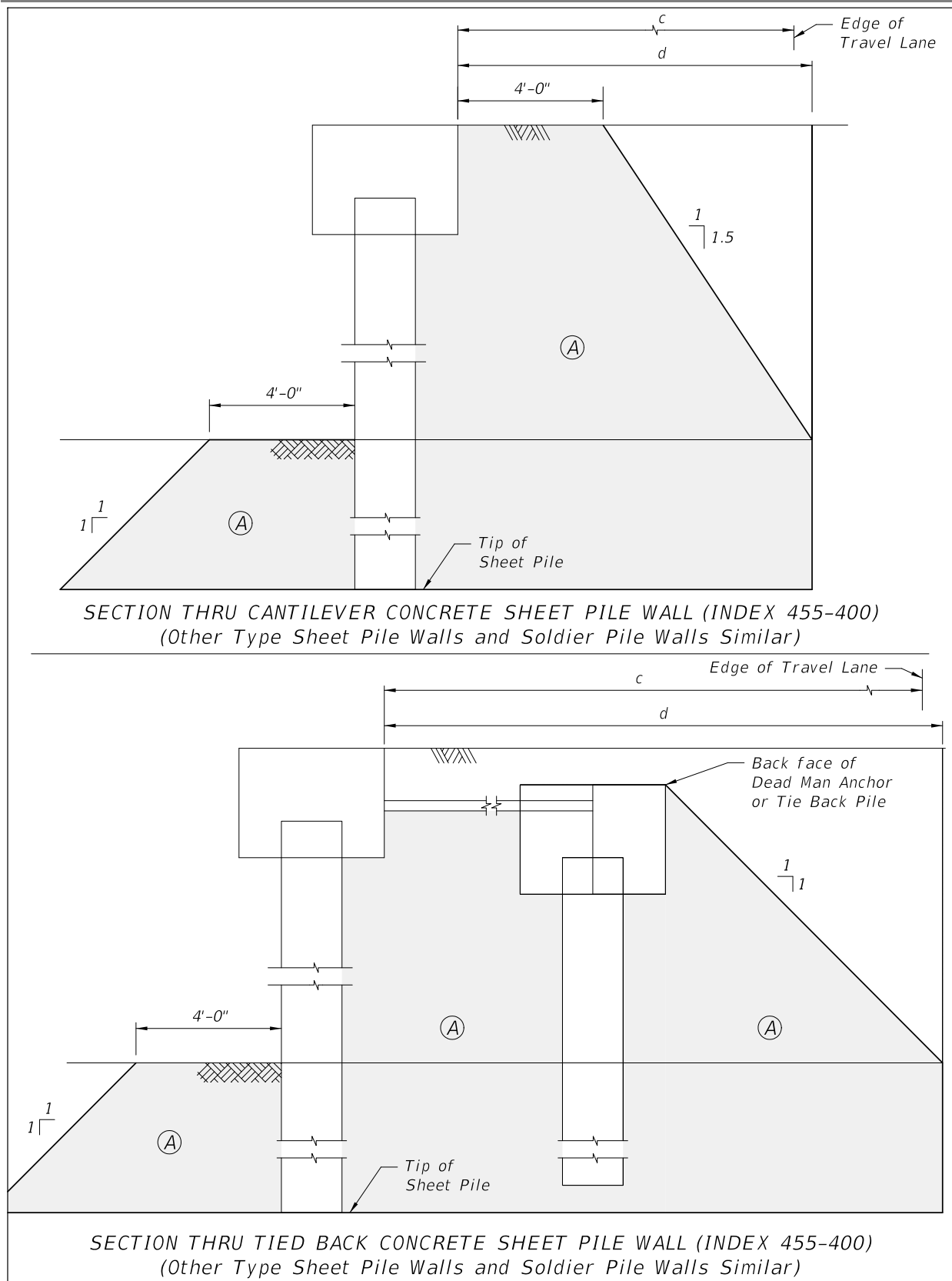

Figure D-5

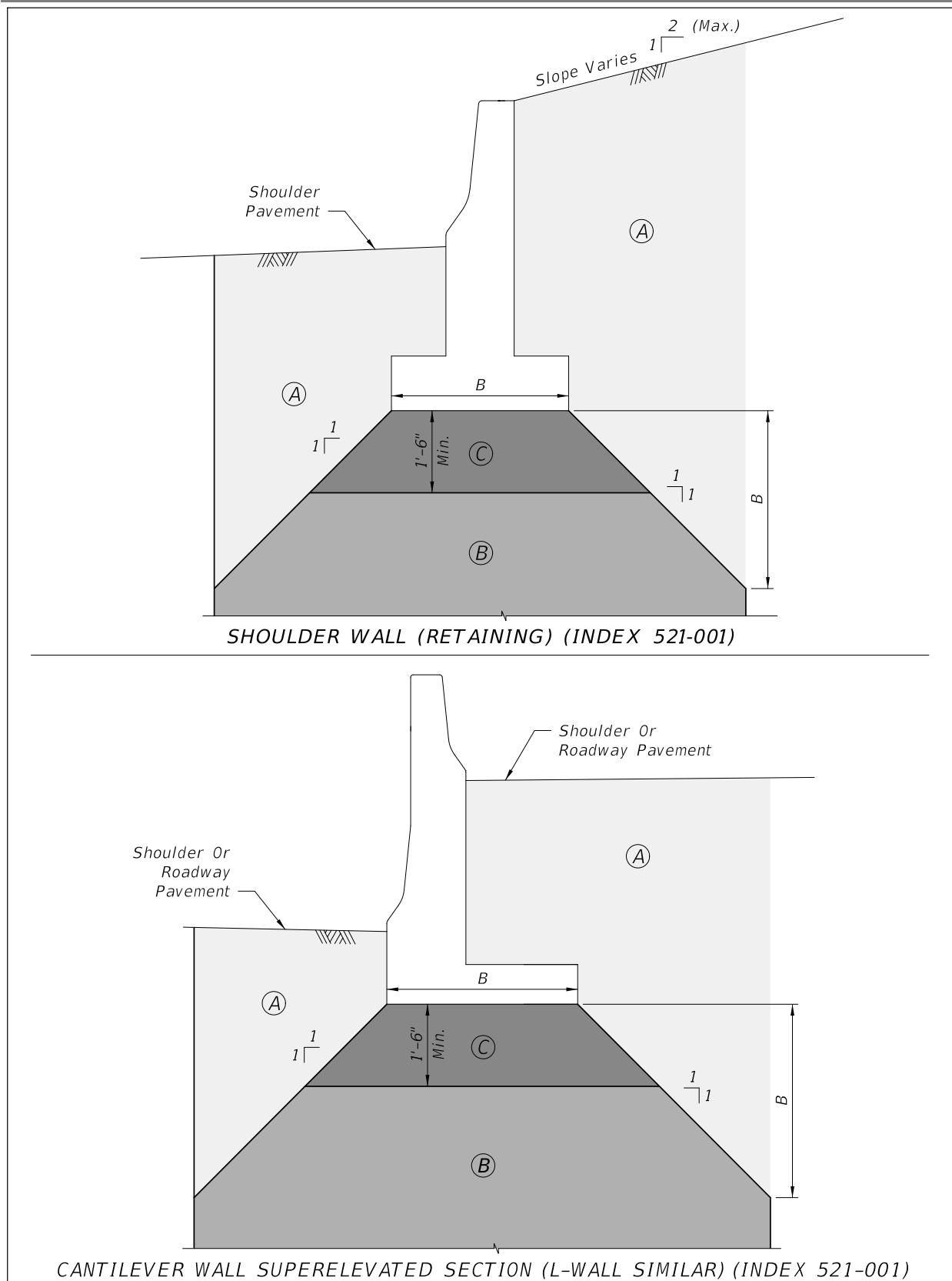

Figure D-6

APPENDIX E

INTENSITY-DURATION-FREQUENCY CURVES

AND FDOT RAINFALL DISTRIBUTIONS

Drainage Manual

IDF Curves

ZONES FOR PRECIPITATION IDF CURVES DEVELOPED BY THE DEPARTMENT

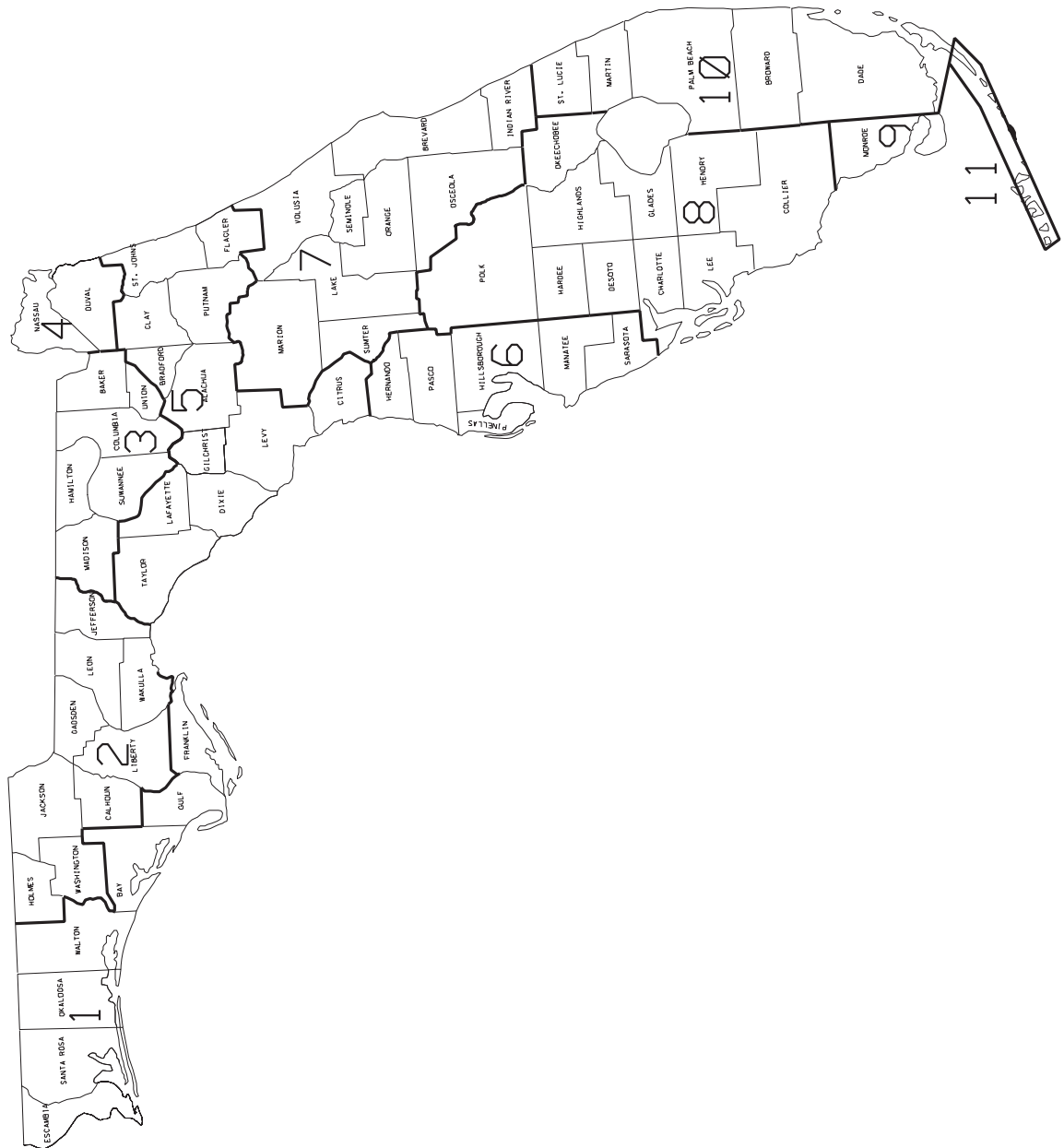

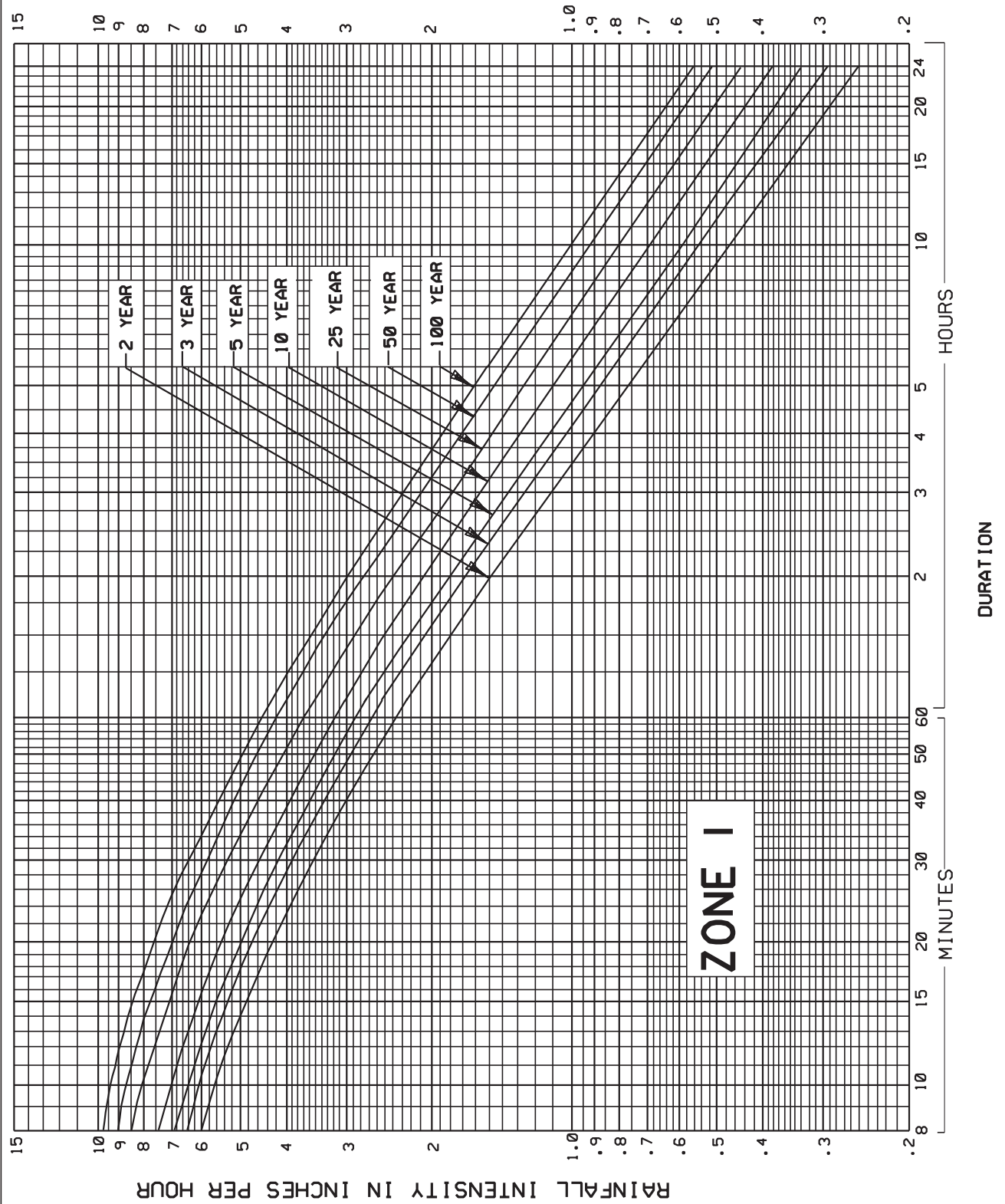

RAINFALL INTENSITY-DURATION-FREQUENCY CURVES
ZONE 1

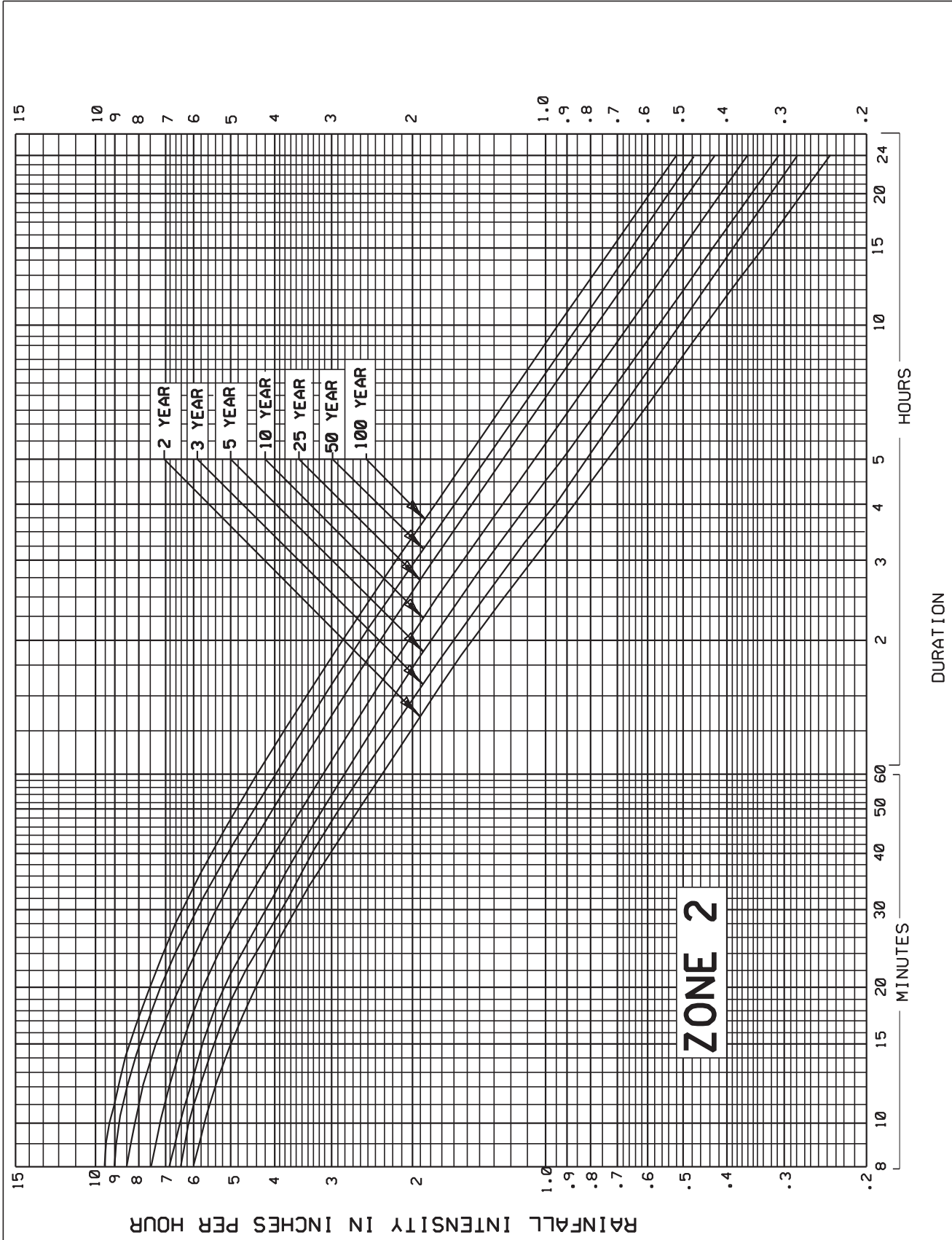

RAINFALL INTENSITY-DURATION-FREQUENCY CURVES
ZONE 2

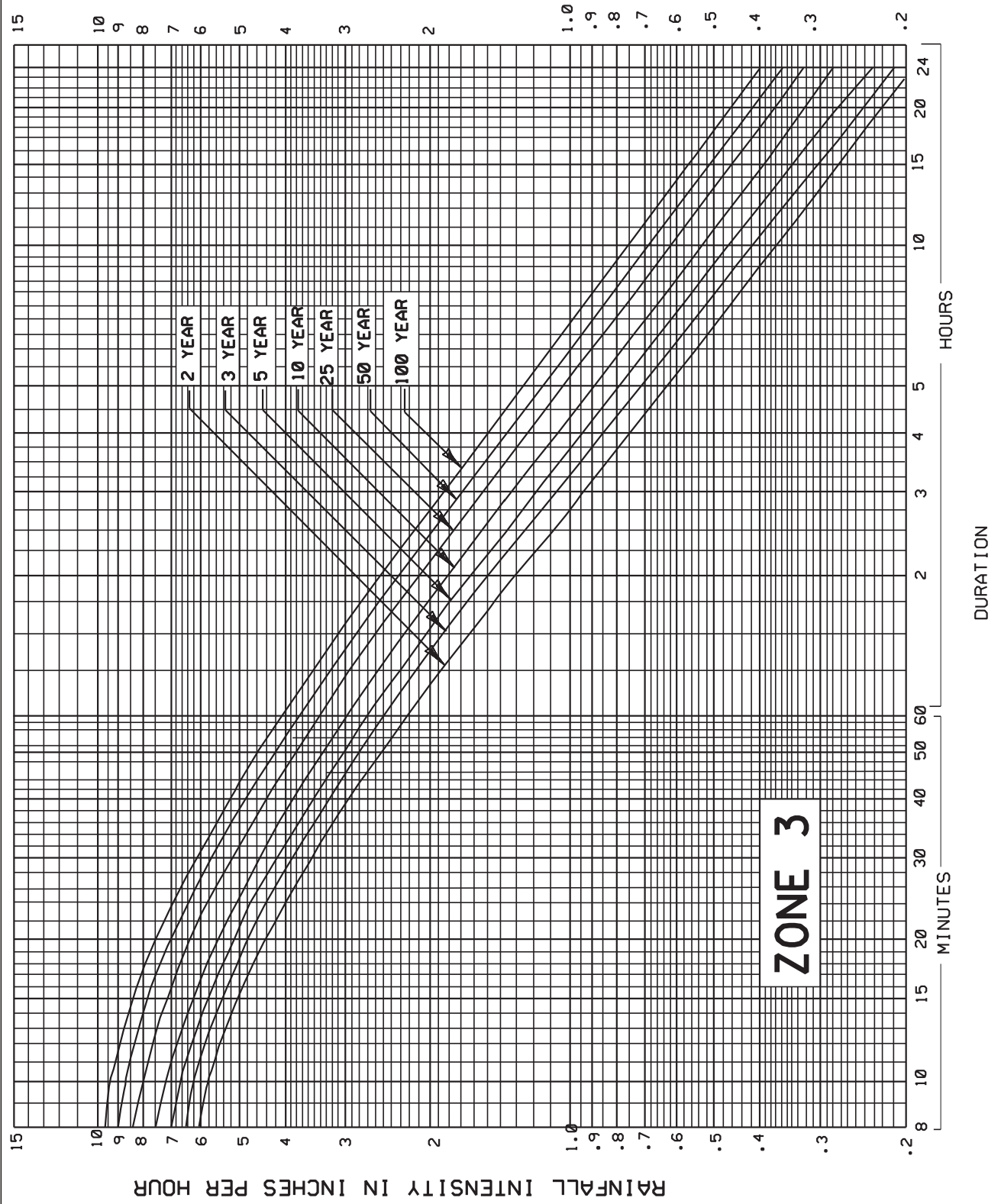

RAINFALL INTENSITY-DURATION-FREQUENCY CURVES

ZONE 3

Drainage Manual
IDF Curves

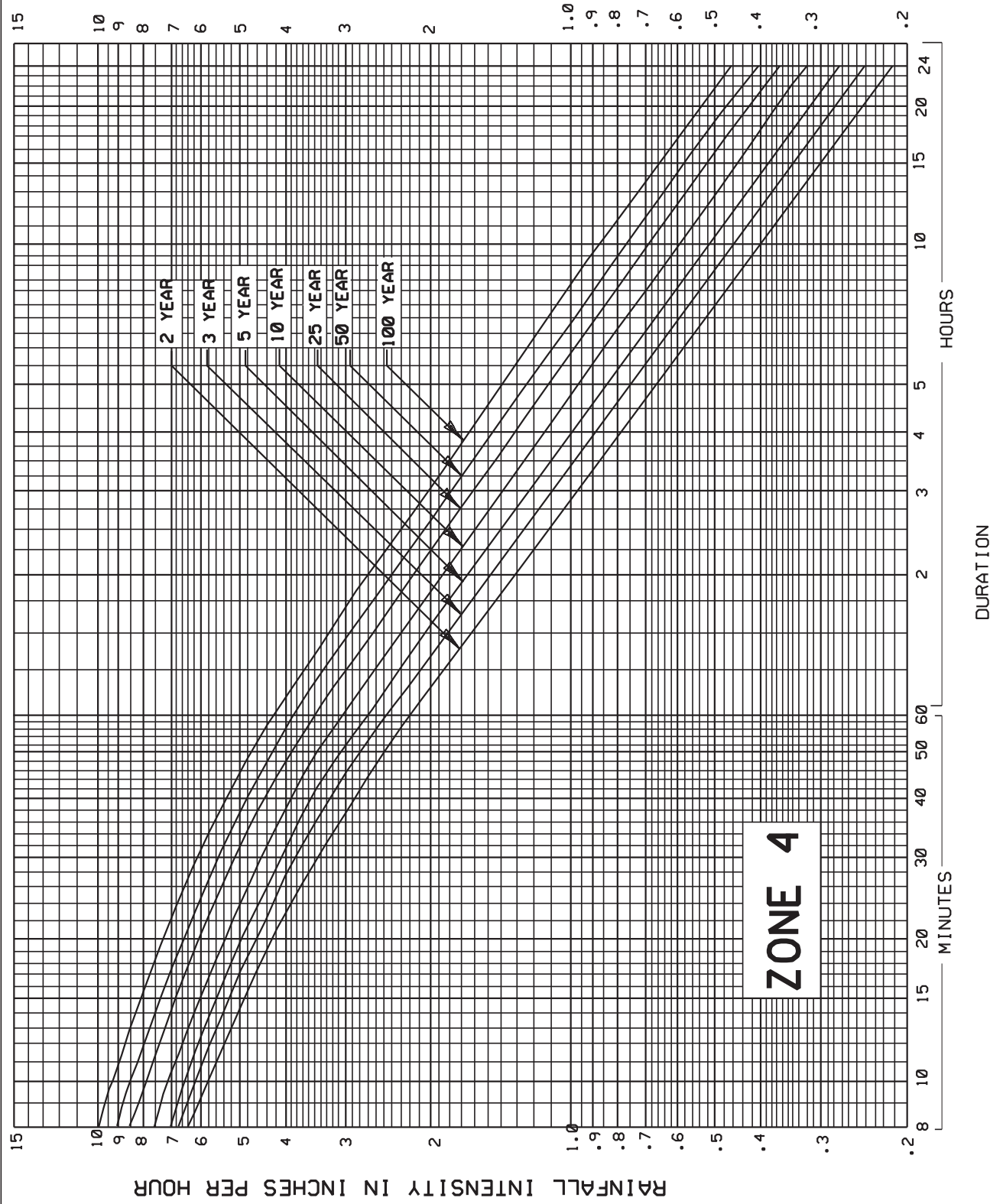

RAINFALL INTENSITY-DURATION-FREQUENCY CURVES
ZONE 4

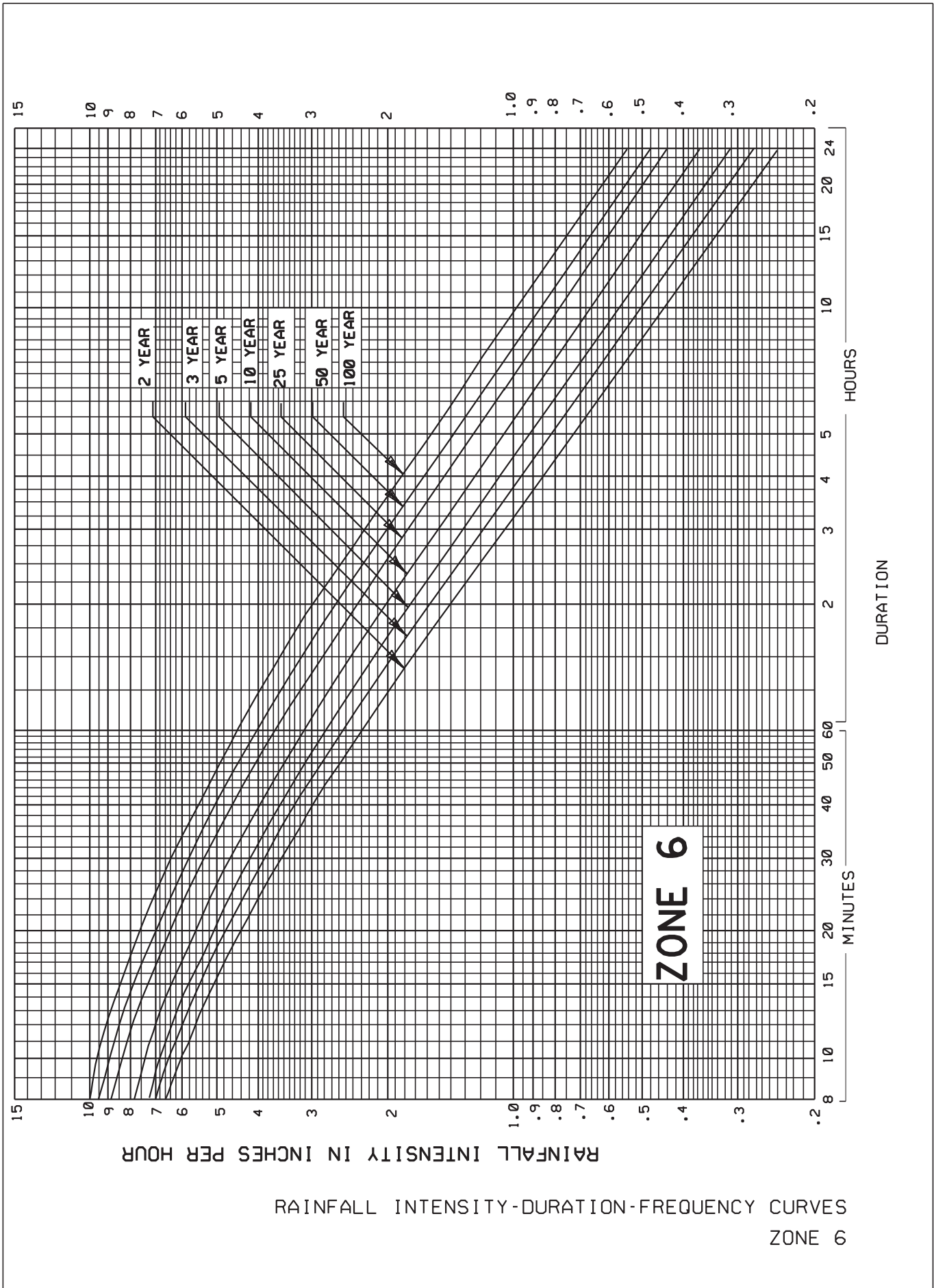

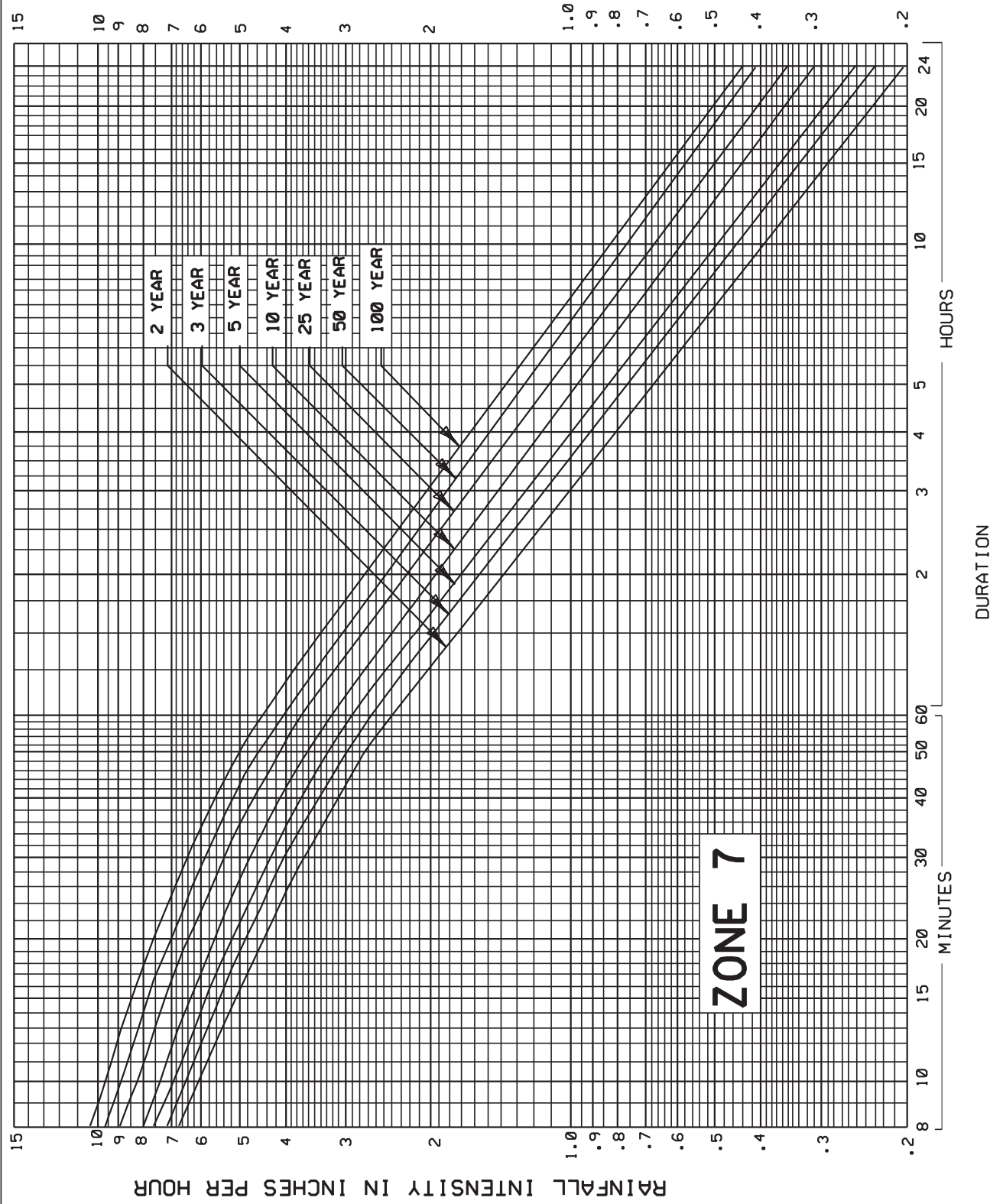

RAINFALL INTENSITY-DURATION-FREQUENCY CURVES
ZONE 7

Drainage Manual
IDF Curves

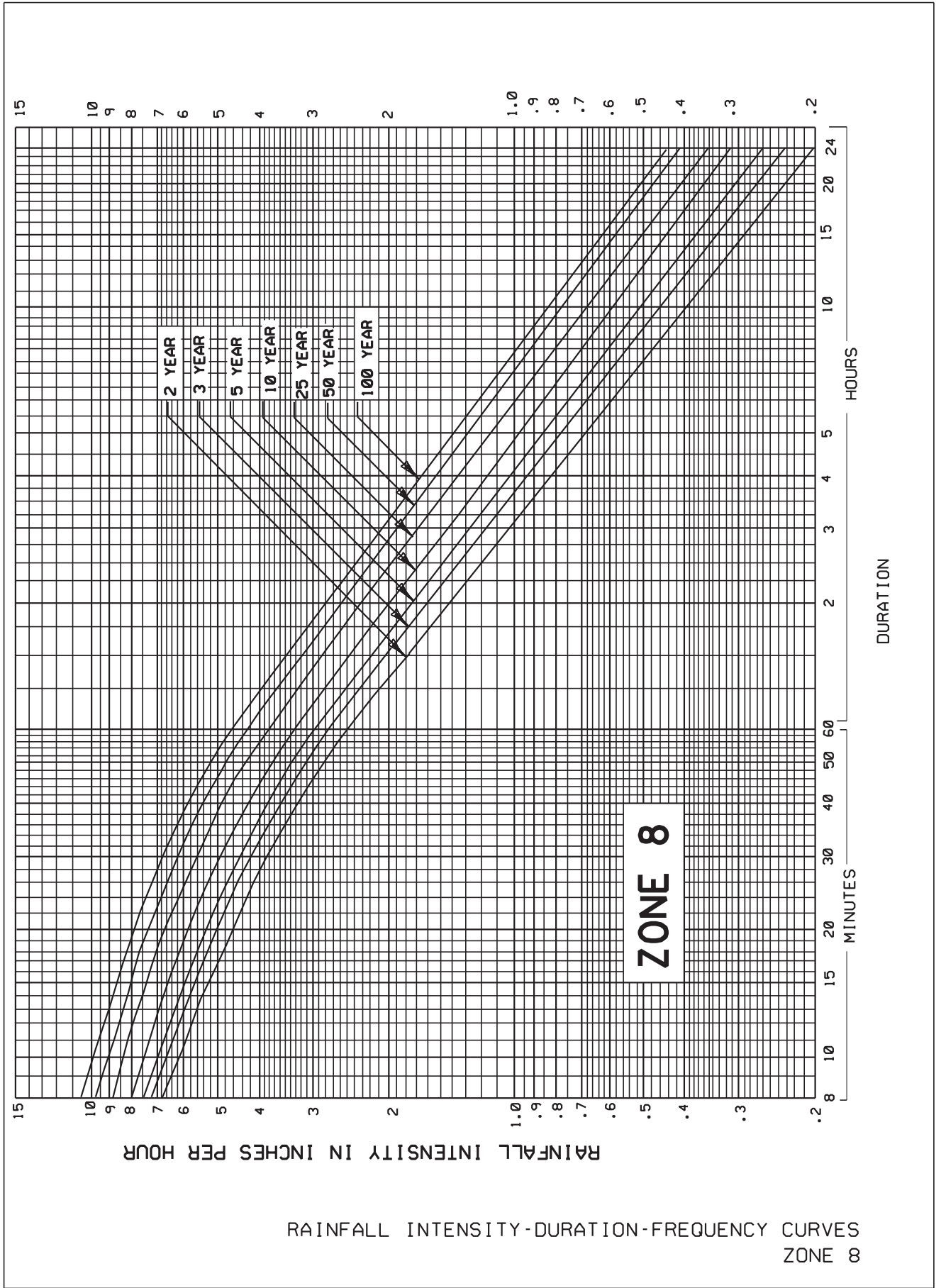

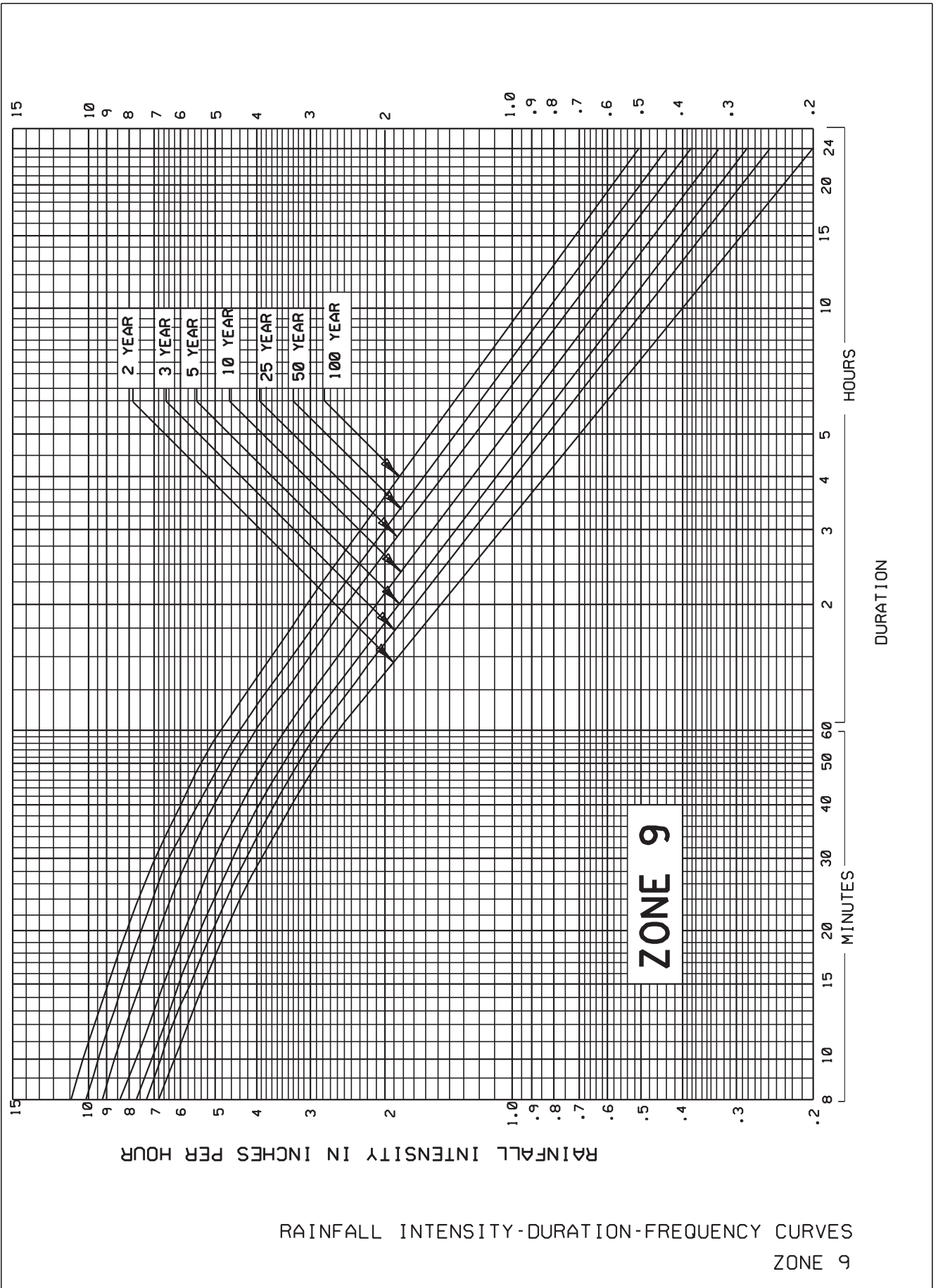

Drainage Manual
IDF Curves

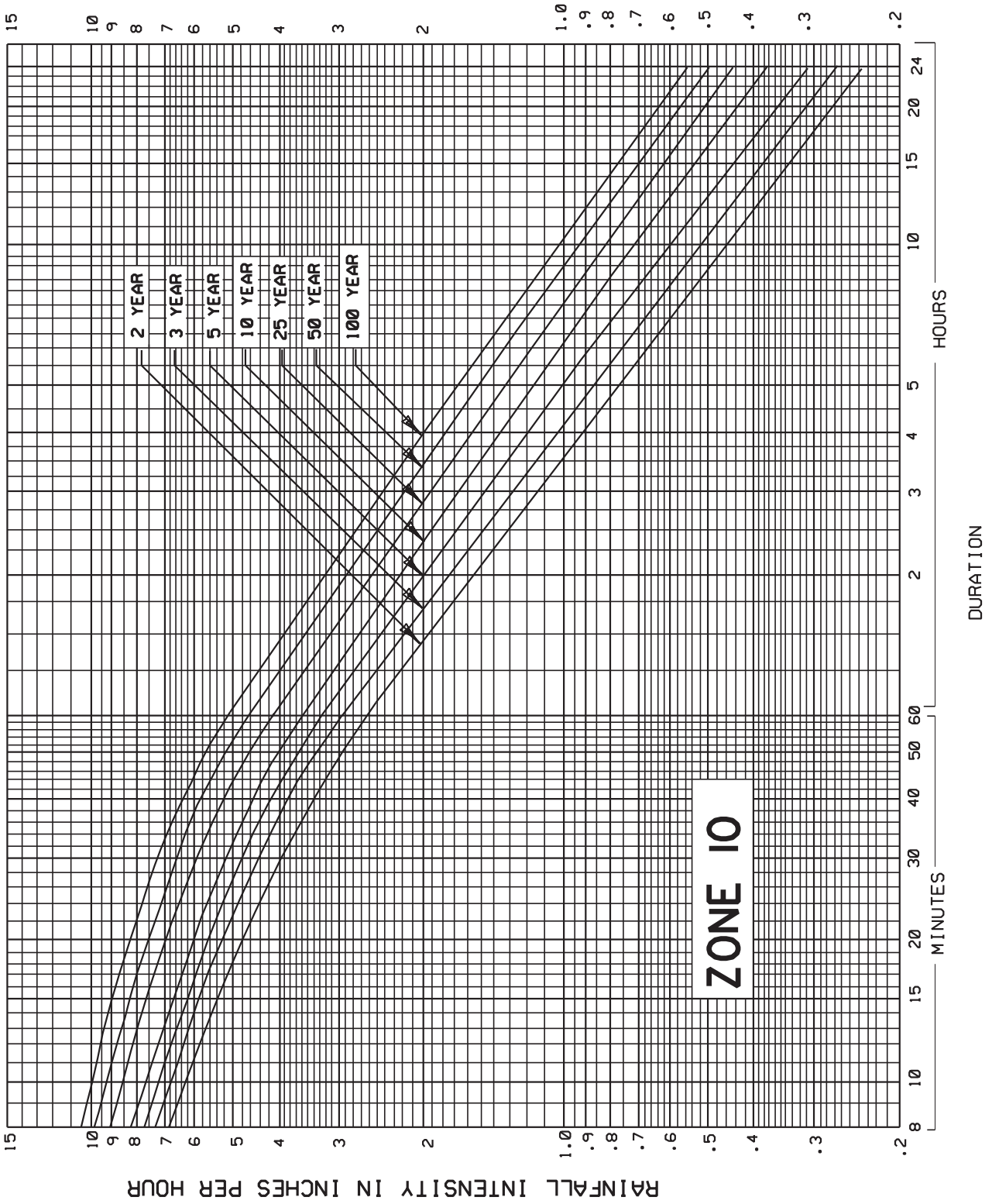

RAINFALL INTENSITY-DURATION-FREQUENCY CURVES
ZONE 10

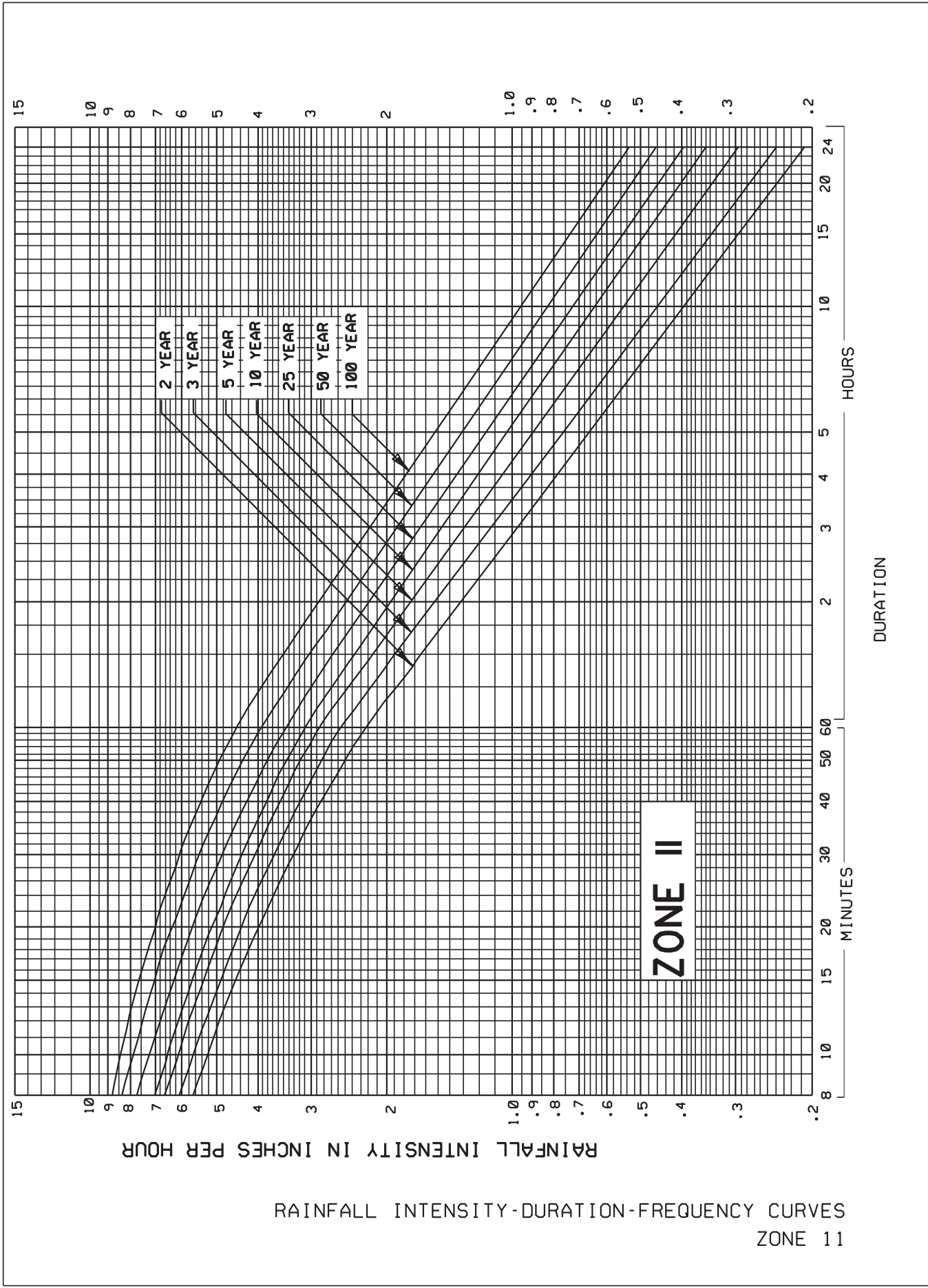

Rainfall Distribution Curves 1 Hour Duration

1 Hour Duration Mass Rainfall Curve

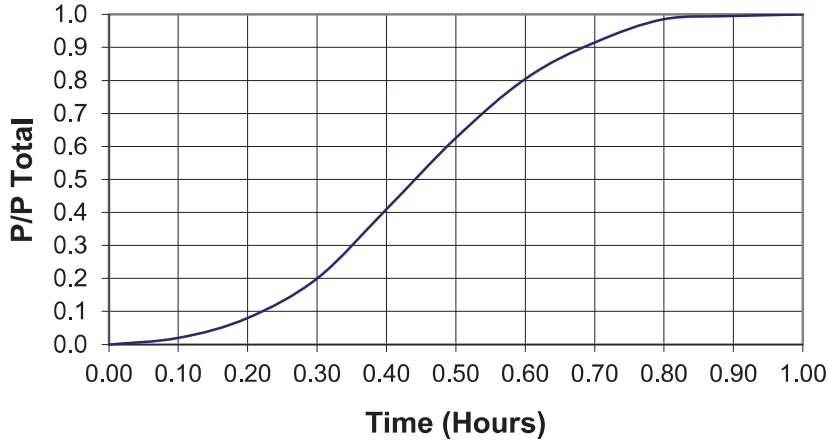

T(hrs)	P/P tot	i/P tot
0.0	0.000	0.000
0.1	0.020	0.200
0.2	0.080	0.600
0.3	0.200	1.200
0.4	0.410	2.100
0.5	0.625	2.150
0.6	0.805	1.800
0.7	0.915	1.100
0.8	0.985	0.700
0.9	0.995	0.100
1.0	1.000	0.000

1 Hour Duration Intensity Curve

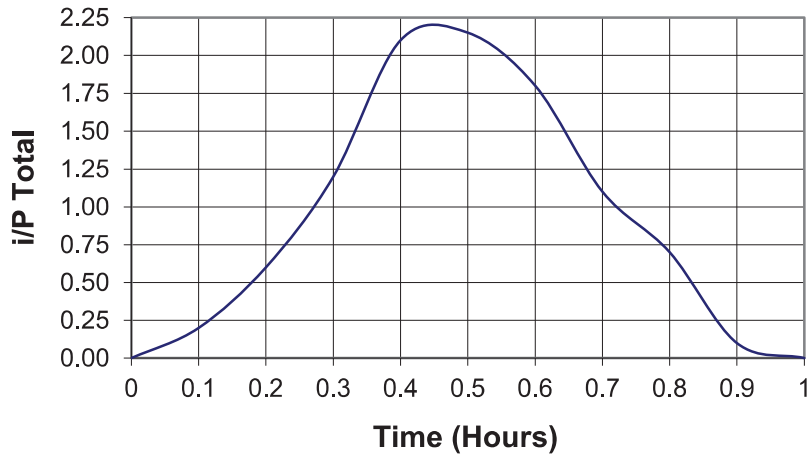

Rainfall Distribution Curves 2 Hour Duration

2 Hour Duration Mass Rainfall Curve

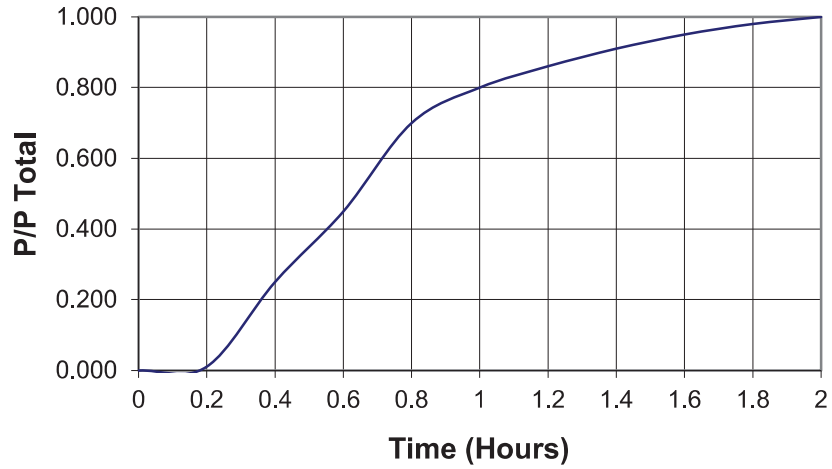

T(hrs)	P/P tot	i/P tot
0.0	0.000	0.000
0.2	0.010	0.500
0.4	0.250	0.750
0.6	0.450	1.000
0.8	0.700	1.250
1.0	0.800	0.500
1.2	0.860	0.300
1.4	0.910	0.250
1.6	0.950	0.200
1.8	0.980	0.150
2.0	1.000	0.000

2 Hour Duration Intensity Curve

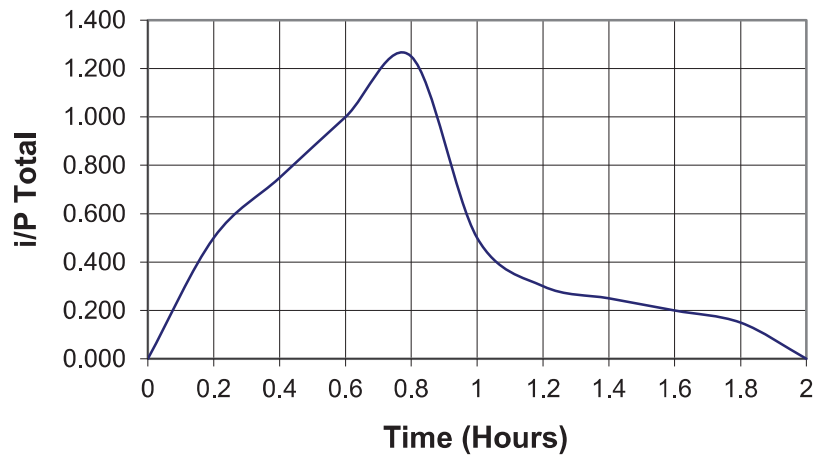

Rainfall Distribution Curves 4 Hour Duration

4 Hour Duration Mass Rainfall Curve

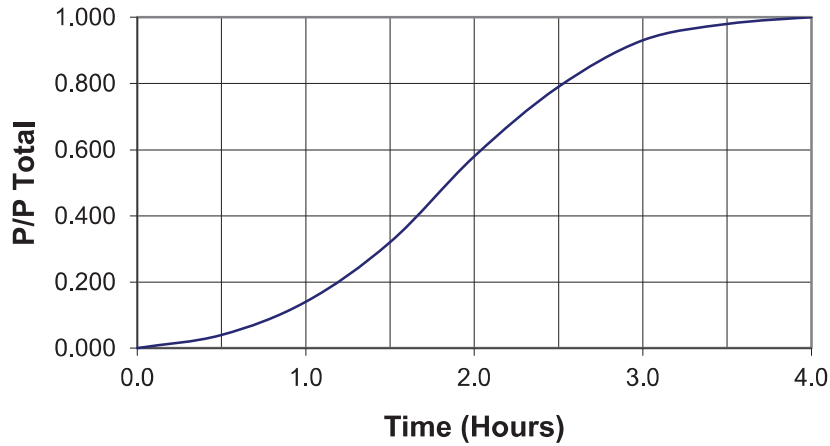

T (hrs)	P/P tot	i/P tot
0.0	0.000	0.000
0.5	0.040	0.080
1.0	0.140	0.200
1.5	0.320	0.360
2.0	0.580	0.520
2.5	0.790	0.420
3.0	0.930	0.280
3.5	0.980	0.100
4.0	1.000	0.000

4 Hour Duration Intensity Curve

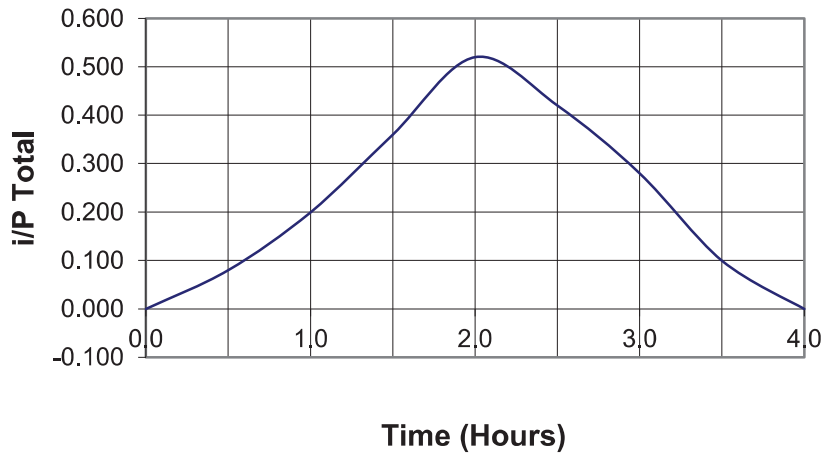

Rainfall Distribution Curves 8 Hour Duration

8 Hour Duration Mass Rainfall Curve

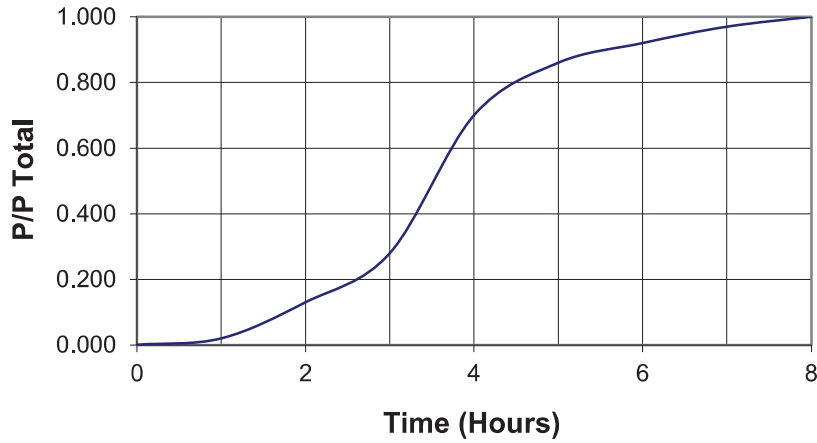

T (hrs)	P/P tot	i/P tot
0	0.000	0.000
1	0.020	0.020
2	0.130	0.060
3	0.280	0.150
4	0.700	0.420
5	0.860	0.160
6	0.920	0.060
7	0.970	0.050
8	1.000	0.000

8 Hour Duration Intensity Curve

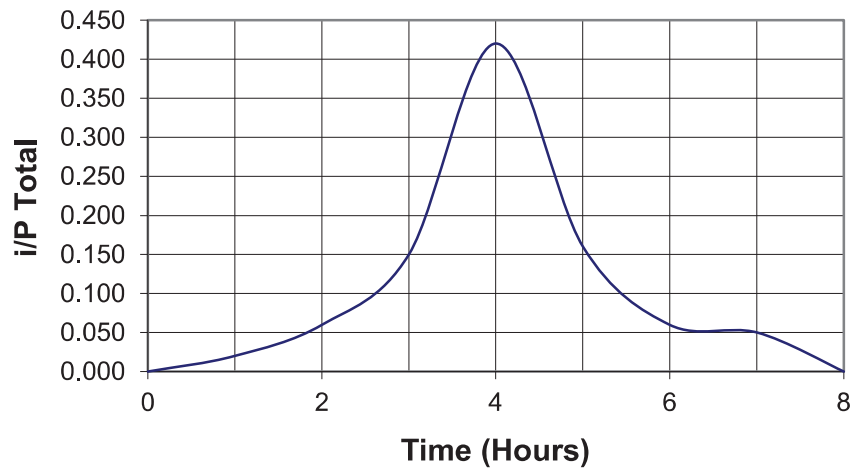

Rainfall Distribution Curves 24 Hour Duration

24 Hour Duration Mass Rainfall Curve

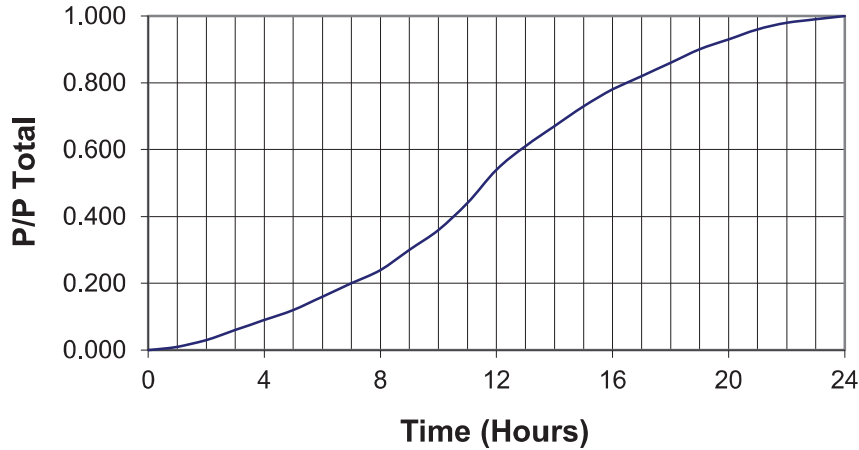

T (hrs)	P/P tot	i/P tot
0	0.000	0.000
1	0.010	0.010
2	0.030	0.020
3	0.060	0.030
4	0.090	0.030
5	0.120	0.030
6	0.160	0.040
7	0.200	0.040
8	0.240	0.040
9	0.300	0.060
10	0.360	0.060
11	0.440	0.080
12	0.540	0.100
13	0.610	0.070
14	0.670	0.060
15	0.730	0.060
16	0.780	0.050
17	0.820	0.040
18	0.860	0.040
19	0.900	0.040
20	0.930	0.030
21	0.960	0.030
22	0.980	0.020
23	0.990	0.010
24	1.000	0.000

24 Hour Duration Intensity Curve

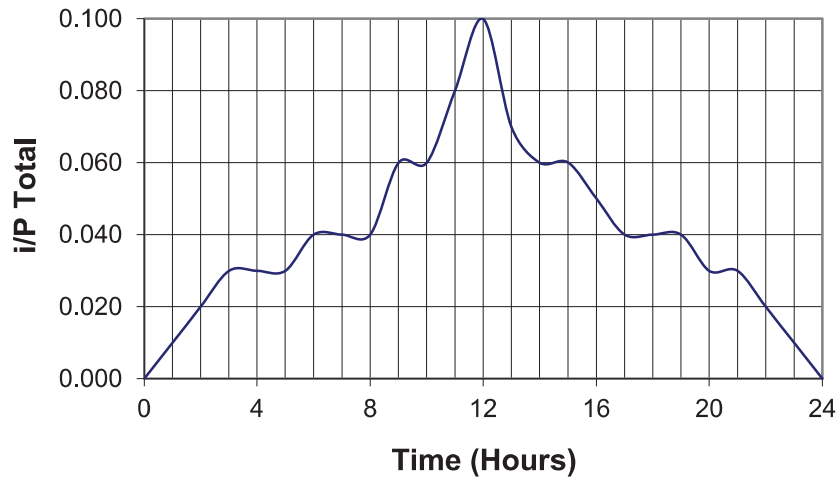

Rainfall Distribution Curves 3 Day Duration

3 Day Duration Mass Rainfall Curve

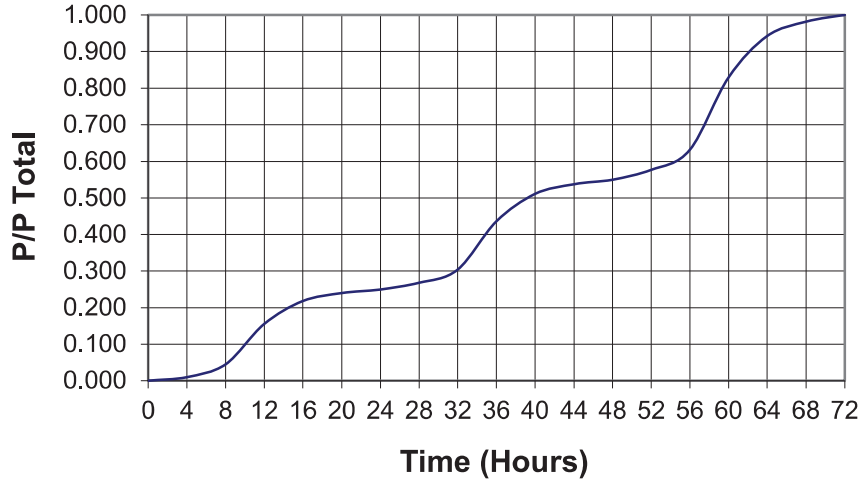

T (hrs)	P/P tot	i/P tot
0	0	0
4	0.01	0.003
8	0.045	0.009
12	0.155	0.028
16	0.218	0.016
20	0.24	0.006
24	0.25	0.003
28	0.268	0.005
32	0.304	0.009
36	0.436	0.033
40	0.511	0.019
44	0.538	0.007
48	0.55	0.003
52	0.577	0.007
56	0.631	0.014
60	0.829	0.05
64	0.942	0.028
68	0.982	0.01
72	1	0

3 Day Duration Intensity Curve

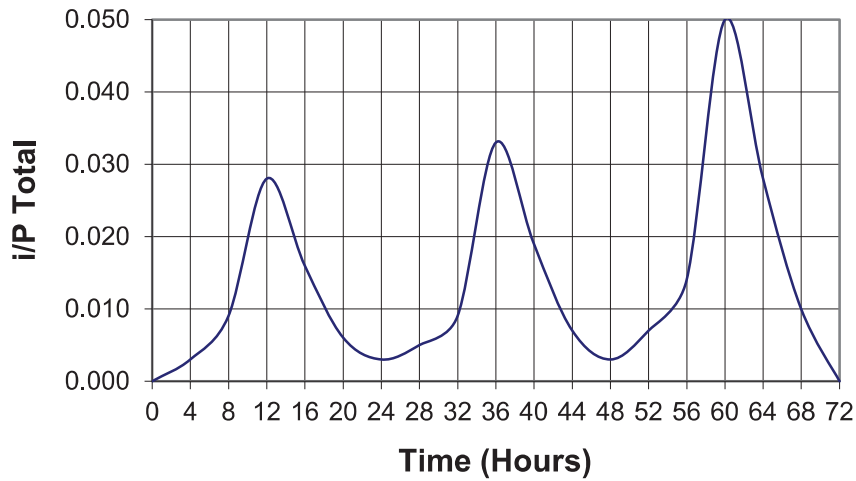

Rainfall Distribution Curves 7 Day Duration

7 Day Duration Mass Rainfall Curve

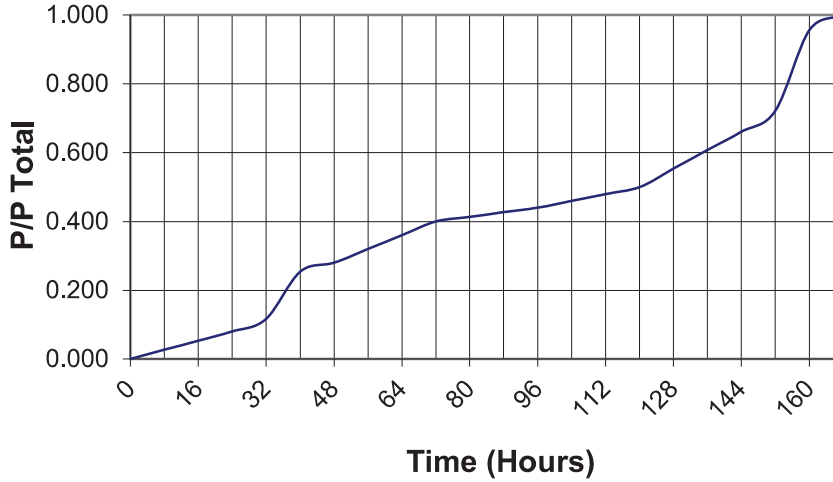

T (hrs)	P/P tot	i/P tot
0	0.000	0.000
8	0.027	0.003
16	0.053	0.003
24	0.080	0.003
32	0.116	0.005
40	0.254	0.017
48	0.280	0.003
56	0.320	0.005
64	0.360	0.005
72	0.400	0.005
80	0.413	0.002
88	0.427	0.002
96	0.440	0.002
104	0.460	0.003
112	0.480	0.003
120	0.500	0.003
128	0.553	0.007
136	0.607	0.007
144	0.660	0.007
152	0.721	0.008
160	0.956	0.029
168	1.000	0.000

7 Day Duration Intensity Curve

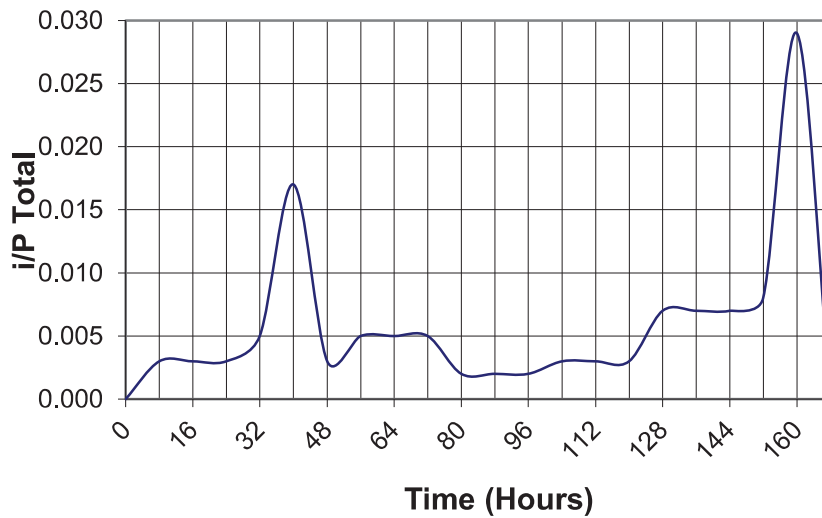

Rainfall Distribution Curves 10 Day Duration

10 Day Duration Mass Rainfall Curve

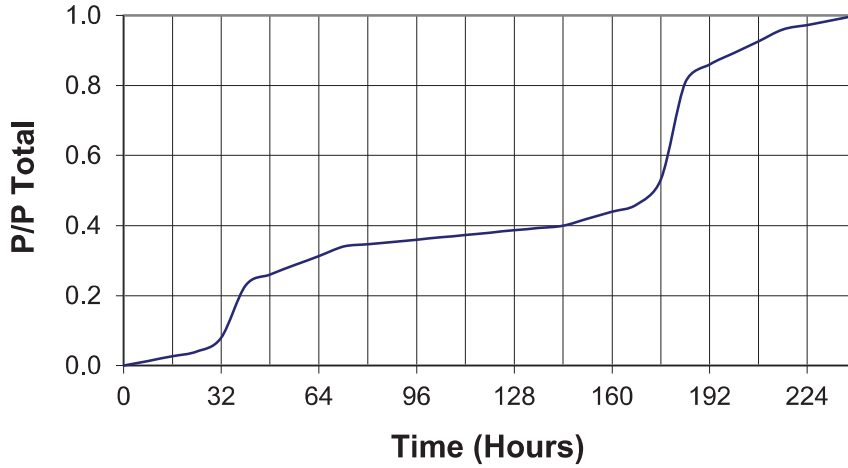

T (hrs)	P/P tot	i/P tot
0	0.000	0.000
8	0.013	0.002
16	0.027	0.002
24	0.040	0.002
32	0.080	0.005
40	0.229	0.019
48	0.260	0.004
56	0.287	0.003
64	0.313	0.003
72	0.340	0.003
80	0.347	0.001
88	0.353	0.001
96	0.360	0.001
104	0.367	0.001
112	0.373	0.001
120	0.380	0.001
128	0.387	0.001
136	0.393	0.001
144	0.400	0.001
152	0.420	0.003
160	0.440	0.003
168	0.460	0.003
176	0.532	0.009
184	0.808	0.035
192	0.860	0.007
200	0.893	0.004
208	0.926	0.004
216	0.960	0.004
224	0.973	0.002
232	0.986	0.002
240	1.000	0.000

10 Day Duration Intensity Curve

