

STATE OF FLORIDA DEPARTMENT OF TRANSPORTATION



DRAINAGE MANUAL

**OFFICE OF DESIGN, DRAINAGE SECTION, JANUARY 2020
TALLAHASSEE, FLORIDA**

TABLE OF CONTENTS

Chapter 1	1
Introduction	1
1.1 Purpose.....	1
1.2 Authority.....	1
1.3 Scope.....	1
1.4 General	1
1.5 Documentation of Drainage Design	2
1.6 Appendices	2
1.7 Distribution	3
1.8 Procedure for Revisions and Updates.....	3
1.9 Training	3
1.10 Forms Access	4
CHAPTER 2	5
Open Channel.....	5
2.1 Introduction	5
2.2 Design Frequency	5
2.3 Hydrologic Analysis.....	5
2.4 Hydraulic Analysis.....	6
2.4.1 Manning's "n" Values	6
2.4.2 Slope.....	6
2.4.3 Channel Linings and Velocity.....	6
2.4.4 Channel Bottom	7
2.4.5 Channel Freeboard.....	8
2.5 Construction and Maintenance Considerations.....	8
2.6 Safety.....	8
2.6.1 Protective Treatment.....	8
2.6.2 Roadside Safety.....	9
2.7 Documentation	9
CHAPTER 3	13
Storm Drain Hydrology and Hydraulics	13
3.1 Introduction	13
3.2 Pipe Materials	13
3.3 Design Frequency	13
3.4 Design Tailwater	14
3.4.1 Sea Level Rise.....	15
3.5 Hydrologic Analysis.....	18

3.5.1	Time of Concentration.....	18
3.6	Hydraulic Analysis.....	18
3.6.1	Pipe Slopes.....	18
3.6.2	Hydraulic Gradient	18
3.6.3	Outlet Velocity.....	19
3.6.4	Manning's Roughness Coefficients.....	19
3.7	Hydraulic Openings and Protective Treatment.....	20
3.7.1	Entrance Location and Spacing	22
3.7.2	Manholes	23
3.7.3	Shoulder Gutter.....	23
3.7.4	Inlet Placement	24
3.8	Grades	27
3.8.1	Longitudinal Gutter Grade.....	27
3.9	Pavement Hydraulics	27
3.9.1	Spread Criteria.....	27
3.9.2	Trench Drain	28
3.9.3	Hydroplaning.....	28
3.10	Construction and Maintenance Considerations.....	28
3.10.1	Pipe Size and Length.....	29
3.10.2	Minimum Pipe Cover and Clearances.....	30
3.10.3	Pipe Joint Designs Greater than 5 psi.....	31
3.10.4	Existing Pipe Inspection and Siltation	31
3.11	Pipes within or Adjacent to Retained Earth (Walled) Embankment Sections	32
3.12	Additional Design Considerations	32
3.12.1	Noise Walls	32
3.12.2	French Drains	33
3.12.3	Resilient Connectors.....	34
3.12.4	Floatation	34
3.13	Documentation.....	34
3.13.1	Tabulation Form.....	34
3.13.2	Other Documentation.....	34
CHAPTER 4	37
Cross Drain Hydraulics.....		37
4.1	Introduction	37
4.2	General	37
4.3	Design Frequency	38
4.3.1	Permanent Facilities	38
4.3.2	Temporary Facilities.....	38
4.4	Backwater	39
4.5	Tailwater	39
4.6	Clearances.....	39

4.7	Hydrologic Analysis.....	39
4.7.1	Freshwater Flow	39
4.7.2	Tidal Flow	40
4.8	Hydraulic Analysis.....	40
4.8.1	Riverine Crossings.....	40
4.8.2	Tidal Crossings	40
4.9	Specific Standards Relating to Bridges	41
4.9.1	Berms for Spill-Through Abutment Bridges.....	41
4.9.2	Scour Estimates.....	42
4.9.3	Scour Protection Considerations.....	44
4.9.4	Bridge Deck Drainage.....	46
4.9.5	Wave and Current Forces on Coastal Bridges.....	46
4.10	Specific Standards Relating to all Cross Drains except Bridges ...	47
4.10.1	Culvert Materials	47
4.10.2	Manning’s Roughness Coefficients.....	47
4.10.3	End Treatment	48
4.10.4	Construction and Maintenance Considerations	48
4.11	Documentation.....	49
4.11.1	Culverts (all culverts less than a 20-foot bridge culvert). ..	49
4.11.2	Bridges.....	50
4.11.3	Document Processing.....	53
CHAPTER 5		54
Stormwater Management.....		54
5.1	Introduction	54
5.2	Regulatory Requirements	54
5.2.1	Chapter 14-86, Florida Administrative Code	54
5.2.2	Section 373.4596, Florida Statutes	54
5.2.3	Chapter 62-25, Florida Administrative Code	54
5.2.4	Chapter 62-40, Florida Administrative Code	54
5.2.5	National Pollutant Discharge Elimination System	55
5.3	Environmental Look Arounds (ELA).....	55
5.4	Design Standards.....	56
5.4.1	Design of Systems	56
5.4.2	Hydrologic Methods	58
5.4.3	Protective Treatment.....	58
5.4.4	Construction and Maintenance Considerations	58
5.5	Documentation.....	61
CHAPTER 6		64
Optional Culvert Materials		64
6.1	Introduction	64
6.2	Durability	64
6.2.1	Culvert Service Life Estimation	65

6.3	Structural Evaluation	65
6.4	Hydraulic Evaluations.....	65
6.5	Pipes within Walled Embankment Sections	66
6.6	Culvert Material Types	66
6.7	Jack and Bore	67
6.8	Documentation	67
Appendix A Drainage Law		70
Appendix B Acquisition of Real Property Rights.....		86
Appendix C Cover Height Tables		90
Appendix D Pipes within Walled Embankment Sections.....		110
<u>Appendix E Intensity-Duration-Frequency Curves</u>		119

CHAPTER 1

INTRODUCTION

1.1 PURPOSE

The *Drainage Manual* sets forth drainage design standards for Florida Department of Transportation (FDOT) projects.

1.2 AUTHORITY

This *Manual* derives authority from Chapter 334, *Florida Statute (F.S.)*, Sections 20.23(4)(a) and 334.048(3).

1.3 SCOPE

The principal users of this *Manual* are consultants and FDOT personnel who prepare FDOT construction plans.

1.4 GENERAL

Chapter 334, F.S., known as the *Florida Transportation Code*, establishes the responsibilities of the state, counties, and municipalities for the planning and development of the transportation systems serving the people of Florida, with the objective of assuring development of an integrated, balanced statewide system. The *Code's* purpose is to protect the safety and general welfare of the people of the state and to preserve and improve all transportation facilities in Florida. Under *Section 334.044, F.S.*, the *Code* sets forth the powers and duties of the Department of Transportation to develop and adopt uniform minimum standards and criteria for the design, construction, maintenance, and operation of public roads.

The standards in this *Manual* provide a basis for uniform design practice for typical roadway drainage design situations. Realizing that drainage design is primarily a matter of sound application of good engineering judgment, it is impossible to give precise rules that would apply to all possible situations which may arise. Thus, for proper drainage design, we must preserve flexibility to account for varying site conditions, permitting, and sustainable design solutions. Situations will exist where these standards will not apply. THE INAPPROPRIATE USE OF AND/OR ADHERENCE TO THESE STANDARDS DOES NOT EXEMPT THE ENGINEER FROM THE PROFESSIONAL RESPONSIBILITY OF DEVELOPING AN APPROPRIATE DESIGN. The engineer is responsible for identifying those standards that do not apply to a particular design, and for obtaining approval to deviate from those standards. Authority for project-specific changes from this *Manual* rests with the District Drainage Engineer, and deviation from a standard in this

Manual must be approved by the District Drainage Engineer. The request for deviation must include the engineering justification.

23 Code of Federal Regulations (CFR) 650A (<http://www.fhwa.dot.gov/legsregs/directives/fapg/cfr0650a.htm>) prescribes the Federal Highway Administration (FHWA) policies and procedures for the location and hydraulic design of highway encroachments on floodplains. While the standards presented in the FDOT **Drainage Manual** conform to federal requirements, drainage designers should become familiar with **23 CFR 650A** to develop a basic understanding of some of the design standards for cross drains and bridges.

Use statistical rainfall depth data for Florida in the National Oceanic and Atmospheric Administration (NOAA) Atlas 14 Rainfall Data. This data is available at http://hdsc.nws.noaa.gov/hdsc/pfds/pfds_map_cont.html?bkmrk=fl. Users will find FDOT rainfall distributions and intensity-duration-frequency curves in Appendix E.

Various Department publications play an integral role supporting and supplementing the content of this **Manual**. These publications include, but are not limited to the; **FDOT Design Manual (FDM)**, **Structures Design Guidelines (SDG)**, **Standard Plans for Road and Bridge Construction (Standard Plans)**, and **Standard Specifications for Road and Bridge Construction (Standard Specifications)**.

The shaded boxes labeled “**Modification for Non-Conventional Projects**” throughout this **Manual** are intended for design-build projects.

1.5 DOCUMENTATION OF DRAINAGE DESIGN

Include approvals of deviation from this **Manual** in the project drainage design documentation, along with supporting justifications. The hydraulic designer will provide a Drainage Design Report to accompany all phase submittals (signed and sealed for the Final Phase submittal) that addresses the entire project design. This is a record set of all drainage computations, both hydrologic and hydraulic, and includes all necessary support data. All phase submittals must include hydrologic and hydraulic models. The Drainage Design Report must include, at a minimum, pond routing, with justifications for the utilization of all tailwater stages, a clear description of the overall stormwater management system, storm drain tabulations in Department format, pond recovery calculations, hydraulic spread calculations, special gutter grade calculations, drainage structure and liner flotation calculations, ditch conveyance calculations, a node-reach diagram superimposed on Department drainage maps, skimmer calculations, cross drain calculations, and other calculations relative to drainage.

1.6 APPENDICES

This **Manual** includes four appendices:

Appendix A contains a general overview of drainage law, with a discussion of case histories in Florida. It appears as an appendix rather than a chapter since it is primarily informational and does not constitute a standard.

Appendix B contains guidance on general FDOT practice pertaining to acquiring drainage easements, flood rights, etc.

Appendix C contains minimum and maximum cover heights for design.

Appendix D contains policy on the selection of pipes in proximity to structural walls.

Appendix E contains the Intensity-Duration-Frequency Curves.

1.7 DISTRIBUTION

This **Manual** is available for downloading from the website link: [Manual](#).

1.8 PROCEDURE FOR REVISIONS AND UPDATES

FDOT invites comments and suggestions for changes to the **Manual**. Submit comments and suggestions by e-mailing the State Drainage Engineer. Appropriate Roadway Design or Drainage Design staff will review each idea or suggestion received in a timely manner.

Statewide meetings of the District Drainage Engineers and the State Drainage Engineer are held at least annually, and teleconferences are held monthly. A major agenda item at these meetings will be the review of planned revisions, and suggestions and comments that may warrant revisions. Based on input from these meetings, FDOT compiles official proposed revisions.

The State Drainage Engineer will coordinate the proposed revisions with all the affected offices and with FHWA. The State Drainage Engineer officially adopts the proposed revisions, with input from the District Drainage Engineers.

Prior to release, the Forms and Procedures Office coordinates all revisions to ensure conformance with and incorporation into the Department's **Standard Operating System**.

1.9 TRAINING

There is no mandatory training required.

1.10 FORMS ACCESS

There are no forms related to this *Manual*.

CHAPTER 2

OPEN CHANNEL

2.1 INTRODUCTION

This chapter presents standards for the design of artificial or manmade open channels, including roadside ditches, median ditches, interceptor ditches, outfall ditches, and canals.

2.2 DESIGN FREQUENCY

Design open channels to collect and convey without damage, and to confine within the ditch, stormwater flow with standard design frequencies as follows:

Table 2.1: Design Storm Frequencies of Open Channels

TYPE CHANNEL	FREQUENCY
Roadside, Median, and Interceptor ditches or swales	10-year
Outfalls	25-year
Canals	25-year
Temporary roadside and median ditches or swales	2-year
Temporary Outfalls and Canals	5-year

Site-specific factors may warrant the use of an atypical design frequency. Acquire flood rights where offsite stages increase and impact land use values.

Design sidewalks adjacent to channels (ditches) to be above the design stage.

2.3 HYDROLOGIC ANALYSIS

As appropriate for the site, base hydrologic data used for the design of open channels on one of the following methods:

1. A frequency analysis of observed (gage) data, when available. If insufficient or

-
- no observed data are available, use one of the procedures below, as appropriate. However, calibrate the procedures below to the extent practicable with available observed data for the drainage basin, or nearby similar drainage basins.
- a. Regional or Local Regression Equation developed by the USGS
 - b. Rational Equation for drainage areas up to 600 acres
 - c. For outfalls from stormwater management facilities, use the method for the design of the stormwater management facility; see **Chapter 5** for hydrologic methods to design stormwater management facilities
2. For regulated or controlled canals, request hydrologic data from the controlling entity; prior to use for design, verify these data to the greatest extent practical

2.4 HYDRAULIC ANALYSIS

Use Manning's Equation for the design of open channels. Provide ditch computations for all changes in ditch slope, cross section, lining type, or quantity of flow. The flow shown as contributing to the point of interest include all contributions upstream of that point of interest.

2.4.1 Manning's "n" Values

Manning's n values for channels with bare soil and vegetative linings are presented in **Table 2.2**. Manning's n values for rigid linings are presented in **Table 2.3**.

In selecting a Manning's n value, consider the probable condition of the channel during the design event may occur. To account for increased vegetation growth between extended maintenance periods, use higher "n" values for ditches with bottoms at or near the seasonal high groundwater level.

2.4.2 Slope

Provide a minimum physical slope of 0.0005 feet/feet for all conveyance ditches.

2.4.3 Channel Linings and Velocity

Standard Plans, Index 524-001 and **Standard Specification 985**, provide standard lining types. **Tables 2.4 and 2.5** present maximum velocities for the various forms of soils and channel linings. When design flow velocities do not exceed the maximum permissible for bare earth as given in **Table 2.4**, standard treatment of ditches consists of grassing and mulching. For higher design velocities, provide sodding, ditch paving, or other forms of lining consistent with **Tables 2.4 and 2.5**.

Check shear stress at locations of steep slopes (>1 percent), such as ditch flow down a pond slope, gore drainage, and offsite flow entering the right-of-way via the back slope of a roadside swale.

The *Drainage Design Guide (DDG)* provides additional guidance on types of lining materials, as well as the proper application of various types of linings.

2.4.3.1 Limitations on Use of Linings

2.4.3.1.1 Grassing and Sodding

Do not use grassing or sodding under the following conditions:

1. Continuous standing or flowing water
2. Areas that do not receive the regular maintenance necessary to prevent domination by taller vegetation
3. Non cohesive sandy soils with excessive soil drainage
4. Excessively shady areas

2.4.3.1.2 Concrete Lining

To prevent cracking or failure, place concrete lining on a firm, well-drained foundation. Avoid concrete linings where expansive clays are present.

When using concrete linings where soils may become saturated, design for the potential for buoyancy. Acceptable countermeasures include:

1. Increasing the thickness of the lining to add additional weight
2. For sub-critical flow conditions, specifying weep holes at appropriate intervals in the channel bottom to relieve the upward pressure on the channel
3. For super-critical flow conditions, using subdrains in lieu of weep holes

2.4.3.1.3 Turf Reinforcement Mat (TRM)

Do not use turf reinforcement mats where you expect high siltation. During desilting operations, damage can occur to the TRM.

2.4.4 Channel Bottom

The minimum channel bottom width is five feet to accommodate mitered end sections

and maintenance mowers. Do not use V-bottom ditches unless both front and back slopes are 1:6 or flatter.

The minimum ditch bottom elevation is one foot above the estimated seasonal high groundwater elevation for maintainability. To enable mowing, fine-grained soils may require more than one foot of clearance from the seasonal high groundwater.

2.4.5 Channel Freeboard

Provide a minimum of one foot of channel freeboard above the design stage within the channel if in a fill slope and 0.5 foot if the channel is in a cut slope. Freeboard is measured to the ditch top of bank or low edge of shoulder, whichever is lower. If a channel connects hydraulically to or is part of the stormwater management facility, provide no less than one foot of channel freeboard above the peak design stage of the downstream, hydraulically connected pond. Apply downstream tailwater in freeboard calculations.

- Install inlets, flumes, or embankment protection when pavement runoff is sufficient to cause erosion of the shoulder. (See **Section 3.7** for inlet placement criteria)
- Install inlets to properly collect stormwater runoff for curbed roadway driveways.

2.5 CONSTRUCTION AND MAINTENANCE CONSIDERATIONS

Design open channels consistent with the standard construction and maintenance practices of the Department. The **Standard Plans** and **Standard Specifications** present details on standard ditch linings. In the event the **Standard Plans** and **Standard Specifications** are not suitable for a specific project need, develop a detailed design. Specify this information in the design documents.

Provide berms and other physical access devices that facilitate maintenance activities in ditches, outfall ditches, retention/detention areas, and other drainage-related features. Consider future expansion of the facilities and possible increased maintenance requirements. Use absolute minimum values only in extremely stable areas, in areas requiring infrequent maintenance, or in areas where existing physical constraints require their use. Base berms at the narrowest point; keep right-of-way reasonably uniform. If the design specifies double ditches, the minimum berm width between the two ditches for maintenance access is 10 feet if the ditches are dry or 15 feet if the ditches are wet. Contact the local maintenance office for minimum access requirements when the minimum berm width is not feasible.

2.6 SAFETY

2.6.1 Protective Treatment

Review drainage designs to determine requirements regarding some form of protective

treatment to prevent entry to facilities that present a hazard to children and, to a lesser extent, all persons. **Section 3.7** provides general criteria. Provide protective treatment for open channels in the form of fencing when a potential hazard exists.

2.6.2 Roadside Safety

The design and location of open channels will comply with roadside safety and clear zone requirements. See the **FDM** for clear zone requirements, including special clearance criteria for canals.

2.7 DOCUMENTATION

Design documentation for open channels will include hydrologic and hydraulic analyses, calculated freeboard and channel lining requirements. For roadside ditches, **Figure 2-1** provides the required standard format for documentation.

Table 2.2: Manning's "n" Values for Artificial Channels with Bare Soil and Vegetative Linings

<u>Channel Lining</u>	<u>Description</u>	<u>Design "n"</u>
Bare Earth, Fairly Uniform	Clean, recently completed	0.02
Bare Earth, Fairly Uniform	Short grass and some weeds	0.03
Dragline Excavated	No Vegetation	0.03
Dragline Excavated	Light Brush	0.04
Maintained Grass or Sodded Ditches	Good stand, well maintained 2 to 6 inches	0.06*
Channels not Maintained	Clear bottom, brush sides	0.08
Channels not Maintained	Dense weeds to flow depth	0.10
Maintained Grass or Sodded Ditches	Fair stand, length 12 to 24 inches	0.20*

* Decrease 30 percent for flows > 0.7 ft depth (max flow depth 1.5 ft)

Table 2.3: Manning's "n" Values for Artificial Channels with Rigid Linings

<u>Channel Lining</u>	<u>Description</u>	<u>Design "n"</u>
Concrete Paved	Broomed*	0.016
Concrete Paved	"Roughened" - Standard	0.020
Concrete Paved	Gunite	0.020
Concrete Paved	Over Rubble	0.023
Rubble Riprap	Ditch Lining	0.035

* Broomed is not the standard finish and must be specified when used (see **Standard Specification 524-7**)

Table 2.4: Maximum Shear Stress Values and Allowable Velocities for Different Soils

<u>Soil Type</u>	<u>Shear Stress (psf)</u>	<u>* Allowable Velocity (ft/sec)</u>
Silt or Fine Sand	0.027	1.50
Sandy Loam	0.037	1.75
Silt Loam	0.048	2.00
Firm Loam	0.075	2.50
Stiff Clay	0.260	3.75
Hardpans	0.670	6.00

* For a flow depth of approximately 3 ft

Reference: University of Florida (1972)

Table 2.5: Maximum Velocities for Various Lining Types

<u>Lining Type</u>	<u>Maximum Velocity (fps)</u>
Grass with Mulch	Bare Soil (Table 2.4)
Sod	4 ^{***}
Staked Sod	5
Lapped Sod	5.5
Erosion Control Blanket (Biodegradable, Standard Specification 104-6)	6.5
Plastic Erosion Mat (Permanent, Standard Specifications 571 and 985)	
- Type 1	10
- Type 2	14
- Type 3	18
Riprap (Rubble)(Ditch Lining)	6
Other flexible	FHWA HEC-15
Geotextile Grid	4 - 8*
Rigid	10**

* Varies with grid

** Higher velocities acceptable with provisions for energy dissipation

*** If long term turf density is expected to be poor, use 3 fps maximum velocity

FLORIDA DEPARTMENT OF TRANSPORTATION
 HYDRAULIC WORKSHEET FOR ROADSIDE DITCHES

Road: _____
 Project Number: _____

Sheet _____ of _____
 Prepared by: _____ Date: _____
 Checked by: _____ Date: _____

STATION TO STATION	SIDE	% Slope	Drain Area	"C"	t _c	i ₁₀	Q (cfs)	Ditch Section			"n"	"d"	"d _{allowed} "	Calculated Freeboard	Vel. (fps)	Ditch Lining	Side Drain Pipe Dia.	Remarks	
								F.S.	B.W.	B.S.									

Note: F.S. = Front Slope B.W. = Bottom Width B.S. = Back Slope

Figure 2-1: Hydraulic Worksheet for Roadside Ditches

CHAPTER 3

STORM DRAIN HYDROLOGY AND HYDRAULICS

3.1 INTRODUCTION

This chapter presents minimum standards for the design of FDOT storm drain systems.

3.2 PIPE MATERIALS

Pipe material selection must follow *Chapter 6* of this *Manual*.

3.3 DESIGN FREQUENCY

Standard design storm frequencies for the design of storm drain systems are as follows:

Table 3.1: Design Storm Frequencies of Storm Drain Systems

TYPE STORM DRAIN	FREQUENCY
General design	3-year
<ul style="list-style-type: none"> • General design work that involves replacement of a roadside ditch with a pipe system by extending side drain pipes • General design on work to Interstate Facilities 	10-year
<ul style="list-style-type: none"> • Outfalls 	25-year
<ul style="list-style-type: none"> • Interstate Facilities for which roadway runoff would have no outlet other than a storm drain system, such as in a sag inlet or cut section • Outlets of systems requiring pumping stations 	50-year

Acquire flood rights where offsite stages increase and impact land use values.

If a system has both curb inlets and ditch bottom inlets (DBIs), check the hydraulic grade line (HGL) for the DBIs for a 10-year design frequency. All structures in these mixed systems must meet the three-year design frequency.

3.4 DESIGN TAILWATER

For the determination of hydraulic gradient and the sizing of storm drain conduits, use a tailwater elevation coincident with the design storm event and that can be reasonably expected to occur. Standard design tailwater conditions for the design of storm drain systems are as follows:

Crown of pipe at the outlet, or if higher:

Lakes -----	Normal High Water
Rivers and Streams --	Normal High Water
Stormwater Ponds ----	Peak stage in the pond during the storm drain design event; see Chapter 5 for routing requirements; assume all orifices and v-notches to be clogged for the purposes of establishing the design tailwater for storm drain systems connected to ponds
Tidal Bays -----	Mean High Tide*
Ditches, Free Flowing --	Normal depth flow in the ditch at the storm drain outlet for the storm drain design storm event; may differ from ditch design storm event
Downstream control --	The higher of: (1) the stage due to free-flow conditions (described above) or, (2) the maximum stage at the storm drain outlet due to backwater from the downstream control using flows from the storm drain design storm event
Existing Systems -----	Elevation of hydraulic grade line of the system at the connection for the design storm event
French Drains -----	Design head over the outlet control structure
Closed Basin -----	Varies, depending on site-specific conditions
Regulated Canals ----	Agency regulated control elevation

3.4.1 Sea Level Rise

The design of coastal projects (including new construction, reconstruction, and projects rebuilding drainage systems) must incorporate sea level rise analysis to assess the vulnerability of flooding over the design life of the facility. The sea level rise data table (**Table 3.2**) in this section is from historical tidal records gathered by the National Water Level Observation Network (NWLON) and managed by NOAA: <https://tidesandcurrents.noaa.gov/sltrends/sltrends.html>

NOAA manages tidal gage stations located around the state of Florida. Use the station nearest the site for analysis. Analysis must consist of straight line regression equation extrapolation based on the design service life of the project. Consider existing system criticality/vulnerability and project costs when implementing this best practice analysis.

Table 3.2: Sea Level Rise Data

Station ID	Station Name	MSL Trends (in/yr)	+/- 95% CI (in/yr)	Latitude	Longitude
8720030	Fernandina Beach, FL	0.083	0.01	30.6717	-81.465
8720218	Mayport, FL	0.103	0.01	30.3967	-81.43
8721120	Daytona Beach Shores, FL	0.091	0.02k	29.1467	-80.9633
8723170	Miami Beach, FL	0.094	0.02	25.7683	-80.1317
8723970	Vaca Key, FL	0.144	0.02	24.7117	-81.105
8724580	Key West, FL	0.095	0.01	24.5557	-81.8079
8725110	Naples, FL	0.112	0.02	26.1317	-81.8075
8725520	Fort Myers, FL	0.122	0.02	26.6477	-81.8712
8726520	St. Petersburg, FL	0.109	0.01	27.7606	-82.6269
8726724	Clearwater Beach, FL	0.145	0.03	27.9783	-82.8317
8727520	Cedar Key, FL	0.084	0.01	29.135	-83.0317
8728690	Apalachicola, FL	0.094	0.03	29.7267	-84.9817
8729108	Panama City, FL	0.096	0.03	30.1523	-85.6669
8729840	Pensacola, FL	0.094	0.01	30.4044	-87.2112
8722670	Lake Worth Pier, FL	0.139	0.02	26.6167	-80.0333



Figure 3-1: Tidal Station Data

3.5 HYDROLOGIC ANALYSIS

The Department requires use of the Rational Method for performing hydrologic calculations for storm drains. When storm drain systems are integrated with French drain systems or ditch storage systems, perform calculations using hydrographs to account for storage.

3.5.1 Time of Concentration

The minimum allowable time of concentration is 10 minutes.

3.6 HYDRAULIC ANALYSIS

Base hydraulic calculations for determining storm drain conduit sizes on open channel and pressure flow, as appropriate, using Manning's equation.

3.6.1 Pipe Slopes

Use a physical slope that will produce a velocity of at least 2.5 feet per second (fps) and no greater than 15 fps when the storm drain is flowing full.

For pressure flow storm drain systems, the minimum physical slope is 0.1 percent.

3.6.2 Hydraulic Gradient

Include friction losses in computing the design hydraulic gradient for all storm drain systems. Also include energy losses associated with special pollution control structures (weirs, baffles, etc.) and those caused by utility conflict structures.

When hydraulic calculations include only the major losses, such as those described above, and do not include all minor energy losses, provide a minimum of 1 foot of clearance between the elevations of the hydraulic gradient for design storm conditions and the theoretical gutter elevation (i.e., 1.13 feet below the edge of pavement for Type E or F Curb). This does not apply to ditch bottom inlets and other similar conditions where temporary ponding or overload is acceptable.

If design includes all major and minor energy losses, it is acceptable for the hydraulic gradient to reach the theoretical gutter elevation. Minor losses include: entrance, exit, junction and manhole, expansion, contraction, and bend.

Include minor losses in hydraulic calculations when the velocity is greater than 7.5 fps. Check total minor losses for systems longer than 2,000 feet to ensure that the minor losses do not exceed the one-foot allowance. If greater than one foot, use calculated minor losses to design the system.

If hydraulic calculations show that intermediate manholes are under pressure, specify that the manhole lids are bolted down.

3.6.3 Outlet Velocity

When the outlet velocity for the design storm discharge exceeds 4 fps, evaluate the need for special channel lining (revetment or armoring) and/or energy dissipation to protect against undesirable scour. To compute the outlet velocity, assume the lowest anticipated tailwater condition that can reasonably be expected to occur during a storm event.

In areas where turf sustainability may be an issue, coordinate with maintenance to determine appropriate channel lining material.

3.6.4 Manning's Roughness Coefficients

Values for Manning's roughness coefficient are as follows:

Concrete Box Culverts	n = 0.012
Concrete Pipes	n = 0.012

Metal Pipes:

Pipe and Pipe Arch—Helical Fabrication Re-corrugated Ends—All Flow Conditions*	
12" to 24"	n = 0.020
30" to 54"	n = 0.022
60" and larger	n = 0.024

Pipe and Pipe Arch—Spiral Rib Fabrication Re-corrugated Ends—All Flow Conditions*	
All Sizes	n = 0.012

Plastic Pipes:

Polyvinyl Chloride-PVC (external rib/smooth interior) All Sizes	n = 0.012
Polyethylene (All Sizes) Single Wall	n = 0.024

Double Wall (Smooth)	n = 0.012
Polypropylene (All Sizes)	
Single Wall	n = 0.024
Double & Triple Wall (Smooth)	n = 0.012

* "Spiral" flow will not occur for most design situations. Therefore, the Department has not established "spiral" flow design values. Values for spiral flow, as recommended by the Southeast Corrugated Steel Pipe Association, are contained in the ***AISI Handbook of Steel Drainage & Highway Construction Products***.

3.7 HYDRAULIC OPENINGS AND PROTECTIVE TREATMENT

Select/design inlets and other hydraulic structures to satisfy hydraulic capacity, structural capacity, safety (vehicular, pedestrian, cyclist), and durability requirements.

Use alternate "G" (hot dipped galvanized) grates and frames when the structure is located on any barrier island, the Florida Keys, or within a half-mile of any body of brackish water containing chlorides > 2,000 ppm.

Review drainage designs to determine if some form of protective treatment is necessary to prevent entry into long or submerged storm drain systems, steep ditches, or water control facilities. Also evaluate protection in systems that are partially submerged at the entrance and fully submerged at locations farther along in the system. If other modifications, such as landscaping or providing flat slopes, can eliminate the potential hazard and thus the need for protective treatment, evaluate them first. Because vehicular and pedestrian safety are achieved by differing protective treatments, this often requires the designer to make a compromise in which one type of protection is more completely realized than the other. In such cases, evaluate the relative risks and dangers involved to provide the design that gives the best balance. Remember that the function of the drainage feature will be essentially in conflict with total safety, and that only a reduction rather than elimination of all risk is possible.

The three basic types of protective treatment used by the Department are:

<u>Feature</u>	<u>Typical Use</u>
Grates	To prevent persons from being swept into long or submerged drainage systems.
Guards	To prevent entry into long sewer systems under no-storm conditions, to prevent persons from being trapped.
Fences	To prevent entry into areas of unexpected deep standing water or high-velocity water flow, or into areas where grates or guards are warranted but are unsuitable for other reasons.

Review the following when determining the type and extent of protective treatment:

- Establish the nature and frequency of the presence of children in the area, e.g., the proximity to schools, school routes, and parks.
- Consider drainage facilities located outside a limited access area or adjacent to a limited access highway to be unlimited access facilities; a limited-access highway typically does not warrant protective treatment.
- Require adequate debris and access control on all inlet points if guards or grates are used at outlet ends.
- Check the hydraulic function of the drainage facility and adjust it so the protective treatment will not cause a reduction in function.
- Design grates for major structures in a manner that allows items to be carried up by increasing flood stages to avoid debris or persons being trapped against the hydraulic opening.
- Use of a guard may result in a person being pinned against it. A guard is usually used on outlet ends.
- Locate and build fences to reflect the effect of debris-induced force; a fence may capture excessive amounts of debris, which could possibly result in its destruction and subsequent obstruction of the culvert.
- Design protective treatments to prevent entry of certain wildlife, such as manatees.

3.7.1 Entrance Location and Spacing

3.7.1.1 Inlets

The following items determine inlet type, location, and spacing:

1. Inlet capacity and width of spread
2. Movement of vehicles to and from adjacent property on driveways
3. Pedestrian and bicycle safety
4. Maximum pipe length without maintenance access (**Section 3.10.1**)
5. Roadway geometry (e.g., super-elevation transitions, roadway profile, etc.)
6. Hydraulic efficiency of the system
7. Potential for flooding of off-site property
8. Potential for ponding at turn lanes, bus bays and driveways
9. Maintenance accessibility
10. Potential for concentrated flow to cause erosion when it leaves the pavement (including driveways)

Locate inlets at all low points in the gutter grade and/or ditch, and as appropriate at intersections, median breaks, driveways and on side streets where drainage would adversely flow onto the highway pavement. Base inlet spacing on spread standards and maximum allowable pipe lengths provided below in **Section 3.9 and Section 3.10**. Position inlets 10 feet prior to the level section in super-elevation transitions to avoid concentrated flows across the pavement.

Do not locate curb inlets, including inlet transitions, within handicap drop curb locations or on curb returns.

Do not place inlets in bridge approach slabs.

When an inlet is located behind a guardrail post, offset the inlet structure a minimum of 15 inches from the post. For the additional option of mounting special guardrail posts on top of inlet structures, see Standard Plans, Index 536-001.

Inlets in sag vertical curves that have no overflow outlet other than the storm drain system (i.e., barrier wall, bridge abutment, cut sections) must have flanking inlets on one or both sides. Locate the flanking inlets to satisfy spread criteria when the sag inlet is blocked.

Consider the following items pertaining to parking lot drainage:

1. Do not use curb inlets in areas of heavy pedestrian traffic; specifically,

service plaza parking lots. Alternately, you may use ditch bottom inlets with pedestrian-rated grates.

2. Consider positioning ditch bottom inlets in the center of the travel lanes and not in hidden locations, such as parking spaces.
3. Grade parking lots away from the heaviest pedestrian areas to more remote locations for better safety. Alternately, you may use cuts in the curb to allow pavement to drain into grassed swales prior to entering ditch bottom inlets.

3.7.2 Manholes

Place manholes outside of the wheel path of vehicles. Manholes are not allowed in the travel lanes of interstate facilities.

3.7.3 Shoulder Gutter

Shoulder gutter is required in the following situations:

- On embankments higher than 20 feet or on embankments higher than 10 feet where the longitudinal slope is greater than 2 percent; see the *FDM* for standard slopes.
- On interchange and grade separation embankments higher than five feet with slopes steeper than 1:6, to minimize erosion
- At bridge ends where concentrated flow from the bridge deck otherwise would run down the fill slope.
- In areas of guardrail where embankment slopes are steeper than 1:4 and any pavement is sloped toward the embankment.
- Where shoulder gutter is required per the above criteria, develop special profiles in areas of roadway cross slope transitions and at roadway-bridge interfaces to ensure that stormwater drains properly and does not become trapped.

3.7.4 Inlet Placement

Table 3.3: Curb and Gutter Inlet Application Guidelines

STANDARD PLANS INDEX	INLET TYPE	TYPE CURB/ GUTTER	GRADE CONSIDERATION	BICYCLE COMPATIBLE	ACCEPTABLE IN AREAS OF OCCASIONAL PEDESTRIAN TRAFFIC [6]	Notes
425-020	1	E & F	Continuous	Yes	Yes	
	2 [1]	E & F	Sag	Yes	Yes	
	3	E & F	Continuous	Yes	Yes	
	4 [1]	E & F	Sag	Yes	Yes	
425-021	5	E & F	Continuous	Yes	Yes	
	6 [1]	E & F	Sag	Yes	Yes	
425-022	7	Separator I & II	Continuous or Sag	Yes	Yes	
425-023	8	Separator IV & V	Continuous or Sag	Yes	Yes	
425-024	9 [2]	D & F	Continuous or Sag	Yes	Yes	
425-025	10 [2]	D & F	Continuous or Sag	Yes	Yes	
425-030	1	Median Barrier Wall	Continuous or Sag	No	Yes [4]	
	2 [3]	Median Barrier Wall	Continuous or Sag	No	Yes [4]	
425-031	-	Barrier Wall	Continuous or Sag	No [5]	Yes	See Index 425-031 Inset B
425-032	-	Barrier Wall (Rigid, C & G)	Continuous or Sag	No [5]	Yes	See Index 425-032 Inset B & C
425-040	S [7]	Shoulder	Continuous	No [5]	Yes	See Index 425-040 Bar Stub Detail
425-041	V	Valley	Continuous or Sag	No [5]	Yes	

- [1] Double-throated inlets usually are not warranted unless the minor gutter flow exceeds 50 ft in length or 0.5 cfs.
- [2] Use curb inlets 9 and 10 only where flows are light and right-of-way does not permit the use of throated curb inlets.
- [3] These are double inlets; one on each side of the barrier wall.
- [4] Specify the reticuline grate.
- [5] Bicycle compatible as long as a minimum 4-foot riding surface is provided around the inlet, with a preferred 1-foot offset from the inlet. Consider use of pavement markings shown in the 2009 MUTCD to alert cyclists to the inlet in the bicycle lane or shoulder pavement.
- [6] Do not place these inlets in pedestrian ways, but may be used in areas subject to occasional pedestrian traffic near pavement, grassed, or landscaped areas where pedestrians are not directed over the inlet and can walk around the inlet.
- [7] Intended for use in shoulder gutter on facilities subject to heavy wheel loads.

Table 3.4: Ditch Inlet Application Guidelines

STANDARD PLANS INDEX	INLET TYPE [1], [2]	TRAFFIC	BICYCLE COMPATIBLE	ACCEPTABLE IN AREAS OF OCCASIONAL PEDESTRIAN TRAFFIC [5]
425-050	A	Heavy Wheel Loads	No	No
425-051	B	Heavy Wheel Loads	No	Yes
425-052	C [3]	Infrequent Traffic	Yes [6]	Yes [4]
	D	Infrequent Traffic	Yes [6]	Yes [4]
	E	Infrequent Traffic	Yes [6]	Yes [4]
	H	Infrequent Traffic	Yes	Yes
425-053	F	Heavy Wheel Loads	Yes	Yes
	G	Heavy Wheel Loads	Yes	Yes
425-054	J	Heavy Wheel Loads	No	Yes
425-055	K	N/A	N/A	N/A

[1] Specify alternate G grates when in salt-water environment.

[2] Inlets with slots are more debris tolerant than inlets without slots. Debris may buildup on Type B fence of Type K inlet.

[3] For back of sidewalk location, see Index 425-060.

[4] Slotted inlets located in areas accessible to pedestrians must have traversable slots.

[5] Do not place these inlets in pedestrian ways but may be used in areas subject to occasional pedestrian traffic near pavement, grassed, or landscaped areas where pedestrians are not directed over the inlet and can walk around the inlet.

[6] Do not use inlets with traversable slots in areas subject to bicycle traffic.

Table 3.5: Drainage End Treatment - Lateral Offset Criteria

INDEX	STRUCTURE DESCRIPTION	LATERAL OFFSET CRITERIA ^[1]
400-289 to 400-292	Concrete Box Culvert - End Treatments	Outside Clear Zone
425-020 to 425-041	Curb, Barrier & Gutter Inlets	Permitted within Clear Zone
425-050 to 425-051	Ditch Bottom Inlets – (Types A ^[2] and B) ^[3]	
425-052	Ditch Bottom Inlets – (Types C, D, E and H) ^[3] ^[4]	Permitted within Clear Zone
	Ditch Bottom Inlet - Type H w/Slot	Outside Clear Zone
425-053 & 425-054	Ditch Bottom Inlets – (Types F, G and J) ^[3]	Permitted within Clear Zone
425-055	Ditch Bottom Inlet - Type K	Outside Clear Zone
425-060	Back of Sidewalk Drain	Permitted within Clear Zone for Urban Curb & Gutter Sections Only with Design Speed ≤ 45 mph
430-010	U-Type Concrete Endwalls With Grates - 15" to 30" Pipe	Permitted within Clear Zone for Low Design Velocities & Negligible Debris
430-011	U-Type Concrete Endwalls Baffles and Grate Optional - 15" to 30" Pipe	Permitted within Clear Zone w/Grate
430-012	U-Type Concrete Endwalls Energy Dissipator - 30" to 72" Pipe	Outside Clear Zone See Index for "Location Reference"
430-020	Flared End Section	≤ 15" Diameter Inside Clear Zone > 15" Diameter Outside Clear Zone
430-021	Cross Drain Mitered End Section ^[6]	≤ 24" Diameter Inside Clear Zone ^[5] > 24" Diameter Outside Clear Zone
430-022	Side Drain Mitered End Section	Permitted within Clear Zone
430-030 to 430-034	Straight Concrete Endwalls	Outside Clear Zone See Indexes for "Location Reference"
430-040	Winged Concrete Endwalls - Single Round Pipe	
430-090	Safety Modifications for Endwalls	Permitted within Clear Zone w/Grate

[1] Lateral offset criteria for vehicular traffic only. Additional considerations may be needed for pedestrian or bicycle traffic. See Indexes for additional information.

[2] Designed for use on limited-access facilities where debris may be a problem.

[3] When slots are required due to debris considerations, the inlet must contain a traversable slot design to be located within a clear zone. See Indexes for traversable slot designs.

[4] Designs intended for areas of infrequent traffic loading.

[5] Equivalent size pipe arch or elliptical pipes are permitted within clear zone. Recommended MES slope is 1:4, otherwise steeper slopes require DDrE approval.

[6] Include slope and ditch transitions when the roadway slope must be flattened to place end section outside clear zone. See Standard Plans, Index 430-021 for detail.

3.8 GRADES

3.8.1 Longitudinal Gutter Grade

The minimum longitudinal gutter grade is 0.3 percent.

3.9 PAVEMENT HYDRAULICS

3.9.1 Spread Criteria

The spread criteria listed is for permanent design and temporary construction conditions. Limit the spread resulting from a rainfall intensity of 4.0 inches per hour as follows.

Table 3.6: Spread Criteria

Typical Section Condition	Design Speed (mph)	Spread Criteria*
Parking Lane or Full Width Shoulders	All	No encroachment into the lane
Left Turn Lanes	Design Speed > 45	Keep 8' of lane clear
Right Turn Lanes	All	Keep ½ of lane clear
All Other	Design speed ≤ 45	Keep ½ of lane clear
	45 < Design Speed ≤ 55	Keep 8' of lane clear
	Design Speed > 55	No encroachment into the lane

* The criteria in this column apply to travel, turn, or auxiliary lanes adjacent to barrier wall or curb, in normal or super-elevated sections.

In addition to the above standards, for sections with a shoulder gutter, the spread resulting from a 10-year frequency storm will not exceed one foot, three inches outside the gutter in the direction toward the front slope. This distance limits the spread to the face of guardrail posts. See **Standard Plans, Index 536-001**.

Design temporary drainage, for traffic diversions and construction staging, to provide drainage where construction activities might divert or trap water and compromise safety

and efficiency. Give additional attention to expected spread for areas that are: (1) flood sensitive, (2) high-speed facilities (> 55 mph posted speed), or (3) using a low side barrier wall.

3.9.2 Trench Drain

Consider trench drains only when traditional inlets are not feasible. Do not place in pedestrian paths unless ADA compliant grates are used. Where placed adjacent to reinforced concrete barrier, detail in plans the position of the drain relative to the barrier to avoid conflicts with the foundation.

Identify in the plans the type of drain, the design flow (Q) of the drain, begin and end locations of the drain and the location of the outlet pipe (if the drain is not stubbed directly into a drainage structure).

Slope outlet pipes and preformed channel inverts at 0.6% or steeper toward the outlet regardless of the surface slope.

Modification for Non-Conventional Projects:

Trench drains are not allowed for the final constructed condition unless approved by the District Drainage Engineer. Trench drains are only allowed for temporary drainage.

3.9.3 Hydroplaning

The **FDM, Section 210.2.4.2, Hydroplaning Risk Analysis**, addresses policy for the analysis of hydroplaning potential when associated with typical section approval.

Capture accumulated runoff from driveways, side streets and ramps to prevent discharging into the mainline travel lanes or other areas where the additional sheet flow may cause hydroplaning. Design the inlet to capture 100 percent of the flow.

3.10 CONSTRUCTION AND MAINTENANCE CONSIDERATIONS

Design storm drain systems consistent with the standard construction and maintenance practices of the Department. The **Standard Plans** provide standard details for inlets, manholes, junction boxes, end treatments, and other miscellaneous drainage details. Specifications are provided in the **Standard Specifications**. In the event the **Standard Plans** are not suitable for a specific project need, develop a detailed design and include

it in the plans; and, as appropriate, provide special provisions for inclusion with the project specifications. Consider maintenance concerns of adequate physical access for cleaning and repair in the design.

Provide topside access at all pipe junctions and bends. The use of junction boxes without topside access will require District Drainage Engineer approval. Consider the use of a new inlet in place of a junction box or manhole to capture roadway runoff.

Drainage structures with internal weirs must have manhole access on each side of the weir. For areas of expected frequent entry, ask FDOT Maintenance if a two piece, three-foot diameter manhole cover is needed for maintenance access.

Modification for Non-Conventional Projects:

Delete the last sentence in the paragraph above and see the RFP for additional requirements.

Provide a four-foot minimum sump in outfall structures and structures with pollution-retardant baffles or skimmers installed inside the structure. When two or more baffles or skimmers are used in the same structure, provide a minimum horizontal distance of 2.5 feet between baffles for maintenance access. For submerged systems where cleanout velocity is not maintained, use a two-foot sump for all affected inlets.

For urban roadways with significant leaf drop potential and a posted speed limit of 40 mph or less, consider using a curb inlet screen to keep debris out of the storm drain system. If a curb inlet screen is used, use a catch basin pipe connection screen in conjunction with it.

All constructed inlets and manholes, excluding closed French drain systems, will not have storm drain pipe(s) exiting a drainage structure with a flow line higher than any storm drain pipe entering the same structure.

3.10.1 Pipe Size and Length

The minimum pipe size for trunk lines and laterals is 18 inches. The minimum pipe diameter for all proposed exfiltration trench pipes (French drain) is 24 inches.

The 18-inch minimum pipe size does not apply to connections from external, private stormwater management facilities. The pipe size for these connections is the size required to convey the Chapter 14-86, F.A.C. or other authoritative permitted discharge limitations.

The maximum pipe lengths without maintenance access structures are as follows:

Pipes without French drains:

18" pipe	300 feet
24" to 36" pipe	400 feet
42" and larger and all box culverts	500 feet

French drains that have access through only one end:

24" to 30" pipe	150 feet
36" and larger pipe	200 feet

French drains that have access through both ends:

24" to 30" pipe	300 feet
36" and larger pipe	400 feet

3.10.2 Minimum Pipe Cover and Clearances

1. If a material option is listed in the plans, the minimum cover must adhere to the criteria shown in **Appendix C**. If this isn't possible, District Drainage Engineer approval will be required.
2. Storm drain systems that cross railroad tracks must meet special below-track clearance requirements and must use special strength pipe. Coordinate early with the District Rail Administrator and the railroad company to determine the specific pipe and clearance requirements.
3. Utility Clearances:
 - a. When a utility crosses a storm drain alignment, the minimum design clearance between the outside of the pipe and the outside of the conflict is 0.5 foot if the utility has been accurately located at the point of conflict. If the utility has been approximately located, the minimum design clearance is one foot. Utility company recommended clearances can vary from these design values, but electrical transmission lines and gas lines must never come into direct contact with the storm drain.
 - b. Locate storm drain lines so they do not disturb existing utilities to the greatest extent practical. If a utility conflict occurs, contact the District Drainage Engineer and the Utilities Section to review potential problems and feasible solutions.
 - c. When a sanitary line or other utility, including other storm drains, must

pass through a manhole, provide minimum clearances in accordance with **Standard Plans, Index 125-001**. Account for the head loss caused by an obstruction in the computation of the design hydraulic grade line. (Note: Gas mains must not pass through inlet and manhole structures.)

- d. Utility conflict structures must provide manhole access on both sides of the conflict when the conflicting utility is large (≥ 12 inches) or the conflict is close to the top of the structure. Maintenance vacuum trucks have a rigid suction pipe that cannot bend around obstructions. If the degree of access is uncertain, contact the local FDOT maintenance office for direction.
- e. The distance between the bottom of the utility and the conflict structure bottom must be no less than the internal diameter of the outlet pipe. Use a two-foot or four-foot sump in areas where sedimentation is expected. Use of a sump will require that the system be designed to account for the head loss generated if the sump is completely blocked.

3.10.3 Pipe Joint Designs Greater than 5 psi

When the pipe joints are expected to withstand design conditions greater than 5 psi but no more than 10 psi, include a plan note requiring the pipe supplier to test the proposed pipe joint to 10 psi using the methodology described in the **Standard Specifications**. If a pressure rating greater than 10 psi is required, call for a pressure pipe in the plans, including the needed ASTM(s) to clearly identify the pipe requirements.

3.10.4 Existing Pipe Inspection and Siltation

Contact the local maintenance office to obtain historic flooding information, pipe or culvert inspection reports and drainage related pavement structural deficiencies. Field reviews are required to assess the condition for all existing piped storm sewer systems and culverts that are being considered to "Remain in Service." Pipe inspections may include video inspection depending on access and complexity of the system. In most cases, pipe desilting is necessary to properly inspect pipe joints and other locations where pavement structural deficiencies have occurred. Develop and submit a summary report of the inspection findings to the District Drainage and Maintenance offices.

Based on the coordination and field review findings, coordinate with the District Drainage and local maintenance office to determine what actions are needed to maintain the required function of the existing piped and culverted systems. Coordinate and obtain approval from both the District Drainage and local maintenance offices prior to any desilting and/or dewatering activities.

Prior to extending any existing pipe that exhibits signs of corrosion and/or structural

cracking, further evaluation is required to determine whether pipe repair or replacement is warranted to extend the service life of the rehabilitated system.

3.11 PIPES WITHIN OR ADJACENT TO RETAINED EARTH (WALLED) EMBANKMENT SECTIONS

The design requirements of this section pertain to all pipes that are within or adjacent to embankments confined by retaining walls. Avoid placing drainage pipes through retaining walls and similar structures when possible. If pipes must be placed within or adjacent to retaining walls, coordinate the design of the drainage system with the geotechnical and structural engineers.

The drawings in Appendix D detail three categories of pipes within retained earth (walled) embankments. Pipes proposed for installation within these wall zones are defined as Wall Zone Pipes.

The Optional Materials Tabulation Sheet must note those pipes that are deemed Wall Zone Pipes. When steel pipes are listed as an option for Wall Zone Pipes also show the minimum pipe wall thickness, meeting the requirements of Appendix D on the Optional Materials Tabulation Sheet.

Pipes used as vertical drains passing under or through retaining walls must satisfy the structural requirements of the American Association of State Highway and Transportation Officials (AASHTO) Load and Resistance Factor Design *Bridge Design Specifications (LRFD – BDS)*, Chapter 12.

When incorporating existing pipes within or adjacent to retained earth embankment sections, assess the condition of the pipe—both water tightness and structural adequacy under the proposed loading—and confer with the geotechnical and structural engineers.

3.12 ADDITIONAL DESIGN CONSIDERATIONS

3.12.1 Noise Walls

Evaluate the capacity of drainage openings in noise walls and locate them horizontally and vertically to ensure that offsite stormwater inflows are accommodated without increasing offsite stormwater stages for the appropriate regulatory design events. Document the existing drainage patterns, including taking photographs along the location of the proposed sound barrier. If the capacity and/or location of noise wall drainage openings are insufficient and cannot be amended to handle offsite inflows, design a drainage system to maintain historic flows and to minimize the maintenance required behind the wall, especially for locations with limited right-of-way behind the wall.

3.12.2 French Drains

Design exfiltration systems (French drains) using **Standard Plans, Index 443-001**. Designs must include provisions for overflow resulting from floods exceeding the design storm condition.

Provide French drain details with dimensional changes or otherwise different from the standard cross-sections represented in **Standard Plans, Index 443-001**. Generally, pipe invert is placed above water table.

Provide baffles, skimmers, and four-foot minimum sumps at inlet points to minimize the entrance of oil and sediments into the French drain system. Use skimmers in French drain catch basins and in other locations where there is a need to prevent oil, debris or other floating contaminants from exiting the catch basins through outlet pipes. Provide detailed geometry for the skimmers per **Standard Plans, Index 443-002**.

Do not locate exfiltration trenches where there are contaminated soils and in well field protection zones with less than 30 days' travel time to potable water supply wells. French drains are not allowed in embankments/fill conditions (not natural or compacted soil material).

Provide a minimum of 10 feet between French drains and overhead sign foundations, drill shafts, light pole foundations, or retaining walls. If this minimum distance cannot be met, the segment of perforated pipe and trench within the 10 feet of influence of the drill shaft or foundation must be replaced with a solid segment of pipe.

Install stormwater exfiltration systems at least two feet from parallel underground utilities and 20 feet from existing large trees that will remain in place.

Establish the depth and location of the French drain trench based on prudent benefit/cost analysis, considering the following factors:

1. Depth of transmissive strata that satisfy design needs
2. Safety, feasibility, and expected frequency of required French drain maintenance activities
3. Loss of functionality of the French drain due to its being under impervious surfaces.
4. Location of trees, utilities, and other features that may compromise the integrity of the trench envelope.
5. The cost of providing other stormwater management infrastructure in lieu of the French drain.
6. Cost of replacing the French drain in the future
7. Potential geotechnical failures in Karst areas

3.12.3 Resilient Connectors

All storm drain manholes and inlets may utilize resilient connectors, as specified in ***Standard Specifications 430***.

Do not specify or require resilient connectors for the following conditions:

- The interface angle of connection between the structure and pipe is greater than 15 degrees in either the horizontal or vertical direction.
- The structure and all connections fall outside the 1:2 roadway template control line, as per ***Standard Plans, Index 120-001***.
- The remaining beam height of the single precast unit, from the top of that segment to the existing crown of pipe chosen, is less than eight inches.
- In projects where elliptical pipes are specified on the plans.

Use resilient connectors to accommodate movement of the bridge collection piping.

3.12.4 Floatation

Design to prevent floatation under design conditions for structures larger than 10 feet by 10 feet, and greater than 14 feet below the anticipated groundwater table. Recognize that, for sandy soils, the groundwater may briefly but significantly elevate during a large rainfall event.

3.13 DOCUMENTATION

3.13.1 Tabulation Form

Figure 3-2 presents the required format for tabulating the results of hydrologic and hydraulic calculations for storm drain systems. This figure also notes the minimum information for producing a Storm Drain Tabulation Form. File a copy of the completed form for permanent record as a part of the signed and sealed design documentation. You will find descriptions and examples of the form content in the ***Drainage Design Guide***.

3.13.2 Other Documentation

File other supporting calculations and design documentation, including:

1. For complex systems, a narrative describing how the storm drain system will function.

2. Hydrologic computations:
 - a. Time of concentration
 - b. Runoff coefficients
3. Spread and inlet capacity analysis
4. Determination of design tailwater
5. Optional materials evaluation
6. Computation of minor energy losses and design resource for the loss coefficient assigned
7. Completed drainage map with drainage areas to each inlet identified, and structures numbered consistent with drainage computations and tabs
8. Outlet scour protection analysis, if applicable

CHAPTER 4

CROSS DRAIN HYDRAULICS

4.1 INTRODUCTION

This chapter presents standards and procedures for the hydraulic design of cross drains, including culverts, bridge-culverts¹, and bridges. The *FDOT Project Development and Environmental Manual* addresses preliminary planning and location studies for cross drains.

4.2 GENERAL

Prepare the hydraulic design of cross drains in accordance with good engineering practice and comply with **23 CFR 650A** and the *National Flood Insurance Program (NFIP)*. Specifically:

1. Design all cross drains to have sufficient hydraulic capacity to convey the selected design frequency flood without damage to the structure and approach embankments, with due consideration to the effects of greater floods.
2. Perform scour calculations with normal safety factors to withstand the design flood condition listed in Section 4.9.2.2 and provide to the structural engineer for foundation design. Ensure that the design has a minimum factor of safety of one against failure due to the scour design check flood condition listed in Section 4.9.2.2.
3. Analyze the design of all cross drain structures for the Design Flood, Base Flood (100-year frequency flood), and the Greatest Flood (overtopping flood or the 500-year frequency flood where overtopping is not practicable) that you expect to flow to the structure. Include a summary of this analysis, showing the peak stages and discharges for these events on the final project plans.
4. For projects that encroach into a Regulatory Floodway, coordinate the design with the appropriate local government flood insurance program official.
5. Designers shall reference the latest edition of the *AASHTO LRFD Bridge Design Specifications (LRFD – BDS)*, Section 2.6.

¹ A culvert qualifies as a bridge if it meets the requirements of Item 112 in the FDOT [Bridge Management System Coding Guide](#).

4.3 DESIGN FREQUENCY

4.3.1 Permanent Facilities

Standard design frequencies for permanent culverts, bridge-culverts, and bridges are as follows:

Table 4.1: Design Storm Frequencies of Permanent Facilities

FACILITY	FREQUENCY
Mainline Interstate	50 years
High Use or Essential: Projected 20-year AADT* > 1,500	50 years
Other: Projected 20-year AADT* < 1,500	25 years
<ul style="list-style-type: none"> • Roadside ditch culverts • Pedestrian and trail bridges 	10 years

* AADT preferred but if not available ADT may be used.

Note: The flood frequencies used for scour analysis differ. See **Section 4.9.2**.

4.3.2 Temporary Facilities

Design temporary traversing works accounting for the permitted duration of the work. Temporary traversing work will cause no more than a one-foot increase in the Design Storm Frequency (DSF) flood elevation immediately upstream and no more than one tenth of a foot increase in the DSF flood elevation 500 feet upstream.

If the existing structure does not have flooding or scour concerns, a 10-year design storm event is the minimum design frequency for temporary culverts, bridge-culverts, and bridges.

4.4 BACKWATER

Hydraulically design cross drains to meet the following backwater conditions:

1. Backwater created by the structure will be consistent with Flood Insurance Study requirements adopted by the local community in accordance with the **National Flood Insurance Program** and **FEMA** guidelines in addition to other relevant sources.
2. Acquire flood rights where offsite stages increase and impact land use values.
3. Keep the backwater for design frequency conditions at or below the travel lanes.

4.5 TAILWATER

For the sizing of cross drains and the determination of headwater and backwater elevations, use the highest tailwater elevation coincident with the design storm event and that can be reasonably expected to occur.

For culverts with tidally influenced tailwaters, adjust the MHW elevation for sea level rise using the methodology in Section 3.4.1.

4.6 CLEARANCES

Refer to the **FDM, Section 260** for the minimum vertical, horizontal, and regulatory clearance requirements for bridges.

4.7 HYDROLOGIC ANALYSIS

4.7.1 Freshwater Flow

Base hydrologic data on one of the following methods, as appropriate for the site:

1. Use a frequency analysis of observed (gage) data when available. If insufficient or no observed data is available, use one of the procedures below as appropriate. To the extent practical, calibrate the procedures below with available observed data for the drainage basin or nearby similar drainage basins.
 - a. Regional or local regression equation developed by the USGS
 - b. Rational Equation for drainage areas up to 600 acres

2. For regulated or controlled canals, request hydrologic data from the controlling entity. Prior to use for design, verify these data to the greatest extent practical.

4.7.2 Tidal Flow

When analyzing creeks and small rivers flowing into tidal water bodies, consider hurricane rainfall runoff in conjunction with surge-driven tailwater. In such cases, since hurricane rainfall is largely independent of peak surge stage, use the U.S. Army Corps of Engineers (USACE) tropical storm rainfall runoff procedure from the **1986 Engineering and Design Storm Surge Analysis Manual (EM1110-2-1412)**, Chapter 4, to estimate runoff from any design surge regardless of the surge return frequency being analyzed. The above procedure may be found at the website: ftp://ftp.library.noaa.gov/noaa_documents.lib/NOAA_related_docs/USACE/19860415_S_torm_surge_analysis_EMI_1110-2-1412.pdf

Alternatively, you may use a steady discharge equal to the peak flow from a 10-year storm in lieu of the above **USACE procedure**.

4.8 HYDRAULIC ANALYSIS

4.8.1 Riverine Crossings

4.8.1.1 Bridges

FHWA's Finite Element Surface Water Modeling System (**FESWMS**), and **USACE's** **HEC-RAS**, **ICPR** and **RMA-2**, are acceptable computer programs to analyze the hydraulic performance of bridges over riverine waterways.

4.8.1.2 Bridge-Culverts and Culverts

Analyze the hydraulic performance of bridge-culverts and culverts at riverine waterways based on the techniques provided in **FHWA Hydraulic Design Series #5**.

4.8.2 Tidal Crossings

Use coastal engineering analysis, as typified by the USACE and consistent with current coastal engineering practice, in the analysis of astronomical tides and hurricane storm surges. The computer programs acceptable for hydraulic analyses at tidal crossing are **HEC-RAS**, **RMA-2**, **ADCIRC**, and **FESWMS**.

4.8.2.1 Ocean Boundary Hydrographs

When ocean coast hurricane hydrographs are used for driving surge models inland, use stage/time hydrographs from the following website:

<https://www.fdot.gov/roadway/Drainage/DHSH.shtm>

Adjust the hurricane hydrograph for sea level rise using the methodology in Section 3.4.1.

4.8.2.2 Use of Qualified Coastal Engineers

If coastal hydraulics is significant to the bridge or culvert design, a qualified coastal engineer should review the complexity of the tidal conditions to determine the appropriate level of coastal engineering expertise needed in the design. Ideally, this assessment should be performed during the PD&E phase as specified in the *FDOT PD&E Manual*, Chapter 4. Conditions that typically require direct attention by a coastal engineer during the final design phase include:

- Hydraulic analysis of interconnected inlet systems
- Analysis of inlet or channel instability, either vertically or horizontally
- Determination of design wave parameters
- Prediction of overwash and channel cutting
- Design of countermeasures for inlet instability, wave attack, or channel cutting
- Prediction of sediment transport or design of countermeasures to control sediment transport
- Assessment of wave loading on bridges and other structures

Modification for Non-Conventional Projects:
Delete Section 4.8.2.2 and see the RFP for requirements.

4.9 SPECIFIC STANDARDS RELATING TO BRIDGES

4.9.1 Berms for Spill-Through Abutment Bridges

To facilitate construction, reduce scour potential, and provide for abutment stability, provide a minimum berm width of 10 feet between the top edge of the main channel and the toe of spill-through at bridge abutments. See **Section 4.9.3.2**. For manmade canals, the berm may be omitted at the direction of the maintaining agency.

4.9.2 Scour Estimates

4.9.2.1 Coordination

Develop scour estimates for bridges using a multi-disciplinary approach involving the hydraulics engineer, the geotechnical engineer, the coastal engineer (if needed per **Section 4.8.2**, above), and the structures engineer.

4.9.2.2 Scour Estimates

Develop scour elevation estimates for each bent as follows:

Table 4.3: Scour Estimates

Hydraulic Design Flood Frequency	Scour Design Flood Frequency	Scour Design Check Flood Frequency
Q ₁₀	Q ₂₅	Q ₅₀
Q ₂₅	Q ₅₀	Q ₁₀₀
Q ₅₀	Q ₁₀₀	Q ₅₀₀

- "Long-term scour" for structures required to meet the extreme event vessel collision load.
- For temporary bridges, with lengths less than the existing bridge being replaced, a 25-year scour analysis is recommended.

Estimate scour depths using the procedures of **FHWA's Hydraulic Engineering Circulars (HEC) 18 and 20**, except for the following:

- Follow **Section 4.8.2** for tidal hydraulics analysis methodology.
- Use **Sheppard's Pier Scour Equation** rather than the **CSU Pier Scour Equation** when the total scour (general scour, contraction scour, and local scour) is greater than six feet.
- Use the **Florida Complex Pier Scour Procedure** in lieu of the complex pier scour procedure in **HEC 18**.
- Use the Florida Rock/Clay Scour Procedure to evaluate scour in scour-resistant soils.
- Use SED-2D to evaluate contraction scour in the absence of a clearly defined upstream tidal floodplain. You can find guidance on the above Florida procedure at the website:

<https://www.fdot.gov/roadway/Drainage/Bridge-Scour-Policy-Guidance.shtm>

4.9.2.3 Scour Components

Scour estimates consist of the total scour resulting from the following:

1. Natural channel aggradation and degradation anticipated during the life of the structure
2. Channel migration anticipated during the life of the structure
3. Contraction scour
4. Local scour, including pier scour and abutment scour from currents and waves
(Note: Abutment scour estimates are not required when the minimum abutment protection is provided.)

The "long-term scour" is the total design scour for structures subject to clear water scour. For structures subject to live bed scour, the "long-term scour" is the normal, everyday scour at the piers combined with the degradation scour anticipated during the life of the structure. The following inset provides criteria for determining normal, everyday scour at the piers.

Normal, Everyday Scour at the Piers

Bridge inspection reports and the design survey are the primary basis for determining normal everyday scour for bridge replacements, parallel bridges, major widenings, etc.

If the proposed piers are the same as the existing, the normal, everyday scour elevation is that which is reflected in the inspection reports and the design survey. Slight differences in scour will likely exist between inspection reports and between the reports and the design survey. In these cases, an average scour elevation will be a reasonable estimate of normal, everyday scour. If there is a large difference, it may be due to an extreme storm event that occurred just before the inspection or survey was made. Investigate this and address these situations on a case by case basis.

For structures in which the proposed piers will be a different size or shape than the existing, adjust the pier scour depth. Using the inspection reports and the survey as discussed above, determine a normal, everyday scour depth at the pier. Adjust this depth using the following formula. The formula was derived by assuming only the pier width and shape change. Flow, velocity, and depth remain unchanged from existing to proposed.

$$y_{sp} = \frac{k_{1p}}{k_{1e}} \left[\frac{a_p}{a_e} \right]^{0.65} y_{se}$$

where:

y_{sp} & y_{se} = Scour depth for proposed pier and existing pier, respectively

k_{1p} & k_{1e} = Pier nose shape correction factor for proposed and existing pier, respectively

a_p & a_e = Pier width for proposed and existing pier, respectively

For new bridges/new alignments where there are no historical records available, the drainage engineer should look for hydraulically similar bridges in the area (preferably on the same water body) and estimate scour using the above guidelines. If there are no similar structures to use for comparison, contact the District Drainage Engineer for guidance on other methods for estimating normal everyday scour.

4.9.3 Scour Protection Considerations

4.9.3.1 General

Design pier spacing and orientation, along with abutment protection, in coordination with other bridge design concerns to minimize flow disruption and potential scour, subject to navigation requirements.

Design abutment and pier protection as follows:

1. For protection against the effects of scour conditions consistent with design requirements stated above
2. For the effects of wind-generated waves and boat wake

Document revetment options deemed to be inappropriate for the site in the BHR. Write a Technical Specification, if a **Standard Specification** does not exist, based on the use of the most desirable revetment material, with the option to substitute the other allowable materials at no additional expense to the Department.

Specify the environmental classification for gabions based on the criteria found in the **Structures Manual, Volume 1: Structures Design Guidelines, Section 1.3**.

Follow the **USACE Shore Protection Manual** for design of coastal revetment.

4.9.3.2 Minimum Abutment and Retaining/Sea Wall Protection

For wave heights greater than 2.4 feet (typically in coastal applications), use Specific Gravity (S.G.) = 2.65 or greater rubble. In such cases, extend abutment protection beyond

the bridge along embankments and retaining/sea walls that may be vulnerable to wave attack during a hurricane. Design for both wave attack above the peak design surge elevation and wave rebound scour at the toe of bulkheads. In such cases, obtain the size and coverage of the revetment from a qualified coastal engineer

4.9.3.2.1 Spill-through Abutments

For spill-through abutments, minimum protection consists of one of the following placed on a slope no steeper than 1(vertical) to 2 (horizontal):

- Rubble riprap (bank and shore), bedding stone, and filter fabric: Rubble riprap (bank and shore) as defined in the **Standard Specification 530** where (1) design flow velocities do not exceed 7.7 fps, (2) Froude numbers are ≤ 0.80 , and (3) wave heights do not exceed 2.4 feet
- Articulated concrete block (cabled and anchored), as defined in Standard Specification 530

The **Structures Detailing Manual** provides typical details for standard revetment protection of abutments and extent of coverage. Determine the horizontal limits of protection using **HEC 23**. Provide a minimum distance of 10 feet if **HEC 23** calculations show less than 10 feet.

Prepare site-specific details as stated in Specification 530 when using articulating concrete block abutment protection.

4.9.3.2.2 Bulkhead Abutments

When bulkhead abutments are protected by a structural wall, consult with the structural engineer to determine the need for toe protection below the wall and revetment protection above the wall. When the design velocity in the contracted section is less than or equal to 7.2 fps, use bank and shore rubble riprap. When the design velocity is above 7.2 fps, design the size and density of the rubble for site conditions. In all cases, design the spatial extent of the rubble protection for individual site conditions.

4.9.3.3 Pier Protection

Where revetment is deemed necessary to protect piers from scour, and upstream design flow velocities do not exceed 7.2 fps for rectangular piles or bascule piers, and 8.2 fps for round piling or drilled shafts, use one of the following for pier scour protection:

- Rubble riprap (bank and shore), bedding stone, and filter fabric: Rubble riprap (bank and shore) is defined in the **Standard Specification 530**

-
- Articulated concrete block (cabled)
 - Gabions (rock-filled baskets)

4.9.3.4 Use of Bedding Stone with Revetments

Geotextile type and material referenced below is based on ***Standard Specification 985***.

Use bedding stone to cushion the underlying filter fabric during installation of rubble and to keep the filter fabric flat against the parent soil to avoid the piping of sheet flow cascading from the top side of the rubble.

4.9.4 Bridge Deck Drainage

4.9.4.1 Spread Standards

The spread standards in ***Section 3.9*** apply to bridge decks and bridge approaches.

4.9.4.2 Scupper Drains

The standard scupper drain is four inches in diameter and spaced on 10-foot centers, unless spread calculations indicate closer spacing is required. Design using a factor of safety of 2. Scuppers will not be directly discharging onto railroads, roadway travel lanes, shared-use paths, or sidewalks. Provide erosion protection, which could include splash pads or rubble, for scuppers discharging onto erodible surfaces.

4.9.4.3 Bridge Sidewalk Drainage

Where bridge sidewalks are sloped away from the travel lanes, no measures to capture runoff from the sidewalks are required, except at bridge ends. If bridge sidewalk drainage is installed, scuppers must satisfy Americans with Disabilities Act (ADA) requirements to have no more than a one-half inch hole in the walking surface.

4.9.5 Wave and Current Forces on Coastal Bridges

Where coastal bridges are not elevated at least one foot above the design wave crest elevation (DWC), a qualified coastal engineer with experience in wave mechanics must address the requirements of the ***AASHTO Guide Specifications for Bridges Vulnerable to Coastal Storms***.

4.9.5.1 Required Level of Analysis

Use a qualified coastal engineer as part of the PD&E scoping effort, especially with structures exposed to severe wave attack. Make determinations, including the appropriate level of analysis, as outlined in the ***Structures Design Guidelines***, Section 2.5.

4.10 SPECIFIC STANDARDS RELATING TO ALL CROSS DRAINS EXCEPT BRIDGES

4.10.1 Culvert Materials

Select culvert material in accordance with **Chapter 6** of this **Manual**.

4.10.2 Manning's Roughness Coefficients

Standard values for Manning's roughness coefficient are as follows:

Concrete Box Culverts	n = 0.012
Concrete Pipes	n = 0.012

Metal Pipes:

Pipe and Pipe Arch—Helical Fabrication	
Re-corrugated Ends—All Flow Conditions*	
12" – 24"	n = 0.020
30" – 54"	n = 0.022
60" and larger	n = 0.024

Pipe and Pipe Arch—Spiral Rib Fabrication	
Re-Corrugated Ends—All Flow Conditions*	
All sizes	n = 0.012

Structural Plate—Pipe and Pipe Arch	
Annular Fabrication—All Flow Conditions*	
All—6 x 2	n = 0.033
All—9 x 2-1/2	n = 0.034

Plastic Pipes:

Polyvinyl Chloride-PVC (external rib/smooth interior)	
All Sizes	n = 0.012

Polyethylene	
Single Wall	n = 0.024
Double Wall (Smooth)	n = 0.012
Polypropylene (All Sizes)	
Single Wall	n = 0.024
Double & Triple Wall (Smooth)	n = 0.012

* "Spiral" flow will not occur for most design situations. Therefore "spiral" flow design values have not been established. Values recommended by the Southeast Corrugated Steel Pipe Association are contained in the ***AISI Handbook of Steel Drainage & Highway Construction Products***.

4.10.3 End Treatment

Select/design the choice of end treatment and other hydraulic structures to satisfy hydraulic capacity, structural capacity, and safety (vehicular, pedestrian, cyclist) requirements.

Treatments are presented in the ***Standard Plans***. The ***Standard Plans*** provide criteria on end treatment selection.

4.10.3.1 Protective Treatment

Review drainage designs to determine if some form of protective treatment will be required to prevent entry to facilities that present a hazard to children and, to a lesser extent, all persons or certain wildlife. **Section 3.7** presents direction on protective treatment. When grates are used, consider the effect of the grate and potential debris on the hydraulic capacity of the cross drain.

4.10.3.2 Roadside Safety

The type and location of end treatments must consider roadside safety and clear zone requirements. See the ***FDM*** for clear zone requirements and the ***Standard Plans*** for end treatment safety guidance.

4.10.4 Construction and Maintenance Considerations

Design culverts to be consistent with the standard construction and maintenance practices of the Department. Standard details for inlets, manholes, junction boxes, end treatments, and other miscellaneous drainage details are provided in the ***Standard Plans***. Specifications are provided in the ***Standard Specifications***. In the event the ***Standard Plans*** are not suitable for a specific project need, develop a detailed design

and include it in the plans; and, as appropriate, provide special provisions for inclusion with the project specifications. Proper design also considers maintenance concerns of adequate physical access for cleaning and repair. Refer to the criteria in **Section 3.10.1** for the recommended maximum pipe lengths without maintenance access. Refer to Section **3.10.4** for criteria on existing pipe inspection.

4.10.4.1 Minimum Culvert Sizes

Minimum culvert sizes are as follows:

<u>Culvert Type</u>	<u>Minimum Size</u>
Cross Drain	18"
Median Drain	15" *, **
Side Drain	15" *
Box Culvert (Precast)	3' x 3'
Box Culvert (Cast in Place)	4' x 4'
Drains from inlets on high fills (e.g., gutter drains)	15" **

* Some locations require 18" minimum. Consider future improvements, hydraulic requirements, debris control, and maintenance access.

** When debris control is not provided by grates, use 18" minimum.

For culverts requiring more than a double line of pipe, investigate other alternatives.

4.11 DOCUMENTATION

4.11.1 Culverts (all culverts less than a 20-foot bridge culvert)

4.11.1.1 Extensions of Culverts with No Known Historical Problems

For extensions of culverts that have no signs of undesirable scour at inlet and outlet ends, no excessive sedimentation, and no history of problems, include in the documentation, at a minimum, the following:

1. Evidence of contact with Maintenance Office
2. Evidence of Field Review
3. Discharge computations
4. Hydraulic computations (**HDS 5**), including any design assumptions

4.11.1.2 New or Replacement Culverts and Extensions of Culverts with Known Historical Problems

At a minimum, include in the documentation:

1. Evidence of contact with a maintenance office
2. Evidence of Field Review
3. Drainage map
4. Hydrologic computations
5. Hydraulic computations (**HDS 5**), including any design assumptions
6. Assessment of the problem (for culverts with known problems)
7. Alternative analysis
8. Optional materials evaluation

4.11.2 Bridges

Document bridge hydraulic design computations and analyses in a permanent record file. The permanent record file will address all design standards provided herein. Provide documentation in detail commensurate with the complexity of the project. Documentation must be sufficient enough that an independent engineer with expertise in bridge hydraulics, but not involved with the design, can fully interpret, follow, and understand the logic, methods, computations, analysis, and considerations used to develop the final design.

4.11.2.1 Bridges on Controlled Canals

Bridges on controlled canals not affected by hurricane surge may utilize the short-format BHR located in Chapter 5 of the ***Drainage Design Guide***.

4.11.2.2 Bridge or Bridge Culvert Widening

At a minimum, include in the documentation:

1. For bridges, a completed Bridge Hydraulics Recommendations Sheet (BHRS), including complete design recommendations, is required; this is not required for bridge culverts; the format for the BHRS is provided in the ***FDM***
2. Evidence of Field Review
3. Hydrologic analysis, including sources of data and methodology
4. Hydraulic computations, including any design assumptions; provide an electronic copy with the input and output file(s) for the final computer run
5. Scour analysis:
 - a) Scour computations
 - b) Scour protection needs

6. Applicable regulatory agency documents that affect the final design; this may include documents from the Corps of Engineers, Coast Guard, Water Management District, DEP, etc.
7. Deck drainage analysis and computations

4.11.2.3 Bridge Culverts

At a minimum, include in the documentation:

1. Evidence of Field Review
2. Hydrologic analysis, including sources of data and methodology
3. Hydraulic computations, including any design assumptions; provide an electronic copy with the input and output file(s) for the final computer run
4. Scour analysis addressing the need for inlet and/or outlet protection
5. A summary of the alternatives considered, including cost estimates and reasons for selecting the recommended structure, and a clear explanation as to why it is the most economical structure for the site in question
6. Applicable regulatory agency documents that affect the final design; this may include documents from the Corps of Engineers, Coast Guard, Water Management District, DEP, etc.
7. For interstate system bridges over floodplains where a regulatory floodway has not been established, the documentation must include the evaluation required in Section 4.4 of this Chapter.

4.11.2.4 Category 1 and 2 Bridges

At a minimum, include in the documentation:

1. A completed Bridge Hydraulics Recommendations Sheet (BHRS). The format for the BHRS is provided in the **FDM**.
2. Bridge Hydraulics Report, including:
 - A. A summary of all design recommendations, including:
 - 1) Bridge length, including locations (stations) of abutments
 - 2) Channel excavation requirements
 - 3) Minimum vertical clearance
 - 4) Minimum horizontal clearance
 - 5) Abutment type and orientation
 - 6) Pier orientation
 - 7) Scour depths
 - a. Scour design event
 - b. Scour check event

-
- 8) Scour protection requirements for abutments, piers, and channel; for spill-through abutments, recommendations will include:
 - a. Abutment slope
 - b. Type of protection (rubble riprap is standard)
 - c. Horizontal and vertical extent of protection
 - d. Consideration of wildlife connectivity
 - 9) Deck drainage requirements
 - 10) Wave and surge parameters and force determination (or calculation) and analysis (for coastal bridges not elevated one foot above the design wave crest elevation)
- B. Evidence of Field Review
- C. Hydrologic analysis, including sources of data and methodology
- D. Alternative analysis or evaluation of structure sizes (length and vertical height/clearance) performed consistent with Department policy for bridge hydraulic design and including:
- 1) Cost
 - 2) Design standards
 - 3) Structure hydraulic performance, including backwater, velocity, and scour
 - 4) Impacts of the structure on adjacent property
 - 5) Environmental impacts
- E. The alternative analysis will address the reasons for selecting the recommended structure, and a clear explanation as to why it is the most economical structure for the site in question; at a minimum, the following structure sizes will be evaluated:
- 1) The minimum structure size required to meet hydraulic standards for vertical and horizontal clearance, scour, and backwater
 - 2) Existing structure size if applicable
 - 3) The recommended structure size if different from (1) or (2)
- F. Deck drainage analysis
- G. Supporting hydraulic computations, including:
- 1) Computer analysis, if appropriate, including a plan view of cross section locations and an electronic copy with the input and output file(s) for the final computer run
 - 2) Scour computations
 - 3) Deck drainage computations
 - 4) Design assumptions
 - 5) Wave and surge parameters and force determinations and analysis (for coastal bridges not elevated one foot above the design wave crest elevation)

-
- H. Applicable regulatory agency documents that affect the final design, which may include documents from the Corps of Engineers, Coast Guard, WMD, DEP, etc.

4.11.3 Document Processing

Processing of the BHR/BHRS and other supporting design documents will be in accordance with the ***FDM***.

CHAPTER 5

STORMWATER MANAGEMENT

5.1 INTRODUCTION

This chapter presents standards for the design of stormwater management systems for Department projects. Guidance for drainage connection permits are covered in the ***FDOT Drainage Connection Permit Handbook***.

5.2 REGULATORY REQUIREMENTS

5.2.1 Chapter 14-86, Florida Administrative Code

The design of stormwater management systems for Department projects will comply with the water quality, rate, and quantity requirements of ***Section 334.044(15), F.S., Chapter 14-86, F.A.C.***, Rules of the Department of Transportation, only in basins closed during storms up to and including the 100-year storm event, or areas subject to historical flooding.

5.2.2 Section 373.4596, Florida Statutes

Section 373.4596, Florida Statutes requires the Department of Transportation to fully comply with state, Water Management District, and—when delegated by the state—local government stormwater management programs.

5.2.3 Chapter 62-25, Florida Administrative Code

Chapter 62-25, F.A.C., rules of the Florida Department of Environmental Protection specify minimum water quality treatment standards for new development.

5.2.4 Chapter 62-40, Florida Administrative Code

Chapter 62-40, F.A.C., rules of the Florida Department of Environmental Protection outlines basic goals and requirements for surface water protection and management to be implemented and enforced by the Florida Department of Environmental Protection and Water Management Districts.

5.2.5 National Pollutant Discharge Elimination System

The ***National Pollutant Discharge Elimination System (NPDES) permit program*** is administered by the U. S. Environmental Protection Agency and delegated to FDEP. This program requires permits for stormwater discharges into waters of the United States from industrial activities; and from large and medium municipal separate stormwater systems.

5.3 ENVIRONMENTAL LOOK AROUNDS (ELA)

After determining project stormwater management requirements and before planning stormwater management design decisions, convene a meeting with regional stakeholders to explore watershed wide stormwater needs and alternative permitting approaches. Evaluate the following opportunities for application on the project:

1. WMD/DEP issues: wetland rehydration, water supply needs, minimum flows and levels, flooding, TMDL needs, acquisition of fill from DEP/WMD lands, etc.
2. City/County issues: stormwater re-use, flooding, discharge to golf courses or parks, NPDES needs, water supply needs
3. DOT project permitting: regional treatment, stormwater re-use, joint use facilities

Appropriate personnel are as follows:

WMD/Regional DEP: ERP, water quality, water supply, wetland, and Minimum Flows & Levels personnel, BMAP coordinator(s)

DOT: DDrE, PD&E Planning, or Design PMs, permit coordinator, NPDES representative

City/County: (as decided by the city/county) City Engineer, Public Works Director, Stormwater Engineer

Document areas of potential cooperation in the project reports for future follow up as the design moves forward.

The best time for holding these ELA meetings is before identification of right-of-way acquisition in the PD&E phase. If no right-of-way acquisition or PD&E phase is scheduled, then target as early as feasible within the design phase.

5.4 DESIGN STANDARDS

5.4.1 Design of Systems

5.4.1.1 General

Design stormwater management facilities to provide the necessary quantity, rate, and quality control based on the presumption that for the existing discharge all necessary quantity, rate, and quality control of stormwater from upper property has occurred prior to reaching the right-of-way.

For facilities designed to be dry, or using underdrains or exfiltration, provide the appropriate geotechnical analysis, certified by the project Geotechnical Engineer.

Accommodate all offsite runoff in accordance with the Department's criteria and all regulatory agency criteria. Maintain all historical flow patterns for offsite flows. If economically prudent, the Department's wet detention facilities may accept (co-mingle) offsite discharges into them without increasing the required water quality treatment design; in such cases, avoid hydraulic impacts on upstream property owners. For co-mingling offsite discharges into the Department's dry retention facilities, consult the District Drainage Engineer for direction on whether to co-mingle or bypass offsite inflows.

Modification for Non-Conventional Projects:
--

Delete the previous paragraph and see the RFP for requirements.

Stormwater pond control structures consist of ditch bottom inlets in conjunction with outfall pipes. Do not use trapezoidal weirs, shaped into the pond berm, as primary control structures except where inlets and pipes are not feasible.

Start initial pond routing at the control elevation unless otherwise required by the Water Management District permit.

No pump or any other mechanical means may control any component of a permanent stormwater system.

With facilities designed to be wet, provide a minimum permanent pool depth of six feet to minimize aquatic growth.

Adjust the tailwater elevation for coastal pond outfalls to account for sea level rise using the methodology in **Section 3.4.1**.

While the Department does not encourage the use of pond liners, unique project

conditions may necessitate their use. Consult the District Drainage Office prior to beginning design. The DDG Section 9.3.4.2 provides additional pond liner design considerations.

5.4.1.2 Watersheds with Positive Outlets

Projects discharging to offsite areas subject to reported historical flooding, up to the 100-year, 24-hour storm event, must assess the discharge requirements of **Rule 14-86 FAC**. Additionally, any Department projects discharging into drainage systems with heightened public safety risks, such as roadway drainage systems, must comply with **Rule 14-86 FAC**.

5.4.1.3 Watersheds without Positive Outlets

For projects that are located within a watershed that contributes to a depressed low area, or a lake that does not have a positive outlet such as a river or stream to provide relief (i.e., closed basin or isolated depression), a detention/retention system is required.

The detention/retention system must assess the discharge requirements of **Rule 14-86 FAC**. The retention volume must recover at a rate such that one-half of the volume is available in seven days, with the total volume available in 30 days. A sufficient amount must be recovered within the time necessary to satisfy applicable water quality treatment requirements.

5.4.1.4 Exceptions

5.4.1.4.1 Tidal Areas

Water quantity and rate control criteria are not applicable for projects that discharge directly into tidal areas. This is subject to permission of the appropriate permitting authority.

5.4.1.4.2 Downstream Improvement

Water quantity and rate control criteria are not applicable where it can be demonstrated that downstream conveyance and storage systems have adequate capacity or will be improved to have adequate capacity for the increased quantity and rate of runoff created by the project.

5.4.1.4.3 Compensatory Treatment

For projects where proper treatment (volume, rate, quality), cannot be feasibly obtained,

treatment of existing untreated areas that discharge to the same receiving water body may be substituted in lieu of treating the project.

5.4.1.4.4 Permission from the Downstream Property Owner

Water quantity and rate control criteria can be waived when the downstream property owner(s) agrees to accept the increased quantity and rate of runoff created by the project.

5.4.1.5 Aviation

When designing stormwater facilities within five miles of airports, coordinate with the District Aviation Administrator to determine if stormwater facilities are within Federal Aviation Administration (FAA) oversight. If ponds are within FAA oversight and cannot be prudently moved, these facilities must be designed using FAA guidelines. These FAA design guidelines are intended to reduce plane/bird strikes by making stormwater facilities less attractive to birds.

5.4.2 Hydrologic Methods

The hydrologic method used will consider one of the following:

1. Natural Resources Conservation Service (NRCS) Unit Hydrograph Method
2. Modified Rational Method for basins having a time of concentration of 15 minutes or less

5.4.3 Protective Treatment

Design stormwater management facilities with due consideration of the need for protective treatment to prevent hazards to persons. General guidance on protective treatment is provided in **Section 3.7**. Use flat slopes when practical. Only fence retention areas in accordance with **Section 5.4.4.2 (4)**.

5.4.4 Construction and Maintenance Considerations

5.4.4.1 General

Design stormwater management systems consistent with the standard construction and maintenance practices of the Department. Standard details for inlets, manholes, junction boxes, end treatments, and other miscellaneous drainage details are provided in the **Standard Plans**. Specifications are provided in the **Standard Specifications**. In the event the **Standard Plans** are not suitable for a specific project need, develop a detailed

design and include it in the plans; and, as appropriate, provide special provisions for inclusion with the project specifications. Proper maintenance access for cleaning and repair will be addressed.

5.4.4.2 Detention and Retention Ponds

Design stormwater management facilities consistent with the Highway Beautification Policy and Context Sensitive Solutions Policy. Integrate facilities with existing and proposed landscaping and adjoining land uses. With the time, space and money available, consider attractive pond shapes, tree plantings, selective clearing, and other strategies to preserve or improve aesthetics. Rely on an interdisciplinary team consisting of the Landscape Architect, Drainage Engineer, and local maintenance office. Collaborate with the Landscape Architect to address an aesthetic design approach early enough within the project production schedule to include it in the determination of pond right-of-way acquisition needs.

Standard design features for detention and retention ponds are shown in **Figure 5.1** and are as follows:

1. Maintenance Berm:

Design ponds to provide a minimum 20 feet of horizontal clearance between the top edge of the control elevation and the right-of-way line. Provide at least 15 feet adjacent to the pond at a slope of 1:8 or flatter. Create the inside edge of the maintenance berm to have a minimum radius of 30 feet toward the pond and be a minimum of one foot above the maximum design stage elevation. Sod the berm area. Discuss maintenance needs with the Department before acquiring additional right-of-way to construct maintenance access around the full perimeter.

2. Slopes:

For facilities designed to be wet, sod pond slopes to the control elevation of the pond. For facilities designed to be dry, sod pond slopes to the bottom of the slope.

3. Freeboard:

As a safety factor for hydrologic inaccuracies, grading irregularities, control structure clogging, and downstream stage uncertainties, at least one foot of freeboard is required above the maximum design stage of the pond. The freeboard is the vertical distance between the maximum design stage elevation of the pond and the inside edge of the berm, as illustrated in **Figure 5-1**.

For linear treatment swales, the minimum freeboard is 0.5 foot.

4. Fencing:

Install fences around ponds only when a documented maintenance need for

restricted access has been demonstrated. The installation of fencing around stormwater ponds requires a Design Variation approved by the State Roadway Design Engineer. Where approved, make sure fences are context sensitive and do not detract from the appearance of the ponds or adjoining property.

When requesting the approval of a Design Variation to install fence around stormwater management facilities, the conditions below, when properly documented, typically are acceptable justifications for ponds designed to be permanently wet (permanent design water depth of two feet or greater):

- Above-water pond slopes steeper than 1:4 are unavoidable. Note: Stormwater permits typically require wet ponds to be fenced when the above-water slopes of the pond are steeper than 1:4. Ponds that enjoy the benefit of fence at the right-of-way line need no additional fencing around them.
- A hidden hazard occurs within five feet of the water's edge. Examples of a hidden hazard are a sharp drop off, such as a 1:2 slope, sharp objects, or otherwise potentially injurious, hidden, underwater hazards.
- The site is likely to experience significant exposure to children or the elderly. Examples of such locations are ponds immediately adjacent to schools, daycares, assisted living facilities, nursing homes, public playgrounds, public basketball courts, etc.

In addition, when requesting the approval of a Design Variation to install fence around ponds of any water depth, the conditions below, when properly documented, are typically acceptable justifications:

- Livestock are expected to wander into the stormwater management facility
- Illicit dumping has historically occurred or is expected to occur

5. Access Easements:

When pond areas are not accessible directly from the road right-of-way, provide an access easement.

6. Seepage:

When diking or berming a stormwater pond above surrounding grade, evaluate seeping and piping and consult geotechnical expertise for the stability of the earthwork berm. Avoid planting woody species with developed root structures on embankment berms, as this can cause piping and geotechnical failures.

7. Traversable Pond Overflow:

Design and construct all berm-style weirs in pond or swale berms to be traversable. Berm-style weirs require a structural and geotechnical design to support the

loading of maintenance vehicles without failure.

Modification for Non-Conventional Projects:

Do not use any proposed berm-style weirs, trapezoidal or otherwise, unless explicitly allowed in the RFP.

5.5 DOCUMENTATION

The documentation for stormwater management facilities must justify the facility and describe the design and operation. At a minimum, the documentation will include:

1. Pond siting evaluation (required only if additional right-of-way is obtained for the pond) consisting of:
 - a. Identification of alternate sites
 - b. For each alternate, include preliminary information about:
 - i. Right-of-way costs
 - ii. Water quality and quantity volumes
 - iii. Soil and groundwater conditions
 - iv. Potential hazardous waste contaminations
 - v. Potential impacts to endangered species
 - vi. Potential impacts to cultural resources
 - vii. Potential impacts to utilities
 - viii. Potential impacts to existing landscapes and adjoining land uses
 - ix. Aesthetic effects
 - x. Construction costs including earthwork
2. Drainage Map
3. Evidence of Field Review
4. Description of applicable regulatory requirements
5. Description of pre-developed runoff characteristics, such as basin boundaries, outfall locations, peak runoff rates, and methods of conveyance.
6. Description of post-developed runoff characteristics, such as those listed in item 5, above
7. Schematic of interconnected ponds (if applicable)
8. Description of the operation of the facility; this will be used by design reviewers, but is intended for maintenance personnel who may have to certify that the facility is operating as designed
9. Soils and groundwater information
10. Stage versus storage values
11. Electronic file of routing calculations

12. Any special maintenance requirements
13. Justification for any proposed fencing
14. Documentation of ELA efforts and results
15. Description of how pond aesthetics are addressed
16. Additional information as requested by the District Drainage Engineer

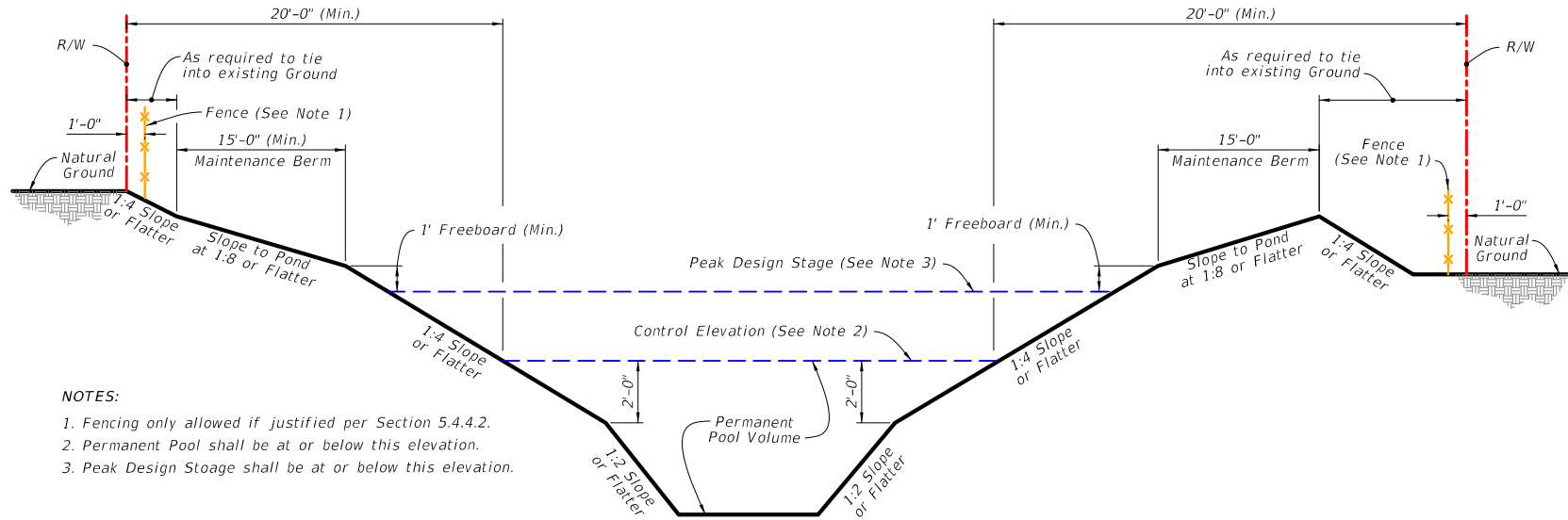

NOTES:

1. Fencing only allowed if justified per Section 5.4.4.2.
2. Permanent Pool shall be at or below this elevation.
3. Peak Design Stage shall be at or below this elevation.

Figure 5-1: Minimum Clearance Retention-Detention Ponds

CHAPTER 6

OPTIONAL CULVERT MATERIALS

6.1 INTRODUCTION

Analyze optional culvert materials for all culvert applications including, but not limited to, storm drains, cross drains, side drains, gutter drains, vertical drains, and French drains. Evaluate all culvert materials shown in **Table 6-1** for the application being designed. Evaluate the functionally equivalent performance in three areas: durability, structural capacity, and hydraulic capacity.

6.2 DURABILITY

Design culverts for a design service life (DSL) appropriate for the culvert function and highway type. Department requirements for DSL are provided in **Table 6-1**. The projected service life of pipe material options called for in the plans will satisfy, as a minimum, the Design Service Life. Do not reduce pipe material standards when projected service life exceeds design service life.

In estimating the projected service life of a material, evaluate the actual performance of the material in nearby similar environmental conditions, its theoretical corrosion rate, the potential for abrasion, and other appropriate site factors. Base theoretical corrosion rates on the environmental conditions of both the soil and water. At a minimum, evaluate the following corrosion indicators:

1. pH
2. Resistivity
3. Sulfates
4. Chlorides

Base all tests for the above characteristics on FDOT-approved test procedures. For projects with a small amount of pipe, to avoid unnecessary site-specific testing, generalized soil maps may be used to delete unsuitable materials from consideration. When known, also evaluate the potential for future land use changes that may change soil and water corrosion indicators.

6.2.1 Culvert Service Life Estimation

Use the latest version of the computer program, tables, and figures (found in **Chapter 8** and **Appendix M** of the **Drainage Design Guide, DDG**), and/or criteria stated below to evaluate the estimated service life for the following culvert materials:

The Culvert Service Life Estimator Program is available here: [Drainage Design Aids](#)

Galvanized Steel:	DDG Figure 6-1 and DDG Table 6.2
Aluminized Steel:	DDG Figure 6-2 and DDG Table 6.3
Aluminum:	DDG Figure 6-3 and DDG Table 6.4
Reinforced Concrete:	DDG Figure 6-4 and DDG Table 6.5
Non-reinforced Concrete:	100 Years (pH \geq 4.0)
HDPE Class-II:	100 Years
HDPE Class-I:	50 Years
Polypropylene (PP)	100 Years
Steel Reinforced Polyethylene (SRPE)	100 Year
F949 PVC	100 Years
Other Polyvinyl Chloride:	50 Years

Note: Estimated Service Life for metal pipe may be increased by 10 years if it is coated with a bituminous coating.

6.3 STRUCTURAL EVALUATION

Appendix C provides minimum and maximum cover requirements. The Appendix C cover requirements do not include loadings from structural walls. **Section 6.5** addresses the structural adequacy of pipes in proximity to structural walls. Evaluate the minimum thickness established to meet durability requirements to assure structural adequacy and increase it if necessary. Evaluate materials and sizes not listed in **Appendix C** using the guidelines found within the **AASHTO LRFD - BDS** and industry recommendations and modified as necessary to be consistent with **Appendix C** and any applicable specifications and installation procedures.

6.4 HYDRAULIC EVALUATIONS

The hydraulic evaluation is intended to establish the hydraulic size in accordance with the design standards provided in the **Drainage Manual** for the particular culvert application. For storm drains and cross drains, the design will use the Manning's roughness coefficient associated with concrete pipe, spiral rib pipe, polyethylene pipe, and polyvinyl chloride pipe.

For side drains, the hydraulic design considers a one-size design. If a material type is inappropriate, it must be eliminated as an option in the plans.

In addition, the hydraulic evaluation must verify that the standard joint performance, as required by the **Standard Specification 430-4.1** will be sufficient. For situations where the minimum joint performance as required by the **Standard Specifications** is not sufficient, provide special provisions to specify the proper joint in the plans. For example, a pump station with a small-diameter pressurized storm drain should use a high-pressure joint. (Note: Joints are tested and rated by the State Materials Office.)

6.5 PIPES WITHIN WALLED EMBANKMENT SECTIONS

Wall Zone pipes are defined as pipes, existing or proposed, that are: (1) within or adjacent to embankment retaining walls, (2) connected to inlets that are within embankment retaining walls, or (3) beneath a bridge substructure element, such as an end bent or pier. Refer to Appendix D for wall types and criteria.

6.6 CULVERT MATERIAL TYPES

The types of culvert materials to consider for the various culvert applications are listed below.

Extend existing culverts (side drains, storm drains, and cross drains) with the existing pipe material. In the event that the existing pipe material is no longer produced, use the most similar material available, i.e., extend fiber reinforced concrete pipe with concrete pipe (RCP or NRCP).

Application	Materials to be Considered
Cross Drain French Drain Side Drain Storm Drain	Aluminized Steel Aluminum Concrete (all approved types) Corrugated Polyethylene (60" maximum) Steel Reinforced Polyethylene (120" Maximum) Polyvinyl Chloride (42" maximum) Polypropylene (60" maximum) Galvanized Steel
Gutter Drain	Corrugated Aluminized Steel (n > 0.020) Corrugated Aluminum (n > 0.020) Corrugated Steel (n > 0.020)

Vertical Drain	Ductile Iron (In saline environments, consider fiberglass reinforced pipe with welded joints, F949 PVC, and steel pipe)
Wall Zone Pipes	Polyvinyl Chloride (42" maximum) Polypropylene (60" maximum) Steel

Present the acceptable pipe materials for side drains, storm drains, and cross drains in the plans. The **FDM** illustrates a method of presenting the acceptable pipe materials in the plan.

6.7 JACK AND BORE

When installing drainage structures using jack and bore, use the casing as the carrier pipe except under railroads or in higher-pressure designs. You can find information on calculating pipe thickness for corrosion resistance in the **Culvert Service Life Estimator** (2013 version or later) and in the **Drainage Design Guide**.

6.8 DOCUMENTATION

The documentation for optional pipe materials will justify eliminating material types. Include, at a minimum, the following:

1. Design Service Life required
2. Soil and water corrosion indicators used in estimating service life
3. Estimates of service life at cross drains and at various locations of storm drain systems
4. Structural evaluation (comparison of maximum and minimum cover heights to actual cover height).

Modification for Non-Conventional Projects:

The above documentation in Section 6.8 will be required only for the pipe materials selected for use. Document the selected materials on one of the following: Summary of Drainage Structures Sheets, Optional Materials Sheet, or the plan sheets during design.

Table 6-1: Culvert Material Applications and Design Service Life

Application	Storm Drain		Cross Drain		Side Drain ⁴	Gutter Drain	Vertical Drain ¹⁰	Wall Zone Pipe ¹¹	French Drain			
	Minor	Major	Minor	Major	All	All	All	All	Replacement will Impact the Roadway ⁵		Other	
Design Service Life →	50	100	50	100	25	25 ⁶	100	100	50	100	50	
Culvert Material	An * indicates suitable for further evaluation											
PIPE	Corrugated Aluminum Pipe	*	*	*	*	*	*			*	*	*
	Corrugated Steel Pipe	*	*	*	*	*	*			*	*	*
	Corrugated Aluminized Steel	*	*	*	*	*	*			*	*	*
	Spiral Rib Aluminum Pipe	*	*	*	*	*	*			*	*	*
	Spiral Rib Steel Pipe	*	*	*	*	*	*			*	*	*
	Spiral Rib Aluminized Steel	*	*	*	*	*	*			*	*	*
	Steel Reinforced Concrete Pipe	*	*	*	*	*	*			*	*	*
	Non-reinforced Concrete Pipe	*	*	*	*	*	*			*	*	*
	Polyethylene Pipe – Class I	*		*		*				*		*
	Polyethylene Pipe – Class II ⁸	*	*	*	*	*	*			*		*
	Polypropylene Pipe PP	*	*	*	*	*	*		*	*	*	*
	Steel Reinforced Polyethylene Pipe	*	*	*	*	*	*					
	Polyvinyl-Chloride Pipe ⁷	*	F949	*	F949	*		F949	*	*	F949	*
	Fiberglass Pipe							*				
	Steel pipe (per Spec 556-2.1)							*	*			
	Ductile Iron Pipe (per Spec 556-2)							*				
STRUCTURAL PLATE	Structural Plate Aluminum Pipe	*	*	*	*	*						
	Structural Plate Alum. Pipe-Arc	*	*	*	*	*						
	Structural Plate Steel Pipe	*	*	*	*	*						
	Structural Plate Steel Pipe-Arch	*	*	*	*	*						
BOX	Aluminum Box Culvert	*	*	*	*	*						
	Concrete Box Culvert CBC	*	*	*	*	*		*				
	Steel Box Culvert	*	*	*	*	*						

Table notes are on the following page.

Notes for Table 6-1

1. A minor facility is permanent construction such as minor collectors, local streets and highways, and driveways, provided culvert cover is less than 10 feet. Additionally, this category may be called for at the discretion of the District Drainage Engineer where pipe replacement is expected within 50 years or where future replacement of the pipe is not expected to impact traffic or require extraordinary measures such as sheet piling.
2. A major facility is any permanent construction of urban and suburban typical sections and limited-access facilities. Urban facilities include any typical section with a fixed roadside traffic barrier such as curb or barrier wall. Additionally, rural typical sections with greater than 1,600 AADT also are included in this category.
3. Temporary construction normally requires a much shorter design service life than permanent does. However, treat temporary measures that will be incorporated as permanent facilities as though they are permanent construction with regard to design service life determination.
4. Although culverts under intersecting streets (crossroads) function as side drains for the project under consideration, design these culverts using applicable cross drain service life criteria, not the shorter side drain service life criteria. Use **Standard Plans, Index 430-022** for end treatment.
5. Replacing this pipe would require removal and replacement of the project's pavement or curb.
6. Use a 100-year DSL for gutter drains under retaining or through walls.
7. F949 PVC pipe service life is 100 years. Other PVC pipe has a 50-year service life. Do not use PVC pipe in direct sunlight unless it meets the requirements of **Standard Specification 948-1.1**.
8. Class II HDPE pipe may not be used in the Florida Keys.
9. For any pipes under or adjacent to permanent structures such as retaining walls, MSE walls, buildings, etc., use a 100-year DSL.
10. Resilient connectors are required for all vertical pipes.
11. Due to the expected high cost of steel pipe, only list steel pipe as an option if no other pipe material is allowed. For wall zone pipe, concrete box culvert is only an option if cast in place with no joints.

Appendix A

Drainage Law

APPENDIX A

DRAINAGE LAW

A.1 OVERVIEW

Current drainage law has evolved from case law in the courts, administrative hearing rulings, and the requirements that have been placed on the Department by other regulatory agencies. The discussion presented in this appendix about the Department's legal rights and responsibilities to the public as they relate to highway drainage is not intended as a substitute for legal counsel, but rather to familiarize engineers with basic drainage law, terminology, rules, and applications as they relate to state road design and maintenance.

A.2 TERMINOLOGY

Applicable Standards or Applicable Water Quality Standards or Minimum Design and Performance Standards: Those discharge standards of the appropriate regulatory entity that apply to the facility under consideration.

Approved Stormwater Management Plan or Master Drainage Plan: A regional plan adopted or approved by a city, county, Water Management District, or other agency with specific drainage or stormwater management authority; provided that (a) such plan is actively being implemented; (b) any required construction is substantially complete; (c) downstream mitigative measures have been provided for in the plan; and (d) the use of any Department facilities either existing or planned, which are part of such plan, have been agreed to by the Department.

Artesian Waters: Percolating waters confined below impermeable formations with sufficient pressure to spring or well up to the surface.

Backwater: An unnaturally high stage in a stream caused by obstruction or confinement of flow, as by a dam, a bridge, or a levee. Its measure is the excess of unnatural over natural stage, not the difference in stage upstream and downstream from its cause.

Concentration: The unnatural collection or convergence of waters, discharging in a narrower width and at a greater depth or velocity.

Critical Duration: The length of time of a specific storm frequency that creates the largest volume or highest rate of net stormwater runoff (post-improvement runoff less pre-improvement runoff) for typical durations up through and including the 10-day duration for closed basins and up through the three-day duration for basins with positive outlets. The critical duration for a given storm frequency is determined by calculating the peak rate

and volume of stormwater runoff for various storm durations and then comparing the pre-improvement and post-improvement conditions for each of the storm durations. The duration resulting in the highest peak rate or largest net total stormwater volume is the “critical duration” storm (volume is not applicable for basins with positive outlets).

Diversion: (1) The taking of water from a stream for a beneficial purpose (irrigation, water supply, power, etc.) even though a portion may return to the same stream. (2) The deflection of surface waters or stream waters so that they discharge into a watercourse to which they are not naturally tributary. Deflection of flood water is not diversion.

Drainage Connection: Any structure, pipe, culvert, device, paved or unpaved area, swale, ditch, canal, or any other appurtenance or feature, whether naturally occurring or created, that is used or functions as a link to convey stormwater.

Easement: The right to use the land of others. It may derive from the common law or be acquired, usually by purchase or condemnation, but occasionally by prescription or inverse condemnation. The right is not exclusive, but subject to rights of others in the same land, the lesser right being servient to a prior dominant right. Easements for drainage may give rights to impound, divert, discharge, concentrate, extend pipelines, deposit silt, erode, scour, or to perform any other necessary activity of a highway development.

Use of land of others without right usually leads to right in the future. If use is adverse and notorious for a statutory period, an easement is acquired by prescription with compensation, but, at any earlier time, the owner of the other land may sue for compensation by inverse condemnation.

Erosion and Accretion: Loss and gain of land, respectively, by the gradual action of a stream in shifting its channel by cutting one bank while it builds on the opposite bank. Property is lost by erosion and gained by accretion, but not by avulsion, when the shift from one channel to another is sudden. Property is gained by reliction when the water in an ocean, lake, river, or stream recedes.

Engineer: A Professional Engineer registered in Florida pursuant to the provisions of Chapter 471, **Florida Statutes**, who as appropriate is competent in the fields of hydraulics, hydrology, stormwater management, or stormwater pollution control.

Erosion and Scour: The cutting or wearing away by the force of water of the banks and bed of a channel in horizontal and vertical directions, respectively.

Facility: Anything built, installed, or maintained by the Department within the Department’s right-of-way.

Flood Waters: Former stream waters that have escaped from a watercourse (and its

overflow channel) and flow or stand over adjoining lands. Flood waters remain as such until they disappear by infiltration, evaporation, or return to a natural watercourse; they do not become surface waters by mingling with such waters or stream waters by eroding a temporary channel.

Groundwater: Water situated below the surface of the land, irrespective of its source and transient status. Subterranean streams are flows of groundwater parallel to and adjoining stream waters, and usually are determined to be integral parts of the visible streams.

Impervious Areas: Surfaces that do not allow, or minimally allow, the penetration of water. Examples of impervious areas are building roofs; all concrete and asphalt pavements; compacted traffic-bearing areas, such as limerock roadways; lakes, wet ponds, pond liners, and other standing water areas, including some retention/detention areas.

Improvement: Any manmade change to property from previously existing conditions.

Marshes: Lands saturated by waters flowing over the surface in excess of infiltration capacity, such as sloughs or rivers and tidal channels.

Navigable Waters: Those stream waters lawfully declared or actually used as such.

Navigable Waters of the United States: Those bodies of water determined by the Chief of the U. S. Army Corps of Engineers to be so used in interstate or international commerce. Other streams have been ruled navigable by courts under the common law that navigability in fact is navigability in law.

Owner: Any owner of land, usually specified in relation to another owner. Of two owners affected by the flow of water, the one upland is the upper owner and the other the lower owner. The highway has an owner with the same rights in common law as private owners.

Peak Discharge: The maximum flow of water passing the point of interest during or after a rainfall event.

Perched Waters: Percolating waters detained or retained above an impermeable formation, standing above and detached from the main body of groundwater.

Percolating Waters: Those waters that have infiltrated the surface of the land and moved slowly downward and outward through devious channels (aquifers) unrelated to stream waters, until they either reach an underground lake or regain and spring from the land surface at a lower point.

Positive Outlet: A point of stormwater runoff into surface waters that, under normal conditions, would drain by gravity through surface waters ultimately to the Gulf of Mexico, or the Atlantic Ocean, or into sinks, closed lakes, or recharge wells provided the receiving waterbody has been identified by the appropriate Water Management District as

functioning as if it recovered from runoff by means other than transpiration, evaporation, percolation, or infiltration.

Pre-Improvement: The condition of property before an improvement is made or, in regard to ***Rule 14-86, F.A.C.***, the condition of property: (a) before November 12, 1986; or (b) on or after November 12, 1986, with connections which have been permitted under ***Rule 14-86, F.A.C.*** or permitted by another governmental entity based on stormwater management requirements equal to or more stringent than those in ***Rule 14-86, F.A.C.***

Stormwater: The flow of water that results from and occurs immediately following a rainfall event.

Stream Waters: Former surface waters that have entered and now flow in a well-defined natural watercourse together with other waters reaching the stream by direct precipitation or from springs in the bed or banks of a watercourse. They continue as stream waters as long as they flow in the watercourse, including in overflow and multiple channels as well as the ordinary or low water channel.

Surface Water: Water upon the surface of the earth, whether contained in natural or artificial boundaries or diffused. Water from natural springs shall be classified as surface water when it exits onto the Earth's surface.

Swamps: Lands saturated by groundwater standing at or near the surface.

Volume: The total amount of water coming to a point of interest. It may be from surface water, watercourses, groundwater, or direct precipitation.

Watercourse: A definite channel with bed and banks within which water flows, either continuously or in season. A watercourse is continuous in the direction of flow and may extend laterally beyond the definite banks to include overflow channels contiguous to the ordinary channel. The term does not include artificial channels such as canals and drains, except as natural channels are lawfully trained or restrained by the works of man. It also does not include depressions or swales through which surface or errant waters pass.

Watershed: The region draining or contributing water to a common outlet, such as a stream, lake, or other receiving area.

A.3 SURFACE WATER LAW

A.3.1 Upland Owner

Generally, an upland owner has an easement over the land of the lower land owner for surface waters that flow over the lower land. In exchange for this privilege, the upland owner has the duty not to divert surface waters, change the velocity of flow, add to the pollution, or increase the amount of waters from other directions to the extent that damage occurs on the lower-lying property of the other land owner. Ideally, the surface-water flow should imitate the conditions in existence when the lands were in a natural state. Realistically, changes made in the development of real property are reviewed by the courts on a case-by-case basis to determine whether the changes that occur are substantial and whether the development has been reasonable. A major factor, if the courts find that a nuisance has been created by the upland owner on the lower land, is whether the lower land owner came to the nuisance.

A.3.2 Lower Land Owner

Generally, the lower land owner has the duty to the upland owner not to prevent or obstruct the flow of surface waters onto his land from that of the upland owner. The lower land owner cannot exclude these surface waters, nor can he cause the water to flow back to his upland neighbor. One exception to this rule is when such a backflow is a natural condition that could be anticipated from the natural configurations of the land. An example of this exception would be a land-locked storage basin that overflows in an intense storm of long duration. Even if it is foreseeable, the overflow onto the neighboring land when caused by natural conditions is not a trespass by the lower land owner. However, if the lower land owner diverted additional waters into the land-locked basin, and took the chance that such a natural event could occur, the lower land owner may be responsible for the surface-water overflow onto the neighboring property.

You will find another exception to the responsibilities owed to the lower land owner in the low-lying areas in South Florida where indiscriminate rim ditching was allowed. If the lower land owner came to this condition, he cannot assert a trespass or nuisance claim.

If the Department is involved in any way, on any side of the mentioned situations, contact with the legal department is required.

If a lower land owner accepts surface water from the upland owner over and above the natural surface water, and the upland owner developed property in reliance on that acceptance, the lower land owner may be prevented from refusing to accept that water volume in the future. An example of this would be an owner of a cow pasture who accepts Department highway drainage into a pond on his land for use as a drinking area for his herd of cows. If he or a subsequent owner later decided to build a shopping center by the state roadway, he would continue to be responsible for the storage of the water placed on his property by the Department.

A.3.3 Status Quo and Reasonably Foreseeable Development

Two important items in highway drainage design for the Department to review from a legal perspective are the current natural state of the adjoining property to the highway and the reasonably foreseeable development that will occur in the area. Address the first concern by creating current and/or reviewing historical drainage maps of the area. Evaluate the second concern by reviewing local comprehensive zoning and stormwater management plans for the area in question. When feasible, integrate the highway system design with the local plans.

A.3.4 Summaries of Current Florida Case Law

The following summaries of the leading Florida cases on surface-water management should assist the drainage engineer in his review of problematic drainage areas:

In Koger Properties, Inc. v. Allen, 314 So.2d 792 (Fla. 1st DCA 1984), a developer had improved its property by constructing office buildings and parking areas, which gathered rainfall that had been previously absorbed by the earth and channeled it through storm drains that terminated at an opening directly in front of the lower land owner's (the plaintiff) property. The developer agreed that it would pipe the water through a 36-inch pipe under the road owned by the City of Tallahassee in front of the plaintiff's property, and the City agreed to carry the water from that point through a ditch which it agreed to enlarge.

The developer went ahead with construction without keeping the City advised of its progress, so that the City was unaware as to when it needed to improve its facilities.

Stormwater from a subsequent rainfall event was projected with great force from the terminus of the developer's storm drainage system at a point directly across the road from the plaintiff's home. The water overflowed the ditch, ran across the road in a small river, and flooded the plaintiff's property, causing great damage to his home.

A jury awarded the plaintiff compensatory and punitive damages against the developer for knowingly flooding the plaintiff's property. The jury found that the City was not responsible for any of the damages suffered by the plaintiff.

In Leon County v. Smith, 397 So.2d 362 (Fla. 1st DCA 1980), a developer of a subdivision designed a drainage system that would collect surface water and transport it east to west to a central ditch and then southerly through a ditch to the plaintiff/landowner's property. The outfall point for this water was along the northern boundary line of the landowner's property and no provisions were made for transporting the water across his land.

Later, the County accepted ownership of and responsibility for the drainage system. As homes were built in the subdivision, increasing amounts of stormwater entered the drainage system and discharged onto the plaintiff's property. The County then enclosed

portions of the drainage system with pipes, and other drainage systems were connected to it. The velocity of the water flow was so increased by these actions that the drainage carved gullies four- to six-feet deep into the plaintiff's land. In addition, water continued flowing from the subdivision for days after the rain stopped and the area in and around the ditches remained a muddy ooze. Eventually, the flooding rendered the plaintiff's land useless.

The court held that, as a result of the County's action, the County had taken the plaintiff's property and was required to pay him just compensation for that property.

In Hanes v. Silgain, 448 So.2d 1130 (Fla. 1st DCA 1984), the plaintiff Hanes alleged that the manner in which Silgain Motel Corporation and Gulf Oil Corporation developed their property unreasonably diverted the natural flow of surface water to the detriment of the Hanes' property. Hanes further alleged that Silgain was negligent in designing and constructing an inadequate retention basin. Silgain then brought a third-party action against the Department of Transportation alleging, among other things, that the Department negligently maintained a storm drainage system in such a manner as to wrongfully divert and disperse large volumes of surface waters onto Silgain's land in a concentrated stream.

The Department in turn brought a third-party action seeking contribution against various landowners and users, asserting that the defendants developed their property in a manner that diverted and cast unreasonable quantities of surface water into the Department storm drainage system. The Department also alleged that such diversion overtaxed its drainage system, thereby rendering the defendants proportionately responsible for such damage as may have resulted to Silgain and Hanes from any excess drainage system discharge.

The Department's complaint was dismissed with prejudice. The appellate court upheld this dismissal, ruling that the Department was solely responsible for the maintenance of its drainage system and that commercial developments draining into this system did not jointly share in this responsibility.

In Department of Transportation v. Burnette, 384 So.2d 916 (Fla. 1st DCA 1980), the Department was enjoined from collecting water in pipes and ditches, and from diverting the water from its natural course and sending it onto Burnette's property.

The court found that the natural drainage path for land immediately surrounding U.S. 90 within a half mile west of Madison was northward under the highway and across property later occupied by North Florida Junior College. A culvert system was installed on the highway. Subsequently, those northward drainage courses were plugged, apparently to protect North Florida Junior College. This action caused ponding immediately south of the highway.

Then, in 1969, the Department allegedly changed the drainage by constructing and buying a ditch on an easement from the highway 500 feet south toward the northern

boundary of the subject property. During the same project, the Department added more drainage to this system through a culvert along the south side of State Road 10, adding the runoff from 103 acres of improved land in municipal Madison. Burnette's engineer testified that an estimated 14 million gallons (43 acre-ft) of water from the City of Madison would be included in the drainage system and that under such conditions, 50 low acres of Burnette's land would be flooded and access would be limited on the remaining 50 acres.

The court concluded, however, that an action for inverse condemnation did not lie, because all beneficial uses to the property were not deprived and because the property had always been subject to intermittent flooding.

Stoer v. Ocala Mfg. Ice and Packing Co., 24 So.2d 579 (Fla. 1946), created an exception to upland owner liability in Florida in situations where the upland owner drains water into a natural watercourse. In such cases, an upland owner can increase the volume and velocity of the water flow into a natural watercourse without incurring any liability as long as the natural flow of water is not diverted or the watercourse is not overtaxed to the injury of the lower land owners.

A.4 POLLUTION CONTROL

Pollution control is becoming increasingly important in drainage law. The engineer faces a potential legal problem with environmental consequences at practically every point on a highway. There are three primary areas of highway drainage in which the Department must be especially concerned with regulation and liability:

1. Dredge and fill
2. Stormwater runoff
3. Underground injection wells

The following is a general discussion of regulated activities that require permits from various agencies. It is not intended to be project specific. Obtain design permit assistance for a particular project from the Bureau of Environment and the permit coordinator for the project.

The Department of Environmental Protection (DEP) is the chief pollution control agency in the state. Their jurisdiction over water pollution control extends to "waters of the state" as defined in Section 403.031, **Florida Statutes**:

"Rivers, lakes, streams, springs, impoundments, and all waters or bodies of water including fresh, brackish, saline, tidal surface, or underground."

It is not necessary for the area included in the waters of the state to be perpetually submerged in water; the DEP includes in its jurisdiction landward areas which are only

covered by water some of the time. The boundaries of these areas are defined by the presence of plant species currently listed in **Rule 17-4.02, FAC**.

A.4.1 Dredge and Fill

All dredge and fill activities conducted in areas either in or connected to waters of the state are required to comply with water quality standards specified in **Rule 17-3, FAC**. The standards establish criteria that define the maximum level of listed pollutants allowable in a water body, determined by the water use classification for that body. Five levels of classification are used to delineate water use. For example, the Fenholloway River is designated as Class V, which allows commercial and industrial uses. The water quality standards allowable for that river are much lower than those for a Class I water source, which provides potable water, or for a Class II water source such as the Apalachicola Bay where shellfish are harvested.

Pursuant to **Rule 17-4.28, FAC**, Dredge and Fill Permits must be obtained where dredge and fill activity is undertaken in:

1. Rivers and natural tributaries thereto
2. Streams and natural tributaries thereto
3. Bays, bayous, sounds, estuaries, and natural tributaries thereto
4. Natural lakes, except those owned entirely by one person (except for lakes of no more than 10 acres of water at the maximum average depth existing throughout the year)
5. The Atlantic Ocean and Gulf of Mexico out to the state territorial boundaries

Activities exempt from dredge and fill permitting requirements are:

1. The repair or replacement of existing pipes to original configurations for the purpose of discharge of stormwater runoff
2. The construction and maintenance of swales
3. The maintenance of existing drainage ditches to their original design configurations (except when listed plants begin to grow)

Within the limits of the DEP regulations, the Department would need to obtain dredge and fill permits when constructing new roadbeds, when constructing new drainage systems, and when using new drainage systems involving underground piping.

For facilities that require use of state-owned lands, DEP usually issues an easement or dedication for DOT use of state-owned submerged land. Permit applications for groin or jetty construction, beach restoration, coastal revetments, or other similar coastal construction activities that will take place in or adjacent to tidal waters of the state may require a coastal construction permit.

A.4.2 Stormwater Runoff

Pursuant to **Rule 17-25.01, FAC**, the DEP regulates discharge of untreated stormwater that could be a potential source of pollution to the state. This regulatory scheme is qualitative and quantitative. All stormwater discharges must meet the water quality standards of the class of water body the stormwater actually reaches. Additionally, the rule regulates stormwater by requiring retention or retention with filtration systems that allow separation of polluting substances by percolating the water into the ground. The DEP may delegate its regulatory authority to Water Management Districts, flood control districts, and local government entities. Control of stormwater runoff has been delegated to all Water Management Districts except the Northwest.

A.4.3 Drainage Wells

Certain local situations may dictate the use of drainage wells. Typically, this would occur on barrier islands and coastal locations, where the stormwater would be introduced into saltwater and could be effective in maintaining the existing fresh/saline water interface. Groundwater withdrawal typically is not permitted in these areas. However, due to the nature of drainage wells, specific design approval for the construction of drainage wells must be granted by the State Drainage Engineer on an individual project basis.

Drainage wells are considered by the DEP to be Class V, Group 5 wells, regulated under **Chapter 17-28, FAC**. Drainage well use and treatment of the surface water prior to discharge must be consistent with these regulations. Recognize that some existing wells and all future wells drilled into potable or potentially potable aquifers may require pretreatment of the surface water prior to discharge.

It is important to understand that **17-4.245,(2)(6), FAC**, specifically disallows discharges through natural conduits such as sinkholes when there is a direct connection to certain classes of groundwater. The DEP has interpreted this to mean that a sinkhole is comparable to a drainage well when it provides a direct connection with Class G-I and Class G-II groundwater. Therefore, discharges to sinkholes that exhibit a direct connection to these classes of groundwater must be treated as discharges to a drainage well and require the same permit process.

A.5 WATER MANAGEMENT DISTRICTS

A.5.1 General

Prior to 1972, water management legislation in Florida had developed on a piecemeal basis. In that year, a comprehensive law was enacted to provide extensive protection and management of water resources throughout the state.

The **Florida 1972 Water Resources Act**, Chapter 373, **Florida Statutes**, provides a two-tiered administrative structure headed at the state level by the DEP. The DEP supervises five regional Water Management Districts designed to provide the diverse types of regulation needed in different areas of the state. These include the previously existing Central and Southern Florida Flood Control District, renamed the South Florida and the Southwest Florida Water Management Districts. Since these two districts had already been established and were authorized to levy *ad valorem* taxes to pay for their regulatory functions, they were promptly delegated full regulatory and permitting powers by the Department of Natural Resources (DNR), at that time the state-level regulatory agency. The three new districts established under the Act were the Suwannee River, St. Johns River, and Northwest Florida Water Management Districts.

A.5.2 Basin Boards

Basin boards in the Water Management Districts handle administrative and planning functions in the particular basin, such as developing plans for secondary water control facilities and for water supply and transmission facilities for counties, municipalities, or regional water authorities. Basin boards do not exercise regulatory or permitting authority, but help to relieve the Water Management Districts of some of their administrative chores.

A.5.3 Governing Boards

The governing boards of the Water Management Districts exercise broad statutory powers under Chapter 373, **Florida Statutes**. In regard to water works, they are authorized to:

"Clean out, straighten, enlarge, or change the course of any waterway, natural or artificial, within or without the district; to provide such canals, levees, dikes, dams, sluiceways, reservoirs, holding basins, floodways, pumping stations, bridges, highways, and other works and facilities which the board may deem necessary; establish, maintain, and regulate water levels in all canals, lakes, rivers, channels, reservoirs, streams, or other bodies of water owned or maintained by the district; cross any highway or railway with works of the district and to hold, control, and acquire by donation, lease, or purchase, or to condemn any land, public or private, needed for rights-of-way or other purposes; any way remove any building or other obstruction necessary for the construction, maintenance, and operation of the works; and to hold and have full control over the works and rights-of-way of the district."

These boards also establish rules and regulations related to water use, adopted after public hearing and subject to review by the Governor and Cabinet sitting as the Land and Water Adjudicatory Commission.

A.5.4 Permitting Authority

Permitting authority has been conferred on the Water Management Districts for artificial recharge projects or the intentional introduction of water into any underground formation; the construction, repair, and abandonment of water wells; the construction or alteration of dams, impoundments, reservoirs, and other water storage projects; the licensing and registration of water well contractors; and the hookup of local water works to the district's works. Such broad regulatory powers are consistent with the declared policy of the Florida Water Resources Act for the DEP "to the greatest extent practicable," to delegate conservation, protection, management, and control authority over state waters to the Water Management Districts.

A.5.5 Interagency Cooperation

The DEP has been concerned most directly with water quality control while the Water Management Districts have been primarily involved with water quantity control. This has inevitably resulted in regulatory overlap and confusion, since water quality and water quantity considerations are seldom mutually exclusive. This regulatory overlap has made it necessary for the DEP and the Water Management Districts to work out an effective policy to avoid confusion and redundancy in the state's regulatory scheme.

Permitting criteria overlap between the DEP and the Districts often requires permit applicants to approach both agencies for action on a single proposed activity. The extent of this overlap depends largely on the extent to which a Water Management District has implemented its own permitting authority and established a broad range of rules and regulations for water resource management within its jurisdiction. Because they were in existence prior to enactment of the Water Resources Act, the two southern districts have experienced the major share of problems with overlapping responsibilities. Negotiations between the DEP and the Water Management Districts have led to increased regulatory efficiency and greater convenience for the environmental permit applicant.

One cooperative approach has been the designation of a "primary" and "secondary" agency for specific permitting areas. Applicants would apply for a permit from the primary agency only; the secondary agency would provide input and guidance according to the terms of an interagency agreement. The DEP's Bureau of Water Resources has assigned a coordinator to attend District board meetings and act as a direct link between the agencies for the resolution of overlap problems. Also, joint quarterly meetings and the development of standardized rules have been helpful in promoting cooperation.

In dealing with highway drainage problems and issues, the Department engineer must be aware of the rules and regulations of the Water Management District in which the project is located. Since the Department issues permits for connections to the highway drainage system, it has become even more essential from the agency's standpoint to coordinate water storage plans and state resources, and to continue to preserve comprehensive

water management plans.

A.6 WATER CONTROL DISTRICTS

Prior to July 1, 1980, the DEP, or a majority of the owners, or the owners of the majority of the acreage of any contiguous body of wet or overflowed lands or lands subject to overflow situated in one or more counties were empowered pursuant to **Chapter 298, Florida Statutes**, to form water control or drainage districts for agricultural purposes, or when conclusive to the public health, convenience, and welfare, or of public utility or benefit. On July 1, 1980, Chapter 298 was amended to provide that water control districts could only be created by special act of the legislature. The drainage districts in existence prior to that time were grandfathered in.

Drainage districts are governed by a board of supervisors who are elected by the land owners in the district. The DEP's voting rights in the elections are proportional to the extent of the acreage owned by the state in the districts. Presumably, that acreage would include Department of Transportation right-of-way existing in the district.

The board of supervisors is empowered to hire a chief engineer, who is responsible for the drainage works in the area, to adopt and carry out the plan of reclamation.

The Department of Community Affairs recently has been actively charged with the responsibility of coordinating growth management in the State, which will reflect on drainage facilities and projected area growth.

A.7 GOVERNMENT PROGRAMS THAT DEAL WITH SURFACE WATER RUNOFF

Under present law, municipalities have authority to provide for drainage of city streets and reclamation of wet, low, or overflowed lands within their jurisdiction. They may construct sewers and drains and may levy special assessments on benefited property owners to pay all or part of the costs of such works. Additionally, municipalities have the power of eminent domain to condemn property for these purposes. Thus, they have the means to deal directly with storm- and surface-water runoff problems.

The general zoning power that municipalities may exercise pursuant to **Chapter 166, Florida Statutes**, enables them to enact floodplain zoning ordinances. Such ordinances may simply require compliance with special building regulations or may exclude certain types of development in a designated floodplain. Enactment of such ordinances is another method by which municipalities can address runoff problems.

Most counties and municipalities have a drainage plan ordinance that requires submittal of a drainage plan for proposed developments. In addition, they commonly require that a

drainage impact assessment be prepared and submitted if there is to be a change in the development site. Several local governments have ordinances restricting the amount of surface-water runoff that may be carried by a particular drainage system, or the amount of sediment transported by the runoff.

Many local ordinances also incorporate a floodplain regulation element or minimum elevations for old and new buildings to comply with the Federal National Flood Insurance Act of 1968 and the various current Flood Disaster Protection Acts. The virtues of flood control ordinances are multiple. As one study concluded:

"While such regulations are primarily designed to avoid direct flood damage to life and property, they yield clear benefits in the context of water quality maintenance as well. Overflows from septic tanks and combined sewers, for example, may be closely linked with improperly designed sewage and drainage systems within the floodplain. By preventing excessive encroachment of developments upon the floodplain, these special zoning laws also seem to retard rates of runoff and consequent water pollution from stream bank erosion and adjacent land surfaces."

Subdivision regulations relating to surface-water runoff control tend to be more detailed than local government ordinances, and often require submittal of a comprehensive drainage plan, approval of which is often a prerequisite for plat approval. Some regulations include runoff and rainfall criteria to which the proposed drainage system must conform, while others indicate permitted or preferred surface-water runoff control structures and techniques. Other provisions found in subdivision regulations include: a requirement that runoff from paved areas meet certain water quality standards; the encouragement or requirement of onsite retention of runoff; the regulation of grading and erosion control methods; and a monitoring requirement for the discharge of surface-water runoff into lakes, streams, and canals.

Whether the Department must comply with these local rules and programs is a question that generates great doubt and confusion. The law is so uncertain that evaluation must be made on a case-by-case basis. There are some general principles to observe however. First, although there are cases that state that Department power over roads and bridges is plenary, **Section 339.155(2), Florida Statutes**, requires that the Department, in adopting its statewide transportation plan, coordinate and be consistent with local government regulations "to the maximum extent feasible." Also, in developing the Florida Transportation Plan, the Department must take into account regional and local comprehensive plans and "the total environment of the community and region, including land uses, local stormwater management plans, and social and community values." Thus as a general rule, the Department should cooperate and comply with local regulations where such compliance would not be detrimental to the Department's interests.

However, the law is clear that the authority of a state agency prevails over local regulations when the regulations are in direct conflict with a statute or the subject of the local regulation has been preempted by the statutory scheme. In the absence of such a

conflict or preemption, the courts balance the interests of the state agency versus the local governmental entity to determine whose interest is superior, and the superior interest prevails.

Appendix B

Acquisition of Real Property Rights

APPENDIX B

ACQUISITION OF REAL PROPERTY RIGHTS

B.1 PROPERTY PURCHASES

The Department currently purchases three types of real property interests:

1. Drainage easements (permanent easements)
2. Flooding and water storage easements (temporary easements)
3. Fee simple title

By dividing the property needs into these categories, the Department is able to conform to requirements that empower it to take and make use of only as much real property as is necessary and best suited to a project.

Drainage Easements

The Department acquires a permanent easement on property needed to ensure permanent maintenance of drainage facilities. Purchase of fee simple title is avoided, since the only public purpose for which the land is intended is drainage and drainage maintenance.

Under the drainage easement, the Department is empowered to remove any artificial or natural barriers that interfere with the use for which the easement was purchased. This includes fences, trees, shrubs, large root systems, or other obstacles to proper drainage or maintenance. The Department cannot be held legally accountable if actions taken to prevent hindrances to usage damage or destroy natural growth.

In many developed areas of the state, parking facilities have been built over drainage easements, with approval contingent on installation of piping that continues to satisfy the Department's objectives. The following conditions also apply:

- The design must be for ground-level parking facilities.
- The Department will not be responsible for the cost of piping needed to maintain Department standards for the easement.
- The costs borne by the fee simple owner include design, construction, and the Department's inspection activities.

Since maintenance or roadway reconstruction activities may require removal of some or all of the parking facility, the Department should make sure that any agreement specifically releases it from any liability for physical damage to or loss of use of the facility.

Flooding and Water Storage Easements

On occasion, water from heavy rainfall events or non-permitted drainage hookups will exceed the design limits of the highway drainage system, leaving the closed system and flowing onto land the Department does not own. When you can identify areas where this may occur in advance, and when such flooding occurs under a limited set of conditions and is temporary in nature, the Department may acquire a temporary flooding easement. This gives the Department flood rights, allowing temporary use of private property to ease flooding. The flood easement may or may not define conditions under which flooding may occur and the elevation water would be expected to reach under those conditions. Emphasis on public safety and cost is paramount when negotiating for the easement.

Flood rights usually are purchased on land in a natural state, which already floods under certain weather conditions from non-highway sources. An example of this type of land is a land-locked natural basin, such as those found in northern Florida.

To provide a retention or detention storage area for discharging water from the closed highway drainage system, the Department may purchase either a temporary or permanent water storage easement. This storage area may allow the water to be transported to waterways of the state or to evaporate or percolate into the soil over time, and may be in response to certain temporary conditions or can become part of the drainage system design.

Many current comprehensive county zoning plans require that developers provide storage for runoff that occurs from land development. Since these storage areas generally are available to public and private entities, the Department should consider their use whenever possible and only purchase storage rights needed for roadway drainage when no other alternative is available.

Fee Simple Title

Make the decision to purchase fee simple title rather than an easement to real property on a case-by-case basis that evaluates the benefits in terms of public safety and convenience against the additional cost. A typical example would be property containing open drainage ditches with sufficient depth or velocity to pose a clear and present hazard to the public. Possession of fee simple title would allow the Department to fence the property and otherwise minimize potential dangers in accordance with state safety standards.

B.2 PROPERTY EXCHANGES

As a general rule, either rights of way or easements can be exchanged in-kind between the Department and a property owner when the property owner requests the exchange and no additional costs or inconveniences will be borne by the Department as a result of

the exchange. All costs of necessary reconstruction, legal services, documentation, or recording the exchange will be borne by the property owner. Before approving the exchange, the Department must evaluate the potential for use, liabilities, and increased maintenance engendered by the exchange.

B.3 CRITERIA FOR ESTABLISHING PROPERTY INTERESTS

This *Manual* establishes the minimum criteria for establishing property interests for drainage purposes, including width and alignments. Allow a sufficient additional allowance for construction and maintenance requirements.

Appendix C

Cover Height Tables

APPENDIX C

COVER HEIGHT TABLES

The following tables have been calculated for FDOT based on FDOT **Standard Specification 125**. If the design of the pipe requires unique installation requirements varying from the standard specification, the Engineer of Record (EOR) will compute pipe cover in accordance with the **AASHTO LRFD - BDS**.

Notable Abbreviations

NA—Not Available

NS—Not Suitable (for Highway LRFD HL-93 Live Loadings)

General Notes

1. The tabulated values are recommended minimum dimensions to withstand anticipated highway traffic loads. Additional cover may be required to support construction equipment loads or highway traffic loads before pavement is completed. Some size thickness combinations may require minimum cover greater than those listed within this appendix.
2. Tabulated values are based on the guidelines found in the **AASHTO LRFD - BDS** and other general site design assumptions. Alternative values may be used in lieu of the values tabulated within this appendix based on site-specific calculations developed by suitable methods and detailed in the plans. The assumptions made for use in the development of the tabulated values include:
 - a. 120 lb/cubic feet soil density
 - b. The pipes will be installed at or above the established water table
 - c. Pipe trench excavation per FDOT Specification 125-4.4
 - d. Pipe trench backfill allowable soils, bedding, and compaction per FDOT Specification 125-8
 - e. Pipes maximum deflection = 5 percent per FDOT Specification 430-8
 - f. Pipes maximum strains per AASHTO
3. Calculate minimum cover as shown in the figures for each pipe type. If the minimum cover provided is not sufficient to avoid placement of the pipe within the base course, then increase the minimum cover to a minimum of the bottom of base course.
4. Measure maximum cover from top of finished grade to the outside crown of pipe for all pipe shapes and types.
5. Unless otherwise noted, the minimum cover in unpaved areas is the same as with flexible pavement.
6. Allowable cover heights as specified in this Appendix do not account for loadings from structural walls in proximity to pipes.

Concrete Pipe – Round and Elliptical

Minimum Cover

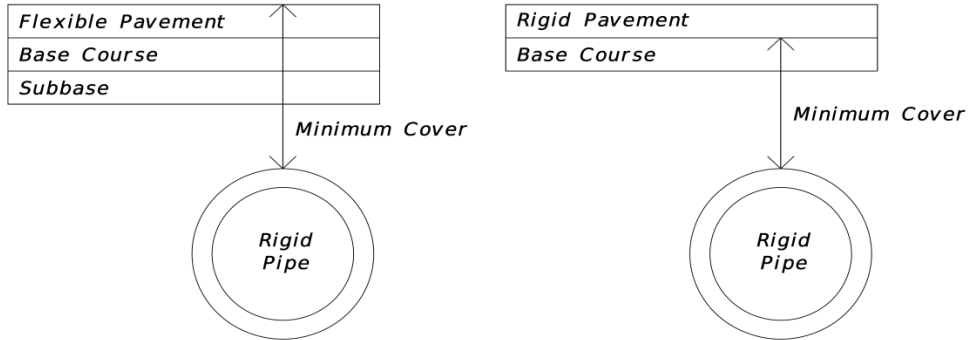

Concrete Pipe Minimum Cover

Unpaved or Flexible
Pavement
12 in.

Rigid
Pavement
9 in.

Concrete Pipe – Round

Maximum Cover

Round Pipe (B Wall)—Type I Installation					
Pipe Diameter	Maximum Cover (ft)				
	Class I	Class II	Class III	Class IV	Class V
12"	11	16	22	34	45
15"	12	16	23	34	45
18"	12	16	23	35	45
24"	11	16	22	34	45
30"	11	15	22	34	45
36"	11	15	21	33	45
42"	10	15	21	33	45
48"	10	14	21	32	45
54"	10	14	21	32	45
60"	9	14	20	32	45
66"	9	13	20	31	45
72"	7	12	18	29	45
78"	7	12	18	29	45
84"	7	12	18	29	45
90"	6	11	18	29	45
96"	5	11	18	29	45
102"	-	11	17	28	45
108"	-	11	17	28	45
114"	-	11	17	28	45
120"	-	10	17	28	44

- Pipe Class I D-Load = 800 lbs./ft./ft. (0.01" crack)
 D-Load = 1,200 lbs./ft./ft. (ultimate)

- Pipe Class II D-Load = 1,000 lbs./ft./ft. (0.01" crack)
 D-Load = 1,500 lbs./ft./ft. (ultimate)

- Pipe Class III D-Load = 1,350 lbs./ft./ft. (0.01" crack)
 D-Load = 2,000 lbs./ft./ft. (ultimate)

- Pipe Class IV D-Load = 2,000 lbs./ft./ft. (0.01" crack)
 D-Load = 3,000 lbs./ft./ft. (ultimate)

- Pipe Class V D-Load = 3,000 lbs./ft./ft. (0.01" crack)
 D-Load = 3,750 lbs./ft./ft. (ultimate)

Concrete Pipe—Round Dimensions		
Equiv. Dia. (in)	Area (Sq. Ft.)	Wall Thickness (in.)* Classes II, III, IV, V B Wall
12	0.8	2
15	1.2	2 1/4
18	1.8	2 1/2
24	3.1	3
30	4.9	3 1/2
36	7.1	4
42	9.6	4 1/2
48	12.6	5
54	15.9	5 1/2
60	19.6	6
66	23.8	6 1/2
72	28.3	7
78	33.2	7 1/2
84	38.5	8
90	44.4	8 1/2
96	50.3	9
102	56.7	9 1/2
108	63.7	10
114	70.9	-
120	78.5	-
<p>* For Informational Purposes Only.</p> <p>Do Not Specify Wall Thickness.</p> <p>Option B Wall is Industry Standard.</p>		

Concrete Pipe – Elliptical

Maximum Cover

Elliptical Pipe—Installation Type II						
Pipe Equiv. ID	Span	Rise	Maximum Cover (ft)			
			Class HE-I	Class HE-II	Class HE-III	Class HE-IV
18"	23"	14"	8	12	17	25
24"	30"	19"	8	11	16	25
30"	38"	24"	8	11	16	25
36"	45"	29"	8	11	16	25
42"	53"	34"	7	11	16	25
48"	60"	38"	7	11	16	25
54"	68"	43"	7	11	16	25
60"	76"	48"	7	10	15	24
66"	83"	53"	7	10	15	24
72"	91"	58"	6	10	15	24
78"	98"	63"	6	10	15	24
84"	106"	68"	6	10	15	24
90"	113"	72"	6	10	15	24
96"	121"	77"	5	9	15	24
102"	128"	82"	5	9	14	23
108"	136"	87"	5	9	14	23
114"	143"	92"	5	9	14	23
120"	151"	97"	5	9	14	23

Pipe Class HE II D-Load = 1,000 lbs./ft./ft. (0.01" crack)
 And VE II D-Load = 1,500 lbs./ft./ft. (ultimate)

Pipe Class HE III D-Load = 1,350 lbs./ft./ft. (0.01" crack)
 And VE III D-Load = 2,000 lbs./ft./ft. (ultimate)

Pipe Class HE IV D-Load = 2,000 lbs./ft./ft. (0.01" crack)
 And VE IV D-Load = 3,000 lbs./ft./ft. (ultimate)

Concrete Pipe—Elliptical Dimensions						
Nominal Dimensions				Equiv. Dia. (in)	Area (Sq. Ft.)	Wall Thickness (in.)
Horiz.		Vert.				Classes HE II, III, IV VE II, III, IV
Rise (in.)	Span (in.)	Rise (in.)	Span (in.)			
12	18	18	12	15	1.3	2 ^{1/2}
14	23	23	14	18	1.8	2 ^{3/4}
19	30	30	19	24	3.3	3 ^{1/4}
24	38	38	24	30	5.1	3 ^{3/4}
29	45	45	29	36	7.4	4 ^{1/2}
34	53	53	34	42	10.2	5
38	60	60	38	48	12.9	5 ^{1/2}
43	68	68	43	54	16.6	6
48	76	76	48	60	20.5	6 ^{1/2}
53	83	83	53	66	24.8	7
58	91	91	58	72	29.5	7 ^{1/2}
63	98	98	63	78	34.6	8
68	106	106	68	84	40.1	8 ^{1/2}
72	113	113	72	90	46.1	9
77	121	121	77	96	52.4	9 ^{1/2}
82	128	128	82	102	59.2	10
87	136	136	87	108	66.4	10 ^{1/2}
92	143	143	92	114	74	11
97	151	151	97	120	82	11 ^{1/2}
* For Informational Purposes Only.						

Plastic Pipe

Minimum Cover

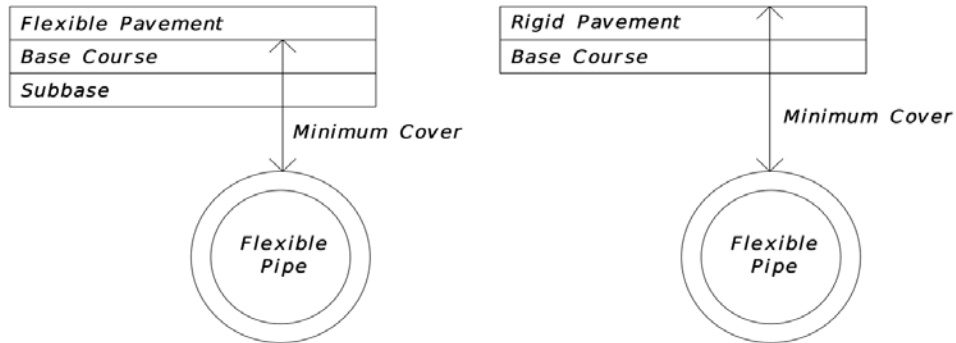

Note: Unpaved areas have a minimum cover of 12 inches

Pipe Type & Size	Minimum Cover (in)
Corrugated Polyethylene	
12" - 48"	24
60"	30
Corrugated Polypropylene	
12" - 48"	24
60"	30
Corrugated Polyvinylchloride	24

Pipe Type & Size	Minimum Cover (in)
Steel Reinforced Polyethylene	
30" - 60"	12
66" - 72"	18
84" - 96"	24
108"	30
120"	36

Maximum Cover

Corrugated Polyethylene Pipe	
Diameter	Max Cover (ft)
12"	19
15"	20
18"	17
24"	13
30"	13
36"	14
42"	13
48"	12
60"	13

Corrugated Polypropylene Pipe	
Diameter	Max Cover (ft)
12"	21
15"	22
18"	19
24"	16
30"	19
36"	16
42"	15
48"	15
60"	16

Corrugated Polyvinylchloride Pipe	
Diameter	Max Cover (ft)
12"	42
15"	45
18"	42
21"	41
24"	41
30"	40
36"	40

Steel Reinforced Polyethylene Pipe	
Diameter	Max Cover (ft)
30"-42"	50
48"-96"	30
108"-120"	25

Corrugated Aluminum Pipe

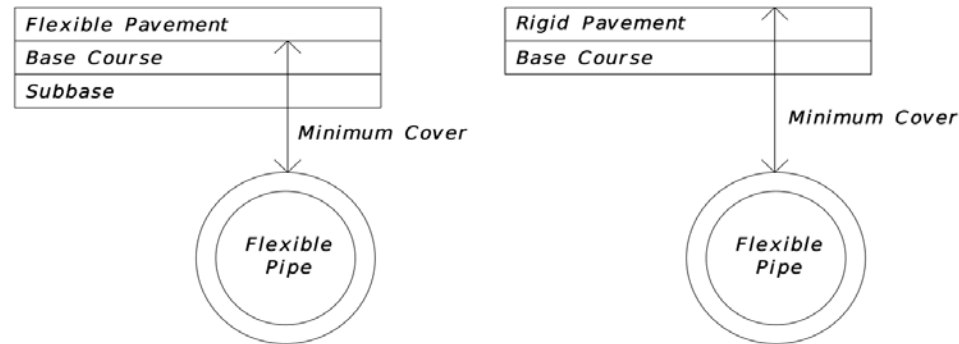

Aluminum—Round Pipe—2 2/3" x 1/2" Corrugation											
D (in.)	Area (sq. ft.)	Minimum Cover (in.)					Maximum Cover (ft.)				
		Sheet thickness in Inches (Gage)					Sheet thickness in Inches (Gage)				
		0.06 (16)	0.075 (14)	0.105 (12)	0.135 (10)	0.164 (8)	0.06 (16)	0.075 (14)	0.105 (12)	0.135 (10)	0.164 (8)
12	0.8	12	12	NA	NA	NA	100+	100+	NA	NA	NA
15	1.2	12	12	NA	NA	NA	100+	100+	NA	NA	NA
18	1.8	12	12	12	NA	NA	83	100+	100+	NA	NA
21	2.4	12	12	12	NA	NA	71	89	100+	NA	NA
24	3.1	12	12	12	NA	NA	62	78	100+	NA	NA
30	4.9	12	12	12	NA	NA	50	62	87	NA	NA
36	7.1	NS	12	12	12	NA	NS	52	73	94	NA
42	9.6	NS	NS	12	12	NA	NS	NS	62	80	NA
48	12.6	NS	NS	12	12	12	NS	NS	54	70	86
54	15.9	NS	NS	NS	12	12	NS	NS	NS	62	76
60	19.6	NS	NS	NS	NS	NS	NS	NS	NS	NS	NS
66	23.8	NS	NS	NS	NS	NS	NS	NS	NS	NS	NS
72	28.3	NS	NS	NS	NS	NS	NS	NS	NS	NS	NS

Aluminum—Round Pipe—3" x 1" Corrugation											
D (in.)	Area (sq. ft.)	Minimum Cover (in.)					Maximum Cover (ft.)				
		Sheet thickness in Inches (Gage)					Sheet thickness in Inches (Gage)				
		0.06 (16)	0.075 (14)	0.105 (12)	0.135 (10)	0.164 (8)	0.06 (16)	0.075 (14)	0.105 (12)	0.135 (10)	0.164 (8)
36	7.1	12	12	12	NA	NA	47	60	84	NA	NA
42	9.6	12	12	12	NA	NA	40	51	72	NA	NA
48	12.6	12	12	12	12	NA	35	44	62	84	NA
54	15.9	12	12	12	12	NA	31	39	55	74	NA
60	19.6	12	12	12	12	NA	28	35	50	67	NA
66	23.8	12	12	12	12	12	25	32	45	61	72
72	28.3	NS	12	12	12	12	NS	29	41	55	65
78	33.2	NS	12	12	12	12	NS	26	38	51	60
84	38.5	NS	NS	12	12	12	NS	NS	35	47	56
90	44.2	NS	NS	12	12	12	NS	NS	32	44	52
96	50.3	NS	NS	12	12	12	NS	NS	30	41	48
102	56.7	NS	NS	NS	13	13	NS	NS	NS	38	45
108	63.6	NS	NS	NS	NS	NS	NS	NS	NS	NS	NS
114	70.9	NS	NS	NS	NS	NS	NS	NS	NS	NS	NS
120	78.5	NS	NS	NS	NS	NS	NS	NS	NS	NS	NS

Aluminum—Round Pipe—Spiral Rib									
Rib Spacing (3/4" x 3/4" x 7 1/2")									
D (in.)	Area (sq. ft.)	Minimum Height of Fill (in.)				Maximum Height of Fill (ft.)			
		Sheet thickness in Inches (Gage)				Sheet thickness in Inches (Gage)			
		0.06 (16)	0.075 (14)	0.105 (12)	0.135 (10)	0.06 (16)	0.075 (14)	0.105 (12)	0.135 (10)
12	0.79	NA	NA	NA	NA	NA	NA	NA	NA
15	1.23	12	12	NA	NA	53	73	NA	NA
18	1.77	12	12	NA	NA	44	61	NA	NA
21	2.4	12	12	NA	NA	38	52	NA	NA
24	3.14	12	12	NA	NA	33	45	NA	NA
30	4.91	15	15	15	NA	26	36	59	NA
36	7.1	24	18	18	NA	*21	30	49	NA
42	9.6	NS	21	21	NA	NS	*25	41	NA
48	12.6	NS	NS	24	24	NS	NS	36	51
54	16	NS	NS	24	24	NS	NS	32	45
60	19.6	NS	NS	24	24	NS	NS	*28	41
66	23.8	NS	NS	NS	24	NS	NS	NS	37

* Special installation required. Refer to AASHTO Standard Specifications for Highway Bridges or ASTM B788-88 and manufacturer's recommendations.

Corrugated Steel Round

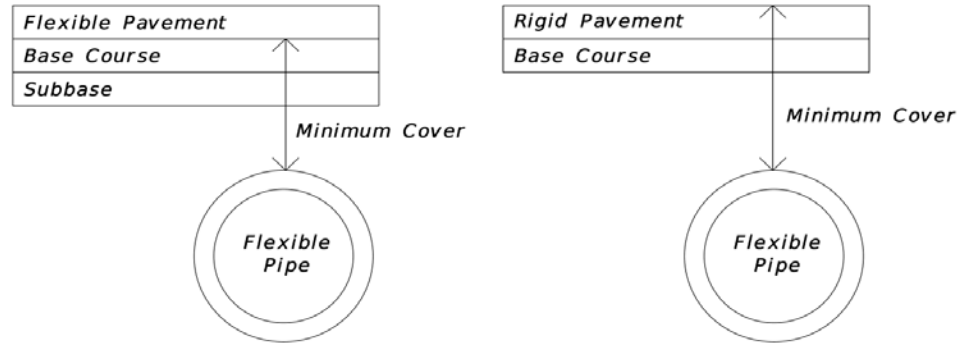

Steel—Round Pipe—2 2/3" x 1/2" Corrugation											
D (in.)	Area (sq. ft.)	Minimum Cover (in.)					Maximum Cover (ft.)				
		Sheet thickness in Inches (Gage)					Sheet thickness in Inches (Gage)				
		0.064 (16)	0.079 (14)	0.109 (12)	0.138 (10)	0.168 (8)	0.064 (16)	0.079 (14)	0.109 (12)	0.138 (10)	0.168 (8)
12	0.79	12	12	NA	NA	NA	100+	100+	NA	NA	NA
15	1.23	12	12	NA	NA	NA	100+	100+	NA	NA	NA
18	1.77	12	12	12	NA	NA	100+	100+	100+	NA	NA
21	2.4	12	12	12	NA	NA	100+	100+	100+	NA	NA
24	3.14	12	12	12	NA	NA	100+	100+	100+	NA	NA
30	4.91	12	12	12	NA	NA	82	100+	100+	NA	NA
36	7.1	12	12	12	12	NA	68	86	100+	100+	NA
42	9.6	12	12	12	12	NA	51	73	100+	100+	NA
48	12.6	12	12	12	12	12	40	64	90	100+	100+
54	16	12	12	12	12	12	NS	57	80	100+	100+
60	19.6	NS	NS	12	12	12	NS	NS	72	93	100+
66	23.8	NS	NS	12	12	12	NS	NS	NS	84	100+
72	28.3	NS	NS	NS	12	12	NS	NS	NS	77	94
78	33.2	NS	NS	NS	NS	12	NS	NS	NS	NS	87
84	38.5	NS	NS	NS	NS	12	NS	NS	NS	NS	80

Steel—Round Pipe—3" x 1" Corrugation											
D (in.)	Area (sq. ft.)	Minimum Cover (in.)					Maximum Cover (ft.)				
		Sheet thickness in Inches (Gage)					Sheet thickness in Inches (Gage)				
		0.064 (16)	0.079 (14)	0.109 (12)	0.138 (10)	0.168 (8)	0.064 (16)	0.079 (14)	0.109 (12)	0.138 (10)	0.168 (8)
36	7.1	12	12	12	NA	NA	79	99	100+	NA	NA
42	9.6	12	12	12	NA	NA	67	84	100+	NA	NA
48	12.6	12	12	12	12	NA	59	74	100+	100+	NA
54	16	12	12	12	12	NA	52	65	92	100+	NA
60	19.6	12	12	12	12	NA	47	59	83	100+	NA
66	23.8	12	12	12	12	12	42	53	75	97	100
72	28.3	12	12	12	12	12	38	48	69	89	100
78	33.2	12	12	12	12	12	35	45	63	82	100
84	38.5	12	12	12	12	12	33	41	58	76	93
90	44.2	12	12	12	12	12	30	38	54	70	87
96	50.3	NS	12	12	12	12	NS	36	51	66	81
102	56.7	NS	13	13	13	13	NS	33	48	62	76
108	63.6	NS	NS	14	14	14	NS	NS	45	58	72
114	70.9	NS	NS	15	15	15	NS	NS	42	55	68
120	78.5	NS	NS	15	15	15	NS	NS	40	52	64
132	95	NS	NS	NS	17	17	NS	NS	NS	47	58

Steel—Round Pipe—Spiral Rib Rib Spacing 3/4" x 3/4" x 7 1/2"									
D (in.)	Area (sq. ft.)	Minimum Cover (in.)				Maximum Cover (ft.)			
		Sheet thickness in Inches (Gage)				Sheet thickness in Inches (Gage)			
		0.064 (16)	0.079 (14)	0.109 (12)	0.138 (10)	0.064 (16)	0.079 (14)	0.109 (12)	0.138 (10)
12	0.79	NA	NA	NA	NA	NA	NA	NA	NA
15	1.23	NA	NA	NA	NA	NA	NA	NA	NA
18	1.77	12	12	NA	NA	90	100+	NA	NA
21	2.4	12	12	12	NA	77	100+	100+	NA
24	3.14	12	12	12	12	68	95	100+	100+
30	4.91	12	12	12	12	54	76	100+	100+
36	7.1	12	12	12	12	45	63	100+	100+
42	9.6	12	12	12	12	38	54	90	100+
48	12.6	12	12	12	12	33	47	78	100+
54	16	14	14	14	14	29	41	70	100+
60	19.6	NS	15	15	15	NS	37	62	91
66	23.8	NS	17	17	17	NS	33	57	83
72	28.3	NS	NS	18	18	NS	NS	52	76
78	33.5	NS	NS	20	20	NS	NS	48	70
84	38.5	NS	NS	21	21	NS	NS	44	64
90	44.2	NS	NS	NS	23	NS	NS	NS	60
96	50.3	NS	NS	NS	NS	NS	NS	NS	NS
102	56.7	NS	NS	NS	NS	NS	NS	NS	NS
108	63.6	NS	NS	NS	NS	NS	NS	NS	NS

Corrugated Aluminum Pipe Arch

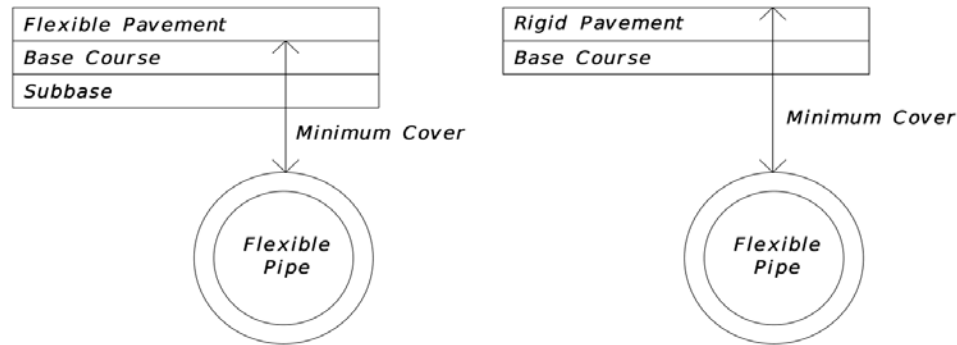

Aluminum—Pipe Arch—2 2/3" x 1/2" Corrugation												
Equivalent Diameter D (in.)	Span in.	Rise in.	Minimum Cover (in.)					Maximum Cover (ft)				
			Sheet thickness in Inches (Gage)					Sheet thickness in Inches (Gage)				
			0.06 (16)	0.075 (14)	0.105 (12)	0.135 (10)	0.164 (8)	0.06 (16)	0.075 (14)	0.105 (12)	0.135 (10)	0.164 (8)
15	17	13	33	28	28	28	28	12	12	12	12	12
18	21	15	30	30	30	30	30	11	11	11	11	11
21	24	18	27	27	27	27	27	12	12	12	12	12
24	28	20	29	29	29	29	29	11	11	11	11	11
30	35	24	NS	29	29	29	29	NS	11	11	11	11
36	42	29	NS	30	30	30	30	NS	11	11	11	11
42	49	33	NS	NS	30	30	30	NS	NS	11	11	11
48	57	38	NS	NS	NS	NS	NS	NS	NS	NS	NS	NS
54	64	43	NS	NS	NS	NS	NS	NS	NS	NS	NS	NS
60	71	47	NS	NS	NS	NS	NS	NS	NS	NS	NS	NS

Aluminum—Pipe Arch—3" x 1" Corrugation												
Equivalent Diameter D (in.)	Span in.	Rise in.	Minimum Cover (in.)					Maximum Cover (ft)				
			Sheet thickness in Inches (Gage)					Sheet thickness in Inches (Gage)				
			0.06 (16)	0.075 (14)	0.105 (12)	0.135 (10)	0.164 (8)	0.06 (16)	0.075 (14)	0.105 (12)	0.135 (10)	0.164 (8)
48	53	41	12	12	12	12	12	20	20	20	20	20
54	60	46	12	12	12	12	12	20	20	20	20	20
60	66	51	12	12	12	12	12	20	20	20	20	20
66	73	55	NS	12	12	12	12	NS	20	20	20	20
72	81	59	NS	NS	12	12	12	NS	NS	16	16	16
78	87	63	NS	NS	12	12	12	NS	NS	16	16	16
84	95	67	NS	NS	12	12	12	NS	NS	16	16	16
90	103	71	NS	NS	NS	13	13	NS	NS	NS	15	15
96	112	75	NS	NS	NS	NS	NS	NS	NS	NS	NS	NS
102	117	79	NS	NS	NS	NS	NS	NS	NS	NS	NS	NS

Aluminum—Pipe Arch—Spiral Rib Rib Spacing (3/4" x 3/4" x 7 1/2")										
Equivalent Diameter D (in.)	Span in.	Rise in.	Minimum Cover (in.)				Maximum Cover (ft)			
			Sheet thickness in Inches (Gage)				Sheet thickness in Inches (Gage)			
			0.06 (16)	0.075 (14)	0.105 (12)	0.135 (10)	0.06 (16)	0.075 (14)	0.105 (12)	0.135 (10)
18	20	16	23	23	23	23	15	15	15	15
21	23	19	24	24	24	24	14	14	14	14
24	27	21	26	26	26	26	12	12	12	12
30	33	26	26	26	26	26	12	12	12	12
36	40	31	27	27	27	27	12	12	12	12
42	46	36	24	24	24	24	12	12	12	12
48	53	41	NS	24	24	24	NS	14	14	14
54	60	46	NS	24	24	24	NS	17	20	20
60	66	51	NS	24	24	24	NS	17	20	20
66	73	55	NS	NS	27	27	NS	NS	20	20

Corrugated Steel Pipe Arch

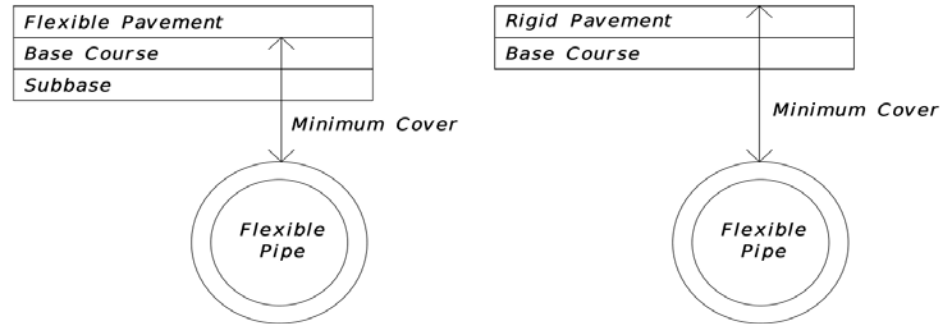

Steel—Pipe Arch—2 2/3" x 1/2" Corrugation												
Equivalent Diameter D (in.)	Span in.	Rise in.	Minimum Cover (in.)					Maximum Cover (ft)				
			Sheet thickness in Inches (Gage)					Sheet thickness in Inches (Gage)				
			0.064 (16)	0.079 (14)	0.109 (12)	0.138 (10)	0.168 (8)	0.064 (16)	0.079 (14)	0.109 (12)	0.138 (10)	0.168 (8)
15	17	13	28	28	28	28	28	12	12	12	12	12
18	21	15	30	30	30	30	30	11	11	11	11	11
21	24	18	27	27	27	27	27	12	12	12	12	12
24	28	20	29	29	29	29	29	11	11	11	11	11
30	35	24	29	29	29	29	29	11	11	11	11	11
36	42	29	30	30	30	30	30	11	11	11	11	11
42	49	33	NS	30	30	30	30	NS	11	11	11	11
48	57	38	NS	NS	23	25	23	NS	NS	11	11	11
54	64	43	NS	NS	20	20	20	NS	NS	11	11	11
60	71	47	NS	NS	NS	22	22	NS	NS	NS	10	10
66	77	52	NS	NS	NS	NS	NS	NS	NS	NS	NS	NS
72	83	57	NS	NS	NS	NS	NS	NS	NS	NS	NS	NS

Steel—Pipe Arch—3" x 1" Corrugation

Equivalent Diameter D (in.)	Span in.	Rise in.	Minimum Cover (in.)					Maximum Cover (ft)				
			Sheet thickness in Inches (Gage)					Sheet thickness in Inches (Gage)				
			0.064 (16)	0.079 (14)	0.109 (12)	0.138 (10)	0.168 (8)	0.064 (16)	0.079 (14)	0.109 (12)	0.138 (10)	0.168 (8)
48	53	41	12	12	12	12	12	20	20	20	20	20
54	60	46	12	12	12	12	12	20	20	20	20	20
60	66	51	12	12	12	12	12	20	20	20	20	20
66	73	55	12	12	12	12	12	20	20	20	20	20
72	81	59	12	12	12	12	12	16	16	16	16	16
78	87	63	12	12	12	12	12	16	16	16	16	16
84	95	67	NS	12	12	12	12	NS	16	16	16	16
90	103	71	NS	NS	13	13	13	NS	NS	15	15	15
96	112	75	NS	NS	14	14	14	NS	NS	15	15	15
102	117	79	NS	NS	15	15	15	NS	NS	15	15	15
108	128	83	NS	NS	NS	16	16	NS	NS	NS	15	15
114	137	87	NS	NS	NS	18	18	NS	NS	NS	15	15
120	142	91	NS	NS	NS	NS	18	NS	NS	NS	NS	15

Steel—Pipe Arch—Spiral Rib										
Rib Spacing (3/4" x 3/4" x 7 1/2")										
Equivalent Diameter D (in.)	Span in.	Rise in.	Minimum Cover (in.)				Maximum Cover (ft)			
			Sheet thickness in Inches (Gage)				Sheet thickness in Inches (Gage)			
			0.064 (16)	0.079 (14)	0.109 (12)	0.138 (10)	0.064 (16)	0.079 (14)	0.109 (12)	0.138 (10)
18	20	16	23	23	23	23	15	15	15	15
21	23	19	24	24	24	24	14	14	14	14
24	27	21	26	26	26	26	12	12	12	12
30	33	26	26	26	26	26	12	12	12	12
36	40	31	27	27	27	27	12	12	12	12
42	46	36	24	24	24	24	12	12	12	12
48	53	41	NS	18	18	18	NS	12	12	12
54	60	46	NS	15	15	15	NS	20	20	20
60	66	51	NS	NS	17	17	NS	NS	20	20

Appendix D

Pipes within Walled Embankment Sections

APPENDIX D

PIPES WITHIN WALLED EMBANKMENT SECTIONS

Wall Zone Criteria

Wall Zone	Requirements	Comments
A	Wall Zone Pipe (see <i>Drainage Manual</i> , Table 6-1)	Not likely to leak and used when probable first indicator of leak is topside settlement or soil loss
B	Wall Zone Pipe. No longitudinal conveyances ² allowed. Transverse conveyances must meet AASHTO LRFD criteria ³	First indicator of leak is wall damage: pipe must endure unique loading with no chance of leakage
C	No pipes allowed	First indicator of leak is bridge/wall damage

Notes

1. Requirements apply to all retaining walls, including those shown in the following sketches. Wall types not shown or project-specific wall designs will incorporate the same restrictions.
2. For the purposes of this table and these figures, a longitudinal conveyance is defined as a pipe run that is aligned with the wall stationing and deviating no more than 45 degrees from the wall alignment. For skewed walls and in the cases where the criteria for longitudinal and transverse directions overlap, e.g., at wall corners, the more stringent criteria must apply.
3. Design pipes in Zone B to provide adequate structural integrity after the expected section loss due to corrosion over the design service life of the pipe. Assume the following:
 - a. 120 lb/cubic feet soil density (moist)
 - b. Pipe trench excavation per Subarticle 125-4.4 of the **Standard Specifications**
 - c. Pipe trench backfill allowable soils, bedding, and compaction per Article 125-8 of the **Standard Specifications**
4. Implement site specific design when a pressurized pipe is placed within, through, under, or immediately adjacent to a retaining wall. This is to assure the design of structural elements takes into consideration support limitations that may be created by the presence of utilities and potential damage or failure of the structure if a pressurized pipe leaks.

5. French Drains are not permitted within any retained earth (walled) embankment sections or wall zones.
6. Hydraulically size drainage pipes to allow for future internal lining.
7. Use two-phased MSE walls, per **SDG 3.12.1.D**, when expecting significant settlement. For two-phased MSE walls, install transverse piping after as much of the settlement as practical has occurred. Coordinate this effort with the Geotechnical Engineer.

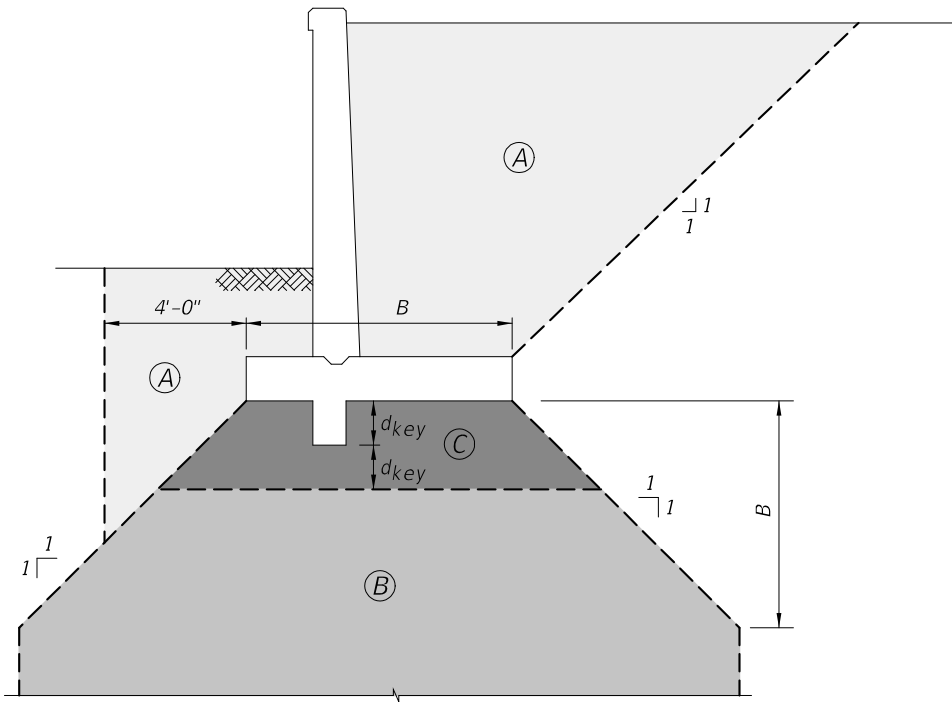

SECTION THRU CAST IN PLACE CANTILEVER RETAINING WALL (INDEX 400-010)

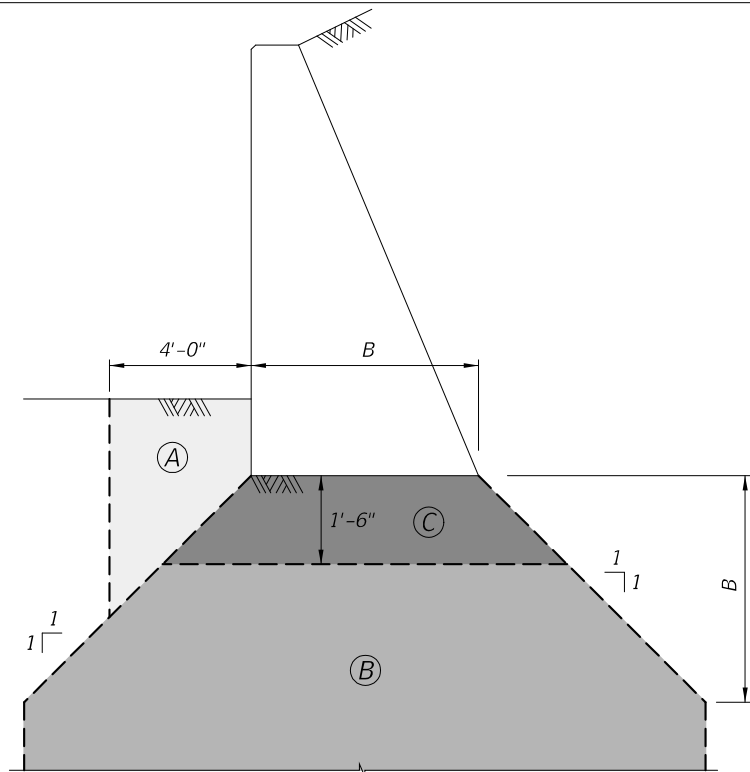

SECTION THRU CAST IN PLACE GRAVITY WALL (INDEX 400-011)

Figure F-1

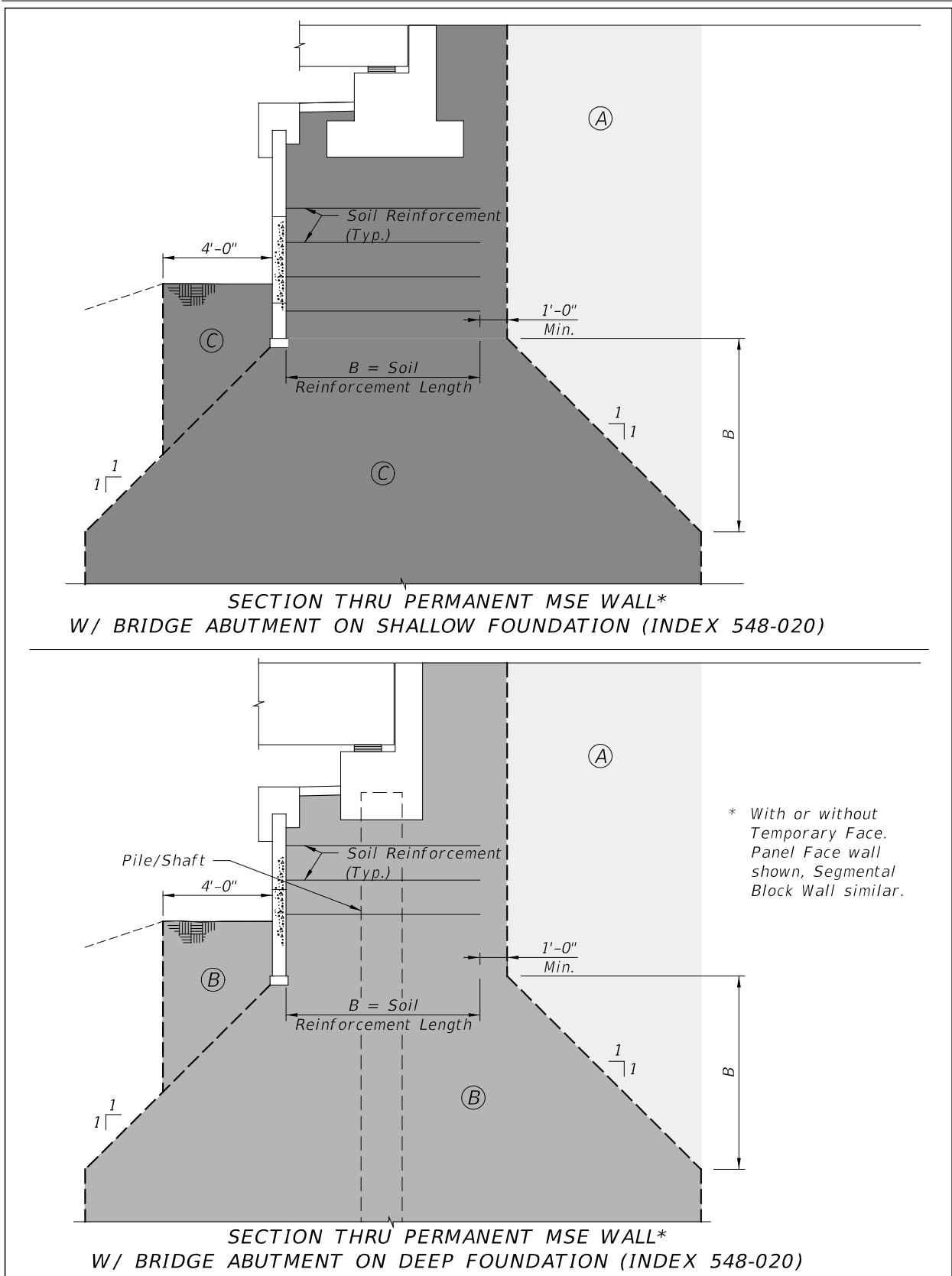

Figure F-2

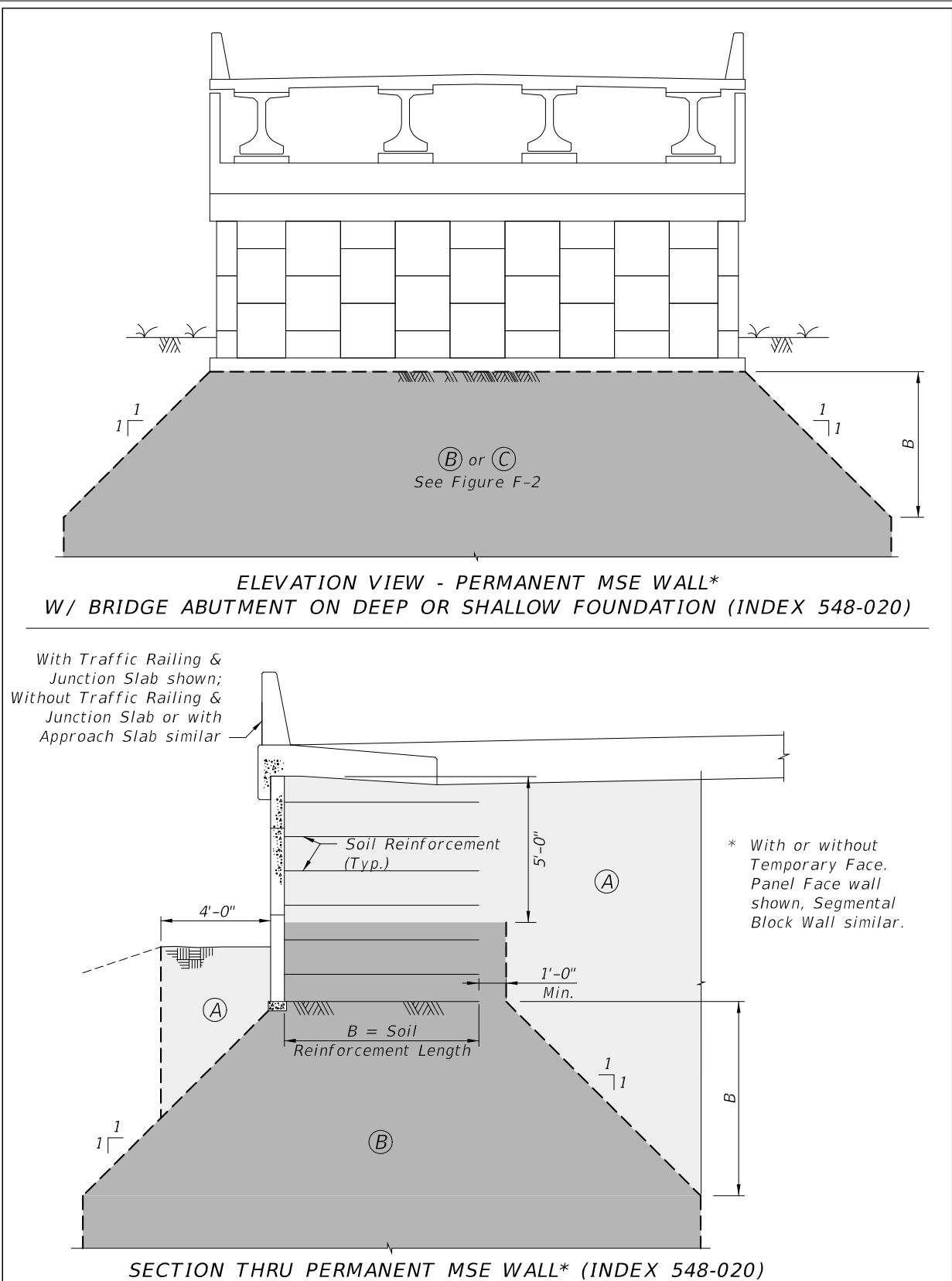

Figure F-3

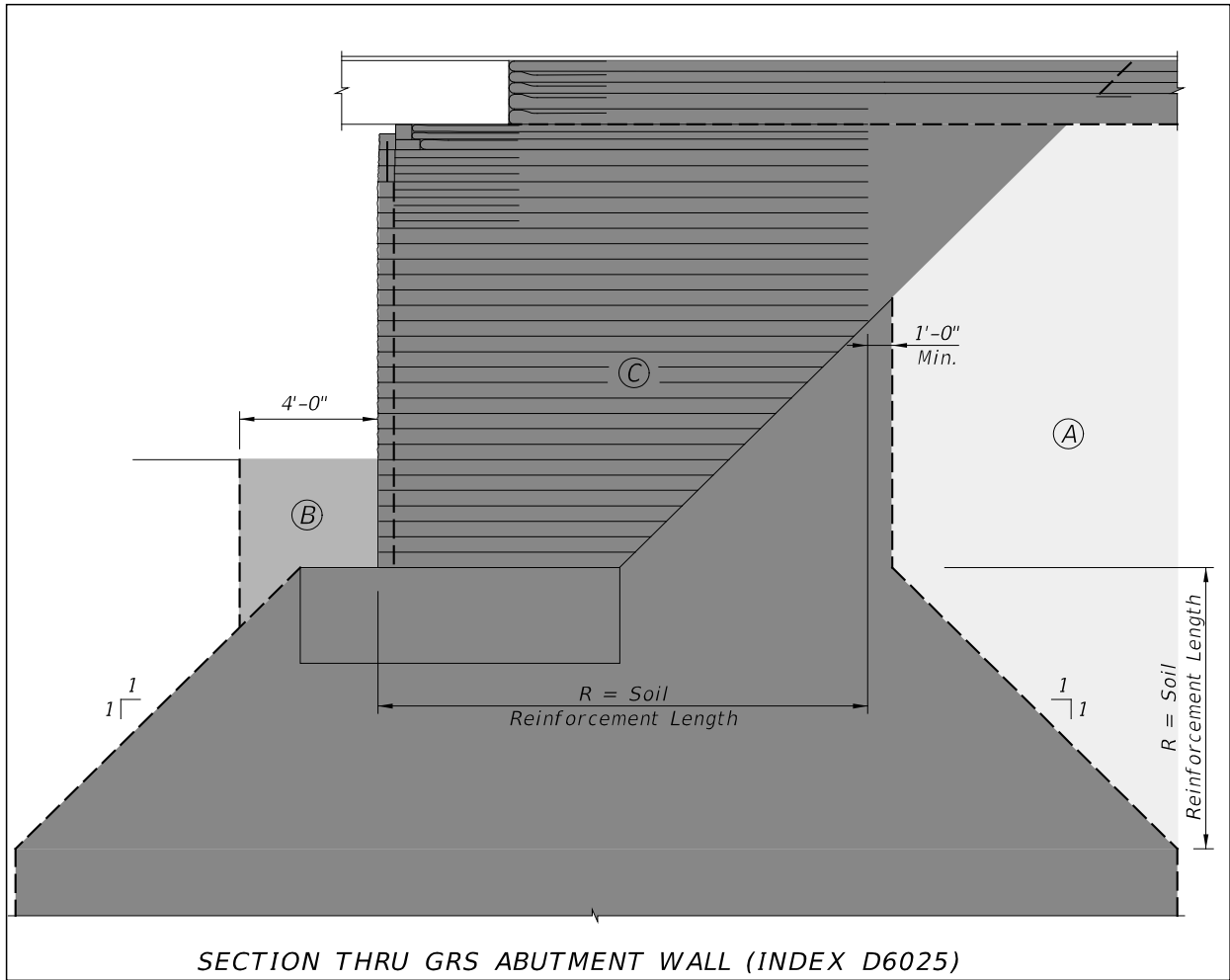

Figure F-4

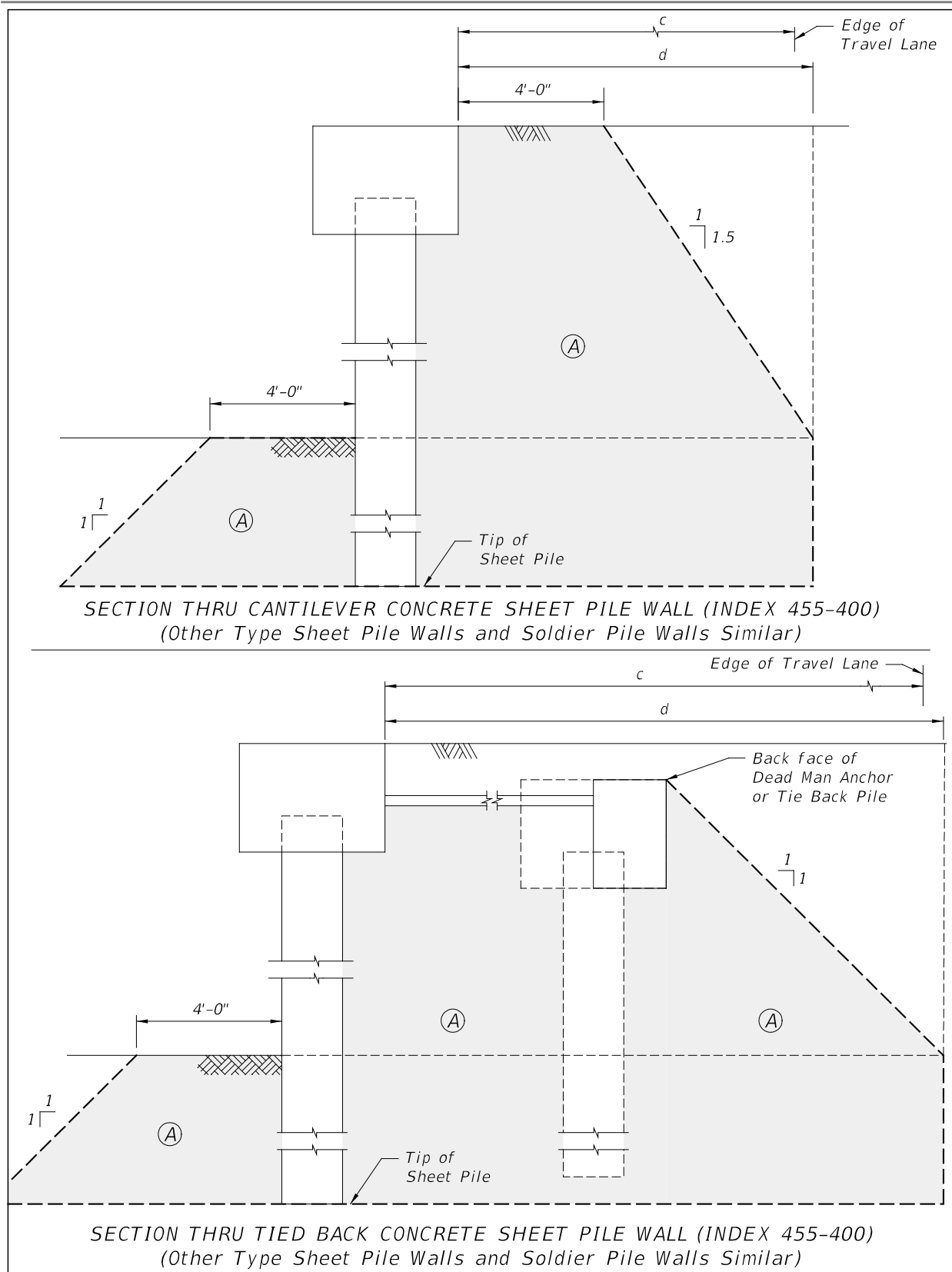

Figure F-5

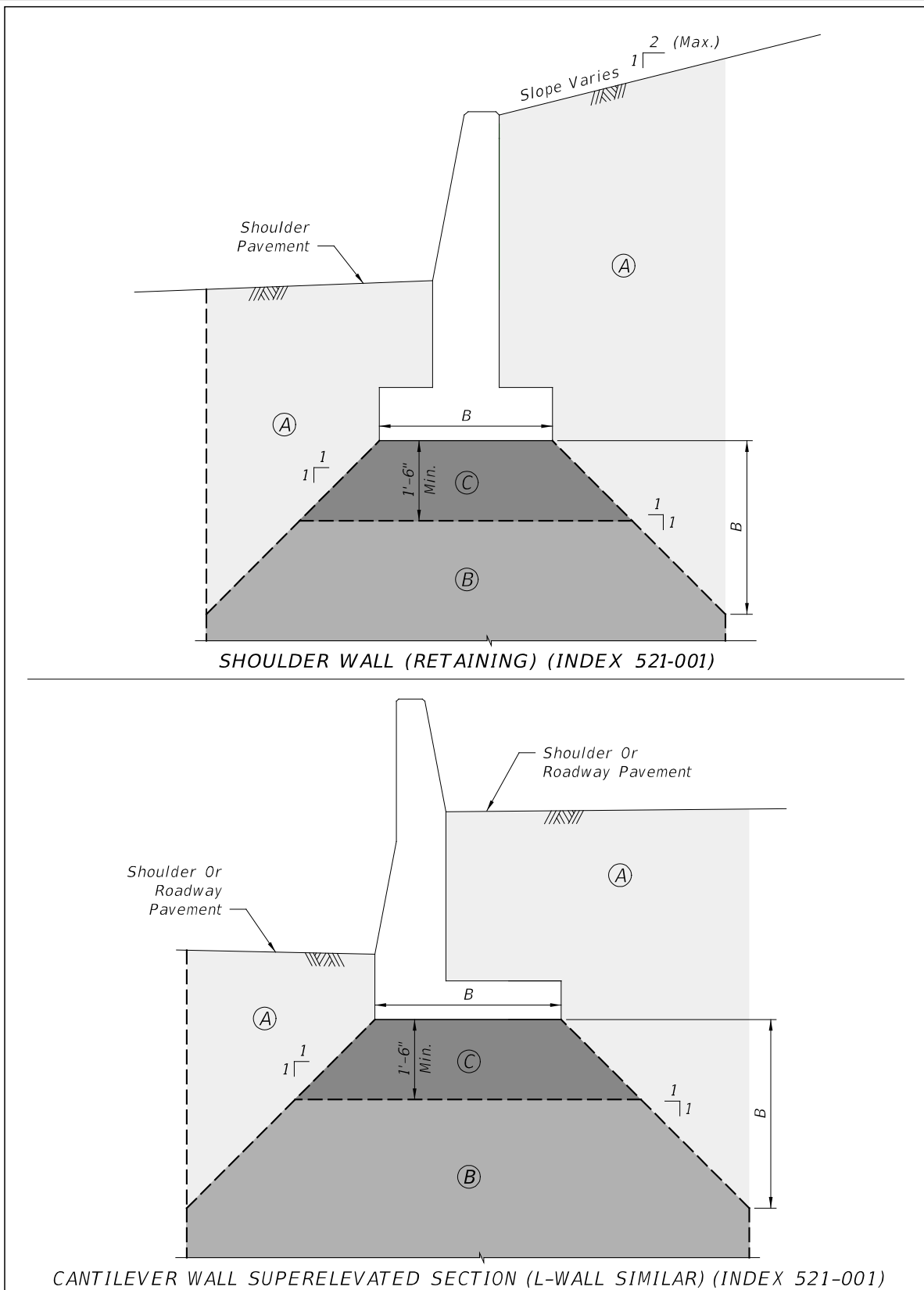

Figure F-6

Appendix E

IDF Curves

Drainage Manual IDF Curves

ZONES FOR PRECIPITATION IDF CURVES DEVELOPED BY THE DEPARTMENT

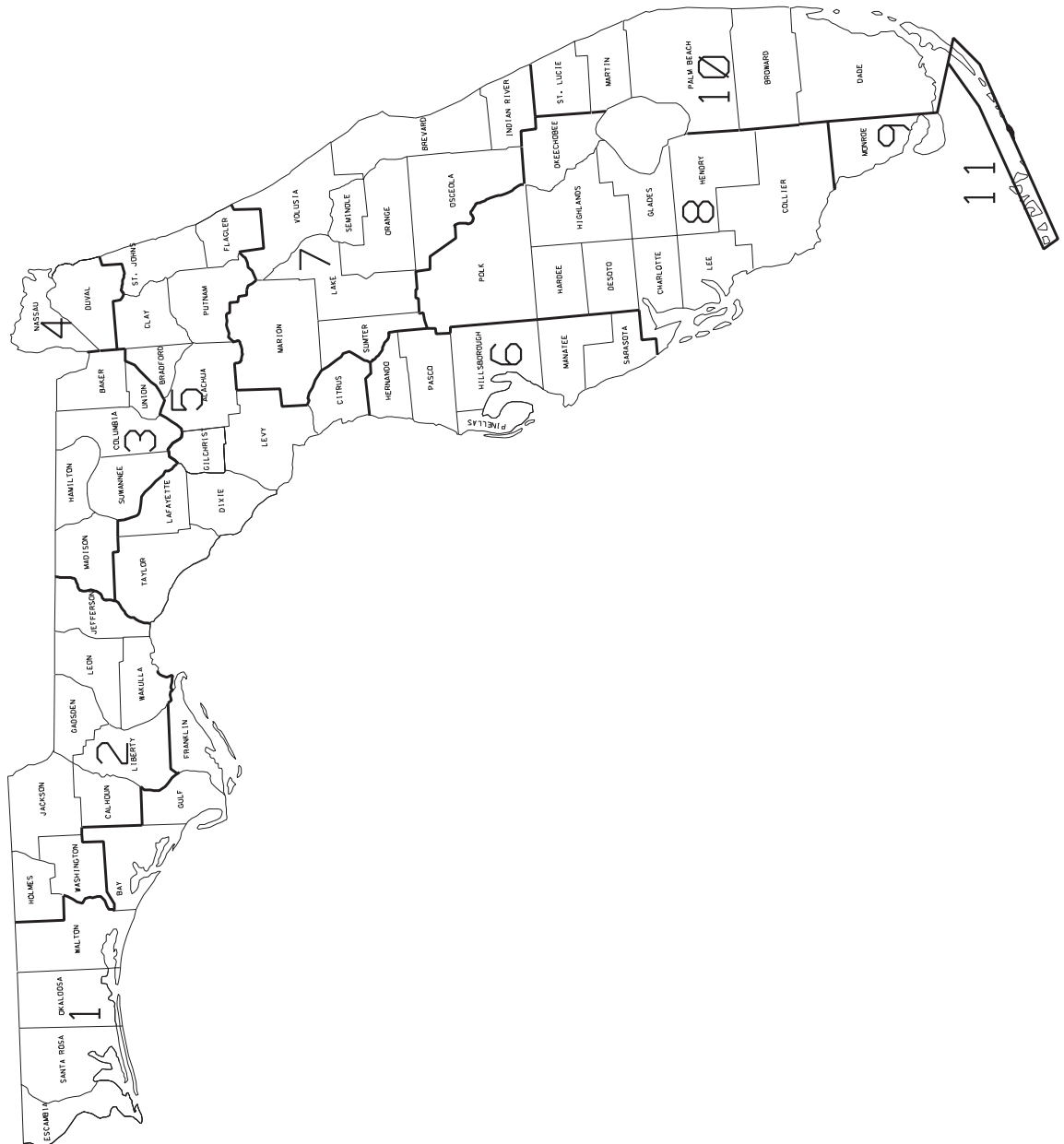

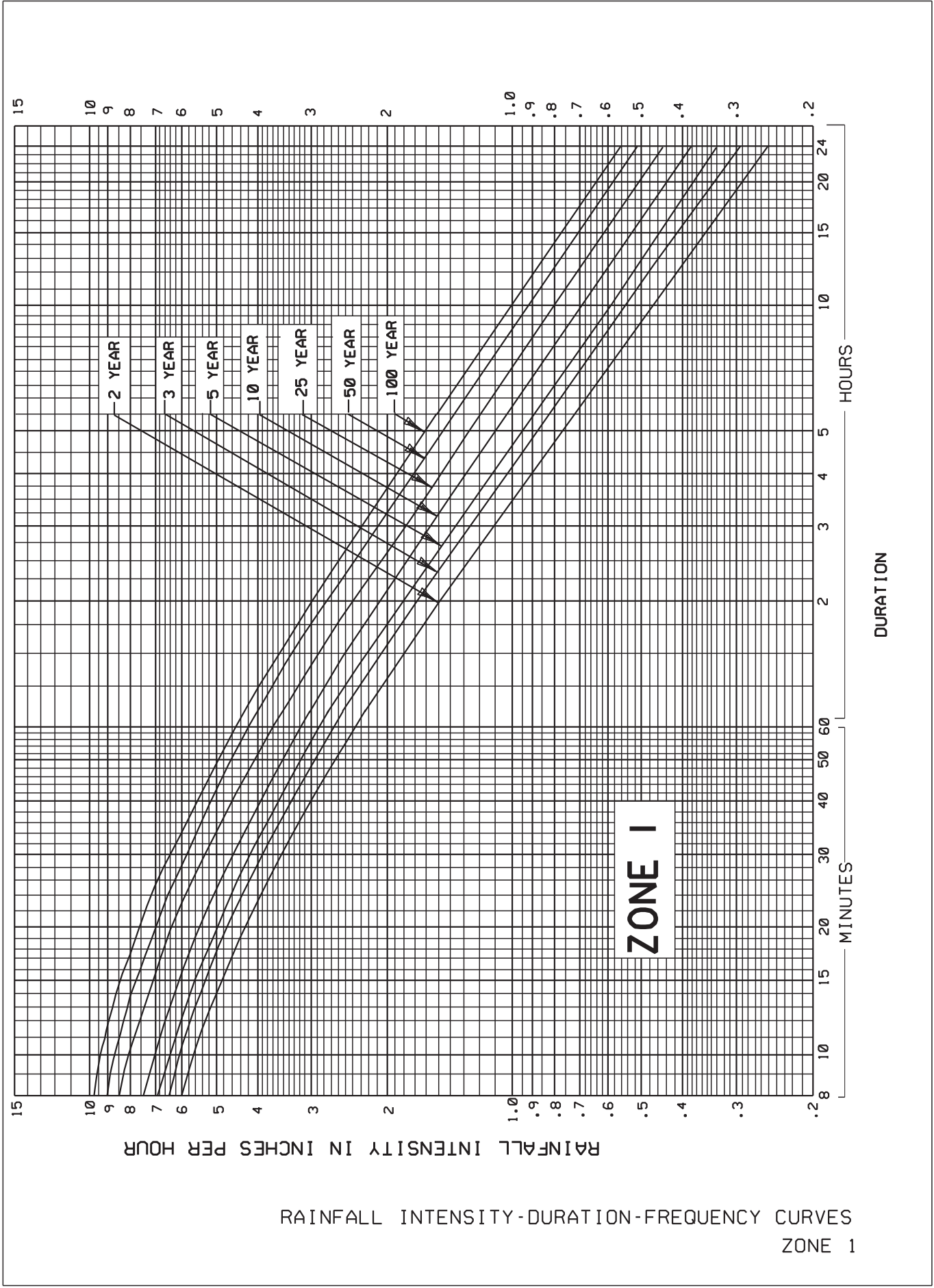

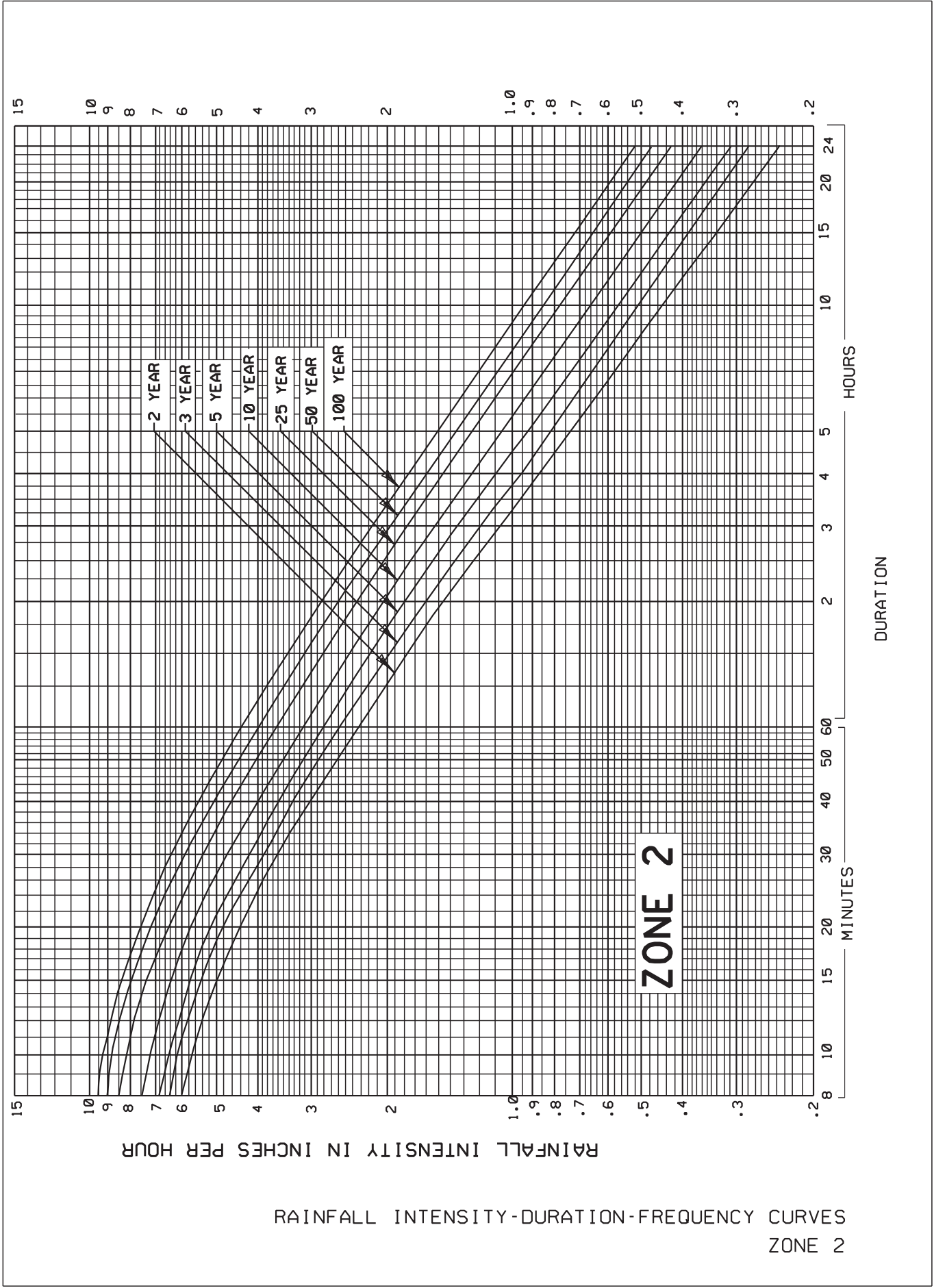

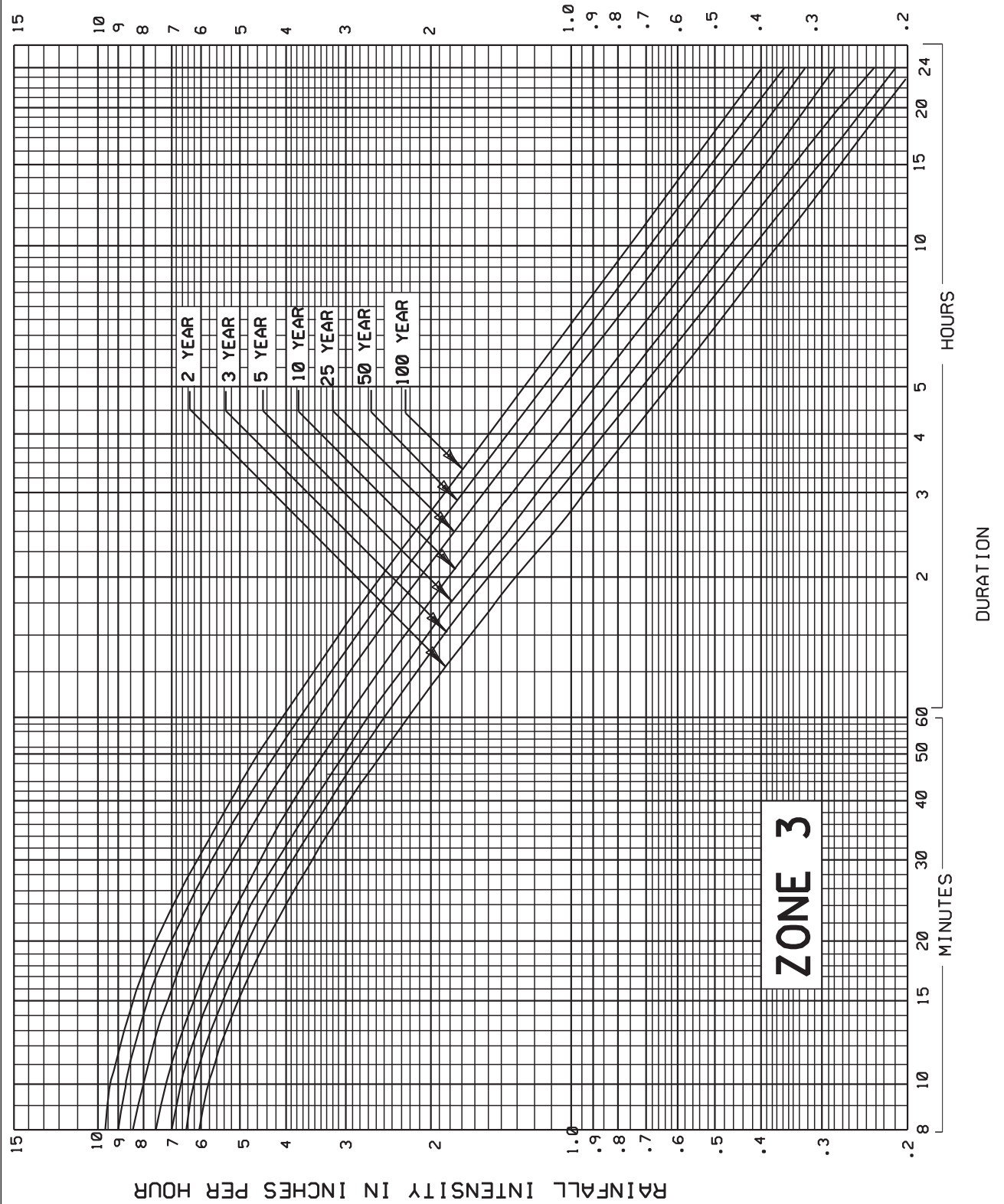

RAINFALL INTENSITY-DURATION-FREQUENCY CURVES

ZONE 3

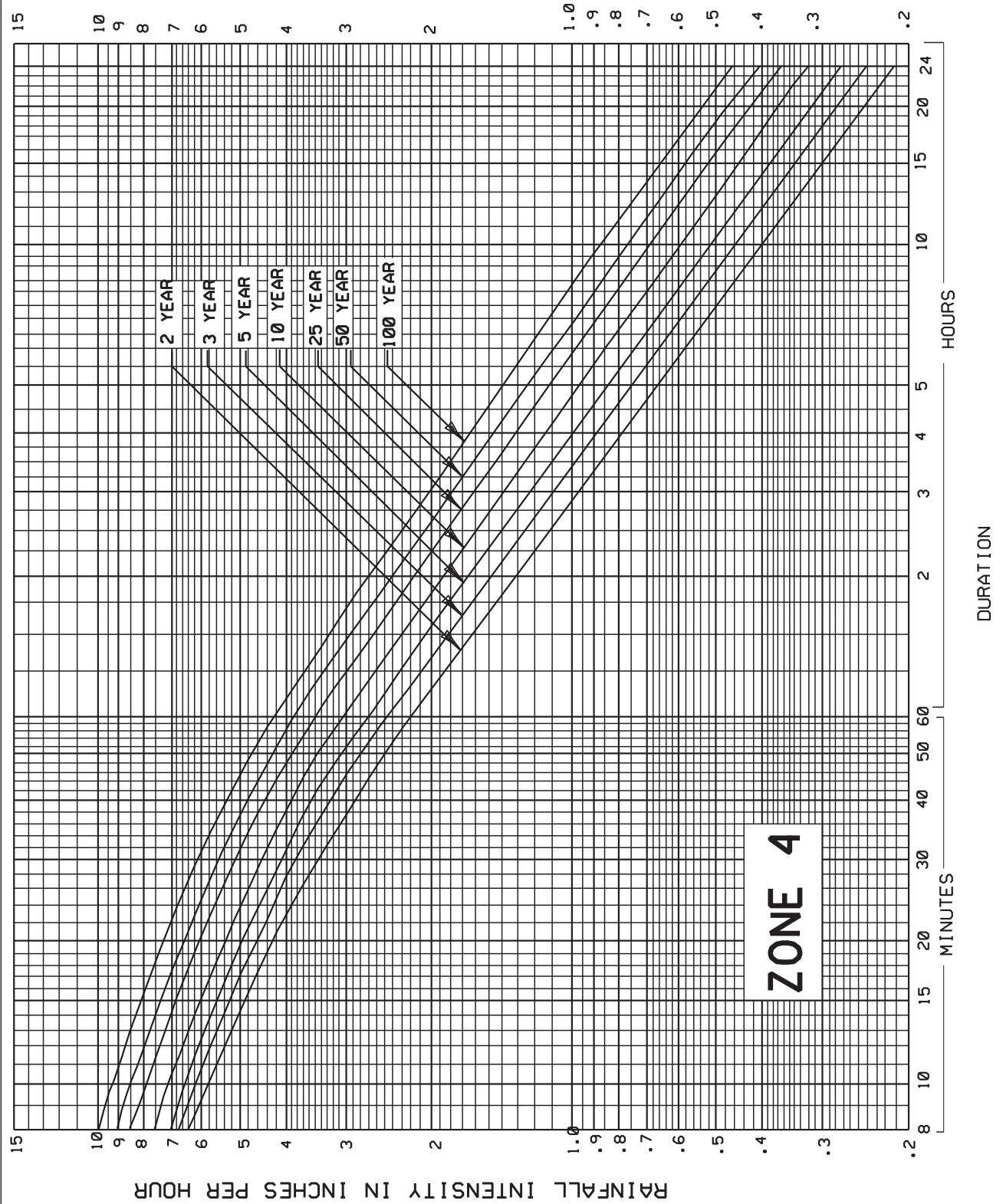

RAINFALL INTENSITY-DURATION-FREQUENCY CURVES
ZONE 4

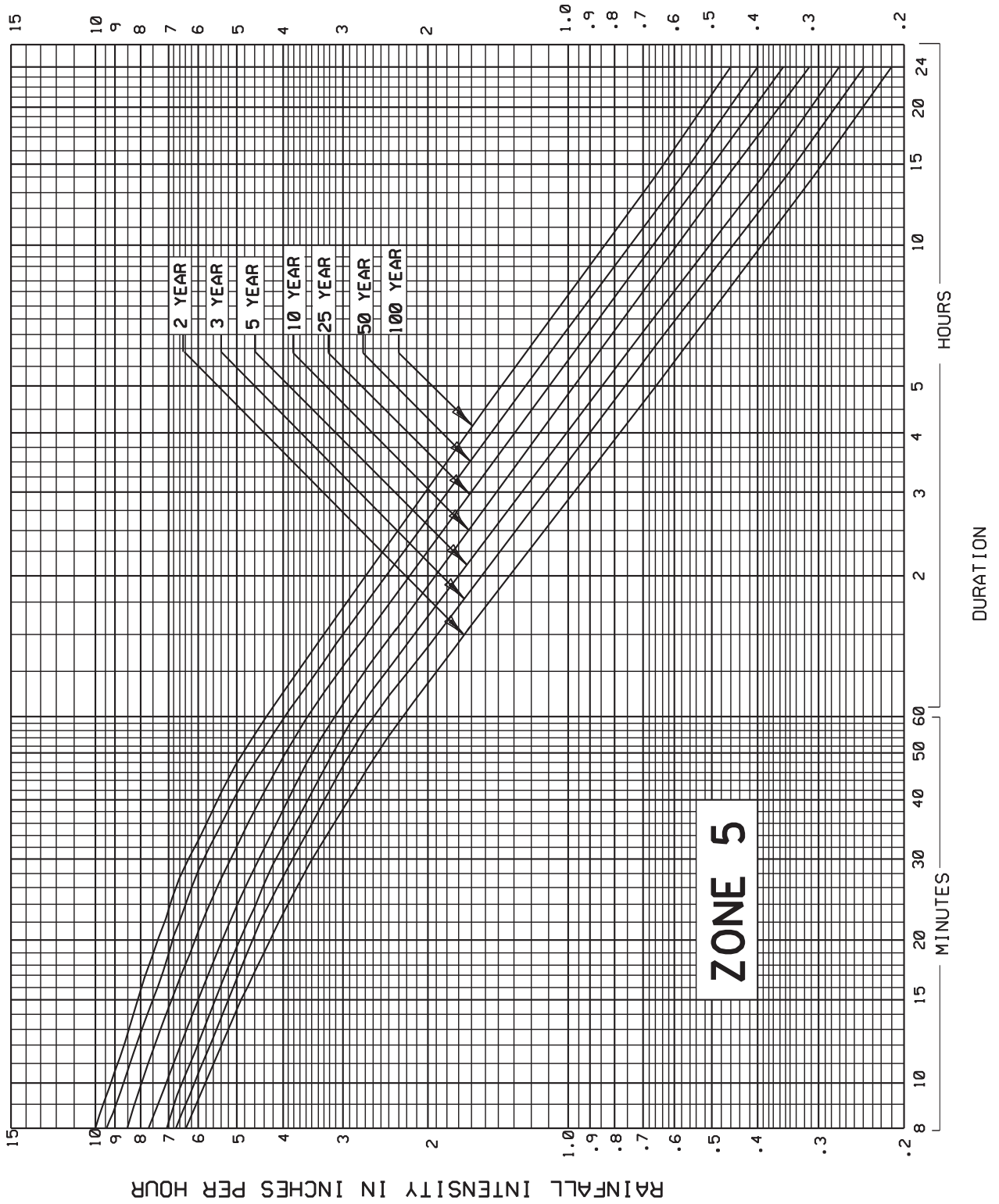

RAINFALL INTENSITY-DURATION-FREQUENCY CURVES
ZONE 5

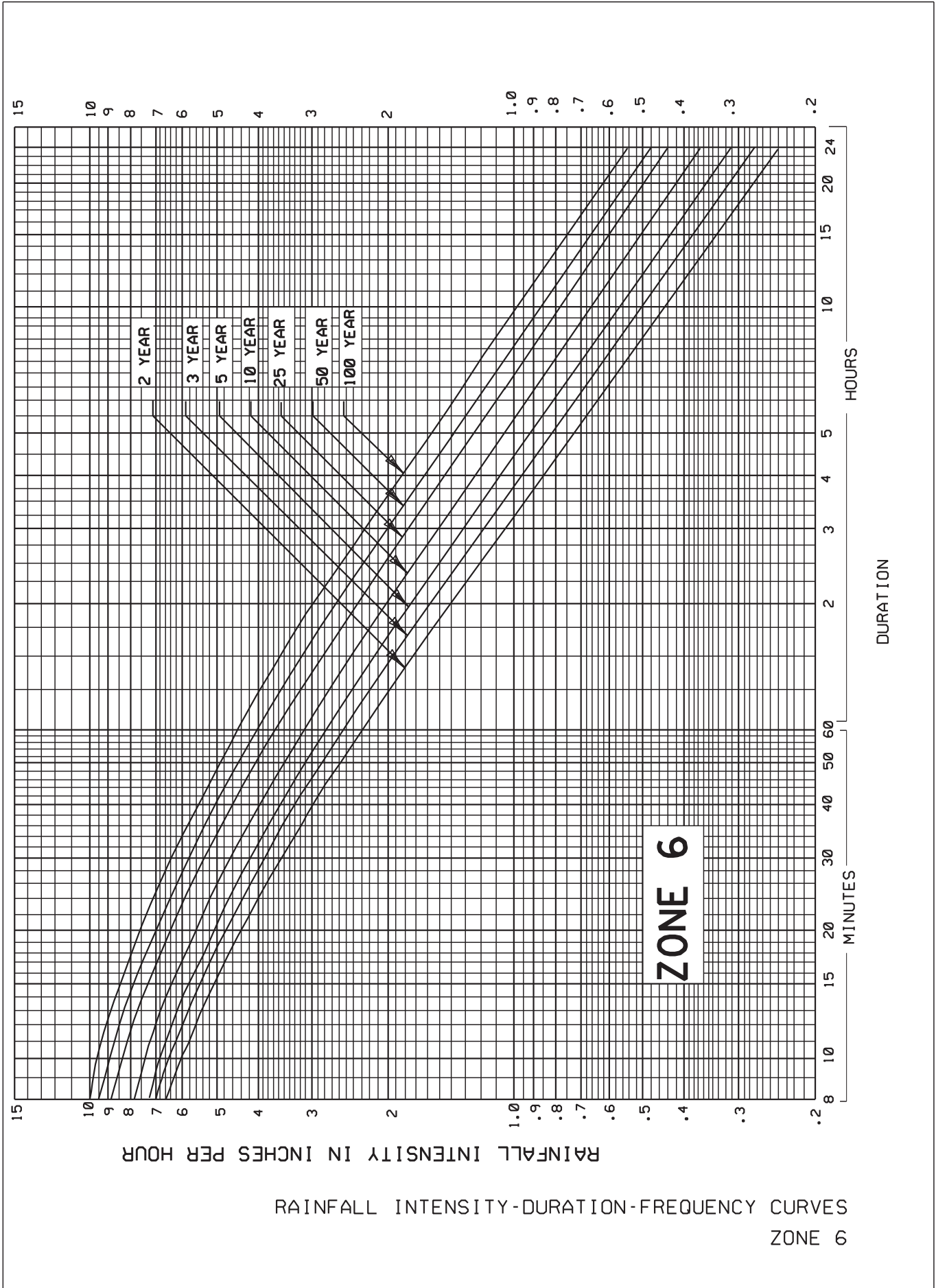

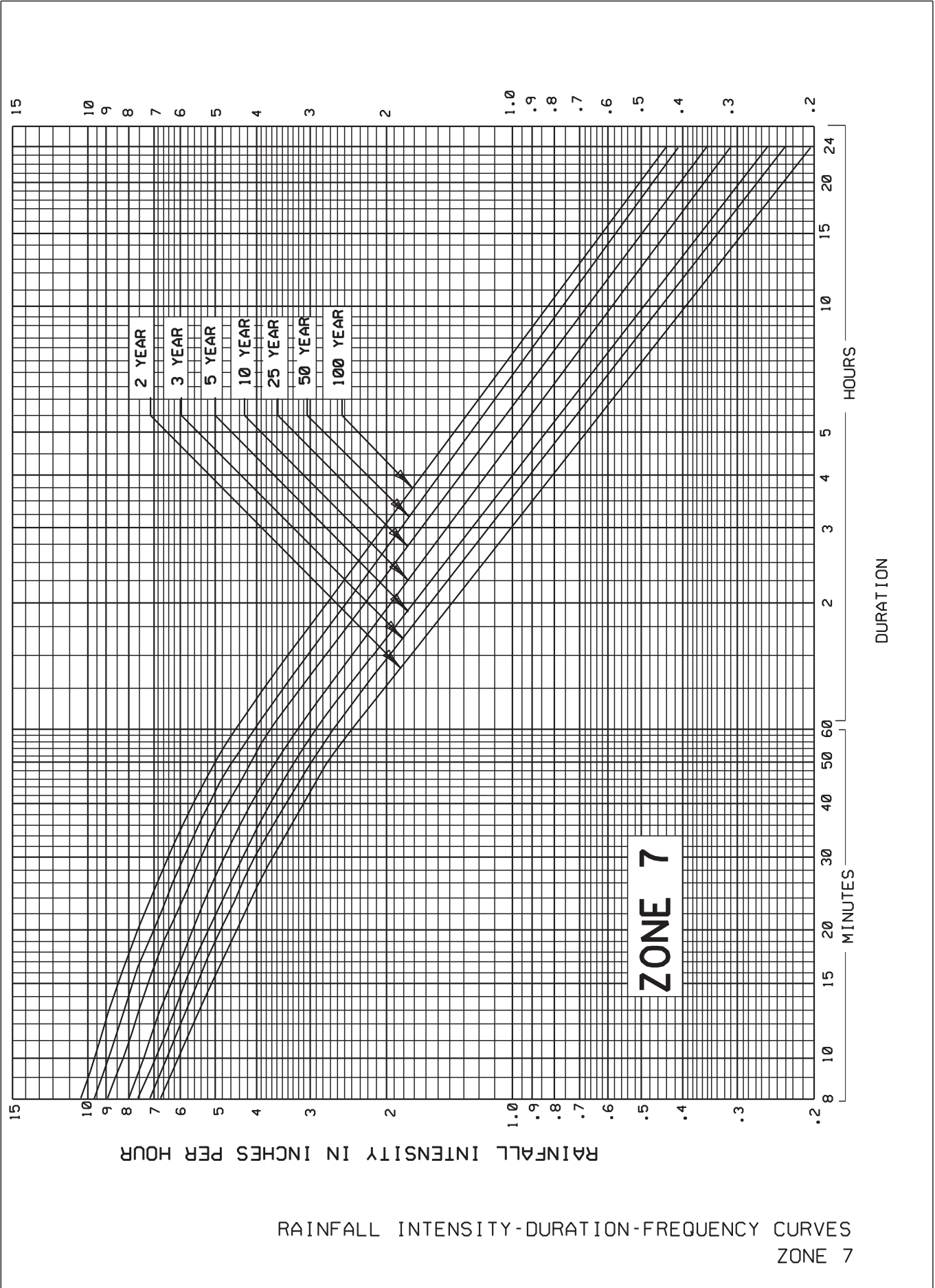

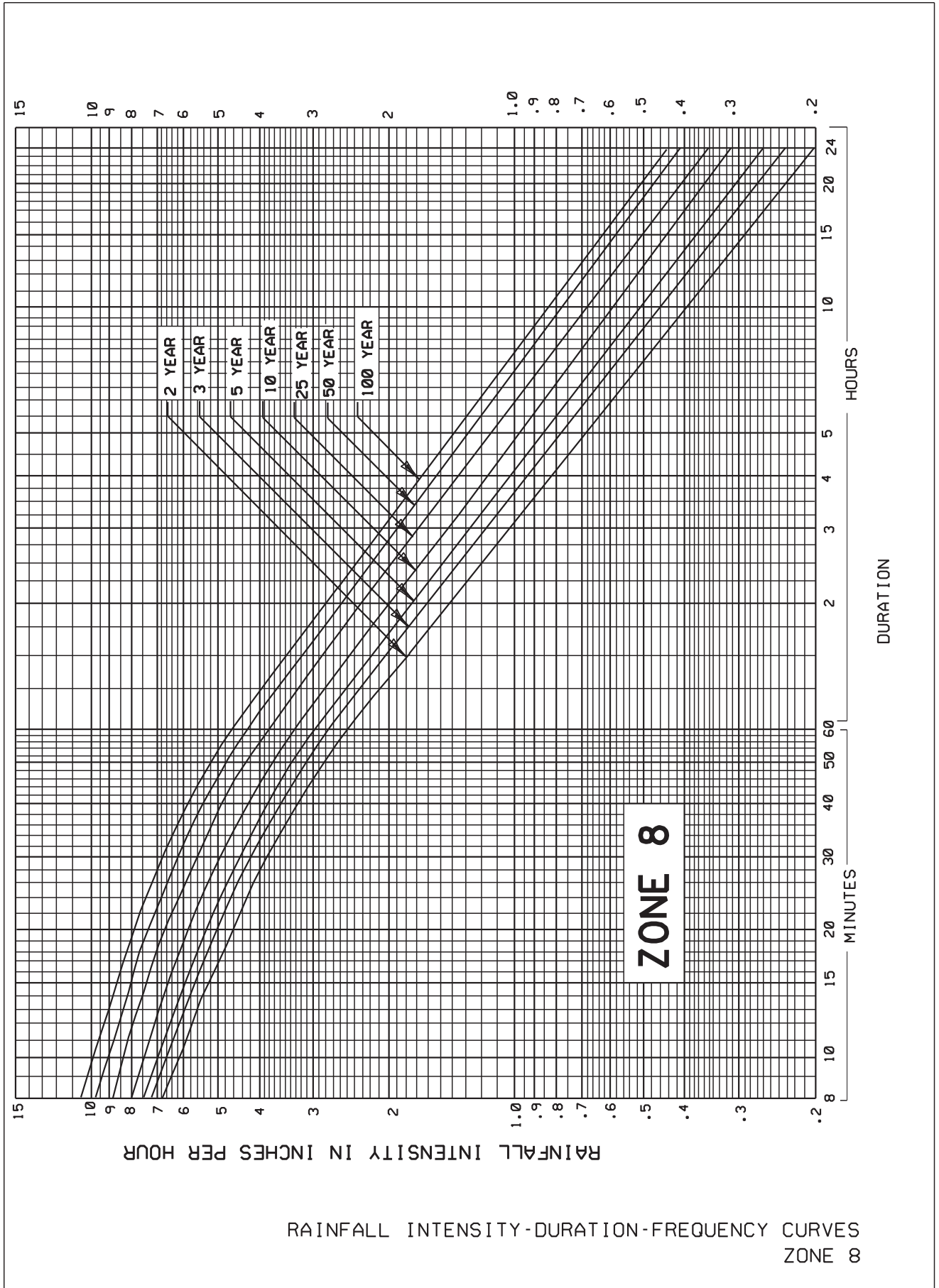

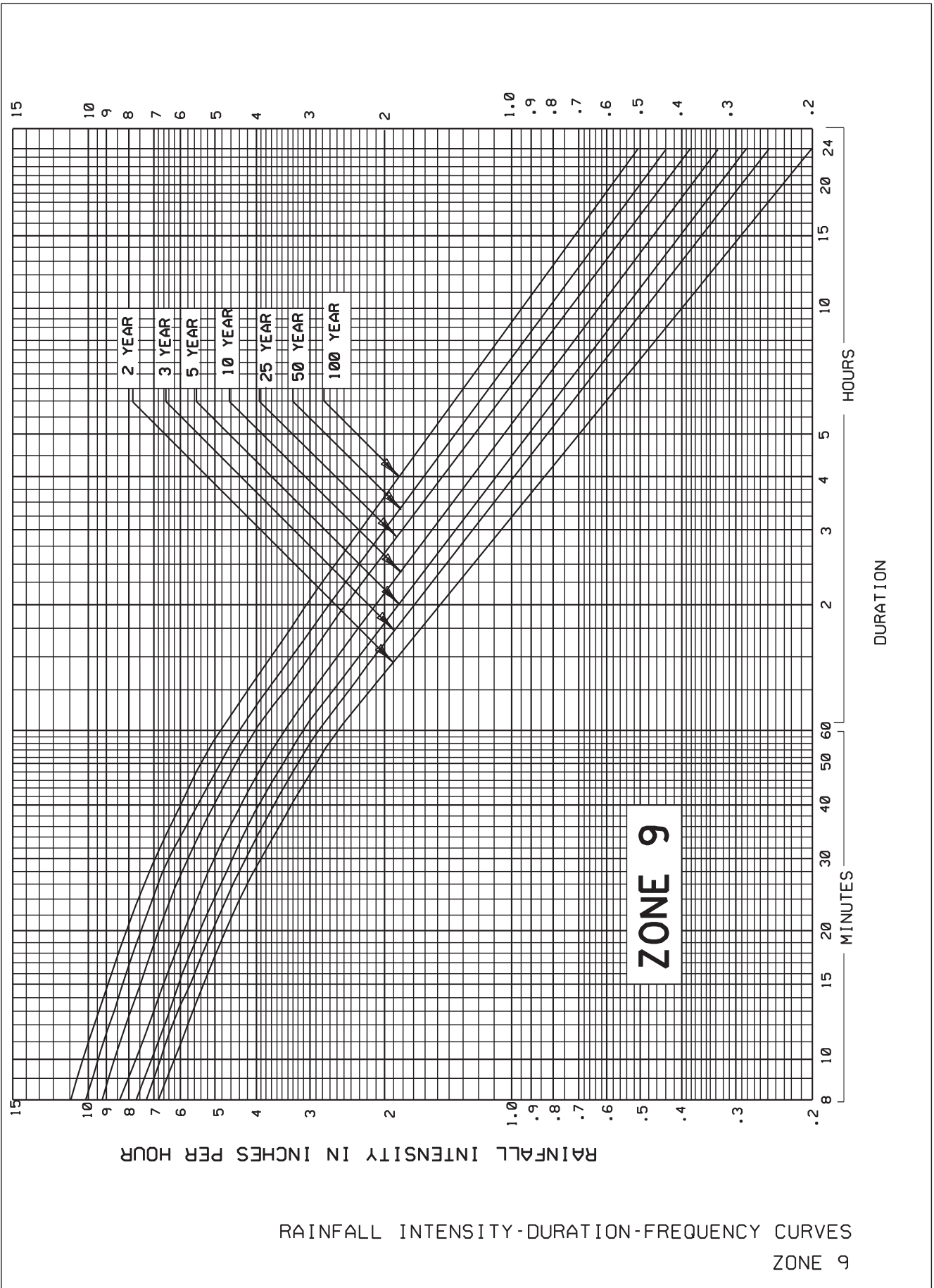

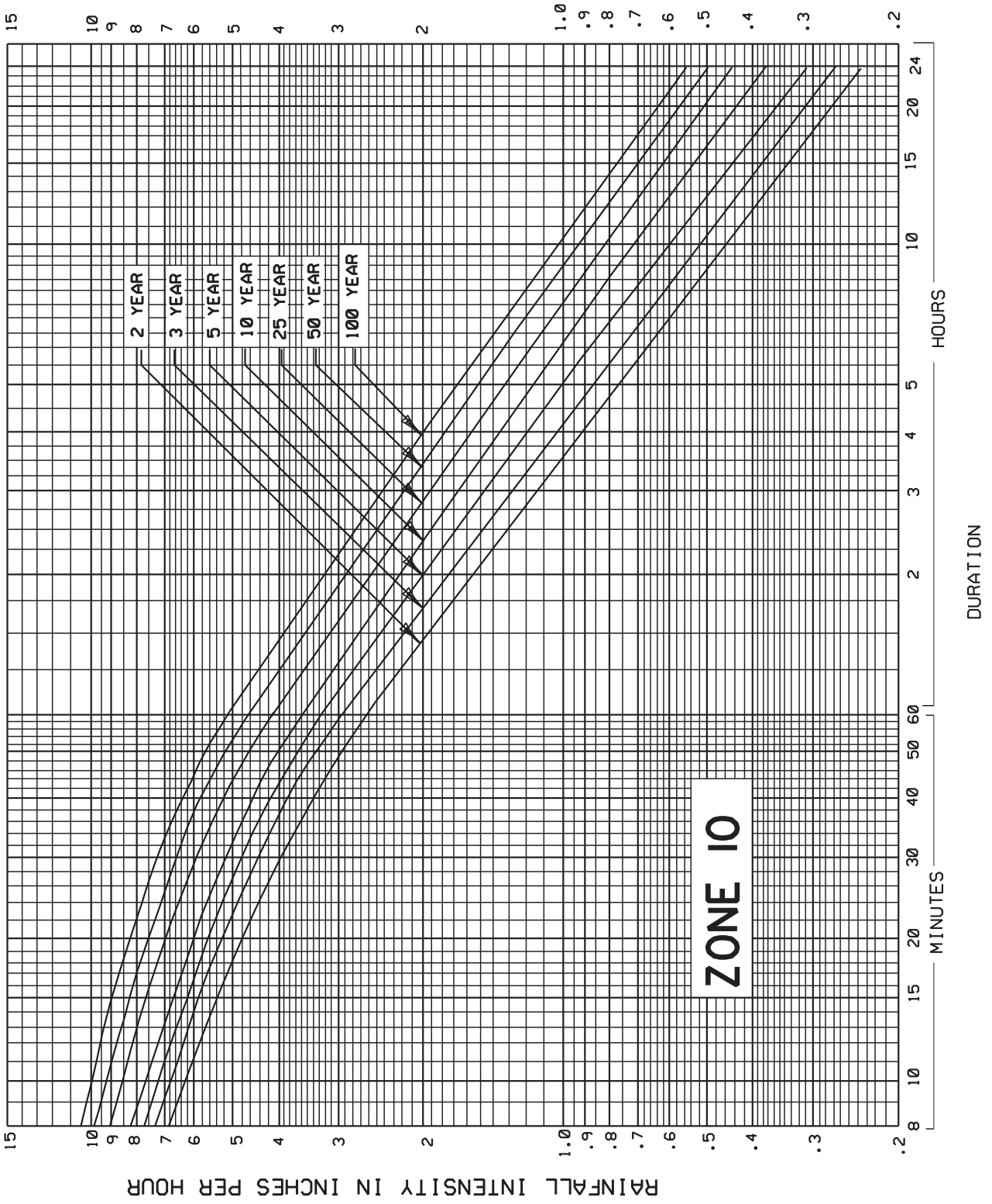

RAINFALL INTENSITY IN INCHES PER HOUR

RAINFALL INTENSITY-DURATION-FREQUENCY CURVES
ZONE 10

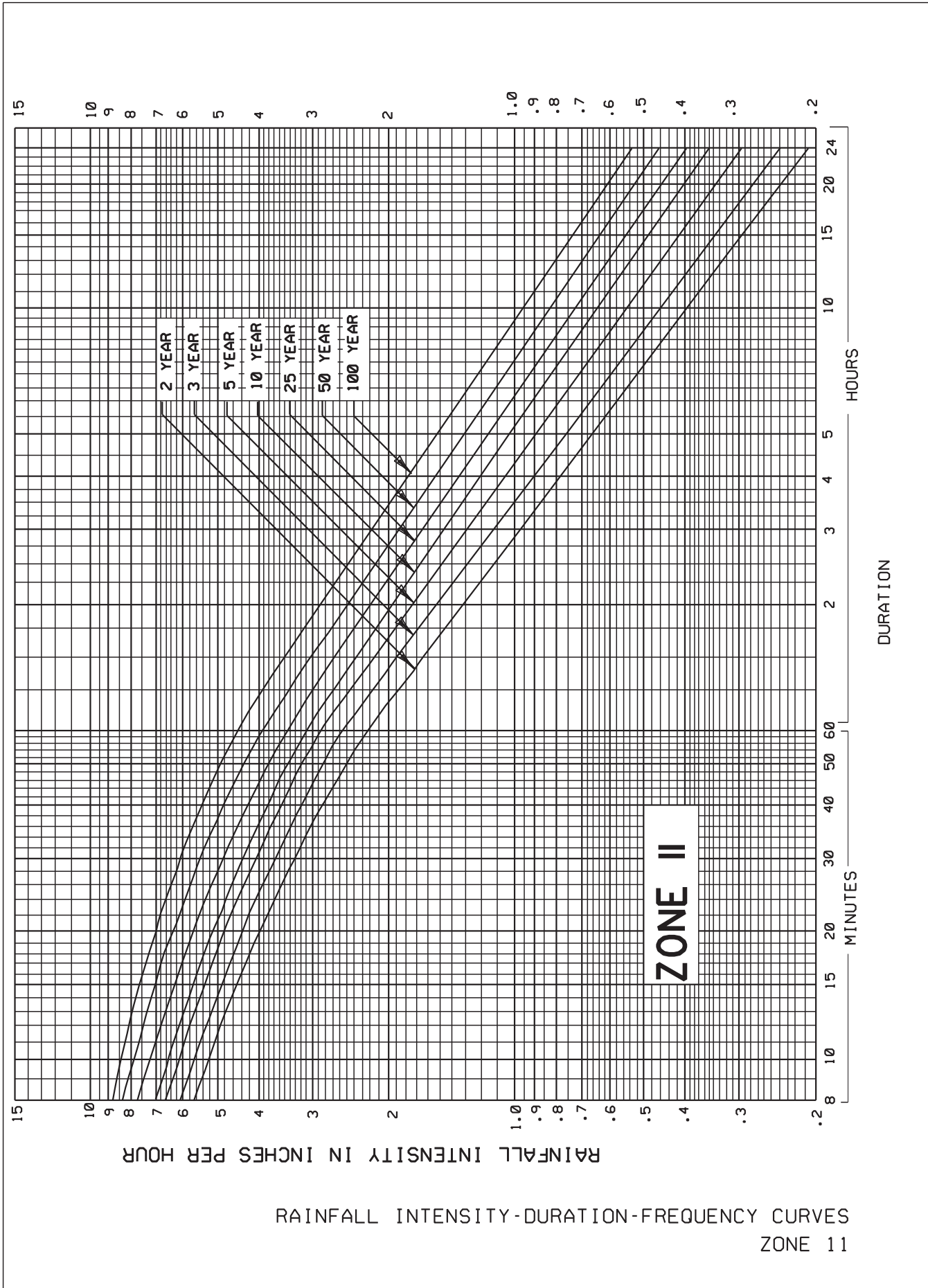

Rainfall Distribution Curves 1 Hour Duration

1 Hour Duration Mass Rainfall Curve

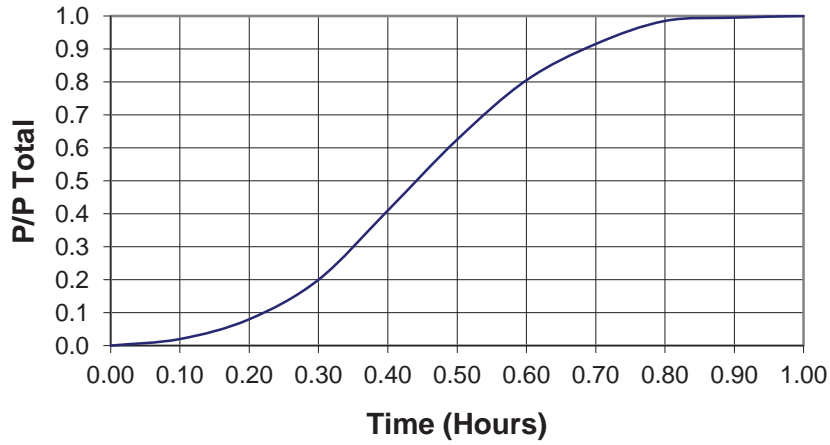

T(hrs)	P/P tot	i/P tot
0.0	0.000	0.000
0.1	0.020	0.200
0.2	0.080	0.600
0.3	0.200	1.200
0.4	0.410	2.100
0.5	0.625	2.150
0.6	0.805	1.800
0.7	0.915	1.100
0.8	0.985	0.700
0.9	0.995	0.100
1.0	1.000	0.000

1 Hour Duration Intensity Curve

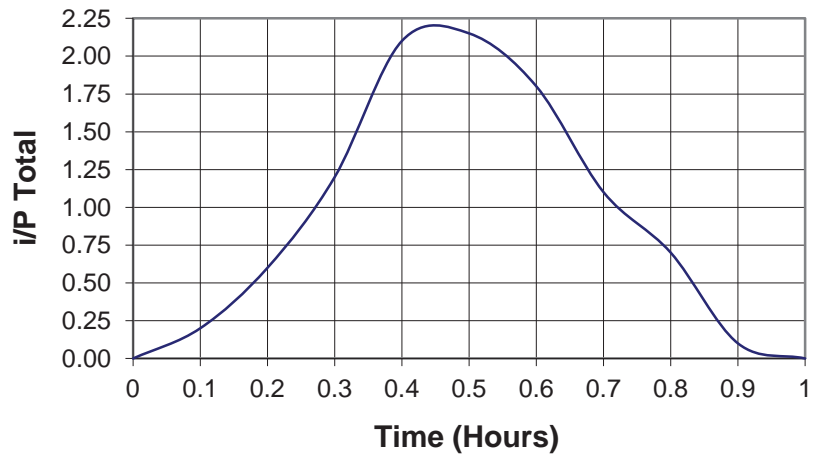

Rainfall Distribution Curves 2 Hour Duration

2 Hour Duration Mass Rainfall Curve

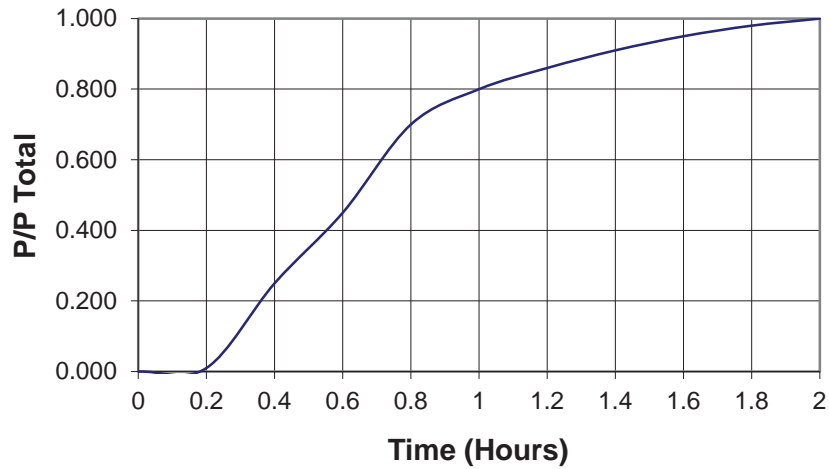

T(hrs)	P/P tot	i/P tot
0.0	0.000	0.000
0.2	0.010	0.500
0.4	0.250	0.750
0.6	0.450	1.000
0.8	0.700	1.250
1.0	0.800	0.500
1.2	0.860	0.300
1.4	0.910	0.250
1.6	0.950	0.200
1.8	0.980	0.150
2.0	1.000	0.000

2 Hour Duration Intensity Curve

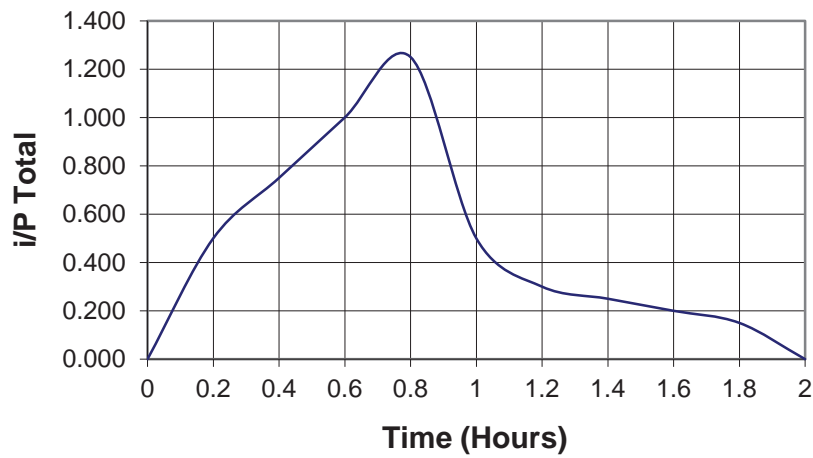

Rainfall Distribution Curves 4 Hour Duration

4 Hour Duration Mass Rainfall Curve

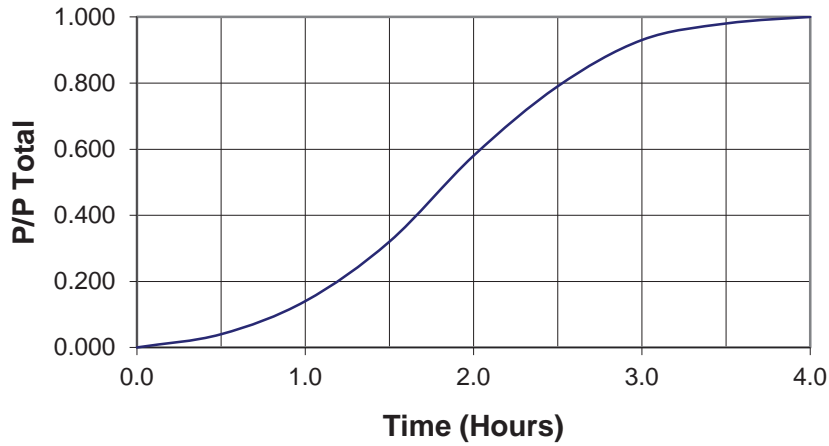

T (hrs)	P/P tot	i/P tot
0.0	0.000	0.000
0.5	0.040	0.080
1.0	0.140	0.200
1.5	0.320	0.360
2.0	0.580	0.520
2.5	0.790	0.420
3.0	0.930	0.280
3.5	0.980	0.100
4.0	1.000	0.000

4 Hour Duration Intensity Curve

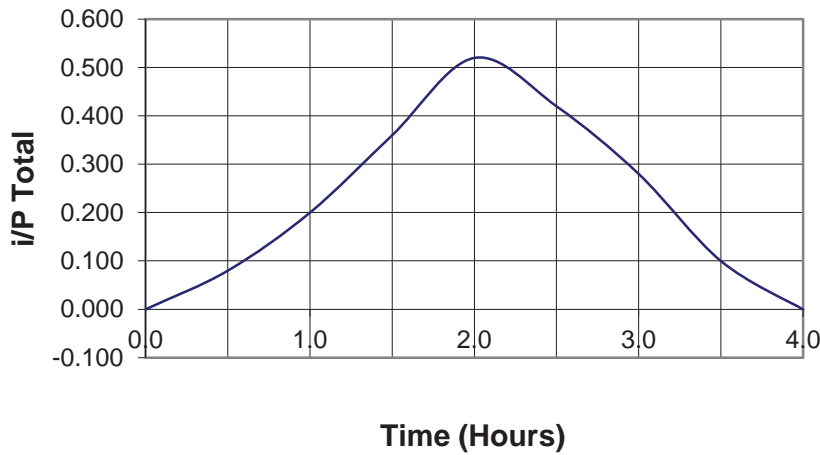

Rainfall Distribution Curves 8 Hour Duration

8 Hour Duration Mass Rainfall Curve

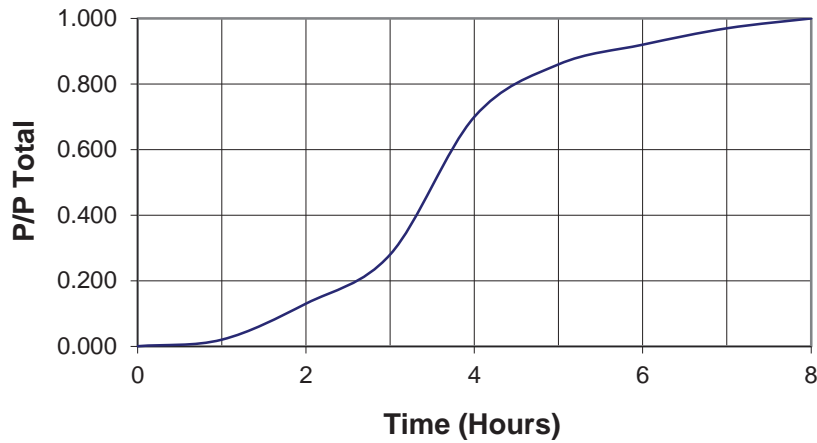

T (hrs)	P/P tot	i/P tot
0	0.000	0.000
1	0.020	0.020
2	0.130	0.060
3	0.280	0.150
4	0.700	0.420
5	0.860	0.160
6	0.920	0.060
7	0.970	0.050
8	1.000	0.000

8 Hour Duration Intensity Curve

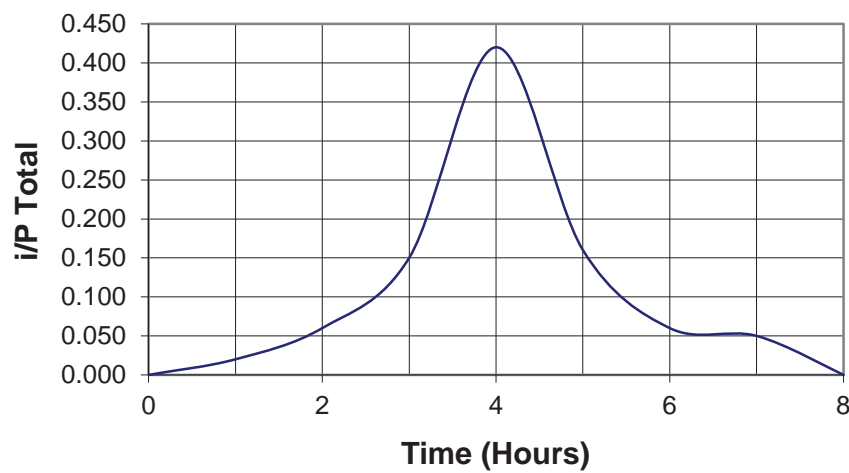

Rainfall Distribution Curves 24 Hour Duration

24 Hour Duration Mass Rainfall Curve

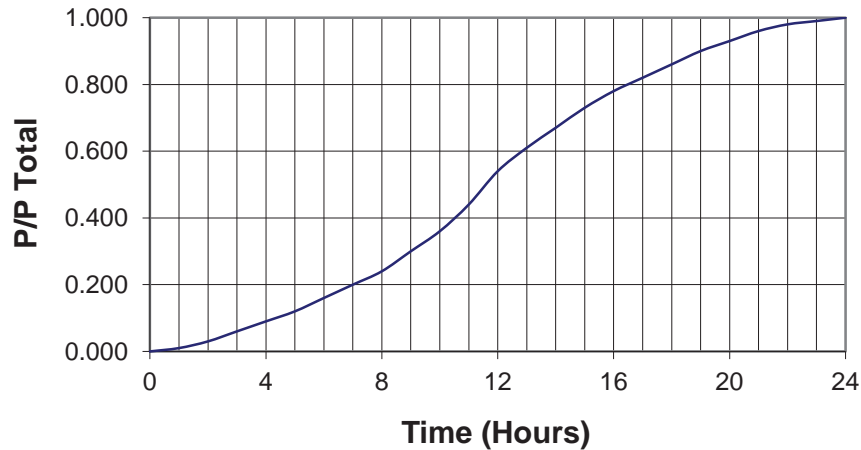

T (hrs)	P/P tot	i/P tot
0	0.000	0.000
1	0.010	0.010
2	0.030	0.020
3	0.060	0.030
4	0.090	0.030
5	0.120	0.030
6	0.160	0.040
7	0.200	0.040
8	0.240	0.040
9	0.300	0.060
10	0.360	0.060
11	0.440	0.080
12	0.540	0.100
13	0.610	0.070
14	0.670	0.060
15	0.730	0.060
16	0.780	0.050
17	0.820	0.040
18	0.860	0.040
19	0.900	0.040
20	0.930	0.030
21	0.960	0.030
22	0.980	0.020
23	0.990	0.010
24	1.000	0.000

24 Hour Duration Intensity Curve

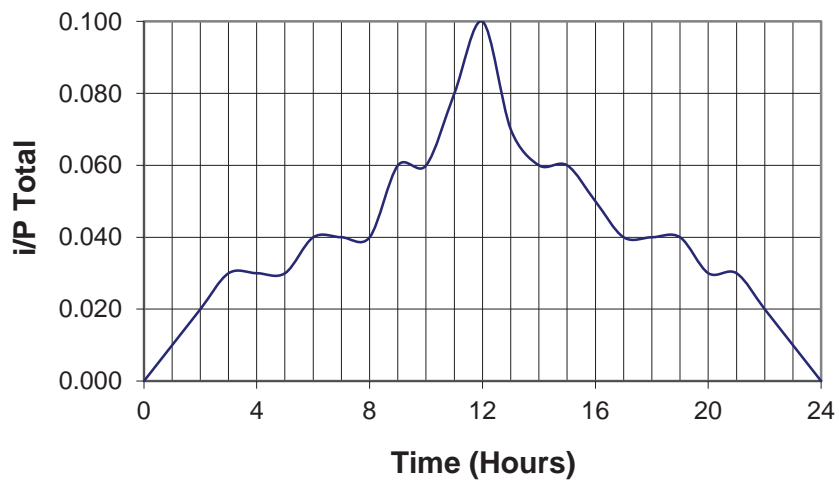

Rainfall Distribution Curves 3 Day Duration

3 Day Duration Mass Rainfall Curve

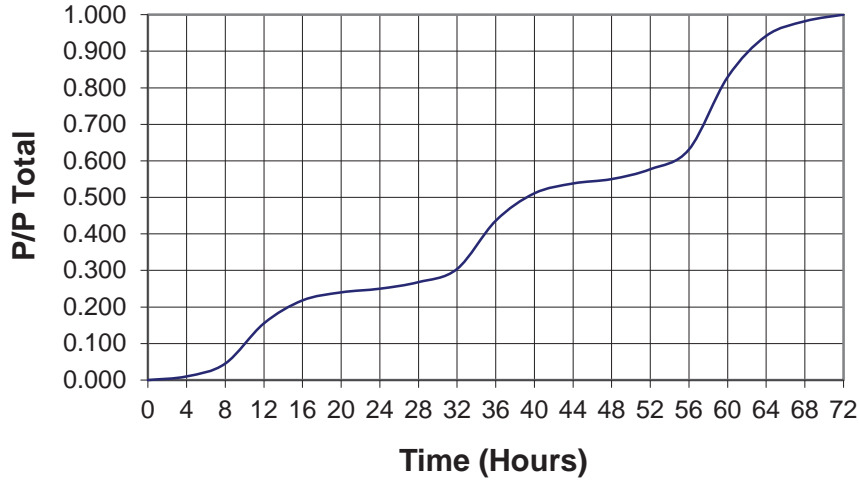

T (hrs)	P/P tot	i/P tot
0	0	0
4	0.01	0.003
8	0.045	0.009
12	0.155	0.028
16	0.218	0.016
20	0.24	0.006
24	0.25	0.003
28	0.268	0.005
32	0.304	0.009
36	0.436	0.033
40	0.511	0.019
44	0.538	0.007
48	0.55	0.003
52	0.577	0.007
56	0.631	0.014
60	0.829	0.05
64	0.942	0.028
68	0.982	0.01
72	1	0

3 Day Duration Intensity Curve

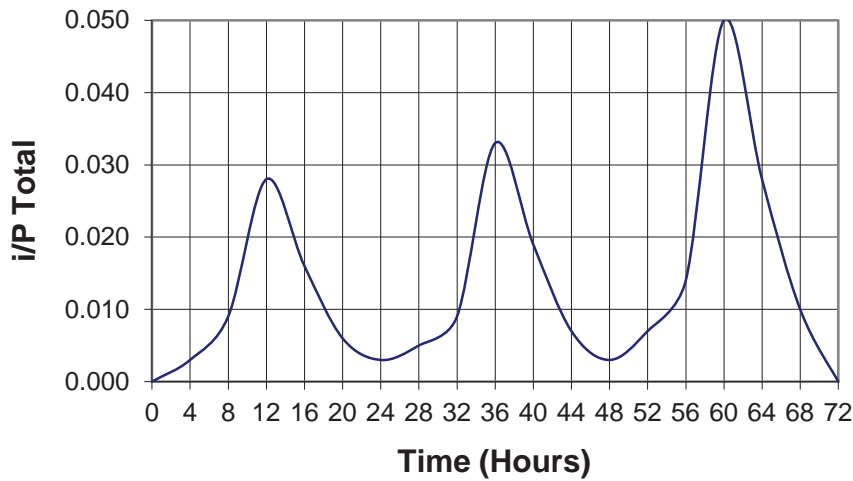

Rainfall Distribution Curves 7 Day Duration

7 Day Duration Mass Rainfall Curve

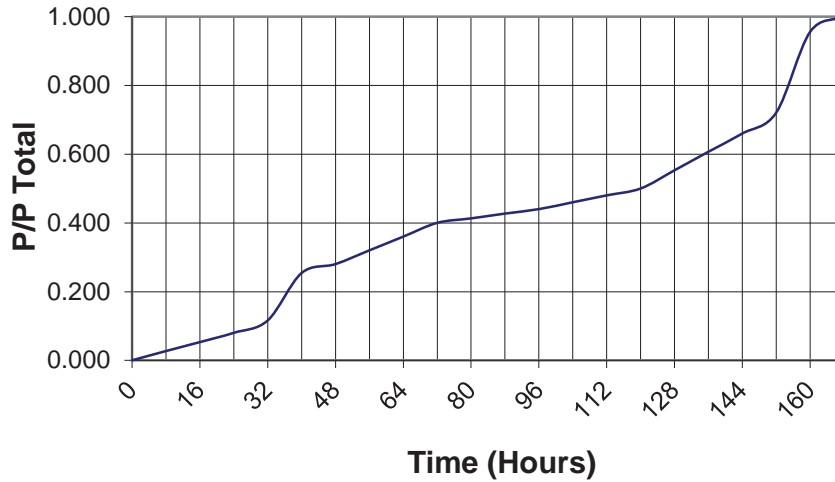

T (hrs)	P/P tot	i/P tot
0	0.000	0.000
8	0.027	0.003
16	0.053	0.003
24	0.080	0.003
32	0.116	0.005
40	0.254	0.017
48	0.280	0.003
56	0.320	0.005
64	0.360	0.005
72	0.400	0.005
80	0.413	0.002
88	0.427	0.002
96	0.440	0.002
104	0.460	0.003
112	0.480	0.003
120	0.500	0.003
128	0.553	0.007
136	0.607	0.007
144	0.660	0.007
152	0.721	0.008
160	0.956	0.029
168	1.000	0.000

7 Day Duration Intensity Curve

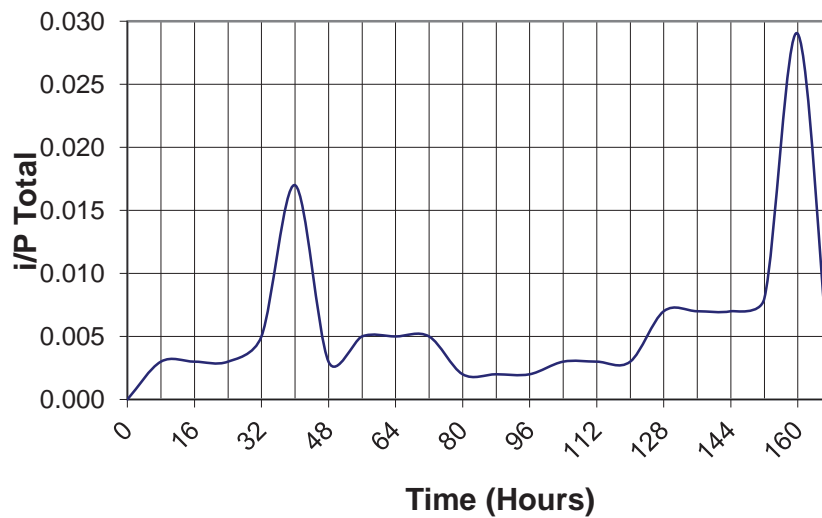

Rainfall Distribution Curves 10 Day Duration

10 Day Duration Mass Rainfall Curve

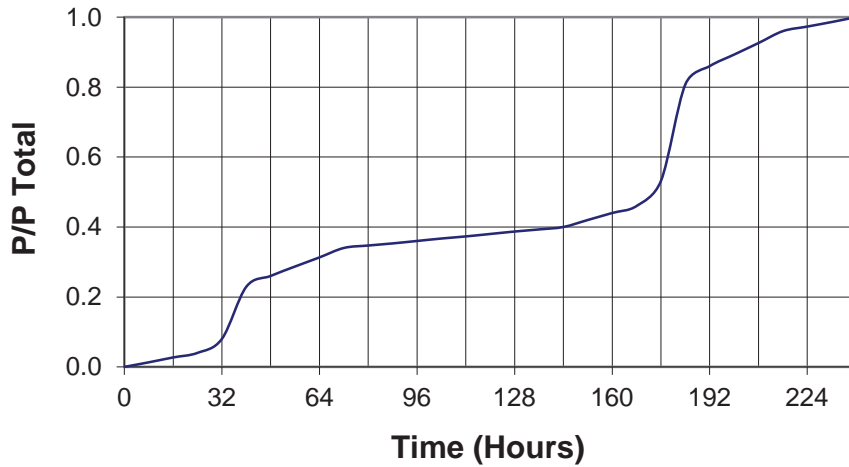

T (hrs)	P/P tot	i/P tot
0	0.000	0.000
8	0.013	0.002
16	0.027	0.002
24	0.040	0.002
32	0.080	0.005
40	0.229	0.019
48	0.260	0.004
56	0.287	0.003
64	0.313	0.003
72	0.340	0.003
80	0.347	0.001
88	0.353	0.001
96	0.360	0.001
104	0.367	0.001
112	0.373	0.001
120	0.380	0.001
128	0.387	0.001
136	0.393	0.001
144	0.400	0.001
152	0.420	0.003
160	0.440	0.003
168	0.460	0.003
176	0.532	0.009
184	0.808	0.035
192	0.860	0.007
200	0.893	0.004
208	0.926	0.004
216	0.960	0.004
224	0.973	0.002
232	0.986	0.002
240	1.000	0.000

10 Day Duration Intensity Curve

