

STATE OF FLORIDA DEPARTMENT OF TRANSPORTATION



DRAINAGE DESIGN GUIDE

**OFFICE OF DESIGN, DRAINAGE SECTION JANUARY 2024
TALLAHASSEE, FLORIDA**

This page left blank intentionally.



Florida Department of Transportation

RON DESANTIS
GOVERNOR

605 Suwannee Street
Tallahassee, FL 32399-0450

JARED W. PERDUE, P.E.
SECRETARY

MEMORANDUM

DATE: October 30, 2023
TO: FDOT Drainage Designers
FROM: Central Office Drainage Group
SUBJECT: FDOT Drainage Design Guide – January 2024

The Drainage Design Guide (DDG) has been revised for the January 2024 scheduled release date. Significant revisions and pertinent details are listed below. If you have any questions, please contact Tim Holley at Tim.Holley@dot.state.fl.us or by phone at (850) 414-4117.

Chapter 2 – Hydrology

2.2: Added information on use of NOAA Atlas 14 precipitation data and updates for use in CADD.

Chapter 5 – Bridge Hydraulics

5.1.4: Added FDM references, and new subsection for Canal Right-of-Way.

Chapter 6 – Storm Drains

6.1: Updated to include information for use of the FDM 900 Series.

6.2: Added description on interpolating between values with Atlas 14 data.

Chapter 7 – Exfiltration Systems

7.3.4: Replaced reference to FDOT IDF curves with NOAA Atlas 14 data.

Appendix B – Hydrology Design Aids

Removed FDOT IDF curve coefficient tables to reflect usage of NOAA Atlas 14 data.

FDOT IDF curves have been archived on the Drainage Manuals and Handbooks webpage (<https://www.fdot.gov/roadway/drainage/manualsandhandbooks.shtm>).

TABLE OF CONTENTS

| | |
|------------|--------------------------------|
| Chapter 1 | Introduction |
| Chapter 2 | Hydrology |
| Chapter 3 | Open Channel |
| Chapter 4 | Culvert |
| Chapter 5 | Bridge Hydraulics |
| Chapter 6 | Storm Drains |
| Chapter 7 | Exfiltration Systems |
| Chapter 8 | Optional Pipe Material |
| Chapter 9 | Stormwater Management Facility |
| Chapter 10 | Temporary Drainage Design |

APPENDICES

| | |
|------------|--|
| Appendix A | Data Collection/Published Data |
| Appendix B | Hydrology Design Aids |
| Appendix C | Open Channel Flow Design Aids |
| Appendix D | Gutter Flow Using HEC-RAS |
| Appendix E | Partial Depth Pipe Flow Graphs |
| Appendix F | Application Guidelines for Pipe End Treatments |
| Appendix G | Risk Evaluations |
| Appendix H | Shoulder Gutter Transition Slope at Bridges |
| Appendix I | Inlet Efficiencies |
| Appendix J | Exfiltration Design - Hydro-Geotechnical Aids - K for Saturated and Compacted Lab Soil Specimens |
| Appendix K | Drainage Well Design - Reasonable Assurance Report |
| Appendix L | Exfiltration Design - Sample Plans |
| Appendix M | Pipe Corrosion Tables and Charts |
| Appendix N | A Rational for Stormwater Rule Standards |

CHAPTER 1: INTRODUCTION

| | |
|---|------------|
| 1. INTRODUCTION | 1-1 |
| 1.1 Background..... | 1-1 |
| 1.2 Purpose | 1-1 |
| 1.3 Revisions..... | 1-2 |
| 1.4 Definitions of Terms and Acronyms..... | 1-3 |

1. INTRODUCTION

1.1 BACKGROUND

In 1987, Florida Department of Transportation (FDOT) published the Drainage Manual as a three volume set: Volume 1 - Policy; Volumes 2A and 2B - Procedures; Volume 3 - Theory.

In October 1992, the FDOT revised Volume 1 - Policy to Volume 1- Standards and designated Volumes 2A, 2B, and 3 as general reference documents.

In January 1997, the FDOT renamed Volume 1 - Standards to “Drainage Manual”. In the years that followed, the FDOT developed numerous handbooks to replace Volumes 2A, 2B, and 3 of the original 1987 Drainage Manual. With this, the Drainage Manual was maintained as a “standards” document while the handbooks provided guidance addressing drainage design practice, analysis and computational methods, along with design aids and reference material.

In 2016, the Department consolidated the handbooks into the Drainage Design Guide. Chapters 2 through 10 of the Drainage Design Guide each represent a handbook in previous form. The appendices of the handbooks, with a few exceptions, were incorporated as appendices in the Drainage Design Guide. Whereas, the remaining handbook appendices were inserted into the appropriate chapter of the Drainage Design Guide.

1.2 PURPOSE

The Drainage Design Guide is a reference for designers, which provides guidelines for common drainage and stormwater aspects of FDOT projects. The guidelines do not replace the need for professional engineering judgment or preclude the use of other information. These guidelines are suggested or preferred approaches, not requirements. The Drainage Manual provides minimum standards and governs over the Drainage Design Guide, when discrepancies are noted between both documents.

The technical information in these guidelines is written by Central Office Drainage and is then reviewed and commented upon by the district drainage engineers. The district drainage engineer has the final project specific decisions concerning the application of these guidelines, especially given the subjective judgment required to do good drainage design. If you have project specific questions on this material, please collaborate with your district drainage engineer.

1.3 REVISIONS

Any comments or suggestions concerning this handbook may be made by e-mailing the [State Drainage Engineer](#). The FDOT will routinely make revisions to keep the Drainage Design Guide consistent with other FDOT documents and to reflect changes and trends in drainage design.

1.4 DEFINITIONS OF TERMS AND ACRONYMS

| | |
|-------------|---|
| AASHTO | American Association of State Highway and Transportation Officials |
| Abstraction | Hydrologic processes that remove water from precipitation before it becomes surface runoff; types include evaporation, infiltration, transpiration, interception, depression storage, and detention storage. |
| Abutment | The portion of a bridge containing the embankment at each end of the bridge. Abutments may be sloped or vertical. |
| Accretion | The build-up of land or bottom elevation. |
| ADA | Americans with Disabilities Act |
| Aggradation | The build-up of a stream bed over time along the entire stream reach due to deposition of sediments eroded from the channel or banks farther upstream in the watershed. |
| Annulus | The area between the outside of a pipe and the precast opening in which the pipe is placed. |
| ASTM | American Society for Testing and Materials |
| Attenuation | In flood control: to temporarily hold back or store stormwater to control the rate of discharge. Also, see Detention. |
| Backwater | Backwater is defined as the increase of water surface elevation induced upstream from a bridge, culvert, dike, dam, another stream at a higher stage, or other similar structures; or as conditions that obstruct or constrict a channel relative to the elevation occurring under natural channel and floodplain conditions. |
| Bay | In coastal hydrology: a recess in the shore or an inlet of a sea between two capes or headlands; a bay is not as large as a gulf, but larger than a cove. |
| Berm | An embankment typically used for containment or separation of water. |
| BMP | Best Management Practice. Refers to standard practices used to improve stormwater quality prior to discharge. |
| CFS | Cubic Feet per Second |

| | |
|-----------------------------|--|
| Channel section | The cross section of a channel taken at an angle perpendicular to the direction of water flow in the channel. |
| Conveyance | A measure of the carrying capacity of a channel or pipe section. Often denoted as “K”. $K = Q/(\text{slope})^{0.5}$. |
| Coefficient of permeability | A measure of the rate of flow of water through a medium (soil, membrane, fabric, etc.) under a given hydraulic gradient in units of length/time (i.e., ft/day; cm/sec). |
| Critical depth (D_c) | The depth associated with the minimum total energy for a particular flow rate in a particular cross section. The flow depth can drop through critical depth at the outlet of a pipe section if the water surface downstream is low enough. |
| Critical duration | As defined by Rule 14-86.002 F.A.C.: “Critical Duration” means the length of time of a specific storm frequency that creates the largest volume or highest rate of net stormwater runoff (post-improvement runoff less pre-improvement runoff) for typical durations up through and including the 10-day duration for closed basins and up through the 3-day duration for basins with positive outlets. The critical duration for a given storm frequency is determined by calculating the peak rate and volume of stormwater runoff for various storm durations and then comparing the pre-improvement and post-improvement conditions for each of the storm durations. The duration resulting in the highest peak rate or largest net total stormwater volume is the “critical duration” storm (volume is not applicable for basins with positive outlets). See Chapter 9 for additional discussion. |
| Cross drain | A structure supporting a public roadway that crosses transversely over a watercourse. |
| Curve number | A dimensionless site-specific runoff parameter developed by the (former) Soil Conservation Service (now Natural Resources Conservation Service) to empirically estimate rainfall excess; it accounts for infiltration losses and initial abstractions. |

| | |
|-------------------------------------|--|
| Darcy's Law | Darcy's Law characterizes the flow through porous media, assuming that the viscosity, temperature, and density of the fluids are constant. The flow rate is a function of the proportionality constant (coefficient of permeability), the hydraulic gradient, and the flow area; $Q = k i A$. |
| Degradation | The lowering of land or bottom elevation. In stream stability assessment, the lowering occurs through natural erosion of sediment without sufficient incoming sediment to replenish. |
| DEM | Digital Elevation Model |
| Department | Florida Department of Transportation |
| Depth of flow | The vertical distance between the lowest point of a channel section and the free surface. |
| Detention | To temporarily hold back or store stormwater to control the rate of discharge. Normally, the term "Wet Detention" is associated with water quality treatment. Sometimes the term is used for flood control attenuation. |
| Drainage Manual | Refers to the current release of the Florida Department of Transportation Drainage Manual |
| Diurnal tide | The diurnal tide is represented by one high tide and one low tide per day. |
| Diversion structure | For stormwater treatment, a diversion structure may be used to divert the "first flush" of stormwater to a facility for treatment. |
| Drainage basin | A subdivision of a watershed. |
| Duration | The time from beginning to end of a rain storm event used to perform runoff calculations. |
| Ebb phase | The period when the water level of the tide is falling. |
| ECB | Erosion Control Blanket. A temporary degradable mat composed of natural or polymer fibers used to reduce erosive impact in low-velocity ditches during short periods of construction. (See Ch. 3.) |
| Environmental Resource Permit (ERP) | Conceptual approval granted via an individual or general permit for a surface water management system issued pursuant to Part IV, Chapter 373, Florida Statutes. |
| Estuary | A body of water affected by tidal influence as well as freshwater inflows from a riverine system. |

| | |
|-----------------------------|--|
| Exfiltration | The loss of water from a drainage system as a result of percolation or absorption into the surrounding soil. |
| Exfiltration trench | A subsurface system consisting of a conduit, such as a perforated pipe, surrounded by natural or artificial aggregate that temporarily stores and filters stormwater runoff. Also known as a French Drain. |
| Fabric formed revetments | Woven fabric forms that are filled with concrete grout. These include Filter Point Linings and Articulating Block Mats. |
| FDEP | Florida Department of Environmental Protection |
| FDM | FDOT Design Manual |
| FDOT | Florida Department of Transportation |
| FHWA | Federal Highway Administration |
| Flood | Inundation of land by water to depths greater than typically occur during a normal wet season. See Chapter 4 for definitions of: Design, Base, Greatest, and Overtopping Floods. |
| Flood hydrograph | A continuous plot of the surface runoff flow rate versus time. The volume is equal to the volume of water contained in the rainfall excess hyetograph. |
| Flood phase | The period when the water level of the tide is rising. |
| FM | Florida Method of Testing Materials. This is the standard FDOT method of testing materials. |
| Frequency | In hydrology, frequency is the inverse value of the anticipated recurrence interval. A 4-percent chance of recurrence (of rainfall or flood event) in any year is referred to as a 25-year frequency. |

Froude Number (Fr) The Fr value is the dimensionless ratio of inertial forces to gravity forces. If Fr values are less than 1, gravity forces dominate and the open channel is said to be operating in the sub-critical range of flow. If Fr values are greater than 1, inertial forces dominate and the open channel is said to be operating in the super-critical range of flow.

$$Fr = \frac{v}{(gL)^{1/2}}$$

Full flow friction loss For pipes flowing full, the full flow friction loss is the full flow friction slope times the pipe length.

Full flow friction slope The slope obtained from Manning's Equation using an area equal to the full cross sectional area of the pipe and a flow rate equal to the design flow rate.

$$S = [Qn / (1.49AR^{2/3})]^2$$

Where:

Q = design flow rate

A & R = based on full cross section area of pipe

Gabions Wire mesh forms filled with stones. These include mattresses and baskets.

Gutter drain A pipe, used along steep slopes, to convey stormwater from shoulder gutter inlets on elevated roadways to drainage conveyance systems below at a much lower elevation.

HEC Hydraulic Engineering Circular. Produced by the FHWA.

HGL Hydraulic grade line. In open channel flow, it is the water surface along the channel reach. In pressure flow, it is a theoretical line connecting hydraulic gradient points (points to which the water would rise in a tube or inlet connecting the flow pipe to atmospheric pressure) along the flow path.

HG Hydraulic gradient. The difference in water surface divided by the flow distance (dimensionless value often expressed in percent).

Hindcast To retrospectively employ measured data to develop a model wind or wave field for a specific historical event.

| | |
|------------------------|--|
| Hydraulic conductivity | The ratio of discharge perpendicular through a unit area per unit of head (i.e., cfs/ft ² - ft). |
| Hydraulic depth | The ratio of the water flow cross section area to top width. $D = \frac{A}{T}$ |
| Hydraulic head | The difference in water surface (i.e., potential energy) available to drive flow (between an inlet and an outlet; upstream to downstream; through a filter, etc.) |
| Hydraulic radius | The ratio of the water flow cross sectional area to its wetted perimeter. $R = \frac{A}{P}$ |
| Hydrology | The science dealing with the disposition of water on the Earth. |
| Hyetograph | A graphical representation of the distribution of rainfall over time. |
| Infiltration | Abstraction process in which water flows or is absorbed into the ground. |
| Infiltration rate | The maximum rate at which water can enter the soil from the surface under specified conditions. The units are length per time. |
| Inlet | In coastal hydrology: a short, narrow waterway connecting a bay, lagoon, or similar body of water with a large parent body of water. |
| Intensity | The rate of precipitation, usually in inches/hour. |
| Karst | A geological term to describe a landform underlain by highly porous limestone rock with solution channels. Springs, disappearing streams, and sinkholes are typical of Karst topography. "Closed basins" are associated with Karst topography. |
| LiDAR | Light Detection And Ranging. This is a remote-sensing method that uses light in the form of a pulsed laser to measure ranges (variable distances) to the Earth. These light pulses—combined with other data recorded by the airborne system—generate precise, three-dimensional information about the shape of the Earth and its surface characteristics. |

| | |
|--------------------|--|
| Manning's Equation | A formula used to estimate the average velocity of a liquid flowing in a conduit that does not completely enclose the liquid, i.e., open channel flow . |
| MHW | Mean High Water. The average height of tidal high waters over a 19-year period. For shorter periods of observations, corrections are applied to eliminate known variations and reduce the results to the equivalent of a mean 19-year value. All high water heights are included in the average where the type of tide is semi-diurnal or mixed. Only the higher high water heights are included in the average where the type of tide is diurnal. So determined, mean high water in the latter case is the same as mean higher high water. |
| MHHW | Mean Higher High Water. The average of the higher high water height of each tidal day observed over the National Tidal Datum Epoch. For stations with shorter series, comparison of simultaneous observations with a control tide station is made to derive the equivalent datum of the National Tidal Datum Epoch. For locations with diurnal tides—one high tide and one low tide per day—this datum will be unavailable. At most locations, there are semi-diurnal tides—the tide cycles through a high and low water level twice each day, with one of the two high tides being higher than the other and one of the two low tides being lower than the other. |
| MLW | Mean Low Water. The average height of the low waters over a 19-year period. For shorter periods of observations, corrections are applied to eliminate known variations and reduce the results to the equivalent of a mean 19-year value. All low water heights are included in the average where the type of tide is either semi-diurnal or mixed. Only lower low water heights are included in the average where the type of tide is diurnal. So determined, mean low water in the latter case is the same as mean lower low water. |

| | |
|--------------|--|
| MLLW | Mean Lower Low Water. The average of the lower low water height of each tidal day observed over the National Tidal Datum Epoch. For stations with shorter series, comparison of simultaneous observations with a control tide station is made to derive the equivalent datum of the National Tidal Datum Epoch. For locations with diurnal tides—one high tide and one low tide per day—this datum will be unavailable. At most locations, there are semi-diurnal tides—the tide cycles through a high and low water level twice each day, with one of the two high tides being higher than the other and one of the two low tides being lower than the other. |
| MSL | Mean Sea Level. The arithmetic mean of hourly heights observed over the National Tidal Datum Epoch. Shorter series are specified in the name; i.e., monthly mean sea level and yearly mean sea level. |
| MTL | Mean Tide Level. The arithmetic mean of mean high water and mean low water. |
| Minor losses | All losses that are not due to friction. Generally, these are energy losses due to changes or disturbances in the flow path. Minor losses include entrance, exit, bend, and junction losses. |
| Neap tide | Tide of decreased range occurring semi-monthly as the result of the moon being in quadrature. |
| NFIP | National Flood Insurance Program. Administered by the Federal Emergency Management Agency (FEMA) pursuant to 44 Code of Federal Regulations (CFR) parts 59 through 80. Part 65 pertains to mapping of Special Hazard Areas. |
| NHW | Normal High Water. For bridge hydraulics, the water stage associated with a flow that has a 43-percent chance of recurrence (2.33-year frequency) in a given year. In some cases, stain lines may be used to estimate NHW. |

| | |
|-------------------|---|
| Non-uniform flow | A flow condition where the depth of flow changes with respect to distance along a channel or conduit. Non-uniform flow may be classified as either rapidly varied or gradually varied. Rapidly varied flow also is known as a local phenomenon, examples of which include the hydraulic jump and hydraulic drop. The primary example of gradually varied flow occurs when sub-critical flow is restricted by a culvert or storage reservoir. The water surface profile caused by such a restriction generally is referred to as a backwater curve. |
| Normal depth | The depth of flow in a channel determined by the channel properties and physical slope using Manning's Equation. The solution is not direct because the channel depth is unknown and, therefore, requires an iterative process using trial and error to solve implicitly for depth. |
| NRCS | Natural Resources Conservation Service (formerly Soil Conservation Service) |
| NTDE | National Tidal Datum Epoch. The specific 19-year period adopted by the National Ocean Service as the official time segment over which tide observations are taken and reduced to obtain mean values (e.g., mean lower low water, etc.) for tidal datums. It is necessary for standardization because of periodic and apparent secular trends in sea level. The present NTDE is 1983 through 2001 and is actively considered for revision every 20 years to 25 years. Tidal datums in certain regions with anomalous sea level changes (Alaska, Gulf of Mexico) are calculated on a Modified 5-Year Epoch. |
| NWFWMD | Northwest Florida Water Management District |
| Open channel flow | Fluid flow in which the liquid surface is subject to atmospheric pressure (i.e., has an open or free water surface). Open channel conditions are the basis for most hydraulic calculations. |
| Overland flow | Water that travels over the ground surface to the stream channel, usually limited to a maximum length of 100 feet. |

| | |
|---------------------|--|
| Physical velocity | The velocity in a pipe that is flowing full, but not under pressure. This condition is sometimes called gravity full flow and the velocity is determined from Manning's Equation. Actual velocity may be greater than or less than physical velocity depending on actual flow conditions. |
| Positive outlet | As defined by Rule 14-86.002 F.A.C.: A point of stormwater discharge into surface waters that, under normal conditions, would drain by gravity through surface waters ultimately to the Gulf of Mexico, the Atlantic Ocean, or into sinks or closed lakes provided the receiving water body has been identified by the appropriate Water Management District as functioning as if it recovered from runoff by means other than transpiration, evaporation, percolation, or infiltration. |
| Prismatic channel | An artificial channel with non-varying cross section and constant bottom slope. |
| Recovery time | For stormwater facilities; the time it takes to recover the volume of water stored above the facility control elevation. |
| Regression equation | A statistical method that correlates peak discharge with physical features such as watershed area and stream slope. |
| Retention | To retain stormwater and prevent any surface water discharge. The retained stormwater is either infiltrated into the ground or evaporated. |
| Riverine flow | For bridge hydraulics, those crossings with no tidal influence during the design storm, such as (a) inland rivers, or (b) controlled canals with a salinity structure oceanward intercepting the design hurricane surge. |
| Runoff | Precipitation remaining after appropriate hydrologic abstractions have been accounted for. |
| Runoff coefficient | Empirical parameter used to calculate rainfall excess as a fixed percentage of precipitation; it accounts for interception, surface storage, and infiltration. |
| Scour | Erosion of streambed material, typically at hydraulic conveyance. See Chapters 5, 4, and 3. |
| Scupper | A drain used on a bridge deck that has a free discharge (as opposed to drainage collected in a pipe system or down-drain). |

| | |
|-------------------------------|---|
| Semi-diurnal tide | Two high tides and two low tides per day. |
| SFWMD | South Florida Water Management District |
| SHWT | Seasonal High Water Table. Elevation to which the ground and surface water can be expected to rise due to a normal wet season. |
| Side drain | A side drain conveys non-public access roads across roadside swales or ditches. |
| Significant wave height | The average height of the one-third highest waves of a given wave group. Note that the composition of the highest waves depends upon the extent to which the lower waves are considered. |
| SJRWMD | St. Johns River Water Management District |
| Skimmer | A continuous baffle around a discharge structure or weir that skims floatable debris and oil upstream while allowing flow under the lower edge toward the discharge structure. |
| Spit | A small point of land or a narrow shoal projecting into a body of water from the shore. |
| Spread | The horizontal distance of the stormwater flowing down a pavement and gutter section from the face of the gutter to the water's edge. |
| Spring tide | A tide that occurs at or near the time of the new or full moon and which rises highest and falls lowest from the mean sea level. |
| SRWMD | Suwannee River Water Management District |
| Stage | The elevation or vertical distance of the free surface above a given point. |
| Standard Plans | Standard Plans for Road and Bridge Construction |
| State water quality standards | Water quality standards adopted by the state pursuant to Chapter 403, Florida Statutes. |
| Steady flow | A flow condition where the discharge or rate of flow at any location along a channel or conduit remains constant with respect to time. The maintenance of steady flow in any channel reach requires that the rates of inflow and outflow be constant and equal. |

| | |
|----------------------------|--|
| Storm surge | A long wave generated offshore that may propagate into coastal bays and estuaries. The five components of storm surge are: wind setup, atmospheric pressure setup, Coriolis effect, wave setup, and the rainfall effect. |
| Stormwater injection wells | Wells used for stormwater runoff disposal into pervious underground soils or the water table. |
| Swell | Wind-generated waves that have traveled out of their generating area. Swell characteristically exhibits a more regular and longer period and has flatter crests than waves within their fetch. |
| SWFWMD | Southwest Florida Water Management District |
| t_c | Time of concentration. The time required for runoff to travel from the hydraulically most distant point of a watershed to the design point. |
| Tailwater | The water surface elevation at the downstream end of a hydraulic conveyance. |
| Thalweg | In hydraulics, the line joining the deepest points along a flow path. |
| Tidally dominated flow | For bridge hydraulics, crossings where the tidal influences are dominated by the design hurricane surge. Large bays, ocean inlets, and open sections of the Intracoastal Waterway typically are tidally dominated so much so that even extreme rainfall events have little influence on the design flows in these systems. |
| Tidally influenced flow | Flows in tidal creeks and rivers opening to tidally dominated waterways are affected by both river flow and tidal fluctuations. Tidally affected river crossings do not always experience flow reversal; however, backwater effects from the downstream tidal fluctuation can induce water surface elevation fluctuations up through the bridge reach. |
| TN | Total nitrogen. Various species of nitrogen, both particulate and dissolved. |
| Top width | The width of the channel section at the free surface. |
| TP | Total phosphorus. Various species of phosphorus, both particulate and dissolved. |

| | |
|-------------------|---|
| Treatment | Generally referring to stormwater management practices to improve the quality of stormwater discharged. |
| Treatment volume | The volume of runoff usually associated with the first flush of pollutants, which must be retained, detained, or filtered to remove pollutants and improve discharge water quality. |
| TRM | Turf Reinforcement Mat. A long-term, non-biodegradable mat composed of synthetic fibers used to increase erosion resistance in ditches during long periods of construction. (See Ch. 3.) |
| Turbulent flow | A flow condition where the viscous forces are weak relative to the inertial forces. In turbulent flow, the water particles move in irregular paths that are neither smooth nor fixed, and the result is a random mixing motion. Turbulent flow is the most common type occurring in roadway drainage facilities. |
| Underdrain system | For stormwater management facilities; a system of perforated pipes below a pond that are designed to lower the groundwater table to facilitate pond volume recovery, and/or to filter stormwater runoff prior to discharge. |
| Uniform flow | A flow condition where the mean velocity and depth of flow are constant with respect to distance along a channel or conduit of constant cross section, slope, and roughness. When the requirements for uniform flow are met, the depth of flow for a given discharge is defined as the normal depth of flow. |
| Unsteady flow | A flow condition where the discharge at any location in the channel changes with respect to time. During periods of stormwater runoff, the inflow hydrograph to an open channel is usually unsteady. However, in practice, open channel flow is generally assumed to be steady at the discharge rate for which the channel is being designed (i.e., peak discharge of the inflow hydrograph). |
| USDW | Underground source drinking water. An aquifer that contains a total of dissolved solids concentration of less than 10,000 milligrams per liter or parts per million (ppm). |

| | |
|-----------------------|--|
| Velocity head | <p>The velocity head represents the kinetic energy of the fluid per unit volume and is computed by:</p> $h_v = \frac{\alpha Q^2}{2g A^2}$ <p>Where α is the kinetic correction factor for non-uniform velocity distribution.</p> <p>Or, ignoring the effect of a non-uniform velocity distribution, velocity head is $v^2/2g$</p> |
| Watershed | An area bounded peripherally by a drainage divide that concentrates runoff to a particular watercourse or body; the catchment's area or drainage basin from which the waters of a stream are drawn. |
| Watershed lag time | Time from the center of mass of the rainfall excess to the runoff hydrograph peak. |
| Wave height | The vertical distance between a wave's crest and the preceding trough. |
| Wave radiation stress | Excess flow of momentum in the horizontal plane due to waves. |
| Wave runup | The vertical distance above the still water level where breaking waves propel water up a sloping surface. |
| Wave setup | Vertical increase in the water surface above the still water level near shore due to onshore mass transport of water due to wave radiation stresses. |
| Wave shoaling | Transformation of wave profile due to inshore propagation. |
| Weir | A flow restriction with a fixed flowline, width, and height; used to control discharge from a stormwater management facility. |
| Well casing | A well casing serves as a lining to limit discharge to the aquifer. It also provides structural support against caving materials outside the well. Materials commonly used are wrought iron and steel. |
| Wetted perimeter | The length of the line of intersection of the channel wetted surface with a cross-sectional plane perpendicular to the direction of flow. |
| Wind set-down | The vertical drop below the still water level on the windward side of a water body due to wind stresses on the surface of the water. |

| | |
|------------|---|
| Wind setup | The vertical rise above the still water level on the leeward side of a water body due to wind stresses on the surface of the water. |
| Wind wave | Waves being formed and built up by the wind. |
| WMD | Water Management District |

CHAPTER 2: HYDROLOGY

| | |
|--|------------|
| 2. HYDROLOGY | 2-1 |
| 2.1 Drainage Data..... | 2-1 |
| 2.2 Procedure Selection | 2-1 |
| 2.2.1 Rainfall Data | 2-2 |
| 2.2.2 Time of Concentration..... | 2-7 |
| 2.2.2.1 Velocity Method | 2-7 |
| 2.2.2.2 Kirpich (1940) Equation | 2-11 |
| 2.2.3 Peak Runoff Rates—Ungaged Sites..... | 2-11 |
| 2.2.3.1 Rational Equation | 2-11 |
| 2.2.3.2 Regression Equations..... | 2-15 |
| 2.2.4 Flood Hydrographs | 2-23 |
| 2.2.4.1 Modified Rational Method | 2-24 |
| 2.2.4.2 NRCS Hydrograph..... | 2-24 |

2. HYDROLOGY

2.1 DRAINAGE DATA

Identifying drainage data needs should be a part of the early design phase of a project, best accomplished at the same time that you select appropriate procedures for performing hydrologic and hydraulic calculations. Several categories of data may be relevant to a particular project:

- Published data on precipitation, soils, land use, topography, streamflow, and flood history
- Field investigations and surveys to:
 - determine drainage areas
 - identify pertinent features
 - obtain high water information
 - survey lateral ditch alignments
 - survey bridge and culvert crossings

Information on types of data available and the sources of that data are presented in Appendix A of this document.

2.2 PROCEDURE SELECTION

Occasionally, streamflow measurements for determining peak runoff rates for pre-project conditions are available from agencies such as water management districts and/or the USGS. Where measurements are available, the Florida Department of Transportation (Department) usually relies upon agencies such as the United States Geological Survey (USGS) to perform the statistical analysis of streamflow data; however, guidelines for determining flood flow frequencies from observed streamflow data may be obtained from Bulletin 17C of the U.S. Geological Survey (May 2019, ver. 1.1).

Where streamflow measurements are not available, it is accepted practice to estimate peak runoff using the Rational Method or one of the regression equations developed for Florida. In general, the method that best reflects project conditions should be used, while also documenting the reasons for using that method.

It is generally adequate to consider peak runoff rates for design conditions for conveyance systems such as storm drains or open channels. However, if the design must include flood routing (e.g., storage basins or complex conveyance networks), a flood hydrograph must typically be created. Computer programs are available to help develop a runoff hydrograph.

In general, apply procedures using streamflow analysis and unit hydrograph theory to all watershed categories.

Table 2.2-1 shows guidelines for selecting peak runoff rate and flood hydrograph procedures.

| Application | Watershed Category | Streamflow Analysis | Peak Runoff Rates | | | | Flood Hydrographs | |
|-----------------------|--------------------|---------------------|-------------------|-----------------------------|--------------------------|---------------------------|---------------------------------|---|
| | | | Rational Method | Natural Flow USGS Equations | Developed USGS Equations | Developed Tampa Equations | Developed Leon County Equations | ^a Modified Rational Method or NRCS Unit Hydrograph |
| Storm Drains | 0 to 600 acres | X | X | | | | | |
| Cross Drains | 0 to 600 acres | X | X | | X | X | X | |
| Side Drains | 600+ acres | X | | X | X | | | |
| Stormwater Management | None | X | | | | | | X |

^a The Modified Rational Method is not recommended for drainage basins with t_c greater than 15 minutes.

2.2.1 Rainfall Data

The National Oceanic and Atmospheric Administration's (NOAA's) Hydrometeorological Design Studies Center developed historical point precipitation frequency estimates for all areas of Florida. These estimates, commonly referred to as NOAA Atlas 14 Rainfall Data, provide a reasonable basis for design. Under the FLOODS Act (Public Law No. 117-316, Dec. 2022) NOAA is authorized to update these precipitation frequency estimates no less than once every 10-years. NOAA's Atlas 14 interactive map is available on NOAA Precipitation Frequency Data Server (PFDS):

http://hdsc.nws.noaa.gov/hdsc/pfds/pfds_map_cont.html?bkmrk=fl

Frequency can be defined either in terms of an annual exceedance probability or a return period. The annual exceedance probability is the probability that an event having a specified volume and duration will be exceeded in a year. The inverse of the annual exceedance probability is known as the return period, which is the average length of time between events having the same volume and duration. The problem with using return period is that it can be misinterpreted. If a 50-year flood occurs one year, some people believe that it will be 50 years before another flood of that magnitude occurs. Instead, because floods occur randomly, there is a finite probability that the 50-year flood could occur in two consecutive years.

The annual exceedance probability (p) and return period (T) are related as follows:

$$p = \frac{I}{T}$$

(2.2-1)

A 25-year storm has a 0.04 or 4-percent exceedance probability (probability of occurrence in any given year), a 50-year storm has a 0.02 or 2-percent exceedance probability, etc.

Rainfall depths or intensities are required for many types of design problems. A designer must estimate this for a selected location, duration, and return period. The rainfall associated with a storm frequency and duration at a particular location can be determined from the NOAA Atlas 14 webpage mentioned above. Once the location is entered, it is displayed on an interactive map. As an example, if the project is located at latitude 28.2424 degrees N and longitude 81.2844 W, you can enter this location into the NOAA Atlas 14 webpage:

Select location

1) Manually:

a) By location (decimal degrees, use "-" for S and W): Latitude: Longitude:

b) By station (list of FL stations):

c) By address

2) Use map (if ESRI interactive map is not loading, try adding the host: <https://js.arcgis.com/> to the firewall, or contact us at hdsc.questions@noaa.gov):

a) Select location
Move crosshair or double click

b) Click on station icon
 Show stations on map

Location information:
Name: Saint Cloud, Florida, USA*
Latitude: 28.2424°
Longitude: -81.2844°
Elevation: 71.87 ft **

* Source: ESRI Maps
** Source: USGS

Choose the rainfall data type as either precipitation depth (inches) or precipitation intensity (inches per hour) from the menu. Two different time series options are available, Partial Duration Series (PDS) and Annual Maximum Series (AMS). The differences

between these series are notable for smaller storm events (<15-years) but are negligible for larger storm events (i.e. both have similar rainfall and intensity results for larger storm events). PDS includes all rainfall amounts for specified durations above a pre-defined threshold, thus it can include data for more than one event in any particular year, whereas AMS includes only the largest precipitation amounts in a continuous calendar or water year for the specified durations. This difference in analysis results in PDS having higher rainfall and intensity results, especially for the smaller storm return frequencies. PDS is considered more reliable for designs based on frequent events (**NOAA Atlas 14 Volume 9 Version 2.0, Section 4.6.1**). Therefore, PDS is the recommended time series option for design.

| | | |
|-------------------------|-----------------------|------------------|
| Data description | | |
| Data type: | Precipitation depth ▾ | Units: English ▾ |
| Time series type: | Partial duration ▾ | |

For our example, the precipitation depth is shown below:

PF tabular PF graphical Supplementary information Print page

PDS-based precipitation frequency estimates with 90% confidence intervals (in inches)¹

| Duration | Average recurrence interval (years) | | | | | | | | | |
|----------|-------------------------------------|------------------------|------------------------|------------------------|-----------------------|-----------------------|-----------------------|----------------------|----------------------|----------------------|
| | 1 | 2 | 5 | 10 | 25 | 50 | 100 | 200 | 500 | 1000 |
| 5-min | 0.473 (0.379-0.593) | 0.540 (0.432-0.677) | 0.645 (0.514-0.811) | 0.728 (0.577-0.921) | 0.838 (0.640-1.09) | 0.918 (0.688-1.22) | 0.994 (0.722-1.38) | 1.07 (0.746-1.52) | 1.16 (0.781-1.71) | 1.22 (0.808-1.85) |
| 10-min | 0.693 (0.555-0.888) | 0.791 (0.632-0.991) | 0.944 (0.752-1.19) | 1.07 (0.845-1.35) | 1.23 (0.937-1.60) | 1.34 (1.01-1.79) | 1.46 (1.06-2.00) | 1.56 (1.09-2.22) | 1.70 (1.14-2.50) | 1.79 (1.18-2.71) |
| 15-min | 0.845 (0.676-1.08) | 0.964 (0.771-1.21) | 1.15 (0.918-1.45) | 1.30 (1.03-1.85) | 1.50 (1.14-1.95) | 1.64 (1.23-2.18) | 1.77 (1.29-2.44) | 1.91 (1.33-2.71) | 2.07 (1.40-3.05) | 2.18 (1.44-3.30) |
| 30-min | 1.36 (1.09-1.70) | 1.55 (1.24-1.94) | 1.84 (1.47-2.32) | 2.08 (1.65-2.63) | 2.39 (1.83-3.11) | 2.61 (1.96-3.48) | 2.83 (2.08-3.89) | 3.04 (2.13-4.33) | 3.31 (2.23-4.88) | 3.50 (2.31-5.29) |
| 60-min | 1.82 (1.46-2.28) | 2.08 (1.66-2.80) | 2.48 (1.98-3.12) | 2.80 (2.22-3.54) | 3.22 (2.46-4.20) | 3.53 (2.64-4.69) | 3.82 (2.77-5.24) | 4.10 (2.87-5.82) | 4.45 (3.00-6.55) | 4.69 (3.10-7.10) |
| 2-hr | 2.28 (1.84-2.84) | 2.61 (2.10-3.25) | 3.12 (2.50-3.90) | 3.53 (2.81-4.43) | 4.05 (3.12-5.25) | 4.44 (3.35-5.86) | 4.80 (3.51-6.54) | 5.15 (3.62-7.27) | 5.58 (3.79-8.17) | 5.89 (3.91-8.84) |
| 3-hr | 2.52 (2.03-3.12) | 2.88 (2.33-3.58) | 3.46 (2.79-4.31) | 3.93 (3.14-4.92) | 4.54 (3.51-5.87) | 5.00 (3.79-6.59) | 5.44 (4.00-7.40) | 5.87 (4.15-8.27) | 6.42 (4.38-9.37) | 6.81 (4.55-10.2) |
| 6-hr | 2.93 (2.38-3.61) | 3.35 (2.73-4.13) | 4.07 (3.29-5.03) | 4.67 (3.76-5.81) | 5.53 (4.33-7.17) | 6.21 (4.78-8.20) | 6.91 (5.12-9.41) | 7.63 (5.45-10.8) | 8.61 (5.93-12.6) | 9.37 (6.30-13.9) |
| 12-hr | 3.39 (2.77-4.14) | 3.87 (3.16-4.73) | 4.74 (3.89-5.82) | 5.54 (4.49-6.95) | 6.77 (5.39-8.85) | 7.82 (6.06-10.4) | 8.95 (6.72-12.2) | 10.4 (7.35-14.4) | 11.9 (8.32-17.4) | 13.4 (9.04-19.8) |
| 24-hr | 3.88 (3.20-4.71) | 4.44 (3.66-5.41) | 5.52 (4.53-6.74) | 6.56 (5.35-8.05) | 8.20 (6.60-10.7) | 9.64 (7.55-12.8) | 11.2 (8.50-15.3) | 13.0 (9.46-18.3) | 15.5 (10.9-22.6) | 17.6 (12.0-25.9) |
| 2-day | 4.44 (3.68-5.38) | 5.10 (4.22-6.16) | 6.36 (5.26-7.72) | 7.59 (6.23-9.25) | 9.53 (7.72-12.4) | 11.2 (8.85-14.8) | 13.1 (10.0-17.8) | 15.2 (11.2-21.3) | 18.2 (12.9-26.4) | 20.7 (14.2-30.3) |
| 3-day | 4.88 (4.07-5.87) | 5.52 (4.59-6.65) | 6.77 (5.61-8.18) | 8.00 (6.60-9.72) | 9.98 (8.13-13.0) | 11.7 (9.30-15.4) | 13.7 (10.5-18.5) | 15.9 (11.7-22.2) | 19.0 (13.5-27.5) | 21.7 (14.9-31.5) |
| 4-day | 5.27 (4.40-6.32) | 5.88 (4.91-7.08) | 7.10 (5.90-8.55) | 8.31 (6.87-10.1) | 10.3 (8.40-13.3) | 12.0 (9.56-15.8) | 14.0 (10.8-18.9) | 16.2 (12.0-22.6) | 19.4 (13.8-28.0) | 22.1 (15.3-32.0) |
| 7-day | 6.26 (5.25-7.47) | 6.88 (5.76-8.21) | 8.09 (6.76-9.69) | 9.29 (7.72-11.2) | 11.2 (9.22-14.4) | 13.0 (10.4-16.9) | 14.9 (11.5-20.0) | 17.1 (12.7-23.6) | 20.3 (14.5-29.0) | 22.9 (15.9-33.0) |
| 10-day | 7.14 (6.01-8.49) | 7.81 (6.57-9.29) | 9.09 (7.62-10.8) | 10.3 (8.61-12.4) | 12.3 (10.1-15.6) | 14.0 (11.2-18.1) | 15.9 (12.3-21.2) | 18.0 (13.4-24.8) | 21.1 (15.1-30.0) | 23.6 (16.4-33.9) |
| 20-day | 9.70 (8.22-11.5) | 10.6 (9.01-12.6) | 12.3 (10.3-14.5) | 13.7 (11.5-16.3) | 15.8 (12.9-19.7) | 17.5 (14.0-22.3) | 19.4 (15.0-26.3) | 21.3 (15.9-28.9) | 24.0 (17.3-33.7) | 26.2 (18.4-37.4) |
| 30-day | 12.0 (10.2-14.1) | 13.2 (11.2-15.5) | 15.2 (12.8-17.9) | 16.8 (14.2-20.0) | 19.2 (15.7-23.8) | 21.0 (16.8-26.4) | 22.8 (17.7-29.6) | 24.7 (18.5-33.2) | 27.2 (19.6-37.8) | 29.1 (20.5-41.4) |
| 45-day | 14.9 (12.8-17.5) | 16.5 (14.1-19.4) | 19.1 (16.2-22.4) | 21.1 (17.8-24.9) | 23.8 (19.5-29.0) | 25.8 (20.7-32.1) | 27.7 (21.5-35.6) | 29.6 (22.1-39.4) | 31.9 (23.1-44.1) | 33.7 (23.8-47.6) |
| 60-day | 17.6 (15.1-20.5) | 19.5 (16.7-22.8) | 22.5 (19.2-28.4) | 24.9 (21.1-29.4) | 28.0 (22.9-33.9) | 30.1 (24.2-37.3) | 32.2 (25.1-41.1) | 34.1 (26.6-45.2) | 36.5 (26.4-50.0) | 38.1 (27.0-53.7) |

¹ Precipitation frequency (PF) estimates in this table are based on frequency analysis of partial duration series (PDS). Numbers in parenthesis are PF estimates at lower and upper bounds of the 90% confidence interval. The probability that precipitation frequency estimates (for a given duration and average recurrence interval) will be greater than the upper bound (or less than the lower bound) is 5%. Estimates at upper bounds are not checked against probable maximum precipitation (PMP) estimates and may be higher than currently valid PMP values. Please refer to NOAA Atlas 14 document for more information.

Estimates from the table in CSV format:

Rainfall intensity is calculated from the precipitation depth and storm duration of a particular return period. For example, designing for a 25year, 30-minute storm, the intensity is (2.39 inches / 0.5 hour =) 4.78 inches per hour. Or, you can obtain intensities directly from the NOAA Atlas 14 data by selecting the precipitation intensity option:

Data description

Data type: Units: Time series type:

This provides the rainfall curves and tabulated data:

Drainage Design Guide
Chapter 2: Hydrology

PF tabular
PF graphical
Supplementary information
 Print page

| PDS-based precipitation frequency estimates with 90% confidence intervals (in inches/hour) ¹ | | | | | | | | | | |
|---|-------------------------------------|------------------------|------------------------|------------------------|------------------------|------------------------|------------------------|------------------------|------------------------|------------------------|
| Duration | Average recurrence interval (years) | | | | | | | | | |
| | 1 | 2 | 5 | 10 | 25 | 50 | 100 | 200 | 500 | 1000 |
| 5-min | 5.68 (4.55-7.12) | 6.48 (5.18-8.12) | 7.74 (6.17-9.73) | 8.74 (6.92-11.1) | 10.1 (7.68-13.1) | 11.0 (8.26-14.6) | 11.9 (8.66-16.4) | 12.8 (8.95-18.2) | 13.9 (9.37-20.5) | 14.7 (9.70-22.2) |
| 10-min | 4.16 (3.33-5.21) | 4.75 (3.79-5.95) | 5.66 (4.51-7.13) | 6.40 (5.07-8.09) | 7.36 (5.62-9.59) | 8.06 (6.04-10.7) | 8.73 (6.34-12.0) | 9.38 (6.55-13.3) | 10.2 (6.88-15.0) | 10.7 (7.10-16.2) |
| 15-min | 3.38 (2.70-4.23) | 3.86 (3.08-4.83) | 4.61 (3.67-5.79) | 5.20 (4.12-6.58) | 5.98 (4.57-7.80) | 6.55 (4.91-8.72) | 7.10 (5.16-9.74) | 7.62 (5.33-10.8) | 8.28 (5.68-12.2) | 8.74 (5.77-13.2) |
| 30-min | 2.72 (2.17-3.40) | 3.09 (2.47-3.87) | 3.68 (2.93-4.63) | 4.15 (3.29-5.25) | 4.77 (3.65-6.22) | 5.23 (3.92-6.96) | 5.67 (4.12-7.78) | 6.09 (4.26-8.66) | 6.62 (4.47-9.75) | 6.99 (4.62-10.6) |
| 60-min | 1.82 (1.46-2.28) | 2.08 (1.69-2.60) | 2.48 (1.98-3.12) | 2.80 (2.22-3.54) | 3.22 (2.46-4.20) | 3.53 (2.64-4.69) | 3.82 (2.77-5.24) | 4.10 (2.87-5.82) | 4.45 (3.00-6.55) | 4.69 (3.10-7.10) |
| 2-hr | 1.14 (0.920-1.42) | 1.30 (1.05-1.62) | 1.56 (1.25-1.95) | 1.76 (1.41-2.22) | 2.03 (1.58-2.62) | 2.22 (1.67-2.93) | 2.40 (1.76-3.27) | 2.58 (1.81-3.64) | 2.79 (1.89-4.08) | 2.94 (1.98-4.42) |
| 3-hr | 0.838 (0.677-1.04) | 0.959 (0.775-1.19) | 1.15 (0.928-1.44) | 1.31 (1.05-1.64) | 1.51 (1.17-1.98) | 1.67 (1.26-2.19) | 1.81 (1.33-2.47) | 1.96 (1.38-2.78) | 2.14 (1.46-3.12) | 2.27 (1.51-3.40) |
| 6-hr | 0.489 (0.398-0.602) | 0.560 (0.455-0.690) | 0.679 (0.550-0.840) | 0.780 (0.629-0.970) | 0.923 (0.723-1.20) | 1.04 (0.794-1.37) | 1.15 (0.859-1.57) | 1.27 (0.910-1.80) | 1.44 (0.991-2.10) | 1.57 (1.05-2.33) |
| 12-hr | 0.281 (0.230-0.344) | 0.321 (0.262-0.393) | 0.393 (0.320-0.483) | 0.460 (0.373-0.568) | 0.562 (0.447-0.735) | 0.649 (0.503-0.861) | 0.743 (0.558-1.01) | 0.845 (0.610-1.19) | 0.991 (0.690-1.45) | 1.11 (0.751-1.64) |
| 24-hr | 0.162 (0.133-0.196) | 0.185 (0.152-0.225) | 0.230 (0.189-0.281) | 0.273 (0.223-0.335) | 0.342 (0.275-0.448) | 0.401 (0.314-0.533) | 0.467 (0.354-0.639) | 0.541 (0.394-0.763) | 0.647 (0.455-0.943) | 0.735 (0.501-1.08) |
| 2-day | 0.093 (0.077-0.112) | 0.106 (0.088-0.128) | 0.133 (0.109-0.161) | 0.158 (0.130-0.193) | 0.198 (0.161-0.259) | 0.234 (0.184-0.308) | 0.273 (0.208-0.371) | 0.316 (0.232-0.444) | 0.380 (0.289-0.550) | 0.432 (0.298-0.630) |
| 3-day | 0.068 (0.056-0.082) | 0.077 (0.064-0.092) | 0.094 (0.078-0.114) | 0.111 (0.092-0.135) | 0.139 (0.113-0.180) | 0.163 (0.129-0.214) | 0.190 (0.148-0.257) | 0.220 (0.162-0.308) | 0.264 (0.188-0.382) | 0.301 (0.207-0.437) |
| 4-day | 0.055 (0.046-0.066) | 0.061 (0.051-0.074) | 0.074 (0.061-0.089) | 0.087 (0.072-0.105) | 0.107 (0.088-0.139) | 0.125 (0.100-0.164) | 0.146 (0.112-0.197) | 0.169 (0.125-0.235) | 0.202 (0.144-0.291) | 0.230 (0.159-0.334) |
| 7-day | 0.037 (0.031-0.044) | 0.041 (0.034-0.049) | 0.048 (0.040-0.058) | 0.055 (0.046-0.067) | 0.067 (0.055-0.086) | 0.077 (0.062-0.100) | 0.089 (0.069-0.119) | 0.102 (0.078-0.141) | 0.121 (0.088-0.172) | 0.136 (0.095-0.198) |
| 10-day | 0.030 (0.025-0.035) | 0.033 (0.027-0.039) | 0.038 (0.032-0.045) | 0.043 (0.036-0.052) | 0.051 (0.042-0.065) | 0.058 (0.047-0.075) | 0.066 (0.051-0.088) | 0.075 (0.059-0.103) | 0.088 (0.063-0.125) | 0.098 (0.068-0.141) |
| 20-day | 0.020 (0.017-0.024) | 0.022 (0.019-0.026) | 0.026 (0.022-0.030) | 0.029 (0.024-0.034) | 0.033 (0.027-0.041) | 0.037 (0.029-0.046) | 0.040 (0.031-0.053) | 0.044 (0.033-0.060) | 0.050 (0.038-0.070) | 0.055 (0.038-0.078) |
| 30-day | 0.017 (0.014-0.020) | 0.018 (0.016-0.022) | 0.021 (0.018-0.025) | 0.023 (0.020-0.028) | 0.027 (0.022-0.033) | 0.029 (0.023-0.037) | 0.032 (0.025-0.041) | 0.034 (0.028-0.046) | 0.038 (0.027-0.053) | 0.040 (0.029-0.057) |
| 45-day | 0.014 (0.012-0.016) | 0.015 (0.013-0.018) | 0.018 (0.015-0.021) | 0.020 (0.017-0.023) | 0.022 (0.018-0.027) | 0.024 (0.019-0.030) | 0.026 (0.020-0.033) | 0.027 (0.020-0.036) | 0.030 (0.021-0.041) | 0.031 (0.022-0.044) |
| 60-day | 0.012 (0.010-0.014) | 0.014 (0.012-0.016) | 0.016 (0.013-0.018) | 0.017 (0.015-0.020) | 0.019 (0.016-0.024) | 0.021 (0.017-0.026) | 0.022 (0.017-0.029) | 0.024 (0.018-0.031) | 0.025 (0.018-0.035) | 0.026 (0.019-0.037) |

¹ Precipitation frequency (PF) estimates in this table are based on frequency analysis of partial duration series (PDS). Numbers in parenthesis are PF estimates at lower and upper bounds of the 90% confidence interval. The probability that precipitation frequency estimates (for a given duration and average recurrence interval) will be greater than the upper bound (or less than the lower bound) is 5%. Estimates at upper bounds are not checked against probable maximum precipitation (PMP) estimates and may be higher than currently valid PMP values. Please refer to NOAA Atlas 14 document for more information.

Estimates from the table in CSV format:

By clicking the graphical tab, you can display the intensity-duration-frequency (IDF) graph:

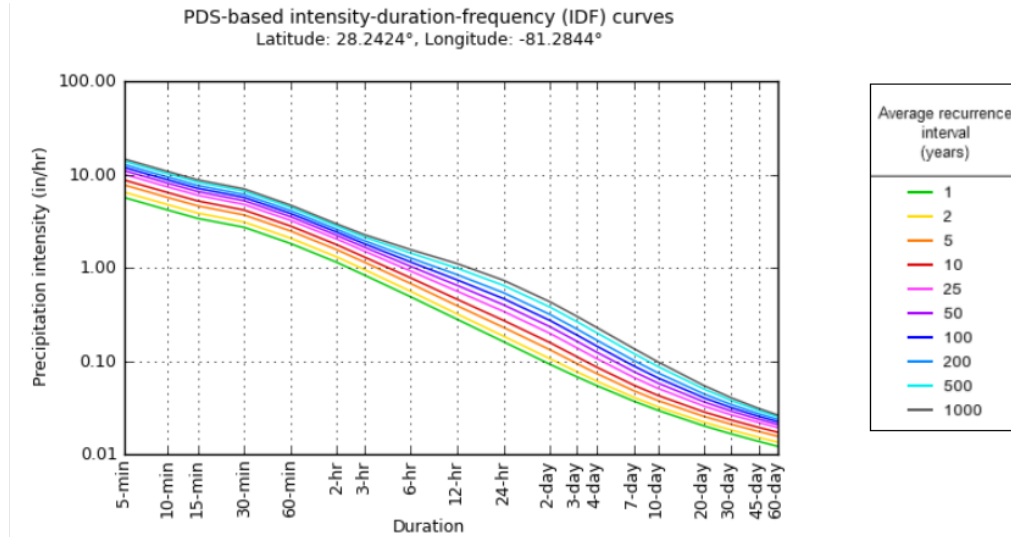

To import the NOAA Atlas 14 IDF curves into OpenRoads Designer (ORD), refer to ***FDOTConnect Drainage Design & 3D Modeling with Plans Development Training Guide*** for the step-by-step procedure.

<https://www.fdot.gov/cadd/main/FDOTCaddTraining.shtm>

2.2.2 Time of Concentration

The time of concentration is defined as the time it takes runoff to travel from the most remote point in the watershed to the point of interest. Refer to ***Drainage Manual*** for the minimum allowable time of concentration, as applicable.

You can use either of the following methods for calculating the time of concentration:

2.2.2.1 Velocity Method

The Velocity Method is a segmental approach, which you can use to account for overland flow, shallow channel flow (rills or gutters), and main channel flow. By considering the average velocity in each segment being evaluated, you can calculate a travel time using the equation:

$$t_i = \frac{L_i}{60 v_i} \quad (2.2-2)$$

where:

t_i = Travel time for velocity in segment i , in minutes

L_i = Length of the flow path for segment i , in feet
 v_i = Average velocity for segment i , in feet/second

The time of concentration is calculated as:

$$t_c = t_1 + t_2 + t_3 + \dots + t_i \quad (2.2-3)$$

where:

t_c = Time of concentration, in minutes
 t_1, t_2, t_3, t_i = Travel time in minutes for segments 1, 2, 3, i , respectively

The segments should have uniform characteristics and velocities. Determining travel time for overland flow, shallow channel flow, and main channel flow are discussed below.

(A) Overland Flow (t_1)

If you know the average slope and the land use, you can determine the time of concentration for overland flow using Figure B-2 in Appendix B (Hydrology Design Aids). This chart gives reasonable values and is used by district drainage staff around the state.

The Federal Highway Administration (FHWA) prefers the Kinematic Wave Equation developed by Ragan (1971) for calculating the travel time for overland conditions. Figure B-1 in Appendix B (Hydrology Design Aids) presents a nomograph that you can use to solve this equation, as follows:

$$t_1 = \frac{0.93 L^{0.6} n^{0.6}}{i^{0.4} S^{0.3}} \quad (2.2-4)$$

where:

t_1 = Overland flow travel time, in minutes
 L = Overland flow length, in feet (maximum 100 feet recommended by Natural Resources Conservation Service [NRCS])
 n = Manning roughness coefficient for overland flow (See Table B-1 in Appendix B, Hydrology Design Aids)
 i = Rainfall intensity, in inches/hour
 S = Average slope of overland flow path, in feet/feet

Manning's n values reported in Table B-1 in Appendix B were determined specifically for overland flow conditions and are not appropriate for conventional open channel flow calculations. Equation 2.2-4 generally involves a trial-and-error process using the following steps:

1. Assume a trial value of rainfall intensity (i).
2. Find the overland travel time (t_1) using Figure B-1 (Appendix B).
3. Find the actual rainfall intensity for a storm duration of t_1 , using the appropriate IDF curve.
4. Compare the trial and actual rainfall intensities. If they are not similar, select a new trial rainfall intensity and repeat the process.

(B) Shallow Channel Flow (t_2)

Knowing the slope of the flow segment, average velocities for shallow channel flow (shallow concentrated flow) are obtained from Figure B-3 in Appendix B (Hydrology Design Aids).

Calculate the velocity using this equation:

$$V = kS^{0.5} \quad (2.2-5)$$

where:

V = Velocity (feet per second)

S = Longitudinal slope in feet / feet

k = Constant for different flow types. (Refer to table below Figure B-3 in Appendix B)

You also can calculate gutter flow velocities using the following equation:

$$V = \frac{1.12}{n} S^{0.5} S_x^{0.67} T^{0.67} \quad (2.2-6)$$

where:

S = Longitudinal slope

n = Manning's n for street and pavement gutters (Appendix B, Table B-2)

S_x and T are as shown on (1) below.

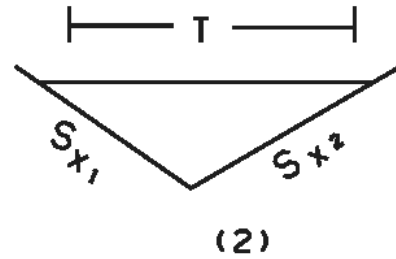
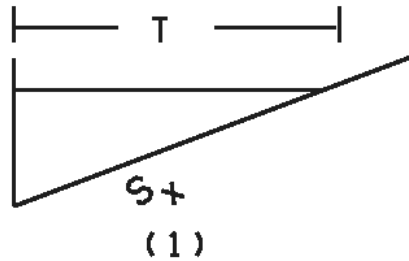

For a triangular gutter, S_x and T are as shown in (2) above.

$$S_x = \frac{S_{x1}S_{x2}}{S_{x1} + S_{x2}} \quad (2.2-7)$$

Use the conventional form of Manning's Equation to evaluate shallow channel flow.

(C) Main Channel Flow (t_3)

Flow in rills, gullies, and/or gutters empties into channels or pipes. Assume that open channels begin where either a blue line stream shows on USGS quad maps or where the channel is visible on aerial photos.

Evaluate average velocities for main channel flow using Manning's Equation.

$$V = \frac{1.486}{n} R^{0.67} S^{0.5} \quad (2.2-8)$$

where:

- V = Velocity in feet per second
- n = Manning's n value from Table B-3 (Appendix B)
- R = Hydraulic Radius (A/P)
- S = Longitudinal Slope in feet/feet
- P = Wetted perimeter of channel, in feet
- A = Cross-sectional area of the open channel, in square feet

More discussion on using Manning's Equation is provided in Chapter 3, Section 3.1.2.1.

2.2.2.2 Kirpich (1940) Equation

You can use the Kirpich Equation for rural areas to estimate the watershed t_c directly. The Kirpich Equation is based on data reported by Ramser (1927) for six small agricultural watersheds near Jackson, Tennessee. The slope of these watersheds was steep, the soils well drained, the timber cover ranged from zero percent to 56 percent, and watershed areas ranged from 1.2 acres to 112 acres. Although these data appear to be limited and site-specific, the Kirpich Equation has given good results in Florida applications. The Kirpich Equation is expressed as:

$$t_c = 0.0078 \frac{L^{0.77}}{S^{0.385}} F_s \quad (2.2-9)$$

where:

| | |
|---------|---|
| t_c = | Time of concentration, in minutes |
| L = | Length of travel, in feet |
| S = | Slope, in feet/feet |
| F_s = | 1.0 for natural basins with well-defined channels, overland flow on bare earth, and mowed grass roadside channels |
| = | 2.0 for overland flow on grassed surfaces |
| = | 0.4 for overland flow on concrete or asphaltic surfaces |
| = | 0.2 for concrete channels |

Separate the flow path into different reaches if there are breaks in the slope and changes in the topography. Add together the times of travel in each reach to obtain the time of concentration (see Equation 2.2-3).

2.2.3 Peak Runoff Rates—Ungaged Sites

Synthetic procedures recommended for developing peak flow rates include the Rational equation and USGS regression equations.

2.2.3.1 Rational Equation

The Rational equation is an easy method for calculating peak flow rates. The equation is expressed as:

$$Q = C i A \quad (2.2-10)$$

where:

| | |
|-------|--|
| Q = | Peak flow rate (cubic feet per second) |
| C = | Runoff coefficient |

i = Rainfall intensity (inches per hour)
A = Area (acres)

(A) Runoff Coefficient

The runoff coefficient is a dimensionless number that represents the percent of rainfall that runs off a site. Table B-4 in Appendix B (Hydrology Design Aids) presents runoff coefficient ranges for various land uses, soil types, and watershed slopes. Perform a site review and use your best engineering judgment to select the coefficient within these ranges. Table B-5 in Appendix B presents adjustment factors for pervious area runoff coefficients for design storm frequencies greater than 10 years. (Note: The adjusted runoff coefficient should not be greater than 1. See Example 2.2-1.) For sites with several land uses, the weighted average of the runoff coefficient is expressed as:

$$\text{Weighted } C = \frac{\sum C_i A_i}{A_{Total}} \quad (2.2-11)$$

(B) Rainfall Intensity

The rainfall intensity is determined using NOAA Atlas 14 data based on the time of concentration and the storm frequency (recurrence interval).

(C) Assumptions and Limitations

1. Rainfall is constant for the duration of the time of concentration.
2. Peak flow occurs when the entire watershed is contributing.
3. Drainage area is limited to those given in the Drainage Manual.

Example 2.2-1: Use of the Rational Method

A flooding problem exists along a farm road near Somewhere Springs, Florida (sandy soil). A low water crossing is to be replaced by a culvert to improve the road safety during rainstorms. The drainage area is shown above and has an area of 108.1 acres. Determine the maximum flow the culvert must pass for a 25-year storm.

1. Determine the weighted "C," assuming sandy soil. From the sketch and Tables B-4 and B-5 in Appendix B, develop a summary of "C" values, adjusted for design storm frequency.

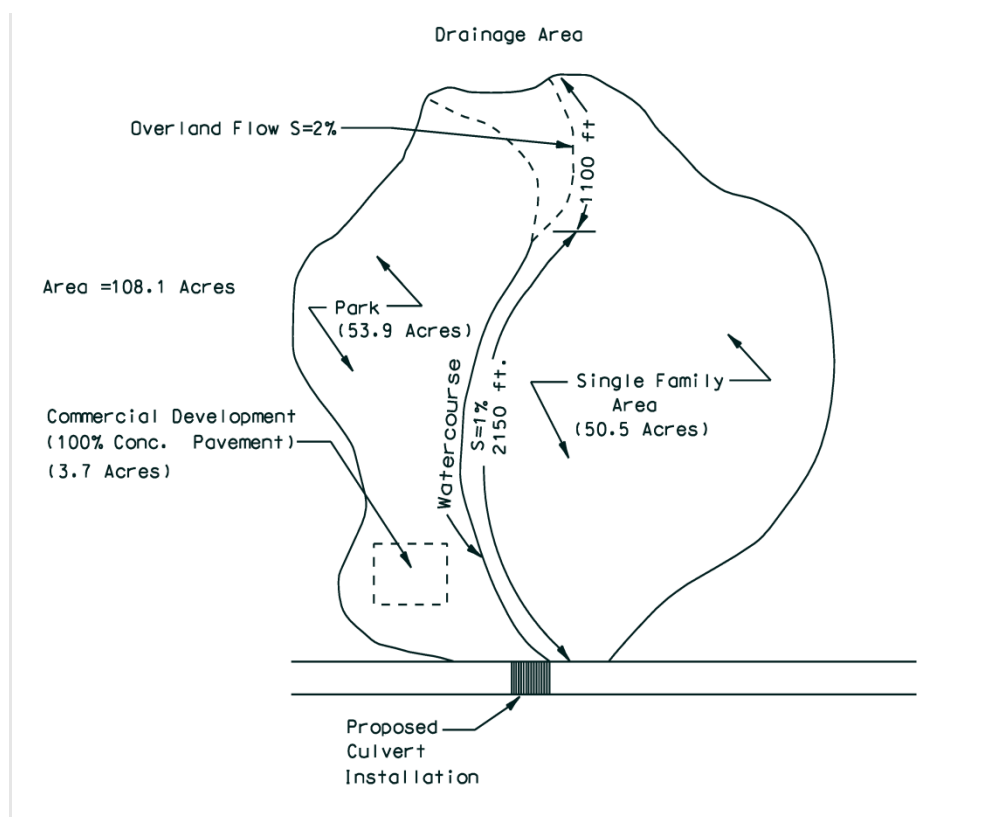

| Description | "C" Value | Adjustment | Adjusted C | Area | C _i A _i |
|------------------------|-----------|------------|------------|-------|-------------------------------|
| Park | 0.20 | 1.1 | 0.22 | 53.9 | 11.9 |
| Commercial Development | 0.95 | N/A | 0.95 | 3.7 | 3.5 |
| Single Family | 0.40 | 1.1 | 0.44 | 50.5 | 22.2 |
| | TOTALS | | | 108.1 | 37.6 |

$$\text{Weighted } C = \frac{\sum C_i A_i}{A} = \frac{37.60}{108.1} = 0.35$$

2. Determine intensity. To determine the intensity, the time of concentration (t_c) must first be determined.

a. Overland flow (1,100 ft) – "Residential" at 2-percent slope.

From Figure B-2 (Appendix B)
Velocity = 57 ft/min

$$t_1 = \sum \frac{Distance_1}{Velocity_1} = \frac{1100 \text{ ft}}{57 \text{ ft/min}} = 19.3 \text{ min.}$$

b. Channelized flow (2,150 ft) – "Grassed Waterway" at 1-percent slope.

From Figure B-3 (Appendix B)
Velocity = 1.6 ft/sec

$$t_2 = \sum \frac{Distance_2}{Velocity_2} = \frac{2150 \text{ ft}}{1.6 \text{ ft/sec} \times 60 \text{ sec/min}} = 22.4 \text{ min.}$$

c. Time of concentration is estimated as:

$$t_c = t_1 + t_2 = 19.3 + 22.4 = 41.7 \text{ min.}$$

d. Intensity is obtained from the NOAA Atlas 14 data using a duration equal to the time of concentration (t_c). For this project location, the following NOAA Atlas 14 data is generated:

| PDS-based precipitation frequency estimates with 90% confidence intervals (in inches/hour) ¹ | | | | | | | | | | |
|---|-------------------------------------|-----------------------|----------------------|---------------------|---------------------|---------------------|---------------------|---------------------|---------------------|---------------------|
| Duration | Average recurrence interval (years) | | | | | | | | | |
| | 1 | 2 | 5 | 10 | 25 | 50 | 100 | 200 | 500 | 1000 |
| 5-min | 6.31 (5.21-7.49) | 7.10 (5.86-8.42) | 8.33 (6.84-9.92) | 9.29 (7.58-11.1) | 10.5 (8.26-13.0) | 11.4 (8.76-14.5) | 12.3 (9.07-16.1) | 13.1 (9.24-17.8) | 14.1 (9.53-19.9) | 14.7 (9.74-21.4) |
| 10-min | 4.63 (3.82-5.48) | 5.20 (4.28-6.17) | 6.10 (5.00-7.27) | 6.80 (5.55-8.15) | 7.72 (6.04-9.54) | 8.38 (6.41-10.6) | 9.00 (6.64-11.8) | 9.59 (6.77-13.0) | 10.3 (6.98-14.5) | 10.8 (7.13-15.7) |
| 15-min | 3.76 (3.10-4.46) | 4.23 (3.48-5.02) | 4.96 (4.07-5.90) | 5.53 (4.52-6.63) | 6.28 (4.91-7.76) | 6.81 (5.22-8.61) | 7.32 (5.40-9.56) | 7.80 (5.50-10.6) | 8.38 (5.67-11.8) | 8.78 (5.80-12.8) |
| 30-min | 2.91 (2.40-3.45) | 3.28 (2.70-3.89) | 3.85 (3.16-4.59) | 4.30 (3.51-5.15) | 4.88 (3.82-6.03) | 5.30 (4.06-6.70) | 5.69 (4.20-7.44) | 6.06 (4.28-8.23) | 6.52 (4.41-9.19) | 6.83 (4.51-9.92) |
| 60-min | 1.92 (1.58-2.27) | 2.14 (1.76-2.54) | 2.50 (2.06-2.98) | 2.80 (2.29-3.36) | 3.20 (2.51-3.97) | 3.50 (2.69-4.44) | 3.79 (2.81-4.98) | 4.09 (2.89-5.57) | 4.47 (3.03-6.33) | 4.75 (3.14-6.89) |
| 2-hr | 1.19 (0.986-1.40) | 1.32 (1.10-1.56) | 1.54 (1.27-1.82) | 1.73 (1.42-2.05) | 1.98 (1.57-2.45) | 2.17 (1.68-2.75) | 2.37 (1.77-3.10) | 2.57 (1.83-3.49) | 2.84 (1.94-4.00) | 3.04 (2.02-4.39) |
| 3-hr | 0.861 (0.718-1.01) | 0.957 (0.797-1.13) | 1.12 (0.929-1.32) | 1.26 (1.04-1.50) | 1.46 (1.17-1.81) | 1.62 (1.26-2.05) | 1.79 (1.34-2.34) | 1.96 (1.40-2.66) | 2.19 (1.51-3.10) | 2.38 (1.59-3.42) |

Although IDF curves are available from the NOAA Atlas 14 website, it can be

difficult to accurately pick data from the IDF curve, so using the tabular data just above and below the time-of-concentration should be used to interpolate for the desired value. The resulting two data points are:

$$i_{25\text{yr},30\text{min}} = 4.88 \text{ in/hr}$$

$$i_{25\text{yr},60\text{min}} = 3.20 \text{ in/hr}$$

Using a rainfall duration equal to the time of concentration of 42 minutes (or 0.7 hours), a linear interpolation* is performed, and the resulting rainfall intensity:

$$i_{25} = 4.21 \text{ in/hr}$$

*IDF Curves are plotted on log-log distributions. Linear interpolation skews towards the lower duration value, resulting in slightly higher intensities and slightly lower rainfall depths than a log-log interpolation. For rational methods, which use intensities, linear interpolation provides some additional conservatism to the design. Analysis of linear interpolation of rainfall depths shows the difference is negligible as compared to log-log interpolation, and results are typically within the 90% confidence intervals. Therefore, linear interpolation is an acceptable practice, with verification the results are within the 90% confidence interval bounding values.

3. Calculate the peak flow.

$$Q_{25} = C \times i_{25} \times A = 0.35 \times 4.21 \times 108.1 = 159.29 \text{ cubic feet per second}$$

2.2.3.2 Regression Equations

(A) Urban Conditions

You can use regression equations developed by the USGS (Verdi, 2006) to estimate peak runoff for natural flow conditions.

The USGS equations in “Magnitude and Frequency of Floods for Rural Streams in Florida, 2006” by Verdi (2006) supersede the information presented by Bridges (1982) and in the USGS Water Supply Paper (WSP) No. 1674 by Pride (1958). Although not recommended as a design procedure, you can use the method presented in WSP No. 1674 as an independent check for evaluating natural flow estimates for watershed areas between 100 and 10,000 square miles.

The Statistical Analysis System (SAS) was used to perform multiple regression analyses of flood peak data from 275 gaging stations in Florida and 30 in the adjacent states of Georgia and Alabama. Tables B-10 through B-13 in Appendix B (Hydrology Design Aids) show the USGS Regression Equations for each designated region in the State of Florida.

The natural flow regression equations for Regions 1 through 4 take the following general form:

$$Q_T = C A^a (ST + 1.0)^b \quad (2.2-12)$$

where:

- Q_T = Peak runoff rate for return period T, in ft³/sec.
 C = Regression constant (See Appendix B, B-10 through B-13)
 A = Drainage area in square miles
 ST = Basin storage, the percentage of the drainage basin occupied by lakes, reservoirs, swamps, and wetland. In-channel storage of a temporary nature, resulting from detention ponds or roadway embankments, is not included in the computation of ST.
 a, b = Regression exponents (See Appendix B, B-10 through B-13).

The standard error of prediction, in percent, is reported for each natural flow regression equation for each of the Regions 1 through 4, Tables B-10 through B-13 (Appendix B). The standard error of prediction is a measure of how well the regression equation estimates flood flows when applied to ungaged basins.

The square of the multiple regression coefficient (R^2), unit less, and the standard error, in percent, are reported for each regression equation for the urban and Tampa Bay area and Leon County, Tables B-14 through B-16 (Appendix B). The R^2 value provides a measure of the equation's ability to account for variation in the dependent variable. The standard error is the standard deviation of the distribution of residuals about the regression line.

The standard error of model, in percent, is reported for each West-Central Florida regression equation, Table B-17 (Appendix B). The standard error of model is a measure of how well the regression equation model estimates flood flows.

When applying the regression equations, you should consider the following limitations:

1. The relationship of the regression equations for areas with basin characteristics outside the ranges given above. Do not use the equations for watershed conditions

outside the range of applicability shown in Tables B-10 through B-13 in Appendix B (Hydrology Design Aids).

2. In areas of karst topography for the Tampa Area and Leon County regression equations, some basins may contain closed depressions and sinkholes, which do not contribute to direct runoff. When you determine the drainage area from 7.5-minute topographic maps, subtract any area containing sinkholes or depressions (non-contributing areas) from the total drainage area.
3. Regression equations are not applicable where manmade changes have a significant effect on the runoff. These changes may include construction of dams, reservoirs, levees and diversion canals, strip mines, and areas with significant urban development.

To apply the USGS regression equations, you should take the following steps:

1. Locate the appropriate region on Figure B-4 (Appendix B).
2. Select the appropriate equations (from Appendix B, Tables B-10 through B-13) for the region in which your site is located.
3. Determine the input parameters for your selected regression equation.
4. Calculate peak runoff rates for the desired return periods.

(B) Urban Conditions

You can use regression equations developed by the USGS as part of a nationwide project to estimate peak runoff for urban watershed conditions. Regionalized regression equations for the Tampa Bay area, Leon County, and West-Central Florida also are available.

(1) Nationwide Equations

Sauer, *et al.* (1983), provide two seven-parameter equations and a third set based on three parameters. The seven-parameter equations based on lake and reservoir (presented in Appendix B, Table B-14) are recommended. The equations account for regional runoff variations through the use of the equivalent rural peak runoff rate (RQ). The equations adjust RQ to an urban condition using the basin development factor (BDF), the percentage of impervious area (IA), and other variables. These equations have the following general form:

$$UQ_T = C A^{B_1} SL^{B_2} (i_2 + 3)^{B_3} (ST + 8)^{B_4} (13 - BDF)^{B_5} IA^{B_6} (RQ_T)^{B_7} \quad (2.2-13)$$

where:

UQ_T = Peak discharge, in cubic feet per second, for the urban watershed for

| | |
|------------------|--|
| | recurrence interval T |
| C = | Regression constant (See Appendix B, Table B-14) |
| A = | Contributing drainage area in square miles |
| SL = | Channel slope (feet/mile) between points 10 percent and 85 percent of the distance from the design point to the watershed boundary |
| i_2 = | Rainfall intensity, in inches, for the two-hour, two-year occurrence |
| ST = | Basin storage, the percentage of the drainage basin occupied by lakes, reservoirs, swamps, and wetland. In-channel storage of a temporary nature, resulting from detention ponds or roadway embankments, is not included in the computation of ST. |
| BDF = | Basin development factor is an index of the prevalence of (1) channel improvements, (2) impervious channel linings, (3) storm drains, and (4) curb and gutter streets and ranges from 0 to 12. More discussion and an example follow these definitions. |
| IA = | Impervious area is the percentage of the drainage basin occupied by impervious surfaces, such as buildings, parking lots, and streets. |
| RQ_T = | Peak discharge, in cubic feet per second, for an equivalent rural drainage basin in the same hydrologic area as the urban basin for recurrence interval T. This value is developed using the USGS regression equations for natural flow conditions for the appropriate region. |
| B_1 to B_7 = | Regression exponents (See Appendix B, Table B-14) |

Basin Development Factor—Determine the BDF from drainage maps and by field inspection of the watershed. First, divide the basin into three sections so that each sub-area contains approximately one-third of the drainage area. Mark distances along main streams and tributaries so that, within each third, the travel distances of two or more streams are about equal. Generally, you can draw the lines on the drainage map by visual estimate without the need for measurements. Complex basin shapes and drainage patterns require more judgment when subdividing.

You will examine four drainage aspects for each subsection, assigning a code of zero or one to each aspect for each subsection. The BDF, therefore, can range from zero for an undeveloped watershed to 12 for a completely urbanized watershed. A code of zero does not mean that the watershed is completely unaffected by urbanization. A basin could have some impervious area, some improved channels and some curb and gutter streets and still have a BDF of zero. The four drainage aspects are:

1. **Channel Improvements**—If 50 percent or more of the main channels and principal tributaries (those that drain directly into the main channel) have been improved from natural conditions, assign a code of one; otherwise, assign a code of zero. Improvements include straightening, enlarging, deepening, and clearing.
2. **Channel Linings**—Assign a code of one if more than 50 percent of the length of the main channels and principal tributaries have impervious linings, such as concrete; otherwise, assign a code of zero. Lined channels are an indication of a more

- developed drainage system in which channels probably have been improved.
3. **Storm Drains**—Storm drains are enclosed drainage structures (usually pipes) frequently used on the secondary tributaries (those that drain into principal tributaries) that receive drainage directly from streets or parking lots. Many of these drains empty into open channels; in some basins, however, they empty into channels enclosed as box or pipe culverts. When more than 50 percent of the secondary tributaries within a sub-basin consist of storm drains, assign a code of one to this aspect; otherwise, assign a code of zero. Note that if 50 percent or more of the main drainage channels and principal tributaries are enclosed, you also would assign the aspects of channel improvements and channel linings a code of one.
 4. **Curb and Gutter Streets**—If more than 50 percent of a sub-basin is urbanized (covered by residential, commercial, or industrial development), and if more than 50 percent of the streets and highways in the sub-basin are constructed with curbs and gutters, then assign a code of one to this aspect; otherwise, assign a code of zero. Drainage from curb and gutter streets frequently empties into storm drains.

These guidelines are not intended to be precise measurements. A certain amount of subjectivity will be involved, and you should perform field checks to obtain the best estimate.

Example 2.2-2: Estimating the BDF

A watershed is divided into three sub-areas based on homogeneity of hydrologic conditions. Information for the watershed is collected from topographic maps and field reviews and is tabulated below:

| Subarea | Main channel length (ft) | Length of secondary tributaries (ft) | Road length (ft) | Length of channel improved (ft) | Length of channel lined (ft) | Length of storm drains (ft) | Length of curb & gutter (ft) |
|---------|--------------------------|--------------------------------------|------------------|---------------------------------|------------------------------|-----------------------------|------------------------------|
| Upper | 2500 | 5180 | 2850 | 460 | 0 | 1345 | 690 |
| Middle | 3800 | 3940 | 4700 | 2020 | 1770 | 2330 | 3020 |
| Lower | 3000 | 2160 | 5610 | 1720 | 1570 | 1510 | 3180 |

The BDF is determined as follows:

Channel Improvements

Upper third: 460 ft have been straightened and deepened
 $460/2,500 < 50\%$ Code = 0
 Middle third: 2,020 ft have been straightened and deepened
 $2,020/3,800 > 50\%$ Code = 1
 Lower third: 1,720 ft have been straightened and deepened
 $1,720/3,000 > 50\%$ Code = 1

Channel Linings

Upper third: 0 ft have been lined
 $0/2,500 < 50\%$ Code = 0
 Middle third: 1,770 ft have been lined
 $1,770/3,800 < 50\%$ Code = 0
 Lower third: 1,570 ft have been lined
 $1,570/3,000 > 50\%$ Code = 1

Storm Drains on Secondary Tributaries

Upper third: 1,345 ft have been converted to storm drains
 $1,345/5,180 < 50\%$ Code = 0
 Middle third: 2,330 ft have been converted to storm drains
 $2,330/3,940 > 50\%$ Code = 1
 Lower third: 1,510 ft have been converted to storm drains
 $1,510/2,160 > 50\%$ Code = 1

Curb and Gutter Streets

Upper third: 690 ft of curb and gutter street
 $690/2,850 < 50\%$ Code = 0
 Middle third: 3,020 ft of curb and gutter street
 $3,020/4,700 > 50\%$ Code = 1
 Lower third: 3,180 ft of curb and gutter street
 $3,180/5,610 > 50\%$ Code = 1

Total BDF = 7

(2) Tampa Bay Area, Leon County, West-Central Florida:

You can use regression equations developed as part of a nationwide project by the USGS (Sauer et al., 1983) to estimate peak runoff for urban watershed conditions. Regionalized regression equations for urban watersheds in the Tampa Bay area and for Leon County are presented by Lopez and Woodham (1983), Franklin and Losey (1984), and Hammett and DelCharco (2001) respectively. Tables B-15, B-16, and B-17 in Appendix B show the USGS Regionalized Regression Equations for the Tampa Bay area, Leon County, and West-Central Florida respectively.

(a) Tampa Bay Area

For urban drainage areas of less than 10 square miles in the Tampa Bay area, the general form of the regression equations are:

For 2-, 5-, and 10-year frequencies:

$$Q_T = C A^{B_1} BDF^{B_2} SL^{B_3} (DTENA + 0.01)^{B_4} \quad (2.2-14)$$

For 25-, 50-, and 100-year frequencies:

$$Q_T = C A^{B_1} (13 - BDF)^{B_2} SL^{B_3} \quad (2.2-15)$$

where:

- Q_T = Peak runoff rate for return period T, in cubic feet per second
- C = Regression constant (See Appendix B, Table B-15)
- A = Drainage area in square miles
- BDF = Basin development factor (dimensionless)
- SL = Channel slope (feet/mile) between points 10 percent and 85 percent of the distance from the design point to the watershed boundary.
- $DTENA$ = Surface area of lakes, ponds, and detention and retention basins expressed as a percent of drainage area.
- $B_1, B_2, \text{ etc.}$ = Regression exponents (See Appendix B, Table B-15)

The equations are not to be used for watershed conditions outside the range of applicability shown in Table B-15 (Appendix B). To apply the Tampa Bay regression equations:

1. Determine input parameters, including drainage area, basin development factor (see Example 2.2-2), channel slope, and the surface area of lakes,

ponds, etc.

2. Calculate peak runoff rates for the desired return periods.

(b) Leon County

For urban drainage areas of less than 16 square miles in Leon County, Franklin and Losey (1984) developed regression equations for areas inside and outside the Lake Lafayette Basin.

The general form of both sets of equations is:

$$Q_T = C A^{B_1} IA^{B_2} \quad (2.2-16)$$

where:

| | |
|--------------|--|
| Q_T = | Peak runoff rate for return period T, in cubic feet per second |
| C = | Regression constant (See Appendix B, Table B-16) |
| A = | Drainage area in square miles |
| IA = | Impervious area, in percent of drainage area |
| B_1, B_2 = | Regression exponents (See Appendix B, Table B-16) |

These equations must not be used for watershed conditions outside the range of applicability shown in Table B-16 (Appendix B). The following steps are used to apply the Leon County regression equations:

- 1) Determine input parameters, including drainage area and impervious area.
- 2) Select the appropriate equations from Table B-16 (Appendix B), depending on whether the area is inside or outside the Lake Lafayette Basin.
- 3) Calculate peak runoff rates for the desired return periods using the equations in Table B-16 (Appendix B).

(c) West-Central Florida

For drainage areas in West-Central Florida, Hammett and DelCharco (2001) developed regression equations for areas inside and outside the Southwest Florida Water Management District. The general form of the regression equations are:

For Region 1:

$$Q_T = C A^{B_1} (LK + 0.6)^{B_2} \quad (2.2-17)$$

For Regions 2 through 4:

$$Q_T = C A^{B_1} (LK + 3.0)^{B_2} SL^{B_3} \quad (2.2-18)$$

where:

- Q_T = Peak runoff rate for return period T, in cubic feet per second
 C = Regression constant (See Appendix B, Table B-17)
 A = Drainage area in square miles
 LK = Drainage area covered by lakes, in percent of drainage area
 SL = Channel slope (feet/mile) between points 10 percent and 85 percent of the distance from the design point to the watershed boundary
 B_1, B_2, B_3 = Regression exponents (See Appendix B, Table B-17)

These equations must not be used for watershed conditions outside the range of applicability shown in Table B-18 (Appendix B). The following steps are used to apply the West-Central Florida regression equations:

- 1) Locate the appropriate region on Figure B-5 (Appendix B).
- 2) Select the appropriate equations (from Appendix B, Table B-17) for the region in which your site is located.
- 3) Determine the input parameters for your selected regression equation.
- 4) Calculate peak runoff rates for the desired return periods.

(3) Water Management District and Local Drainage District Procedures

Some Water Management Districts (WMDs) in Florida set allowable discharge or removal rates for specific watershed areas. WMDs also may have computer programs for surface hydrology calculations available. Consult the appropriate WMD handbook and, if needed, appropriate WMD or FDOT District drainage personnel for guidance. There are also local drainage districts that control runoff amounts to particular streams or water bodies.

2.2.4 Flood Hydrographs

When observed data for deriving unit hydrograph parameters is not available, use either the Modified Rational Method or the NRCS unit hydrograph procedures. Both procedures utilize the precipitation frequency data from NOAA Atlas 14 described above in Section 2.2.1. The Department's rainfall distributions are available from the Department's Internet site. Each Water Management District specifies rainfall distributions appropriate for their respective regions.

2.2.4.1 Modified Rational Method

Because of the assumptions and limitations of the Rational Method (see Section 2.2.3), use of the Modified Rational Method for flood hydrograph procedures is limited to small basins having a time of concentration of 15 minutes or less. (See the Drainage Manual, Section 5.4.2.)

Example: Using a drainage area of 0.981 acres, t_c of 10 minutes, Rational runoff coefficient (C) of 0.82, and NOAA Atlas 14 data, calculate an inflow hydrograph for the 100-year, 2-hour rainfall.

From the [NOAA Atlas 14 data](#), the 100-year, 2-hour precipitation frequency estimate (P_{total}) can be found. For this case, assume that the webpage provides $P_{total} = 5.4$ inches

| (1) Time (hours) | (2) i/P_{total} | (3) i (in/hr) | (4) Q (cfs) |
|---------------------|----------------------|--------------------|----------------|
| 0.2 | 0.50 | 2.70 | 2.21 |
| 0.4 | 0.75 | 4.05 | 3.31 |
| 0.6 | 1.00 | 5.40 | 4.41 |
| 0.8 | 1.25 | 6.75 | 5.51 |
| 1.0 | 0.50 | 2.70 | 2.21 |
| 1.2 | 0.30 | 1.62 | 1.32 |
| 1.4 | 0.25 | 1.35 | 1.10 |
| 1.6 | 0.20 | 1.08 | 0.88 |
| 1.8 | 0.15 | 0.81 | 0.66 |
| 2.0 | 0.00 | 0.00 | 0 |

Columns 1 & 2 are from the rainfall distribution data table

Column 3 is Column 2 times P_{total}

Column 4 is Column 3 times CA (0.82 for this example)

2.2.4.2 NRCS Hydrograph

Techniques developed by the NRCS, formerly the Soil Conservation Service (SCS), for calculating rates of runoff require the same basic data as the Rational Method: drainage area, a runoff factor, time of concentration, and rainfall. The NRCS approach also considers the time distribution of the rainfall, initial losses to interception and depression storage, and infiltration that decreases during the storm. Since NRCS hydrographs are calculated using computers, the discussion in this guide will address the basic concepts rather than computation methods.

(A) Time of Concentration

Calculate the time of concentration using any of the methods in Section 2.2.2.

(B) Curve Number

The NRCS developed an empirical relationship for estimating rainfall excess that accounts for infiltration losses and initial abstractions by using a site-specific runoff parameter called the curve number (CN). The watershed CN is a dimensionless coefficient that reflects watershed cover conditions, hydrologic soil group, land uses, and antecedent moisture conditions.

Three levels of antecedent moisture conditions are considered by the NRCS relationship. Antecedent Moisture Condition I (AMC-I) is the lower limit of antecedent rainfall or the upper limit of the potential maximum soil storage (S). Antecedent Moisture Condition II (AMC-II) represents average antecedent rainfall conditions, and Antecedent Moisture Condition III (AMC-III) is the upper limit of antecedent rainfall or the lower limit of S. Only AMC-II generally is selected for design purposes. The curve number values in the tables in the Appendix B (Hydrology Design Aids) are based on AMC-II.

To determine the curve number:

1. Identify soil types using the appropriate county soil survey report.
2. Assign a hydrologic group (A, B, C, or D) to each soil type. (See Appendix B, Table B-6.) In general:
 - A = deep sand, deep loess, aggregated silts, high infiltration
 - B = shallow loess, sandy loam, moderate infiltration
 - C = clay loams, shallow sandy loam, soils low in organic content, soils usually high in clay, slow infiltration,
 - D = soils that swell significantly, heavy plastic clays, some saline soils, very slow infiltration
3. Identify drainage areas with uniform soil type and land use conditions.
4. Use tables B-7 through B-9 (Appendix B) or other references to select curve number values for each uniform drainage area identified in Step 3.
5. Calculate a composite curve number using the equation:

$$CN_C = \frac{\sum CN_i A_i}{A_T} \quad (2.2-19)$$

where:

| | |
|----------|-----------------------------|
| CN_C = | Composite curve number |
| CN_i = | Curve number for sub-area i |
| A_i = | Area for sub-area i |
| A_T = | Total area of watershed |

The curve number tables developed by the U.S. Department of Agriculture (USDA) are based on the assumption that all impervious areas have a CN of 98 and are hydraulically connected. If the rain on the roof of a house runs off onto the lawn, that roof area is not hydraulically connected. If the roof drains into a gutter, which in turn flows onto the driveway, then on to the street, that area is hydraulically connected.

If these assumptions don't fit the project area, there is an alternate method of predicting curve number from Department-sponsored research on estimating coefficients for hydrologic methods used for the design of hydraulic structures. The results were reported in "Techniques for Estimating Hydrologic Parameters for Small Basins in Florida," by Scott Kenner, et al, FDOT Project Number 99700-3542, April 1996.

The resulting equation for estimating the CN is:

$$CN = 58.38 - 8.2716 \ln(A) + 0.50274 HCIA + 6.22971 \ln(L) + 0.68079 \ln(L_c) - 0.14986 S \quad (2.2-20)$$

where:

| | |
|------------------|--|
| A = | Drainage area (acres) |
| HCIA = | Hydraulically connected impervious area (percent of A) |
| L = | Length of main flow channel (feet) |
| L _c = | Length to centroid (feet) |
| S = | Main channel slope (feet/mile) |

(C) Rainfall-Runoff Relationship

The maximum soil storage and the CN value for a watershed are related by the following expression:

$$S = \frac{1000}{CN} - 10 \quad (2.2-21)$$

where:

| | |
|------|---|
| S = | Potential maximum soil storage, in inches |
| CN = | Watershed curve number, dimensionless |

Knowing the potential maximum soil storage, calculate the rainfall excess using the following NRCS relationship:

$$R = \frac{(P - 0.2S)^2}{P + 0.8S} \quad (2.2-22)$$

where:

R = Accumulated rainfall excess (or runoff), in inches
 P = Accumulated rainfall, in inches
 S = Maximum soil storage, in inches

Additional information on the NRCS relationship is available in USDA, NRCS publications TP-149 (1973), NEH-4 (1972), and TR-55 (1986).

(D) Shape Factor

The hydrograph shape factor (B) generally is considered to be a constant characteristic of a watershed. The NRCS dimensionless unit hydrographs are based on a B value of 484. However, since the value of B generally ranges from 600 in steep terrain to 300 or less in flat swampy areas, you may need to make adjustments to the unit hydrograph shape. You can make these adjustments by changing the percent of area under the rising and recession limbs of the unit hydrograph to reflect the corresponding change in the hydrograph shape factor. The B value of 484 reflects a hydrograph that has $\frac{3}{8}$ of its area under the rising limb. For mountainous terrain, a larger percentage of the area would probably be under the rising limb, represented by a larger B value.

The South Florida Water Management District has a memorandum (dated June 25, 1993) concerning hydrograph shape (peak rate) factors. For slopes less than 5 feet per mile, a factor of 100 is recommended, and for slopes in South Florida greater than 5 feet per mile, a factor of 256 is recommended.

Hal Wilkening of the St. Johns River Water Management District prepared a memorandum for a "Procedure for Selection of SCS Peak Rate Factors for Use in MSSE Permit Applications", dated April 25, 1990. The memorandum provides a summary of the NRCS unit hydrograph methodology and information on research on, as well as recommendations for the selection of, hydrograph shape (peak rate) factors. His recommendations are outlined in the following table.

| Site Conditions | Shape Factor |
|---|--------------|
| Represents watersheds with very mild slopes, recommended by NRCS for watersheds with average slope of 0.5 percent or less. Significant surface storage throughout the watershed. Limited onsite drainage ditches. Typical ecological communities include: North Florida flat woods, South Florida flat woods, freshwater marsh and ponds, swamp hardwoods, cabbage palm flatlands, cypress swamp, and similar vegetative communities. | 256 to 284 |
| Intermediate peak rate factor representing watersheds with moderate surface storage in some locations due to depression areas, mild slopes, and/or lack of existing drainage features. Typical ecological communities include: oak hammock, upland hardwood hammock, mixed hardwood and pine, and similar vegetative communities. | 323 to 384 |
| Standard peak rate factor developed for watersheds with little or no storage. Represents watersheds with moderate to steep slopes and/or significant drainage works. Typical ecological communities include: long leaf pine, turkey oak hills, and similar vegetative communities. | 484 |

The Department sponsored research on estimating coefficients for hydrologic methods used for the design of hydraulic structures. The results were reported in "Techniques for Estimating Hydrologic Parameters for Small Basins in Florida," by Scott Kenner, *et al.*, FDOT Project Number 99700-3542, April 1996. The resulting equation for estimating the NRCS shape factor is:

$$B = \exp[390 - 0.01396A - 0.00473HCIA + 0.00064L - 0.00053L_c + 0.00567S]$$

(2.2-23)

where:

- A = Drainage area (acres)
- HCIA = Hydraulically connected impervious area (percent)
- L = Length of main flow channel (feet)
- L_c = Length to centroid (feet)
- S = Main channel slope (feet/mile)

The designer should consult with district drainage personnel and, if necessary, WMD personnel before using a shape (peak rate) factor other than the standard factor of 484.

CHAPTER 3: OPEN CHANNEL

| | |
|--|-------------|
| 3. OPEN CHANNEL | 3-1 |
| 3.1 Open Channel Flow Theory | 3-1 |
| 3.1.1 Mass, Energy, and Momentum | 3-1 |
| 3.1.1.1 Mass | 3-1 |
| 3.1.1.2 Energy | 3-1 |
| 3.1.1.3 Momentum | 3-4 |
| 3.1.2 Uniform Flow | 3-5 |
| 3.1.2.1 Manning's Equation | 3-5 |
| 3.1.3 Critical Flow | 3-10 |
| 3.1.3.1 Specific Energy and Critical Depth | 3-10 |
| 3.1.3.2 Critical Velocity | 3-14 |
| 3.1.3.3 Super-Critical Flow | 3-14 |
| 3.1.3.4 Sub-Critical Flow | 3-14 |
| 3.1.3.5 Theoretical Considerations | 3-15 |
| 3.1.4 Non-Uniform Flow | 3-15 |
| 3.1.4.1 Gradually Varied Flow | 3-17 |
| 3.1.4.2 Gradually Varied Flow Profile Computation | 3-17 |
| 3.1.4.3 Rapidly Varied Flow | 3-24 |
| 3.1.5 Channel Bends | 3-27 |
| 3.2 Open Channel Design | 3-29 |
| 3.2.1 Types of Open Channels for Highways | 3-29 |
| 3.2.2 Roadside Ditches | 3-31 |
| 3.2.3 Median Ditches | 3-35 |
| 3.2.4 Interceptor Ditches | 3-36 |
| 3.2.5 Outfall Ditches | 3-37 |
| 3.2.6 Hydrology | 3-37 |
| 3.2.6.1 Frequency | 3-38 |
| 3.2.6.2 Time of Concentration | 3-38 |
| 3.2.7 Tailwater and Backwater | 3-38 |
| 3.2.8 Side Drains | 3-47 |
| 3.2.8.1 Design Analysis Requirements for Side Drains | 3-47 |
| 3.2.8.2 Material Requirements | 3-48 |
| 3.2.8.3 End Treatment | 3-48 |
| 3.3 Channel Linings | 3-51 |
| 3.3.1 Flexible Linings | 3-51 |
| 3.3.1.1 Vegetation | 3-51 |
| 3.3.1.2 Other Flexible Linings | 3-52 |
| 3.3.2 Rigid Linings | 3-54 |
| 3.3.2.1 Cast-in-Place Concrete | 3-55 |
| 3.3.2.2 Fabric Formed Revetment | 3-55 |

| | | |
|------------|--|-------------|
| 3.3.3 | Velocity and Shear Stress Limitations | 3-55 |
| 3.3.4 | Application Guidance for Some Common Channel Linings | 3-58 |
| 3.3.4.1 | Rubble Riprap | 3-58 |
| 3.3.4.2 | Fabric Formed Revetments | 3-59 |
| 3.3.4.3 | Gabions | 3-61 |
| 3.3.4.4 | Soil Stabilizers | 3-65 |
| 3.4 | Drainage Connection Permitting and Maintenance Concerns | 3-67 |
| 3.4.1 | Drainage Connection Permitting | 3-67 |
| 3.4.1.1 | Roadside Ditch Impacts | 3-67 |
| 3.4.1.2 | Median Ditch Impacts..... | 3-69 |
| 3.4.1.3 | Outfall Ditch Impacts..... | 3-71 |
| 3.4.2 | Maintenance Concerns..... | 3-71 |
| 3.4.2.1 | Ditch Closures | 3-71 |
| 3.4.2.2 | Acquisition of Ditches from Local Ownership..... | 3-77 |
| 3.4.2.3 | Addition of Sidewalks to Roadway Projects..... | 3-77 |

3. OPEN CHANNEL

3.1 OPEN CHANNEL FLOW THEORY

3.1.1 Mass, Energy, and Momentum

The three basic principles that generally apply to flow analysis, including open channel flow evaluations, are:

- Conservation of mass
- Conservation of energy
- Conservation of linear momentum

3.1.1.1 Mass

You can mathematically express the conservation of mass for continuous steady flow in the Continuity Equation as:

$$Q = v \times A \quad (3.1-1)$$

where:

| | |
|-----|--|
| Q = | Discharge, in cubic feet per second |
| A = | Cross-sectional area, in square feet |
| v = | Average channel velocity, in feet per second |

For continuous unsteady flow, the Continuity Equation must include time as a variable. For additional information on unsteady flow, see Chow (1959) or Henderson (1966).

3.1.1.2 Energy

The total energy head at a point in an open channel is the sum of the potential and kinetic energy of the flowing water. The potential energy is represented by the elevation of the water surface. The water surface elevation is the depth of flow, d , defined in Section 1.4, added to the elevation of the channel bottom, z . The water surface elevation is a measure of the potential work that the flow can do as it transitions to a lower elevation. The kinetic energy is the energy of motion as measured by the velocity, v .

If a straight tube is inserted down into the flow, the water level in the tube will rise to the water surface elevation in the channel. If a tube with a 90-degree elbow is inserted into the flow with the open end pointing into the flow, then the water level will rise to a level higher than the water surface elevation in the channel—this distance is a measure of the ability of the water velocity to do work. Using Newton's Laws of Motion, this distance is

$v^2/2g$, where g is the acceleration due to gravity. Therefore, the total energy head at a point in an open channel is: $d + z + v^2/2g$.

As water flows down a channel, the flow loses energy because of friction and turbulence. The total energy head between two points in a channel reach may be set equal to one another if the losses between the sections are added to the downstream total energy head. This equality is commonly known as the Energy Equation, which is expressed as:

$$d_1 + \frac{v_1^2}{2g} + z_1 = d_2 + \frac{v_2^2}{2g} + z_2 + h_{loss} \quad (3.1-2)$$

where:

| | |
|--------------|--|
| $d_1, d_2 =$ | Depth of open channel flow at channel sections 1 and 2, respectively, in feet |
| $v_1, v_2 =$ | Average channel velocities at channel sections 1 and 2, respectively, in feet per second |
| $z_1, z_2 =$ | Channel elevations above an arbitrary datum at channel sections 1 and 2, respectively, in feet |
| $h_{loss} =$ | Head or energy loss between channel sections 1 and 2, in feet |
| $g =$ | Acceleration due to gravity, 32.174 ft/sec ² |

A longitudinal profile of total energy head elevations is called the energy grade line (gradient). The longitudinal profile of water surface elevations is called the hydraulic grade line (gradient). The energy and hydraulic grade lines for uniform open channel flow are illustrated in Figure 3.1-1. For flow to occur in an open channel, the energy grade line must have a negative slope in the direction of flow. A gradual decrease in the energy grade line for a given length of channel represents the loss of energy caused by friction. When considered together, the hydraulic and energy grade lines reflect not only the loss of energy by friction, but also the conversion between potential and kinetic forms of energy.

For uniform flow conditions, the energy grade line is parallel to the hydraulic grade line, which is parallel to the channel bottom (see Figure 3.1-1). **Thus, for uniform flow, the slope of the channel bottom becomes an adequate basis for the determination of friction losses.** During uniform flow, no conversions occur between kinetic and potential forms of energy. If the flow is accelerating, the hydraulic grade line would be steeper than the energy grade line, while decelerating flow would produce an energy grade line steeper than the hydraulic grade line.

The Energy Equation presented in Equation 3.1-2 ignores the effect of a non-uniform velocity distribution on the computed velocity head. The actual distribution of velocities over a channel section are non-uniform (i.e., slow along the bottom and faster in the middle). The velocity head for actual flow conditions generally is greater than the value computed using the average channel velocity. Find guidance on kinetic energy coefficients that account for non-uniform velocity conditions in Chapter 5 (Bridge Hydraulics).

For typical prismatic channels with a fairly straight alignment, the effect of disregarding the existence of a non-uniform velocity distribution is negligible, especially when compared to other uncertainties involved in such calculations. Therefore, Equation 3.1-2 is appropriate for most open channel problems. However, if velocity distributions are non-typical, obtain additional information related to velocity coefficients, as presented by Chow (1959) or Henderson (1966).

Equation 3.1-2 also assumes that the hydrostatic law of pressure distribution is applicable. This law states that the distribution of pressure over the channel cross section is the same as the distribution of hydrostatic pressure; that is, that the distribution is linear with depth. The assumption of a hydrostatic pressure distribution for flowing water is valid only if the flow is not accelerating or decelerating in the plane of the cross section. Thus, restrict the use of Equation 3.1-2 to conditions of uniform or gradually varied non-uniform flow. If the flow will be varying rapidly, obtain additional information, as presented by Chow (1959) or Henderson (1966).

3.1.1.3 Momentum

According to Newton's Second Law of Motion, the change of momentum per unit of time is equal to all the resultant external forces applied to the moving body. Applying this principle to open channel flow produces a relationship that is virtually the same as the Energy Equation expressed in Equation 3.1-2. Theoretically, these principles of energy and momentum are unique, primarily because energy is a scalar quantity (magnitude only), while momentum is a vector quantity (magnitude and direction). In addition, the head loss determined by the Energy Equation measures the internal energy dissipated in a particular channel reach, while the Momentum Equation measures the losses due to external forces exerted on the water by the walls of the channel. However, for uniform flow, since the losses due to external forces and internal energy dissipation are equal, the Momentum and Energy Equations give the same results.

Applying the momentum principle has certain advantages for problems involving substantial changes of internal energy, such as a hydraulic jump. Thus, the momentum principle for evaluating rapidly varied non-uniform flow conditions should be used. Theoretical details of the momentum principle applied to open channel flow are presented by Chow (1959) and Henderson (1966). Section 3.1.4.3 provides a brief presentation of hydraulic jump fundamentals.

3.1.2 Uniform Flow

Although steady uniform flow is rare in drainage facilities, it is practical in many cases to assume that steady uniform flow occurs in appropriate segments of an open channel system. The results obtained from calculations based on this assumption will be approximate and general, but still can provide satisfactory solutions for many practical problems.

3.1.2.1 Manning's Equation

Determine the hydraulic capacity of an open channel by applying Manning's Equation, which determines the average velocity when given the depth of flow in a uniform channel cross section. Given the velocity, calculate the capacity (Q) as the product of velocity and cross-sectional area (see Equation 3.1-1).

Manning's Equation is an empirical equation with values of constants and exponents derived from experimental data of turbulent flow conditions. According to Manning's Equation, the mean velocity of flow is a function of the channel roughness, the hydraulic radius, and the slope of the energy gradient. As noted previously, for uniform flow, assume that the slope of the energy gradient is equal to the channel bottom slope. Manning's Equation is expressed mathematically as follows:

$$v = \frac{1.486}{n} R^{2/3} S^{1/2} \quad (3.1-3)$$

or

$$Q = \frac{1.486}{n} AR^{2/3} S^{1/2} \quad (3.1-4)$$

where:

- v = Average channel velocity, in feet per second
- Q = Discharge, in cubic feet per second
- n = Manning's roughness coefficient
- R = Hydraulic radius of the channel, in feet, calculated: $R = \frac{A}{P}$

P = Wetted perimeter of channel, in feet
 S = Slope of the energy gradient, in feet per foot
 A = Cross-sectional area of the open channel, in square feet

Values for Manning's roughness coefficient for artificial channels (i.e., roadside, median, interceptor, and outfall ditches) are listed in Chapter 2 (Section 2.7) of the *Drainage Manual*. Guidance on methods for estimate Manning's roughness coefficient for natural channels is found in Chapter 5 (Bridge Hydraulics).

Example 3.1-1—Discharge given Normal Depth

Given: Depth = 0.6 ft
 Longitudinal Slope = 0.005 ft/ft
 Trapezoidal Cross Section shown below
 Manning's Roughness = 0.06

Calculate: Discharge, assuming normal depth

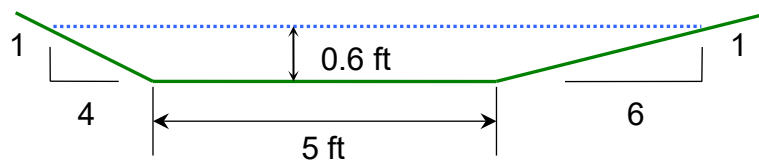

*Not to scale

Note: To make things easier, try breaking the drawing into three parts: two triangles and a rectangle.

Step 1: Calculate Wetted Perimeter and Cross-Sectional Area

Wetted Perimeter (P):

Solve for the left triangle's hypotenuse

$$x = \sqrt{0.6^2 + (4 \times 0.6)^2}$$

$$x = 2.474 \text{ ft}$$

Solve for the right triangle's hypotenuse

$$x = \sqrt{0.6^2 + (6 \times 0.6)^2}$$

$$x = 3.650 \text{ ft}$$

Wetted Perimeter (P) = 2.474 + 3.650 + 5 = 11.124 ft

Cross-Sectional Area (A):

Solve for the left triangle's area

$$A_1 = \frac{1}{2}(4 \times 0.6)(0.6)$$

$$A_1 = 0.72 \text{ ft}^2$$

Solve for the right triangle's area

$$A_2 = \frac{1}{2}(6 \times 0.6)(0.6)$$

$$A_2 = 1.08 \text{ ft}^2$$

Solve for the rectangle's area

$$A_3 = 5 \times 0.6$$

$$A_3 = 3 \text{ ft}^2$$

$$\text{Cross-Sectional Area (A)} = 0.72 + 1.08 + 3 = 4.8 \text{ ft}^2$$

Step 2: Calculate Hydraulic Radius

$$\text{Hydraulic Radius (R)} = \frac{A}{P}$$

$$\text{Hydraulic Radius (R)} = \frac{4.8}{11.124} = 0.4315 \text{ ft}$$

Step 3: Calculate Average Velocity

$$\text{Average Velocity (v)} = \frac{1.486}{n} (R)^{2/3} (S)^{1/2}$$

$$\text{Average Velocity (v)} = \frac{1.486}{0.06} (0.4315)^{2/3} (0.005)^{1/2} = 1.00 \text{ ft/sec}$$

Step 4: Calculate the Discharge

$$\text{Discharge (Q)} = v \times A$$

$$\text{Discharge (Q)} = 1.00 \text{ ft/sec} \times 4.8 \text{ ft}^2 = 4.80 \text{ ft}^3/\text{sec}$$

As an alternative approach, Example C.1 of Appendix C solves this example problem using equations from Figure C-4.

Example 3.1-1 has a direct solution because the depth is known. The next problem will be more difficult to solve because the discharge will be given and the normal depth must be calculated. The equations cannot be solved directly for depth, so an iterative process is used to solve for normal depth. You also can solve Example 3.1-1 using the charts in Appendix C.

Example 3.1-2—Normal Depth given Discharge

Given:

Discharge = $9 \text{ ft}^3/\text{sec}$

Use the channel cross section shape, slope, and Manning's roughness coefficient given in Example 3.1-1

Calculate:

Normal Depth

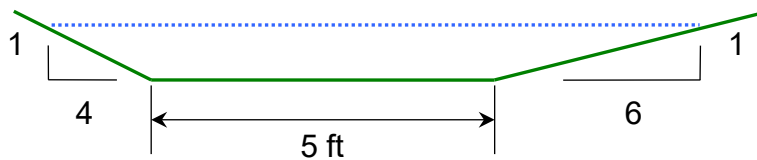

Note: The solution must use trial and error since you cannot solve the equations implicitly for depth. Perform the first trial in the steps below and the remaining trials will be shown in a table. The initial trial depth (i.e., the first guess) should be greater than the depth given previously in Example 3.1-1 because the discharge is greater. So we will perform our trial with an estimated depth of flow of 0.8 ft.

Step 1: Calculate Wetted Perimeter and Cross-Sectional Area

Wetted Perimeter (P):

Solve for the left triangle's hypotenuse

$$x = \sqrt{0.8^2 + (4 \times 0.8)^2}$$

$$x = 3.298 \text{ ft}$$

Solve for the right triangle's hypotenuse

$$x = \sqrt{0.8^2 + (6 \times 0.8)^2}$$

$$x = 4.866 \text{ ft}$$

$$\text{Wetted Perimeter (P)} = 3.298 + 4.866 + 5 = 13.164 \text{ ft}$$

Cross-sectional Area (A):

Solve for the left triangle's area

$$A_1 = \frac{1}{2}(4 \times 0.8)(0.8)$$

$$A_1 = 1.28 \text{ ft}^2$$

Solve for the right triangle's area

$$A_2 = \frac{1}{2}(6 \times 0.8)(0.8)$$

$$A_2 = 1.92 \text{ ft}^2$$

Solve for the rectangle's area

$$A_3 = 5 \times 0.8$$

$$A_3 = 4 \text{ ft}^2$$

$$\text{Cross-Sectional Area (A)} = 1.28 + 1.92 + 4 = 7.2 \text{ ft}^2$$

Step 2: Calculate Hydraulic Radius

$$\text{Hydraulic Radius (R)} = \frac{A}{P}$$

$$\text{Hydraulic Radius (R)} = \frac{7.2}{13.164} = .547 \text{ ft}$$

Step 3: Calculate Average Velocity

$$\text{Average Velocity (v)} = \frac{1.486}{n} (R)^{2/3} (S)^{1/2}$$

$$\text{Average Velocity (v)} = \frac{1.486}{0.06} (0.547)^{2/3} (0.005)^{1/2} = 1.171 \text{ ft/sec}$$

Step 4: Calculate the Discharge

$$\text{Discharge (Q)} = v \times A$$

$$\text{Discharge (Q)} = 1.171 \text{ ft/sec} \times 7.20 \text{ ft}^2 = 8.43 \text{ ft}^3/\text{sec}$$

The discharge calculated in Step 4 is still less than 9 ft³/sec, so normal depth is greater than 0.8 feet. Use a slightly higher depth of flow for the next guess. The following table summarizes subsequent trials. The trial-and-error process continues until you achieve the ideal level of accuracy.

| Depth (ft) | Area | Perimeter | Radius | Velocity | Discharge |
|------------|---------|-----------|----------|----------|-----------|
| 0.8 | 7.2 | 13.16469 | 0.546917 | 1.171 | 8.433 |
| 0.85 | 7.8625 | 13.67499 | 0.574955 | 1.211 | 9.521 |
| 0.82 | 7.462 | 13.36881 | 0.558165 | 1.187 | 8.859 |
| 0.826 | 7.54138 | 13.43005 | 0.56153 | 1.192 | 8.989 |

The normal depth for the given channel and flow rate is 0.83 feet. You should perform intermediate calculations using more significant digits than needed, and then round in the last step to avoid rounding errors.

The *Drainage Manual* recommends that, where the flow depth is greater than 0.7 feet, reduce the roughness value to 0.042. However, the normal depth using $n = 0.042$ is 0.69 feet. The recommended roughness for flow depths less than 0.7 feet is 0.06. The abrupt change in the recommended roughness values causes this anomaly. If the flow depth is

the primary concern, then using $n = 0.06$ will give a conservative answer. However, if the velocity is the primary concern, then using $n = 0.042$ is conservative.

3.1.3 Critical Flow

The energy content of flowing water with respect to the channel bottom often is referred to as the specific energy head, which is expressed by the equation:

$$E = d + \frac{v^2}{2g} \quad (3.1-5)$$

where:

| | |
|-----|---|
| E = | Specific energy head, in feet |
| d = | Depth of open channel flow, in feet |
| v = | Average channel velocity, in feet per second |
| g = | Acceleration due to gravity, 32.174 ft/sec ² |

Considering the relative values of potential energy (depth) and kinetic energy (velocity head) in an open channel can help you with the hydraulic analysis of open channel flow problems. Usually, you will perform these analyses using a curve that shows the relationship between the specific energy head and the depth of flow for a given discharge in a given channel that you can place on various slopes. Generally, you will use the curve representing specific energy head for an open channel to identify regions of super-critical and sub-critical flow conditions. This information usually is necessary to properly perform hydraulic capacity calculations and evaluate the suitability of channel linings and flow transition sections.

3.1.3.1 Specific Energy and Critical Depth

Figure 3.1-2 (Part B) illustrates a typical curve representing the specific energy head of an open channel. The straight diagonal line on this figure represents points where the depth of flow and specific energy head are equal. At these points, the kinetic energy is zero; therefore, this diagonal line is a plot of the potential energy, or energy due to depth. The ordinate interval between the diagonal line of potential energy and the specific energy curve for the ideal discharge is the velocity head, or kinetic energy, for the depth in question. The lowest point on the specific energy curve represents flow with the minimum content of energy. The depth of flow at this point is known as the critical depth. Express the general equation for determining the critical depth as:

$$\frac{Q^2}{g} = \frac{A^3}{T} \quad (3.1-6)$$

where:

| | |
|-----|---|
| Q = | Discharge, in cubic feet per second |
| g = | Acceleration due to gravity, 32.174 ft/sec ² |
| T = | Top width of water surface, in feet |
| A = | Cross-sectional area, in square feet |

You can calculate critical depth for a given channel through trial and error by using Equation 3.1-6. Chow (1959) presents a procedure for the analysis of critical flow that uses the Critical Flow Section Factor (Z), defined as the ratio of the cross-sectional area and the square root of the hydraulic depth, expressed mathematically as:

$$Z = \frac{A}{\sqrt{D}} = \frac{A}{\sqrt{A/T}} \quad (3.1-7)$$

where:

| | |
|-----|---|
| Z = | Critical flow section factor |
| A = | Cross-sectional area of the flow perpendicular to the direction of flow, in square feet |
| D = | Hydraulic depth, in feet |
| T = | Top width of the channel, in feet |

Using the definition of the critical section factor and a velocity distribution coefficient of one, the equation for critical flow conditions is:

$$Z = \frac{Q}{\sqrt{g}} \quad (3.1-8)$$

where:

| | |
|-----|---|
| Z = | Critical flow section factor |
| Q = | Discharge, in cubic feet per second |
| g = | Acceleration due to gravity, 32.174 ft/sec ² |

When you know the discharge, Equation 3.1-8 gives the critical section factor and, thus, by substitution into Equation 3.1-6, the critical depth. Conversely, when you know the critical section factor, you can calculate the discharge with Equation 3.1-8.

It is important to note that the determination of critical depth is independent of the channel slope and roughness, since critical depth simply represents a depth for which the specific energy head is at a minimum. According to Equation 3.1-6, the magnitude of critical depth depends only on the discharge and the shape of the channel. Thus, for any given size and shape of channel, there is only one critical depth for the given discharge, which is independent of the channel slope or roughness. However, if Z is not a single-valued

function of depth, it is possible to have more than one critical depth. For a given value of specific energy, the critical depth results in the greatest discharge, or conversely, for a given discharge, the specific energy is a minimum for the critical depth.

Example 3.1-3—Critical Depth given Discharge

Given:

Discharge = 9 ft³/sec

Cross Section and Roughness from Example 3.1-1

Calculate:

Critical Depth

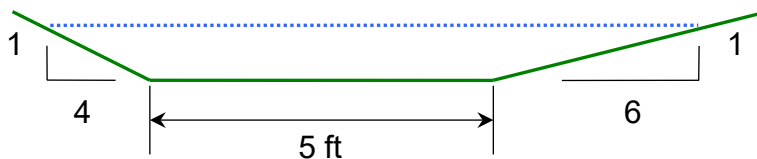

Note: The solution must use trial and error since you cannot implicitly solve the equations for depth. You can perform the first trial as shown in the steps below, with the remaining trials shown in a table. Typically, the slope of a roadside ditch channel must exceed 2 percent to have a normal depth that is super-critical. Since the slope in Example 3.1-1 and Example 3.1-2 is 0.5 percent, the critical depth is probably much less than the normal depth of 0.83 feet calculated in Example 3.1-2 for 9 cfs. So, we will perform our trial with an estimated depth of flow of 0.4 ft.

Step 1: Calculate Cross-Sectional Area

Cross-Sectional Area (A):

Solve for the left triangle's area

$$A_1 = \frac{1}{2}(4 \times 0.4)(0.4)$$

$$A_1 = 0.32 \text{ ft}^2$$

Solve for the right triangle's area

$$A_2 = \frac{1}{2}(6 \times 0.4)(0.4)$$

$$A_2 = 0.48 \text{ ft}^2$$

Solve for the rectangle's area

$$A_3 = 5 \times 0.4$$

$$A_3 = 2 \text{ ft}^2$$

$$\text{Cross-Sectional Area (A)} = 0.32 + 0.48 + 2 = 2.8 \text{ ft}^2$$

Step 2: Calculate Top Width

Top Width (T):

$$\text{Base Length of Left Triangle} + \text{Bottom Width} + \text{Base Length of Right Triangle} \\ (4 \times 0.4) + 5 + (6 \times 0.4) = 9 \text{ ft}$$

Step 3: Rearrange Equation 3.1-6 to Solve for Discharge

$$\frac{Q^2}{g} = \frac{A^3}{T}$$

$$Q^2 = \frac{A^3}{T} \times g$$

$$Q = \sqrt{\frac{A^3}{T} \times g}$$

$$Q = \sqrt{\frac{2.8^3}{9} \times 32.174} = 8.86 \text{ ft}^3/\text{sec}$$

The discharge calculated in Step 3 is less than 9 ft³/sec, so critical depth is greater than 0.4 feet. Use a slightly higher depth of flow for the next guess. The following table summarizes subsequent trials. The trial-and-error process continues until you achieve the ideal level of accuracy.

| Depth (ft) | Area (sq. ft.) | Top Width | Discharge (cfs) |
|------------|----------------|-----------|-----------------|
| 0.4 | 2.8 | 9 | 8.858665864 |
| 0.45 | 3.2625 | 9.5 | 10.84467413 |
| 0.41 | 2.8905 | 9.1 | 9.2404111 |
| 0.404 | 2.83608 | 9.04 | 9.010440628 |

You also can solve this problem by determining the minimum specific energy, as discussed in the previous section. The following table solves Equation 3.1-5 for depths bracketing the critical depth determined above and shows that the critical depth has the minimum specific energy.

| Depth (ft) | Area (sq. ft.) | Perimeter (ft) | Velocity (ft/sec) | V ² /2g | Specific Energy |
|------------|----------------|----------------|-------------------|--------------------|-----------------|
| 0.403 | 2.827045 | 9.112965 | 3.18354 | 0.1575 | 0.560501438 |
| 0.404 | 2.83608 | 9.123171 | 3.17339 | 0.1565 | 0.560499521 |
| 0.405 | 2.845125 | 9.133377 | 3.16331 | 0.15551 | 0.56050604 |

Most computer programs that solve water surface profiles for natural channels use the minimum specific energy approach. For more information, refer to Chapter 5 (Bridge Hydraulics).

3.1.3.2 Critical Velocity

The velocity at critical depth is called the critical velocity. An equation for determining the critical velocity in an open channel of any cross section is:

$$v_c = \sqrt{gd_m} \quad (3.1-9)$$

where:

v_c = Critical velocity, in feet per second
 g = Acceleration due to gravity, 32.174 ft/sec²
 d_m = Mean depth of flow, in feet, calculated from:

$$d_m = \frac{A}{T} \quad (3.1-10)$$

where:

A = Cross-sectional area, in square feet
 T = Top width of water surface, in feet

3.1.3.3 Super-Critical Flow

For conditions of uniform flow, the critical depth, or point of minimum specific energy, occurs when the channel slope equals the critical slope (i.e., the normal depth of flow in the channel is critical depth). When channel slopes are steeper than the critical slope and uniform flow exists, the specific energy head is higher than the critical value due to higher values of the velocity head (kinetic energy). The specific head curve segment to the left of critical depth in Figure 3.1-2 (Part B) illustrates this characteristic of open channel flow, which is known as super-critical flow. Super-critical flow is characterized by relatively shallow depths and high velocities, as shown in Figure 3.1-2 (Part A). If the natural depth of flow in an open channel is super-critical, you can influence the depth of flow at any point in the channel by an upstream control section. The relationship of super-critical flow to the specific energy curve is shown in Figure 3.1-2 (Parts A and B).

3.1.3.4 Sub-Critical Flow

When channel slopes are flatter than the critical slope and uniform flow exists, the specific energy head is higher than the critical value due to higher values of the normal depth of flow (potential energy). The specific head curve segment to the right of critical depth in Figure 3.1-2 (Part B) illustrates this characteristic of open channel flow, which is known as sub-critical flow. Sub-critical flow is characterized by relatively large depths with low velocities, as shown in Figure 3.1-2 (Part C). If the natural depth of flow in an open channel is sub-critical, a downstream control section can influence the depth of flow at any point in the channel. The relationship of sub-critical flow to the specific energy curve is shown in Figure 3.1-2 (Parts B and C).

3.1.3.5 Theoretical Considerations

There are several noteworthy points about Figure 3.1-2. First, at depths of flow near the critical depth for any discharge, a minor change in specific energy will cause a much greater change in depth. Second, the velocity head for any discharge in the sub-critical portion of the specific energy curve in Figure 3.1-2 (Parts B and C) is relatively small when compared to specific energy. For this sub-critical portion of the specific energy curve, changes in depth of flow are approximately equal to changes in specific energy. Finally, the velocity head for any discharge in the super-critical portion of the specific energy curve increases rapidly as depth decreases. For this super-critical portion of the specific energy curve, changes in depth are associated with much greater changes in specific energy.

3.1.4 Non-Uniform Flow

In locations where changes in the channel section or slope will cause non-uniform flow profiles, you cannot directly solve Manning's Equation since the energy gradient for this situation does not equal the channel slope. Three typical examples of non-uniform flow are illustrated in Figures 3.1-3 through 3.1-5, below. The following sections describe these non-uniform flow profiles and briefly explain how to use the total head line for approximating these water surface profiles in a qualitative manner.

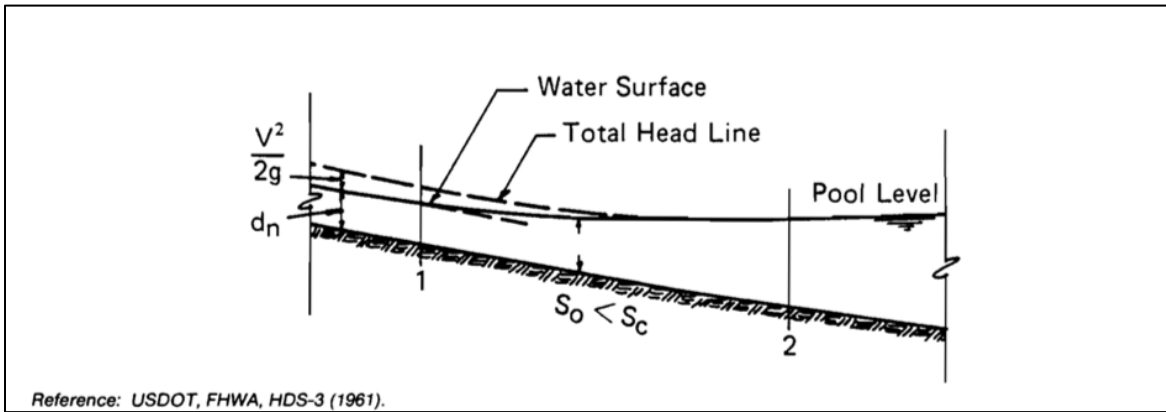

Figure 3.1-3: Non-Uniform Water Surface Profile for Downstream Control Caused by a Flow Restriction

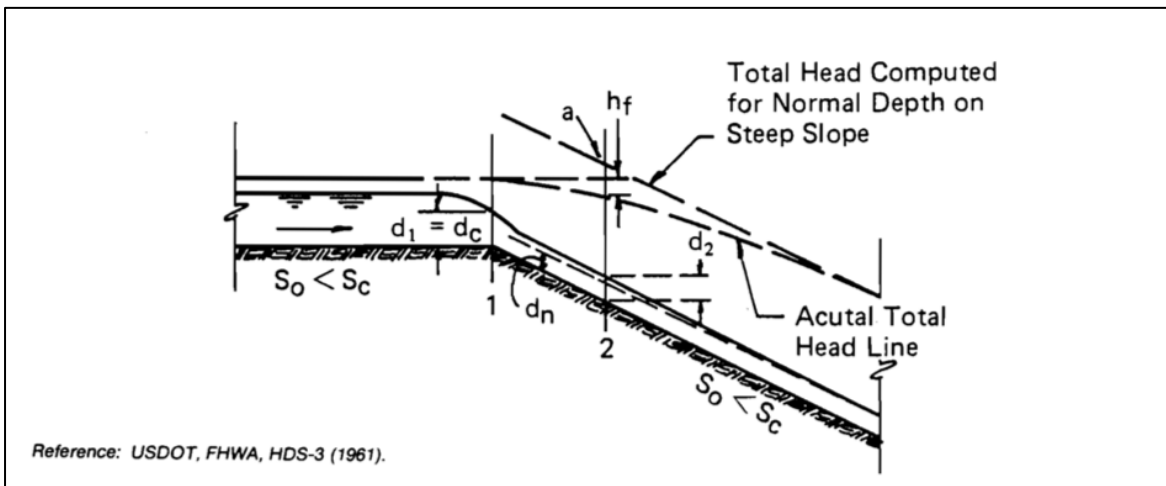

Figure 3.1-4: Non-Uniform Water Surface Profile Caused by a Change in Slope Conditions

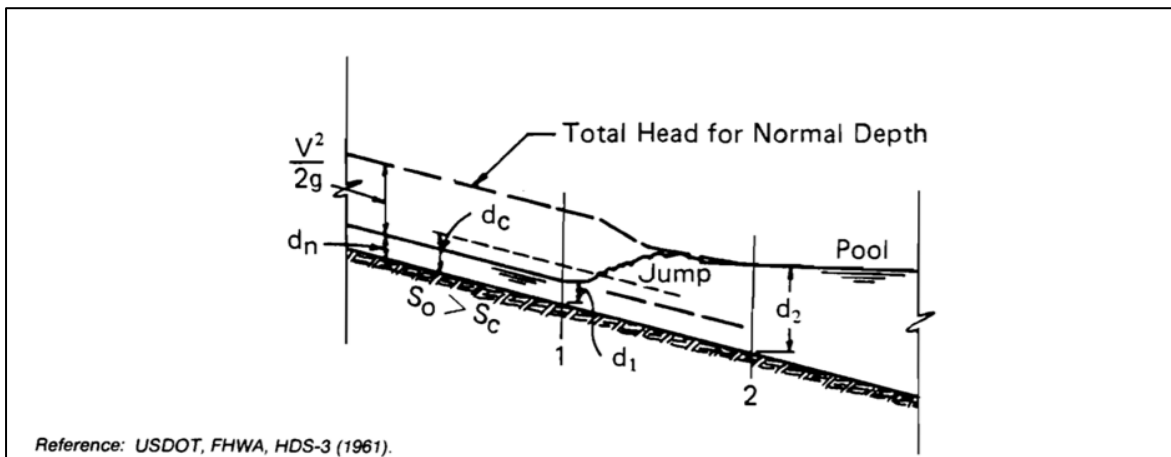

Figure 3.1-5: Non-Uniform Water Surface Profile Caused by a Hydraulic Jump

3.1.4.1 Gradually Varied Flow

Figure 3.1-3 illustrates a channel on a mild slope (sub-critical) discharging into a reservoir or pool. The figure exaggerates the vertical scale for clearer illustration.

Cross Section 1 is upstream of the pool, where uniform flow occurs in the channel. Cross Section 2 is at the beginning of a level pool. The depth of flow between Sections 1 and 2 is changing, and the flow is non-uniform. The water surface profile between the sections is known as a backwater curve and is characteristically very long.

Figure 3.1-4 illustrates a channel in which the slope changes from sub-critical (mild) to super-critical (steep). The flow profile passes through critical depth near the break in slope (Section 1). This is true whether the upstream slope is mild, as in the sketch, or the water above Section 1 is ponded, as would be the case if Section 1 were the crest of a dam spillway. If, at Section 2, you were to compute the total head, assuming normal depth on the steep slope, it would plot above the elevation of total head at Section 1 (Point “a” in Figure 3.1-4). This is physically impossible, because the total head line must slope downward in the direction of flow. The actual total head line will take the position shown and have a slope approximately equal to S_o , the slope of the channel bottom, at Section 1 and approaching S_o farther downstream. The drop in the total head line (h_{loss}) between Sections 1 and 2 represents the loss in energy due to friction.

At Section 2, the actual depth (d_2) is greater than normal depth (d_n) because sufficient acceleration has not occurred, and the assumption of normal depth at this point would clearly be in error. As you move Section 2 downstream, so that the total head for normal depth drops below the pool elevation above Section 1, the actual depth quickly approaches the normal depth for the steep channel. This type of water surface curve (Section 1 to Section 2) is characteristically much shorter than the backwater curve discussed previously.

Another common type of non-uniform flow is the drawdown curve to critical depth that occurs upstream from Section 1 (Figure 3.1-4) where the water surface passes through critical depth. The depth gradually increases upstream from critical depth to normal depth, provided that the channel remains uniform over a sufficient distance. The length of the drawdown curve is much longer than the curve from critical depth to normal depth in the steep channel.

3.1.4.2 Gradually Varied Flow Profile Computation

Typically, you can compute water surface profiles using the Energy Equation (Equation 3.1-2). Given the channel geometry, flow, and the depth at one of the cross sections, compute the depth at the other cross section.

The losses between cross sections include friction, expansion, contraction, bend, and other form losses. Expansion, contraction, bend, and other form losses will be neglected in the computations presented in this design guide. Refer to Chapter 5 (Bridge Hydraulics) for more information. Determine the remaining loss—the friction loss—which is expressed as:

$$h_f = S_f L \quad (3.1-11)$$

where:

h_f = Friction head loss, in feet
 S_f = Slope of the energy grade line, in feet per foot
 L = Flow length between cross sections, in feet

Calculate the slope of the energy grade line at each cross section by rearranging Manning's Equation (Equation 3.1-4) into the following expression:

$$S = \left(\frac{Qn}{1.49AR^{2/3}} \right)^2 \quad (3.1-12)$$

For uniform flow, the slope of the channel bed, the slope of the water surface (hydraulic grade line), and the slope of the energy grade line are all equal. For non-uniform flow, including gradually varied flow, each slope is different.

Use the slope determined at each cross section to estimate the average slope for the entire flow length between the cross sections. You can use several different averaging schemes to estimate the average slope, and these techniques are discussed in more detail in the Chapter 5 (Bridge Hydraulics). The simplest estimate of slope of the energy gradient between two sections is:

$$S_f = \frac{S_1 + S_2}{2} \quad (3.1-13)$$

where:

S_1, S_2 = Slope of the energy gradient at Sections 1 and 2, in feet per foot

Computing backwater curves in a quantitative manner can be quite complex. If you require a detailed analysis of backwater curves, consider using computer software for this purpose. Typical computer programs used for water surface profile computations include HEC-RAS by the U.S. Army Corps of Engineers, HEC-2 by the U.S. Army Corps of Engineers (1991), E431 by the USGS (1984), and WSPRO by the USGS (1986). In

addition, textbooks by Chow (1959), Henderson (1966), or Streeter (1971), and publications by the USGS (1976b), Brater and King (1976), or the USDA, SCS (NEH-5, 2008) may be useful.

Example 3.1.4—Gradually Varied Flow Example

Upon consultation, the District Drainage Engineer approved an exception to the minimum ditch bottom width (5.0 ft.) due to a right-of-way constraint. The ditch cross section previously used must be reduced to a 3.5-foot bottom width and a 1:3 back slope for a distance of 100 feet. The transition length between the two ditch shapes is 15 feet.

Given:

Discharge = 25 ft³/sec

Roughness = 0.04

Cross Section from Example 3.1-1

Slope = 0.005 ft/ft

Calculate:

Depth of flow in narrower cross section

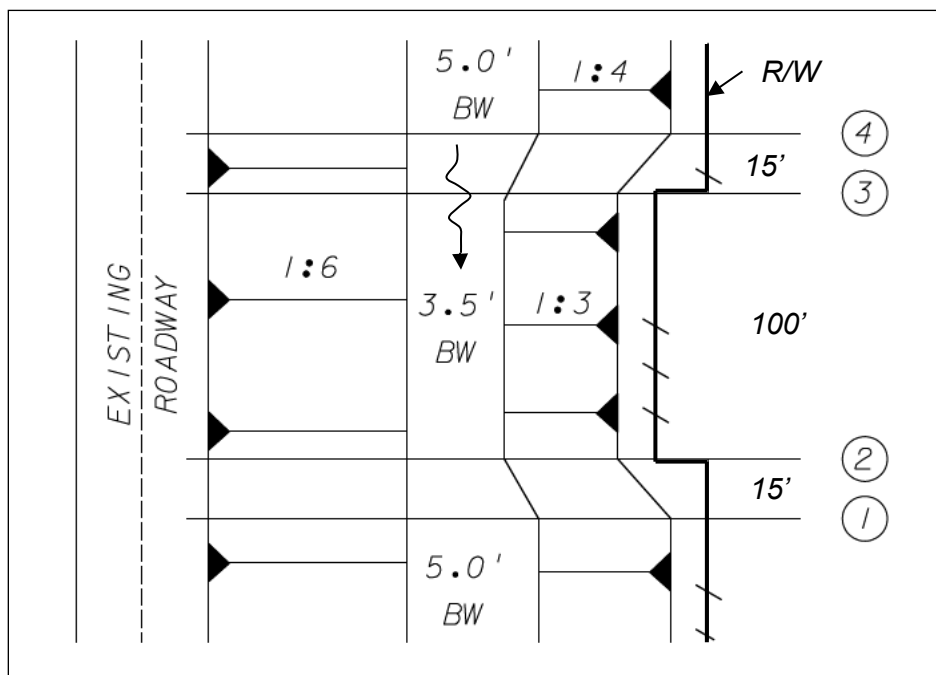

Figure 3.1-6: Plan View

You can estimate the flow depths in the two cross sections using the slope conveyance method, which solves Manning’s Equation and assumes that the ditch is flowing at normal depth. Example C.2 (Appendix C) shows the computation of the normal depths for the

ditch in this problem using the nomographs in Appendix C. The normal depth in the standard ditch is 1.12 feet, and the normal depth in the narrowed ditch is 1.25 feet.

Although it is not standard practice to perform a standard step backwater analysis in a roadside ditch, solving this example will illustrate how a gradually varied profile can be computed using Equations 3.1-2 and 3.1-10 through 3.1-12.

The Froude Number (Fr) for normal depth flow at the first section is:

$$Area = (1.12 \times 5) + \frac{1}{2}(6 \times 1.12)(1.12) + \frac{1}{2}(4 \times 1.12)(1.12) = 11.87 \text{ sq. ft.}$$

$$T = 5 + (6 + 4)1.12 = 16.2 \text{ ft.} \quad D = \frac{A}{T} = \frac{11.87}{16.2} = 0.733$$

$$v = \frac{Q}{A} = \frac{25}{11.87} = 2.11 \text{ fps}$$

$$Fr = \frac{v}{(gD)^{1/2}} = \frac{2.11}{(32.174 \times 0.733)^{1/2}} = 0.43$$

Because Fr is less than one, the flow in the channel will be sub-critical. Therefore, you will start the analysis at the downstream cross section and proceed upstream. Assume normal depth in the standard ditch at a point just downstream of the downstream transition (Section 1 in the figure above). This assumes that the ditch downstream is uniform for a sufficient distance to establish normal depth at Section 1.

The water depth at Section 1 is 1.12 feet, as determined in Example C.2 (Appendix C). The first row of the table on the next page shows this depth, along with other geometric and hydraulic values needed for the computations. The elevation, z , is arbitrarily taken as zero. Next, you will determine the depth at Section 2 from a trial-and-error procedure. The first trial depth will be the normal depth at Section 2, which is 1.25 feet. Use Equations 3.1-10, 3.1-11, 3.1-12, and 3.1-2 to back calculate the depth at Section 2. The back-calculated depth of 1.11 feet is shown in the last column. You can assume additional trial depths until the trial and the back-calculated depths agree at the chosen level of accuracy.

After you have calculated the depth at Section 2, then calculate the depth at Section 3 using the same trial-and-error process. Repeat the same process to solve for the depth at Section 4.

Drainage Design Guide
Chapter 3: Open Channel

| | 1 | 2 | 3 | 4 | 5 | 6 | 7 | 8 | 9 | 10 | 11 |
|------|------------------|-------------------------|----------------|-------------|------------------|--------------------------|--------|----------|----------|-----------|------------|
| XS # | Depth Guess (ft) | Area (ft ²) | Perimeter (ft) | Radius (ft) | Velocity (ft /s) | V ² / 2g (ft) | Z (ft) | EGL (ft) | Slope | Loss (ft) | Depth (ft) |
| 1 | 1.12 | 11.872 | 16.43057 | 0.72256 | 2.105795 | 0.068912 | 0 | 1.188912 | 0.005 | | |
| | 1.25 | 11.40625 | 15.0563 | 0.75757 | 2.191781 | 0.074655 | 0.075 | 1.399655 | 0.00504 | 0.075301 | 1.114558 |
| | 1.1 | 9.295 | 13.66954 | 0.67998 | 2.689618 | 0.112421 | 0.075 | 1.287421 | 0.008766 | 0.103245 | 1.104737 |
| | 1.104 | 9.348672 | 13.70652 | 0.68206 | 2.674177 | 0.111134 | 0.075 | 1.290134 | 0.00863 | 0.102228 | 1.105007 |
| 2 | 1.105 | 9.362113 | 13.71577 | 0.68258 | 2.670337 | 0.110815 | 0.075 | 1.290815 | 0.008597 | 0.101977 | 1.105075 |
| | 1.25 | 11.40625 | 15.0563 | 0.75757 | 2.191781 | 0.074655 | 0.575 | 1.899655 | 0.00504 | 0.681854 | 1.323014 |
| | 1.29 | 12.00345 | 15.4261 | 0.77812 | 2.082735 | 0.067411 | 0.575 | 1.932411 | 0.004392 | 0.649423 | 1.297827 |
| | 1.296 | 12.09427 | 15.48157 | 0.78120 | 2.067094 | 0.066403 | 0.575 | 1.937403 | 0.004303 | 0.645002 | 1.294414 |
| 3 | 1.295 | 12.07911 | 15.47233 | 0.78069 | 2.069688 | 0.066569 | 0.575 | 1.936569 | 0.004318 | 0.645732 | 1.294977 |
| | 1.12 | 11.872 | 16.43057 | 0.72256 | 2.105795 | 0.068912 | 0.65 | 1.838912 | 0.004955 | 0.069549 | 1.287206 |
| | 1.28 | 14.592 | 18.06351 | 0.80781 | 1.713268 | 0.045616 | 0.65 | 1.975616 | 0.002827 | 0.053585 | 1.294538 |
| | 1.294 | 14.84218 | 18.20639 | 0.81522 | 1.684389 | 0.044091 | 0.65 | 1.988091 | 0.002699 | 0.052628 | 1.295107 |
| 4 | 1.295 | 14.86013 | 18.2166 | 0.81575 | 1.682355 | 0.043985 | 0.65 | 1.988985 | 0.002691 | 0.052562 | 1.295147 |

- Column 2. Use Area formula for trapezoid with the depth guessed in Column 1
- Column 3. Use Wetted Perimeter formula for trapezoid with depth guessed in Column 1
- Column 4. Column 2 ÷ Column 3
- Column 5. Q ÷ Column 2
- Column 8. Column 1 + Column 6 + Column 7
- Column 9. Solve Equation 3.1-12 using Column 2 and Column 4 values
- Column 10. Calculate S_f with Equation 3.1-13 using Column 9 from this row and last row of previous section. Calculate the loss with Equation 3.1-11 by multiplying S_f by the distance to the previous cross section.
- Column 11. Back calculate Depth by calculating the Total Energy (Col. 8 of previous cross section + Col. 10) and subtracting the Datum and the Velocity Head (Col. 7 + Col. 6).

Looking at the results of the profile analysis on the previous page, there are several things you might not expect. First, the flow depth at Section 2 (1.105 feet) is less than the flow depth at Section 1 (1.12 feet), which might be unexpected because the normal depth of Section 2 is greater than Section 1. However, this is not an unusual occurrence in contracted sections. The reason that the flow depth decreases is because the velocity, and, therefore, the velocity head, increases. The increase in the velocity head is greater than the losses between the sections; therefore, the depth must decrease to balance the energy equation. The opposite can occur in an expanding reach, resulting in an unexpected rise in the flow depth even though the normal depth decreases.

The next unusual result is that the flow depth at Section 3 is greater than the normal depth in the narrow section. Since the flow depth is less than normal depth at Section 2, the water surface profile should approach normal depth from below as the calculations proceed upstream. Therefore, the flow depth at Section 3 should be less than the normal depth. The reason that the profile jumps over the normal depth line is because of numerical errors introduced by Equation 3.1-13. When the change in the energy gradient between two cross sections is too large, Equation 3.1-13 does not accurately estimate the average energy gradient between the sections. Cross sections must be added between these cross sections to reduce the numerical errors to an acceptable amount.

This example was solved using HEC-RAS with the extra cross sections added. The details are described below, but the results indicate that the flow depth essentially converges to normal depth within the 100-foot distance between Sections 2 and 3. The normal depth is 1.25 feet compared to the 1.24 feet computed by HEC-RAS at Section 3. This illustrates one of the primary reasons that **water surface profiles are not necessary in the typical roadside ditch design**. The water depth does not significantly vary from normal depth at any location. So, assuming that the design includes some freeboard, the ditch will operate adequately when designed by assuming normal depth.

HEC-RAS Solution:

Four cross sections with the trapezoidal ditch shapes and slope were input into the program. The expansion and contraction coefficients were changed to zero so that the only the friction loss will be calculated. The friction loss method also was changed to the Average Friction Loss to match Equation 3.1-13. The results of the analysis are shown below.

| HEC-RAS Plan: [Reload Data] | | | | | | | | | | | | |
|-----------------------------|-----------|---------|------------------|-------------------|-------------------|-------------------|-------------------|-----------------------|--------------------|----------------------|-------------------|--------------|
| Reach | River Sta | Profile | Q Total (cfs) | Min Ch El (ft) | W.S. Elev (ft) | Crit W.S. (ft) | E.G. Elev (ft) | E.G. Slope (ft/ft) | Vel Chnl (ft/s) | Flow Area (sq ft) | Top Width (ft) | Froude # Chl |
| Narrow | 130 | PF 1 | 25.00 | 0.65 | 1.94 | | 1.99 | 0.002703 | 1.69 | 14.84 | 17.94 | 0.33 |
| Narrow | 115 | PF 1 | 25.00 | 0.57 | 1.87 | | 1.94 | 0.004270 | 2.06 | 12.12 | 15.16 | 0.41 |
| Narrow | 15 | PF 1 | 25.00 | 0.08 | 1.18 | | 1.29 | 0.008655 | 2.68 | 9.34 | 13.43 | 0.57 |
| Narrow | 0 | PF 1 | 25.00 | 0.00 | 1.12 | 0.72 | 1.19 | 0.005003 | 2.11 | 11.83 | 16.17 | 0.44 |

To compare the results with the spreadsheet solution, the depth of flow must be calculated from the water surface elevation.

| Section | River Station | Water Surface | Z | Flow Depth (Ft.) |
|---------|---------------|---------------|-------|------------------|
| 1 | 0 | 1.12 | 0 | 1.12 |
| 2 | 15 | 1.18 | 0.075 | 1.11 |
| 3 | 115 | 1.87 | 0.575 | 1.30 |
| 4 | 130 | 1.94 | 0.65 | 1.29 |

The flow depths match the solution in Section 2. However, a conveyance ratio warning at Section 3 indicates a possible error at that location. To improve the analysis, extra cross sections were inserted between Section 2 and 3. Four cross sections are added by interpolation and the profile is recomputed. The results are shown below:

| HEC-RAS Plan: Plan 02 River: Ditch Reach: Narrow Profile: PF 1 [Reload Data] | | | | | | | | | | | | |
|--|-----------|---------|------------------|-------------------|-------------------|-------------------|-------------------|-----------------------|--------------------|----------------------|-------------------|--------------|
| Reach | River Sta | Profile | Q Total (cfs) | Min Ch El (ft) | W.S. Elev (ft) | Crit W.S. (ft) | E.G. Elev (ft) | E.G. Slope (ft/ft) | Vel Chnl (ft/s) | Flow Area (sq ft) | Top Width (ft) | Froude # Chl |
| Narrow | 130 | PF 1 | 25.00 | 0.65 | 1.90 | | 1.95 | 0.003100 | 1.77 | 14.11 | 17.52 | 0.35 |
| Narrow | 115 | PF 1 | 25.00 | 0.57 | 1.81 | | 1.89 | 0.005171 | 2.21 | 11.29 | 14.66 | 0.44 |
| Narrow | 95.* | PF 1 | 25.00 | 0.47 | 1.71 | | 1.78 | 0.005300 | 2.24 | 11.18 | 14.58 | 0.45 |
| Narrow | 75.* | PF 1 | 25.00 | 0.37 | 1.60 | | 1.68 | 0.005491 | 2.26 | 11.04 | 14.49 | 0.46 |
| Narrow | 55.* | PF 1 | 25.00 | 0.27 | 1.48 | | 1.56 | 0.005833 | 2.32 | 10.79 | 14.34 | 0.47 |
| Narrow | 35.* | PF 1 | 25.00 | 0.17 | 1.35 | | 1.44 | 0.006451 | 2.40 | 10.41 | 14.13 | 0.49 |
| Narrow | 15 | PF 1 | 25.00 | 0.08 | 1.18 | | 1.29 | 0.008655 | 2.68 | 9.34 | 13.43 | 0.57 |
| Narrow | 0 | PF 1 | 25.00 | 0.00 | 1.12 | 0.72 | 1.19 | 0.005003 | 2.11 | 11.83 | 16.17 | 0.44 |

Total flow in cross section.

The new flow depth at Section 3 is $1.81 - 0.575 = 1.24$ feet. The profile in the narrow section has essentially converged to normal depth (1.25 feet). The depth of the complete profile is shown below:

| Section | River Station | Water Surface | Z | Flow Depth (Ft.) |
|---------|---------------|---------------|-------|------------------|
| 1 | 0 | 1.12 | 0 | 1.12 |
| 2 | 15 | 1.18 | 0.075 | 1.11 |
| | 35 | 1.35 | 0.175 | 1.18 |
| | 55 | 1.48 | 0.275 | 1.21 |
| | 75 | 1.60 | 0.375 | 1.23 |
| | 95 | 1.71 | 0.475 | 1.24 |
| 3 | 115 | 1.81 | 0.575 | 1.24 |
| 4 | 130 | 1.90 | 0.65 | 1.25 |

3.1.4.3 Rapidly Varied Flow

A hydraulic jump occurs as an abrupt transition from super-critical to sub-critical flow. You should consider the potential for a hydraulic jump in all cases where the Froude Number is close to 1.0 and/or where the slope of the channel bottom changes abruptly from steep to mild. For grass-lined channels, unless the erosive forces of the hydraulic jump are controlled, serious damage may result.

It is important to know where a hydraulic jump will form, since the turbulent energy released in a jump can cause extensive scour in an unlined channel. For simplicity, you can assume that the flow in the channel is uniform except in the reach between the jump and the break in the channel slope. The jump may occur in either the steep channel or the mild channel, depending on whether the downstream depth is greater or less than the depth sequent to the upstream depth.

Using the equation below, you can calculate the sequent depth:

$$d_2 = -\frac{d_1}{2} + \sqrt{\frac{d_1^2}{4} + \frac{2v_1 d_1}{g}} \quad (3.1-14)$$

where:

- d_2 = Depth below jump, in feet
- d_1 = Depth above jump, in feet
- v_1 = Velocity above jump, in feet per second
- g = Acceleration due to gravity, 32.174 ft/sec²

If the downstream depth is greater than the sequent depth, the jump will occur in the steep region. If the downstream depth is lower than the sequent depth, the jump will move into the mild channel (Chow). For more discussion on the location of hydraulic jumps, refer to *Open-Channel Hydraulics*, by V.T. Chow, PhD.

When you have determined the location of the jump, you can determine the length using Figure 3.1-7. This figure plots the Froude Number of the upstream flow against the dimensionless ratio of jump length to downstream depth. The curve was prepared by V.T. Chow from data gathered by the Bureau of Reclamation for jumps in rectangular channels. You also can use the curve for approximate results for jumps formed in trapezoidal channels.

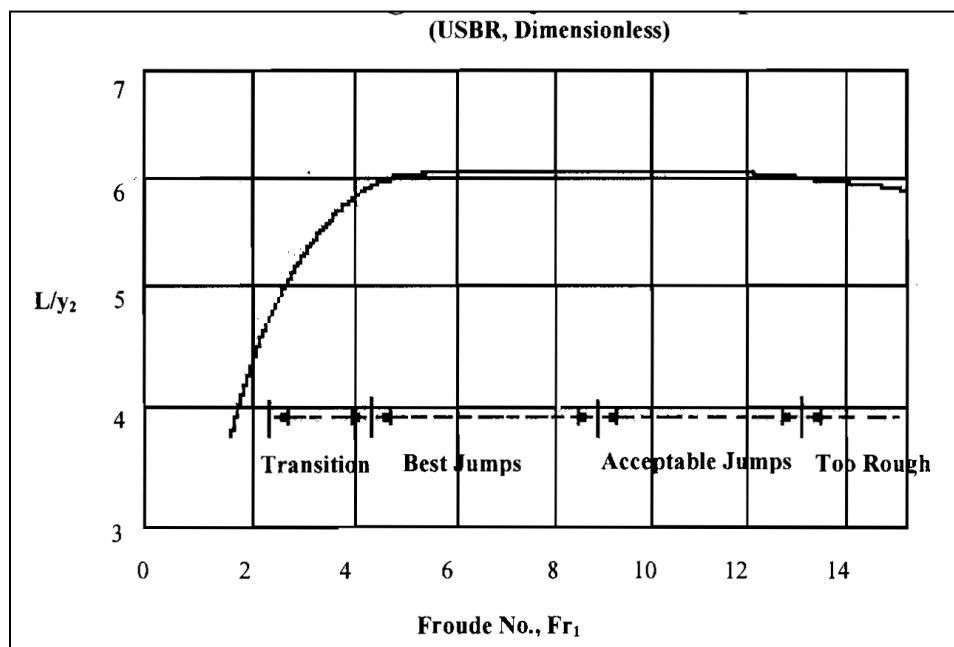

Figure 3.1-7: Lengths of Hydraulic Jumps

When you have determined the location and the length of the hydraulic jump, you can determine the need for alternative channel lining, as well as the limits the alternative lining will need to be applied.

Detailed information on the quantitative evaluation of hydraulic jump conditions in open channels is available in publications by Chow (1959), Henderson (1966), and Streeter (1971), and in HEC-14 from USDOT, FHWA (1983). In addition, handbooks by Brater and King (1976) and the USDA, SCS (NEH-5, 2008) may be useful.

Example 3.1-5—Hydraulic Jump Example

Given:

$$Q = 60.23 \text{ cfs}$$

$$V_1 = 13.81 \text{ fps}$$

$$g = 32.2 \text{ ft/s}^2$$

$$d_1 = 0.33 \text{ ft}$$

$$d_2 = 6.74 \text{ ft}$$

You calculated the depths above using Manning's Equation. The ditch has a 12.5-foot bottom width with 1:2 side slopes. The longitudinal slopes are 10 percent and 0.001 percent, respectively. The roughness value for the proposed rubble riprap is 0.035.

Calculate:

Hydraulic Jump and the extent of rubble needed.

Step 1: Calculate Froude Number and the Length of the Hydraulic JumpFroude Number, F_1 :

$$F_1 = \frac{V_1}{\sqrt{gd_1}}$$

$$F_1 = \frac{13.81}{\sqrt{(32.2)(0.33)}}$$

$$F_1 = 4.24$$

Length of the Hydraulic Jump, L :

From Figure 3.1-7,

$$\frac{L}{d_2} = 5.85$$

Therefore,

$$L = 5.85d_2 = (5.85)(6.74)$$

$$L = 39.4 \text{ ft} \approx 40 \text{ ft}$$

Step 2: Calculate the Upstream Sequent DepthUpstream Sequent Depth, d_1' :

$$d_1' = -\frac{d_1}{2} + \sqrt{\frac{2V_1^2 d_1}{g} + \frac{d_1^2}{4}}$$

$$d_1' = -\frac{0.33}{2} + \sqrt{\frac{2(13.81)^2(0.33)}{32.2} + \frac{(0.33)^2}{4}}$$

$$d_1' = 1.81 \text{ ft}$$

Since the downstream depth d_2 (6.74 ft) is greater than the upstream sequent depth d_1' (1.81 ft), the hydraulic jump occurs in the steep region.

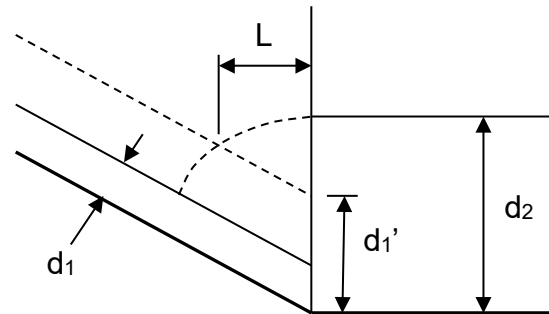

Assuming a more conservative approach, you can split the length of the hydraulic jump between the two regions and provide rubble riprap ditch protection for 20 feet downstream.

3.1.5 Channel Bends

At channel bends, the water surface elevation increases at the outside of the bend because of the super-elevation of the water surface. Additional freeboard is necessary in bends, and you can calculate it using the following equation:

$$\Delta d = \frac{V^2 T}{g R_c} \quad (3.1-15)$$

where:

- Δd = Additional freeboard required because of super-elevation, in feet
- V = Average channel velocity, in feet per second
- T = Water surface top width, in feet
- g = Acceleration due to gravity, in feet per second squared
- R_c = Radius of curvature of the bend to the channel centerline, in feet

Example 3.1-6—Channel Bend Example

The channel of Example 3.1-2 takes a 45-degree bend with a radius of 30 feet. What is the increased depth on the outside of the channel at the bend?

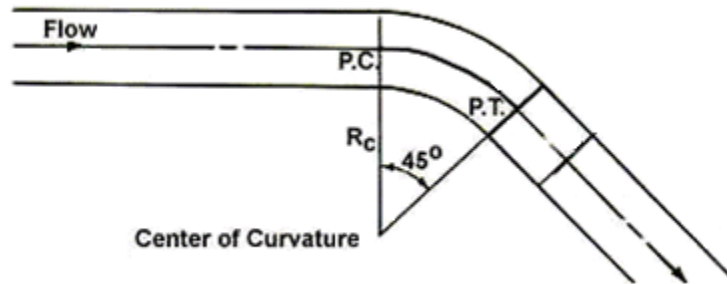

From Example 3.1-2, $V = 1.192$ ft/sec

Calculate Top Width

$$T = 5 + 0.826(4 + 6) = 13.26 \text{ ft.}$$

$$\Delta d = \frac{V^2 T}{g R_c} = \frac{1.192^2 (13.26)}{32.174(30)} = 0.02 \text{ ft}$$

The depth of flow on the outside edge of the ditch is $0.86 + 0.02 = 0.88$ ft.

The super-elevation is insignificant for this example problem, as it is for many ditches in Florida. The variable that affects water surface super-elevation the most is the velocity because it is squared in Equation 3.1-15. Ditches with a high velocity at a bend with a small radius will have greater super-elevations.

3.2 OPEN CHANNEL DESIGN

Channel shape, slope, and roughness were given in the previous example problems. From these example problems, the flow depths and velocities were determined using the analysis methods described in this chapter. If a project incorporates existing channels, then apply the analysis methods to those channels similar to the example problems. However, many projects will require designing new channels. This section discusses how to select the channel geometry and channel linings for FDOT projects.

3.2.1 Types of Open Channels for Highways

You can classify open channels generally as those that occur naturally and those that are manmade, including improved natural channels. The latter, called artificial channels, are used on most roadway projects. The types of channels commonly used on FDOT projects are listed in Chapter 2 of the *Drainage Manual*:

- Roadside Ditch
- Median Ditch
- Interceptor Ditch
- Outfall Ditch
- Canals

Section 2.2 of the *Drainage Manual* recommends design frequencies for each of these channel types.

The roadside ditch receives runoff from the roadway pavement and shoulders as directed by the cross slope and shoulder slopes. The roadside ditch also may receive flow from offsite drainage areas on adjacent properties. The roadside ditch also may intercept ground water to protect the base of the roadway. The roadside ditch conveys the flow to an outfall point, although the ditch may flow into other ditches or components of the stormwater management system before reaching the ultimate outfall point from FDOT right of way. Depressed medians will collect runoff and a median ditch will be needed to convey runoff to an outfall point. In general, roadside and median ditches are relatively shallow trapezoidal channels, while swales are shallow, triangular, zero-bottom-width channels.

Interceptor ditches have various purposes. They provide a method for intercepting offsite flow above cut slopes, thereby controlling slope erosion. They can also collect offsite flow and keep it separate from the project stormwater. This flow can bypass the stormwater treatment facilities, reducing their size and cost.

Design outfall ditches, in most cases, to receive runoff from numerous secondary drainage facilities, such as roadside ditches or storm drains. The delineation between a roadside ditch and an outfall ditch can become blurred. If the discharge from a stormwater

management facility is brought back to the roadside ditch to convey the flow to another point on the project for ultimate discharge, then consider the roadside ditch to be an outfall ditch for the purpose of selecting the design frequency. If you combine considerable flows from offsite areas and onsite project flows together in the roadside ditch to become a significant discharge, then consider the roadside ditch to be an outfall ditch for the purpose of selecting the design frequency. It is unwise to use a roadside ditch as an outfall ditch, since its probable depth and size could create a potential hazard.

Canals, like outfalls, also are large artificial channels that accept flows from other drainage components. The added connotation of a canal is that there is always water in the channel, unlike many outfalls that only flow immediately after a rainfall event. If the canal, which always has water, is close to the road, then it can be a potential hazard. For the purpose of identifying a hazard, the *FDM* defines a canal as an open ditch parallel to the roadway for a minimum distance of 1,000 feet, and with a seasonal water depth in excess of three feet for extended periods of time (24 hours or more). Water Management Districts and local agencies may have a different definition for canals when determining regulatory jurisdiction.

Other FDOT publications mention other types of ditches. Right-of-way ditches are mentioned in the *Standard Specifications* and a detail is given on *Standard Plans, Index 524-001*. The right-of-way ditch often functions as a type of relief ditch, handling drainage needs other than those for the roadway and thus freeing roadside ditches from carrying anything except roadway runoff. You usually can consider right-of-way ditches as interceptor ditches when selecting the design frequency.

The term “lateral ditch” is used in the *FDM* and the *Standard Specifications*. The term is used to determine:

- How the ditch excavation will be paid for
- How the ditch is shown in the plans

A lateral ditch generally is perpendicular to the roadway and can flow either toward or away from the road. However, a lateral ditch also can run parallel to the road right of way if the ditch or channel is separate from the roadway template. Refer to the *FDM* for guidance on selecting the excavation pay item. Consider the purpose of the lateral ditch and associate it with one of the ditch types listed above to select the design frequency.

Several FDOT publications use the term roadway ditch rather than roadside ditch. These two terms are interchangeable. Other FDOT publications or engineers performing work for the Department also may use many other terms to refer to open channels. The definitions of most of these terms are self-explanatory because of their descriptive names. Some examples are:

- Drainage ditch
- Stormwater ditch
- Bypass ditch
- Diversion ditch
- Conveyance channel
- Agricultural ditch

A swale is a special kind of artificial ditch that has become important in Florida. The following legal definition of a swale as it relates to the regulation and treatment of stormwater discharge is from section 403.803(11), Florida Statutes:

"Swale" means a manmade trench which:

- a) has a top width-to-depth ratio of the cross section equal to or greater than 6:1, or side slopes equal to or greater than 3 feet horizontal to one-foot vertical; and
- b) contains contiguous areas of standing or flowing water only following a rainfall event; and
- c) is planted with or has stabilized vegetation suitable for soil stabilization, stormwater treatment, and nutrient uptake; and
- d) is designed to take into account the soil erodibility, soil percolation, slope, slope length, and drainage area so as to prevent erosion and reduce pollutant concentration of any discharge.

3.2.2 Roadside Ditches

You can design roadside ditches using the following steps:

Step 1—Establish a Preliminary Drainage Plan. Roadside ditches will be components of an overall drainage system. Since the roadside ditch generally will follow the grade of the road, the high points in the roadway grade will be initial drainage boundaries. However, you can adjust these boundaries by using special ditch grades so that the ditch flows in a different direction than the roadway grade. You also can adjust the boundaries significantly for projects in flat terrain. It is, however, best to keep existing drainage patterns if possible. You also can adjust low points with special ditch grades if the ideal discharge point is not at the low point of the roadway grade.

Most projects will have stormwater management facilities, so the roadside ditches will connect with the conveyance components to the various facilities. Not all portions of the roadside ditch can physically be directed to a stormwater management facility, so short segments may need to discharge to other points, such as streams or ditches near cross drains and bridges, or other points along the roadway.

When determining initial ditch grades, provide a ditch slope with sufficient grade to minimize ponding and sediment accumulation. The *Drainage Manual* requires a minimum physical slope of 0.0005 feet/feet for ditches where positive flow is required. These flat

slopes are difficult to grade during construction and clumps of grass left behind by mowers easily impede the flow.

Existing utilities also may control the grade of the ditch to maintain minimum cover over the utility.

Step 2—Select Standard Ditch Components. The standard roadside ditch will be shown in the plans on the typical section. You can find standard ditch sections in the *FDM* for several roadway types, and in Figures 3.2-1 and 3.2-2, below. You may need to adjust the standard ditch due to peculiarities that are consistent throughout the project. An example might be a narrow border width and limited right of way.

The typical ditch shown in Figure 3.2-1 for two-lane roads is narrower than most mitered end sections. In some situations, you can use a wider typical ditch section. If the wider ditch is not used, then check the right of way at each mitered end to be sure the right of way will be adequate to accommodate a wider ditch at the mitered end section.

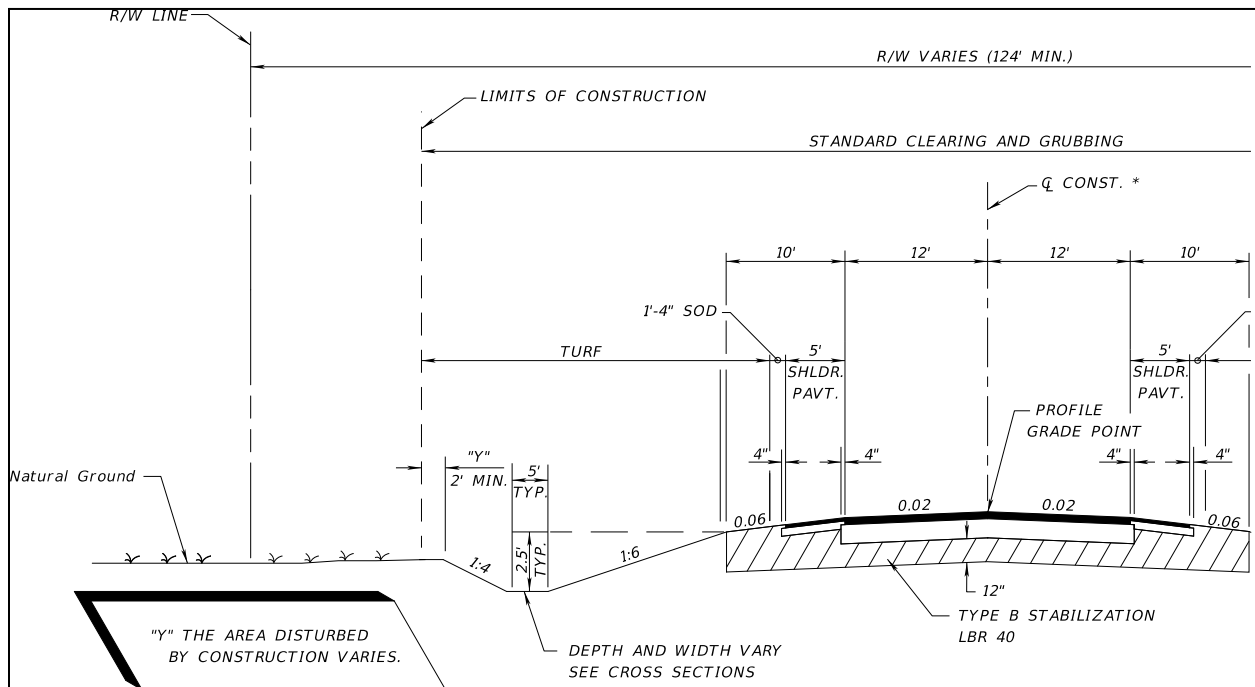

Figure 3.2-1: Typical Ditch for Two-Lane Rural Roadway

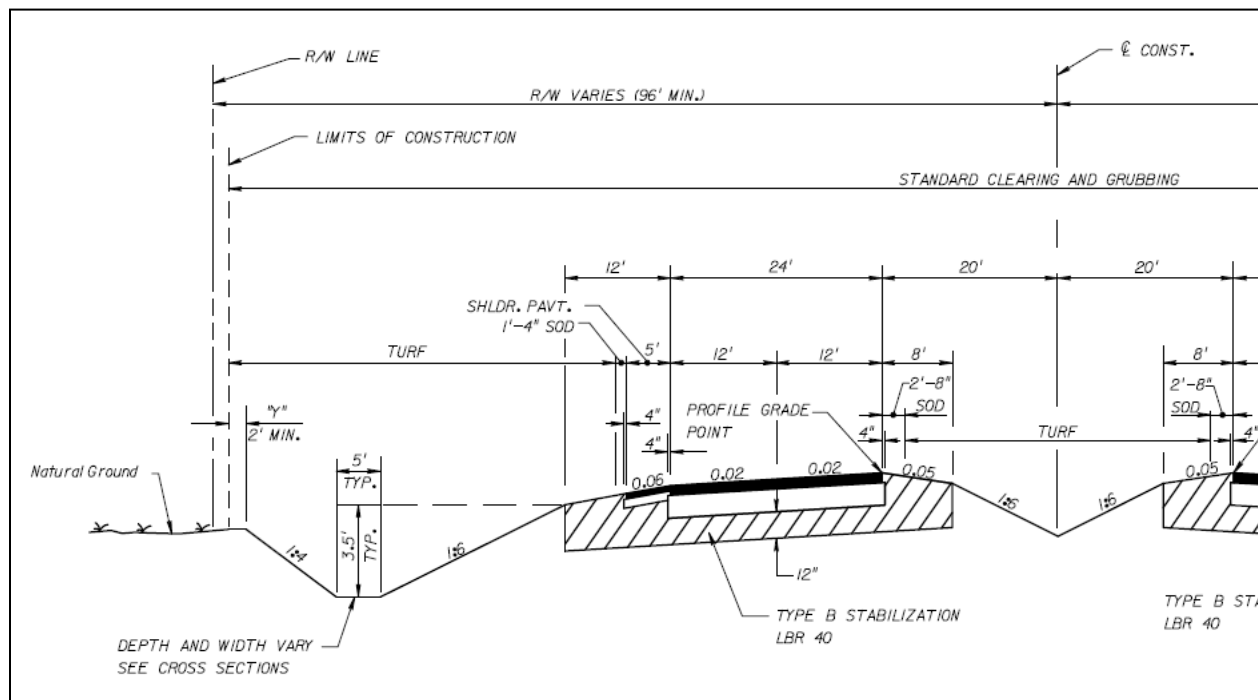

Figure 3.2-2: Typical Roadside and Median Ditches

If the ditch size needs to be reduced due to right-of-way limitations, you can consider the following options:

- Vary the front slope as noted in the **FDM Section 215.2.7.1**.
- You can narrow the bottom width. Five feet is an ideal minimum, but Maintenance and Construction may have equipment to build and maintain a two-foot bottom width. Avoid V-bottomed ditches with steep side slopes. Refer to Chapter 2 of the *Drainage Manual* for criteria regarding V-bottomed ditches. Avoid using a bottom width narrower than the side drain endwalls.
- You can steepen the back slope if the following is considered:
 - Steeper slopes are harder to maintain, especially 1:3 and steeper
 - Check the soils for stability
 - Significant offsite drainage down a steep back slope will cause erosion on the slope
- You can reduce the depth to the shoulder point if the following is considered:
 - Check the ditch capacity
 - Consider the type of facility and base clearance needs
- You also can enclose the ditch with a pipe system, although a ditch or swale usually still is needed to collect the roadway runoff into inlets. Enclosing the system will increase construction costs, but may be less expensive than obtaining more right of way.

Step 3—Check for locations where the standard ditch will not work. A good way to check is to plot the standard ditch on the cross sections. Look for places where the ditch extends beyond the right of way or conflicts with utilities and other obstructions. Also look in the Plan View to check for obstructions between the cross sections.

You can adjust the size of the ditch while also considering the same issues identified in the previous step. If the grade of the ditch must be adjusted, then you must develop a special ditch profile and plot it in the plans. Some locations where the ditch grade may need to be adjusted include:

- Outfall locations—The grade of the standard ditch will follow the grade of the road. If the outfall location is not at the lowest point in the roadway profile, then you need to develop a special ditch profile.
- Locations of high water table—These areas may require feedback to the roadway designer to raise the roadway grade.
- Cross drains, median drains, and side drains—These structures may need to be at a lower elevation than the standard ditch elevation. If the entrance end of the culvert is depressed below the stream bed, more head is exerted on the inlet for the same headwater elevation. Usually, the sump is paved, but for small depressions, an unpaved excavation may be adequate.
- Locations where the top of the back slope creates a ditch that is too shallow—Sometimes, you can use a berm to contain the ditch instead of changing the grade. Be careful that offsite drainage is not blocked. If you use a berm, provide an adequate top width and side slopes for ease of maintenance. A suggested minimum top width is three feet, but five feet is ideal.

You will need to develop special ditch profiles if the profile grade is less than the minimum ditch slope. Refer to the *Drainage Manual* for minimum ditch slope criteria. At vertical curve crests, the ditch grade will be less than the minimum ditch grade criteria given in the *Drainage Manual*. (In fact, the ditch grade will go to zero at the high point.) A special ditch grade is not necessary at a vertical curve crest.

Step 4—Compute the Flow Depths and Velocities. Although some designers check the ditch at regular intervals, it is not necessary. Checking at critical locations is adequate. Check the ditch at the outfall point. The discharge will be greatest at this location, so it may represent the worst-case conditions for the entire ditch. Other critical locations to check are:

- Changes in slope, specifically steeper slopes
- Changes in shape, specifically narrower sections
- Shallowest ditch depths
- Changes in lining (roughness)
- Changes in flow

Determine the maximum allowable depth of the ditch at these sections, including freeboard. Section 2.4.5 of the *Drainage Manual* provides freeboard requirements. If the actual depth exceeds the maximum allowable depth in the ditch, then the ditch does not have enough capacity. Possible ways to increase the ditch capacity include:

- Increase bottom width
- Make ditch side slopes flatter
- Make longitudinal ditch slope steeper
- Provide a smoother ditch lining
- Install drop inlets and a storm drain pipe beneath the ditch
- Berm up the back slope of the ditch

Step 5—Check Lining Requirements. When the ditch geometry components are set and the depth of flow is determined to be adequate, then the ditch needs to be checked to determine if you need a ditch lining. Check the maximum velocity in the ditch against the allowable velocities for bare earth shown in Table 2.4 of the *Drainage Manual*. If these velocities are met, then you can use the standard treatment of grassing and mulching.

If the maximum ditch velocity exceeds the allowable velocity for bare earth, then you should provide sodding, ditch paving, or other forms of ditch lining. See Section 3.3 for more discussion of ditch linings.

3.2.3 Median Ditches

The design steps for median ditches are similar to those for roadside ditches.

Step 1—Establish a Preliminary Drainage Plan. As with roadside ditches, median ditches also will be components of an overall drainage system. The grade of the median ditch generally will follow the grade of the road. Generally, curbs are not provided on the edge of the pavement and the median ditch drains part or all of the shoulder area in addition to the median itself. Even where curbs are provided, it is preferable to slope medians wider than 15 feet to a ditch. This keeps water in the median off the pavement. Medians less than 15 feet wide generally are crowned for drainage, and, if they are less than six feet in width, they usually are paved. Permitting agencies may request that the median ditch be depressed.

When the width of the median ditch is established, locate outfall points from the median. If the travel lanes slope to the outside and the median is impervious, then the median runoff may not need to be conveyed to a stormwater treatment facility. The median may be able to discharge directly into cross drains via inlets.

Median cross overs, bridge piers, or other structures often interrupt continuous flow in medians. Decide whether to convey around the obstruction or to one side of the roadway.

Consider the flow depth in the median, feasible means to convey the flow around the obstruction, the size of pipe to convey the flow to the outside, the cover available, and the elevation of the roadside ditch to which the flow will be conveyed. Also consider the actual low point of the median ditch, which is usually at the low point of the roadway grade. This may be affected by guardrail, turn lanes, etc. Turn lanes and other non-typical roadway configurations also may create a depressed gore area. You will need to analyze these areas with methods similar to those used for roadside ditches.

Considerations to determine which side of the roadside to discharge to include:

- Maintenance of traffic phasing and construction sequencing
- Which side the outfall or stormwater facility is located on
- Commingling with offsite runoff

Step 2—Select Standard Ditch Components. The standard median ditch will be shown in the Plans on the Typical Section. Standard ditch sections are given in the *FDM* for several roadway types, and one is shown in Figure 3.2-2.

Step 3—Compute the Flow Depths and Velocities. Determine critical locations to check depth of flow and velocities, as outlined above. In addition to the critical areas for the roadside ditch, you also should evaluate the median ditch in gore areas caused by turn lanes or additional pavement. If the actual depth exceeds the maximum allowable depth, then you will need to increase the capacity of the ditch. Use methods similar to those for increasing the capacity of a roadside ditch. Be mindful of the additional clear zone requirements for median ditches.

Step 4—Check Lining Requirements. After you establish the section of the ditch, check the maximum velocities against the allowable velocities for bare soil. If those velocities are exceeded, then you need to research further to determine the appropriate lining for the ditch. See Section 3.3 of this design guide for further discussion.

3.2.4 Interceptor Ditches

Interceptor ditches run along the natural ground near the top edge of a cut slope or along the edge of the right of way to intercept the runoff before it reaches the roadway. Interceptor ditches along the edge of the right of way are commonly referred to as right-of-way ditches.

The interceptor ditch generally will follow the grade of the natural ground adjacent to the project, not the profile grade of the road. If possible, locate the high points in an interceptor ditch at the drainage divides of the adjacent property to maintain existing drainage patterns. Low points also typically follow the adjacent terrain, allowing the interceptor ditch to discharge to points such as streams near cross drains and bridges.

Most projects will have stormwater management facilities. These facilities often are set off from the project area, so it is important to consider conflicts that may arise where the outfall ditch intersects the interceptor ditch.

The design steps for interceptor ditches are the same as those for the roadside ditch. See Section 3.2.2 for the design procedure.

3.2.5 Outfall Ditches

Since outfall ditches receive runoff from numerous secondary drainage facilities, including stormwater management facilities, design the standard ditch section for a larger capacity. You should evaluate the standard ditch section against the clear zone criteria for the project. Even though outfall ditches have a larger design event and carry larger flows, the design steps are the same as those for the roadside ditch. See Section 3.2.2 for the design procedure.

The design also should include consideration of the following:

- The drainage area that flows into the outfall ditch by overland flow. Designers often forget to include this area in the total drainage area when determining the design flow rates for the outfall ditch. Another concern is erosion down the side slope from the sheet flow from these areas. You can use spoil from the ditch construction to create berms to block and collect the flow in inlets to prevent this erosion.
- Check for existing outfall easements. Some easements may require a specific type of conveyance, such as a ditch or a pipe system.

3.2.6 Hydrology

As stated in Section 2.3 of the *Drainage Manual*, hydrologic data used for the design of open channels will be based on one of the following methods, as appropriate for the particular site:

- Use a frequency analysis of observed (gage) data when available
- Use the regional or local regression equation developed by the USGS
- Use the Rational Equation for drainage areas up to 600 acres
- Use the method applied for the design of the stormwater management facility in the design of the outfall from this facility
- Request hydrologic data from the controlling entity for regulated or controlled canals

For a more detailed discussion on procedure selection and method for calculating runoff rates, refer to Chapter 2 (Hydrology).

3.2.6.1 Frequency

Roadside or median ditches or swales, including bypass and interceptor ditches, usually are designed to convey a 10-year frequency storm without damage; outfall ditches or canals should convey a 25-year frequency storm without damage. However, because the risks and drainage requirements for each project are unique, site-specific factors may warrant the use of an atypical design frequency. Regardless of the frequency selected, you should always consider the potential for flooding that exceeds standard criteria. Pre-development stages for all frequencies up to and including the 100-year event must not be exceeded unless flood rights are obtained or the flow is contained within the ditch.

It also is important to consider sediment transport requirements for conditions of flow below the design frequency. A low flow channel component within a larger channel can reduce the maintenance effort by improving sediment transport in the channel.

Design temporary open channel facilities for use during construction to handle flood flows commensurate with risks. The recommended minimum frequency for temporary facilities and the temporary lining of permanent facilities is 20 percent of the standard frequency for permanent facilities, which extrapolates as a two-year frequency for roadside ditches and a five-year frequency for outfall ditches.

3.2.6.2 Time of Concentration

The time of concentration is defined as the time it takes runoff to travel from the most remote point in the watershed to the point of interest. When using the Velocity Method, calculate the time of travel for main channel flow using the velocity in the section and the channel length. Segments used to determine the velocity should have uniform characteristics. Use a new segment each time there is a change in the channel geometry, such as cross section or channel slope. Calculate the time for each segment and then add them together to determine the total time of concentration for the channel. See Chapter 2 (Hydrology) for a discussion of methods and procedures to determine the time of concentration.

3.2.7 Tailwater and Backwater

The water depth at the downstream end of the ditch will affect the flow depth and velocities in the ditch for some distance upstream. The downstream water depth, or tailwater, may cause a backwater condition with a gradually varied water surface profile. In roadside ditches, you can approximate the water surface profile as a flat water surface at the tailwater (T_w) elevation that intercepts the normal depth (d_n) of flow in the ditch, as shown in Figure 3.2-3. If the tailwater depth is less than the normal depth in the ditch, then you can approximate the water surface profile in the ditch as the normal depth in the ditch, as shown in Figure 3.2-4. For the low tailwater condition, perform the velocity check for lining requirements using the velocity for the tailwater depth, not the normal depth.

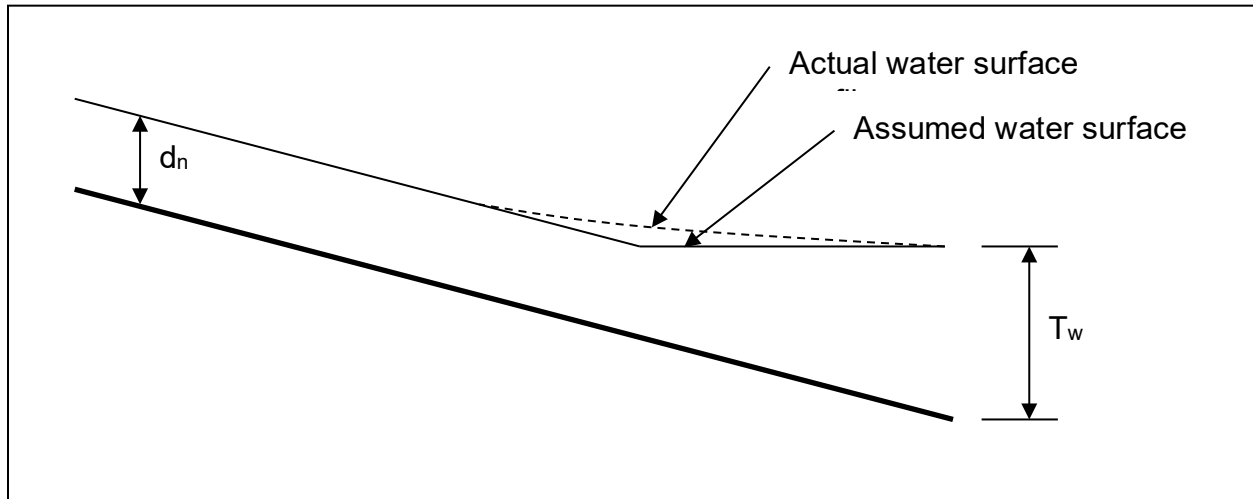

Figure 3.2-3: Assumed Water Surface for $T_w > d_n$

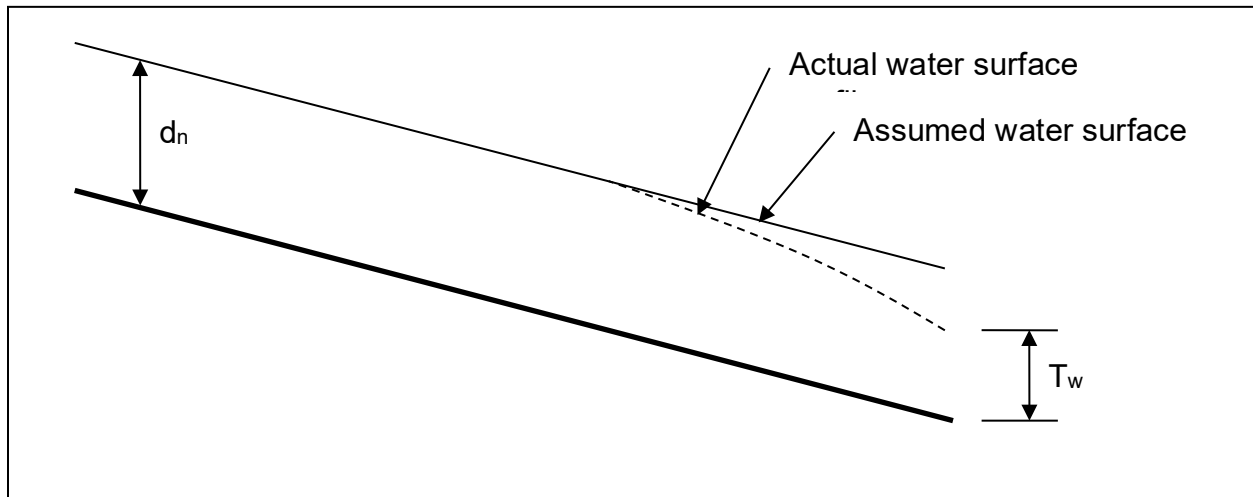

Figure 3.2-4: Assumed Water Surface for $T_w < d_n$

To summarize the water surface approximation, the water surface elevation at any point in the ditch is the higher of the normal depth elevation or the tailwater elevation. You can determine the frequency of the design tailwater elevation using the same recommendations for storm drains in Section 3.4 of the *Drainage Manual*.

The same water surface profile assumptions illustrated above also apply to other backwater conditions in the ditch. Side drains are an example. The water surface elevation in the ditch at any point upstream of a side drain should be the greater of the normal depth elevation or the headwater elevation of the culvert. The normal depth in the ditch changes if the ditch slope, cross section, or roughness changes. If the downstream normal depth is greater, then the assumed water surface is shown in Figure 3.2-5.

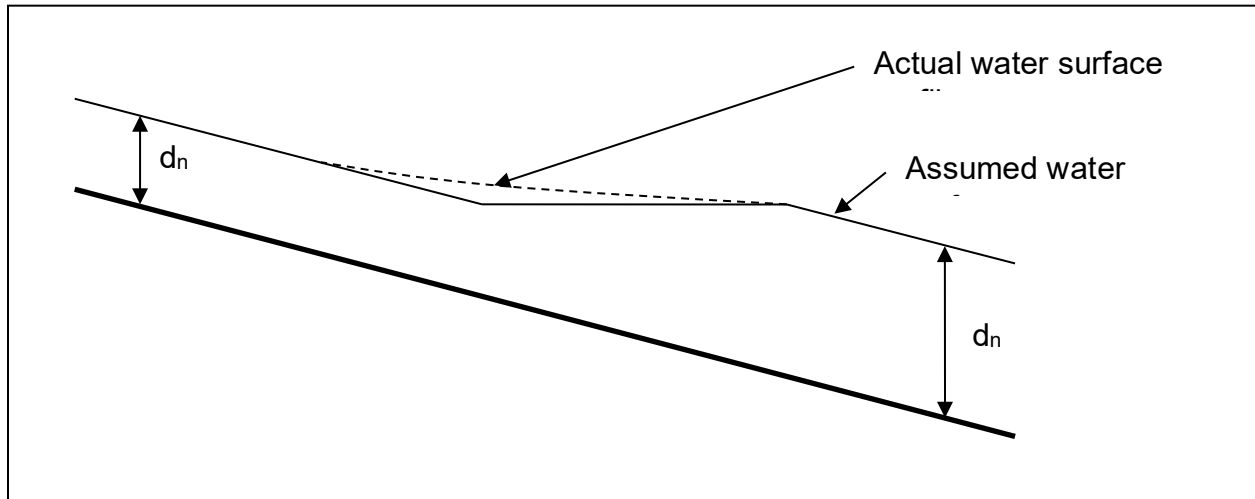
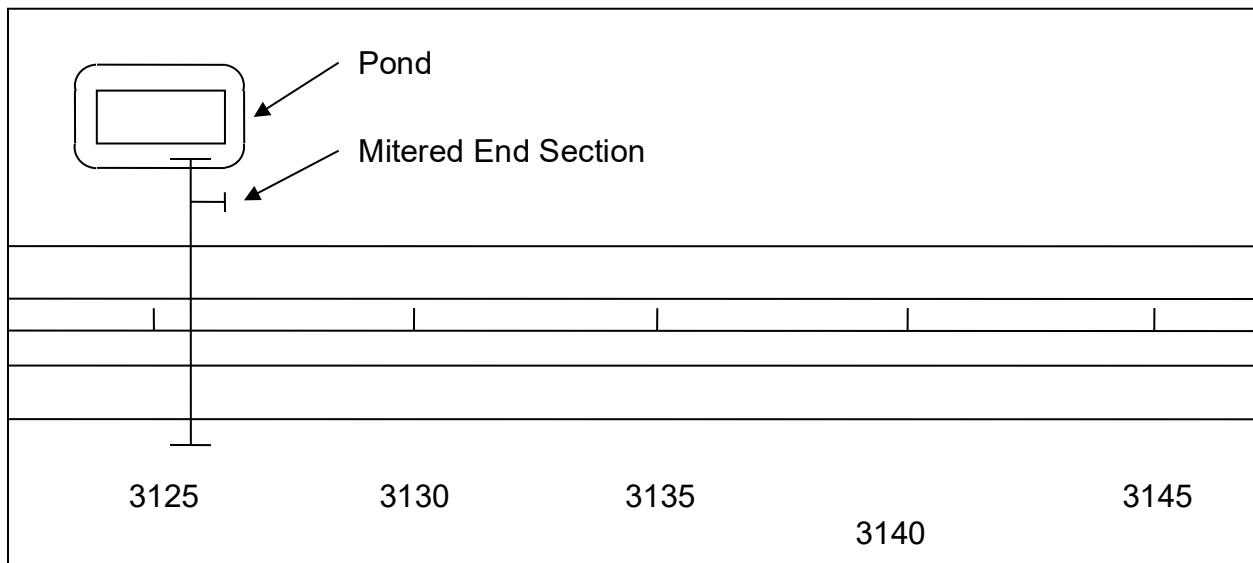
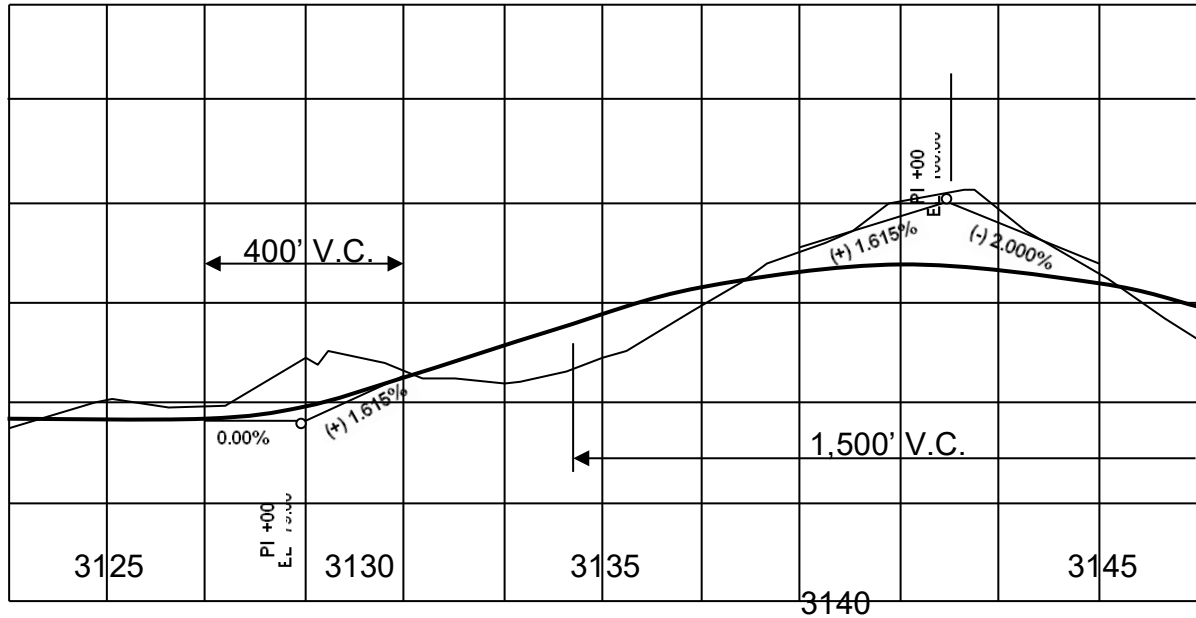

Figure 3.2-5: Assumed Water Surface for change in d_n

Example 3.2-1—Roadside Ditch Design Example

The figures below show the plan and profile views of a proposed four-lane roadway. Complete the design of the left roadside ditch.



Step 1—Drainage Plan. On the left side of the roadway near Station 3125+00A, there is a stormwater pond to treat and attenuate the roadway runoff. Roadside ditches will collect the runoff from the roadway and convey it to the cross drain, which empties into the pond. The offsite drainage area is small; therefore, dual ditches are not needed to reduce the size of the pond.

The left roadside ditch will discharge into a mitered end section at Station 3126+50. The design frequency for the ditch will be 10 years (refer to the *Drainage Manual* for the design frequency). The pipe system and the pond may have different design frequencies than the ditch, but you can determine a 10-year elevation in the pond and the 10-year hydraulic grade line for the pipe system at the mitered end section. The hydraulic grade line of the pipe system at this headwall will be the tailwater elevation for the ditch.

The design of the overall drainage system may be iterative. The design of one component, such as the pond, can affect the design of other components, such as the left and right roadside ditches, the cross drain, and even the median ditch. To simplify this example, the tailwater elevation for the ditch will be given as 76.52 feet.

Step 2—Standard Ditch Components. The standard ditch shown in Figure 3.2-2 will be used. The vertical distance from the profile grade line (PGL) to the ditch bottom elevation of the standard ditch will be:

$$\text{Elevation Difference} = (24 \text{ ft.} \times 0.02) + (12 \text{ ft.} \times 0.06) + 3.5 \text{ ft.} = 4.7 \text{ ft.}$$

Step 3—Check for locations where the standard ditch will not work. Three reasons why the standard ditch will not work are:

- The backslope tie in to natural ground extends beyond the right-of-way line and acquiring additional right of way is not prudent.
- The natural ground elevation is lower than the standard ditch bottom elevation, or low enough that the standard ditch is too shallow.
- The profile grade is less than the minimum ditch slope.

Plotting the standard ditch on the roadway cross sections is a good way to look for locations where the standard ditch will not work. Also, starting at the downstream end of the ditch and working upstream will afford an orderly approach to design the ditch. For this example, the profile grade elevation will be 79.00 and the bottom of the standard ditch will be 74.3 feet at Station 3127+00, as shown in the figure below.

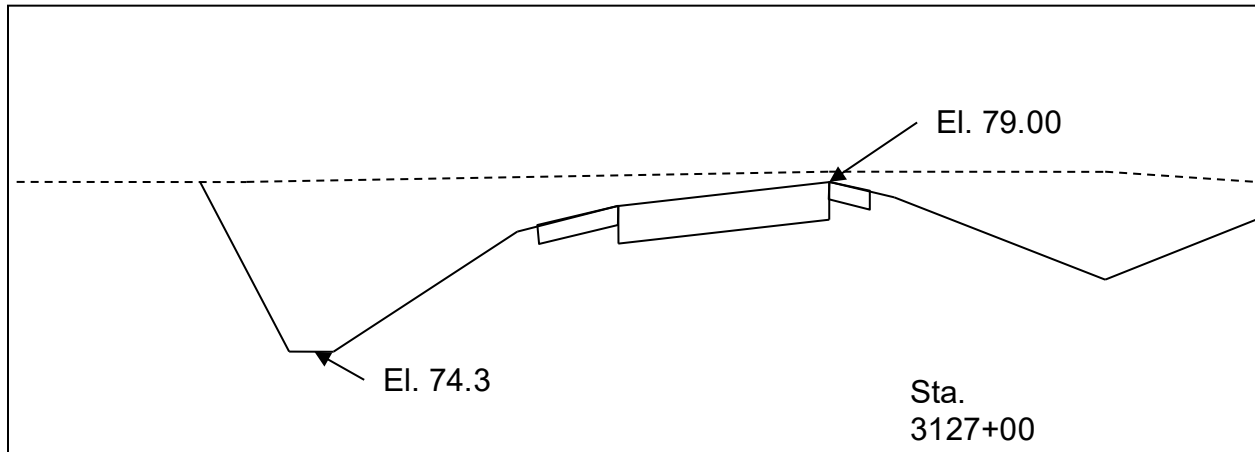

The PGL is flat (0.000 percent) between this cross section and the end section at Station 3126+50. The minimum slope of the ditch is 0.05 percent, and the ideal slope is at least 0.1 percent. Therefore, you will need a special ditch grade between these stations. If the flowline at the headwall (Station 3126+50) is set at 74.2 feet, the ditch grade between these stations will be $0.1/50 = 0.002$, or 0.2 percent.

At this point in the design process, calculate the discharge at the downstream end of the ditch. For this example, the discharge will be given as 12.7 cfs at the end section. Refer to the Chapter 2 (Hydrology) for an explanation of how to calculate the discharge. Solving Manning's Equation with the standard ditch shape (five-foot bottom width, 1:6 front slope, 1:4 back slope), the slope of 0.2 percent, $n = 0.042$, and the discharge of 12.7 cfs gives a flow depth in the ditch of 1.03 feet. At the headwall, the normal depth elevation would be $74.2 + 1.03 = 75.23$ feet. This elevation is less than the tailwater elevation. Therefore, the flow depth in the ditch is the tailwater elevation of 76.52 feet. The outside edge of the shoulder elevation is lower than the back of the ditch elevation at this location and will, therefore, control the allowable flow depth in the ditch. Since the tailwater elevation is lower than the allowable flow depth, the ditch depth is adequate.

Proceed upstream to continue the design. Looking at the cross sections between Stations 3133+00 and 3136+00, the standard ditch bottom elevation will be higher than the natural ground elevation for several hundred feet, as typified by the cross section shown below for Station 3134+00.

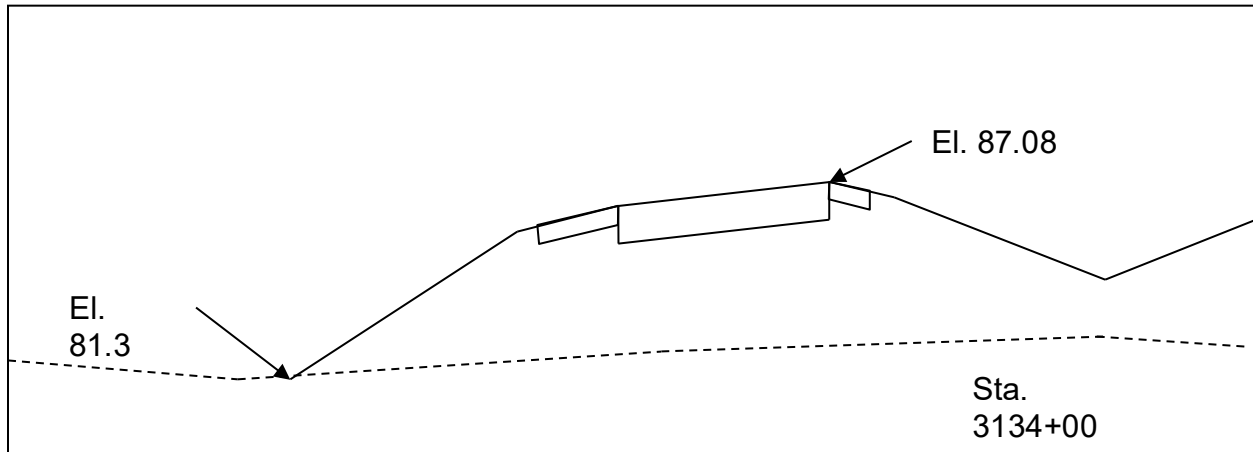

The standard ditch could be used if a berm was constructed. However, there are at least two reasons not to construct the berm. First, some offsite flow to the ditch would be blocked. Second, the cost of constructing the berm is unnecessary since you can use a special ditch profile to lower the ditch into the natural ground.

The discharge needs to be determined at this point to continue the design. A conservative assumption would be to use the discharge at the downstream end of the ditch. In this case, the designer judges that the discharge might be significantly different and calculates the discharge at this point. To simplify the example, the discharge at this location is given as 10.2 cfs.

Assuming a ditch bottom elevation of about 79.3 ft (2 feet below natural ground), the slope to Station 3127+00 would be $(79.3 - 74.3)/700 = 0.007$, or 0.07 percent. Selecting the value of 2 feet was based on some preliminary calculations of the flow depth and including some freeboard. Solving Manning's Equation with the standard ditch shape, the slope of 0.7 percent, $n = 0.042$, and the discharge of 10.2 cfs gives a flow depth in the ditch of 0.68 feet. This would leave a freeboard of approximately 1.3 feet at this location, which is more than needed. The flow depth of 0.68 feet is close enough to 0.7 feet that using n of 0.042 is reasonable given the amount of freeboard provided. A special ditch grade of 0.07 percent will be used between Stations 3127+00 and 3134+00.

The special ditch grade has to tie back into the standard ditch grade someplace further upstream. The standard ditch bottom will return to an adequate depth into natural ground to contain the flow at Station 3137+00. The PGL at Station 3137+00 is 91.17 feet. The ditch bottom elevation for the standard ditch is 86.47 feet. The ditch grade will be $(86.47 - 79.3)/300 = 0.0239$, or 2.39 percent. Solving Manning's Equation with the standard ditch shape, the slope of 2.39 percent, $n = 0.06$, and the discharge of 10.2 cfs gives a flow depth in the ditch of 0.59 feet and a velocity of 2.2 fps. Note that the roughness changes because the flow depth is less than 0.7 feet. The velocity is low enough that ditch lining

will not be needed. However, sod will be needed, instead of seed and mulch, to establish grass during construction.

Checking the cross sections between 3134+00 and 3137+00, the ditch depth is at least 1.5 feet, which will provide acceptable freeboard.

To summarize, the special ditch grades will be:

- 0.2 percent from Station 3126+50 to 3127+00
- 0.07 percent from Station 3127+00 to 3134+00
- 2.39 percent from Station 3134+00 to 3137+00

The standard ditch will provide an adequate depth from 3137+00 to the top of the hill. Checking the cross section plots shows that the earthwork to construct the standard ditch will not extend beyond the proposed right-of-way line.

Step 4—Compute the Flow Depths and Velocities. These values were calculated in the description of the previous step. In most cases, the designer will be iterating through Steps 3 and 4 as the ditch is designed.

Figure 3.2-6 shows the ditch checks appropriate for including in the Drainage Documentation to prove the design.

Drainage Design Guide
Chapter 3: Open Channel

| HYDRAULIC WORKSHEET FOR ROADSIDE DITCHES | | | | | | | | | | | | | Sheet | | 1 | | of | | 1 | |
|---|------|---------|------------|------|----|-------------------------|---------|---------------|------|------|-------|---------------------|-------------------------|----------------------|-----------|--------------|---------------------|---------|---|--|
| Road: <u>New Road</u> | | | | | | Prepared by: <u>XXX</u> | | | | | | Date: <u>4/1/09</u> | | | | | | | | |
| Project Number: <u>1234567</u> | | | | | | Checked by: <u>YYY</u> | | | | | | Date: <u>4/1/09</u> | | | | | | | | |
| STATION TO STATION | SIDE | % Slope | Drain Area | "C" | Tc | I ₁₀ | Q (cfs) | Ditch Section | | | "n" | "d" | "d _{allowed} " | Calculated Freeboard | Vel (fps) | Ditch Lining | Side Drain Pipe Dia | Remarks | | |
| | | | | | | | | F.S. | B.W. | B.S. | | | | | | | | | | |
| 3126+50 | LT | 0.20 | 2.61 | 0.75 | 15 | 6.5 | 12.7 | 6 | 5.0 | 4 | 0.042 | 1.03 | | 1.2 | SOD | | TW El. will control | | | |
| 3127+00 | LT | 0.70 | | | | | 12.7 | 6 | 5.0 | 4 | 0.042 | 0.75 | | 1.9 | SOD | | TW El. will control | | | |
| 3134+00 | LT | 0.70 | 1.79 | 0.75 | 10 | 7.6 | 10.2 | 6 | 5.0 | 4 | 0.042 | 0.68 | | 1.87 | SDO | | | | | |
| 3134+00 | LT | 2.39 | | | | | 10.2 | 6 | 5.0 | 4 | 0.6 | 0.59 | | 2.2 | SOD | | | | | |
| Note: F.S. = Front Slope B.W. = Bottom Width B.S. = Back Slope Manning "N" is Transitioning as the depth Approaches 0.7' | | | | | | | | | | | | | | | | | | | | |

Figure 3.2-6: Roadside Ditch Design Example

3.2.8 Side Drains

Continuous flow in a roadside ditch can be interrupted by side street/road connections and/or driveway connections to the project roadway. Even a limited access roadway, such as an interstate highway, may have an occasional access driveway that will impede roadside ditch flow, especially at or near adjacent stormwater pond locations. You can maintain ditch flow continuity through such obstructions via roadside ditch culverts or side drains.

A side drain is a class of culvert pipe that can transport flow through fill placed in a roadside ditch. A side drain is normally aligned parallel or nearly parallel to the project roadway and along the flowline of the ditch. Side drains located under public roads connecting to the project roadway, are identified and hydraulically sized as a cross drains (see Chapter 4, Culverts). Side drains and cross drains are similar in many ways, but there are some differences in design analysis requirements, materials, and end treatment. Cross drains have to meet more rigorous criteria for some parameters.

3.2.8.1 Design Analysis Requirements for Side Drains

You size a side drain for the storm frequency required to design the roadside ditch that contains the side drain (usually the 10-year frequency, as mentioned in Section 3.2.6.1). You can determine the side drain design flow by applying the same hydrologic method used to compute the corresponding ditch design flows (usually the Rational Equation, described in Section 2.2.3). Then, you can determine the side drain pipe dimensions via the inlet-control/outlet-control procedure described in Section 4.5. (Note: The FHWA HY-8 computer software is one of several computer programs capable of applying this procedure to the side drain design data.)

You will normally develop the design flow for a side drain in the design calculations spreadsheet or worksheet for the roadside ditch that contains the side drain. (Figure 2-1 of the *Drainage Manual* depicts such a ditch design worksheet.) The design flow and surface water depth for the ditch section at the upstream end of the side drain are determined in the ditch calculations, and this ditch flow is the side drain design inflow as well. This flow typically is also the design flow for the ditch section at the downstream end of the side drain, and must be accounted for in the calculations for the remainder of the downstream ditch length. Of course, if additional flow enters the side drain between its upstream and downstream ends, this additional flow also must be appropriately accounted for in both the side drain hydraulic design and in the downstream ditch design calculations.

Determine the tailwater elevation at the culvert outlet. Since the culvert usually is placed through fill in the roadside ditch, the ditch calculations downstream of the culvert are used to determine the tailwater. The culvert tailwater will be the normal depth in the

downstream ditch unless the tailwater for the ditch controls the water surface elevation at the side drain outlet. Refer to Section 3.2.7 for more discussion on tailwater.

Then you can generate the hydraulic calculations for a side drain, using the procedure described above to determine the pipe dimensions needed to safely pass the design flow to the downstream ditch segment. Include these side drain calculations in the Drainage Documentation Report as either a separate section or as part of the Ditch Calculations section.

Note that the surface water depth computed for culvert flow at the upstream end of a side drain generally will be larger than the depth computed for ditch flow at that location. If the difference in this flow depth is not significant, evaluate the ditch flow depths upstream from the side drain and adjust (if appropriate) for the “flat pool” that will be established in the ditch by the higher of the two water surface elevations. If the difference in surface water flow depth at the side drain is substantial and the ditch design is sensitive to actual flow depths, a backwater analysis may be needed rather than the “flat pool” approximation in determining the actual flow depth estimates.

3.2.8.2 Material Requirements

In general, side drains are not considered to be as critical as cross drains. Therefore, material service life requirements for side drains are less stringent than for cross drains. Consult Chapter 6 of the *Drainage Manual*, the FDOT *Standard Specifications*, Chapter 8 (Optional Pipe Materials) in this handbook, and the appropriate District Drainage Engineer for any clarification needed on pipe materials acceptable for use as side drains. Culvert and ditch calculations may show the need for two allowable pipe sizes, depending on the Manning’s roughness coefficients of the optional pipe materials for the side drain.

3.2.8.3 End Treatment

The only allowable side drain end treatment is the mitered end section (*Standard Plans, Index 430-022*). Due to the normal side drain alignment and close proximity to the project roadway (usually within the clear zone), *Standard Plans, Index 430-022* specifies that grates be installed for the larger pipe sizes. The grates are intended to provide a measure of safety for errant vehicles that encounter the end treatment. The grates, however, will potentially collect debris and will increase the entrance loss coefficient, K_e , from 0.7 to 1.0 for the mitered end section. When a grate is likely to be used, consider the following items:

- Recognize that the specification of a grate could increase the required side drain size (due to the increase in K_e).
- In critical hydraulic locations, evaluate the potential debris transport prior to using grates. Vegetated ditch grades in excess of 3 percent, pipe with less than 1.5 feet of cover, or paved ditch grades in excess of 1 percent will require such an evaluation.

- Determine highly corrosive locations and specify in the plans when the grates need to be hot-dipped galvanized after fabrication.

Example 3.2-2 – Side Drain Design

Problem Statement:

A driveway is included in the design of the left roadside ditch for a new two-lane rural roadway segment. Figure 3.2-1 depicts the typical section for the left side of the roadway. The ditch extends and flows from Station 10+00 to Station 45+00, with the centerline of the driveway located at Station 40+00. The width of the proposed driveway base at the ditch flowline is 40 feet, and the ditch section is uniform throughout its length with a 2-foot allowable depth below the left top-of-bank. At its upstream and downstream ends, the ditch flowlines must match elevations of 100.0 feet and 96.0 feet, respectively. The following sketch shows the ditch longitudinal slopes are 0.1 percent from Station 10+00 to Station 35+00, and 0.15 percent from Station 35+00 to Station 45+00. The natural ground slopes away from the left top-of-bank of the ditch section.

Determine the required side drain diameter.

Design Approach:

First, develop the ditch design calculations to determine the side drain design inflow at Station 39+80. These calculations are shown on Figure 3.2-7, and identify a side drain design flow of 4.60 cfs.

Next, refer to Section 4.5 for the side drain hydraulic design procedure. Use either the inlet control and outlet control nomographs from FHWA HDS-5, or software such as HY-8, to develop the required side drain size.

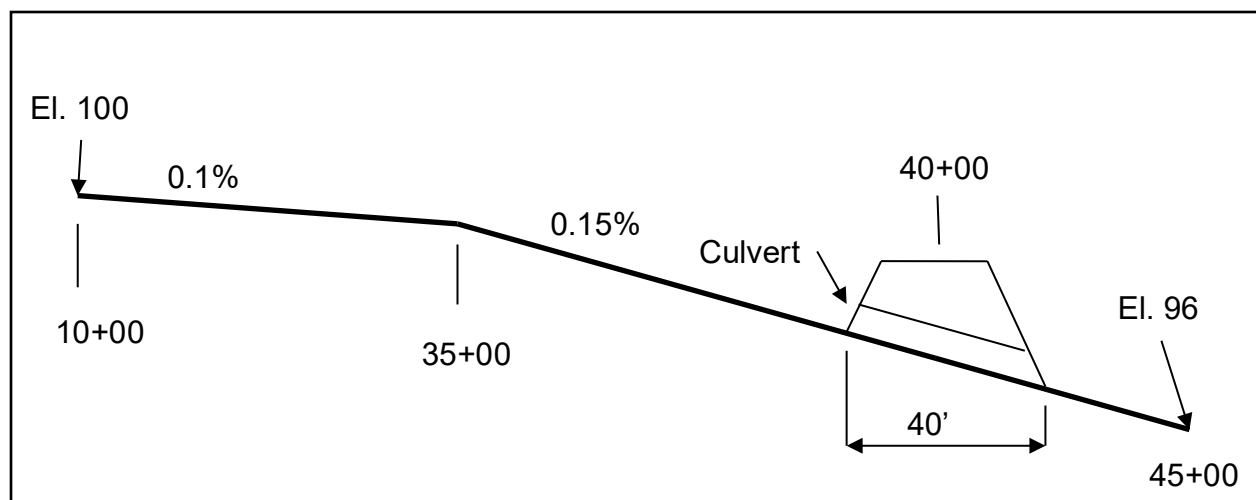

Drainage Design Guide
Chapter 3: Open Channel

| HYDRAULIC WORKSHEET FOR ROADSIDE DITCHES | | | | | | | | | | | | | Sheet | | 1 | | of | | 1 | |
|---|------|---------|------------|------|------|-----------------|---------|-------------------------|------|------|-------|------|-------------------------|----------------------|--------------|--------------|---|---------|---|--|
| Road: <u>New Road</u> | | | | | | | | Prepared by: <u>XXX</u> | | | | | | Date: <u>4/1/09</u> | | | | | | |
| Project Number: <u>1234567</u> | | | | | | | | Checked by: <u>YYY</u> | | | | | | Date: <u>4/1/09</u> | | | | | | |
| STATION TO STATION | SIDE | % Slope | Drain Area | "C" | Tc | I ₁₀ | Q (cfs) | Ditch Section | | | "n" | "d" | "d _{allowed} " | Calculated Freeboard | Vel (fps) | Ditch Lining | Side Drain Pipe Dia | Remarks | | |
| | | | | | | | | F.S. | B.W. | B.S. | | | | | | | | | | |
| 10+00 - 35+00 | LT | 0.10 | 2.75 | 0.47 | 60.1 | 3.24 | 4.19 | 6 | 5.0 | 4 | 0.042 | 0.7 | | 0.7 | Seed & Mulch | | | | | |
| 35+00 - 39+80 | LT | 0.15 | 3.31 | 0.47 | 69.5 | 2.96 | 4.60 | 6 | 5.0 | 4 | 0.042 | 0.67 | | 0.83 | Seed & Mulch | | Drain Area includes 1/2 of driveway width | | | |
| 39+80 - 40+20 | LT | | | | | | 4.60 | | | | | | | | | 18" | See Side Drain Calcs for details | | | |
| 40+20 - 45+00 | LT | 0.15 | 3.86 | 0.47 | 78.6 | 2.72 | 4.93 | 6 | 5.0 | 4 | 0.042 | 0.69 | | 0.85 | Seed & Mulch | | Drain Area includes 1/2 of driveway width | | | |
| Note: F.S. = Front Slope B.W. = Bottom Width | | | | | | | | B.S. = Back Slope | | | | | | | | | | | | |
| Manning "N" is Transitioning as the depth Approaches 0.7' | | | | | | | | | | | | | | | | | | | | |

Figure 3.2-7: Side Drain Design Example

3.3 CHANNEL LININGS

As stated in Section 2.4.3 of the *Drainage Manual*, when designing open channels, determine channel lining requirements. Erosion and sloughing cause most maintenance problems in channels. Channel linings often solve these problems. The *Standard Plans*, and the *Standard Specifications* identify standard lining types. The two main classifications of open channel linings are flexible and rigid. Flexible linings include vegetative linings such as grass, rubble riprap, and geotextile or interlocking concrete grids. Rigid linings include concrete, asphalt, and soil-cement. From an erosion control standpoint, the primary difference between rigid and flexible channel linings is their response to changes in channel shape (i.e., width, depth, and alignment). For most artificial channels, the ideal lining is natural, emerging vegetation, with grass used to provide initial and long-term erosion resistance.

The following are examples of lining materials in each classification.

1. Flexible Linings:
 - a. Grasses or natural vegetation
 - b. Rubble riprap
 - c. Wire-enclosed riprap (gabions)
 - d. Turf reinforcement (non-biodegradable)
2. Rigid Linings:
 - a. Cast-in-place concrete or asphaltic concrete
 - b. Soil cement and roller-compacted concrete
 - c. Fabric formed revetment
 - d. Partially grouted riprap
 - e. Articulated concrete blocks

3.3.1 Flexible Linings

Flexible linings have several advantages compared to rigid linings. They generally are less expensive, permit infiltration and exfiltration, and can be vegetated to have a natural appearance. Flow in channels with flexible linings is similar to that found in natural small channels. Natural conditions offer better habitat opportunities for local flora and fauna. In many cases, flexible linings are designed to provide only transitional protection against erosion while vegetation establishes and becomes the permanent lining of the channel; flexible channel linings are best suited to conditions of moderate shear stresses. Channel reaches with accelerating or decelerating flow (expansions, contractions, drops, and backwater) and waves (transitions, flows near critical depth, and shorelines) will require special analysis and may not be suitable for flexible channel linings.

3.3.1.1 Vegetation

Vegetative linings consist of seeded or sodded grasses placed in and along the channel, as well as naturally occurring vegetation. Vegetation is one of the most common and most

ideal channel linings for an artificial channel. It stabilizes the body of the channel, consolidates the soil mass of the bed, checks erosion on the channel surface, and controls the movement of soil particles along the channel bottom. Vegetative channel lining also is recognized as a best management practice for stormwater quality design in highway drainage systems. The slower flow of a vegetated channel helps the uptake of highway runoff contaminants (particularly suspended sediments) before they leave the highway right of way and enter streams.

There are conditions for which vegetation may not be acceptable, so you will need to consider other linings. These conditions include, but are not limited to:

- Standing or continuous flowing water
- Areas which do not receive the regular maintenance necessary to prevent domination by taller vegetation
- Lack of nutrients and excessive soil drainage
- Areas where sod will be excessively shaded

The Department operates on the premise that, with proper seeding and mulching during construction, maintenance of most ditches on normal sections and grades can be handled economically until a growth of grass becomes established. The use of temporary erosion control measures in ditches with low velocities will provide time for grassing and mulching to establish a vegetative ditch. When velocities exceed those for bare soils, seeding and mulching should not be used.

Sodding is recommended when the design velocity exceeds the value permitted for the bare base soil conditions but is less than 4 feet per second. Lapped or shingle sod is recommended when the design velocity exceeds that for sod (4 feet per second), and is suitable with velocities up to 5.5 feet per second.

3.3.1.2 Other Flexible Linings

Flexible linings usually are less expensive than rigid linings, provide a safer roadside, and have self-healing qualities that reduce maintenance. They also allow the infiltration and exfiltration of water.

(A) Rubble Riprap

After grass, rubble riprap is the most common type of flexible lining. It presents a rough surface that can dissipate energy and mitigate velocity increases. There are two standard types of rubble riprap. Use ditch lining rubble riprap in standard or typical ditches or channels. It consists of smaller stone sizes, which reduces construction costs over bank and shore rubble. Limit bank and shore rubble riprap to uses such as revetments and linings along stream banks and shorelines where extreme flows or wave action occurs.

Limited right of way and availability of material may restrict the use of this type of flexible lining. Place rubble riprap on a filter blanket and prepared slope to form a well-graded mass with a minimum of voids. Riprap and gabion linings can perform in the initial range of hydraulic conditions where you would use rigid linings. Stones used for riprap and gabion installations preferably have an angular shape that allow them to interlock. These linings usually require a filter material between the stone and the underlying soil to prevent soil washout and migration of fine grained soils. Sometimes you will need a bedding stone layer to protect the filter fabric from larger stone.

(B) Gabion Mats

Gabions are made of riprap enclosed in a wire container or closed structure that binds units of the riprap lining together. The wire enclosure normally consists of a rectangular container made of steel wire woven in a uniform pattern and reinforced on corners and edges with heavier wire. The containers are filled with stone, connected together, and anchored to the channel side slope. The forms of wire-enclosed riprap vary from thin mattresses to boxlike gabions. Use gabions typically when rubble riprap is either not available or not large enough to be stable. Although flexible, wire mesh restricts gabion movement. The wire mesh must provide an adequate service life. If the wire mesh fails, the individual stones will migrate.

(C) Articulating Concrete Block (ACB) Revetment Systems

ACB systems consist of a precast block matrix connected together by cables. The articulating properties of the matrix allow the system to accommodate changes in the ground surface that may occur due to settling. The block configuration varies with the manufacturer. The systems typically are manufactured in units of multiple precast blocks that can be lifted easily and placed with construction equipment. HEC-23 and the National Concrete Masonry Association's *Design Manual for Articulating Concrete Block Revetment Systems* provide guidance for the design of these systems.

(D) Turf Reinforcement

Depending on the application, materials, and method of installation, turf reinforcement may serve a transitional or long-term function. The concept of turf reinforcement is to provide a structure to the soil/vegetation matrix that will both assist in the establishment of vegetation and provide support to mature vegetation. Two types of turf reinforcement commonly are available: soil/gravel methods and turf reinforcement mats (TRMs).

To create soil/gravel turf reinforcement, you mix gravel mulch into on-site soils and seed the soil-gravel layer. The rock products industry provides a variety of uniformly graded gravels for use as mulch and soil stabilization. A gravel/soil mixture provides a non-degradable lining that is created as part of the soil preparation and is followed by seeding.

A TRM is a non-degradable rolled erosion control product (RECP) composed of UV-stabilized synthetic fibers, filaments, netting, and/or wire mesh processed into a three-dimensional matrix. TRMs provide sufficient thickness, strength, and void space to permit soil filling and establishment of grass roots within the matrix. One limitation to the use of TRMs is in areas where siltation is a problem. When the ditch is cleaned by maintenance, it is likely that the geofabric will be snagged and pulled out by the equipment.

3.3.2 Rigid Linings

Rigid linings generally are constructed of concrete, asphalt, or soil-cement pavement whose smoothness offers a higher capacity for a given cross-sectional area. Higher velocities, however, create the potential for scour at channel lining transitions from the rigid lining back to the grass lining. A rigid lining can be destroyed by flow undercutting the lining, channel headcutting, or the buildup of hydrostatic pressure behind the rigid surfaces. When properly designed, rigid linings may be appropriate where the channel width is restricted. Rigid linings are useful in flow zones where high shear stress or rapidly varied or turbulent flow conditions exist, such as at transitions in channel shape or at an energy dissipation structure.

Rigid linings are particularly vulnerable to a seasonal rise in the water table that can cause a static uplift pressure on the lining. If you need a rigid lining in such conditions, incorporate a reliable system of under drains and weep holes as a part of the channel design. Evaluate the migration of fine grained soils into filter layers to ensure that the ground water is being discharged without filter clogging or collapse of the underlying soil. A related case is the buildup of soil pore pressure behind the lining when the flow depth in the channel drops quickly. Using watertight joints and backflow preventers on weep holes can help to reduce the buildup of water behind the lining.

Section 2.4.3.1.2 of the *Drainage Manual* requires the design for the potential for buoyancy due to the uplift water pressure when concrete linings are to be used where soils may become saturated. The total upward force is equal to the weight of the water displaced by the channel. The total weight of the lining helps to resist the uplift pressure. When the weight of the lining is less than the uplift pressure, the channel is unstable.

Acceptable countermeasures include:

- Increasing the thickness of the lining to add additional weight
- For sub-critical flow conditions, specifying weep holes at appropriate intervals in the channel bottom to relieve the upward pressure on the channel
- For super-critical flow conditions, using sub-drains in lieu of weep holes

3.3.2.1 Cast-in-Place Concrete

Refer to *Standard Plans, Index 524-001* for typical ditch pavement details. Asphalt linings have limited use since routine maintenance activities often damage or destroy them. Use filter fabric to prevent soil loss through pavement cracks.

Despite the non-erodible nature of concrete linings, they are susceptible to failure from foundation instability. The major cause of failure is undermining that can occur in a number of ways. Inadequate erosion protection at the outfall, at the channel edges, and on bends can initiate undermining by allowing water to carry away the foundation material and leaving the channel to break apart. Concrete linings also may break up and deteriorate due to conditions such as a high water table or swelling soils that exert an uplift pressure on the lining. When a rigid lining breaks and displaces upward, the lining continues to move due to dynamic uplift and drag forces. The broken lining typically forms large, flat slabs that are particularly susceptible to these forces.

3.3.2.2 Fabric Formed Revetment

Fabric formed revetments, also known as grout-filled mattresses, are the result of pumping a concrete mix into fabric envelopes or cases. The advantage of using fabric formed revetments is that they reduce construction time by eliminating the need for wooden forms and expensive lifting machines and also allow the concrete to be pumped and cured below the water line.

Filter point fabric formed revetments consist of a dual wall fabric that is injected with concrete. This type of fabric formed revetment is characterized by a deeply cobbled surface. The filter points woven into the fabric provide a means for groundwater to escape and to provide release for the hydrostatic pressure. Filter point fabrics provide a higher coefficient of friction to promote energy dissipation.

As of June 2020, FDOT has Developmental Specification 531 for fabric formed revetment systems available.

3.3.3 Velocity and Shear Stress Limitations

HEC-15 provides a detailed presentation of stable channel design concepts for roadside and median channels. This section provides a brief summary of significant concepts.

Stable channel design concepts provide a means of evaluating and defining channel configurations that will perform within acceptable limits of stability. Most highway drainage channels cannot tolerate bank instability and lateral migration. When the material forming the channel boundary effectively resists the erosive forces of the flow, then you have achieved stability. You can apply principles of rigid boundary hydraulics to evaluate this type of system.

Apply both velocity and tractive force methods to help determine channel stability. Permissible velocity procedures are empirical in nature, so they have been used to design numerous channels in Florida and throughout the world. However, tractive force methods consider actual physical processes occurring at the channel boundary and represent a more realistic model of the detachment and erosion processes.

The hydrodynamic force that water flowing in a channel creates causes a shear stress on the channel bottom. The bed material, in turn, resists this shear stress by developing a tractive force. Tractive force theory states that the flow-induced shear stress should not produce a force greater than the tractive resisting force of the bed material. This tractive resisting force of the bed material creates the permissible or critical shear stress of the bed material. In a uniform flow, the shear stress is equal to the effective component of the gravitational force acting on the body of water parallel to the channel bottom. The average shear stress is equal to:

$$\tau = \gamma R S \quad (3.3-1)$$

where:

| | |
|------------|---|
| τ = | Average shear stress, in pounds per square feet |
| γ = | Unit weight of water, 62.4 lb/ft ³ |
| R = | Hydraulic radius, in feet |
| S = | Average bed slope or energy slope, in feet per feet |

The maximum shear stress for a straight channel occurs on the channel bed and is less than or equal to the shear stress at maximum depth. Compute the maximum shear stress as follows:

$$\tau_d = \gamma d S \quad (3.3-2)$$

where:

| | |
|------------|---|
| τ_d = | Maximum shear stress, in pounds per square feet |
| d = | Maximum depth of flow, in feet |
| S = | Channel bottom slope, in feet per feet |

Velocity limitations for artificial open channels should be consistent with stability requirements for the selected channel lining. As indicated above, use seed and mulch only when the design velocity does not exceed the allowable velocity for bare soil. Table 2.3 of the *Drainage Manual* presents maximum shear stress values and allowable velocities for different soils. When design velocities exceed those acceptable for bare soil, sod, or lapped sod, consider flexible or rigid linings. Table 2.4 of the *Drainage Manual* summarizes maximum velocities for these lining types.

Side Slope Stability

The shear stress on the channel sides generally is less than the maximum shear stress calculated on the channel bottom, but you should consider this issue when determining the height of a channel lining along the side slope of the channel. The maximum shear stress on the side of a channel is given by:

$$\tau_s = K_1 \tau_d \quad (3.3-3)$$

where:

- τ_s = Side shear stress on the channel, in pounds per square feet
 K_1 = Ratio of channel side to bottom shear stress
 τ_d = Shear stress in channel at maximum depth, in pounds per square feet

The value K_1 depends on the size and shape of the channel. For parabolic channels, the shear stress at any point on the side slope is related to the depth at that point and you can calculate it using Equation 3.3-2. For trapezoidal and triangular channels, K_1 is based on the horizontal dimension 1: Z (V: H) of the side slopes.

| | |
|-----------------------|---------------|
| $K_1 = 0.77$ | $Z \leq 1.5$ |
| $K_1 = 0.066Z + 0.67$ | $1.5 < Z < 5$ |
| $K_1 = 1.0$ | $5 \leq Z$ |

Avoid using side slopes steeper than 1:3 for flexible linings other than riprap or gabions because of the potential for erosion at the side slopes. Steep side slopes are allowable within a channel if cohesive soil conditions exist.

Maintenance Considerations

Also consider maintenance of the channel when choosing a channel lining. The channel will need to be accessible by mowers and trucks.

Mowing

Side slopes of vegetated channels will need to be traversable for mowing equipment and crews. The maximum traversable slope for this equipment is 1:4.

Access Across Channel

If there is rubble riprap lining the channel and a vegetated buffer on the backside of the channel along the right of way, the irregularity of the riprap typically prevents access. In this situation, it may become impractical to maintain the vegetation.

3.3.4 Application Guidance for Some Common Channel Linings

3.3.4.1 Rubble Riprap

Types

- **Ditch Lining**—Flexible layer or facing of rock placed on a filter blanket and prepared slope used to line a ditch or channel for protection from erosion.
- **Bank and Shore**—Flexible layer or facing of rock placed on a bank or shore to prevent erosion or scour of the embankment or a structure.

What is its purpose?

Use rubble riprap in channels, along embankments, or around structures that are vulnerable to erosion or scour.

Where and how is it commonly used?

- **Ditch Lining**—In this case, use rubble riprap to line ditches and channels to protect slopes from erosion.
- **Bank and Shore**—In this case, use it as a flexible revetment to line banks and shores subject to erosion.

When should it be installed?

- **Ditch Lining**—Install rubble riprap in channels with moderate shear stresses. To prevent uplifting forces on the lining, the filter requires adequate permeability.
- **Bank and Shore**—Use rubble riprap to protect banks or shores with flows that generally are greater than 50 ft³/s or that are subject to wave action.

When should it not be installed?

- **Bank and Shore**—Do not install rubble riprap when ditch lining methods are applicable.

Advantages and disadvantages

ADVANTAGES

- Flexible
- Not weakened by minor shifting caused by settlement
- Easily repaired by additional rock placement
- Simple construction method
- Recoverable/reusable
- Long-term or temporary installations

DISADVANTAGES

- Hauling and installation costs
- Prohibits maintenance equipment from traversing channels
- If hand placement is required, then labor is intensive

- Vegetation growth can hinder inspections

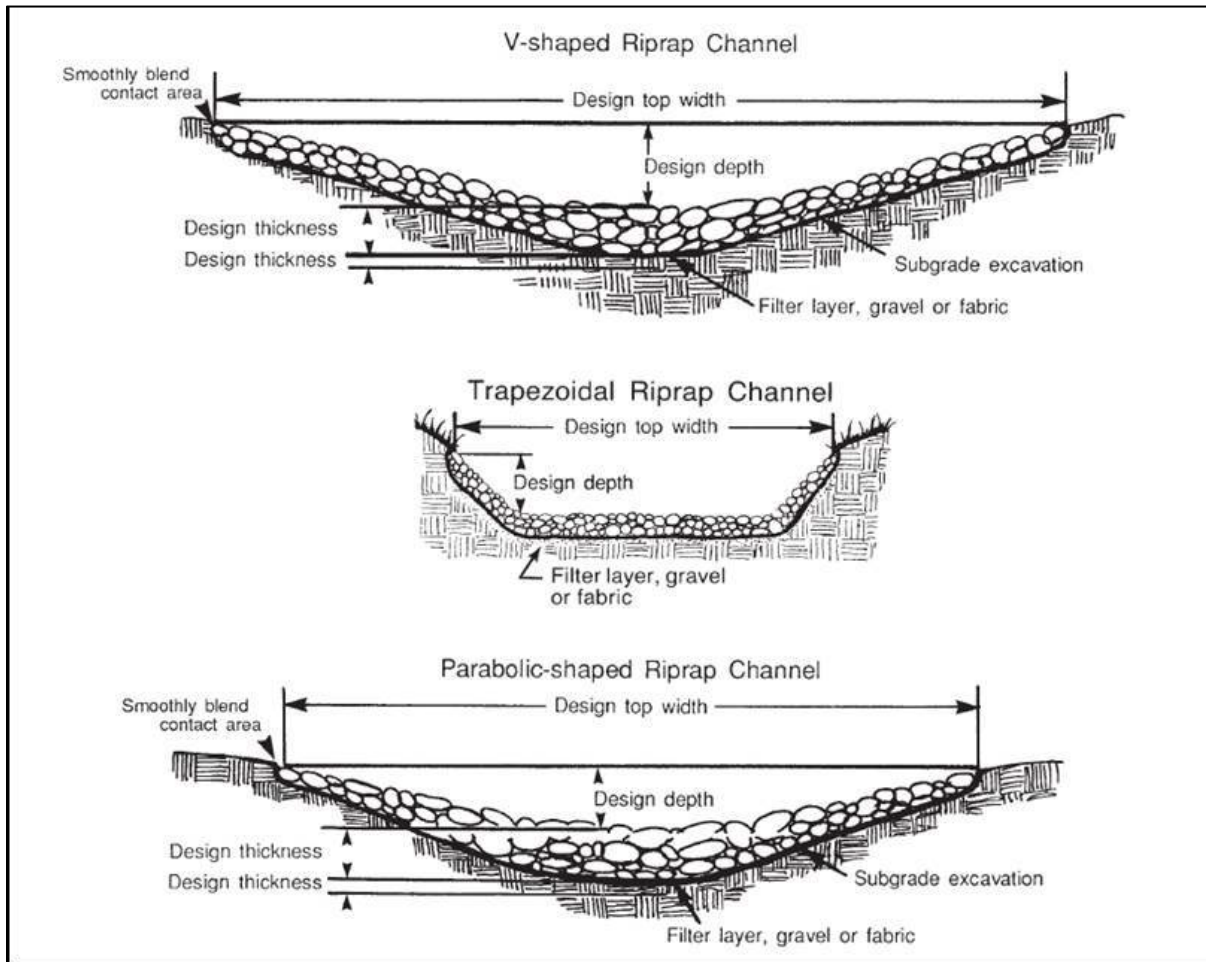

North Carolina Erosion and Sediment Planning and Control Manual

Figure 3.3-1: Riprap-lined Channel Cross Sections

3.3.4.2 Fabric Formed Revetments

Types

Fabric formed revetments for concrete with filtering points that provide for the relief of hydrostatic pressures.

What is the purpose?

Use fabric formed revetments—filter point or articulating—for slopes or areas that are subject to severe to moderate erosion problems.

Where and how are they commonly used?

Use fabric formed revetments in ditches, channels, canals, streams, rivers, ponds, lakes, reservoirs, marinas, and ports/harbors to reduce the impact of erosion.

When should they be installed?

Install fabric formed revetments where there are moderate to severe erosion problems and where the channel is subjected to hydrostatic uplift pressures. Also, install these where there is a need to allow water to permeate into the soil and not remain wet.

When should they not be installed?

Do not use fabric formed revetments in ditches or channels that are subject to changes in soil conditions such as erosion under the mat or consolidation.

Advantages and disadvantages**ADVANTAGES**

- Adapts easily to contours
- Easy to install
- Permeable
- Reduces uplift pressure
- Can be installed under the water line

DISADVANTAGES

- Needs to be installed on a prepared slope
- Not aesthetically pleasing
- Easily undermined if not toed properly

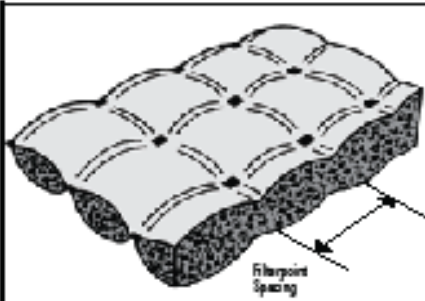

| Designation Style | CAST-IN-PLACE | | | | | | | |
|-------------------|---------------------|-----|--------------------------------|-----|-----------------------|-----------------------|--------------------------|-------------------|
| | Filterpoint Spacing | | Average Thickness ^a | | Coverage Per | | Dry Weight ^{**} | |
| | in. | mm | in. | mm | Y ^a Mortar | M ^a Mortar | lb/ft ² | kg/m ² |
| 5" FPNN | 5 | 127 | 2.2 | 56 | 135 ft ² | 16.39 m ² | 25 | 122 |
| 8" FPNN | 8 | 200 | 4 | 100 | 75 ft ² | 9.11 m ² | 45 | 220 |
| 10" FPNN | 10 | 250 | 6 | 150 | 50 ft ² | 6.07 m ² | 68 | 330 |

(Source: <http://www.fabriform1.com>)
Construction Techniques, Inc.

Figure 3.3-2: Fabric Formed Revetment with Filter Point Linings

3.3.4.3 Gabions

Types

- **Gabion Mats**—Wire mesh mats filled with stones
- **Gabion Baskets**—Wire mesh baskets filled with stones

What is the purpose?

Rock-filled baskets or mattresses that are used to line large ditches, channels, canals, and coastal shores for stabilization and protection.

Where and how are they commonly used?

Gabion Mats—Use gabion mats in ditches, channels, canals, streams, rivers, ponds, lakes, reservoirs, marinas, and ports/harbors to reduce the impact of erosion.

When should they be installed?

Gabion Mats—Install gabion mats in large areas where there are moderate to severe erosion problems due to extreme velocities. Also where there is a need to allow water to permeate into the soil and not remain wet.

When should they not be installed?

Gabion Baskets—Small areas subject to low velocities and when a temporary situation exists.

Advantages and disadvantages

ADVANTAGES

- Protects seed mix from eroding when used
- Permeable
- Increases retention of soil moisture
- Permits the growth of vegetation
- Able to span minor pockets of bank subsidence without failure

DISADVANTAGES

- Cost of installation
- Susceptibility of the wire baskets to corrosion and abrasion damage
- More difficult and expensive to repair
- Less flexible than standard riprap

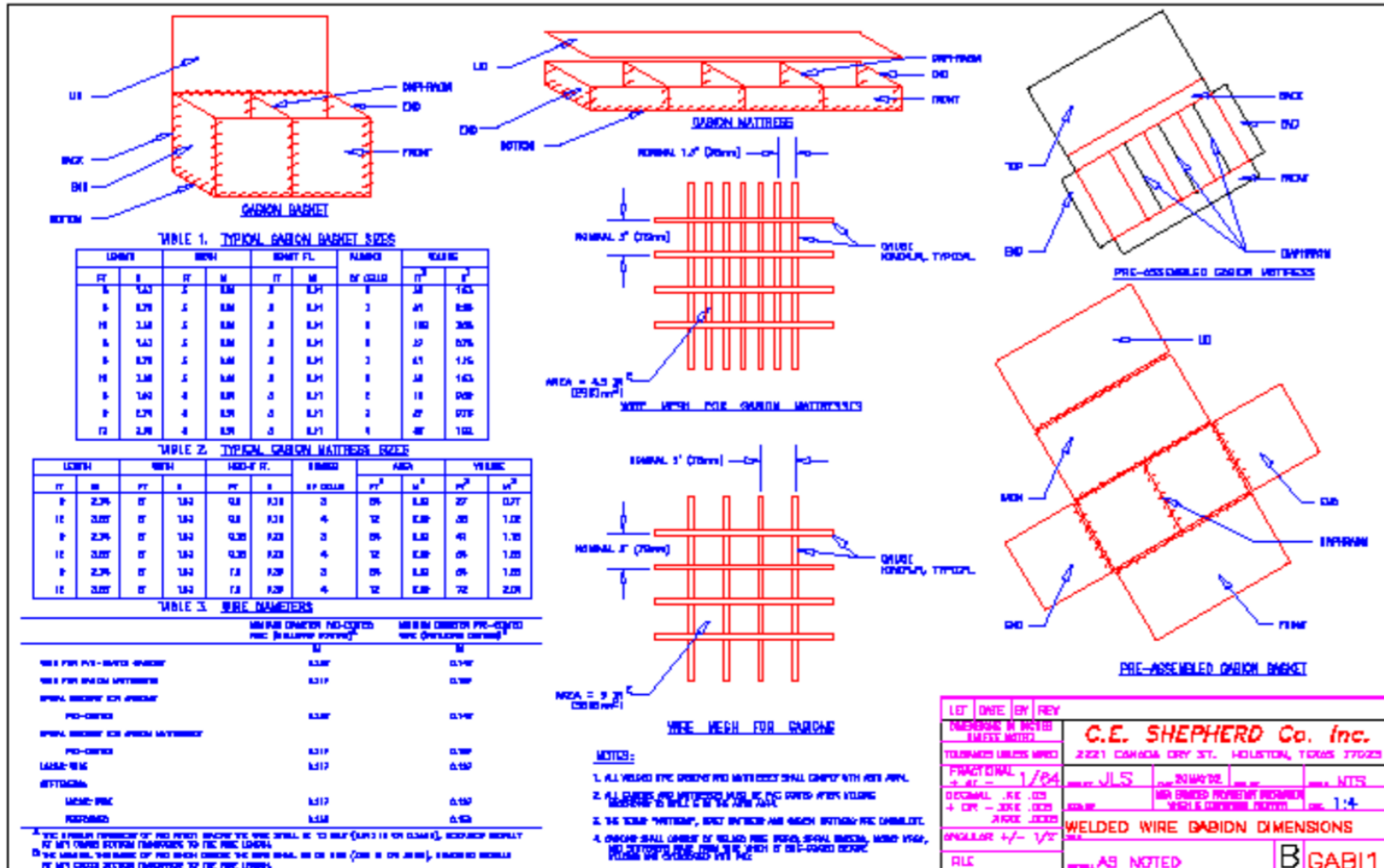

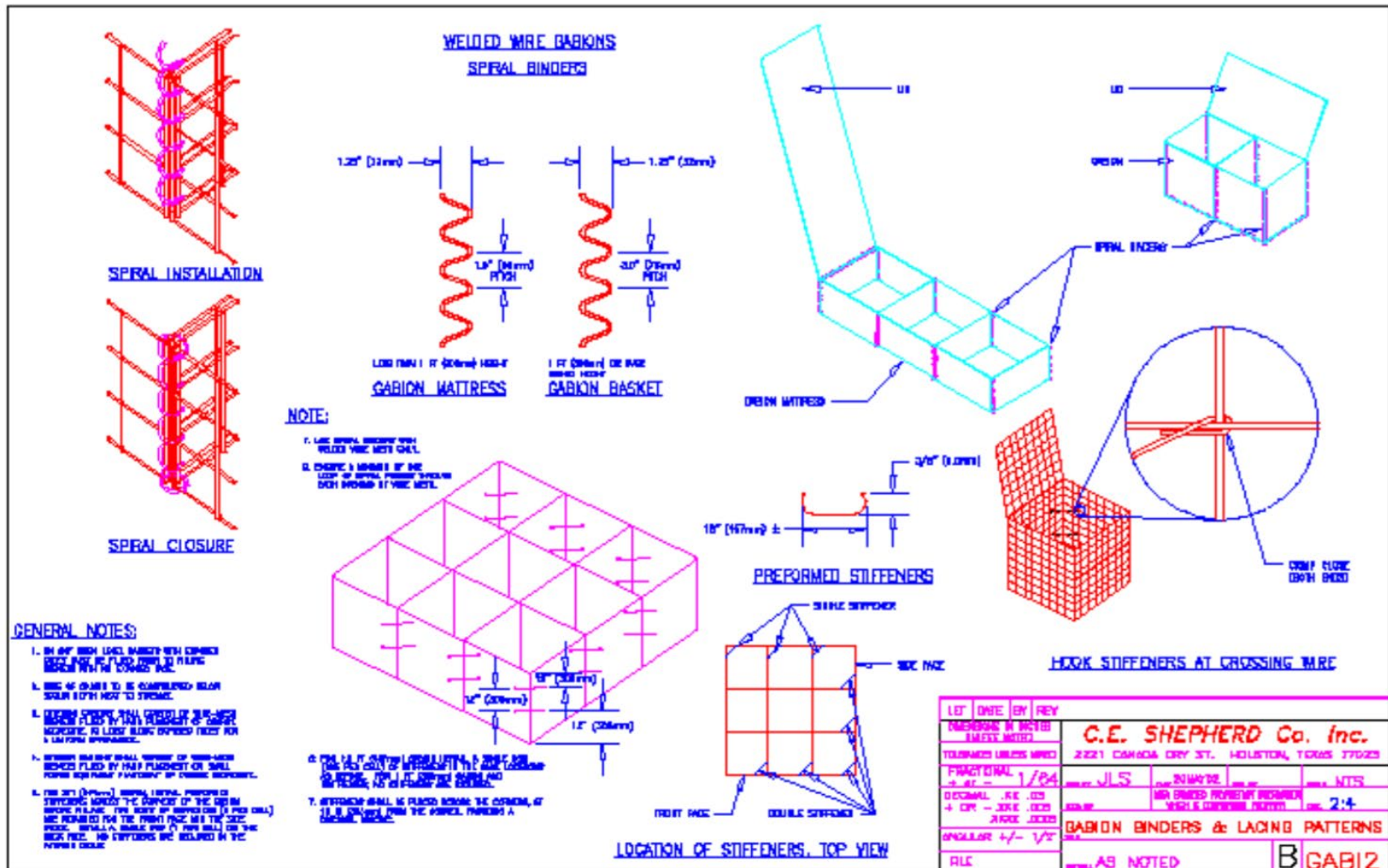

(Source: <http://www.gabions.net/downloads.html>)
Modular Gabion Systems, a division of C.E. Shepherd Company

Figure 3.3-4: Gabion Binding

3.3.4.4 Soil Stabilizers

Types

- **Turf Reinforcement Mats**—A long-term non-degradable mat composed of UV stabilized synthetic fibers, nettings, and/or filaments.
- **Erosion Control Blankets**—A temporary degradable mat composed of processed natural or polymer fibers mechanically, structurally, or chemically bound together to form a continuous matrix.

What is the purpose?

To protect disturbed slopes and channels from wind and water erosion. The blanket materials are natural materials, such as straw, wood excelsior, coconut, or are geotextile synthetic woven materials, such as polypropylene.

Where and how are they commonly used?

- **Turf Reinforcement Mats**—Use them on ditch slopes and fill slopes to reduce the impact of erosion for long periods of construction.
- **Erosion Control Blankets**—Use them on ditch slopes and fill slopes to reduce the impact of erosion during short periods of construction.

When should they be installed?

- **Turf Reinforcement Mats**—Where there are low velocities of flow
- **Erosion Control Blankets**—Where there are low velocities of flow and where there are sensitive environmental areas

When should they not be installed?

- **Turf Reinforcement Mats**—Do not install for permanent situations and where there are high velocities of flow.
- **Erosion Control Blankets**—Do not install for permanent situations and where there are high velocities of flow.

Advantages and disadvantages

ADVANTAGES

- Adapts easily to contours
- Easy to install
- Permeable
- Reduced uplift pressure

DISADVANTAGES

- Cost
- Maintenance equipment can damage or pull out

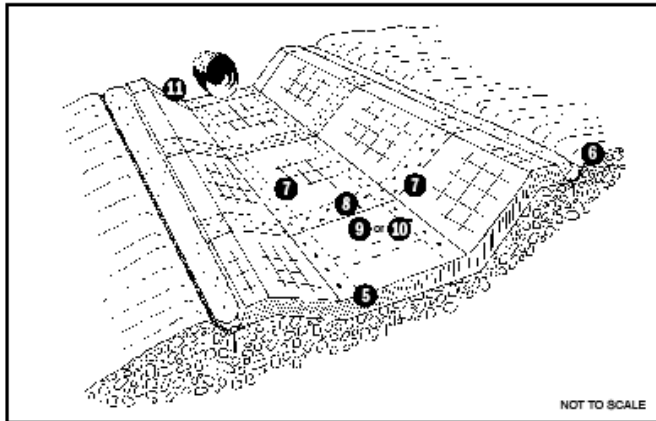

(Source: <http://propexglobal.com/>)
Propex Geosynthetics

**Figure 3.3-5: Erosion Control Mat in Channel
(Downstream)**

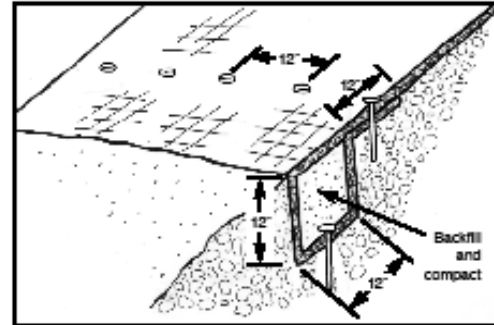

(Source: <http://propexglobal.com/>)
Propex Geosynthetics

Figure 3.3-6: Initial Anchor

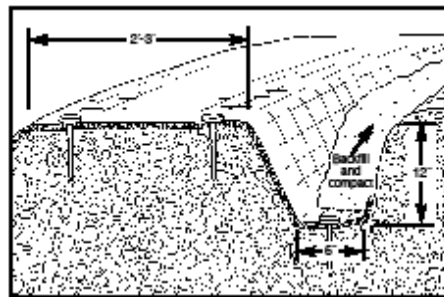

(Source: <http://propexglobal.com/>)
Propex Geosynthetics

Figure 3.3-7: Longitudinal Anchor Trench Detail (Trapezoidal Channel)

3.4 DRAINAGE CONNECTION PERMITTING AND MAINTENANCE CONCERNS

3.4.1 Drainage Connection Permitting

Adjacent property owners must obtain a Drainage Connection Permit from FDOT according to Section 334.044(15), Florida Statute (F.S.), Chapter 14-86, Florida Administrative Code (F.A.C.), Rules of the Department of Transportation, when developing their property. In general terms, the Drainage Connection Permit ensures that the development will not overload the Department's stormwater conveyance systems and cause flooding on either the roadway or other downstream properties. For more information on Drainage Connection Permits, refer to the *Drainage Connection Permitting Handbook*. This section will discuss several aspects of the Department's ditches that you should consider during the Drainage Connection Permitting process.

3.4.1.1 Roadside Ditch Impacts

Discharges to the roadside ditch from the proposed development will be limited by the Permit so that the ditch flow will not be increased. However, the proposed development can physically impact the roadside ditch by placing or widening driveways to the property or by widening the roadway to add turn lanes.

If the roadside ditch is a linear treatment pond, then any reduction in the volume of the ditch could violate the conditions of the permit obtained for the facility. The simplest way to resolve this issue is to rework the ditch so that any volume lost as a result of the development is replaced. This may require that the property owner donate some property to the Department to provide an area to rework the ditch.

Even if the roadside ditch is not a linear treatment facility, you must maintain the capacity of the ditch. Include a side drain to convey the ditch flow from one side of the turnout to the other, unless the turnout is located at a high point in the ditch and the flow is away from the turnout in both directions. An added turn lane may require that the roadside ditch be relocated. The relocated portion of the ditch should have the same capacity or more than the existing ditch. If the existing right of way is not wide enough to accommodate the relocated ditch, then right of way may need to be donated to FDOT for the ditch. A turnout requiring a side drain and a turn lane requiring donated right of way for the ditch relocation are shown in Figure 3.4-1.

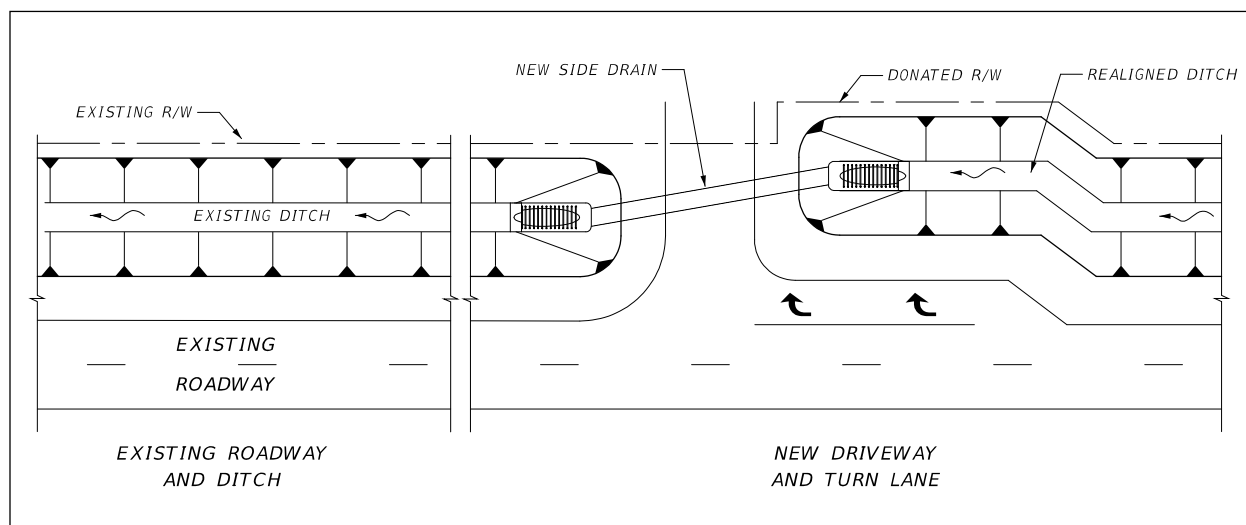

Figure 3.4-1: Effect of Adjacent Development on a Roadside Ditch

In some cases, the developer may need to add a left-turn lane. Widening the road to accommodate the left-turn lane also may affect the ditch on the opposite side of the road from the development. Often, the developer will not own the property on both sides of the road. In this case, the roadside ditches and roadway must be redesigned to accommodate the new turn lanes in such a way as to require donated right of way on the new development's side of the road.

The flow lines of the side drain should match the existing ditch. Also ensure that the flow lines of the new side drain are higher than the next side drain downstream and lower than the next side drain upstream to avoid temporary ponding in the ditch.

Make sure to size the side drain properly. You can make some judgments about the size of the pipe by looking at the side drains upstream and downstream of the new drive. Analyze the side drain to ensure the new pipe does not cause the water levels to pop out of the ditch. In some cases, you can obtain the design discharge for the ditch from the old plans for the roadway. Or you can calculate the flow by determining the drainage area and performing the proper hydrologic calculations; typically, the Rational Equation. You can find more details on these hydrology calculations in Chapter 2. Calculate the losses through the pipe using methods given in Chapter 4. Additional sizing considerations are discussed in Section 3.2.8.

When adding new side drains, another consideration is the proximity of other existing side drains. If side drains are too close to each other, then the hydraulic losses can be too large. The general requirement is that the end sections of two side drains in series should be at least 25 feet apart. If the distance is less than 25 feet, then you should enclose the area and add an inlet to collect the runoff from the area between the driveways.

Evaluate potential erosion at the infall point of the connection, especially for pipe connections. Chapter 4 explains how to calculate the outlet velocity from a pipe. Refer to Section 3.3 for channel linings. You can find outlet erosion protection criteria in the *Drainage Manual*.

3.4.1.2 Median Ditch Impacts

A new development can impact the median ditch if the Department allows a new median opening or left-turn lane.

Unless you can place a new median opening at the high point in the median ditch, or close enough to the high point that it is possible to regrade the ditch to flow away from the new median opening in both directions, then the new opening will block the flow in the ditch. Figure 3.4-2 shows a typical situation where there is an existing median opening at the high point in the median ditch and the ditch flows to a median drain, which consists of a ditch bottom inlet, pipe, and endwall. The median drain discharges runoff from the median to keep the median from filling with water and spilling across the roadway.

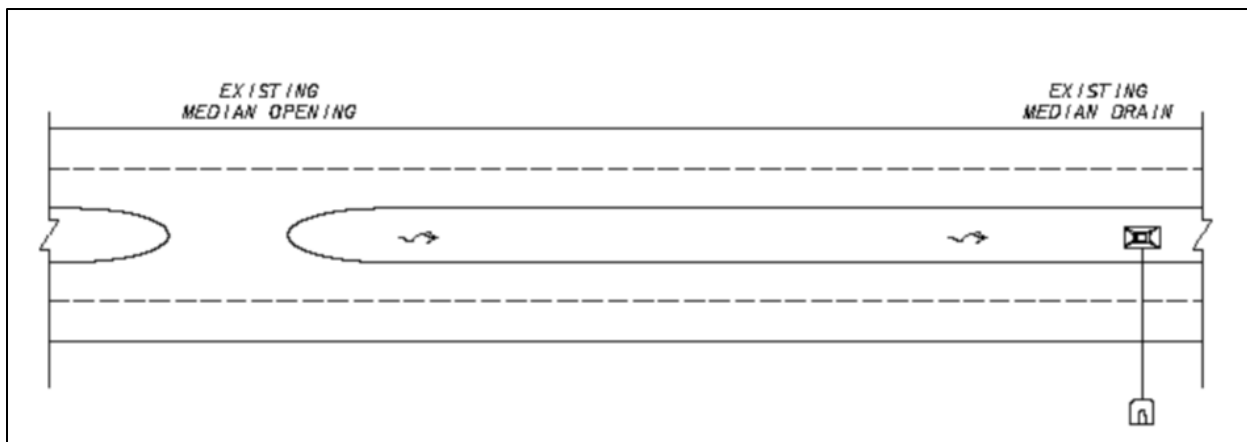

Figure 3.4-2: Existing Median Ditch

If you add a new median opening to accommodate an adjacent development, the opening may block the flow in the median ditch. Include a new drainage structure with the opening to discharge the flow from the median. Figure 3.4-3 shows a side drain included to convey the ditch flow from one side of the new median opening to the other. This often will be the most economical method to provide adequate drainage for the median. However, in many cases, the median ditch will be too shallow and the side drain will not have adequate cover over the pipe. Refer to Appendix C of the *Drainage Manual* for the minimum cover needed over the pipe.

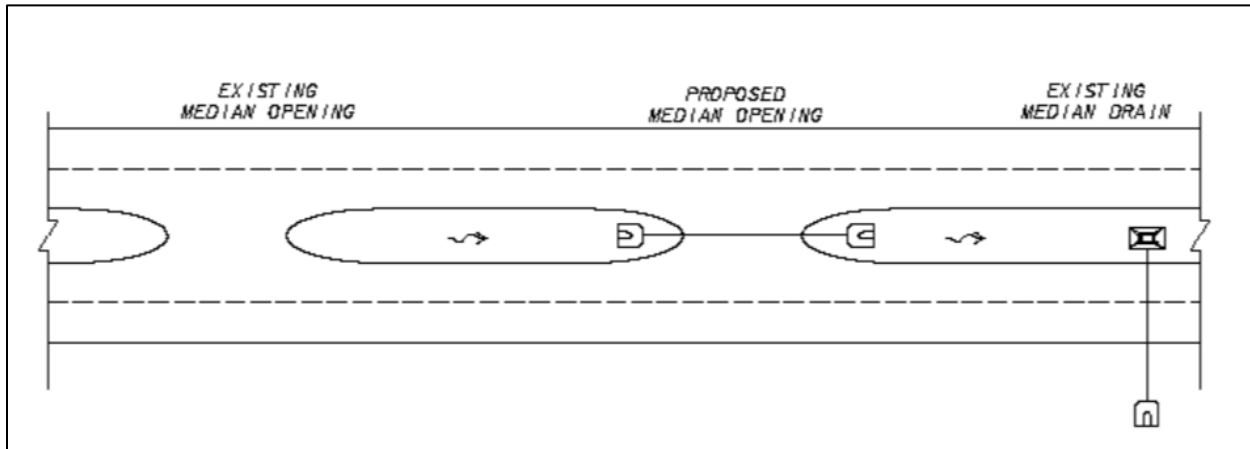

Figure 3.4-3: New Median Opening with Side Drain

Figure 3.4-4 includes a new median drain to accommodate the median flow. If you choose to use this option, check the capacity of the roadside ditch with the added discharge from the median. Unless you jack and bore the pipe, the existing pavement would have to be cut and patched to install the pipe. Make sure to consider the cutting and patching operations in maintenance of traffic plans.

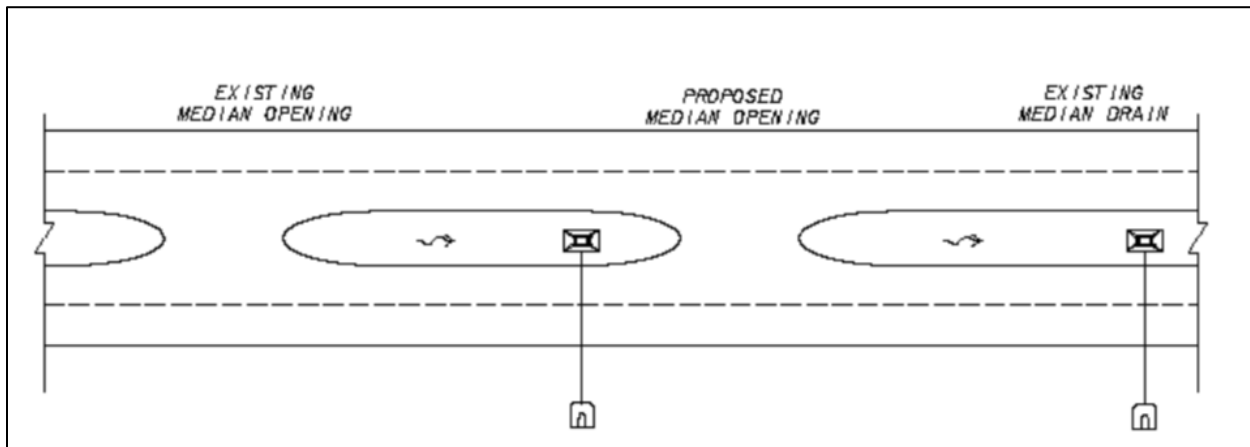

Figure 3.4-4: New Median Drain

Another option that might avoid the expense of jacking and boring or the concerns of cutting and patching the existing roadway is shown in Figure 3.4-5. You could connect the new ditch bottom inlet (DBI) to the existing median drain with a pipe beneath the new median opening.

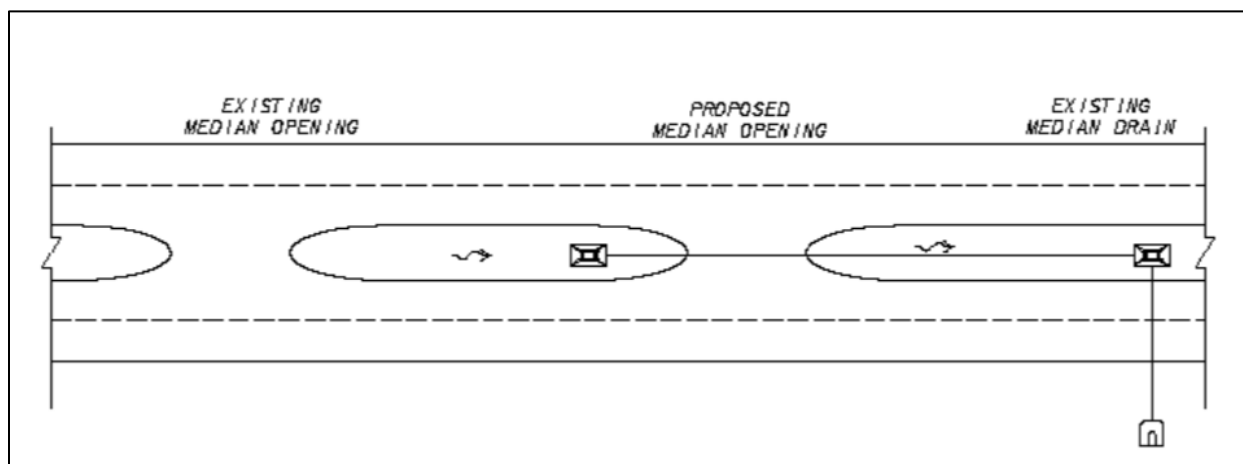

Figure 3.4-5: New Median Drainage System

Adding a turn lane in the median often will reduce the size of the median ditch adjacent to the new turn lane. Check the reduced ditch for capacity, and add extra median drainage structures if needed. Super-elevated roadways that drain to the median can worsen the capacity problems in areas where the ditch has been reduced.

3.4.1.3 Outfall Ditch Impacts

Requested connections or crossing may physically impact outfall ditches. Usually, the permitted flow will not be greater than the existing flow rate because of the requirements of the connection permit. However, you need to evaluate losses associated with the physical impacts to ensure there is no compromise to the capacity of the outfall ditch.

Overland flow connections can cause bank erosion and sloughing if the flow becomes concentrated. To avoid this problem, use point connections through pipes or ditches. Erosion problems also can occur at the connections to an outfall ditch. Refer to Section 3.4.1.1 for guidance to protect the infall point.

3.4.2 Maintenance Concerns

3.4.2.1 Ditch Closures

Residents or other property owners occasionally will request that the roadside ditch in front of their property be filled and replaced with a pipe system. Piping a ditch can increase the energy loss and reduce infiltration. Under storm conditions, open ditching is an efficient method of accommodating a significantly greater quantity of drainage than a pipe. Therefore, any piping or filling of a roadside ditch generally is of no benefit to the Department and may reduce operational and maintenance aspects of the road.

Drainage connection applicants should perform a hydraulic assessment to determine ditch piping or filling impacts on the area drainage system. These impacts should adhere to Rule 14-86 requirements, as consistent with the *Drainage Manual*. Unless you acquire flood rights, any increase over pre-development stages should not change land use values significantly.

Do not consider filling an open ditch if the basis for the modification is for aesthetic purposes, for landscaping, or to benefit the abutting private property owner only. Table 3.4-1 lists criteria and other considerations for converting existing drainage ditches to closed drainage systems.

Table 3.4-1:

| Capacity of Closed System | |
|--|---|
| Criteria | Comments |
| <p>Design Storms: The more stringent of:</p> <ul style="list-style-type: none"> • Rule 14-86, F.A.C. Storms: • Original Ditch Design Storms: • <i>Drainage Manual</i> Design Storms: <ul style="list-style-type: none"> ○ Evacuation route? ○ Upstream owner constraints? <ul style="list-style-type: none"> ▪ Potential for flooding upstream? ○ Downstream constraints? <ul style="list-style-type: none"> ▪ Tailwater • Planned work program improvements: | <p>Primary considerations:</p> <ul style="list-style-type: none"> • Minimize adverse impact on Department & other facility users • Maximize capacity of facility • Maximize life of facility <ul style="list-style-type: none"> ○ Avoid need to reconstruct for later foreseeable projects • Minimize maintenance cost |
| <p>Pipe Size: The more stringent of:</p> <ul style="list-style-type: none"> • Rule 14-86, F.A.C. Criteria: • Original Ditch Design Criteria: • <i>Drainage Manual</i> Criteria: • Future Work Program Requirements: | <p>Check various scenarios and use the criteria that most satisfies the Department's interests.</p> |

Table 3.4-1 (continued)

| Capacity of Closed System (continued) | |
|---|--|
| Criteria | Comments |
| <p>Method: Prove that the headwater elevation for the design storms shall not be increased immediately upstream of the proposed system.</p> <p>Base design on hydrologic conditions in the field, not the size of existing pipe systems.</p> <p>Base design on condition that entire length of the ditch will eventually have a closed system.</p> | <p>Do not rely solely on the size of existing upstream systems for designing capacity of ditch systems downstream. While knowledge of upstream systems is useful in many ways, these existing systems:</p> <ul style="list-style-type: none"> • May be undersized due to: <ul style="list-style-type: none"> ○ Design errors ○ Under estimated watershed area ○ Subsequent land development activity ○ Subsequent system changes or diversion • May not reflect current design standards • May not be adequate for current or future needs <ul style="list-style-type: none"> ○ Existing flooding conditions ○ Future road improvements |
| <p>Other considerations: Remember that the Department owns not only the current capacity of its outfall easements, but also the right to use any potential excess capacity available in the outfall.</p> <p>Any proposed piped outfall must be sized for the Design Frequency noted in Chapter 2 of the <i>Drainage Manual</i>.</p> <p>Select solutions that maximize preservation of the Department's ability to expand its system to the full use of its facility for future needs.</p> <p>Consider the consequences that result when the proposed system fails and make any reasonable adjustments to minimize damage and liability for the Department.</p> | <p>The applicant usually hopes to reduce the Department's easement area by closing the open ditch with pipe or other structures.</p> <p>This usually represents a false economy when one adds the requirements necessary to maintain the closed system at minimum expense.</p> <hr/> <p>Oftentimes, you can eliminate or greatly reduce major risk of damage due to system failure by careful attention to the failure mode and addition of details to re-route overflows or provide protective measures such as curbs, berms, emergency spillways, etc.</p> |

Table 3.4-1 (continued)

| Work Program | |
|--|--|
| Criteria | Comments |
| <p>Considerations:</p> <ul style="list-style-type: none"> • In Work Program: <ul style="list-style-type: none"> ○ If already designed & approved – use the design ○ If not designed – coordinate design for approval by DOT project engineer • Not in Work Program: <ul style="list-style-type: none"> ○ Route design submittal for review and approval by District Drainage Engineer among others | <p>The possibility exists that the applicant can simply build the outfall already under design by the Department, especially if the applicant cannot wait for the Department's future construction job to complete the work.</p> |
| Erosion Control | |
| <p>Considerations:</p> <ul style="list-style-type: none"> • Erosion at outlet • Erosion when flows exceed system capacity • Soils • Flow velocity • Slopes | <p>May result in failure of the pipe outfall system.</p> <p>Possible turbid discharge downstream.</p> |
| <p>Methods:</p> <ul style="list-style-type: none"> • <i>Drainage Manual</i> • Erosion and Sediment Control Designer and Reviewer Manual • Protective measures <ul style="list-style-type: none"> ○ Structural solutions ○ Non-structural methods | |
| Maintenance | |
| <p>Responsibility:</p> <ul style="list-style-type: none"> • Applicant (local government) responsible <ul style="list-style-type: none"> ○ When concession needed from Department in negotiation ○ When special structures require more maintenance attention or expense • DOT responsible <ul style="list-style-type: none"> ○ At DOT discretion | <p>Define this carefully in the agreement.</p> |

Table 3.4-1 (continued)

| Maintenance (continued) | |
|---|--|
| Criteria | Comments |
| <p>Considerations:</p> <ul style="list-style-type: none"> • Reasonable & Safe Access <ul style="list-style-type: none"> ○ For equipment ○ For personnel ○ For operations – spoil, staging, etc. • Other facilities in easement <ul style="list-style-type: none"> ○ Above ground - trees, fences, sheds, etc. ○ Underground - utilities, drainage, etc. • Potential to damage adjacent facilities <ul style="list-style-type: none"> ○ Above ground structures, buildings, etc. ○ Overhanging structures, utilities, etc. • Limitations: <ul style="list-style-type: none"> ○ Depth of work - shoring needed? ○ Groundwater | <p>Consider these factors when negotiating the terms of agreement.</p> <p>Remember: If the new facility cannot be reasonably maintained in a safe and cost effective manner, then perhaps the easement should remain an open ditch.</p> |
| Right-of-way | |
| <p>Considerations:</p> <ul style="list-style-type: none"> • Additional right-of-way required: <ul style="list-style-type: none"> ○ To maintain access ○ To enable maintenance ○ To minimize Cost of Maintenance ○ To preserve or secure drainage rights • Donation of right-of-way • Reduction of right-of-way: <ul style="list-style-type: none"> ○ Only when fully justified ○ Must meet <i>Drainage Manual</i> requirements for dimension, etc. | <p>Consult with right-of-way attorney to determine:</p> <ul style="list-style-type: none"> • the appropriate style of easement • relation to downstream owners not involved in the transaction <ul style="list-style-type: none"> ○ Where to end the easement when drainage exits applicant's property and falls onto another person's property? • special terms to add into the easement document |

Table 3.4.1 (continued)

| Permitting | |
|---|--|
| Criteria | Comments |
| <p>Document:</p> <ul style="list-style-type: none"> • Contractual Agreement • Easement Agreement • Easement Donation / Exchange • Drainage Connection Permit | <p>A Drainage Connection Permit is not the appropriate form for approval of this category of work, unless the work is performed as part of a larger scope of property improvements that require the permit and there is no need to alter the existing easement in any way.</p> <p>A contractual agreement with appropriate terms and conditions is the preferred method of approval.</p> |
| <p>Process:</p> <ul style="list-style-type: none"> • If easement relocation or exchange required: <ul style="list-style-type: none"> ○ Follow “Property Management Related Reconstruction Process” chart • If no change needed to existing easement : <ol style="list-style-type: none"> 1. Consult early with Legal Department to determine form of agreement 2. Perform review proposed design to determine any special conditions or terms required in the agreement 3. Legal Department to draft agreement 4. Maintenance to review draft agreement and resolve any issues. 5. Deliver agreement to applicant for signature. 6. Obtain Department signature 7. Administer terms of agreement | <p>Some typical contract terms:</p> <ul style="list-style-type: none"> • Review and approval of plans • Party responsible for maintenance • Failure-to-perform provisions • Responsibility to obtain all required permits • Review of plans • Notice of changes • As-built plans & computations • Final certification by engineer • May waive need for other permits, if practicable • Other conditions as needed |
| Construction | |
| <p>Considerations:</p> <ul style="list-style-type: none"> • Pre-construction meeting • All permits in hand • Erosion control measures in place • Oversight & Inspection | |

Table 3.4-1 (continued)

| Construction (continued) | |
|---|--|
| <p>Inspection:</p> <ul style="list-style-type: none"> • Administer contract • Obtain approval from engineer for changes • Erosion control | |
| <p>Acceptance:</p> <ul style="list-style-type: none"> • Follow contract terms for completion of contract • File as-built plans & design computations | |

3.4.2.2 Acquisition of Ditches from Local Ownership

When roadways pass from local ownership to FDOT, it is not unusual for issues to arise. Often, the roadside ditches on these roadways do not meet FDOT standards. They often were designed for a lesser design frequency and do not contain enough capacity. Other ditches have substandard slopes located within the clear zone. When safety concerns force these roadways to be updated, evaluate the existing conditions to bring the ditches up to current standards.

In some cases, there may be enough right of way available to reconstruct the ditch to standards. More frequently, though, right of way is not sufficient to provide these upgrades. Then, it may be practical to purchase additional right of way or drainage easements in which to upgrade the current ditch system. If additional right of way proves to be too costly, consider a closed system with a series of inlets and storm drain pipes. The least ideal but often unavoidable option will consist of obtaining exceptions or variances of the current standards for the existing ditch.

3.4.2.3 Addition of Sidewalks to Roadway Projects

In an ongoing attempt to connect communities with pedestrian walkways, existing roadways often have sidewalks added. The sidewalks often are located outside of the existing ditch system along the right-of-way line. When designing these sidewalks, ensure that the sidewalk does not impede flow from offsite runoff. Place it so that offsite runoff can sheet flow over the sidewalk into the existing ditch or that the system can collect runoff and pipe it under the sidewalk into the ditch or an existing storm drain system. In many cases, you can construct a simple pedestrian bridge to cross over existing ditches without impacts to the ditch.

CHAPTER 4: CULVERT

| | |
|--|-------------|
| 4. CULVERT | 4-1 |
| 4.1 General | 4-1 |
| 4.1.1 Cross Drain Design | 4-1 |
| 4.1.2 Scour Estimate | 4-1 |
| 4.1.3 Flood Definition..... | 4-2 |
| 4.2 Design Frequency | 4-11 |
| 4.3 Backwater | 4-12 |
| 4.3.1 Backwater Consistent with the Flood Insurance Study Requirements..... | 4-12 |
| 4.4 Tailwater..... | 4-13 |
| 4.5 Hydraulic Analysis..... | 4-13 |
| 4.6 Specific Standards Relating To All Cross Drains Except Bridges..... | 4-27 |
| 4.6.1 Culvert Materials..... | 4-27 |
| 4.6.2 Scour Estimates..... | 4-27 |
| 4.7 Recommended Design Procedure..... | 4-28 |
| 4.7.1 Culvert Extensions..... | 4-28 |
| 4.7.2 Small Cross Drains..... | 4-43 |
| 4.7.3 Large Cross Drains..... | 4-47 |

4. CULVERT

4.1 GENERAL

4.1.1 Cross Drain Design

Section 4.2 of the *Drainage Manual* states, "All cross drains shall be designed to have sufficient hydraulic capacity to convey the selected design frequency flood without damage to the structure and approach embankments, with due consideration to the effects of greater floods." This requires evaluation of the following:

Backwater

Refer to Section 4.3 of this design guide and Section 4.4 of the *Drainage Manual*.

Tailwater

Refer to Section 4.4 of this design guide and Section 4.5 of the *Drainage Manual*.

Scour

Refer to Sections 4.1.2 and 4.6.2 of this design guide and Section 4.9.2 of the *Drainage Manual*.

You may need to perform a risk analysis to evaluate damage to structures and/or embankments caused by backwater and/or scour. Refer to Appendix G, Risk Evaluations.

4.1.2 Scour Estimate

When producing scour estimates for bridge culvert foundation designs, it is best not to use the methods in FHWA'S HEC-18. Instead, consider the outlet velocity and degradation of the stream, discussed in Section 4.6.2 of this document.

To use bridge culverts with no bottom slab and toe wall, you need to get the following approval/evaluation:

- a) Prior approval from the District Drainage Engineer.
- b) An analysis of the degradation that could take place through the bridge culvert. This would require you to recommend the toe wall depths of the bridge culvert and the need for scour protection for the design-year frequency, 100-year frequency, and 500-year frequency.

4.1.3 Flood Definition

Design Flood

The “design flood” is defined as the flood or storm surge associated with the probability of exceedance (frequency) selected for the design of a highway encroachment. This frequency, known also as the “design-year frequency,” is discussed in Section 4.2.

Base Flood

The “base flood” (100-year frequency flood event) is defined as the flood or storm surge having a 1-percent chance of being exceeded in any given year. The base flood is the standard in Federal Emergency Management Agency (FEMA) flood insurance studies and many agencies have adopted it to comply with regulatory requirements.

Greatest Flood

The “greatest flood” (500-year frequency flood event) is defined as the flood or storm surge having a 0.2-percent chance of being exceeded in any given year. This event is used to define the possible consequences of a flood occurrence significantly greater than the 1-percent flood event. While it is seldom possible to compute the discharge for the 500-year frequency flood with the same accuracy that you would compute the discharge for the base flood, it serves to draw attention to the fact that floods greater than the base flood can occur. In some cases, FEMA and other agencies compute the 500-year frequency flood.

Overtopping Flood

The “overtopping flood” is described by the probability of exceedance and water surface elevation at which water begins to flow over the highway, a watershed divide, or through structure(s) providing for emergency relief.

The overtopping flood is of particular interest because it will indicate one of the following:

1. When a highway will be inundated
2. The limit (stage) at which the highway, ditch, or some other control point will act as a significant flood relief for the structure of interest

Carefully compare roadside ditch elevations with respect to the water surface elevation for the structure being designed or analyzed. There may be instances where the ditch elevation will provide significant relief to the structure for a certain flood. This ditch elevation will define the overtopping flood stage.

Example 4.1-1 shows how the overtopping flood is determined.

Example 4.1-1—Computing the Overtopping Flood

Given the information below, determine the discharge and frequency for the overtopping flood.

| | | | |
|-----------------|---------------------------|---------------------|-------------|
| Q (25) | = 31 ft ³ /sec | Stage (25) | = 134.3 ft. |
| Q (100) | = 55 ft ³ /sec | Stage (100) | = 139.0 ft. |
| Q (Overtopping) | = ? | Stage (Overtopping) | = 140.9 ft. |

Solution

Step 1:

- a. To determine the overtopping discharge, plot stage versus discharge on algebraic scale graph paper for the 25-year and 100-year floods, as shown on Figure 4.1-1.

Note: Graphical estimation methods are explained in *Hydraulic Design Series No. 2 (HDS-2)*, Publication No. FHWA-NHI-02-001, October 2002.

- b. Draw the best-fit line through these points.
- c. Knowing what the overtopping stage is, you can conservatively approximate the overtopping discharge. The overtopping discharge was found to be 64 ft³/sec.

Note: For stages above overtopping, the overtopping flow can provide significant relief. The stage versus discharge relationship usually flattens out after overtopping.

Step 2:

- a. To determine the overtopping frequency, plot frequency versus discharge on log-normal probability paper for the 25-year and 100-year floods, as shown in Figure 4.1-2.
- b. Draw the best-fit line through these points.
- c. Knowing the overtopping discharge from Step 1c, you can determine the probability of the overtopping flood being exceeded in any year. In this case, the probability is 0.65 percent. This corresponds to a frequency of 154 years (i.e., $100/0.65$).

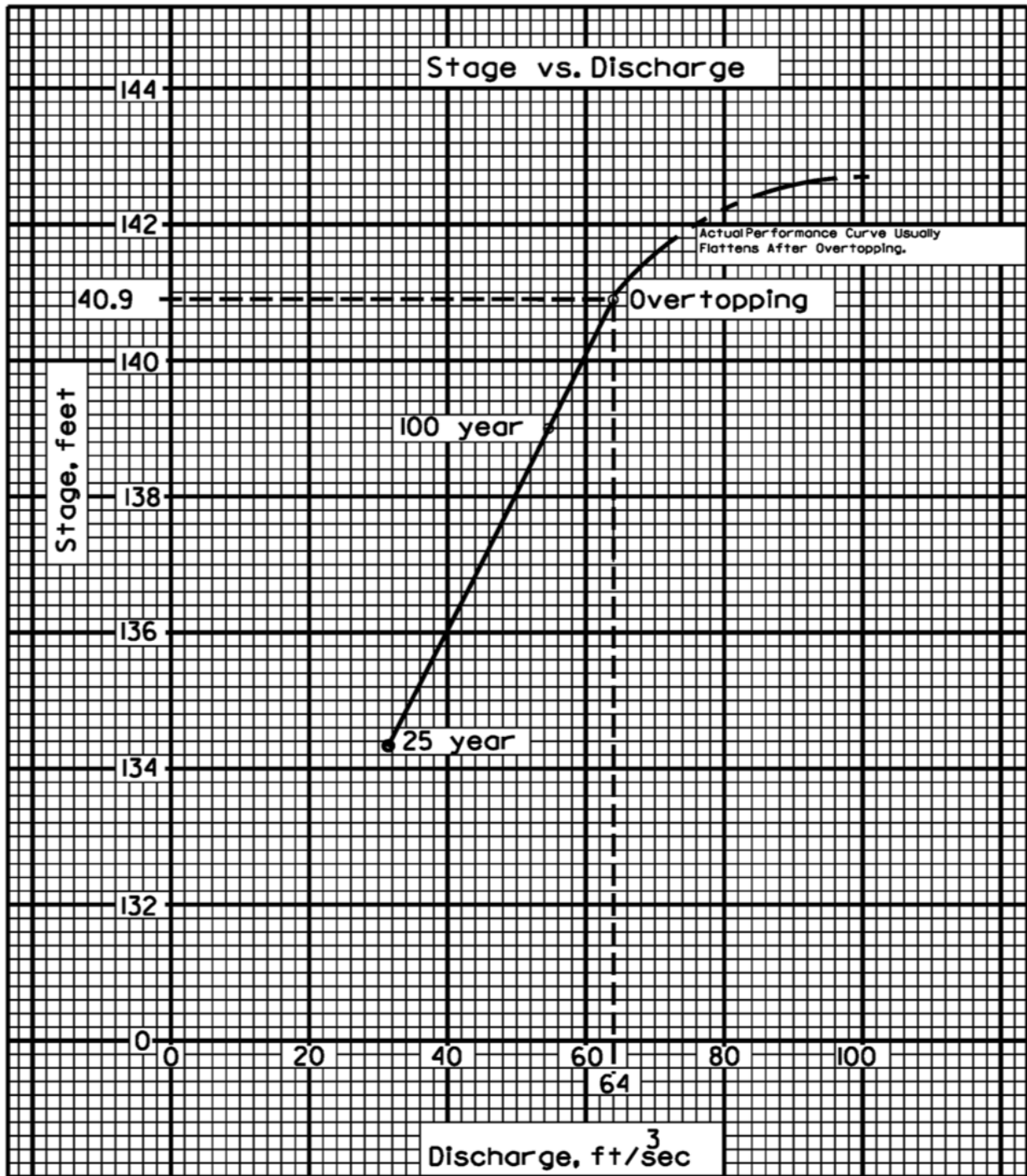

Figure 4.1-1: Example I - Computing Overtopping Flood (cont.)

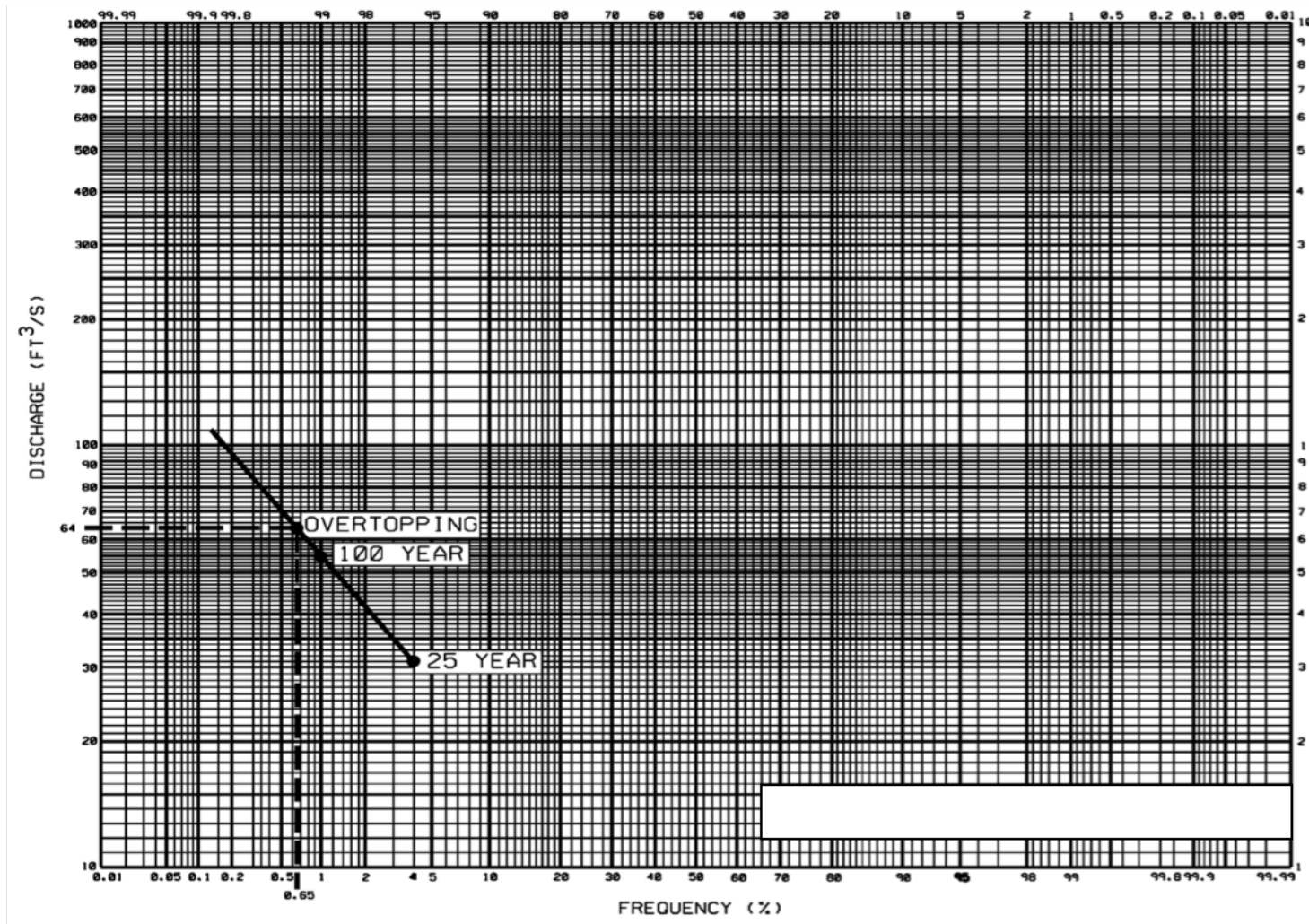

Figure 4.1-2: Example I - Computing Overtopping Flood (cont.)

Flood Data Summary Box

For culverts other than bridge culverts, include hydraulic data in a Flood Data Summary Box similar to the example shown in Figure 4.1-3. Include these data for those conditions discussed in *FDM 305*.

| STRUCTURE NO. | STATION | DESIGN FLOOD | | BASE FLOOD | | OVERTOPPING FLOOD | | | | GREATEST FLOOD | | | |
|---------------|---------|---------------------|-------|---------------------|-------|-------------------|-------|--------|----------|----------------|-------|--------|---------|
| | | % PROB. ___ YR FREQ | | % PROB. ___ YR FREQ | | DISCHARGE | STAGE | PROB % | FREQ. YR | DISCHARGE | STAGE | PROB % | FREQ YR |
| | | DISCHARGE | STAGE | DISCHARGE | STAGE | | | | | | | | |
| | | | | | | | | | | | | | |
| | | | | | | | | | | | | | |
| | | | | | | | | | | | | | |
| | | | | | | | | | | | | | |

Note: The hydraulic data are shown for informational purposes only, to indicate the flood discharges and water surface elevations that may be anticipated in any given year. These data were generated using highly variable factors determined by a study of the watershed. Many judgments and assumptions are required to establish these factors. The resultant hydraulic data are sensitive to changes, particularly of antecedent conditions, urbanization, channelization, and land use. Users of these data are cautioned against the assumption of precision, which cannot be attained. Discharges are in cubic feet per second and stages are in feet.

Definitions:

- Design Flood: The flood selected by FDOT to be utilized to assure a standard level of hydraulic performance
- Base Flood: The flood having a 1-percent chance of being exceeded in any given year (100-year frequency)
- Overtopping Flood: The flood that causes water to flow over the highway, over a watershed divide, or through emergency relief structures
- Greatest Flood: The most severe flood that can be predicted, where overtopping is not practicable; normally, one with a 0.2-percent chance of being exceeded in any given year (500-year frequency)

Figure 4.1-3: Flood Data Summary Box

Fill out the hydraulic flood data sheet according to the Federal Aid Policy Guide (23 CFR 650A). You can find this policy guide at <http://www.fhwa.dot.gov/legsregs/directives/fapg/cfr0650a.htm>. In general, the following applies.

- a. If the overtopping flood is less than the standard design frequency, perform a risk assessment to define the design flood as the overtopping flood. Fill out the information for the design flood, base flood, and overtopping flood.
- b. If the overtopping flood is between the standard design frequency and the base flood (100-year flood), then fill out the information for the design flood, base flood, and overtopping flood.
- c. If the overtopping flood is between the base flood (100-year flood) and the greatest flood (500-year flood), then fill out the information for the design flood, base flood, and overtopping flood.
- d. If the overtopping flood is larger than the greatest flood (500-year flood), then fill out the information for the design flood, base flood, and greatest flood.

Example 4.1-2 shows you how to complete the Flood Data Summary Box when the overtopping flood is less than the greatest flood (500-year flood).

Example 4.1-3 shows you how to complete the Flood Data Summary Box when the overtopping flood occurs at a 10-year frequency.

Example 4.1-2—Completing the Flood Data Summary Box

Referring back to Example 4.1-1, assume the design flood is the 25-year frequency. Fill out the Flood Data Summary Box.

Solution

Since the overtopping flood is between the base flood (100-year flood) and the greatest flood (500-year flood), then fill out the information for the design flood, base flood, and overtopping flood.

| | |
|-------------|---------------------------|
| Q (25) | = 31 ft ³ /sec |
| Stage (25) | = 134.3 ft. |
| Q (100) | = 44 ft ³ /sec |
| Stage (100) | = 136.4 ft. |

Q (Overtopping) = 64 ft³/sec
Stage (Overtopping) = 140.9 ft.

Put these values in the corresponding column, as shown in Figure 4.1-4. From Example 4.1-1, the overtopping flood was found to have a 0.65 percent chance of being exceeded in any year, or a frequency of 154 years.

| STRUCTURE NO. | STATION | DESIGN FLOOD | | BASE FLOOD | | OVERTOPPING FLOOD | | | | GREATEST FLOOD | | | |
|---------------|---------|---------------------|-------|----------------------|-------|-------------------|-------|--------|----------|----------------|-------|--------|---------|
| | | 4% PROB. 25-YR FREQ | | 1% PROB. 100-YR FREQ | | DISCHARGE | STAGE | PROB % | FREQ. YR | DISCHARGE | STAGE | PROB % | FREQ YR |
| | | DISCHARGE | STAGE | DISCHARGE | STAGE | | | | | | | | |
| S-1 | 30+50 | 31 | 134.3 | 44 | 136.4 | 64 | 140.9 | 0.65 | 154 | | | | |
| | | | | | | | | | | | | | |
| | | | | | | | | | | | | | |
| | | | | | | | | | | | | | |

Note: The hydraulic data are shown for informational purposes only, to indicate the flood discharges and water surface elevations that may be anticipated in any given year. These data were generated using highly variable factors determined by a study of the watershed. Many judgments and assumptions are required to establish these factors. The resultant hydraulic data are sensitive to changes, particularly of antecedent conditions, urbanization, channelization, and land use. Users of these data are cautioned against the assumption of precision, which cannot be attained. Discharges are in cubic feet per second and stages are in feet.

Definitions:

- Design Flood: The flood selected by FDOT to be utilized to assure a standard level of hydraulic performance
- Base Flood: The flood having a 1-percent chance of being exceeded in any given year (100-year frequency)
- Overtopping Flood: The flood that causes water to flow over the highway, over a watershed divide, or through emergency relief structures
- Greatest Flood: The most severe flood that can be predicted, where overtopping is not practicable; normally, one with a 0.2-percent chance of being exceeded in any given year (500-year frequency)

Figure 4.1-4: Flood Data Summary Box

Example 4.1-3—Completing the Hydraulic Flood Data Sheet

Given the information below, fill out the Hydraulic Flood Data Sheet.

The standard frequency for Structure 1 is 50 years, based on the criteria from Section 4.3 of the *Drainage Manual*.

The structure overtops during a 10-year frequency flood.

Perform a risk assessment to define the design flood as the overtopping flood.

Q (Overtopping) = 20 ft³/sec
Stage (Overtopping) = 45 ft.

Q (100) = 37 ft³/sec
Stage (100) = 50.5 ft.

Solution

Since the overtopping flood is less than the standard design frequency and you performed a risk assessment to define the design flood as the overtopping flood, fill out the information for the design (overtopping) flood, base flood, and overtopping flood. Put these values in the corresponding columns, as shown in Figure 4.1-5.

Q (Overtopping) = 20 ft³/sec
Stage (Overtopping) = 45 ft.

Q (100) = 37 ft³/sec
Stage (100) = 50.5 ft.

Example 4.1-3—Completing the Flood Data Summary Box

| STRUCTURE NO. | STATION | DESIGN FLOOD | | BASE FLOOD | | OVERTOPPING FLOOD | | | | GREATEST FLOOD | | | |
|---------------|---------|----------------------|-------|----------------------|-------|-------------------|-------|--------|----------|----------------|-------|--------|---------|
| | | 10% PROB. 10-YR FREQ | | 1% PROB. 100-YR FREQ | | DISCHARGE | STAGE | PROB % | FREQ. YR | DISCHARGE | STAGE | PROB % | FREQ YR |
| | | DISCHARGE | STAGE | DISCHARGE | STAGE | | | | | | | | |
| S-1 | 30+50 | 20 | 45 | 37 | 50.5 | 20 | 45 | 10 | 10 | | | | |
| | | | | | | | | | | | | | |
| | | | | | | | | | | | | | |
| | | | | | | | | | | | | | |

Note: The hydraulic data are shown for informational purposes only, to indicate the flood discharges and water surface elevations that may be anticipated in any given year. These data were generated using highly variable factors determined by a study of the watershed. Many judgments and assumptions are required to establish these factors. The resultant hydraulic data are sensitive to changes, particularly of antecedent conditions, urbanization, channelization, and land use. Users of these data are cautioned against the assumption of precision, which cannot be attained. Discharges are in cubic feet per second and stages are in feet.

Definitions:

- Design Flood: The flood selected by FDOT to be utilized to assure a standard level of hydraulic performance
- Base Flood: The flood having a 1-percent chance of being exceeded in any given year (100-year frequency)
- Overtopping Flood: The flood that causes water to flow over the highway, over a watershed divide, or through emergency relief structures
- Greatest Flood: The most severe flood that can be predicted, where overtopping is not practicable; normally, one with a 0.2-percent chance of being exceeded in any given year (500-year frequency)

Figure 4.1-5: Flood Data Summary Box

4.2 DESIGN FREQUENCY

“Design frequency” means a frequency that accommodates an adopted design criterion. After you determine the design frequency, you can then determine a discharge for the selected frequency. This discharge is known as the “design discharge.” By definition, the design discharge does not overtop the road. After you determine the design discharge, you can determine a headwater. This headwater also is known as the “design discharge headwater.” The design discharge headwater may be at an elevation lower than the road's profile grade to meet other design criteria, such as protection of property, accommodating land use needs, lowering velocities, reducing scour, or complying with regulatory mandates.

To provide an acceptable standard level of service against flooding, the Department typically employs widely used pre-established design frequencies, which are based on the importance of the transportation facility to the system and allowable risk for that facility. Selecting the appropriate design storm from these standards is a matter of professional judgment since it is rarely either possible or practical to provide for the greatest possible flood. The design flood frequency standards for cross drains listed in Section 4.3 of the *Drainage Manual* provide an engineering consensus on reasonable values. The actual design must consider the consequences of greater events, such as the 100-year flood for culverts and bridges and even the 500-year flood for bridges.

Under certain conditions, it may be appropriate to establish a level of risk allowable for a site and to design to that level. When the risks associated with a particular project are significant for floods of greater magnitude than the standard design flood, evaluate a greater return interval design flood by using a risk analysis. Risk analysis procedures are provided in FHWA's HEC 17 and discussed briefly in Appendix G, Risk Evaluations. In addition, consider incorporating or addressing design standards of other agencies that have control or jurisdiction over the waterway or facility of concern in the design.

4.3 BACKWATER

Backwater is defined as the increase of water surface elevation induced upstream from a bridge, culvert, dike, dam, another stream at a higher stage, or other similar structures; or conditions that obstruct or constrict a channel relative to the elevation occurring under natural channel and floodplain conditions.

4.3.1 Backwater Consistent with the Flood Insurance Study Requirements

Backwater Effects on Land Use

Backwater effects are important to consider in the design/analysis of cross drains in rural and urban areas.

In rural areas, the concern centers on increased flood stages. The degree and duration of an increased flood stage could affect present and future land uses. You certainly must evaluate agricultural land use for increased risks due to flooding. As an example, inundation may impact crops or livestock.

In urban areas, the effects of increased flood stages or increased velocities become an important consideration. In addition to the impact on future land use, the existing property may suffer extensive physical damage. Many urban areas have stream or watershed management regulations or are part of the National Flood Insurance Program (NFIP). These regulations may dictate limits on changes that can be made to flow characteristics of a watershed.

You may need to perform a risk evaluation to determine damage to surrounding property. Refer to Appendix G, Risk Evaluations.

Obtaining Flood Rights

The Department does not encourage obtaining flood rights; however, it is recognized that, in some instances, it may be necessary. Evaluate all possible alternatives before recommending that the Department obtains flood rights.

Alternatives to obtaining flood rights for upstream flooding include:

- Prior approval from the property owner
- Purchase of the property
- Upsizing the structure as long as there is no increased flooding to the downstream owner

Consider performing a risk analysis for situations where you are evaluating acquiring flood rights. Appendix G briefly discusses risk analysis, whereas the topic is extensively covered in HEC 17 (USDOT, FHWA, 2016).

Further discussion about obtaining flood rights is included in Appendix B of the *Drainage Manual*.

4.4 TAILWATER

Section 4.5 of the *Drainage Manual* states: "For the sizing of cross drains and the determination of headwater and backwater elevations, use the highest tailwater elevation that can reasonably be expected to occur coincident with the design storm event."

Additional guidelines for tailwater elevations are provided in Section 4.5. For cross drains subject to tidal conditions, include in the tailwater determination a sea-level rise analysis, as described in Section 3.4.1 of the *Drainage Manual*.

4.5 HYDRAULIC ANALYSIS

During a storm event, a culvert may operate under inlet control, outlet control, or both. Different variables and equations determine the culvert capacity for each type of control. For more detailed information on theory, refer to Federal Highway Administration Hydraulic Design Series No. 5 (HDS-5), *Hydraulic Design of Highway Culverts*. You can find the publication on FHWA's website at:

http://www.fhwa.dot.gov/engineering/hydraulics/library_arc.cfm?pub_number=7&id=13.

Guidelines that pertain to the hydraulic analysis of bridge culverts and other culverts are presented below.

- **Allowable Headwater**

You can determine the allowable headwater elevation by evaluating land use upstream of the culvert and the proposed or existing roadway elevation. The criteria in Section 4.4 of the *Drainage Manual* apply, but other factors that may limit the allowable headwater are:

- Identify non-damaging or permissible upstream flooding elevations (e.g., existing buildings or flood insurance regulations). Keep headwater below these elevations.
- Identify state regulatory constraints (e.g., Water Management District).
- Address other site-specific design considerations, as required.

In general, the constraint that gives the lowest allowable headwater elevation should establish the basis for hydraulic calculations.

- **Inlet Control**

Nomographs

FHWA has developed inlet nomographs, shown in FHWA HDS-5, to provide graphical solutions to headwater equations for various culvert materials, cross sections, and inlet combinations. Because of the low velocities in most entrance pools and the difficulty in determining the velocity head for all flows, ignore the approach velocity and assume the water surface and energy line at the entrance are coincident. The headwater depths obtained by using the nomographs can be higher than will occur in some instances because of this factor.

You can determine the headwater elevation for inlet control by taking the culvert invert elevation at the entrance and adding the headwater depth.

- **Outlet Control
Nomographs**

Outlet control nomographs have been developed and are shown in FHWA HDS-5 to provide graphical solutions to the head loss equations for various culvert materials, cross sections, and inlet combinations.

Culvert Entrance Loss Coefficients

Appendix F, *Applications Guide for Pipe End Treatments* presents culvert entrance loss coefficients (k_e) for the end treatments. For other types of end treatments, refer to FHWA HDS-5.

Critical Depth

Use FHWA HDS-5 or other suitable methods to determine the critical depth for various sizes and types of culverts.

Equivalent Hydraulic Elevation

For culverts flowing partially full, the distance from the invert of the culvert outlet to the equivalent hydraulic grade line is termed the equivalent hydraulic elevation and is expressed as:

$$h_o = \frac{D + d_c}{2} \quad \text{(Equation 4.5-1)}$$

where:

h_o = Equivalent hydraulic elevation, in feet, for an unsubmerged outlet condition

D = Depth of the culvert, in feet

d_c = Critical depth at the culvert outlet, in feet

If the value for d_c from the figures of FHWA HDS-5 is greater than D , then h_o will equal D .

The equivalent hydraulic elevation is valid as long as the headwater is not less than $0.75D$. For headwaters lower than $0.75D$, perform backwater calculations to obtain headwater elevations.

Tailwater

Tailwater (TW) is the depth of water measured from the invert of the culvert at the outlet to the water surface elevation due to downstream conditions. Evaluate the hydraulic conditions downstream of the culvert site to determine a tailwater depth for the discharge and frequency under consideration. Determine tailwater as follows:

- a. If an upstream culvert outlet is near the inlet of a downstream culvert, the headwater elevation of the downstream culvert may define the tailwater depth for the upstream culvert.
- b. For culverts that discharge to an open channel, the tailwater may be equal to the normal depth of flow in that channel. Calculate normal depth using a trial-and-error solution of the Manning's equation. The known inputs are channel roughness, slope, and geometry.

For bridge culverts that discharge to an open channel, you may have to determine the tailwater by performing a standard backwater calculation. Consider this analysis if the open channel does not have constant channel roughness, slope, and geometry or if there is a control structure downstream that could cause backwater.

- c. If the culvert discharges to a lake, pond, or other major water body, the expected high-water elevation of the particular water body may establish the culvert tailwater. However, it is probably not appropriate to use a 25-year lake

stage for a cross drain that uses a 25-year design frequency, due to the difference in time relationship between occurrences. Usually, the mean annual stage would be appropriate.

- d. If tidal conditions occur at the outlet, the mean high water, as determined by sources such as the National Oceanic and Atmospheric Administration (NOAA), usually establishes the initial basis for tailwater conditions. Adjust the mean high water for sea level rise as described in Section 3.4.1 of the *Drainage Manual*.

Design Tailwater

The tailwater condition that prevails during the design event is called the design tailwater (DTW). The design tailwater may be a function of either downstream or culvert outlet conditions.

Two tailwater conditions can affect the selection of a design tailwater:

- a. For the submerged outlet condition shown in Figure 4.5-1, TW is greater than h_o and, thus, TW becomes DTW.
- b. For the unsubmerged outlet shown in Figure 4.5-2, TW is less than h_o , so the h_o elevation becomes DTW.

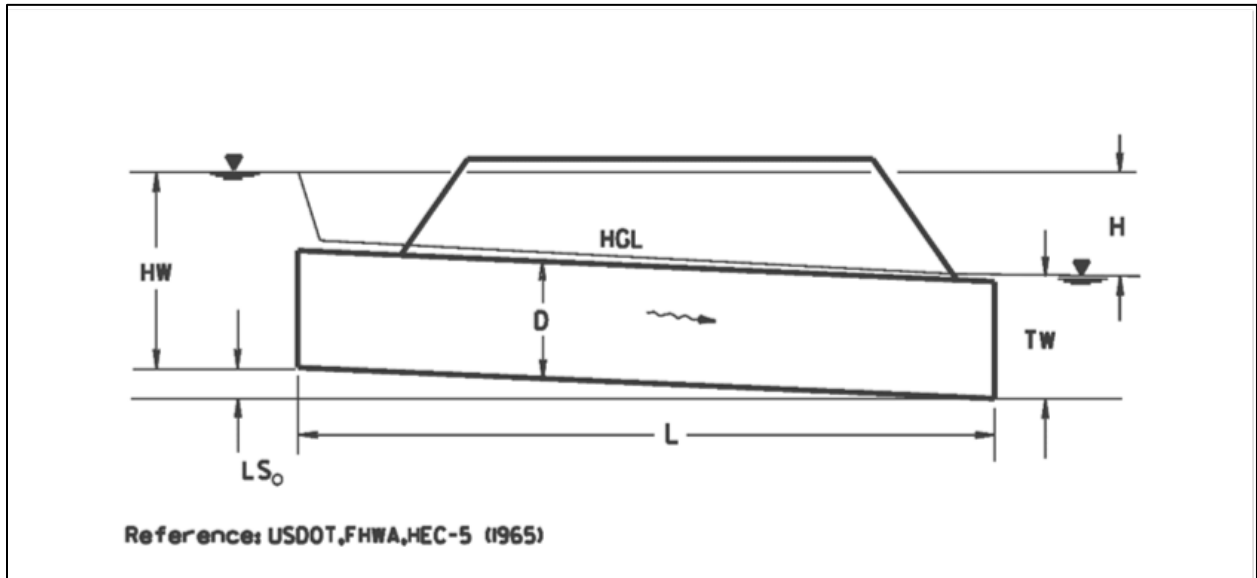

Figure 4.5-1: Tailwater for Submerged Outlet Conditions

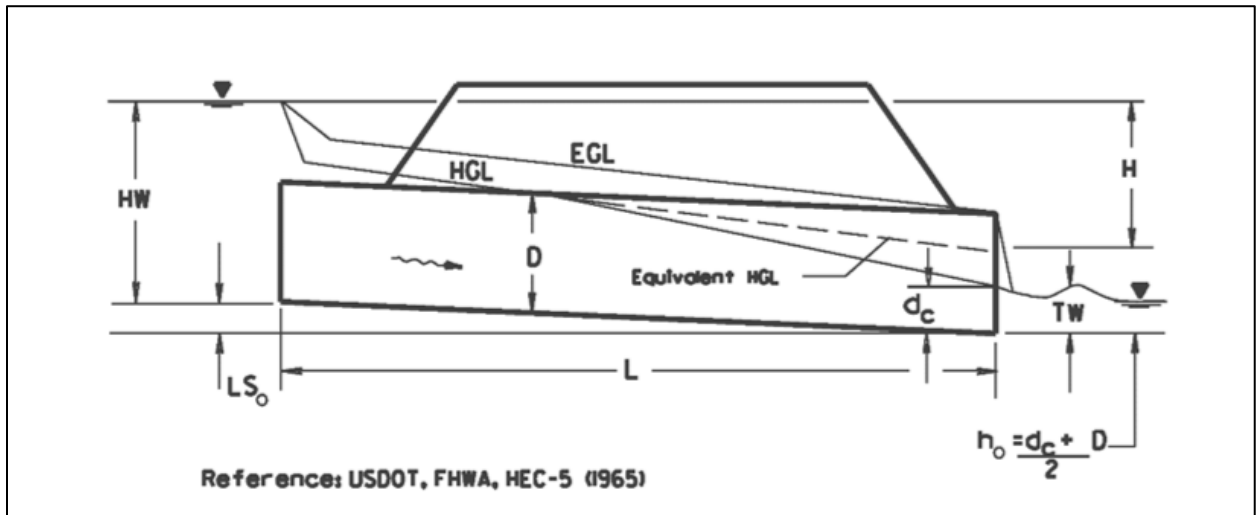

Figure 4.5-2: Tailwater for Unsubmerged Outlet Conditions

Headwater Depth

Having established the total head loss (H) and the design tailwater depth (DTW), compute the headwater depth (HW), as follows:

$$HW = H + DTW - LS_o \quad \text{(Equation 4.5-2)}$$

where:

- HW = Headwater depth for outlet control, in feet
- H = Total head, in feet
- DTW = Design tailwater depth, in feet
- L = Length of culvert barrel, in feet
- S_o = Barrel slope, in feet/feet

The difference in elevation between the culvert inlet and the culvert outlet is equal to LS_o. You may use it directly in Equation 4.5-2.

Determine the headwater elevation for outlet control by taking the culvert invert elevation at the entrance and adding the headwater depth.

- **Controlling Headwater Depth or Elevation**

The controlling headwater depth or elevation is defined as the greatest headwater depth or elevation between the inlet and outlet control conditions.

- **Outlet Velocity
Inlet Control**

In inlet control, you may need to make backwater calculations to determine the outlet velocity. These calculations begin at the culvert entrance and proceed downstream to the exit. Obtain the flow velocity from the flow and the cross sectional area at the exit:

$$V = \frac{Q}{A} \quad \text{(Equation 4.5-3)}$$

where:

- V = Average velocity in the culvert, in feet per second
- Q = Flow rate, in cubic feet per second
- A = Cross sectional area of the flow, in square feet

To avoid backwater calculations in determining outlet velocity, you may use an approximation. Since the water surface profile converges toward normal depth as calculations proceed downstream, you can assume the normal depth and use it to define the area of flow at the outlet. Then you can use the normal depth obtained to determine the outlet velocity (see Figure 4.5-3). The velocity obtained may be higher than the actual velocity at the outlet.

Calculate normal depth using a trial-and-error solution of the Manning equation. The known inputs are barrel resistance, slope, and geometry. Then, determine the area of flow prism based on the culvert barrel geometry and depth equal to normal depth. You also can determine normal depth and area of flow using the charts for various pipe cross section shapes in Appendix E.

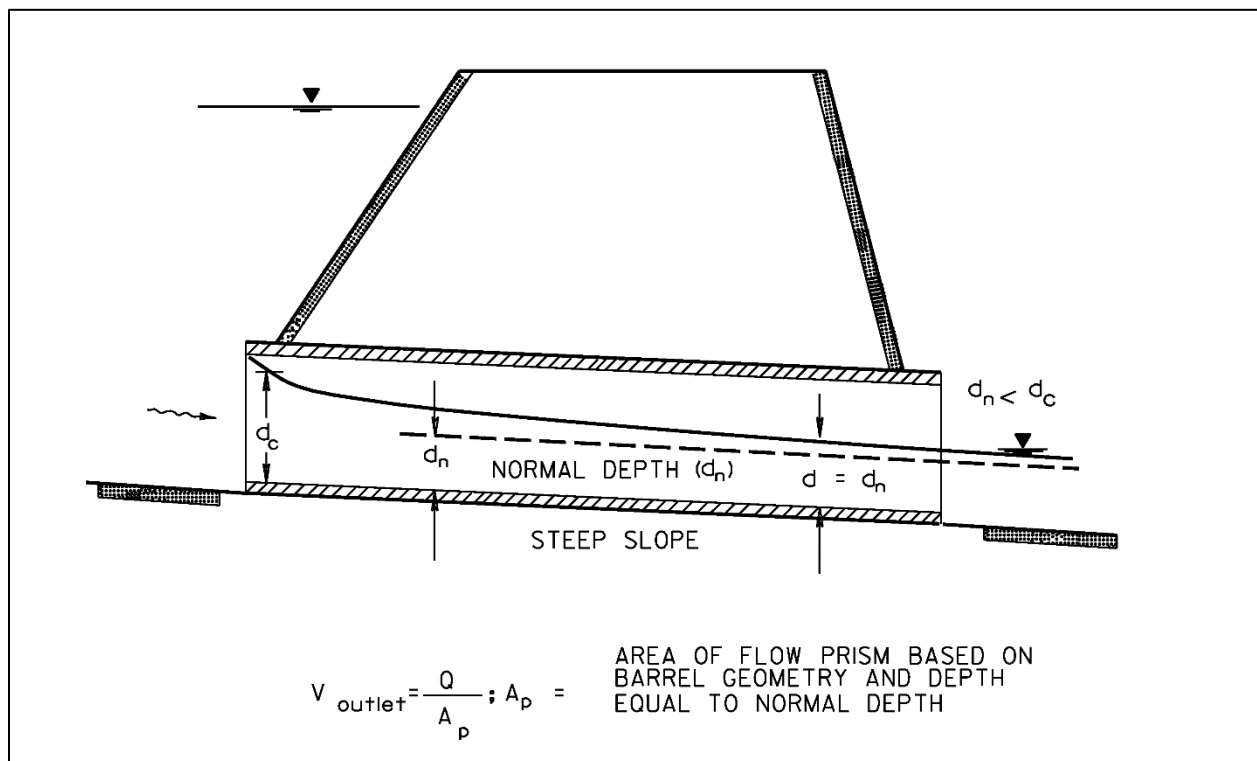

Figure 4.5-3: Outlet Velocity for Inlet Control

Example 4.5-1 illustrates computing outlet velocity for inlet control.

Example 4.5-1—Computing Outlet Velocity for Inlet Control

Given the information below, determine the outlet velocity for inlet control.

where:

$$\begin{aligned} Q_{\text{design}} &= 18 \text{ ft}^3/\text{sec} \\ \text{Diameter of Pipe (D)} &= 24 \text{ in.} \\ \text{Slope of Pipe (S)} &= 0.01 \text{ ft./ft.} \\ \text{Roughness Coefficient (n)} &= 0.012 \end{aligned}$$

Solution

Step 1: Determine area, wetted perimeter, and hydraulic radius of the pipe flowing full.

$$\text{Area (A)} = \frac{(\pi D^2)}{4} = \frac{\pi \times (24 \text{ inches} / 12)^2}{4} = 3.14 \text{ ft}^2$$

$$\text{Wetted perimeter (WP)} = \pi D = \pi * (24 \text{ in.}/12) = 6.28 \text{ ft.}$$

$$\text{Hydraulic radius (R)} = A/\text{WP} = 3.14 \text{ ft}^2/6.28 \text{ ft.} = 0.5 \text{ ft.}$$

Step 2: Using Manning's Equation, determine the discharge and velocity of the pipe flowing full.

$$Q_{\text{Full}} = \frac{1.49}{n} A R^{2/3} S^{1/2}$$

$$Q_{\text{Full}} = \frac{1.49}{0.012} (3.14 \text{ ft}^2) (0.5 \text{ ft.})^{2/3} (0.01 \text{ ft./ft.})^{1/2} = 24.56 \text{ ft}^3/\text{s} \text{ (say } 25 \text{ ft}^3/\text{s})$$

$$V_{\text{Full}} = Q_{\text{Full}} / A_{\text{Full}} = 25 \text{ ft}^3/\text{s} / 3.14 \text{ ft}^2 = 7.96 \text{ ft/s} \text{ (say } 8.0 \text{ ft/s)}$$

Step 3: Using Figure 4.5-4, determine the area of flow for the design discharge using the following relationship:

$$\frac{Q_{\text{Design}}}{Q_{\text{Full}}} = \frac{18 \text{ ft}^3/\text{s}}{25 \text{ ft}^3/\text{s}} = 0.72 \text{ or } 72 \% \text{ of value for section}$$

1. Enter on Figure 4.5-4 the value of 0.72 on the horizontal axis.
2. Project vertically up until the flow curve is met.
3. Project horizontally from the flow curve to the area of the flow curve.
4. Project vertically down from the area of the flow curve and read from the horizontal axis a value of 0.66 or 66 percent of value for full section.
5. You can make a relationship between the full flow area and the normal depth area (A_{Design}):

$$\frac{A_{Design}}{A_{Full}} = 0.66 ; A_{Design} = 0.66 \times 3.14 \text{ ft}^2 = 2.07 \text{ ft}^2$$

Step 4: Determine the outlet velocity using Q_{Design} and A_{Design} :

$$V_{Design} = \frac{Q_{Design}}{A_{Design}} = \frac{18 \text{ ft}^3 / \text{s}}{2.07 \text{ ft}^2} = 8.70 \text{ ft/s}$$

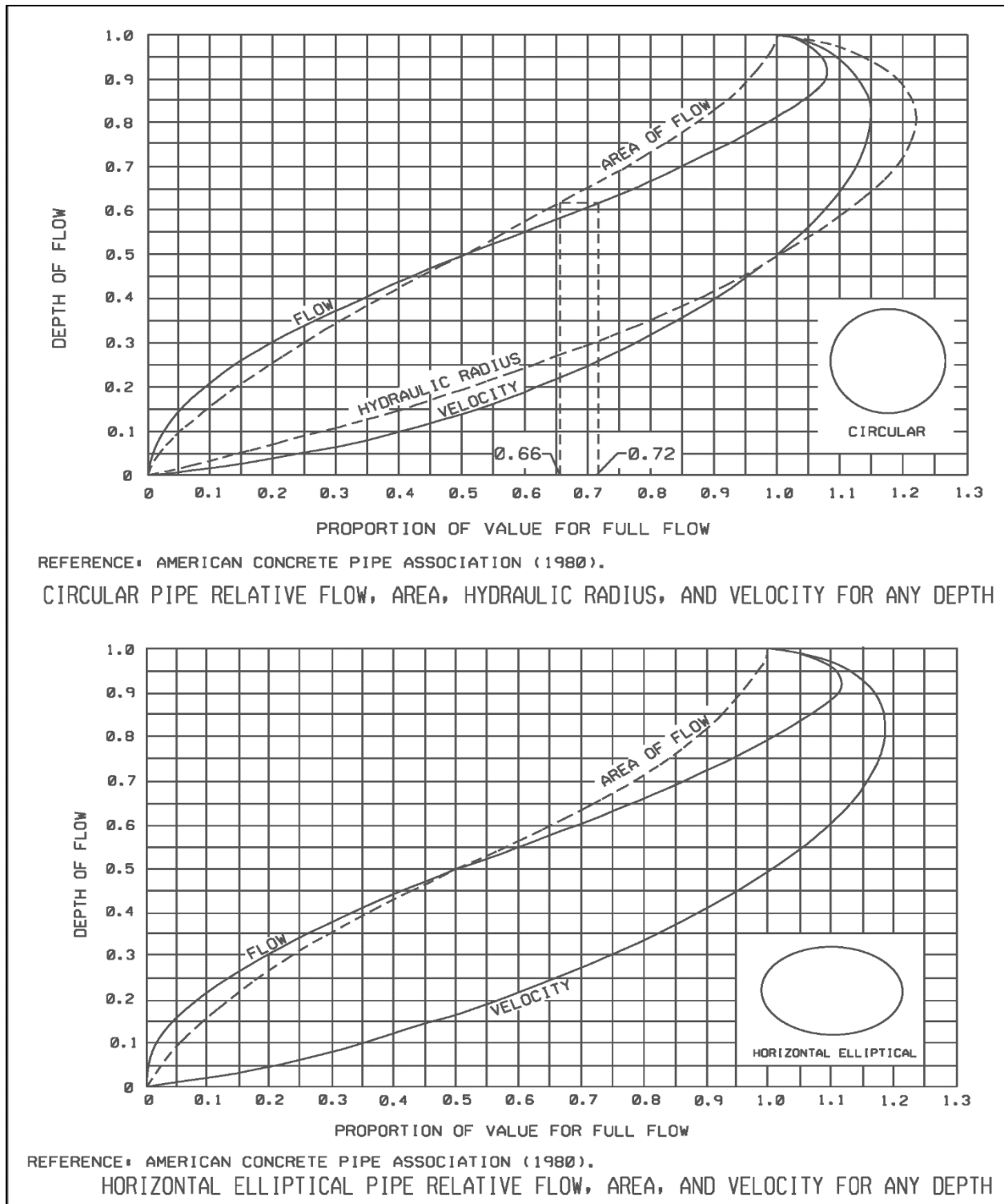

Figure 4.5-4: Example 4.5-1

Outlet Control:

In outlet control, the cross sectional area of the flow (A_p) is defined by the geometry of the outlet and either critical depth, tailwater depth, or the height of the culvert (see Figure 4.5-5).

Use critical depth when the tailwater is less than critical depth; use the tailwater depth when tailwater is greater than critical depth but below the top of the barrel. The total barrel area is used when the tailwater exceeds the top of the barrel.

$$V = \frac{Q}{A_p} \qquad \text{(Equation 4.5-4)}$$

where:

V = Average velocity in the culvert, in feet per second

Q = Flow rate, in cubic feet per second

A_p = Cross sectional area of the flow defined by the geometry of the outlet and either critical depth, tailwater depth, or the height of the culvert, in square feet

You can determine the area of flow prism based on barrel geometry and depth of flow (d) using the charts for various pipe cross section shapes in Appendix E.

Example 4.5-2 illustrates computing outlet velocity for outlet control.

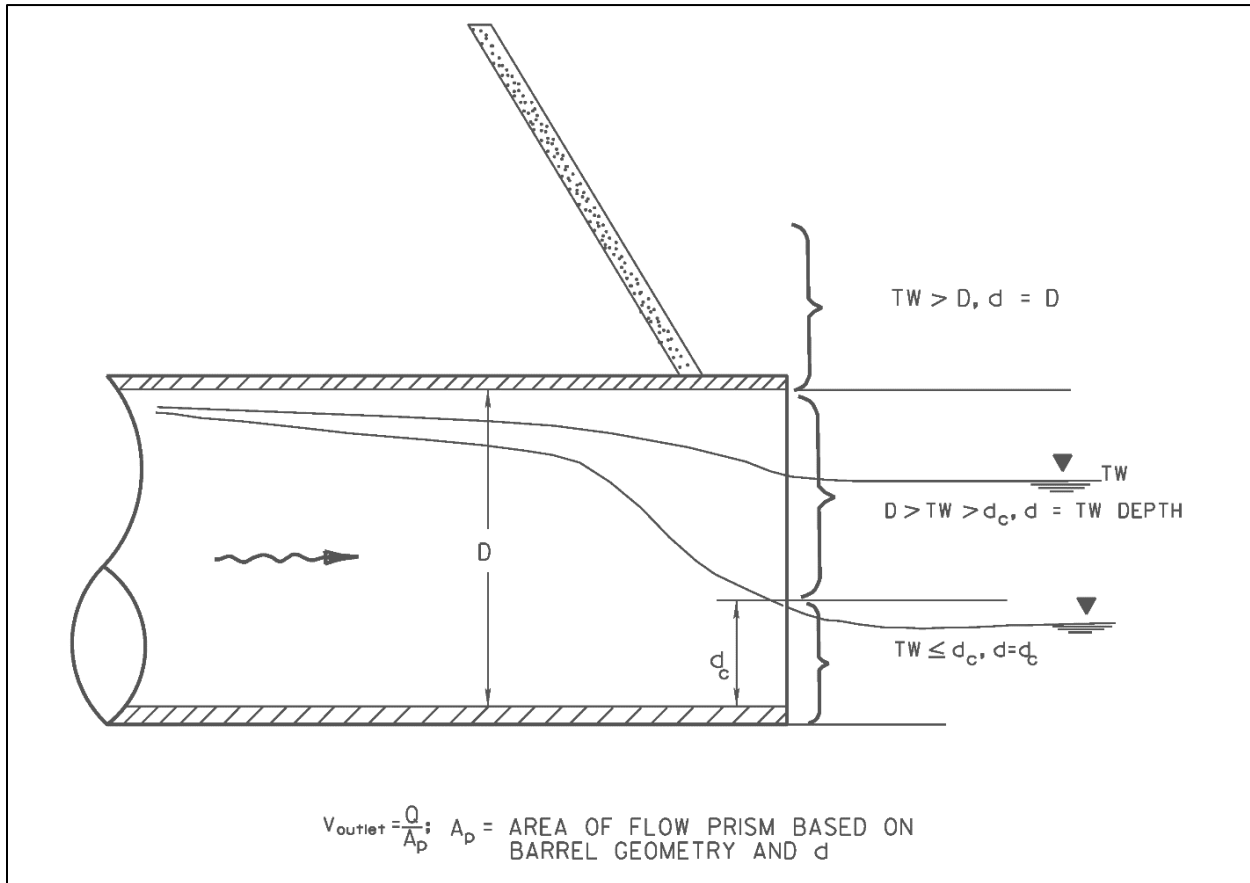

Figure 4.5-5: Outlet Velocity for Outlet Control

Example 4.5-2—Computing Outlet Velocity

Given the information below, determine the outlet velocity for outlet control.

where:

| | |
|---------------------------|---|
| Q_{Design} | = 18 ft ³ /s |
| Diameter of Pipe | = 36 in. |
| Slope of Pipe | = 0.01 ft./ft. |
| Roughness Coefficient (n) | = 0.012 |
| Critical Depth (d_c) | = 1.4 ft. (determined from FHWA HDS-5, for $Q_{\text{Design}} = 18 \text{ ft}^3/\text{s}$) |
| Tailwater (TW) | = 2.0 ft. |

Solution

Step 1: Determine the area of the pipe flowing full:

$$\text{Area } (A) = \frac{\pi D^2}{4} = \frac{\pi \times (36 \text{ inches} / 12)^2}{4} = 7.07 \text{ ft}^2$$

Step 2: Since $D > TW > d_c$, then $d = TW$ Depth or $d = 2.0 \text{ ft}$

Step 3: Using Figure 4.5-6 determine the depth of flow to full depth flow (TW/D) or $2 \text{ ft.} / 3 \text{ ft.} = 0.67$, or 67 percent of the full depth.

1. Enter on Figure 4.5-6 this value of 0.67 on the horizontal axis.
2. Project horizontally to the area of flow curve.
3. Project vertically down from the area of flow curve and read from the horizontal axis a value of 0.73, or 73 percent for full section.
4. Use this relationship to determine the normal depth area (A_{Design}):

$$\frac{A_{\text{Design}}}{A_{\text{Full}}} = 0.73; A_{\text{Design}} = 0.73 \times 7.07 \text{ ft}^2 = 5.61 \text{ ft}^2$$

Step 4: Determine the outlet velocity using Q_{Design} and A_{Design} :

$$V_{\text{Design}} = Q_{\text{Design}} / A_{\text{Design}} = \frac{18 \text{ ft}^3 / \text{s}}{5.61 \text{ ft}^2} = 3.2 \text{ ft/s}$$

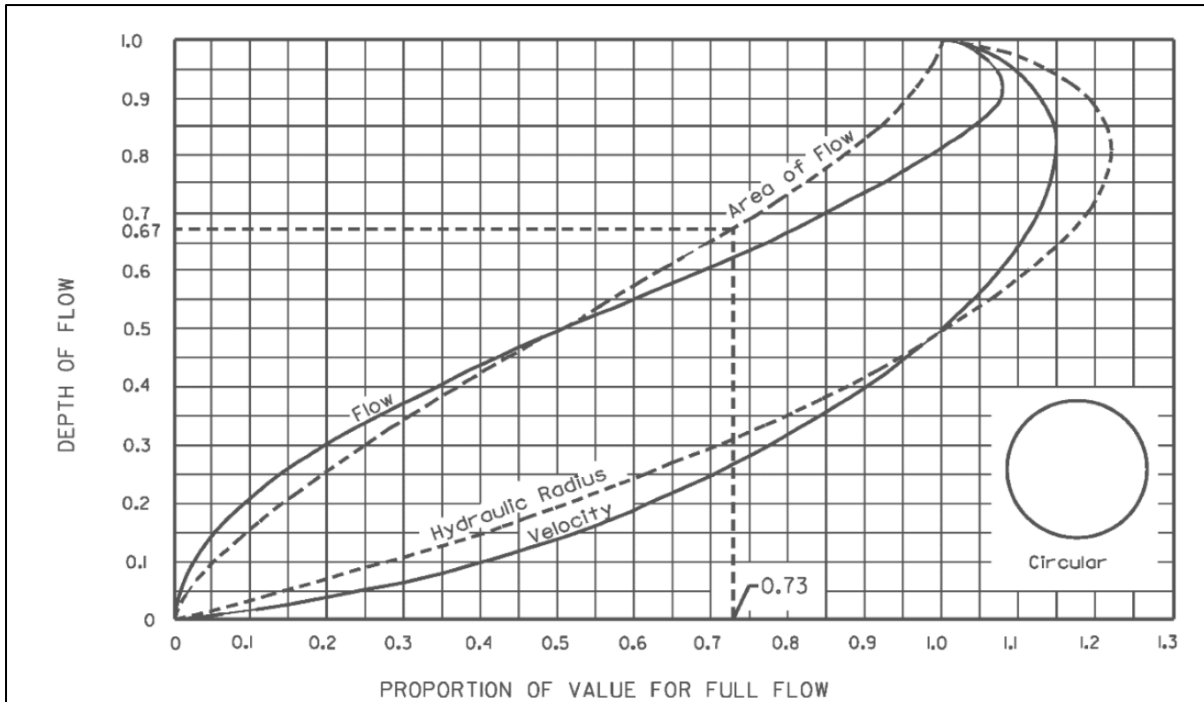

Reference: American Concrete Pipe Association (1980).

Circular Pipe Relative Flow, Area, Hydraulic Radius, and Velocity for Any Depth

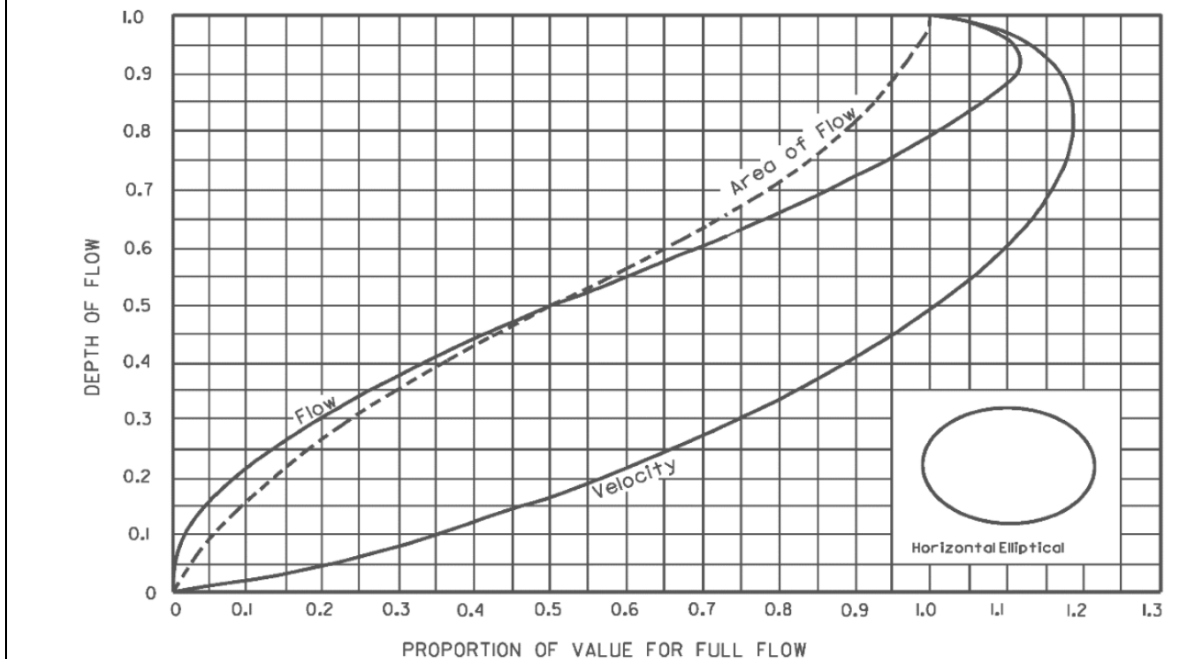

Reference: American Concrete Pipe Association (1980).

Horizontal Elliptical Pipe Relative Flow, Area, and Velocity for Any Depth

Figure 4.5-6: Example 4.5-2

Culvert Capacity Calculations

- a. Worksheet for manual calculations

FHWA's HDS-5 presents a worksheet for doing culvert capacity calculations.

- b. Computer programs

FHWA's HY-8 computer program is only one of several programs that are capable of culvert capacity calculations. The Department has accepted the computer program for use and it is available through FHWA's website (<http://www.fhwa.dot.gov/engineering/hydraulics/software/hy8/>). Before you use other computer programs in the design of a Department project, the District Drainage Engineer should approve them.

4.6 SPECIFIC STANDARDS RELATING TO ALL CROSS DRAINS EXCEPT BRIDGES

4.6.1 Culvert Materials

Chapter 6 of the *Drainage Manual* provides standards for suitable optional culvert materials.

When the vertical distance from invert to roadway is limited, arch culverts may be appropriate. When the rise of a culvert exceeds four feet, consider the use of box culverts since they may offer cost advantages.

4.6.2 Scour Estimates

Scour prediction at culvert outlets depends on the following characteristics:

- Channel bed and bank material
- Velocity and depth of flow in the channel and at the culvert outlet
- Velocity distribution
- Amount of sediment and other debris in the flow
- Culvert end section and treatment

A method for estimating the dimensions of a scour hole at a culvert outlet is available in HEC 14, Chapter 5, linked below:

<http://www.fhwa.dot.gov/engineering/hydraulics/pubs/06086/hec14ch05.cfm>.

A good guide in estimating potential scour at the outlet of proposed culverts is to look for scour developed at the outlet of similar existing culverts. Scour does not develop at all suspected locations because the susceptibility of the stream to scour is difficult to assess and the flow conditions that will cause scour do not occur at all flow rates. At locations where you expect scour to develop only during relatively rare flood events, the most economical solution may be to repair or retrofit the damage after it occurs.

At many locations, using simple outlet treatments—such as aprons of concrete or riprap—will provide adequate protection against scour. At other locations, using a rougher culvert material may be sufficient to prevent damage from scour.

When the outlet velocity is greater than or equal to 12 ft/sec, consider energy dissipation devices, such as those shown in the *Standard Plans*.

4.7 RECOMMENDED DESIGN PROCEDURE

The following procedures normally will result in acceptable, cost-effective designs. However, you are not exempt from developing an appropriate design. You are responsible for identifying which standards are not applicable to a particular design and for obtaining variances as necessary to achieve proper design.

The design procedures below do not account for structures within regulatory floodways; therefore, you may need to deviate from these procedures to satisfy regulatory agencies. Evaluate and determine the level of effort needed to produce an acceptable design.

Design procedures for three categories of cross drains are provided, including:

1. Culvert extensions (including side drain pipes)
2. Small cross drains (up to 48 inches round or equivalent other shape)
3. Large cross drains (more than 48 inches, but less than a 20-foot bridge)

4.7.1 Culvert Extensions

- **Contact the appropriate FDOT Maintenance Office** to determine if there is any history of problems associated with the existing culvert (e.g., flooding, scour, etc.).
- **Conduct a field review** to evaluate the condition/adequacy of the existing culvert. Review for condition, signs of scour, and sedimentation. Check the available right of way to see if there is room to transition ditches to meet the culvert extension. You can use a review checklist (see the following suggested format) to document the field review.

Review Checklist

Date: _____

Project: _____

Location: _____ Size/Type _____

Road surface/Leaking joints? _____

Recent development in basin? _____

Overtopping? *Roadway* *Basin divide* *In roadway ditch*

Concerns with culvert extension? *Limited right of way* *Wetlands*

Normal high water marks: _____

Tailwater: *Ditch* *Piped outfall* *Overland flow* *Swamp*

Erosion/Sedimentation: _____

Misc. Comments: _____

- **Method 1: No Known Historical Problems**

If there are no signs of undesirable scour at inlet and outlet ends, no excessive sedimentation, and no history of problems, you may extend the existing culvert. The hydrologic and hydraulic analysis would follow the procedure shown below:

a. Estimate discharges as follows:

i. 25 yr. $Q = AV$ where

A = Existing Culvert Area

V = 6 feet per second (Confirm this value with the District Drainage Engineer; some districts use a lower velocity)

ii. 100 yr. $Q = 1.4 \times (25 \text{ yr } Q)$

iii. 500 yr. $Q = 1.7 \times (100 \text{ yr } Q)$

b. Estimate tailwater. If the outlet is in a free-flowing condition, assume the crown of the pipe at the outlet is the tailwater.

c. Conduct hydraulic analysis to compute stages using FHWA HDS 5 techniques.

d. Document as required in the *Drainage Manual*.

General Concerns

Make sure enough right of way exists beyond the ends of the extended culvert to tie in the roadside ditches and provide for outlet treatment if necessary. There is a detail in the *Standard Plans* for ditch transitions at culvert locations. If right of way is inadequate, consider adjusting the ditch cross-section. If there is not enough room for the transition shown in the *Standard Plans*, you may design a sharper transition, but evaluate the need for channel lining to prevent erosion of the ditch side slopes. Example 4.7-1 illustrates this method.

Example 4.7-1—Culvert Extension

Existing: Two-lane rural road
 ADT = 2,000 vehicles
 36-inch diameter round concrete pipe (RCP)
 Length of pipe is 59 feet
 Straight end walls

Elevations are as follows:

Allowable headwater (Edge of travel lane) = 105.0 feet

Flow line (upstream) = 100.0 feet

Flow line (downstream) = 99.8 feet

- **Contact the appropriate FDOT Maintenance Office** to determine if there is any history of problems associated with the existing culvert (e.g., flooding, scour, etc.).

Spoke with Mr. Steve Smith from the FDOT Maintenance Office on November 18, 1993. From our discussion, we found that there has been no history of problems in overtopping of the roadway and no complaints of flooding from upstream property owners have been found.

- **Conduct a field review** to evaluate condition/adequacy of existing culvert. Review for condition, signs of scour, and sedimentation.

We performed a field review with Mr. Smith on November 21, 1993. From our review, we determined the culvert was in good condition, with no signs of sedimentation or scour.

- **No Known Historical Problems**

Since there were no known historical problems, use Method 1. Recommend that the existing 36-inch RCP be extended four feet in both directions with 36-inch RCP and straight endwalls (*Standard Plans, Index 430-030*). The proposed flow line elevations are as follows:

Flow line (upstream) = 100.1 feet

Flow line (downstream) = 99.7 feet

- Estimate discharges as follows:

$$\text{Area of 36-inch RCP} = (\pi D^2)/4 = (\pi(36 \text{ inch}/12)^2)/4 = 7.07 \text{ ft}^2$$

$$Q(25) = AV = 7.07 \text{ ft}^2 \times 6 \text{ ft/sec} = 42 \text{ ft}^3/\text{sec}$$

$$Q(100) = 1.4 \times Q(25) = 59 \text{ ft}^3/\text{sec}$$

$$Q(500) = 1.7 \times Q(100) = 100 \text{ ft}^3/\text{sec}$$

Since this roadway has an ADT > 1,500, the design frequency is 50 years (determined from the *Drainage Manual*). To determine the 50-year discharge, a procedure similar to that used in Example 4.1-1 is appropriate. For this example, the $Q(50)$ is $50 \text{ ft}^3/\text{sec}$.

- b. Estimate tailwater as discussed in Chapter 3 (Open Channel) or if outlet is in a free-flowing condition, assume the crown of the pipe at the outlet is the tailwater.

For this example, the 50-year tailwater elevation to be used will be:

$$\text{TW (50 year)} = 2.7 \text{ ft.}$$

- c. Conduct hydraulic analysis using the procedures in FHWA HDS 5.

For this example, only the hydraulic analysis for the 50-year frequency will be computed. However, you also would need to compute an analysis for the other frequencies. The analysis is for the proposed conditions. Figure 4.7-1 summarizes the following calculations.



| HYDROLOGIC AND CHANNEL INFORMATION | | | | SKETCH STATION: _____ | | | | | | | | | | | | | | | |
|---|--------|---|---|--|----------------|------|----------------|-------|-------|---------------------|------|------|--------|----------------|-----------------|------|----------|--|-------------------|
|  $Q_1 =$ _____ $Q_2 =$ _____ ($Q_1 =$ DESIGN DISCHARGE, SAY Q_{25} $Q_2 =$ CHECK DISCHARGE, SAY Q_{50} OR Q_{100}) | |  $D =$ Diameter or Height $B =$ Span $TW_1 =$ _____ $TW_2 =$ _____ | |  $EL. 105.0'$ $AHW = 5.0'$ $EL. 100.1'$ $S_0 = \frac{0.005}{L = 67'}$ $EL. 99.7'$ TW $LS_0 = 0.4'$ MEAN STREAM VELOCITY = _____ MAX. STREAM VELOCITY = _____ | | | | | | | | | | | | | | | |
| CULVERT DESCRIPTION (ENTRANCE TYPE) | Q | SIZE | | HEADWATER COMPUTATION | | | | | | | | | | CONTROLLING HW | OUTLET VELOCITY | COST | COMMENTS | | |
| | | D | B | INLET CONTROL | | | OUTLET CONTROL | | | | | | | | | | | | |
| | | | | $\frac{Q}{B}$ | $\frac{HW}{D}$ | HW | K_e | H | d_c | $\frac{d_c + D}{2}$ | TW | DTW | LS_0 | HW | | | | | |
| 36" RCP | 50 cfs | 36" | | | 1.27' | 3.8' | 0.2 | 1.55' | 2.3' | 2.65' | 2.7' | 2.7' | 0.4' | 3.9' | 3.9' | | | | 50 year frequency |
| | | | | | | | | | | | | | | | | | | | |
| | | | | | | | | | | | | | | | | | | | |
| | | | | | | | | | | | | | | | | | | | |
| | | | | | | | | | | | | | | | | | | | |
| | | | | | | | | | | | | | | | | | | | |
| | | | | | | | | | | | | | | | | | | | |
| | | | | | | | | | | | | | | | | | | | |
| SUMMARY & RECOMMENDATION: | | | | | | | | | | | | | | | | | | | |

Figure 4.7-1: Culvert Capacity Worksheet for Example 4.7-1

- Inlet Control

Nomographs:

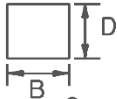
Using Chart 1 in FHWA HDS 5, HW/D = 1.27
Therefore,
HW = 1.27 x D = 1.27 x 3 ft. = 3.81 ft., say 3.8 ft.

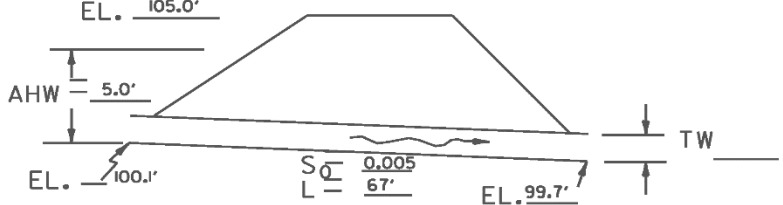
Determine the headwater elevation by taking the culvert invert at the entrance and adding the headwater depth:

HW Elevation = 100.1 ft. + 3.8 ft. = 103.9 ft.

- Outlet Control

Nomographs:

Using Chart 5 in FHWA HDS 5 with a pipe length of 67 feet (existing 59 ft. + 8 ft. of extension) and an entrance loss coefficient of 0.2 feet (as determined below), the headwater (H) for the 50-year discharge is 1.55.

Culvert Entrance Loss Coefficients (K_e):

Culvert entrance loss is 0.2 as determined from the *Application Guidelines for Pipe End Treatment*, Appendix F, based on the structure having a standard end wall treatment.

Critical Depth (d_c):

Using Chart 4 in FHWA HDS 5, the critical depth was found to be 2.3 feet.

Equivalent Hydraulic Elevation (h_o):

$$h_o = \frac{D + d_c}{2} = \frac{3 \text{ ft} + 2.3 \text{ ft}}{2} = 2.65 \text{ ft.}$$

Design Tailwater (DTW):

Since the $TW > h_o$, then the $DTW = TW = 2.7$ ft.

Headwater Depth (HW):

Having established the total head loss (H) and the design tailwater depth (DTW) as described above, compute the headwater depth (HW), as follows:

$$\begin{aligned} HW &= H + DTW - LS_o \\ HW &= 1.55 \text{ ft.} + 2.70 \text{ ft.} - (0.4 \text{ ft.}) \\ HW &= 3.85 \text{ ft., say } 3.9 \text{ ft.} \end{aligned}$$

Determine the headwater elevation by taking the culvert invert at the entrance and adding the headwater depth:

$$HW \text{ Elevation} = 100.1 \text{ ft.} + 3.9 \text{ ft.} = 104.0 \text{ ft.}$$

- Controlling Headwater (HW) Depth or Elevation

Since the HW depth or elevation for outlet control (HW Elevation = 104.0 feet) is greater than that of inlet control (HW Elevation = 103.9 feet), then the controlling HW Elevation is 104.0 feet.

- Outlet Velocity

Outlet velocity for a culvert for this type of problem does not need to be computed since the discharges were estimated using a 25-year velocity of 6 ft/sec.

- d. Document as required in the *Drainage Manual*.

End of Example 4.7-1

- **Method 2: Known Historical Problems or If the Analysis Yields Unrealistic Results**

If scour, sedimentation, or other known historical problems exist, or if Method 1 yields unrealistic results, conduct complete hydrologic and hydraulic analysis and evaluate alternatives.

- a. Conduct a complete hydrologic analysis using one of the following methods, as appropriate (see Section 4.7 of the *Drainage Manual*):
 - Frequency analysis of observed data
 - Regional or local regression equation
 - Rational Equation (up to 600 acres)
- b. Determine tailwater conditions.
- c. Conduct hydraulic analysis using procedures in FHWA HDS 5.
- d. Assess cause of problem and investigate/evaluate alternative solutions. Final recommended design should address the problem with consideration to design standards.
- e. Document as required in the *Drainage Manual*.

General Considerations

The ditch transition concerns in the previous section also apply here. In addition, any problems such as scour, sedimentation, etc., should be limited to within the right of way or not extend any further outside the right of way than they currently extend. Example 4.7-2 illustrates this procedure.

Example 4.7-2—Culvert Extension

Existing: Two-lane rural road
ADT = 2,000
2 foot x 2 foot concrete box culvert cross drain
Length of pipe is 50 feet
Straight end walls

Elevations are as follows:

Allowable headwater (edge of travel lane) = 104.6 feet

Flow line (upstream) = 100.0 feet

Flow line (downstream) = 99.8 feet

- **Contact appropriate FDOT Maintenance Office** to determine if there is any history of problems associated with the existing culvert (e.g., flooding, scour, etc.).

Spoke with Mr. Steve Smith from the FDOT Maintenance Office on November 18, 1993. We found that there has been history of overtopping of the roadway.

- **Conduct a field review** to evaluate condition/adequacy of existing culvert. Review for condition, signs of scour, and sedimentation.

We performed a field review with Mr. Smith on November 21, 1993. From our review, we discovered that the area around the outlet end of the culvert showed signs of scouring.

- **Known Historical Problem**

Since the area around the outlet end of the culvert showed signs of scouring, analyze the structure using Method 2.

- a. Conduct a complete hydrologic analysis using one of the following methods, as appropriate (see Section 4.7 of the *Drainage Manual*):
 - Frequency analysis of observed data
 - Regional or local regression equation
 - Rational Equation (up to 600 acres)

From the field review and hydrologic calculations, the following design information is known:

$$Q(50) = 35 \text{ ft}^3/\text{sec}$$

$$Q(100) = 52 \text{ ft}^3/\text{sec}$$

$$Q(500) = 88 \text{ ft}^3/\text{sec}$$

- b. Determine tailwater as discussed in Chapter 3 (Open Channel) or if outlet is in a free-flowing condition, the crown of the pipe at the outlet may be assumed.

For this example, the 50-year tailwater elevation to be used will be TW (50 year) = 2.5 ft.

- c. Conduct hydraulic analysis using the procedures in FHWA HDS 5.

For this example, only a hydraulic analysis for the 50-year frequency will be computed. The other frequencies also would need to be analyzed for an actual project. The analysis is for the existing conditions. Figure 4.7-2 summarizes the following calculations.

- Inlet Control

Nomographs

Using Chart 8 in FHWA HDS 5, $Q/B = (35 \text{ ft}^3/\text{sec})/2 \text{ ft.} = 17.5 \text{ ft}^3/\text{sec}$.
Therefore, $HW/D = 2.4$ and $HW = 2.4 \text{ ft.} \times D = 2.4 \text{ ft.} \times 2 \text{ ft} = 4.8 \text{ ft}$.

Determine the headwater elevation by taking the culvert invert at the entrance and adding the headwater depth:

$$HW \text{ Elevation} = 100.0 \text{ ft} + 4.8 \text{ ft} = 104.8 \text{ ft}$$

- Outlet Control

Nomographs

Using Chart 15 in FHWA HDS 5, the headwater (H) for the 50-year discharge is 2.2 feet based on the pipe length of 50 feet and entrance loss coefficient of 0.2, as determined below.

Culvert Entrance Loss Coefficients (K_e)

Culvert entrance loss is 0.2 as determined from the *Application Guidelines for Pipe End Treatments*, Appendix F, based on the structure having a straight end wall treatment.

Critical Depth (d_c)

Using Chart 14 in FHWA HDS 5, the critical depth was found to be 2 feet.

Equivalent Hydraulic Elevation (h_o)

$$h_o = \frac{D + d_c}{2} = \frac{2 \text{ ft.} + 2 \text{ ft.}}{2} = 2 \text{ ft.}$$

Design Tailwater (DTW)

Since the TW > h_o , then the DTW = TW = 2.5 ft.

Headwater Depth (HW):

Having established the total head loss (H) and the design tailwater depth (DTW) as described above, compute the headwater depth (HW), as follows:

$$\begin{aligned} HW &= H + DTW - LS_o \\ HW &= 2.2 \text{ ft.} + 2.5 \text{ ft.} - (0.2 \text{ ft.}) \\ HW &= 4.5 \text{ ft.} \end{aligned}$$

Determine the headwater elevation by taking the culvert invert at the entrance and adding the headwater depth:

$$\text{HW Elevation} = 100.0 \text{ ft.} + 4.5 \text{ ft.} = 104.5 \text{ ft.}$$

- Controlling Headwater (HW) Depth or Elevation

Since the HW depth or elevation for inlet control (HW elevation = 104.8 feet) is greater than that of outlet control (HW elevation = 104.5 feet), then the controlling HW elevation is 104.8 feet.

- Outlet Velocity

Since the existing structure was found to be inlet control, the outlet velocity was determined as discussed earlier in this section.

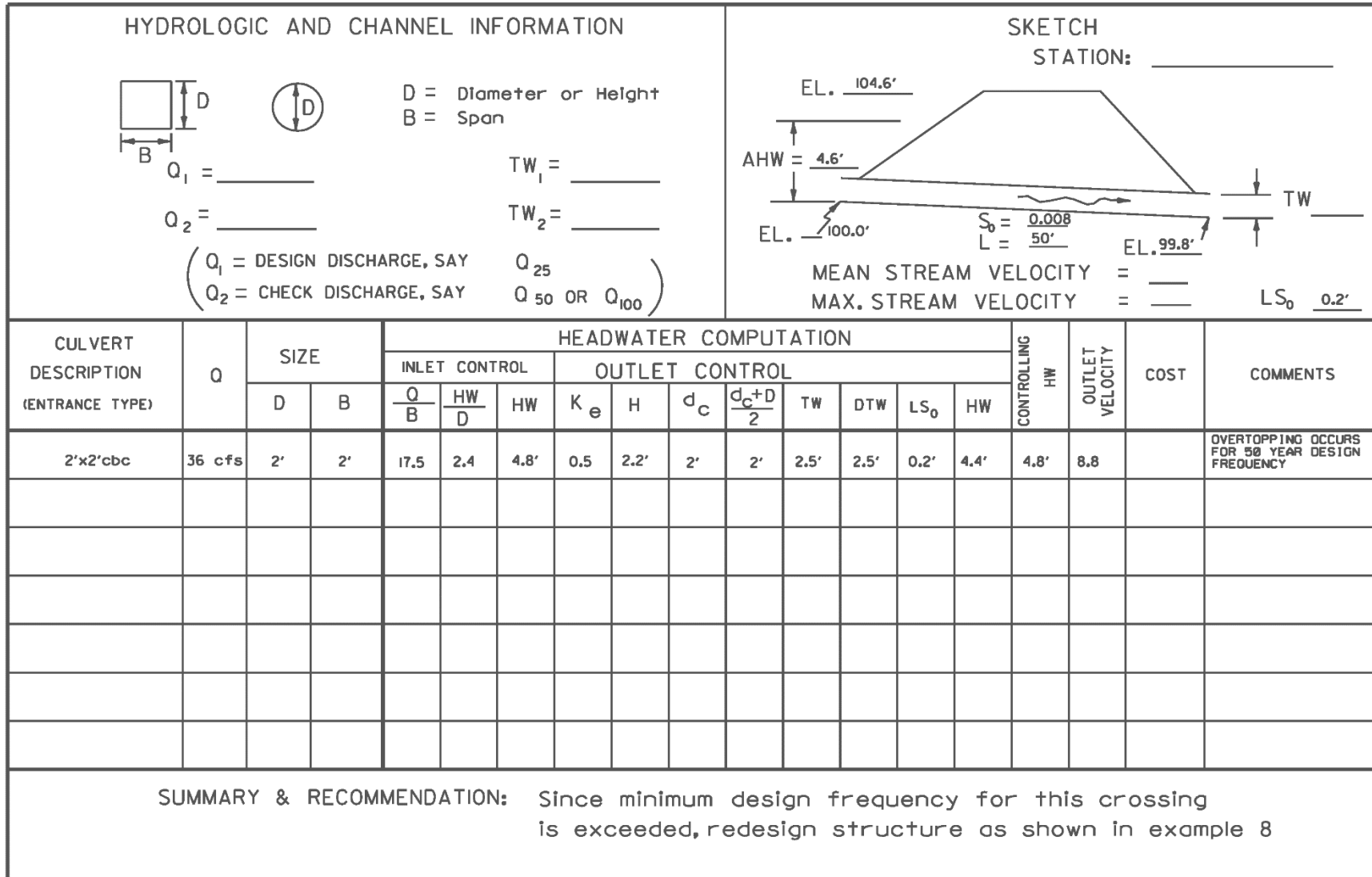

Figure 4.7-2: Worksheet for Example 4.7-2

- d. Assess the cause of the problem and investigate/evaluate alternative solutions. Final recommended design should address the problem with consideration to design standards.

Review of Figure 4.7-2 indicates that the roadway is overtopped for a 50-year design frequency. Therefore, recommend replacing the structure. It is anticipated that a cross drain no larger than a 48-inch diameter would be appropriate for this location. The procedure in Section 4.7.2, following, could be used. Example 4.7-3 illustrates this using the information from this example.

- e. Document as required in the *Drainage Manual*.

End of Example 4.7-2

4.7.2 Small Cross Drains

This information applies to cross drains having an area of opening up through a 48-inch-diameter round culvert or the equivalent.

- **Conduct hydrologic analysis**
Estimate discharges for design year frequency, base flood, and greatest flood. Use one of the following procedures as appropriate (see Section 4.7 of the *Drainage Manual*):
 - Rational Equation (up to 600 acres)
 - Regional or Local Regression Equation
- **Select trial culvert size** based on the following:

$$A = Q/V$$

Where:

A = Culvert area (square feet)

Q = Design discharge (e.g., 50 year)

V = Average velocity (feet per second); use an average velocity of four feet per second

- **Estimate tailwater.** If the outlet is in a free-flowing condition, the crown of the pipe at the outlet may be assumed.
- **Conduct hydraulic analysis** using techniques provided in FHWA HDS 5. Compute headwater conditions for the selected size for the design flood, base flood, and greatest flood or overtopping flood as appropriate.
- **Check hydraulic results** against design standards for backwater, minimum size, and scour. If these standards are satisfied, the trial culvert size is acceptable.
- **Determine the most economical culvert size** that satisfies all standards. If the trial selected size does not satisfy all design standards, obtain a variance.
- **Document** as required in the *Drainage Manual*.

Example 4.7-3 illustrates this procedure.

Example 4.7-3—Design of Small Cross Drain

Referring back to Example 4.7-2, you determined that the two-foot x two-foot concrete box culvert should be replaced. A design frequency of 50 years was determined as the minimum for this roadway. The existing length of the two-foot x two-foot concrete box culvert was 50 feet. However, since the structure will have to be extended four feet on each side, the design length of the proposed structure will be 58 feet.

Proposed Elevations are as follows:

Allowable headwater (edge of travel lane) = 104.6 ft

Flow line (upstream) = 100.1 ft

Flow line (downstream) = 99.7 ft

- **Conduct hydrologic analysis**

Estimate discharges for design-year frequency, base flood, and greatest flood. Use one of following procedures as appropriate (see Section 4.7 of the *Drainage Manual*):

- Rational Equation (up to 600 acres)
- Regional or Local Regression Equation

Use the same discharges from Example 4.7-2:

$$Q(50) = 35 \text{ ft}^3/\text{sec}$$

$$Q(100) = 52 \text{ ft}^3/\text{sec}$$

$$Q(500) = 88 \text{ ft}^3/\text{sec}$$

- **Select trial culvert size**

$$A = \frac{Q}{V} = \frac{35 \text{ ft}^3/\text{s}}{4 \text{ ft}/\text{s}} = 8.8 \text{ ft}^2$$

D = 3.3 ft., so try D = 36-inch pipe and 42-inch pipe

- **Conduct hydraulic analysis** using FHWA HDS 5 procedures.

The hydraulic analysis would be similar to what was done in Example 4.7-1 and Example 4.7-2. A worksheet of the calculations for the 50-year frequency is shown in Figure 4.7-3. The other frequencies also would need to be analyzed for an actual project. The analysis shown in Figure 4.7-3 is for the proposed conditions.

- **Check hydraulic results** against design standards.

Review of the worksheet in Figure 4.7-3 indicates that the roadway will not overtop for the 50-year frequency for either culvert size. There is very little difference between the 36-inch and 42 inch pipe as far as controlling headwater. Therefore, either pipe size would be adequate. However, it is recommended that the 36-inch pipe be installed since it would be slightly less in cost than the 42-inch pipe. In addition, it would be recommended that a rubble ditch lining design be installed at the outlet end due to velocities exceeding six feet per second.

- If design does not meet standards or if you can use more economical culvert size that satisfies the standards, then perform new computations for that design.

Document as required in the *Drainage Manual*.

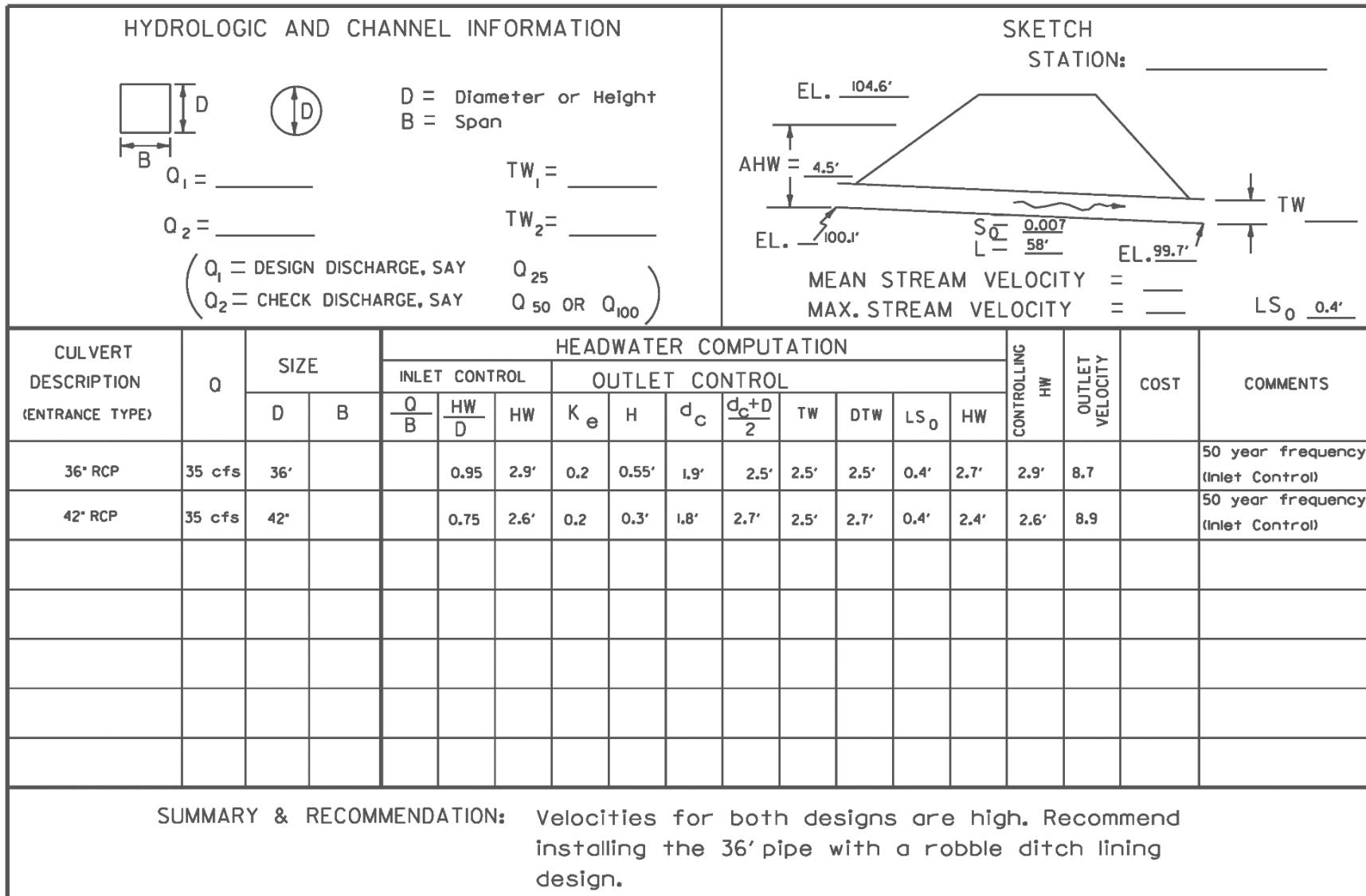

Figure 4.7-3: Worksheet for Example 4.7-3

4.7.3 Large Cross Drains

This information applies to cross drains having an area of opening greater than a 48-inch diameter pipe and less than a 20-foot bridge. The procedure for large cross drains is similar to that for small cross drains except that a greater level of effort and detail is expected in developing the hydrologic estimates and the determination of tailwater conditions.

- **Conduct hydrologic analysis**

Estimate discharges for design-year frequency, base flood, and greatest flood. Use one of following procedures as appropriate (see Section 4.7 of the *Drainage Manual*):

- Frequency analysis of observed conditions
- Regional or Local Regression Equation
- Rational Equation (up to 600 acres)

The remaining steps are the same as those identified in Section 4.7.2 for small cross drains.

CHAPTER 5: BRIDGE HYDRAULICS

| | |
|--|-----------|
| 5. BRIDGE HYDRAULICS..... | 1 |
| 5.1 Project Approach and Miscellaneous Considerations | 1 |
| 5.1.1 Identify Hydraulic Conditions..... | 1 |
| 5.1.2 Floodplain Requirements | 4 |
| 5.1.2.1 FEMA Requirements..... | 4 |
| 5.1.2.2 Other Government Agency Requirements..... | 8 |
| 5.1.3 Design Frequencies | 8 |
| 5.1.4 Clearances..... | 10 |
| 5.1.4.1 Debris | 10 |
| 5.1.4.2 Canal Right-Of-Way..... | 10 |
| 5.1.4.3 Navigation..... | 11 |
| 5.1.4.4 Waves..... | 11 |
| 5.1.5 Bridge Length Justification..... | 11 |
| 5.1.6 Berms and Spill-Through Abutment Bridges..... | 12 |
| 5.1.7 Design Considerations for Dual Bridges | 15 |
| 5.1.8 Design Considerations for Bridge Widening..... | 17 |
| 5.2 Riverine Analysis | 20 |
| 5.2.1 Data Requirements | 20 |
| 5.2.1.1 Geometric Data..... | 20 |
| 5.2.1.2 Geotechnical Data | 22 |
| 5.2.1.3 Historical Data | 23 |
| 5.2.1.4 Drainage Basin Information | 31 |
| 5.2.1.5 FEMA Maps | 31 |
| 5.2.1.6 Upstream Controls..... | 32 |
| 5.2.1.7 Site Investigation | 32 |
| 5.2.2 Hydrology..... | 33 |
| 5.2.3 Model Selection | 33 |
| 5.2.3.1 One-Dimensional versus Two-Dimensional | 34 |
| 5.2.3.2 Steady versus Unsteady Flow | 37 |
| 5.2.3.3 Commonly Used Programs..... | 37 |
| 5.2.4 Model Setup..... | 38 |
| 5.2.4.1 Defining the Model Domain..... | 38 |
| 5.2.4.2 Roughness Coefficient Selection | 42 |
| 5.2.4.3 Model Geometry | 43 |
| 5.2.4.4 Boundary Conditions..... | 66 |
| 5.2.4.5 Bridge Model..... | 67 |
| 5.2.5 Simulations | 73 |
| 5.2.5.1 Calibration..... | 73 |
| 5.2.5.2 Existing Conditions | 79 |
| 5.2.5.3 Design Considerations..... | 79 |

| | |
|---|------------|
| 5.3 Tidal Analysis | 80 |
| 5.3.1 Data Requirements | 80 |
| 5.3.1.1 Survey Data | 80 |
| 5.3.1.2 Geotechnical Data | 82 |
| 5.3.1.3 Historical Information | 82 |
| 5.3.1.4 FEMA Maps | 94 |
| 5.3.1.5 Inland Controls..... | 94 |
| 5.3.1.6 Site Investigation | 94 |
| 5.3.2 Hydrology (Hurricane Rainfall)..... | 95 |
| 5.3.3 Model Selection | 96 |
| 5.3.3.1 Storm Surge Model..... | 98 |
| 5.3.3.2 Wave Model..... | 99 |
| 5.3.3.3 Model Coupling..... | 99 |
| 5.3.4 Model Setup..... | 100 |
| 5.3.4.1 Defining the Model Domain..... | 100 |
| 5.3.4.2 Roughness Selection..... | 101 |
| 5.3.4.3 Model Geometry | 102 |
| 5.3.4.4 Boundary Conditions..... | 102 |
| 5.3.4.5 Bridge | 109 |
| 5.3.5 Simulations | 110 |
| 5.3.5.1 Model Calibration..... | 110 |
| 5.3.5.2 Storm Surge Simulations | 112 |
| 5.3.5.3 Design Considerations..... | 113 |
| 5.3.5.4 Wave Simulations | 114 |
| 5.3.6 Wave Forces on Bridge Superstructures | 115 |
| 5.4 Manmade Controlled Canals | 118 |
| 5.4.1 Introduction | 118 |
| 5.4.2 Watershed Description & Flow..... | 118 |
| 5.4.3 Channel Excavation, Clearance, and Other Owner Requirements | 119 |
| 5.4.4 Scour Estimation..... | 119 |
| 5.4.5 Abutment Protection | 119 |
| 5.4.6 Bridge Deck Drainage..... | 119 |
| 5.4.7 Appendix..... | 119 |
| 5.5 Bridge Scour | 120 |
| 5.5.1 Scour Components | 120 |
| 5.5.1.1 Long-Term Channel Processes | 120 |
| 5.5.1.2 Contraction Scour | 123 |
| 5.5.1.3 Local Scour (Pier and Abutment)..... | 128 |
| 5.5.1.4 Scour Considerations for Waves | 132 |
| 5.5.2 Scour Considerations for Ship Impact..... | 133 |
| 5.5.3 Florida Rock/Clay Scour Procedure..... | 135 |
| 5.5.3.1 Pressure Scour | 137 |
| 5.5.3.2 Debris Scour | 137 |
| 5.5.4 Scour Countermeasures | 138 |

| | | |
|------------|--|------------|
| 5.5.4.1 | Abutment Protection | 138 |
| 5.5.4.2 | Scour Protection at Existing Piers..... | 148 |
| 5.6 | Deck Drainage | 150 |
| 5.6.1 | Bridge End Drainage..... | 150 |
| 5.6.2 | No Scuppers or Inlets (Option 1)..... | 151 |
| 5.6.3 | Scuppers (Option 2)..... | 155 |
| 5.6.4 | Closed Collection Systems (Option 3) | 171 |
| 5.7 | BRIDGE HYDRAULICS REPORT FORMAT and DOCUMENTATION | 173 |
| 5.7.1 | Bridge Hydraulics Report Preparation..... | 174 |
| 5.7.1.1 | Executive Summary | 174 |
| 5.7.1.2 | Introduction | 175 |
| 5.7.1.3 | Floodplain Requirements | 176 |
| 5.7.1.4 | Hydrology..... | 176 |
| 5.7.1.5 | Hydraulics | 176 |
| 5.7.1.6 | Scour | 190 |
| 5.7.1.7 | Deck Drainage | 190 |
| 5.7.1.8 | Appendices | 190 |
| 5.7.2 | Bridge Hydraulics Report Process | 190 |
| 5.7.3 | Common Review Comments | 195 |
| 5.7.4 | Bridge Hydraulics Recommendations Sheet (BHRS) | 198 |

BRIDGE HYDRAULICS

5.1 PROJECT APPROACH AND MISCELLANEOUS CONSIDERATIONS

The material in this section addresses background information and initial decision making needed in preparation for a bridge hydraulic design. The following sections present more detailed design guidance.

Most bridge projects in Florida receive funding from the Federal Highway Administration (FHWA). Even if the project is not planned to receive federal funding, the funding situation may change before the project is complete. As a result, much of the hydraulic analyses and documentation required by the Department's standards are tailored to satisfy federal regulations and requirements.

Title 23 Code of Federal Regulations (CFR) 650A outlines the principal hydraulic analysis and design requirements that you must satisfy to qualify bridge projects (as well as any other project involving floodplain encroachments) for Federal Aid. The requirements in 23 CFR 650A are very comprehensive, so you, as the drainage engineer, should become familiar with them. The Title 23 CFR with FHWA's supplemental information is available at <https://www.fhwa.dot.gov/legisregs/directives/cfr23toc.htm>

5.1.1 Identify Hydraulic Conditions

Before beginning any hydraulic analysis of a bridge, first you must determine the mode of flow for the waterway. For purposes of bridge hydraulics, the Department separates the mode of flow into three categories of tidal influence during the bridge design flows:

1. Riverine flow—Crossings with no tidal influence during the design storm, such as: (a) inland rivers, or (b) controlled canals with a salinity structure oceanward intercepting the design hurricane surge. Bridges identified as riverine dominated require only examination of design runoff conditions.
2. Tidally dominated flow—Crossings where the tidal influences are dominated by the design hurricane surge. Flows in tidal inlets, bays, estuaries, and interconnected waterways are characterized by tide propagation evidenced by flow reversal (Zevenbergen et al., 2004). Large bays, ocean inlets, and open sections of the Intracoastal Waterway typically are tidally dominated, so much so that even extreme rainfall events have little influence on the design flows in these systems. Tidally dominated areas with negligible upland influx require only examination of design storm surge conditions.

3. Tidally influenced flow—Both river flow and tidal fluctuations affect flows in tidally influenced crossings, such as tidal creeks and rivers opening to tidally dominated waterways. Tidally affected river crossings do not always experience flow reversal; however, backwater effects from the downstream tidal fluctuation can induce water surface elevation fluctuations up through the bridge reach. Tidally influenced bridges require you to examine both design runoff and surge conditions to determine which hydraulic (and scour) parameter will dictate design. For example, a bridge located near the mouth of a river that discharges into a tidal bay (see Figure 5.1-1) may experience a high stage during a storm surge event. However, high losses through the bridge and a relatively small storage area upstream may limit the flow (and velocities) through the bridge. In fact, the design flow parameters (and thus scour) may occur during the design runoff event while the design stage (for clearance) and wave climate occurs during the storm surge event. Given that tidally influenced crossings may require both types of analyses, plan to include a coastal engineer for these bridge projects.



Figure 5.1-1: Example of a Bridge Requiring both Riverine and Tidal Analyses (US-90 over Escambia Bay)

The level of tidal influence is a function of several parameters, including distance from the open coast, size of the upstream watershed, elevation at the bridge site, conveyance between the bridge and the open coast, upstream storage, and tidal range. By far, the best indicator is distance from the coast. Comparisons of gage data or tidal benchmarks with distance from the coast will illustrate the decrease in tidal influence with increasing distance (see Figure 5.1-2). The figure shows that with increasing distance, the tidal range decreases, the flow no longer reverses, and, eventually, the tidal signal dies out completely. This illustrates the transition from tidally controlled (gage 2323592), to tidally influenced (gages 2323590, and 2323567, and 2323500), and finally to a riverine dominant system (gage 2323000).

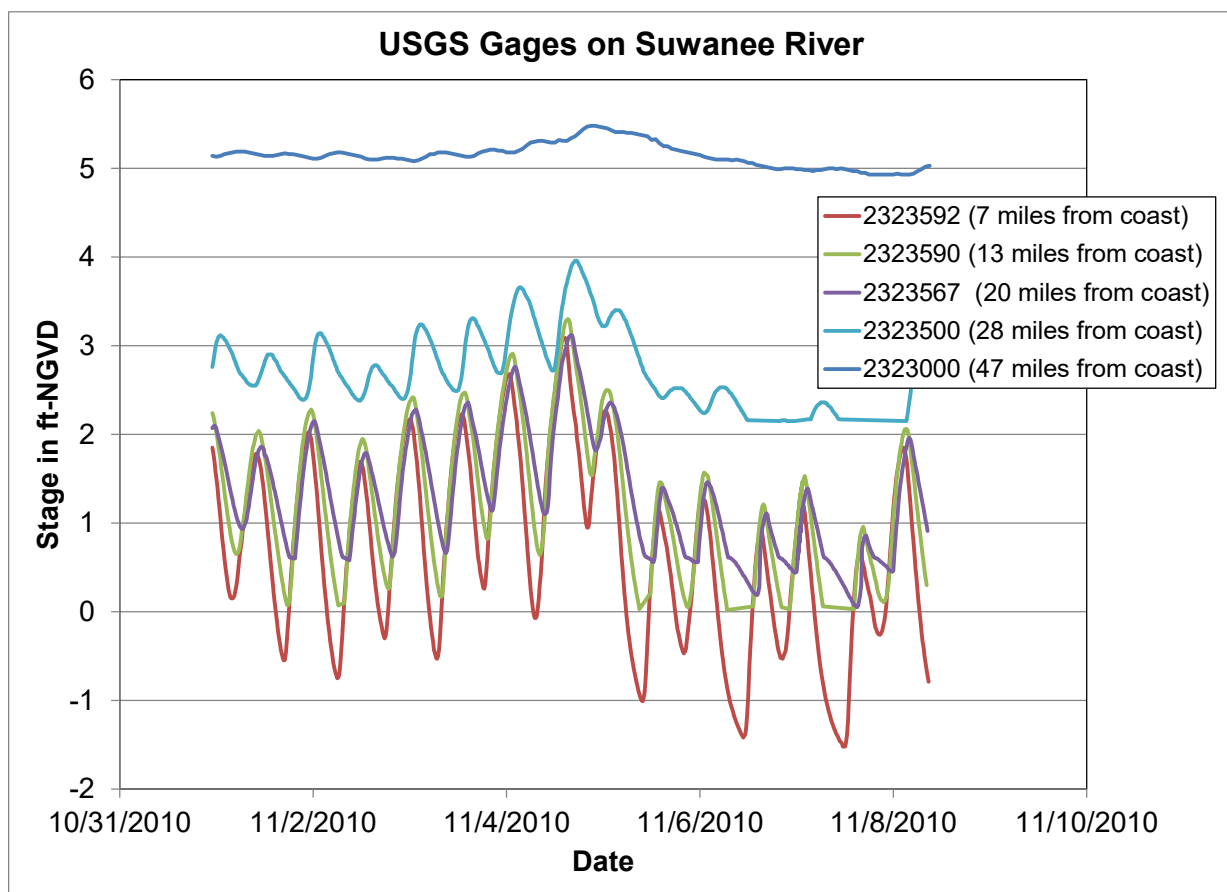

Figure 5.1-2: USGS Gage Data from the Suwannee River with Increasing Distance from the Coast

For the purposes of Department work, a coastal engineer is an engineer who holds a Master of Science or doctoral degree in coastal engineering or a related engineering field and/or has extensive experience (as demonstrated by publications in technical journals with peer review) in coastal hydrodynamics and sediment transport processes.

5.1.2 Floodplain Requirements

Address potential floodplain impacts during the Project Development and Environment (PD&E) phase of the project. Usually, you will not prepare a Bridge Hydraulics Report (BHR) during PD&E studies. However, if you do not prepare a BHR for a bridge, then the Location Hydraulic Study should address:

- Conceptual bridge length
- Conceptual scour considerations
- Preliminary vertical grade requirements
- The need, if any, for the input of a coastal engineer during final design

Refer to the PD&E or environmental documents and the Location Hydraulic Report for commitments made during the PD&E phase. Refer to Part 2, Chapter 24 of the FDOT *Project Development and Environment Manual* for more information on floodplain assessment during PD&E.

5.1.2.1 FEMA Requirements

All bridge crossings must be consistent with the National Flood Insurance Program (NFIP), which will depend on the presence of a floodway and the participation status of the community. To determine these factors, review:

- Flood maps for the bridge site, if available, to determine if the floodplain has been established by approximate methods or by a detailed study, and if a floodway has been established.
- Community Status Book Report to determine the status of the community's participation in the NFIP.

Both the flood maps and the Status Book are available at the Federal Emergency Management Agency (FEMA) website: <http://www.fema.gov/>.

The Special Flood Hazard Area (SFHA) is the area within the 100-year floodplain (refer to Figure 5.1-3). If a floodway has been defined, it will include the main channel of the stream or river, and usually a portion of the floodplain. The remaining floodplain within the SFHA is called the floodway fringe. The floodway is established by including simulated encroachments in the floodplain that will cause the 100-year flood elevation to increase one foot (refer to Figure 5.1-4).

Figure 5.1-5 shows an example of a floodway on the flood map. The floodway, as well as other map features, may have a different appearance on different community flood maps. Each map will have a legend for the various features on the map.

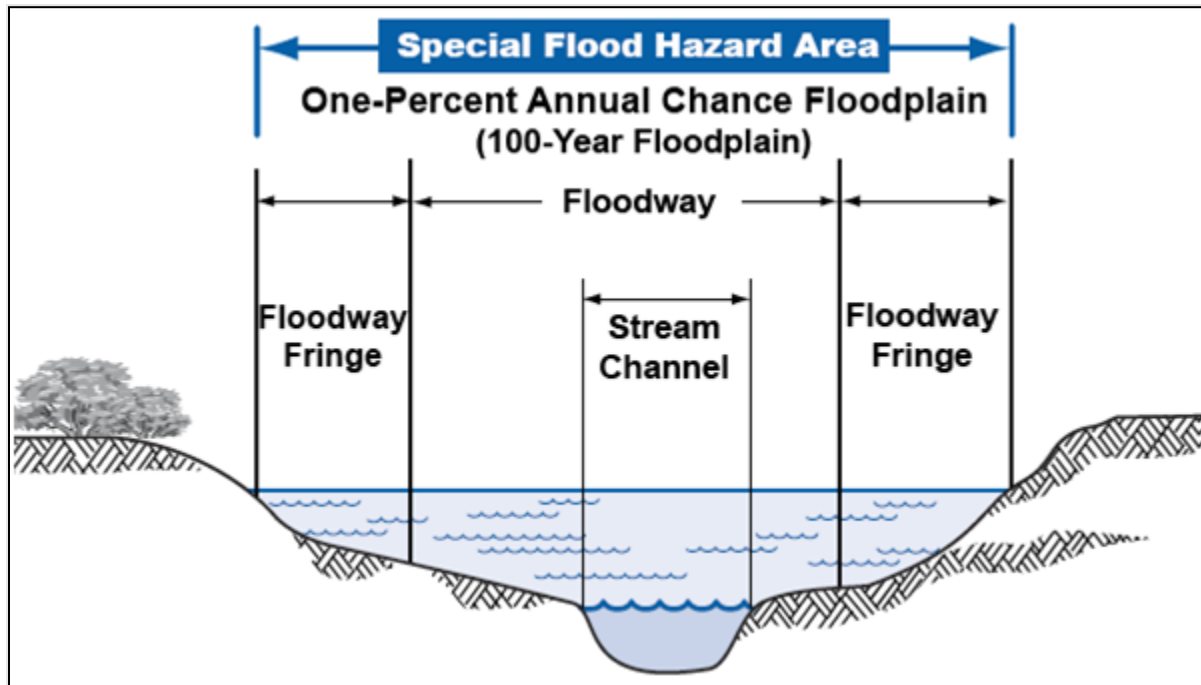

Figure 5.1-3: Special Flood Hazard Area

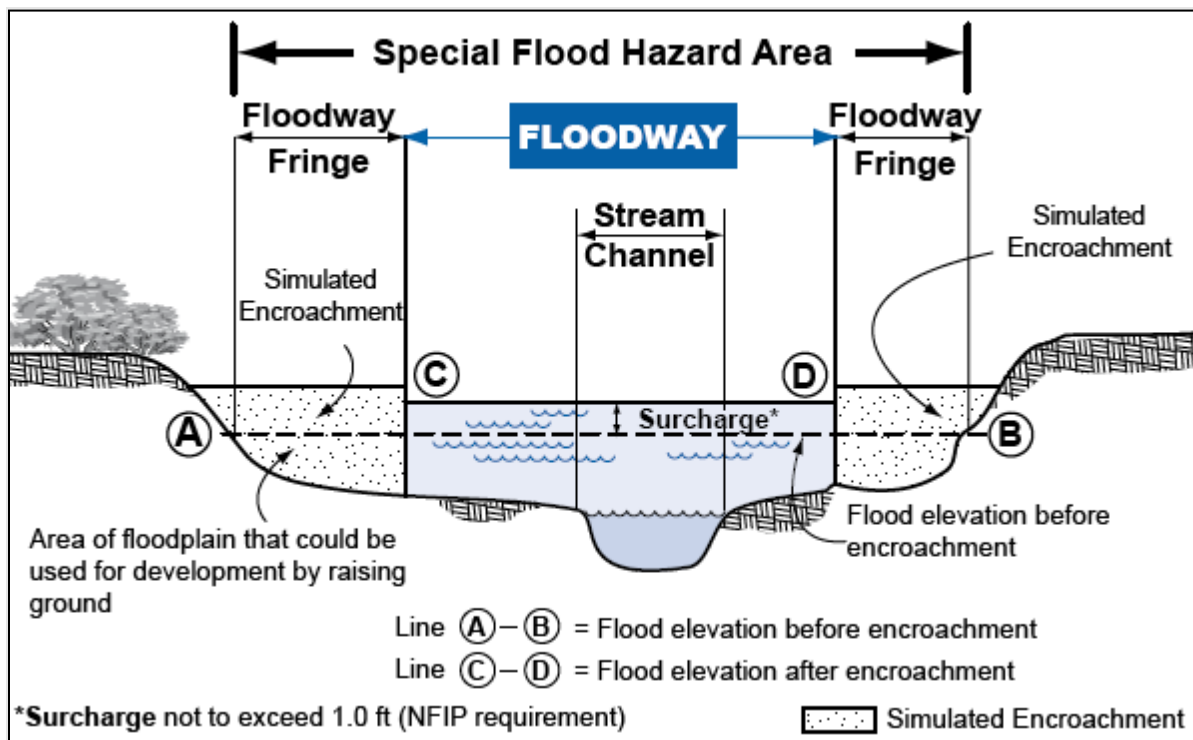

Figure 5.1-4: Floodway Definitions

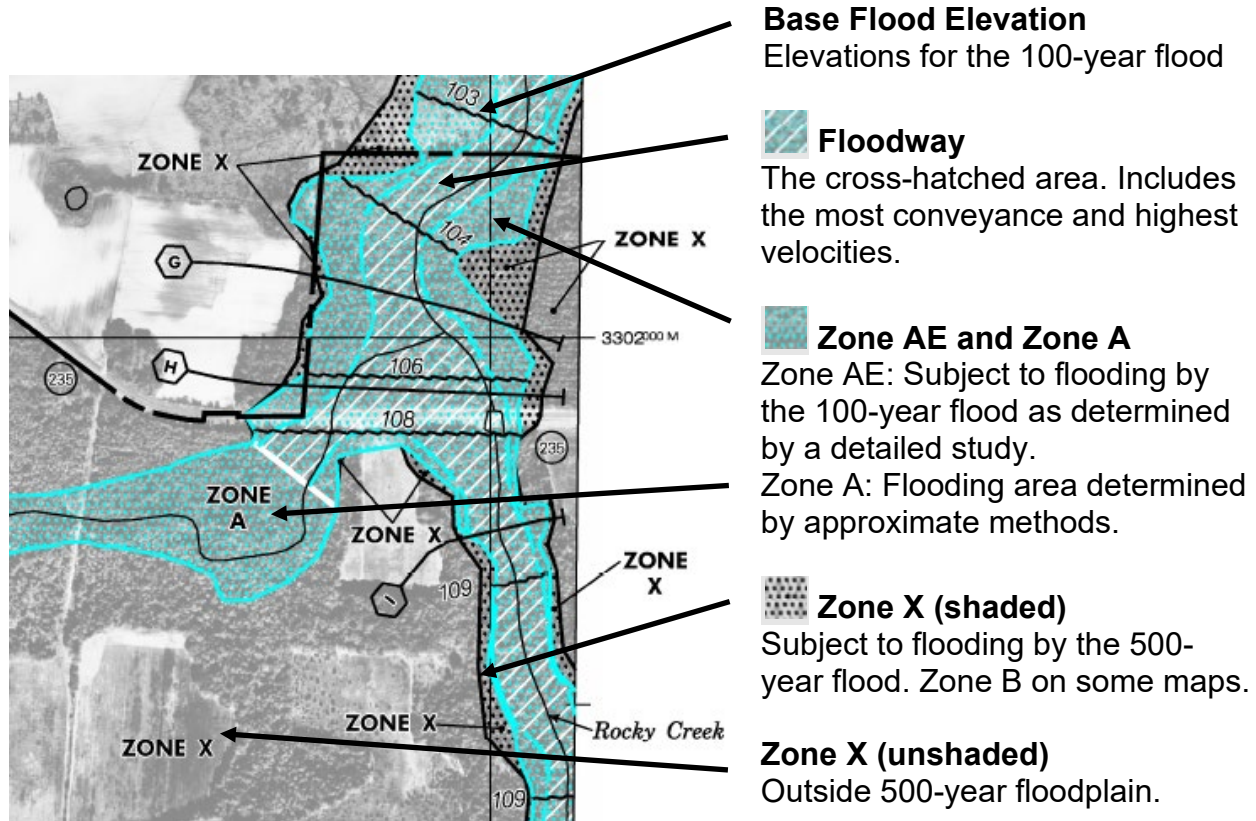

Figure 5.1-5: Example Flood Map

The simplest way to be consistent with the NFIP standards for an established floodway is to design the bridge and approach roadways so that you exclude their components from the floodway. If a project element encroaches on the floodway but has a very minor effect on the floodway water surface elevation (such as piers in the floodway), the project may be considered consistent with the standards if hydraulic conditions can be improved so that no water surface elevation increase is reflected in the computer printout for the new conditions. You will prepare a No-Rise Certification and support it by technical data. Base the data on the original model used to establish the floodway. The FEMA website has contact information to obtain the original model.

A Flood Insurance Study (FIS) documents methods and results of the detailed hydraulic study. The report includes the following information:

- Name of community
- Hydrologic analysis methods
- Hydraulic analysis methods
- Floodway data, including areas, widths, average velocities, base flood elevations, and regulatory elevations
- Water surface profile plots

The FIS can be obtained from the FEMA website. Note that the report does not include the original hydraulic model.

For some rivers and streams, a detailed study was performed, but a floodway was not established (refer to Figure 5.1-6). In this case, the bridge and roadway approaches may be designed to allow no more than a one-foot increase in the base flood elevation depending on local regulations and if offsite land use values will not be significantly impacted (see Section 4.4 of the *Drainage Manual*). Use information from the FIS and the original hydraulic model to model the bridge and submit technical data to the local community and FEMA.

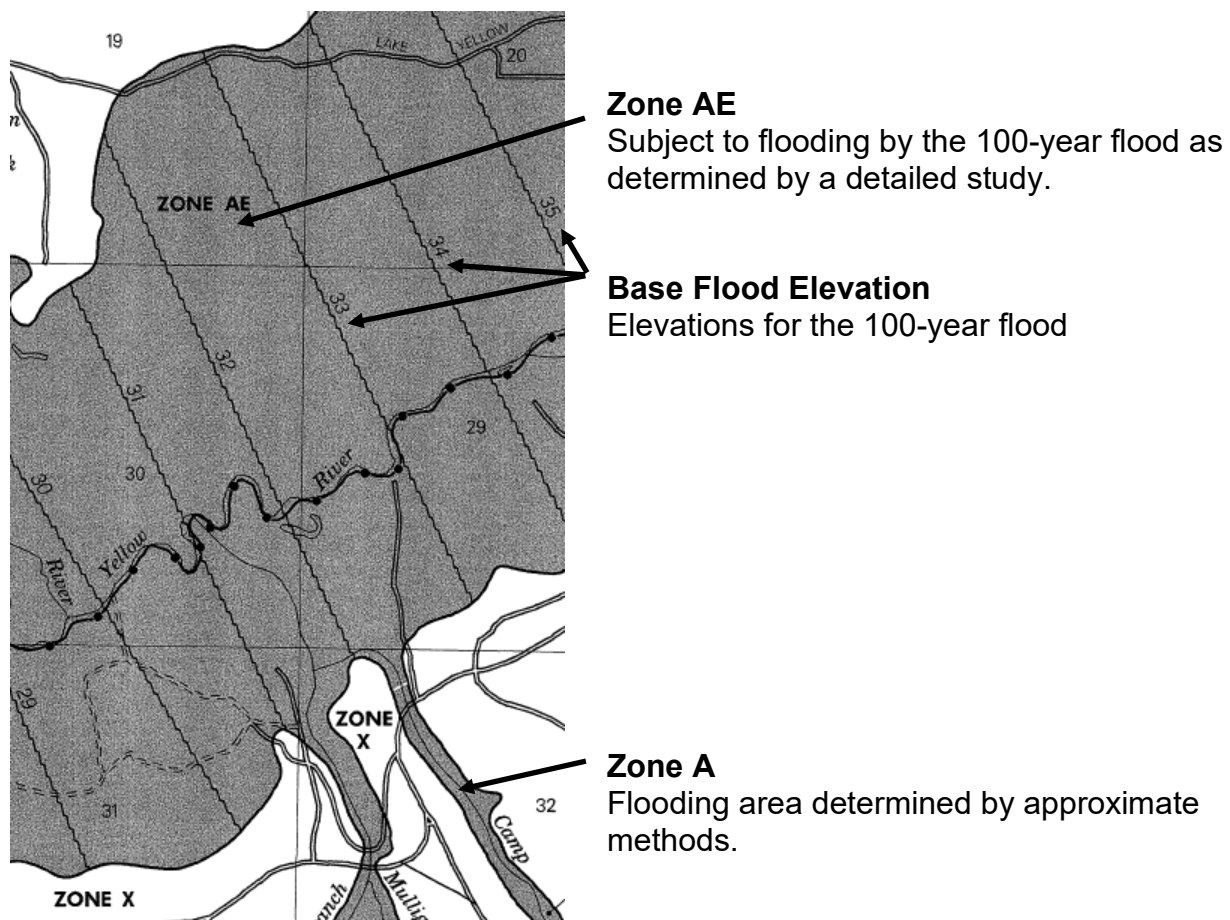

Figure 5.1-6: Example Flood Map

If the encroachment is in an area without a detailed study (Zone A on Figure 5.1-5 and Figure 5.1-6), then generate technical data for the project. You should give base flood information to the local community. Pursuant to NFIP regulations in CFR 60.3(c)(10), no more than a foot of increase in base flood elevation is allowed for cumulative development within the floodplain.

5.1.2.2 Other Government Agency Requirements

Many government agencies (cities, counties, Water Management Districts, etc.) will have additional limitations on backwater conditions in floodplains. The agency may designate the limitations at multiple distances upstream from the bridge. For example, backwater increase immediately upstream must be limited to one foot, and backwater increase 1,000 feet upstream must be limited to 0.1 foot.

Many of these agencies also have implemented mitigation requirements for fill within the floodplain, because it reduces the storage capacity in the floodplain and may increase discharges downstream. Therefore, other agencies may require a compensation area that creates the amount of storage lost due to the roadway approach fill.

5.1.3 Design Frequencies

Design frequency requirements are given in Section 4.3 of the *Drainage Manual*. These design frequencies are based on the importance of the transportation facility to the system and allowable risk for that facility. They provide an acceptable standard level of service against flooding.

Criteria that are based on the design frequency include:

- The bridge must convey the design frequency without damage (Section 4.2 of the *Drainage Manual*).
- Backwater for the design frequency must be at or below the travel lanes (Section 4.4 of the *Drainage Manual*).
- The bridge must have adequate debris clearance.

Figure 5.1-7 shows the relationship between these design frequency criteria and the geometric design. These criteria tend to create a crest curve on the bridge, with the profile of the approach roadway lower than the bridge profile. This is a desirable profile because the roadway will overtop before the bridge is inundated. Losing the roadway is preferable to losing the bridge.

Backwater criteria also apply for floods other than the design flood:

- Backwater must be consistent with the NFIP.
- Backwater must not change the land use of affected properties without obtaining flood rights.

When the risks associated with a particular project are significant for floods of greater magnitude than the standard design flood, a greater return interval design flood should be evaluated by use of a risk analysis. Risk analysis procedures are provided in FHWA HEC 17 and discussed briefly in Appendix G, Risk Evaluations. Discuss changing the

design frequency with the District Drainage Engineer before making a final decision. In addition, incorporate or address in the design hydraulic design frequency standards of other agencies that have control or jurisdiction over the waterway or facility.

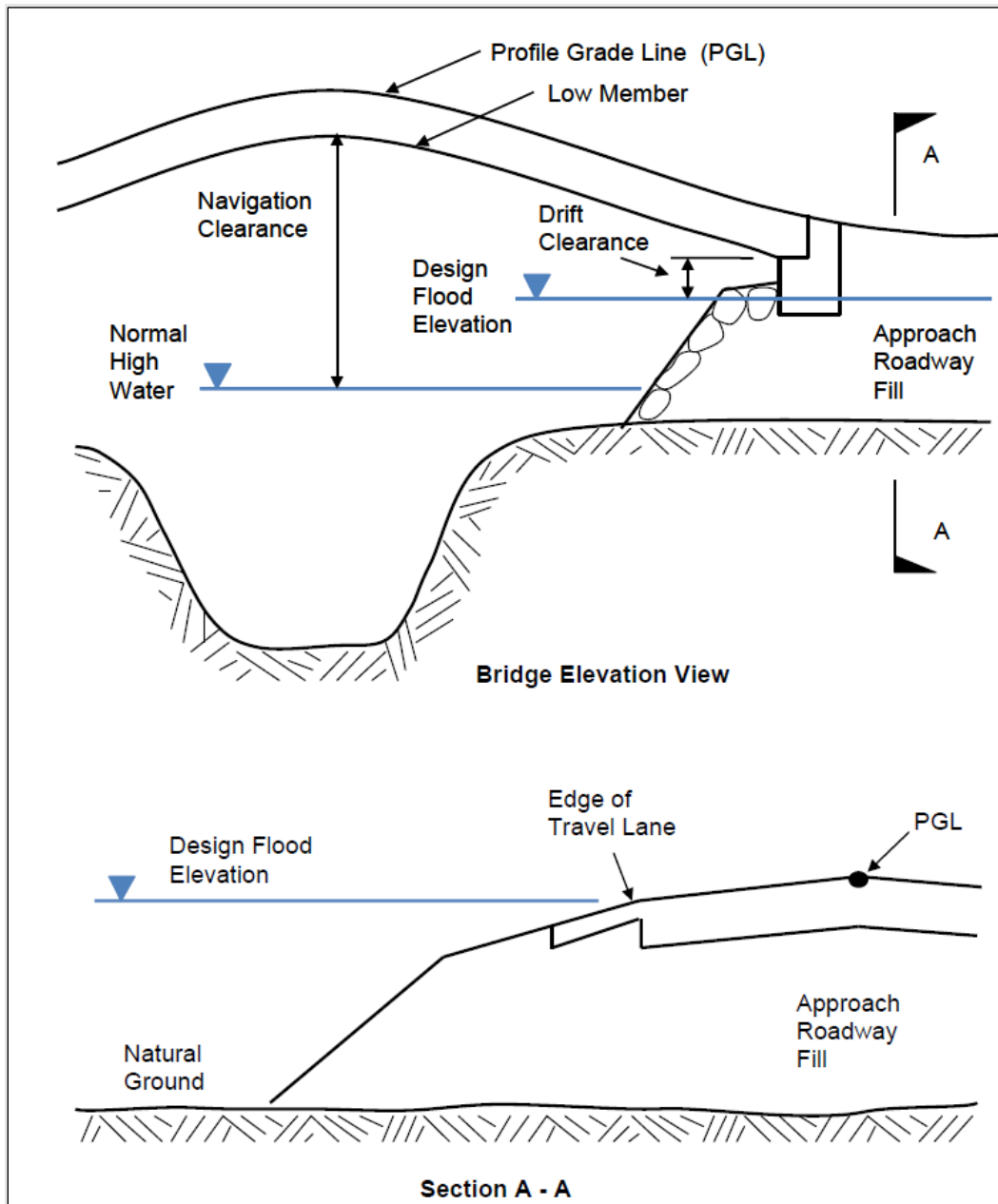

Figure 5.1-7: Bridge and Cross Drain Roadway Grade Controls

Scour analysis and design has a separate design frequency, discussed in Section 4.9 of the *Drainage Manual*. You will find national standards for scour design in FHWA HEC 18, *Evaluating Scour at Bridges*.

The worst-case condition for scour usually will occur at overtopping of the approach roadway or another basin boundary. Overtopping flow at the bridge often provides flow relief, and scour conditions will be a maximum at overtopping.

For more guidance on scour computation and design, refer to Section 5.5 of this document and the FDOT *Bridge Scour Manual*.

5.1.4 Clearances

The span lengths of a bridge affect the cost of the bridge, with longer spans generally increasing the cost. Increased height above the ground increases the cost of the foundations and the earthen fill of the approach roadways. However, minimum vertical and horizontal clearance requirements must be maintained to ensure the hydraulic crossing functions in conformance with the design criteria. Minimum clearances are addressed in the *FDM 260*.

5.1.4.1 Debris

Per *FDM 260*, a two-foot minimum debris drift clearance used by the Department traditionally has provided an acceptable level of service. Though this clearance usually is adequate for facilities of all types, review bridge maintenance records for the size and type of debris that may be expected. For example, if the watershed is a forested area subject to timbering activities, anticipate sizeable logs and trees among the debris. Meandering rivers also will tend to fell trees along the banks, carrying them toward downstream bridge crossings. On the other hand, bridges immediately downstream from a pump station may have little opportunity to encounter debris. Also, manmade canals tend to be stable laterally and will fell many fewer trees than sinuous, moving natural rivers. In such low debris cases, if a reduced vertical clearance is economically ideal, the hydraulic designer should approach the District Drainage Engineer for a variation to reduce the debris drift clearance.

For new bridges, you should advocate for aligning the piers normal to the flow if there is a possibility of debris being lodged between the pilings. The debris drift clearance is shown on the Bridge Hydraulics Recommendation Sheet (BHRS).

5.1.4.2 Canal Right-Of-Way

When a bridge crosses over a local permitting agencies' canal, additional permitting may be required. Early coordination with the local entity for any additional requirements for the crossing is recommended.

For example, any roadway going over a SFWMD Canal, the roadway is required to obtain a SFWMD Right-of-Way Occupancy Permit. SFWMD has a *ROW Permit Information Manual* on guidelines that specify vertical and horizontal clearances, among other criteria,

required to obtain the permit. SFWMD R/W Occupancy Permit information can be reviewed at <https://www.sfwmd.gov/doing-business-with-us/permits/right-of-way>

5.1.4.3 Navigation

Per *FDM 260*, crossings subject to small boat traffic, the minimum vertical navigation clearance is set as six feet above the mean high water, normal high water, or control elevation. Notably, other agencies may require different navigational clearances.

For tidally controlled or tidally influenced bridges, the BHR should document the tidal datums for the bridge location. This includes not only the Mean High Water (MHW) for use in navigational clearances, but also any other tidal datums available for the site. If taken from a tidal bench mark, the BHR should document the bench mark ID as well as the tidal epoch referenced.

Normal High Water is considered to be equivalent to the mean annual flood. The mean annual flood is the average of the highest flood stage for each year. For gaged sites, you can obtain this information from the U.S. Geological Survey (USGS). Statistically, the mean annual flood is equivalent to the 2.33-year frequency interval (recurrence interval). Therefore, if you use a synthetic hydrologic method to determine the Normal High Water, use the 2.33-year event. In some cases, stain lines at the site indicating the normal flood levels can be used to estimate the Normal High Water.

Obtain control elevations from the regulating agency (Water Management Districts, water control districts, U.S. Army Corps of Engineers, etc.).

5.1.4.4 Waves

Elevate coastal bridges one foot above the design wave crest, as required in the *FDM 260*. If the clearance is less than one foot, which often occurs near the bridge approaches, you must design the bridge according to the *Guide Specifications for Bridges Vulnerable to Coastal Storms*, a publication from the American Association of State Highway and Transportation Officials (AASHTO).

5.1.5 Bridge Length Justification

It is typically unnecessary to span the entire width of a stream at flood stages. Where conditions permit, you can extend approach embankments onto the flood plain to reduce costs, recognizing that in doing so the embankments will constrict the flow of the stream during flood stages. Normally, this is an acceptable practice, provided that the water surface profile and scour conditions are evaluated properly.

The BHR should demonstrate clearly that the proposed structure length and configuration are justified for the crossing. Use historical records from the life of the bridge, along with hydrologic and hydraulic calculations, to make recommendations. Using the same length as an existing structure that may have been in place for many years is not justification to use the same bridge length, given that the existing structure may not be hydraulically appropriate and may not have experienced a significant flooding event.

The most effective way to justify the length of a proposed structure is with the analysis of alternate structure lengths. Typical alternative bridge lengths that might be appropriate include:

- Existing structure length
- Structure length that goes from bank to bank plus 20 feet to provide the minimum maintenance berms
- Target velocity structure (for example, an average velocity through the bridge of 2 fps)
- Structure that spans the wetlands (the no-mitigation structure length)
- Concrete Box Culvert (CBC) structure
- Roadway geometrics structure length

As the analysis proceeds, the need to analyze another length may become apparent, and that may turn out to be the proposed structure length.

5.1.6 Berms and Spill-Through Abutment Bridges

Normally, you would not place spill-through abutments in the main channel of a stream or river for several reasons:

- Construction difficulties with placing fill and riprap below water
- Abutment slope stability during and after construction
- Increased exposure to scour
- Environmental concerns
- Stream stability or channel migration
- Maintenance

As stated in Section 4.9 of the *Drainage Manual*, you must determine the horizontal limit of protection using the methods in HEC 23. However, a 10-foot width between the top of the main channel and the toe of spill-through abutment slopes is considered the minimum width necessary to address the above concerns. For stable banks, make the horizontal 10-foot measurement from the top edge of the main channel. The use of the minimum berm width does not excuse the drainage engineer from conducting sufficient site analysis to determine the existence of unusual conditions. If the natural channel banks are very

steep, unstable, and/or if the channel is very deep, or channel migration exists, additional berm width may be necessary for proper stability. For these conditions, you should make the horizontal 10-foot measurement from the point where an imaginary 1V:2H slope from the bottom of the channel intersects the ground line in the floodplain.

In most situations, the structure that provides the minimum berm width often will be the shortest bridge length considered as a design alternative.

The minimum abutment protection is stated in Section 4.9 of the *Drainage Manual*. The standard rubble riprap was sized in accordance with HEC 23 for flow velocities (average) not exceeding 7.7 fps, or wave heights not exceeding 2.4 feet. Determine the horizontal and vertical extent using HEC 23. A minimum of 10 feet is recommended as a horizontal extent even if HEC 23 shows that a horizontal extent less than 10 feet is acceptable. Review the limits of right of way to be sure the apron at the toe of the abutment slope can extend out and along the entire length of the abutment toe, around the curved portions of the abutment to the point of tangency with the plane of embankment slopes. If calculations from HEC 23 show that the horizontal extent is outside the right-of-way limits, you can do the following:

- a. Recommend additional right of way.
- b. Provide an apron at the toe of the abutment slope that extends an equal distance out around the entire length of the abutment toe. In doing so, consider specifying a greater rubble riprap thickness to account for reduced horizontal extent.

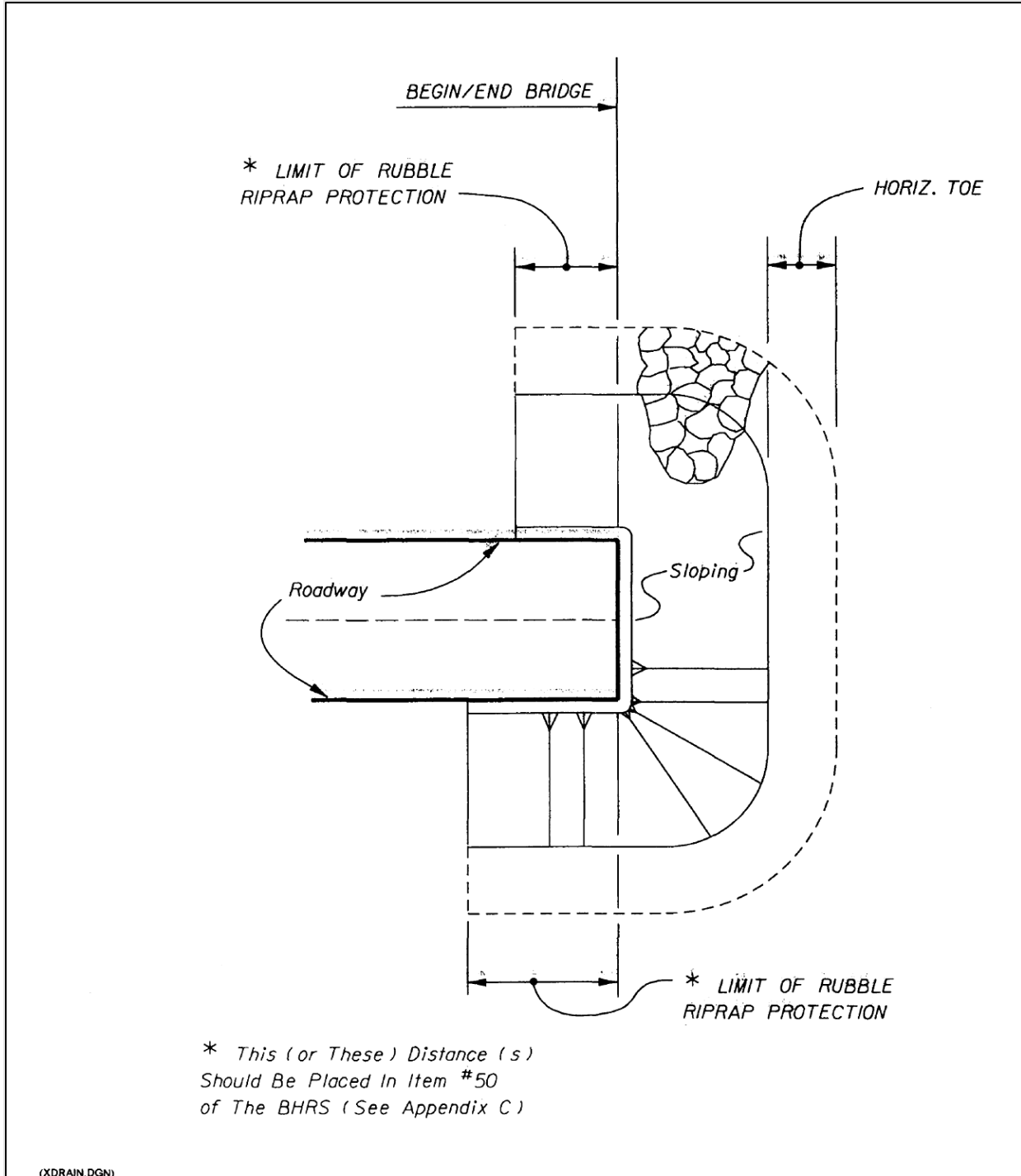

Figure 5.1-8: Limits of Rubble Riprap Protection

Figure 5.1-8 is a plan view that defines the limit of rubble riprap protection. Refer to the *FDOT Structures Detailing Manual* for the recommended minimum distance.

In contrast, controlled canals in developed areas typically have very low velocities, no stability problems, no overbank flow contracting into the bridge opening, and few abutment maintenance problems. In such cases, the abutment slope usually drops steeply from the abutment directly into the canal.

Use rubble with a specific gravity of 2.65 or other extra heavy revetment where large wave attack is expected, typically in coastal applications. Avoid corrodible metal cabling or baskets in coastal environments; even if coated, the coating may be marred and allow corrosion. Follow the USACE *Shore Protection Manual* for design of coastal revetment.

Use bedding stone on all bank and shore rubble installations to guard against tearing of the filter fabric during placement of the rubble. The bedding stone also helps dissipate wave impacts on the revetment.

For revetment installations where wave attack is not expected to be significant, include all options (e.g., fabric-formed concrete, standard rubble, or cabled interlocking block, etc.) that are appropriate based on-site conditions. Write a technical specification based on the use of the most desirable revetment material, with the option to substitute the other allowable materials at no additional expense to the Department. This recommendation will help in eliminating revetment Cost Savings Initiative Proposals (CSIPs) during construction.

No matter what options are allowed, match the bedding (filter fabric and bedding stone) to the abutment material. Some of the options are not self-healing, and a major failure can occur if loss of the embankment material beneath the protection takes place.

5.1.7 Design Considerations for Dual Bridges

When two-lane roadways are upgraded to multi-lane divided highways, the existing bridge on the existing roadway often has many years of remaining life. So a new dual bridge is built next to the existing bridge. Years later, when the original bridge needs to be replaced, the newer bridge still has years of remaining life. So a cycle of replacing one of the dual bridges at a time is repeated. There is a tendency to keep the bridge ends aligned with the bridge remaining in place. However, consider the potential for lateral migration of the stream, and plan that the new bridge end locations should accommodate the stream.

Scour estimates must consider the combined effects of both bridges. Ideally, the foundation of the new or replacement bridge will be the same type as the other foundation and will be aligned with the other foundation. In such cases, the scour calculations will be similar to that of a single bridge.

In some cases, it may not be reasonable to match and align the foundations of both bridges because of such things as economics, geotechnical considerations, and channel

migration, etc. If the foundation designs are not the same, or are not aligned, or both, the scour estimates must consider the combined obstruction of both foundations to the flow. The techniques of HEC 18 do not specifically address this situation. If another approach is not available, assume a single foundation configuration that accounts for the obstruction of both foundations and use the techniques of HEC 18. You can develop a conservative configuration by assuming each downstream pile group is moved upstream (parallel to flow) a sufficient distance to bring it in line with the adjacent upstream pile group. Figure 5.1-9 shows some configurations.

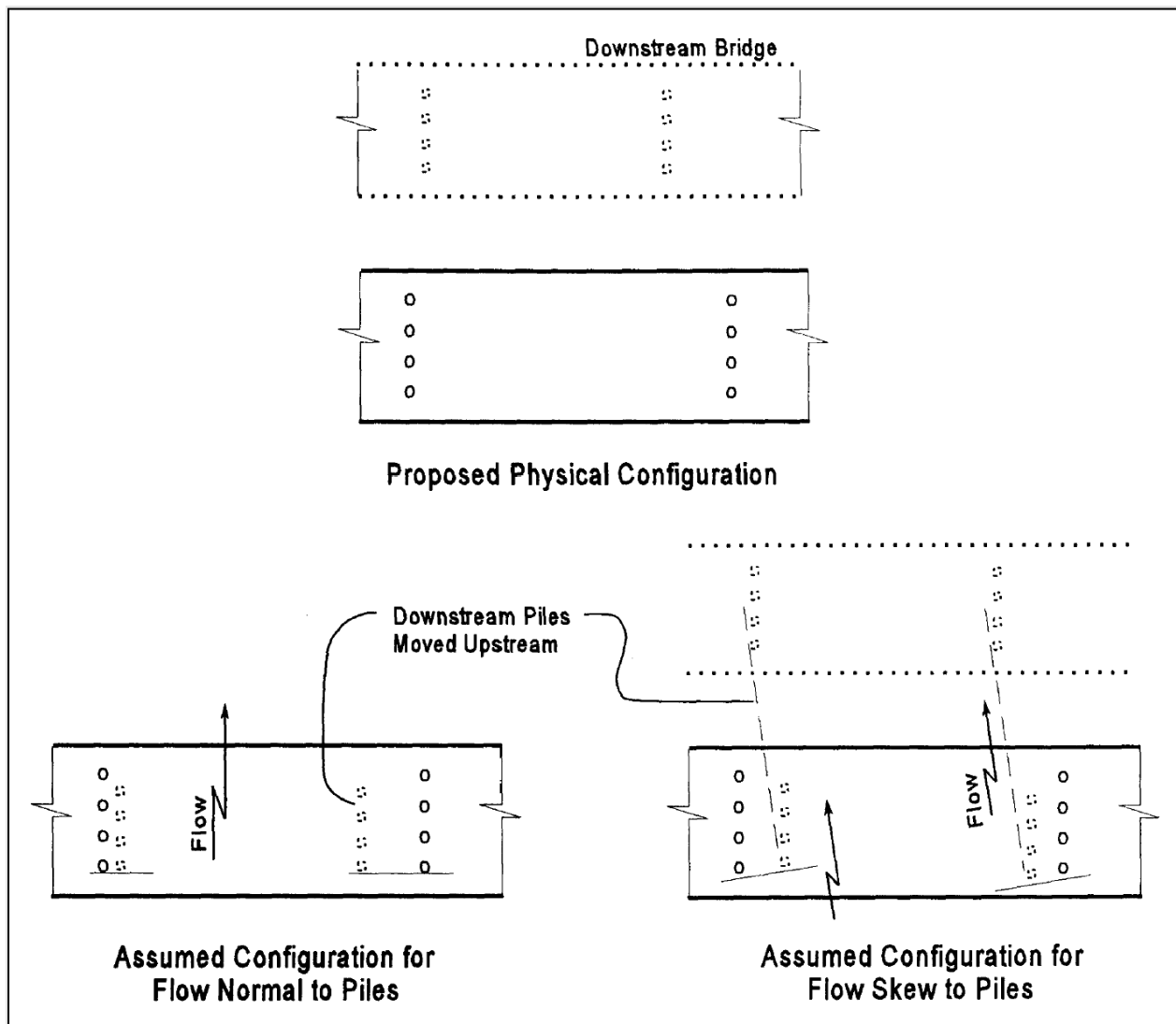

Figure 5.1-9: Configurations for Computing Scour of Dual Bridges

5.1.8 Design Considerations for Bridge Widening

The new substructure or foundations under the widened portion of a bridge often are different than the existing substructure in shape or depth. If a bridge has been through the Statewide Bridge Scour Evaluation Process and, as a part of that process, has been identified as "scour critical," the existing foundation must accommodate the predicted scour. If the existing foundation design cannot accommodate the predicted scour, the first alternative is to reinforce the existing foundation so that it can. If it is not practical to reinforce the existing foundation, the next alternative is to replace the existing structure so that it can be removed from the scour critical list. These approaches are consistent with the goal to remove all bridges from the scour critical list.

For minor widening (defined in Chapter 6 of the FDOT *Structures Design Guidelines*) of bridges that have been through the Statewide Bridge Scour Evaluation Process and have not been identified as scour critical, it is acceptable to leave the existing foundation without modification. The foundation under the widened portion must be properly designed to accommodate the predicted scour.

Widening existing bridges often will result in a minor violation of vertical clearances due to the extension of the cross slope of the bridge deck. Consult the District Drainage Engineer in documenting justification for deviating from criteria.

Structural Pier Protection Systems

Dolphins and fender systems are two structural systems designed to protect piers, bents, and other bridge structural members from damage due to collision by marine traffic. Dolphins are large structures with types ranging from simple pile clusters to massive concrete structures that can either absorb or deflect a vessel collision. Typically, they are located on both sides of the structure being protected, as shown in Figure 5.1-10. Fender system types are less variable, consisting usually of pile-supported wales, as shown in Figure 5.1-11. Fender systems typically wrap around the protected piers and run along the main navigation channel.



Figure 5.1-10: Dolphin Pier Protection at the Sunshine Skyway Bridge



Figure 5.1-11: Fender System at the Old Jewfish Creek Bridge

For design purposes, you can calculate scour around dolphins in the same manner as bridge piers. Typically, dolphins are located sufficiently far from the piers so that you can calculate local scour independently. However, check to ensure there is sufficient spacing (greater than 10 effective diameters).

Scour at fender systems typically is taken as equal to that of the pier it is protecting. In some cases, fender systems may “shield” bridge piers, reducing velocities and scour at the pier. However, this shielding effect can vanish or be modified if the fender system is lost due to collision or unforeseen scour problems, or if the flow attack angle is skewed so that the pier is not in the hydraulic shadow of the fender system. Piers and fender systems introduced into relatively narrow rivers may cause contraction scour between the fender systems. This scour usually is greatest near the downstream end of the system.

5.2 RIVERINE ANALYSIS

A riverine analysis applies to inland streams and rivers. Flooding conditions for riverine systems result from runoff from extreme rainfall events. Steady-state flow conditions usually can be assumed.

5.2.1 Data Requirements

The data collected will vary depending on the site conditions and the data available. Two-dimensional models require substantially more data than one-dimensional models.

5.2.1.1 Geometric Data

Follow these steps to collect geometric data for the analysis:

1. Determine the model domain. The geometric data must extend far enough upstream, downstream, and laterally to provide an accurate representation of the terrain within the domain. Refer to Section 5.2.4 for guidance.
2. Locate available geometric data within the model domain. You can use liberally estimated boundaries of the domain when the cost of collecting existing data is low.
3. Order survey for those portions of the model domain that do not have adequate coverage from existing geometric data. Survey will be expensive, so estimate the domain boundaries conservatively.

Existing Geometric Data

There are many potential sources of geometric data, and new sources of data continually become known. The following is a list of potential sources:

- USGS
 - Quadrangle maps
 - A public source in both scanned and vector formats is the FDEP Land Boundary Information System (LABINS) located at: <http://www.labins.org/>
 - Digital Elevation Models (DEMs)
 - DEMs are essentially x, y, z coordinate points on a 90-meter grid. They were derived from the Quadrangle Maps. DEMs also are available at LABINS.
 - LiDAR
 - Coverage in Florida is not yet complete. Available data can be downloaded at: https://www.usgs.gov/centers/eros/science/usgs-eros-archive-products-overview?qt-science_center_objects=0#qt-science_center_objects
- U.S. Army Corps of Engineers
 - USACE performs hydrographic surveys on navigable waterways, which can provide main channel information.
 - Mobile District: <https://www.sam.usace.army.mil/Missions/Spatial-Data-Branch/>

- Jacksonville District:
<http://www.saj.usace.army.mil/Missions/CivilWorks/Navigation/HydroSurveys.aspx>
- Florida Department of Emergency Management
 - Data for the Florida Coastal LiDAR project and links to other compatible data:
<http://www.floridadisaster.org/gis/lidar/>
- Water Management Districts
- Cities and counties
- Old plans and BHRs
- FEMA studies
 - Refer to Section 5.2.1.1 for more information on how to determine if a detailed study is available.

USGS Quadrangle Maps and DEMs are available for the entire state of Florida. They may be useful for preliminary analysis and, in some circumstances, you may use them to fill in gaps farther away from the site.

The remaining data sources usually will have a level of accuracy that was adequate for hydraulic modeling at the time of collection. However, consider the age of the data. If the terrain within the model domain has changed significantly, then you must find newer existing data sources or you will need to order survey.

You may need data from different sources to cover the entire model terrain. Sometimes, one source will have data within the overbank and floodplain areas, and a different source will have hydrographic data within the channel. Be sure to convert all data to a common datum and projection.

Ordering Survey Data

The FDOT *Surveying Handbook* (dated October 31, 2003) states that bridge survey and channel survey requirements are project specific. You will need to provide site-specific instructions to the surveyors so that they do not default to the previously used *Location Survey Manual*.

Survey can be in either cross section or Digital Terrain Model (DTM) format for one-dimensional models. Although you can use cross sections to develop two-dimensional models, a DTM format is preferable. Discuss the survey format with the surveyor to determine which format is most appropriate.

Always order survey in the immediate vicinity of the proposed bridge. The accuracy needs in this area are greater than the accuracy needs of the hydraulic model, for two reasons:

1. Bridge and roadway construction plans need a higher degree of accuracy.

2. The approach roadway and bridge abutment, including abutment protection, must fit within the right of way.

The typical roadway survey will be a DTM within the proposed right of way, and may extend a minimal distance outside of the proposed right of way. Coordinate with the roadway design engineer.

Determine the location of the approach and exit cross sections for the model and extend survey information in the main channel to these locations. Additional survey information in the adjacent floodplain and farther upstream and downstream of these extents will depend upon the other available geometric data.

Provide a sketch to the surveyor on a topographic map or aerial showing the limits of the DTM or the location, orientation, and length of cross sections. Also ask the surveyor for:

- Survey(s) of any adjacent utility crossings
- Elevations of stains on the existing pilings
- Any high-water marks determined by the hydraulics engineer during the site visit
- Elevation of the water level on the day of the survey

When ordering survey, remember that most floodplains in Florida often have dense vegetation. Surveying in these areas will be difficult. Not all cross sections need to be surveyed at the actual location used in the hydraulic model. Surveyed cross sections can be reasonably manipulated into model cross sections, so look for areas that would be easier to survey, such as along power lines and open fields.

5.2.1.2 Geotechnical Data

Geotechnical information is required at bridge foundations to establish the bed composition and its resistance to scour. Near surface bed materials in Florida range from sand and silts to clays to rock. As will be discussed in Section 5.5, the composition of the bed material dictates the procedure employed in the calculation of scour. For scour studies, the required information is a characterization of the near surface bed material, i.e., the layer over which scour will occur. The thickness of this layer will be a function of the expected scour at the site.

For bridges with foundations in cohesionless sediments (sands and silts), include sieve analyses in the geotechnical data collection to characterize the size of the bed sediments. Obtain a sufficient number of samples to confidently characterize the sediment size, both over the length of the bridge as well as over the thickness of the expected scour layer. The parameter from the sieve analyses necessary for scour calculation is the median

grain size (D_{50}). NRCS soil surveys can provide an estimated median grain size for preliminary scour estimates.

For bridges with foundations in cohesive sediments (rock or clay), establish the bed material's scour resistance. For rock, the FHWA provides guidelines for scourability of rock formations in HEC 18 (refer to Chapter 4).

Additionally, the Department has developed a Rock Scour Protocol, which you can find at:

<http://www.fdot.gov/roadway/Drainage/Bridgescour/Bridge-Rock-Scour-Analysis-Protocol-Jan2008.pdf>.

The referenced protocol recommends obtaining core borings at each pier for testing at the State Materials Office. It is your responsibility to follow the protocol procedure when encountering soils of this type.

For smaller streams where a bridge culvert may be an appropriate hydraulic option, consider obtaining a preliminary soil boring to determine if increased foundation costs for the culvert need to be included in the alternatives cost comparisons.

5.2.1.3 Historical Data

Historical data provide important information for many aspects of the bridge hydraulics and scour analysis. They provide numbers for calibration through gage measurements and historical high water marks, data for calculation of long-term scour processes through historical aerial photography and Bridge Inspection Reports, and characterization of the hurricane vulnerability through the hurricane history.

Speak with local residents, business owners and employees, and local officials—including fire and emergency services—to obtain anecdotal information about past floods. This information can be very important in the absence of other historical data.

Gage Measurements

In bridge hydraulics analysis, you can use gage data in a number of ways:

- To determine the peak flow rates, although the Department usually relies upon agencies, such as the USGS, to perform statistical analysis of the stream flow data. Refer to Section 2.2 (Hydrology) for more information.
- To provide starting water surface elevations, or boundary conditions, for the model if the gage is downstream of the bridge. Refer to Section 5.2.4.9 for more information.
- To calibrate the model. Refer to Section 5.2.5.1 for more information.

If the gage is located at a distance from the bridge site, the gage flow rates may not be the same as the bridge flow rates. However, the gage data still may be useful if the flow rates can be adjusted. Refer to Section 4.5, Peak Flow Transposition in FHWA Highway Hydrology, Hydraulic Design Series 2 (HDS-2), for more information.

USGS gage information can be found at this website:
<https://waterdata.usgs.gov/fl/nwis/current/?type=flow>

Gage data may also be available from the Water Management Districts and other local agencies.

Historical Aerial Photographs

Historical aerial photographs provide a means to determine the stream stability at a highway crossing. Comparison of photographs over a number of years can reveal long-term erosion or accretion trends of the shorelines and channel near the bridge crossing. You also can use current aerial photographs as a base for figures in the Bridge Hydraulics Report, showing such things as cross section locations and upstream and downstream controls.

Recent and current aerial photographs can be found at many Internet sites. Be careful of copyright infringements when using these aerials in the Bridge Hydraulics Report. For this reason, it is probably best to obtain the photographs from government sites that give free access.

Older aerial photographs can be obtained from the Aerial Photography Archive Collection (APAC), maintained by the FDOT Surveying and Mapping Office. APAC archives aerials dating back to the 1940s. Ordering information is available at the following link:

<https://www.fdot.gov/gis/aerialmain.shtm>

The University of Florida also maintains a database of older aerial photographs:

<http://ufdc.ufl.edu/aerials>

Another useful site to obtain aerial photography is the FDEP Land Boundary Information System (LABINS), which can be accessed at the following link:

<http://www.labins.org/>

Existing Bridge Inspection Reports

The District Structures Maintenance Office is responsible for the inspection of each bridge in the state at regular time intervals, including bridges owned by local agencies. The reports will document any observed hydraulically related issues, such as scour or erosion around the piers or abutments. Obtain Bridge Inspection Reports from the District Structures Maintenance Office. Of particular interest will be the channel profiles that have been collected at the site, which may show channel bottom fluctuations over time.

Channel profiles usually are created by taking soundings from the bridge deck. Soundings are measurements taken using a weighted tape measure to keep the tape vertical. The measurements are the distance from a consistent point on the bridge (usually the bridge rail) to the stream bed. The measurements are made on both sides of the bridge at each bridge pier and often at mid-span.

You may be able to find the Phase 1 Scour Evaluation Report for existing bridges. This report will plot some of the bridge inspection profiles against the cross section from the original construction, assuming that old plans or pile driving records were available to obtain the original cross section. The example bridge shown in Figures 5.2-1 and 5.2-2 has a very wide excavated cross section beneath the bridge. This was a common bridge design practice before dredge and fill permitting requirements brought the practice to an end unless the required wetland impact was justified and mitigated. In the example, the widened channel has filled back in and narrowed since the initial construction in 1963.

You can use the channel profiles to determine long-term bed changes at the bridge site.

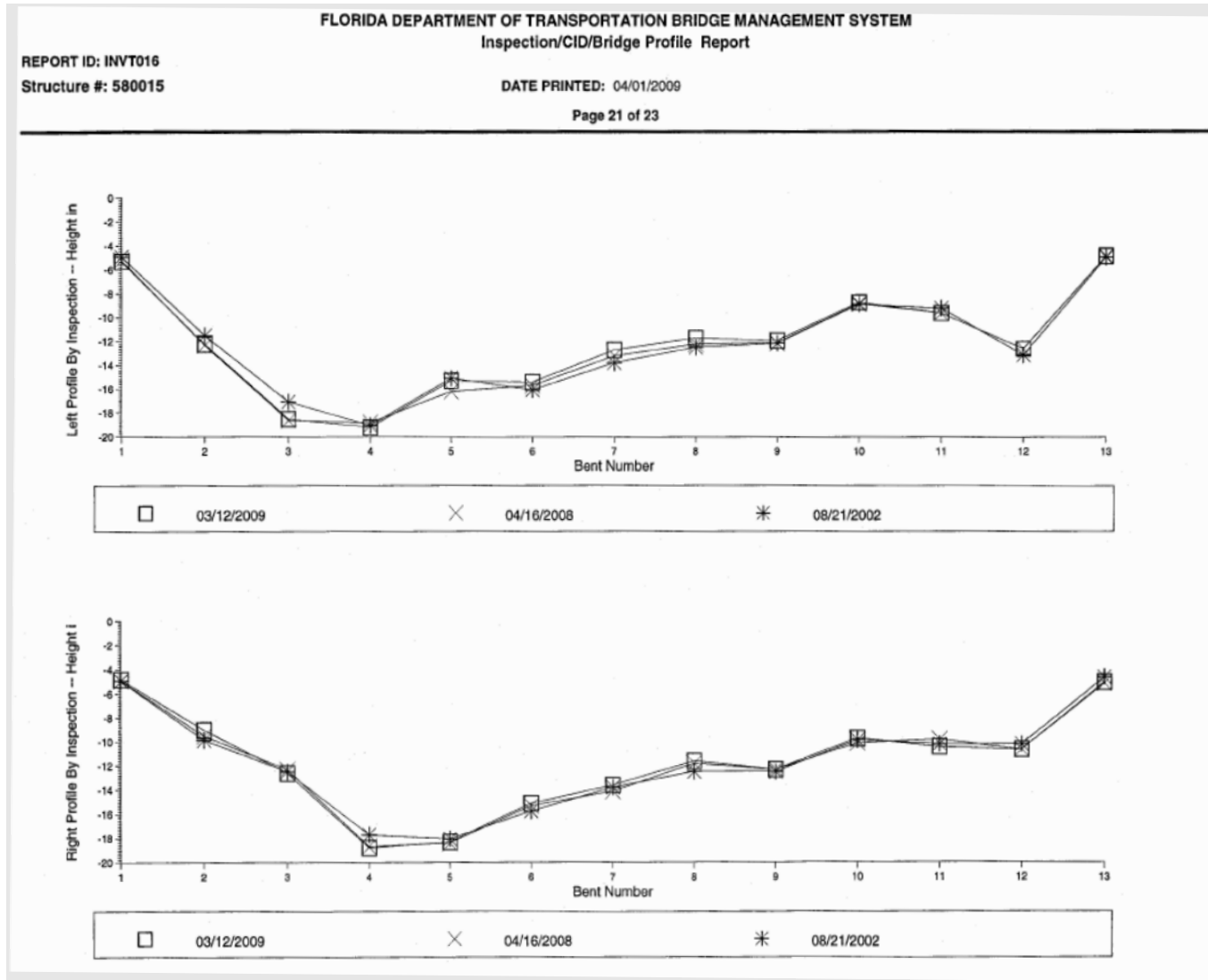

Figure 5.2-1: Example Bridge Profile from a Bridge Inspection Report

| FLORIDA DEPARTMENT OF TRANSPORTATION BRIDGE MANAGEMENT SYSTEM | | | | | |
|---|------|--------------------------|-------------|--------------|---------------------------|
| Inspection/CID/Bridge Profile Report | | | | | |
| REPORT ID: INVT016 | | DATE PRINTED: 04/01/2009 | | | |
| Structure #: 580015 | | Page 22 of 23 | | | |
| Profile Data - Numerical Summary | | | | | |
| Inspection Date and Key: | CXYM | Bent # | Left Height | Right Height | (All Heights Are In Feet) |
| 03/12/2009 | CXYM | 1 | 5.3 | 4.8 | |
| | | 2 | 12.2 | 9 | |
| | | 3 | 18.5 | 12.6 | |
| | | 4 | 19.2 | 18.8 | |
| | | 5 | 15.3 | 18.3 | |
| | | 6 | 15.4 | 15.1 | |
| | | 7 | 12.7 | 13.6 | |
| | | 8 | 11.7 | 11.6 | |
| | | 9 | 11.9 | 12.3 | |
| | | 10 | 8.7 | 9.7 | |
| | | 11 | 9.6 | 10.4 | |
| | | 12 | 12.6 | 10.6 | |
| | | 13 | 4.8 | 5 | |
| Air Temp: | | | | | |
| Profile Notes: | | | | | |
| Waterway Measurements: Top of rail to water line at Bent 4; 16.5 ft left and right. | | | | | |
| Groundline Measurements from top of rail. | | | | | |
| Inspection Date and Key: | HOWV | Bent # | Left Height | Right Height | (All Heights Are In Feet) |
| 04/16/2008 | HOWV | 1 | 5.2 | 4.9 | |
| | | 2 | 12.3 | 9.5 | |
| | | 3 | 18.6 | 12.3 | |
| | | 4 | 18.8 | 18.7 | |
| | | 5 | 16.2 | 18.4 | |
| | | 6 | 15.7 | 15.3 | |
| | | 7 | 13.2 | 14.1 | |
| | | 8 | 12.2 | 11.8 | |
| | | 9 | 12.1 | 12.3 | |
| | | 10 | 8.8 | 10.1 | |
| | | 11 | 9.6 | 9.8 | |
| | | 12 | 12.6 | 10.6 | |

Figure 5.2-1: Example Bridge Profile from a Bridge Inspection Report (cont.)

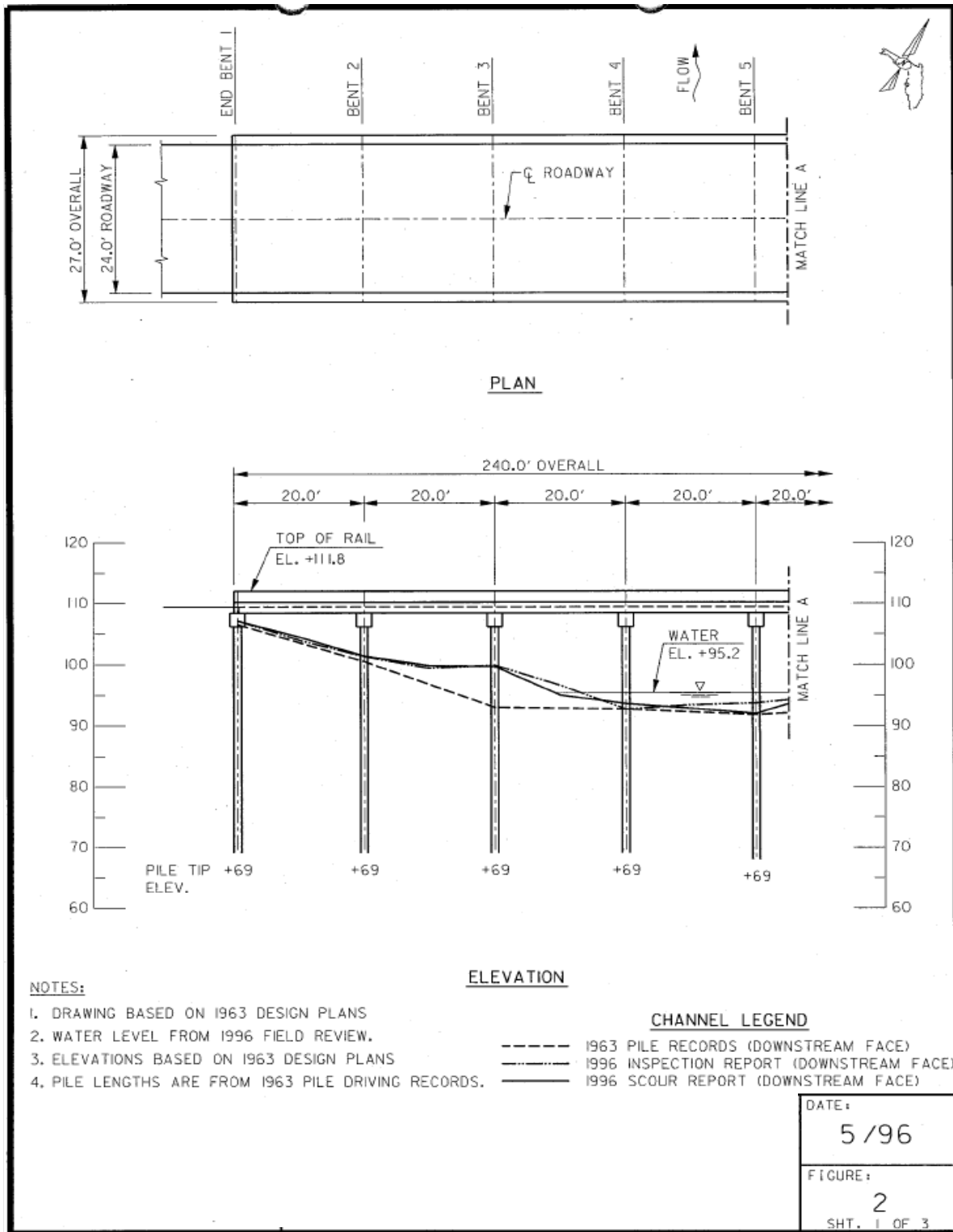

Figure 5.2-2: Excerpt from Scour Evaluation Report

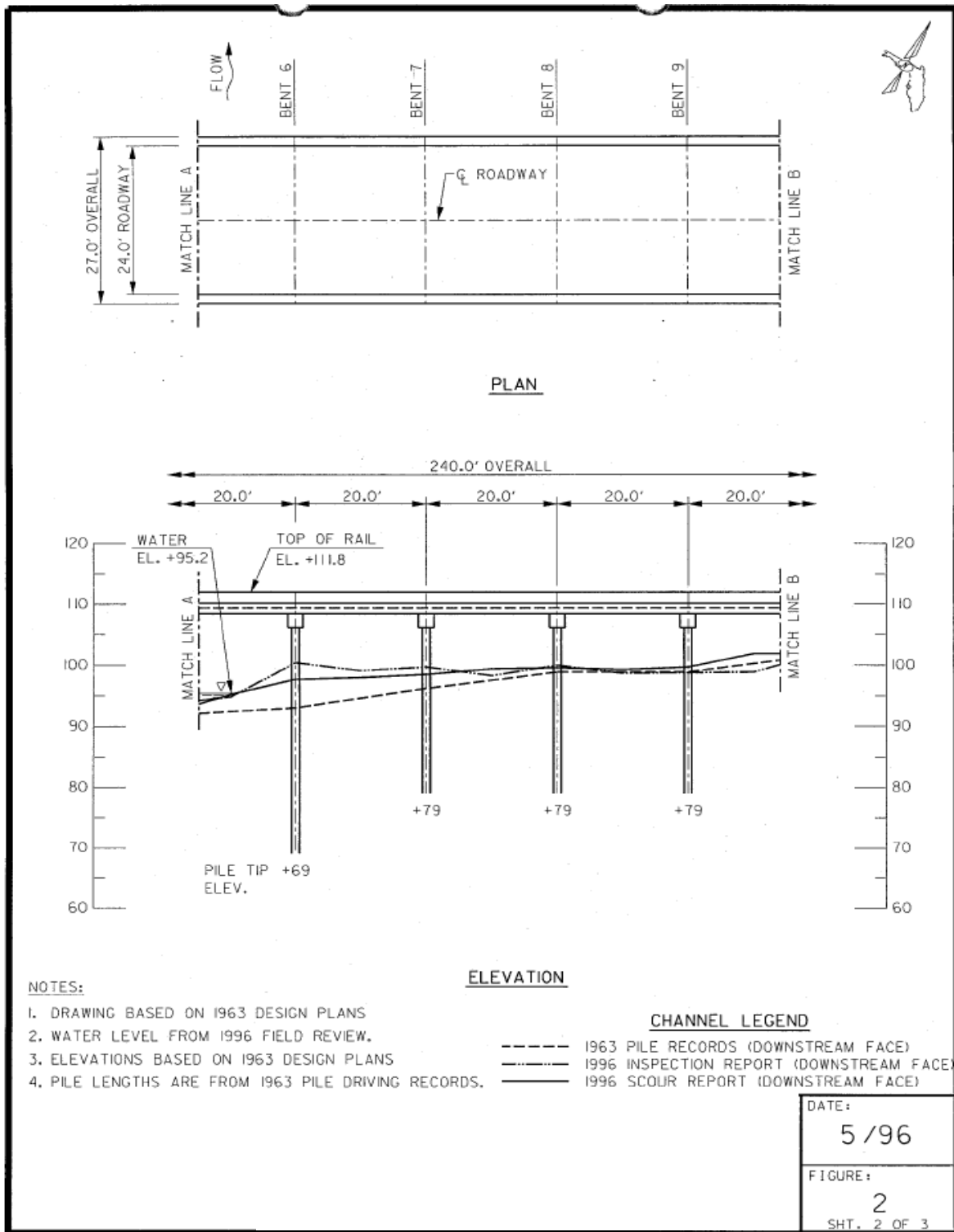

Figure 5.2-2: Excerpt from Scour Evaluation Report (continued)

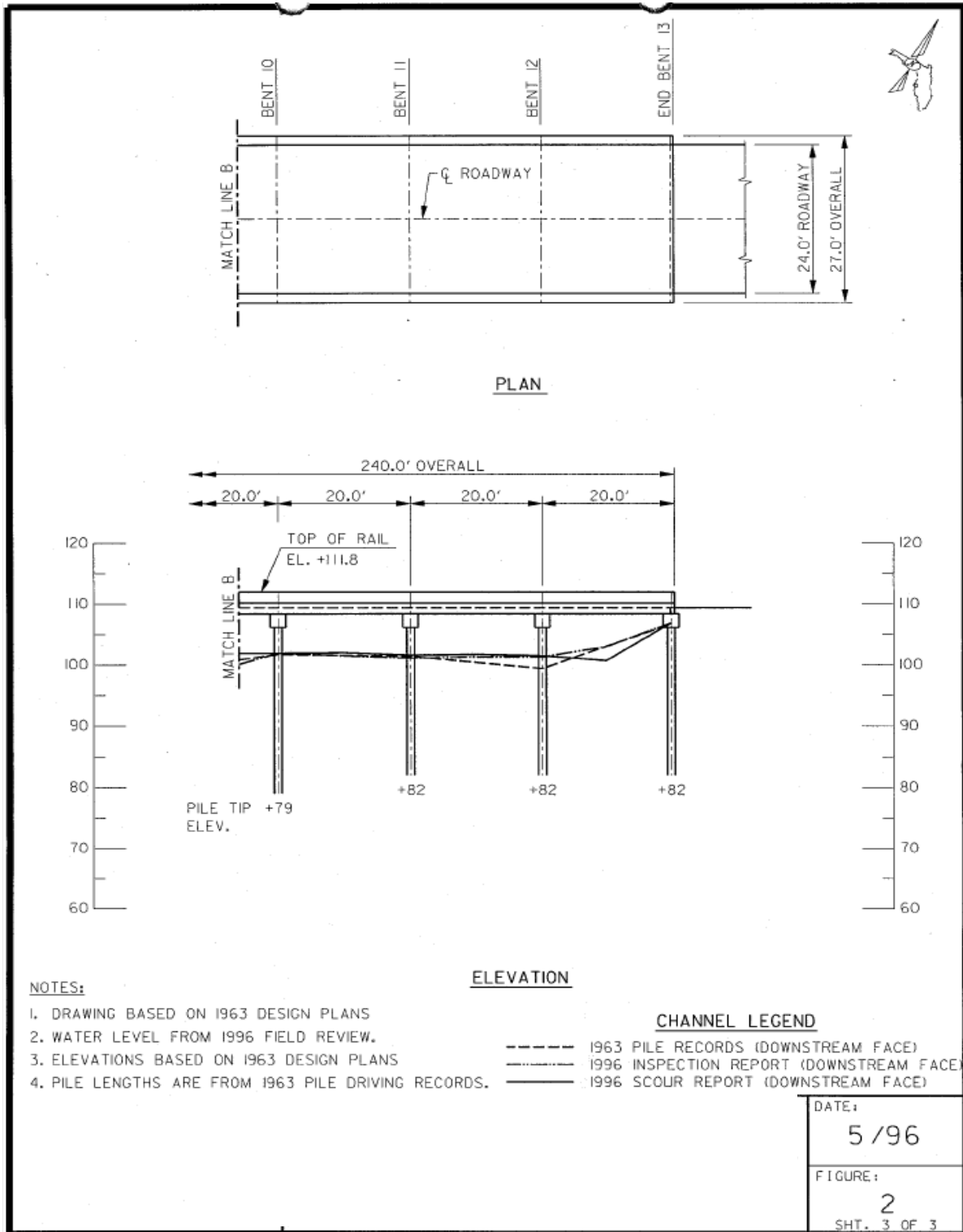

Figure 5.2-2: Excerpt from Scour Evaluation Report (continued)

Previous Studies

If the project replaces or widens an existing bridge, obtain the BHR or other hydraulic calculations for the existing bridge, if possible. Other BHRs for bridges over the same water body also may provide useful information.

If a detailed study was performed by FEMA, then obtain the Flood Insurance Study, the NFIP Maps, and the original model (refer to Section 5.2.1.5).

Additional sources of existing studies can include the Water Management Districts, the Florida Department of Environmental Regulation, county offices, and the U.S. Army Corps of Engineers.

Maintenance Records

Contact the local district or local agency maintenance staff for bridge inspection reports, historical overtopping, and/or maintenance issues at the bridge site.

5.2.1.4 Drainage Basin Information

Obtain drainage basin information for the hydrologic analysis. The type of information collected depends upon the hydrologic method used in the analysis. Refer to Section 5.2.2 and Chapter 2 (Hydrology) for guidance on the hydrologic analysis and data requirements.

Delineate the drainage basin boundaries on the Bridge Hydraulics Recommendation Sheet. Federal, state, and local agencies—including the Water Management Districts—often publish basin studies and delineate basin areas. Many of these are available online. Verify the boundaries found on older maps.

Also gather information on other structures on the river upstream and downstream of the proposed bridge site, including the size and type of structure for comparison with the proposed structure.

5.2.1.5 FEMA Maps

Obtain the FEMA Flood Insurance Rate Map and the Flood Insurance Study for the site. You can order these maps or download them from the FEMA Map Service Center at the following link:

<https://msc.fema.gov/portal/home>

Backup and supporting data for a detailed study, if the area has a detailed study, also can be obtained from FEMA. A data request form must be completed and sent to FEMA. Contact the FEMA Map Service Center for ordering information.

https://www.fema.gov/sites/default/files/documents/fema_flood-insurance-study-data-request-form.pdf

5.2.1.6 Upstream Controls

Upstream controls may influence the discharge at the crossing. Pump stations and dams are two common controls. Salinity intrusion structures are another example. Contact the agency exercising control over these structures to obtain information regarding geometrics, intended mode of operation, flow rate data, and history, including structure failures. It is important to consider the likelihood of upstream structure failures when considering flow regimes. A dam break analysis may be appropriate.

5.2.1.7 Site Investigation

A field investigation is recommended for all new bridge construction. Data obtained during a field investigation can aid in hydraulic model construction, identify problem erosion areas, and characterize stream stability. Perform a field investigation during the early stages of design. The following checklist (Neill, 1973) outlines some key items of basic data to be collected (not all may apply to a particular site):

- Look for channel changes and new tributaries compared to the latest aerial photographs or maps from the office data collection
- Look for evidence of scour in the area of the existing structure and check the adequacy of existing abutment protection
- Check for recent repairs to the existing abutment protection (as compared with the age of the bridge)
- Check for local evidence of overflow or breaching of the approaches
- Search the site for evidence of high flood levels, debris, or stains on the structure that may indicate flood levels
- Search for local evidence of wave-induced erosion along the banks
- Note the velocity direction through the bridge and estimate the velocities (note the date and time of these observations)
- Photograph the channel and adjacent areas
- Seek evidence of the main overflow routes and flood relief channels
- Search for hydraulic control points upstream and downstream of the structure

- Assess the roughness or flow capacity of the floodplain areas
- Describe and photograph the channel and overbank material in situ
- Seek evidence on largest size of stone moved by flood or waves
- Seek local evidence of channel shifting, bank and shore erosion, etc., and their causes
- Seek local evidence of channel bed degradation or aggradation
- Seek evidence of unrecorded engineering works that would affect flows to the bridge, such as dredging, straightening, flow diversions, etc.
- Observe the nearby land uses that might be affected by flood level changes

Consider visiting other structures across the stream or river upstream and downstream of the proposed bridge site.

5.2.2 Hydrology

In most riverine analyses, you can assume steady-state conditions and perform the hydraulic analysis using the peak discharge for each frequency analyzed. The peak discharge may vary at different locations on the stream if there are tributaries within the reach, but each discharge will be assumed to remain constant with respect to time.

Section 4.7.1 of the *Drainage Manual* gives criteria for selecting discharges used for riverine analysis. Further guidance is given in Chapter 2 (Hydrology).

Generally, the length of the structure does not control the hydrology. That is, in general, a longer structure will not significantly increase the discharge downstream. When considering the inaccuracies associated with the hydrology, the effect of the structure length and the resulting backwater (or reduction of backwater) usually will not significantly affect the amount of water going downstream. However, if you or the regulatory agency are significantly concerned about this effect, then you should conduct an analysis to verify the concern. You can calculate the pre- and post-water surface profiles and route them with an unsteady flow model.

5.2.3 Model Selection

Before selecting a specific model to use at a given bridge site, you must make two general decisions to isolate groups of appropriate models.

The two basic decisions are:

1. One-dimensional or two-dimensional model?
2. Steady flow conditions or unsteady flow conditions?

5.2.3.1 One-Dimensional versus Two-Dimensional

It is important for the hydraulic engineer to accurately represent the hydraulic condition. The engineer should understand the model assumptions because they form the limitations of that approach. The approach should be selected based primarily on its advantages and limitations, though also considering the importance of the structure, potential project impacts, cost, and schedule.

One-dimensional modeling requires that variables (velocity, depth, etc.) change predominantly in one defined direction, x , along the channel. Because channels are rarely straight, the computational direction is along the channel centerline. Two-dimensional models compute the horizontal velocity components (V_x and V_y) or, alternatively, velocity vector magnitude and direction throughout the model domain. Therefore, two-dimensional models avoid many assumptions required by one-dimensional models, especially for the natural, compound channels (free-surface bridge flow channel with floodplains) that make up the majority of bridge crossings over water.

Advantages of two-dimensional modeling include a significant improvement in calculating hydraulic variables at bridges. One-dimensional models are best suited for in-channel flows and when floodplain flows are minor. They are also frequently applicable to small streams. For extreme flood conditions, one-dimensional models generally provide accurate results for narrow to moderate floodplain widths. They can also be used for wide floodplains when the degree of bridge constriction is small and the floodplain vegetation is not highly variable. In general, where lateral velocities are small one-dimensional models provide reasonable results. Avoiding significant lateral velocities is the reason why cross section placement and orientation are so important for one-dimensional modeling.

Two-dimensional models generally provide more accurate representations of:

- Flow Distribution
- Velocity Distribution
- Water Surface Elevation
- Backwater
- Velocity Magnitude
- Velocity Direction
- Flow Depth
- Shear Stress

Although this list is general, these variables are essential information for new bridge design, evaluating existing bridges for scour potential, and countermeasure design.

Two-dimensional models should be used when flow patterns are complex and one-dimensional model assumptions are significantly violated. If the hydraulic engineer has great difficulty in visualizing the flow patterns and setting up a one-dimensional model that realistically represents the flow field, then two-dimensional modeling should be used.

One study that developed criteria for selecting one- versus two-dimensional models is "Criteria for Selecting Hydraulic Models" (NCHRP 2006). The recommendations from that study are summarized and expanded on below.

Multiple Openings. Multiple openings along an embankment are often used on rivers with wide floodplains. Rather than using a single bridge, additional floodplain bridges are included. Although one-dimensional models can be configured to analyze multiple openings, the judgment and assumptions that are made by the hydraulic engineer in combination with the assumptions and limitations of the software result in an extreme degree of uncertainty in the results. The proportion of flow going through a particular bridge and the corresponding flow depth and velocity are important for structure design and scour analysis. Because multiple opening bridges represent a large investment, two-dimensional analysis is always warranted.

Another type of multiple opening is multiple bridges in series. There are conditions when this bridge configuration should be analyzed using two-dimensional models. These include unmatched bridge openings or foundations that do not align. An upstream or downstream railroad or parallel road may significantly alter the flow conditions and warrant two-dimensional analysis.

Wide Floodplains. Floodplains often include features that significantly impact flow conveyance and flow distribution. Historic channel alignments and changes in land use or vegetation affect floodplain flow distribution. In a one-dimensional model, cross sections may have significantly different vegetation or topography due to land use activities. Using the cross sections exactly as they exist, the one-dimensional model will depict a sudden change in flow distribution that is not physically possible. The two-dimensional model avoids these difficulties because in the simulation all the flow is interconnected. Therefore, wide and complex floodplains benefit from two-dimensional analysis.

Skewed Roadway Alignment. Roadways should be aligned perpendicular to channel and floodplain flows. FHWA (1978) indicates that skewed crossings with angles of up to 20 degrees produced no objectionable flow patterns. Two-dimensional modeling is the recommended approach for higher skew angles or moderate amounts of skew combined with moderate to high flow contraction. Not only will the flow patterns and bridge conveyance be better defined, but potential problems with backwater will also be evident.

Bends, Confluences and Angle of Attack. Highly sinuous rivers are, by definition, not one-dimensional, especially during floods when water in the floodplain moves in and out of the channel. Two-dimensional models do not make any simplifying assumptions related to channel versus floodplain flow distance because the two-dimensional network directly incorporates flow paths. Flow conditions at confluences also vary depending on the proportion of flow in the main stem and tributary. Two-dimensional models provide improved estimates of angle of attack because velocity direction is computed directly.

Two-dimensional modeling may also be considered for design conditions including road overtopping, upstream obstructions, multiple channels, or countermeasure designs.

| Table 4.1. Bridge Hydraulic Modeling Selection. | | |
|--|---------------------------|-----------------|
| Bridge Hydraulic Condition | Hydraulic Analysis Method | |
| | One-Dimensional | Two-Dimensional |
| Small streams | ● | ◐ |
| In-channel flows | ● | ◐ |
| Narrow to moderate-width floodplains | ● | ◐ |
| Wide floodplains | ◐ | ● |
| Minor floodplain constriction | ● | ◐ |
| Highly variable floodplain roughness | ◐ | ● |
| Highly sinuous channels | ◐ | ● |
| Multiple embankment openings | ◐/○ | ● |
| Unmatched multiple openings in series | ◐/○ | ● |
| Low skew roadway alignment (<20°) | ● | ◐ |
| Moderately skewed roadway alignment (>20° and <30°) | ◐ | ● |
| Highly skewed roadway alignment (>30°) | ○ | ● |
| Detailed analysis of bends, confluences and angle of attack | ○ | ● |
| Multiple channels | ◐ | ● |
| Small tidal streams and rivers | ● | ◐ |
| Large tidal waterways and wind-influenced conditions | ○ | ● |
| Detailed flow distribution at bridges | ◐ | ● |
| Significant roadway overtopping | ◐ | ● |
| Upstream controls | ○ | ● |
| Countermeasure design | ◐ | ● |
| ● well suited or primary use ◐ possible application or secondary use ○ unsuitable or rarely used ◐/○ possibly unsuitable depending on application | | |

5.2.3.2 Steady versus Unsteady Flow

Use an unsteady flow model for the following conditions:

- Mild stream slopes less than two feet per mile. If the slope is greater than five feet per mile, steady flow can be used. For slopes between these values, consider the cost and complexity of an unsteady model versus the cost importance of the bridge.
- Situations with rapid changes in flow and stage. Models of dam breaks are the primary example of this situation.
- Bifurcated streams (streams where the flow divides into one or more channels and recombines downstream).

You can find more information on these situations in USACE Manual EM 1110-2-1416 (15 October 1993), *River Hydraulics*.

5.2.3.3 Commonly Used Programs

The most commonly used one-dimensional models are HEC-RAS and WSPRO. HEC-RAS was developed by the U.S. Army Corps of Engineers Hydrologic Engineering Center for a number of river hydraulic modeling applications, including the hydraulic design of waterway bridges. WSPRO (Water Surface PROFILE) is the acronym for the computer program developed by FHWA specifically for the hydraulic design of waterway bridges. Make sure you are using the latest version and document the version in the Bridge Hydraulics Report.

HEC-RAS and WSPRO both are suitable to analyze one-dimensional, gradually varied, steady flow in open channels, and you also can use them to analyze flow through bridges and culverts, embankment overflow, and multiple-opening stream crossings. HEC-RAS has the additional capability of analyzing unsteady flow.

The WSPRO program analyzes unconstricted valley sections using the standard step method, and incorporates research for losses across a bridge constriction. HEC-RAS allows the user to select the method used to analyze the bridge losses, including energy (standard step), momentum, Yarnell, and WSPRO methods. Both programs allow you to readily analyze alternate bridge openings. The output provides water surface elevations, bridge losses, and velocities for both the constricted (with bridge) and the unconstricted (with no bridge) condition. You can use this information to estimate the backwater effects of the structure and provide input information for scour analysis.

The most commonly used two-dimensional models are FESWMS and RMA 2. The Finite Element Surface Water Modeling System (FESWMS) was developed originally for FHWA and the USGS. The FHWA has continued to maintain and sponsor development of subsequent versions, which continue to incorporate features specifically designed for modeling highway structures in complex hydraulic environments. As such, it includes many features that other available two-dimensional models do not have, such as pressure flow under bridge decks, flow resistance from bridge piers, local scour at bridge piers, live-bed and clear-water contraction scour at bridges, bridge pier riprap sizing, flow over roadway embankments, flow through culverts, flow through gate structures, and flow through drop-inlet spillways. FESWMS can perform either steady-state or unsteady flow modeling.

The Resource Management Associates software RMA 2 is a two-dimensional, unsteady, depth-averaged, finite-element, hydrodynamic model. It computes water surface elevations and depth-averaged horizontal velocity for subcritical, free-surface flow in two-dimensional flow fields. The program contains the capability of solving both steady- and unsteady-state (dynamic) problems. Model capabilities include: wetting and drying of mesh elements, including Coriolis effects; applying wind stress; simulating five different types of flow control structures; and applying a wide variety of boundary conditions. Applications of the model include calculating: water levels and flow distribution around islands; flow at bridges having one or more relief openings; in contracting and expanding reaches; into and out of off-channel hydropower plants; at river junctions; and into and out of pumping plant channels; circulation and transport in water bodies with wetlands; and general water levels and flow patterns in rivers, reservoirs, and estuaries.

5.2.4 Model Setup

You will need the following data to perform the hydraulic and scour analysis for a bridge crossing:

- Geometric data
- Flow data (upstream boundary)
- Loss coefficients
- Starting water surface elevations (downstream boundary)
- Geotechnical data (D_{50} soils information)

5.2.4.1 Defining the Model Domain

You will need upstream, downstream, and lateral study boundaries to define the limits of data collection. The model must begin far enough downstream to assure accurate results at the bridge, and far enough upstream to determine the impact of the bridge crossing on upstream water surface elevations. The lateral extent should ensure that the model includes the area of inundation for the greatest flood analyzed. Underestimating the

domain causes the water surface calculations to be less accurate or requires additional survey at a higher cost than the inclusion in the initial survey. Overestimation results in greater survey, data processing, and analysis cost.

Upstream

At a minimum, the upstream boundary should be set far enough upstream of the bridge to encompass the point of maximum backwater caused by the bridge. If a point of concern where the water surface elevation must be known is farther upstream, then the model must be extended to that point. An example would be upstream houses or buildings because the 100-year water surface elevation must be kept below their floor elevation. Check with permitting agencies, including cities and counties, as some have limits on the amount of backwater allowed at a given distance upstream.

The following equation can be used to determine how far upstream data collection and analysis needs to be performed.

$$L_u = 10,000 * HD^{0.6} * HL^{0.5}/S$$

where:

- Lu = Upstream study length (along main channel), in feet for normal depth starting conditions
- HD = Average reach hydraulic depth (1-percent chance flow area divided by cross section top width), in feet
- S = Average reach slope, in feet per mile
- HL = Head loss, ranging between 0.5 feet and 5.0 feet at the channel crossing structure for the 1-percent chance flow

The values of HD and HL may not be known precisely since the model has not yet been run to determine these values. They can be estimated from FEMA maps, USGS Quadrangle Maps (or other topographic information).

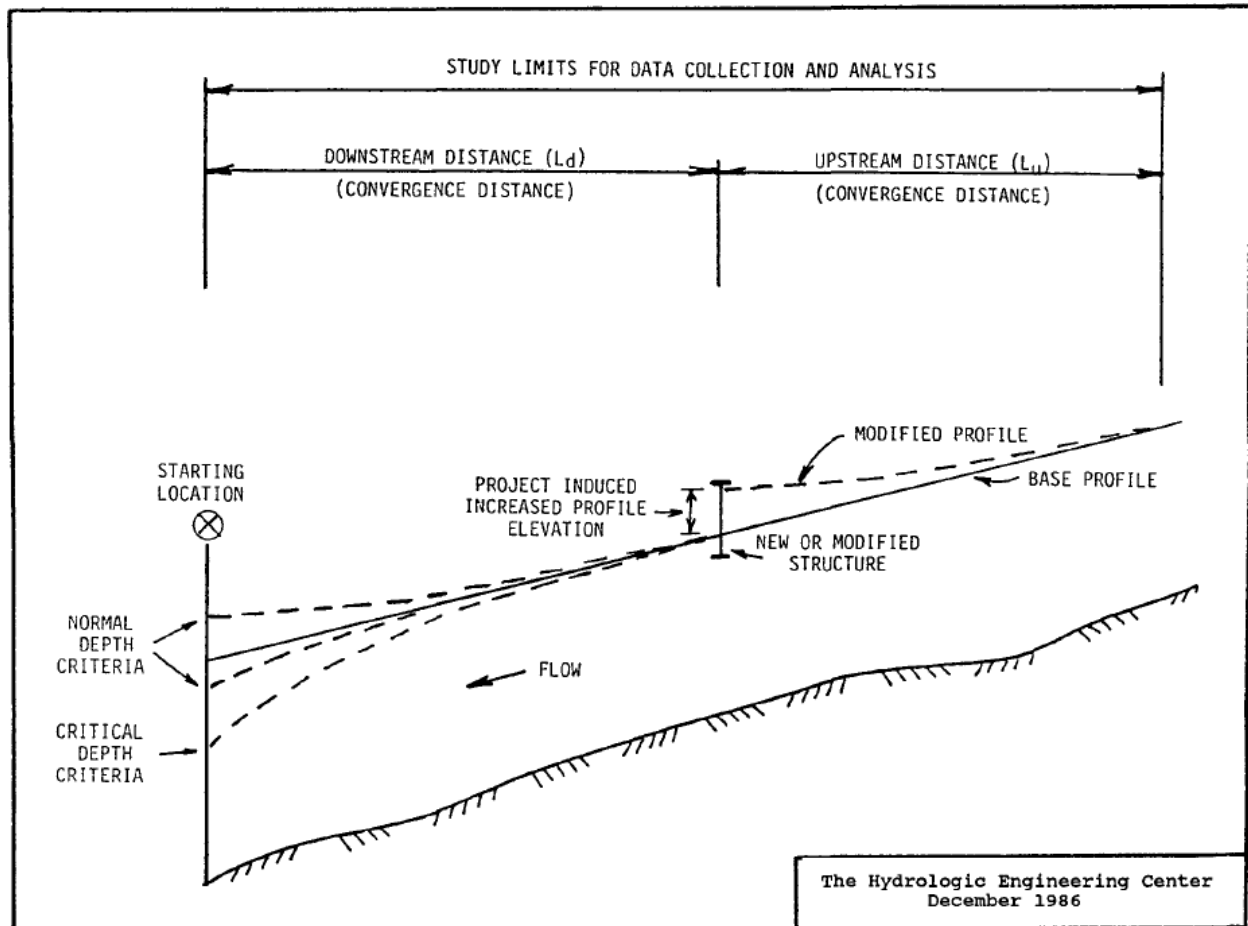

Figure 5.2-3: Open Channel Depth Profiles

Downstream

Open channel hydraulics programs must have a starting water surface elevation specified by the user at the downstream boundary of the model.

The programs allow for one or more of the following methods of specifying the starting water surface elevation:

- Enter a water surface elevation at the downstream boundary.
- Enter a slope at the downstream boundary, which is used to calculate the normal depth from Manning's Equation.
- Assume critical depth at the downstream boundary.

The modeler must decide which method to use, and the decision will affect the distance to the downstream boundary of the model.

For the storm frequency being modeled, if a point of known water surface elevation is within a reasonable distance downstream, extend the model to that point. Refer to the section below on convergence for guidance on determining if the point is within a reasonable distance.

Gages are points with a known relationship between the discharge and the water surface elevation. Lakes and sea level also can be points of known elevation. Other locations where you can calculate the water surface elevation from the discharge can include weirs, dams, and culverts if these locations are not significantly influenced by their tailwater.

When the downstream channel and overbank are nearly uniform, use the normal depth assumption to determine the starting water surface elevation, both in cross section and slope, for a long reach downstream. The length of uniform channel that will be adequate will vary with the slope and properties of the channel. This reach should not be subject to significant backwater from farther downstream. The following equation can be used to determine how far downstream data collection and analysis needs to be performed.

$$Ldn = 8,000 * HD^{0.8}/S$$

where:

Ldn = Downstream study length (along main channel), in feet for normal depth starting conditions

HD = Average reach hydraulic depth (1-percent chance flow area divided by cross section top width), in feet

S = Average reach slope, in feet per mile

Make some sound engineering judgment when determining the variables HD, S, and HL. Guidelines are presented below:

- a. **Average reach hydraulic depth (HD):** If limited existing data are available, an estimate can be made using FEMA maps and quadrangle maps. Using the FEMA map, outline on the Quadrangle Map the boundary of the 1-percent chance flow. Select a representative location and plot a cross section using the Quadrangle Map. Plotting several cross sections may improve the estimate. The area (A), top width (TW), and, thus, the hydraulic depth (A/TW) for these cross sections are now determined. Average these hydraulic depths to determine an average reach hydraulic depth. Use survey data or other existing geometric data that are more accurate than the Quadrangle Maps if available.
- b. **Average reach slope (S):** Using the Quadrangle Maps, determine and average the slope of the main channel, left overbank, and right overbank.
- c. **Head loss (HL):** This term also is known as the "backwater." Backwater is defined as the difference in the water surface elevation between the constricted (bridge)

flow condition and the unconfined (no bridge) flow condition at a point of interest upstream of the structure crossing. Make an educated guess at the anticipated head loss. For a new bridge, the allowable head loss would be a reasonable estimate. In most cases, a maximum head loss of one foot would be expected for Florida.

Lateral Extents

Extend the model laterally on both sides of the floodplain to an elevation that is above the highest water surface elevation that will be modeled. Often, this water surface elevation will be unknown until the model is complete. But you must collect data to complete the model. So, you must estimate the water surface elevation and lateral extent for the data-gathering effort. You can estimate the elevation or the lateral extent from FEMA maps and other historical studies of the site. In some cases, it is appropriate to set up a preliminary model based on limited data to estimate the water surface elevations. Whichever method you use to estimate the lateral extent of the model, consider making a conservative estimate to avoid additional data gathering at a later time, especially survey data.

5.2.4.2 Roughness Coefficient Selection

You can use a number of references to select Manning's Roughness Coefficient within the main channel and overbank areas of riverine waterways. Two recommended references are:

1. *Guide for Selecting Manning's Roughness Coefficients for Natural Channels and Flood Plains*, USGS Water-Supply Paper 2339 (replaces Report Number FHWA-TS-84-204), which can be accessed at the following link: <http://www.fhwa.dot.gov/bridge/wsp2339.pdf>
2. *Estimating Manning's Roughness Coefficients for Natural and Man-Made Streams in Illinois*, USGS and Illinois Department of Natural Resources. <http://il.water.usgs.gov/proj/nvalues/>

Roughness values from previous models or studies can be useful. However, you should verify these roughness values because conditions may have changed.

Roughness values can be varied within reasonable limits representative of the physical conditions of the site to calibrate the hydraulic model.

5.2.4.3 Model Geometry

Model selection is discussed in Section 5.2.3. This section discusses the creation of one- and two-dimensional models.

One-Dimensional Models

One-dimensional models use cross sections to define the geometry of the channel and floodplain. There are several good references available for use as guidelines to locate and subdivide the cross sections. One good source is *Computation of Water-Surface Profiles in Open Channels*, by Jacob Davidian: USGS—Techniques of Water-Resources Investigations Reports, Book 3, Chapter A15, 1984. This publication can be downloaded from: http://pubs.usgs.gov/twri/twri3-a15/pdf/twri_3-A15_b.pdf.

Some of the guidelines presented below are from this reference.

- a. Take cross sections where there is an appreciable change in slope.
- b. Take cross sections where there is an appreciable change in cross sectional area (i.e., minimum and maximum flow areas).
- c. Space cross sections around abrupt changes in roughness to properly average the friction loss between the sections. One method is to evenly space cross sections on either side of the abrupt change. Refer to the spacing between XSEC1 and XSEC2 and between XSEC3 and XSEC4 in Figure 5.2-4 as an example. Another method is to locate a section at the abrupt change. Include the cross section twice, separated by a short flow length (maybe 0.1 foot), and using the two different roughness values as appropriate.

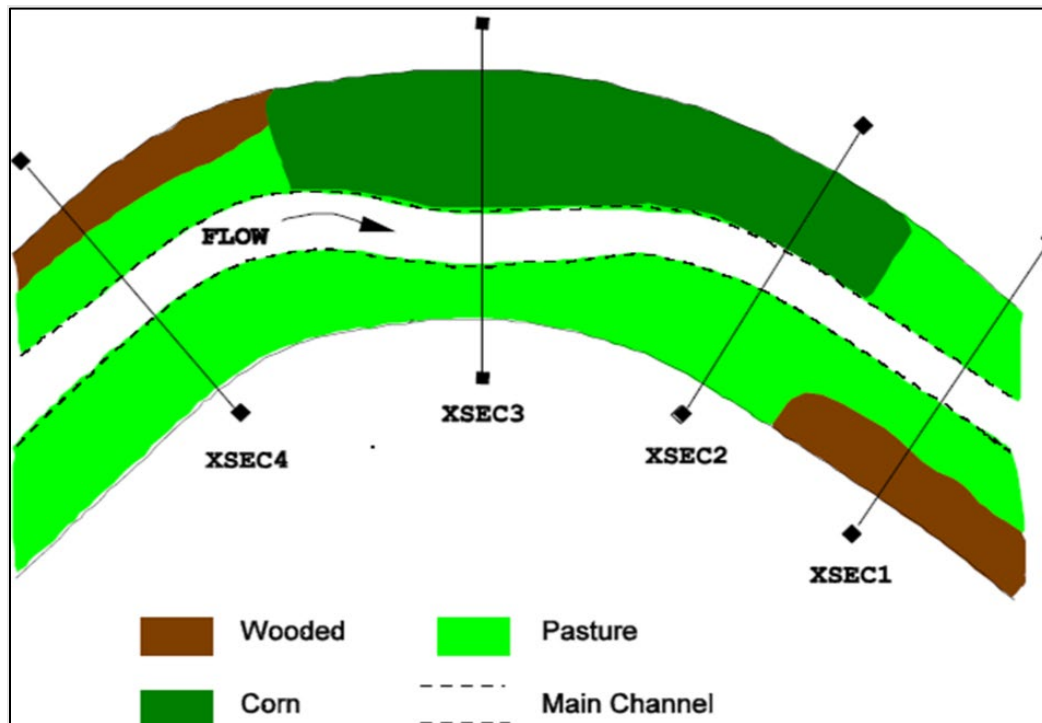

Figure 5.2-4: Example Cross Section Spacing

- d. Take cross sections normal to the flood flow lines. In some cases, you may need to “dog leg” cross sections. Figure 5.2-5 illustrates this procedure.
- e. Place cross sections at closer intervals in reaches where the conveyance changes greatly as a result of changes in width, depth, or roughness. The relation between upstream conveyance, K_1 , and downstream conveyance, K_2 , should satisfy the criterion: $0.7 < (K_1/K_2) < 1.4$.
- f. Avoid areas with dead flow, eddies, or flow reversals.
- g. Extend cross section ends higher than the expected water surface elevation of the largest flood that is to be considered in the sub-reach.
- h. Place cross sections between sections that change radically in shape, even if the two areas and the two conveyances are nearly the same.
- i. Place cross sections at shorter intervals in reaches where the lateral distribution of conveyance in a cross section changes radically from one end of the reach to the other, even though the total areas, total conveyance, and cross sectional shape do not change drastically. Increasing the number of subdivisions generally will increase the value of alpha, and, therefore, increase the velocity head. Spacing the cross sections closer together will help prevent drastic changes in the velocity head.

- j. Locate cross sections at or near control sections.
- k. Locate cross sections at tributaries that contribute significantly to the main stem. The cross sections should be placed such that the tributary enters the main stem in the middle of the sub-reach.

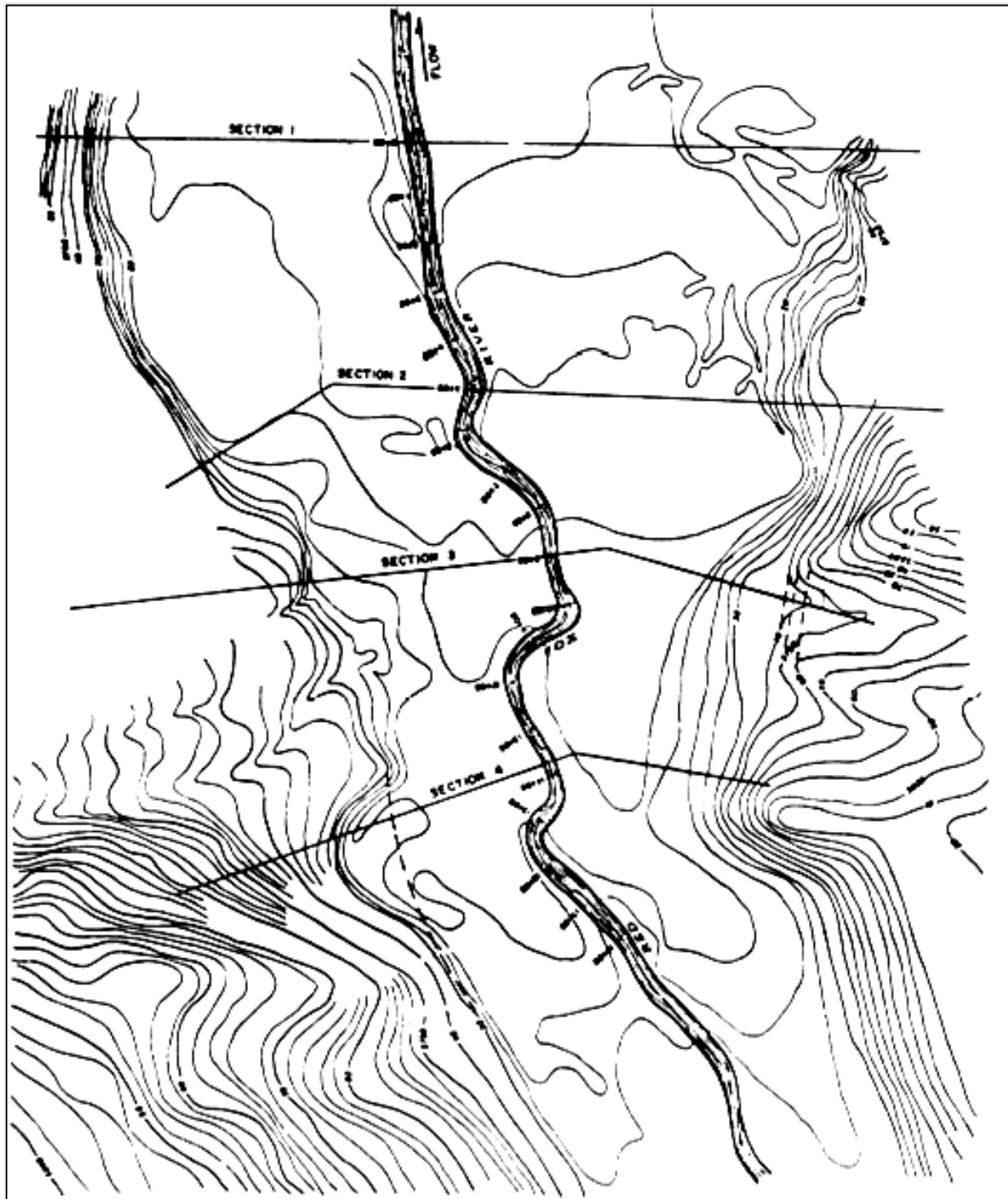

Figure 5.2-5: “Dog Legging” Cross Section

Subdivisions of cross sections should be done primarily for major breaks in cross-sectional geometry. Major changes in the roughness coefficient also may call for more subdivisions.

Figures 5.2-6 and 5.2-7 show guidelines on when to subdivide.

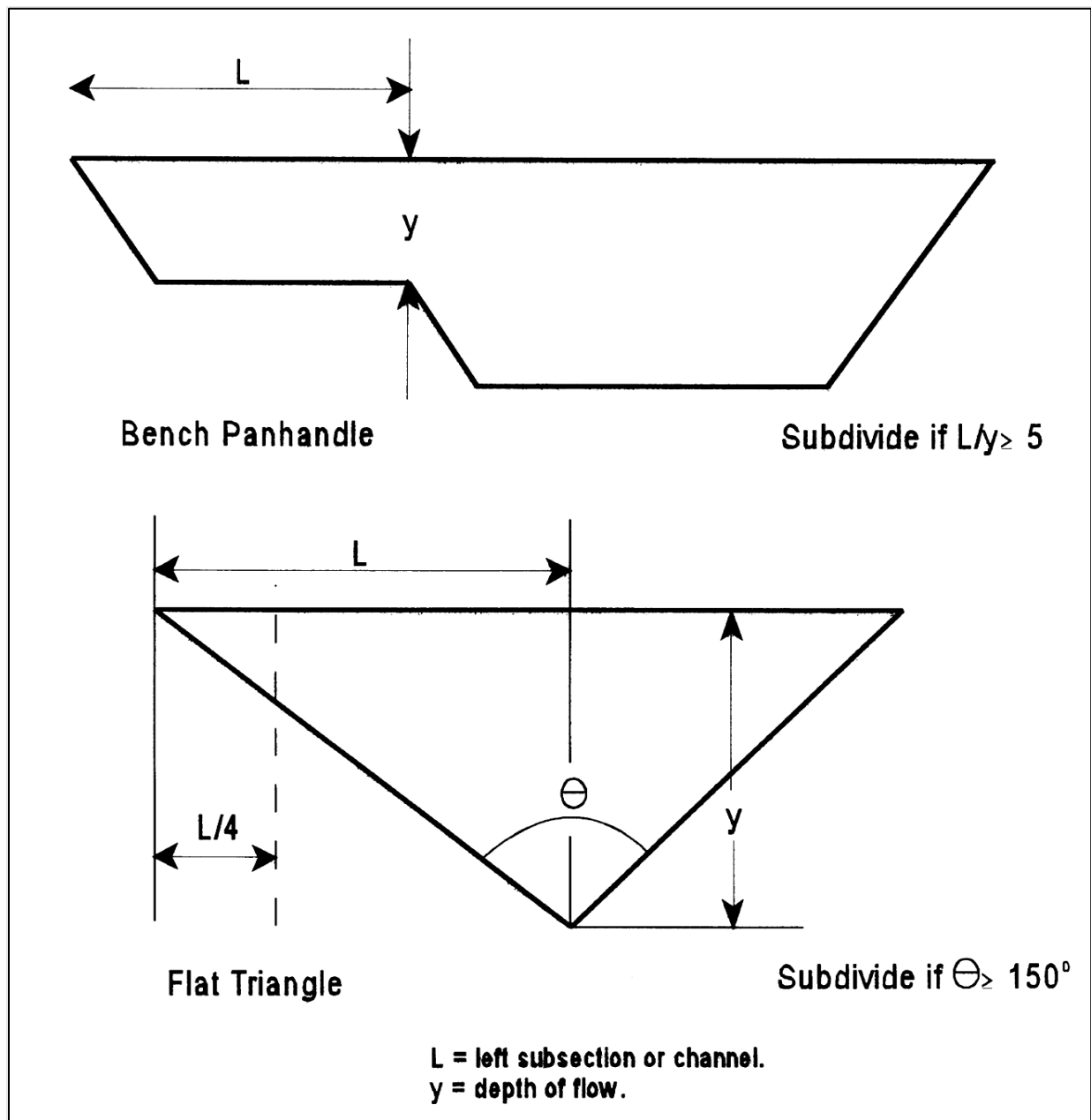

Figure 5.2-6: Subdivision Criteria of Tice (written communication, 1973)

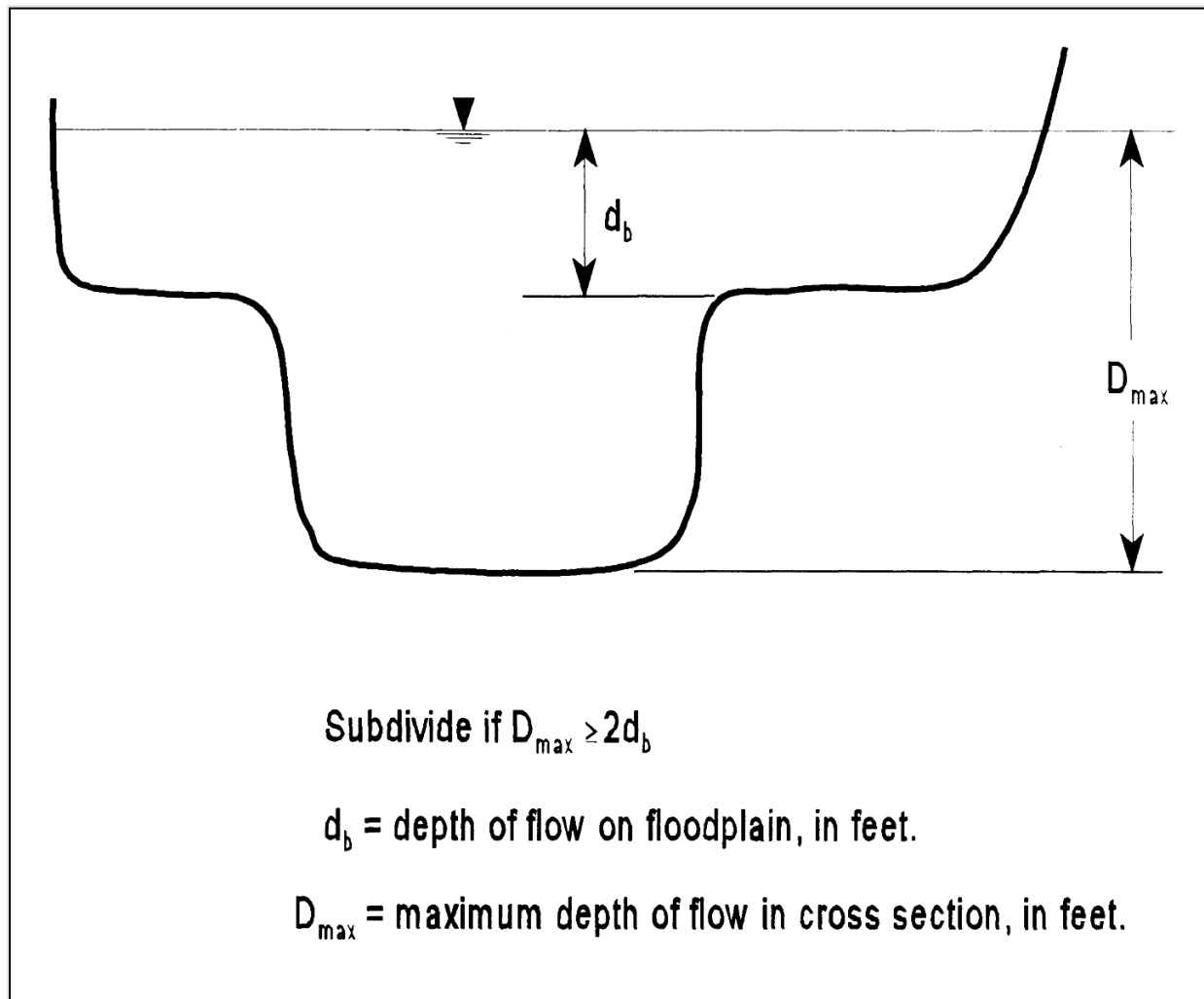

Figure 5.2-7: Subdivision Criteria of Tice (written communication, 1973)

(A) Conveyance

Conveyance is a measure of the ability of a channel to transport flow. In streams of irregular cross section, it is necessary to divide the water area into smaller but more or less regular subsections, assigning an appropriate roughness coefficient to each, and computing the discharge for each subsection separately. By rearranging the Manning's Equation, the following relationship is derived:

$$k = \frac{q}{S^{1/2}} = \frac{1.49}{n} a r^{2/3}$$

where:

- k = Channel subsection conveyance
 q = Subsection discharge, in cubic feet per second
 S = Channel bottom slope, in feet/feet
 n = Manning's roughness coefficient
 a = Subsection cross-sectional area, in square feet
 r = Subsection hydraulic radius, in feet

Conveyance can, therefore, be expressed either in terms of flow factors or strictly geometric factors. In bridge waterway computations, conveyance is used as a means of approximating the distribution of flow in the natural river upstream from a bridge. Total conveyance (K) is the summation of the individual conveyances comprising the particular section. Example 5.2-1 illustrates a conveyance computation of a subdivided cross section.

Example 5.2-1—Computing Conveyance

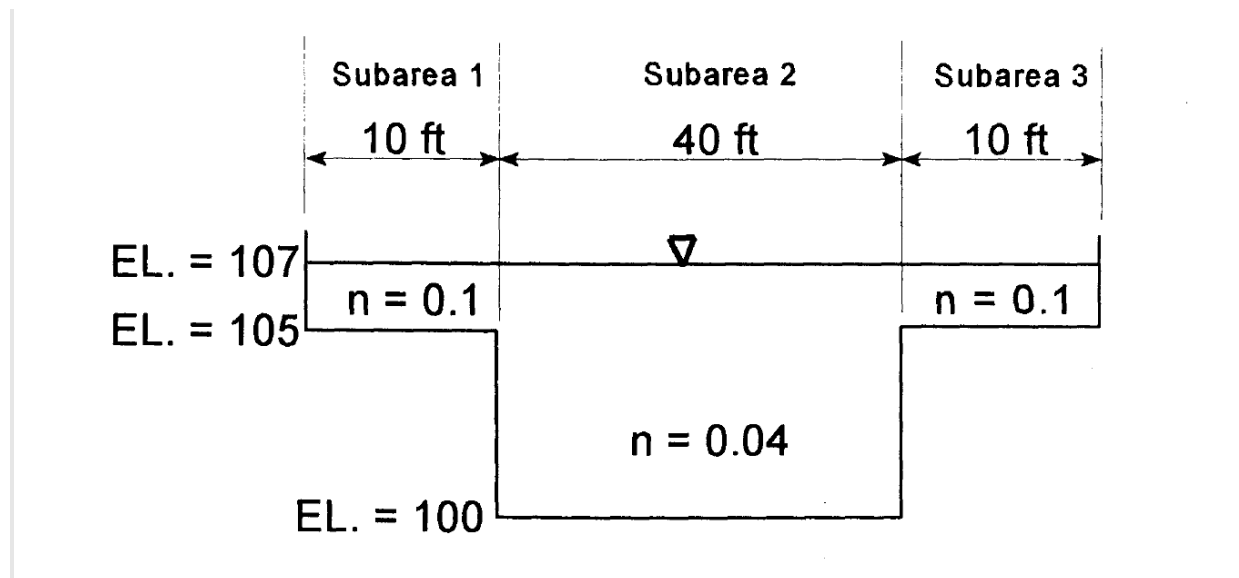

- a. Compute the conveyance for the cross section shown above.

Solution:

- Step 1: Compute the area, hydraulic radius, and conveyance for each of the subareas:

Subarea 1:

$$\begin{aligned}a_1 &= 10 \text{ ft.} \cdot 2 \text{ ft.} = 20 \text{ ft}^2 \\wp_1 &= 10 \text{ ft.} + 2 \text{ ft.} = 12 \text{ ft.} \\r_1 &= a_1/wp_1 = 20 \text{ ft}^2/12 \text{ ft.} = 1.67 \text{ ft.}\end{aligned}$$

$$k_1 = \frac{1.49}{n_1} a_1 r_1^{2/3} = \frac{1.49}{0.1} (20 \text{ ft.}^2) (1.67 \text{ ft.})^{2/3} = 419.5$$

Subarea 2:

$$\begin{aligned}a_2 &= 40 \text{ ft.} \cdot 7 \text{ ft.} = 280 \text{ ft}^2 \\wp_2 &= 40 \text{ ft.} + 5 \text{ ft.} + 5 \text{ ft.} = 50 \text{ ft.} \\r_2 &= a_2/wp_2 = 280 \text{ ft}^2/50 \text{ ft.} = 5.60 \text{ ft.}\end{aligned}$$

$$k_2 = \frac{1.49}{n_2} a_2 r_2^{2/3} = \frac{1.49}{0.04} (280 \text{ ft.}^2) (5.60 \text{ ft.})^{2/3} = 32890.9$$

Subarea 3:

$$\begin{aligned}a_3 &= 10 \text{ ft.} \cdot 2 \text{ ft.} = 20 \text{ ft}^2 \\wp_3 &= 10 \text{ ft.} + 2 \text{ ft.} = 12 \text{ ft.} \\r_3 &= a_3/wp_3 = 20 \text{ ft}^2/12 \text{ ft.} = 1.67 \text{ ft.}\end{aligned}$$

$$k_3 = \frac{1.49}{n_3} a_3 r_3^{2/3} = \frac{1.49}{0.1} (20 \text{ ft.}^2) (1.67 \text{ ft.})^{2/3} = 419.5$$

$$\begin{aligned}\text{Total Conveyance } (K_{\text{total}}) &= k_1 + k_2 + k_3 \\&= 419.5 + 32,890.9 + 419.5 \\&= \underline{\underline{33,729.9}}\end{aligned}$$

- b. Assuming the total discharge for the water surface elevation of 107.0 feet in part (a) is 4,000 cubic feet per second, determine the discharge distribution for each subarea.

Solution:

Subarea 1:

$$Q_1 = \frac{k_1}{k_{total}} * Q_{total} = \left(\frac{419.5}{33729.9} \right) * 4000 \text{ ft}^3 / \text{s} = 49.8 \text{ ft}^3 / \text{s}$$

Subarea 2:

$$Q_2 = \frac{k_2}{k_{total}} * Q_{total} = \left(\frac{32890.9}{33729.9} \right) * 4000 \text{ ft}^3 / \text{s} = 3900.5 \text{ ft}^3 / \text{s}$$

Subarea 3:

$$Q_3 = \frac{k_3}{k_{total}} * Q_{total} = \left(\frac{419.5}{33729.9} \right) * 4000 \text{ ft}^3 / \text{s} = 49.8 \text{ ft}^3 / \text{s}$$

(B) Velocity Head

The velocity head represents the kinetic energy of the fluid per unit volume and is computed by:

$$h_v = \frac{\alpha Q^2}{2g A^2}$$

where:

- Q = Discharge at the section, in cubic feet per second
- h_v = Velocity head, in feet
- α = Kinetic correction factor for nonuniform velocity distribution
- A = Total cross sectional flow area, in square feet

As the velocity distribution in a river varies from a maximum at the deeper portion of the channel to essentially zero along banks, the average velocity head, computed as $(Q/A)^2/2g$, does not give a true measure of the kinetic energy of the flow. You can obtain a weighted average value of the kinetic energy by multiplying the average velocity head above by a kinetic energy coefficient (α_1) defined as:

$$\alpha_1 = \frac{\sum (qv^2)}{Qv_1^2}$$

where:

- α_1 = Kinetic energy coefficient, before the bridge
- q = Discharge in a subsection, in cubic feet per second
- v = Average velocity in same subsection, in feet per second
- Q = Total river discharge, in cubic feet per second
- v_1 = Average velocity in river at Section 1, or Q/A_1 , in feet per second

Typical values of velocity coefficient, α , are shown in Table 5.2-1:

Table 5.2-1: Typical Values of Velocity Coefficient

| Channel Types | Value of α | | |
|---|-------------------|------|------|
| | Min. | Avg. | Max. |
| Regular Channels, Flumes, and Spillways | 1.1 | 1.15 | 1.2 |
| Natural Streams | 1.15 | 1.30 | 1.5 |
| River Valleys, Overflooded | 1.5 | 1.75 | 2.0 |

Source: Chow, V.T., 1959, *Open-Channel Hydraulics*: New York, McGraw-Hill.

Additional guidelines on velocity coefficients can be found in the *Techniques of Water-Resource Investigations* (TWRI) Reports of the United States Geological Survey.

In general, the more subdivisions in a cross section, the higher the alpha (α) value.

The energy equation for flow along a channel includes a term for the kinetic energy or velocity head, $V^2/2g$. Use the average velocity, V , for the entire cross section in the equation. In reality the velocity is not a constant value. It is highest in the middle of the channel near the water surface and lowest at the edges of the channel near the channel bottom. Using the average velocity in the equation means that the sum of the differing velocities in the cross section is being squared, $(v_1 + v_2 + \dots + v_n)^2$. However, to correctly determine the kinetic energy, you should first square the differing velocities and then sum them, $v_1^2 + v_2^2 + \dots + v_n^2$. Since the sum of the squares is greater than the square of the sum, you will need to use the kinetic energy correction factor. This factor usually is represented by the Greek letter alpha in the energy equation, and is, therefore, referred to as alpha for short.

Alpha values are calculated and reported for each cross section in both HEC-RAS and WSPRO. However, neither program provides warnings when alpha values are out of

range. Incorrect alpha values can cause significant errors. Check the alpha values to be sure they are appropriate.

Alpha values typically should stay in the ranges shown in Table 5.2-1. In general, the more subdivisions in a cross section, the larger alpha will become. Alpha values greater than 3 should be checked. If adjacent cross sections have comparable values, or if the changes are not sudden between cross sections, such values can be accepted. But if the change is sudden, some attempt should be made to obtain uniformity. Consider the following:

- a. Resubdivide the cross section(s).
- b. Place additional cross sections to provide a smoother transition of the alpha values from one cross section to the next. Note that if the bridge routine in WSPRO is used, additional cross sections cannot be placed between the exit and approach sections.

Additional guidance is provided in the *Techniques of Water-Resource Investigations* (TWRI) Reports.

The following examples illustrate the importance of proper subdivision, as well as the effects of improper subdivision.

Example 5.2-2—Effects of Subdivision on a Panhandle Section

In Figure 5.2-8, the section given has a constant n value for the entire cross section. The four calculations shown represent four methods of calculating total flow (conveyance), depending on how the cross section is subdivided.

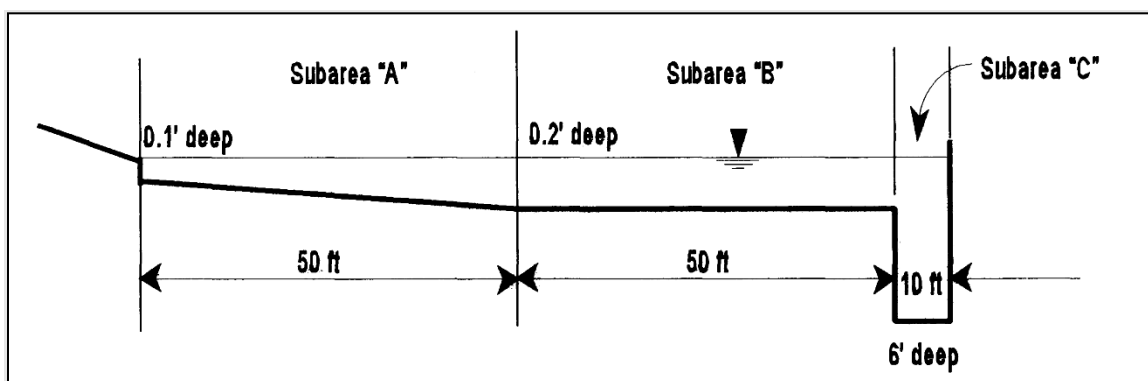

Figure 5.2-8: Effects of Subdivision on a Panhandle Section

Given:

$$K = 1.49/n (AR^{2/3})$$

n is constant over cross section

Factor out 1.49 and compare $AR^{2/3} = K$ feet

Note: K feet varies as to the number of sections selected as a function of R, or more specifically Wp.

Method 1: Consider K_1 feet as one section encompassing subareas “A,” “B,” and “C.”

$$K_1' = AR^{2/3}; K_1' = [(6 \times 10) + (50 \times 0.2) + (50 \times 0.15)] \left[\frac{(6 \times 10) + (50 \times 0.2) + (50 \times 0.15)}{(0.1 + 50 + 50 + 5.8 + 10 + 6)} \right]^{2/3} = \underline{57.3}$$

Method 2: Consider K_2 feet as two sections, “A” and “B” combined and “C.”

$$K_2' = [(6 \times 10)(60/21.8)^{2/3}] + [(50 \times 0.2) + (50 \times 0.15)] \left[\frac{(50 \times 0.2) + (50 \times 0.15)}{100.1} \right]^{2/3} = 117.8 + 5.5 = \underline{123.3}$$

Method 3: Consider K_3 feet as section “C” and ignore sections “A” and “B.”

$$K_3' = (6 \times 10) \left(\frac{60}{5.8 + 10 + 6} \right)^{2/3} = \underline{117.8}$$

Method 4: Consider K_4 feet with “A,” “B,” and “C” treated as independent sections.

$$K_4' = [(6 \times 10)(60/21.8)^{2/3}] + [(50 \times 0.2)(10/50)^{2/3}] + [(50 \times 0.15)(7.5/50.1)^{2/3}]$$

$$K_4' = 117.8 + 3.4 + 2.1 = \underline{123.3}$$

Method 1 is incorrect. The problem is the method neglects the impact the hydraulic radii of the shallow areas have on the overall flow calculation. This can be seen by looking at method 3, which shows conveyance in just the main channel as being greater. Two reasons why method 1 is incorrect are:

1. The total conveyance must be the sum of the conveyance of a channel's subsections.

2. Combining significantly different geometric sections of a cross section to simplify a calculation is a misuse of the conveyance equation and will yield an incorrect answer.

Method 2 is correct. It combines subareas of the channel cross section that have similar hydraulic properties to yield a reasonable answer of total conveyance. If n values between section “A” and “B” were significantly different, combining them to determine conveyance might not provide the desired accuracy.

Method 3 is incorrect but exemplifies how easily you can underestimate total conveyance by not considering the conveyance from the other subareas. Obviously, the total conveyance cannot be less than that contained in one section.

Method 4 is correct. This may be considered overkill, but technically it is the most accurate solution. If n values were significantly different between section “A” and “B,” this type of subdivision for determining conveyance would be essential.

Example 5.2-3 Effects of Subdivision on a Trapezoidal Section

In Figure 5.2-9, a trapezoidal cross section having heavy brush and trees on the banks has been subdivided near the bottom of each bank because of the abrupt change of roughness there. A large percentage of the wetted perimeters (P) of the triangular subareas (A_1 and A_3) and of the main channel (A_2) have been eliminated. A smaller wetted perimeter abnormally increases the hydraulic radius ($R = A/P$), and this, in turn, results in a computed conveyance different from the conveyance determined for a section with a complete wetted perimeter. In Figure 5.2-9, the total conveyance (K_T) has been computed to be 102,000 for the cross section. This would require a composite n value of 0.034. This is less than the n values of 0.035 and 0.10 that describe the trapezoidal shape. The basic shape should be left unsubdivided, and an effective value of n somewhat higher than 0.035 should be assigned to this cross section, to account for the additional drag imposed by the larger roughness on the banks.

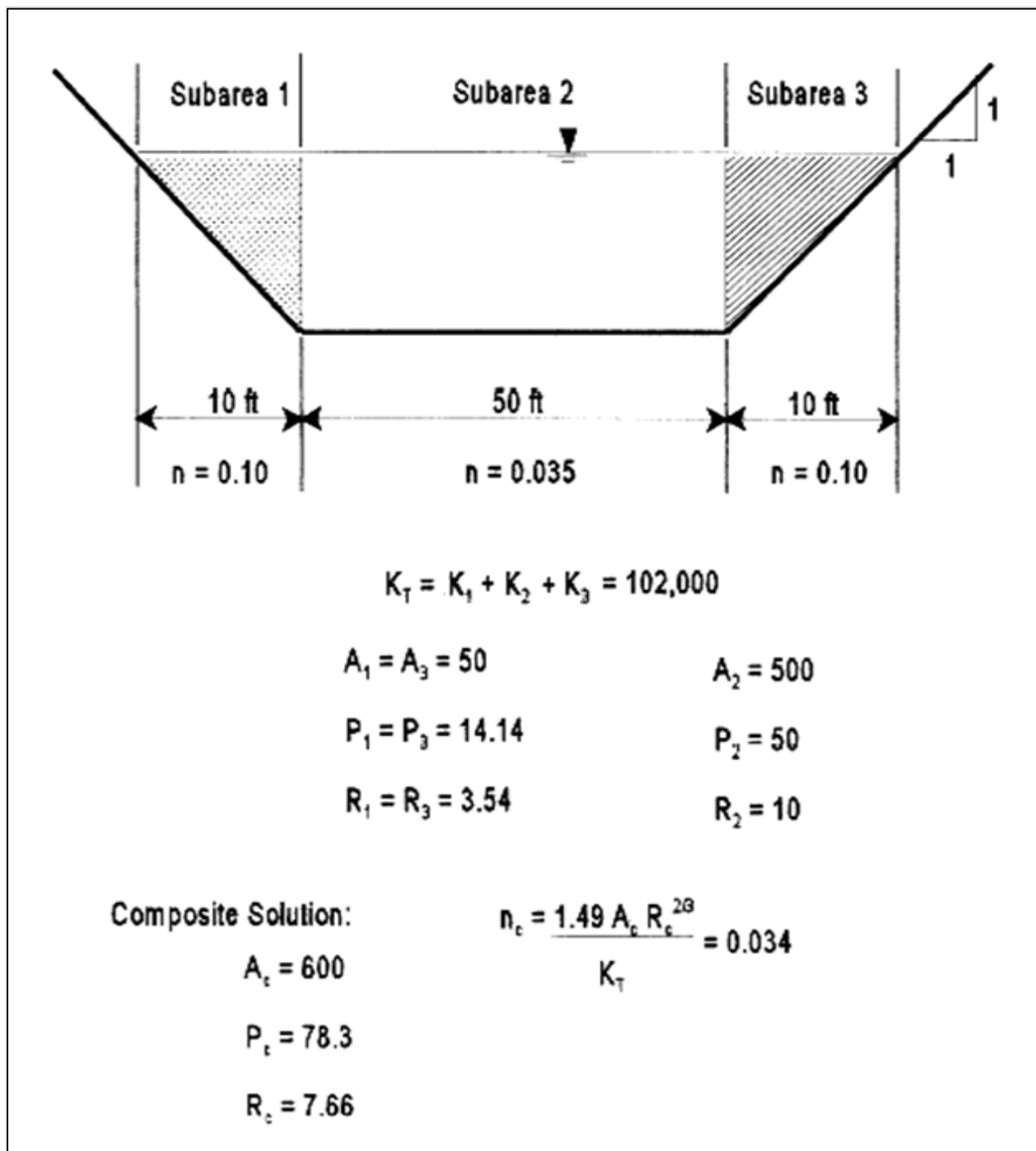

Figure 5.2-9: Effects of Subdivision on a Trapezoidal Section

(C) Friction Losses

Compute the friction loss as follows:

$$h_f = L S_f$$

where:

L = Flow length, in feet

S_f = Average friction slope, in feet/foot

You can calculate the average friction slope using either the geometric mean slope method, the average conveyance method, the average friction slope method, or the harmonic mean friction slope method. WSPRO uses the geometric mean slope method as the default option. The geometric mean slope is computed as:

$$S_f = \frac{[0.5(Q_1 + Q_2)]^2}{K_1 K_2}$$

where:

S_f = Average friction slope, in feet/foot

Q₁ = Discharge at Section 1, in cubic feet per second

Q₂ = Discharge at Section 2, in cubic feet per second

K₁ = Conveyance at Section 1

K₂ = Conveyance at Section 2

(D) Expansion/Contraction Losses**Expansion Losses**

Compute the expansion loss as follows:

$$h_e = k_e (h_{v2} - h_{v1})$$

where:

k_e = Expansion loss coefficient

h_{v1} = Velocity Head in Section 1, in feet

h_{v2} = Velocity Head in Section 2, in feet

The expansion loss coefficient varies from 0.0 to 1.0 from ideal transitions to abrupt transitions. HEC-RAS uses an expansion value of 0.3 as its default. WSPRO uses an expansion value of 0.5 as its default. Brater and King's *Handbook of Hydraulics* provides additional guidance for selection of expansion coefficients.

Contraction Losses

Compute the contraction loss as follows:

$$h_c = k_c (h_{v2} - h_{v1})$$

where:

k_c = Contraction loss coefficient

h_{v1} = Velocity Head in Section 1, in feet

h_{v2} = Velocity Head in Section 2, in feet

The contraction loss coefficient varies from 0.0 to 0.5 from ideal transitions to abrupt transitions. HEC-RAS uses a contraction value of 0.1 as its default. WSPRO uses a contraction value of 0.0 as its default. Brater and King's *Handbook of Hydraulics* provides additional guidance for selection of contraction coefficients.

(E) Step Backwater Computations

HEC-RAS and WSPRO computational procedure employs the Standard Step Method for profile computations. The procedure used is similar to that described by Chow. The standard step method is based on the principle of conservation of energy, i.e., the total energy head at an upstream section must equal the total energy head at the downstream section plus any energy losses that occur between the two sections.

Energy Equation

Write the energy equation between two adjacent cross sections as follows:

$$h_1 + h_{v1} = h_2 + h_{v2} + h_f + h_e + h_c$$

where:

h_1 = Water surface elevation in Section 1, in feet

h_{v1} = Velocity head in Section 1, in feet

h_2 = Water surface elevation in Section 2, in feet

h_{v2} = Velocity head in Section 2, in feet

h_f = Friction loss between Sections 1 and 2, in feet

h_e = Expansion loss between Sections 1 and 2, in feet

h_c = Contraction loss between Sections 1 and 2, in feet

It is not possible to find a direct solution of the above equation when either h_1 or h_2 is unknown, since the associated velocity head and the energy loss terms also are then unknown. Therefore, an iterative procedure must be used to determine the unknown elevation. The WSPRO model computes the difference in total energy between two sections, H , as:

$$\Delta H = (h_1 + h_{v1}) - (h_2 + h_{v2} + h_f + h_e + h_c)$$

Use successive estimates of unknown elevations to compute the unknown velocity head and the energy loss terms until the equation yields an absolute value of ΔH that is within an acceptable tolerance. Generally, a tolerance between 0.01 and 0.05 is sufficient to obtain satisfactory results. Slightly higher results may be satisfactory for some higher-velocity situations. However, if a tolerance value exceeding 0.1 is required to obtain a satisfactory solution, then there would be reason to suspect data inadequacies (example: insufficient cross sections).

Computational Procedure

Given: Discharge Q and WSE at one cross section and the fact that the flow is subcritical. We want to compute the WSE at the next upstream cross section.

- Step 1: Calculate all the geometric and hydraulic properties of the downstream most station using the known flows and WSE at that location.
- Step 2: Estimate water surface elevation at the next upstream station.
- Step 3: Calculate hydraulic properties that correspond to estimated water surface elevation.
- Step 4: Determine energy losses that correspond to estimated water surface elevation.
- Step 5: Calculate water surface elevation using energy equation and energy losses determined in Step 4.
- Step 6: Compare estimated and computed water surface elevations.
- Step 7: If the computed and estimated elevations do not agree within some predetermined limit of error, try another value and start the procedure again beginning with Step 2.

Example 5.2-4 illustrates a step backwater computation. Descriptions of conveyance, velocity head, friction loss computations, and expansion and contraction losses are provided after the example.

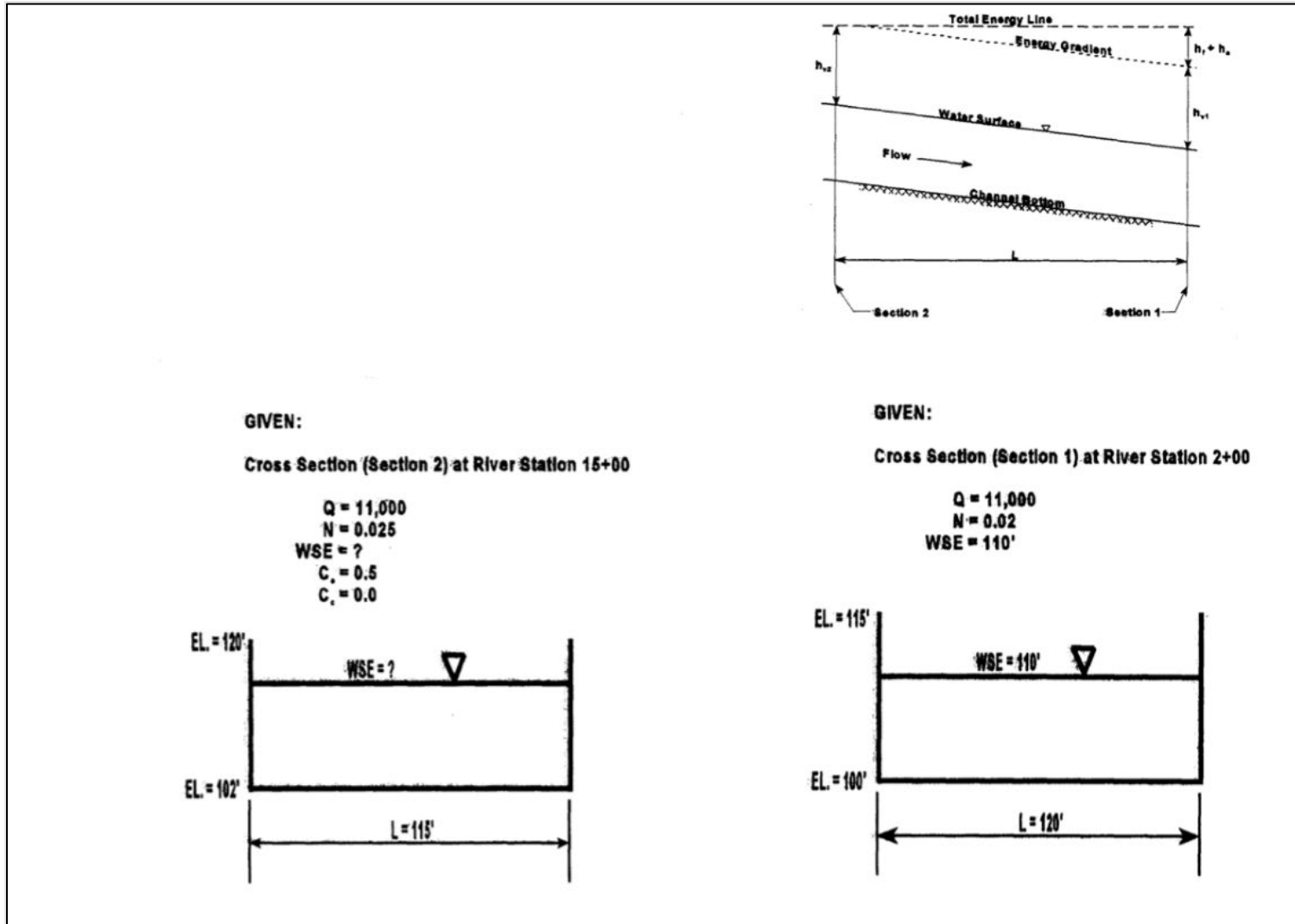

Example 5.2-4: Standard Step Backwater Computation

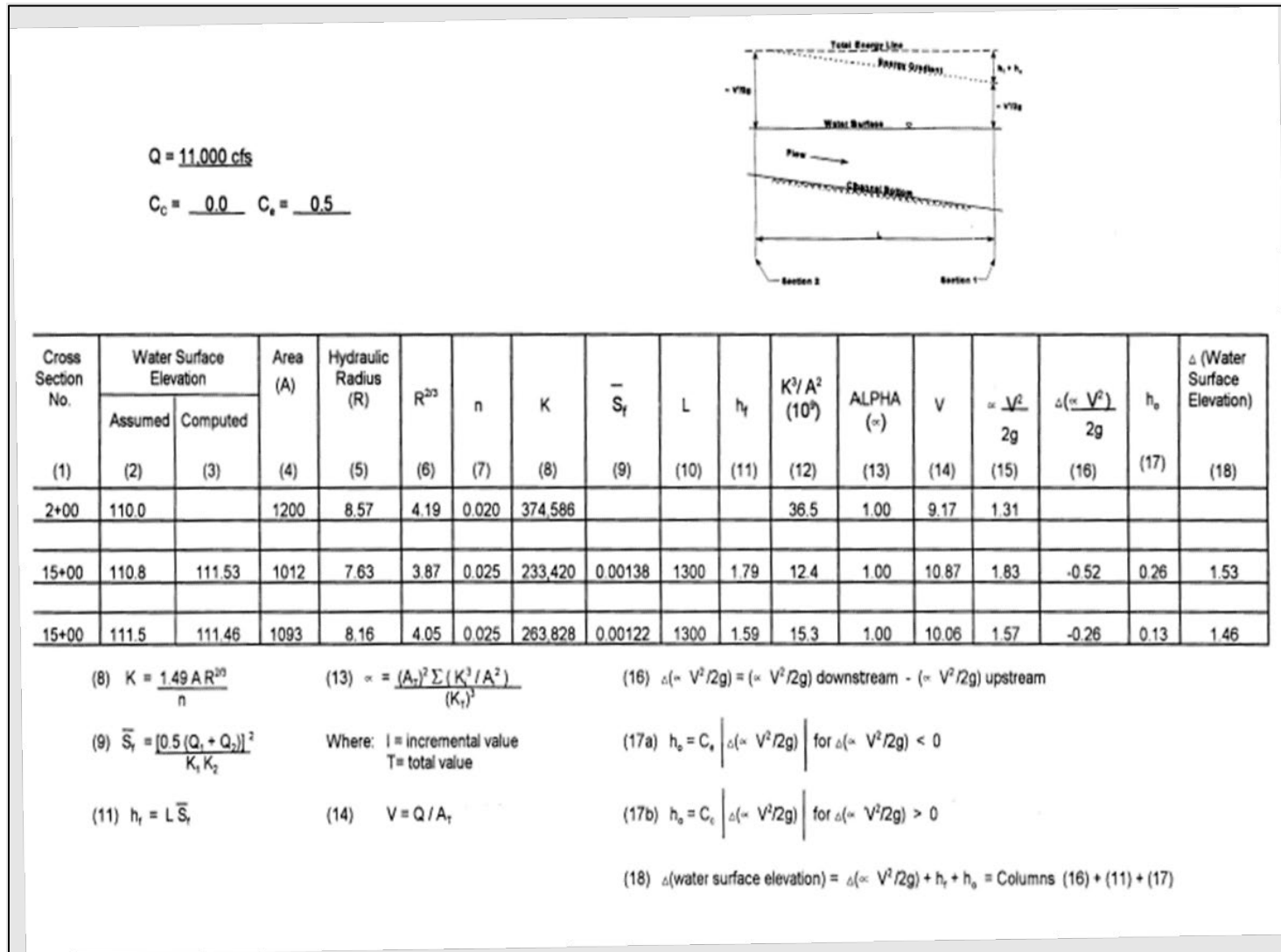

Example 5.2-4: Standard Step Backwater Computation (continued)

5.2.4.3.2 Two-Dimensional Models

Recommendations for developing model geometry for two-dimensional models will depend upon the model employed. Two-dimensional models employ either finite element or finite difference computation schemes. Finite difference models represent the model domain with a regular grid of ground elevations. Figure 5.2-10 displays examples of the different types of grids employed in finite difference modeling. Finite element methods represent the model domain with a network of triangular and quadrilateral elements that can vary widely in both size and orientation. Figure 5.2-11 and Figure 5.2-12 display examples of finite difference and finite element model meshes.

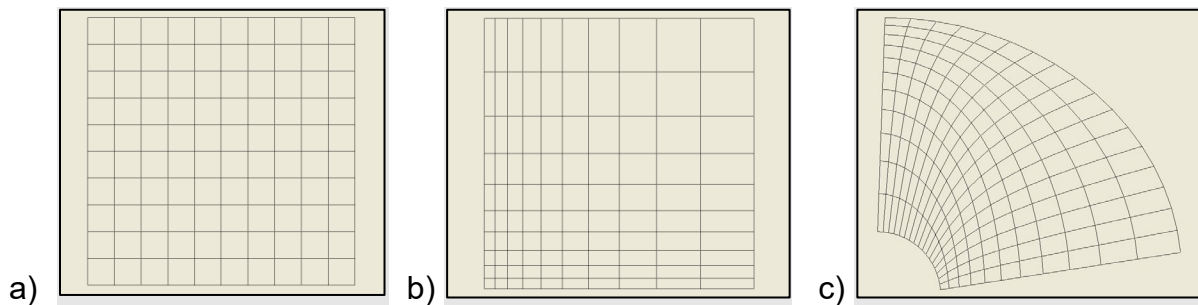

Figure 5.2-10: Example of (a) Cartesian, (b) Rectilinear, and (c) Curvilinear Grids

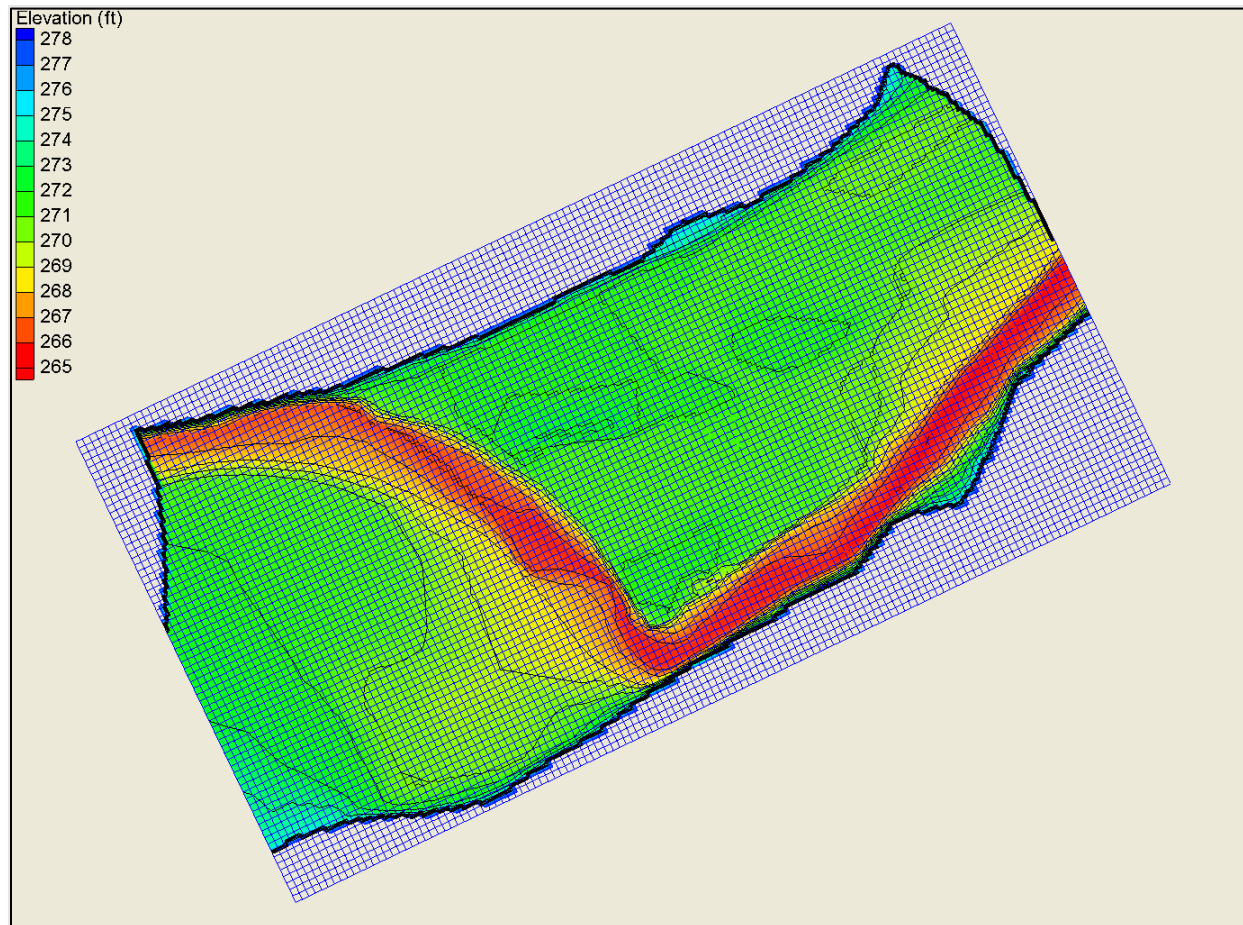

Figure 5.2-11: Example of a Finite Difference Model Mesh

After defining the model domain, the next step in the model geometry development is to specify element locations, sizes, and orientation. In other words, specify the resolution of the model. Finite element models typically will incorporate increased resolution at the project location, along bathymetric features that influence flow through the waterway (shoals, point bars, etc.), and around physical structures in the flow field (causeways, embankments, weirs, etc.) and less resolution with increased distance from the location of interest. Additionally, higher resolution often is incorporated in areas of rapidly changing bathymetry or topography. Examples include at channel banks, head cuts, drop structures, seawalls, and bridge abutments. This varying resolution allows for optimization of computation speed. An example of varying resolution is illustrated in Figure 5.2-12 with the increased resolution at the inlet and along the navigation channel and decreased resolution in the deeper areas offshore. Mesh generation typically takes place via a Graphical User Interface (GUI). One example is SMS (Surface Water Modeling System), available through Aquaveo, which provides a number of mesh generation and editing tools as well as pre- and post-processors for a wide variety of hydraulic and wave models. Model resolution oftentimes is one of the model parameters that is modified to achieve both model stability and model calibration.

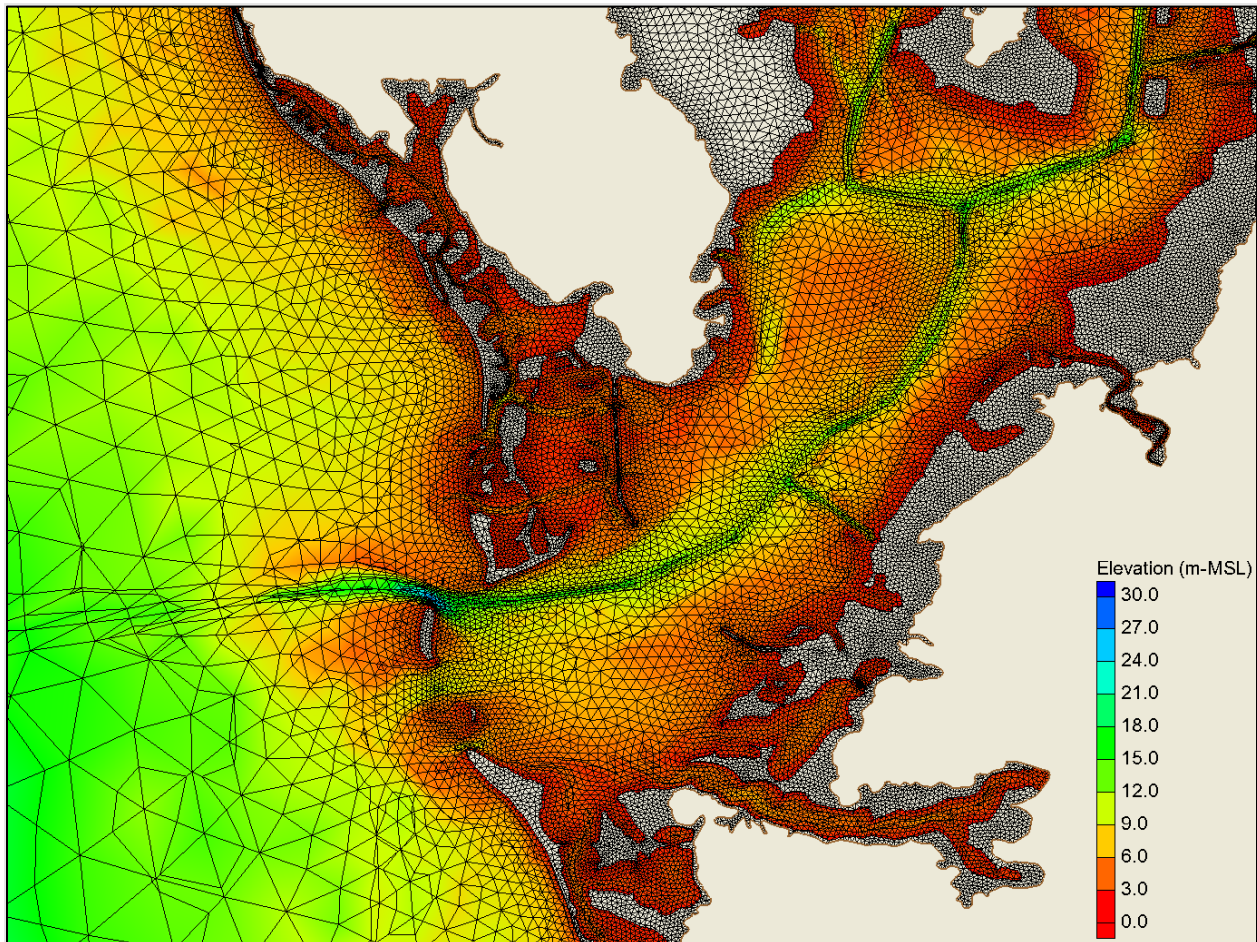

Figure 5.2-12: Example of a Finite Element Model Mesh

Resolution specification for finite difference models is more challenging than with finite element models. For models that can employ curvilinear or rectilinear grids, resolution can be increased in a few select locations. By nature of the grids, however, this resolution propagates in both ordinal directions from the area of interest through the remainder of the grid. For Cartesian grids, the resolution of a grid is uniform throughout the domain. Thus, the resolution at the bridge location will dictate the resolution for the remaining domain. For large domains requiring fine resolution at the bridge location, a common technique is to employ a nested grid scheme.

After specifying the model resolution, the final step in preparing the model geometry involves specifying the elevations at the model element nodes. Again, this is typically performed with automated mesh generation programs that interpolate a survey data set onto the prepared grid or mesh. This step can sometimes lead to interpolation errors depending upon the relative resolution of the survey data and the model grid/mesh as well as the quality of the TIN (triangular irregular network) representing the survey data.

Careful examination of how well the grid/mesh represents the elevations of the model domain is an important part of the model calibration process.

5.2.4.4 Boundary Conditions

Upstream Flow

For a riverine analysis, give the flow at the upstream boundary. For a steady-state analysis, specify the peak discharge for each frequency at the upstream boundary. For an unsteady flow analysis, specify a flow hydrograph at the upstream boundary.

Downstream Stage

Specify the stage at the downstream cross section. Known water surface elevations are the first choice. These can be lake levels, sea levels, or control sections such as a gage, studies (e.g., FEMA), or critical depth sections.

You can use normal depth in many cases when the stream channel is nearly uniform for a fairly long reach. You can use HEC-RAS or WSPRO to compute the normal depth by providing an energy slope equal to the channel slope. This method also is known as “slope conveyance.” Determine the channel slope using a USGS Quadrangle Map. Determine the slope below the last downstream cross section where contour lines cross the stream channel. You can use other estimates of energy slope; however, the resulting water surface elevation would not be “normal depth.”

When there is no gage information available and when normal depth flow (slope conveyance) cannot be assumed at the bridge site, you should use “convergence.”

Convergence

Water surface profiles will converge to a single profile if given enough distance to converge. The distance depends on the channel and overbank properties and the slope of the river. Estimate the distance as the downstream study length described in Section 5.2.4.1.

Determine convergence as follows:

- a. Make trial-and-error calculations assuming a range of water surface elevations. This assumed range of water surface elevations should bracket your best guess of the water surface elevation at the farthest downstream cross section. Typically, this is done using an estimate of the friction slope and calculating normal depth.
- b. Using the estimate of water surface elevation at the farthest downstream cross section, develop four water surface profiles for the design discharge based on a range of potential water surface elevations. Two of the bracketed elevations should represent the range between which the water surface should be, and the other two

should represent the range outside of which the water surface is unlikely to be. Refer to Figure 5.2-13.

- c. The computed profiles will converge toward the true profile. The profiles should converge within an acceptable tolerance by the first section of interest in the reach (see Figure 5.2-13). If the profiles do not adequately converge, then you should obtain additional geometric data downstream.

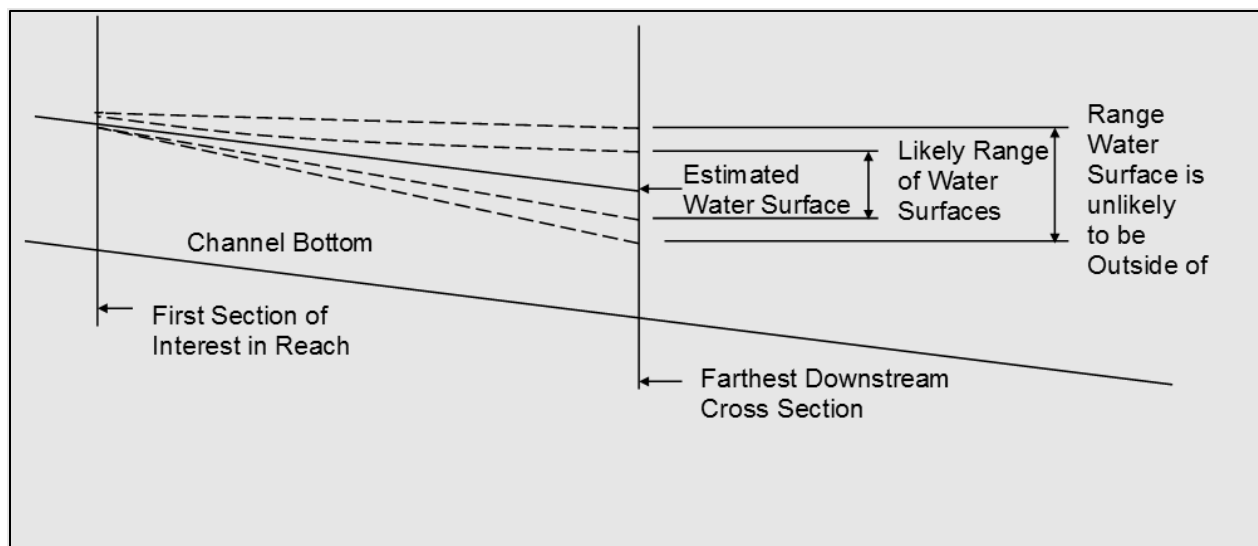

Figure 5.2-13: Convergence Profiles

5.2.4.5 Bridge Model

Flow Characteristics at Bridges

Figure 5.2-14 illustrates the manner in which flow contracts in passing through the channel constriction. The flow bounded by each adjacent pair of streamlines is the same (1,000 cubic feet per second). Note that the channel constriction appears to produce practically no alteration in the shape of the streamlines near the center of the channel. A very marked change occurs near the abutments, however, since the momentum of the flow from both sides (or floodplains) must force the advancing central portion of the stream over to gain entry to the constriction. Upon leaving the constriction, the flow gradually expands (5 to 6 degrees per side) until normal conditions in the stream are re-established.

Constriction of the flow causes a loss of energy, with the greater portion occurring in the re-expansion downstream. This loss of energy is reflected in a rise in the water surface and in the energy line upstream of the bridge. This is best illustrated by a profile along the center of the stream, as shown in Figure 5.2-15 (Part A). The dashed line labeled "normal water surface" represents the normal stage of the stream for a given discharge before

constricting the channel. The solid line labeled "actual water surface" represents the nature of the water surface after constriction of the channel. Note that the water surface starts out above normal stage at Section 1, passes through normal stage close to Section 2, reaches minimum depth in the vicinity of Section 3, and then returns to normal stage a considerable distance downstream, at Section 4. Determination of the rise in water surface at Section 1 is denoted by the symbol h_1^* and referred to as the bridge backwater.

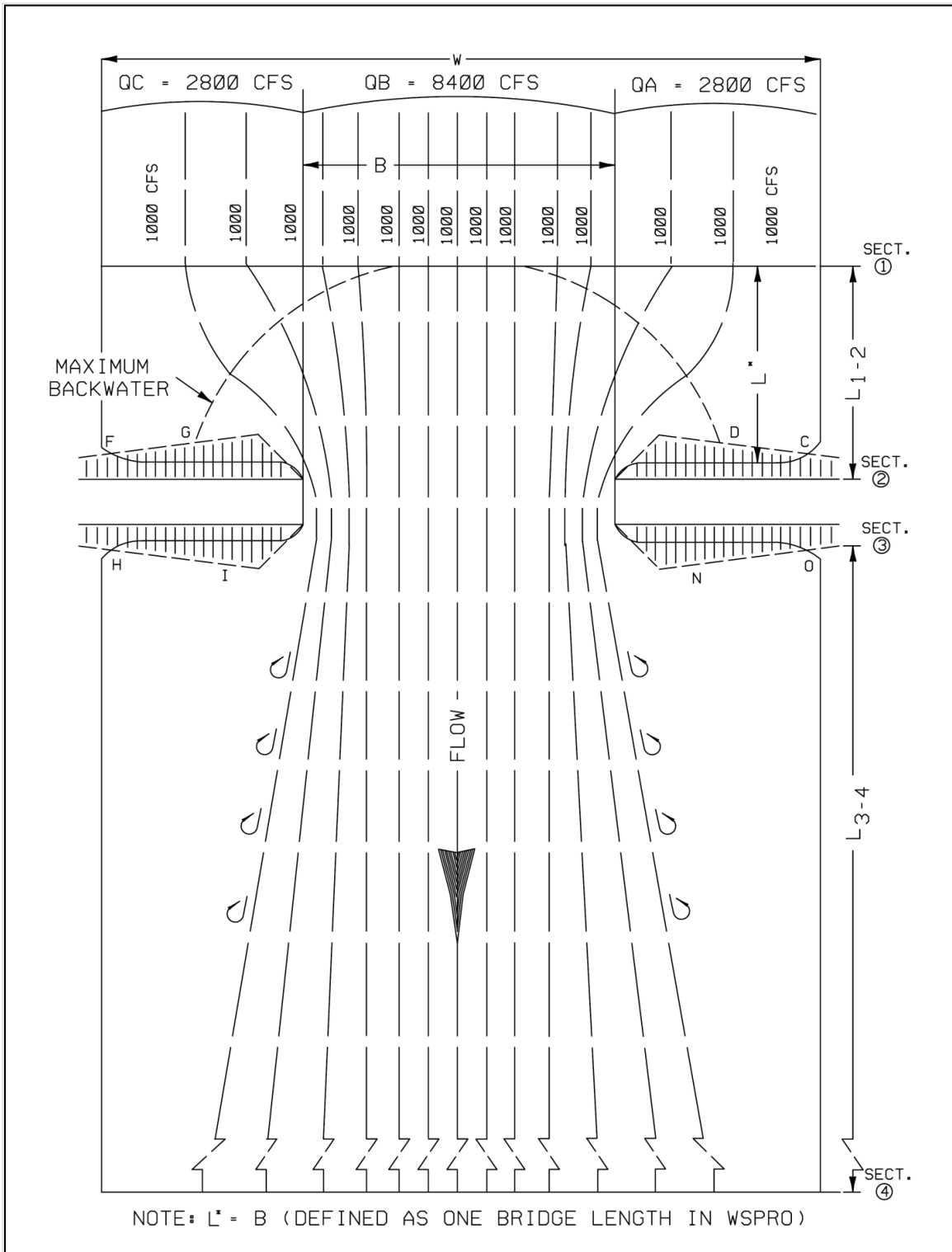

Reference: USDOT, FHWA HDS-1 (1978)

Figure 5.2-14: Flow Lines for Typical Bridge Crossing

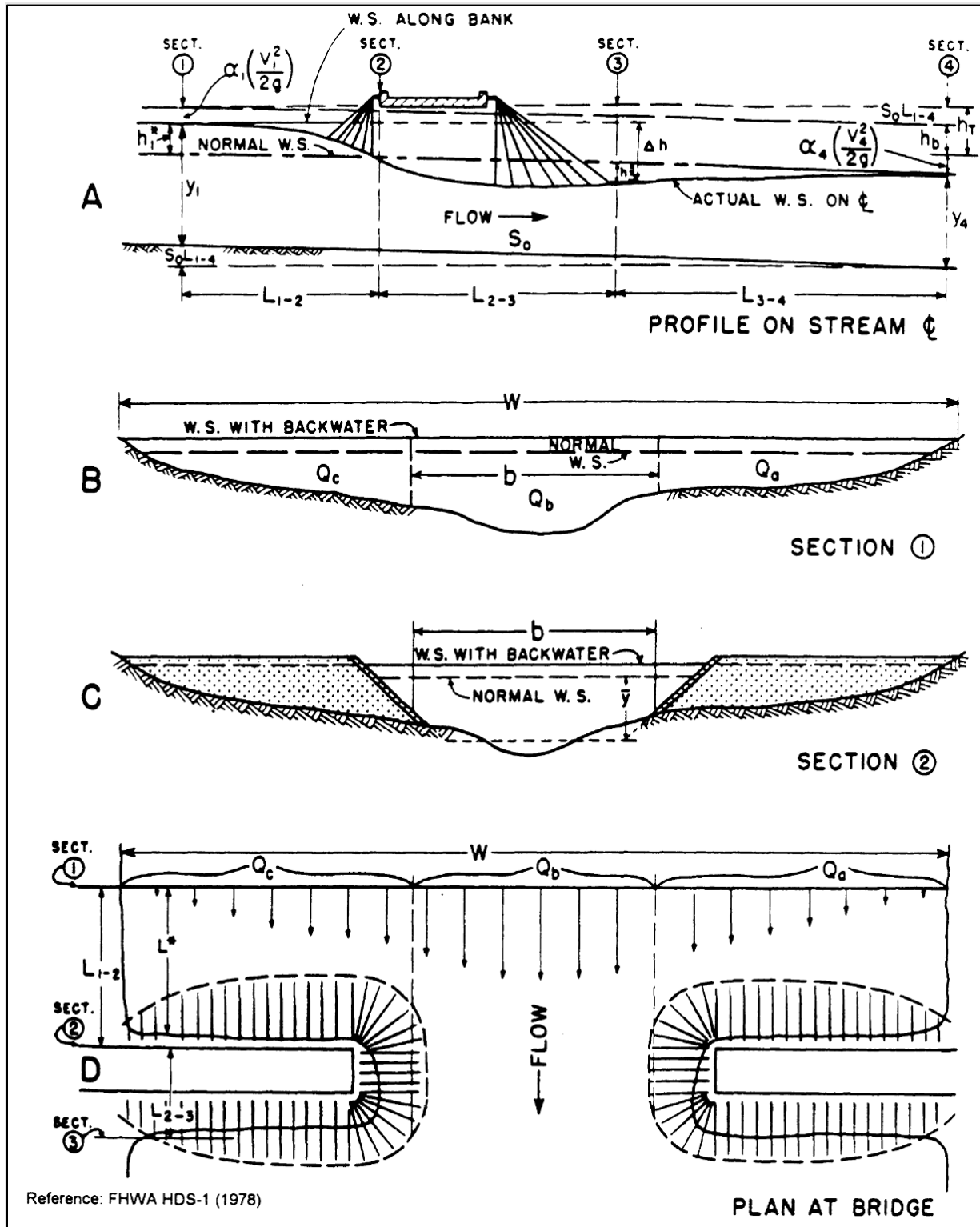

Figure 5.2-15: Normal Crossings: Spill-through Abutments

Roughness

The roughness around and under the bridge can be significantly different than the roughness upstream and downstream due to rubble riprap protection and clearing of trees and underbrush. The main channel roughness often is the same through the bridge from upstream to downstream. The most common reason that the roughness will change is if there is a significant extent of rubble riprap protecting the piers or channel banks.

Many Florida floodplains are heavily vegetated. Many riverine bridges span a significant length across the floodplain. The area beneath the bridge often is cleared of the trees and underbrush, and is maintained that way. This will reduce the roughness. However, rubble protection of the abutment will increase the roughness. The guidelines for subdivision (refer to Section 5.2.4.3) usually would recommend against subdividing at the toe of the abutment, so a weighted roughness should be determined.

Be careful to model abrupt changes in roughness appropriately to properly account for the friction loss between the cross sections. The Standard Step Method uses an average of the conveyance for each cross section to calculate the friction loss between the cross sections, which essentially averages the roughness values of the two sections. A good method of modeling abrupt roughness changes is to include two cross sections closely spaced at the change location. However, some of the bridge routines of the various models will not allow the extra cross section.

Nodes and elements in two-dimensional models can be placed such that abrupt roughness changes do not bisect elements.

Bridge Routine

Refer to HEC-RAS documentation for cross section location information. However, if you are using the WSPRO bridge routine when modeling in HEC-RAS, don't follow the documentation; instead, use the following recommendations.

The bridge routine in WSPRO uses the Standard Step Backwater Method, only with more complexity. The bridge hydraulics is based on the reach from the exit section to the approach section, as defined in the WSPRO Manual. Although the manual specifies "one bridge length," this does not mean the exit section must be exactly one bridge length downstream from the full-valley section or that the approach section must be exactly one bridge length (plus roadway width) upstream from the Full-Valley section. The locations of these sections can vary as follows.

Exit Section:

The exit section can be located no less than, but as much as 10 percent greater than, one bridge length from the full-valley section. See Figure 5.2-16.

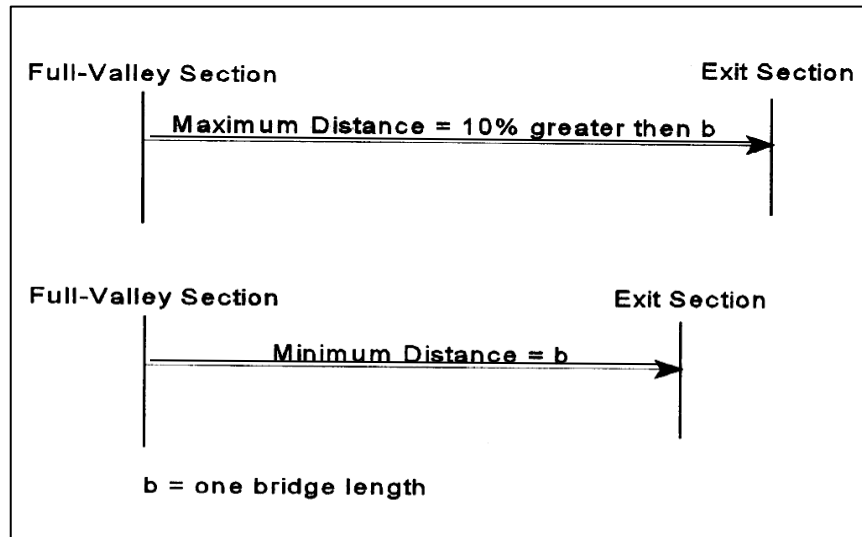

Figure 5.2-16: Location of Exit Section

Approach Section:

The approach section can be located as much as 15 percent less than or greater than one bridge length plus the roadway width from the upstream face of the bridge. See Figure 5.2-17.

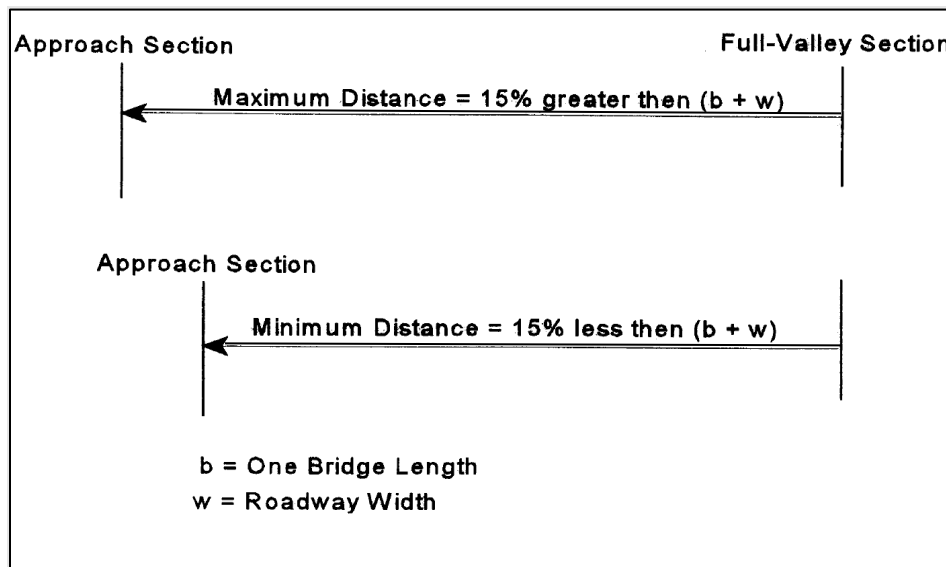

Figure 5.2-17: Location of Approach Section

If, for some reason, it is impossible to follow the cross section requirements, you may need to analyze the site without using the bridge routine.

Piers

You can model single-row pile-bent bridges without modeling the piles and the hydraulic results will be the same as if they were included. However, regulatory agencies may want to see the piles included in the model. As the blockage becomes greater for more complex piers, the hydraulic results will change.

5.2.5 Simulations**5.2.5.1 Calibration**

Calibration involves changing the value of coefficients until the model results match observed field conditions for one or more known events. When the model has been calibrated to known events, then you can model an unknown event, such as the design frequency event, with more confidence.

Observed field data for a flood event can include:

- Water surface elevations
- Discharge measurements
- Velocity measurements

Obtain data from multiple flood events, if available. The closer the magnitudes of the observed events are to the magnitude of the design events, the more certain the results will be.

Generally, the most reliable source of information is gage data. Most gages used in riverine situations measure the water surface elevation. Figure 5.2-18 shows a simple staff gage that you must observe and record manually. More complex gaging stations will record stages automatically and either store the records for later download or transmit the data using telemetry.



Figure 5.2-18: Staff Gage on the Suwannee River

You can determine discharges indirectly from the water surface elevations. Traditionally, you would use a velocity meter to take measurements at intervals across the stream and then determine the discharge, as shown in Figure 5.2-19. When you have determined the discharge at enough different water surface elevations, you can establish a stage versus discharge relationship for the gage.

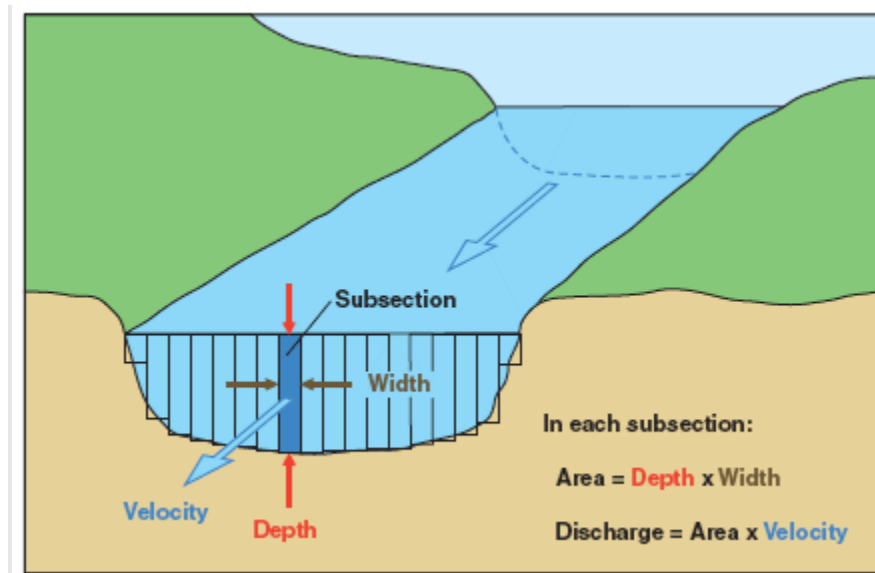

Figure 5.2-19: Discharge Determination with a Velocity Meter (from USGS Streamgaging Fact Sheet 2005-3131, March 2007)

More recently, discharges have been measured on some larger rivers with an Acoustic Doppler Current Profiler mounted on a boat (see Figure 5.2-20).

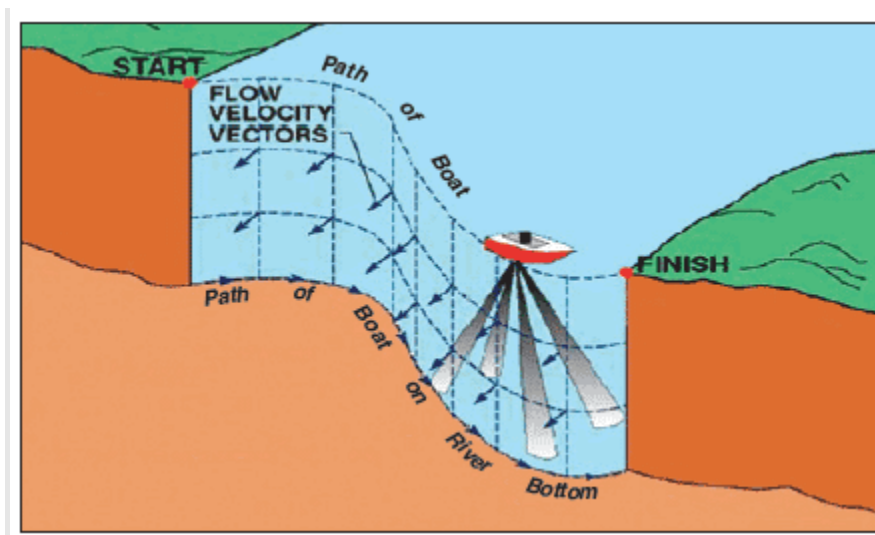

Figure 5.2-20: Discharge Determination with an Acoustic Doppler Current Profiler (from USGS Streamgaging Fact Sheet 2005-3131, March 2007)

The primary benefit of a gage is to establish the discharge for an observed flood. If a gage is located within the model reach, then the gage also can supply stage and velocity information at one point in the model.

If gage data are unavailable, consider sending survey out to measure:

- High water marks associated with known floods (Figure 5.2-21)
- Local resident or official high water permanent markers/signs (Figure 5.2-22)
- Ordinary high water marks (stain lines on existing bridge pilings or vegetative indicators)

Occasionally, the Department and agencies such as USGS, FEMA, DEM, or the Water Management Districts may have surveyed or collected high water marks following a flood. Contacting them is an avenue to pursue.



Figure 5.2-21: Examples of High Water Marks after a Flood

If a gage is not available to determine the discharge of the known event, then estimating the discharge associated with the various high water marks will be difficult or impossible. Obtaining rain gage information for the flood and estimating the runoff from the rainfall is an option, assuming data from a suitable rain gage are available. Otherwise, the high water marks can only be compared to the computed design frequency profiles from the model to check the magnitudes for reasonableness.



Figure 5.2-22: Local Resident indicating Flood Level on the Caloosahatchee River near LaBelle in 1913

After you obtain available gage data and/or high water mark elevations, the next step is to develop the hydraulic model for the existing site conditions. In some situations, this might entail creating multiple existing-condition models if the site conditions have changed since some of the calibration floods. Develop the model using standard guidance for the coefficients used in the model. Then compare the initial model results to the high water marks and adjust the coefficients. The common coefficients to adjust are:

- Manning's Roughness Coefficient
- Bridge loss coefficients (depending on the bridge routine used)
- Expansion and Contraction Coefficients

Manning's roughness coefficient is the basic adjustment tool for unobstructed reaches. Considerable uncertainty exists when estimating roughness values. Estimates by experienced hydraulics engineers often vary by ± 20 percent (from USACE EM 1110-2-1416). If you hold the channel roughness constant and vary the overbank roughness, you should be well served.

Also, remember that Manning's roughness varies with depth, which can affect calibration as follows:

- As the depth over the roughness elements increases, n decreases.
- If the flow encounters a new roughness element as the flow depth increases, n will increase. For example, if tree branches are higher than a certain depth in the floodplain, the roughness will increase when the flow reaches the tree branches.

Do not adjust the calibration coefficients outside of their normal ranges. If the calibration attempts are not acceptable, re-examine the model. Common model parameters to review if calibration is a problem include:

- Ineffective flow areas
- Starting conditions downstream
- Cross section locations
- Cross section subdivisions
- Accuracy of survey data or other geometric data
- Datums of geometric data
- Flow lengths
- Warning messages

Note that calibration problems can be caused by different issues. Use your best judgment in the calibration process. There is no universally accepted procedure or criterion for calibration.

Calibrating unsteady flow models is more difficult than calibrating steady flow models.

Adjust to steady flow conditions first, if possible. Unsteady flow models need to be calibrated over a wider range of flows than steady-state models. Storage in the system is an important parameter for unsteady flow, and essentially can be used as an adjustment parameter. For more detail on techniques for unsteady flow calibration, refer to USACE Manual EM 1110-2-1416, *River Hydraulics*.

Two-dimensional models have eddy viscosity, or turbulent loss coefficient, that becomes another calibration parameter. This term in essence replaces expansion and contraction losses in a one-dimensional model. However, there is not an established correlation between the two losses. The best way to calibrate eddy viscosity is with measured velocities. Remember that the two-dimensional velocity is depth-averaged, so you must

convert the measured velocity to a depth-averaged velocity for comparison. Set the value high first, and then lower it until you obtain the ideal velocity distribution. The general order of calibration for two-dimensional models would be to calibrate roughness values to observed water surface elevations, and then adjust eddy viscosity to observed velocities.

When using both velocities and stages for calibration, check for internal consistency of the observed data. The velocity times the area for the stage should be approximately equal to the discharge.

5.2.5.2 Existing Conditions

Model the existing conditions to compare with the results from the proposed structure and to calibrate the model to observed flood data. If the existing condition has a bridge at the site, then consider also modeling the natural conditions at the site prior to construction of the existing bridge.

5.2.5.3 Design Considerations

Review Project Development and Environment (PD&E) documents for commitments made during the NEPA process. During PD&E, a Location Hydraulics Study should look at alternate locations for the plan view of the roadway crossing of the stream or river. Identify adverse hydraulic conditions in the Location Hydraulics Study for consideration when planning the roadway crossing. The final location will not depend solely on hydraulic aspects, but consider them during the initial planning of the roadway. The location and alignment of the highway can either magnify or eliminate hydraulic problems at the crossing. By the time the Bridge Hydraulics Report is prepared, the location and alignment of the road should be set; however, minor changes to the alignment still may be possible.

Usually, you will evaluate and select the length of the bridge and the location of the abutments in the Bridge Hydraulics Report. Traditionally, at least three lengths are analyzed. One is the minimum hydraulic structure, the bridge that creates no more than one foot of backwater and does not violate other allowable water surface conditions. Another bridge length examined is the bridge that spans all wetlands. Other potential bridge lengths to investigate include:

- The length of the existing bridge
- For dual bridges, the length of the existing dual bridge that will be left in place
- Breaks in fill height if bridging is less expensive than roadway fill
- Minimum bridge length based on setbacks from the channel banks

Other considerations when designing and modeling the proposed conditions are:

- Place the bridge in a crest vertical curve, if possible. Allowing the approach roadways to overtop more frequently than the bridge will provide relief for the bridge, and reduce the possibility of damage to the structure. If a portion of the roadway is damaged, it usually can be repaired more easily than the bridge.
- Try to center the bridge over the main channel of the flow. At a minimum, set the toe of the abutments 10 feet back from the top of the channel bank.
- Consider skewing the abutments and intermediate bents to align with the flood flow direction to reduce scour potential.

5.3 TIDAL ANALYSIS

A qualified coastal engineer should perform hydraulic and scour analyses of tidal and tidally influenced bridges. Section 5.1.1 defines the requirements and credentials of coastal engineers qualified to perform tidal analyses for the Department.

5.3.1 Data Requirements

Evaluation and design of tidally influenced bridges requires a preliminary, systematic data collection effort to determine the hydraulic conditions at the structure, calculate the scour, and develop the wave climate at the structure. This information includes details of the bridge geometry, the bed composition and elevations, and historical measurements and studies.

5.3.1.1 Survey Data

You will need survey data to perform several aspects of a bridge hydraulics and scour analysis. Survey data not only provide the elevation data to construct hydraulic and wave models, but also provide needed sediment characteristics for scour calculations. The requirements for a tidal analysis are the same as those for riverine analyses with one exception: typically, the size of the modeling domain for tidal studies is substantially larger than for riverine studies. Since new survey acquisition of the required data over the entire domain is rarely cost-effective, you can supplement survey data acquired around the bridge with publicly available data. Several sources exist for supplemental data, including the following examples:

- Bathymetric and topographic data from the National Geophysical Data Center (<http://www.ngdc.noaa.gov/mgg/bathymetry/relief.html>, Example: Figure 5.3-1)
- Digital Elevation Models from the FDEP Land Boundary Information System website (http://www.labins.org/mapping_data/dem/dem.cfm)

- Coastal LiDAR data from NOAA's Coastal Services Center (<https://coast.noaa.gov/digitalcoast/data/coastallidar.html>)

Be careful when combining data from several sources. There can be wide ranges in accuracy due to differing measurement techniques and survey dates. Pay close attention to conversion between different horizontal and vertical coordinate systems. Examine boundaries between survey data sets for inconsistencies and corrections.

The accuracy and density of survey data become more important near the site of interest. This is especially true of bathymetry for wave modeling when you expect depth limitation to govern wave conditions.

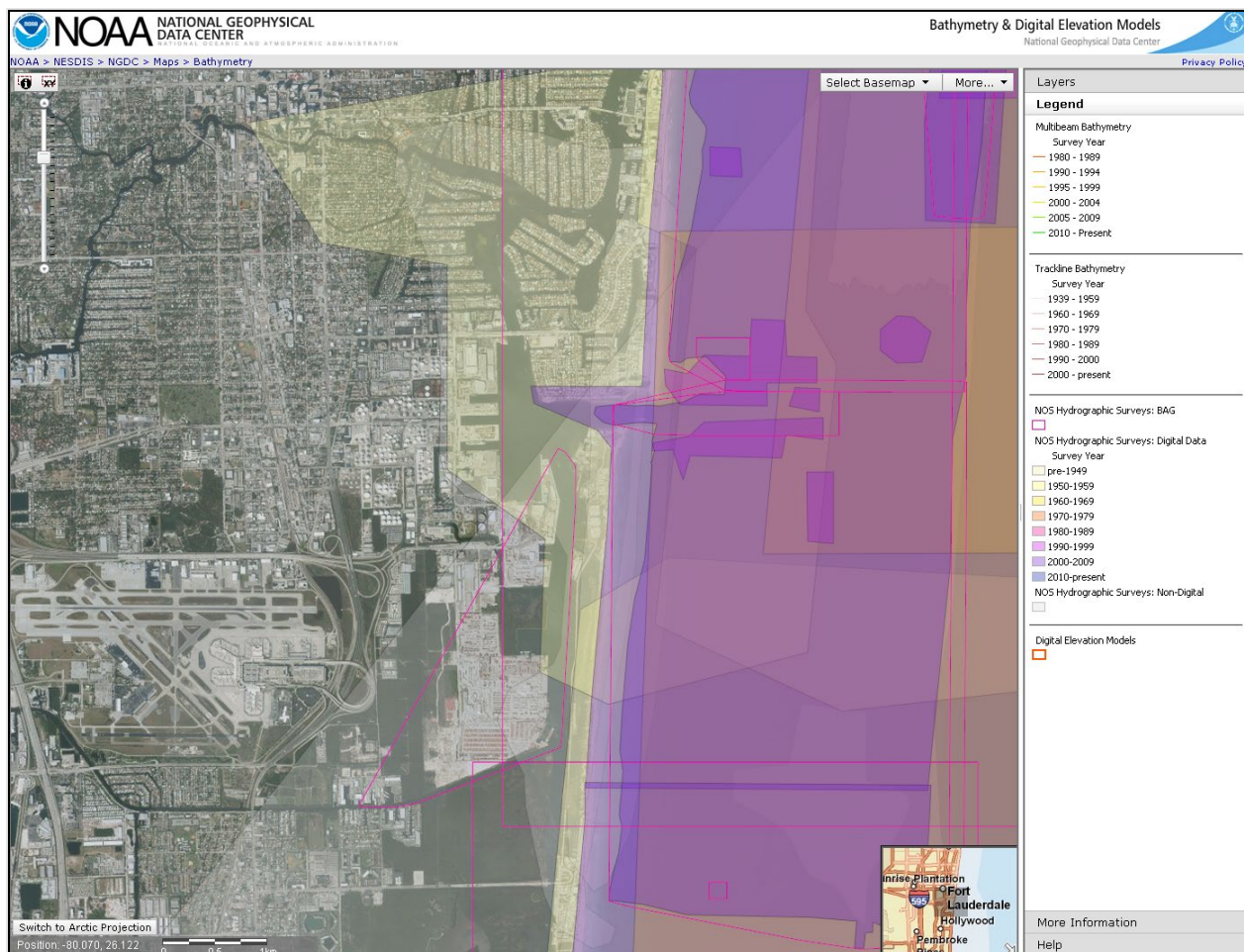

Figure 5.3-1: NOAA National Geophysical Data Center Website

5.3.1.2 Geotechnical Data

To calculate scour at bridge foundations, you will need geotechnical information to establish the bed composition and its resistance to scour. Data requirements for tidal bridges are the same as those for riverine bridges. Refer to Section 5.2.1.2 for a discussion of geotechnical data requirements.

5.3.1.3 Historical Information

Historical information provides data for calibration through gage measurements and historical high water marks, data for calculation of long-term scour processes through historical aerial photography and Bridge Inspection Reports, and data for characterization of the hurricane vulnerability through the hurricane history.

Tidal Bench Marks

Tidal datums are vertical elevations that describe the tidal fluctuation at a particular location. Several tidal datums are in common use, including mean high water (MHW), which is the base elevation for structure heights, bridge clearances, etc., and mean low water (MLW), which is the officially designated navigational chart datum for the United States and its territories. To be accessible when needed, these datums are referenced to fixed points known as bench marks. NOAA maintains numerous tidal bench marks throughout the state of Florida that are available from the Center for Operational Oceanographic Products and Services (CO-OPS) website (<https://tidesandcurrents.noaa.gov/products>). The Florida Department of Environmental Protection (FDEP) is an additional source for this information. The FDEP website LABINS (Land Boundary Information System) contains a water boundary data map interface that lists not only the MLW and MHW at the NOAA bench mark locations, but also these datums at interpolated locations along interior tidal waterways. The LABINS website information (http://www.labins.org/survey_data/water/water.cfm) is recommended for locations where NOAA tidal bench marks are either unavailable or display a wide range of vertical variation around the project location.

Several other tidal datums are available, and you should document them for each tidally controlled or influenced project.

The east coast of Florida experiences semi-diurnal tides and the panhandle experiences diurnal tides. The coastline from the tip of the peninsula to Apalachicola experiences mixed tides—tides characterized by a conspicuous diurnal inequality in the higher high and lower high waters and/or higher low and lower low waters. Figure 5.3-2 and Table 5.3-1 display an example of tidal bench mark information and gage data (with tidal datums) for Key West, Florida.

Table 5.3-1: Elevations of Tidal Datums in ft-NAVD88 for NOAA Tidal Bench Mark #8724580 (Key West, FL) for the 1983-2001 Tidal Epoch

| | |
|-------------------------------|-------|
| MEAN HIGHER HIGH WATER (MHHW) | +0.05 |
| MEAN HIGH WATER (MHW) | -0.24 |
| MEAN TIDE LEVEL (MTL) | -0.88 |
| MEAN SEA LEVEL (MSL) | -0.87 |
| MEAN LOW WATER (MLW) | -1.52 |
| MEAN LOWER LOW WATER (MLLW) | -1.76 |

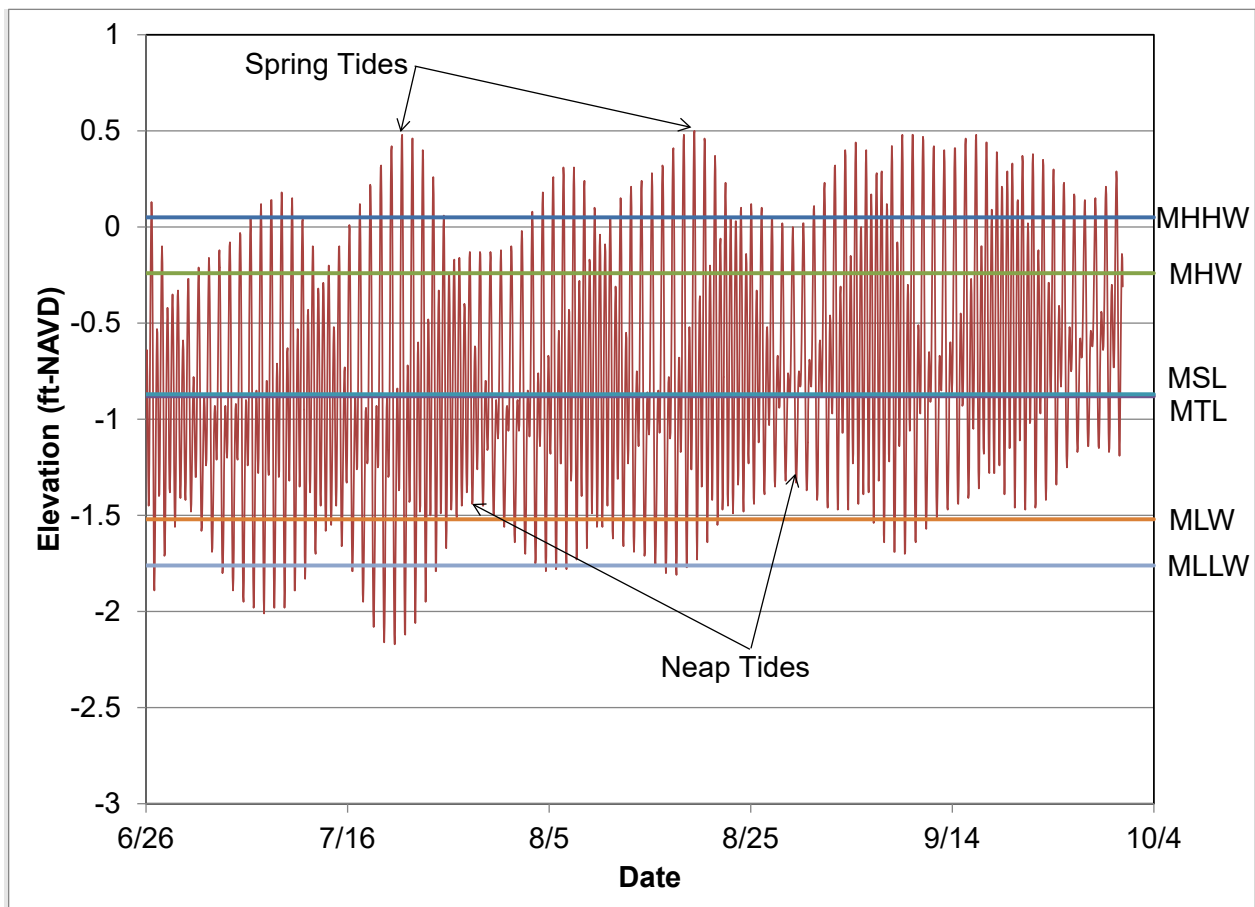

Figure 5.3-2: Measured Tides at Key West and Tidal Datums

Gage Measurements

Gage measurements provide information both for model calibration and model boundary conditions. Several sources of gage data are available to the public. The types of gage measurements typically employed in tidal analyses include:

- Streamflow and river stage gages—for establishing inland boundary conditions and calibration
- Tide gages—for oceanward boundary conditions and calibration of tidal circulation
- Wave gages—for calibration of wave models

Data sources of streamflow and river stage records are the same as those discussed for riverine analyses.

You also can employ tide gage data for development of model boundary conditions, as well as for model calibration. Tide gages record stages at a fixed location in tidally influenced areas. NOAA maintains gages throughout the state. You can access both recent and historic data online (https://tidesandcurrents.noaa.gov/water_level_info.html). In Florida, the site provides data at 29 active stations (Figure 5.3-3) and historic data at 722 locations.

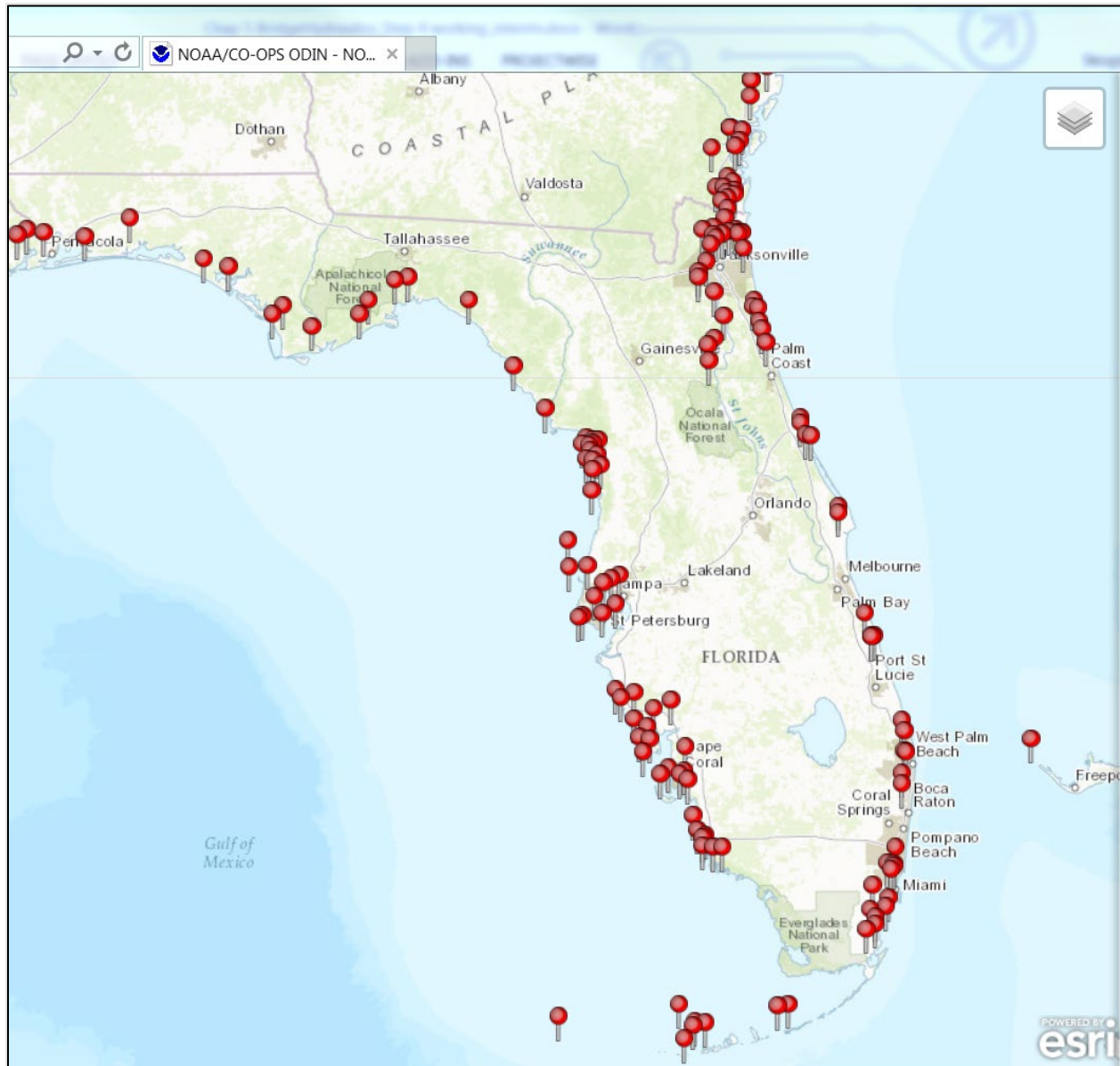

Figure 5.3-3: Location of Florida’s Active Tide Stations Maintained by NOAA
(Source: <https://tidesandcurrents.noaa.gov/map/index.html?region=Florida>)

Used to calibrate data for wave models, wave gage data typically is much more rare than either streamflow or stage records. The National Data Buoy Center (NDBC)—a part of the National Weather Service (NWS)—designs, develops, operates, and maintains a network of data-collecting buoys and coastal stations. Several of these stations measure wave parameters, including significant wave height, swell height, swell period, wind wave height, wind wave period, swell wave direction, wind wave direction, wave steepness, and average wave period. The NDBC website (<http://www.ndbc.noaa.gov/>) provides both

recent and historical observations at several locations around Florida (Figure 5.3-4). Figure 5.3-5 provides an example of these data as time series of significant wave heights. Sources of wave gage data for interior waters (such as bays, estuaries, intracoastal waterways, etc.) are much harder to locate. Possible sources may include previous studies and academic institutions.

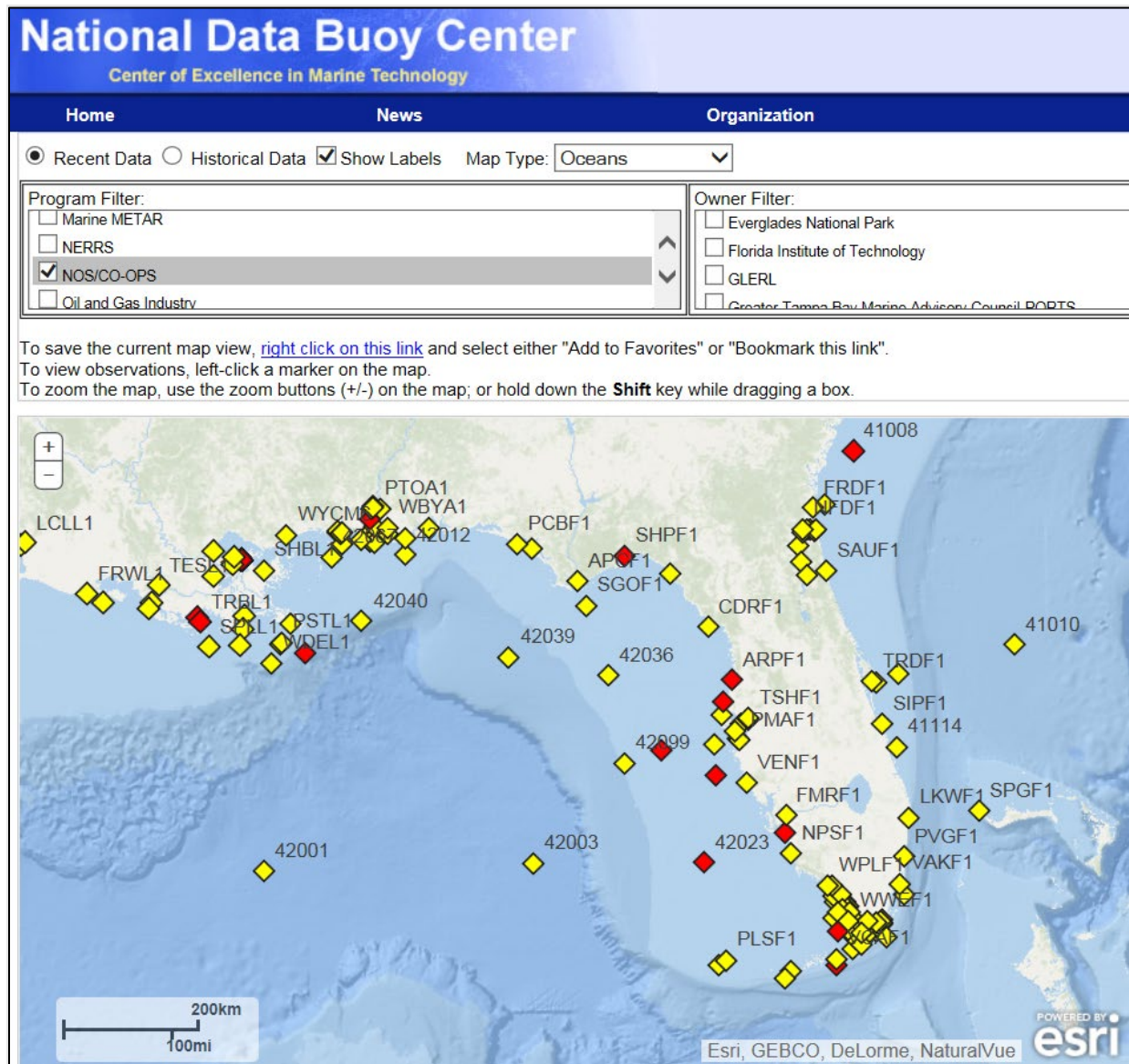

Figure 5.3-4: Locations of NDBC Stations around Florida
 (Source: <http://www.ndbc.noaa.gov/>)

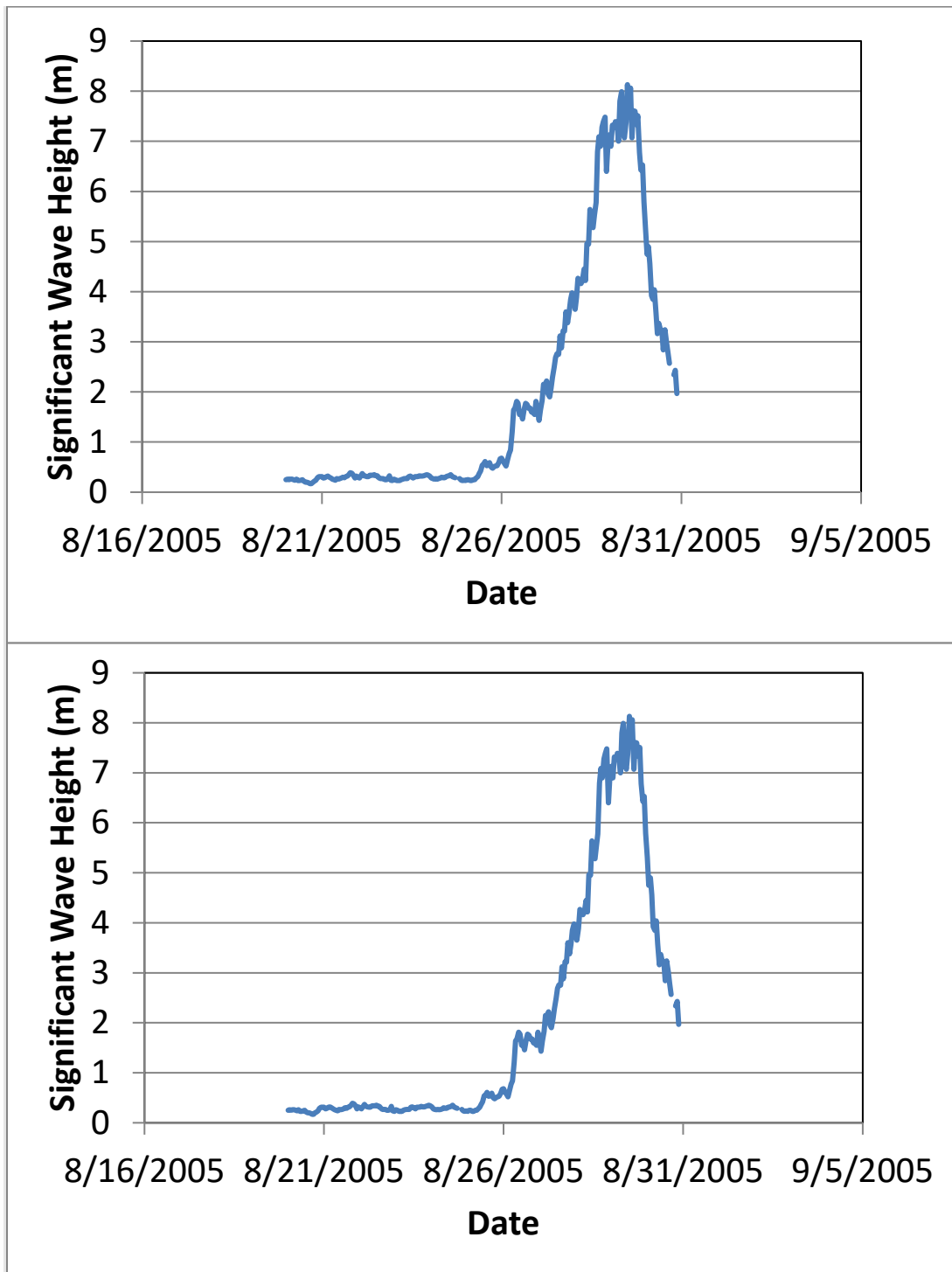

Figure 5.3-5: Example of Wave Gage Data at NDBC Station 42039 during Passage of Hurricane Katrina

Historical High Water Marks

The historical hurricane high water marks provide additional calibration data sets for the storm surge numerical model during specific hurricane events. FEMA typically performs post-storm damage assessments. Although the survey accuracy has significantly increased in recent years, be cautious when using these data. Coastal high water marks typically are designated as one of three basic types:

- Surge—represents the rise in the normal water level
- Wave height—represents the coastal high water mark elevation due to more direct wave action
- Wave run-up—represents the height of water rise above the stillwater level due to water running up from a breaking wave

You often can find high water marks near each other and they can vary widely in elevation. Surge-only high water marks occur only where the structure is at a location sheltered from waves. As waves propagate inland during a surge, the high water conditions on structures and land can vary widely. When the crest of the wave rides on the surge, this creates coastal wave height flooding. Thus, differences will occur between high water marks measured on the interior and exterior walls of a structure. Finally, wave run-up high water marks include the effects of waves breaking on sloping surfaces. After a wave breaks on a beach or sloping surface, a portion of the remaining energy will propel a bore that will run up the face of the slope. The vertical distance the bore travels above the still water level is termed the wave run-up. Wave run-up often pushes debris to its maximum limit, where it is left as a wrack line (a line of debris illustrating the extent of the wave run-up).

Hurricane History

The hurricane history of the project location characterizes the hurricane frequency at the project, as well as the historical impacts to the site location. Including this information in the Bridge Hydraulics Report elevates the importance of examining hurricane surge and wave impacts, providing a qualitative examination of the frequency of hurricane influences at the bridge site. Additionally, it can provide a tool for comparing the selected calibration hurricane to the overall activity for the area. The BHR should include the historical hurricane paths, historical storm year, and category, as well as discussion of significant storms to impact the area. An example of the hurricane paths and listing of the historical hurricanes is displayed in Figure 5.3-6 and Table 5.3-2 (from <https://coast.noaa.gov/hurricanes/>).

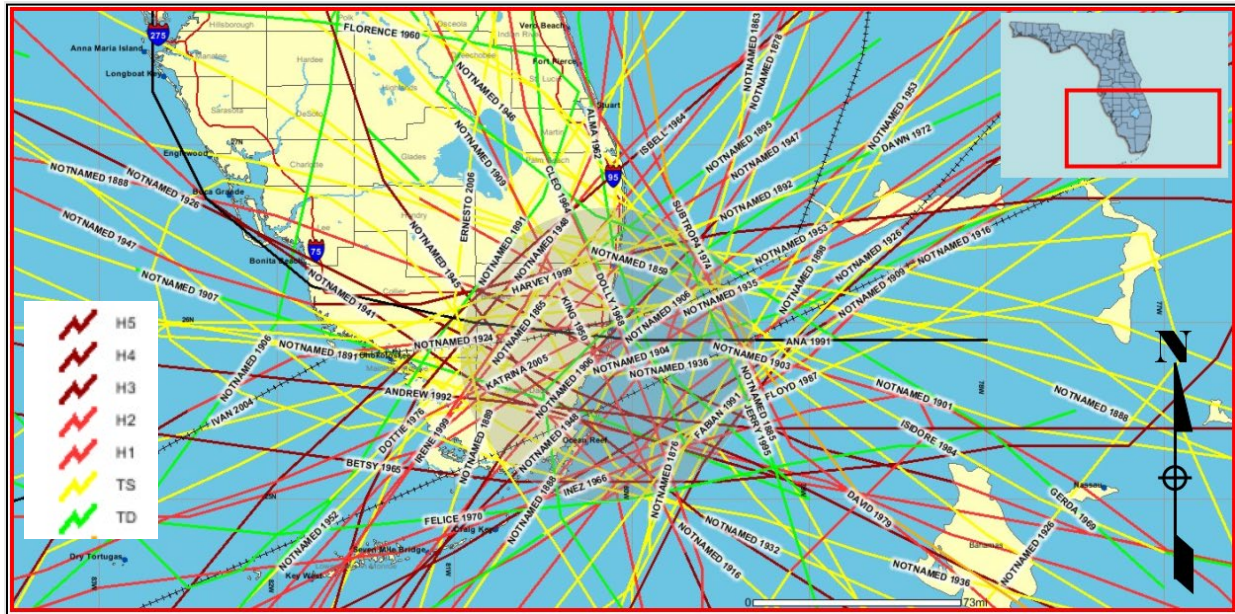

Figure 5.3-6: Hurricane and Tropical Storm Tracks Passing within 50 Nautical Miles (nmi) of Miami (Source: NHC)

Table 5.3-2: Hurricanes Passing within 50 nmi of Miami

| Year | Month | Day | Storm Name | Wind Speed (kts) | Pressure (mb) | Category |
|------|-------|-----|------------|------------------|---------------|----------|
| 1865 | 10 | 23 | NOTNAMED | 90 | 0 | H2 |
| 1870 | 10 | 10 | NOTNAMED | 90 | 0 | H2 |
| 1878 | 10 | 21 | NOTNAMED | 70 | 0 | H1 |
| 1885 | 8 | 24 | NOTNAMED | 70 | 0 | H1 |
| 1888 | 8 | 16 | NOTNAMED | 110 | 0 | H3 |
| 1891 | 8 | 24 | NOTNAMED | 75 | 0 | H1 |
| 1903 | 9 | 11 | NOTNAMED | 75 | 976 | H1 |
| 1904 | 10 | 17 | NOTNAMED | 70 | 0 | H1 |
| 1906 | 10 | 18 | NOTNAMED | 105 | 953 | H3 |
| 1909 | 10 | 11 | NOTNAMED | 100 | 957 | H3 |
| 1924 | 10 | 21 | NOTNAMED | 70 | 0 | H1 |
| 1926 | 9 | 18 | NOTNAMED | 120 | 0 | H4 |
| 1926 | 10 | 21 | NOTNAMED | 95 | 0 | H2 |
| 1935 | 9 | 28 | NOTNAMED | 100 | 0 | H3 |
| 1935 | 11 | 4 | NOTNAMED | 65 | 973 | H1 |
| 1941 | 10 | 6 | NOTNAMED | 105 | 0 | H3 |
| 1945 | 9 | 15 | NOTNAMED | 120 | 0 | H4 |
| 1947 | 9 | 17 | NOTNAMED | 135 | 947 | H4 |
| 1947 | 10 | 12 | NOTNAMED | 75 | 0 | H1 |
| 1948 | 9 | 22 | NOTNAMED | 100 | 0 | H3 |
| 1948 | 10 | 5 | NOTNAMED | 110 | 975 | H3 |
| 1950 | 10 | 18 | KING | 95 | 0 | H2 |
| 1964 | 8 | 27 | CLEO | 90 | 968 | H2 |
| 1964 | 10 | 14 | ISBELL | 110 | 968 | H3 |
| 1965 | 9 | 8 | BETSY | 110 | 952 | H3 |
| 1966 | 10 | 4 | INEZ | 75 | 984 | H1 |
| 1979 | 9 | 3 | DAVID | 85 | 973 | H2 |
| 1987 | 10 | 12 | FLOYD | 65 | 993 | H1 |
| 1992 | 8 | 24 | ANDREW | 130 | 937 | H4 |
| 1999 | 10 | 16 | IRENE | 65 | 986 | H1 |
| 2005 | 10 | 24 | WILMA | 110 | 953 | H3 |

Historical Aerial Photographs

Historical aerial photographs aid in evaluating the channel stability at a bridge crossing. Comparison of photographs over a number of years can reveal long-term erosion or accretion trends of the shorelines and channel near the bridge crossing. An example of this is provided in Figure 5.3-7 and Figure 5.3-8. From the figures, changes in shoreline location occur south of the east abutment as well as to the spit south of the inlet. Section 5.5.1.1 further discusses calculation of long-term trends. Sources of historical aerial photography are the same as those discussed in Section 5.2.1.3.



Figure 5.3-7: Heckscher Drive (SR-A1A) near Ft. George Inlet in 1969



Figure 5.3-8: Heckscher Drive (SR-A1A) near Ft. George Inlet in 2000

Existing Bridge Inspection Reports

Existing Bridge Inspection Reports often provide sources of recent and historical cross section measurements, as well as identify areas of hydraulic/scour-related damage or repairs. Refer to Section 5.2.1.3 for additional discussion on obtaining and using these reports in hydraulic analyses.

Wave Information Studies

Another source of coastal wave hindcast data is the Wave Information Studies (WIS), developed and maintained by the U.S. Army Corps of Engineers (USACE) Coastal and Hydraulic Laboratory. The WIS project produced an online database of hindcast, nearshore wave conditions along the U.S. coasts. The hindcast data provide a source of decades-long wave data that can provide boundary conditions or calibration data for nearshore wave modeling. The data include hourly wave parameters of significant wave height, peak period, mean period, mean wave direction, and wind speed and direction (Figure 5.3-9). The database includes both nearshore and offshore gages along both Florida's Atlantic Ocean and Gulf of Mexico shorelines. The data are available via the following link: <https://cirp.usace.army.mil/products/cms.php>

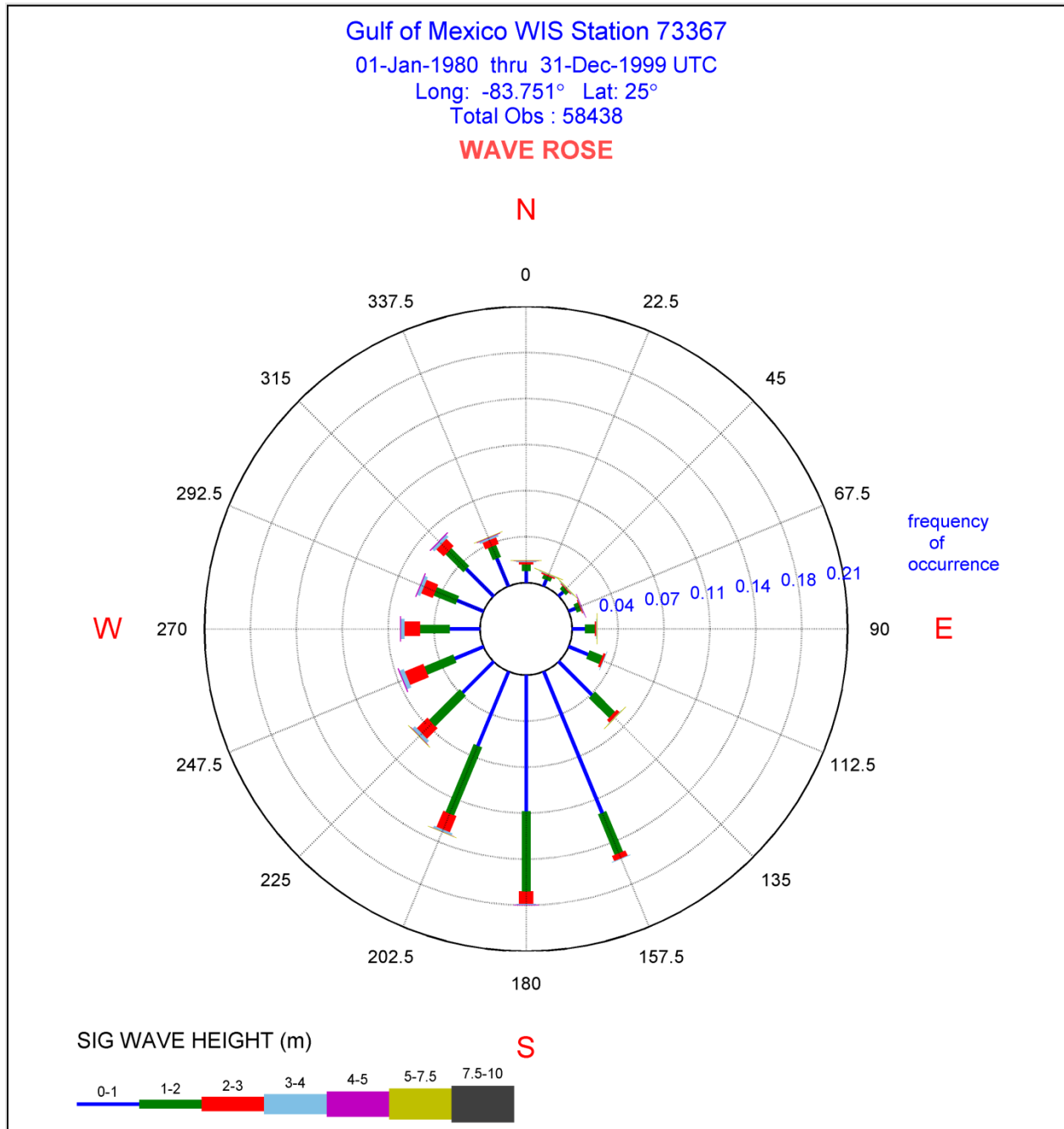

Figure 5.3-9: Example of Available WIS Data from:
<https://cirp.usace.army.mil/products/cms.php>

Previous Studies

Previously performed studies of a waterway can provide additional sources of data. Refer to Section 5.2.1.3 for sources and discussion of previous studies.

5.3.1.4 FEMA Maps

FEMA Flood Insurance Rate Maps (FIRM) are the official maps of communities that display the floodplains—specifically, special hazard areas and risk premium zones—as delineated by FEMA. They are located at <https://msc.fema.gov/portal>. These maps display areas that fall within the 100-year flood boundary. Information pertinent to bridge hydraulics analysis includes whether the bridge resides in a FEMA floodway (see Section 5.1.2). Additionally, the map's 100-year elevations can provide a check for modeling results for the area. It is not unusual for the FEMA-listed elevations to differ significantly from hurricane storm surge modeling results developed at an individual site. Many of FEMA's older coastal studies were performed via application of either the TTSURGE or FEMA SURGE two-dimensional models, models driven with atmospheric (wind and pressure) boundary conditions. A Joint Probability Method analysis of the model results determined the return periods of surge elevations. The last time the FEMA SURGE model was used in a new or updated flood insurance study to revise the FIRMs occurred in the late 1980s. Thus, you can attribute deviation in 100-year flood elevations from the published FEMA values to differences in the numerical models, boundary conditions, inclusion of wave setup, as well as in the post-simulation analysis. More recently, FEMA has begun to perform coastal restudies of locations throughout Florida, employing more up-to-date modeling and statistical analyses. As the new maps become available, they will replace older currently available maps.

5.3.1.5 Inland Controls

Data collection for inland controls follows the same recommendations as for the upstream controls of riverine analysis (see Section 5.2.1.6).

5.3.1.6 Site Investigation

You should plan to do a field investigation for all new bridge construction. Refer to Section 5.2.1.7 for a detailed list outlining key items you should collect during site investigations. In addition to this list, data collection at tidal bridges also should include the following:

- Look for evidence of wave scarping in bridge approaches.
- Note directions of largest fetches.
- Look for evidence of wave overtopping of seawalls and bulkheads.
- Note scattering of rubble riprap at toes of revetments, seawalls, and bulkheads by waves.

5.3.2 Hydrology (Hurricane Rainfall)

During hurricane events associated with heavy rainfall, you can experience significant surface runoff from land. For coastal areas, even though the storm surge is the larger concern, surface runoff may increase or decrease the surge effects depending on the phasing between the two (Douglass and Krolak, 2008).

The USACE reference, *Engineering and Design Storm Surge Analysis EM 1110-2-1412* (1986), provides a methodology for estimating rainfall associated with landfalling hurricanes. The methodology applies to the area within 25 miles of the coast. It provides graphs of point rainfall depth for a given frequency and a given distance from the left or right of the storm track. The rainfall varies uniformly along the coast for any given storm. Also, the rainfall depths are uniform along any line parallel to the storm track extending across the 25-mile-wide zone. The reference provides point rainfall graphs (Figure 5.3-10) for selected frequency levels at either 6-hour or 12-hour intervals before landfall and after landfall. The reference provides techniques for estimating rainfall associated with hurricanes traveling at high, moderate, and slow speeds by multiplying the rainfall from the graphs by a ratio coefficient that is a function of area.

Alternatively, as a rule of thumb, you may assume a steady 10-year discharge over the duration of the surge. This is likely to be conservative in light of a recent examination of hurricane rainfall in North Carolina that suggests that a two-year rainfall well represented historical storms in that state (OEA, 2011). Bridges over streams with short times of concentration (< four hours) are more likely to have coincidence between the storm surge passage and high runoff values. Historical review of the timing and magnitude of runoff at gaged locations near the project site can provide additional insight into the appropriate return period flow rates for boundary conditions. At a minimum, you should perform a sensitivity study to characterize the influence of the runoff magnitude on the flow properties at a subject bridge during a surge event.

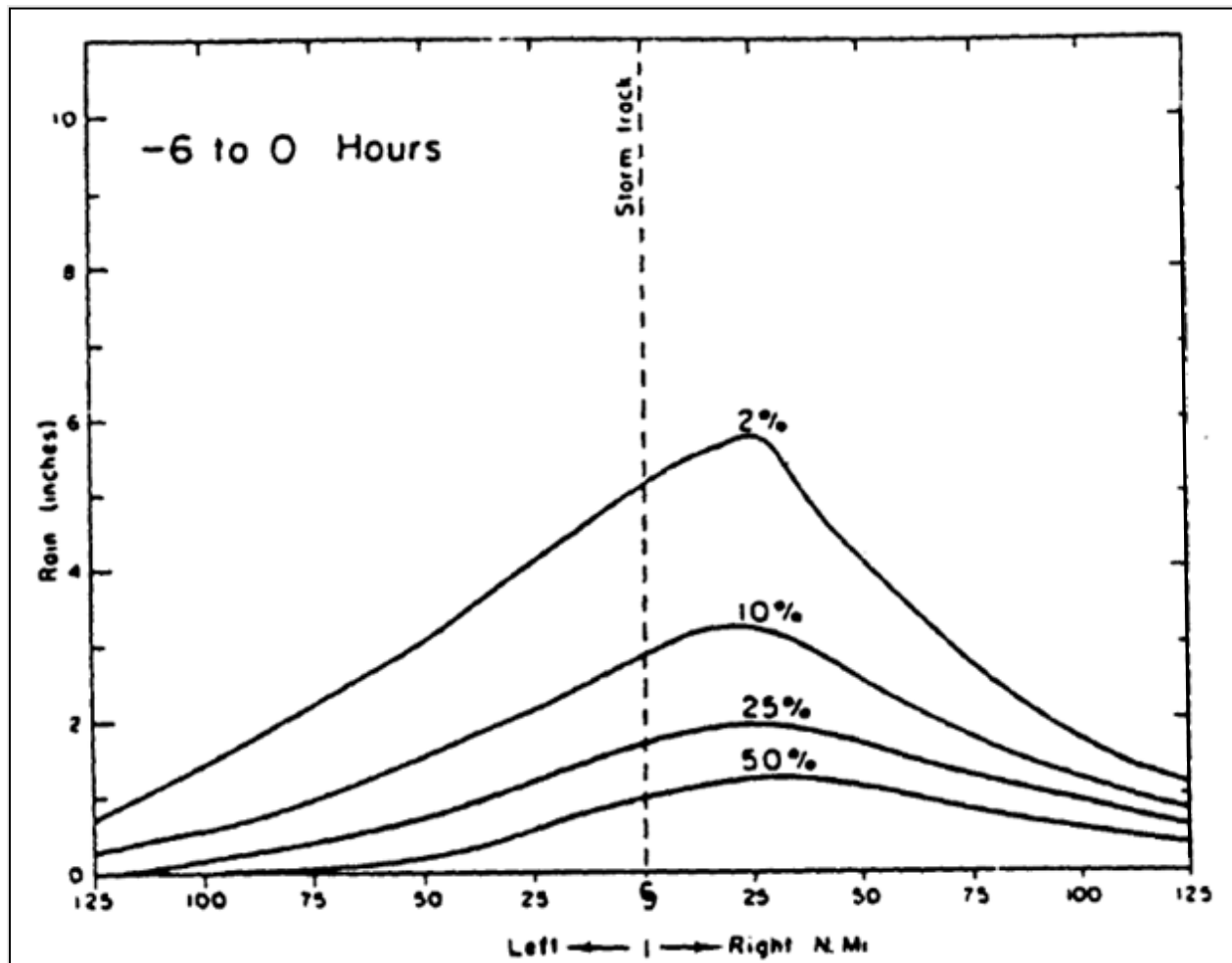

Figure 5.3-10: Rainfall for Selected Frequency Levels for Six Hours before Landfall (Source: USACE 1986)

5.3.3 Model Selection

If you perform hydraulic studies, you must weigh several factors when selecting a modeling approach, including:

- Types of models (e.g., one-dimensional vs. two-, or three-dimensional models; finite-element vs. finite-difference models)
- Site conditions (e.g., embankment skew, multiple openings, etc.)
- Data availability (e.g., survey data, design flows/stages, etc.)
- Familiarity with the model
- Schedule and budget

Weigh all the factors mentioned above and select the appropriate model for the application. *NCHRP Web-Only Document 106: Criteria for Selecting Hydraulic Models* (Gosselin et al., 2006) provides a decision analysis tool and guidelines for selecting the most appropriate numerical model for analyzing bridge openings in riverine and tidal systems. The decision tool takes the form of a decision matrix that incorporates all the factors that influence model selection, including site conditions, design elements, available resources, and project constraints. The utility of the decision tool is that it presents a formal procedure to apply for the selection of the appropriate model rather than an intuitive process.

Figure 5.3-11 presents an example where an engineer is selecting between one- and two-dimensional models. The figure shows the scoring and weighting of different aspects of the project, with the final selection of the one-dimensional model based largely on advantages in scheduling. The selection procedure provides an easy-to-understand and defensible method for presentation to non-technical readers or policy makers. Also, through its application, it clearly identifies which features of the project are most important in the model selection for a specific application.

| Design Criteria | Weight | One Dimensional Model | | Two Dimensional Model | |
|-------------------------------------|---------------|--------------------------------------|----------------------|--------------------------------------|----------------------|
| | | Score 1=low 3=medium 5=high | Weight x Score | Score 1=low 3=medium 5=high | Weight x Score |
| Site Conditions | (1-10) | | | | |
| Bridges over Meandering Rivers | 2 | 3 | 6 | 5 | 10 |
| Bridges with Asymmetric Floodplains | 7 | 3 | 21 | 5 | 35 |
| Design Requirements | (1-10) | | | | |
| Riprap | 9 | 3 | 27 | 3 | 27 |
| Pier Scour Calculation | 3 | 3 | 9 | 3 | 9 |
| Other Considerations | (1-10) | | | | |
| Modeler Experience | 3 | 5 | 15 | 5 | 15 |
| Scheduling | 10 | 5 | 50 | 3 | 30 |
| Data Availability | 3 | 5 | 15 | 5 | 15 |
| Totals (Sum of Weight x Score) | | | 143 | | 141 |

Figure 5.3-11: Example of Model Selection Worksheet from NCHRP Web-Only Document 106

For tidal analyses, in general, one-dimensional modeling works well for waterways with well-defined channels in areas that are not subject to lateral overtopping. An example would include rivers or canals that discharge directly to the open coast (e.g., Suwannee River, Florida Barge Canal). More complex waterways and flow circulation will require two-dimensional modeling. Examples requiring two-dimensional flow modeling include:

- Multiple interconnected channels
- Influence of multiple inlets
- Overtopping of barrier islands
- Bridges over tidal inlets
- Bridges over causeway islands
- Bridges through island chains

For wave models, there is not currently a similar selection procedure available. Selecting the appropriate model is left to your experience and discretion after carefully weighing the required design criteria and model features. Confirm your final model selection with the District Drainage Engineer.

5.3.3.1 Storm Surge Model

Developing design hydraulic parameters at a bridge location requires the model to simulate storm surge propagation from an open coast to the bridge site. This necessitates application of an unsteady-state model. The following partial list includes several commonly employed one-dimensional and two-dimensional models for simulating hurricane storm surge:

- Advanced Circulation Model (ADCIRC) 2DDI
- TUFLOW
- DELFT3D
- FESWMS 2DH
- HEC-RAS 3.1.1 and up
- MIKE 11 HD v.2009 SP4
- MIKE 21 (HD/NHD)
- TABS RMA2
- UNET 4.0

5.3.3.2 Wave Model

You can use either numerical models or deterministic methods in developing design wave climate parameters. The USACE references *Coastal Engineering Manual* (2002) and *Shore Protection Manual* (1984) both provide empirical equations and methodologies for calculating wave parameters over open water fetches. The following partial list includes several commonly employed tools and models for simulating hurricane-generated waves:

- ACES
- MIKE 21 Flexible Mesh Spectral Wave Model
- MIKE 21 Nearshore Spectral Wave Model (NSW)
- RCPWAVE
- Simulating Waves Nearshore (SWAN)
- Steady-State Spectral Wave (STWAVE)

5.3.3.3 Model Coupling

Model coupling refers to the interaction between the wave model and the surge model when simulating hurricanes. With no coupling, the surge and wave models run independently. Since the wave model requires a water surface elevation for input, this can lead to under-prediction if the surge is not taken into account. Figure 5.3-12, taken from Sheppard et al., *Design Hurricane Storm Surge Pilot Study, FDOT Contract No. BD 545 #42* (2006), displays wave simulation modeling of Hurricane Katrina at a location offshore of Mississippi. In the figure, the “Without SS” curve is the wave height simulated without the storm surge as an input boundary condition. The “With SS” curve includes storm surge as an input into the wave model. Including storm surge produces a four-meter increase in the predicted significant wave height.

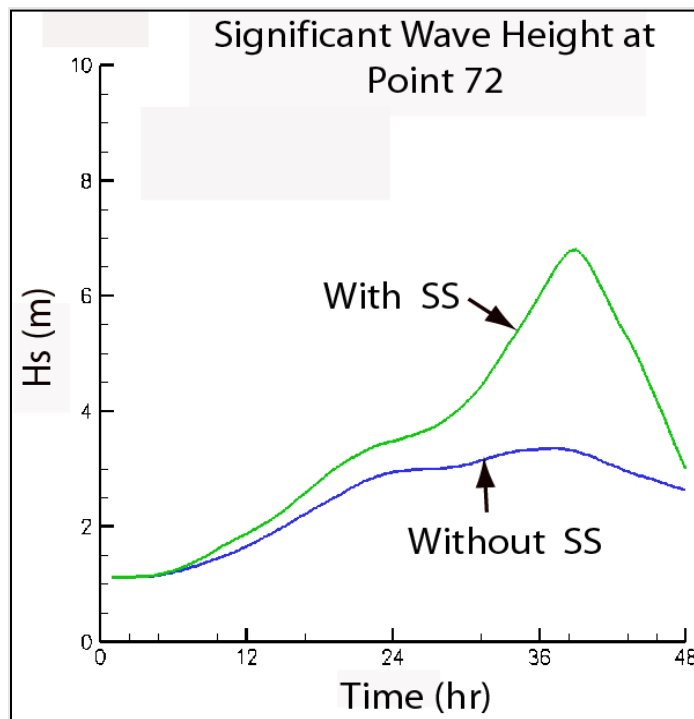

Figure 5.3-12: Wave Height Simulation during Hurricane Katrina with No Coupling (Without SS Curve) and with One-Way Coupling (With SS Curve) (Source: Sheppard et al., 2006)

With one-way coupling, input results (water elevations and currents) from the surge model into the wave model. This leads to more accurate prediction of the wave climate. With two-way coupling, transmit results from each model between the models at regular intervals. The wave model receives the simulated surge elevations and currents as an input, and the surge model receives the wave radiation stresses (a source term in the momentum equations that gives rise to wave setup) as an input. In general, two-way coupling provides the most accurate predictions.

5.3.4 Model Setup

Model setup involves development of the model inputs for the hydraulic or wave model. It includes defining the model domain, assigning friction (roughness), creating the model geometry, and developing boundary conditions.

5.3.4.1 Defining the Model Domain

The model domain is the spatial coverage of the model upstream of and oceanward of the bridge. The limits of the model extents are different for storm surge modeling than for riverine flood modeling. The model domain oceanward should extend to the point where

boundary conditions can be well described. For storm surge studies, this is generally the open coast. Application of storm surge hydrograph boundary conditions, developed for the open coast, at upland locations (e.g., at river entrances on estuaries or bays) will result in overly conservative estimates of both surge elevation and flow rate at the bridge location. If the model involves wind and pressure boundary conditions rather than a hydrograph, the model should extend far enough offshore to accurately describe the coastal effects (wind and wave setup) that contribute to the storm surge.

At a bridge, the accuracy of the surge hydrograph will be a function of the model resolution between the open coast and the bridge location. Definition of the major tidal waterways between the ocean and the bridge is recommended. Often, this includes extending the model not only from the closest tidal inlet to the bridge, but also to nearby inlets as well. This is particularly true for bridges located on or near intracoastal waterways.

Flow through the bridge is a function of the storage upstream (inland) of the bridge. The model domain should extend far enough upstream and upland to accurately describe the flow prism during the surge event. Underestimating the storage area upstream of a bridge will result in underestimation of flow and scour at the site.

Definition of wave model extents will depend on the purpose of the wave model. If the modeling results will provide wave radiation stresses for the surge model, then the wave model should include similar offshore and lateral extents as the surge model as well as the interior waters. If the purpose of the wave model is only to provide local wave conditions at the site, then the model should extend from the bridge to the shoreline in all directions so that the fetch (distance that the wind blows over a water body) is adequately described in all directions.

5.3.4.2 Roughness Selection

Specification of the roughness parameters for tidal analyses follows the same procedures as for riverine conditions (Section 5.2.4.2). Some surge models can include different bottom stress parameterizations. For example, ADCIRC provides options for linear and quadratic bottom friction assignment in addition to a Manning's n formulation. Refer to the individual model documentation for roughness specification other than Manning's coefficient. Most wave models also include options for bottom friction. For example, the SWAN model includes frictional dissipation via the methodologies of JONSWAP, Collins, and Madsen. Again, refer to the software documentation for recommended values of friction parameters.

Roughness values through developed areas, inundated during the surge, are especially difficult to predict. The density of buildings is a key influence on roughness in these areas. Calibration data are helpful in targeting the proper roughness value.

5.3.4.3 Model Geometry

Model geometry refers to the spatial resolution incorporated into the model to describe the waterway bathymetry and overbank topography. For one-dimensional models, this refers to not only the cross section locations, but also the number of points across the cross section. For two-dimensional models, this refers to the nodes and elements that comprise either the finite element mesh or the finite difference grid.

One-Dimensional Models

Specification of one-dimensional model geometry for tidal analyses follows the same recommendations as for riverine analyses (Section 5.2.4.3.1). In general, the only difference is the size of the model domain, which is discussed in Section 5.3.4.1.

Two-Dimensional Models

Specification of two-dimensional model geometry for tidal analyses follows the same recommendations as for riverine analyses (Section 5.2.4.3.2). Again, the only difference is the size of the model domain, discussed in Section 4.4.1, which can extend into the offshore area. Adequate resolution should be incorporated into the model to resolve tidal inlet and offshore features (such as flood and ebb shoals, or coastal structures) that affect the flow properties of the inlets.

5.3.4.4 Boundary Conditions

Boundary conditions for tidal analyses depend upon the types of simulations, the models employed, and site-specific properties. One-dimensional modeling of coastal bridges during surge events typically involves specification of an upstream flow boundary condition and an oceanward stage boundary condition where the stage is an open coast hurricane hydrograph. Two-dimensional surge modeling has more options for boundary conditions. These can include:

- Specifying the stage and flow similar to the one-dimensional model
- Specifying the same boundary conditions as above, with an additional wind boundary condition specified over the entire model domain
- Specifying tidal constituent boundary conditions on the offshore, upstream flow, and meteorological forcing (wind and pressure) at each node

This section describes several of the possible model boundary conditions for coastal bridge hydraulics analyses.

Upstream Flow Boundary Conditions

Specification of upstream flow boundary conditions follows the same recommendations as those for riverine flow boundary conditions (Section 5.2.4.1), with some exceptions. In tidal analyses in Florida, inland boundaries typically are located far from the bridge locations. This is done to accurately describe the storage inland of the bridge, which is a significant factor in determining flow through the bridge. In general, bridges over low-elevation, wide floodplains inland will experience more flow during a surge than bridges over high-elevation, narrow floodplains inland. This is because low-elevation, wide floodplains have substantial storage compared to high-elevation, narrow floodplains. The greater storage makes the floodplain less responsive to incoming flood flow of a storm surge, so the stage of low-elevation, wide floodplains rises more slowly than for floodplains with less storage. This creates a greater difference in water surface across the bridge, which increases the flow rate through the bridge.

The hydrology for the boundary condition should be developed for the bridge location rather than at the location where the boundary condition is applied. Hurricane hydrology is discussed in Section 5.3.2.

Storm Surge Hydrographs

A frequent type of coastal bridge hydraulics analysis involves application of an open coast storm surge hydrograph as the oceanward boundary condition. Fortunately, in Florida, several agencies have developed coastal surge elevations associated with several return period intervals. In a study for the Department, Sheppard and Miller (2003) reviewed the literature to determine what information was available regarding 50-, 100-, and 500-year return interval open coast storm surge peak elevations and time history hydrographs. Based on information from the literature review, the study developed recommendations for selecting ocean boundary conditions for modeling inland storm surge propagation in Florida's coastal waters. From their findings, Sheppard and Miller recommended that the Department employ the storm surge heights for 50-, 100- and 500-year return interval hurricane storm surges developed by the FDEP. This recommendation was made on the basis that FDEP had included all of the major surge generation mechanisms (astronomical tides, wind setup, wave setup, etc.) in their analyses and that they had compared their results with near coast water marks in buildings where possible. One shortcoming of the FDEP values was that only the counties with sandy beaches (25 of the 34 coastal counties) in Florida were analyzed by FDEP. To address this problem, Sheppard and Miller developed surge elevations by interpolating values from the surrounding counties using FEMA and NOAA results as guides. Figure 5.3-13 presents the locations of the FDEP-developed elevations, as well as the locations of the interpolated elevations (in italics).

simulation represented by line labeled Surge Only, the wind speeds in the boundary condition file were set to zero only at inland locations. Thus, this line represents the case where surge at the bridge is only created from propagation of the surge hydrograph inland.

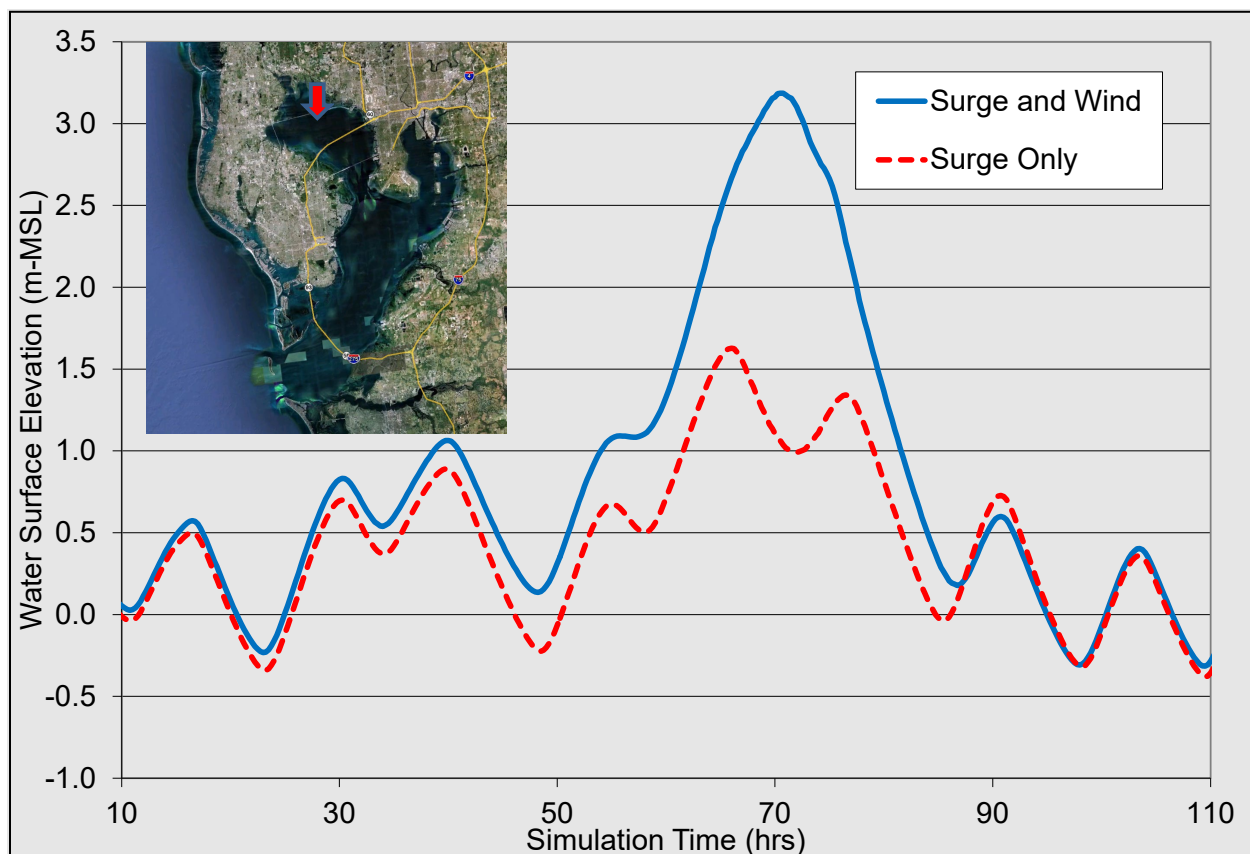

Figure 5.3-14: Surge Elevations at the Courtney Campbell Bridge Location during the 1852 Unnamed Hurricane both with and without Local Wind Effects

Another example of how bridge location affects the importance of wind setup is seen in the hindcast of Hurricane Ivan in 2004 that made landfall near Pensacola, Florida. Figure 5.3-15 displays the calculated storm surge elevation time series at the Interstate 10 (I-10) Bridge over Escambia Bay (red line) and at the Pensacola Bay Bridge (blue line). Located near the back of Escambia Bay, the I-10 Bridge experienced a significantly higher storm surge than did the Pensacola Bay Bridge even though the Pensacola Bay Bridge was located nearer to the inlet. This is directly attributable to the wind setup that occurred near the back of Escambia Bay.

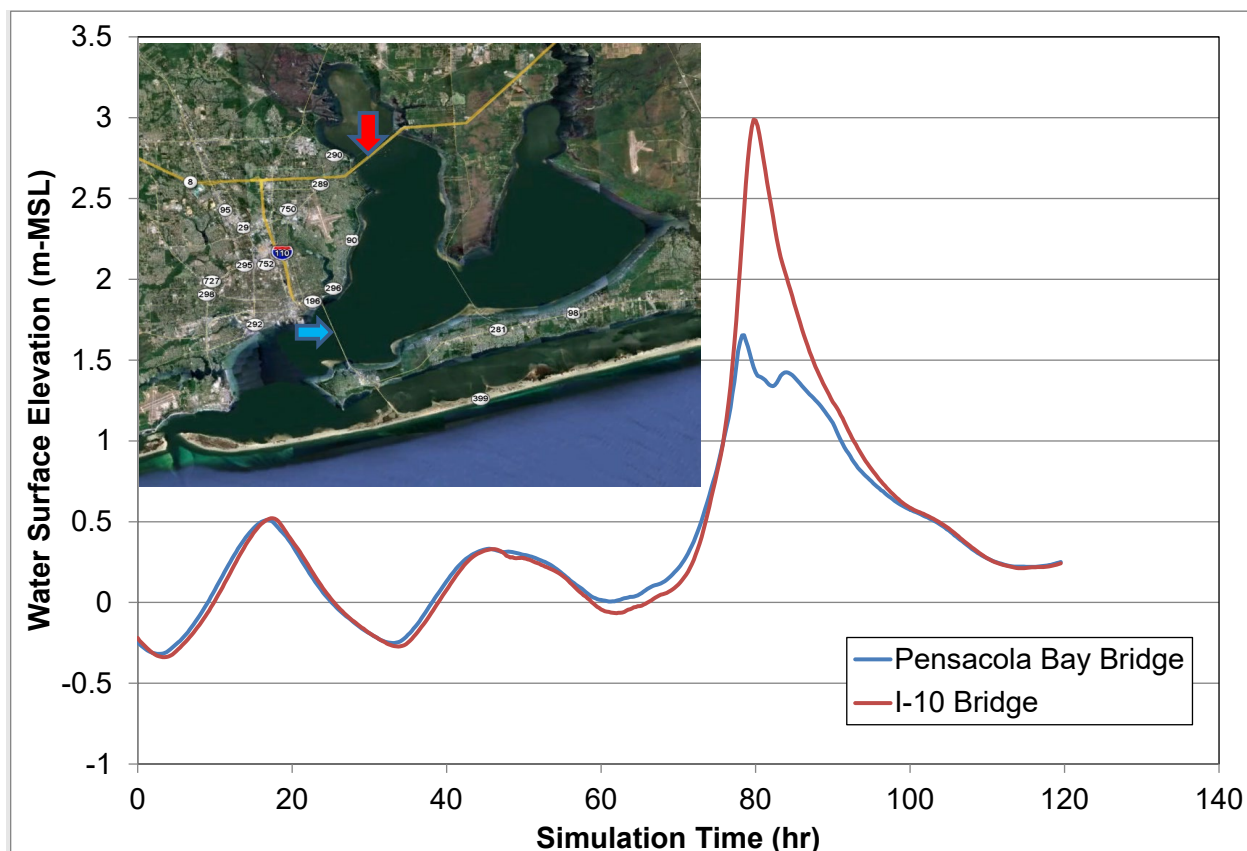

Figure 5.3-15: Hindcasted Surge Elevations at the I-10 over Escambia Bay Bridge and Pensacola Bay Bridge during Hurricane Ivan 2004.

Figure 5.3-15 shows that hurricane winds can play a major role in describing surge propagation. The reference *AASHTO Guide Specifications for Bridges Vulnerable to Coastal Storms* (AASHTO 2008) provides a methodology for determining peak design wind speeds for a number of mean recurrence intervals. It references ASCE Standard 7-05 as the source for determining design wind speeds throughout the country. The *AASHTO Specification* also states that if design coastal storm wind speeds exist at a site, then these values should be used.

In Florida, Dr. Michel Ochi at the University of Florida (Ochi, 2004) presents a methodology for predicting the hurricane landfall wind speeds along the Florida coast. He examined tropical cyclones (including hurricanes) that landed on or passed nearby the Florida coast from the NOAA hurricane database HURDAT. He divided the Florida coast into 15 districts (Figure 5.3-16), and developed expected extreme values for different return periods. Table 5.3-3 gives the expected maximum sustained (1-min average) wind speed for landfalling hurricanes calculated from Ochi's methodology.

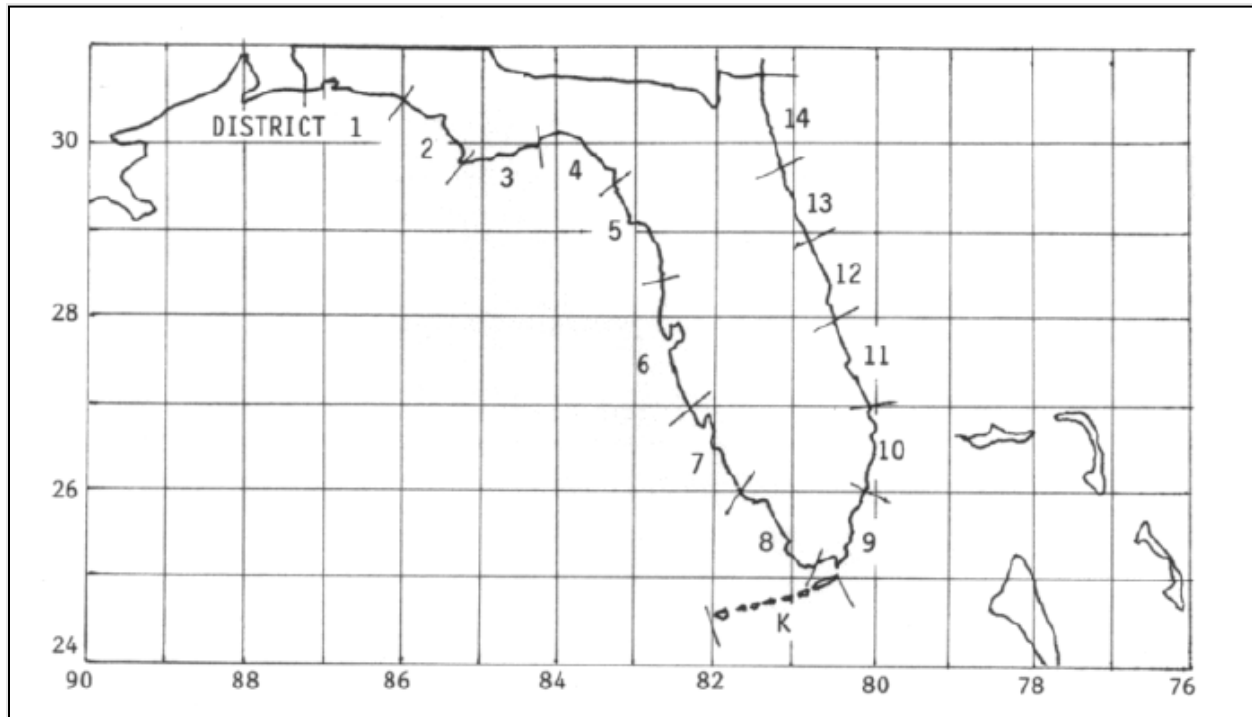

Figure 5.3-16: Locations of Coastline Division Employed in Wind Speed Analysis by Ochi (2004) (Source: Ochi, 2004)

Table 5.3-3: Example of Extreme Landfall Wind Speeds for Florida using the Ochi Methodology

| District* | Most Probable Maximum Sustained Wind Speed (mph) | | |
|-----------|--|----------|----------|
| | 50-year | 100-year | 500-year |
| K | 130.9 | 141.4 | 162.3 |
| 1 | 110.5 | 120.5 | 140.5 |
| 2 | 107.0 | 116.6 | 135.7 |
| 3 | 97.5 | 107.5 | 127.5 |
| 4 | 82.9 | 88.8 | 100.3 |
| 5 | 104.0 | 115.3 | 138.4 |
| 6 | 89.7 | 101.3 | 125.1 |
| 7 | 96.8 | 112.4 | 144.9 |
| 8 | 127.1 | 137.9 | 159.4 |
| 9 | 136.5 | 148.0 | 171.2 |
| 10 | 140.2 | 147.7 | 162.8 |
| 11 | 104.0 | 112.0 | 127.6 |

* Districts 12-14 did not have enough storm impacts to generate a confident statistical analysis.

Hurricane Hindcasts

Hurricane hindcasts simulate the wave and surge climate associated with a unique historical hurricane (Section 5.3.5). These types of simulations are performed primarily with two-dimensional models. Boundary conditions typically take the form of temporally and spatially variable wind and pressure fields (meteorological boundary conditions) applied over the entire model domain. Additional boundary conditions include an offshore stage boundary condition equal to the daily tidal fluctuation at the condition locations. This can take the form of either specified tidal elevation time series (e.g., tidal hydrographs) or be a feature of the model as selected tidal constituents (e.g., ADCIRC). The best source for tidal hydrographs is NOAA's Center for Operational Oceanographic Products and Services (<https://tidesandcurrents.noaa.gov/products>) for real-time and measured tidal gage data, as well as tidal prediction.

Hurricane wind and pressure fields can be developed in a number of ways. They range from simple analytic models (e.g., Holland, 1980) to three-dimensional modeling. Several agencies—including FEMA, NOAA, and USACE—have performed hindcasts of specific storms. These hindcasts are available sometimes upon request. Additionally, several commercially available sources of hindcast data also exist.

5.3.4.5 Bridge

When constructing a model to simulate hurricane surge propagation and wave climate, you will need an accurate representation of the bridge and its influence on the hydrodynamic processes. In general, the same techniques employed for riverine analyses also apply to the analysis of coastal bridges during storm surges.

Roughness

Roughness specification at bridge cross sections for tidal analyses follows the same recommendations as for riverine analysis (Section 5.2.4.2).

Bridge Routine

Selection of the appropriate bridge routines for tidal analyses follows the same recommendations as for riverine analysis (Section 5.2.4.5).

Piers

Incorporating the effects of bridge piers into the hydraulic model for analysis of coastal bridges follows the same procedure as for riverine bridges (Section 5.2.4.5). For two-dimensional modeling, typically, you would not model piers directly because their planform areas are significantly smaller than the areas of elements that resolve the bridge openings. However, there are several options for including the effects of bridge piers. Several models incorporate the loss effects into the hydraulic computation routines. An example is FST2DH (part of FESWMS). FST2DH contains an automatic routine that accounts for the effect of piers or piles on flow by increasing the bed friction coefficient within elements that contain them (Froelich 2002). ADCIRC also contains routines for incorporating the effects of bridge piers through a loss term in the momentum equations due to the pier drag (<http://adcirc.org/home/documentation/special-features/>).

Gosselin et al. (2006) examined the effects of resolving bridge piers through element elimination in cases where the pier width was a large percentage (5 percent to 35 percent) of the overall bridge cross section top width. The piers were incorporated by deleting elements within the mesh occupied by the piers. The authors compared results of the two-dimensional modeling with one-dimensional modeling results for the same geometry and flow conditions. The results compared well at the bridge cross section, but compared poorly downstream of the piers. The authors concluded that whereas the one-dimensional model incorporates the frictional losses from the piers through an increase in the wetted perimeter, by modeling the piers through element deletion, the two-dimensional model does not account for frictional losses if using a slip boundary condition along the model edges. Rather, you can attribute losses from the piers to the momentum losses associated with the creation of the secondary flows around the piers and in the wake region.

Regarding wave models, most publicly available software does not include effects of bridge piers on wave propagation.

5.3.5 Simulations

Following construction of the surge and wave model domains, development of the boundary conditions, and specification of the input model parameters, you can begin running the model simulations. This section describes the model simulations typically performed as part of the hydraulic analysis of a coastal bridge.

5.3.5.1 Model Calibration

Before performing design simulations, you should calibrate the surge and wave model properly. Typically, you evaluate model performance through calibration and verification both qualitatively and quantitatively, involving both graphical comparisons and statistical tests. For surge models, calibration should include both tidal propagation simulations and historical storm events. For wave models, calibration is achieved by comparing tidal simulations for a period of record to either measured data collected at specific locations or to widely available NOAA predictions at several locations. FEMA (2007) recommends that your calibration results for amplitude variation throughout the domain and phase variation be within 10 percent. In general, you typically do not perform flow rate or velocity calibration because of lack of reliable data. Flow calibration is more difficult to achieve than for water surface elevation data. However, if these data are available, acceptable limits for calibration should be more generous than those for tidal amplitude, yet still provide reasonable representation of the flow. FEMA also indicates that failure to achieve calibration may be indicative of inadequate grid resolution, especially at inlets and other critical points. Zevenbergen et al. (2005) provides a thorough description of model troubleshooting, including suggestions for addressing model execution failures, numerical instability, and calibration problems. These suggestions are contained in Table 5.3-4:

Table 5.3-4: Suggestions for Model Calibration (Source: Zevenbergen et al. (2005))

| If a model fails to execute, check: | The causes of numerical instability are: | Model calibration will be affected by: |
|---|--|--|
| <ul style="list-style-type: none"> • Program output error messages • Missing input data • Incorrect input data • Missing input files • Inconsistent input data | <ul style="list-style-type: none"> • Computational time step too long • Lack of geometric refinement • Wetting and drying problems • Weir flow | <ul style="list-style-type: none"> • Appropriate model extents • Accuracy of model bathymetry • Correct datum conversions for bathymetry • Correct datum conversions for tide gages • Inclusion of wind effects • Inclusion of appropriate upstream inflow |

Calibration to known storm events is significantly more complex than tidal calibration. Ideally, the calibration would include accurate measurements of both the model inputs (surge hydrograph or wind and pressure fields), as well as accurate surge measurements at locations throughout the model domain (gage measurements or high water marks). This is seldom the case. In fact, high water marks provide one of the more difficult data sources to calibrate to since they often contain effects of local wave climate and can vary significantly in close proximity to each other. If reliable information is available, calibration to a known storm event is ideal. Comparison of model results with gage data or high water marks helps identify problems with domain extents, model resolution, grid resolution, or friction assignment.

Calibration of wave models also is difficult because calibration data are rarely available. If you can acquire the data, then the calibration process should involve qualitative and quantitative comparisons of measured and simulated wave height, period, and direction. However, if measurements are unavailable, then the coastal engineer should demonstrate that the wave model simulations provide reasonable results, were performed employing accepted standards for input parameters, and incorporate an appropriate level of conservatism.

5.3.5.2 Storm Surge Simulations

Storm surge simulations should include, at a minimum, the design and check events for scour and the design frequency event for the bridge as specified in Section 5.1.3 (e.g., the 50-year for mainline interstate, high use, or essential bridges). Results from the simulations include time series of water surface elevation, velocity, and flow rate. Extract simulation results not only at the bridge cross section, but at locations upstream of the bridge piers (for local pier scour calculation). The length of the bridge dictates the number of locations. For shorter bridges, extracting conditions at the location of the maximum velocity will be sufficient. For longer bridges, there will be greater variation in velocity magnitude and direction. Thus, you should extract results at a greater number of locations to resolve the variation. Extract flow rates and water depths upstream of the bridge constriction for contraction scour calculations.

Figure 5.3-17 displays an example of water surface elevation and velocity time series during the 100-year return period hurricane through Wiggins Pass near Naples, Florida. The figure is typical of storm surge propagation through coastal waters. A peak in velocity magnitude precedes the peak in water surface elevation as the surge propagates inland. A second peak in velocity magnitude occurs as the surge recedes. The magnitude, phase, and duration of the velocity magnitude peaks are a function of the shape of the surge hydrograph and the response of the interior waterways.

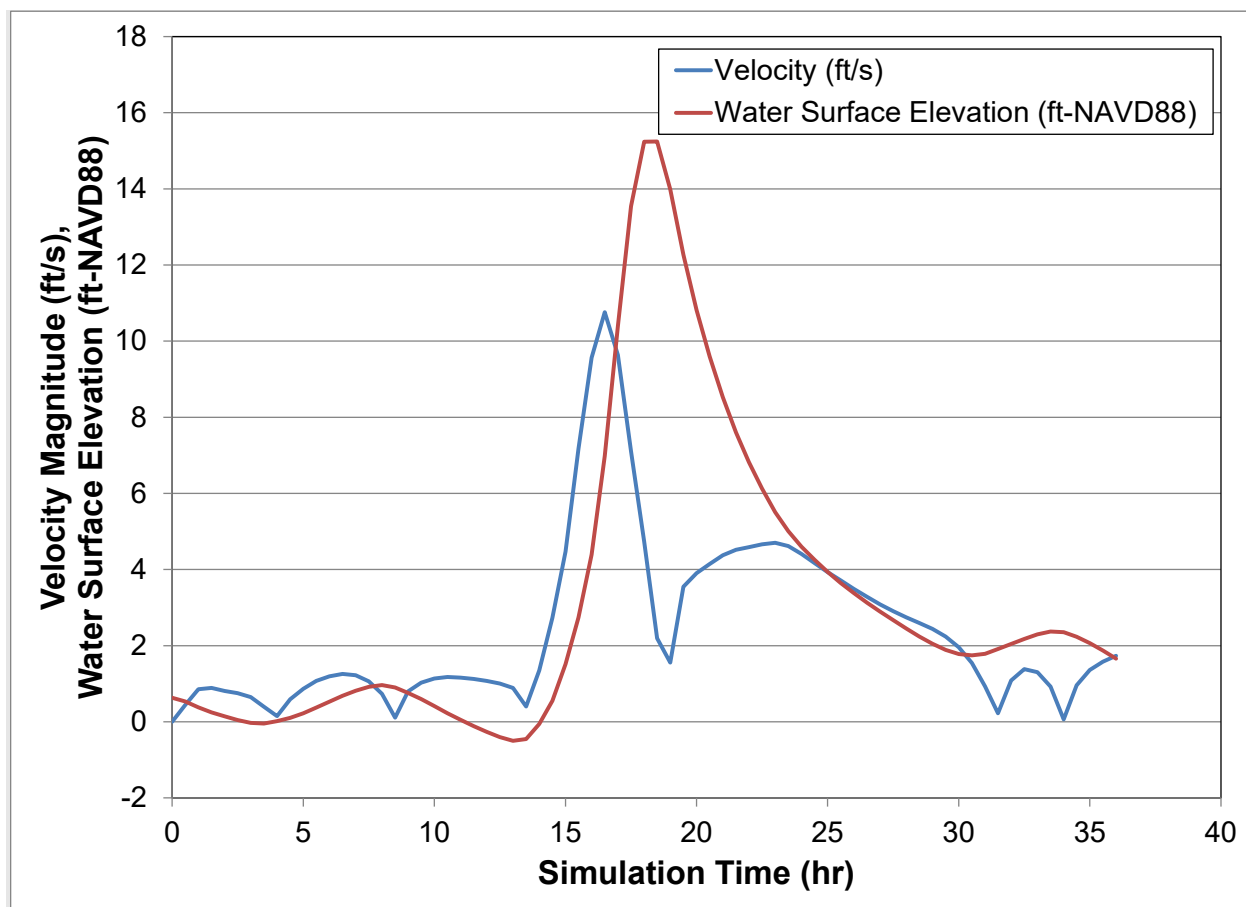

Figure 5.3-17: Example of Water Surface Elevation and Velocity Time Series during the 100-year Return Period Hurricane through Wiggins Pass near Naples, FL

5.3.5.3 Design Considerations

Typically, coastal bridges are not located in FEMA floodways and are not examined for their effects on backwater. As the designer, you would select the bridge location and profile for reasons related to right of way, environmental impacts, navigation, corrosion, etc., rather than for bridge hydraulics (backwater impacts). Review the recommendations contained in Section 5.2.5.3 for riverine studies to determine whether they apply for a particular coastal bridge location. Situations that do require comparison of existing and proposed conditions include: major modifications to the bridge profile or to the floodplain (e.g., causeway islands), bridge replacements that transition from spill-through to wing-wall abutments, etc.

An additional design consideration involves vessel collision. The LRFD specifications require using the “average current velocity across the waterway.” Determining this

velocity for tidal flows requires a separate simulation of the spring tidal flows. The average current velocity should correspond to the peak velocity occurring over this simulation.

5.3.5.4 Wave Simulations

Wave parameters are necessary both for calculation of wave forces on bridge superstructures and for design of abutment protection. According to AASHTO (2008), calculate wave forces (discussed in Section 5.3.5.6) from 100-year return period wave conditions only. Similarly, design abutment protection to resist the 100-year wave conditions. The wave model should simulate, at a minimum, the 100-year return period hurricane-generated wave conditions at the site.

Time-dependent (unsteady) wave modeling gives more accurate design wave conditions at the bridge location. As an alternative, steady-state modeling of the wave conditions during the peak storm surge provides sufficient, though conservative, design conditions. Inputs to the wave modeling will include design wind speeds, water surface elevations, bathymetry/topography, and wind direction. If the wind direction is unknown, the wave modeling should include, at a minimum, steady-state simulations of the wind field along the direction of the longest fetches (Figure 5.3-18).

Wave models typically provide the significant wave height and the peak period. The significant wave height is a statistical parameter representing the average of the highest one-third of the waves in a wave spectrum. The peak period is the wave period corresponding to the maximum of the wave energy spectrum. For design of bridge superstructures, AASHTO recommends employing the maximum wave height rather than the significant wave height. The AASHTO equation for converting between the two is $H_{\max} = 1.80 H_{\text{significant}}$.

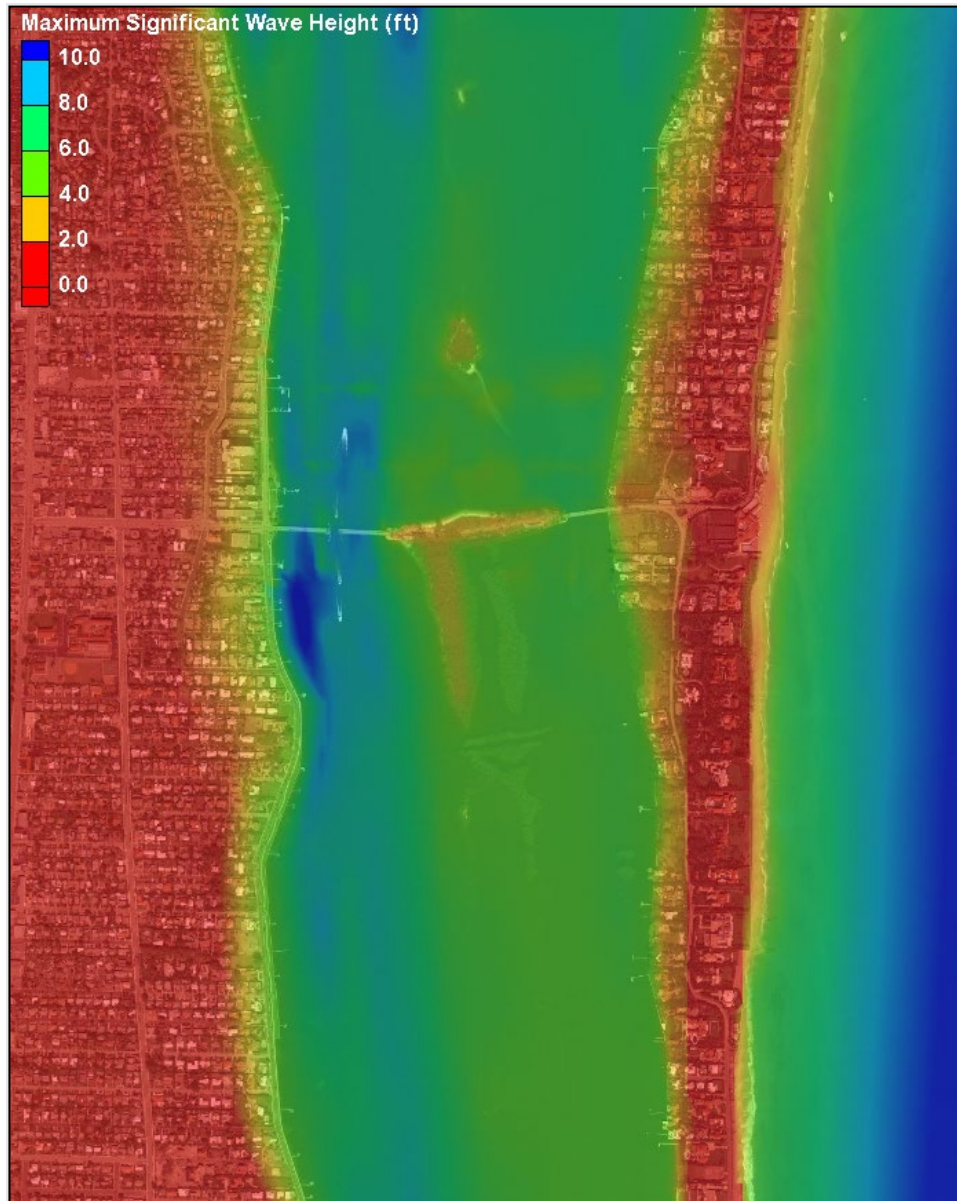

Figure 5.3-18: Example of Significant Wave Height Contours from Wave Modeling

5.3.6 Wave Forces on Bridge Superstructures

Bridge design must consider wave forces on bridge superstructures to prevent the type of damage experienced at the I-10 bridge over Escambia Bay during Hurricane Ivan in 2004 (Figure 5.3-19). Section 4.9.5 of the *Drainage Manual* and Section 2.5 of the *Structures Design Guidelines* address wave forces on bridge superstructures. The bulletin provides guidance on applying the specifications in the *AASHTO Guide Specifications for Bridges Vulnerable to Coastal Storms* to Department bridges. For bridges spanning waters subject to coastal storms, it states that the superstructure low

chord must have a minimum one-foot vertical clearance above the 100-year design wave crest elevation. If this clearance cannot be met, the bridge superstructure should be raised as high as feasible and the bridge superstructure designed to resist storm wave forces. For these bridges, the design strategy depends on the importance/criticalness of the bridge when considering the consequences of bridge damage caused by wave forces. If you judge a bridge to be extremely critical, you would design it to resist wave forces. Bridges that you might judge to be non-critical do not require evaluation for wave forces.



Figure 5.3-19: Damage to the I-10 Bridge over Escambia Bay during Hurricane Ivan (2004)

Figure 5.3-20 defines the parameters involved in estimating wave forces and moments on bridge superstructures from the *AASHTO Specifications*. The interaction between the wave and bridge superstructure produces vertical (uplift) forces, horizontal forces, and over-turning moments. Computing design surge/wave-induced forces and moments on bridge superstructures requires knowledge of the meteorological and oceanographic (met/ocean) design conditions and the proper force and moment equations. The *AASHTO Specifications* provide methods to determine both.

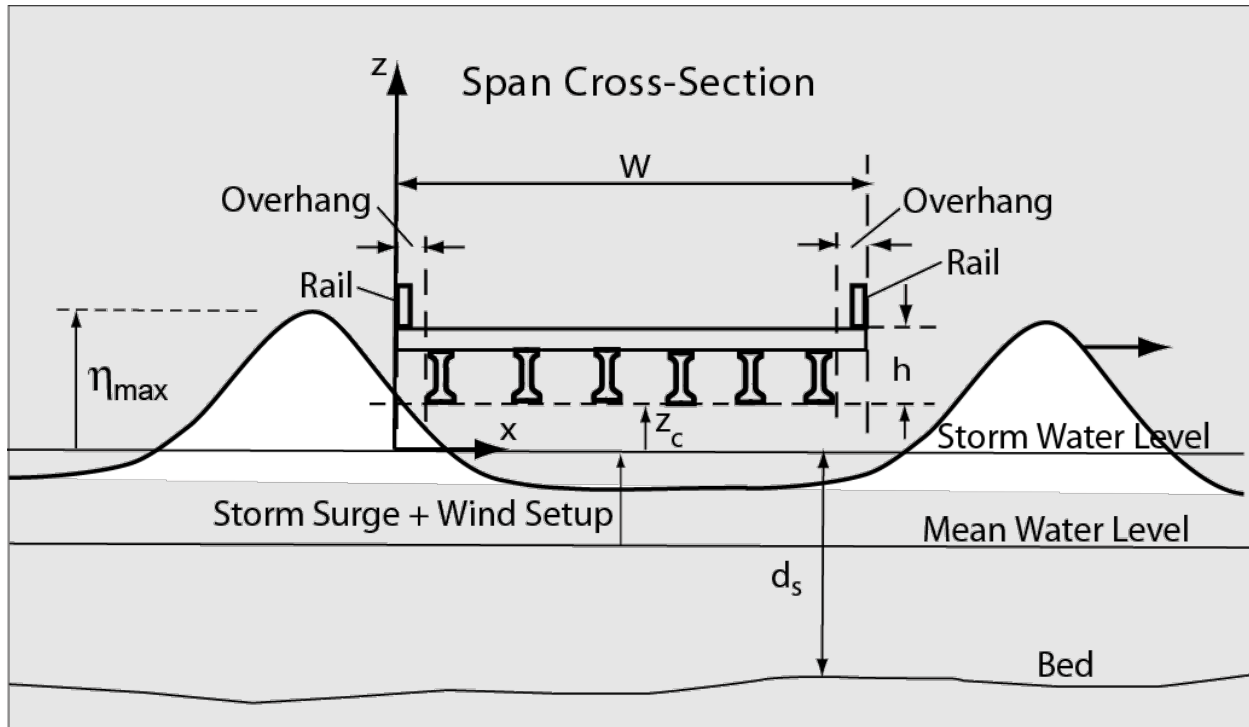

Figure 5.3-20: Definition Sketch for Wave Forces

The *AASHTO Specifications* provide a series of parametric equations for calculating the wave forces. There are two sets of equations—one corresponds to the time of the maximum vertical force and one corresponding to the time of the maximum horizontal force. For example, for the maximum vertical force, the vertical force is the maximum value experienced by the structure during passage of the design wave and the horizontal force and moment are the values at the time of maximum vertical force.

5.4 MANMADE CONTROLLED CANALS

Manmade controlled canals have the following typical characteristics:

- They will have some type of downstream control structure, such as salt water intrusion barriers, flood control weir, and/or pumps that will regulate the discharge.
- They will not normally flood out of bank, even in a 100-year storm.
- They have low design velocities—typically 1 fps to 3 fps—and often are subject to aggradation requiring periodic dredging to maintain the needed cross section
- Their abutments typically do not encroach into the cross section of the canal; therefore, there will be no contraction of flow and little backwater caused by the bridge.
- Even if there are piles in the flow of the canal, the design discharge will not create substantial scour around the piles because the velocity is low and the pile size typically is small.
- Usually, the canal owner can provide the hydraulic design discharge and stage.

Given the typically innocuous hydraulic and scour conditions at controlled canal bridges, you will find that the prudent level of effort required to perform the bridge hydraulics analysis is considerably less than for the typical bridge. In fact, you can abbreviate the traditional Bridge Hydraulics Report. Use the following outline for topics that should be included for controlled canals:

5.4.1 Introduction

- Bridge Location Map
- Waterway owner (LWDD, SFWMD, CBDD, etc.)
- Description of waterway: manmade, straight, controlled canal, etc.
- Use of canal: navigation, recreation, flood protection, irrigation, etc.
- Other unusual details

5.4.2 Watershed Description & Flow

- Basin map from Water Management District or permitting agency
- Any available information on drainage area: maps, acreage, control structures, etc.
- Design discharge and stage information from owner: usually 10- or 25-year (Note: If design frequency information is less than frequency requirements in the *Drainage Manual* for hydraulic or scour design, consult the District Drainage

Engineer. Also, if the design discharge and stage are not available, then a full bridge hydraulics analysis is needed.)

- Testimony from Bridge Inspection records: aggradation/degradation, condition of revetment, debris problems, etc.

5.4.3 Channel Excavation, Clearance, and Other Owner Requirements

- Required canal typical section from owner
- Lateral limits of channel excavation—usually 10 feet beyond bridge drip edge
- Any other pertinent information from owner: sacrificial pile, bank overtopping, vertical and horizontal clearance requirements, etc.

5.4.4 Scour Estimation

- General scour—usually none due to lack of natural meander and tendency toward aggradation
- Contraction scour—none if no overbank flow, unless pile blockage is > 10 percent of the waterway width
- Typically, pier scour on controlled canals is less than five feet; with no additional general or contraction scour, the CSU equations may be used

5.4.5 Abutment Protection

- Refer to Minimum Abutment Protection in Section 4.9.1 of the *Drainage Manual*
- Boat wakes and wave impact may dictate more robust abutment protection than would be needed to protect for the flood flow velocities; consider this and document as needed
- Owner may have specific requirements for abutment protection

5.4.6 Bridge Deck Drainage

Refer to Section 3.9 of the *Drainage Manual*, and Appendix H and Section 5.6 of this document.

5.4.7 Appendix

- Correspondence with owner regarding canal design parameters and requirements
- Pictures from Bridge Inspection Reports, if significant
- Evidence of field review

5.5 BRIDGE SCOUR

Lowering the streambed at bridge piers is referred to as bridge sediment scour or simply bridge scour. Bridge scour is one of the most frequent causes of bridge failure in the United States and a major factor that contributes to the total construction and maintenance costs of bridges in the United States. Under-predicting design scour depths can result in costly bridge failures and possibly in the loss of lives; while over-predicting can result in significant construction cost increases. For these reasons, proper prediction of the amount of scour anticipated at a bridge crossing during design conditions is essential. Policy on scour estimates can be found in the Section 4.9.2 of the *Drainage Manual*.

For new bridge design, bridge widenings, and evaluation of existing structures, develop scour elevation estimates for each pier/bent for the following conditions:

1. Worst-case scour condition (long-term channel processes, contraction scour and local scour) up through the design flood event (Scour Design Flood Event)
2. Worst-case scour condition (long-term channel processes, contraction scour and local scour) up through the check flood event (Scour Check Flood Event)
3. Long-term scour for structures required to meet the extreme-event vessel collision load; “long-term scour” refers to either everyday scour for live-bed conditions or the 100-year total scour for clear-water conditions; refer to Section 5.5.2 for further discussion

Include the components discussed in the following sections in your scour estimates.

5.5.1 Scour Components

For engineering purposes, sediment scour at bridge sites is divided into three categories:

1. Long-term channel processes (channel migration and aggradation/degradation)
2. Contraction scour
3. Local scour

5.5.1.1 Long-Term Channel Processes

Scour associated with long-term channel processes is the change in bed elevation associated with naturally occurring or manmade movement of the reach over which the bridge is located. These bed changes are characterized both as horizontal changes (channel migration) and as vertical changes (aggradation/degradation).

Changes upstream and downstream affect stability at the bridge crossing. Natural and manmade disturbances may change sediment load and flow dynamics, resulting in adverse changes in the stream channel at the bridge crossing. These changes may include channel bank migration, aggradation, or degradation of the channel bed. During aggradation or degradation of a channel, the channel bed and thalweg tend to accrete or erode.

Channel stability, as characterized by channel migration and aggradation/degradation of the channel bed, is an important consideration in evaluating the potential scour at a bridge for two reasons. First, because aggradation and degradation influence the channel's hydraulic properties and, second, because bank migration, thalweg shifting, and degradation may cause foundation undermining regardless of whether the bridge experiences the design event.

Channel Migration

Lateral channel migration is an important factor to consider when deciding on a bridge's location. Factors affecting lateral channel migration include stream geomorphology, bridge crossing location, flood characteristics, characteristics of the bed and bank material, and wash load (Richardson and Davis, 2001).

There are techniques to address channel migration in the FHWA document HEC 20 (Legasse et al., 2001). These techniques generally include critical examination/comparison of historical measurements/records combined with field observations to forecast future trends. Sources of historical records include bridge inspection records, historical maps, historical aerial photography, and historical surveys. In general, at bridges where the waterway exhibits a history of meandering, the hydraulics engineer should consider assuming that the elevation of the thalweg could occur at any point within the bridge cross section, including along the floodplain. If this conservative approach is excessively costly, it may be more cost-effective to mitigate potential future meander by river training or armoring.

Chapter 6 of HEC 20 (Legasse et al., 2001) provides procedures for predicting and evaluating lateral channel migration through aerial photograph analysis. See Section 5.2.1.3 for sources of aerial photographs.

A special case of migration found in coastal zones is inlet migration. Inlets either migrate along the coast or remain fixed in one location. This is due to a complex interaction between the tidal prism (volume of water transported through the inlet during tides), open coast wave energy, and sediment supply. Although many of Florida's inlets are improved through jetty construction and bank stabilization, several inlets are not—particularly along the southwest coast. New bridge construction and evaluation of existing structures over unimproved inlets should include a thorough investigation of the historical behavior of the inlet (through examination of historical aerial photographs and charts) to discern the

migration trends to incorporate into the foundation design/evaluation, as well as design/evaluation of the abutment protection. Types of inlet behavior can include:

- Updrift migration
- Downtdrift migration
- Fluctuations in inlet width and depth
- Spit growth and breaching (resulting in oscillation of inlet location)

A coastal engineer should perform the analysis of coastal hydraulics for the design and evaluation of bridges over tidal inlets. References and aids in design/evaluation include the USACE's EM 1110-2-1810 *Engineering and Design—Coastal Geology* (1995) and EM 1110-2-1100 *Coastal Engineering Manual* (2006).

Aggradation/Degradation

Aggradation and degradation relate to the overall vertical stability of the bed. Long-term aggradation and degradation refers to the change in the bed elevation over time over an entire reach of the water body. Aggradation refers to the deposition of sediments eroded from the channel or watershed upstream of the bridge resulting in a gradual rise in bed elevation. Degradation refers to the gradual lowering of the bed elevation due to a deficit in sediment supply from upstream.

Given the potential influence of changes in the watershed on stability at a bridge location, you must not only evaluate the current stability of the stream and watershed, but also the potential future changes in the river system (within reason). Examples of this include incorporation of watershed management plans or known planned projects (bridge/culvert replacements, dams, planned dredging, etc.) into evaluation of the vertical stability at the bridge location. As such, it is important that you perform the necessary data collection (including contacting local agencies) to become aware of future projects/plans and incorporate them appropriately into the analysis.

For information on aggradation/degradation in riverine environments, refer to FHWA's HEC 18 and HEC 20. For more information, refer to the U.S. Army Corps of Engineers' *Coastal Engineering Manual*.

For existing bridge locations, the most common evaluation of a channel's vertical stability is through examination of Bridge Inspection Reports. The reports (available upon request from the individual Districts) typically contain recent and historical inspection survey information. These surveys (typically lead-line surveys at each pier location on both sides of the bridge) are an excellent source of data on long-term aggradation or degradation trends. Additionally, inspection reports from bridges crossing streams in the same area or region also can provide information on the behavior of the overall waterway if

information at a new location is unavailable. For new alignments, a review of historical aerial photography is another method of channel stability analysis.

Estimate long-term vertical stability trends over the lifetime (for new projects) or remaining lifetime (for evaluations of existing bridge or widening projects) of the subject bridge. If the result is degradation, add the estimate at the end of the project life to the total scour. If the result is aggradation, then document the estimate in the BHR. However, do not include this estimate in the estimate of total scour. Rather, the existing ground elevation should serve as the starting elevation for contraction and local scour.

As with channel migration, inlet stability is a special case of vertical stability. Examining long-term trends through available historical information provides indicators of the inlet behavior over time. Additionally, inlet stability analyses can provide information on the evolutionary trends at the subject project. A qualified coastal engineer should perform these analyses. The references USACE's EM 1110-2-1810 *Engineering and Design—Coastal Geology* (1995) and EM 1110-2-1100 *Coastal Engineering Manual* (2006) provide additional resources.

5.5.1.2 Contraction Scour

Contraction scour occurs when a channel's cross section is reduced by natural or manmade features. Possible constrictions include the construction of long causeways to reduce bridge lengths (and costs), the placement of large (relative to the channel cross section) piers in the channel, the encroachment of abutments, and the presence of headlands (examples in Figure 5.5-1 and Figure 5.5-2). For design flow conditions that have long durations—such as those created by stormwater runoff in rivers and streams in relatively flat country—contraction scour can reach near equilibrium depths. Equilibrium conditions exist when the sediment leaving and entering a section of a stream is equal. Laursen's contraction scour prediction equations were developed for these conditions. A summary of Laursen's equations is presented below. For more information and discussion, refer to HEC 18.

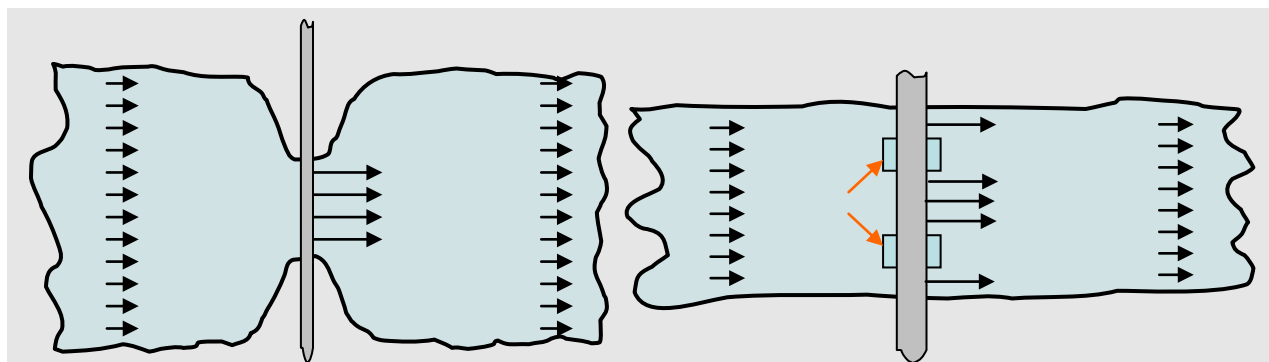

Figure 5.5-1: Examples of Contractions at Bridge Crossings



Figure 5.5-2: Example of Manmade Causeway Islands Creating a Channel Contraction

Steady, Uniform Flows

Laursen's contraction scour equations (Laursen, 1960), or rather a modified version of the equations recommended by HEC 18, were developed for steady uniform flow situations. This methodology provides the estimation of contraction scour for most bridge locations. However, predictions using these equations tend to be conservative, since the rate of erosion decreases significantly with increased contraction scour depth. Laursen developed different equations for clear-water and live-bed scour flow regimes. If the estimates of contraction scour via these equations are deemed too conservative (through application of engineering judgment), you may pursue alternative analyses, including sediment transport modeling. In these situations, consult the District Drainage Engineer regarding the need to perform such an analysis.

A brief summary of the HEC 18 equations are presented below. Refer to HEC 18 for more information.

Live-Bed Contraction Scour Equation

The live-bed scour equation assumes that the upstream flow velocities are greater than the sediment-critical velocity, V_c . The contraction scour in the section, y_s , is calculated from the equation below:

$$\frac{y_2}{y_1} = \left(\frac{Q_2}{Q_1} \right)^{\frac{6}{7}} \left(\frac{W_1}{W_2} \right)^{K_1}$$

$$y_s = y_2 - y_0 = \text{average contraction scour}$$

where:

- y_1 = Average depth in the upstream channel, ft
- y_2 = Average depth in the contracted section after scour, ft
- y_0 = Average depth in the contracted section before scour, ft
- Q_1 = Discharge in the upstream channel transporting sediment, ft³/sec
- Q_2 = Discharge in the contracted channel, ft³/sec
- W_1 = Bottom width of the main upstream channel that is transporting bed material, ft
- W_2 = Bottom width of the main channel in the contracted section less pier widths, ft
- K_1 = Exponent listed in Table 5.5-1

Table 5.5-1: Determination of Exponent, K_1

| V^*/ω | K_1 | Mode of bed material transport |
|--------------|-------|---|
| <0.50 | 0.59 | Mostly contact bed material discharge |
| 0.50 to 2.0 | 0.64 | Some suspended bed material discharge |
| >2.0 | 0.69 | Mostly suspended bed material discharge |

where:

- $V^* = (\tau_o/\rho)^{0.5}$, Shear velocity in the upstream section, ft/sec
- $\omega =$ Fall velocity of bed material based on the D_{50} , ft/sec (Figure 5.5-3)
- $g =$ Acceleration of gravity, 32.17 ft/sec² (9.81 m/s²)
- $\tau_o =$ Shear stress on the bed, lbf /ft² (Pa (N/m²))
- $\rho =$ Density of water, 1.94 slugs/ft³ (1,000 kg/m³)

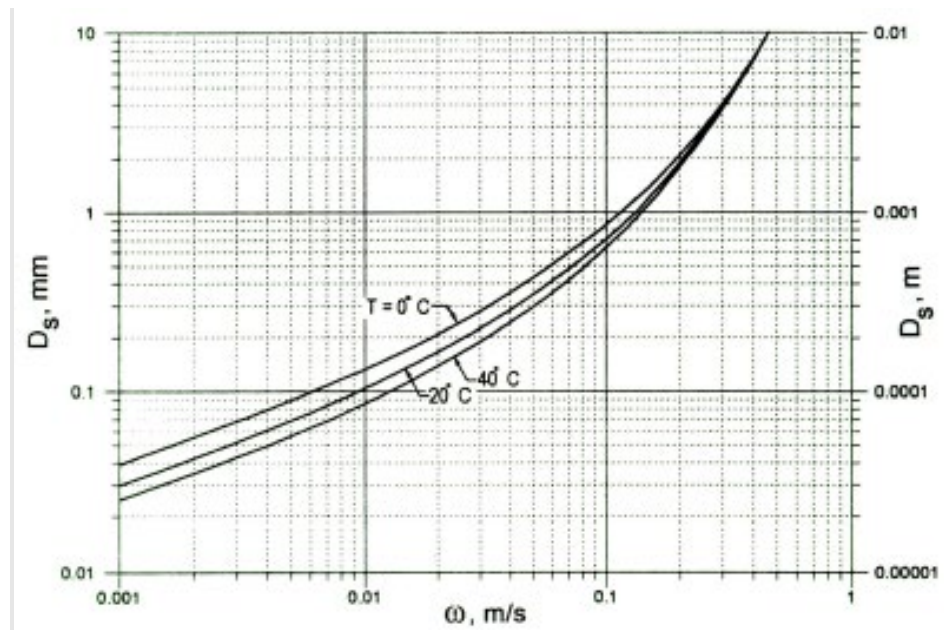

Figure 5.5-3: Fall Velocity of Sediment Particles with Diameter D_s and Specific Gravity of 2.65 (Source: HEC 18, 2001)

HEC 18 provides guidance for selecting upstream cross section locations, as well as the widths at the bridge and upstream cross sections. Notably, separate contraction scour calculations should be performed for the channel and left and right overbank areas (assuming they extend through the bridge). For cross sections that include multiple openings (including causeway bridges), upstream width selection involves delineating the flow patterns upstream of the bridge to properly identify the division of the flow from the upstream sections to the bridge.

As stated previously, application of this methodology may result in overly conservative estimates. See the subsection “Unsteady, Complex Flows” in this section for an alternative methodology for calculating contraction scour.

Clear-Water Contraction Scour Equation

The clear-water scour equation assumes that the upstream flow velocities are less than the sediment-critical velocity. The contraction scour in the section, y_s , is calculated from the equation below:

$$y_2 = \left[\frac{K_u Q^2}{\frac{2}{D_m^3 W^2}} \right]^{\frac{3}{7}}$$

$y_s = y_2 - y_o =$ average contraction scour

where:

$y_2 =$ Average equilibrium depth in the contracted section after contraction scour, ft

$Q =$ Discharge through the bridge or on the set-back overbank area at the bridge associated with the width W , ft³/sec

$D_m =$ Diameter of the smallest non-transportable particle in the bed material (1.25 D_{50}) in the contracted section, ft

$D_{50} =$ Median diameter of bed material, ft

$W =$ Bottom width of the contracted section less pier widths, ft

$y_o =$ Average existing depth in the contracted section, ft

$K_u =$ 0.0077 (English units) or 0.025 (SI units)

For a more detailed discussion of these equations, the reader is referred to HEC 18.

Unsteady, Complex Flows

Application of Laursen's modified contraction scour equations at locations that experience design flows that are either unsteady or exhibit a complex flow field sometimes results in overly conservative estimates of contraction scour. These situations include cases where: (1) the flow boundaries are complex, (2) the flows are unsteady (and/or reversing), and (3) the duration of the design flow event is short, etc. In these situations, an alternative to employing Laursen's modified equations is to perform two-dimensional flow and sediment transport modeling to estimate contraction scour depths (e.g., the USACE's RMA2 hydraulics model and SED2D sediment transport model). In these situations, consult the District Drainage Engineer regarding the need to perform sediment transport modeling.

5.5.1.3 Local Scour (Pier and Abutment)

You can divide local scour into pier and abutment scour. The main mechanisms of local scour are: (1) increased mean flow velocities and pressure gradients in the vicinity of the structure; (2) the creation of secondary flows in the form of vortices; and (3) increased turbulence in the local flow field. Two kinds of vortices may occur: (1) wake vortices downstream of the points of flow separation on the structure, and (2) horizontal vortices at the bed and free surface due to stagnation pressure variations along the face of the structure and flow separation at the edge of the scour hole.

You can divide local scour into two different scour regimes that depend on the flow and sediment conditions upstream of the structure. Clear-water scour refers to the local scour that takes place under the conditions where sediment is not in motion on a flat bed upstream of the structure. If sediment upstream of the structure is in motion, then the local scour is called live-bed scour.

For work in Florida, calculation of local pier scour must involve application of the Sheppard Pier Scour Equations detailed in the FDOT *Bridge Scour Manual* (Sheppard, 2005) rather than the CSU Pier Scour Equation when the total scour (long-term channel conditions, contraction scour, and pier scour) is greater than five feet. The Florida Complex Pier Scour Procedure is described in HEC 18, Fifth Edition. The Florida Complex Pier Scour Calculator and Procedure can be downloaded at:

<http://www.fdot.gov/roadway/Drainage/Bridge-Scour-Policy-Guidance.shtm> .

A brief overview of Sheppard's Pier Scour Equation and the Florida Complex Pier Scour Procedure are presented below. Refer to the FDOT *Bridge Scour Manual* for detailed guidelines and examples.

Sheppard's Pier Scour Equations

Sheppard's Pier Scour Equations target three dimensionless hydraulic and sediment transport parameter groups to predict scour at simple piers. You can apply the equation to both riverine and tidal flows and to sediment sizes typical within the continental U.S. The equations give good results for both narrow and wide piers. The FDOT *Bridge Scour Manual* includes a detailed discussion. The pier scour equations are summarized below:

In the clear-water scour range:

$$\left(0.4 \leq \frac{V}{V_c} \leq 1.0\right)$$

$$\frac{y_s}{D} = 2.5 f_1 f_2 f_3$$

In the live-bed scour range:

$$\left(1.0 < \frac{V}{V_c} \leq \frac{V_{lp}}{V_c}\right)$$

$$\frac{y_s}{D^*} = f_1 \left[2.2 \left(\frac{\frac{V}{V_c} - 1}{\frac{V_{lp}}{V_c} - 1} \right) + 2.5 f_3 \left(\frac{\frac{V_{lp}}{V_c} - \frac{V}{V_c}}{\frac{V_{lp}}{V_c} - 1} \right) \right]$$

and in the live-bed scour range above five feet:

$$\left(\frac{V}{V_c} > \frac{V_{lp}}{V_c}\right)$$

$$\frac{y_s}{D^*} = 2.2 f_1,$$

where:

$$f_1 \equiv \tanh \left[\left(\frac{y_0}{D^*} \right)^{0.4} \right],$$

$$f_2 \equiv \left\{ 1 - 1.2 \left[\ln \left(\frac{V}{V_c} \right) \right]^2 \right\},$$

$$f_3 \equiv \left[\frac{\left(\frac{D^*}{D_{50}} \right)}{0.4 \left(\frac{D^*}{D_{50}} \right)^{1.2} + 10.6 \left(\frac{D^*}{D_{50}} \right)^{-0.13}} \right], \text{ and}$$

$$V_1 = 5V_c$$

$$V_2 = 0.6\sqrt{gy_0}$$

$$V_{lp} = \text{live bed peak velocity} = \begin{cases} V_1 & \text{for } V_1 > V_2 \\ V_2 & \text{for } V_2 > V_1 \end{cases}$$

where:

y_s = Equilibrium scour depth, ft

D^* = Effective diameter of the pier, ft

y_0 = Water depth adjusted for general scour, aggradation/degradation, and contraction

- scour, ft
- V = Mean depth-averaged velocity, ft/sec
- V_c = Critical depth-averaged velocity, ft/sec
- V_{lp} = Depth-averaged velocity at the live-bed peak scour depth, ft/sec
- D_{50} = Median sediment diameter, ft

Methodology for determining depth-averaged critical velocity and depth-averaged live-bed peak velocity are found in the FDOT *Bridge Scour Manual*.

Florida Complex Pier Procedure

Most large bridge piers are complex in shape and consist of several clearly definable components. While these shapes are sensible and cost effective from a structural standpoint, they present a challenge for those responsible for estimating design sediment scour depths at these structures. The Complex Pier Methodology applies to any bridge piers different from a single circular pile. They can be composed of up to three components referred to here as the column, pile cap, and pile group, as shown below in Figure 5.5-4.

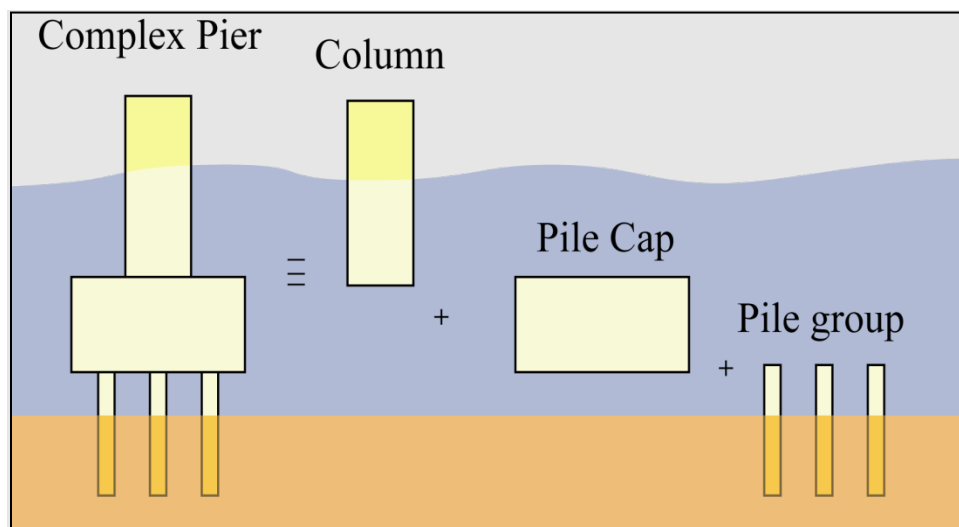

Figure 5.5-4: Complex Pier Components

The methodology is based on the assumption that a complex pier can be represented (for the purposes of scour depth estimation) by a single circular pile with an “effective diameter” denoted by D^* . The magnitude of the effective diameter is such that the scour depth at this circular pile is the same as that at the complex pier for the same sediment and flow conditions. The problem of computing equilibrium scour depth at the complex pier is, therefore, reduced to one of determining the value of D^* for that pier and applying Sheppard’s Pier Scour Equation to the circular pile for the sediment and flow conditions of interest. The methodology to determine the total D^* for the complex structure can be

approximated by the sum of the effective diameters of the components making up the structure, that is:

$$D^* = D_{col}^* + D_{pc}^* + D_{pg}^*$$

where:

- D^* = Effective diameter of the complex structure
 D_{col}^* = Effective diameter of the column
 D_{pc}^* = Effective diameter of the pile cap
 D_{pg}^* = Effective diameter of the pile group

The procedure for computing local scour depth for complex piers is further divided into three cases, as illustrated in Figure 5.5-5 below:

- Case 1 complex pier with pile cap above the sediment bed
- Case 2 complex pier with pile cap partially buried
- Case 3 complex pier with pile cap completely buried

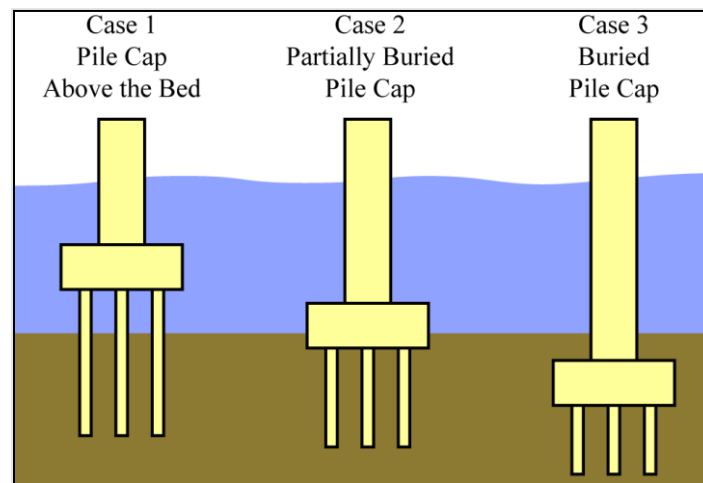

Figure 5.5-5: Three Cases of Local Scour Depth for Complex Pier Computations

Refer to the FDOT *Bridge Scour Manual* for a more detailed discussion on the procedure and the application of the equations.

HEC 18 also provides equations for calculating local scour at abutments. However, as stated in the Drainage Manual, abutment scour estimates are not required when the design provides the minimum abutment protection. Where you have significantly wide

floodplains with high-velocity flow around abutment, consider analyzing abutment spatial requirements using HEC 23.

5.5.1.4 Scour Considerations for Waves

Waves are an important factor that you must address when designing bridges exposed to long fetches. This is particularly true at bridge abutments and approach roadways. Figure 5.5-6 displays an example of the damage waves can cause during a hurricane event. The photograph shows the east approach to the I-10 Westbound Bridge over Escambia Bay after Hurricane Ivan. During the storm, waves breaking on the shoreline removed the undersized protection and eroded the fill at the approach slab, eventually undermining it. Proper design of abutment protection to withstand wave impact will be discussed in Section 5.5.4.

Many bridges in coastal environments incorporate seawalls into the design of abutment protection. Scour at vertical walls occurs when waves either break on or near the wall or reflect off the wall, thus increasing the shear stress at the bottom of the wall. This is known as toe scour. Toe scour decreases the effective embedment of the wall and can threaten the stability of the structure. Current USACE guidance (CEM, 2001) indicates that, as a rule of thumb, the depth of scour experienced in front of a vertical wall structure is on the same order of magnitude as the incident maximum wave height. Methodologies for designing toe scour protection are presented in Section 5.5.4.



Figure 5.5-6: East Approach to the I-10 WB Bridge over Escambia Bay After Hurricane Ivan (2004)

Regarding the impacts of waves on scour at bridge piers, laboratory modeling indicates that vertical piles subject to both waves and currents experience an increase in the effective shear stress at the bed. Additionally, there is an increase in the amount of suspended sediment and, thus, the sediment transport in the vicinity of the pile as compared with the transport associated with currents or waves alone. No current analytical methods are available for design purposes. However, some sediment transport models (e.g., SED2D) include methodologies for calculating the shear stress due to combined waves and currents.

5.5.2 Scour Considerations for Ship Impact

Piers designed to resist ship impact include in their load combinations estimates of “long-term scour.” This long-term scour is different from the long-term channel conditions discussed in the previous section. The previous information referred to the lateral or vertical long-term processes that occur at a bridge crossing over the lifetime of the bridge. Rather, the scour incorporated into design for ship impact is the scour that may be present at a pier when the impact occurs. For sites where everyday (normal daily) flows are in the clear-water regime—i.e., below the critical value for incipient motion of the bed sediments—this scour is the total 100-year scour for the structure. The reasoning is that if a design event occurs during the lifetime of the bridge, the daily flows are not sufficient to fill in the hole. For bridges where flows are in the live-bed regime, the “long-term scour” is the normal, everyday scour at the piers combined with the degradation and channel migration anticipated during the life of the structure. The reasoning here is that if the

structure experiences a design event, the flows are sufficient to refill the scour hole following such an event.

For bridge replacements, parallel bridges, major widenings, etc., Bridge Inspection Reports and the design survey should be the primary basis for determining normal everyday scour. If the proposed piers are the same as the existing piers, the normal, everyday scour elevation should be reflected in the inspection reports and the design survey (Figures 5.5-7 and 5.5-8). Slight differences in scour will likely exist between inspection reports and between the reports and the design survey. In these cases, an average scour elevation will be a reasonable estimate of normal, everyday scour. If there is a large difference, an extreme storm event may have occurred just before the inspection or survey. Investigate this and address it on a case-by-case basis.

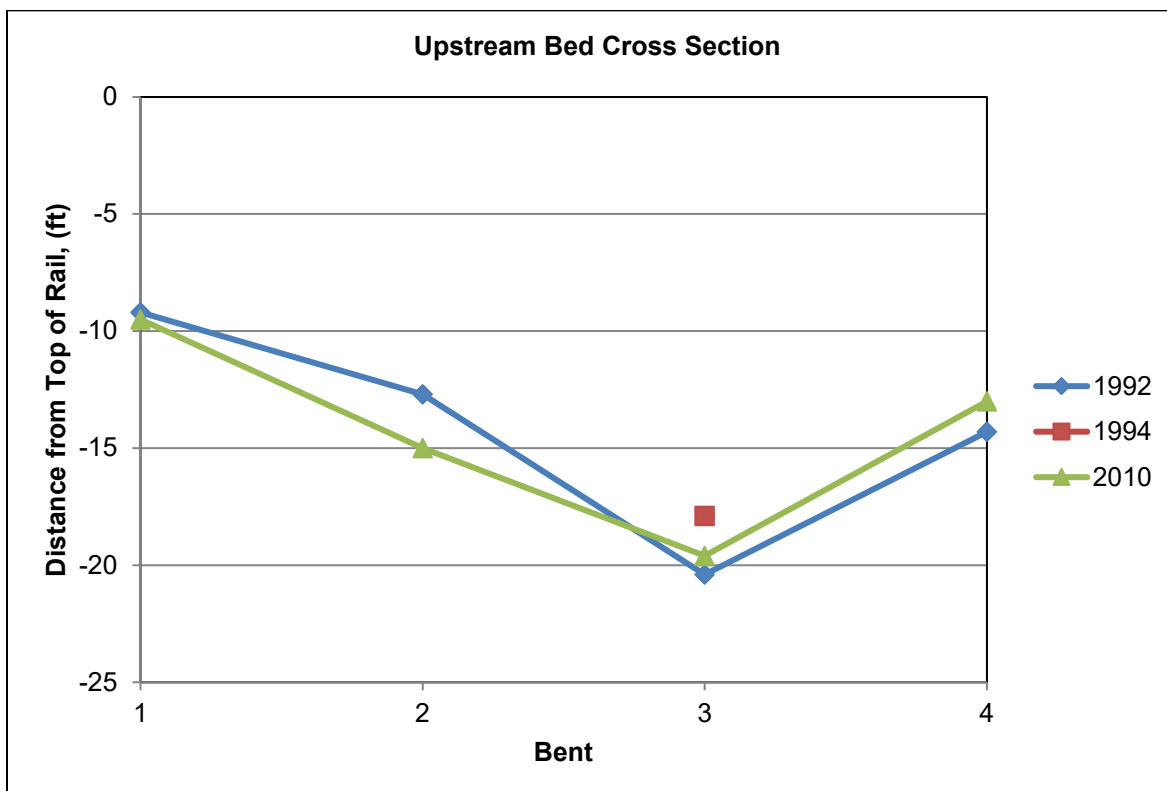

Figure 5.5-7: Example of Normal, Everyday Scour Holes from Bridge Inspection Data

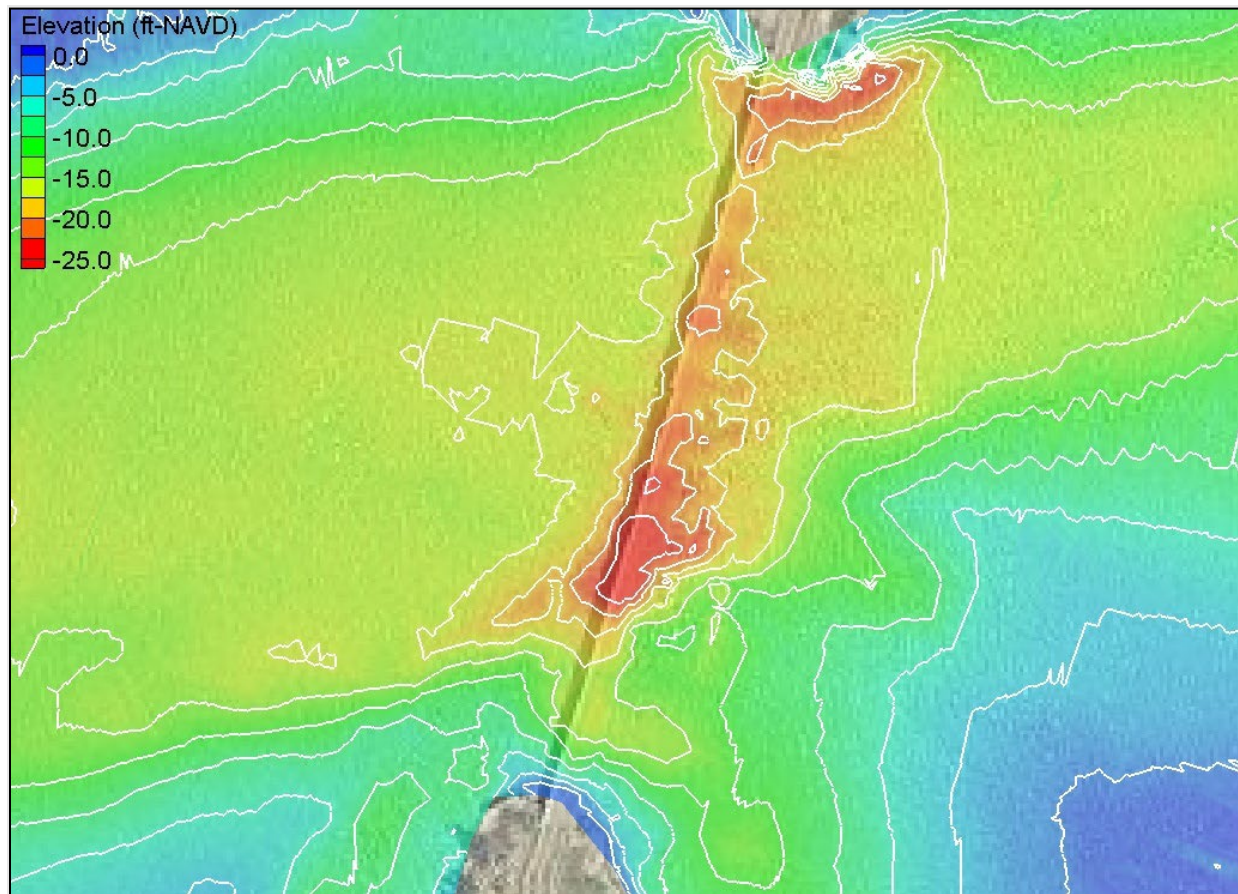

Figure 5.5-8: Example of Normal, Everyday Scour Holes from Survey Data

For structures in which the proposed piers will be a different size or shape than the existing or for new bridges/new alignments where there are no historical records available, base estimates of the normal everyday scour on hydraulic modeling results of expected daily flows. For riverine bridges, this should correspond to flows equal to the normal high water. For tidal flows, everyday flows correspond to the maximum flows experienced during spring tides.

5.5.3 Florida Rock/Clay Scour Procedure

The Florida Rock/Clay Scour Procedure was developed to address the scour resistance of cemented strata, rock, and clay. The procedure was originally developed for cohesive bed materials considered “scourable” according to FHWA guidelines. Refer to HEC 18, Fifth Edition, Chapter 4 for an explanation of rock characteristics that relate to strength and scour potential. Consult the District Drainage Engineer and the District Geotechnical Engineer before initiating the Rock/Clay Scour Procedure.

The test methods establish the shear stress response of soils and the procedure integrates that response over the lifetime of expected flows at the bridge site. The procedure involves establishing the shear stress response of a site-specific sample using the RETA (Rotating Erosion Test Apparatus) and SERF (Sediment Erosion Recirculating Flume) devices, shown below in Figures 5.5-9 and 5.5-10, respectively, and then integrating that response over the flows expected in the life of the bridge to predict contraction or local scour at the bridge.

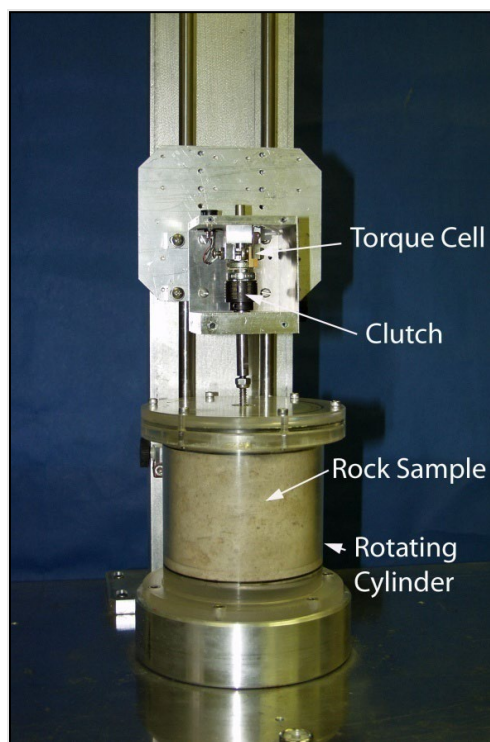

Figure 5.5-9: Rotating Erosion Test Apparatus (RETA, above)

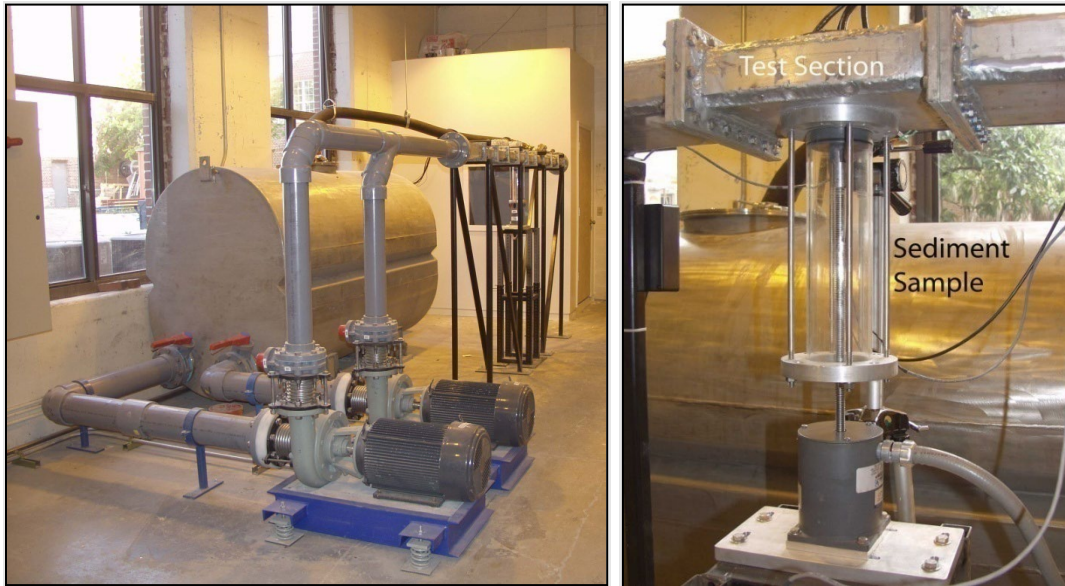

Figure 5.5-10: Sediment Erosion Recirculating Flume (SERF)

The procedure includes an appropriate amount of conservatism by incorporating the following assumptions: (1) the shear stress does not decrease within a local scour hole, (2) the bridge experiences an extremely aggressive bridge flow history over the bridge lifetime, (3) there is no refill of the predicted scour, and (4) only the more conservative of the RETA and SERF results of all cores tested for a particular bridge characterize the erosion properties of the bed. Districts should contact the State Drainage Engineer if scour-resistant soils are expected to be encountered in bridge design or the evaluation of existing bridge scour. The following link contains the FDOT Bridge Rock Scour Analysis Protocol and describes initiation of the process:

<http://www.fdot.gov/roadway/Drainage/Fla-Rockclay-Proc.shtm>

5.5.3.1 Pressure Scour

See HEC 18 for detailed information on pressure scour.

5.5.3.2 Debris Scour

See HEC 18 for detailed information on debris scour.

5.5.4 Scour Countermeasures

Scour countermeasures are defined as a measure intended to prevent, delay, or reduce the severity of scour problems. For this discussion, they address the class of armoring countermeasures (as defined by HEC 23, Legasse et al., 2009) to resist the erosive forces caused by a hydraulic condition. This section addresses scour countermeasures at both abutments and interior bents.

5.5.4.1 Abutment Protection

Proper bridge design includes abutment protection to resist the hydrodynamic forces experienced during design events. The *Drainage Manual* specifies the following minimum protection requirements:

Spill-Through Abutments

Where flow velocities do not exceed 7.7 fps, and/or wave heights do not exceed 2.4 feet, minimum protection consists of one of the following protection methods placed on a 1V:2H or gentler slope:

- Rubble riprap (Bank and Shore), bedding stone, and filter fabric—Rubble riprap (Bank and Shore) is defined in the FDOT *Standard Specifications for Road and Bridge Construction*, Section 530
- Articulated concrete block (cabled and anchored)—Articulating concrete block also is defined in Section 530
- Fabric formed revetment, also called grout-filled mattress (articulating with cabling throughout the fabric forms)

Create site-specific designs when using articulated concrete block or fabric formed revetment abutment protection. As of June 2020, the Department has Developmental Specification 531 for Fabric Formed Revetment Systems. The FDOT *Structures Detailing Manual* provides typical details for standard revetment protection of abutments and extent of coverage. Determine the horizontal limits of protection using HEC 23. Provide a minimum distance of 10 feet if HEC 23 calculations show less than 10 feet. Notably, neither grouted sand-cement bag abutment protection nor slope paving is considered adequate protection for bridges spanning waterways. Slope paving can develop cracks or upheaved slabs where loss of fill can occur. Grouted sand-cement bags often fail when cracks form around the individual bags and sediment is lost through cracks or displaced elements (Figure 5.5-11). Additionally, these systems are prone to failure due to undermining (erosion at the toe of the protection) or flanking (erosion at the edges of the protection) when the edges of the protection are not sufficiently buried.



Figure 5.5-11: Damage to Sand-Cement Grouted Riprap Abutment Protection

Determine the horizontal and vertical extents, regardless of protection type, using the design guidelines contained in HEC 23. If the results from the HEC 23 calculations show that a horizontal extent less than 10 feet is acceptable, you should still provide a minimum of 10 feet. Review the limits of right of way to ensure the minimum apron width at the toe of the abutment slope both beneath and around the bridge abutments along the entire length of the protection. If calculations from HEC 23 result in a horizontal extent outside the right of way limits, do the following:

- a. Recommend additional right of way.
- b. Provide an apron at the toe of the abutment slope that extends an equal distance out around the entire length of the abutment toe. In doing so, consider specifying a greater rubble riprap thickness to account for reduced horizontal extent (Figure 5.5-12).

Make additional considerations regarding extents in coastal areas subject to wave attack. Prolonged exposure to hurricane-generated waves on unprotected approaches may lead to damage to the approach slabs (Figure 5.5-6) as well as the approach roadways. Consider extending the limits of protection to include the approach spans in wave-vulnerable areas.

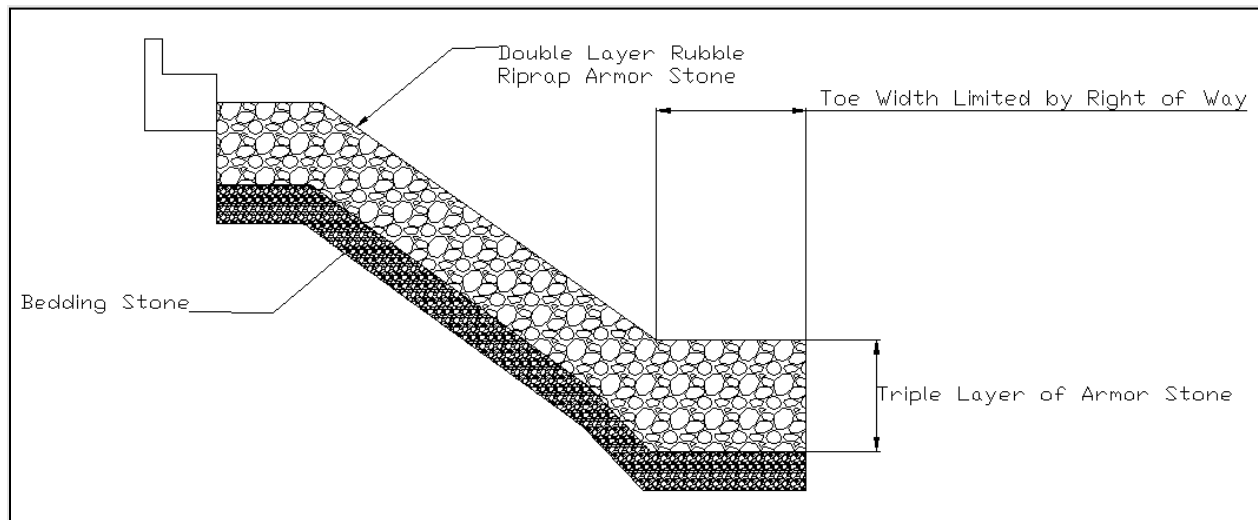

Figure 5.5-12: Example of Increased Toe Thickness to Offset Decrease in Toe Width

When bridges are to be widened, you may not be able to simply recommend using standard rubble riprap, as defined in Section 4.9 of the *Drainage Manual*. Constructability issues may arise at existing bridges where the low chord elevations may prevent uniform riprap placement due to height constrictions. If this case arises, you can do the following:

- a. Rather than simply employing the minimum FDOT Bank and Shore Rubble Riprap, size the rubble according to the design average velocities determined at the abutment using HEC 23. This may result in smaller armor stone sizes, thus enabling easier placement.
- b. Provide an alternate material in the plans that should be approved prior to installation.

Bulkhead/Vertical Wall Abutments

You must protect abutments by sheet piling with rubble toe protection below the bulkhead, and with revetment protection above the bulkhead when appropriate. Design the size and extent of the protection for the individual site conditions.

Allow abutment protection to extend beyond the bridge along embankments that may be vulnerable during a hurricane surge. You need to consider wave attack above the peak design surge elevation and wave-induced toe scour at the foot of bulkheads. In such cases, consult a qualified coastal engineer to determine the size and coverage of the toe scour protection. The choice of cabling material for interlocking block or concrete mattresses must consider the corrosiveness of the waterway. Avoid using steel cabling in salt or brackish waters (stainless steel is permissible).

Rubble riprap abutment protection is the preferred protection type for new bridges. Rubble riprap has several advantages (HEC 11), including:

- The riprap blanket is flexible and is not impaired or weakened by minor movement of the bank caused by settlement or other minor adjustments.
- Local damage or loss can be repaired by placement of more rock.
- Construction is not complicated.
- Vegetation often will grow through the rocks, adding aesthetic and structural value to the bank material and restoring natural roughness.
- Riprap is recoverable and may be stockpiled for future use.

A drawback to rubble riprap is that it can be more sensitive than some other bank-protection schemes to local economic factors. For example, transport costs can significantly affect the construction costs. For an illustration of bridge abutment slope protection adjacent to streams, refer to the FDOT *Structures Detailing Manual* at the following link:

<https://www.fdot.gov/structures/structuresmanual/currentrelease/structuresmanual.shtm>

Where velocities do not exceed 7.7 fps and waves do not exceed 2.4 feet on a 1V:2H slope, protection should consist of a 2.5-foot-thick armor layer comprised of FDOT Standard Bank and Shore Rubble Riprap over a one-foot thick layer of bedding stone over filter fabric. Size the filter fabric appropriately to prevent loss of the fill sediments. The purpose of the bedding stone is to ensure consistent contact between the filter fabric and the soil; and to prevent the armor stone from damaging the filter fabric during construction; and to inhibit movement during design events. Ensure the riprap has a well-graded distribution to promote interlocking between the individual units, which improves performance of the protection. For riverine applications, compare these minimums to the guidance presented in HEC 23 (Design Guideline No. 14) to ensure proper design. A notable feature of the slope protection cross-sections, illustrated in the FDOT *Structures Detailing Manual's* link above, is the sand cement bags located between the revetment and the abutment. This detail was added to the Standard following field inspection observations that the protection/abutment interface often was a point of failure. Shifting of the stones during a minor event would cause a gap to open at the top of the slope, allowing erosion to take place. This addition ensures that the filter fabric remains in contact with the abutment so that any settlement will not produce a gap between the structure and the stones.

For locations subject to wave impacts with wave heights greater than 2.4 feet, you must also design the revetment to resist hurricane-generated waves. Design of abutment protection should follow the same procedures and methodologies as design of rubble

riprap protection that serves as shore protection. The U.S. Army Corps of Engineers provides guidance in the references (USACE, 2006, and USACE, 1995). USACE Engineering Manual 1110-2-1614 (USACE 1995), in particular, provides multiple methodologies for properly sizing armor stone as well as designing the revetment extents, toe geometry, bedding stone, and armor layer distribution.

Often, this analysis will result in an armor stone size greater than that provided by the FDOT Standard Bank and Shore Rubble Riprap. When this occurs, use the more conservative (larger stone size) design. For these designs, develop a modified special provision for the non-standard rubble riprap. The provision must specify the new riprap distribution developed employing the techniques located in USACE (1995) or a similar procedure. Develop a well-graded distribution to the armor stone to ensure optimal performance. Additionally, for large armor stone, it may become necessary to include additional intermediate stone layers into the design to prevent loss of bedding stone between gaps in the armor stone. The USACE (1995) reference presents guidelines for design of granular filter layers as a function of the armor stone size.

For toe scour protection, the USACE (1995) reference provides guidance on sizing stones and designing the apron width. Toe apron width will depend on both geotechnical and hydraulic factors. For a sheet-pile wall, you must protect the passive earth pressure zone. The minimum width from a hydraulic perspective should be at least twice the incident wave height for sheet-pile walls and equal to the incident wave height for gravity walls. Additionally, the apron should be at least 40 percent of the depth at the structure. Compare this apron width to that required by geotechnical factors and adjust it appropriately. Regarding size of the armor stone, the reference provides a method developed by Brebner and Donnelly. USACE (2006) also provides guidance for toe scour protection in front of vertical wall structures in Section VI-5-6 of the *Coastal Engineering Manual*.

For revetment installations where you don't expect significant wave attack, include all options that are appropriate based on site conditions (e.g., fabric-formed concrete, standard rubble, cabled interlocking block, etc.; see Figure 5.5-13 through Figure 5.5-15). HEC 23 provides guidance for design of these protection systems, as follows:

- Design Guideline 8—Articulating Concrete Block Systems
- Design Guideline 9—Grout-Filled Mattresses (Fabric Formed Revetment Systems)
- Design Guideline 14 – Rock Riprap at Bridge Abutments



Figure 5.5-13: Example of Rubble Riprap Abutment Protection



Figure 5.5-14: Example of Articulating Concrete Block Abutment Protection



Figure 5.5-15: Example of Fabric Formed Revetment Abutment Protection

Document options shown to be appropriate for the site in the BHR. You may write a technical specification based on the use of the most ideal revetment material, with the option to substitute the other allowable materials at no additional expense to the Department. This recommendation would help to eliminate revetment CSIPs (Cost Savings Initiative Proposals) during construction. No matter what options are allowed, match the bedding (filter fabric and bedding stone) to the abutment material. Some of the options are not self-healing (i.e., not rubble riprap), and a major failure can occur if loss of the embankment material beneath the protection takes place.

As a final note, coastal bridges often incorporate seawalls into the abutment protection design. The caps of these structures often have a low elevation (below the design surge elevation) to tie into neighboring structures. Address the design of these structures as containing elements of both spill-through and vertical wall abutments. The area in front of the seawall should include a toe scour apron designed in the same manner as for vertical wall abutments. Design areas between the seawall and the abutment using the same procedures as spill-through abutments. These designs should ensure encapsulation of the fill behind the seawall (Figure 5.5-16) to prevent loss of fill and potential failure of the anchoring system (Figure 5.5-17).

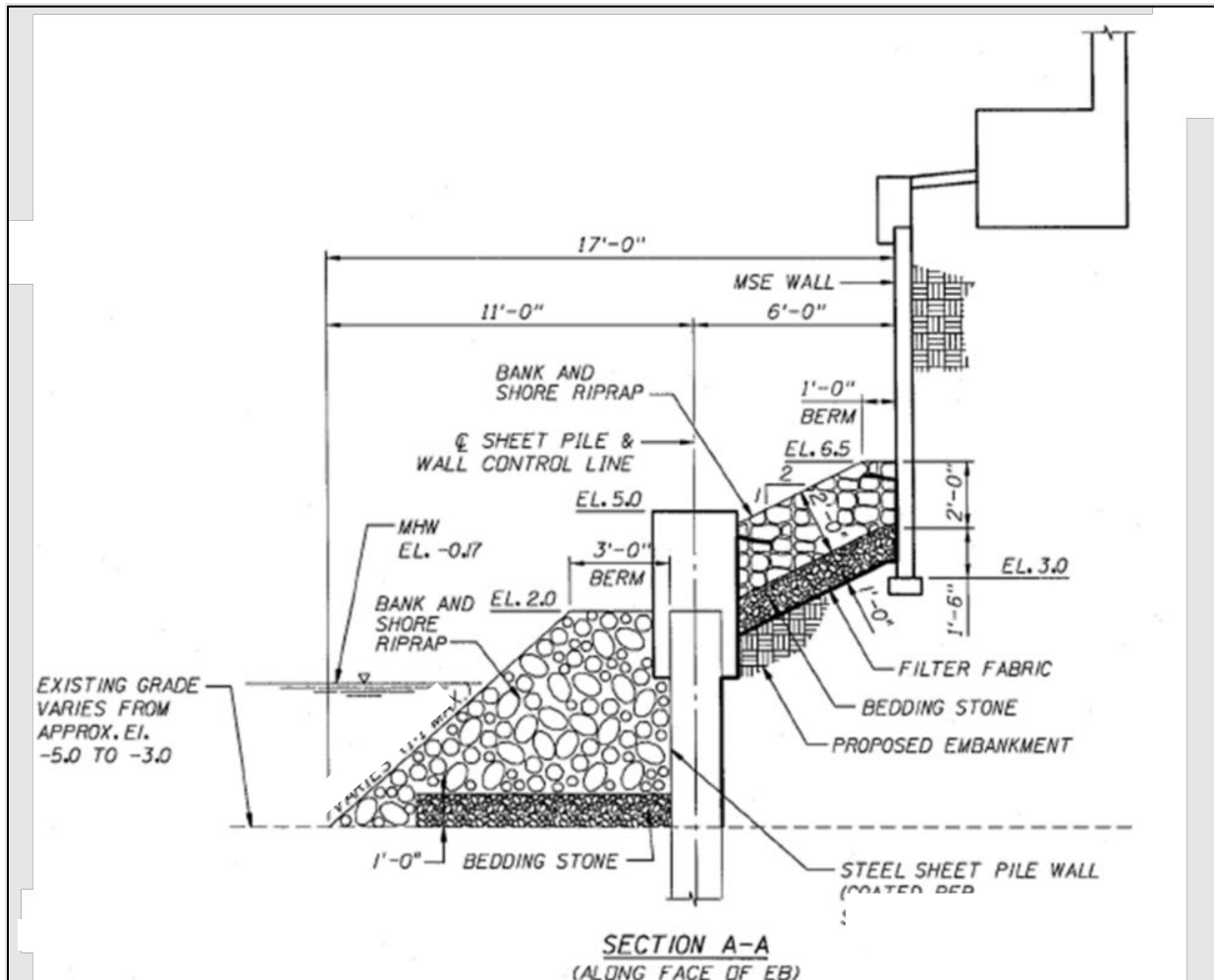

Figure 5.5-16: Example of Abutment Protection Design Including a Seawall



Figure 5.5-17: Seawall Failure Following Hurricane Frances (2004)

5.5.4.2 Scour Protection at Existing Piers

For bridges evaluated as scour critical and where monitoring is not an option, and the upstream design flow velocities do not exceed 7.2 fps for rectangular piles or bascule piers and 8.2 fps for round piling or drilled shafts, one of the countermeasures you should consider is a bed armoring countermeasure around the critical pier. As with abutment protection, pier scour protection can take many forms. Examples of these include rubble riprap, articulating concrete block, fabric formed revetments, gabion/marine mattresses, and partially grouted riprap. HEC 23 provides design guidance for these protection systems in the following design guidelines (located in Volume 2 of the reference):

- Design Guideline 8—Articulating Concrete Block Systems at Bridge Piers
- Design Guideline 9—Grout-Filled Mattresses at Bridge Piers (Fabric Formed Revetment Systems)
- Design Guideline 10—Gabion Mattresses at Bridge Piers
- Design Guideline 11—Rock Riprap at Bridge Piers
- Design Guideline 12—Partially Grouted Riprap at Bridge Piers

The guidelines provide:

- Procedures for selecting safety factors
- Methodologies for sizing the material
- Recommendations for designing coverage extents, filter requirements, and installation guidelines

You will see several similarities between the procedures. All guidelines recommend ensuring that the top of the protection remain level with the bed of the approach. Suggestions for achieving this include placing sand-filled geotextile containers within the scour hole to raise the bed elevation and serve as a filter for the overlaying protection. The guidelines all also recommend that the horizontal extent of the protection extend a distance equal to twice the effective diameter of the pier in all directions. For the non-riprap options, the guidelines recommend that the protection slope away from the pier with the edges of the protection buried below the maximum scour depth for the overall cross section (i.e., depth of contraction scour and long-term degradation). A common failure point of the non-riprap protection schemes is at the edges of the protection if the mattress becomes undermined. Thus, it is important to incorporate trenching of the edges and use of anchoring systems (if appropriate) into the protection design. Another common failure point is at the pier/protection interface. The guidelines suggest grouting this interface to prevent loss of fill for both the articulating concrete block and gabion

protection systems. You should review disadvantages and advantages of each system, including construction feasibility and cost.

5.6 DECK DRAINAGE

To drain the deck of a bridge, there are three options, in order of preference:

1. Rely on the longitudinal grade of the bridge to convey the deck runoff to the end of the bridge.
2. Use freely discharging scuppers or inlets to drain the deck runoff to the area directly below the bridge. These sometimes are referred to as open systems.
3. Collect the discharge from the scuppers or inlets in a pipe system. The pipe system can discharge down a pier or at the ends of the bridge. These systems sometimes are referred to as closed systems.

Spread criteria will control the need to eliminate option 1 and use either option 2 or 3. The inability to discharge to the area below the bridge will control the need to eliminate option 2 and use option 3. An evaluation of the bridge calculated spread during Maintenance of Traffic phases could affect the selection of options and must be included in the analysis for selection of deck drainage schemes.

5.6.1 Bridge End Drainage

If the profile grade of the roadway is sloping off of the bridge, roadway inlets collect runoff from the bridge, often immediately beyond the bridge approach slab. Inlets typically are not placed in the approach slab so that runoff does not seep between the concrete approach slab and the roadway inlet. If spread issues mandate that you place an inlet in the approach slab, obtain concurrence from the District Drainage Engineer and coordinate with the District Structures Design Engineer.

For rural roadways, shoulder gutter is typically used to convey the bridge flow to a shoulder gutter inlet (See Standard Plans, Index 425-040, Gutter Inlet Type S). This inlet, including its 5-foot-long gutter transition, is usually located about 35 feet from the end of the approach slab to provide space for the guardrail's Approach Transition Connection to Rigid Barrier, including its curb transition to shoulder gutter (See Standard Plans, Index 536-001, Guardrail). Additionally, check the spread at the shoulder gutter inlet for the 10-year flow to ensure that runoff does not overtop the shoulder, causing erosion of the embankment (refer to Chapter 6 and Appendix H for more information).

If the profile grade is sloping onto the bridge for rural roadways, then the calculations for the deck drainage may need to include roadway runoff flowing onto the bridge. The shoulder gutter transition directs the rainwater from the bridge into the inlet (refer to Figure 5.6-1). For standard cross slopes of 0.02 ft/ft for bridge shoulders and 0.06 ft/ft for roadway shoulders, with a 10-foot wide shoulder, the longitudinal slope of the gutter due to the transition is 2.1 percent. For this situation, the roadway grade would need to be

greater than 2.1 percent for roadway runoff to flow onto the bridge. Appendix H shows how this slope was determined, and the same method can be used to calculate the slope for other situations.

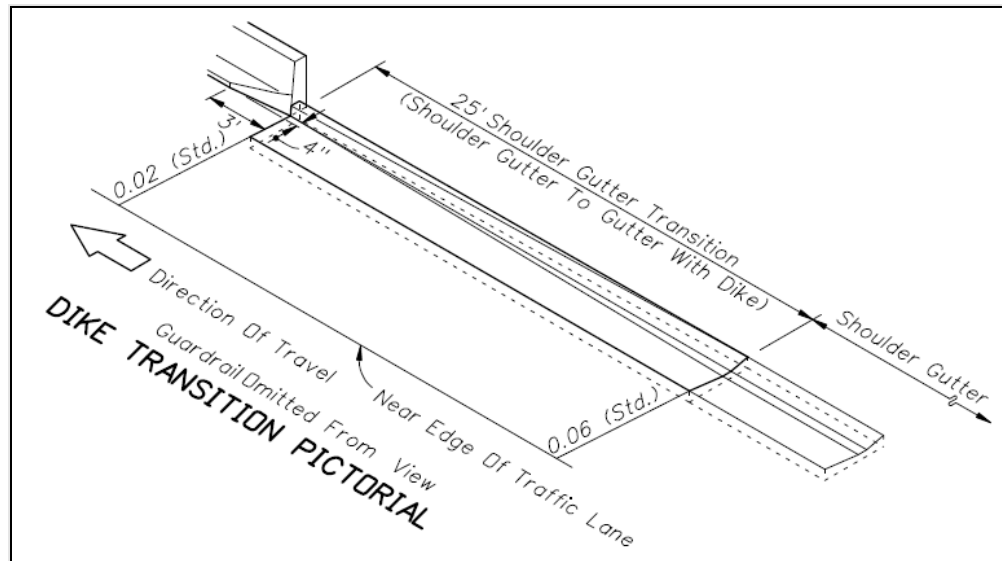

Figure 5.6-1: Shoulder Gutter Transition at Bridge End

For urban locations, if there is not a barrier wall between the sidewalk and the travel lanes, or if there is no sidewalk, a curb inlet can be placed at the end of the approach slab.

The *Drainage Manual* does not require bridge sidewalk runoff to be collected on the bridge. Scuppers or drains are not necessary to control the runoff on the bridge sidewalk unless the runoff becomes great enough to overwhelm the collection system at the end of the bridge. Scuppers used to drain the sidewalk must be ADA compliant.

In handling runoff from the sidewalk at the end of the bridge, the best option is to transition the sidewalk slope toward the roadway immediately downstream of the bridge. The flow then can be picked up in the first curb inlet or barrier wall inlet off of the bridge.

5.6.2 No Scuppers or Inlets (Option 1)

If possible, allow stormwater to flow to the end of the bridge and collect in the roadway drainage system. To determine if this option is feasible, check the spread:

- Where the barrier wall or curb ends at the edge of the approach slab
- At the first inlet off of the bridge

Calculate spread based on the Gutter Flow Equation in Section 6.3.2 of this document. Spread criteria are given in Chapter 3.9 of the *Drainage Manual*. If the spread exceeds the allowable spread criteria, then use scuppers or inlets on the bridge to reduce the spread. If the spread exceeds the criteria, consider adjusting the profile grade to reduce the spread before adding scuppers or inlets on the bridge. Reduce spread by:

- Steepening the longitudinal slope of the bridge at the bridge ends
- Including a profile crest in the middle of the bridge rather than using a profile that slopes to only one end of the bridge

After determining grades that would eliminate the need for scuppers or inlets, talk with the roadway designer to determine the feasibility of adjusting the profile grade.

Example 5.6-1

A bridge for a two-lane rural roadway has the following characteristics:

- 200-foot length
- 30-foot approach slabs
- A longitudinal slope of 0.3 percent
- Shoulder gutter inlets located 30 feet from the uphill approach slab
- The bridge typical section has two 12-foot travel lanes, 10-foot outside shoulders, 1.5-foot barriers, 0.02 ft/ft cross slopes, and is crowned in the middle.

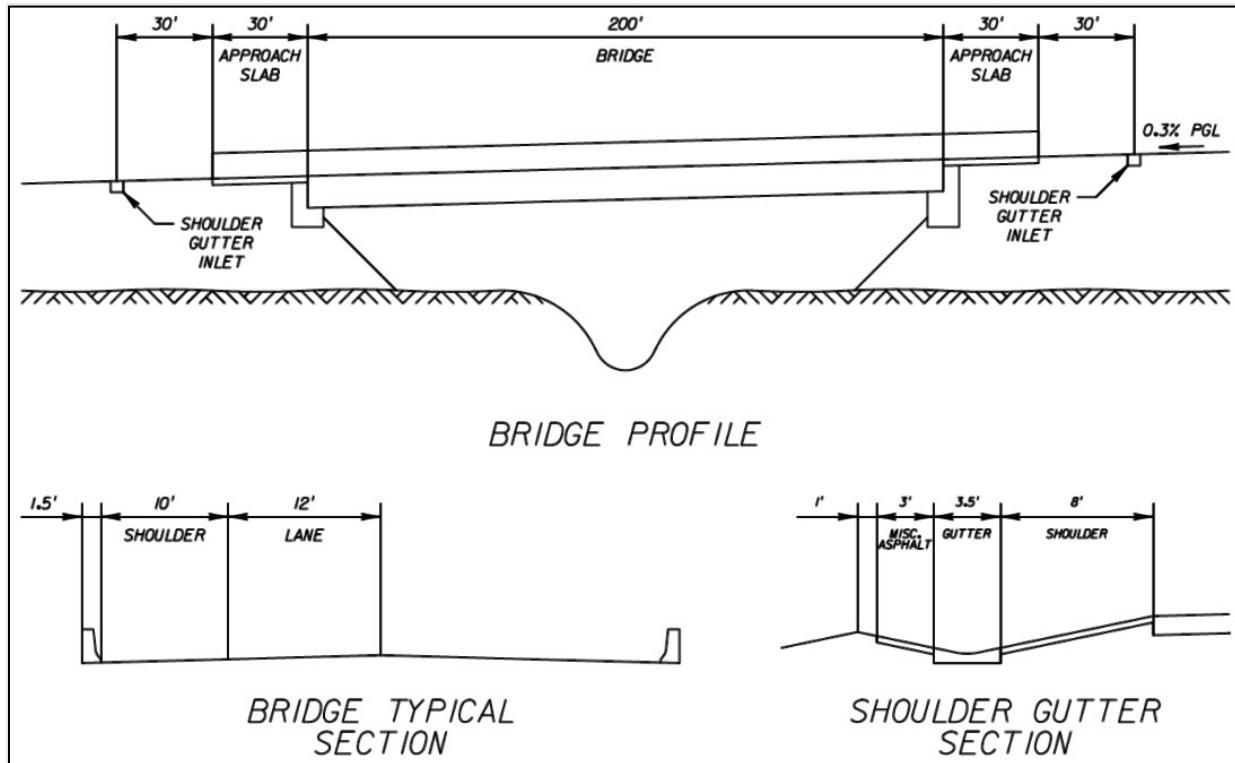

Solution:

Determine the drainage area to the end of the downhill approach slab. On the uphill end of the bridge, the shoulder gutter transition will cause the runoff from the area between the shoulder gutter inlet and the end of the approach slab to flow back to the shoulder gutter inlet. Therefore, the drainage area contributing to the downhill side will include the bridge deck and the approach slabs:

$$\text{Area} = (12+10+1.5) (30+200+30) / 43560 = 0.14 \text{ acres}$$

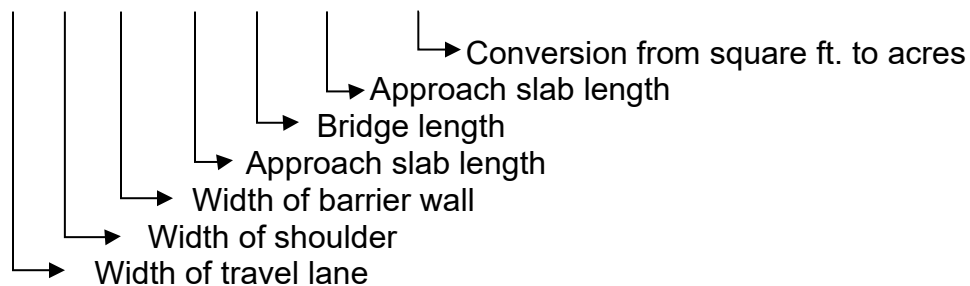

The flow is:

$$Q = CiA = 0.95 (4) (0.14) = 0.53 \text{ cfs}$$

where:

- C = Rational runoff coefficient
 i = Rainfall intensity, inches per hour
 (4 in/hr, refer to Chapter 6 for explanation)
 A = Drainage area, acres

Solving the gutter flow equation for spread:

$$\text{Spread} = \left[\frac{Qn}{0.56S_x^{5/3}S^{1/2}} \right]^{3/8} = \left[\frac{(0.53)(0.016)}{0.56(0.02)^{5/3}(0.003)^{1/2}} \right]^{3/8} = 7.1 \text{ ft.}$$

Since the spread at the end of the downhill approach slab is less than 10 feet, with 10 feet being the width of the shoulder, scuppers are not necessary.

Also check the spread at the shoulder gutter inlet on the downhill side of the bridge. There will be an additional drainage area from the end of the approach slab that needs to be added to the drainage on the bridge. The drainage area to the shoulder gutter inlet is:

$$\text{Area} = 0.14 + (((12+8+3.5+4) (30)) / 43560) = 0.16 \text{ acres}$$

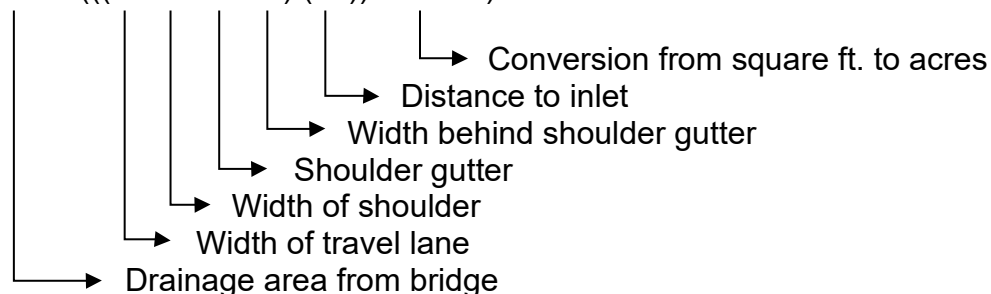

Assume that the location of the bridge and the NOAA Atlas 14 Point Precipitation Frequency Estimates webpage are used to provide the 10-year, 10 minute rainfall intensity of 7.0 inches per hour. The flow to the inlet is:

$$Q = CiA = 0.95 (7.0) (0.16) = 1.06 \text{ cfs}$$

Note that this value is slightly conservative. The one-foot unpaved strip behind the guardrail was assumed to be paved in this calculation.

The allowable conveyance in the shoulder gutter is $K = 28$ cfs. Refer to Section 6.3.2.3 of this document for further explanation of this value. The allowable flow at the shoulder gutter inlet is:

$$Q = K S^{1/2} = (28) (0.003)^{1/2} = 1.53 \text{ cfs}$$

Since the gutter flow just uphill of the shoulder gutter inlet is less than the allowable flow, the deck drainage design is acceptable.

5.6.3 Scuppers (Option 2)

Scuppers typically are formed by tying PVC pipe into place prior to pouring the concrete for the bridge deck (Figure 5.6-2). The deck runoff will flow into the scuppers, through the deck, and then freefall to the ground or water surface below the bridge.

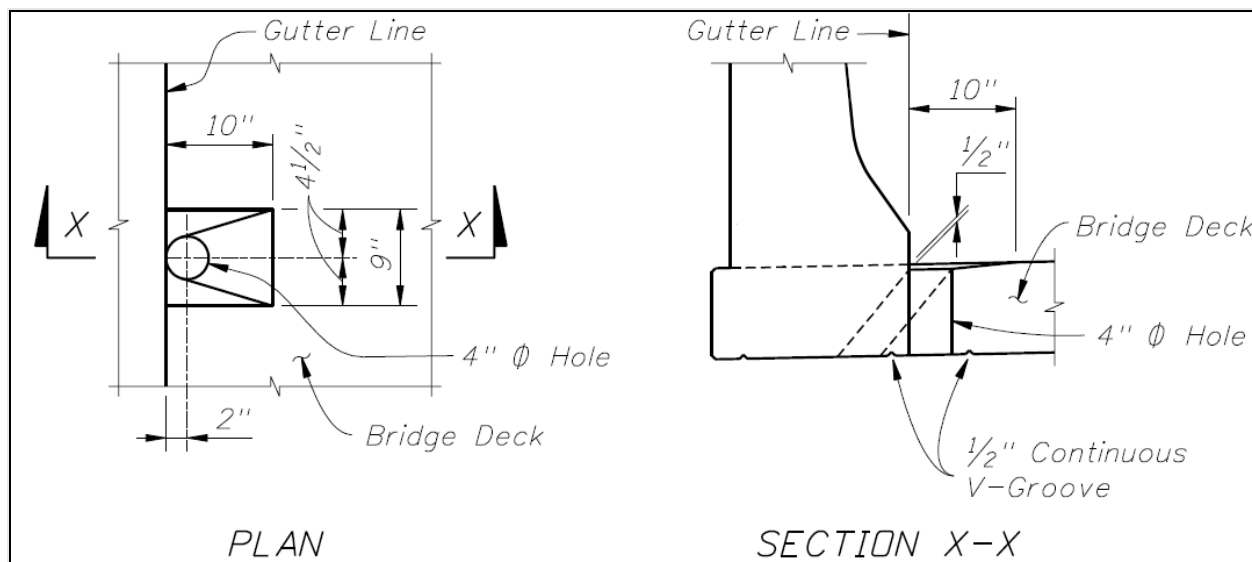

Figure 5.6-2: Standard FDOT Scupper Detail

Avoid placing scuppers over certain areas due to the direct discharge. These areas include:

- Driving lanes, railroad tracks, and sidewalks
- Major navigation channels
- Bridge bents
- Erodible soil, unless the free discharge is at least 25 feet above the soil
- Environmentally sensitive water bodies as negotiated with permitting agencies
- Wildlife shelves, unless the bottom of the bridges is 25 feet or more above the shelf

As stated in Section 4.9.4 of the *Drainage Manual*, the standard scupper drain is four inches in diameter and spaced on 10-foot centers, unless spread calculations indicate closer spacing is required. Typically, the 10-foot spacing will provide adequate drainage for most bridges. You can evaluate the intercepted flow for four-inch bridge scuppers on a grade using the capacity curves in Figure 5.6-3 and Figure 5.6-4. The curves were derived from laboratory studies performed at the University of South Florida (Anderson, 1973).

Grated scuppers or inlets, as shown in Figure 5.6-5, are more uncommon, especially as free-draining scuppers. Although grated inlets can be used with open systems, they are normally used with closed systems. You might use this type of grated scupper, or perhaps one with a smaller grate, to drain a bridge sidewalk or if you expect significant bicycle or pedestrian traffic on the shoulder. The four-inch ungrated scuppers will not meet ADA requirements.

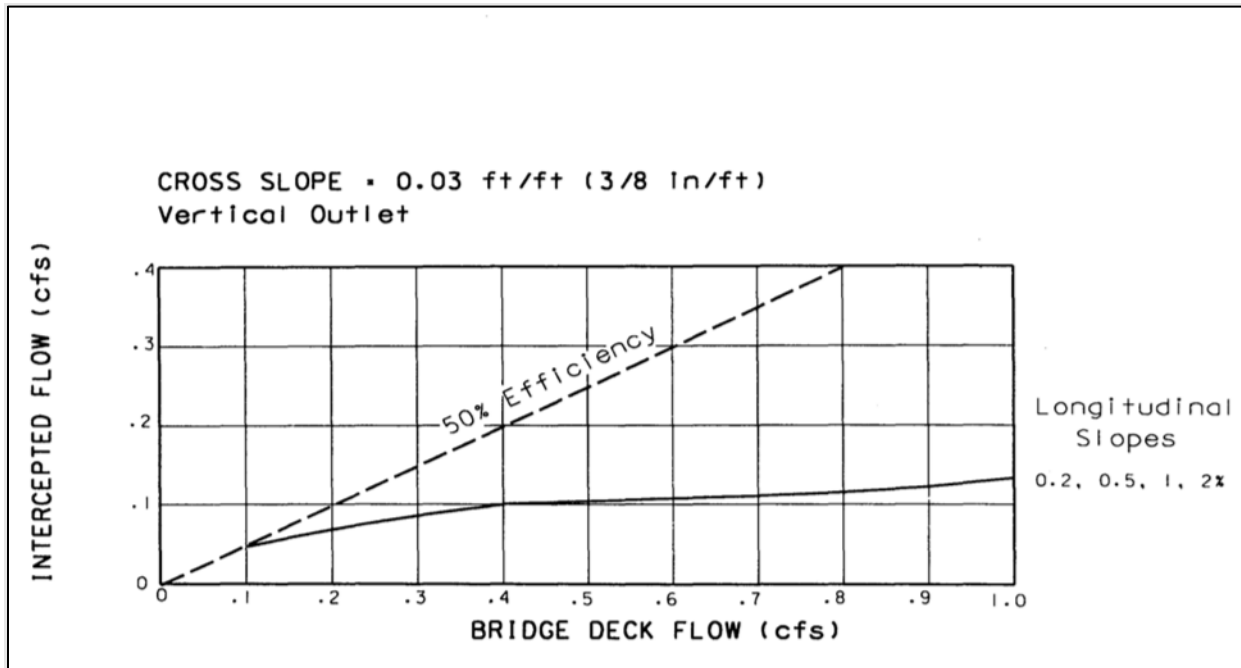

**Figure 5.6-3: Intercepted Flow for 4-inch Bridge Scuppers
Cross Slope = 0.03 ft/ft**

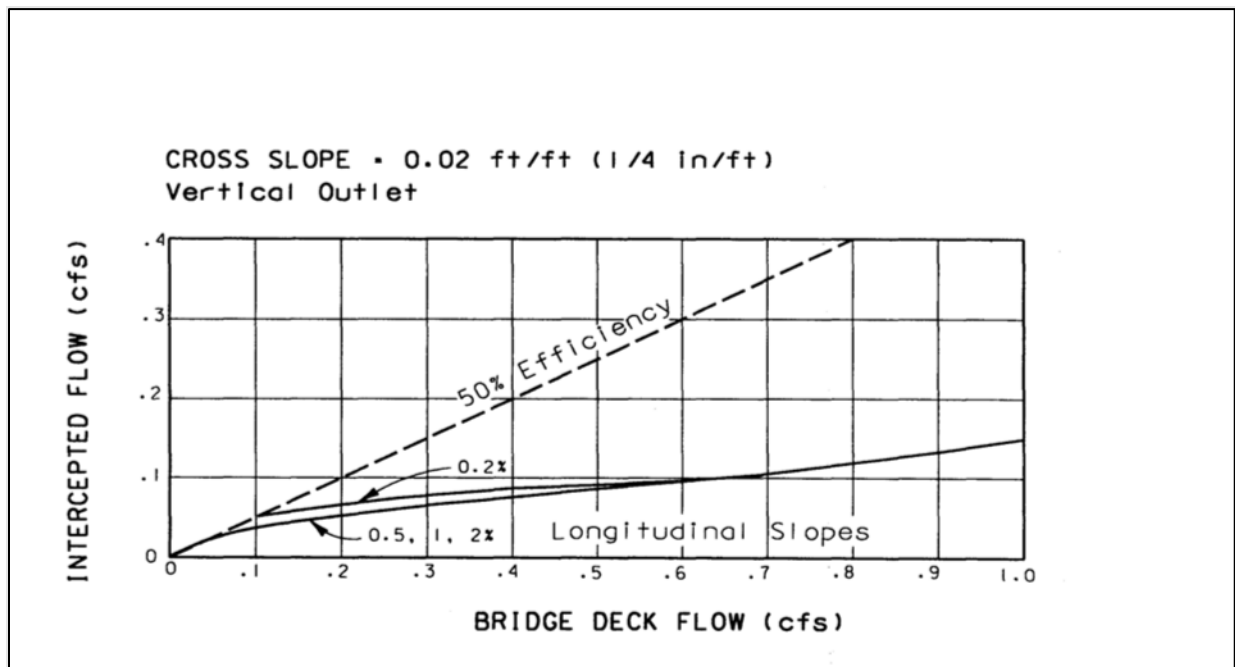

**Figure 5.6-4 Intercepted Flow for 4-inch Bridge Scuppers
Cross Slope = 0.02 ft/ft**

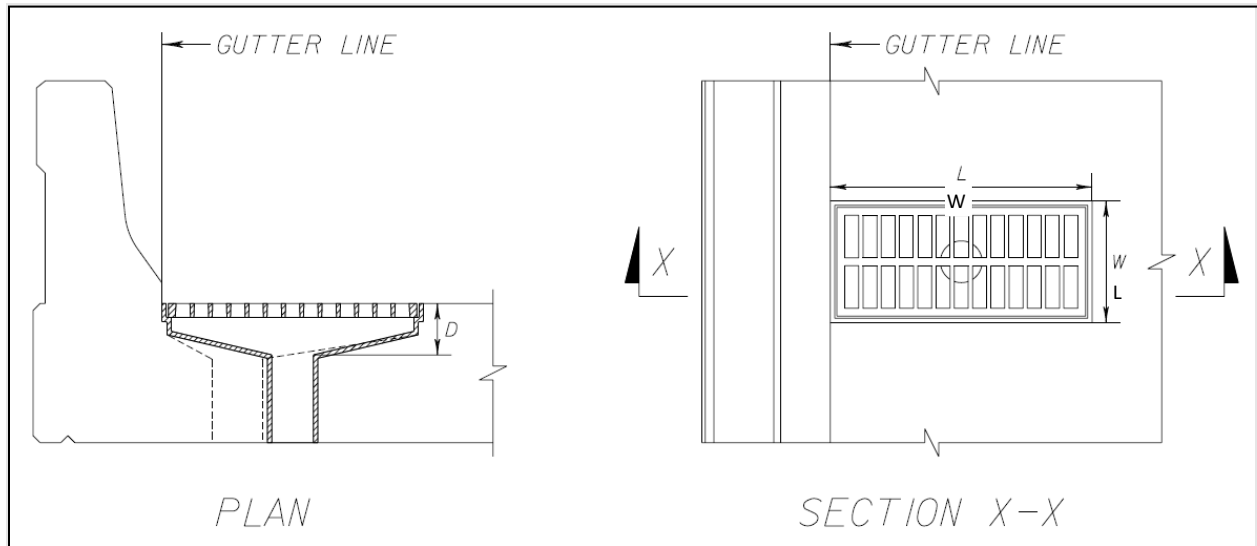

Figure 5.6-5: Grated Free-Draining Scupper

The Department does not have standard grated scuppers or inlets; therefore, it does not have capacity charts as with other standard Department inlets. Section 6.3.1.5 provides references to documents that you can use to derive inlet capacities. Manufacturers may publish capacity charts for their inlets. Keep in mind that the pipe opening at the bottom of the inlet may control the capacity rather than the inlet opening.

The length, width, and depth of the grated inlet will be limited by the reinforcement in the deck of the bridge. Coordinate the dimensions and locations of the inlets with the structural engineer. Use standard prefabricated inlets whenever possible. Refer to Section 7.4 for more information on grated scuppers.

Example 5.6-2

A bridge deck grated scupper is located where the shoulder width is 10 feet and the cross slope is 0.02 ft/ft. The longitudinal grade of the bridge is 1.5%. The dimensions of the grated scupper as defined in Figure 5.6-5 are:

$W = 5$ feet

$L = 1$ foot

$D = 7$ inches

Outlet Pipe Diameter = 8 inches

The flow along the barrier wall at the scupper is 1.65 cfs. Determine the intercepted flow.

Solution:

The spread in the gutter prior to the inlet is:

$$Spread = \left[\frac{Qn}{0.56S_x^{5/3} S^{1/2}} \right]^{3/8} = \left[\frac{(1.65)(0.016)}{0.56(0.02)^{5/3} (0.015)^{1/2}} \right]^{3/8} = 8.06 \text{ ft.}$$

Calculate the intercepted flow using the method presented in FHWA Hydraulic Engineering Circular No. 12, *Drainage of Highway Pavements*, March 1984 (HEC 12).

The flow directly over the grate is called the frontal flow. The frontal flow can be determined using Equation 7 from HEC 12:

$$E_0 = \frac{Q_w}{Q} = 1 - \left(1 - \frac{W}{T} \right)^{8/3} = 1 - \left(1 - \frac{5}{8.06} \right)^{8/3} = 0.924$$

where:

E_0 = Ratio of flow in width, W , to the total flow, Q

Q_w = Flow in width, W , less than T , in cfs

Q = Total flow, in cfs

W = Width of flow, W , in feet

T = Total width of flow (also called the spread), in feet

The frontal flow, $Q_w = E_0Q = 0.924 (1.65) = 1.52$ cfs

The inlet will intercept all of the frontal flow unless the velocity is great enough to cause the flow to skip over the grate. This velocity is called the splash-over velocity. Use Chart 7 of HEC 12 to determine the splash-over velocity. Figures 8 through 13 of HEC 12 show the dimensions of the grates in Chart 7. If the grate dimensions do not match one of the grates shown on Chart 7, then the reticuline grate usually will provide a conservative assumption for the splash-over velocity.

Determine the velocity in the gutter:

$$\text{Flow Area} = \frac{S_x T^2}{2} = \frac{0.02(8.06)^2}{2} = 0.650 \text{ ft.}$$

$$\text{Gutter Velocity} = \frac{Q}{A} = \frac{1.65}{0.65} = 2.53 \text{ fps}$$

The splash-over velocity is estimated conservatively as 2.4 fps from Chart 7, HEC 12. Using Equation 9 from HEC 12, the flow in width, W , that is intercepted can be determined:

$$R_F = 1 - 0.09(V - V_0) = 1 - 0.09(2.53 - 2.4) = 0.988$$

where:

R_F = Ratio of the frontal flow intercepted to the total frontal flow

V = Velocity of flow in the gutter, in fps

V_0 = Splash-over velocity, in fps

The intercepted frontal flow is:

$$R_F * Q_W = 0.988(1.52) = 1.50 \text{ cfs}$$

The gutter flow that does not flow directly over the grate is called the side flow, Q_S . You can determine the side flow by subtracting the frontal flow from the total gutter flow.

$$Q_S = Q - Q_W = 1.65 - 1.52 = 0.13 \text{ cfs}$$

Momentum can carry the side flow past the inlet before all of the flow can turn into the side of the inlet. The amount of flow that turns into the inlet and is intercepted can be calculated using Equation 10 from HEC 12:

$$R_S = 1 / \left(1 + \frac{0.15V^{1.8}}{S_x L^{2.3}} \right) = 1 / \left(1 + \frac{0.15(2.53)^{1.8}}{0.02(1)^{2.3}} \right) = 0.0245$$

R_S is the ratio of the side flow intercepted to the total side flow. The intercepted side flow is: $R_S * Q_S = 0.0245(0.13) = 0.00$ cfs. Therefore, the total flow intercepted, which is the sum of the frontal and side flows intercepted, is conservatively estimated as 1.50 cfs.

Also check the capacity of the outlet pipe in the bottom of the scupper inlet using the orifice equation.

$$Q = CA(2gh)^{1/2}$$

where:

- C = Orifice coefficient = 0.6
 A = Area of the orifice opening, in square feet
 g = Gravitational force (32.17 ft/sec²)
 h = Head on the orifice opening, in feet

Assuming that the orifice will not impact the intercepted flow unless the head is equal to the distance from the outlet pipe opening to the top of the grate, D, the outlet pipe capacity is:

$$A = \frac{\pi D^2}{4} = \frac{\pi(8/12)^2}{4} = 0.349 \text{ ft}^2$$

$$Q = 0.6(0.349)[2(32.17)(7/12)]^{1/2} = 1.28 \text{ cfs}$$

This flow is less than the capacity of the grate, and, therefore, the outlet pipe controls the interception capacity of the inlet. The actual capacity of the outlet pipe will be slightly greater because the actual head on the pipe will be slightly greater than the top of the grate. However, this value is a conservative estimate of the intercepted flow.

Example 5.6-3 **Constant Grade**

Scupper flow on bridges with a constant grade will reach an equilibrium state if the bridge is long enough. The equilibrium state occurs when the runoff from the area between scuppers is equal to the flow intercepted by the scuppers.

The spread at scuppers prior to reaching equilibrium will be less than the equilibrium spread. Therefore, equilibrium spread is a conservative estimate for scuppers on a constant grade.

Determine the equilibrium spread for standard scuppers on a bridge with the following characteristics:

- One of dual bridges for a six-lane divided roadway
- The deck has a constant 0.02 ft/ft cross slope
- The typical section has three 12-foot travel lanes, a 10-foot outside shoulder, and a 6-foot inside shoulder. The barrier walls on each side are 1.5 feet wide. The total deck width is 55 feet.

- The longitudinal grade is a constant 0.2 percent. (Normally, the minimum gutter grade of 0.3 percent also should be applied to a bridge with flow along its barrier wall. However, older bridges with flatter slopes are sometimes widened rather than replaced. Occasionally, even flat-grade bridges are widened.)

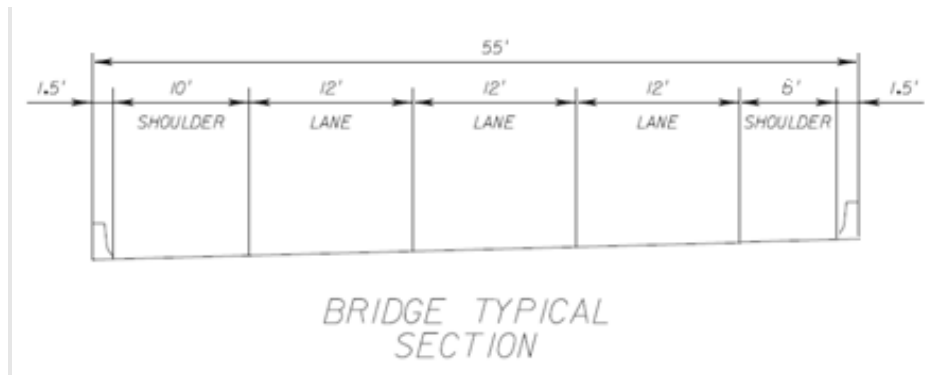
**Solution:**

Since clogging can be a problem for scuppers, it is common to assume that every other scupper is clogged. This assumption doubles the length between functioning scuppers from 10 feet to 20 feet. Using this assumption, the deck runoff generated between each scupper is:

$$Q = CiA = (0.95)(4)[(55)(20)/43560] = 0.096 \text{ cfs}$$

If the bridge is long enough, the equilibrium flow intercepted by the last scupper also will be equal to this flow rate. Using 0.096 cfs as the intercepted flow, you can use Figure 5.6-4 to determine the bridge deck flow just upstream of a scupper. Entering the y-axis with the equilibrium intercepted flow of 0.096, an equilibrium flow just upstream of the scupper of 0.61 cfs is read from the x-axis.

The spread just upstream of the scupper is:

$$Spread = \left[\frac{Qn}{0.56S_x^{5/3}S^{1/2}} \right]^{3/8} = \left[\frac{(0.61)(0.016)}{0.56(0.02)^{5/3}(0.002)^{1/2}} \right]^{3/8} = 8.1 \text{ ft.}$$

This is the equilibrium spread. Since this value is less than 10 feet, the width of the shoulder, the standard scuppers will be adequate for this bridge.

Usually, scuppers are omitted near the end of a bridge, if not using bridge piping, due to potential soil erosion near the abutments. Add the runoff from this area and the approach slab to the bypass at the last scupper and the combined Q used to check the spread at the end of the approach slab.

Example 5.6-4

For this example, use the information for the bridge in Example 5.6-3, with the following substitutions:

- Omit scuppers in the last 50 feet of the bridge.
- Use a 30-foot approach slab for the bridge.

Determine the spread at the end of the approach slab.

Solution:

If a bridge has scuppers continuously from the crest of the bridge, then a conservative estimate of the bypass from the last scupper is the equilibrium bypass. From Example 5.6-3, the equilibrium bypass is:

$$0.61 \text{ cfs} - 0.096 \text{ cfs} = 0.51 \text{ cfs}$$

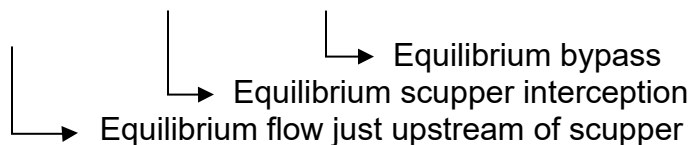

The runoff from the area between the last scupper and the end of the approach slab is:

$$Q = CiA = 0.95 (4) [(50 + 30) 55 / 43560] = 0.38 \text{ cfs}$$



The total flow at the end of the approach slab can be conservatively estimated as:

$$Q_{Total} = 0.51 + 0.38 = 0.89 \text{ cfs}$$

The spread can be conservatively estimated as:

$$Spread = \left[\frac{Qn}{0.56S_x^{5/3} S^{1/2}} \right]^{3/8} = \left[\frac{(0.89)(0.016)}{0.56(0.02)^{5/3} (0.002)^{1/2}} \right]^{3/8} = 9.3 \text{ ft.}$$

Since the spread is less than 10 feet, the scupper design is acceptable.

If this estimate exceeded the allowable spread, the bridge deck drainage design does not necessarily need to be changed. The spread can be checked with a more accurate approach that accounts for the flow at each scupper, as described in Section 5.6.4.

Example 5.6-5

Flat Grade

You can determine the capacity of a scupper on a bridge with 0-percent longitudinal grade from the figure shown below:

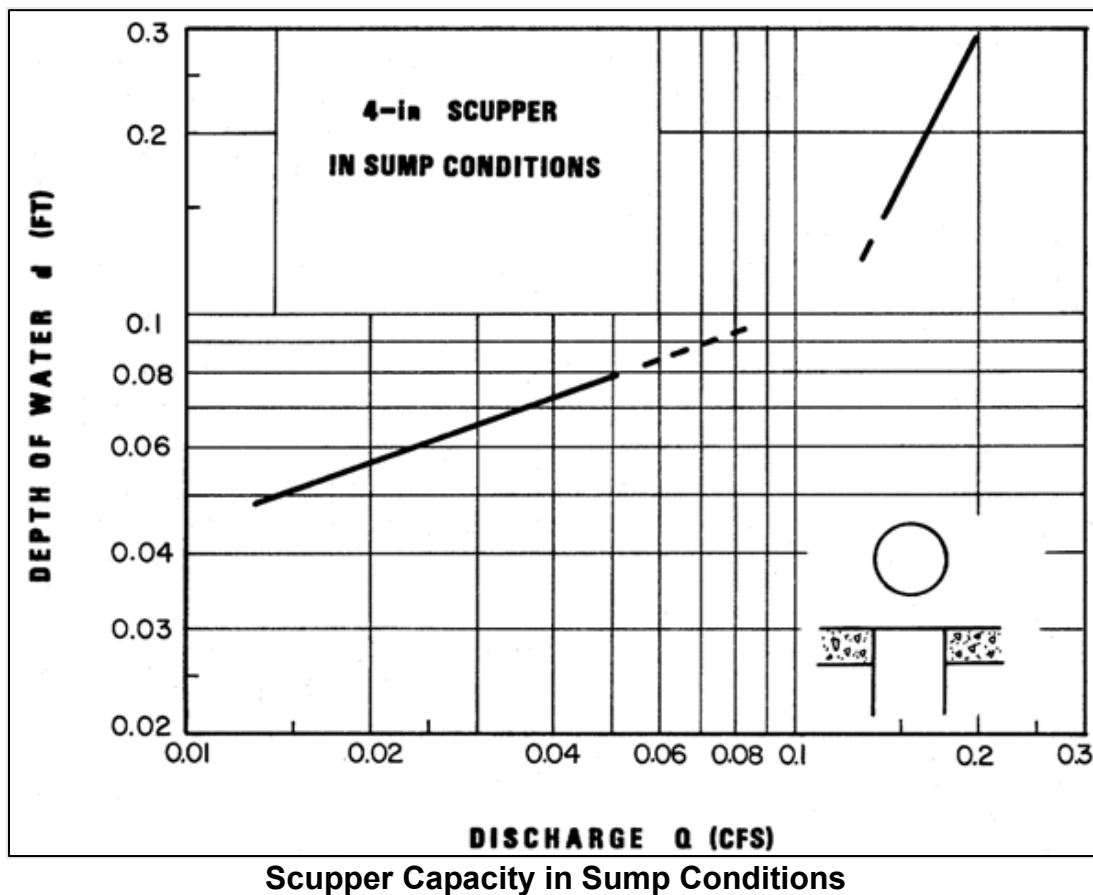

Using the bridge from Example 5.6-3, except with a 0-percent grade, determine if standard scuppers are adequate.

Solution:

Assuming that every other scupper is clogged, each scupper would need to take the flow from a strip of the bridge deck that is 20 feet wide. The runoff from this area in Example 5.6-3 is 0.096 cfs. Entering the above figure with this discharge, the scupper flow will be in the transitional range between weir and orifice flow. The flow conditions are imprecise

because of this transition. However, the depth of water above the orifice can be conservatively estimated as 0.11 feet. The spread is:

$$\text{Spread} = \text{depth} / S_x = 0.11 / 0.02 = 5.5 \text{ feet}$$

Since the spread is less than the width of the shoulder, which is 10 feet, standard scuppers meet the criteria.

Vertical Curves

Vertical curves complicate the analysis of scupper interception and spacing. However, you can check scuppers on crest curves at various locations by assuming the grade at that location is a constant grade. This will be conservative for crest vertical curves, but also can be overly conservative. Consider using a more detailed analysis procedure, as described in Section 5.6.4, before using scupper spacing that deviates from the standard.

At the crest of a vertical curve, there is a point where the slope is zero, and—depending on the length of the curve—there can be a significant portion where the slope is almost flat. The flow depth in this area is not well represented by the gutter flow equation because this equation is a normal depth equation. The flow at the crest will not be at normal depth because it will be experiencing a drawdown due to the combination of steeper slopes and scupper interception downhill. Checking the spread near the crest with the gutter flow equation will be conservative. For slopes less than 0.002 ft/ft, check the spread with the flat grade assumptions if the spread criteria is violated using the gutter flow equation. This is true for both the equilibrium analysis of this section and the more detailed analysis of Section 5.6.4.

Avoid sag vertical curves. If this is not possible, then use the more detailed analysis procedure described in Section 5.6.4.

Example 5.6-6

Use the bridge from Example 5.6-3, except with the following roadway profile information:

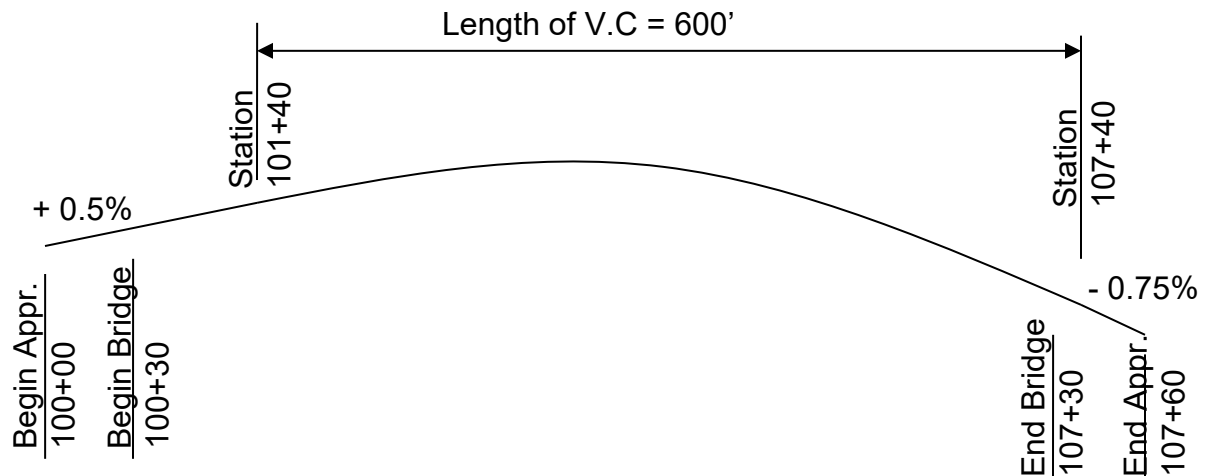

The ground beneath the bridge is less than 25 feet below the bottom of the bridge deck for a distance of 50 feet from each bridge end. Determine the required deck drainage features.

Solution:

Determine the location of the high point on the bridge:

$$\begin{aligned} X_{\text{HIGH POINT}} &= (g_1 \times L) / (g_2 - g_1) \\ &= (0.005 \times 600) / (0.0075 - 0.005) \\ &= 240 \text{ feet} \end{aligned}$$

Therefore, the high point is located at Station 103+80. The drainage area at the edge of the approach slab at Station 100+00 is:

$$\text{Area} = (55) (380) / 43560 = 0.48 \text{ acres}$$

The flow is:

$$Q = CiA = 0.95 (4) (0.48) = 1.82 \text{ cfs}$$

where:

- C = Rational runoff coefficient
 i = Rainfall intensity, inches per hour
 (Refer to Chapter 6 for explanation to use 4 in/hr)
 A = Drainage area, acres
 Solving the gutter flow equation for spread:

$$Spread = \left[\frac{Qn}{0.56S_x^{5/3} S^{1/2}} \right]^{3/8} = \left[\frac{(1.82)(0.016)}{0.56(0.02)^{5/3} (0.005)^{1/2}} \right]^{3/8} = 10.3 \text{ ft.}$$

The spread exceeds the allowable spread of 10 feet. Minor changes to the roadway and bridge profile would reduce the spread to an acceptable amount, which is less than 10 feet. However, after discussions with the roadway and the bridge engineers, if you cannot adjust the roadway grade, then consider using standard scuppers. For this example, we will assume the roadway grade cannot be adjusted.

The drainage area and flow are the same at the other bridge end at Station 107+60. The spread is:

$$Spread = \left[\frac{Qn}{0.56S_x^{5/3} S^{1/2}} \right]^{3/8} = \left[\frac{(1.82)(0.016)}{0.56(0.02)^{5/3} (0.0075)^{1/2}} \right]^{3/8} = 9.5 \text{ ft.}$$

Since this spread is less than 10 feet, scuppers are not needed from the high point of the bridge at Station 103+80 to the bridge end at Station 107+30.

Omitting scuppers within 50 feet of the bridge end, place standard scuppers every 10 feet starting at Station 100+80 and ending at Station 103+70. The next step is to determine if this design meets spread criteria. The previous examples show this design will work:

- Example 5.6-5 shows that standard scuppers on this bridge will meet the spread criteria for flat grades. Therefore, scuppers at the top of the vertical curve where the longitudinal slope is less than 0.002 ft/ft will meet the spread criteria.
- Example 5.6-3 shows that standard scuppers on this bridge will meet the spread criteria for grades equal to or greater than 0.002 ft/ft.
- Example 5.6-4 shows that the spread at the end of the approach slab also will meet the spread criteria.

Therefore, the deck drainage design for this bridge is standard scuppers starting at Station 100+80 and ending at Station 103+70.

The evaluation above uses simplified, but conservative, assumptions of equilibrium flow. If the design failed to meet criteria under the conservative assumptions, then you can perform a more-detailed analysis to evaluate the design. The following will illustrate the detailed analysis procedure and explain how a spreadsheet can be used to automate the analysis.

Enter the values of the cells in Row 1 through Row 8 of the spreadsheet as shown; i.e., none of these cells have formulae.

| | A | B | C | D | E | F | G | H | I | J | K |
|---|--------------|----------|-------|------------|--------|-----------|--------|----------------|---|-------|-------|
| 1 | Spacing = 20 | | | Curve Data | | | | | | | |
| 2 | Sx = 0.02 | | | G1 = 0 | | | | | | | |
| 3 | n = 0.016 | | | G2 = 0.005 | | | | | | | |
| 4 | Width = 55 | | | L = 240 | | | | | | | |
| 5 | | | | | | | | | | | |
| 6 | Distance | Dr. Area | Flow | Slope | Spread | Int. Flow | Bypass | | | 0.002 | 0.005 |
| 7 | (feet) | (acres) | (cfs) | (ft./ft.) | (feet) | (cfs) | (cfs) | | | | |
| 8 | 0 | 0 | 0 | 0 | 0 | 0 | 0 | Station 103+80 | | | |

Although the scupper spacing is 10 feet, the spacing was entered as 20 feet to conservatively assume that every other scupper was clogged.

The vertical curve data are not entered in the same manner as listed on the profile sheets in the Plans or in Geopak. For the formulation in this spreadsheet, the peak of the vertical curve must be determined, and all distances referenced from the peak. The slopes must be entered so that the calculated slopes always have a positive value. G1 should be the slope at the uphill end, and G2 the slope at the downhill end.

The remaining rows will have formulae in some of the cells.

| | A | B | C | D | E | F | G | H | I | J | K |
|----|-----|----------|----------|----------|----------|----------|----------|---|---|----------|----------|
| 9 | 20 | 0.025253 | 0.09596 | 0.000417 | 5.431296 | 0.05165 | 0.04431 | | | 0.05165 | 0.037082 |
| 10 | 40 | 0.025253 | 0.14027 | 0.000833 | 5.499062 | 0.05997 | 0.0803 | | | 0.05997 | 0.042832 |
| 11 | 60 | 0.025253 | 0.176259 | 0.00125 | 5.552224 | 0.063001 | 0.113258 | | | 0.063001 | 0.047151 |
| 12 | 80 | 0.025253 | 0.209218 | 0.001667 | 5.609947 | 0.066198 | 0.14302 | | | 0.066198 | 0.051383 |
| 13 | 100 | 0.025253 | 0.238979 | 0.002083 | 5.655207 | 0.069672 | 0.169307 | | | 0.070067 | 0.055847 |
| 14 | 120 | 0.025253 | 0.265267 | 0.0025 | 5.683265 | 0.071202 | 0.194064 | | | 0.073485 | 0.05979 |
| 15 | 140 | 0.025253 | 0.290024 | 0.002917 | 5.709225 | 0.07267 | 0.217354 | | | 0.076703 | 0.063504 |
| 16 | 160 | 0.025253 | 0.313314 | 0.003333 | 5.731697 | 0.073554 | 0.23976 | | | 0.079331 | 0.066331 |
| 17 | 180 | 0.025253 | 0.33572 | 0.00375 | 5.75362 | 0.073989 | 0.261731 | | | 0.081572 | 0.068572 |
| 18 | 200 | 0.025253 | 0.357691 | 0.004167 | 5.776778 | 0.07438 | 0.28331 | | | 0.083769 | 0.070769 |
| 19 | 220 | 0.025253 | 0.37927 | 0.004583 | 5.800493 | 0.074733 | 0.304537 | | | 0.085927 | 0.072927 |
| 20 | 240 | 0.025253 | 0.400497 | 0.005 | 5.824365 | 0.07505 | 0.325447 | | | 0.08801 | 0.07505 |

In Row 9, enter the following formulae in each column:

Column A: =A8+\$B\$1

Column B: =(A9-A8)*\$B\$4/43560

Column C: =G8+0.95*4*B9

Column D: =(E\$3-E\$2)*A9/E\$4+E\$2

Column E: =(C9*\$B\$3/0.56/\$B\$2^(5/3)/D9^0.5)^(3/8)

Column F: =IF(D9<0.002,J9,(IF(D9>0.005,K9,(J9+(K9-J9)*(D9-0.002)/0.003)))

Column G: =C9-F9

Column J: =IF(C9>1,Chart!\$B\$15,PERCENTILE(Chart!\$B\$4:\$B\$15,PERCENTRANK(Chart!\$A\$4:\$A\$15,C9,20)))

Column K: =IF(C9>1,Chart!\$E\$15,PERCENTILE(Chart!\$E\$4:\$E\$15,PERCENTRANK(Chart!\$D\$4:\$D\$15,C9,20)))

Column A keeps track of the distance from the upstream end.

Column B determines the drainage area between the current scupper and the previous scupper uphill. This spreadsheet assumes that the bridge has a constant width along the length of the bridge being analyzed.

Column C determines the flow immediately upstream of the current scupper using the Rational Equation. The rainfall intensity is assumed to be four inches per hour and the Runoff Coefficient is assumed to be 0.95. The bypass from the previous scupper is combined with the runoff from the area between the scuppers.

Column D determines the slope of the profile grade at the current scupper.

Column E determines the spread using the gutter flow equation.

Column F determines the intercepted flow rate based on Figure 5.6-4. If the slope is less than 0.002, the curve labeled “0.2%” is used. If the slope is greater than 0.005, the curve labeled “0.5, 1, 2%” is used. If the slope is between 0.002 ft/ft and 0.005 ft/ft, a value is interpolated between the two curves. Values for these two curves are determined in Column J and Column K.

Column G determines the scupper bypass flow.

Column J and Column K read the flows for the two curves of Figure 5.6-4. In the formulation of this spreadsheet, the curves are represented on another sheet named “Chart.” The values for the chart are presented on the next page.

At the end of the vertical curve (or, in this case, at the Begin Vertical Curve Station, since the flow is in the opposite direction of the stationing), the profile grade slope becomes a constant value. The formula in Column D is changed to the constant of 0.005 ft/ft, as shown below.

| | A | B | C | D | E | F | G | H | I | J | K |
|----|-----|----------|----------|-------|----------|----------|----------|----------------|---|----------|----------|
| 21 | 260 | 0.025253 | 0.421407 | 0.005 | 5.936589 | 0.077141 | 0.344266 | | | 0.088428 | 0.077141 |
| 22 | 280 | 0.025253 | 0.440226 | 0.005 | 6.034651 | 0.079023 | 0.361203 | | | 0.088805 | 0.079023 |
| 23 | 300 | 0.025253 | 0.457163 | 0.005 | 6.120691 | 0.080716 | 0.376447 | Station 100+80 | | 0.089143 | 0.080716 |
| 24 | 380 | 0.10101 | 0.760285 | 0.005 | 7.40696 | | | Station 100+00 | | | |

The last scupper is at Station 100+80, which is 300 feet from the crest. The final row, Row 24, checks the spread at the edge of the approach slab. Since the spread at each scupper and at the edge of the approach slab is less than the shoulder width of 10 feet, the design meets the spread criteria.

As noted above, a separate sheet named “Chart” is included to represent the two curves in Figure 5.6-4. The values entered on “Chart” are shown below:

| | A | B | C | D | E | F |
|----|--------------------|-------------|---|------------|-------------|---|
| 1 | Cross Slope = 0.02 | | | | | |
| 2 | S = 0.002 | | | S => 0.005 | | |
| 3 | Total | Intercepted | | Total | Intercepted | |
| 4 | 0 | 0 | | 0 | 0 | |
| 5 | 0.056 | 0.028 | | 0.056 | 0.028 | |
| 6 | 0.105 | 0.057 | | 0.1 | 0.038 | |
| 7 | 0.2 | 0.065 | | 0.2 | 0.05 | |
| 8 | 0.3 | 0.078 | | 0.3 | 0.065 | |
| 9 | 0.4 | 0.088 | | 0.4 | 0.075 | |
| 10 | 0.5 | 0.09 | | 0.5 | 0.085 | |
| 11 | 0.6 | 0.095 | | 0.6 | 0.095 | |
| 12 | 0.7 | 0.105 | | 0.7 | 0.105 | |
| 13 | 0.8 | 0.12 | | 0.8 | 0.12 | |
| 14 | 0.9 | 0.133 | | 0.9 | 0.133 | |
| 15 | 1 | 0.148 | | 1 | 0.148 | |

5.6.4 Closed Collection Systems (Option 3)

The third option is a closed system. You will need to use a closed system if:

- The spread criteria is exceeded without scuppers or inlets on the bridge
- The deck drainage cannot be allowed to freefall to the area below the bridge
- The roadway profile or shoulder width cannot be adjusted

Use grated inlets in closed systems to minimize debris in the piping system. Refer back to Section 5.6.3 for guidance on determining the interception capacity of grated inlets. Coordinate the dimensions and locations of the inlets with the structural designer. Analyze the above-deck design (i.e., size and location of the grated inlets) using a more detailed procedure rather than the equilibrium assumptions from the previous sections. Table 5.6-1 illustrates a typical procedure.

Table 5.6-1: Typical Inlet Location Analysis

| Inlet Location | Drainage Area | Discharge | Spread | Bypass |
|----------------|---------------|-----------|--------|--------|
| Station 1 | | | | |
| Station 2 | | | | |
| ⋮ | | | | |
| Station n | | | | |

| | |
|----------------|--|
| Station 1: | The first inlet downhill of the crest |
| Drainage Area: | The area between the inlet and the crest for the first inlet; for subsequent inlets, the area uphill to the previous inlet |
| Discharge: | The sum of the discharge from the drainage area plus the bypass from the previous inlet |
| Spread: | Calculated using the gutter flow equation or the flat area assumptions |
| Bypass: | Determined by the inlet or scupper capacity |

The below-deck system will have a network of pipes to convey the discharge collected by the inlets to an outlet location. There are two types of systems. One type discharges downward at the piers or bents. This type of system is more commonly found at overpasses. Typically, you will locate the inlets near the pier, so there are few horizontal segments of pipe and flow is not combined from multiple inlets. Therefore, the controlling point hydraulically typically will be the entrance to the piping system at the inlet.

The other type of system discharges at the bridge ends. The system will require longitudinal pipes along the bridge that will carry the combined flow of multiple inlets. Design the below-deck piping system using a procedure similar to the procedure in Chapter 6 of this document. The procedure may be modified to use the driver visibility-limiting rainfall intensity of four inches per hour.

Beside the hydraulic capacity of the piping system, the layout of the system also should consider:

- Minimum cleaning velocities—Three feet per second is recommended.
- Cleanout locations—The locations should consider both access to all segments of the pipe system and access to the cleanout by maintenance personnel.

- Underdeck closed drainage system—Design the system to minimize sharp bends, corner joints, junctions, etc. These features occasionally reduce the hydraulic capacity of the system but, more importantly, they provide opportunities for debris to snag and collect. Use Y-connections and bends for collector pipes and downspouts to help prevent clogging in mid-system.
- UV resistance—Pipes should be UV resistant. If they are not, then locate pipes to prevent UV exposure. Tucking the pipe system behind the bridge beams will prevent UV exposure.

Optional material for bridge collection pipes is located in Chapter 22 of the *Structures Detailing Manual*. No matter what type of pipe is used, give attention to the design of a hanger system, which the bridge design engineer should design, or design in coordination with the bridge design engineer. If the collection system is connected to a roadway structure, specify a resilient connector in the plans. For proper design, it is critical that you coordinate with the structures engineer.

5.7 BRIDGE HYDRAULICS REPORT FORMAT AND DOCUMENTATION

Section 4.11.2 of the *Drainage Manual* lists the minimum information that you must include in the BHR. The minimum requirements are broken down for:

- Bridge and bridge culvert widening
- Bridge culverts
- Category 1 and 2 bridges

The introduction to Section 4.11.2 has a concise set of rules to guide production of all sections in the BHR. Reviewing this brief paragraph before compiling the documentation can help focus the BHR. Additional general guidance to follow while preparing the BHR is:

- Present the BHR in clear and concise language, without redundant information or unsubstantiated comments.
- Make sure graphics address the technical aspects of the project with the public's point of view in mind.
- Use a consistent report format, as well as consistent units with alternative units presented where appropriate.

5.7.1 Bridge Hydraulics Report Preparation

Although the level of detail will vary depending on the type of work (i.e., bridge widening, bridge replacement, or a new bridge crossing), the complexity of the hydrology and hydraulics of the site, and the regulatory requirements, the following general chapter outline is sufficient for most reports:

- Executive Summary
- Introduction
- FEMA/Regulatory Requirements
- Hydrology
- Hydraulics
- Scour
- Deck Drainage
- Appendices

The required documentation can be organized into this suggested outline.

5.7.1.1 Executive Summary

The Executive Summary should be a concise statement of findings. Describe the existing and proposed bridges. Include a summary of all design recommendations for the proposed bridge crossing (Items 1-10 for Category 1 and 2 bridges from Section 4.11.2.4 of the *Drainage Manual*).

The objective of the Executive Summary is to provide the findings in an opening statement so that when the reviewer assesses the report in the future, the reviewer would immediately understand the reasons for choosing the particular bridge. Include a brief conclusion recounting why you selected the proposed bridge length. The discussion should include other bridge considerations that were pertinent or had an important influence on this project. (For bridge widening, this discussion is not necessary.) The important influences might include the following:

- Costs
- Maintenance of traffic
- Roadway geometrics that affect bridge length
- Hydrology

- Hydraulics
- Scour
- Stream geomorphology
- Constructability
- Environmental concerns
- Wildlife shelf requirements
- Other unique concerns particular to the site

Include a discussion of any variations from policies in the *Drainage Manual*, *FDM*, or *Structures Manual*.

5.7.1.2 Introduction

The introduction should describe the location of the bridge briefly, including the name of the water body being crossed. Giving the latitude and longitude and/or the township, range, and section will enhance the location description. Include a figure showing a location map.

Describe the waterway and floodplain at the proposed crossing. Describe the existing crossing, if any, including the bridge, relief bridges, and roadway embankment within the floodplain. The description of bridges should include only details that affect the hydraulics:

- Bridge length and width
- Span lengths
- Foundation type and sizes
- Low member elevations
- Deck and beam heights
- Bridge Skew
- Abutment type
- Condition of existing abutment and/or pier protection, if any
- Other details that affect the hydraulics such as piles not in line with the flow.

Also, describe the purpose of the project (widening, replacement, etc.).

Describe the land use in the area potentially affected by backwater from the crossing. Discuss any nearby buildings or other structures that potentially will control the allowable backwater from the crossing.

State the date of the site visit, and include photographs as figures.

Describe any pertinent information from the latest Bridge Inspection Report (BIR) and include a copy of the report in an appendix. Discuss any information obtained from contact with Department Maintenance.

State the associated datums for each data source and provide datum conversions needed to convert elevations between differing datums.

5.7.1.3 Floodplain Requirements

Discuss requirements of FEMA and other regulatory agencies (Section 5.1.2) that may influence the design of the crossing. Consider including an appendix with the correspondence, meeting minutes, phone notes, etc. from coordination efforts with the agencies. If the original FEMA model was obtained, include a copy in the appendix.

5.7.1.4 Hydrology

Discuss the methods used to determine and check the flow rates applied in the analysis. Include a summary table of frequencies and discharges used in the final analysis.

The hydrologic calculations, computer input and output, or documentation obtained from others used to establish the design flow rates should be included in an appendix.

5.7.1.5 Hydraulics

One-Dimensional Model Setup

Identify and briefly describe the computer program used to calculate the water surface elevations. Include a figure showing the location of the cross sections used in one-dimensional models. Figures 5.7-1(1) and 5.7-2 are examples of cross section location figures. Describe the following aspects of the model development:

- How the data for all the cross sections were obtained and how cross section locations were selected
- How the starting water surface elevations (tailwater conditions) were determined
- How the Manning's roughness coefficients were selected

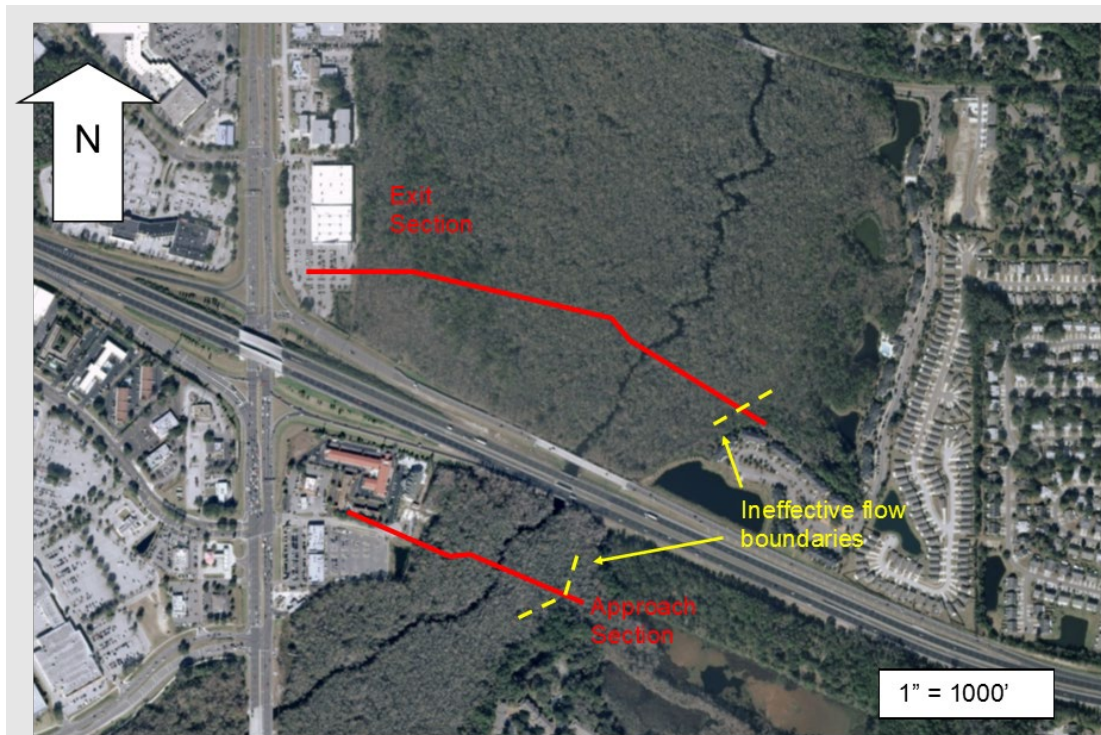

Figure 5.7-1: Example Cross Section Location Figure on an Aerial

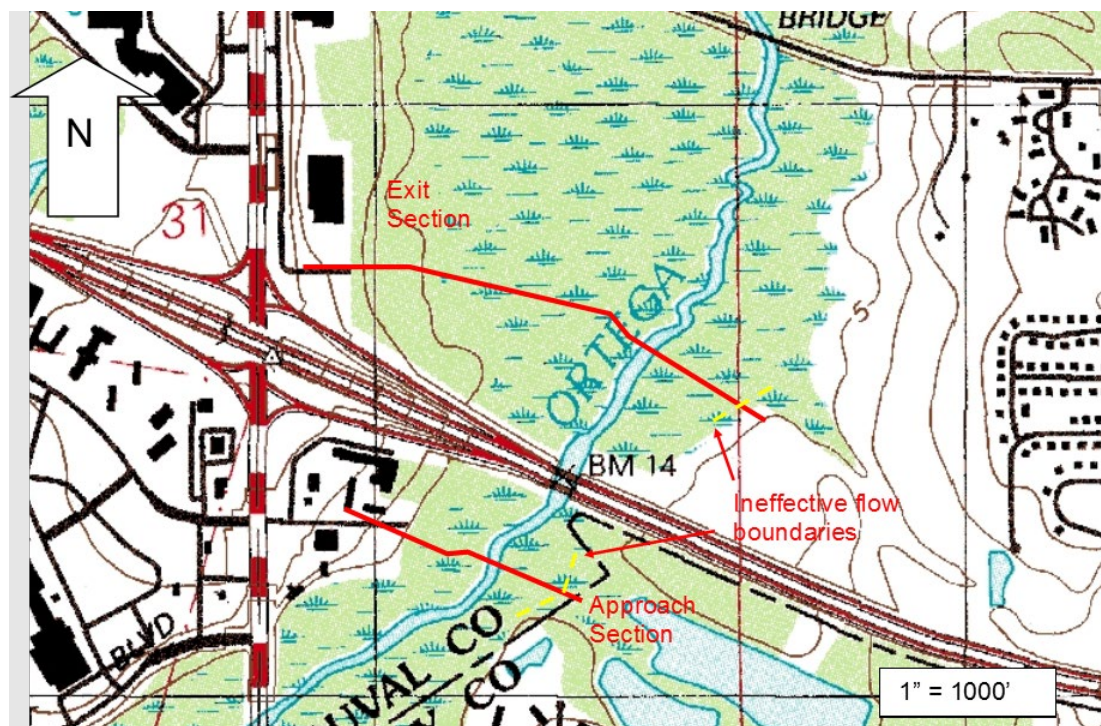

Figure 5.7-2: Example Cross Section Location Figure on a Quadrangle Map

If warning messages remain in the final output, describe any attempts to eliminate the warnings and the reasoning for not resolving them. Input and output from the computer programs used to analyze the crossing should be included in the appendixes. Electronic copies of the input files also will be provided to the Department.

In some cases, such as bridge widenings that do not affect the water surface profiles, calculations may not be performed. However, you must still include the flood data at the site in the plans, per FHWA requirements. If you do not calculate the flood data, then you must obtain them from another source. Typical sources that can be used are hydraulic reports for the existing crossing or FEMA Flood Insurance Studies. Document the source in the report.

Compare water surface elevations for the existing and proposed alternative bridges. The location of the approach section may vary between the existing bridge and each of the alternative bridges. For the comparison to be valid, perform the water surface elevation comparisons at a section that is at a common location in each model. As illustrated in Figure 5.7-3, make the comparison at the location of the approach section that is farthest upstream.

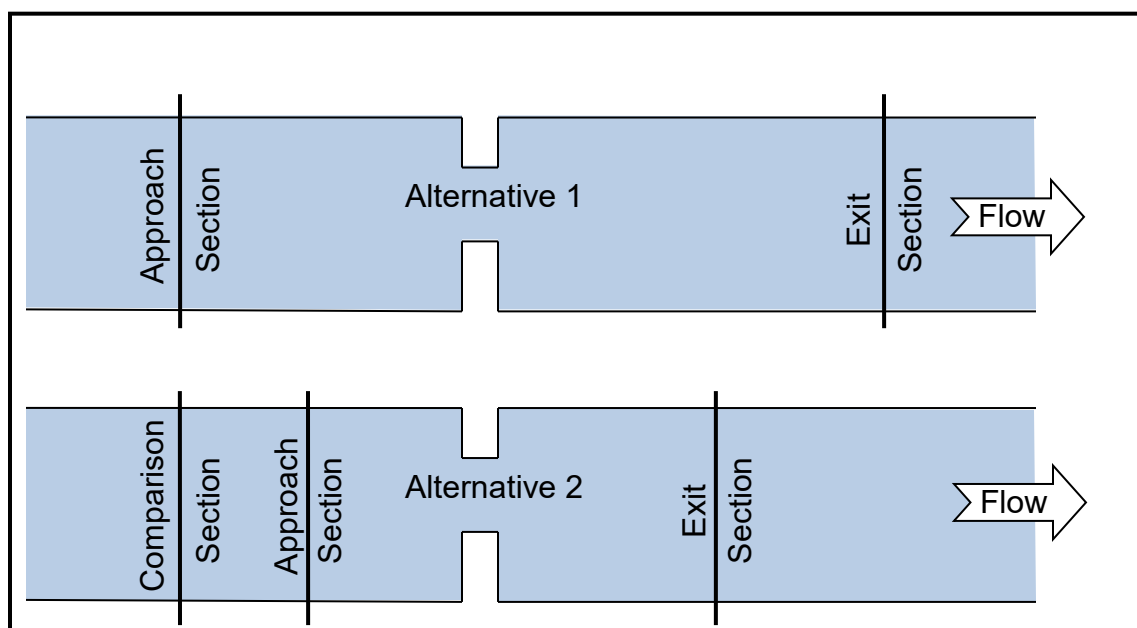

Figure 5.7-3: Water Surface Elevation Comparisons

Include a table that summarizes the water surface elevations for the existing and alternative bridges. Table 5.7-1 is an example of a table comparing water surface elevations.

Table 5.7-1: Example Water Surface Elevation Comparison

| | 50-Year Elevation | 100-Year Elevation | 500-Year Elevation |
|---------------------|-------------------|--------------------|--------------------|
| Existing Conditions | 57.4 | 57.8 | 59.0 |
| Proposed Conditions | 57.2 | 57.8 | 59.1 |

Elevations are NGVD 1929. Elevations shown on the BHR in the Appendix have been converted to NAVD 88. The elevations are adjusted by subtracting 0.65 feet.

Two-Dimensional Model Setup and Results

If two-dimensional modeling was performed as part of the hydraulic analysis of the bridge, the BHR should contain sufficient documentation of the model development and simulation to provide the reviewer and subsequent readers of the report a clear understanding of both the modeling process and the results of the modeling. This begins with a description of the model selected and justification for that selection. The report should document who or what agency developed the model (e.g., FHWA's FESWMS model), as well as the features of either the model or the physical features of the study area that make the model the appropriate choice.

Documentation of the model development should include the following:

- A description of the survey data employed (including horizontal and vertical datums)
- A description of the boundary conditions, as well as sufficient documentation of their development
- Documentation of the selected friction specification
- A listing of other model input parameters (e.g., turbulent closure parameters, time step size, etc.)
- Graphic representations of the model mesh clearly displaying both elevation contours and elements (e.g., Figure 5.7-4 through Figure 5.7-6). Figures should display both the model domain as well as a close-up of the bridge location to ensure documentation of the resolution of the study area.

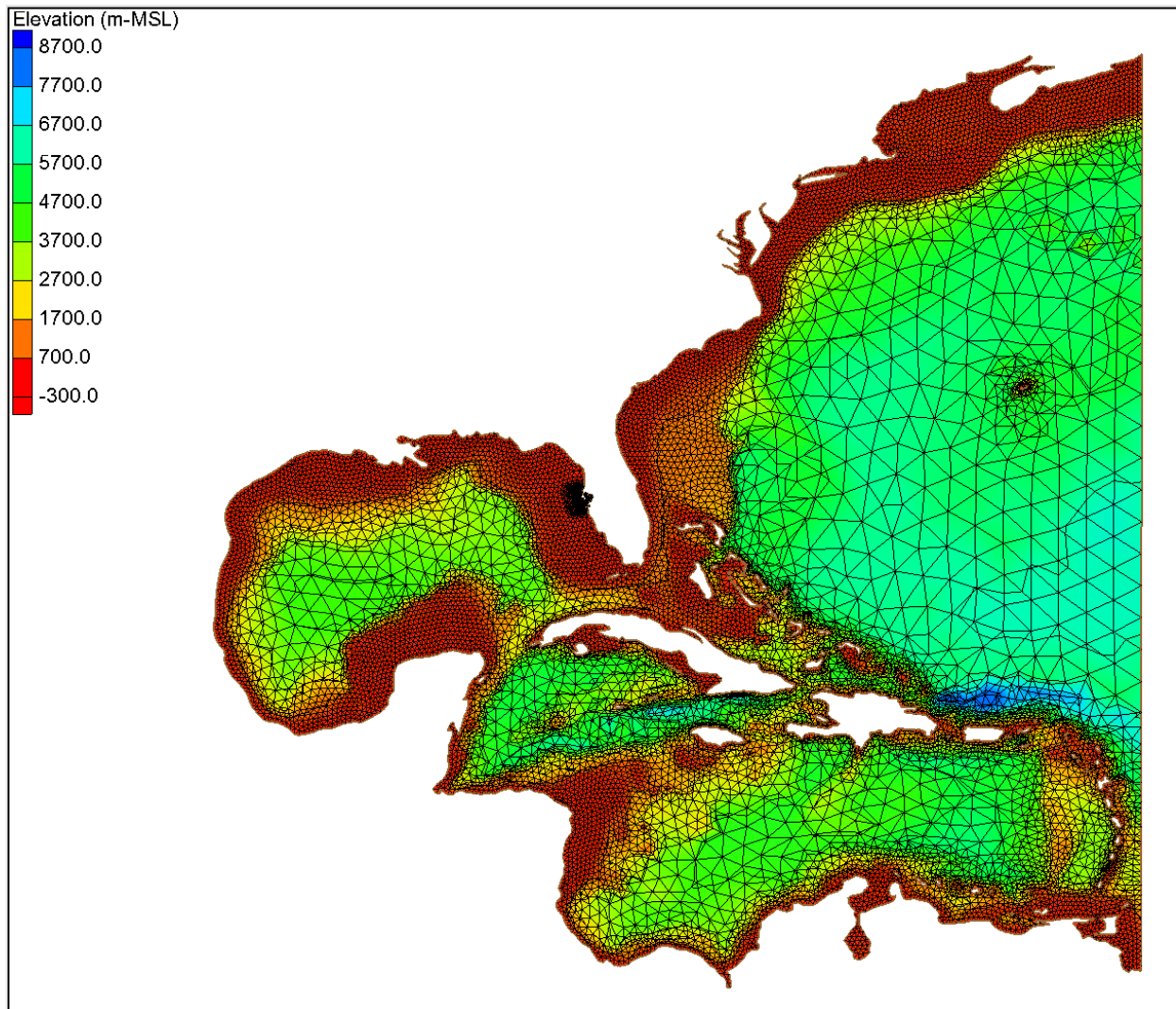

Figure 5.7-4: Tampa Bay Model Mesh Domain

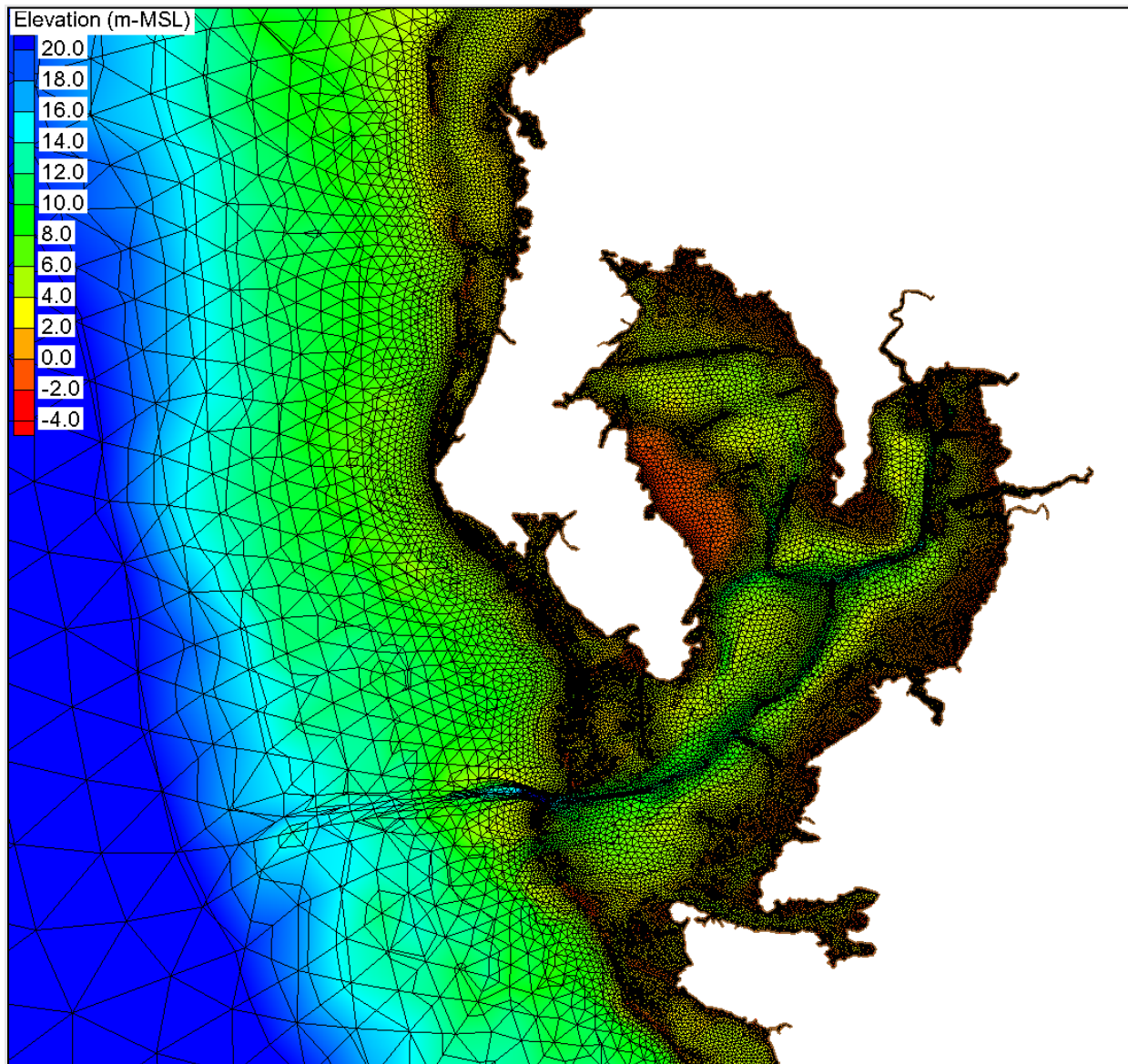

Figure 5.7-5: Model Mesh at Tampa Bay

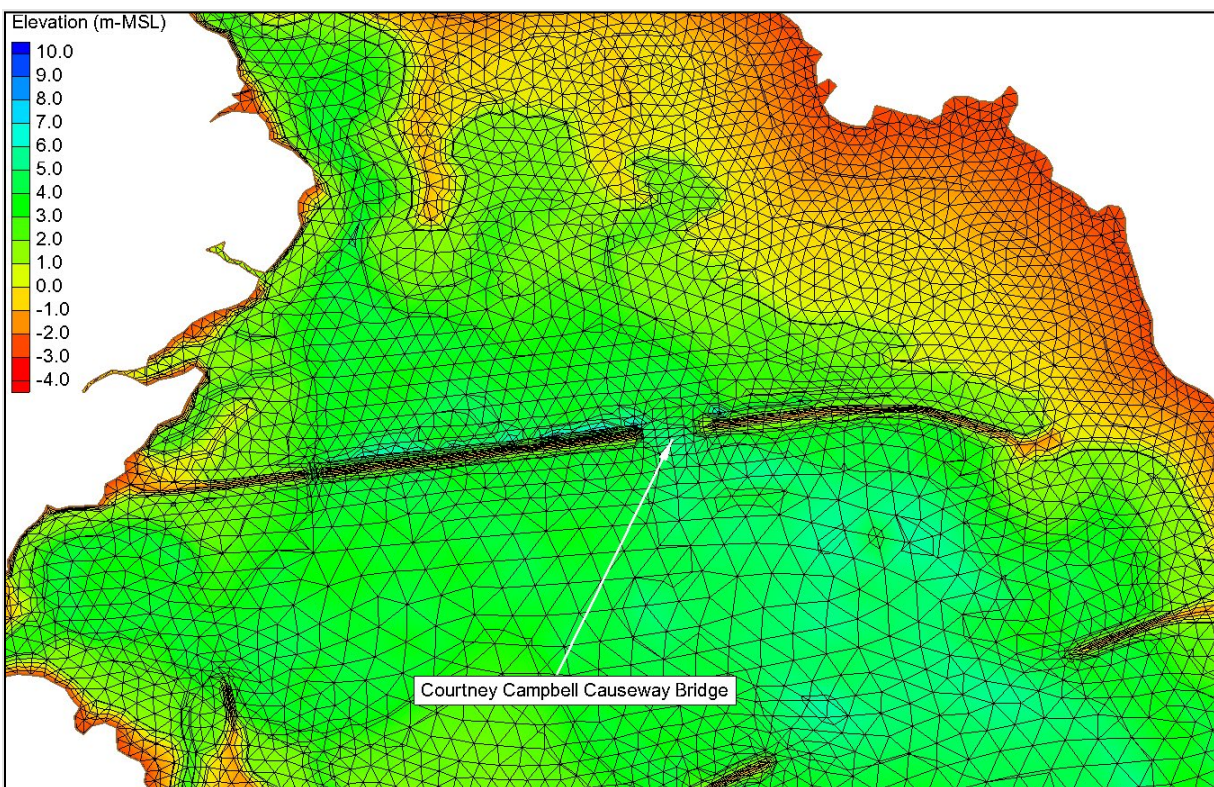

Figure 5.7-6: Model Mesh at the Courtney Campbell Causeway Bridge

Documentation of the two-dimensional model should include:

- A complete description of the calibration process
 - Calibration data
 - The simulations
 - Parameters changed to achieve calibration
 - Parameters of the model
- Both a qualitative and quantitative description of the model's capability to predict measured data
 - Calculation of mean error
 - Standard deviation
 - Percentage error, etc. over time series, between observed high water marks, measured stages, or comparison with predicted tidal ranges.

Examples of qualitative descriptions are provided in Figure 5.7-7 and Figure 5.7-8, which show comparisons between measured and modeled water surface elevations and flow rates.

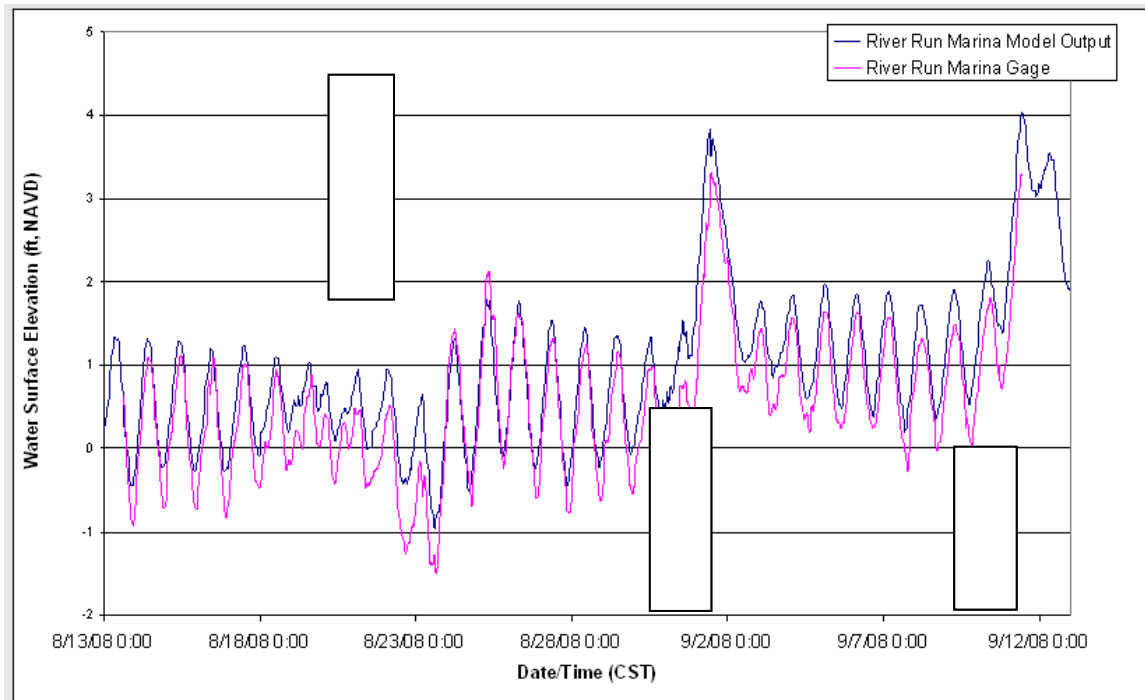
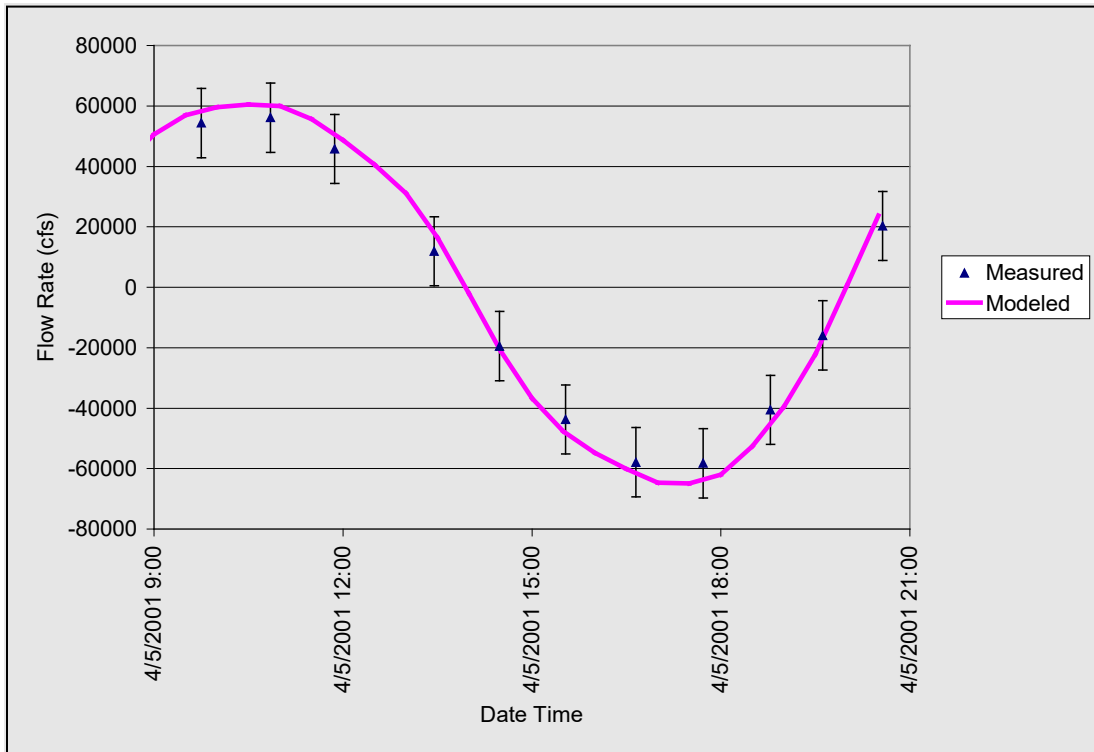

Figure 5.7-7: Model Calibration Plot for the US 90 Bridge over Macavis Bayou Replacement Project at the River Run Marina



**Figure 5.7-8: Flow Rate Calibration at Lake Worth Inlet
 (Error Bars Indicate 10% Error)**

Documentation of two-dimensional modeling simulation results should include, at a minimum:

- Table of max conditions for each simulation at the bridge
- Figures of each simulation (Figure 5.7-9):
 - Display contours of velocity magnitude
 - Velocity vectors displaying the direction of the flow across bridge
- For long bridges, hydraulic parameters at each pier or groups of piers should list:
 - Max stage
 - Max flow rate
 - Max velocity
 - Angle of attack
- Tidal analysis (time-dependent simulation)
 - Time series plot of design values for stage, velocity, and flow rate (Figure 5.7-10 through Figure 5.7-12)

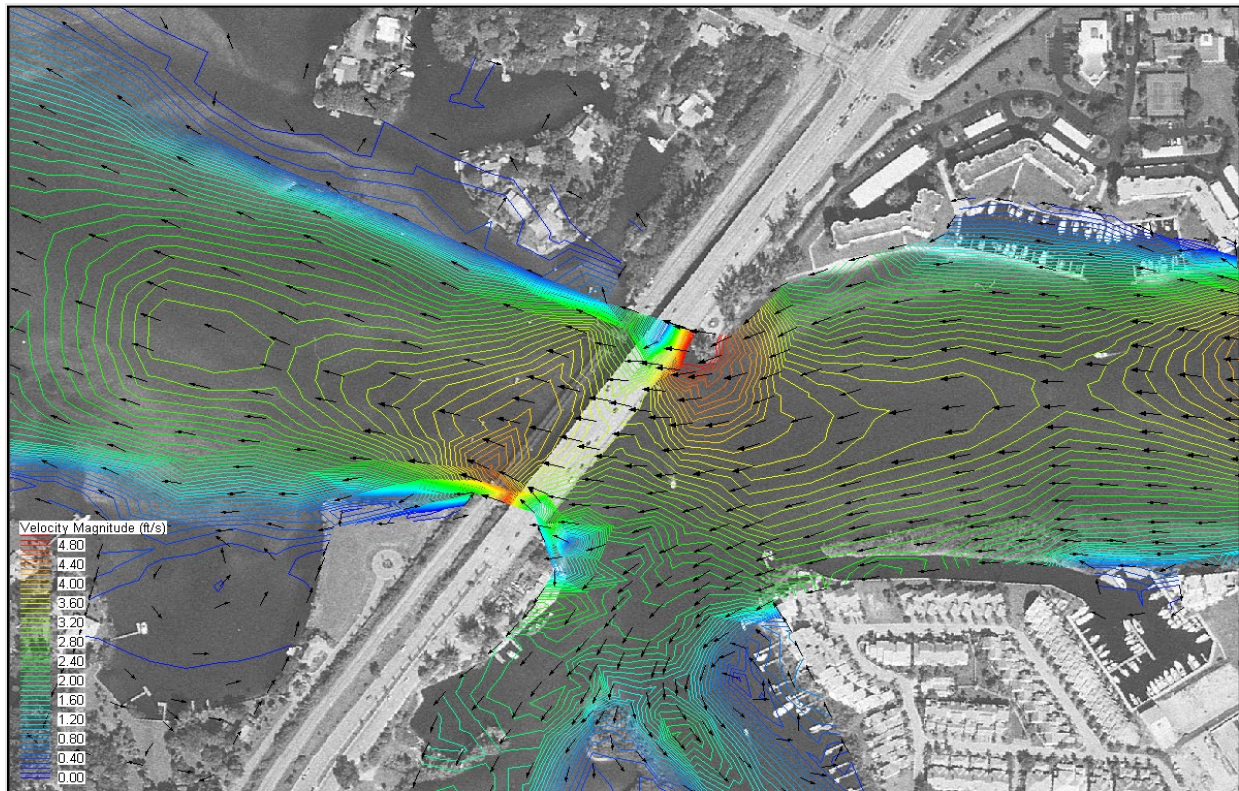

Figure 5.7-9: Velocity Magnitude Contours and Velocity Vectors at the Time of Maximum Velocity during the 100-Year Storm Surge Event at the SR-A1A Bridge over the Loxahatchee River

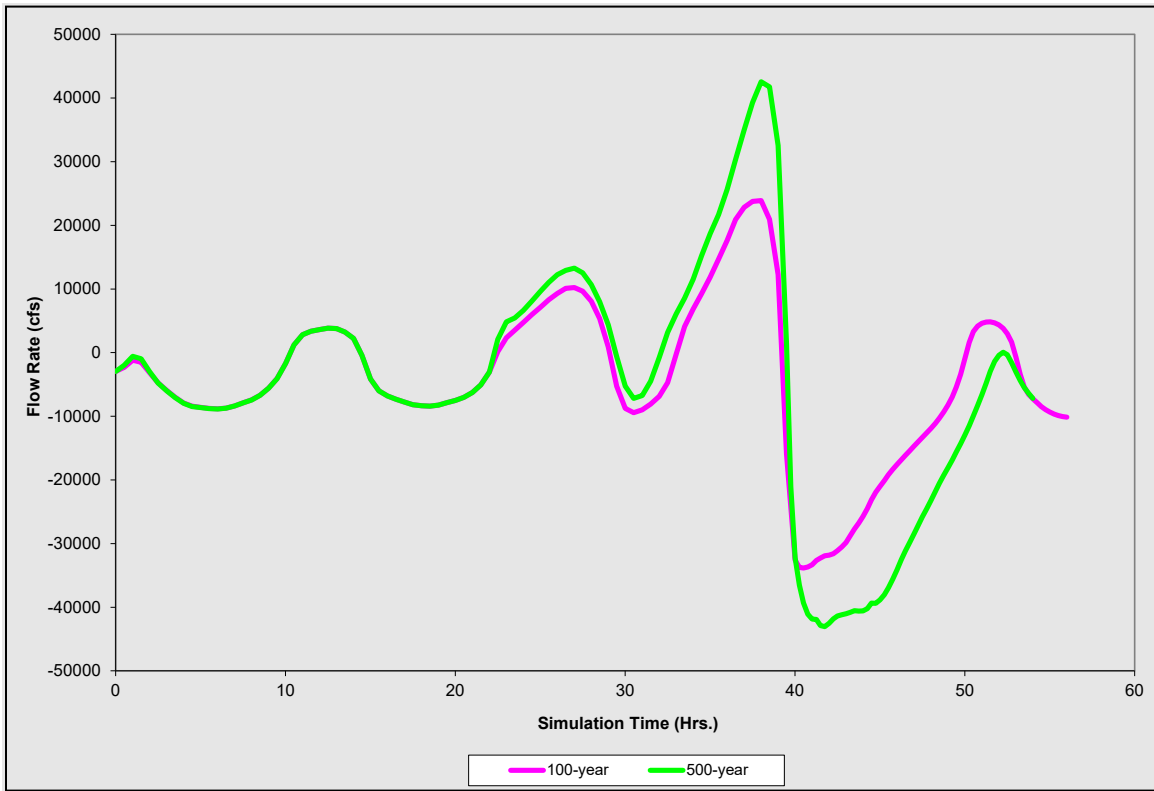

Figure 5.7-10: Flow Rate Time Series during the Design and Check Event at the SR-A1A Bridge over the Loxahatchee River

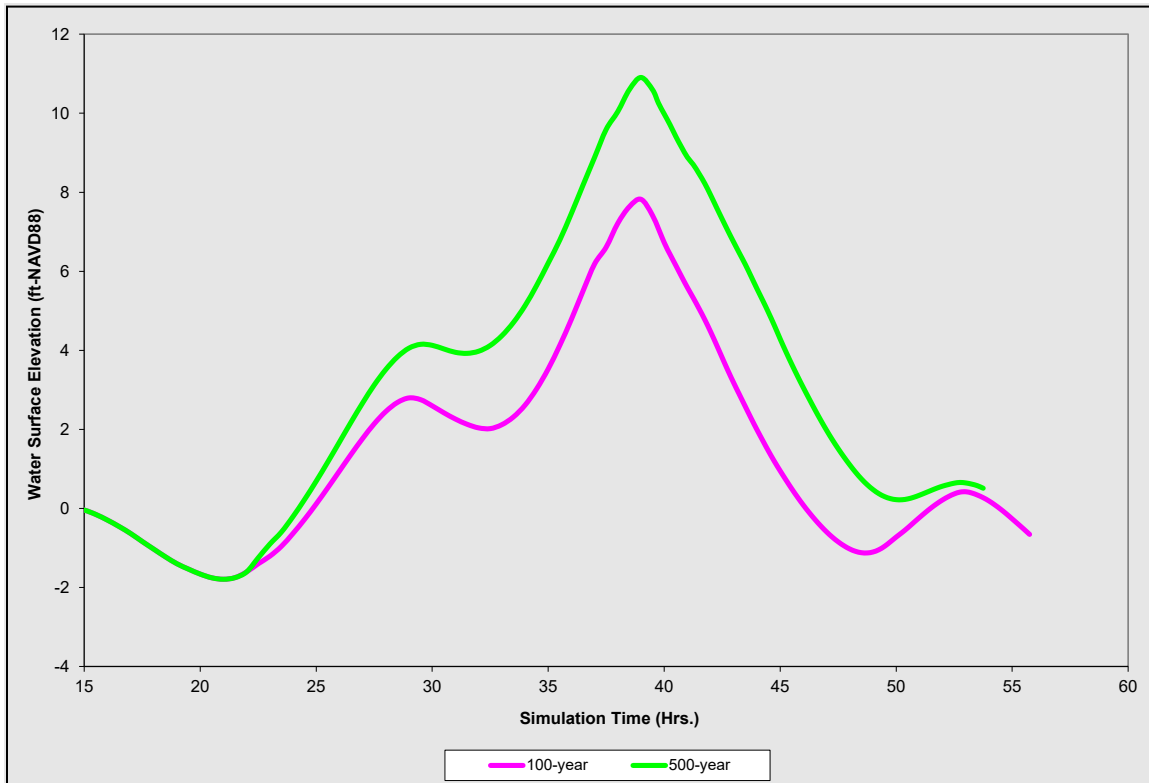

Figure 5.7-11: Water Surface Elevation Time Series during the Design and Check Event at the SR-A1A Bridge over the Loxahatchee River

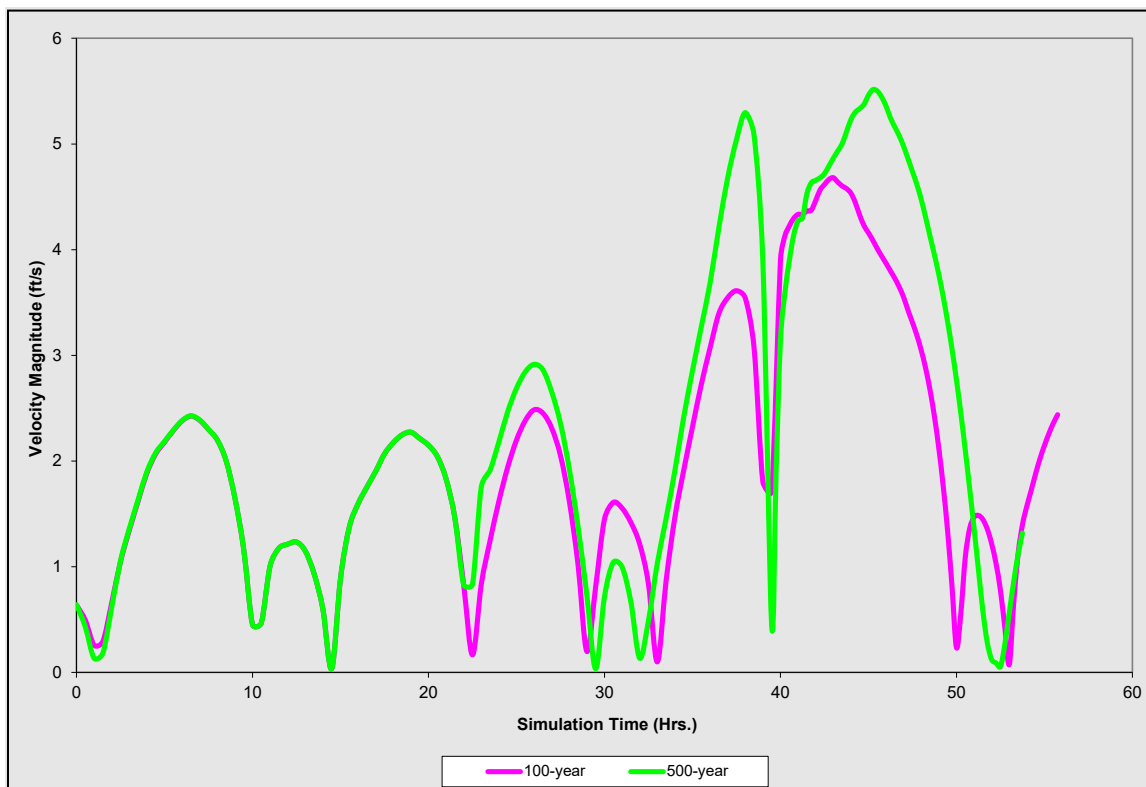

Figure 5.7-12: Velocity Magnitude Time Series during the Design and Check Event at the SR-A1A Bridge over the Loxahatchee River

Required documentation of two-dimensional wave modeling is almost identical to that for hydraulic analyses. The only difference is in the parameters themselves. At a minimum, the wave parameters should include the highest significant wave height at the bridge cross section, the associated peak period, the maximum wave height, and the maximum crest elevation with all parameters associated with the 100-year return period conditions.

Alternatives Analysis

You will not need this section for bridge-widening projects. For new and replacement bridges, this section should document the cost analysis, environmental impacts, and other impacts on adjacent properties. Each alternative still should meet the design standards, but if exceptions must be made for an alternative, then the exception should be included in the comparisons. This section must document the reasons for selecting the recommended alternative.

5.7.1.6 Scour

You should plan to include a discussion of the stream geomorphology, the scour history, the long-term aggradation or degradation, and the scour values, including information on the methods used to determine each of these items. Plot scour depths in a figure.

Discuss the proposed abutment protection. If using one of the standard abutment protection designs given in Section 4.9.3.2 of the *Drainage Manual*, abutment scour need not be calculated and plotted. You may use other abutment protection designs in certain circumstances, but not without prior approval from the District Drainage Office.

5.7.1.7 Deck Drainage

Document the proposed method of deck drainage. Justify the use of longitudinal collection systems. Include in the appendix spread and interception calculations, as well as capacity calculations for any longitudinal collection systems.

5.7.1.8 Appendices

Include calculations and other backup documentation as appendixes to the BHR to avoid disrupting the flow of the main body of the report. Items to consider including in the appendixes are:

- Hydrology calculations
- Hydrology reports from other sources
- Hydraulic calculations
- Hydraulic reports from other sources
- Bridge Inspection Reports
- FEMA report excerpts and maps
- Scour computations
- Cost calculations for alternatives
- Deck drainage calculations
- Regulatory requirements and permits
- Memos, meeting minutes, and phone notes

5.7.2 Bridge Hydraulics Report Process

FDM 250 specifies the multidisciplinary approach to follow for scour consideration, along with submittal requirements. Prepare the BHR in conjunction with the Bridge

Development Report and preliminary Structures Plans. Figure 250.2.1 of the *FDM* outlines a flow chart for the Structural Plans Development Process.

The process flow chart in Figure 5.7-13 shows the general sequence of events necessary to prepare a Bridge Hydraulics Report. You also may need to perform additional coordination, especially for projects involving floodways or for other complex elements.

After you have a relatively good idea of the approximate structure length and location, you should conduct a field review. Then, submit the preliminary structure length and location, along with preliminary scour depths and low member elevations to the Structures Design Office for their preliminary evaluation. After you have developed the proposed bridge configuration and foundation type and submitted them back for review, perform the final hydraulic and scour analyses and submit them to the Structures and Geotechnical Departments.

Have the BHR and BHRS reviewed internally (or by an outside consultant, if necessary). After you have addressed all comments, **approve** the BHR and BHRS and submit them to the Department for **concurrence**. After the BHR and BHRS receive concurrence from the Department, the final BHR and BHRS should be submitted to the structural and geotechnical engineers so that they can complete the BDR and geotechnical reports.

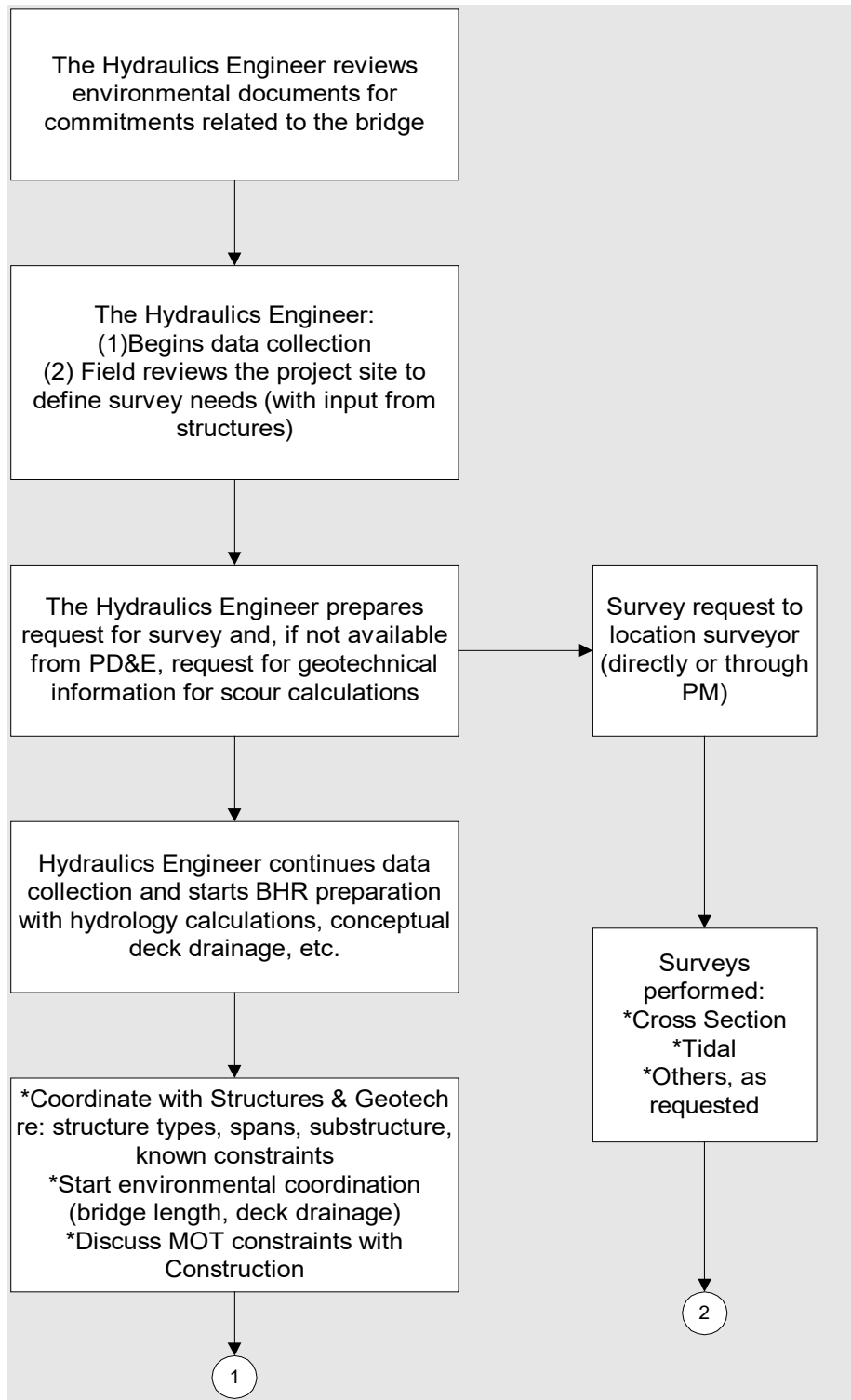

Figure 5.7-13: Bridge Hydraulics Report Process

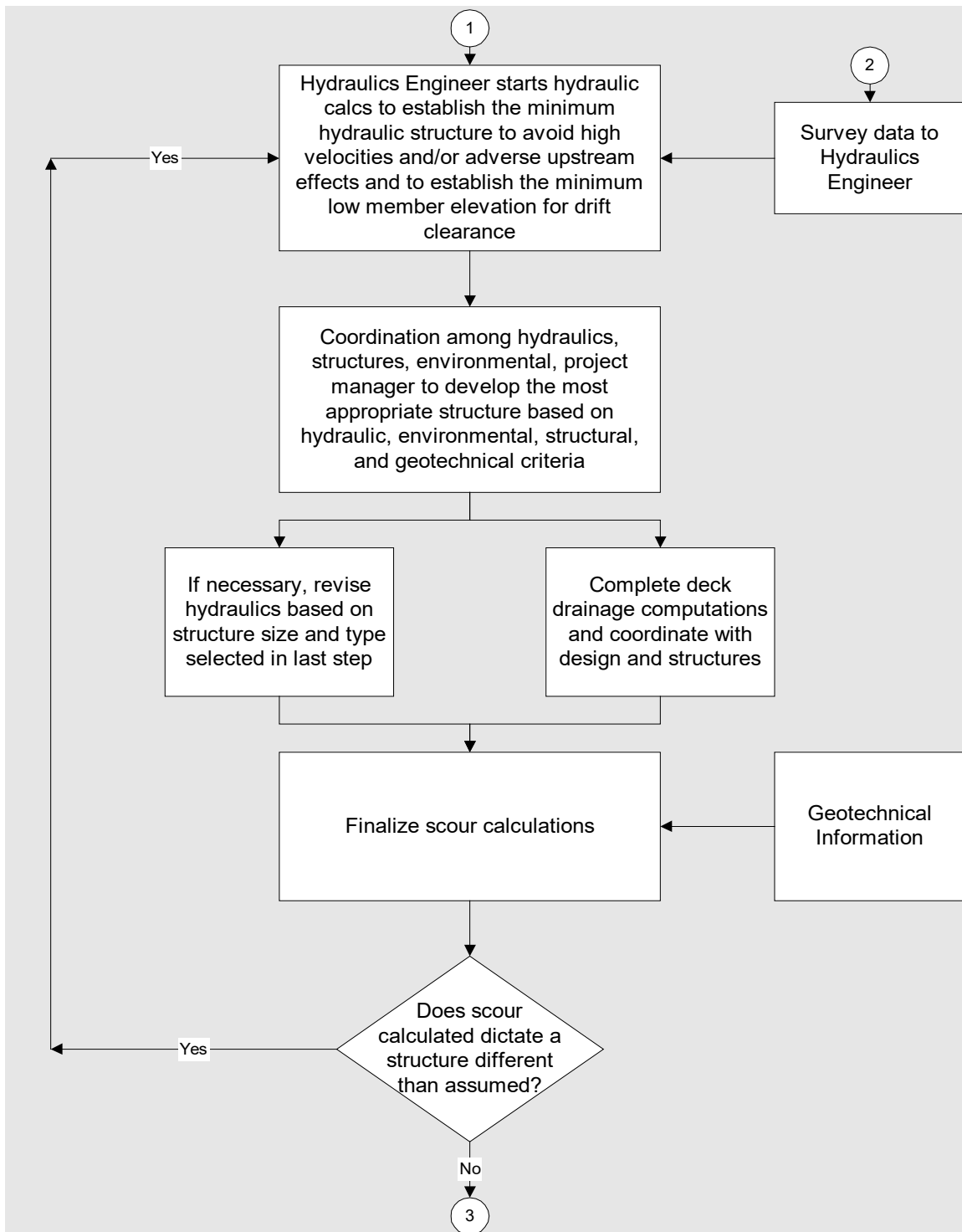

Figure 5.7-13: Bridge Hydraulics Report Process (continued)

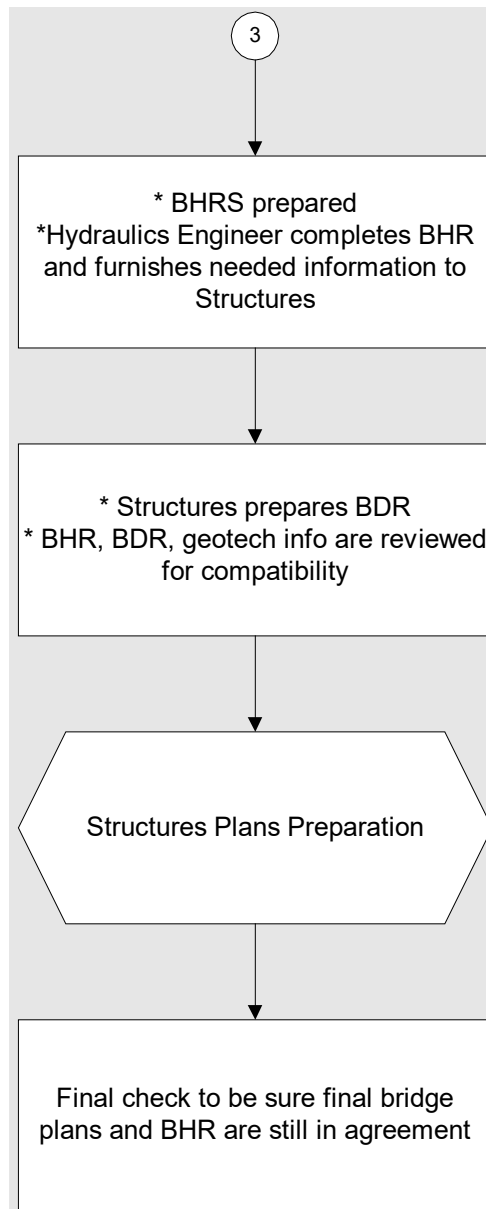

Figure 5.7-13: Bridge Hydraulics Report Process (continued)

5.7.3 Common Review Comments

By far, the most frequent comments associated with the BHR and BHRS address omissions or requests for supporting documentation. The following checklist should provide an additional resource to ensure a quality product for submission to the Department:

- Draft Bridge Hydraulics Report
 - Verify that the report contains the following information:
 - Bridge location
 - Bridge number (if available)
 - Florida County
 - Description of all data collected in the office data collection
 - Description of all data collected in the field data collection
 - List of relevant datums (e.g., NAVD 88, NGVD 29, etc.); provide the difference between datums if supporting documents, new data, and the Plans use different datums
 - Description of the model hydrology
 - Description of the constructed hydraulic model
 - Description of the modeling procedures (inputs, boundary conditions, etc.)
 - Quantitative and qualitative presentation of the calibration simulation results
 - Presentation of the simulation results
 - Description of scour calculation procedures
 - Aggradation/degradation calculation (methodology and results)
 - Channel migration calculation results (methodology and results)
 - Contraction scour mode and calculation results (inputs and output)
 - Local scour calculations and results (inputs and output)
 - Total design scour prediction; total check event scour prediction; recognize that maximum scour for these events can occur at a flow less than the associated return interval flow rate, i.e., if overtopping occurs before either the total design scour or total check event scour
 - Wave climate/wave modeling discussion
 - Wave force calculation procedure and results (inputs and output)

- Abutment protection recommendations and calculations (inputs and output)
 - Deck drainage discussion
- Check the report for the following:
 - Language is clear and concise
 - Presentation graphics address the technical aspects of the project with the public's point of view in mind
 - Report format is consistent
 - Units are consistent, with alternative units presented where appropriate
 - Cross referencing of figures, tables, section numbers within the document have been double-checked
- Draft Bridge Hydraulics Recommendations Sheet
 - Verify that the BHRS contains the following information:
 - Plan View
 - Stationing, scale, and north arrow; include the channel baseline if one was created
 - Existing topography (including existing bridge) and contours (show elevations)
 - The name of the water body
 - Arrows showing the direction of the flow
 - Proposed bridge begin and end station
 - Limits and type of abutment protection
 - Right-of-way lines
 - Profile View
 - Stationing and scale
 - Existing surveyed cross section
 - Road profile for the proposed structure with stationing and elevations
 - Proposed bridge with begin and end station, low member, and pier locations
 - Abutment locations (toe of slope) and abutment protection
 - Design flood elevation

- Normal High Water/Mean High Water
- New bridge number
- Drainage Map and Location Map
 - Location map with north arrow
 - Range and township and an arrow showing the project location
 - Entire drainage area for the proposed structure
 - Calculated drainage area
 - Water elevations on date of survey
- Existing Structures, Hydraulic Design Data, and Hydraulic Recommendations
 - Existing structures
 - Proposed structure
 - Foundation
 - Overall length
 - Span length
 - Type of construction
 - Area of opening
 - Bridge width
 - Elevation of low member
- Hydraulic Information
 - Normal High Water (non-tidal)
 - Control (non-tidal)
 - Mean High Water (tidal)
 - Mean Low Water (tidal)
 - Maximum event of record
 - Design flood information
 - Base flood hydraulic and scour information
 - Overtopping flood/greatest flood hydraulic and scour information
 - Begin bridge station

- End bridge station
- Skew angle
- Navigation clearances—required and provided
- Drift clearances—required and provided
- Abutment protection description—begin and end bridge
- Deck drainage
- Remarks
- Final Bridge Hydraulics Report
 - Verify that the report contains the following information:
 - Changes to the report as specified by the responses to comments following the Department review process
- Final Bridge Hydraulics Recommendations Sheet
 - Verify that the BHRS contains the following information:
 - Changes to the BHRS as specified by the responses to comments following the Department review process

5.7.4 Bridge Hydraulics Recommendations Sheet (BHRS)

The Bridge Hydraulics Recommendations Sheet (BHRS) provides a single reference that summarizes the findings and recommendations of the hydraulic analysis. The BHRS flood data must match those given in the BHR and computer output.

The BHRS is divided into four sections:

- Plan View
- Profile View
- Location Map and Drainage Area
- Existing Structures, Hydraulic Design Data, and Hydraulic Recommendations

FDM 305 gives the minimum requirements of the first three sections. In addition, consider the following items:

- In the Plan View, the *FDM* requires that the limits of riprap be shown. However, abutment protection other than riprap may be proposed. Show the horizontal extents and label the protection type in either the plan or profile view.

- Plot and label the profile of the existing natural ground in the Profile View, and note the existing elevation at each end.
- When practical, you should show the profile of the expected design scour (contraction and long-term scour along the entire unprotected cross section and the local scour at the intermediate piers/bents). Display local scour holes as beginning at the foundation element edges at the design scour depth and extending up at a 1V:2H slope to meet the profile, illustrating the contraction/long-term scour profile.
- Although the profile grade line must be plotted in the Profile View, you do not need to show percent of grade. Plot the PC, PI, and PT of vertical curves using their respective standard symbols; however, there is no need to note data (station, elevation, length of curve). Flag begin and end bridge stations.

Figure 5.7-14 shows a larger view of the section of the BHRS that includes Existing Structures, Hydraulic Design Data, and Hydraulic Recommendations. The hydraulic design data and hydraulic recommendations are for the proposed structure. The required data are identified by bold numbers in parentheses and a brief description is provided on the following pages.

| (REFERENCE) | EXISTING STRUCTURES (1) | | | | PROPOSED (2) STRUCTURE |
|----------------------------|-------------------------|-------|-------|-------|---------------------------|
| | (1) | (2) | (3) | (4) | |
| FOUNDATION (3) | _____ | _____ | _____ | _____ | _____ |
| OVERALL LENGTH (4) | _____ | _____ | _____ | _____ | _____ |
| SPAN LENGTH (5) | _____ | _____ | _____ | _____ | _____ |
| TYPE CONSTRUCTION (6) | _____ | _____ | _____ | _____ | _____ |
| AREA OF OPENING @ D.F. (7) | _____ | _____ | _____ | _____ | _____ |
| BRIDGE WIDTH (8) | _____ | _____ | _____ | _____ | _____ |
| ELEV. LOW MEMBER (9) | _____ | _____ | _____ | _____ | _____ |

HYDRAULIC DESIGN DATA

NOTE:
The hydraulic data is shown for informational purposes only to indicate the flood discharges and water surface elevations which may be anticipated in any given year. This data was generated using highly variable factors determined by a study of the watershed. Many judgements and assumptions are required to establish these factors. The resultant hydraulic data is sensitive to changes, particularly antecedent conditions, urbanization, channelization and land use. Users of this data are cautioned against the assumption of precision which cannot be obtained.

TERMS:
Design Flood: Utilized to assure a desired level of hydraulic performance.
Base Flood: Has a 1% chance of being exceeded in any given year (100 year frequency)
Overtopping Flood: Causes flow over the highway, over a watershed divide, or thru emergency relief structures.
Greatest Flood: The most severe that can be predicted where overtopping is not practicable.

WATER SURFACE ELEVATIONS: N.H.W. (Non-Tidal) (10) _____ M.H.W. (Tidal) (12) _____
 CONTROL (Non-Tidal) (11) _____ M.L.W. (Tidal) (13) _____

FLOOD DATA: MAX. EVENT OF RECORD (14) _____ DESIGN FLOOD (15) _____ BASE FLOOD (16) _____ OVERTOPPING or GREATEST FLOOD (17)

STAGE ELEV. NGVD (ft) (18) _____
 DISCHARGE (cfs) (19) _____
 AVERAGE VELOCITY (f/s) (20) _____
 EXCEEDANCE PROB. (%) (21) _____
 FREQUENCY (yr.) (22) _____

SCOUR PREDICTIONS FOR PROPOSED STRUCTURE DESCRIBED ABOVE: _____ TOTAL SCOUR ELEVATION _____

| | | | |
|--------------------|----------------------------------|---|---|
| PIER INFORMATION | LONG TERM SCOUR ELEV. (27) _____ | WORST CASE < 100 yr. FREQ. (yr.) (23) _____ | WORST CASE < 500 yr. FREQ. (yr.) (24) _____ |
| NUMBERS (25) _____ | SIZE AND TYPE (26) _____ | (28) _____ | (29) _____ |

HYDRAULIC RECOMMENDATIONS

1. BEGIN BRIDGE STATION (30) _____ END BRIDGE STATION (31) _____ SKEW ANGLE (32) _____

2. CLEARANCE PROVIDED: NAV: HORIZ.(33) VERT.(34) ABOVE EL.(35) DRIFT: HORIZ.(36) VERT.(37) ABOVE EL.(38)

3. MINIMUM CLEARANCE: NAV: HORIZ.(39) VERT.(40) ABOVE EL.(35) DRIFT: HORIZ.(41) VERT.(42) ABOVE EL.(38)

4. ABUTMENTS:

| | | |
|----------------------------------|--------------|------------|
| | BEGIN BRIDGE | END BRIDGE |
| RUBBLE GRADE: | (43) _____ | (43) _____ |
| SLOPE: | (44) _____ | (44) _____ |
| BURIED OR NON-BURIED HORIZ. TOE: | (45) _____ | (45) _____ |
| TOE HORIZ. DISTANCE: | (46) _____ | (46) _____ |
| LIMIT OF PROTECTION: | (47) _____ | (47) _____ |

5. DECK DRAINAGE: (48) _____

REMARKS: (49)(50) _____

Figure 5.7-14: BHRS Required Data

- (1) Existing Structures: Structure 1 refers to the structure being replaced or modified. Structures 2, 3, and 4 refer to relief structures, immediate upstream and downstream structures, and those structures that affect the hydraulics of the proposed structure.
- (2) Proposed Structure: This column should have information pertaining to the proposed structure.
- (3) Foundation: This row should have information describing the type of foundation (e.g., timber piles, concrete piles, etc.).

- (4) Overall Length (ft): This row should give the total length of the structure in feet. The length should be measured from the top of the abutments. For the proposed structure, this length should match the total length shown in the final plans.
- (5) Span Length (ft): This row should give the span length of the structure in feet. This length should be based on the length at the main span.
- (6) Type of Construction: This row should have information describing the material(s) used for construction of the structure (e.g., steel, concrete, steel and concrete, etc.).
- (7) Area of Opening (ft²) @ D.F.: This row should have the area of opening in square feet below the design flood elevation less the assumed pile area, if significant, at the bridge section.
- (8) Bridge Width (ft): The bridge width should be from rail to rail, including the rails, in feet.
- (9) Elev. Low Member (ft): This elevation in feet should be the lowest point along the low member of the structure.
- (10) N.H.W. (Non-Tidal) (ft): The Normal High Water at the bridge. This water surface elevation in feet only applies to non-tidal areas.
- (11) Control (Non-Tidal) (ft): The water surface elevation in feet controlled by the operation of pump stations, dams, or other hydraulic structures.
- (12) M.H.W. (Tidal) (ft): The Mean High Water elevation in feet at the bridge. This water surface elevation only applies to tidal areas.
- (13) M.L.W. (Tidal) (ft): The Mean Low Water elevation in feet at the bridge. This water surface elevation only applies to tidal areas.
- (14) Max. Event of Record: This column provides information related to the maximum event recorded based on historical information (if available).
- (15) Design Flood: This column provides information related to the design flood.
- (16) Base Flood: This column provides information related to the base flood.

(17) Overtopping Flood/Greatest Flood: If the overtopping flood has a lower return period than the greatest flood, then the block indicating overtopping flood is checked and the information related to the overtopping flood is shown. Otherwise, the block indicating greatest flood is checked and the information related to the greatest flood is shown.

(18) Stage Elev. NAVD 88 or NGVD 29 (ft): For freshwater flow, the elevation in feet typically taken from the hydraulic model at the approach section for the design flood and/or base flood, overtopping flood, greatest flood. Proper engineering judgment is required for long bridges since it may not be realistic to use the elevation at the approach section because the losses between the bridge and approach section are large.

For tidal flow, the maximum elevation during the flood or ebb storm surge at the bridge for the design flood and/or base flood, overtopping flood, greatest flood. Add a remark that stage, discharge, and the velocity described in the flood data do not occur at the same time.

(19) Discharge (cfs): For freshwater flow, the total discharge in cubic feet per second used in the simulations for the design flood, base flood, overtopping flood, and/or greatest flood.

For tidal flow, the maximum discharge during the flood or ebb storm surge at the bridge for the design flood, base flood, overtopping flood and/or greatest flood. Add a remark that stage, discharge, and the velocity described in the flood data do not occur at the same time.

(20) Average Velocity (fps): For freshwater flow, the average velocity in feet per second taken from the computer simulations at the Bridge Section for the design flood, base flood, overtopping flood and/or greatest flood.

For tidal flow, the maximum average velocity at the bridge section during the flood or ebb storm surge for the design flood, base flood, overtopping flood and/or greatest flood.

(21) Exceedance Prob. (%): The probability that the conditions are exceeded. Determined as 100% times unity over the return interval (e.g., $100\% \times (1/100) = 1\%$).

(22) Frequency (yr): The return period of the conditions in years.

- (23) Frequency (yr): The frequency (return period) in years of the worst case scour condition up through the design return period flow conditions.
- (24) Frequency (yr): The frequency (return period) in years of the worst case scour condition up through the design check period flow conditions.
- (25) Pier No.: The pier number or range of pier numbers that correspond to the pier size and type in Column 26 and the scour elevations in Columns 27, 28, and 29.
- (26) Pier Size and Type: The proposed pier size and type that produces the greatest scour. If necessary for clarity, place a reference to the appropriate details of the bridge plans. If the space provided is not adequate, place the information in the plan or profile view.
- (27) Long-Term Scour (ft): Applicable only to structures required to meet extreme event vessel collision load. See Section 6.2 for the definition of long-term scour. If it is not applicable, state so.
- (28) Total Scour Elevation (< 100-year) (ft): The predicted total scour elevation in feet for the worst-case scour condition up through the scour design flood frequency. This includes aggradation or degradation, channel migration, local scour (pier and abutment), and contraction scour.
- (29) Total Scour Elevation (< 500-year) (ft): The predicted total scour elevation in feet for the worst-case scour condition up through the scour design check flood frequency. This includes aggradation or degradation, channel migration, local scour (pier and abutment), and contraction scour.
- (30) Begin Bridge Station: The station for the beginning of the bridge.
- (31) End Bridge Station: The station for the end of the bridge.
- (32) Skew Angle (degrees): The angle in degrees at which the structure is skewed from the centerline of construction. See Standard Plans, Index 400-289, Sheet 1, Schematic "B" for further explanation.
- (33) Navigation Clearance (Horiz.) (ft): The actual horizontal navigation clearance in feet provided between fenders or piers.
- (34) Navigation Clearance (Vert.) (ft): The actual vertical navigational clearance in feet provided between fenders or piers.

- (35) Navigation Clearance (Above El.) (ft): For freshwater flow, the elevation (NAVD 88 or NGVD 29, ft) at the normal high water (NHW) elevation or control elevation.

For tidal flow, this is the elevation at mean high water (MHW).

- (36) Drift Clearance (Horiz.) (ft): The actual minimum horizontal clearance in feet provided.

- (37) Drift Clearance (Vert.) (ft): The actual minimum vertical clearance in feet provided above the design flood.

- (38) Drift Clearance (Above El.) (ft): For freshwater flow, this is the design flood elevation (NAVD 88 or NGVD 29, ft) and either of two values is appropriate. In many cases, it is reasonable to use the elevation at the approach section, realizing that this will be slightly higher than actual elevation at the bridge.

For tidal flow, use the maximum stage associated with an average velocity of 3.3 fps through the bridge section during the flood or ebb for the storm surge for the design flood. If the maximum velocity due to the storm surge is less than 3.3 fps, use the stage associated with the maximum velocity through the bridge section. If either of these stages causes the profile to be higher than the profile of the bridge approaches, consider other alternatives. One alternative is to discuss with personnel in the Structures Design Office the potential of having less drift clearance and designing the structure for debris loads. Another alternative is to do a more rigorous and site-specific analysis to set the stage above which to provide the standard drift clearance. Investigate and address these situations on a site-specific basis.

- (39) Navigation Clearance (Horiz.) (ft): The minimum horizontal navigation clearance in feet required. See the *FDM 260* for the minimum requirements. Other agencies may have minimum clearance requirements.

- (40) Navigation Clearance (Vert.) (ft): The minimum vertical navigation clearance in feet required. The Department minimum clearances are given in the *FDM 260*. Other agencies may have minimum clearance requirements.

- (41) Drift Clearance (Horiz.) (ft): The minimum horizontal debris drift clearance in feet required. The Department minimum clearances are given in the *FDM 260*.

- (42) Drift Clearance (Vert.) (ft): The minimum vertical debris drift clearance in feet required above the design flood. The Department minimum clearances are given in *FDM 260*.
- (43) Rubble Grade: Grade of rubble (e.g., Riprap (Bank & Shore), etc.) to be constructed at the begin and end bridge abutments. References can be made to details sheets if non-standard riprap is employed.
- (44) Slope: Slope of the abutments at the begin and end bridge (e.g., 1H:2V, etc.).
- (45) Non-buried or Buried Horiz. Toe: Indicate whether the toe of the abutment will be non-buried or buried when extended horizontally from the bridge. See Section 5.5.4 of this document for details.
- (46) Toe Horizontal Distance (ft): Horizontal extent in feet of the rubble protection measured from the toe of the abutment. See Section 5.5.4 of this document for details.
- (47) Limit of Protection (ft): Distance measured parallel to the stationing in feet, from the edge of the rubble protection to the bridge begin/end station. If the distance is different on each side, indicate both distances with their corresponding sides.
- (48) Deck Drainage: Type of deck drainage to be used for the proposed structure (e.g., scuppers, storm drain system, etc.)
- (49) Remarks: This space is available to record any pertinent remarks.
- (50) Wave Crest Elevation (ft): The 100-year design wave crest elevation in feet, including the storm surge elevation and wind setup. The vertical clearance of the superstructure must be a minimum of 1 foot above the wave crest elevation. The Department minimum clearances are given in *FDM 260*.

CHAPTER 6: STORM DRAINS

| | |
|--|-------------|
| 6. STORM DRAINS | 6-1 |
| 6.1 FDOT Storm Drain Tabulation Form..... | 6-1 |
| 6.2 Hydrology | 6-6 |
| 6.2.1 Design Frequency..... | 6-6 |
| 6.2.1.1 Storms of Greater Magnitude..... | 6-6 |
| 6.2.2 Time of Concentration..... | 6-8 |
| 6.2.2.1 Peak Flow from Reduced Area | 6-9 |
| 6.2.2.2 Ignoring Time of Flow in Section..... | 6-13 |
| 6.3 Inlets and Pavement Hydraulics | 6-14 |
| 6.3.1 Inlets | 6-14 |
| 6.3.1.1 Apparent Locations | 6-14 |
| 6.3.1.2 Sags..... | 6-14 |
| 6.3.1.3 Continuous Grades..... | 6-15 |
| 6.3.1.4 Back of Sidewalk | 6-15 |
| 6.3.1.5 Inlet Capacity | 6-16 |
| 6.3.2 Pavement Hydraulics | 6-17 |
| 6.3.2.1 Gutter Grades | 6-17 |
| 6.3.2.2 Cross Slope | 6-20 |
| 6.3.2.3 Shoulder Gutter | 6-20 |
| 6.3.2.4 Determining the Spread | 6-22 |
| 6.4 Pipe System Placement..... | 6-34 |
| 6.4.1 Plan Layout | 6-34 |
| 6.4.1.1 Retaining Wall Drainage | 6-35 |
| 6.4.2 Profile Placement..... | 6-35 |
| 6.4.2.1 Slopes..... | 6-35 |
| 6.4.2.2 Minimum Pipe Depth..... | 6-37 |
| 6.4.3 Utility Coordination..... | 6-38 |
| 6.4.4 Pipe-to-Structure Connections | 6-38 |
| 6.5 Pipe Hydraulics | 6-48 |
| 6.5.1 Pressure Flow | 6-48 |
| 6.5.2 Partially Full Flow | 6-49 |
| 6.5.3 Lower-End Hydraulic Gradient..... | 6-49 |
| 6.5.3.1 Design Tailwater (DTW)..... | 6-52 |
| 6.5.4 Upper-End Hydraulic Gradient..... | 6-52 |
| 6.5.5 Flow Velocity in the Pipe Section | 6-54 |

| | | |
|------------|----------------------------------|-------------|
| 6.5.6 | Utility Conflict Box Losses..... | 6-56 |
| 6.5.7 | Minor Losses..... | 6-57 |
| 6.6 | Procedure | 6-58 |

6. STORM DRAINS

6.1 FDOT STORM DRAIN TABULATION FORM

The primary means of documenting storm drain design is the Department's storm drain tabulation form shown in Figure 6.1-1. On this form, record items identified by numbers in parentheses on Figure 6.1-1. These items are discussed in the description following the form. This information also is available on the FDOT Drainage web site.

For projects that utilize the 900 Series of the FDM, use alternative Flex tables to represent the same information that is shown below in Figure 6.1-1 and provided in the Drainage Manual, Section 3.13. For guidance to analyze storm sewer systems and develop the appropriate flex tables for the Drainage Report documentation is provided in FDOT CADD Office publication, FDOTConnect Drainage Design & 3D Modeling with Plans Development Training Guide. <https://www.fdot.gov/cadd/main/FDOTCaddTraining.shtm>

Drainage Design Guide
Chapter 6: Storm Drains

**FLORIDA DEPARTMENT OF TRANSPORTATION
STORM DRAIN TABULATION FORM**

Financial Project Identification:
Description:

County:
Organization:

Network:
State Road:

Prepared:
Checked:

Date:
Date:

| LOCATION OF UPPER END | | | STRUCTURE NO. | TYPE OF STRUCTURE | LENGTH (ft.) | DRAINAGE AREA (Acres) | | SUB-TOTAL (C*A) | TIME OF CONCENTRATION (min) | TIME OF FLOW IN SECTION (min) | INTENSITY (in/hr) | TOTAL (C*A) | BASE FLOW (cfs) * | TOTAL FLOW (cfs) | MINOR LOSSES (ft.) * | INLET ELEVATION (ft.) | HGL CLEARANCE (ft.) | HYDRAULIC GRADIENT | | | PIPE SIZE (in.) | SLOPE (%) | ACTUAL VELOCITY (fps) | NOTES AND REMARKS | | |
|-----------------------|----------------|------|---------------|-------------------|--------------|-----------------------|-----------|-----------------|-----------------------------|-------------------------------|-------------------|-------------|-------------------|------------------|----------------------|-----------------------|---------------------|-----------------------|---------------------------|------------|---------------------|-----------|-----------------------|-------------------------|-------------------------|------------|
| ALIGNMENT NAME | | | | | | UPPER | INCREMENT | | | | | | | | | | | TOTAL | CROWN | | | | | | RISE | HYD. GRAD. |
| STATION | DISTANCE (ft.) | SIDE | LOWER | TYPE OF STRUCTURE | LENGTH (ft.) | INCREMENT | TOTAL | SUB-TOTAL (C*A) | TIME OF CONCENTRATION (min) | TIME OF FLOW IN SECTION (min) | INTENSITY (in/hr) | TOTAL (C*A) | BASE FLOW (cfs) * | TOTAL FLOW (cfs) | MINOR LOSSES (ft.) * | INLET ELEVATION (ft.) | HGL CLEARANCE (ft.) | FLOWLINE | | | NUMBER OF BARRELS * | SPAN | MIN. PHYS. | PHYSICAL VELOCITY (fps) | | |
| | | | | | | | | | | | | | | | | | | UPPER ELEVATION (ft.) | LOWER END ELEVATION (ft.) | FALL (ft.) | | | | | TAILWATER EL (ft): (41) | |
| (2) | | | (6) | (7) | (8) | (9) | (10) | (11) | (12) | (13) | (14) | (15) | (16) | (17) | (18) | (19) | (20) | (21) | (22) | (27) | (29) | (30) | (32) | (35) | (42) | |
| (3) | (4) | (5) | (6) | | | (9) | (10) | (11) | | | | | | | | | | (23) | (24) | (28) | | (31) | (33) | (36) | | |
| | | | | | | (9) | (10) | (11) | | | | | | | | | | (25) | (26) | | | | (34) | | | |
| | | | | | | | | | | | | | | | | | | | | | | | | | | |
| | | | | | | | | | | | | | | | | | | | | | | | | | | |
| | | | | | | | | | | | | | | | | | | | | | | | | | | |
| | | | | | | | | | | | | | | | | | | | | | | | | | | |

* Denotes optional information.

** A composite runoff coefficient may be shown in lieu of individual C-values, provided the composite C calculations are included in the drainage documentation.

Figure 6.1-1: Storm Drain Tabulation Form

Tabulation Form Description:

1. Runoff Coefficients (C): You will be limited to three runoff coefficients. For most projects, this provides sufficient flexibility.
2. Alignment Name: The name of the alignment that the structure's station and offset references.
3. Station: The survey station number for the structure being used.
4. Distance (ft): The offset distance, in feet, from reference point of the structure to the reference station.
5. Side: The side, Right (Rt) or Left (Lt), of the reference station.
6. Structure Number: The structure number at the upper end is shown above the structure number at the lower end. Each major row (three minor rows) of the form identifies an inlet and the downstream pipe from that inlet.
7. Type of Structure: Usually shown with abbreviations such as Type P-3 or P-5 for inlets; Type C or E for ditch bottom inlets (DBI); Type P-8 or J-7 (MH) for manholes; and Type J-7 (Junct) for junction boxes.
8. Length (ft): The length, in feet, from the hydraulic center of the structure to the hydraulic center of the next downstream structure.
9. Increment: The incremental drainage areas, in acres, corresponding to the runoff coefficients being used. It is normally only the area that drains overland to an inlet, but it can include areas that drain to structures

through existing pipes. If so, note it in the Remarks Column (42) or use the optional Base Flow Column.

Manholes usually do not have incremental areas as they are handling areas already tabulated. If the incremental drainage area does not fit one of the three runoff coefficients selected, mathematically adjust the size of the area to fit one of the selected runoff coefficients. Note the adjustment in the Remarks Column (42).

$$\text{Area}_{\text{ADJ}} = (\text{C}_{\text{ACT}}/\text{C}_{\text{SELECT}}) \times \text{Area}_{\text{ACT}}$$

10. Total: The total area, in acres, associated with each runoff coefficient and passing through the structure. Identify all the areas that drain to the structure through pipes from upstream structures. Add these "upstream areas" to the incremental drainage areas for the structure (9).
11. Sub-Total (C*A): The result of multiplying the total area associated with each runoff coefficient (10) by the corresponding runoff coefficient.
12. Time of Concentration (min): Usually, the time required for the runoff to travel from the most hydraulically remote point of the area drained to the point of the storm drain system under consideration. This time consists of overland flow, gutter flow, and flow time within the pipe system. Occasionally, this time is associated with a reduced area that creates a peak flow. If so, note it in the Remarks Column (42). Show this number in minutes.
13. Time of Flow in Section (min): The time, in minutes, it takes the runoff to pass through the section of pipe.

- $T_{SECT} = \text{Hydraulic Length (8)} / \text{Actual Velocity (35)}$
14. Intensity (in/hr): Determined from NOAA Atlas 14 data. Intensity depends on the design frequency and the time of concentration. Intensity at the pipe segment for the given time of concentration (T) can be interpolated from NOAA's Atlas 14 tabular intensity (i) table via a linear interpolation and verification the interpolated intensity is within the 90% confidence limit bounding values. Show this number in inches per hour.
 15. Total ($C \cdot A$): The sum of the sub-total $C \cdot A$ values (11).
 16. Base Flow (cfs): This is an optional column to account for known flows from underdrains, offsite pipe connections, etc. Show this number in cubic feet per second.
 17. Total Flow (cfs): The product of the intensity (14) and the Total $C \cdot A$ (15) plus Base Flows (16). Show this number in cubic feet per second.
 18. Minor Losses (ft): This is an optional column to account for minor losses according to Section 3.6.2 of the *Drainage Manual*. Show this number to one hundredth of a foot.
 19. Inlet Elevation (ft): The elevation of the edge of pavement for curb inlets (Standard Plans, Indexes 425-020 through 425-025 and 425-061). The elevation of the theoretical grade point for barrier wall inlets of Standard Plans, Indexes 425-030 and 425-032. The grate elevation as shown in the Indexes for barrier wall inlet (Standard Plans, Index 425-031) and gutter inlets (Standard Plans, Indexes 425-040 and 425-041). The grate elevation for ditch bottom inlets (Standard Plans, Indexes 425-050 through 425-055). The elevation of the manhole cover for manholes. Show this number to one hundredth of a foot.
 20. HGL Clearance (ft): This value is determined by calculating the difference between the Inlet Elevation (19) and the Upper End Hydraulic Gradient Elevation (21). Show this number to one hundredth of a foot.
 21. Upper End Elevation (ft) (Hydraulic Gradient): The elevation of the hydraulic gradient at the upper end of the pipe section. The elevation, under design conditions, to which water will rise in the various inlets and manholes. Show this number to one hundredth of a foot.
 22. Lower End Elevation (ft) (Hydraulic Gradient): The elevation of the hydraulic gradient at the lower end of the pipe section. Show to one hundredth of a foot.
 23. Upper End Elevation (ft) (Crown): The inside crown elevation at the upper end of the pipe section. Show this number to one hundredth of a foot.
 24. Lower End Elevation (ft) (Crown): The inside crown elevation at the lower end of the pipe section. Show to one hundredth of a foot.
 25. Upper End Elevation (ft) (Flowline): The flowline at the upper end of the pipe section. Show this number to one hundredth of a foot.
 26. Lower End Elevation (ft) (Flowline): The flowline at the lower end of the pipe section. Show this number to one hundredth of a foot.

27. Fall (ft) (Hydraulic Gradient): The elevation change of the hydraulic grade line from the upper end to lower end of the pipe section. Show this number to one hundredth of a foot.
28. Fall (ft) (Crown/Flowline): The physical fall of the pipe section. Show this number to one hundredth of a foot.
29. Number of Barrels: This optional column should be used for systems with pipe segments that have multiple barrels.
30. Pipe Size (Rise) (in): The vertical distance between the Flowline (25) and the Crown (23) in inches.
31. Pipe Size (Span) (in): The horizontal distance of the inside of a pipe at its widest point in inches.
32. Slope (%) (Hydraulic Gradient): For pipes under pressure flow, this is the full-flow friction slope. For pipes flowing partially full, this is: [Upper End HG (21) – Lower End HG (22)] /Hydraulic Length (8). Show this number to one hundredth of a percent.
33. Slope (%) (Physical): Determined from Physical Fall (28)/Hydraulic Length (8). Show this number to one hundredth of a percent.
34. Slope (%) (Minimum Physical): The flattest physical slope to maintain a velocity of 2.5 FPS flowing full, obtained from rearranging Manning's equation:
- $$S_{\text{MIN}} = [Vn / (1.49R^{2/3})]^2$$
- Show this number to one hundredth of a percent.
35. Actual Velocity (fps): Determined by Total Flow (17) divided by the average cross-sectional flow area. See discussion in Section 6.5. Show this number to a minimum of one tenth of a foot per second.
36. Physical Velocity (fps): The velocity produced when the pipe is flowing full based on the Physical Slope (33). Show this number to a minimum of one tenth of a foot per second.
- $$V = (1.49/n)R^{2/3}S_{\text{PHYSICAL}}^{1/2}$$
37. Full-Flow Capacity (cfs): This optional column is the product of the Physical Velocity (36) and the cross-sectional area of the pipe. Show this number in cubic feet per second.
38. Frequency (Yrs): The Storm Drain Design Frequency according to Section 3.3 of the *Drainage Manual*.
39. Manning's "n": For storm drains, this value should be 0.012 according to Section 3.6.4 of the *Drainage Manual*. Document any other Manning's "n" values used in the Remarks Column (42).
40. Tailwater EL (ft): The water elevation coincident with the outlet pipe and established by Section 3.4 of the *Drainage Manual*. Some districts may have more stringent criteria.
41. Remarks: Include such things as: area adjustments, partial flow depths, existing pipe connections, or anything unusual.

6.2 HYDROLOGY

The rational method is used for pipe sizing, inlet capacity, and spread calculations.

$$Q = C i A$$

where:

- Q = Runoff, in cubic feet per second (cfs)
- C = Runoff Coefficient (see Table B-4, Appendix B)
- i = Rainfall intensity, in inches per hour (NOAA Atlas 14)
- A = Area, in acres

6.2.1 Design Frequency

The *Drainage Manual* states the design frequency for storm drains. For the Department's facilities, the frequencies range from NOAA Atlas 14 five-year to 50-year, with five-year as the most common design frequency. These frequencies apply to pipe hydraulics, not inlet capacity or spread within the roadway. Section 6.3, below, discusses the criteria for inlet capacity and spread. If a storm drain system includes both curb inlets and ditch bottom inlets, check the ditch bottom inlets for a 10-year design frequency and all structures in the mixed system should meet the five-year design frequency.

6.2.1.1 Storms of Greater Magnitude

You should always consider the intent of the Department's criteria regarding the flooding of properties upstream or downstream of the Department's right of way. In several chapters of the *Drainage Manual*, it says that any increases over pre-development stages must not significantly change land use values. So, you should consider the impacts of storm events that are more severe than the standard design frequency of the storm drain. Initially, this should be a qualitative evaluation. Realize there are several reasons why urban typical sections with storm drains can handle storms of greater magnitude.

The first reason is conservatism within the storm drain design procedure. The flow rate calculated for each pipe section is the peak flow rate. This is conservative because we calculate the hydraulic gradient assuming that peak flow rates exist in all of the pipe sections simultaneously. In reality, when one pipe section is at peak flow, usually one or more of the other pipe sections have flow rates less than peak. This is most evident when considering the differences between the upper and lower parts of a long system. For example, consider a system where the outlet pipe's flow is calculated based on a Time of Concentration of 35 minutes. The flow rates of the first several pipes were based on Times of Concentration of 10 minutes to 15 minutes. If a 35-minute storm and its

associated intensity is applied to the entire system, the flow rates in the first several pipes would be less than the flow rate we calculated based on Times of Concentration = 10 minutes to 15 minutes. Therefore, the friction losses in these pipes actually are less than we calculated. Conversely, during short, intense storms, the upper pipes could reach their design flow rates, but the downstream portion of the system does not have the entire area contributing, so downstream pipes do not see the design flows. This conservatism exists to some degree throughout all pipe systems, but has a minimal effect on short systems where the differences in Times of Concentration are small.

Another reason an urban typical section can handle storms of greater magnitude is that the roadway itself can convey substantial flow. A standard pavement section of 0.02 ft/ft cross slope on a 0.3-percent longitudinal grade can convey approximately 7 cfs¹ with the depth of the flow at the top of the curb.

The last reason, although less significant, is that when the flow in the road reaches the height of the curb, there is more pressure on the piping system, thus forcing more flow through the pipes.

Considering these reasons, look at the system to see if there are any places where the water elevations or discharge rates could be increased.

- Are there sags in the profile? If so, could the pond water leave the right of way at these locations? Would water have gone that direction in the pre-developed condition?
- Is the roadway blocking overland flow in any areas? If so, would the blocked water substantially change land use values?
- Where back-of-sidewalk inlets are used, should check valves or flap gates be used to prevent the water in the pipes from backing off of the right of way?
- Would the inlets at the ends of the system bypass flow during a more severe storm event? If so, would water have gone that direction in the pre-developed condition?

If you have concerns after considering these factors, it may be appropriate to do a more detailed evaluation. Perhaps check the operation of the storm drain system with higher frequency (less frequent) storm. Perhaps the storage in the road and the pipes could be modeled. You may need a more detailed model of the pre-developed conditions.

If, after evaluating these situations, it is evident there would be increased discharge or

¹ $Q = (0.56/n) \cdot S_x^{1.67} \cdot S^{0.5} \cdot T^{8/3} = (0.56/0.016) \cdot 0.02^{1.67} \cdot 0.003^{0.5} \cdot 18.75^{8/3} \approx 7$ cfs where T = curb height / cross slope = (4.5/12)/0.02 = 18.75'

increases over pre-developed stages that would significantly change land use values, document this conclusion. Then change the storm drain design as necessary to bring the stages down or to reduce the discharge. This is not saying use a higher design frequency for the storm drain system. Instead, use larger pipes where necessary. Increasing pipe size to prevent the adverse impacts to adjacent properties is different than using a higher design frequency and maintaining the standard hydraulic gradient clearance.

6.2.2 Time of Concentration

The Time of Concentration (t_c) is the time required for the runoff to travel from the most remote point in the drainage basin to the point of the storm drain system under consideration. This will be the longer of: (a) the overland flow time to the inlet, or (b) the sum of the t_c to the inlet immediately upstream in the piping system plus the time of flow through the upstream pipe section. For inlets that have more than one upstream pipe, you will need to compare the t_c and Time of Flow through Section of all the upstream inlets and pipes with the overland travel time to the subject inlet. Use the longest of these as the t_c . See Figure 6.2-1. For pipe segments that do not have upstream pipes, the t_c will be simply the overland flow time.

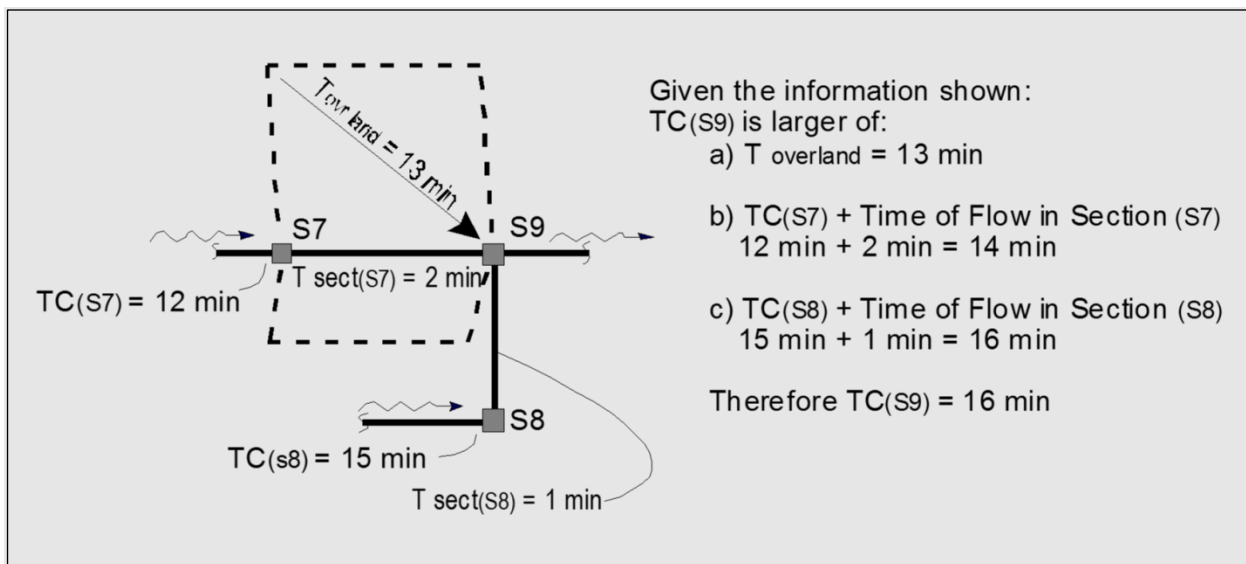

Figure 6.2-1: Determining Time of Concentration

6.2.2.1 Peak Flow from Reduced Area

Check to see if a portion of the drainage area will produce a larger flow rate than the entire area. This could occur where a larger portion of the drainage area exists toward the bottom or outlet, as in Figure 6.2-2. This is even more likely if the land cover of the area toward the outlet is more impervious than the upstream area. Mathematically, you will observe this where the reduction in area is more than offset by an increased intensity and possibly an increased runoff coefficient.

The Department encourages that this check be made at apparent junctions or inlets in a storm drain system. It is acceptable but not necessary to check every pipe section for peak flow from reduced area. Some computer programs may do this automatically.

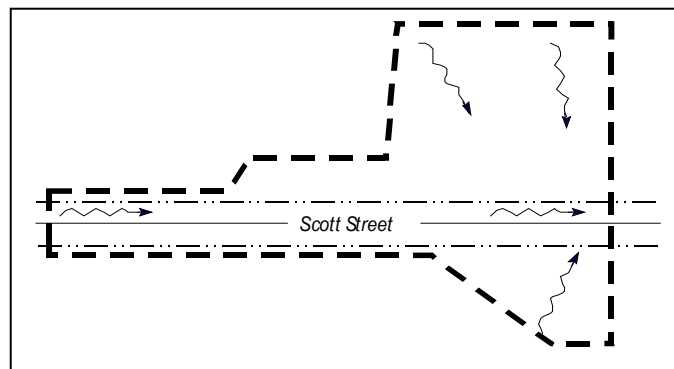

Figure 6.2-2: Drainage Basin with Larger Portion of Area Near Outlet

Example 6.2-1—Peak Flow from a Reduced Area

Given:

- The partial storm drain system shown in Figure 6.2-3
- The design standard is a 10-year return period

Find:

- The design flow rate for pipe section P₃₁₋₃₂.

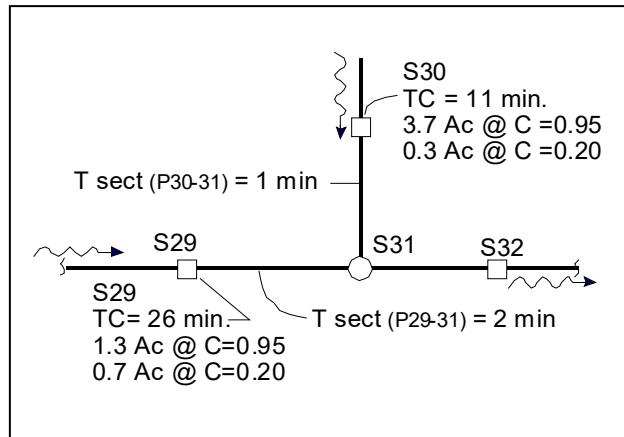
**Figure 6.2-3: Example 6.2.1**

First, calculate the flow rate using the total drainage area (maximum t_c).

1. Add the product of $C \cdot A$ for the upstream areas. Note, S31 is a manhole, therefore, there is no additional surface drainage area to this structure and flow is contributed from upstream pipes only.

$$\begin{aligned} \text{Total } C \cdot A_{S-29} &= 0.95 \times 1.3 \text{ ac} + 0.2 \times 0.70 \text{ ac} &= 1.38 \\ \text{Total } C \cdot A_{S-30} &= 0.95 \times 3.7 \text{ ac} + 0.2 \times 0.30 \text{ ac} &= \underline{3.58} \\ \text{Total } C \cdot A_{S-31} & &= 4.96 \end{aligned}$$

2. Determine the time of concentration.

The t_c is the time it takes for the entire drainage area to contribute. It is the longer of:

$$(t_c)_{S-29} + \text{Time of Flow in Section P}_{29-31} = 26 + 2 = 28 \text{ min}$$

$$(t_c)_{S-30} + \text{Time of Flow in Section P}_{30-31} = 11 + 1 = 12 \text{ min}$$

$$\text{Therefore, } (t_c)_{S-31} = 28 \text{ min.}$$

3. Determine the design rainfall intensity from the 10 year storm frequency having a duration equal to the time of concentration.

NOAA Atlas 14 data for the site has tabulated intensities for a 15-minute duration

and 30-minute duration. The intensity for 28-minute time of concentration can be estimated from NOAA's IDF curve (under PF Graphical tab) or can be interpolated from NOAA's IDF Precipitation Frequency (PF) tabulation table.

$$i_x = \left(\frac{T_x - T_1}{T_2 - T_1} \right) * (i_2 - i_1) + i_1$$

For the purposes of this example, assume NOAA's 15-minute intensity is 4.32 in/hr and 30-minute intensity is 3.97 in/hr.

$$i_x = \left(\frac{28 - 15}{30 - 15} \right) * (3.97 - 4.32) + 4.32$$

$$i_x = 4.0 \text{ in/hr}$$

4. Determine the flow.

$$Q = (C * A) * i = 4.96 * 4.0 = 19.8 \text{ cfs}$$

Now, check for a larger flow from part of the drainage area (peak flow from reduced area).

5. Determine the intensity associated with the shorter t_c .

The shorter system time is from S-30 and is 11 + 1 min = 12 min.
For the purposes of this example, assume the intensity from NOAA's webpage referenced above for 12 min = 6.0 in/hr.

6. Estimate the area that will contribute from S-29 during a 12-minute storm.

One approach is to reduce the area from the pipes having long times of concentration by the ratio of the times of concentrations. Ratio = (Short t_c)/(t_c of the associated pipe).

A_{S-29} is reduced by 12 min/28 min = 0.43

$A_{S-29 \text{ REDUCED @ } C = 0.95} = 1.3 \text{ ac} * 0.43 = 0.56 \text{ ac}$

$A_{S-29 \text{ REDUCED @ } C = 0.20} = 0.7 \text{ ac} * 0.43 = 0.30 \text{ ac}$

7. Add the areas that will contribute to S-31 during a 12-minute storm.

Area TOTAL = Areas-29 REDUCED + Areas-30

@ 0.95 = 0.56 + 3.7 = 4.26

@ 0.20 = 0.30 + 0.3 = 0.60

8. Add the product of $C * A$ contributing to S-31 during a 12-minute storm.

$$\begin{aligned}\text{Total } C \cdot A &= 0.95 \times 4.26 + 0.2 \times 0.6 \\ &= 4.05 + 0.12 = 4.17\end{aligned}$$

9. Determine the flow from the reduced area.

$$\begin{aligned}Q_{\text{Reduced Area}} &= (C \times A) \times i_{12 \text{ min}} \\ &= 4.17 \times 6.0 = 25.0 \text{ cfs}\end{aligned}$$

For pipe sections downstream of P₃₁₋₃₂, add the incremental drainage areas to the reduced areas recorded for P₃₁₋₃₂. Then, add the time of flow in downstream sections to the reduced time of concentration for P₃₁₋₃₂.

Table 6.2-1 shows a way of presenting these approaches on the Tabulation form.

6.3 INLETS AND PAVEMENT HYDRAULICS

6.3.1 Inlets

Factors controlling the selection of an inlet type include hydraulics, utility conflicts, right-of-way limits, bicycle and pedestrian safety, etc. Guidelines for selecting inlets are located in Section 3.7.4 of the *Drainage Manual*.

6.3.1.1 Apparent Locations

- **At low points in the gutter.** Double-throated inlets—such as Type 2, 4, and 6—are symmetrical about the centerline and are intended to accept flow from both sides. Use these where the minor gutter flow exceeds 50 feet in length or 0.5 cubic feet per second.
- **Upstream of pedestrian cross walks.**
- **Upstream of curb returns.**
- **10 feet outside the flat cross sections in super elevation transitions.** Although the flow may be small, the cross slope is nearly flat so the spread potential is high.
- **Outside of driveway turnouts.** If the adjacent property is under development or redevelopment, try to obtain the site plans to identify future driveway locations.

6.3.1.2 Sags

Normally, one inlet at the low point in combination with inlets on each of the approaching grades is sufficient to meet spread criteria.

Use flanking inlets for sags that have no outlet other than the storm drain system—for instance, underpasses, barrier wall sections, or depressed sections where the roadway is much lower than the surrounding ground. Flanking inlets are those placed on one or both sides of and fairly close to the sag inlet. They provide backup capacity for the sag inlet if it becomes clogged. The flanking inlets must be located to satisfy spread criteria when the sag inlet is blocked. Figure 6.3-1 shows a representation of this location pattern. Figure 6.3-9 provides vertical curve formulae to help determine the flanking inlet locations.

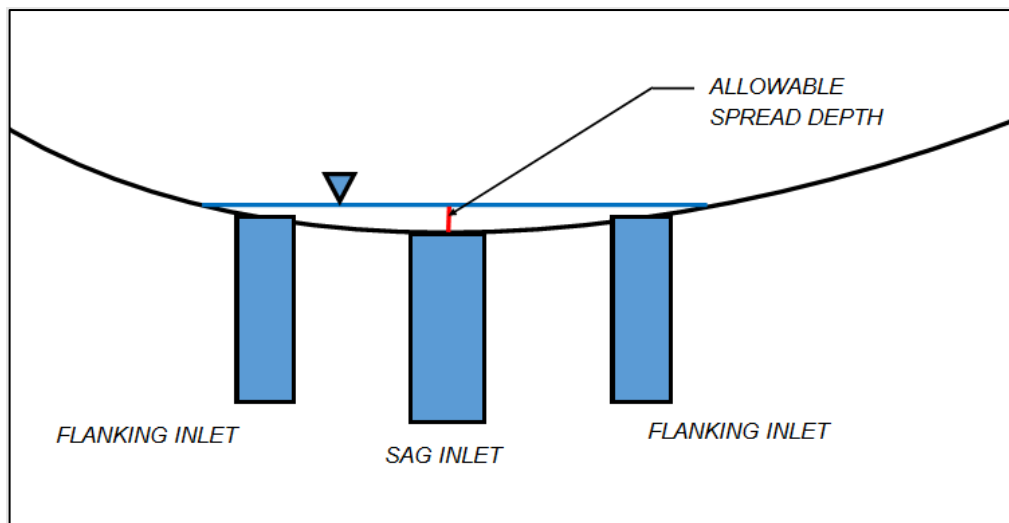

Figure 6.3-1: Inlet Location Satisfying the Sag Requirements

6.3.1.3 Continuous Grades

When deciding about the initial placement of curb and gutter inlets on a continuous grade, base placement on the 300-foot maximum spacing for an 18-inch pipe (Drainage Manual, Section 3.10.1). After the initial placement of inlets, check the spread and add or move inlets as necessary to meet the spread standards.

The piping system layout may affect the locations of curb and gutter inlets. As you lay out the piping system, you may need a manhole to redirect the flow, to provide maintenance access, or merely to connect stub pipes. If you use an inlet rather than a manhole, you get the benefit of an additional hydraulic opening for little or no additional cost. Section 6.4, below, discusses piping system layout.

6.3.1.4 Back of Sidewalk

Locate back-of-sidewalk inlets where concentrated flows drain toward the road and where the proposed sidewalk would block overland flow. Often, you can identify these areas from the survey, the back-of-sidewalk profiles, and the proposed cross sections. Do not rely on these alone! Walk the entire project area looking for places where concentrated runoff flows to the road and for localized depressed areas that were not identified in the survey. Development may have changed the existing ground line since the time the survey was done. Your field review with the back-of-sidewalk profiles and proposed cross sections will identify areas where you need back-of-sidewalk inlets.

The Field Review is Critical
to Designing
Back-of-Sidewalk Drainage

In instances where you may need numerous back-of-sidewalk inlets, check with the

roadway designer about modifying the roadway profile grade to better accommodate overland flow.

Standard Plans, Index 425-060 contains the standard back-of-sidewalk drainage inlets. Use yard drains and the double four-inch pipes under the sidewalk to correct small existing flooding problems. For any other back-of-sidewalk drainage, obtain right of way as necessary to construct a ditch bottom inlet or other substantial back-of-sidewalk drainage conveyance.

Where the Department's storm drain system connects to back-of-sidewalk inlets, check the hydraulic grade line elevation at these inlets to see if water would back up or cause the system to create adverse impacts to adjacent properties. If so, first consider increasing the size of some downstream pipe sections. If avoiding adverse impacts by increasing pipe sizes is not feasible, consider using check valves or flap gates in the pipe connected to the back-of-sidewalk inlet (see Figure 6.3-2). Flap gates and check valves are not ideal because they require maintenance; nevertheless, they may be the most practical option for some situations.

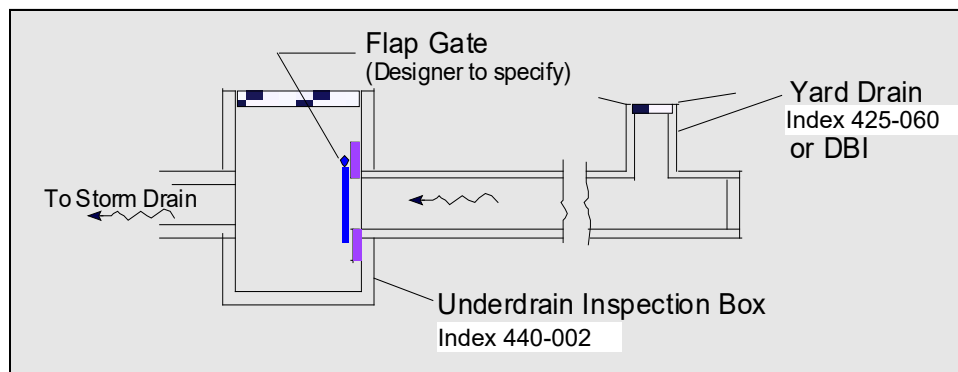

Figure 6.3-2: Flap Gate Connected to the Back-of-Sidewalk Inlet

6.3.1.5 Inlet Capacity

Capacity data for most of the Department's inlets were developed by laboratory studies done at the University of South Florida (Anderson, 1972). A graphical presentation of these data is given in Appendix I. Separate curb inlet capacity charts are presented for various cross slopes. You also can use methods described in FHWA's *Hydraulic Engineering Circular* HEC 12 or HEC 22 to evaluate the interception capacity of the Department's inlets.

6.3.2 Pavement Hydraulics

The Department uses driver visibility as a basis for the spread standards. There is a rainfall intensity that reduces the driver's sight distance to less than the minimum stopping sight distance. Removing the water from the road for intensities greater than this serves no purpose. If a driver's sight distance is less than the minimum stopping sight distance when the driver sees an object, the driver cannot stop in time regardless of how much water is on the road. So removing the water from the road for intensities greater than this is over-design from a vehicle standpoint.

The Department uses four inches per hour (in/hr) as the intensity that reduces the driver's sight distance to less than the minimum stopping sight distance. This is based on information summarized in FHWA HEC 21.

Use the integrated form of Manning's equation to calculate spread in gutters.

$$Q = \frac{0.56}{n} S_x^{5/3} S_L^{1/2} T^{8/3}$$

where:

- Q = Gutter flow rate, in cubic feet per second (cfs)
- n = Manning's roughness coefficient (see Table B-2, Appendix B)
- S_x = Pavement Cross Slope, in feet per foot (ft/ft)
- S_L = Longitudinal Slope, in feet per foot (ft/ft)
- T = Spread, in feet (ft)

Figure 6.3-8 provides a nomograph for solving this equation, which is intended for use with triangular gutter sections. The standard Type F curb forms a composite section when combined with the pavement cross slope. In most cases, it is reasonable to ignore the gutter depression and treat the flow section as a simple gutter formed by the cross slope of the road and the curb. Ignoring the gutter depression is conservative², but allows for debris buildup in the gutter. If you need to determine the additional capacity of the gutter depression, use Figure 6.3-10 or the procedures provided in FHWA's HEC 12 or HEC 22.

6.3.2.1 Gutter Grades

Standard gutter grades should not be less than 0.3 percent. Some District Drainage Engineers will approve a 0.2-percent gutter grade in very flat terrain. Use of a saw tooth

² The gutter depression can add approximately 31% to the conveyance of the flow section in cases where the pavement cross slope is 0.02 and the spread width is 7.5 feet.

profile can maintain minimum grades in very flat terrain.

To provide adequate drainage in sag vertical curves, maintain a minimum gutter grade of 0.3 percent down to the inlet at the low point. Without this minimum grade, the flat longitudinal grade near the low point would cause the spread to be greater than allowable. Maintaining the minimum gutter grade up to the inlet increases the cross slope at the low point, thus providing additional drainage. To maintain the minimum gutter grade, develop and show special gutter grades in the plans.

Example 6.3-1—Special Gutter Grade

Given:

- The sag vertical curve described in the figure below.

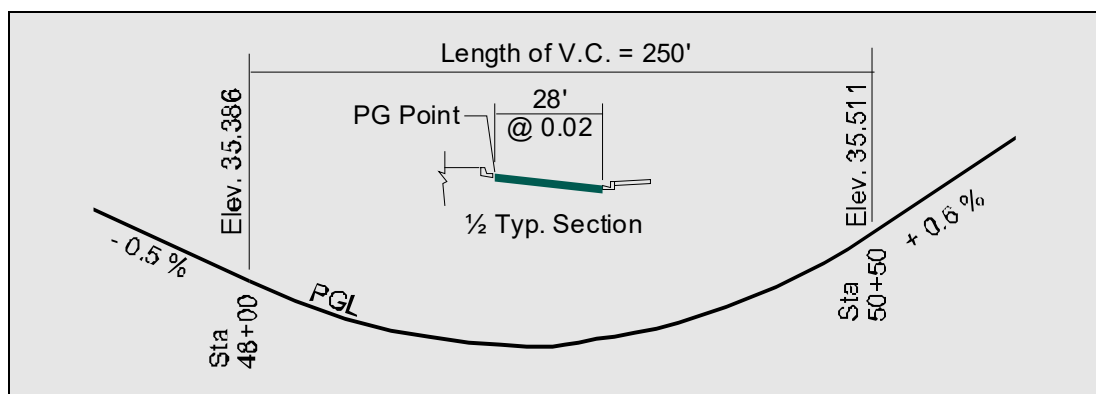

Figure 6.3-3: Example 6.3-1 Given Information

Find:

- The limits of the special gutter grade
 - The theoretical gutter elevation at the low point
 - The cross slope at the low point
- Determine the rate of change of longitudinal slope. (Formula from Fig. 6.3-9)

$$\text{Rate of change} = r = (g_2 - g_1)/L = 0.6 - (-0.5)/2.5 = 0.44$$

- Find the location of the low point and the location where the longitudinal slope on the curve is -0.3 percent and +0.3 percent. Use the equation for longitudinal slope at any point and rearrange to solve for X.

$$\begin{aligned} X_{-0.3\%} &= (S_L - g_1)/r \\ &= [-0.3 - (-0.5)]/0.44 = 0.4545 \text{ stations} \end{aligned}$$

$$\backslash \quad \text{Station} = 48+00 + 0+45.45 = 48+45.45$$

$$\begin{aligned} X_{+0.3\%} &= (S_L - g_1)/r \\ &= [0.3 - (-0.5)]/0.44 = 1.8182 \text{ stations} \end{aligned}$$

$$\therefore \text{Station} = 48+00 + 1+81.82 = 49+81.82$$

Using the equation for the station of the turning point:

$$\begin{aligned} X_{\text{LOW POINT}} &= (g_1 \times L)/(g_1 - g_2) \\ &= (-0.5 \times 2.5)/(-0.5 - 0.6) \\ &= 1.1364 \text{ stations} \end{aligned}$$

$$\therefore \text{Station} = 48+00 + 1+13.64 = 49+13.64$$

So, a special gutter grade of -0.3 percent is needed from Sta. 48+45.45 to Sta. 49+13.64 and a special gutter grade of +0.3 percent is needed from Sta. 49+13.64 to Sta. 49+81.82.

- Find the elevation of the profile grade line at Sta. 48+45.45 and Sta. 49+81.82. Both are equal distance from the center, so we only need to find one elevation.

$$\begin{aligned} \text{Elev}_{48+45.45} &= \text{Elev}_{48+00} + g_1 X + \frac{1}{2} r X^2 \\ &= 35.386 \text{ ft.} + (-0.5)(0.4545) + \frac{1}{2} (0.44)(0.4545)^2 \\ &= 35.204 \text{ ft.} \end{aligned}$$

- Find the elevation at the gutter at Sta. 48+45.45. (This equals the elevation of the gutter at Sta. 49+81.82.)

The edge of pavement is 0.56 ft. (28 ft. x 0.02) lower than profile grade line and the gutter is 1.5 inches (0.125 ft.) below the edge of pavement, so:

$$\begin{aligned} \text{Elev}_{\text{GUTTER}} &= \text{Elev PGL}_{\text{Sta. } 48+45.45} - 0.56 - 0.125 = 35.204 \text{ ft.} - 0.56 \text{ ft.} - 0.125 \text{ ft.} \\ &= 34.519' \end{aligned}$$

- Find the theoretical gutter elevation at the low point.

$$\begin{aligned} \text{Elev} &= \text{Elev}_{\text{Sta. } 48+45.45} - (\text{special gutter grade} \times \text{length of special gutter}) \\ \text{Elev} &= 34.519 \text{ ft.} - [0.3 \times (49.1364 - 48.4545)] = 34.314 \text{ ft.} \end{aligned}$$

This elevation would be used to check the hydraulic grade line clearance below the sag inlet.

- Find the cross slope at the low point.

The elevation of the profile grade line at the low point is:

$$\text{PGL Elev}_{49+13.64} = \text{Elev}_{48+00} + g_1 X + \frac{1}{2} r X^2$$

$$= 35.386 \text{ ft.} + (-0.5)(1.1364) + \frac{1}{2} (0.44)(1.1364)^2$$

$$= 35.102 \text{ ft.}$$

The elevation at the edge of pavement at the low point is:

$$\text{EOP Elev}_{49+13.64} = \text{Elev}_{\text{GUTTER}} + 1.5 \text{ inches}$$

$$= 34.314 \text{ ft.} + 0.125 \text{ ft.} = 34.439 \text{ ft.}$$

$$\text{Cross Slope} = (35.102 \text{ ft.} - 34.439 \text{ ft.})/28 \text{ ft.} = 0.024 \text{ ft./ft.}$$

This would be used to check the spread of the inlet at the low. Interpolate between the values in Appendix I, Figures I-17 through I-19, where the cross slope value is between the values of the figures.

6.3.2.2 Cross Slope

FDM 210 and 211 gives the standard cross slopes.

6.3.2.3 Shoulder Gutter

Use shoulder gutter on fill slopes and at bridge ends to protect the slopes from erosion caused by water from the roadway and bridge. Use shoulder gutter in accordance with Section 3.7.3 of the *Drainage Manual*. When placed at bridge ends, the gutter should be long enough to construct the gutter transitions shown on Standard Plans, Indexes 536-001 and 425-040. The terminal shoulder gutter inlet should intercept all of the flow coming to it for a 10-year storm.

The *Drainage Manual* gives two spread criteria for sections with shoulder gutter. One is related to driver visibility (rainfall intensity of four inches per hour) and the other is related to erosion protection of the fill slope (10-year design storm). Both criteria need to be met. Consider the potential for future additional lanes in the median when determining the flow rates in shoulder gutter.

In a typical situation where standard cross slopes and shoulder widths exist, the criterion for protecting the fill slope has a higher intensity and less allowable spread than the criterion for driver safety. Thus, the criterion for protecting the fill slope will set the inlet spacing.

Given the typical situation where both the shoulder and the miscellaneous asphalt behind the gutter slope upward at 0.06 ft/ft from the gutter, the spread across the gutter and pavement section should not exceed six feet for the 10-year storm. This section has a conveyance of approximately 28 cubic feet per second [$K = Q/S_L^{1/2} = 28 \text{ cfs}$]. You can use the conveyance to determine maximum allowable flow rates for various longitudinal slopes. Another approach is to treat the shoulder gutter and pavement section as a triangular gutter with a cross slope of 0.05 ft/ft, designing for 10-year flows, and limiting the spread to six feet (see Figure 6.3-4).

1. The maximum shoulder gutter design conveyance should be $K = 28$ cfs adjacent to guardrail, and $K = 15$ cfs with no guardrail for the 10-year storm. $K = 28$ cfs is derived from the flow area being limited to 15 inches outside the shoulder gutter and $n = 0.016$. $K = 15$ cfs is derived from limiting the flow area to the shoulder gutter section.
2. The maximum shoulder gutter design conveyance approaching a terminal gutter inlet should be $K = 15$ cfs to intercept 100 percent of the design storm flow.
3. Consider placing two gutter inlets at the down gradient shoulder gutter terminus to provide 100-percent interception, unless 100-percent interception by one inlet ($K = 15$ cfs) is demonstrated by appropriate calculation.
4. Inlet spacing must meet spread criteria (*Drainage Manual*, Section 3.9), maximum pipe length criteria (*Drainage Manual*, Section 3.10.1), and 10-year frequency gutter capacity criteria. In most cases, the 10-year frequency storm may govern inlet spacing.
5. Where applicable, design inlet spacing to accommodate the additional runoff from future widening.
6. Place gutter inlet(s) at the down gradient end of all shoulder gutter, in lieu of concrete spillways or flumes, to reduce the potential for erosion.

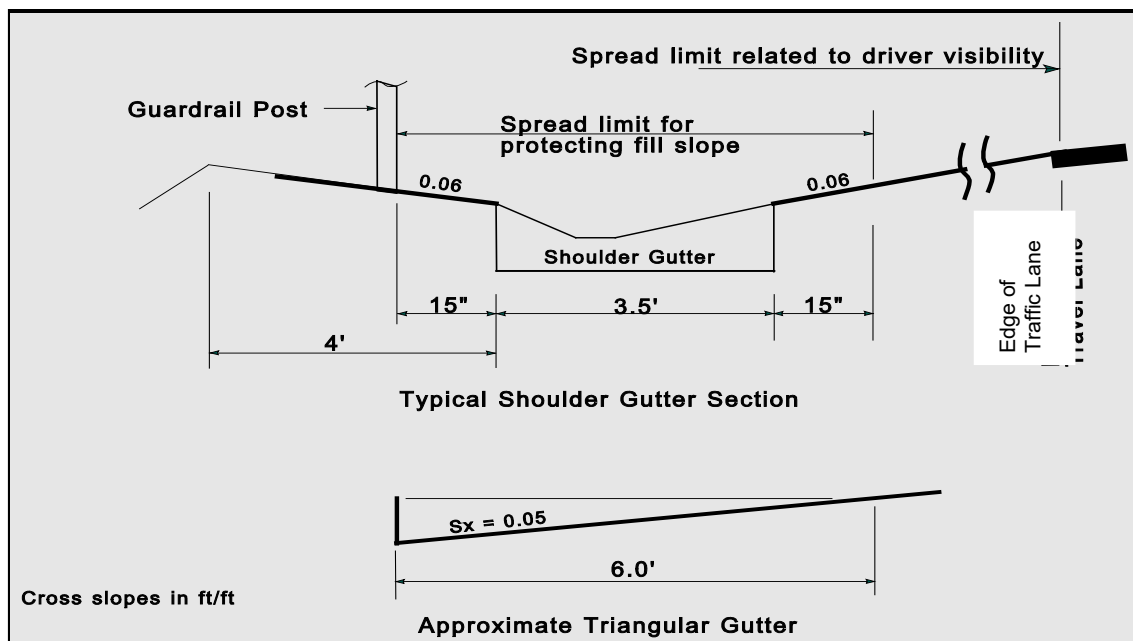

Figure 6.3-4: Determining the Spread for a Shoulder Gutter

6.3.2.4 Determining the Spread

For roads that have uniform longitudinal grades and cross slopes, the spread calculations may be as simple as calculating the spread and bypass for the inlets with the largest overland flow. For these projects, you usually can make a reasonable assumption that if the inlets with the largest overland runoff do not exceed the spread standards and do not have any bypass, the other inlets will not exceed the spread standards and will not have any bypass. If you cannot comfortably make this assumption, you can determine the spread by the following procedure used with Table 6.3-1. In general, the information in Table 6.3-1 is the minimum required for spread calculations. You may need additional information in certain situations.

Start at the upper-most inlet and work to the low point, then start at the opposite high side and work back to the low.

1. Determine the drainage area and runoff coefficient of the overland runoff. Record the product of the area and runoff coefficient ($C \cdot A$) in column 2.
2. Calculate the overland runoff by multiplying the product of $C \cdot A$ in column 2 by the appropriate intensity (four inches per hour or 10-year storm design).
 $Q = C \cdot A \cdot i$.
3. Calculate the total flow to the inlet by adding the overland runoff in column 3 to the bypass from the upstream inlets.
4. Record the cross slope and longitudinal slope in column 6 and column 7, respectively.
5. Calculate the spread and compare it to the allowable spread, keeping in mind that allowable spread can vary along the project due to super-elevation slope toward the median, turn lanes, and design speed. If it is within the standards, record the number in column 8 and go to the next step. If it is not, move the inlet (and add and move inlets as necessary) to make the spread acceptable and repeat Step 1 through Step 5.
6. Calculate intercepted flow and bypass flow. (The figures in Appendix I can be used in lieu of calculations to determine intercepted flow. Record these numbers in column 9 and column 10, respectively.)
7. Proceed to the next downstream inlet and repeat Step 1 through Step 6.

Example 6.3-2—Sag Vertical Curve Given

Given:

- The sag vertical curve and associated approach grades shown below.
- Four-lane curb and gutter section with 12-foot lanes, 12-foot continuous two-way left-turn lane, four-foot bike lane, and six-foot sidewalk.
- Offsite drains to the road from 65 feet beyond the sidewalk.
- Offsite area draining to the road is impervious ($C = 0.95$).
- Type 1 and Type 2 inlets are preferred by the District.
- Inlet location is not restricted by driveways or side streets.
- Design speed = 45 mph, then allowable spread is 11.5 feet [1.5-foot gutter + four-foot bike lane + six feet (half of a travel lane)].
- A minimum gutter grade of 0.3 percent is used approaching the sag.

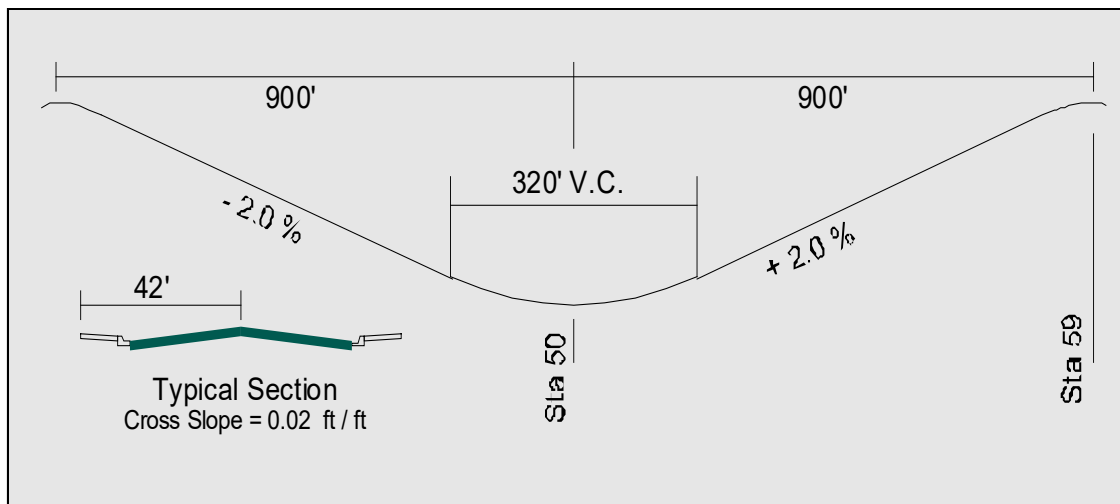
**Figure 6.3-5: Example 6.3-2 Given Information**

Find:

- Inlet spacing necessary to meet the spread criterion
1. For the first try, place the inlets at the maximum 300-foot spacing out from the low point. So, the inlets will be placed at Station 44+00, Station 47+00, Station 50+00, Station 53+00, and Station 56+00.

The area to each inlet on the approach grades is:

$$\begin{aligned} \text{Area} &= (\frac{1}{2} \text{ Rdwy Width} + 65 \text{ ft.}) \times 300 \text{ ft.} \\ \text{Area} &= (42 \text{ ft.} + 65 \text{ ft.}) \times 300 \text{ ft.} / 43,560 = 0.74 \text{ ac @ } C = 0.95 \\ C \times A &= 0.95 \times 0.74 = 0.70 \\ Q_{\text{OVERLAND}} &= CAi \\ &= 0.95 \times 0.74 \times 4 = 2.8 \text{ cfs.} \end{aligned}$$

2. Determine the spread, the intercepted flow, and the bypass (if any) for the uppermost inlets. (Sta. 44 & 56)

$$\text{Spread (T)} = [(Q \times n)/(0.56 \times S_x^{5/3} \times S_L^{1/2})]^{3/8}$$

This conservatively ignores the 1.5-inch gutter depression.

$$= [(2.8 \times 0.016)/(0.56 \times 0.02^{5/3} \times 0.02^{1/2})]^{3/8}$$

$$= 9.3 \text{ ft.} \quad \text{Acceptable (allowable spread is 11.5 ft.)}$$

$$Q_{\text{INTRCEPT}} \sim 2.1 \text{ cfs} \quad \text{From Figure I-1, Appendix I}$$

$$Q_{\text{BYPASS}} = 2.8 - 2.1 = 0.7 \text{ cfs}$$

3. Determine total flow to the next downstream inlets. (Sta. 47 & 53)

$$Q_{\text{TOTAL}} = Q_{\text{OVERLAND}} + Q_{\text{BYPASS}}$$

$$= 2.8 + 0.7 = 3.5 \text{ cfs}$$

4. Determine the spread, the intercepted flow, and the bypass.

$$\text{Spread} = 10.2 \text{ ft.} \quad \text{Still acceptable}$$

$$Q_{\text{INTRCEPT}} = 2.3 \text{ cfs} \quad \text{From Figure I-1.}$$

$$Q_{\text{BYPASS}} = 3.5 - 2.3 = 1.2 \text{ cfs}$$

5. Determine the spread approaching the sag inlet from either side.

$$Q_{\text{TOTAL}} = Q_{\text{OVERLAND}} + Q_{\text{BYPASS}}$$

$$= 2.8 + 1.2 = 4.0 \text{ cfs}$$

6. Determine the spread approaching the sag inlet. The longitudinal slope is 0.3 percent approaching the sag. For this example, the cross slope at the low point is 0.021 ft./ft. due to maintaining 0.3-percent gutter grade to the sag inlet. This was calculated using the approach in Example 6.3-1.

$$T = [(4.0 \times 0.016)/(0.56 \times 0.021^{5/3} \times 0.003^{1/2})]^{3/8}$$

$$= 14.7 \text{ ft.} \quad \text{Not acceptable (Allowable spread is 11.5 ft.)}$$

The following table summarizes the above calculations.

| Flow in cfs | | Allowable spread = 11.5 ft. | | | | | Manning's n = 0.016 | | | |
|----------------------------------|------------|-----------------------------|-------------------------|--------------------|--------------------------------|---------------------------|---------------------|---------------------------|----------------------|---------------------------------------|
| 1 Inlet Location (Sta.) | 2 C • A | 3 Overland Runoff | 4 Previous Bypass | 5 Total Flow | 6 Cross Slope (ft/ft) | 7 Long Slope (%) | 8 Spread | 9 Intercepte d Flow | 10 Bypass Flow | 11 Bypass to Inlet @ Station |
| 44+00 | 0.70 | 2.8 | -- | 2.8 | 0.02 | 2.0 | 9.3 | 2.1 | 0.7 | 47+00 |
| 47+00 | 0.70 | 2.8 | 0.7 | 3.5 | 0.02 | 2.0 | 10.2 | 2.3 | 1.2 | 50+00 |
| 56+00 | 0.70 | 2.8 | -- | 2.8 | 0.02 | 2.0 | 9.3 | 2.1 | 0.7 | 53+00 |
| 53+00 | 0.70 | 2.8 | 0.7 | 3.5 | 0.02 | 2.0 | 10.2 | 2.3 | 1.2 | 50+00 |
| 50+00 Approach | 0.70 | 2.8 | 1.2 | 4.0 | 0.021 | 0.3 | 14.7 | ← Exceeds Standard | | |

7. Add and adjust inlets.

There is no direct solution. It is a trial-and-error process of moving inlets to reduce the spread. Adding an inlet to each side of the sag and adjusting the spacing of the inlets on the continuous grades should reduce the flow to the sag inlet and reduce the spread. Try placing the inlets at Stations 44+30, 46+80, 48+80, 50+00, 51+20, 53+20, and 55+70 as shown in Figure 6.3-6.

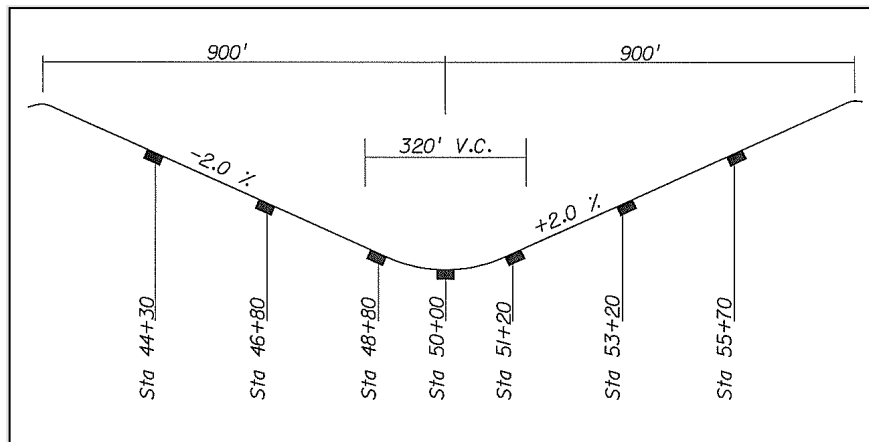

Figure 6.3-6: Location of Inlets

Example 6-3.2—Second Iteration

The drainage area to the first continuous grade inlets (43+30, 55+70) is:

$$\begin{aligned} \text{Area} &= (\frac{1}{2}\text{Rdwy Width} + 65 \text{ ft.}) \times 250 \text{ ft.} \\ \text{Area} &= (42 \text{ ft.} + 65 \text{ ft.}) \times 330 \text{ ft.}/43,560 = 0.81 \text{ ac @ } C = 0.95 \end{aligned}$$

The drainage area to the next inlets (46+80, 53+20) is:

$$\text{Area} = (42 \text{ ft.} + 65 \text{ ft.}) \times 250 \text{ ft.}/43,560 = 0.61 \text{ ac @ } C = 0.95$$

The drainage area to the next inlets (48+80, 51+20) is:

$$\text{Area} = (42 \text{ ft.} + 65 \text{ ft.}) \times 200 \text{ ft.}/43,560 = 0.49 \text{ ac @ } C = 0.95$$

The drainage area to each side of the sag is:

$$\text{Area} = (42 \text{ ft.} + 65 \text{ ft.}) \times 120 \text{ ft.}/43,560 = 0.29 \text{ ac @ } C = 0.95$$

The inlets at stations 48+80 and 51+20 are on the vertical curve; therefore, the longitudinal slope is flatter than 2.0 percent. Using vertical curve formulae:

$$\begin{aligned} \text{Rate of change of grade (r)} &= (g_2 - g_1)/L \\ &= [2 - (-2)]/3.2 = 1.25 \text{ ft./station} \end{aligned}$$

$$\begin{aligned} \text{Long slope} &= g_1 + r X \quad (X \text{ is distance along curve in Sta.}) \\ &= -2 + 1.25 (0.4) \\ &= -1.5 \text{ percent} \end{aligned}$$

For this example, the cross slope at the low point is 0.021 ft./ft. due to maintaining 0.3-percent gutter grade down to the sag inlet. You can calculate this using the approach in Example 6.3-1. Using Figure I-17 (cross slope = 0.02) will provide a slight conservatism.

The following table shows the results of the change.

Flow in cfs Allowable Spread = 11.5 ft Manning's n = 0.016

| 1 Inlet Location (Sta) | 2 CxA | 3 Overland Runoff | 4 Previous By-Pass | 5 Total Flow | 6 Cross Slope (ft/ft) | 7 Long Slope (%) | 8 Spread (ft) | 9 Intercepted Flow | 10 Bypass Flow | 11 Bypass to Inlet @ |
|---------------------------------|----------|-------------------------|--------------------------|--------------------|--------------------------------|---------------------------|---------------------|--------------------------|----------------------|----------------------------|
| 44+30 | 0.77 | 3.1 | 0 | 3.1 | 0.02 | 2 | 9.7 | 2.2 | 0.9 | 46+80 |
| 46+80 | 0.58 | 2.3 | 0.9 | 3.2 | 0.02 | 2 | 9.8 | 2.2 | 1.0 | 48+80 |
| 48+80 | 0.47 | 1.9 | 1.0 | 2.9 | 0.02 | 1.5 | 9.9 | 2.4 | 0.5 | 50+00 |
| 50+00 | 0.28 | 1.1 | 0.5 | 1.6 | 0.021 | 0.3 | 10.5 | n/a | n/a | n/a |
| 55+70 | 0.77 | 3.1 | 0.0 | 3.1 | 0.02 | 2 | 9.7 | 2.2 | 0.9 | 53+20 |
| 53+20 | 0.58 | 2.3 | 0.9 | 3.2 | 0.02 | 2 | 9.8 | 2.2 | 1.0 | 51+20 |
| 51+20 | 0.47 | 1.9 | 1.0 | 2.9 | 0.02 | 1.5 | 9.9 | 2.4 | 0.5 | 50+00 |
| 50+00 | 0.28 | 1.1 | 0.5 | 1.6 | 0.021 | 0.3 | 10.5 | n/a | n/a | n/a |
| 50+00 | 0.56 | 2.2 | 1.0 | 3.2 | 0.021 | n/a | 6.3 | n/a | n/a | n/a |

In an actual project, the inlet location is affected by driveways and side streets.

Example 6.3-3—Shoulder Gutter

Given:

- The bridge approach grades shown below.
- Four-lane rural divided highway, two 12-foot lanes, 10-foot paved outside shoulder, four-foot slope to gutter under guardrail (3-foot paved)
- Cross slope of shoulder and asphalt under guardrail = 0.06 ft./ft.
- Fill slope is 10 feet high at Station 67+00
- Using the project location with NOAA Atlas 14 data, the 10-year/10-minute intensity = 7.4 in/hr
- Additional lanes may be added in the future
- Runoff from bridge = 0.2 cfs (scuppers used on bridge)

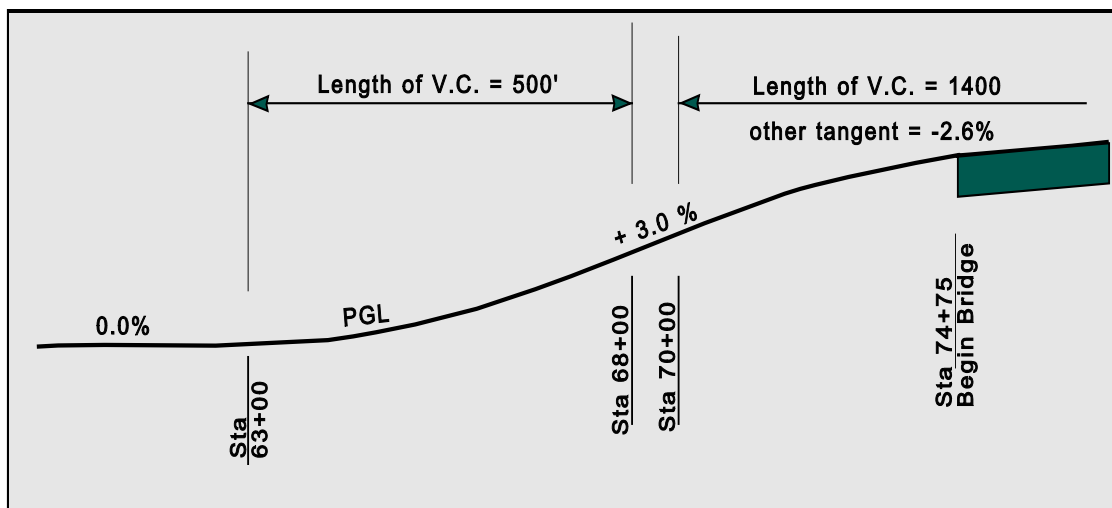

Figure 6.3-7: Example 6.3-3 Given Information

Find:

1. The location of the shoulder gutter inlets.
2. Determine the vertical curve geometry.

Crest Curve:

$$\text{Rate of change of curve } (r) = (g_2 - g_1)/L = (-2.6 - 3.0)/14 = -0.4$$

$$\text{Long Slope at any point } X = g_1 + r X = 3.0 - 0.4 X$$

Sag Curve:

$$\text{Rate of change of curve } (r) = (g_2 - g_1)/L = (3.0 - 0.0)/5 = 0.6$$

$$\text{Long Slope at any point } X = g_1 + r X = 0.0 + 0.6 X$$

3. Estimate the lowest point at which shoulder gutter is needed.

You should use shoulder gutter on all fill slopes greater than 10 feet long if the roadway grade is greater than 2 percent. For this example, the fill is approximately 10 feet at Station 67+00. The longitudinal slope at this station 67+00 is: $0.6 \times (67 - 63) = 2.4$ percent. Since this is steeper than 2 percent, shoulder gutter should begin at or before Station 67+00.

4. For the first try at inlet spacing, divide the distance between Station 67+00 and the beginning of the bridge into equal distances that are less than 300 feet.
Distance = $74+75 - 67+00 = 775$ feet

This equates to three spaces at approximately 258 feet. Rounding it to 260 feet, the first inlet will be located at $74+75 - 260$ feet = 72+15. The other inlets are at 69+55 and 66+95.

5. Determine the longitudinal slope at these inlets:

@ 72+15, the longitudinal slope = $3 - 0.4 (72+15 - 70+00) = 3 - 0.4 \times 2.15 = 2.14$ percent

@ 69+55, the longitudinal slope = 3 percent

@ 66+95, the longitudinal slope = $0.6 \times (66+95 - 63+00) = 0.6 \times 3.95 = 2.37$ percent

6. Determine area and overland runoff to each inlet.

An additional lane may be added toward the median in the future, so use 36 feet of pavement.

Width = travel lanes + shoulder + gutter + slope* under guardrail.

*Conservatively assume that all four feet sloping back to gutter is paved.

$$= 36 + 10 + 3.5 + 4 = 53.5 \text{ ft.}$$

$$\text{Area} = 260 \text{ ft.} \times 53.5 \text{ ft.} = 0.32 \text{ ac.}$$

$$C \times A = 0.95 \times 0.32 = 0.30$$

The travel time for flow along 260 feet of pavement is small, so we will use the 10-minute intensity for the 10-year storm. $i = 7.4 \text{ in/hr}$

$$Q = CiA = 0.95 \times 7.4 \times 0.32 = 2.2 \text{ cfs}$$

- Approximate the shoulder gutter as a triangular section with a cross slope of 0.05 ft./ft. and $n = 0.016$. The spread must be limited to six feet in this triangular section to match the capacity of the shoulder gutter section. See previous discussion of shoulder gutter.

$$\text{Spread (T)} = [(Q \times n)/(0.56 \times S_x^{5/3} \times S_L^{1/2})]^{3/8}$$

The intercepted flow is determined from Figure I-16. The following table summarizes the calculations.

All flows (cfs) based on 10-year flow Allowable Spread = 6 ft Manning's n = 0.016

| 1 Inlet Location (Sta.) | 2 C • A | 3 Overland Runoff | 4 Previous By-pass | 5 Total Flow | 6 Cross Slope (ft/ft) | 7 Long Slope (%) | 8 Spread | 9 Intercepte d Flow | 10 Bypass Flow | 11 Bypass to Inlet @ Station |
|----------------------------------|------------|-------------------------|--------------------------|-----------------|--------------------------------|---------------------------|-------------|---------------------------|----------------------|---------------------------------------|
| 72+15 | 0.30 | 2.2 | 0.2 | 2.4 | 0.05 | 2.14 | 4.9 | 2.4 | --- | |
| 69+55 | 0.30 | 2.2 | --- | 2.2 | 0.05 | 3.0 | 4.5 | 2.2 | --- | |
| 66+95 | 0.30 | 2.2 | --- | 2.2 | 0.05 | 2.37 | 4.7 | 2.2 | --- | |

This inlet spacing meets the spread criterion for protecting the fill slopes and the last inlet captures all the runoff coming to it. Therefore, this design is acceptable. There is no need to check the four inches per hour criterion because the intensity would be less and the allowable spread would be greater.

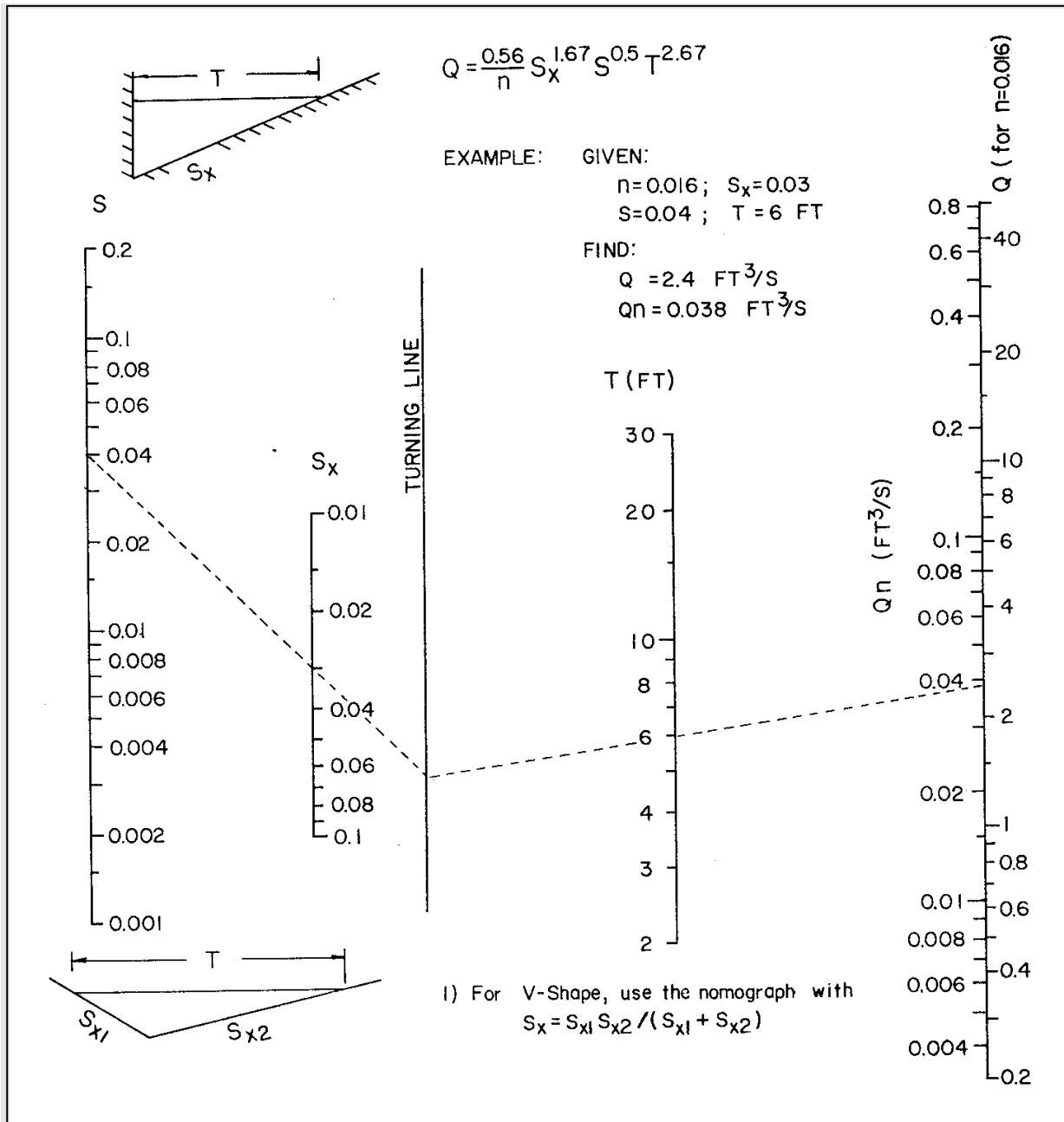

Reference: FHWA Hec-12 (1984)

Figure 6.3-8: Nomographic Solution for Spread in Gutters

VERTICAL CURVE FORMULAE

1. Rate of Change of Grade: $r = \frac{g_2 - g_1}{L}$
2. Offset from tangent to curve: $y = \frac{1}{2}rX^2$
3. Elevation for any point on curve: $E_x = E_{pvc} + g_1X + \left(\frac{1}{2}rX^2\right)$
4. Grade (longitudinal slope) at any point: $\frac{\partial E_x}{\partial X} = g_1 + rX$
5. Station from PVC to turning point (local tangent horizontal) on a curve:
 $X = \frac{g_1L}{g_1 - g_2}$
6. Elevation of turning point: $E_{TP} = E_{pvc} - \frac{1}{2} \left[\frac{Lg_1^2}{g_2 - g_1} \right]$

Where:

All horizontal dimensions (X) are in Stations.

All vertical dimensions (E) are in Feet.

All grades are in percent.

L = Length of vertical curve in Stations.

E_{pvc} = Elevation of the Point of Vertical Curve.

Figure 6.3-9: Vertical Curve Formulae

Conveyance vs. Spread
for Composite Gutter Sections with Type E or Type F Curb
Manning's $n = 0.016$

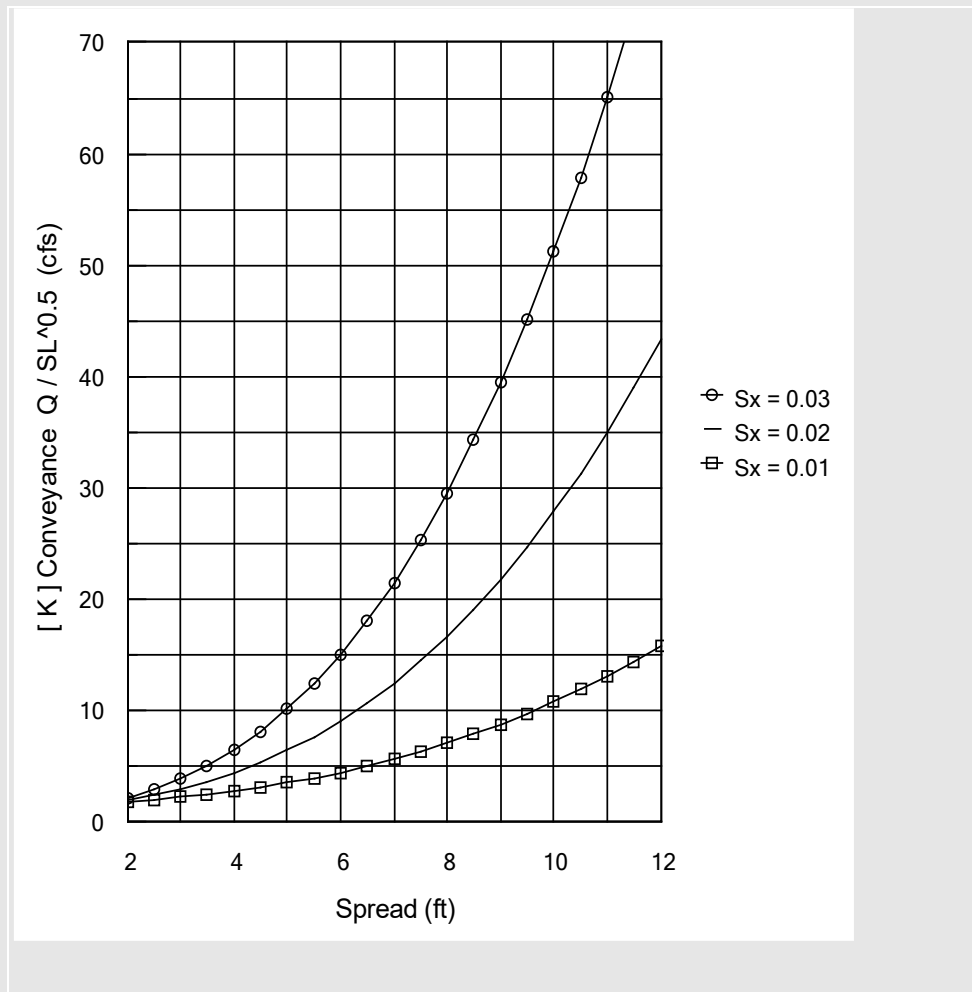

Based on FHWA HEC-12, App. C.

S_L = Longitudinal Slope (ft/ft)
 S_x = Pavement Cross Slope (ft/ft)

Example

Given: $Q = 3$ cfs, $S_x = 0.03$, $S_L = 0.04$ ft/ft

Find Spread:

1. $K = Q/S_L^{0.5} = 3 / 0.04^{0.5} = 15$
2. From Chart at $K = 15$ & $S_x = 0.03$, Spread = 6.0 ft

Figure 6.3-10: Conveyance vs. Spread for Composite Gutter Sections with Type E or Type F Curb

6.4 PIPE SYSTEM PLACEMENT

6.4.1 Plan Layout

After the inlets have been placed to drain the pavement adequately, lay out the piping system to connect the inlets. While laying out the system, you will add manholes as necessary to redirect the flow, or to provide maintenance access, or merely to connect stub pipes. At this stage, consider adding an inlet instead of a manhole. When an inlet is used instead of a manhole, you get the benefit of an additional hydraulic opening for little or no additional cost.

There are several items to consider that can influence the piping system plan layout. The most important issues are hydraulics, constructability, and utility conflicts.

- Avoid placing pipes that would oppose flows from other pipes, especially in high-velocity situations. Impinging flows can be avoided by staggering the elevations of the pipes entering a junction box.
- Consider right of way necessary to open the trench for the pipes. This is especially important for deep pipes. You might use temporary sheet piling during installation to reduce the trench width, but this is very costly, so you will want to explore other alternatives (e.g., moving the trunk line).
- Use either a manhole or an inlet at changes in flow direction. This will provide maintenance access where debris and sediment often collect.
- Preferably, place manholes in or behind the sidewalk. This allows access without closing the travel lanes and is much safer for maintenance personnel. If you must place manholes in the pavement, avoid putting the lids in the wheel path.
- Minimize interference with major utilities, such as fiber optic lines and sanitary and potable water lines greater than eight inches in diameter. See the discussion in Section 6.4.3.
- Where there is one main trunk line, place it on the side of the road constructed first. This prevents constructing stub lines that can't be drained.
- Where there is one main trunk line, locate it, if possible, on the low side of super-elevated roadway sections to minimize the depth of cut.
- Where there is one main trunk line, consider connecting several inlets along the opposite side of the road from the trunk line, and then running only one pipe laterally across the road. This will reduce the number of cuts across the road.

- Consider using two trunk lines to minimize the number of cuts across the road and thus simplify maintenance. In such cases, you should weight the gains in improved maintenance against the increased cost of the additional trunk line.

6.4.1.1 Retaining Wall Drainage

Whenever possible, avoid placing piping within mechanically stabilized earth (MSE) retaining wall embankments. If placing pipes within the MSE wall section is your only option, please refer to Section 3.11 of the *Drainage Manual*.

6.4.2 Profile Placement

6.4.2.1 Slopes

The *Drainage Manual* states that the minimum physical slope must produce a velocity of 2.5 feet per second flowing full. The slope is obtained from the velocity form of Manning's equation using the full cross sectional area of the pipe:

$$V = (1.49/n) R^{2/3} S^{1/2}$$

rearranging:

$$S = [V n / (1.49 R^{2/3})]^2$$

where:

R is based on the full cross sectional area

V = 2.5 fps

Table 6.4-1 provides the minimum physical slope to produce 2.5 feet per second flowing full for various pipe sizes with Manning's roughness coefficient of 0.012. Note that the velocity of 2.5 feet per second is not necessarily the actual velocity in the pipe under design conditions. Refer to Section 6.5.5 for a discussion of flow velocity.

Table 6.4-1: Minimum Slope to Produce Velocity of 2.5 Feet per Second

| Minimum Physical Slope n = 0.012 | |
|-------------------------------------|-----------|
| Diameter (inches) | Slope (%) |
| 18 | 0.150 |
| 24 | 0.102 |
| 30 | 0.076 |
| 36 | 0.059 |
| 42 | 0.048 |
| 48 | 0.041 |
| 54 | 0.035 |
| 60 | 0.030 |
| 66 | 0.027 |
| 72 | 0.024 |
| 78 | 0.021 |
| 84 | 0.019 |

For very flat systems, the minimum physical slope may not be realistic. The overall fall across the system is based on outlet pipe depth and structural clearances at the upper end. Most District Drainage Engineers will approve deviation from the minimum pipe slope in these cases.

Where you cannot attain the minimum slope, try to design the system to avoid appreciable drops in the velocity. This will help to carry sediment through the system instead of dropping sediment at the velocity drop point in the system.

The minimum slope is 0.1 percent for systems under pressure flow.

Setting flow lines relates to the slope. Refer to *FDM 300* for the accuracy level to which you must display flow lines.

6.4.2.2 Minimum Pipe Depth

The minimum depth of the pipe is controlled either by the minimum pipe cover or by the need to have clearance above the top of the pipe to maintain strength in a precast structure. Minimum pipe cover requirements are given in Appendix C of the Drainage Manual.

The loads placed on precast structures during shipping and handling often are greater than the loads placed on them in their final location. Since contractors prefer precast drainage structures and they have become the industry standard, you should consider the potential for breakage during shipping and handling.

Where pipes are placed high in a structure, the structure has little, if any, strength above the pipe. This can result in breakage during shipping or handling. For strength reasons, it is best to maintain a minimum amount of precast concrete section above the pipe.

The ideal amount of precast section varies with the type of inlet and bottom configuration. Generally, where a pipe is placed in grated inlets or in structure bottoms, try to maintain a six-inch precast section that has full wall thickness above the pipe opening, as shown in Figure 6.4-1. For ditch bottom inlets placed on J bottoms, the recommended minimum precast riser section varies depending on if the unit has slots. Refer to Structure/Pipe configuration numbers 4 & 5 in Figure 6.4-5. For ditch bottom inlets without slots, maintain a 10-inch riser section below the grate seat. For ditch bottom inlets with slots, maintain a 12-inch riser section below the slot.

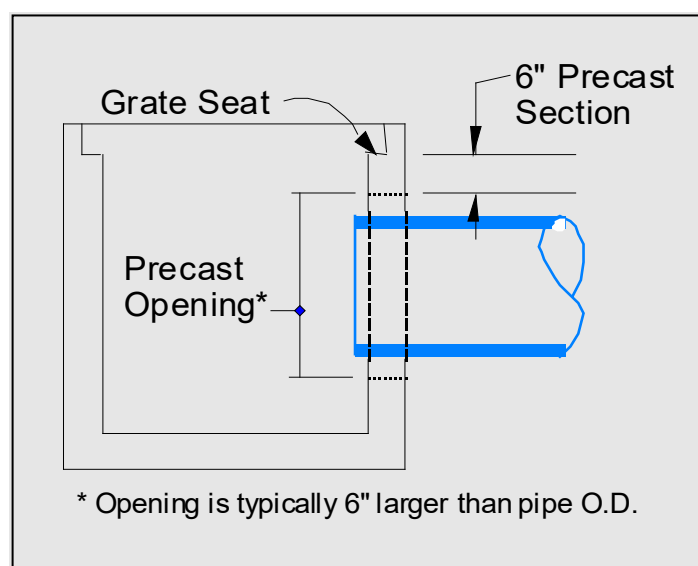

Figure 6.4-1: Maintaining Six Inch From Grate Seat to Opening For Pipe

Tables 6.4-4 and 6.4-5 give recommended minimum distances from inlets to pipe flow lines for most of the Department's standard inlets. These distances provide the precast section discussed above and are based on concrete pipe that is centered in the precast opening. The above discussion represents ideal values that you should try to achieve. On occasion, you will need to use less precast section than discussed above. This is acceptable because the contractor has the option to cast structures in place. When using less precast section, you must add all the appropriate dimensions to assure that no conflict will exist between pipes and the structure.

6.4.3 Utility Coordination

During the design process, avoid designing storm drain systems in the vicinity of utilities where practical unless it would substantially increase the cost of the system. Try to obtain information not only on the location of existing facilities, but on proposed locations as well. The utility companies (both private and public) will view the design proposed on the Phase II plans as part of the utility coordination process. You may be asked to attend utility coordination meetings, which can be very beneficial to the design effort because the concerned parties gather together to resolve utility placement conflicts. The utility companies are accustomed to meeting face-to-face with FDOT representatives. The Department and the utility companies usually negotiate final storm drain design and utility locations, with the goal to minimize the costs to the public.

Sometimes minor changes in the storm drain design can reduce the cost to a utility company and minimize the cost to the public. At other times, it may not be practical or cost effective to accommodate a utility company proposal. Utility companies often take the opportunity to upgrade their systems or add facilities during the Department's construction project. Do not assume they will relocate their systems in the process.

On projects with long storm drain systems in areas of many utilities, include one additional manhole in the quantities for unforeseen utility conflicts.

6.4.4 Pipe-to-Structure Connections

When a bridge deck piping system connects to a roadway structure, use a resilient connector to accommodate the expected thermal movement of the bridge and its piping system.

Check sizes of structure bottoms to make sure that the pipes fit. When doing so, use the outside diameter of concrete pipe³. It has the thickest wall of any of the optional pipe materials. Type P structure bottoms are either 4'-0" or smaller diameter round (Alternate

³ An easy way to remember the wall thickness of the concrete pipe is to take the inside diameter in feet and add one (1). The result is the wall thickness in inches. Examples: 30" pipe, I.D. = 2.5 feet, Wall Thickness = 2.5 + 1 = 3.5".

A) or 3'-6" square (Alternate B). 30-inch pipe is the maximum size that will fit in Type P bottoms. The contractor has the option of using either Alternate A or Alternate B for Type P bottoms unless restricted by the plans. Type J structure bottoms are larger than Type P bottoms and come in various sizes, as described in Standard Plans, Index 425-010. The plans usually specify the alternate and the size of the J bottoms. Table 6.4-2 gives the minimal structure dimensions for various pipe sizes.

Table 6.4-2: Minimum Structure Sizes for Single Pipe Connection Per Side

| MINIMUM STRUCTURE SIZES FOR SINGLE PIPE CONNECTION PER SIDE | | | | |
|---|----------------------|-------------|--------------------------|-----------------------|
| PIPE SIZE | RECTANGULAR | | ROUND | |
| | Side Dimension (L) | | Diameter (D) | |
| | Single Pipe Per Side | Note Number | Single Pipe or θ=180° | 2 to 4 Pipes θ=90° |
| 18" | 3'-6" | | 3'-6" | 4'-0" |
| 24" | 3'-6" | | 3'-6" | 5'-0" |
| 30" | 3'-6"/4'-0" | 2 | 4'-0" | 6'-0" |
| 36" | 4'-0"/5'-0" | 3 | 5'-0" | 7'-0" |
| 42" | 5'-0" | | 6'-0" | 7'-0" |
| 48" | 6'-0" | | 6'-0" | 8'-0" |
| 54" | 6'-0" | | 7'-0" | 10'-0" |
| 60" | 7'-0" | | 7'-0" | 10'-0" |
| 66" | 7'-0"/8'-0" | 4 | 8'-0" | 12'-0" |
| 72" | 8'-0" | | 8'-0" | 12'-0" |
| 78" | 9'-0" | | 10'-0" | 12'-0" |
| 84" | 9'-0" | | 12'-0" | N/A |

TABLE NOTES:

1. For Round Structures sizes with variable angles between pipes and variable pipe sizes, refer to the FDOT Storm Drain Handbook.
2. For 3'-6" Precast Square Structure Bottoms, 30" Pipes with similar invert elevations are not permitted in adjacent walls. Use 4'-0" Side Dimensions when 30" pipe openings are required on adjacent walls and the difference in flow lines is less than 3'-0".
3. For 4'-0" Precast Square Structure Bottoms, 36" Pipes with similar invert elevations are not permitted in adjacent walls. Use 5'-0" Side Dimensions when 36" pipe openings are required on adjacent walls and the difference in flow lines is less than 3'-0".
4. For 7'-0" Precast Square Structure Bottoms, 66" Pipes with similar invert elevations are not permitted in adjacent walls. Use 8'-0" Side Dimensions when 66" pipe openings are required on adjacent walls and the difference in flow lines is less than 4'-0".

The skew at which a pipe enters a precast rectangular structure is limited by the precast pipe opening as shown in Figure 6.4-2. The maximum opening is six inches larger than the pipe outside diameter (Standard Plans, Index 425-001). The maximum pipe skew varies with the structure wall thickness and the pipe size. The maximum skew for various pipe sizes passing through eight-inch structure walls is shown in Table 6.4-3. Standard Plans, Index 425-010 provides skew values for six-inch structure walls and other pipe sizes. Use round structure bottoms (Alternate A) where the pipe enters the structure at a larger angle.

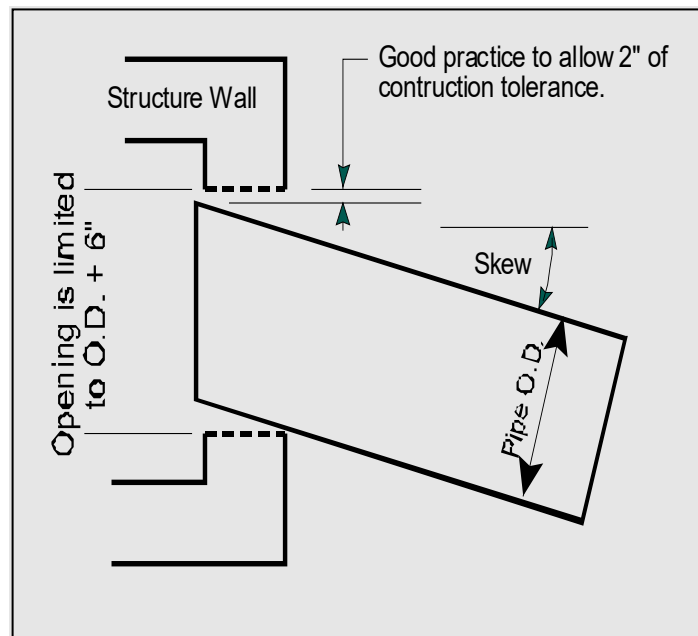

Figure 6.4-2: Skew in Pipe Opening

Standard Plans, Index 425-001 includes a detail of a pipe opening at a corner of a structure. Although a detail exists for this condition, restrict its use to situations where other alternatives do not exist. Make every attempt to ensure pipes do not enter the corner of rectangular structures (“corner-cutouts”).

When placing pipes in existing rectangular structures, the maximum skew is limited by the dimension of the skewed pipe cut fitting between the walls.

Table 6.4-3: Maximum Skew for Pipe Sizes Passing through an Eight Inch Wall

| | Pipe Size | | | | | | | |
|-----------|-----------|-----|-----|-----|-----|-----|-----|-----|
| | 18" | 24" | 30" | 36" | 42" | 48" | 54" | 60" |
| Max. Skew | 19° | 17° | 16° | 16° | 15° | 14° | 14° | 13° |

These values are based on two inches of construction tolerance, precast structures with eight-inch walls, and concrete pipe dimensions.

When using round structure bottoms, consider the need to maintain a precast section between the openings of adjacent pipes. Try to maintain at least a two-inch section along the inside wall between adjacent pipe openings, as shown in Figure 6.4-3. Table 6.4-6 provides the minimum angle between adjacent pipe centerlines to maintain the two-inch precast section along the inside wall. The values in Table 6.4-6 are based on equal pipe centerline elevations and standard concrete pipe openings. Using these minimum angles for pipes with offset centerline elevations and other pipe materials is conservative and would yield more than two inches of precast section.

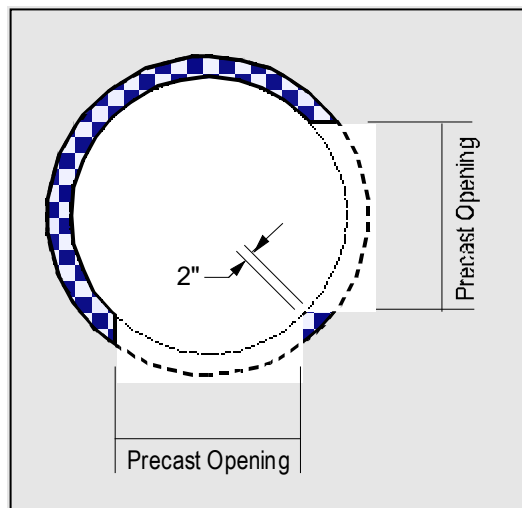

Figure 6.4-3: Adjacent Pipe Openings

Where large pipes are stubbed into the main line or a large main line pipe makes a 90-degree turn, rectangular structures can be smaller than round structures given the same pipe sizes. Figure 6.4-4 shows 48-inch pipes making a 90-degree turn at a structure. An eight-foot round structure is needed, while a six-foot rectangular structure would work.

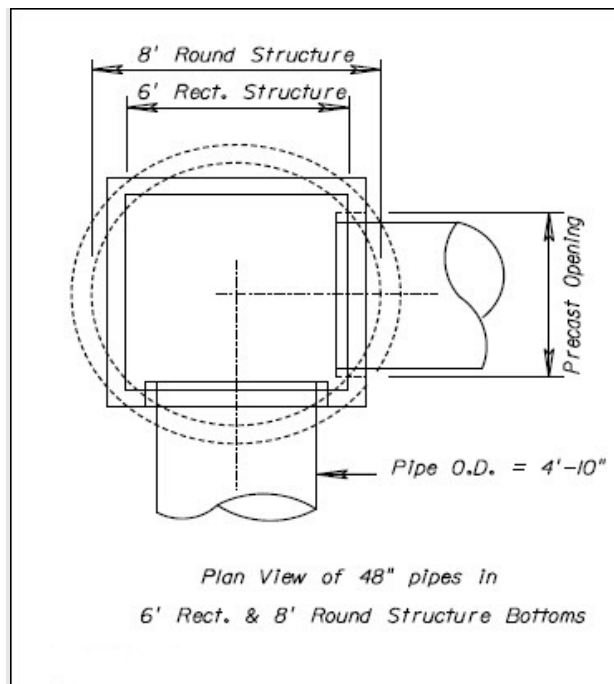

Figure 6.4-4: 48" Pipe at 90 Degrees

Table 6.4-4: Recommended Min. Distance from Inlet Elevation to Pipe Flow Line

| INLET TYPE | SLOT TYPE | PIPE LOCATION | | RECOMMENDED MIN. DISTANCE (FT.) FROM GRATE (INLET) ELEVATION TO PIPE FLOW LINE | | | | | | | | |
|-----------------|-------------------|-------------------|------------|--|----------|----------|----------|----------|----------|----------|----------|----------|
| | | Wall | Wall Dim. | 15" Pipe | 18" Pipe | 24" Pipe | 30" Pipe | 36" Pipe | 42" Pipe | 48" Pipe | 54" Pipe | 60" Pipe |
| Type A | | Short | 2'-0" | 2.2 (1) | 2.5 (1) | 4.8 (5) | 5.4 (5) | 5.9 (5) | 6.5 (5) | 7.0 (5) | 7.5 (5) | 8.1 (5) |
| | | Long | 3'-1" | 2.5 (2) | 2.8 (2) | 4.8 (5) | 5.4 (5) | 5.9 (5) | 6.5 (5) | 7.0 (5) | 7.5 (5) | 8.1 (5) |
| Type B (Note 3) | Travers | Short | No Slot | 2.6 (2) | 2.9 (2) | 3.4 (2) | 4.0 (2) | 6.9 (4) | 7.5 (4) | 8.0 (4) | 8.5 (4) | 9.1 (4) |
| | | | Under Slot | 3.4 (3) | 3.6 (3) | 4.2 (3) | 4.7 (3) | 6.9 (4) | 7.5 (4) | 8.0 (4) | 8.5 (4) | 9.1 (4) |
| | | Long | | 2.6 (2) | 2.9 (2) | 3.4 (2) | 4.0 (2) | 4.5 (2) | 7.5 (4) | 8.0 (4) | 8.5 (4) | 9.1 (4) |
| Type C (Note 3) | None | Short | 2'-0" | 2.2 (1) | 2.5 (1) | 4.7 (5) | 5.2 (5) | 5.8 (5) | 6.3 (5) | 6.8 (5) | 7.4 (5) | 7.9 (5) |
| | | Long | 3'-1" | 2.4 (2) | 2.6 (2) | 4.7 (5) | 5.2 (5) | 5.8 (5) | 6.3 (5) | 6.8 (5) | 7.4 (5) | 7.9 (5) |
| | Travers | Short | No Slot | 2.2 (1) | 2.5 (1) | 5.3 (4) | 5.8 (4) | 6.3 (4) | 6.9 (4) | 7.4 (4) | 8.0 (4) | 8.5 (4) |
| | | Under Slot | 2.8 (3) | 3.0 (3) | 5.3 (4) | 5.8 (4) | 6.3 (4) | 6.9 (4) | 7.4 (4) | 8.0 (4) | 8.5 (4) | |
| | Long | | 2.4 (2) | 2.6 (2) | 5.3 (4) | 5.8 (4) | 6.3 (4) | 6.9 (4) | 7.4 (4) | 8.0 (4) | 8.5 (4) | |
| | | Non-Trav 12" Std. | Short | No Slot | 2.2 (1) | 2.5 (1) | 5.7 (4) | 6.2 (4) | 6.8 (4) | 7.3 (4) | 7.8 (4) | 8.4 (4) |
| | Under Slot | | 3.2 (3) | 3.5 (3) | 5.7 (4) | 6.2 (4) | 6.8 (4) | 7.3 (4) | 7.8 (4) | 8.4 (4) | 8.9 (4) | |
| | Long | | 2.4 (2) | 2.6 (2) | 5.7 (4) | 6.2 (4) | 6.8 (4) | 7.3 (4) | 7.8 (4) | 8.4 (4) | 8.9 (4) | |
| | | | | | | | | | | | | |
| Type D (Note 3) | None | Short | 3'-1" | 2.4 (2) | 2.6 (2) | 3.2 (2) | 5.2 (5) | 5.8 (5) | 6.3 (5) | 6.8 (5) | 7.4 (5) | 7.9 (5) |
| | | Long | 4'-1" | 2.2 (1) | 2.5 (1) | 3.0 (1) | 3.5 (1) | 4.1 (1) | 6.3 (5) | 6.8 (5) | 7.4 (5) | 7.9 (5) |
| | Travers | Short | | 2.4 (2) | 2.6 (2) | 3.2 (2) | 5.8 (4) | 6.3 (4) | 6.9 (4) | 7.4 (4) | 8.0 (4) | 8.5 (4) |
| | | Long | No Slot | 2.2 (1) | 2.5 (1) | 3.0 (1) | 3.5 (1) | 4.1 (1) | 6.9 (4) | 7.4 (4) | 8.0 (4) | 8.5 (4) |
| | Under Slot | | 2.8 (3) | 3.0 (3) | 3.6 (3) | 4.1 (3) | 4.7 (3) | 6.9 (4) | 7.4 (4) | 8.0 (4) | 8.5 (4) | |
| | | | | | | | | | | | | |
| | Non-Trav 12" Std. | Short | | 2.4 (2) | 2.6 (2) | 3.2 (2) | 6.2 (4) | 6.8 (4) | 7.3 (4) | 7.8 (4) | 8.4 (4) | 8.9 (4) |
| | | Long | No Slot | 2.2 (1) | 2.5 (1) | 3.0 (1) | 3.5 (1) | 4.1 (1) | 7.3 (4) | 7.8 (4) | 8.4 (4) | 8.9 (4) |
| | Under Slot | | 3.2 (3) | 3.5 (3) | 4.0 (3) | 4.5 (3) | 5.1 (3) | 7.3 (4) | 7.8 (4) | 8.4 (4) | 8.9 (4) | |
| | | | | | | | | | | | | |
| Type E (Note 3) | None | Short | 3'-0" | 2.2 (1) | 2.5 (1) | 3.0 (1) | 5.2 (5) | 5.8 (5) | 6.3 (5) | 6.8 (5) | 7.4 (5) | 7.9 (5) |
| | | Long | 4'-6" | 2.4 (2) | 2.6 (2) | 3.2 (2) | 3.7 (2) | 4.3 (2) | 6.3 (5) | 6.8 (5) | 7.4 (5) | 7.9 (5) |
| | Travers | Short | No Slot | 2.2 (1) | 2.5 (1) | 3.0 (1) | 5.8 (4) | 6.3 (4) | 6.9 (4) | 7.4 (4) | 8.0 (4) | 8.5 (4) |
| | | Under Slot | 2.8 (3) | 3.0 (3) | 3.6 (3) | 5.8 (4) | 6.3 (4) | 6.9 (4) | 7.4 (4) | 8.0 (4) | 8.5 (4) | |
| | Long | | 2.4 (2) | 2.6 (2) | 3.2 (2) | 3.7 (2) | 4.3 (2) | 6.9 (4) | 7.4 (4) | 8.0 (4) | 8.5 (4) | |
| | | | | | | | | | | | | |
| | Non-Trav 12" Std. | Short | No Slot | 2.2 (1) | 2.5 (1) | 3.0 (1) | 6.2 (4) | 6.8 (4) | 7.3 (4) | 7.8 (4) | 8.4 (4) | 8.9 (4) |
| | | Under Slot | 3.2 (3) | 3.5 (3) | 4.0 (3) | 6.2 (4) | 6.8 (4) | 7.3 (4) | 7.8 (4) | 8.4 (4) | 8.9 (4) | |
| | Long | | 2.4 (2) | 2.6 (2) | 3.2 (2) | 3.7 (2) | 4.3 (2) | 7.3 (4) | 7.8 (4) | 8.4 (4) | 8.9 (4) | |
| | | | | | | | | | | | | |

- Notes:**
1. The number in parentheses () refers to one of the structure pipe combinations shown in Figure 6.4-5.
 2. *** CAUTION *** Where multiple pipes enter a structure, needing a J-bottom because of one pipe could dictate greater distances than shown above for other pipes entering the structure.
 3. The values shown for Type B, C, D, and E inlets are based on Alternate B Bottoms. Alternate A Bottoms have thicker slabs, so add two inches for up through six-foot diameter bottoms. Add four inches for eight-foot diameter bottoms.
 4. The distances are based on precast structures and standard precast openings for concrete pipes.
 5. The designer should check that the minimum cover requirements of *Drainage Manual*, Appendix C are met.

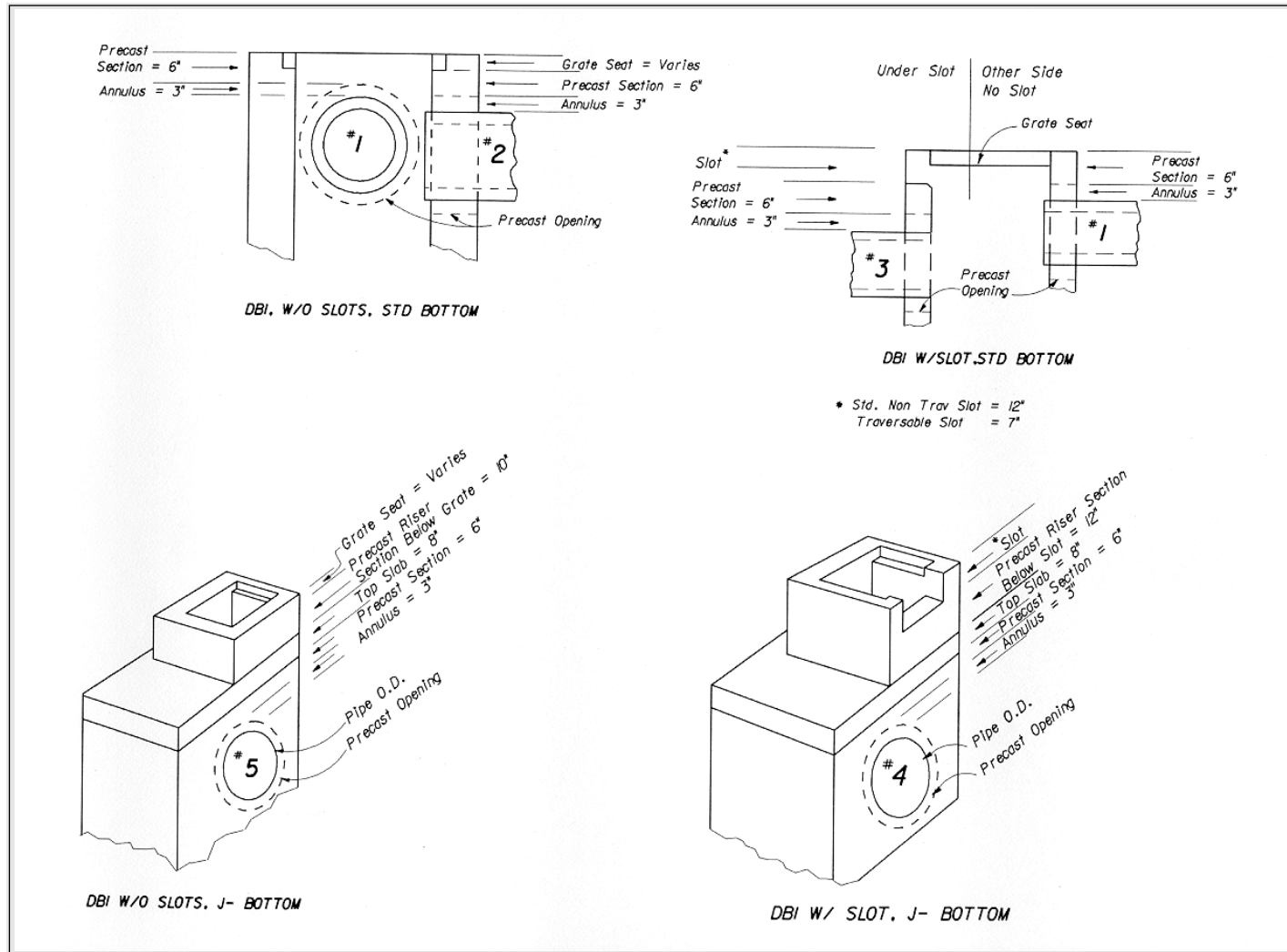

Figure 6.4-5

Table 6.4-5: Recommended Min. Distance from Inlet Elevation to Pipe Flow Line

| INLET TYPE | SLOT TYPE | PIPE LOCATION | | RECOMMENDED MIN. DISTANCE (FT.) FROM GRATE (INLET) ELEVATION TO PIPE FLOW LINE | | | | | | | | | | |
|-------------------|----------------------|---------------|-----------|--|----------|----------|----------|----------|----------|----------|----------|----------|---------|---------|
| | | Wall | Wall Dim. | 15" Pipe | 18" Pipe | 24" Pipe | 30" Pipe | 36" Pipe | 42" Pipe | 48" Pipe | 54" Pipe | 60" Pipe | | |
| Type F | n/a | Short | 2'-6" | 2.2 (1) | 2.5 (1) | 4.8 (5) | 5.3 (5) | 5.8 (5) | 6.4 (5) | 6.9 (5) | 7.5 (5) | 8.0 (5) | | |
| | | Long | 4'-0" | 2.4 (2) | 2.7 (2) | 3.3 (2) | 3.8 (2) | 4.3 (2) | 6.4 (5) | 6.9 (5) | 7.5 (5) | 8.0 (5) | | |
| Type H | None | Short | 3'-0" | 2.2 (1) | 2.5 (1) | 3.0 (1) | n/a | n/a | n/a | n/a | n/a | n/a | | |
| | | Long | 6'-7" | 2.4 (2) | 2.6 (2) | 3.2 (2) | 3.7 (2) | 4.3 (2) | 4.8 (2) | 5.3 (2) | 5.9 (2) | 6.4 (2) | | |
| | Non-Trav 12" std. | Short | 3'-0" | 3.2 (3) | 3.5 (3) | 4.0 (3) | n/a | n/a | n/a | n/a | n/a | n/a | | |
| | | Long | 6'-7" | 2.4 (2) | 2.6 (2) | 3.2 (2) | 3.7 (2) | 4.3 (2) | 4.8 (2) | 5.3 (2) | 5.9 (2) | 6.4 (2) | | |
| Type J | n/a | Short | 3'-3" | 2.6 (2) | 2.9 (2) | 3.4 (2) | 5.5 (5) | 6.0 (5) | 6.5 (5) | 7.1 (5) | 7.6 (5) | 8.2 (5) | | |
| | | Long | 3'-10" | 2.4 (2) | 2.7 (2) | 3.3 (2) | 3.8 (2) | 6.0 (5) | 6.5 (5) | 7.1 (5) | 7.6 (5) | 8.2 (5) | | |
| Type S | n/a | Short | 3'-3" | 2.6 (2) | 2.9 (2) | 3.5 (2) | 5.5 (5) | 6.0 (5) | 6.6 (5) | 7.1 (5) | 7.7 (5) | 8.2 (5) | | |
| | | Long | 3'-10" | 2.3 (2) | 2.5 (2) | 3.1 (2) | 3.6 (2) | 6.0 (5) | 6.6 (5) | 7.1 (5) | 7.7 (5) | 8.2 (5) | | |
| Type V | n/a | Short | 3'-3" | 2.6 (2) | 2.9 (2) | 3.4 (2) | 5.5 (5) | 6.0 (5) | 6.5 (5) | 7.1 (5) | 7.6 (5) | 8.2 (5) | | |
| | | Long | 3'-10" | 2.4 (2) | 2.7 (2) | 3.3 (2) | 3.8 (2) | 6.0 (5) | 6.5 (5) | 7.1 (5) | 7.6 (5) | 8.2 (5) | | |
| Manhole Type 8 | n/a | n/a | | RECOMMENDED MIN. DISTANCES ³ (FT.) FROM TOP ELEVATION TO PIPE FLOW LINE | | | | | | | | | | |
| | | | | 3.7 (10) | 4.0 (10) | 4.5 (10) | 5.0 (10) | 6.3 (11) | 6.8 (11) | 7.3 (11) | 7.9 (11) | 8.4 (11) | | |
| Barr- Wall 218 | n/a | | | RECOMMENDED MIN. DISTANCE (FT.) FROM LOW POINT OF GRATE TO PIPE FLOW LINE | | | | | | | | | | |
| | | | | Short | 3'-3" | 4.2 (8) | 4.5 (8) | 5.0 (8) | 6.2 (9) | 6.8 (9) | 7.3 (9) | 7.8 (9) | 8.4 (9) | 8.9 (9) |
| | | | | Long | 3'-8" | 4.2 (8) | 4.5 (8) | 5.0 (8) | 5.5 (8) | 6.8 (9) | 7.3 (9) | 7.8 (9) | 8.4 (9) | 8.9 (9) |
| Curb 1-9 | n/a | n/a | | RECOMMENDED MIN. DISTANCE (FT.) FROM EDGE OF PAVEMENT TO PIPE FLOW LINE | | | | | | | | | | |
| | | | | 3.9 (6) | 4.2 (6) | 4.7 (6) | 5.3 (6) | 6.5 (7) | 7.0 (7) | 7.5 (7) | 8.1 (7) | 8.6 (7) | | |

- Notes:**
1. The number in parentheses () refers to one of the structure pipe combinations shown in Figure 6.4-6.
 2. ***** CAUTION ***** Where multiple pipes enter a structure, needing a J-bottom because of one pipe could dictate greater distances than shown above for other pipes entering the structure.
 3. ***** CAUTION ***** For curb inlets and manholes, where 30" pipes with similar inverts enter a structure at 90 degrees, a J-bottom is required, thus the minimum distance may be greater than shown above. This may apply to other inlets also.
 4. The distances are based on precast structures and standard precast openings for concrete pipes.
 5. The designer should check that the minimum cover requirements of *Drainage Manual*, Appendix C are met.

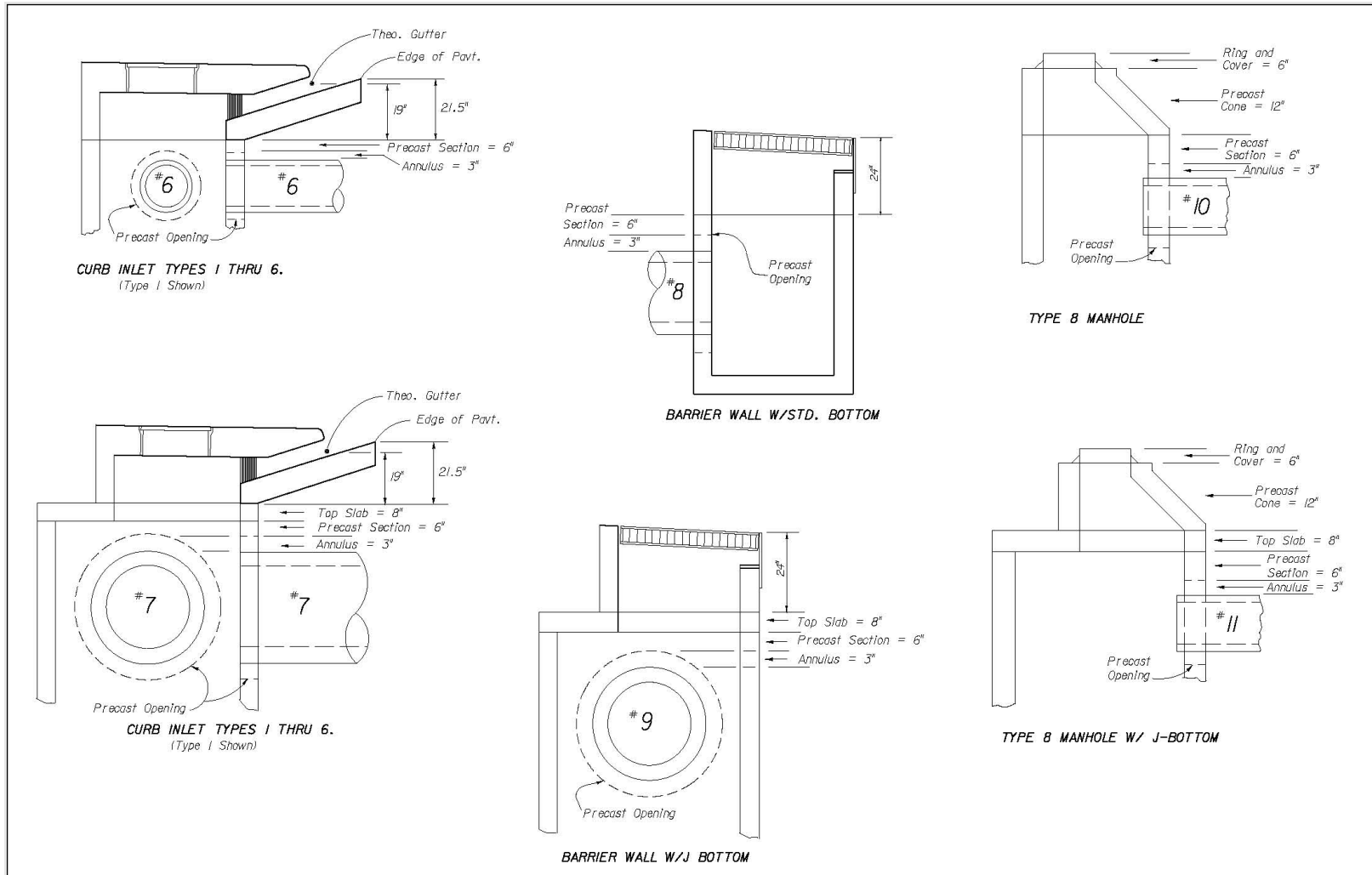
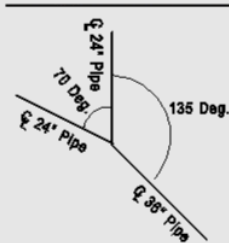

Figure 6.4-6

Table 6.4-6: The Minimum Angle Between Adjacent Pipe Centerlines to Maintain the Two-inch Precast Section along the Inside Wall

| RECOMMENDED MINIMUM ANGLE (in Degrees) BETWEEN ADJACENT PIPE CENTER LINES IN ROUND (Alt. A) STRUCTURE BOTTOMS | | | | | | | | | | | | | | | | | | | | | | | | | | | | | | | | | | | | | | | | |
|--|--------------------|------------|------------|------------|------------|------------|------------|------------|------------|------------|------------|------------|------------|------------|------------|------------|------------|------------|------------|------------|------------|------------|------------|------------|------------|------------|------------|------------|------------|------------|------------|------------|------------|------------|------------|------------|------------|------------|----|------------|
| PIPE SIZE | ADJACENT PIPE SIZE | | | | | | | | | | | | | | | | | | | | | | | | | | | | | | | | | | | | | | | |
| | 18" | 24" | 30" | 36" | 42" | 48" | 54" | 60" | 66" | 72" | 18" | 24" | 30" | 36" | 42" | 48" | 54" | 60" | 66" | 72" | | | | | | | | | | | | | | | | | | | | |
| 18" | 26 | <i>12</i> | 28 | <i>12</i> | 31 | <i>12</i> | 33 | <i>12</i> | 38 | <i>12</i> | 41 | <i>12</i> | 44 | <i>12</i> | 46 | <i>12</i> | 49 | <i>12</i> | 52 | <i>12</i> | 31 | <i>10'</i> | 34 | <i>10'</i> | 37 | <i>10'</i> | 40 | <i>10'</i> | 46 | <i>10'</i> | 50 | <i>10'</i> | 53 | <i>10'</i> | 57 | <i>10'</i> | 61 | <i>10'</i> | 65 | <i>10'</i> |
| | 39 | <i>8'</i> | 43 | <i>8'</i> | 47 | <i>8'</i> | 51 | <i>8'</i> | 59 | <i>8'</i> | 64 | <i>8'</i> | 69 | <i>8'</i> | 75 | <i>8'</i> | 82 | <i>8'</i> | 90 | <i>8'</i> | 45 | <i>7'</i> | 49 | <i>7'</i> | 54 | <i>7'</i> | 59 | <i>7'</i> | 69 | <i>7'</i> | 75 | <i>7'</i> | 83 | <i>7'</i> | 92 | <i>7'</i> | 114 | <i>7'</i> | | |
| | 52 | <i>6'</i> | 58 | <i>6'</i> | 63 | <i>6'</i> | 70 | <i>6'</i> | 84 | <i>6'</i> | 94 | <i>6'</i> | 64 | <i>5'</i> | 71 | <i>5'</i> | 78 | <i>5'</i> | 87 | <i>5'</i> | 64 | <i>5'</i> | 71 | <i>5'</i> | 78 | <i>5'</i> | 87 | <i>5'</i> | | | | | | | | | | | | |
| | 64 | <i>5'</i> | 71 | <i>5'</i> | 78 | <i>5'</i> | 87 | <i>5'</i> | 82 | <i>4'</i> | 90 | <i>4'</i> | 105 | <i>4'</i> | 64 | <i>5'</i> | 71 | <i>5'</i> | 78 | <i>5'</i> | 87 | <i>5'</i> | | | | | | | | | | | | | | | | | | |
| | 82 | <i>4'</i> | 90 | <i>4'</i> | 105 | <i>4'</i> | 82 | <i>4'</i> | 90 | <i>4'</i> | 105 | <i>4'</i> | 82 | <i>4'</i> | 90 | <i>4'</i> | 105 | <i>4'</i> | | | | | | | | | | | | | | | | | | | | | | |
| | 24" | 31 | <i>12</i> | 33 | <i>12</i> | 36 | <i>12</i> | 41 | <i>12</i> | 43 | <i>12</i> | 46 | <i>12</i> | 49 | <i>12</i> | 52 | <i>12</i> | 55 | <i>12</i> | 37 | <i>10'</i> | 40 | <i>10'</i> | 43 | <i>10'</i> | 49 | <i>10'</i> | 53 | <i>10'</i> | 56 | <i>10'</i> | 60 | <i>10'</i> | 64 | <i>10'</i> | 68 | <i>10'</i> | | | |
| 46 | | <i>8'</i> | 50 | <i>8'</i> | 54 | <i>8'</i> | 63 | <i>8'</i> | 68 | <i>8'</i> | 73 | <i>8'</i> | 79 | <i>8'</i> | 85 | <i>8'</i> | 94 | <i>8'</i> | 46 | <i>8'</i> | 50 | <i>8'</i> | 54 | <i>8'</i> | 63 | <i>8'</i> | 68 | <i>8'</i> | 73 | <i>8'</i> | 79 | <i>8'</i> | 85 | <i>8'</i> | 94 | <i>8'</i> | | | | |
| 53 | | <i>7'</i> | 58 | <i>7'</i> | 63 | <i>7'</i> | 74 | <i>7'</i> | 80 | <i>7'</i> | 87 | <i>7'</i> | 96 | <i>7'</i> | 118 | <i>7'</i> | 53 | <i>7'</i> | 58 | <i>7'</i> | 63 | <i>7'</i> | 74 | <i>7'</i> | 80 | <i>7'</i> | 87 | <i>7'</i> | 96 | <i>7'</i> | 118 | <i>7'</i> | | | | | | | | |
| 63 | | <i>6'</i> | 69 | <i>6'</i> | 75 | <i>6'</i> | 90 | <i>6'</i> | 100 | <i>6'</i> | 63 | <i>6'</i> | 69 | <i>6'</i> | 75 | <i>6'</i> | 90 | <i>6'</i> | 100 | <i>6'</i> | | | | | | | | | | | | | | | | | | | | |
| 78 | | <i>5'</i> | 85 | <i>5'</i> | 94 | <i>5'</i> | 78 | <i>5'</i> | 85 | <i>5'</i> | 94 | <i>5'</i> | | | | | | | | | | | | | | | | | | | | | | | | | | | | |
| 102 | | <i>4'</i> | 114 | <i>4'</i> | 102 | <i>4'</i> | 114 | <i>4'</i> | | | | | | | | | | | | | | | | | | | | | | | | | | | | | | | | |
| 30" | 36 | <i>12</i> | 38 | <i>12</i> | 43 | <i>12</i> | 46 | <i>12</i> | 49 | <i>12</i> | 51 | <i>12</i> | 54 | <i>12</i> | 57 | <i>12</i> | 60 | <i>12</i> | 43 | <i>10'</i> | 46 | <i>10'</i> | 52 | <i>10'</i> | 56 | <i>10'</i> | 59 | <i>10'</i> | 63 | <i>10'</i> | 67 | <i>10'</i> | 71 | <i>10'</i> | | | | | | |
| | 54 | <i>8'</i> | 58 | <i>8'</i> | 67 | <i>8'</i> | 72 | <i>8'</i> | 77 | <i>8'</i> | 83 | <i>8'</i> | 89 | <i>8'</i> | 98 | <i>8'</i> | 54 | <i>8'</i> | 58 | <i>8'</i> | 67 | <i>8'</i> | 72 | <i>8'</i> | 77 | <i>8'</i> | 83 | <i>8'</i> | 89 | <i>8'</i> | 98 | <i>8'</i> | | | | | | | | |
| | 63 | <i>7'</i> | 68 | <i>7'</i> | 78 | <i>7'</i> | 85 | <i>7'</i> | 92 | <i>7'</i> | 101 | <i>7'</i> | 123 | <i>7'</i> | 63 | <i>7'</i> | 68 | <i>7'</i> | 78 | <i>7'</i> | 85 | <i>7'</i> | 92 | <i>7'</i> | 101 | <i>7'</i> | 123 | <i>7'</i> | | | | | | | | | | | | |
| | 75 | <i>6'</i> | 81 | <i>6'</i> | 95 | <i>6'</i> | 105 | <i>6'</i> | 75 | <i>6'</i> | 81 | <i>6'</i> | 95 | <i>6'</i> | 105 | <i>6'</i> | | | | | | | | | | | | | | | | | | | | | | | | |
| | 93 | <i>5'</i> | 101 | <i>5'</i> | 93 | <i>5'</i> | 101 | <i>5'</i> | | | | | | | | | | | | | | | | | | | | | | | | | | | | | | | | |
| | 127 | <i>4'</i> | 127 | <i>4'</i> | | | | | | | | | | | | | | | | | | | | | | | | | | | | | | | | | | | | |
| 36" | 41 | <i>12</i> | 46 | <i>12</i> | 48 | <i>12</i> | 51 | <i>12</i> | 54 | <i>12</i> | 57 | <i>12</i> | 60 | <i>12</i> | 49 | <i>10'</i> | 55 | <i>10'</i> | 59 | <i>10'</i> | 62 | <i>10'</i> | 66 | <i>10'</i> | 70 | <i>10'</i> | 74 | <i>10'</i> | | | | | | | | | | | | |
| | 62 | <i>8'</i> | 71 | <i>8'</i> | 76 | <i>8'</i> | 81 | <i>8'</i> | 87 | <i>8'</i> | 93 | <i>8'</i> | 102 | <i>8'</i> | 62 | <i>8'</i> | 71 | <i>8'</i> | 76 | <i>8'</i> | 81 | <i>8'</i> | 87 | <i>8'</i> | 93 | <i>8'</i> | 102 | <i>8'</i> | | | | | | | | | | | | |
| | 72 | <i>7'</i> | 83 | <i>7'</i> | 89 | <i>7'</i> | 97 | <i>7'</i> | 106 | <i>7'</i> | 128 | <i>7'</i> | 72 | <i>7'</i> | 83 | <i>7'</i> | 89 | <i>7'</i> | 97 | <i>7'</i> | 106 | <i>7'</i> | 128 | <i>7'</i> | | | | | | | | | | | | | | | | |
| | 91 | <i>6'</i> | 101 | <i>6'</i> | 111 | <i>6'</i> | 91 | <i>6'</i> | 101 | <i>6'</i> | 111 | <i>6'</i> | | | | | | | | | | | | | | | | | | | | | | | | | | | | |
| | 110 | <i>5'</i> | 110 | <i>5'</i> | | | | | | | | | | | | | | | | | | | | | | | | | | | | | | | | | | | | |
| 42" | 51 | <i>12</i> | 53 | <i>12</i> | 56 | <i>12</i> | 59 | <i>12</i> | 62 | <i>12</i> | 62 | <i>12</i> | 65 | <i>12</i> | 62 | <i>10'</i> | 65 | <i>10'</i> | 69 | <i>10'</i> | 72 | <i>10'</i> | 76 | <i>10'</i> | 81 | <i>10'</i> | | | | | | | | | | | | | | |
| | 80 | <i>8'</i> | 85 | <i>8'</i> | 90 | <i>8'</i> | 95 | <i>8'</i> | 102 | <i>8'</i> | 111 | <i>8'</i> | 80 | <i>8'</i> | 85 | <i>8'</i> | 90 | <i>8'</i> | 95 | <i>8'</i> | 102 | <i>8'</i> | 111 | <i>8'</i> | | | | | | | | | | | | | | | | |
| | 90 | <i>7'</i> | 100 | <i>7'</i> | 107 | <i>7'</i> | 117 | <i>7'</i> | 138 | <i>7'</i> | 90 | <i>7'</i> | 100 | <i>7'</i> | 107 | <i>7'</i> | 117 | <i>7'</i> | 138 | <i>7'</i> | | | | | | | | | | | | | | | | | | | | |
| | 116 | <i>6'</i> | 126 | <i>6'</i> | 116 | <i>6'</i> | 126 | <i>6'</i> | | | | | | | | | | | | | | | | | | | | | | | | | | | | | | | | |
| | 56 | <i>12</i> | 59 | <i>12</i> | 62 | <i>12</i> | 65 | <i>12</i> | 68 | <i>12</i> | 56 | <i>12</i> | 59 | <i>12</i> | 62 | <i>12</i> | 65 | <i>12</i> | 68 | <i>12</i> | | | | | | | | | | | | | | | | | | | | |
| 69 | <i>10'</i> | 72 | <i>10'</i> | 76 | <i>10'</i> | 80 | <i>10'</i> | 84 | <i>10'</i> | 69 | <i>10'</i> | 72 | <i>10'</i> | 76 | <i>10'</i> | 80 | <i>10'</i> | 84 | <i>10'</i> | | | | | | | | | | | | | | | | | | | | | |
| 89 | <i>8'</i> | 94 | <i>8'</i> | 100 | <i>8'</i> | 107 | <i>8'</i> | 115 | <i>8'</i> | 89 | <i>8'</i> | 94 | <i>8'</i> | 100 | <i>8'</i> | 107 | <i>8'</i> | 115 | <i>8'</i> | | | | | | | | | | | | | | | | | | | | | |
| 106 | <i>7'</i> | 114 | <i>7'</i> | 123 | <i>7'</i> | 145 | <i>7'</i> | 106 | <i>7'</i> | 114 | <i>7'</i> | 123 | <i>7'</i> | 145 | <i>7'</i> | | | | | | | | | | | | | | | | | | | | | | | | | |
| 136 | <i>6'</i> | 136 | <i>6'</i> | | | | | | | | | | | | | | | | | | | | | | | | | | | | | | | | | | | | | |
| 54" | 62 | <i>12</i> | 64 | <i>12</i> | 67 | <i>12</i> | 70 | <i>12</i> | 62 | <i>12</i> | 64 | <i>12</i> | 67 | <i>12</i> | 70 | <i>12</i> | | | | | | | | | | | | | | | | | | | | | | | | |
| | 76 | <i>10'</i> | 79 | <i>10'</i> | 83 | <i>10'</i> | 87 | <i>10'</i> | 76 | <i>10'</i> | 79 | <i>10'</i> | 83 | <i>10'</i> | 87 | <i>10'</i> | | | | | | | | | | | | | | | | | | | | | | | | |
| | 100 | <i>8'</i> | 105 | <i>8'</i> | 112 | <i>8'</i> | 121 | <i>8'</i> | 100 | <i>8'</i> | 105 | <i>8'</i> | 112 | <i>8'</i> | 121 | <i>8'</i> | | | | | | | | | | | | | | | | | | | | | | | | |
| | 121 | <i>7'</i> | 130 | <i>7'</i> | 152 | <i>7'</i> | 121 | <i>7'</i> | 130 | <i>7'</i> | 152 | <i>7'</i> | | | | | | | | | | | | | | | | | | | | | | | | | | | | |
| 60" | 67 | <i>12</i> | 70 | <i>12</i> | 73 | <i>12</i> | 67 | <i>12</i> | 70 | <i>12</i> | 73 | <i>12</i> | | | | | | | | | | | | | | | | | | | | | | | | | | | | |
| | 83 | <i>10'</i> | 87 | <i>10'</i> | 91 | <i>10'</i> | 83 | <i>10'</i> | 87 | <i>10'</i> | 91 | <i>10'</i> | | | | | | | | | | | | | | | | | | | | | | | | | | | | |
| | 111 | <i>8'</i> | 118 | <i>8'</i> | 126 | <i>8'</i> | 111 | <i>8'</i> | 118 | <i>8'</i> | 126 | <i>8'</i> | | | | | | | | | | | | | | | | | | | | | | | | | | | | |
| | 139 | <i>7'</i> | 161 | <i>7'</i> | 139 | <i>7'</i> | 161 | <i>7'</i> | | | | | | | | | | | | | | | | | | | | | | | | | | | | | | | | |
| 66" | 73 | <i>12</i> | 76 | <i>12</i> | 73 | <i>12</i> | 76 | <i>12</i> | | | | | | | | | | | | | | | | | | | | | | | | | | | | | | | | |
| | 91 | <i>10'</i> | 95 | <i>10'</i> | 91 | <i>10'</i> | 95 | <i>10'</i> | | | | | | | | | | | | | | | | | | | | | | | | | | | | | | | | |
| | 124 | <i>8'</i> | 133 | <i>8'</i> | 124 | <i>8'</i> | 133 | <i>8'</i> | | | | | | | | | | | | | | | | | | | | | | | | | | | | | | | | |
| 72" | 79 | <i>12</i> | 79 | <i>12</i> | | | | | | | | | | | | | | | | | | | | | | | | | | | | | | | | | | | | |
| | 99 | <i>10'</i> | 99 | <i>10'</i> | | | | | | | | | | | | | | | | | | | | | | | | | | | | | | | | | | | | |
| | 142 | <i>8'</i> | 142 | <i>8'</i> | | | | | | | | | | | | | | | | | | | | | | | | | | | | | | | | | | | | |

Notes: 1. The italicized numbers to the right of the degree values are the structure bottom diameters.
 2. The values are based on the pipe center lines being at equal elevation, a 2" precast section along the inside structure wall between adjacent pipes, and standard precast openings for concrete pipe. The sizes of the precast openings are those proposed by the Florida Precast Concrete Structures Association and are not always O.D. plus 6".
 3. The value for two 36" pipes in a 6' diameter structure is adjusted to be consistent with Index no. 200. A similar change was made for two 42" pipes in a 7' diameter structure.



Example:
 What size round bottom should be used for these pipes?

- Looking at the 2-24" adjacent pipes, the minimum internal angle is 78° for a 5' dia. bottom and 63° for a 6' dia. bottom. Since these pipes enter at 70°, we need a 6' dia. bottom.
- Checking the adjacent 24" and 36" pipes, 75° is needed between the pipes in a 6' dia. bottom. We have 135°, so the 6' dia. bottom works.



6.5 PIPE HYDRAULICS

The *Drainage Manual* states that you must consider friction losses in the computation of the design hydraulic gradient for all storm drain systems. Energy losses associated with pollution control structures (weirs and baffles) and utility conflict structures also must be considered when present in a system. When the hydraulic calculations consider only the above, the elevation of the hydraulic gradient must be at least one foot below the theoretical gutter elevation. This is equivalent to 13.5 inches (1.13 feet) below the edge of pavement for sections with Type E or Type F curb and gutter. For gutter inlets (Standard Plans, Indexes 425-040 and 425-041), ditch bottom inlets used within the roadway section (Standard Plans, Indexes 425-050 through 425-055), and barrier wall inlets (Standard Plans, Index 425-031), the one foot of clearance applies to the grate elevation. For barrier wall inlets (Standard Plans, Indexes 425-030 and 425-032), the one foot of clearance applies to the theoretical grade point.

If you calculate all minor energy losses, it is acceptable for the hydraulic grade line to reach the theoretical gutter elevation. Minor losses include all the losses at inlets, manholes, and junctions due to expansion, contraction, and changes in flow direction. Minor losses also include exit losses at the outlet of the system. The *Drainage Manual* states that minor losses must be calculated when the velocity is greater than 7.5 fps and for systems longer than 2,000 feet.

6.5.1 Pressure Flow

Under pressure flow conditions, the pipe section flows full throughout. Calculate friction losses using Manning's equation, with the flow area equal to the full cross sectional area of the pipe.

$$\text{Head loss [in feet]} = \frac{29n^2LV^2}{R^{1.33}2g} = \frac{4.61n^2LQ^2}{D^{5.33}}$$

where:

- n = Roughness coefficient (refer to the *Drainage Manual*)
- L = Pipe length, in feet (ft.)
- V = Velocity, in feet per second (fps)
- Q = Flow rate, in cubic feet per second (cfs)
- R = Hydraulic radius, in feet (ft.) = Area/wetted perimeter
- D = Pipe diameter, in feet (ft.)
- g = Gravitational constant = 32.2 ft/s²

6.5.2 Partially Full Flow

For pipes that are flowing partially full, the calculations are more complicated. The cross-sectional flow area actually changes as the flow goes through the pipe. For example, the flow area at the downstream end of the pipe shown here is the full cross section area, but at the upstream end the flow area is much less.

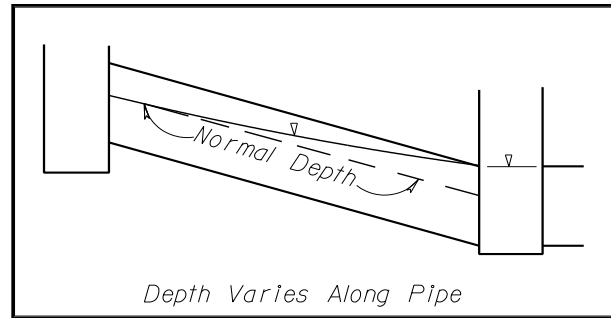

The most accurate approach to calculating this number is to do water surface profile calculations throughout the pipe section. Although acceptable, these calculations are tedious and not usually required. The Department accepts the following approach to calculating the hydraulics of partial full and pressure pipes.

Three values must be determined for each pipe section: (1) the lower-end hydraulic gradient (lower-end HG), (2) the upper-end hydraulic gradient (upper-end HG), and (3) the flow velocity.

6.5.3 Lower-End Hydraulic Gradient

Either the downstream hydraulic gradient or the flow conditions in the pipe controls the lower-end HG. So you must compare the water surface elevations associated with these numbers and use the higher of the two as the lower-end HG.

Where the downstream HG is above the lower-end crown of the subject pipe, the lower-end HG is the downstream HG. See Detail A of Figure 6.5-1. Pipe flow conditions will not control in this situation, and comparing water surface elevations is not necessary. If the downstream HG is below the lower-end crown, you will need to compare the downstream HG with the water elevation associated with the pipe flow conditions.

The downstream hydraulic gradient elevation is the downstream pipe Upper End HG elevation plus junction losses, if they are calculated.

Where the downstream hydraulic gradient is low enough, one of two pipe flow conditions will control the lower-end HG. See Detail C & D of Figure 6.5-1. The appropriate flow condition is dependent on the relationship of the physical pipe slope and the full-flow friction slope. If the pipe is sloped steeper than the full-flow friction slope, it is reasonable to assume that normal depth flow exists at the lower end. Then the lower-end HG is the normal depth plus the lower-end flow line elevation. (Actual depth could be above normal depth because the pipe was not long enough to allow normal depth to be reached.)

Partial depth pipe flow graphs in Appendix E, or the Department's hydraulic calculator, can be used to get normal flow depth and associated velocity.

If the pipe slope is equal to or flatter than the full-flow friction slope, the pipe is flowing full over most of its length. Although the flow may be dropping through critical depth⁴ near the outlet, assuming full flow at the outlet is reasonable and conservative. During very low flow rates, even flat pipes will not flow full, but such low rates are not typical for design conditions.

In short, use the higher of the following for the lower-end HG, as shown in Figure 6.5-1.

Condition 1: The downstream pipe upper-end HG (+ junction losses, if calculated)

OR

Condition 2: The normal depth + lower-end flow line elevation (for pipes sloped steeper than full-flow friction slope) or lower-end crown elevation (for pipes sloped equal to or flatter than full-flow friction slope).

For the outlet pipe of the system, the lower-end HG elevation is the Design Tailwater elevation.

4 - For a slightly more refined analysis in this situation, midway between critical depth and the crown of the pipe of $[(D_c + D)/2]$ could be used as the Lower End HG.

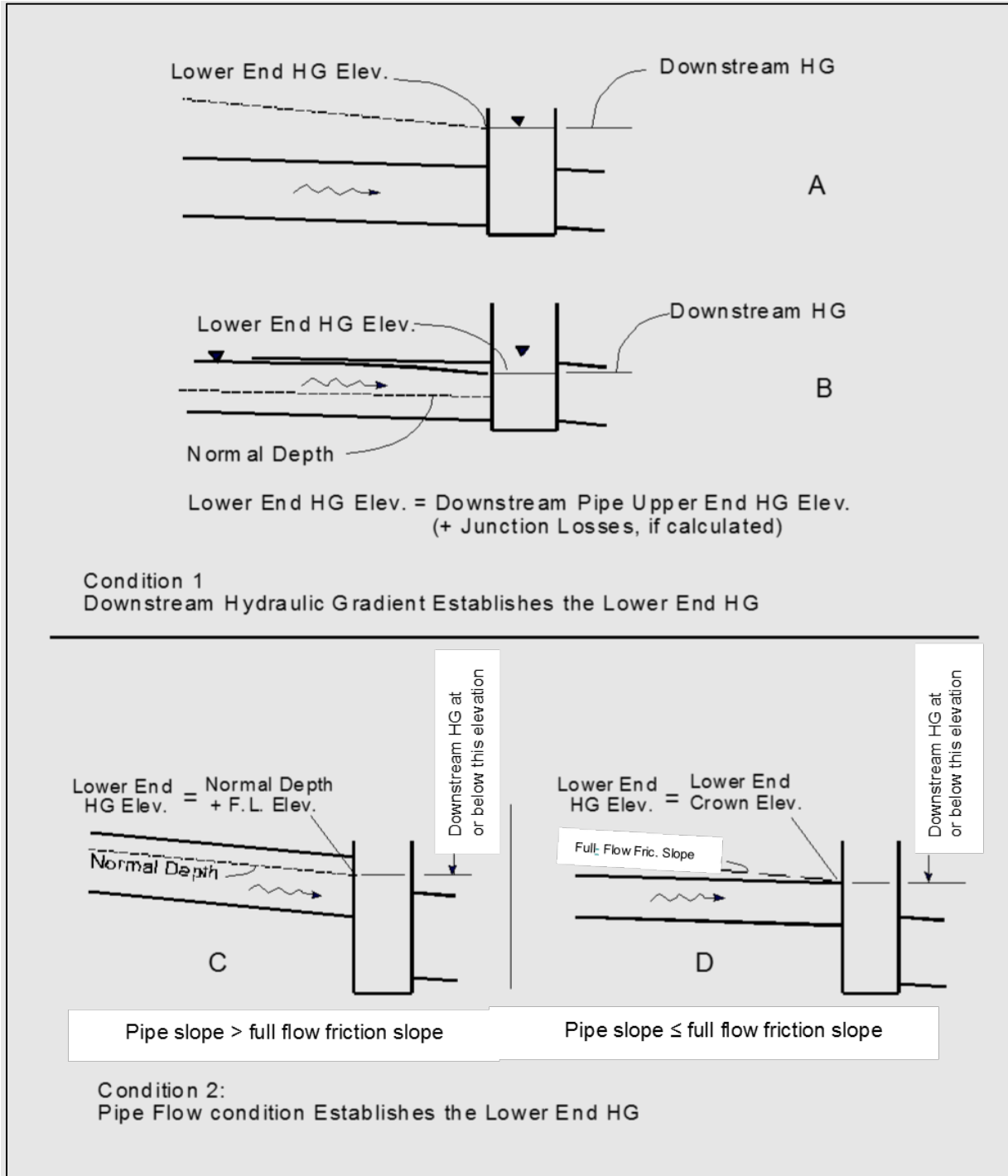

Figure 6.5-1: Determining the Lower End Hydraulic Gradient Elevation

6.5.3.1 Design Tailwater (DTW)

The *Drainage Manual* gives the standard design tailwater conditions. In general, it says use the higher of the crown of the pipe or the downstream condition. Stormwater ponds are commonly constructed at the outlet of storm drains, so the pond stage may be the design tailwater. Some Districts may have more stringent criteria than shown in the *Drainage Manual*.

You can determine the pond stage by “routing” the storm drain design event (frequency) through the pond. “Routing” refers to the use of the storage indication method that is commonly used to simulate runoff hydrographs flowing through stormwater management facilities. HEC 22 contains a discussion and example of the storage indication method.

6.5.4 Upper-End Hydraulic Gradient

Use the higher of the following, as shown in Figure 6.5-2:

Condition 1: The lower-end HG plus the full-flow friction loss

OR

Condition 2: The elevation of normal depth in the pipe at the upper end

A comparison may not be necessary. First, add the full-flow friction loss to the lower-end HG. If this is above the upper-end crown, there is no need to calculate normal depth. The lower-end HG plus full-flow friction loss will control.

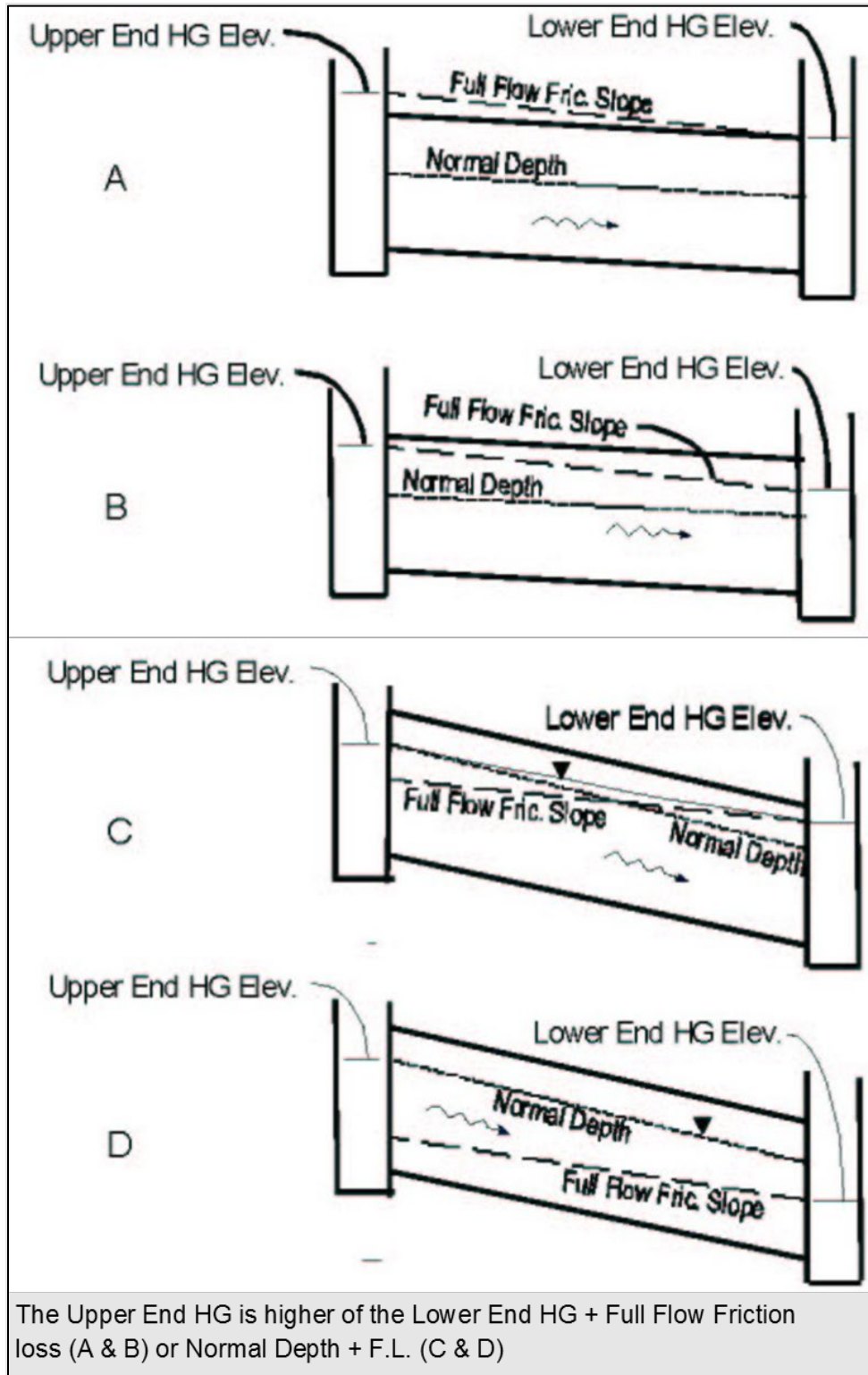

Figure 6.5-2: Determining the Upper-End Hydraulic Elevation

6.5.5 Flow Velocity in the Pipe Section

For pressure flow pipes, the velocity is based on the full cross section area.

$$\text{Velocity (fps)} = \frac{Q}{A} = \frac{Q}{\frac{\pi D^2}{4}}$$

Where the tailwater conditions submerge the storm drain without stormwater flow, the travel time in the pipe can be ignored since the velocity is irrelevant. See the discussion of ignoring travel time in Section 6.2.

where:

Q = Flow rate, in cubic feet per second (cfs)

D = Diameter, in feet (ft.)

For pipes flowing partially full, it is more complicated to determine the velocity. There can be a water surface profile in the pipe, so the cross sectional flow area can change, thus changing the velocity along the pipe section. The most accurate velocity should represent the average velocity through the pipe section, assuming the velocity associated with normal depth is a conservative assumption. See Figure 6.5-3.

You can use partial depth pipe flow graphs in Appendix E, or the Department's hydraulic calculator, to get normal flow depth and associated velocity.

The flow velocity is referred to as the Actual Velocity in the Storm Drain Tabulation Form, Figure 6-1. The actual velocity is sometimes called the design velocity.

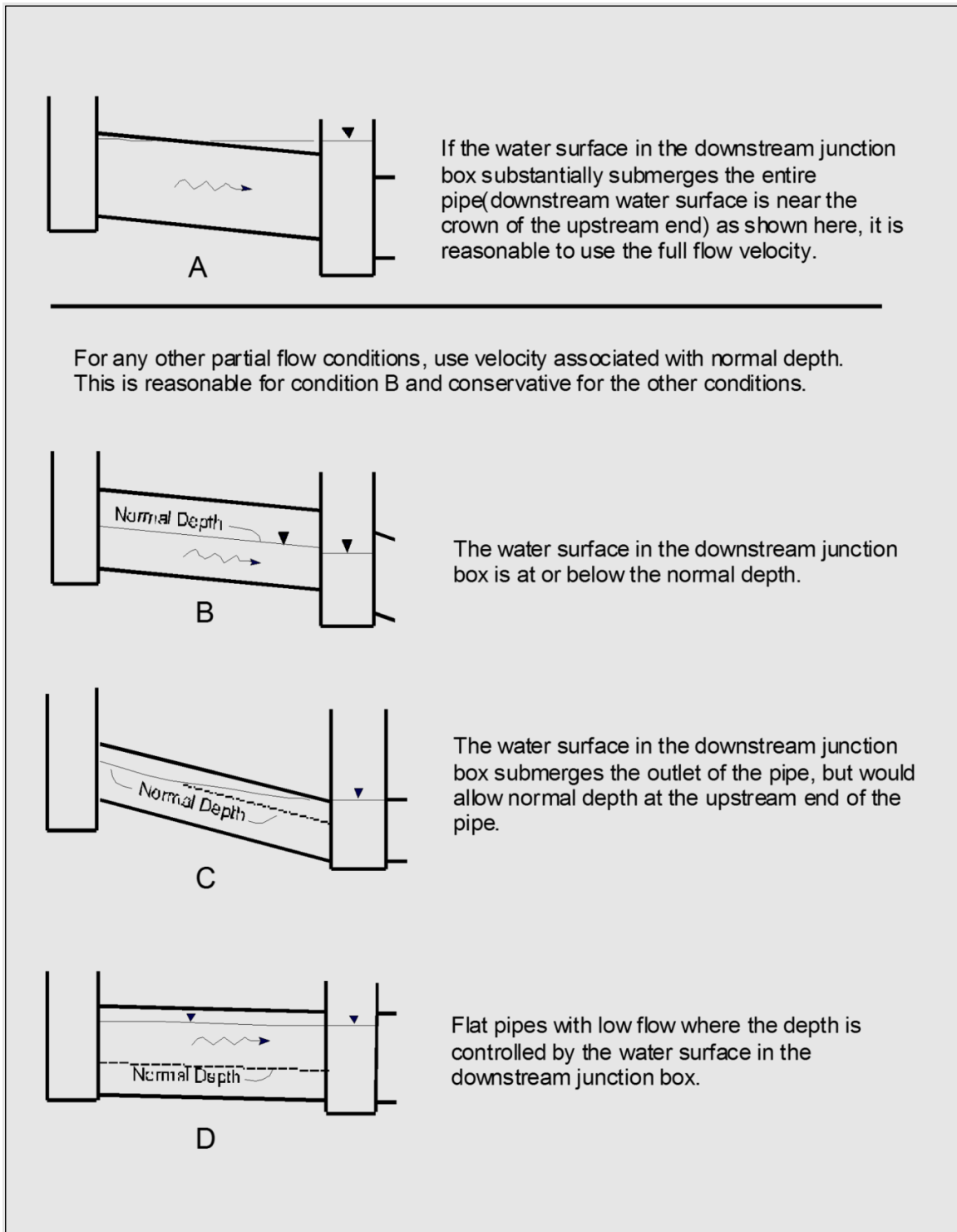

Figure 6.5-3: Determining the Velocity in Partially Filled Pipes

6.5.6 Utility Conflict Box Losses

Calculate the loss through a utility conflict box using the equation:

$$\text{Head Loss [in feet]} = K \frac{V^2}{2g}$$

Where:

- K = Loss factor (or coefficient)
 V = Flow velocity in the storm drain, in feet per second (ft/s)
 g = gravitational constant = 32.2 ft/s²

Use Figure 6.5-4 to determine the loss factor in conflict boxes where the pipes are flowing full.

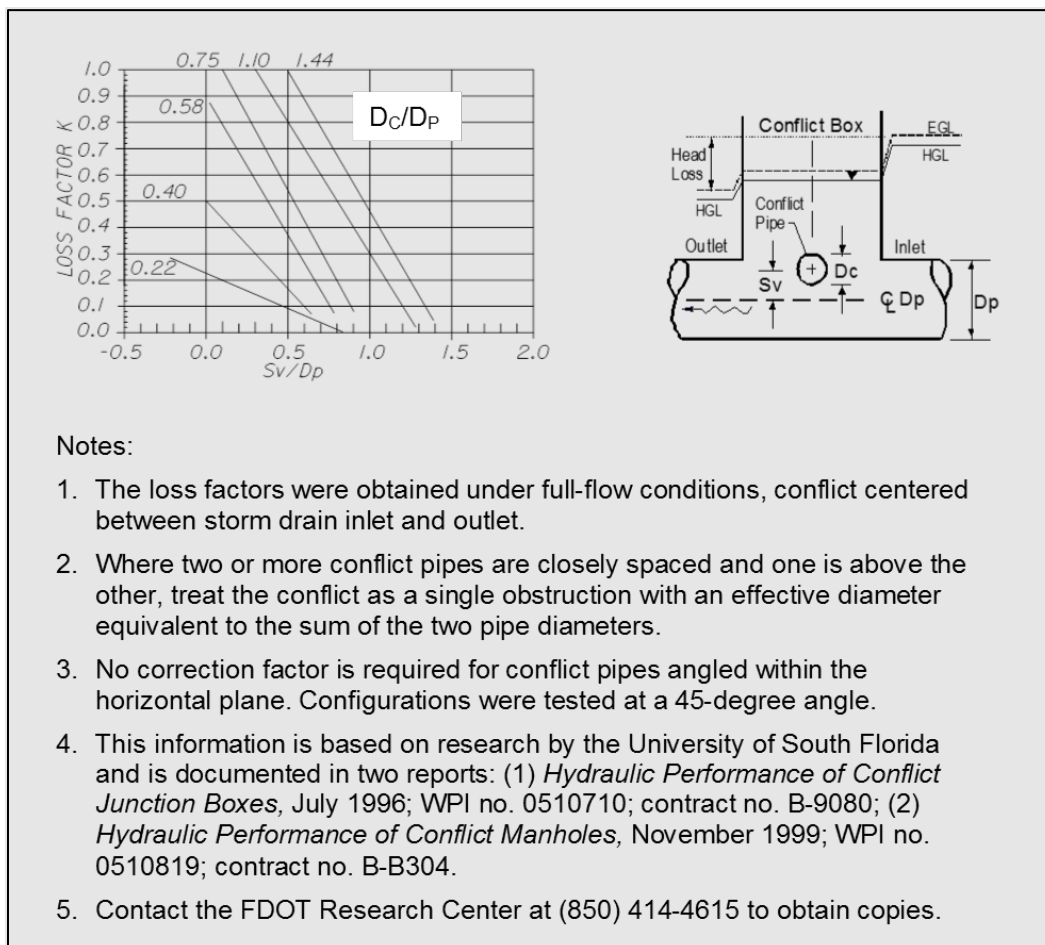

Figure 6.5-4: Loss Factors for Conflict Manholes

6.5.7 Minor Losses

Minor losses are all the losses that are not due to friction. Generally, these are energy losses due to changes or disturbances in the flow path. They include such things as entrance, exit, bend, and junction losses. The losses are calculated from the equation:

$$\text{Head loss [in feet]} = K \frac{V_o^2}{2g}$$

where:

K = Loss factor (or coefficient)

V_o = Flow velocity in the outlet pipe of the junction box, in feet per second (ft/s)

g = Gravitational constant = 32.2 ft/s²

FHWA has printed the latest information on computing minor losses in HEC 22, and they continue to do research on minor losses. A report titled *Junction Loss Experiments: Laboratory Report* summarizes work that has been done more recently than the information published in HEC 22. The report and HEC 22 are available on the Internet at:

http://www.fhwa.dot.gov/engineering/hydraulics/library_listing.cfm?sort=Publication_title&archived=0

It is important to calculate minor losses in high-velocity situations and in long systems. As the velocity approaches eight feet per second, the velocity head ($V^2/2g$) approaches one foot (64/64.4). The standard one foot of HGL clearance would be used up where the total loss coefficient, k, equals 1.0. For long systems, the 1.0 foot of clearance could be used up by numerous small individual junction losses, e.g., 10 junctions with 0.1 foot minor loss each.

6.6 PROCEDURE

The following is a basic procedure for designing a storm drain system. You can vary slightly from the procedure and still develop an adequate design. With experience, you will develop shortcuts and personal preference. The goal is to minimize pipe sizes while meeting the appropriate standards.

The FDOT CADD Office also has several training guides for storm system's layout and tabulation analysis within various software programs (OpenRoads Designer, Autodesk Civil 3D, and Bentley MicroStation SS10) that meet FDOT Drainage standards and guidelines that pair with plans production and design workflow. [FDOT CADD Training](https://www.floridadot.com/cadd/training) publications can be found here: <https://www.floridadot.com/cadd/downloads/documentation>

The numbers in parentheses (**xx**) refer to a space on the Storm Drain Tabulation Form.

| IDENTIFY INLET LOCATIONS | |
|--|---|
| 1. Define the overall basin draining to the project. | Using the drainage map, identify the overall watershed that drains to the project. |
| 2. Determine the outfalls and divide the overall basin into sub-basins. | This is typically done as a part of the stormwater management design. |
| 3. For each sub-basin, select inlet locations. | |
| 4. Determine the drainage area to each inlet. | |
| 5. Calculate spread and revise inlet location, as necessary. | |
| LAYOUT PIPES | |
| 6. Connect pipes between the inlets to create a schematic of the piping system layout. | You will use the schematic of the piping system for the rest of the design procedure. |

| | |
|--|---|
| <p>DETERMINE THE TOTAL “C*A” PRODUCT FOR EACH PIPE SECTION</p> <p>Begin filling out the Storm Sewer Tabulation Form. Record the Inlet Types (7), Inlet Locations (3) (4) (5), Inlet Elevations (19), Structure Numbers (6), Incremental Areas (9), C-Factors (1), and Length (8) on the tabulation form. The incremental areas and C-factors are those used to calculate the spread.</p> | |
| <p>7. Add the areas that contribute flow to the downstream pipe.</p> | <p>This involves checking for all the upstream areas. Refer to the piping system schematic to ensure that all the areas are included. Record these in the space (10) on the tabulation form.</p> |
| <p>8. Multiply the subtotal areas by their respective C-factors.</p> | <p>Record the result in space (11) on the tabulation form.</p> |
| <p>9. Add the sub-total (C*A) values.</p> | <p>Record the total in space (15) on the tabulation form.</p> |
| <p>10. Repeat Step 7 through Step 9 for the entire system.</p> | |
| <p>PRELIMINARY HYDRAULIC GRADE LINE (HGL) SLOPE</p> | |
| <p>11. Estimate a preliminary hydraulic grade line slope.</p> <p>This slope will be used as a guide for selecting the trial pipe size only. It will not control the final design.</p> | <p>For flat terrain, estimate which inlet will be critical. The critical inlet usually will be the lowest inlet in the portion of the system farthest from the outlet. It may be simply the inlet farthest from the outlet. Use the following formula to calculate the slope.</p> $\text{Slope} = \frac{\text{Critical Inlet Elev} - \text{DTW} - 1 \text{ foot}}{\text{System Length between Outlet \& Critical Inlet}}$ <p>For moderately sloped terrain, an average slope of the ground line along the project usually is acceptable for a preliminary HGL slope.</p> <p>For some systems, there may be two or more distinct sections of the system that have noticeably different slopes. For these, calculating a preliminary HGL slope for each section is advised.</p> |

CALCULATE RUNOFF FLOW RATES

The following is the beginning of an iterative process of calculating flow rates as you move down the system and calculating hydraulic grade line elevations as you move up the system. Step 12 through Step 18 are done on each pipe segment, beginning at the upper end of the system and working down toward the outlet.

| | |
|--|--|
| 12. Determine the t_c . | Record the value in space (12) on the tabulation form. |
| 13. Determine the intensity. | Determine the intensity from the NOAA Atlas 14 data using a storm duration equal to the t_c previously computed. Record the value in space (14) on the tabulation form. |
| 14. Calculate total runoff for the pipe segment. | Multiply the total CA times the intensity. Record the value in space (17) on the tabulation form. |
| 15. Select a pipe size. | <p>For the first pass through the system, select a diameter that has a full-flow friction slope close to the preliminary HGL slope. The minimum pipe diameter will probably control the pipe size of the first few pipe sections. You will probably not find a pipe diameter that matches the preliminary HGL exactly. The objective is to maintain the standard HGL clearance at each inlet. Matching the preliminary HGL is merely a technique to begin selecting pipe diameters. Some pipe diameters will likely be revised later.</p> <p>Record the pipe size (30) (31) and associated Minimum Physical Slope (34) on the tabulation form. Record the full-flow friction slope as the hydraulic grade line slope (32) during the first pass down the system. Use the full-flow friction slope in the calculation of the hydraulic gradient.</p> |
| 16. Determine the pipe flow lines, fall, and physical slope. | The flow lines usually will be controlled by such things as cover requirements, structure clearances, and minimum physical pipe slope. Record the Flow Line Elevations (25) (26) , Crown Elevations (23) (24) , Physical Slope (33) , and Pipe Fall (28) on the tabulation form. |
| 17. Calculate the flow velocity. | Actual Velocity: For the first pass through the system, assume full flow unless the pipe is obviously flowing part full. For subsequent passes through the system, use full-flow velocity or velocity associated with normal |

| | |
|---|--|
| | <p>depth, as appropriate. See discussion in Section 6.5. Record the value in space (35) on the tabulation form.</p> <p>Physical Velocity: Record the value in space (36) of the tabulation form.</p> |
| 18. Calculate time of flow in pipe section. | Divide the pipe length by the actual flow velocity. Record the value in space (13) on the tabulation form. |
| 19. Repeat Step 12 through Step 18 for the entire system. | Check for peak flow from reduced area. See discussion in Section 6.2. |

| CALCULATE HYDRAULIC GRADE LINE (HGL) ELEVATION | |
|---|--|
| <p>Step 20 and Step 21 are done on each pipe segment, beginning at the outlet and working up the system toward the most remote inlet.</p> | |
| <p>20. Determine the Lower-End Hydraulic Gradient Elevation.</p> | <p>The Lower-End HG for the outlet is the Design Tailwater (DTW). See the discussion in Section 6.5. Record the value in space (22) on the tabulation form for the outlet pipe and in space (41).</p> |
| <p>21. Determine the Upper-End HG Elevation, HGL Slope, and HGL Fall.</p> | <p>See the discussion in Section 6.5. Record the Upper-End HG Elevation (21). Record the HGL Clearance (20).</p> <p>Where a pipe is flowing full, the full-flow friction slope recorded in Step 15 is the Hydraulic Grade Line Slope (32). The HG Fall (27) is calculated by multiplying the HGL Slope by the pipe length.</p> <p>Where a pipe is flowing partially full and the Upper-End HG is based on normal depth, as in Figure 6.5-2 C and D, the HG Slope and Fall recorded in Step 15 are not correct. Here, the HG Slope and Fall are not critical to the design process, but their values can be recorded as:</p> <p style="padding-left: 40px;">HG Fall (27) = Upper-End HG – Lower-End HG HG Slope (32) = HG Fall/pipe length</p> |
| <p>Repeat Step 20 and Step 21 for the entire system. For the first pass through the system, you may want to calculate the HGL elevation only along the main line from the outlet to the critical inlet. The flow rates and friction losses in the stub lines usually are small. Calculating the HG through the entire system (i.e., all the stubs) for the first iteration is acceptable, but may result in extra effort. For subsequent passes, calculate the HGL elevation for the entire system.</p> | |

| COMPARE HYDRAULIC GRADE LINE (HGL) ELEVATION TO STANDARD | |
|--|--|
| 22. Compare the HGL Elevation to the standard and adjust pipe diameters. | <p>The current standard requires that the Hydraulic Gradient be at least one foot below the inlet elevations.</p> <p>For systems where the distance between the Hydraulic Gradient and the gutter elevation is greater than the standard, the diameter of one or more pipe segments may be reduced to raise the Hydraulic Gradient. Here, try to reduce the larger-diameter pipe segments first, since this will provide a greater cost reduction than reducing the size of the smaller-diameter segments.</p> <p>For systems where the distance between the Hydraulic Gradient and the gutter elevation is less than the standard, you will need to increase the diameter of one or more pipe segments to lower the Hydraulic Gradient. Here, increase the smaller-diameter pipe segments first, since this will provide less of a cost increase than increasing the size of the larger-diameter pipe segments. Look for “flow-pipe size” combinations that have substantial friction losses. For example, there is very little reduction in the losses by increasing the diameter of a 24-inch pipe that is carrying only 3 cfs. Alternatively, if another 24-inch pipe were carrying 15 cfs, increasing the pipe diameter could achieve a significant reduction in friction losses.</p> |
| RECALCULATE THE RUNOFF AND HYDRAULIC GRADE LINE ELEVATION | |
| 23. Return to Step 14, working the changes through the system. | When you have made enough iterations through the system that any changes in diameters of pipe segments would cause the distance between the Hydraulic Gradient and the gutter elevation to be less than the standard, your design is essentially complete. |

Note:

Examples 6.6-1 and 6.6-2 were created before the *Plan Preparation Manual* (Volume 2, Chapter 1.3) required that flow lines be shown to two decimal places and before the *Drainage Manual* required that HGL Clearance be provided in the storm tab. The examples have not been revised to reflect these changes. Although the examples have not been revised, they still represent a valid design procedure.

Example 6.6-1 Flat System—Determining Appropriate Pipe Sizes

Given:

- Inlets, Pipes, Runoff Coefficients & Details shown in Figure 6.6-1 and Table 6.6-1
- System discharges to a pond that stages to elevation 8.3 during a five-year design storm

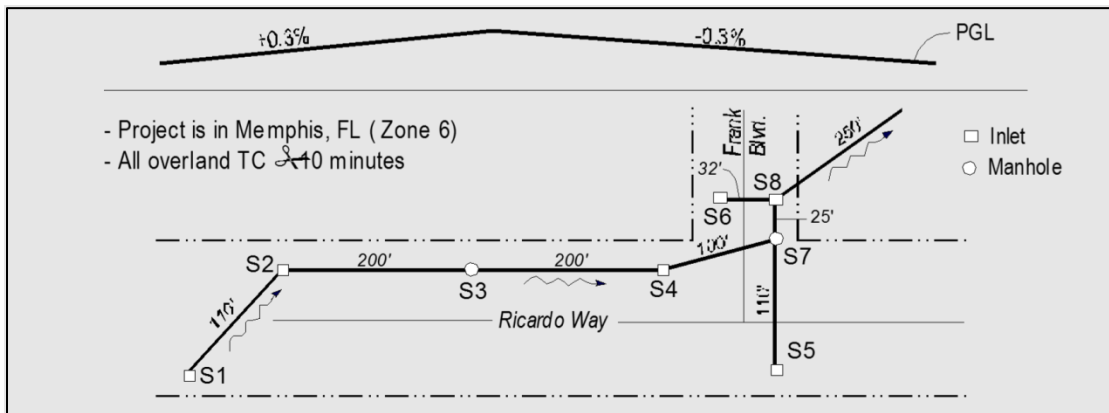

Figure 6.6-1: Example 6.6-1 – Given Information

Table 6.6-1: Data for Example 6.6-1

| LOCATION OF UPPER END | | | STRUCTURE NO. | TYPE OF STRUCTURE | LENGTH (ft) | DRAINAGE AREA (ac) | | INLET ELEV (ft) | NOTES AND REMARKS |
|-----------------------|---------------|------|---------------|-------------------|-------------|--------------------|-------|-----------------|-------------------|
| ALIGNMENT NAME | | | | | | C = 0.95 | C = | | |
| STATION | DISTANCE (ft) | SIDE | UPPER | TYPE OF STRUCTURE | LENGTH (ft) | INCREMENT | TOTAL | INLET ELEV (ft) | |
| | | | LOWER | | | | | | |
| Ricardo Way | | | 1 | P5 | 110 | 0.3 | | 10.90 | |
| 40 + 80 | 46.5 | R | 2 | | | 0.05 | | | |
| Ricardo Way | | | 2 | P5 | 200 | 0.2 | | 11.10 | |
| 41 + 25 | 46.5 | L | 3 | | | 0.03 | | | |
| Ricardo Way | | | 3 | MH | 200 | --- | | 11.40 | |
| 43 + 25 | 44 | L | 4 | | | --- | | | |
| Ricardo Way | | | 4 | P5 | 100 | 0.4 | | 11.10 | |
| 45 + 25 | 46.5 | L | 7 | | | 0.1 | | | |
| Ricardo Way | | | 5 | P5 | 110 | 0.4 | | 10.90 | |
| 46 + 00 | 46.5 | R | 7 | | | 0.5 | | | |
| Frank Blvd | | | 7 | MH | 25 | --- | | 10.50 | |
| 30 + 50 | 10 | R | 8 | | | --- | | | |
| Frank Blvd | | | 6 | P5 | 32 | 0.15 | | 9.60 | |
| 30 + 75 | 16 | L | 8 | | | 0.5 | | | |
| Frank Blvd | | | 8 | P5 | 250 | 0.25 | | 9.60 | |
| 30 + 75 | 16 | R | outlet | | | 0.5 | | | |

Find:

- The pipe sizes to meet the standard hydraulic gradient clearance of 1.13 feet to the inlet (edge of pavement) elevation
- Add the areas that contribute flow to each pipe segment. For each of the pipe segments, the total impervious area (C = 0.95) is obtained as follows.

$$\begin{aligned} \text{Total Area } P_{1-2} &= \text{Inc. Areas}_{S-1}; \text{ no upstream pipes} \\ &= 0.3 \text{ ac.} \end{aligned}$$

$$\begin{aligned} \text{Total Area } P_{2-3} &= \text{Inc. Areas}_{S-2} + \text{Total Area } P_{1-2} \\ &= 0.2 + 0.3 = 0.5 \text{ ac} \end{aligned}$$

$$\begin{aligned} \text{Total Area } P_{3-4} &= \text{Inc. Areas}_{S-3} + \text{Total Area } P_{2-3} \\ &= 0.0 + 0.5 = 0.5 \text{ ac} \end{aligned}$$

$$\begin{aligned} \text{Total Area } P_{4-7} &= \text{Inc. Areas}_{S-4} + \text{Total Area } P_{3-4} \\ &= 0.4 + 0.5 = 0.9 \text{ ac} \end{aligned}$$

$$\begin{aligned}\text{Total Area } P_{5-7} &= \text{Inc. Areas}_{5-7}; \text{ no upstream pipes} \\ &= 0.4 \text{ ac.}\end{aligned}$$

$$\begin{aligned}\text{Total Area } P_{7-8} &= \text{Inc. Areas}_{7-8} + \text{Tot. Area } P_{4-7} + \text{Tot.} \\ &\quad \text{Area } P_{5-7} \\ &= 0.0 + 0.9 + 0.4 = 1.3 \text{ ac}\end{aligned}$$

$$\begin{aligned}\text{Total Area } P_{6-8} &= \text{Inc. Areas}_{6-8}; \text{ no upstream pipes} \\ &= 0.15 \text{ ac.}\end{aligned}$$

$$\begin{aligned}\text{Total Area } P_{8-\text{out}} &= \text{Inc. Areas}_{8-\text{out}} + \text{Tot. Area } P_{7-8} + \text{Tot.} \\ &\quad \text{Area } P_{6-8} \\ &= 0.25 + 1.3 + 0.15 = 1.7 \text{ ac}\end{aligned}$$

The same approach is applied to drainage areas associated with the pervious runoff coefficient. Table 6.6-2 is a partial tabulation form with the above information.

Table 6.6-2: Partially Completed Tabulation Form with Data from Example

| STRUCTURE NO. | DRAINAGE AREA (ac.) | |
|---------------|---------------------|-------|
| | C= 0.95 | |
| | C= | |
| | C= 0.20 | |
| UPPER | INCREMENT | TOTAL |
| LOWER | | |
| 1 | 0.3 | 0.3 |
| 2 | 0.05 | 0.05 |
| 2 | 0.2 | 0.5 |
| 3 | 0.03 | 0.08 |
| 3 | --- | 0.5 |
| 4 | --- | 0.08 |
| 4 | 0.4 | 0.9 |
| 7 | 0.1 | 0.18 |
| 5 | 0.4 | 0.4 |
| 7 | 0.5 | 0.5 |
| 7 | --- | 1.3 |
| 8 | --- | 0.68 |
| 6 | 0.15 | 0.15 |
| 8 | 0.5 | 0.5 |
| 8 | 0.25 | 1.7 |
| outlet | 0.5 | 1.68 |

- For each pipe section, multiply the total area associated with each runoff coefficient by the corresponding runoff coefficient to obtain the subtotal CA values.

$$\begin{aligned}
 P_{1-2}: \quad & 0.3 \times 0.95 = 0.29 \\
 & 0.05 \times 0.20 = 0.01 \\
 P_{2-3}: \quad & 0.5 \times 0.95 = 0.48 \\
 & 0.08 \times 0.20 = 0.02
 \end{aligned}$$

Etc.

- For each pipe section, add the subtotal CA values to obtain the Total CA.

$$\begin{aligned}
 P_{1-2}: \quad & 0.29 + 0.01 = 0.3 \\
 P_{2-3}: \quad & 0.48 + 0.02 = 0.5 \\
 & \text{Etc.}
 \end{aligned}$$

Table 6.6-3 is a partial tabulation form with the above information.

ESTIMATE A PRELIMINARY HYDRAULIC GRADE LINE (HGL) SLOPE

4. Determine the design TW.
The crown of the outlet pipe is not known at this time, so we will use the given information about the stage (8.3 feet) of the stormwater management facility.
5. Assume which inlet will be critical.
For this example, we will assume that S-1 is critical. Elevation S-1 = 10.9 feet
6. Calculate a preliminary HGL slope.
For this example, we will base the preliminary HGL slope on the following formula.

Table 6.6-3: Partially Completed Tabulation Form with Data from Example

| STRUCTURE NO. | DRAINAGE AREA (ac.) | | SUB-TOTAL C*A | TOTAL C*A |
|---------------|---------------------|-------|---------------|-----------|
| | UPPER | LOWER | | |
| | C= 0.95 | | | |
| | C= | | | |
| | C= 0.20 | | | |
| | INCREMENT | TOTAL | | |
| 1 | 0.3 | 0.3 | 0.29 | 0.30 |
| 2 | 0.05 | 0.05 | 0.01 | |
| 2 | 0.2 | 0.5 | 0.48 | 0.50 |
| 3 | 0.03 | 0.08 | 0.02 | |
| 3 | --- | 0.5 | 0.48 | 0.50 |
| 4 | --- | 0.08 | 0.02 | |
| 4 | 0.4 | 0.9 | 0.86 | 0.9 |
| 7 | 0.1 | 0.18 | 0.04 | |
| 5 | 0.4 | 0.4 | 0.38 | 0.48 |
| 7 | 0.5 | 0.5 | 0.1 | |
| 7 | --- | 1.3 | 1.24 | 1.38 |
| 8 | --- | 0.68 | 0.14 | |
| 6 | 0.15 | 0.15 | 0.14 | 0.24 |
| 8 | 0.5 | 0.5 | 0.1 | |
| 8 | 0.25 | 1.7 | 1.62 | 1.96 |
| outlet | 0.5 | 1.68 | 0.34 | |

$$\text{Slope} = \frac{\text{Critical Inlet Elev - DTW - 1 foot}}{\text{System Length between Outlet \& Critical Inlet}}$$

The total pipe length is best seen in Figure 6.6-1.

$$110 + 200 + 200 + 100 + 25 + 250 = 885 \text{ feet}$$

$$\begin{aligned} \text{Prelim HGL Slope} &= 10.9 - 8.3 - 1/885 \\ &= 0.0018 \text{ ft/ft} \\ &= 0.18\% \end{aligned}$$

CALCULATE RUNOFF FLOW RATES (FIRST PASS DOWN THE SYSTEM)

Starting with pipe section P₁₋₂,

7. Determine the time of concentration. [P₁₋₂]
Since this is the first inlet in the system and it has an overland t_c of 10 minutes or less, use 10-minute minimum.
8. Determine the intensity. [P₁₋₂]
From the NOAA Atlas 14 data, the 10-minute intensity is 6.5 in/hr.
9. Calculate the total runoff for the pipe section. [P₁₋₂]
Q = Total CA (Step 3) times the intensity (previous step)
Q = 0.3 x 6.5 = 1.95 cfs
10. Determine pipe size. [P₁₋₂]
For the first pass, we assume full flow.
Using the hydraulic calculator, an 18-inch pipe is acceptable because the friction slope (0.03 percent) is flatter than the preliminary HGL slope (0.18 percent). The minimum physical slope is 0.15 percent (see discussion in Chapter 6.4.2.1). Record the pipe size, and the minimum physical slope. Also, record the full-flow friction slope as the HGL slope. Although it is not necessary to record the HGL slope at this step, it will be used later when moving up the system and calculating the hydraulic gradient. It may save time to record this while the hydraulic calculator is set for the flow and pipe size.
11. Determine the pipe flow lines, physical slope, and fall. [P₁₋₂]
For this example, we will use 4.5 feet clearance between the inlet (edge of pavement) elevation and the flow line of an 18-inch pipe. (The minimum clearance for an 18-inch pipe in a precast Type P-5 structure is 4.2 feet. See Table 6.4-5.)
Then:
Upper-End Flow Line = 10.9 – 4.5 = 6.4 feet

For this example, we will assume there are no constraints such as utilities that would prevent the pipe from being set at the minimum physical pipe slope (0.15

percent). Then:

Minimum pipe fall = $110 \text{ ft} \times 0.15\% = 0.17 \text{ feet}$

Pipe fall = 0.2 ft (minimum fall rounded up to nearest 0.1 foot)

Physical Slope = $0.2 \text{ ft}/110 \text{ ft} = 0.18 \text{ percent}$

Lower End Flow Line = $6.4 - 0.2 = 6.2 \text{ feet}$

If this were an actual project, you also should check that the minimum cover heights in Appendix C of the *Drainage Manual* are satisfied. To simplify this example, we will assume that adequate cover is provided.

12. Calculate the actual flow velocity. [P₁₋₂]

$$Vel = Q/A = 1.95 \text{ cfs}/\pi D^2/4)$$

The full-flow cross sectional area is used for the first pass down the system. This is reasonable for a flat system like this example. If you know the pipe is flowing partially full, use the average cross sectional flow area. See the discussion on page 56 and the next example.

Using the hydraulic calculator, the velocity of 1.95 cfs flowing full through an 18-inch pipe is 1.1 fps.

Calculate the physical velocity. [P₁₋₂]

Using the hydraulic calculator, the full-flow velocity for an 18-inch pipe sloped at 0.18 percent = 2.7 fps

13. Calculate the time of flow in pipe section. [P₁₋₂]

$$\text{Time} = \text{Length}/\text{Actual Velocity}$$

$$= 110 \text{ ft}/1.1 \text{ fps} = 100 \text{ seconds} = 1.7 \text{ minutes}$$

A partially completed tabulation form is shown in Table 6.6-4.

Table 6.6-4: Partially Completed Tabulation Form with Data from Example

| STRUCTURE NUMBER | TYPE OF STRUCTURE | LENGTH (ft) | TIME OF CONCENTRATION (min) | TIME OF FLOW IN SECTION (min) | INTENSITY (in/hr) | TOTAL C • A | TOTAL FLOW (cfs) | INLET ELEV. (ft) | HYD. GRADIENT | | | PIPE SIZE (IN.) | SLOPE (%) | ACTUAL VELOCITY (FPS) |
|------------------|-------------------|-------------|-----------------------------|-------------------------------|-------------------|-------------|------------------|------------------|----------------------|----------------------|-----------|-----------------|------------|-------------------------|
| | | | | | | | | | FLOW LINE | | | | | |
| UPPER | TYPE OF STRUCTURE | LENGTH (ft) | TIME OF CONCENTRATION (min) | TIME OF FLOW IN SECTION (min) | INTENSITY (in/hr) | TOTAL C • A | TOTAL FLOW (cfs) | INLET ELEV. (ft) | UPPER END ELEV. (ft) | LOWER END ELEV. (ft) | FALL (ft) | RISE | HYD. GRAD. | PHYSICAL VELOCITY (FPS) |
| LOWER | | | | | | | | | UPPER END ELEV. (ft) | LOWER END ELEV. (ft) | FALL (ft) | SPAN | PHYSICAL | MIN. PHYS. |
| 1 | P5 | 110 | 10 | 1.7 | 6.5 | 0.30 | 1.95 | 10.90 | 7.9 | 7.7 | 0.2 | 18 | .03 | 1.1 |
| 2 | | | | | | | | | 6.4 | 6.2 | | 18 | .15 | |

For pipe section P₂₋₃,

14. Determine the Time of Concentration. [P₂₋₃]

$t_c \text{ overland} \leq 10 \text{ min.}$

$t_c \text{ system} = 10 + 1.7 = 11.7 \text{ min. therefore}$

$t_c = 11.7 \text{ min.}$

15. Determine the intensity. [P₂₋₃]

From the from NOAA Atlas 14 data, the 11.7-minute intensity is 6.1 in/hr.

16. Calculate the total runoff for the pipe section. [P₂₋₃]

Flow rate = Total CA x Intensity

= 0.5 x 6.1 = 3.1

17. Determine pipe size. [P₂₋₃]

Using the hydraulic calculator, an 18-inch pipe is acceptable because the friction slope (0.07 percent) is less than the preliminary HGL slope (0.18 percent). As done for the previous pipe section, record the pipe size, and the minimum physical slope. Also, record the friction slope as the HGL slope.

18. Determine the pipe flow lines, physical slope, and fall. [P₂₋₃]

Since this inlet is higher than S-1, the potential conflict with the inlet top will not control the flow lines. For this example, we will attempt to match flow line elevations across structures. Therefore:

Upper-end flow line = 6.2 (previous pipe section downstream flow line)

Minimum pipe fall = length x min. phys. slope

= 200 ft x 0.15% = 0.3 ft

Pipe fall = 0.3 ft

Physical slope = 0.3 ft/200 ft = 0.15%

Lower-end flow line = 6.2 – 0.3 = 5.9 feet

19. Calculate the actual flow velocity. [P₂₋₃]

$$Vel = Q/A = 1.95 \text{ cfs}/(\pi D^2/4).$$

The full-flow cross sectional area is used for the first pass through the system. Using the hydraulic calculator, the velocity of 3.1 cfs flowing full through an 18-inch pipe is approximately 1.8 fps.

Calculate the physical velocity. [P₂₋₃]

Using the hydraulic calculator, the full-flow velocity for an 18-inch pipe sloped at 0.15 percent = 2.5 fps

20. Calculate the time of flow in pipe section. [P₂₋₃]

$$\text{Time} = \text{Length}/\text{Actual Velocity}$$

$$= 200 \text{ ft}/1.8 \text{ fps} = 111 \text{ seconds} = 1.9 \text{ minutes}$$

A partially completed tabulation form is shown in Table 6.6-5.

Table 6.6-5: Partially Completed Tabulation Form with Data from Example

| STRUCTURE NO. | TYPE OF STRUCTURE | LENGTH (ft) | TIME OF CONCENTRATION (min) | TIME OF FLOW IN SECTION (min) | INTENSITY (in/hr) | TOTAL C • A | TOTAL FLOW (cfs) | INLET ELEV. (ft) | HYD. GRADIENT | | | PIPE SIZE (IN) | SLOPE (%) | ACTUAL VELOCITY (FPS) |
|---------------|-------------------|-------------|-----------------------------|-------------------------------|-------------------|-------------|------------------|----------------------|----------------------|------|-----------|----------------|------------|-------------------------|
| | | | | | | | | | CROWN | | FALL (ft) | | | |
| UPPER | | | | | | | | UPPER END ELEV. (ft) | LOWER END ELEV. (ft) | SPAN | | RISE | HYD. GRAD. | PHYSICAL VELOCITY (FPS) |
| LOWER | | | | | | | | | | | PHYSICAL | | | |
| | | | | | | | | | | | | MIN. PHYS. | | |
| 1 | P5 | 110 | 10 | 1.7 | 6.5 | 0.30 | 1.95 | 10.90 | 7.9 | 7.7 | 0.2 | 18 | 0.03 | 1.1 |
| 2 | | | | | | | | | 6.4 | 6.2 | | | 0.18 | |
| 2 | P5 | 200 | 11.7 | 1.9 | 6.1 | 0.50 | 3.1 | 11.10 | 7.7 | 7.4 | 0.3 | 18 | 0.07 | 1.8 |
| 3 | | | | | | | | | 6.2 | 5.9 | | | 0.15 | |

Step 14 through Step 20 are repeated for the remaining pipe sections. Situations that are different from the above pipe sections are discussed below. Table 6.6-6 shows the results of doing these steps for the entire system.

Pipe Section P₃₋₄

The manhole contributes no additional flow to the system, nor does it combine flow from several pipes. The time of concentration and the intensity are not applicable. The flow through the pipe section is the same as the upstream pipe section.

Pipe Section P₄₋₇,

The time of concentration is 11.7 + 1.9 + 1.9 = 15.5 minutes.

Pipe Sections P₅₋₇ and P₆₋₈

They receive only overland flow like pipe section P₁₋₂, thus their time of concentration is based on overland flow time. Their flow lines are determined by matching the flow lines of the downstream structure, using the minimum physical slope to the upstream structure, and rounding to the nearest 0.1' such that the minimum slope is maintained.

Pipe Section P₇₋₈

This is similar to similar to pipe section P₃₋₄ in that the manhole contributes no flow. It is different from pipe section P₃₋₄ in that two pipes drain to the manhole. Because of this difference, the pipe section is treated like the other inlets along the main line. The t_c , intensity, and flow are calculated for the section. The time of concentration is $15.5 + 0.6 = 16.1$ minutes.

As stated in Step 18, we will attempt to match flow lines across structures for this example. The upper-end flow line is set to match the lower-end flow line of pipe section P₄₋₇. The lower-end flow line is set to match the flow line of S-8.

Pipe Section P_{8-out}

For this example, we will use a 5.1-foot clearance between the inlet (edge of pavement) elevation and the flow line of a 24-inch pipe. (The minimum clearance for a 24-inch pipe in a precast Type P-5 structure is 4.7 feet. See Table 6.4-5.) Then, upper-end FL = $9.6 - 5.1 = 4.5$ feet. The lower-end FL is set to match the minimum physical slope with the FL rounded to the closest 0.1 foot such that the minimum slope is maintained.

Table 6.6-6: Results of First Pass Down the System

| STRUCTURE NO. | TYPE OF STRUCTURE | LENGTH (ft) | TIME OF CONCENTRATION (min) | TIME OF FLOW IN SECTION (min) | INTENSITY (in/hr) | TOTAL C • A | TOTAL FLOW (cfs) | INLETELEV. (ft) | HYD. GRADIENT CROWN FLOW LINE | | | PIPE SIZE (IN) | SLOPE (%) | ACTUAL VELOCITY (FPS) |
|---------------|-------------------|-------------|-----------------------------|-------------------------------|-------------------|-------------|------------------|-----------------|-------------------------------|----------------------|-----------|----------------|------------|-------------------------|
| | | | | | | | | | UPPER END ELEV. (ft) | LOWER END ELEV. (ft) | FALL (ft) | | | |
| UPPER | TYPE OF STRUCTURE | LENGTH (ft) | TIME OF CONCENTRATION (min) | TIME OF FLOW IN SECTION (min) | INTENSITY (in/hr) | TOTAL C • A | TOTAL FLOW (cfs) | INLETELEV. (ft) | UPPER END ELEV. (ft) | LOWER END ELEV. (ft) | FALL (ft) | RISE | HYD. GRAD. | PHYSICAL VELOCITY (FPS) |
| LOWER | | | | | | | | | | | | SPAN | | |
| 1 | P5 | 110 | 10 | 1.7 | 6.5 | 0.30 | 1.95 | 10.90 | 7.9 | 7.7 | 0.2 | 18 | .03 | 1.1 |
| 2 | | | | | | | | | 6.4 | 6.2 | | 18 | .18 | |
| 2 | P5 | 200 | 11.7 | 1.9 | 6.1 | 0.50 | 3.1 | 11.10 | 7.7 | 7.4 | 0.3 | 18 | 0.07 | 1.8 |
| 3 | | | | | | | | | 6.2 | 5.9 | | 18 | 0.15 | |
| 3 | MH | 200 | N/A | 1.9 | N/A | 0.50 | 3.1 | 11.40 | 7.4 | 7.1 | 0.3 | 18 | 0.07 | 1.8 |
| 4 | | | | | | | | | 5.9 | 5.6 | | 18 | 0.15 | |
| 4 | P5 | 100 | 15.5 | 0.6 | 5.4 | 0.9 | 4.9 | 11.10 | 7.1 | 6.9 | 0.2 | 18 | 0.18 | 2.8 |
| 7 | | | | | | | | | 5.6 | 5.4 | | 18 | 0.2 | |
| 5 | P5 | 110 | 10 | 1.7 | 6.5 | 0.48 | 3.1 | 10.90 | 7.1 | 6.9 | 0.2 | 18 | 0.07 | 1.8 |
| 7 | | | | | | | | | 5.6 | 5.4 | | 18 | 0.18 | |
| 7 | MH | 25 | 16.1 | 0.2 | 5.3 | 1.38 | 7.3 | 10.50 | 7.4 | 6.5 | 0.9 | 24 | 0.09 | 2.4 |
| 8 | | | | | | | | | 5.4 | 4.5 | | 24 | 3.6 | |
| 6 | P5 | 32 | 10 | 0.4 | 6.5 | 0.24 | 1.56 | 9.60 | 6.1 | 6.0 | 0.1 | 18 | 0.02 | 1.3 |
| 8 | | | | | | | | | 4.6 | 4.5 | | 18 | 0.3 | |
| 8 | P5 | 250 | 16.3 | 1.9 | 5.3 | 1.96 | 10.4 | 9.60 | 6.5 | 6.2 | 0.3 | 24 | 0.18 | 3.4 |
| outlet | | | | | | | | | 4.5 | 4.2 | | 24 | 0.12 | |

21. Check for peak flow from reduced area.

Reviewing the size and runoff coefficient for each drainage area, it does not appear that most of the area or most of the imperviousness is concentrated near the lower end of the system. Since we would not expect to have peak flow from reduced area, detailed calculations would not be necessary. For this example, we will check it just to demonstrate an approach.

From the schematic, it appears that a logical reduced area would be area flowing overland to S4, S5, S6, and S8. The overland t_c to S4 was given as 10 minutes. So let's apply a 10-minute storm to pipe section P₄₋₇. Doing so reduces the contributing area from S3.

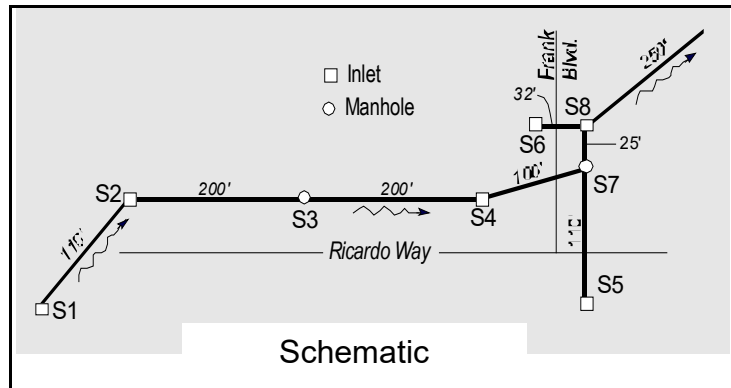

An approach to finding the reduced contributing area is to multiply the area (or the CA product) from S3 by the ratio of the times of concentration. From Table 6.6-6, the t_c for the flow from S3 is 15.5 minutes. So, reduce the Total CA from S3 by the ratio 10/15.5, or 0.65.

From Table 6.6-6, the Total CA from S3 = 0.5.

So the Total CA from S3 is reduced by: $0.5 (1 - 0.65) = 0.18$ This value is not the reduced CA; it is the amount the Total CA is reduced by.

Reducing the Total CA for pipe section P₄₋₇ by this amount yields: $0.9 - 0.18 = 0.72$

The five-year intensity for a 10-minute storm = 6.5 in/hour.

The flow in the pipe downstream of S4 = $CA_i = 0.72 \times 6.5 = 4.7$ cfs.

This is less than the 4.9 cfs calculated for the entire contributing area for P₄₋₇, as shown in Table 6.6-6. So, peak flow in pipe section P₄₋₇ does not result from reduced area. Although other pipe sections could be checked for peak flow from reduced area, this effort shown above is acceptable for this system.

CALCULATE THE HYDRAULIC GRADE LINE ELEVATION (first pass up the system)

For pipe section P_{8-out}:

22. Determine the lower-end HG elevation. [P_{8-out}]
For the outlet pipe, the lower-end HG is the design tailwater. For this example, the design tailwater is the higher of (1) the crown of the pipe (elev. 6.2 feet), or (2) the peak stage of the stormwater facility during the storm drain design event (elev. 8.3 feet). Thus, the lower-end HG = 8.3 feet

23. Determine the upper-end HG elevation. [P_{8-out}]
For this example, the lower-end HG submerges the entire pipe section; therefore,

$$\begin{aligned} \text{Upper-end HG elev.} &= \text{Lower-end HG elev.} + \text{Full-flow friction loss} \\ \text{\& Full-Flow Friction Loss} &= \text{Full-flow friction slope} \times \text{Pipe length} \\ &= 0.18\% \times 250 \text{ ft} = 0.45 \text{ feet} \end{aligned}$$

The full-flow friction slope was previously recorded as the hydraulic gradient slope in Table 6.6-6 when we moved down the system calculating flow rates.

$$\begin{aligned} \text{Then upper-end HG elev.} &= \text{Lower-end HG elev.} + \text{Full-flow friction loss} \\ &= 8.3 + 0.45 = 8.75 \text{ feet (see table below)} \end{aligned}$$

Table 6.6-7

| STRUCTURE NO. | LENGTH (ft) | HYD. GRADIENT | | | SLOPE (%) |
|---------------|-------------|-----------------|-----------------|-----------|------------|
| | | CROWN | | | |
| | | FLOW LINE | | | |
| UPPER | | UPPER ELEV (ft) | LOWER ELEV (ft) | FALL (ft) | HYD. GRAD. |
| LOWER | | | | | PHYSICAL |
| | | | | | MIN. PHYS. |
| 8 | 250 | 8.75 | 8.3 | 0.45 | 0.18 |
| | | 6.5 | 6.2 | 0.3 | 0.12 |
| outlet | | 4.5 | 4.2 | | |

Pipe sections P₆₋₈ and P₅₋₇ are stubs and their hydraulic gradient will not be calculated during the first pass up the system.

For pipe section P₇₋₈:

24. Determine the lower-end HG elevation.

The downstream pipe upper-end HG elevation (8.75 feet) is higher than the lower-end Crown Elevation (6.5 feet); therefore, the lower-end HG elevation = downstream pipe upper-end HG = 8.75 feet

25. Determine the upper-end HG elevation. [P₇₋₈]

For this example, the lower-end HG submerges the entire pipe section; therefore:

Upper-end HG elev. = Lower-end HG elev. + Full-flow friction loss

Full-flow friction loss = Full-flow friction slope x Pipe length

= 0.09% x 25 ft = 0.02 feet

The full-flow friction slope was recorded previously as the hydraulic gradient slope in Table 6-6.

Then, upper-end HG elev. = Lower-end HG elev. + Full-flow friction loss
= 8.75 + 0.02 = 8.77 feet

The same steps are repeated for the remaining mainline pipe sections. Table 6.6-8 shows the results of doing these steps for the entire system.

Table 6.6-8: Results of First Pass Up the System

| STRUCTURE NO. | LENGTH (ft) | TOTAL FLOW (cfs) | INLET ELEV. (ft) | HYD. GRADIENT CROWN FLOW LINE | | | PIPE SIZE (IN) | SLOPE (%) |
|---------------|-------------|------------------|------------------|-------------------------------|---------------------|-----------|----------------|-----------|
| | | | | UPPER END ELEV (ft) | LOWER END ELEV (ft) | FALL (ft) | RISE | |
| UPPER | SPAN | HYD. GRAD. | | | | | | |
| LOWER | | MIN. PHYS. | | | | | | |
| 1 | 110 | 1.95 | 10.90 | 9.26 | 9.23 | 0.03 | 18 | 0.03 |
| | | | | 7.9 | 7.7 | 0.2 | | 0.18 |
| 2 | | | | 6.4 | 6.2 | | 18 | 0.15 |
| 2 | 200 | 3.1 | 11.10 | 9.23 | 9.09 | 0.14 | 18 | 0.07 |
| | | | | 7.7 | 7.4 | 0.3 | | 0.15 |
| 3 | | | | 6.2 | 5.9 | | 18 | 0.15 |
| 3 | 200 | 3.1 | 11.40 | 9.09 | 8.95 | 0.14 | 18 | 0.07 |
| | | | | 7.4 | 7.1 | 0.3 | | 0.15 |
| 4 | | | | 5.9 | 5.6 | | 18 | 0.15 |
| 4 | 100 | 4.9 | 11.10 | 8.95 | 8.77 | 0.18 | 18 | 0.18 |
| | | | | 7.1 | 6.9 | 0.2 | | 0.20 |
| 7 | | | | 5.6 | 5.4 | | 18 | 0.15 |
| 5 | 110 | 3.1 | 10.90 | | | | 18 | 0.07 |
| | | | | 7.1 | 6.9 | 0.2 | | 0.18 |
| 7 | | | | 5.6 | 5.4 | | 18 | 0.15 |
| 7 | 25 | 7.3 | 10.50 | 8.77 | 8.75 | 0.02 | 24 | 0.09 |
| | | | | 7.4 | 6.5 | 0.9 | | 3.60 |
| 8 | | | | 5.4 | 4.5 | | 24 | 0.10 |
| 6 | 32 | 1.56 | 9.60 | | | | 18 | 0.02 |
| | | | | 6.1 | 6.0 | 0.1 | | 0.30 |
| 8 | | | | 4.6 | 4.5 | | 18 | 0.15 |
| 8 | 250 | 10.4 | 9.60 | 8.75 | 8.3 | .45 | 24 | 0.18 |
| | | | | 6.5 | 6.2 | 0.3 | | 0.12 |
| outlet | | | | 4.5 | 4.2 | | 24 | 0.10 |

26. Compare the hydraulic gradient to the standard and adjust pipe sizes. The standard clearance of 1.13 feet between the hydraulic gradient and the inlet elevation (edge of pavement) is not met for S-8 and probably not met for S-6. The remaining inlets have adequate clearance. Increasing the size of the outlet pipe P_{8-out} to 30 inches will reduce the hydraulic gradient at S-6 and S-8, so we will try that. To reduce costs, we also will try reducing the pipe size of section P₇₋₈ to 18 inches.
27. Calculate the hydraulic gradient using the changed pipe sizes. Table 6.6-9 shows the new slopes and the recalculated hydraulic gradient for the entire system.

Table 6.6-9: Results of Second Pass Up the System

| STRUCTURE NO. | LENGTH (ft) | TOTAL FLOW (cfs) | INLET ELEV. (ft) | HYD. GRADIENT | | | PIPE SIZE (IN) | SLOPE (%) |
|---------------|-------------|------------------|------------------|---------------------|---------------------|-----------|----------------|------------|
| | | | | CROWN | | | | |
| UPPER | LOWER | | | FLOW LINE | | | RISE | HYD. GRAD. |
| | | | | UPPER END ELEV (ft) | LOWER END ELEV (ft) | FALL (ft) | | |
| | | | | | | | | MIN. PHYS. |
| 1 | 110 | 1.95 | 10.90 | 9.04 | 9.01 | 0.03 | 18 | 0.03 |
| | | | | 7.9 | 7.7 | 0.20 | | 0.18 |
| 2 | 200 | 3.1 | 11.10 | 6.4 | 6.2 | | 18 | 0.15 |
| | | | | 9.01 | 8.87 | 0.14 | | 0.07 |
| 3 | 200 | 3.1 | 11.40 | 7.7 | 7.4 | 0.30 | 18 | 0.15 |
| | | | | 6.2 | 5.9 | | | 0.15 |
| 4 | 100 | 4.9 | 11.10 | 8.87 | 8.73 | 0.14 | 18 | 0.07 |
| | | | | 7.4 | 7.1 | 0.30 | | 0.15 |
| 7 | 110 | 3.1 | 10.90 | 5.9 | 5.6 | | 18 | 0.15 |
| | | | | 8.73 | 8.55 | 0.18 | | 0.18 |
| 5 | 25 | 7.3 | 10.50 | 7.1 | 6.9 | 0.20 | 18 | 0.20 |
| | | | | 5.6 | 5.4 | | | 0.15 |
| 7 | 32 | 1.56 | 9.60 | 8.55 | 8.45 | 0.10 | 18 | 0.40 |
| | | | | 6.9 | 6.0 | 0.90 | | 3.60 |
| 8 | 250 | 10.4 | 9.60 | 5.4 | 4.5 | | 18 | 0.15 |
| | | | | 8.46 | 8.45 | 0.01 | | 0.02 |
| 6 | 8 | 1.56 | 9.60 | 6.1 | 6.0 | 0.10 | 18 | 0.30 |
| | | | | 4.6 | 4.5 | | | 0.15 |
| 8 | outlet | 10.4 | 9.60 | 8.45 | 8.3 | 0.15 | 30 | 0.06 |
| | | | | 7.0 | 6.8 | 0.20 | | 0.08 |
| outlet | | | | 4.5 | 4.3 | | 30 | 0.08 |

28. Compare the HG to the standard and adjust pipe sizes.
From Table 6.6-9, the standard 1.13 feet of clearance between the hydraulic gradient and the inlet elevation (edge of pavement) exists throughout the system.
29. Recalculate the flow.
Changing pipe sizes changes the velocity, thus changing the time of flow in the section and the time of concentration. These changes affect only the changed pipes and the pipes downstream of the changed pipes. For this example, only pipe sections P₇₋₈ and P_{8-out} are affected.

The increased velocity in pipe section P₇₋₈ reduced the time of flow in the pipe by only 0.1 minute because the pipe is so short. As a result, the time of concentration of the outlet pipe was reduced by only 0.1 minute from 16.3 to 16.2 minutes. The change in the intensity for a change in t_c of 0.1 minute is negligible. Although we

changed the size of the two pipes, there was no noticeable change to the flow rate in the system.

A completed tabulation form is shown in Table 6.6-10.

Example 6.6-1

Table 6.6-10: Completed Tabulation Form For Example 6.6-1

| LOCATION OF UPPER END | | | STRUCTURE NO. | TYPE OF STRUCTURE | LENGTH (ft) | DRAINAGE AREA (ac) | | C • A SUBTOTAL | TIME OF CONCENTRATION (MIN) | TIME OF FLOW IN SECTION (MIN) | INTENSITY (in/hr) | C • A TOTAL | TOTAL FLOW (cfs) | INLET ELEV. (ft) | HYD. GRADIENT | | | PIPE SIZE (IN) | SLOPE (%) | ACTUAL VELOCITY (FPS) | NOTES AND REMARKS |
|-----------------------|---------------|------|---------------|-------------------|-------------|--------------------|-----------------------------|-------------------------------|-----------------------------|-------------------------------|-------------------|------------------|---------------------|---------------------|---------------|------|------------|-------------------------|-------------------------|---------------------------------------|-------------------|
| ALIGNMENT NAME | | | | | | C = 0.95 | C = 0.20 | | | | | | | | CROWN | | | | | | |
| STATION | DISTANCE (ft) | SIDE | UPPER | INCREMENT | TOTAL | C • A | TIME OF CONCENTRATION (MIN) | TIME OF FLOW IN SECTION (MIN) | INTENSITY (in/hr) | C • A TOTAL | TOTAL FLOW (cfs) | INLET ELEV. (ft) | UPPER END ELEV (ft) | LOWER END ELEV (ft) | FALL (ft) | SPAN | MIN. PHYS. | PHYSICAL VELOCITY (FPS) | TAILWATER EL. (ft): 8.3 | All overland t _c < 10 Min. | |
| | | | | | | | | | | | | | | | | | | | | | LOWER |
| Ricardo Way | 1 | | P5 | 110 | 0.3 | 0.3 | 0.29 | 10 | 1.7 | 6.5 | 0.3 | 1.95 | 10.90 | 9.04 | 9.01 | 0.03 | 18 | 0.03 | 1.1 | | |
| 40 + 80 | 46.5 | R | 2 | | 0.05 | 0.05 | 0.01 | | | | | | | 7.9 | 7.7 | 0.2 | | 0.18 | 2.7 | | |
| Ricardo Way | 2 | | P5 | 200 | 0.2 | 0.5 | 0.48 | 11.7 | 1.9 | 6.1 | 0.5 | 3.1 | 11.10 | 9.01 | 8.87 | 0.14 | 18 | 0.07 | 1.8 | | |
| 41 + 25 | 46.5 | L | 3 | | 0.03 | 0.08 | 0.02 | | | | | | | 7.7 | 7.4 | 0.3 | | 0.15 | 2.5 | | |
| Ricardo Way | 3 | | MH | 200 | --- | 0.5 | 0.48 | N/A | 1.9 | N/A | 0.5 | 3.1 | 11.40 | 8.87 | 8.73 | 0.14 | 18 | 0.07 | 1.8 | | |
| 43 + 25 | 44 | L | 4 | | --- | 0.08 | 0.02 | | | | | | | 7.4 | 7.1 | 0.3 | | 0.15 | 2.5 | | |
| Ricardo Way | 4 | | P5 | 100 | 0.4 | 0.9 | 0.86 | 15.5 | 0.6 | 5.4 | 0.9 | 4.9 | 11.10 | 8.73 | 8.55 | 0.18 | 18 | 0.18 | 2.8 | | |
| 45 + 25 | 46.5 | L | 7 | | 0.1 | 0.18 | 0.04 | | | | | | | 7.1 | 6.9 | 0.2 | | 0.2 | 2.9 | | |
| Ricardo Way | 5 | | P5 | 110 | 0.4 | 0.4 | 0.38 | 10 | 1.0 | 6.5 | 0.48 | 3.1 | 10.90 | 8.63 | 8.55 | 0.08 | 18 | 0.07 | 1.8 | | |
| 46 + 00 | 46.5 | R | 7 | | 0.5 | 0.5 | 0.1 | | | | | | | 7.1 | 6.9 | 0.2 | | 0.18 | 2.7 | | |
| Frank Blvd. | 7 | | MH | 25 | --- | 1.3 | 1.24 | 16.1 | 0.1 | 5.3 | 1.38 | 7.3 | 10.50 | 8.55 | 8.45 | 0.1 | 18 | 0.40 | 4.1 | | |
| 30 + 50 | 10 | R | 8 | | --- | 0.68 | 0.14 | | | | | | | 6.9 | 6.0 | 0.9 | | 3.6 | 12.3 | | |
| Frank Blvd. | 6 | | P5 | 32 | 0.15 | 0.15 | 0.14 | 10 | 0.4 | 6.5 | 0.24 | 1.56 | 9.60 | 8.46 | 8.45 | 0.01 | 18 | 0.02 | 1.3 | | |
| 30 + 75 | 16 | L | 8 | | 0.5 | 0.5 | 0.1 | | | | | | | 6.1 | 6.0 | 0.1 | | 0.3 | 3.5 | | |
| Frank Blvd | 8 | | P5 | 250 | 0.25 | 1.7 | 1.62 | 16.2 | 1.9 | 5.3 | 1.96 | 10.4 | 9.60 | 8.45 | 8.3 | 0.15 | 30 | 0.06 | 2.2 | | |
| 30 + 75 | 16 | R | Outlet | | 0.5 | 1.68 | 0.34 | | | | | | | 7.0 | 6.8 | 0.2 | | 0.08 | 2.5 | | |
| | | | | | | | | | | | | | | 4.5 | 4.3 | | | 0.08 | | | |

Example 6.6-2 Steep System—Determining Appropriate Pipe Sizes

Given:

- Inlets, pipes, runoff coefficients, and details in Figure 6.6-6 and Table 6.6-11
- Designer chooses to match crown elevations across structures

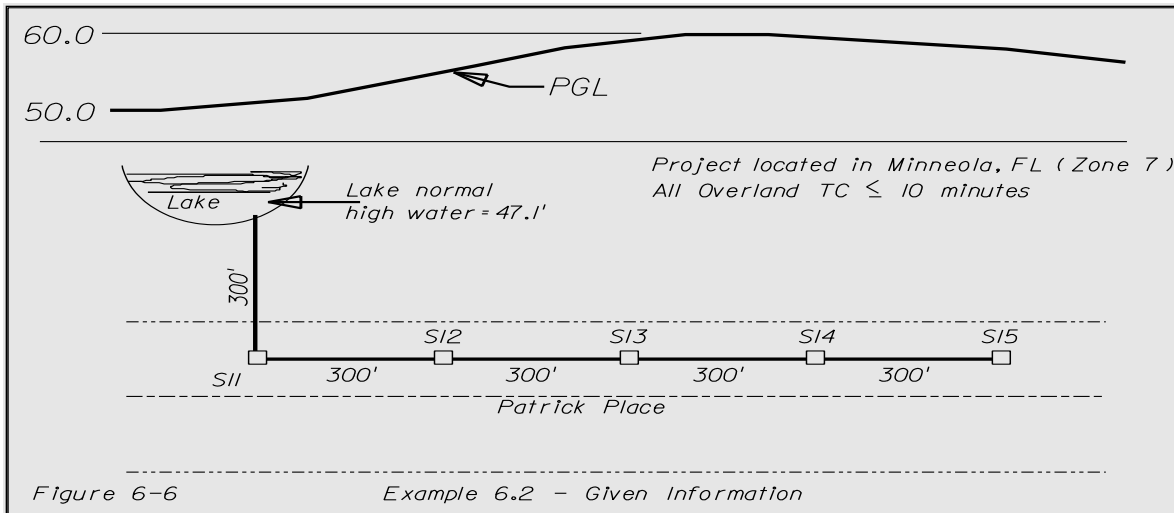

Figure 6.6-6. Details for Example 6.6-2

Table 6.6-11: Data for Example 6.6-2

| LOCATION OF UPPER END | | | STRUCTURE NO. | TYPE OF STRUCTURE | LENGTH (ft) | DRAINAGE AREA (ac) | | INLET ELEV. (ft) | NOTES AND REMARKS |
|-----------------------|---------------|------|---------------|-------------------|-------------|--------------------|-------|---|-------------------|
| ALIGNMENT NAME | | | | | | INCREMENT | TOTAL | | |
| STATION | DISTANCE (ft) | SIDE | UPPER | P1 | 300 | 0.2 | 59.70 | FREQUENCY (Yrs): 5 MANNING'S "n": 0.012 TAILWATER EL. (ft): 47.1 All overland $t_c \leq 10$ min. | |
| | | | LOWER | | | | | | |
| Patrick Place | | | 15 | P1 | 300 | 0.2 | 59.70 | | |
| | | | 14 | | | | | | |
| Patrick Place | | | 14 | P1 | 300 | 1.0 | 59.80 | | |
| | | | 13 | | | | | | |
| Patrick Place | | | 13 | P1 | 300 | 0.6 | 59.00 | | |
| | | | 12 | | | | | | |
| Patrick Place | | | 12 | P1 | 300 | 0.5 | 54.50 | | |
| | | | 11 | | | | | | |
| Patrick Place | | | 11 | P1 | 300 | 1.1 | 50.50 | | |
| | | | outlet | | | | | | |

Example 6.6-2—Given Information

Find:

- The pipe sizes to meet the standard hydraulic gradient clearance of 1.13 feet to the inlet (edge of pavement) elevation.
1. Add the areas that contribute flow to each pipe segment. For each of the pipe segments, the total area is obtained as in Example 6.6-1.
 2. For each pipe section, multiply the total area associated with each runoff coefficient by the corresponding runoff coefficient to obtain the subtotal CA values.
 3. For each pipe section, add the subtotal CA values to obtain the total CA value.

Table 6.6-12 is a partial tabulation form complete with the information from the first three steps.

Table 6.6-12: Partially Completed Tabulation Form with Data from Example

| STRUCTURE NO. | DRAINAGE AREA (ac) | | SUB-TOTAL C • A | TOTAL C • A |
|---------------|--------------------|-------|-----------------|-------------|
| | C = | | | |
| | C = 0.80 | | | |
| | C = | | | |
| UPPER | INCREMENT | TOTAL | | |
| LOWER | | | | |
| 15 | | | | |
| | 0.2 | 0.2 | 0.16 | 0.16 |
| 14 | | | | |
| 14 | | | | |
| | 1 | 1.2 | 0.96 | 0.96 |
| 13 | | | | |
| 13 | | | | |
| | 0.6 | 1.8 | 1.44 | 1.44 |
| 12 | | | | |
| 12 | | | | |
| | 0.5 | 2.3 | 1.84 | 1.84 |
| 11 | | | | |
| 11 | | | | |
| | 1.1 | 3.4 | 2.72 | 2.72 |
| outlet | | | | |

ESTIMATE A PRELIMINARY HGL SLOPE

4. Determine the design TW.
The crown of the outlet pipe is not known at this time, so we will use the given information about the lake stage. DTW = 47.1 feet.
5. Assume which inlet will be critical. For this example, we will assume that S-15 is critical.
6. For this example, we will base the preliminary HGL slope on the following formula.

$$\text{Slope} = \frac{\text{Critical Inlet Elev} - \text{DTW} - 1 \text{ foot}}{\text{System Length between Outlet \& Critical Inlet}}$$

$$\text{Slope} = (59.7 - 47.1 - 1) / 1,500 = 0.8\%$$

CALCULATE RUNOFF FLOW RATES FIRST PASS DOWN THE SYSTEM

Starting with pipe section P₁₅₋₁₄:

7. Determine the time of concentration. [P₁₅₋₁₄]
Since this is the first inlet in the system and it has an overland t_c of 10 minutes or less, use the 10-minute minimum.
8. Determine the intensity. [P₁₅₋₁₄]
From the NOAA Atlas 14 data, the 10-minute intensity is 6.5 in/hr.
9. Calculate the flow rate for the pipe section. [P₁₅₋₁₄]
Q = Total CA (Step 3) times the intensity (previous step)
Q = 0.16 x 6.5 = 1.04 cfs
10. Determine pipe size. [P₁₅₋₁₄]
For the first pass, we are assuming full flow.
Using the hydraulic calculator, an 18-inch pipe is acceptable because the friction slope (<0.04 percent) is flatter than the preliminary HGL slope. The minimum physical slope is 0.15 percent (see discussion in Section 6.4.2.1). Record the pipe size and the minimum physical slope. Also, record the full-flow friction slope as the HGL slope. For this flow rate through an 18-inch pipe, the friction loss is so small that the Department's hydraulic calculator does not show the slope. The loss could be calculated from the equation in Section 6.5.1, but for now we will record the HGL slope as zero.
11. Determine the pipe flow lines, physical slope, and fall. [P₁₅₋₁₄]
For this example, we will use a 4.5-foot clearance between the inlet (edge of pavement) elevation and the flow line of an 18-inch pipe. (The minimum clearance for standard precast structures is 4.2 feet. See Table 6.4-5.) Then:
Upper-end flow line = 59.7 – 4.5 = 55.2 feet

For this example, we will assume there are no constraints such as utilities that would prevent the pipe from being set at the minimum physical pipe slope (0.15 percent). Then:

| | |
|---------------------|--|
| Minimum pipe fall | = 300 ft x 0.15% = 0.45 ft |
| Pipe fall | = 0.5 ft (minimum fall rounded up to nearest 0.1 foot) |
| Physical Slope | = 0.5 ft/300 ft = 0.167% |
| Lower-end flow line | = 55.2 – 0.5 = 54.7 feet |

If this were an actual project, you also should check that the minimum cover heights in Appendix C of the *Drainage Manual* are satisfied. To simplify this example, we will assume that adequate cover is provided.

12. Calculate the actual flow velocity. [P₁₅₋₁₄]

$$V = Q/A = 1.04 \text{ cfs}/(\pi D^2/4)$$

The full-flow cross sectional area used for the first pass through the system. Using the hydraulic calculator, the velocity of 1.04 cfs flowing full through an 18-inch pipe is 0.59 fps.

Calculate the physical velocity. [P₁₅₋₁₄]

Using the hydraulic calculator, the full-flow velocity for an 18-inch pipe sloped at 0.17 percent = 2.6 fps

13. Calculate the time of flow in the pipe section. [P₁₅₋₁₄]

$$\begin{aligned} \text{Time} &= \text{Length}/\text{Actual Velocity} \\ &= 300 \text{ ft}/0.59 \text{ fps} = 508 \text{ seconds} = 8.5 \text{ minutes} \end{aligned}$$

A partially completed tabulation form with the information from this pipe is shown below.

Table 6.6-13: Partially Completed Tabulation Form with Data from Example

| STRUCTURE NO. | LENGTH (ft) | TIME OF CONCENTRATION (MIN) | TIME OF FLOW IN SECTION (MIN) | INTENSITY (in/hr) | TOTAL C • A | TOTAL FLOW (cfs) | INLET ELEV. (ft) | HYD. GRADIENT | | | PIPE SIZE (IN) | SLOPE (%) | ACTUAL VELOCITY (FPS) | |
|---------------|-------------|-----------------------------|-------------------------------|-------------------|-------------|------------------|------------------|---------------------|---------------------|-----------|----------------|-----------|-----------------------|-------------------------|
| | | | | | | | | UPPER END ELEV (ft) | LOWER END ELEV (ft) | FALL (ft) | | | | |
| UPPER | | | | | | | | | | | RISE | SPAN | HYD. GRAD. | |
| LOWER | | | | | | | | | | | | | PHYSICAL | |
| | | | | | | | | | | | | | MIN. PHYS. | PHYSICAL VELOCITY (FPS) |
| 15 | 300 | 10 | 8.5 | 6.5 | 0.16 | 1.04 | 59.70 | | | | 18 | | 0 | .59 |
| | | | | | | | | 56.7 | 56.2 | 0.5 | | | .167 | |
| 14 | | | | | | | | 55.2 | 54.7 | | | 18 | | .15 |

Step 7 through Step 13 are repeated for the remaining pipe sections. We have assumed that all the pipes are flowing full for this pass down the system. Situations that are different from the above pipe section are discussed below.

For Pipe Section P₁₄₋₁₃:

- The time of concentration is $10 + 8.5 = 18.5$ minutes
- The upper-end flow line = 54.7 (set by matching the crowns across the structure)
- The lower-end flow line = $54.7 - 0.5 = 54.2$ (set by minimum pipe slope as was done for P₁₅₋₁₄)

For Pipe Section P₁₃₋₁₂:

- The time of concentration is $18.5 + 1.8 = 20.3$ minutes
- The upper-end flow line = 54.2 (set by matching the crowns across the structure)
- The lower-end flow line = S12 gutter elev. – inlet clearance = $54.5 - 4.5 = 50.0$
- The physical slope = $(54.2 - 50.0)/300 = 1.4$ percent

For Pipe Section P₁₂₋₁₁:

- The time of concentration is $20.3 + 1.3 = 21.6$ minutes.
- The upper-end flow line = 50.0 (set by matching the crowns across the structure)
- The lower-end flow line = S11 gutter elev. – inlet clearance = $50.5 - 4.5 = 46.0$
- The physical slope = $(50.0 - 46.0)/300 = 1.33$ percent

For Pipe Section P_{11-out}:

- Size could be 18-inch pipe or 24-inch pipe based on comparing the full-flow friction loss slope to the preliminary HGL slope. Try 18-inch pipe, since the other pipes seem oversized.
- The time of concentration is $21.6 + 1.0 = 22.6$ minutes
- The upper-end flow line = 46.0 (set by matching the crowns across the structure).

- Several factors may control the lower-end flow line, such as but not limited to cover requirements under roads around the lake, the lake bottom elevation, purposely submerging the outlet to minimize potential erosion at the outlet. For this example, we arbitrarily chose 44.5 feet.
- The physical slope = $(46.0 - 44.5)/300 = 0.5$ percent

The full-flow friction slope was recorded as the hydraulic gradient slope for all the pipes. Table 6.6-14 shows the results of doing Step 7 through Step 13 for the entire system.

Table 6.6-14: Results of First Pass Down the System

| STRUCTURE NO. | LENGTH (ft) | TIME OF CONCENTRATION (MIN) | TIME OF FLOW IN SECTION (MIN) | INTENSITY (in/hr) | TOTAL C-A | TOTAL FLOW (cfs) | INLET ELEV (ft) | HYD. GRADIENT | | | PIPE SIZE (IN) | SLOPE (%) | ACTUAL VELOCITY (FPS) |
|---------------|-------------|-----------------------------|-------------------------------|-------------------|-----------|------------------|-----------------|---------------|-------|------|----------------|-----------|-----------------------|
| | | | | | | | | CROWN | | | | | |
| | | | | | | | | UPPER | LOWER | FALL | RISE | SPAN | PHYSICAL |
| 15 | 300 | 10 | 8.5 | 6.5 | 0.16 | 1.04 | 59.70 | 56.7 | 56.2 | 0.5 | 18 | ≈0 | .59 |
| 14 | | | | | | | | 55.2 | 54.7 | | 18 | .15 | |
| 14 | 300 | 18.5 | 1.8 | 5.1 | 0.96 | 4.9 | 59.80 | 56.2 | 55.7 | 0.5 | 18 | 0.18 | 2.8 |
| 13 | | | | | | | | 54.7 | 54.2 | | 18 | 0.15 | |
| 13 | 300 | 20.3 | 1.3 | 4.9 | 1.44 | 7.05 | 59.00 | 55.7 | 51.5 | 4.2 | 18 | 0.38 | 4.0 |
| 12 | | | | | | | | 54.2 | 50.0 | | 18 | 0.15 | |
| 12 | 300 | 21.6 | 1.0 | 4.7 | 1.84 | 8.65 | 54.50 | 51.5 | 47.5 | 4.0 | 18 | 0.58 | 4.9 |
| 11 | | | | | | | | 50.0 | 46.0 | | 18 | 0.15 | |
| 11 | 300 | 22.6 | - | 4.6 | 2.72 | 12.5 | 50.50 | 47.5 | 46.0 | 1.5 | 18 | 1.2 | 7.0 |
| | | | | | | | | 46.0 | 44.5 | | 18 | 0.15 | |

CALCULATE THE HYDRAULIC GRADE LINE ELEVATION

For pipe section P_{11-out}

14. Determine the Lower-end HG elevation. [P_{11-out}]

For the outlet pipe, the lower-end HG is the design tailwater (DTW). For this example, the design tailwater is the higher of: (1) the crown of the pipe (elev. 46.0 feet), or (2) the normal high water stage (47.1) of the lake. Thus:

Lower-end HG = 47.1 feet

15. Determine the upper-end HG elevation. [P_{11-out}]

The upper-end HG is the higher of:

$$\begin{aligned} 1) \text{ Lower-end HG + full-flow friction loss} &= 47.1 + 1.2\% \times 300 \text{ feet} \\ &= 47.1 + 3.6 = 50.7 \text{ feet} \end{aligned}$$

OR

2) The elevation of normal depth upstream. The above elevation is higher than the upper-end crown, so normal depth cannot control.

Then: Upper-end HG = 50.7 feet

The standard HG clearance is not met (S-11 inlet elev. = 50.5). We will increase this pipe size to 24 inches before continuing upstream. To match the crowns at the upper end, the flow line of the 24-inch pipe will be set 0.5 foot lower than for the 18-inch pipe. [P_{11-out}]

$$\begin{aligned} \text{Upper-end flow line} &= 45.5 \text{ ft} \\ \text{Pipe fall} &= 45.5 - 44.5 = 1 \text{ ft (holding lower-end flow line)} \\ \text{Physical slope} &= 1/300 = 0.33 \text{ percent} \end{aligned}$$

Starting at the outlet pipe again:

16. Determine the lower-end HG elevation. [P_{11-out}]

Using the same approach as in Step 14, the lower-end HG elevation = 47.1 feet

17. Determine the upper-end HG elevation. [P_{11-out}]

The Upper End HG is higher of:

$$\begin{aligned} 1) \text{ Lower-end HG + full-flow friction loss} &= 47.1 + 0.26\% \times 300 \text{ ft} \\ &= 47.1 + 0.78 = 47.9 \text{ ft} \end{aligned}$$

OR

2) The elevation of normal depth upstream. The above elevation (47.9 feet) is higher than the crown (47.5 feet), so normal depth does not apply.

Then, upper-end HG = 47.9 feet

Repeat Step 16 and Step 17 for the other pipe sections.

Table 6.6-16 shows the results of completing these steps for the entire system.
For Pipe Section P₁₂₋₁₁:

The lower-end HG is the higher of:

- 1) Downstream pipe upper-end HG: = 47.9 ft

OR

- 2) Controlling pipe condition at the lower end. The above elevation (47.9 feet) is higher than the crown (47.5 feet), so normal depth does not apply.

Then, lower-end HG = 47.9 feet

The upper-end HG is the higher of:

- 1) Lower-end HG + full-flow friction loss = $47.9 + 0.58\% \times 300 \text{ ft}$
= $47.9 + 1.74 = 49.64 \text{ ft}$

OR

- 2) The elevation of normal depth upstream. Using the hydraulic calculator (Q = 8.65 cfs, 18-inch pipe @ 1.33 percent slope), the normal depth = 0.6 x Diameter

Upper-end normal depth elev. = $50.0 + 0.6 \times 1.5 = 50.9 \text{ ft}$ ($d_{\text{NORM}} = 0.6 \times D$)

Then, upper-end HG = 50.9 feet

For Pipe Section P₁₃₋₁₂:

The lower-end HG is the higher of:

- 1) Downstream pipe upper-end HG = 50.9 ft

OR

- 2) Controlling pipe condition at the lower end. The pipe slope (1.4 percent) is steeper than the full-flow friction slope (0.38 percent) so, if the downstream HG is low enough, the flow depth at the lower end is normal depth. Thus, the controlling pipe condition is normal depth (Figure 5-1C). Using the hydraulic calculator (Q = 7.05 cfs, 18-inch pipe @ 1.4 percent slope) the normal depth = 0.52 x Diameter

$$\text{Lower-end normal depth elev.} = 50.0 + 0.52 \times 1.5 = 50.78 \text{ ft}$$

$$\text{Then, lower-end HG} = 50.9 \text{ feet}$$

The upper-end HG is the higher of:

$$\begin{aligned} 1) \text{ Lower-end HG} + \text{full-flow friction loss} &= 50.9 + .38\% \times 300 \text{ ft} \\ &= 50.9 + 1.14 = 52.04 \text{ ft} \end{aligned}$$

OR

$$\begin{aligned} 2) \text{ The elevation of normal depth upstream.} &= 54.2 + 0.52 \times 1.5 = 54.98 \text{ ft} \\ (\text{d}_{\text{NORM}} = 0.52 \times D) \end{aligned}$$

$$\text{Then, upper-end HG} = 54.98 \text{ feet}$$

For Pipe Section P₁₄₋₁₃:

The lower-end HG is the higher of:

$$1) \text{ Downstream pipe upper end HG} = 54.98 \text{ ft}$$

OR

$$\begin{aligned} 2) \text{ Controlling pipe condition at the lower end. The pipe slope (0.167 percent) is} \\ \text{flatter than the full-flow friction slope (0.18 percent), so use the crown of the} \\ \text{pipe (Figure 6.5-1D) as the controlling pipe condition at the lower end. Lower-} \\ \text{end crown elev.} = 55.7 \text{ ft} \end{aligned}$$

$$\text{Then, lower-end HG} = 55.7 \text{ feet}$$

The upper-end HG is the higher of:

$$\begin{aligned} 1) \text{ Lower-end HG} + \text{full-flow friction loss} &= 55.7 + 0.18\% \times 300 \text{ ft} \\ &= 55.7 + 0.54 = 56.24 \text{ ft} \end{aligned}$$

OR

$$\begin{aligned} 2) \text{ The elevation of normal depth upstream. The above elevation (56.24 feet) is} \\ \text{higher than the crown (56.2 feet), so normal depth does not apply.} \end{aligned}$$

$$\text{Then, upper-end HG} = 56.24 \text{ feet}$$

For Pipe Section P₁₅₋₁₄:

The Lower End HG is the higher of:

- 1) Downstream pipe upper-end HG = 56.24 ft

OR

- 2) Controlling pipe condition at the lower end. The above elevation (56.24 feet) is higher than the crown (56.2 feet), so normal depth does not apply.

Then, lower-end HG = 56.24 feet

The Upper End HG is the higher of:

- 1) Lower-end HG + full-flow friction loss = 56.24 + 0.0 ft = 56.24 ft

OR

- 2) The elevation of normal depth upstream. Using the hydraulic calculator (Q = 1.0 cfs, 18-inch pipe @ 0.17 percent slope), the normal depth = 0.32 x Diameter

$$\text{Normal depth elevation} = 55.2 + 0.32 \times 1.5 = 55.68 \text{ ft}$$

Then, upper-end HG = 56.24 feet

Table 6.6-16 shows the results of doing Step 16 and Step 17 for the entire system.

Table 6.6-15: Results of First Pass up the System

| STRUCTURE NO. | LENGTH (ft) | TOTAL FLOW (cfs) | INLET ELEV (ft) | HYD. GRADIENT | | | PIPE SIZE (IN) | SLOPE (%) |
|---------------|-------------|------------------|-----------------|---------------------|---------------------|-----------|----------------|---------------------|
| | | | | FLOW LINE | | | | |
| UPPER | | | | UPPER END ELEV (ft) | LOWER END ELEV (ft) | FALL (ft) | RISE | HYD. GRAD. |
| LOWER | | | | | | | SPAN | PHYSICAL MIN. PHYS. |
| 15 | 300 | 1.04 | 59.70 | 56.24 | 56.24 | | 18 | ≈0 |
| | | | | 56.7 | 56.2 | 0.5 | | 0.167 |
| 14 | | | | 55.2 | 54.7 | | 18 | 0.15 |
| 14 | 300 | 4.9 | 59.80 | 56.24 | 55.7 | 0.54 | 18 | 0.18 |
| | | | | 56.2 | 55.7 | 0.5 | | 0.167 |
| 13 | | | | 54.7 | 54.2 | | 18 | 0.15 |
| 13 | 300 | 7.05 | 59.00 | 54.98 | 50.9 | | 18 | 0.38 |
| | | | | 55.7 | 51.5 | 4.2 | | 1.4 |
| 12 | | | | 54.2 | 50.0 | | 18 | 0.15 |
| 12 | 300 | 8.65 | 54.50 | 50.9 | 47.9 | | 18 | 0.58 |
| | | | | 51.5 | 47.5 | 4.0 | | 1.33 |
| 11 | | | | 50.0 | 46.0 | | 18 | 0.15 |
| 11 | 300 | 12.5 | 50.50 | 47.9 | 47.1 | 0.78 | 24 | 0.26 |
| | | | | 47.5 | 46.5 | 1.0 | | 0.33 |
| outlet | | | | 45.5 | 44.5 | | 24 | 0.1 |

The HG slopes shown for pipe sections P₁₅₋₁₄, P₁₃₋₁₂, P₁₂₋₁₁ are the full-flow friction slopes. The values are not the true HG slopes because these pipes are flowing part full. The values will be revised in subsequent iterations through the system. The full-flow friction slopes have been shown in Table 6.6-16 to help follow the discussion of Step 16 and Step 17 for the entire system.

18. Compare the hydraulic gradient elevation to the standard.
Throughout the system, the hydraulic gradient elevation is more than 1.13 feet below the inlet elevation (edge of pavement), so it meets the current standard. We will recalculate the flow rates and check again.
19. Recalculate the flow rates.
Several pipes are flowing partly full, so we need to recalculate the velocities and times of flow in those sections. This will change the times of concentration and the flow rates. Pipe sections P₁₅₋₁₄, P₁₃₋₁₂, and P₁₂₋₁₁ are flowing part full and the others are flowing full based on the calculations up to this point. We will assume these modes of flow as we work downstream recalculating flow. The velocity in the three pipes flowing partly full will be based on normal depth velocity (see Figure 6.5-3). Table 6.6-17 shows the results of recalculating the flow rates.

Table 6.6-16: Results of Second Pass down the System

| STRUCTURE NO. | LENGTH (ft) | TIME OF CONCENTRATION (min) | TIME OF FLOW IN SECTION (min) | INTENSITY (in/hr) | TOTAL C*A | TOTAL FLOW (cfs) | PIPE SIZE (IN) | SLOPE (%) | ACTUAL VELOCITY (FPS) | NOTES AND REMARKS |
|---------------|-------------|-----------------------------|-------------------------------|-------------------|-----------|------------------|----------------|-------------|-------------------------|---|
| | | | | | | | | | | FREQUENCY (Yrs): 5 |
| UPPER | | | | | | | RISE | HYD. GRAD. | PHYSICAL VELOCITY (FPS) | TAILWATER EL. (ft): 47.1 |
| LOWER | | | | | | | SPAN | MIN PHYS | | All overland $t_c \leq 10$ min. |
| 15 | 300 | 10.0 | 2.4 | 6.5 | 0.16 | 1.04 | 18 | ≈ 0 | 2.1 | Act Vel based on normal Depth. d/D = 0.32 |
| 14 | | | | | | | 18 | 0.167 | | |
| 14 | 300 | 12.4 | 1.5 | 6.0 | 0.96 | 5.76 | 18 | 0.25 | 3.25 | |
| 13 | | | | | | | 18 | 0.167 | | |
| 13 | 300 | 13.9 | 0.6 | 5.7 | 1.44 | 8.2 | 18 | 0.5 | 8.0 | Act Vel based on normal Depth. d/D = 0.55 |
| 12 | | | | | | | 18 | 1.4 | | |
| 12 | 300 | 14.5 | 0.6 | 5.6 | 1.84 | 10.3 | 18 | 0.8 | 8.3 | |
| 11 | | | | | | | 18 | 1.33 | | |
| 11 | 300 | 15.1 | - | 5.6 | 2.72 | 15.2 | 24 | 0.15 | 7.5 | Act Vel based on normal Depth. d/D = 0.67 |
| Outlet | | | | | | | 24 | 0.38 | | |
| | | | | | | | | 0.33 | 4.8 | |
| | | | | | | | | 0.10 | 4.5 | |

20. Recalculate the hydraulic gradient elevation.
Work up the system, as was done previously in Step 16 and Step 17. Table 6.6-18 shows the results.

Table 6.6-17: Results of Second Pass up the System

| STRUCTURE NO. | LENGTH (ft) | TOTAL FLOW (cfs) | INLET ELEV. (ft) | HYD. GRADIENT | | | PIPE SIZE (IN) | SLOPE (%) | NOTES AND REMARKS |
|---------------|-------------|------------------|------------------|----------------------|----------------------|-----------|---------------------------------|-----------|---|
| | | | | CROWN | | | | | |
| | | | | FLOW LINE | | | | | |
| | | | | UPPER END ELEV. (ft) | LOWER END ELEV. (ft) | FALL (ft) | RISE | | |
| UPPER | | | | | SPAN | PHYSICAL | | | |
| LOWER | | | | | | MON PHYS | All overland $t_c \leq 10$ min. | | |
| 15 | 300 | 1.04 | 59.70 | 56.45 | 56.45 | | 18 | ≈ 0 | Act. Vel based on Norm Depth. d/D = 0.32 |
| | | | | 56.7 | 56.2 | 0.5 | | 0.167 | |
| 14 | | | | 55.2 | 54.7 | | | 0.15 | |
| 14 | 300 | 5.76 | 59.80 | 56.45 | 55.7 | 0.75 | 18 | 0.25 | |
| | | | | 56.2 | 55.7 | | | 0.167 | |
| 13 | | | | 54.7 | 54.2 | 0.5 | | 18 | |
| 13 | 300 | 8.02 | 59.00 | 55.03 | 51.0 | | 18 | 0.5 | Act Vel & Upper End HG Based on Norm Depth D/D = 0.55 |
| | | | | 55.7 | 51.5 | 4.2 | | 1.4 | |
| 12 | | | | 54.2 | 50.0 | | | 0.15 | |
| 12 | 300 | 10.3 | 54.50 | 51.0 | 48.24 | | 18 | 0.8 | Act Vel & Upper End HG Based on Norm Depth D/D = 0.67 |
| | | | | 51.5 | 47.5 | 4.0 | | 1.33 | |
| 11 | | | | 50.0 | 46.0 | | | 0.15 | |
| 11 | 300 | 15.2 | 50.50 | 48.24 | 47.1 | 1.14 | 24 | 0.38 | |
| | | | | 47.5 | 46.5 | 1.0 | | 0.33 | |
| OUT | | | | 45.5 | 44.5 | | | 0.10 | |

The HG slopes shown for pipe sections P₁₅₋₁₄, P₁₃₋₁₂, P₁₂₋₁₁ are the full-flow friction slopes. The values are not the true HG slopes because these pipes are flowing part full. The full-flow friction slopes have been shown in Table 6.6-18 to help you compare HG elevations as you work through the system. The values are changed in Table 6.6-19, which reflects the completed design.

21. Compare the hydraulic gradient to the standard.

Throughout the system, the hydraulic gradient elevation is more than 1.13 feet below the inlet elevation (edge of pavement), so it meets the current standard. Pipe section P_{11-out} cannot be reduced in diameter without violating the standard HG clearance at S-11 (see Step 15). The other pipes are the minimum standard diameter, so their diameter cannot be reduced.

Pipe section P₁₅₋₁₄ is flowing full for about half of its length. Consequently, the flow velocity is less than the 2.1 fps we estimated in Table 6.6-17. We could make another iteration through the system recalculating flows based on the reduced velocity, but there is nothing to be gained from doing that here. None of the pipe diameters can be reduced. A completed tabulation form is shown in Table 6.6-19.

Example 6.6-2

Table 6.6-18: Completed Tabulation Form For Example 6.6-2

| LOCATION OF UPPER END ALIGNMENT NAME | | | STRUCTURE NO. | TYPE OF STRUCTURE | LENGTH (ft) | DRAINAGE AREA (ac) | | SUBTOTAL C•A | TIME OF CONCENTRATION (min) | TIME OF FLOW IN SECTION (min) | INTENSITY (in/hr) | TOTAL C•A | TOTAL FLOW (cfs) | INLET ELEV (ft) | HYD. GRADIENT | | | PIPE SIZE (IN) | SLOPE (%) | ACTUAL VELOCITY (FPS) | NOTES AND REMARKS |
|--------------------------------------|---------------|------|---------------|-------------------|-------------|--------------------|----------|--------------|-----------------------------|-------------------------------|-------------------|-----------|------------------|-----------------|---------------|---------------------|---------------------|----------------|-----------|-----------------------|---|
| STATION | DISTANCE (ft) | SIDE | | | | C = | C = 0.80 | | | | | | | | C = | UPPER END ELEV (ft) | LOWER END ELEV (ft) | | | | |
| | | | INCREMENT | TOTAL | UPPER | | | LOWER | | | | | | | | | | | | | |
| Patrick Place | | | 15 | P1 | 300 | 0.2 | 0.2 | 0.16 | 10 | 2.4 | 6.5 | 0.16 | 1.04 | 59.70 | 56.45 | 56.45 | ≈ 0 | 18 | ≈ 0 | 2.1 | Act Vel based on Norm Depth. d/D = 0.32 |
| | | | 56.7 | | | | | | | | | | | | 56.2 | 0.5 | 0.167 | | | | |
| | | | 14 | | | | | | | | | | | | | | | | | | |
| Patrick Place | | | 14 | P1 | 300 | 1.0 | 1.2 | 0.96 | 12.4 | 1.5 | 6.0 | 0.96 | 5.76 | 59.80 | 56.45 | 55.7 | 0.75 | 18 | 0.25 | 3.25 | |
| | | | 56.2 | | | | | | | | | | | | 55.7 | 0.5 | 0.167 | | | | |
| | | | 13 | | | | | | | | | | | | | | | | | | |
| Patrick Place | | | 13 | P1 | 300 | 0.6 | 1.8 | 1.44 | 13.9 | 0.6 | 5.7 | 1.44 | 8.2 | 59.00 | 55.03 | 51.0 | 4.03 | 18 | 1.3 | 8.0 | Act Vel & Upper End HG based on Norm Depth. d/D = 0.55 |
| | | | 55.7 | | | | | | | | | | | | 51.5 | 4.2 | 1.4 | | | | |
| | | | 12 | | | | | | | | | | | | | | | | | | |
| Patrick Place | | | 12 | P1 | 300 | 0.5 | 2.3 | 1.84 | 14.5 | 0.6 | 5.6 | 1.84 | 10.3 | 54.50 | 51.0 | 48.24 | 2.79 | 18 | 0.9 | 8.3 | Act Vel & Upper End HG based on Norm Depth. d/D = 0.67 |
| | | | 51.5 | | | | | | | | | | | | 47.5 | 4.0 | 1.33 | | | | |
| | | | 11 | | | | | | | | | | | | | | | | | | |
| Patrick Place | | | 11 | P1 | 300 | 1.1 | 3.4 | 2.72 | 15.1 | 1.0 | 5.6 | 2.72 | 15.2 | 50.50 | 48.24 | 47.1 | 1.14 | 24 | 0.38 | 4.8 | |
| | | | 47.5 | | | | | | | | | | | | 46.5 | 1.0 | 0.33 | | | | |
| | | | OUT | | | | | | | | | | | | | | | | | | |
| | | | | | | | | | | | | | | | | | | | | | All overland t _c ≤ 10 min |

CHAPTER 7: EXFILTRATION SYSTEMS

| | |
|--|------------|
| 7. EXFILTRATION SYSTEMS | 7-1 |
| 7.1 General | 7-1 |
| 7.1.1 Hydrology..... | 7-1 |
| 7.1.1.1 Time of Concentration..... | 7-1 |
| 7.1.2 Hydro-Geology..... | 7-1 |
| 7.1.2.1 Darcy’s Law | 7-1 |
| 7.1.2.2 Soil Permeability | 7-2 |
| 7.1.2.3 Hydraulic Conductivity of Soils..... | 7-2 |
| 7.1.2.4 Hydro-Geologic Tests | 7-3 |
| 7.1.2.5 Seasonal High Water Table | 7-3 |
| 7.1.2.6 Average Antecedent Moisture Conditions..... | 7-4 |
| 7.1.3 Data Collection..... | 7-4 |
| 7.1.4 Permitting Considerations..... | 7-5 |
| 7.1.5 Construction and Maintenance Considerations..... | 7-5 |
| 7.2 Exfiltration Trenches | 7-6 |
| 7.2.1 Description..... | 7-6 |
| 7.2.1.1 Use | 7-7 |
| 7.2.2 Design Criteria | 7-8 |
| 7.2.2.1 Water Quality | 7-8 |
| 7.2.2.2 Water Quantity..... | 7-10 |
| 7.2.2.3 Design Ground Water Elevation | 7-10 |
| 7.2.2.4 Control Elevation | 7-10 |
| 7.2.2.5 Effective Head | 7-11 |
| 7.2.2.6 Recovery Time..... | 7-11 |
| 7.2.2.7 Safety Factor | 7-11 |
| 7.2.2.8 Dimensions | 7-11 |
| 7.2.2.9 Maximum Length | 7-11 |
| 7.2.2.10 Pipe Invert..... | 7-12 |
| 7.2.2.11 Aggregates | 7-12 |
| 7.2.2.12 Filter Fabric..... | 7-12 |
| 7.2.2.13 Drainage Structures..... | 7-12 |
| 7.2.3 Boundary Conditions..... | 7-13 |
| 7.2.3.1 Ground Water Elevation..... | 7-13 |
| 7.2.3.2 Tailwater Elevation | 7-13 |
| 7.2.3.3 Headwater Elevation..... | 7-13 |
| 7.2.4 Methodologies to Design Exfiltration Trenches..... | 7-13 |
| 7.2.4.1 Storage-Recovery Method | 7-14 |
| 7.2.4.2 Empirical Equations Method | 7-17 |
| 7.2.4.3 FDOT District VI Method..... | 7-20 |

| | | |
|------------|--|-------------|
| 7.2.4.4 | Other Design Methods | 7-24 |
| 7.3 | Drainage Wells | 7-24 |
| 7.3.1 | Description | 7-24 |
| 7.3.1.1 | Use | 7-24 |
| 7.3.2 | Design Criteria | 7-25 |
| 7.3.3 | Water Quality | 7-25 |
| 7.3.3.1 | Fresh Water-Salt Water Hydrostatic Balance | 7-26 |
| 7.3.3.2 | Hydraulic Head | 7-27 |
| 7.3.3.3 | Safety Factor | 7-28 |
| 7.3.3.4 | Dimensions | 7-28 |
| 7.3.3.5 | Exfiltration Rate | 7-28 |
| 7.3.3.6 | Casing..... | 7-28 |
| 7.3.4 | Methodologies of Calculation | 7-28 |
| 7.3.4.1 | Gravity Wells..... | 7-29 |
| 7.3.4.2 | Pressurized Wells | 7-31 |
| 7.4 | Modeling Exfiltration Systems | 7-32 |
| 7.4.1 | Basic Modeling Concepts..... | 7-32 |
| 7.4.2 | Exfiltration Trenches Modeling..... | 7-33 |
| 7.4.3 | Drainage Well Modeling | 7-34 |

7. EXFILTRATION SYSTEMS

7.1 GENERAL

7.1.1 Hydrology

Chapter 2 in this design guide and the *Drainage Manual* encompass the Department's general guidance regarding hydrology. Coordinate in advance with the District Drainage Engineer for approval of the design criteria and calculation methods.

7.1.1.1 Time of Concentration

Chapter 2 (Hydrology) defines and provides methods to calculate the time of concentration. A longer time of concentration usually reduces the calculated peak discharge. The Rational Method is very sensitive to changes in the time of concentration (i.e., if the time of concentration increases from 10 minutes to 60 minutes, the calculated peak discharge could be reduced by up to 60 percent). The Flow Hydrograph Methods are less sensitive to the time of concentration changes (i.e., up to 15 percent reduction in peak discharge if the time of concentration increases from 10 minutes to 60 minutes).

7.1.2 Hydro-Geology

7.1.2.1 Darcy's Law

Darcy's Law characterizes the flow through porous media, assuming that the viscosity, temperature, and density of the fluids are constants. The flow rate is a function of the flow area, the hydraulic gradient, and the proportionality constant (refer to Figure 7.1-1):

$$Q = k i A$$

where:

Q = Flow rate, in ft³/sec

k = Permeability constant, in ft/sec

i = Hydraulic gradient ($i = \Delta H/L$)

A = Cross-sectional area of soil conveying flow, in ft²

ΔH = Change in the hydraulic grade line, in ft

L = Distance between points of interest, in ft

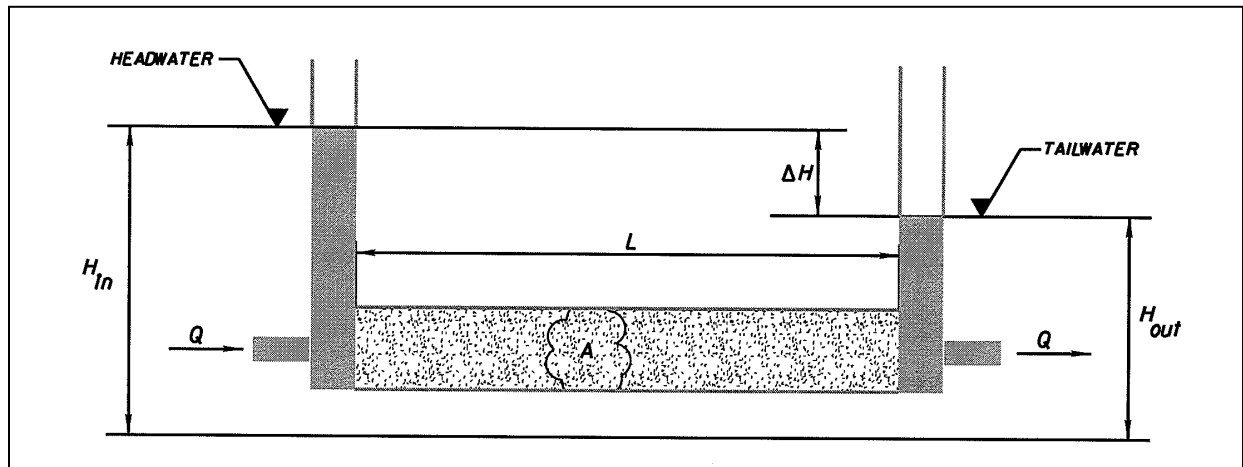

Figure 7.1-1: Saturated Flow through Porous Media

Darcy's Law was established for saturated flow. As such, it may be adjusted for unsaturated and multiphase flows.

7.1.2.2 Soil Permeability

The coefficient of permeability (k) in Darcy's Law is a measure of the rate of water flow through a saturated soil under a given hydraulic gradient in length unit over time unit (i.e., ft/day). The soil permeability is dependent on the grain-size distribution and void ratio. The coefficient of permeability (k) typically varies from 0.03 ft/sec (43 ft/day) for gravels to less than 10^{-8} ft/sec (1.44×10^{-5} ft/day) for clays (refer to Appendix J).

7.1.2.3 Hydraulic Conductivity of Soils

The hydraulic conductivity of a soil (K) measures the relative ease of water transmission through the soil:

$$K = \frac{Q}{A \Delta H}$$

where:

Q = Flow rate, in ft^3/sec

A = Flow area, in ft^2

ΔH = Hydraulic head, in ft

The hydraulic conductivity of a soil is the ratio between the discharge through the unit area of soil perpendicular to the flow per unit of head (i.e., $\text{cfs}/\text{ft}^2 - \text{ft}$ of head). This is the primary factor used to determine the exfiltration rate of a system.

The flow transmission through a soil increases as the water content increases. As such, the maximum hydraulic conductivity occurs under saturated conditions. The hydraulic conductivity for horizontal-saturated flow (K_s) usually is several times greater than the hydraulic conductivity for vertical-unsaturated flow (K_u).

7.1.2.4 Hydro-Geologic Tests

The hydro-geotechnical properties of a soil can be measured in tests under falling or constant head, either in the laboratory or in the field. The most effective soil testing is a combination of laboratory and field methods. Laboratory tests on undisturbed soil samples usually provide accurate results representative of only a point among the soil stratum.

Evaluate the hydrologic and geologic characteristics of the site where the exfiltration system will be installed to define the test procedures to be used. The following tests are suggested:

- **Laboratory Permeameter Test** for saturated hydraulic conductivity on undisturbed soil samples (ASTM D 5084)
- **Double Ring Infiltrometer Test** to estimate the initial vertical unsaturated permeability data of the upper soil layer (ASTM D 3385)
- **Constant Head Test** in soils with permeabilities that allow keeping the test hole filled with water during the field test (AASHTO T 215)
- **Falling Head Test** in areas with excellent soil percolation where keeping the test hole filled with water is not feasible during the test (FM 5-513)
- **DOT Standard Test** (constant head) that can be used for the Department's projects (FM 1-T 215)
- **Well Test Holes** are performed to determine relative permeability and water quality characteristics of the aquifer (ASTM D4050); through continuous water quality testing, the test hole will indicate the depth at which a minimum of 10,000 milligrams per liter total dissolved solids (TDS) concentration is found; the test also will indicate the most favorable depth for stormwater discharge
- A **Pumping Test** is performed at the most favorable depth for stormwater discharge to determine the design discharge capacity normally in gallons per minute per foot of head; the test is normally performed in conjunction with well test holes

7.1.2.5 Seasonal High Water Table

Published information (such as data from the Natural Resources Conservation Service, formerly known as the Soil Conservation Service) provides preliminary guidance related to the water table at a specific location, but you will need site-specific water table information to design exfiltration systems.

The initial data to determine the seasonal high water table (SHWT) elevation is the measurement of the stabilized ground water level in a boring or well. Adjust the initial (encountered) water table elevation to estimate the SHWT based on antecedent rainfall, examination of the soil profile (color variations, depth to hardpan, etc.), consistency with water levels of the adjacent water bodies, vegetative indicators, etc.

7.1.2.6 Average Antecedent Moisture Conditions

The Antecedent Moisture Condition (AMC) indicates the wetness of a soil and its availability to infiltrate water. The soil moisture ranges from dry to saturated, depending on the rainfall amount prior to the moisture measurement. The average AMC means that the soil is neither dry nor saturated, but at an average moisture condition at the beginning of the design storm event.

7.1.3 Data Collection

The design of an exfiltration system requires a good understanding of the site conditions. Information required and potential sources include:

- **Topographic Data.** You usually can find preliminary topographic data in the United States Geological Survey (USGS) quadrangle maps, topographic LIDAR data, and previous project construction plans. Supplement this information with a detailed topographic survey of the project area.
- **Geotechnical Data.** The Soil Survey Reports by the United States Department of Agriculture (USDA) Natural Resources Conservation Service (NRCS) provide general geological and geotechnical properties information. Previous geotechnical reports for the project area and adjacent developments can provide more specific information regarding the geotechnical conditions at the project location. After preliminary evaluation of the available data, request a detailed geotechnical study. The site-specific geotechnical report should classify the types of soils within the project location and soil engineering characteristics, including hydraulic conductivity (refer to Section 7.1.2.3), ground water elevations, etc.
- **Receiving Water Bodies.** The Water Management Districts, FEMA, and some local agencies can provide information regarding water elevations under different storm frequencies for lakes, rivers, canals, and reservoirs. Some agencies also can provide potentiometric surface maps to assist in determining the ground water elevations. Tidal information is available on the National Oceanic and Atmospheric Administration (NOAA) website. You can determine the design tailwater elevation from the above sources.

- **Permit Data.** Previous permit information for the site and surrounding developments can provide information related to design criteria, existing wetlands, possible outfalls, discharge limitations, control elevations, off-site contributors, geotechnical data, prior soil testing results, etc.
- **Right-of-Way Data.** You can obtain the right-of-way information from the Department's right-of-way maps and county and city right-of-way documents.
- **Field Reviews.** Visiting and inspecting the site provides first-hand updated information to the designer regarding the existing drainage system, off-site contributors, water management facilities, outfalls, and other site conditions.

7.1.4 Permitting Considerations

Generally, you will develop the drainage design in compliance with all applicable federal, state, and local environmental regulatory programs. The respective permitting authorities have to be identified and contacted early in the design process. These agencies include local water control districts and county and state water management districts. Each permit agency has specific water quality requirements and may impose restrictions on the construction of exfiltration trenches and well systems.

7.1.5 Construction and Maintenance Considerations

Install stormwater exfiltration systems no less than two feet from parallel underground utilities and 20 feet from existing large trees that will remain in place. To avoid damaging adjacent properties, carefully evaluate the existing soils and the excavation method if the exfiltration system is located in close proximity to the right-of-way line. Implement erosion control measures to impede the access of sediments and debris into the exfiltration system during construction, which can clog the filter fabric and diminish the capacity of the exfiltration trench.

Typically, you would not use exfiltration systems within any type of manmade, compacted embankment since there is little to no percolation in compacted fill as compared to natural soils.

Do not install exfiltration systems in close proximity to or behind MSE walls. Install solid conveyance pipes behind the MSE wall in accordance with the *Drainage Manual*, Appendix D, and install exfiltration systems away from the walls. Do not use exfiltration trenches in locations where a 1H:1V mound could allow the filtrate to impact the MSE soil reinforcements. In this situation, the potential exists for accelerated corrosion of metallic reinforcements to occur without warning. Furthermore, seepage forces would need to be included in the design of the wall, and daylighting filtrate could result in soil washouts, unsightly mildew, vegetation, staining, and other maintenance problems.

Physical access devices must be provided with stormwater exfiltration systems to facilitate maintenance activities. Consider minimum pipe sizes and maximum spacing between drainage structures (refer to Sections 7.2.2.8 to 7.2.2.13) for the efficient operation of maintenance equipment. Also consider future expansion of the facilities and the possible increase of maintenance requirements.

In the case of drainage wells, provide the injection well chamber with physical access devices for maintenance activities. Maintenance of the injection well includes cleaning, removing debris, and, in some cases, redeveloping the well to re-establish discharge capacity. The well location needs to be accessible from the surface to allow these activities to take place.

7.2 EXFILTRATION TRENCHES

7.2.1 Description

An exfiltration trench is an underground drainage system consisting of a perforated pipe surrounded by natural or artificial aggregate, which stores and infiltrates runoff (refer to Figure 7.2-1). Catch basins located at the end of each exfiltration trench segment collect stormwater runoff; the perforated pipe delivers the stormwater into the surrounding aggregate through the pipe perforations. The stormwater ultimately exfiltrates into the ground water aquifer through the trench walls and bottom. As the treatment volume is not discharged into surface waters, exfiltration trench systems are considered a type of retention treatment.

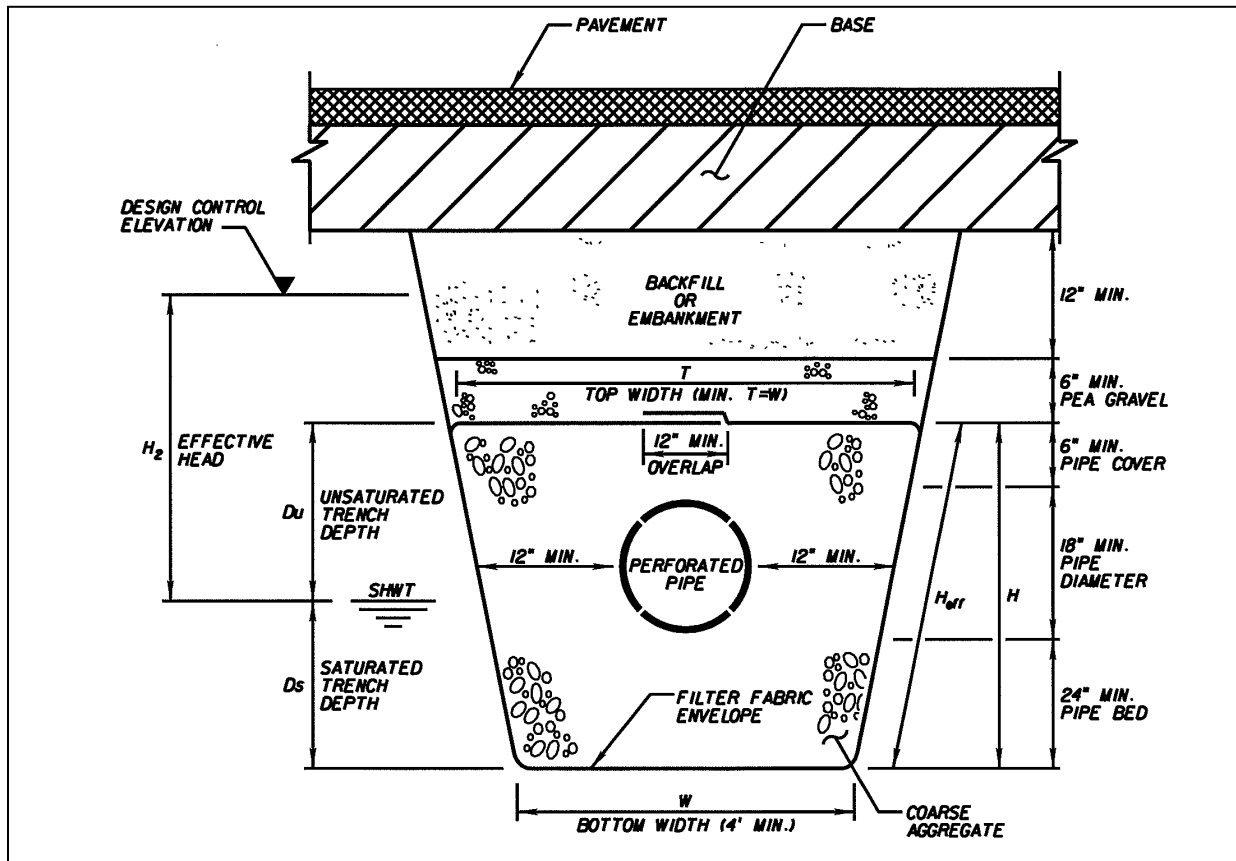

Figure 7.2-1: Typical Exfiltration Trench

The permeability of the soils at the exfiltration trench location and the anticipated water table elevation determine the applicability and performance of the exfiltration trench system. This system must exfiltrate the required stormwater treatment volume and draw down the treatment volume to return to its normal condition within a specific time after the design storm event. When the trench bottom is at or above the average wet season water table, the exfiltration trench is considered a dry system.

7.2.1.1 Use

For projects where the areas available for water management facilities are limited and high right-of-way acquisition costs are anticipated, exfiltration trench systems can provide the required stormwater treatment if the hydro-geological conditions are suitable for runoff infiltration (i.e., permeable soils with hydraulic conductivity exceeding 1×10^{-5} cfs/ft² per foot of head). Exfiltration trenches, like other types of retention systems, are able to efficiently remove stormwater pollutants. Additionally, exfiltration trenches contribute to recharge of the ground water aquifer, thus assisting in combatting saltwater intrusion in coastal areas.

Because of the direct infiltration of the surface runoff with its associated pollutant load into the ground water aquifer, do not install exfiltration trench systems in the proximity of potable water supply wells. Usually, you are not allowed to install exfiltration trenches within the 10-day well field protection contour, but you should verify specific requirements for each well field with the permitting authorities. Do not propose exfiltration trenches within or near contaminated ground water areas to avoid the potential migration of the polluted plume due to the direct injection of surface runoff into or adjacent to the contaminated groundwater plume. In areas with high ground water elevation, the available hydraulic head for exfiltration trench operation is minimal but the required hydraulic head can be obtained by pumping, if feasible.

The limited life span of exfiltration trenches is their main disadvantage. The accumulation of sediments and clogging of the filter fabric and the void spaces of the aggregates usually shorten the operational life of exfiltration trenches. Consider the need of future replacement costs in the evaluation of their effectiveness. Prior to replacing existing systems or using them as part of a new drainage system, test the remaining treatment capacity of existing exfiltration trenches.

7.2.2 Design Criteria

An exfiltration trench transmits the inflow runoff hydrograph into the groundwater during small storm events or in land-locked conditions; but in drainage areas with positive outfall, the fraction of the runoff hydrograph that is not transmitted into the groundwater and retained within the exfiltration trench is transmitted downstream, usually through an outfall control structure.

The [Standard Specifications for Road and Bridge Construction](#) (Section 443, French Drains) includes directions, provisions, and requirements for exfiltration trenches. Standard exfiltration trenches are detailed in Standard Plans, Index 443-001, French Drains. In the cases where Standard Plans, Index 443-001 is not suitable for a specific project need, develop a detailed design and include this information in the design documentation. The following are the Department's general design criteria. It is recommended that additional specific criteria from the permitting agencies be evaluated in the design process.

7.2.2.1 Water Quality

You can install the exfiltration trenches off-line or on-line in the drainage system to provide water quality treatment to a watershed.

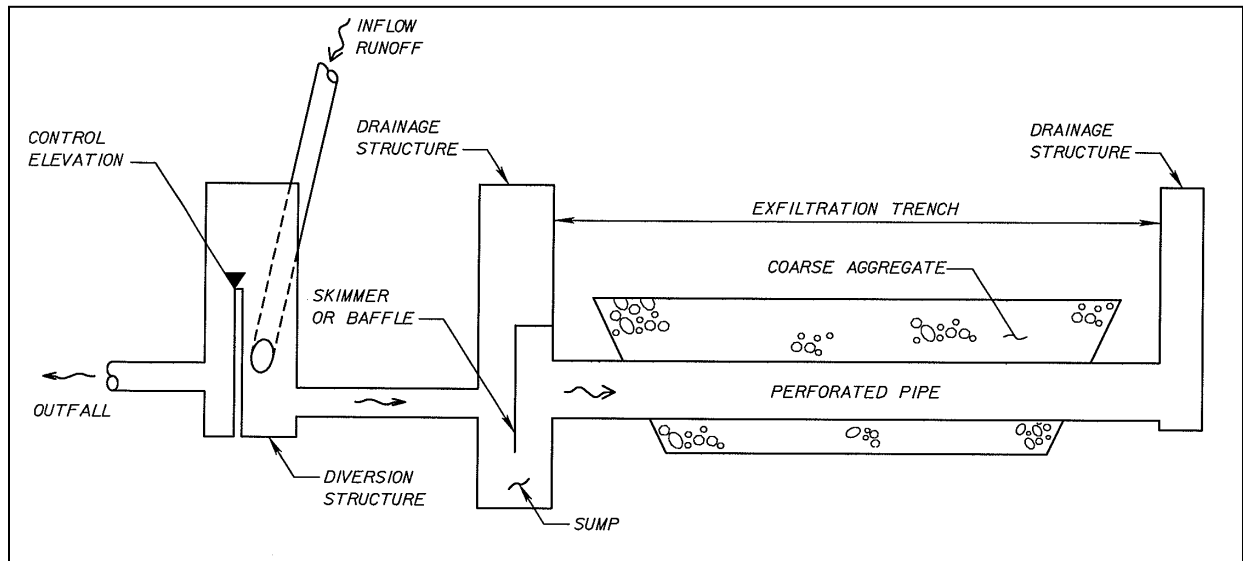

Figure 7.2-2: Off-Line Exfiltration System

The off-line treatment method (Figure 7.2-2) diverts runoff into the exfiltration trench designed to provide the required treatment volume; subsequent runoff in excess of the treatment capacity bypasses the off-line exfiltration trench toward the outfall. For off-line systems, a diversion drainage structure usually is required.

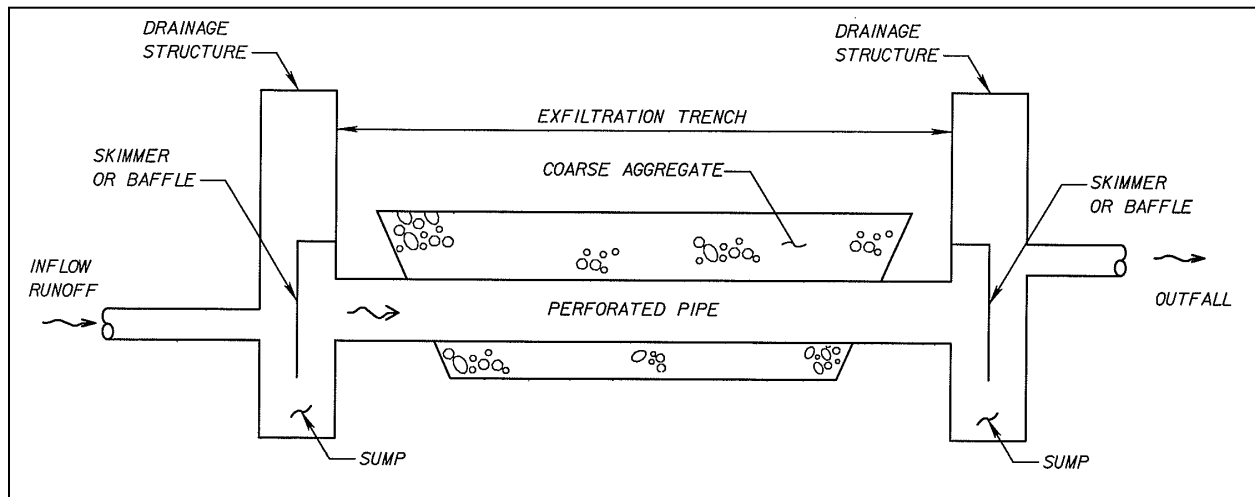

Figure 7.2-3: On-Line Exfiltration System

The on-line exfiltration trench (Figure 7.2-3) provides the required water treatment but the treatment volume is mixed with the total runoff volume. As such, runoff volume in excess of the treatment capacity carries a portion of the pollutant load to the receiving water body.

7.2.2.2 Water Quantity

For exfiltration trenches designed to satisfy water quality requirements rather than provide flood protection, only the fraction of the overall exfiltration trench storage volume, including pipe and aggregate voids, located above the design ground water elevation and below the outfall control elevation should be considered for discharge attenuation.

In some special locations (i.e., Miami-Dade County and Monroe County) with very limited area available for water treatment, the exfiltration trench systems could be credited for discharge attenuation if the ground water is considered variable, rising from the Seasonal High Water Table along with the design storm event.

7.2.2.3 Design Ground Water Elevation

Use the elevation to which the ground water can be expected to rise during a normal wet season to calculate the required exfiltration trench length.

7.2.2.4 Control Elevation

The minimum control elevation for an exfiltration trench system should be at the same elevation as the top of the perforated pipe. The maximum control elevation should not violate the base clearance criteria for the project or produce changes in the land use value of the properties located upstream and downstream of the drainage system. A site-specific survey, the permit files, and the field reviews are the main sources used to determine the design control elevation.

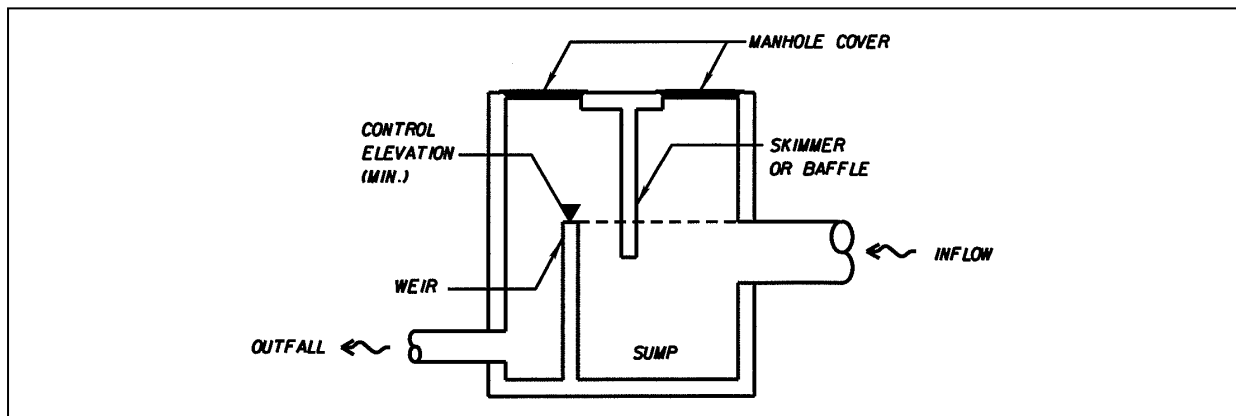

Figure 7.2-4: Outfall Control Structure

7.2.2.5 Effective Head

Positive Discharge. The effective head of the exfiltration trenches (H_{eff}) with discharge to an outfall should be the average vertical distance from the SHWT to the outfall control elevation:

$$H_{\text{eff}} = \frac{\text{Control Elevation} - \text{SHWT}}{2}$$

Closed Systems. The effective head for exfiltration trenches with no outfall (self-contained system) should be the vertical distance from the SHWT to the average distance between the SHWT and the design high water (DHW):

$$H_{\text{eff}} = \frac{\text{DHW} + \text{SHWT}}{2} - \text{SHWT} = \frac{\text{DHW} - \text{SHWT}}{2}$$

7.2.2.6 Recovery Time

If the permitting authorities with jurisdiction over the project location do not have specific recovery time requirements, the water treatment capacity of the exfiltration trench systems should be recovered within the 72 hours following the design storm event, assuming average AMC.

7.2.2.7 Safety Factor

Use a safety factor of two or more to calculate the required length of exfiltration trenches to consider possible geotechnical uncertainties.

7.2.2.8 Dimensions

The minimum pipe diameter is 18 inches, but 24 inches is preferable; and the minimum trench width is four feet. The maximum dimensions should depend on site-specific conditions and construction methods. In general, exfiltration trenches with bottoms wider than eight feet and/or deeper than 20 feet are not recommended. Perforated pipes with a diameter of more than 36 inches should be approved by the District Drainage Engineer.

Pipe perforations can be slotted or perforated. Standard locations and dimensions of the pipe perforations are included in the *Standard Specifications*, Section 443, French Drains.

7.2.2.9 Maximum Length

- a. The maximum length of exfiltration trenches with access through both ends should be:

| | |
|------------------------------|----------|
| For 18-inch to 30-inch pipes | 300 feet |
|------------------------------|----------|

For 36-inch and larger pipes

400 feet

- b. The maximum length of the exfiltration trenches with access through only one end should be half of the maximum length of exfiltration trenches with access through both ends.

7.2.2.10 Pipe Invert

Make the invert elevation of the perforated pipe at least one foot above the trench bottom elevation. Locate the pipe invert above the SHWT to facilitate maintenance operations. This criterion may not be feasible in sites where the water table is close to the ground surface or where a deeply permeable stratum underlies low-permeability soils.

7.2.2.11 Aggregates

Use uniform-graded, natural or artificial coarse aggregate with no more than 3-percent weight of material passing the Number 200 Sieve at the point of use.

7.2.2.12 Filter Fabric

Enclose the coarse aggregate of an exfiltration trench in filter fabric. The perforated pipe also could be enclosed in filter fabric to increase the life span of the exfiltration trench if approved by the District Drainage Engineer.

The filter fabric will comply with the requirements established in the latest FDOT *Standard Specifications*, Section 985. Additionally, the permeability of the filter fabric must be equal to or greater than the permeability of the surrounding soil.

7.2.2.13 Drainage Structures

The minimum side dimension of the drainage structures for exfiltration trenches should be four feet. Inlets must include sediment sumps to collect sediments and skimmers/baffles (refer to Standard Plans, Index 443-002) to prevent oil and floating debris from exiting the catch basin into the exfiltration trench. The minimum clear distance between baffles in the same drainage structure will be 2.5 feet. Fiberglass skimmers and baffles are not recommended due to possible damage from debris impact.

Drainage structures have to provide adequate access to the exfiltration trench for maintenance operations; the minimum grate size should be two feet and two-piece cast iron covers (Standard Plans, Index 425-001) are recommended. Provide manholes for inspection and clean out at the end of each exfiltration trench with no inlet. Inlets Type 1 to 4 (Standard Plans, Index 425-020) are recommended for exfiltration trenches installed along or from a gutter line.

Refer to Sections 3.10 and 3.12 of the *Drainage Manual* for standards related to drainage

structures of exfiltration systems.

7.2.3 Boundary Conditions

The design and performance of an exfiltration trench system depends on the specific boundary conditions of the site, which are: the ground water elevation, the tailwater elevation (if positive outfall), and the allowable headwater.

7.2.3.1 Ground Water Elevation

The ground water elevation to design exfiltration trench systems will be the seasonal high ground water table as defined in Section 7.1.2.5, above.

7.2.3.2 Tailwater Elevation

The receiving water body defines the tailwater conditions for exfiltration trench systems with positive discharge. Define the design tailwater as per the latest *Drainage Manual*, Section 3.4.

7.2.3.3 Headwater Elevation

The maximum allowable stage upstream of the exfiltration trench system will limit the design high water elevation. The drainage design in general should limit the design high water during the design storm event to meet the base clearance requirements and cause no adverse impact to the land use value of the surrounding properties.

7.2.4 Methodologies to Design Exfiltration Trenches

There are several methodologies used to design exfiltration trench systems. All methods are similar in nature, with specific criteria and requirements set by the regulatory agencies and FDOT District Drainage Offices. As such, it is important to coordinate and get approval of the methodology used in each specific project from the District Drainage Engineer and the permitting authorities with jurisdiction over the area where the proposed drainage system will be installed.

The equations and formulas included in the following sections present the conceptual development of the procedures and calculations, which are applicable with any unit system. As such, the conversion factors are not included, but the designer has to convert the units of each parameter as required to be consistent.

To illustrate the calculation methods, use/calculate a sample roadway segment (Figure 7.2-5) with a contributing drainage area of 2.3 acres (including 0.8 acres of pavement) with on-line treatment.

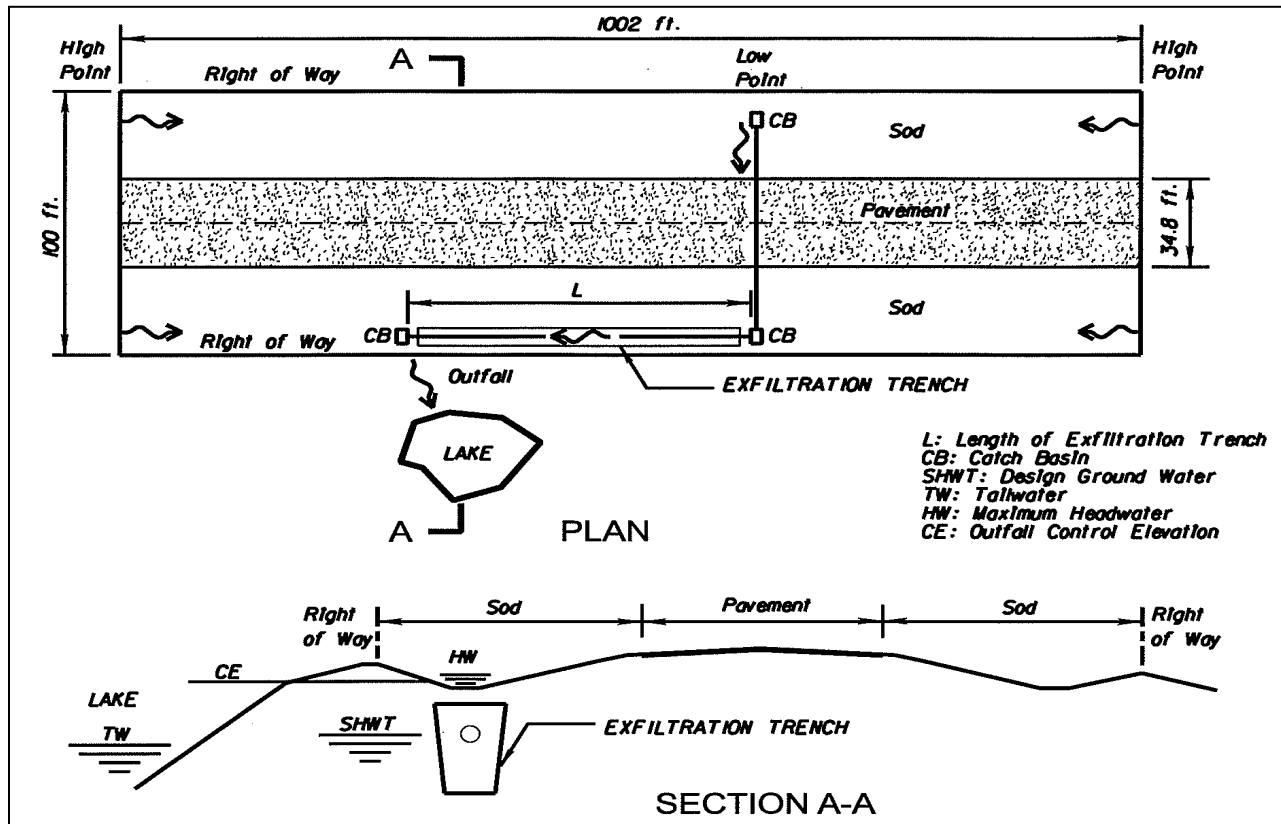

Figure 7.2-5: Sample Problem

7.2.4.1 Storage-Recovery Method

This method is acceptable for most of the permitting agencies and FDOT Districts because it provides the required water quality storage capacity within the exfiltration trench and assures that the treatment capacity will be available again within the required recovery time.

The storage-recovery method is recommended for exfiltration trenches with bottom elevation—or at least the perforated pipe invert—above the design ground water elevation. This method is not applicable if the top of the proposed exfiltration trench is below the design ground water elevation.

Storage-Recovery Design Procedure

Step 1: Data Collection

Total drainage area: $A_T = 2.3$ acres

| | |
|---|--|
| Pavement area: | $A_I = 0.8$ acre |
| Ground water elevation: | SHWT = 6.00 ft |
| Tailwater elevation: | TW = 10.00 ft |
| Headwater elevation: | HW = 14.00 ft |
| Fillable porosity of soil: | $f_s = 0.3$ |
| Fillable porosity of aggregate: | $f = 0.45$ |
| Unsaturated hydraulic conductivity of soil: | $K_u = 0.00007 \frac{\text{ft}^3/\text{sec}}{\text{ft}^2\text{-ft of head}}$ |
| Saturated hydraulic conductivity of soil: | $K_s = 0.00025 \frac{\text{ft}^3/\text{sec}}{\text{ft}^2\text{-ft of head}}$ |

Step 2: Calculate the required storage for water quality

Note: The water quality criterion from St. Johns River Water Management District (SJRWMD) is used for the sample problem.

If off-line treatment is proposed, use the greatest of the following volumes:

$$V_T = 0.5 \text{ inch}/12 A_T \qquad V_T = 0.096 \text{ acre-ft}$$

$$V_I = 1.25 \text{ inches}/12 A_I \qquad V_I = 0.083 \text{ acre-ft} \qquad V_{\text{off}} = 0.096 \text{ acre-ft}$$

If you propose on-line treatment, increase 0.5-inch runoff on the total drainage area to the off-line treatment volume above:

$$V_{\text{on}} = V_{\text{off}} + V_T = 0.096 + 0.096; \quad V_{\text{on}} = 0.192 \text{ acre-ft}$$

If discharging into shellfish harvesting areas or other receiving water bodies with specific regulations, provide the water quality volume as required: $V_{\text{spec}} = 0$ acre-ft

$$\text{Total required water quality volume:} \qquad V_{\text{WQ}} = V_{\text{on}}; \qquad V_{\text{WQ}} = 0.192 \text{ acre-ft}$$

Step 3: Define the preliminary characteristics of the exfiltration trench

| | | | |
|----------------------------|---------------------------|---------------------------|-----------------------------|
| Outfall control elevation: | CE = 13.00 ft | Perforated pipe diameter: | D = 24 inches |
| Trench bottom width: | $W_{\text{tr}} = 5.00$ ft | Perforated pipe invert: | $P_{\text{inv}} = 10.00$ ft |
| Trench bottom elevation: | $B_{\text{el}} = 8.00$ ft | | |

Trench top width: $T_{tr} = 5.00$ ft

Trench top elevation: $T_{el} = 13.00$ ft

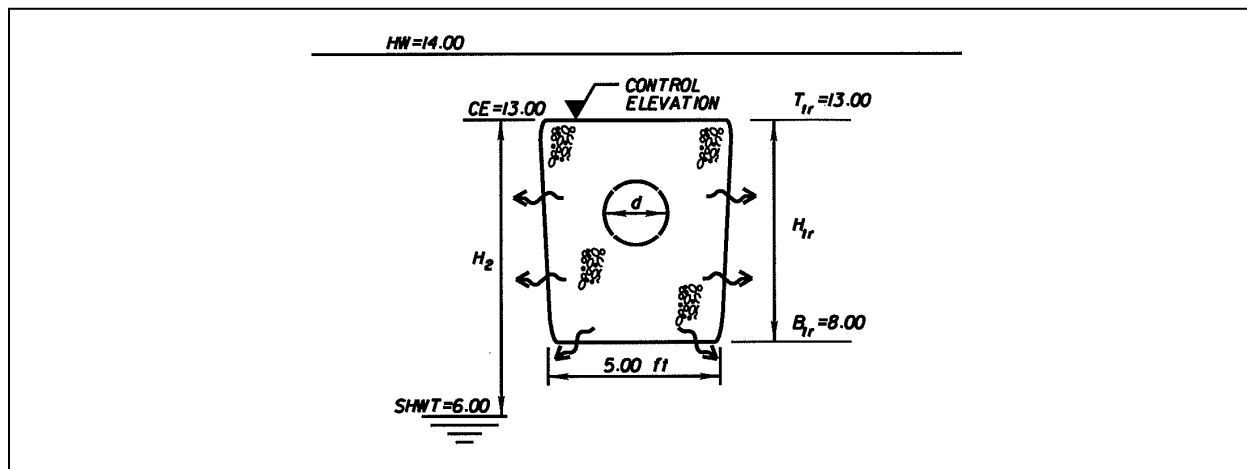

Figure 7.2-6: Sample Exfiltration Trench

Step 4: Calculate the required length of exfiltration trench

The storage capacity of an exfiltration trench is the available void space above the SHWT, including pipe and aggregate voids.

Storage within pipe:

If the pipe invert is higher than the SHWT, the storage area in the pipe is:

$$A_{full} = \frac{\pi D^2}{4} \quad A_{full} = 3.142 \text{ ft}^2$$

Storage within aggregate:

Storage height in trench: $D_u = T_{el} - SHWT$ $D_u = 7.00$ ft
(unsaturated depth)

Storage area in trench: $A_{trench} = f (W_{tr} \cdot D_u - A_{pipe})$ $A_{trench} = 14.34 \text{ ft}^2$

Note: Engineering judgment will be used regarding whether to consider the thickness of the pipe walls to calculate A_{trench} .

Net trench length: $L_{net} = \frac{V_{WQ}}{A_{pipe} + A_{trench}}$ $L_{net} = 477.7$ ft

Safety factor to account for hydro-geotechnical uncertainties ($SF \geq 2$) $SF = 2$

Required trench length: $L_{req} = SF L_{net}$ $L_{req} = 955 \text{ ft}$

Note: If the required length does not fit within the available location, return to Step 2 and modify the preliminary characteristics of the exfiltration trench as necessary.

Step 5: Calculate the recovery time of the treatment volume

Effective head: $H_{eff} = \frac{DHW - SHWT}{2}$ $H_{eff} = 4.00 \text{ ft}$

Trench height: $H_{tr} = T_{el} - B_{el}$ $H_{tr} = 5.00 \text{ ft}$

Unsaturated exfiltration will occur only through the walls (2) and the bottom if the trench bottom is above the SHWT:

$$A_{uwb} = L_{net} (2D_u + W_{tr}) \qquad A_{uwb} = 9,076 \text{ ft}^2$$

Determine the unsaturated exfiltration capacity of the exfiltration trench:

$$Q_u = K_u A_{uwb} H_{eff} \qquad Q_u = 2.54 \text{ ft}^3/\text{sec}$$

Recovery time ($T_{rec} \leq 72\text{hr}$): $T_{rec} = \frac{V_{WQ}}{Q}$ $T_{rec} = 0.91\text{hr} \quad \text{OK}$

7.2.4.2 Empirical Equations Method

The following exfiltration trench design formulas have been developed by the South Florida Water Management District (SFWMD) and are included in the *SFWMD Environmental Resource Permit Information Manual*, Volume IV. This method calculates the required length of exfiltration trench based on a one-hour exfiltration time, which is representative of the majority of small-magnitude and short-duration rainfall events.

Empirical Equations Design Procedure

Step 1: Data Collection (refer to Figures 7.2-1 and 7.2-5)

Total drainage area: $A = 2.3 \text{ acre}$

Pavement area: $A_i = 0.8 \text{ acre}$

| | |
|-------------------------------------|--|
| Ground water elevation: | SHWT = 5.00 ft |
| Tailwater elevation: | TW = 6.00 ft |
| Headwater elevation: | HW = 8.00 ft |
| Saturated hydraulic conductivity: | $K = 0.00025 \frac{\text{ft}^3/\text{sec}}{\text{ft}^2 - \text{ft of head}}$ |
| W.Q. reduction (0.5 for retention): | %WQ = 0.5 |
| Safety factor (2 Minimum): | FS = 2 |

Step 2: Calculate the required storage for water quality

The empirical equations have incorporated the adjustment to consider that exfiltration trenches are retention systems (50 percent of the treatment volume required for wet detention systems) and have a safety factor of 2. As such, the treatment volume to be used in these formulas is the greatest of one-inch runoff on the contributing area or 2.5 inches on the pavement area:

$$V_T = 1.0 \text{ inch}/12 A \qquad V_T = 0.19 \text{ acre}\cdot\text{ft}$$

$$V_I = 2.5 \text{ inches}/12 A_i \qquad V_I = 0.17 \text{ acre}\cdot\text{ft} \qquad V_{WQ} = 0.19 \text{ acre}\cdot\text{ft}$$

Step 3: Define the preliminary characteristics of the exfiltration trench

| | |
|----------------------------|------------------------------|
| Outfall control elevation: | CE = 6.50 |
| Perforated pipe diameter: | D = 24 in |
| Trench bottom width: | W = 5.00 ft |
| Perforated pipe invert: | $P_{inv} = 10.00 \text{ ft}$ |
| Trench bottom elevation: | $B_{el} = 1.00$ |
| Trench top elevation: | $T_{el} = 10.00$ |

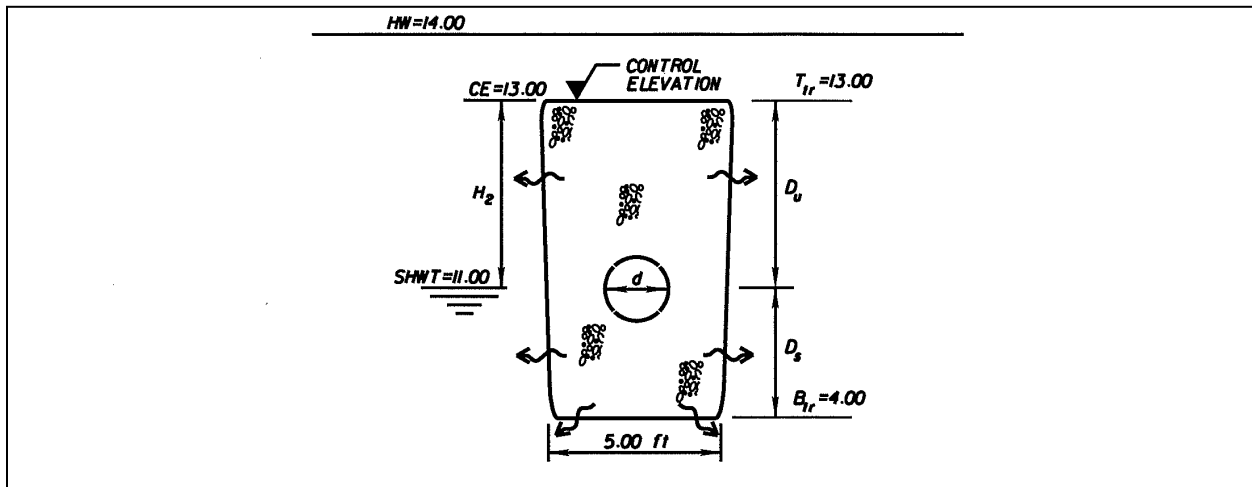

Figure 7.2-7: Sample Exfiltration Trench

Step 4: Calculate the required length of exfiltration trench

Treatment volume in acre-inches: $V = 12V_{WQ}$ $V = 2.30$ acre-in

Effective head: $H_{eff} = \frac{CE - SHWT}{2}$ $H_{eff} = 1.50$ ft

Trench height: $H = T_{el} - B_{el}$ $H = 9.00$ ft

Unsaturated depth of trench: $D_u = T_{el} - SHWT$ $D_u = 5.00$ ft

Saturated depth of trench: $D_s = SHWT - B_{el}$ $D_s = 4.00$ ft

When the unsaturated depth of trench is greater than the saturated depth or the trench width is lesser than two times depth:

$$L_1 = \frac{FS \%WQ \cdot V_{WQ}}{K (H_2W + 2H_{eff} D_u - D_u^2 + 2H_{eff} D_s) + 0.000139 W D_u} \quad L_1 = 33 \text{ ft}$$

When the saturated depth of trench is greater than the unsaturated depth or the trench width is greater than two times depth:

$$L_2 = \frac{FS \%WQ \cdot V_{WQ}}{K (2H_{eff} D_u - D_u^2 + 2H_{eff} D_s) + 0.000139 \cdot W \cdot D_u} \quad L_2 = 579 \text{ ft}$$

Required length of trench (use the greater of these two lengths):

$L_{req} = L_1$ if $D_u \geq D_s$ or L_2 if $D_u < D_s$ $L_{req} = 33$ ft

$L_{req} = L_1$ if $W \leq 2H$ or L_2 if $W > 2H$ $L_{req} = 33$ ft

For the sample problem, the saturated depth of trench is greater than the unsaturated depth, but the trench width is less than two times the trench depth. As such, the required length of trench is 33 feet.

7.2.4.3 FDOT District VI Method

The technical paper *Subsurface Drainage with French Drains*, prepared by the District VI Drainage Section on June 20, 1991 (available on the Department's ERC system as a District VI document) includes criteria and procedures to design exfiltration trenches. This method is acceptable for projects within the FDOT District VI jurisdiction, mainly within Miami-Dade County, and other areas if approved by the permitting authorities.

This method considers that there is no flow through the bottom of the exfiltration trench (assuming that the bottom is the first portion of the trench to get clogged), but only through the vertical areas (walls) of the exfiltration trench. The hydraulic conductivity of the existing soils at the depth where the exfiltration trench will be located is considered in calculating the dimensions and required length of the trench. A test procedure has been developed to determine the hydraulic conductivity (K) of the soils at different depths. The initial investigation includes soils from 0 to 10-foot depths; if the test hole exfiltration rate is less than 6 gpm, then soils from 10-foot to 15-foot depths are investigated. If the accumulated exfiltration rate is still less than 6 gpm, soils from 15-foot to 20-foot depths are investigated. Deeper exfiltration trenches are not considered economically practical. Construct the exfiltration trench with its bottom elevation coinciding with the depth of the selected test results.

FDOT District VI Design Procedure

Step 1: Data collection (refer to Figure 7.2-5)

| | | | |
|-------------------------|------------------|------------------------|----------------|
| Total drainage area: | $A = 2.3$ acres | Time of concentration: | $t_c = 11$ min |
| Pavement area: | $A_i = 0.8$ acre | Runoff coefficient | |
| Pervious area: | $A_p = A - A_i$ | Impervious: | $C_i = 0.9$ |
| Design frequency: | $F = 10$ years | Pervious: | $C_p = 0.3$ |
| Ground water elevation: | SHWT = 11.00 ft | Tailwater elevation: | TW=10.00 |

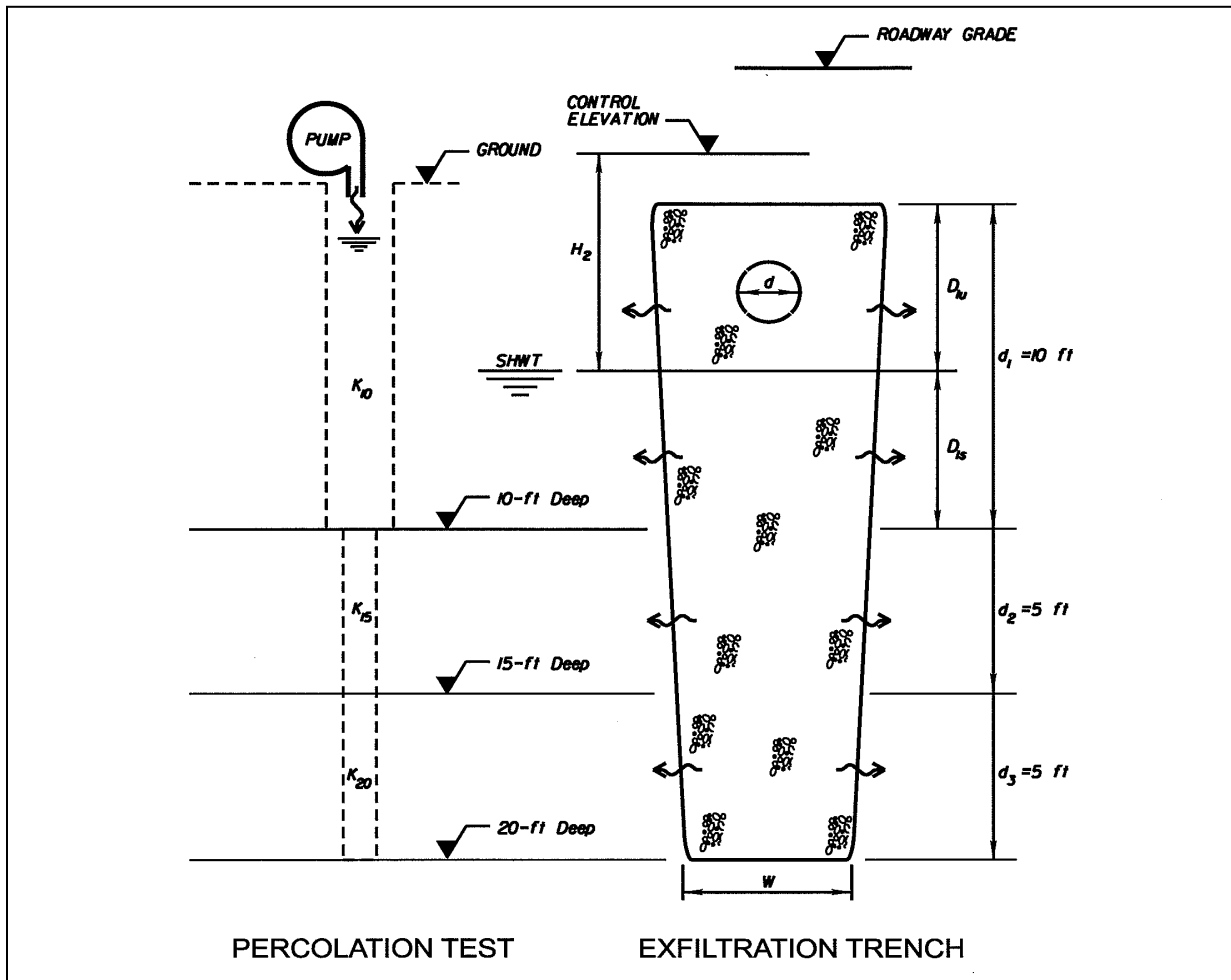

Figure 7.2-8: Sample Exfiltration Trench

Saturated hydraulic conductivity in cfs/square foot per foot of head:

| | | |
|--------------------------------|-----------------------|---------------------|
| Depth from 0 feet to 10 feet: | $d_1 = 10 \text{ ft}$ | $K_{10} = 0.000152$ |
| Depth from 10 feet to 15 feet: | $d_2 = 5 \text{ ft}$ | $K_{15} = 0.000211$ |
| Depth from 15 feet to 20 feet: | $d_3 = 5 \text{ ft}$ | $K_{20} = 0.000349$ |

Step 2: Determine the maximum polluted volume

Note: The following procedure is applicable only in Miami-Dade County, and it is required by the Miami-Dade Department of Environmental Resources Management (DERM).

Weighted runoff coefficient:
$$C = \frac{C_i \cdot A_i + C_p \cdot A_p}{A} \quad C = 0.51$$

Time to generate 1" of runoff:
$$t_1 = \frac{2,940 F^{-0.11}}{308.5 C - 60.5(0.5895 + F^{-0.67})} \quad t_1 = 21.07 \text{ min}$$

| | | |
|--|--|------------------------------|
| Polluted runoff duration: | $t_T = t_1 + t_c = 21.07 + 11$ | $t_T = 32.07$ min |
| Rainfall intensity: (For Miami-Dade-County) | $i = \frac{308.5}{48.6 F^{-0.11} + T_T(0.5895 + F^{-0.67})}$ | $i = 4.86$ in/hr |
| Peak discharge | $Q = C i A$ | $Q = 5.70$ cfs |
| Maximum polluted volume: | $V = 60 Q T_T$ | $V = 10,939$ ft ³ |

Note: All the runoff generated from a storm event lasting T_T or less is assumed to be polluted or contaminated. As such, the maximum polluted volume (V) usually is greater than the treatment volume required by the Water Management Districts.

Step 3: Define the preliminary characteristics of the exfiltration trench

| | | |
|---------------------------------------|---------------------------------|---------------------|
| Outfall control elevation: | $CE = 13.00$ ft | |
| Trench bottom width: | $W = 5.00$ ft | |
| Trench bottom elevation: | $B_{el} = -7.00$ ft | |
| Trench top elevation; | $T_{el} = 13.00$ ft | |
| Perforated pipe diameter: | $D = 24$ in | |
| Perforated pipe invert: | $P_{inv} = 10.00$ | |
| Fillable porosity of aggregate: | $f = 0.5$ | |
| Effective head: | $H_{eff} = \frac{CE - SHWT}{2}$ | $H_{eff} = 2.00$ ft |
| Trench height: | $H = T_{el} - B_{el}$ | $H = 20.00$ ft |
| Unsaturated depth of trench: | $D_u = T_{el} - SHWT$ | $D_u = 2.00$ ft |
| Saturated depth of trench (0' to 10') | $D_s = SHWT - B_e$ | $D_s = 8.00$ ft |

Step 4: Determine the trench storage

The storage capacity of an exfiltration trench is the available void space above the design ground water elevation (SHWT), including pipe and aggregate voids.

Storage within pipe:

If the pipe invert is higher than the SHWT, the storage area in the pipe is:

$$A_{\text{full}} = \frac{\pi (D/12)^2}{4} \quad A_{\text{full}} = 3.14 \text{ ft}^2$$

If the pipe invert is lower than the SHWT, the available storage depth in the pipe is:

$$D_{\text{pipe}} = P_{\text{inv}} + \frac{D}{12} - \text{SHWT} \quad D_{\text{pipe}} = 1.00 \text{ ft}$$

$$\text{Central angle of the circle segment: } \theta = 2 \arccos \left[\frac{(D - 2D_{\text{pipe}})}{D} \right] \quad \theta = 0.82 \text{ rad}$$

$$\text{Storage area in pipe segment: } A_{\text{seg}} = \frac{(D/12)^2}{8} (\theta - \sin \theta) \quad A_{\text{seg}} = 0.04 \text{ ft}^2$$

$$A_{\text{pipe}} = A_{\text{full}} \text{ if } P_{\text{inv}} \geq \text{SHWT}$$

$$A_{\text{pipe}} = A_{\text{seg}} \text{ if } P_{\text{inv}} < \text{SHWT}$$

$$\text{In this example: } A_{\text{pipe}} = A_{\text{full}} \quad A_{\text{pipe}} = 3.14 \text{ ft}^2$$

Storage within aggregate:

$$\begin{array}{l} \text{Storage height in trench:} \\ \text{(unsaturated depth)} \end{array} \quad D_u = T_{\text{el}} = \text{SHWT} \quad D_u = 2.00 \text{ ft}$$

$$\text{Storage area in trench: } A_{\text{trench}} = f (W D_u - A_{\text{pipe}}) \quad A_{\text{trench}} = 3.43 \text{ ft}^2$$

$$\text{Storage in trench: } S = A_{\text{pipe}} + A_{\text{trench}} \quad S = 6.57 \text{ ft}^3/\text{ft}$$

Step 5: Determine the exfiltration rate per foot of trench

$$E_T = 2 K_{10} (D_u/2 + D_s) H_{\text{eff}} + 2 K_{15} d_2 H_{\text{eff}} + 2 K_{20} d_3 H_2$$

$$E_T = 0.0167 \text{ cfs/foot of trench}$$

Note: The exfiltration rate values are limited by the District VI Drainage Section to 0.15 cfs/linear foot of trench.

Step 6: Determine the length of exfiltration trench for water quality

$$L_{\text{net}} = \frac{V}{S + 60 \cdot E_T \cdot T_T} \quad L_{\text{net}} = 283 \text{ ft}$$

$$\text{Safety factor to account for hydro-geotechnical uncertainties (SF} \geq 2\text{): } \text{SF} = 2$$

$$L_{\text{req}} = \text{SF } L_{\text{net}} \quad L_{\text{req}} = 566 \text{ ft}$$

7.2.4.4 Other Design Methods

Design Curves for Exfiltration Systems. The exfiltration curves provide the ratio between the trench storage and the exfiltration rate from the trench to the soil. This method is based on the long-term mass balance of an exfiltration system under local rainfall conditions. As such, limit your use of exfiltration curves outside of areas where they have been developed.

Exfiltration Trenches for Discharge Attenuation. With the exception of Miami-Dade County and Monroe County, exfiltration trenches are not approved for discharge attenuation by most of the permitting agencies. As such, and only under very special conditions, the use of exfiltration trenches to attenuate the outfall discharge will be negotiated with the permitting authorities and with prior approval by the FDOT District Drainage Engineer.

The exfiltration trench design procedure for discharge attenuation should be similar to the procedures described above. The difference is the required treatment volume. For closed basins, the treatment volume should be the pre-development versus post-development discharge increase instead of the required water quality volume. You could apply the same criteria for basins with positive outfall if the Rational Method is used because this method considers the rainfall intensity constant throughout the storm duration. If you use hydrograph methods, the runoff hydrograph has to be combined with the exfiltration hydrograph to determine the outflow from the drainage system. Spreadsheets and modeling programs are available to perform hydrograph calculations.

7.3 DRAINAGE WELLS

7.3.1 Description

The term drainage wells includes all wells that are used to inject surface water directly into an aquifer, or transfer shallow ground water directly into a deeper aquifer. By definition, an injection well is any bored, drilled, driven shaft, or dug hole that is deeper than its widest surface dimension, or an improved sinkhole, or a subsurface fluid distribution system (refer to Standard Plans Index 444-T01).

Drainage wells in Florida are grouped into two broad types: surface-water injection wells and inter-aquifer connector wells. Surface-water injection wells are further categorized as either Floridan aquifer drainage wells or Biscayne aquifer drainage wells.

7.3.1.1 Use

The Floridan aquifer drainage wells generally are effective as a method of urban drainage and lake level control. They emplace more recharge into the Floridan aquifer than the recharge it would receive under natural conditions. The most common use of Floridan

aquifer drainage wells is to supplement surface drainage for urban areas in the karst terrains of the topographically higher areas of central and north Florida. Be cautious, however, with regard to the water quality aspects of these wells because they often inject surface runoff into the same aquifer from which public water supplies are withdrawn.

In southeast Florida, drainage wells to the Biscayne aquifer dispose of stormwater runoff and other surplus water. The majority of these wells dispose of water from swimming pools or heated water from air-conditioning units. Some of the wells dispose of urban runoff or wastewaters from business and industry in the area. The use of Biscayne aquifer drainage wells should have minimal effect on aquifer water quality as long as the injection of runoff and industrial wastes is restricted to zones where chloride concentrations exceed 1,500 milligrams per liter and 10,000 milligrams per liter total dissolved solids (TDS).

7.3.2 Design Criteria

Designing a storm sewer system using drainage wells requires hydrologic analysis and determination of the design peak runoff rate of discharge from the project area. See Chapter 2 (Hydrology) for the procedures to determine the peak runoff rates.

The data collection for drainage well design should include researching similar installed wells within the project area. Local well contractors can provide an estimate of the discharge capacity of wells based on previous drainage well installations and pumping tests. In cases where there is no available data, perform test holes and pumping tests. The exfiltration capacity of a well will be determined in gallons per minute per foot of head.

7.3.3 Water Quality

Address water quality requirements before discharging into injection wells. The typical design of drainage wells provides for the use of a retention basin with baffles or skimmers prior to discharging into the drainage well. Determine the size of the retention basin based on a 90-second detention time. Other options include the use of exfiltration trenches and detention/retention treatment swales.

Stormwater pollutant load is very dependent on climatic and topographic features, such as storm intensity and duration, distribution over the basin, land use, and topographic features such as hills, swamps, and soil types. Design the type of stormwater treatment to meet the needs of the particular location (i.e., more stringent water quality measures should be required for wells discharging into the Floridan aquifer). Pretreatment methods include physical, chemical, and biological control measures. Physical treatment includes typical operations like settling and screening. An example of chemical treatment would be the injection of alum into the stormwater on a storm-by-storm basis. Biological treatment might be accomplished by using plants, fish, or other types of treatment in retention ponds. In many instances, a combination of the above methods are used prior to the discharge of stormwater into the freshwater injection well.

The discharge of the wells needs to occur below the 10,000 ppm Total Dissolved Solids (TDS) level.

7.3.3.1 Fresh Water-Salt Water Hydrostatic Balance

One major consideration in the design of drainage wells in coastal areas is the difference in density between fresh water and saline water. The hydrostatic balance between fresh water and saline water can be illustrated by the U-tube shown in Figure 7.3-2. Pressures on each side of the tube must be equal, therefore:

$$P_s g H_f = P_f g (Z + H_f)$$

where:

P_s = Density of the saline water, in lb/ft³

P_f = Density of the fresh water, in lb/ft³

g = Acceleration of gravity, in ft/sec²

Z = Head difference, in ft

H_f = Fresh water height above Mean Sea Level, in ft

Solving for Z , the Ghyben-Herzberg relation is obtained:

$$Z = (P_f / P_s - P_f) H_f$$

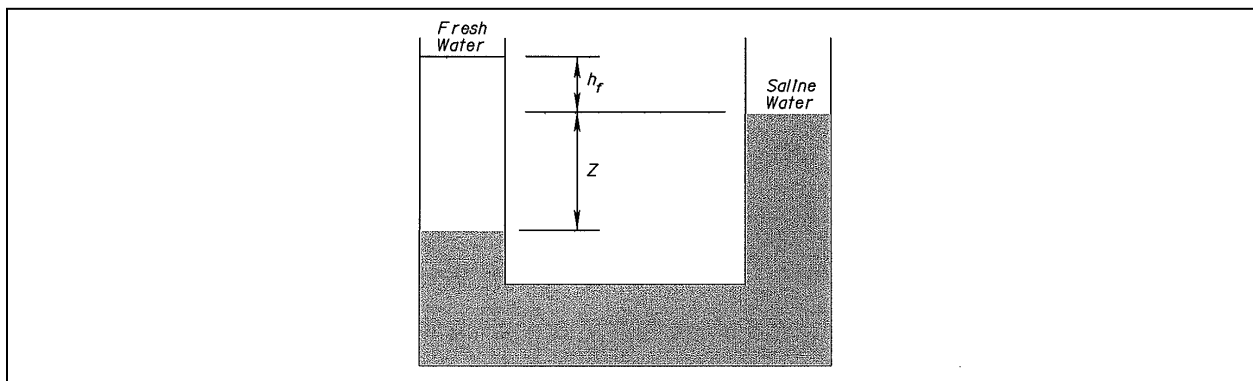

Figure 7.3-1: U-Tube Hydrostatic Balance between Fresh and Saline Water

Translating the U-tube to a coastal situation, as shown in Figure 7.3-3, H_f is the elevation of the water table above the sea level and Z is the depth to the fresh water-saline water interface below the sea level.

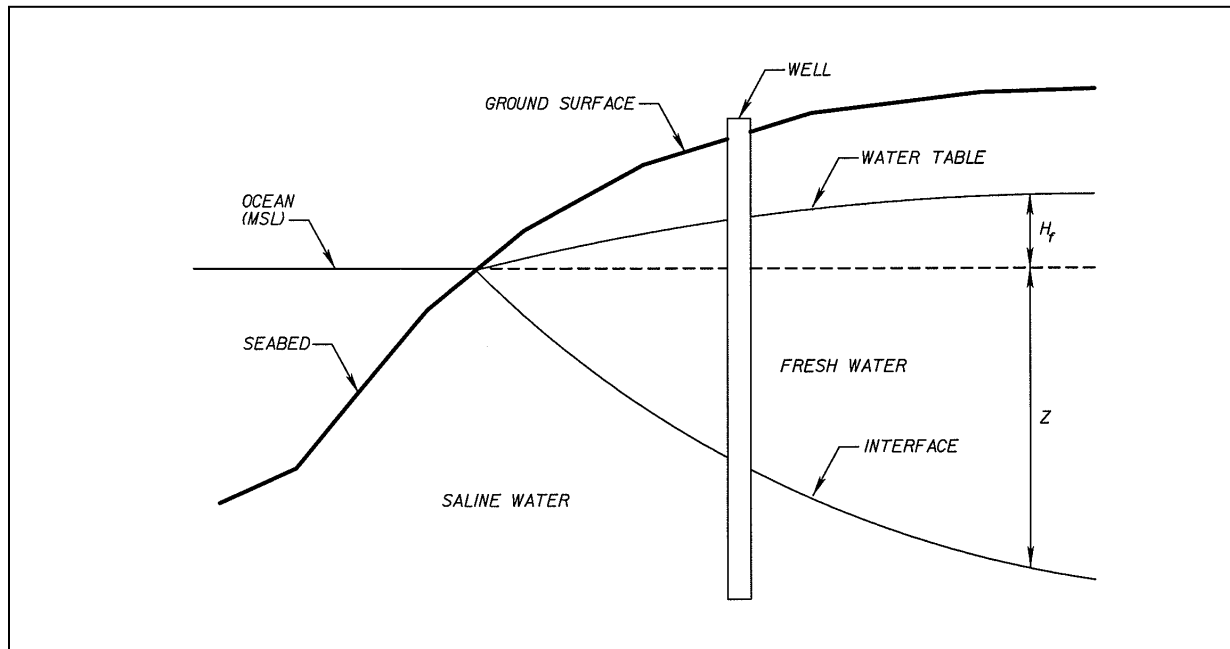

Figure 7.3-2: Fresh-Saline Water Interface

For typical seawater conditions ($P_s = 63.9 \text{ lb/ft}^3$ and $P_f = 62.4 \text{ lb/ft}^3$), the hydrostatic head balance is approximately: $Z = 40 H_f$.

The cased portion of drainage wells in coastal areas is placed at least up to the fresh-saline water interface. You can approximate the head loss due to the difference in the density of salt water and fresh water as one foot of head loss per 40 feet of casing based on the relationship $Z = 40 H_f$. As such, a typical design with 60-foot average casing up to the interface would require 1.5 feet of head to displace the salt water, which is the usual rule-of-thumb value used to design drainage wells discharging into the Biscayne aquifer. This additional head is not required for wells discharging into a freshwater aquifer.

7.3.3.2 Hydraulic Head

The maximum allowable stage upstream of the drainage wells limits the design hydraulic head for gravity drainage wells. The design high water for the design storm event should meet the base clearance requirements and cause no adverse impact to the land use value of the surrounding properties.

In areas where gravity head is not available, you can obtain the required hydraulic head artificially by pumping. Pressurized drainage wells basically have the same design requirements as the gravity wells but the hydraulic head is produced by a lift station. Runoff pretreatment is necessary prior to the lift station, which usually is provided by a retention basin with baffles and a bar screen for protection of the pumps. Typically, you can combine these features with a finer screen to block smaller debris from discharging

into the well. The FDEP has waived the requirement of the Reasonable Assurance Report (refer to Appendix K) when a passive by-pass at or below 8.00-foot NGVD '29 is provided from the pump's common header. This requires a vertical stack pipe with a top elevation at 8.00-foot NGVD '29. If the head on the pumps is larger, there will be overflow in this stack. Provide a cap/bird screen to avoid tampering.

7.3.3.3 Safety Factor

Due to some uncertainty related to geological and other factors of drainage wells, a safety factor of 1.5 is recommended for the design of drainage wells.

7.3.3.4 Dimensions

Drainage (deep) wells usually are 24 inches in diameter and 100 feet to 150 feet deep. When more than one well is necessary for the system, try to separate them by 75 feet to 100 feet.

7.3.3.5 Exfiltration Rate

A drainage well is drilled as an open hole until the desired level of exfiltration is found, based on the results of the well test holes and the pumping tests described in Section 7.1.2.4. Common values of well exfiltration rates (in Miami-Dade County) range from 500 gpm to 1,500 gpm per foot of head.

7.3.3.6 Casing

The casing point is usually determined by finding the required minimum total dissolved solid levels in the aquifer or by finding structurally stable rock formations. Typically, about 70 percent of the well depth is steel encased.

7.3.4 Methodologies of Calculation

The calculation methods to design gravity wells (Section 7.3.4.1) and pressurized wells (Section 7.3.4.2) are illustrated based on a sample roadway segment (Figure 7.3-4) with a contributing drainage area of 2.3 acres, including 0.8 acre of pavement to be drained into an injection well system.

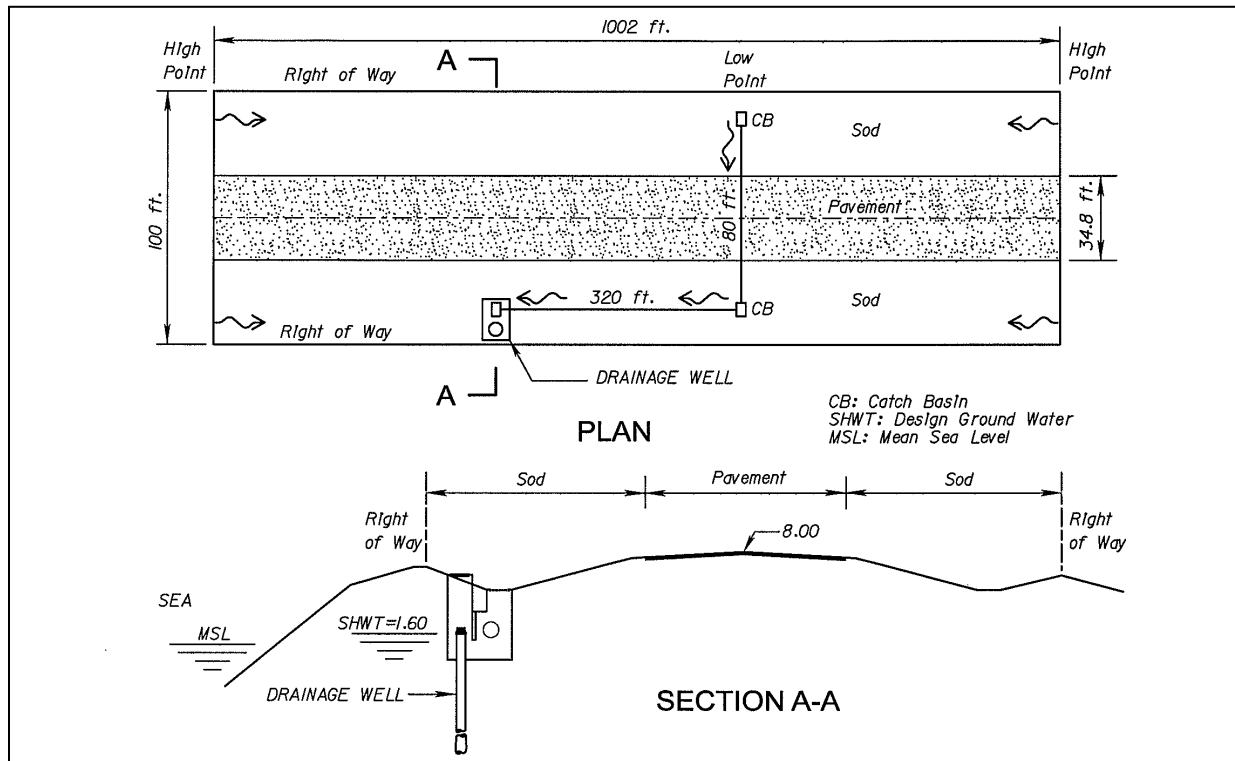

Figure 7.3-3: Sample Problem

7.3.4.1 Gravity Wells

Step 1: Data collection (refer to Figure 7.3-4)

Total drainage area: $A = 2.3$ acres

Pavement area: $A_i = 0.8$ acre

Pervious area: $A_p = A - A_i$

Ground water elevation: SHWT = 1.60

Minimum roadway grade: $G = 8.00$

Hydrologic location: Zone 10

Design frequency: $F = 3$ years

Runoff coefficient

Impervious: $C_i = 0.95$

Pervious: $C_p = 0.30$

Control elevation: CE = 3.60 ft.

Well design data: (Based on information from other wells near the project site)

Well capacity: $Q_w = 750$ gpm/ft of head

Depth to interface: $Z = 60$ ft

Step 2: Determine the peak discharge rate into the gravity well system.

Weighted runoff coefficient: $C = \frac{C_i \cdot A_i + C_p \cdot A_p}{A}$ $C = 0.53$

Time of concentration (t_c):

Note: You will find methods to calculate the time of concentration in Chapter 2 (Hydrology). Use the Rational Method to solve the sample problem. For larger projects, you could use the Unit Hydrograph Method to design the system.

Inlet time: $t_i = 10$ min (based on the minimum t_c)

Travel time (pipe): $t_t = \frac{\text{Flow path length}}{\text{Flow velocity}} = \frac{80 \text{ ft} + 320 \text{ ft}}{2 \text{ ft/sec}} = 3.3$ min

$t_c = t_i + t_t$ $t_c = 13.3$ min

Rainfall intensity: $i = \frac{308.5}{48.6 F^{-0.11} + T_T (0.5895 + F^{-0.67})}$ $i = 5.39$ in/hr
(For Miami-Dade County)

Note: You can determine the rainfall intensity for other project locations using the appropriate Intensity-Duration-Frequency (IDF) Curves. For IDF curves, go to NOAA Atlas 14 website for the Partial Duration Time Series.

Peak discharge $Q = C i A$ $Q = 6.52$ cfs

Note: Consider attenuating the peak discharge when substantial runoff storage capacity exists or is proposed within the contributing area. In these cases, use the NRCS (formerly SCS) Method.

Step 3: Calculate the exfiltration capacity of one gravity well.

Effective head: $H_{\text{eff}} = CE - \text{SHWT} - \Delta H$ $H_{\text{eff}} = 0.50$ ft

Note: The head loss ($\Delta H = 1.5$ ft.) used above is based on the rule of thumb described in Section 7.3.3.1. Although usually disregarded, you can consider additional head loss due to friction along the well casing (approximately 0.001 foot per foot of casing). You may need a more accurate head loss calculation when dealing with deep casings and very high flow rates coupled with low available hydraulic heads.

One-well capacity: $Q_w = 0.00223 q_w H_{\text{eff}}$ $Q_w = 0.84$ cfs

Step 4: Determine the required number of gravity wells.

Safety factor: $SF = 1.5$

Number of gravity wells: $N_w = \frac{SF Q}{Q_w}$ $N_w = 11.69$ wells

Recommendation: Use 12 gravity wells at a minimum spacing of 75 feet. Distribute these wells within the project area or at one location. Consider head losses due to pipe lines to design the stormwater system.

Step 5: Determine the 90-second retention volume for **each** gravity well.

Required detention volume: $V_{90\text{sec}} = \frac{90 Q}{N_w}$ $V_{90\text{sec}} = 48.9$ ft³
(for each gravity well)

Note: Provide the 90-second retention volume right before the drainage wells, below the top of the well (usually at the SHWT).

7.3.4.2 Pressurized Wells

Step 1: Data collection (refer to Figure 7.3-4)

(The same as Section 7.3.4.1 Step 1)

Step 2: Determine the peak discharge rate into the gravity well system.

(The same as Section 7.3.4.1 Step 2)

Step 3: Determine the net hydraulic head required for a pressurized well system.

Number of pressurized wells: $N_p = 1$ well

Safety factor: $SF = 1.5$

Pressurized net head: $H_p = \frac{SF Q}{0.00223 q_w H_2} + \Delta H$ $H_p = 7.34$ ft

Note: The head loss ($\Delta H = 1.5$ ft.) used above is based on the rule of thumb described in Section 7.3.3.1. You can consider additional head loss due to friction along the well casing (approximately 0.001 foot per foot of casing), but usually you would disregard it. You may need a more accurate head loss calculation when dealing with deep casings and very high flow rates coupled with low available hydraulic heads.

Required head elevation: $\text{Head} = \text{SHWT} + H_p$ $\text{Head} = 8.94$ ft NGVD

Note: The sample problem would require approximately 12 wells to function by gravity (see Section 7.3.4.1, Step 4, above). By pressurizing the system with 7.34 ft head (at 8.94 ft NGVD), only one well would be needed. Notice that a Reasonable Assurance Report will be required by FDEP (see Section 7.3.3.2 and refer to Appendix K) because the head elevation at 8.94 ft NGVD is higher than 8.00 ft NGVD.

Step 4: Determine the 90-second retention volume for each pressurized well.

Required detention volume: $V_{90\text{sec}} = \frac{90 Q}{N_p}$ $V_{90\text{sec}} = 586.8 \text{ ft}^3$
(for each gravity well)

Note: The 90-second retention volume has to be provided right before the pump station or stations for the pressurized drainage wells.

Step 5: Design the pump station.

Required pump discharge: $Q_p = SF Q$ $Q_p = 9.78 \text{ cfs}$

Required head elevation (Step 3 above): HEAD = 8.94 ft NGVD

The pump station would have to deliver a flow of 9.78 cfs with a maximum head of 8.94 ft NGVD. The system design then will consist of pump selection, design of the pump pit, and the forced line, which is not in the contents of this document. The procedure for the lift station design could be done by manual methods, spreadsheets, and other computer software commercially available for lift station design.

7.4 MODELING EXFILTRATION SYSTEMS

7.4.1 Basic Modeling Concepts

Hydraulic modeling idealizes existing and proposed hydraulic systems for calculation purposes. The hydraulic models generated for a specific project may vary in complexity based on the accuracy needed by the designer. Several spreadsheets and modeling software programs are available to design or evaluate open and closed stormwater systems, but the designers have to use software accepted by the Department and the permitting agencies with jurisdiction over the area where the project is located.

The main elements in a hydraulic model setup are nodes and links. A node is a point with a defined location in the drainage system used to simulate inlets, manholes, grade breaks, bends, outlets, etc. Nodes usually are points that maintain the conservation of mass during the calculation process. Links are the connections between nodes used to simulate pipes, ditches, and channels. You can use links to transfer or convey water through the drainage system.

Other important modeling elements are the boundary conditions, which usually simulate

the tailwater conditions as time-stage nodes, and the drainage areas, which are closed boundaries contributing into their respective nodes. Rainfall and peak runoff computations, usually related to the drainage areas, are calculated using the Rational Equation or the NRCS methods.

7.4.2 Exfiltration Trenches Modeling

To simulate the exfiltration trench performance, model the trench pipe as a normal pipe link between nodes. One of the nodes connected to the trench usually has the stage-area or the stage-volume characteristics of the exfiltration trench assigned to it. If the modeling program computes the emptiness of the links, only the voids in the aggregate will be considered in the stage-area or the stage-volume capacity of the exfiltration trench. Include a boundary node, usually as a time-stage node, to simulate the design groundwater elevation, which could be constant or variable with time as per the designer's criteria.

It is necessary to include a special link to model the transference of runoff from the node simulating the exfiltration trench to the node simulating the design ground water (See Figure 7.4-1). This special link usually is a head-discharge ratio or rating curve, which could be defined by giving different head values (ΔH) to calculate their respective discharges (Q) using the following equation (refer to Section 7.1.2.3):

$$Q = (K_u A_u + K_s A_s) \Delta H$$

where:

Q = Flow rate, in cfs

K_u = Unsaturated hydraulic conductivity (cfs/ft² – ft of head)

K_s = Saturated hydraulic conductivity (cfs/ft² – ft of head)

A_u = Unsaturated flow area (ft²) = $L_{net} (2D_u)$

A_s = Saturated flow area (ft²) = $L_{net} (2D_s + W)$

ΔH = Hydraulic head (ft)

If the unsaturated depth of the exfiltration trench (D_u) is less than one tenth of the total trench depth, disregard the unsaturated exfiltration because the unsaturated hydraulic conductivity usually is several times less than the saturated hydraulic conductivity of the soils. If the trench width is greater than two times the depth, disregard the exfiltration through the trench bottom ($A_s = 2L_{net} D_s$).

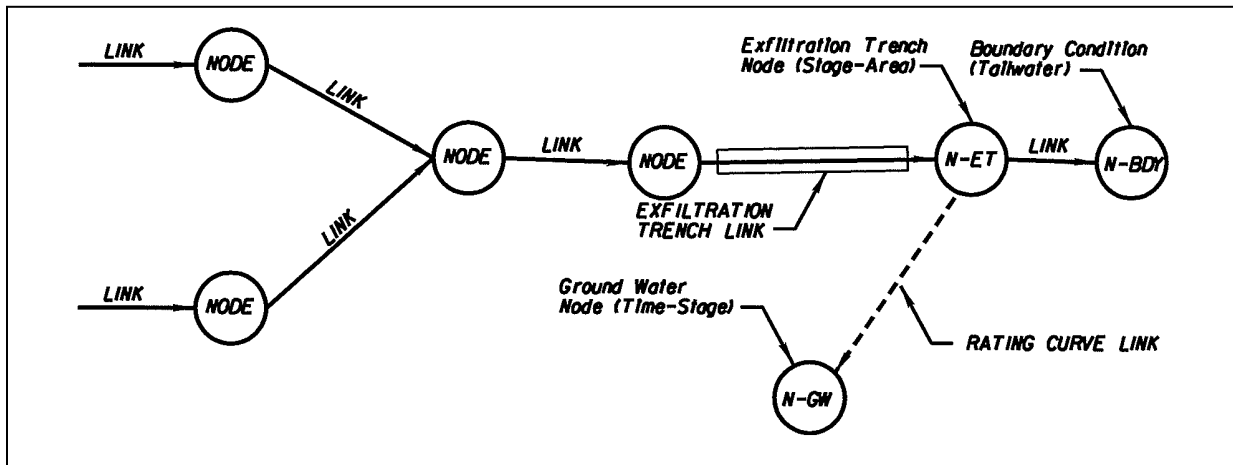

Figure 7.4-1: Sample Nodal Diagram for Exfiltration Trenches

The head-discharge ratio or rating curve may not be accurate if the design ground water is considered variable and the modeling program uses elevations instead of hydraulic head for calculations. You can consider the variable ground water to be rising from the average October ground water elevation to the anticipated ground water elevation at the end of the design storm event. In these cases, a family of tailwater-headwater-discharge rating curves is necessary to simulate the transference of runoff from the exfiltration trench to the ground water. You can calculate the rating curves by giving specific values to couples of tailwater and headwater elevations to calculate their corresponding head values (ΔH). Having the hydraulic head (ΔH), you can calculate the discharges (Q) using the above equation and the tailwater-headwater-discharge relationship would be complete.

7.4.3 Drainage Well Modeling

Calculate the inflow discharge using the approved hydrologic method and assign it to a node that could simulate the retention box. Analyze the drainage well, or a series of them, using rating curves with an elevation versus discharge relationship of the wells. The rating curve link will be connected to a time series node representing the water table at the discharge point. Following is a simple schematic nodal diagram of a well system model.

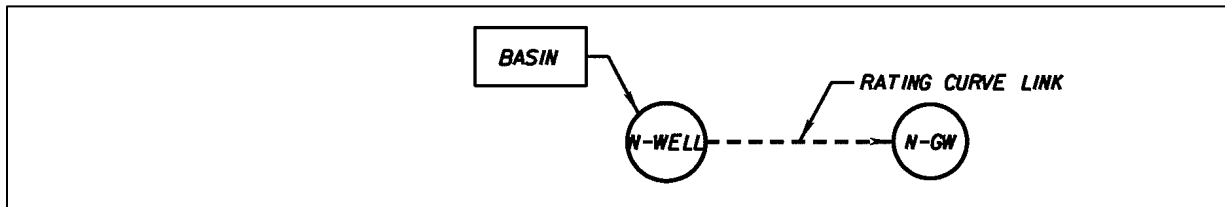

Figure 7.4-2: Rating Curve Link for Drainage Wells

Basin represents the drainage area contributing into the drainage well. Node N-WELL

simulates the retention box prior to discharge into the well. The rating curve link simulates the well discharge into the water table. Node N-GW is the boundary node representing the ground water elevation.

Connect the rating curve link to a time series node representing the water table at the discharge point. If the system includes several drainage wells, you would develop a rating curve for each well. There are a number of acceptable computer software hydrologic and hydraulic models capable of analyzing the system.

CHAPTER 8: OPTIONAL PIPE MATERIAL

| | | |
|------------|---|-------------|
| 8. | OPTIONAL PIPE MATERIAL..... | 8-1 |
| 8.1 | Introduction..... | 8-1 |
| 8.2 | Design Service Life..... | 8-1 |
| 8.3 | Durability..... | 8-2 |
| | 8.3.1 Project Corrosion Evaluation..... | 8-2 |
| | 8.3.2 Project Geotechnical Investigation and Corrosion Tests..... | 8-5 |
| | 8.3.3 Project Pipe Service Life Estimation..... | 8-7 |
| | 8.3.4 Special Cases (Jack and Bore Casings, Ductile Iron Pipe, any Ferrous Metals)..... | 8-12 |
| 8.4 | Pipe Structural Evaluation..... | 8-18 |
| 8.5 | Documentation..... | 8-28 |
| | 8.5.1 Project Example Considering all Potential Pipe Applications..... | 8-28 |
| | 8.5.1.1 Side Drains under Driveways..... | 8-29 |
| | 8.5.1.2 Cross Drains (including Side Drains under Side Streets)..... | 8-36 |
| | 8.5.1.3 Storm Drain..... | 8-43 |
| | 8.5.1.4 Wall Zone Pipe..... | 8-46 |
| | 8.5.1.5 Gutter Drain..... | 8-47 |
| | 8.5.1.6 French Drain..... | 8-49 |
| 8.6 | Specifying Optional Pipe Materials in the Contract Plans..... | 8-50 |

8. OPTIONAL PIPE MATERIAL

8.1 INTRODUCTION

It is important to consider the array of materials available for culverts. After you complete the initial hydraulic design, evaluate the list of culvert materials shown in Table 6-1 of the *Drainage Manual* to choose among potential options. Chapter 3 of the *Drainage Manual* provides the roughness coefficients needed to evaluate the various materials. The evaluation must consider functionally equivalent performance in durability and structural capacity. For culvert extensions, match the existing culvert material to avoid misleading future maintenance assumptions about the type of buried pipe material. However, if the existing culvert fails a corrosion evaluation when the length of time of service is factored in or if it shows signs of deterioration, the existing culvert should be replaced or rehabilitated (e.g., lined).

8.2 DESIGN SERVICE LIFE

The Design Service Life (DSL) is the minimum number of years that a pipe is required to perform for a particular application in the design of a project. For most applications, a 100-year DSL is required. Specific DSLs for a particular highway type and culvert function are shown in Table 6-1 of the *Drainage Manual*. Refer to the example project in Section 8.5 for further guidance on choosing appropriate DSL.

Although Table 6-1 of the *Drainage Manual* provides comprehensive policy on the selection of Design Service Life, practical considerations sometimes will override the guidance material. For instance, gutter drains are listed as a 25-year DSL application, but if a gutter drain, or any other pipe, is to be located where replacement would require closure or major traffic disruption during the design life of the facility, then a longer DSL is appropriate. Any pipe that is beneath or within the soil zone that provides stability to a structural wall must have a 100-year service life due to the potential for wall damage or failure and because of the difficulty of replacing that pipe in the future.

Changing the diameter may change the Estimated Service Life (ESL) of concrete and metal pipe. This occurs because of the change in wall thickness. As the diameter of concrete and metal pipe increases, so logically does the wall thickness of the pipe. For concrete pipes, the wall thickness increases as a result of the thickness change in the cover over the reinforcing wire, and in metal pipes, the increase is due to the thicker gage metal used for larger-diameter metal pipes.

Refer to Table 6-1 in the *Drainage Manual* for culvert material applications and design service life.

8.3 DURABILITY

The requirements for DSL may vary between projects as well as within a project, depending on the highway functional classification and the application of the culvert.

The projected service life, hereafter referred to as the Estimated Service Life (ESL), of a culvert is the duration of service time after which significant deterioration is predicted to occur. After this point, you would need to consider major rehabilitation, lining, or replacement. For a material to be included in the design of a project, its ESL must meet or exceed the required DSL.

For metal pipe, the time of first perforation (complete penetration) is the service life end point. For concrete culvert, the service life ends when the culvert has experienced a corrosion-related crack in the concrete. The ESL of a specific culvert material is determined from an evaluation of the corrosiveness, based on the environmental conditions of both the soil and water, at the intended culvert site.

For plastic pipe (polyvinyl chloride [PVC], polypropylene [PP], and high density polyethylene [HDPE]), the service life is independent of the environmental conditions. The service life ends when any crack appears in the pipe. Plastic pipes sometimes crack from initial field loadings, but can also crack through a creep/rupture mechanism called slow crack growth. The ESL of plastic pipe is determined by the State Drainage Office rather than by site-specific corrosion analysis.

8.3.1 Project Corrosion Evaluation

There are several types of corrosion that may occur with metal pipes or culverts containing steel reinforcement. Some types of corrosion are more severe, and you need to address them in the design stage of a project. You will need to collect environmental data when designing a culvert system for a specific site. Corrosion rates of culverts containing metal are governed primarily by the four environmental parameters listed and discussed below; these site-specific environmental parameters are used to predict the rate of corrosion and the resultant estimated service life at the site or region of interest:

- pH
- Resistivity
- Chlorides concentration
- Sulfates concentration

pH—The measure of alkalinity or acidity. A neutral soil environment has a pH of 7. When a culvert is placed in an environment in which the pH of the soil is low (≤ 5.0) or high (≥ 9.0), the protective layers of the culvert (concrete, galvanizing, aluminizing, etc.) can weaken, leaving the metal vulnerable to early corrosion. For example, any organic material from decomposing vegetation will lower the pH of the soil.

Instances of high pH values are extremely rare. Observed pH values in virtually all soils and waters in Florida are less than 10. pH values between 5.5 and 8.5 are of no concern. pH values less than 5.5 are common in swampy areas; a pH below 5 is an aggressive environment for reinforced concrete and a pH below 4 is highly aggressive. Generally, a low pH is conducive to steel corrosion. Both a low pH and a high pH (> 8.5), coupled with low resistivity, create a corrosive environment for aluminum.

Resistivity—A measure of the electrical resistance of soils and waters. Resistivity is the inverse of conductivity. Highly conductive media tend to promote corrosion. Corrosion is an electrochemical process. For corrosion to occur, charged ions must migrate through the soil or water from a corroding area (anode) to a non-corroding area (cathode). Soils with relatively high resistivity values ($> 3,000$ Ohm-cm) impede the migration of these ions, which slows corrosion. Environments with low resistivity values ($< 1,000$ Ohm-cm) provide an easy path for ions to migrate from anode to cathode, which in turn accelerates corrosion. In general, clayey soils, organic soils, or chloride-bearing soils would tend to generate low resistivity values.

Chloride Concentration—A measure of the number of chloride ions present. Chloride ions react with and break down a protective layer on the surface of metal that otherwise protects against corrosion. When the chloride concentration is high ($> 2,000$ ppm), the protective layer breaks down quickly, leaving the metal vulnerable to corrosion. In addition, high chloride concentrations result in low resistivity values that allow easy electrical paths for ion migration and accelerated corrosion. Salt water or brackish water will be high in chloride concentrations.

Sulfate Concentration—A measure of the number of sulfate ions present. Sulfate can cause concrete components to deteriorate. If the sulfate concentration is high ($> 5,000$ ppm), concrete is vulnerable to accelerated deterioration. Sulfate ion concentrations rarely exceed 1,500 ppm in Florida; therefore, the threat sulfate ions pose is not as considerable as that of chloride ions.

Elevated chloride values typically are seen only in or near coastal areas. High sulfates can be seen anywhere but are more prevalent in coastal areas.

There are other factors that may affect service life. These factors are not the primary factors, and as such are not included in the FDOT Culvert Service Life Estimator (CSLE) Program. They are mentioned here to alert you to their potential affects.

Microbially Induced Corrosion—Microbially Induced Corrosion (MIC) is the deterioration of metals resulting from the metabolic activity of microorganisms. MIC primarily affects metal culverts, but also can affect reinforcing steel in concrete culverts. Many types of microorganisms can survive in a wide pH and temperature range. MIC often presents as corroded surfaces covered in slime, black iron sulfide deposits, algal growth, and as a rotten egg odor. The reactions generally are localized and occur at cracks, crevices, and welds. Readily available oxygen and organic carbon can increase the rate of MIC.

Industrial Effluent—Although discharge of industrial effluents to waterways is regulated, these can occur with accidental spills. Mine tailings or minable geologic formations can be a source of acidic runoff. Certain land uses—golf courses, dairy farms, farming operations, coal burning power plants, or cement plants—can all be sources of corrosive media.

Stray Electrical Current—Electric current in proximity to a pipe can induce corrosion. Sources of stray current include electrified rail lines, high-tension electric transmission lines, and cathodically protected gas transmission mains.

Abrasion—Frequent or continuous movement of rapidly flowing, turbulent water containing a bedload of sands, gravel, and debris can erode protective coatings on pipes and also erode the pipe material itself. Bedload is the portion of the total transported sediment that is carried by intermittent contact with the streambed (or culvert invert) by rolling, sliding, and bouncing. AASHTO's *Highway Design Guidelines* (2007) defines bedload by the two- to five-year return frequency. For these storm recurrences, flow velocities greater than 5 fps that carry sand bedload are considered abrasive. Velocities that exceed 15 fps and carry sand, gravel, and rock bedload are considered very abrasive. The CSLE does not include abrasion, so it is not required to be considered. However, if you determine that site and hydraulic conditions are likely to produce abrasive flow conditions, metal pipe suppliers have tables and programs online to estimate loss of wall thickness due to abrasion.

8.3.2 Project Geotechnical Investigation and Corrosion Tests

Because of the varying complexity of projects and soil conditions, it is difficult to establish a rigid format for conducting subsurface investigations. As stated in the Department's *Soils and Foundation Handbook*, "A subsurface investigation should be performed at the site of all new structure and roadway construction, and at widening, extensions, and rehabilitation locations as directed by the District Geotechnical Engineer or project scope." Typically, you would perform environmental corrosion tests, as discussed above, on soil and water at structure locations (e.g., bridge, box culvert, walls), on structural backfill material, and on subsurface materials along drainage alignments. For drainage systems parallel to roadway alignments, perform corrosion tests at maximum intervals of 1,500 feet along the project (see Section 3.2.2.6 of FDOT's [Soils and Foundation Handbook](#)). To ensure that you collect and analyze sufficient samples, coordinate with the geotechnical engineer on sample locations and depths. In addition to field review of the site and the existing culvert conditions, you can use the [NRCS Web Soil Survey](#) to help plan the soils investigation. Soil type parameters—such as pH, steel corrosion potential, and electrical conductivity—may indicate areas where you should obtain site-specific information. Test values are seasonally affected by such factors as rainfall, flooding, drought, and decaying vegetation. Whenever possible, you should perform environmental tests during periods when no unusual weather conditions exist.

Roadway plans include a "Roadway Soils Survey" sheet, as shown in Figure 8.3-1, which identifies a range of values of all tests performed. The complete geotechnical report contains test results for the specific locations sampled, and you can use these data for culvert analysis. Review the data and correlate them to actual field conditions where possible. A prediction of the actual service life of a culvert material at a particular site can be determined by the performance of a similar culvert material in the same or similar environmental condition. If the test data do not correlate with the observed culvert conditions, then request additional testing at the site in question. Ultimately, you should weight conclusive field performance more heavily than predicted service life when field performance and predicted service life disagree.

Analysis of the test data should take into consideration the most corrosive values of the native soils. However, with site-specific project environmental test data available, you won't need to use the most corrosive individual site data for the entire project or extract the most aggressive individual parameter results from the testing data to create a worst-case, project-wide condition. This over-conservatism is unwarranted and unrealistic. Instead, you can review the soil boring strata and apply test data to those locations that are most representative of the soil strata and conditions where the corrosion test data were obtained. There may be particular segments of the project where corrosive conditions exist, and other segments where the corrosion potential is low.

8.3.3 Project Pipe Service Life Estimation

Use the CSLE Program and/or the Tables and Figures in Appendix M to determine types of culvert material that have ESLs that meet or exceed the required DSL. When the DSL, pipe size, pH, resistivity, chlorides, and sulfates are input, the program provides a listing of those materials that meet the DSL. The program also provides a generated report for documentation.

An example of the CSLE input data and printout follows:

DSL: This application is to be a storm drain system that is located on a major urban facility and will function as an urban principle arterial road. The appropriate DSL for this application is 100 years.

The following data were furnished, and a field review gave no indication that these values were suspect:

pH: 7.6

Resistivity: 2,610 ohm-cm

Chlorides: 2,390 ppm

Sulfates: 1,120 ppm

Diameter (Pipe Size): 42 inches; because this is a storm drain system, an n-value of 0.012 was used.

Once the environmental parameters are entered into the CSLE, click on 'Calculate' to obtain results from the environmental check. Any time inputs are changed, the Results are cleared and the Calculate button must be clicked on to obtain new results.

Figure 8.3-2 illustrates materials you would use in performing the structural analysis.

Drainage Design Guide
Chapter 8: Optional Pipe Material

Environmental Check

Design Life: Years

Max Allowable Manning's (n) Value: < 0.017 >= 0.017

pH: Slider

Resistivity: Ohm-cm Slider

Chlorides: ppm Slider

Sulfates: ppm Slider

Diameter: Inches Slider

Structural Check

Jack and Bore

[Reset Form](#) [Calculate](#)

Pipe Results Add Job Information and Generate PDF

| Gage | Type of Culvert | Service Life | Environmental Check | Structural Check |
|----------------------------------|---|--------------|---------------------|------------------|
| Pass | | | | |
| <input type="button" value="Q"/> | 14 (SRAP) Aluminum - Spiral Rib | 226 | Pass | |
| <input type="button" value="Q"/> | (RCP) Steel-Reinforced Concrete Ellipse | 121 | Pass | |
| <input type="button" value="Q"/> | (RCP) Steel-Reinforced Concrete Round | 121 | Pass | |
| <input type="button" value="Q"/> | 14 (SRASP) Aluminized Steel - Spiral Rib | 108 | Pass | |
| <input type="button" value="Q"/> | (HDPE) High Density Polyethylene, CL II | 100 | Pass | |
| <input type="button" value="Q"/> | (PP) Polypropylene - Class II | 100 | Pass | |
| Fail | | | | |
| <input type="button" value="Q"/> | (HDPE) High Density Polyethylene, CL I - Unavailable in this size or not suitable for use | | Fail | |
| <input type="button" value="Q"/> | (NRCP) Non-Reinforced Concrete - Unavailable in this size or not suitable for use | | Fail | |
| <input type="button" value="Q"/> | (PP) Polypropylene - Class I - Unavailable in this size or not suitable for use | | Fail | |
| <input type="button" value="Q"/> | (PVC) Polyvinyl Chloride, ASTM F-949 - Unavailable in this size or not suitable for use | | Fail | |
| <input type="button" value="Q"/> | (SRPE) Steel Reinforced Polyethylene Pipe - Corrugated - Unavailable in this size or not suitable for use | | Fail | |
| <input type="button" value="Q"/> | (SRPE) Steel Reinforced Polyethylene Pipe - Ribbed | | Fail | |
| <input type="button" value="Q"/> | (SRSP) Galvanized Steel - Spiral Rib - Unavailable in this size or not suitable for use | | Pass | |

Figure 8.3-2

Each material has a magnifying glass icon next to it that can be clicked on for additional information. The colored lines indicate warnings: a yellow highlight indicates a warning concerning environmental data; a red highlight indicates a warning based on the structural data [Appendix C of the *Drainage Manual*].

The program allows you to print and save a PDF with the inputs and results by clicking on the 'Add Job Information and Generate PDF' button. This feature allows you to maintain the site data, but vary the corrosion parameters, pipe size, or roughness coefficient then re-analyze and print unique output files. The printouts are intended for use as documentation of the analyses. See Figure 8.3-3.



Florida Department of Transportation

Culvert Service Life Estimator - Version 2.0

(Generated Wednesday, May 18th 2022, 1:29:50 pm)

| Job Information | | | |
|-----------------|-------------------------------|-------------------------|--------|
| Project Name: | Optional Materials Example #1 | FM Number: | N/A |
| Section Number: | N/A | Structure Number: | S-0 |
| County: | Hollywood | Boring Number/Location: | B-1/85 |
| Station | 00+00 | Designer | TH |

| Environmental Data | | | |
|---------------------------|---------|-----------------------|------|
| Design Life (Years) | 100 | pH | 7.8 |
| Max Allowable Manning's n | < 0.017 | Resistivity (Ohms-cm) | 2610 |
| Diameter (Inches) | 42 | Chlorides (ppm) | 2390 |
| | | Sulphates (ppm) | 1120 |

| Gage | Type of Culvert | Service Life | Environmental | Structural |
|---------------|--|--------------|---------------|------------|
| Passed | | | | |
| 14 | (SRAP) Aluminum - Spiral Rib (1) | 226 | Pass | |
| | (RCP) Steel-Reinforced Concrete Ellipse | 121 | Pass | |
| | (RCP) Steel-Reinforced Concrete Round | 121 | Pass | |
| 14 | (SRASP) Aluminized Steel - Spiral Rib | 108 | Pass | |
| | (HDPE) High Density Polyethylene, CL II (2) | 100 | Pass | |
| | (PP) Polypropylene - Class II | 100 | Pass | |
| Failed | | | | |
| | (HDPE) High Density Polyethylene, CL I - Unavailable in this size or not suitable for use | | Fail | |
| | (NRCP) Non-Reinforced Concrete - Unavailable in this size or not suitable for use | | Fail | |
| | (PP) Polypropylene - Class I - Unavailable in this size or not suitable for use | | Fail | |
| | (PVC) Polyvinyl Chloride, ASTM F-949 - Unavailable in this size or not suitable for use | | Fail | |
| | (SRPE) Steel Reinforced Polyethylene Pipe - Corrugated - Unavailable in this size or not suitable for use | | Fail | |
| | (SRPE) Steel Reinforced Polyethylene Pipe - Ribbed | | Fail | |
| | (SRSP) Galvanized Steel - Spiral Rib - Unavailable in this size or not suitable for use | | Pass | |
| (1) | Special Installation required. Refer to AASHTO Standard Specifications for Highway Bridges or ASTM B788-88 and manufacturer's recommendations. | | | |
| (2) | HDPE not allowed in the Florida Keys for 100 year service life. No restrictions for 50 year service life. | | | |

Figure 8.3-3

Give no additional consideration to one material over another having less service life if all meet the minimum required. In looking at the printout, culverts made from steel-reinforced concrete, aluminum, aluminized steel, polypropylene class II, and high density polyethylene class II all meet the 100-year DSL. If the DSL was 50 years, then additional materials may be allowable.

Pipe size affects materials by invoking different gages of metal pipes. Additionally, pipe size affects the life of reinforced concrete pipe because, with larger diameters, the wall thickness increases, as does the cover over the reinforcing steel. See Figure 8.3-4 for allowable materials when the pipe size is reduced to 24 inches, given the same corrosion parameters and DSL as the previous example. Reinforced concrete pipe is no longer allowable, whereas non-reinforced concrete pipe is allowable. The gage of spiral-ribbed aluminized pipe (SRAP) has changed because of the smaller diameter, and PVC is now an allowable option because it is available in the smaller diameter.

Environmental Check

| | | |
|---|-------------|--|
| Design Life | pH | 7.6 |
| 100 <input type="button" value="Years"/> | | <input type="range"/> |
| Max Allowable Manning's (n) Value | Resistivity | 2610 <input type="button" value="Ohm-cm"/> |
| <input checked="" type="radio"/> < 0.017 <input type="radio"/> >= 0.017 | | <input type="range"/> |
| | Chlorides | 2390 <input type="button" value="ppm"/> |
| | | <input type="range"/> |
| | Sulfates | 1120 <input type="button" value="ppm"/> |
| | | <input type="range"/> |
| | Diameter | 24 <input type="button" value="Inches"/> |
| | | <input type="range"/> |

Structural Check

Jack and Bore

Pipe Results Add Job Information and Generate PDF

| Gage | Type of Culvert | Service Life | Environmental Check | Structural Check |
|----------------------------------|---|--------------|---------------------|------------------|
| Pass | | | | |
| <input type="button" value="Q"/> | (NRCP) Non-Reinforced Concrete | 360 | Pass | |
| <input type="button" value="Q"/> | 16 (SRAP) Aluminum - Spiral Rib | 181 | Pass | |
| <input type="button" value="Q"/> | 14 (SRASP) Aluminized Steel - Spiral Rib | 108 | Pass | |
| <input type="button" value="Q"/> | (HDPE) High Density Polyethylene, CL II | 100 | Pass | |
| <input type="button" value="Q"/> | (PP) Polypropylene - Class II | 100 | Pass | |
| <input type="button" value="Q"/> | (PVC) Polyvinyl Chloride, ASTM F-949 | 100 | Pass | |
| Fail | | | | |
| <input type="button" value="Q"/> | (HDPE) High Density Polyethylene, CL I - Unavailable in this size or not suitable for use | | Fail | |
| <input type="button" value="Q"/> | (PP) Polypropylene - Class I - Unavailable in this size or not suitable for use | | Fail | |
| <input type="button" value="Q"/> | (RCP) Steel-Reinforced Concrete Ellipse - Unavailable in this size or not suitable for use | | Fail | |
| <input type="button" value="Q"/> | (RCP) Steel-Reinforced Concrete Round - Unavailable in this size or not suitable for use | | Fail | |
| <input type="button" value="Q"/> | (SRPE) Steel Reinforced Polyethylene Pipe - Corrugated - Unavailable in this size or not suitable for use | | Fail | |
| <input type="button" value="Q"/> | (SRPE) Steel Reinforced Polyethylene Pipe - Ribbed - Unavailable in this size or not suitable for use | | Fail | |
| <input type="button" value="Q"/> | (SRSP) Galvanized Steel - Spiral Rib - Unavailable in this size or not suitable for use | | Pass | |

Figure 8.3-4

8.3.4 Special Cases (Jack and Bore Casings, Ductile Iron Pipe, any Ferrous Metals)

When installing a culvert by jacking and boring instead of open cutting, use the jacked and bored casing as the conveyance pipe except under railroads or in high-pressure designs. Coordinate with the District Rail Administrator and the railroad for design requirements.

You should specify jack-and-bore installation on high AADT roadways, railroads, or in areas where open cut for installation or repair causes significant impacts on users. If the need to install a culvert using jack-and-bore technology was determined after the roadway soils investigation was made, additional soil borings may be necessary. Determine soil conditions along the jack-and-bore alignment so that you can evaluate the feasibility of jack-and-bore installation or of micro-tunneling. You will need corrosion data to estimate service life.

Because jack-and-bore locations typically have a high AADT, this service life estimation example will assume a 100-year DSL. Use the following steps to determine the casing requirements.

1. Run the Culvert Service Life Estimator Program or use the figures or tables in Appendix M with site-specific environmental parameters. If the casing or pipe will be exposed to water (surface or ground) for extended periods of time, compare the environmental parameters of the water with those of the soil. Use the test results that produce the shortest service life for the galvanized steel option. Note that when using the CSLE Program, reduce the DSL as needed for the galvanized steel option (corrugated steel pipe [CSP] or spiral rib steel pipe [SRSP]) to show up as an allowable option. Although the required DSL may be 100 years, you must first obtain the service life for the particular corrosion parameters, or you can use Figure M1 to determine estimated service life.
2. To be conservative, deduct 10 years from the ESL of the galvanized steel option generated by the program (or determined by service life tables/figures).
3. Determine the pitting rate by dividing the wall thickness of the galvanized steel option estimated by the program by the estimated service life determined in Step 2 (ESL – 10 years). From the *Drainage Manual*, Appendix C, identify the wall thickness of the gage pipe called out on the output.

$$\text{Pitting Rate} = \frac{\text{Gage Thickness}}{\text{ESL (years)}} = \frac{0.\text{xxx inches}}{\text{year}}$$

Knowing the pitting rate, you can determine the required wall thickness by multiplying the DSL for the application by the pitting rate.

Required wall thickness = Pitting rate x (DSL)

Using the galvanized steel option shown on Figure 8.3-5:

Drainage Design Guide
Chapter 8: Optional Pipe Material

Environmental Check

Design Life

50 ▼ Years

Max Allowable Manning's (n) Value

< 0.017 >= 0.017

pH: 7.6

Resistivity: 2610 Ohm-cm

Chlorides: 2390 ppm

Sulfates: 1120 ppm

Diameter: 42 Inches

Structural Check

Jack and Bore

[Reset Form](#) [Calculate](#)

Pipe Results

| | Gage | Type of Culvert | Service Life | Environ |
|----------------------------------|------|---|--------------|---------|
| Pass | | | | |
| <input type="button" value="Q"/> | 14 | (SRAP) Aluminum - Spiral Rib | 226 | Pass |
| <input type="button" value="Q"/> | | (RCP) Steel-Reinforced Concrete Ellipse | 121 | Pass |
| <input type="button" value="Q"/> | | (RCP) Steel-Reinforced Concrete Round | 121 | Pass |
| <input type="button" value="Q"/> | | (HDPE) High Density Polyethylene, CL II | 100 | Pass |
| <input type="button" value="Q"/> | | (PP) Polypropylene - Class II | 100 | Pass |
| <input type="button" value="Q"/> | 16 | (SRASP) Aluminized Steel - Spiral Rib | 83 | Pass |
| <input type="button" value="Q"/> | 14 | (SRSP) Galvanized Steel - Spiral Rib | 57 | Pass |
| <input type="button" value="Q"/> | | (HDPE) High Density Polyethylene, CL I | 50 | Pass |
| <input type="button" value="Q"/> | | (PP) Polypropylene - Class I | 50 | Pass |
| Fail | | | | |
| <input type="button" value="Q"/> | | (NRC) Non-Reinforced Concrete - Unavailable in this size or not suitable for use | | Fail |
| <input type="button" value="Q"/> | | (PVC) Polyvinyl Chloride, ASTM F-949 - Unavailable in this size or not suitable for use | | Fail |
| <input type="button" value="Q"/> | | (SRPE) Steel Reinforced Polyethylene Pipe - Corrugated | | Fail |
| <input type="button" value="Q"/> | | (SRPE) Steel Reinforced Polyethylene Pipe - Ribbed | | Fail |

Design Service Life reduced to 50 to find Service Life value for environmental parameters

Figure 8.3-5

Estimated service life for galvanized steel culvert = 57 years

Deduct 10 years from this: 57 years – 10 years = 47 years

14 gage = 0.079 inches (thickness of 14 gage galvanized steel culvert per *Drainage Manual*, Appendix C)

Therefore, the pitting rate = $0.079/47 = 0.00168$ inches/year

Minimum required wall thickness = 100 years (DSL) x 0.00168 (pitting rate) = 0.1681 inches

Note that the pitting rate determined when other DSLs are input and resultant service lives are obtained will be approximately the same. For example, if a DSL of 25 years is input in the above example, the gage of SRSP allowed is 16 (0.064 inch), with a corresponding service life of 46 years. This results in a pitting rate of 0.00177 inches/year.





In summary, you would need to use a steel casing with a wall thickness of at least 0.17 inches. In the plans, include a note such as: "For corrosion purposes, steel casing must have a minimum wall thickness of 0.17 inches."

The required wall thickness is for corrosion purposes only. Typically, you will need greater wall thicknesses for the structural loadings associated with the jacking of the steel casing. The CSLE program has a checkbox option for "Jack and Bore"; the window will show the approximate wall thickness of pipe suitable for jack and bore and the associated service life. The Default metal thickness shown is that of a typical steel pipe that you would use for jack and bore. The program uses the thickest galvanized steel pipe gage to determine the pitting rate (even if that particular gage is not available in the given size). That pitting rate is applied to the typical jack and bore pipe wall thickness to estimate service life. If the ESL of the jack-and-bore casing pipe is less than that required, select the "Service Life" option and enter the service life value to calculate metal thickness. The print output from the 'Generate Jack and Bore PDF' button contains the pitting rate analysis, pipe size, and the corrosion data.

The minimum thickness that meets service life is that determined by the pitting rate equation. Show the thickness in the construction plans with a note stating it is the minimum thickness to meet service life. The contractor is responsible for determining the wall thickness required for the jack-and-bore pipe to meet Specification 556.

For the example shown in Figure 8.3-6, the minimum metal thickness based on service life is thicker than the typical jack-and-bore pipe because of the aggressive environmental parameters. For this case, an interior carrier pipe should be installed that meets service life and structural requirements.

Environmental Check

| | | |
|---|-------------|---|
| Design Life | pH | 5.2 |
| 50 ▼ Years | |  |
| Max Allowable Manning's (n) Value | Resistivity | 2610 Ohm-cm |
| <input checked="" type="radio"/> < 0.017 <input type="radio"/> >= 0.017 | |  |
| | Chlorides | 2390 ppm |
| | |  |
| | Sulfates | 1120 ppm |
| | |  |
| | Diameter | 42 Inches |
| | |  |

Structural Check

Jack and Bore

Analysis of Jack & Bore steel casing is dependent on the Environmental Check settings above. The environmental check culvert diameter, pH, and resistivity is used as part of this calculation.

| | |
|--|--|
| Parameter Options <input type="radio"/> Default <input checked="" type="radio"/> Service Life <input type="radio"/> Metal Thickness | Service Life 100 Years |
| | Metal Thickness 0.6 Inches |

Generate Jack and Bore PDF

Reset Form
Calculate

Figure 8.3-6

The printout for this jack-and-bore service life analysis is shown in Figure 8.3-7.



Florida Department of Transportation

Culvert Service Life Estimator - Version 2.0

(Generated Wednesday, October 19th 2022, 10:22:44 am)

| Environmental Data | | | |
|---------------------------|---------|-----------------------|------|
| Design Life (Years) | 50 | pH | 5.2 |
| Max Allowable Manning's n | < 0.017 | Resistivity (Ohms-cm) | 2610 |
| Diameter (Inches) | 42 | Chlorides (ppm) | 2390 |
| | | Sulphates (ppm) | 1120 |
| | | | |

| Service Life of Jack and Bore Steel Casing | |
|---|----------|
| 1. Data from Service Life Estimator | |
| Galvanized Steel Service Life (Years) | 38 |
| Gage | 8 |
| 2. Deduct 10 Years From Galvanized Steel Option | |
| Service Life (Years) | 38 |
| Service Life Minus 10 Years | 28 |
| 3. Pitting Rate Analysis (Inches/Year) = Gage Thickness / Service Life | |
| Gage Thickness (Inches) | 0.168 |
| Service Life (Years) | 28 |
| Pitting Rate (Inches/Year) | 0.006 |
| 4. Determine Casing Pipe Service Life | |
| Casing Thickness (Inches) | 0.5 |
| Pitting Rate (Inches/Year) | 0.006002 |
| Steel Casing Service Life (Years) | 83.3 |

Figure 8.3-7

When using the casing alone is not allowed, you should place a note disallowing this practice in the plans to communicate to the Contractor that a VECP (Value Engineering Change Proposal) eliminating the interior pipe will not be approved.

8.4 PIPE STRUCTURAL EVALUATION

After performing the corrosion analysis, the next step in determining the allowable optional material is to determine the acceptability and structural adequacy of these materials. If the pipe is within a walled embankment area—“Wall Zone” as illustrated in the *Drainage Manual*, Appendix D—then the pipe material considered must be within the Wall Zone Pipe column in Table 6-1 of the *Drainage Manual*. All acceptable material types must be evaluated for anticipated loads on the pipe. The *Drainage Manual*, Appendix C, contains cover height tables for the various pipe materials. The information provided in Appendix C was developed based on criteria found in AASHTO *LRFD Bridge Design Specifications*, Section 12.

For each of the acceptable pipe materials based on the corrosion analysis and pipe location within the embankment, verify that the depth of backfill over the pipe is between the minimum and maximum fill heights in the appropriate table in the *Drainage Manual*, Appendix C. If the cover height is outside the limits, the following options are available:

1. Adjust the flow line of the pipe as long as this adjustment does not violate any other design criteria.
2. Increase the gage of metal pipe or the class of concrete pipe. For metal pipe, verify that the specified gage thickness is available for the corrugation specified.
3. Eliminate the material as an option for the job.

The *FDM* requires that you call out all the acceptable types of pipe materials in the plan. You can establish the required class of concrete, or gage and corrugation for metal pipe, using the CSLE program or the service life tables/figures in Appendix M, and the *Drainage Manual*, Appendix C. The tables in Appendix C have been incorporated into the CSLE; however, you will need to back check the results of the CSLE structural check against the tables in Appendix C for final verification. Generally, it is more efficient to look at the tables when determining the structural suitability than to input discrete height values in the Structural Check option of the CSLE. The tables allow you to readily see the lower and upper limits of allowable cover, whereas the CSLE output provides only a “pass” or “fail” for a particular value.

For example, given the allowable pipe materials shown in Figure 8.3-2, find the pipes that are structurally sufficient for a minimum fill height of 23 inches and maximum fill height of 25 feet.

Drainage Design Guide
Chapter 8: Optional Pipe Material

Using the CSLE program with corrosion data and DSL shown on Figure 8.3-2, click on the box next to “Structural Check.” A window drops down for input of pavement type, cover thickness, and pavement thickness. The cover thickness here is input to the flowline of the pipe whereas the cover is shown to the outside crown of the pipe in the Appendix C tables. Pavement thickness is only the thickness of the asphalt or concrete, and does not include the base or subbase. Input a pipe depth of 68 inches (from finished grade to pipe flowline), and 3 inches for the thickness of flexible asphalt pavement and click “Calculate”. The CSLE program results in the elimination of HDPE, and PP pipe (Figure 8.4-1). Referring to the *Drainage Manual*, Appendix C, the table for Plastic Pipe, you can see that the minimum cover from top of base course to top of pipe is 24 inches for both HDPE and PP pipe. Based on our inputs to the CSLE program, the cover is $[(68-3)-(42)] = 23$ inches, not including deduction for pipe wall thickness. The Appendix C table for SRAP shows minimum cover of 21 inches for the 42-inch diameter, 14 gage pipe. Referring to the respective tables for the remaining allowable materials, we find that 12 inches is the minimum cover for both round and elliptical concrete, as well as for the SRSP (SRASP has the same **structural** properties as SRSP).

Environmental Check

| | |
|---|---|
| <p>Design Life: <input type="text" value="100"/> Years</p> <p>Max Allowable Manning's (n) Value: <input checked="" type="radio"/> < 0.017 <input type="radio"/> >= 0.017</p> | <p>pH: <input type="text" value="7.6"/></p> <p>Resistivity: <input type="text" value="2610"/> Ohm-cm</p> <p>Chlorides: <input type="text" value="2390"/> ppm</p> <p>Sulfates: <input type="text" value="1120"/> ppm</p> <p>Diameter: <input type="text" value="42"/> Inches</p> |
|---|---|

Structural Check

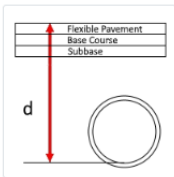
| | |
|---|---|
| <p>Cover Type: <input type="text" value="Flexible Pavement"/></p> <p>Cover thickness measured from the bottom inside radius of the pipe.</p> <div style="text-align: center;">  </div> | <p>Cover thickness (d) measured from flow line of pipe: <input type="text" value="68"/> Inches</p> <p>Asphalt Pavement Thickness: <input type="text" value="3"/> Inches</p> |
|---|---|

Jack and Bore

Drainage Design Guide
Chapter 8: Optional Pipe Material

Pipe Results Add Job Information and Generate PDF













| Gage | Type of Culvert | Service Life | Environmental Check | Structural Check |
|--|---|--------------|---------------------|------------------|
| Pass | | | | |
|  | 14 (SRAP) Aluminum - Spiral Rib | 226 | Pass | Pass |
|  | (RCP) Steel-Reinforced Concrete Round, CL I | 121 | Pass | Pass |
|  | 14 (SRASP) Aluminized Steel - Spiral Rib | 108 | Pass | Pass |
| Fail | | | | |
|  | (HDPE) High Density Polyethylene, CL I - Unavailable in this size or not suitable for use | | Fail | Fail |
|  | (HDPE) High Density Polyethylene, CL II | | Pass | Fail |
|  | (NRCP) Non-Reinforced Concrete - Unavailable in this size or not suitable for use | | Fail | Fail |
|  | (PP) Polypropylene - Class I - Unavailable in this size or not suitable for use | | Fail | Fail |
|  | (PP) Polypropylene - Class II | | Pass | Fail |
|  | (PVC) Polyvinyl Chloride, ASTM F-949 - Unavailable in this size or not suitable for use | | Fail | Fail |
|  | (SRPE) Steel Reinforced Polyethylene Pipe - Corrugated - Unavailable in this size or not suitable for use | | Fail | Fail |
|  | (SRPE) Steel Reinforced Polyethylene Pipe - Ribbed | | Fail | Pass |
|  | (SRSP) Galvanized Steel - Spiral Rib - Unavailable in this size or not suitable for use | | Pass | Fail |

Figure 8.4-1

Minimum cover and maximum fill heights obtained from the tables in the *Drainage Manual*, Appendix C, are summarized in Table 8.4-1 for the acceptable materials shown in Figure 8.3-2.

Table 8.4-1 Example Project Minimum Cover and Maximum Fill Heights

| Allowable material for 42-inch diameter, minimum DSL = 100 years | Appendix C Allowable minimum cover (in.) | Appendix C Allowable maximum fill height (ft.) to finished grade |
|---|---|---|
| 14 gage SRAP | 21; from top of base | 25 ft; special installation |
| Reinforced Concrete Pipe (RCP); Typical Dry Cast | 12; from finished grade | 21 ft to 33 ft; CL IV pipe required |
| RCP; Elliptical Only | 12; from finished grade | max 25 ft; CL HE-IV required |
| 14 gage SRASP (use SRSP table) | 12; from top of base | 54 ft |
| HDPE CL II | 24; from top of base | 13 ft |
| Polypropylene | 24; from top of base | 15 ft |

Preparing a table with the allowable materials and their minimum cover and maximum fill height allows one to quickly ascertain where the materials can be used within the project if locations of the minimum cover and maximum fill are known. Plastic pipe would not be acceptable for installation where the minimum cover is less than 24 inches, and fill heights are greater than 13 feet, but there may be many locations throughout the project where plastic pipe installation would be within the allowable structural limits. That is why it is more efficient to use the tables directly rather than use the CSLE for the structural check.

Note that the fill heights shown in the *Drainage Manual*, Appendix C, are calculated using a very conservative approach. In those cases where you encounter very high or very shallow fill heights, you can use methods set forth in AASHTO LRFD *Bridge Design Specifications*, Section 12. Where you must locate pipes within close proximity to walled embankment areas of any type, review the figures in the *Drainage Manual*, Appendix D, to determine what limitations are imposed on pipe location and material. The figures in Appendix D show Wall Zones A, B, and C. Wall Zone criteria allow both longitudinal and transverse Wall Zone Pipe (as listed in the *Drainage Manual*, Table 6-1) in Wall Zone A. You are allowed to use Transverse Wall Zone Pipe conveyances in Wall Zone B, and you may not use pipe conveyances of any type in Wall Zone C. A few of the figures in Appendix D are reproduced here, with examples of where you may place pipes. Wherever possible, it is best to avoid pipe placement in any of the Wall Zones.

Figure 8.4-2 shows a mechanically stabilized earth (MSE) wall at a bridge abutment on shallow foundation and on deep foundation. Wall Zone B extends under the deep foundation whereas Wall Zone C (no pipes) extends under the shallow foundation. The figure shows pipes only within the allowable zones.

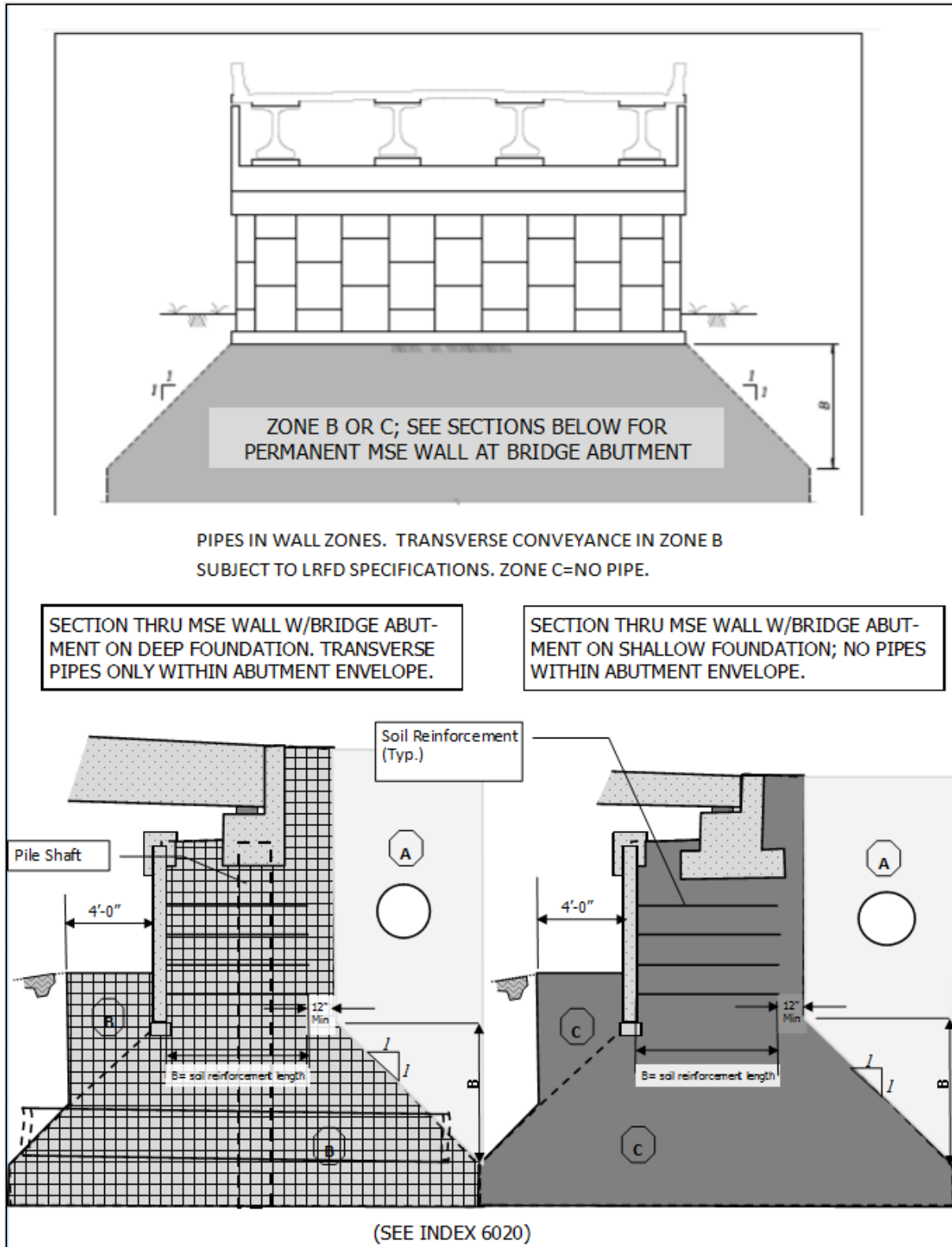

Figure 8.4-2

Another example of pipe within MSE Wall Zone is shown in Figure 8.4-3. Longitudinal conveyances are shown in Wall Zone A. Even though the pipe to the left of the wall is only partially within Wall Zone A, it must meet the Wall Zone pipe requirements. If right of way allows, this pipe should be aligned fully outside of Wall Zone A. The pipe that is within the wall fill embankment can run longitudinally only within the top five feet. Minimize longitudinal runs of pipe in Wall Zone A to the greatest extent practicable. Where inlets are required that would extend into Wall Zone B, the preference would be to outfall transversely to a trunk line located outside of the wall zones. If this is not feasible, then you could use a deeper structure to allow the pipe to outfall transversely through or under the wall; these configurations are not ideal. Any structure or pipe within the reinforcement strap zone must be coordinated with the wall designer.

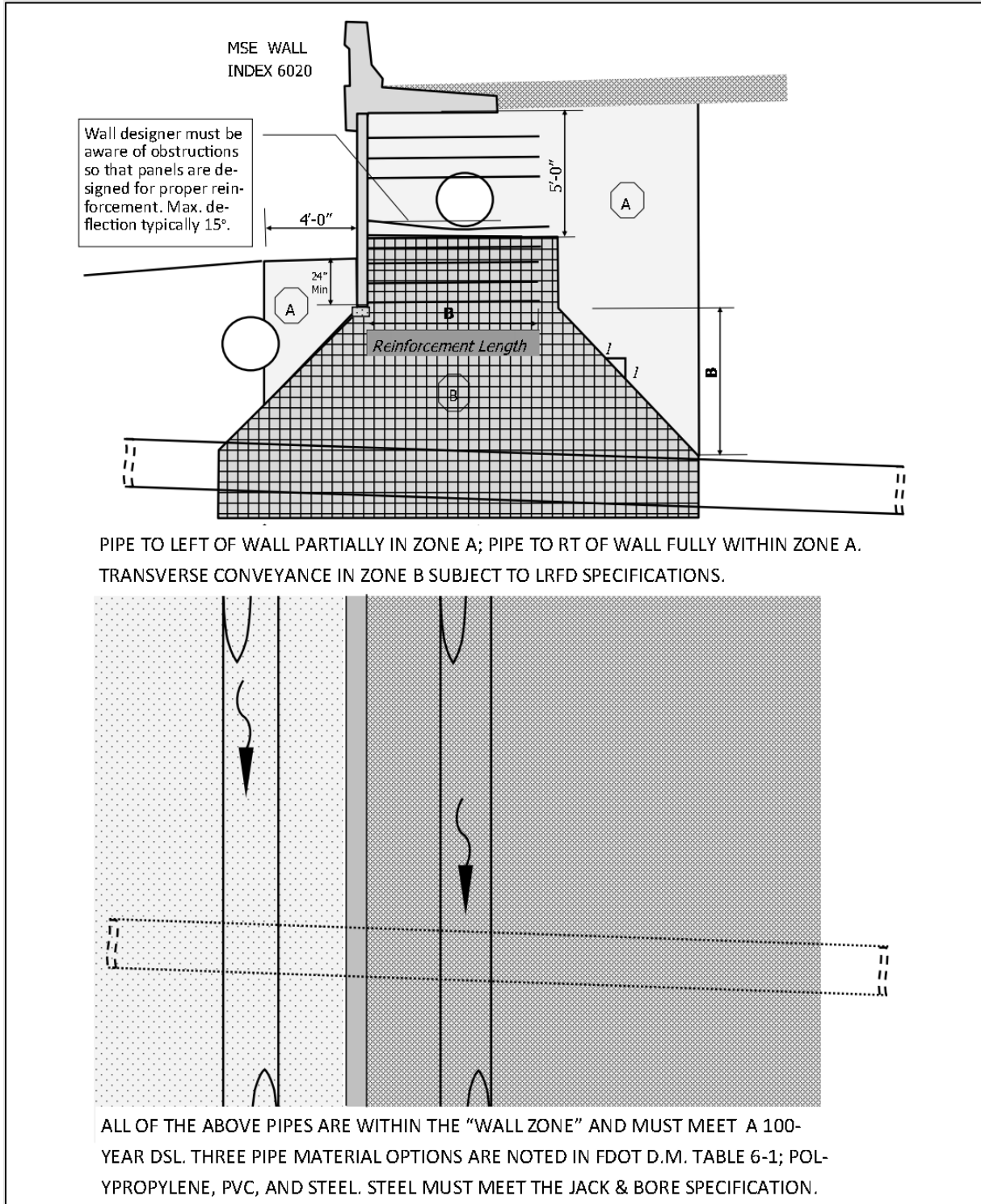

Figure 8.4-3

Figure 8.4-4 shows a gravity wall and its associated wall zones. Ascertain the wall scheme proposed (there are other schemes) to ensure that any proposed drainage structures meet the wall zone criteria.

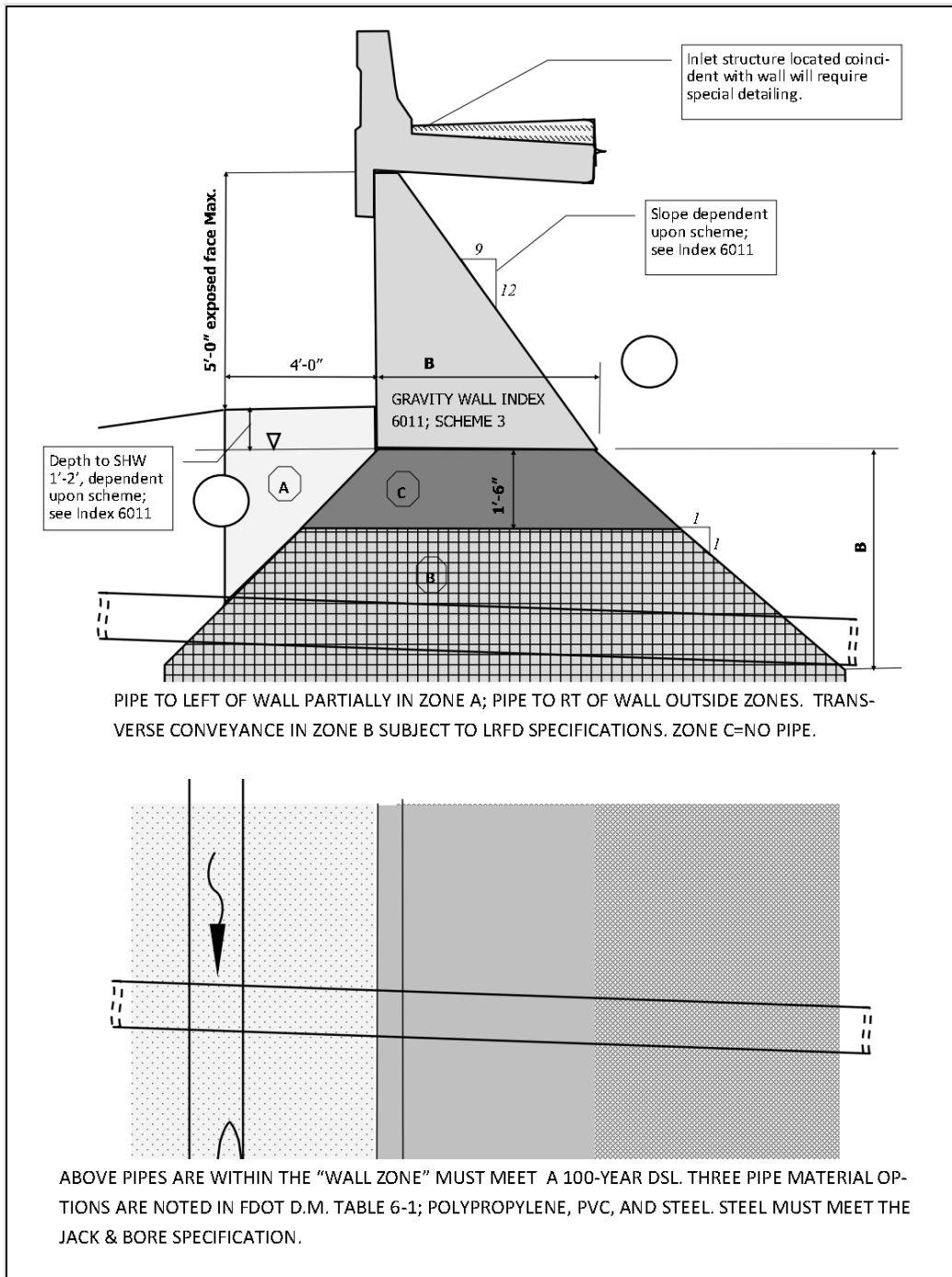

Figure 8.4-4

Figure 8.4-5 shows wall zones associated with a cantilever wall. Note that this configuration, as well as all supporting walls on shallow foundation, has a no-pipe zone, i.e. Wall Zone C, which is directly under the structure and extends out in a trapezoidal shape below the structure. The depth of the trapezoid is dependent upon the particular structure.

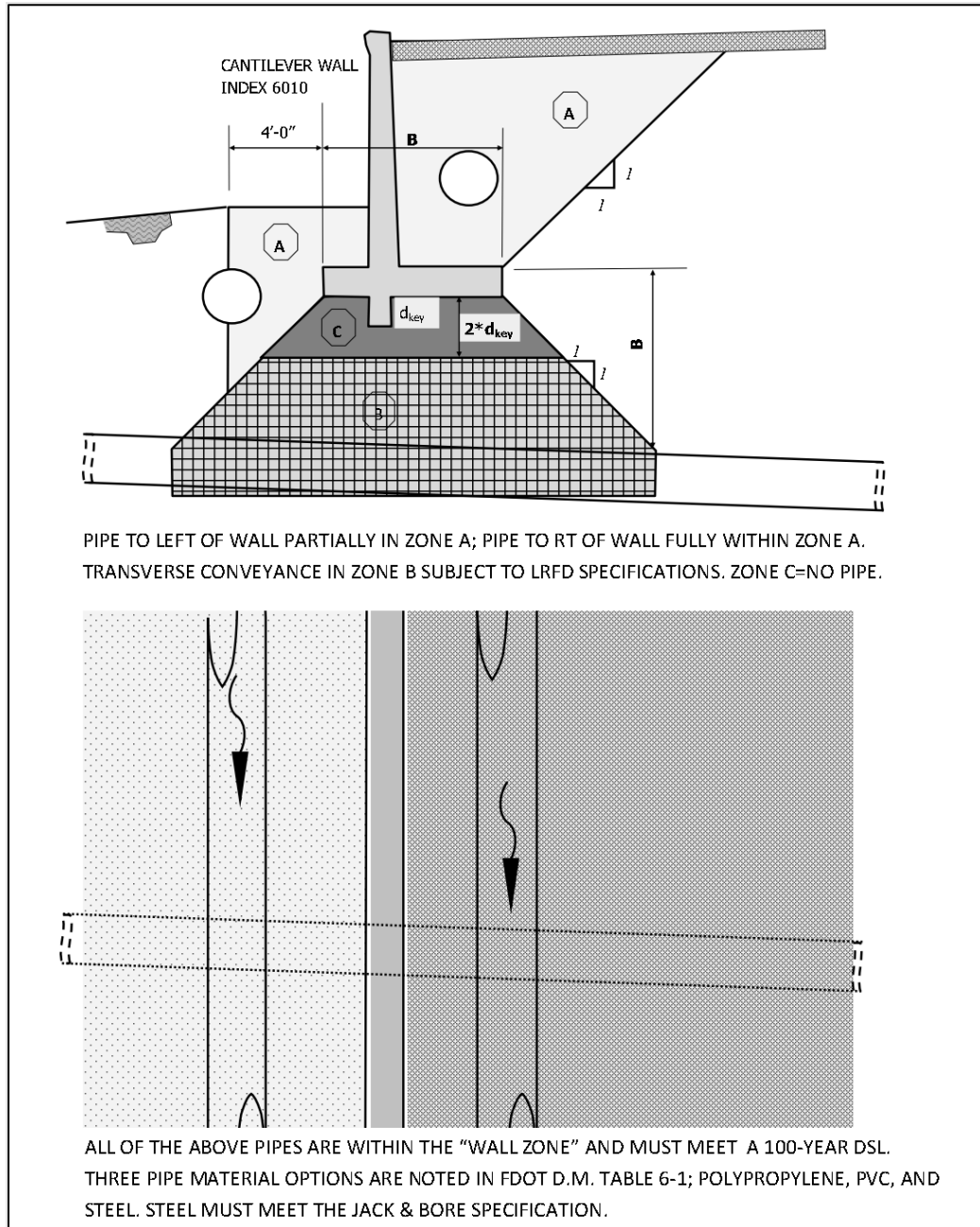

Figure 8.4-5

8.5 DOCUMENTATION

You are required to provide justification if you allow or eliminate a pipe material. You can find documentation requirements in Chapter 6 of the *Drainage Manual*. Requirements include the Design Service Life required for the application, environmental data, and the results of the structural evaluation.

The CSLE program provides an excellent form of corrosion analysis documentation in the printout. The printout documents the site specific environmental parameters, the ESL, and the materials that fail to meet or exceed the DSL. Also, you can add further comments for documentation purposes. An example of additional comments would be: “not allowed per *Drainage Manual*, Appendix C,” “minimum cover not available,” or “maximum cover exceeded.”

8.5.1 Project Example Considering all Potential Pipe Applications

The project consists of widening and resurfacing a state road in northern Leon County, Florida. This particular section of roadway contains both rural and urban sections. The urban section occurs where the roadway approaches and crosses an arterial roadway. The AADT for the roadway within the project limits is 1,500. The roadway project includes widening for bike lanes and turning lanes. You conducted a field review prior to final design; you observed all culverts and side drains for signs of deterioration, siltation, and erosion. All were in reasonably good condition given their current 40-year time of service. The project design includes the following applications:

- Side drain
- Cross drain (replacement and extensions)
- Storm drain
- Wall Zone Pipe
- Gutter drain
- French drain

For this example, each application will be addressed and will include a determination of the design service life, commonly asked questions, and proposed solutions to those questions.

8.5.1.1 Side Drains under Driveways

Due to widening of the roadway, all existing side drains are affected. Referring to Table 6-1, we locate the Side Drain column. From the table, we see that all highway side drains require a 25-year design service life, and that all but three of the listed materials (fiberglass, steel (J&B), and ductile iron) may be applicable.

Check the hydraulics at typical locations to determine if materials with N-values of 0.020 or greater should be included. Generally, if the hydraulic evaluation indicates the structure is outlet controlled, only those materials with N-values equal to 0.012 need be considered. In this case, the roadside ditches have minimal longitudinal slope and hydraulic evaluations of a typical location showed the culvert operated in outlet control, so only materials with $N = 0.012$ are suitable hydraulically. (See Cross Drains for side drains under side streets.) The design calculations result in pipe sizes that include 18-inch, 24-inch, and 30-inch.

Soil corrosion data obtained at shallow depths along the project were fairly consistent and are shown in Table 8.5-1.

Table 8.5-1. Soil Corrosivity Data for Example

| Station | Boring # | pH | Resistivity | Chlorides | Sulfates |
|---------|----------|-----|-------------|-----------|----------|
| 527+50 | A-1 | 5.6 | 32000 | 20 | 108 |
| 592+00 | A-2 | 6.6 | 9500 | 20 | 118 |
| 610+00 | A-3 | 6.8 | 17000 | 20 | 20 |

You can enter the information for each site into the CSLE program, or you can use the tables or figures in Appendix M to determine suitability for the 25-year DSL. Let's use the figures to more quickly evaluate these three sets of test data. Looking at the tables and figures, we can see that the environmental parameters that affect steel and aluminum are pH and Resistivity. Those that affect reinforced concrete are pH, Chlorides, and Sulfates. This example shows some of the Figures and Tables in Appendix M as Figures 8.5-1 through 8.5-4.

From Figure 8.5-1, we see that—as long as the pH is above 5.5 and the resistivity is above 9,000—the DSL of 25 years is met for 16-gage galvanized steel. For 16-gage aluminized steel, Type II, we see on Figure 8.5-2 that the 25-year service life is met for pH between 4.5 and 9, with resistivity greater than 1,500. Figure 8.5-3 reflects the service life of 16-gage aluminum pipe; we can see that low resistivity values (<5,000) with pH values lower than 6 or higher than 8 adversely affect the service life of aluminum. In our case, the pH values range from 5.5 to 6.8 and the resistivity values are all greater than 9,000; therefore, the required DSL is met.

We will use the table in Figure 8.5-4 to evaluate the suitability of reinforced concrete pipe. The table shows that service life decreases with increasing chloride concentrations and as pH drops below 6. If sulfate concentrations go above 1,500 ppm, the service life should be discounted as noted. Since all chloride values from the samples are 20 ppm or below, there is no adverse effect on reinforced concrete. However, the table values are for 60-inch pipe, which has a thick pipe wall. To estimate service life for 18-inch pipe, the service life of 360 years must be multiplied by 0.36. The minimum service life anticipated for reinforced concrete pipe on this project is, therefore, approximately 130 years.

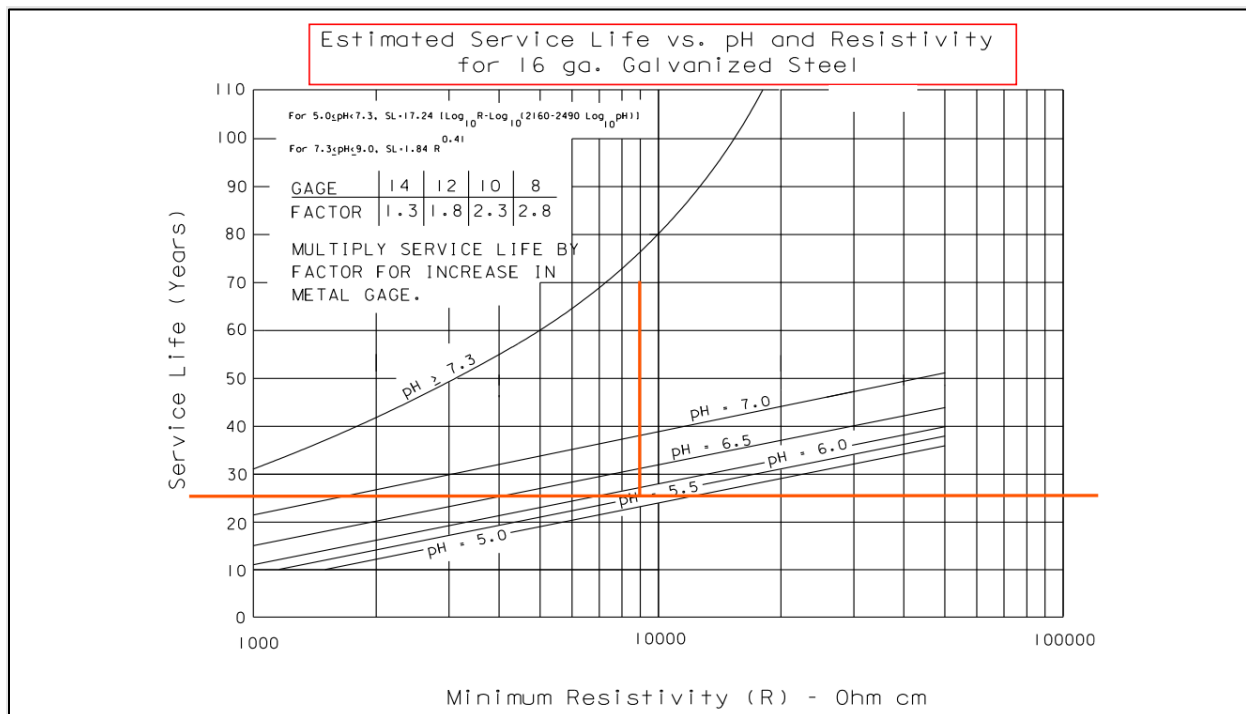

Figure 8.5-1

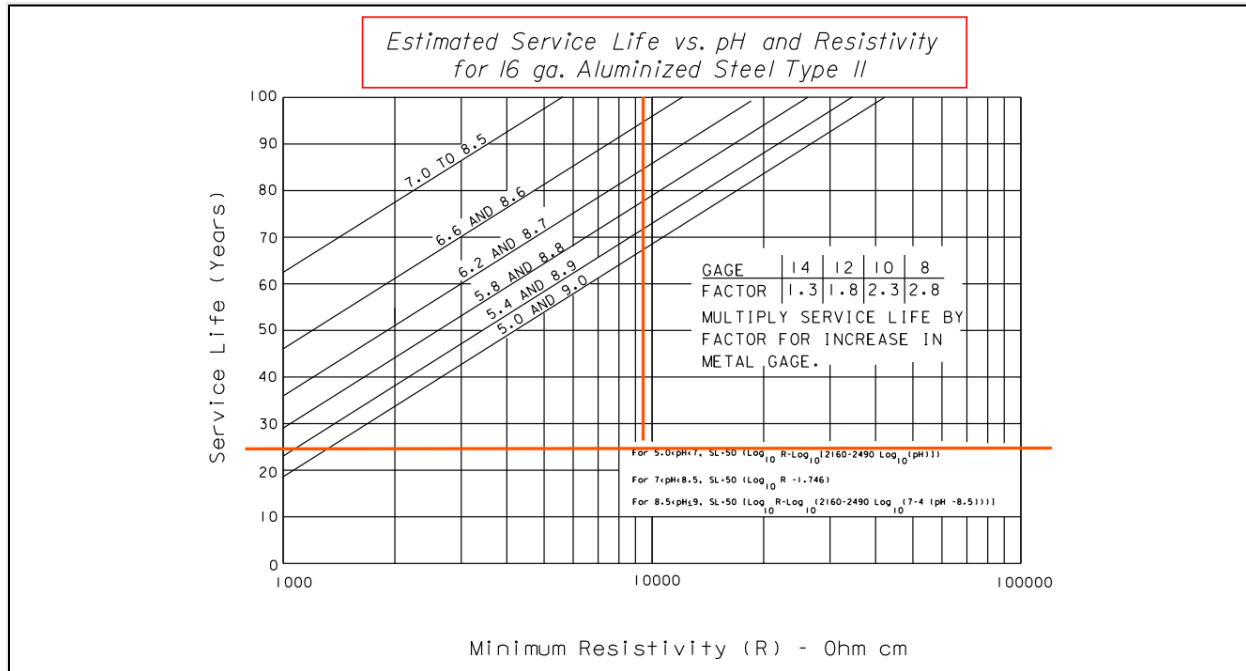

Figure 8.5-2

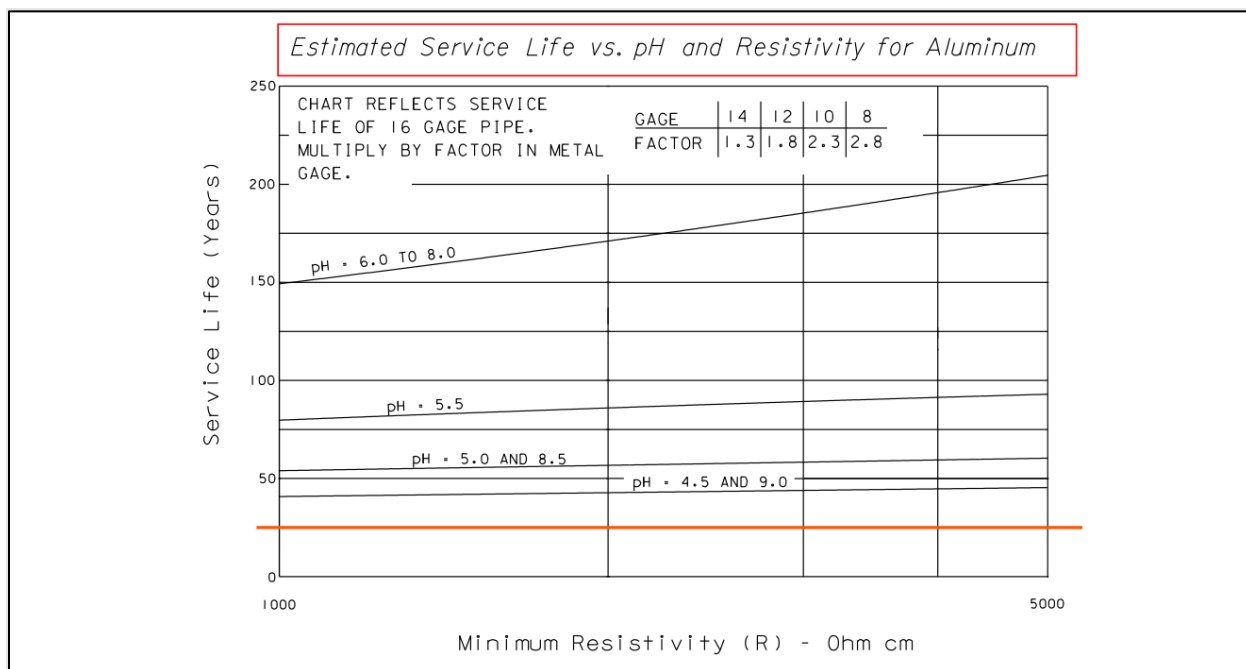

Figure 8.5-3

Drainage Design Guide
Chapter 8: Optional Pipe Material

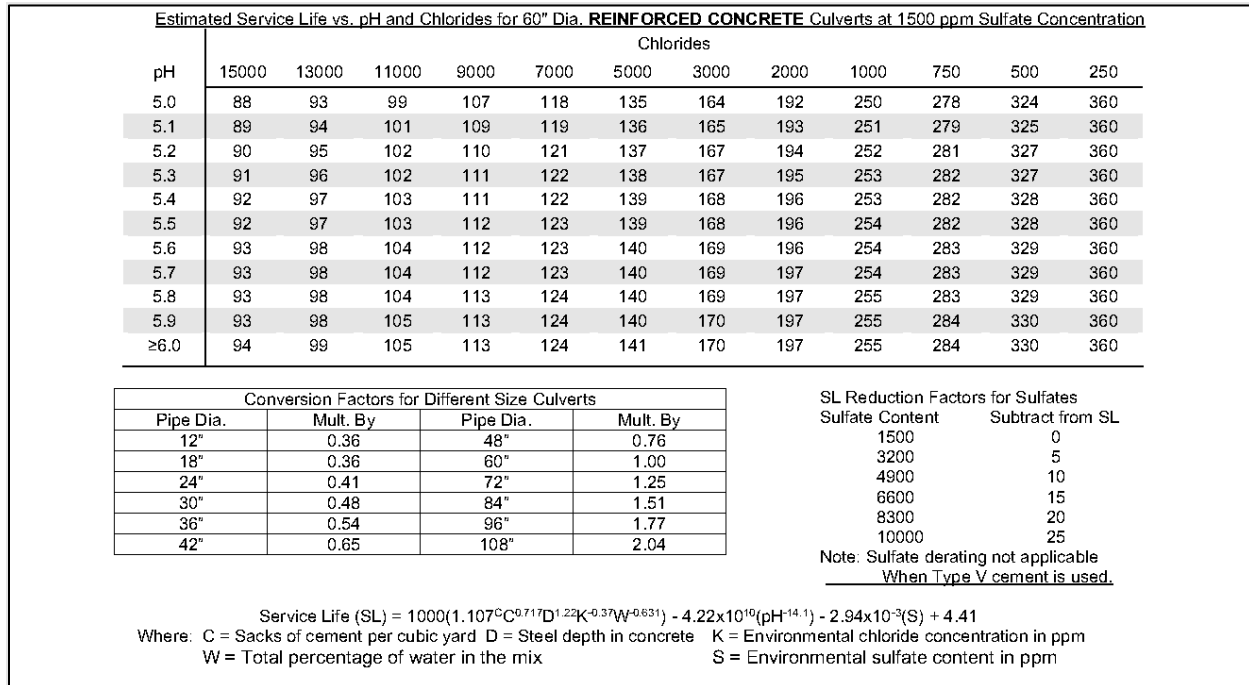

Figure 8.5-4

All roadside ditches are 3.5 feet below the roadway edge of shoulder, and ground at the right-of-way line is at or above the edge of shoulder, so available depth is 3.5 feet. Referring to the cover height tables in the *Drainage Manual*, Appendix C, we see that plastic pipe up to 48 inches in diameter requires 24 inches of cover below the top of base course under flexible pavement. SRAP requires a minimum of 12 inches of cover for pipe diameters up through 24 inches and 15 inches of cover (below the top of base course for flexible pavement) for 30-inch pipe. SRSP requires 12 inches of cover below the top of base course for pipe diameters up through 48 inches. Concrete pipe requires 12 inches of cover from finished grade of flexible pavement.

For 18-inch pipe, 24 inches is available from inside crown of pipe to finished grade, so the plastic pipe minimum cover is not met. Where side drains are 24-inch diameter, there is 18 inches from finished grade to inside crown of pipe and 15 inches from the top of base course. So for 18-inch and 24-inch side drains, you are allowed to use all pipe materials with an N value of ≤ 0.012 except plastic. For 30-inch diameter side drains, there is 12 inches of cover from inside crown of pipe to finished grade; therefore, the SRAP and SRSP pipe cover requirements are not met. Concrete pipe wall is much thicker than other types of pipe materials and must be taken into account. In this case, there will be only 8.5 inches of cover on 30-inch round concrete pipe. The wall thickness for elliptical concrete pipe is slightly greater for a size equivalent to round concrete pipe. A 24-inch by

38-inch elliptical concrete pipe wall is 3.75 inches thick, so there is 14.25 inches of clearance ($42 - 27.75$). The elliptical concrete pipe is the only pipe that will meet the structural requirement where a 30-inch side drain is needed.

Note that if the structural check is used in the CSLE program, it does not use the 30-inch round equivalent dimension (24-inch by 38-inch) for the elliptical pipe; it uses the 30-inch diameter input and will, therefore, show that all pipes will fail the structural check where there is 42 inches from pipe invert to finished grade under flexible pavement. (See the CSLE output for 24-inch and 30-inch pipe in Figure 8.5-5 and Figure 8.5-6.) So, for pipe arch or elliptical pipe, it is best to use the cover height tables and to calculate the cover available based on pipe dimensions.

Environmental Check

| | |
|--|---|
| <p>Design Life 25 Years</p> <p>Max Allowable Manning's (n) Value <input checked="" type="radio"/> < 0.017 <input type="radio"/> >= 0.017</p> | <p>pH: 5.6</p> <p>Resistivity: 9500 Ohm-cm</p> <p>Chlorides: 20 ppm</p> <p>Sulfates: 118 ppm</p> <p>Diameter: 24 Inches</p> |
|--|---|

Structural Check

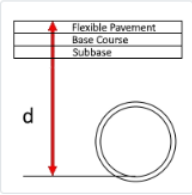
| | |
|---|---|
| <p>Cover Type Flexible Pavement</p> <p>Cover thickness measured from the bottom inside radius of the pipe.</p> <div style="border: 1px solid #ccc; padding: 5px; width: fit-content;">  </div> | <p>Cover thickness (d) measured from flow line of pipe: 42 Inches</p> <p>Asphalt Pavement Thickness: 3 Inches</p> |
|---|---|

Jack and Bore

Reset Form Calculate

Drainage Design Guide
 Chapter 8: Optional Pipe Material

Pipe Results Add Job Information and Generate PDF













| Gage | Type of Culvert | Service Life | Environmental Check | Structural Check |
|--|---|--------------|---------------------|------------------|
| Pass | | | | |
|  | (NRCP) Non-Reinforced Concrete , CL HE I | 360 | Pass | Pass |
|  | (RCP) Steel-Reinforced Concrete Round, CL I | 360 | Pass | Pass |
|  | 16 (SRAP) Aluminum - Spiral Rib | 111 | Pass | Pass |
|  | 16 (SRASP) Aluminized Steel - Spiral Rib | 75 | Pass | Pass |
|  | 16 (SRSP) Galvanized Steel - Spiral Rib | 25 | Pass | Pass |
| Fail | | | | |
|  | (HDPE) High Density Polyethylene, CL I | | Pass | Fail |
|  | (HDPE) High Density Polyethylene, CL II | | Pass | Fail |
|  | (PP) Polypropylene - Class I | | Pass | Fail |
|  | (PP) Polypropylene - Class II | | Pass | Fail |
|  | (PVC) Polyvinyl Chloride, ASTM F-949 | | Pass | Fail |
|  | (SRPE) Steel Reinforced Polyethylene Pipe - Corrugated - Unavailable in this size or not suitable for use | | Fail | Fail |
|  | (SRPE) Steel Reinforced Polyethylene Pipe - Ribbed - Unavailable in this size or not suitable for use | | Fail | Fail |

Figure 8.5-5

Drainage Design Guide
Chapter 8: Optional Pipe Material

Environmental Check

Design Life: Years

Max Allowable Manning's (n) Value: < 0.017 >= 0.017

pH:

Resistivity: Ohm-cm

Chlorides: ppm

Sulfates: ppm

Diameter: inches

Structural Check

Cover Type:

Cover thickness (d) measured from flow line of pipe: inches

Asphalt Pavement Thickness: inches

Cover thickness measured from the bottom inside radius of the pipe.

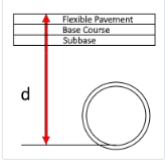

Jack and Bore

[Reset Form](#) [Calculate](#)

Pipe Results Add Job Information and Generate PDF

| Gage | Type of Culvert | Service Life | Environmental Check | Structural Check |
|-------------------|--|--------------|---------------------|------------------|
| Pass | | | | |
| Q | (RCP) Steel-Reinforced Concrete Ellipse, CL HE I | 360 | Pass | Pass |
| Fail | | | | |
| Q | (HDPE) High Density Polyethylene, CL I | | Pass | Fail |
| Q | (HDPE) High Density Polyethylene, CL II | | Pass | Fail |
| Q | (NRCP) Non-Reinforced Concrete | | Pass | Fail |
| Q | (PP) Polypropylene - Class I | | Pass | Fail |
| Q | (PP) Polypropylene - Class II | | Pass | Fail |
| Q | (PVC) Polyvinyl Chloride, ASTM F-949 | | Pass | Fail |
| Q | (RCP) Steel-Reinforced Concrete Round | | Pass | Fail |
| Q | (SRAP) Aluminum - Spiral Rib | | Pass | Fail |
| Q | (SRASP) Aluminized Steel - Spiral Rib | | Pass | Fail |
| Q | (SRPE) Steel Reinforced Polyethylene Pipe - Corrugated | | Pass | Fail |
| Q | (SRPE) Steel Reinforced Polyethylene Pipe - Ribbed | | Pass | Fail |
| Q | (SRSP) Galvanized Steel - Spiral Rib | | Pass | Fail |

Figure 8.5-6

To present the results in the plans, use notes under the side-drain table stating the allowable materials. In this case, an appropriate note might read:

Allowable pipe materials for 18-inch and 24-inch side drains, unless otherwise noted, are: RCP, NRCP, SRSP, SRASP, SRAP and ERCP. Allowable pipe material for 30-inch side drain is ERCP (30-inch-other) only.

See Section 8.6 for examples of plan quantity presentation.

In cases where there is minimal cover and the structural requirements could not be met by using elliptical pipe or pipe arch in lieu of the hydraulically required round pipe, then you will need to analyze alternate pipe configurations. This could include multiple smaller-diameter pipes or, possibly, a larger diameter pipe buried deeper so that the flow area is from normal ditch line to crown. The latter also may require adjustment of the roughness coefficient in the analysis.

For example: if the cover condition at the side drain resulted in less than 12 inches, even with the elliptical concrete pipe, two 24-inch pipes could be used as long as they fit within the ditch. The Mitered End Section (MES) width for a double 24-inch pipe installation is 8.92 feet out to out (Standard Plans, Index 430-022). A 42-inch pipe half buried has the equivalent capacity to a 30-inch (fully open) pipe if the fill has a roughness coefficient only slightly greater than the pipe wall. This installation would be 20 inches narrower than the double 24-inch, with an MES width of 7.25 feet. If you were to use this option, place a note in the plans stating that the pipe size is hydraulically necessary and used to meet cover and dimensional limitations. Additionally, you would need to specify the fill.

8.5.1.2 Cross Drains (including Side Drains under Side Streets)

A cross drain conveys flow under a public roadway. A side street that crosses over a roadside ditch is, therefore, subject to cross drain design criteria, both hydraulic and structural. According to the *Drainage Manual*, Table 6-1, the minimum DSL for a cross drain is 50 years. That minimum applies to minor collectors and local streets, provided culvert cover is less than 10 feet. All other cross drains must have a DSL of at least 100 years. If the cross drain hydraulics show that the structure is outlet controlled, then you may consider only pipe materials with $N = 0.012$. However, if the cross drain is in inlet control, materials with higher roughness coefficients should be included in the analyses. Where pipe options are limited by minimum cover requirements, consider using multiple smaller-diameter pipes that have sufficient cover as an alternative to a single larger-diameter pipe that requires less cover. However, multiple pipe configurations are more susceptible to debris problems and also may require more extensive endwalls. If you have particular concerns about allowing multiple pipes in lieu of a single pipe cross drain

installation, then you should document the rationale for selection of a particular pipe configuration that limits material options.

For the project example, these are local streets with AADT less than 1,000, so the side/cross drains must meet a 50-year DSL. The pipes for the four locations where the side streets cross roadside ditches were hydraulically checked to ensure that the appropriate design frequency flow could be passed without damage to the roadway or offsite properties. The side drains at these locations are 24 inches in diameter. You can classify these “side” drains as cross drains because they are under public roads. Therefore, these structures are not included in the side drain summary table but are instead included with structure numbers in the Summary of Drainage Structures table. The materials for these structures were checked using the CSLE to determine which met the 50-year DSL. See Figure 8.5-7. All materials previously determined are acceptable, but the SRSP has changed from 16-gage to 10-gage so that the service life can be met.

Environmental Check

Design Life: Years

Max Allowable Manning's (n) Value: < 0.017 >= 0.017

pH:

Resistivity: Ohm-cm

Chlorides: ppm

Sulfates: ppm

Diameter: Inches

Structural Check

Cover Type:

Cover thickness (d) measured from flow line of pipe: Inches

Asphalt Pavement Thickness: Inches

Cover thickness measured from the bottom inside radius of the pipe.

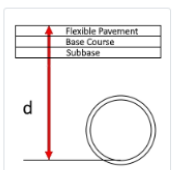

Jack and Bore

| Pipe Results | | Add Job Information and Generate PDF | | |
|----------------------------------|---|--------------------------------------|---------------------|------------------|
| Gage | Type of Culvert | Service Life | Environmental Check | Structural Check |
| Pass | | | | |
| <input type="button" value="Q"/> | (NRCP) Non-Reinforced Concrete, CL HE I | 360 | Pass | Pass |
| <input type="button" value="Q"/> | (RCP) Steel-Reinforced Concrete Round, CL I | 360 | Pass | Pass |
| <input type="button" value="Q"/> | 16 (SRAP) Aluminum - Spiral Rib | 111 | Pass | Pass |
| <input type="button" value="Q"/> | 16 (SRASP) Aluminized Steel - Spiral Rib | 75 | Pass | Pass |
| <input type="button" value="Q"/> | 10 (SRSP) Galvanized Steel - Spiral Rib | 55 | Pass | Pass |
| Fail | | | | |
| <input type="button" value="Q"/> | (HDPE) High Density Polyethylene, CL I | | Pass | Fail |
| <input type="button" value="Q"/> | (HDPE) High Density Polyethylene, CL II | | Pass | Fail |
| <input type="button" value="Q"/> | (PP) Polypropylene - Class I | | Pass | Fail |
| <input type="button" value="Q"/> | (PP) Polypropylene - Class II | | Pass | Fail |
| <input type="button" value="Q"/> | (PVC) Polyvinyl Chloride, ASTM F-949 | | Pass | Fail |
| <input type="button" value="Q"/> | (SRPE) Steel Reinforced Polyethylene Pipe - Corrugated - Unavailable in this size or not suitable for use | | Fail | Fail |
| <input type="button" value="Q"/> | (SRPE) Steel Reinforced Polyethylene Pipe - Ribbed - Unavailable in this size or not suitable for use | | Fail | Fail |

Figure 8.5-7

There are two cross drains that convey offsite runoff under the design roadway. One of the cross drains is located within a sag vertical curve in the rural section of the design roadway; the other is located within the urban section.

The location of the first cross drain has a history of roadway over-topping due to basin diversions and increased runoff from upstream development. It is a 36-inch corrugated galvanized steel culvert with straight endwalls that are located 18 feet from the edge of travel lanes. During the Project Development and Environmental (PD&E) study, it was determined to raise the roadway profile, along with cross drain replacement, to minimize risk to motorists. The location of this cross drain warrants a DSL of 50 years. The new cross drain analysis determined that the cross drain is inlet controlled; therefore, both rough and smooth wall pipe materials were considered. The hydraulic analysis showed that a 54-inch culvert opening is needed to pass the design discharge of 160 cfs.

The location of the second cross drain, a 36-inch RCP, has exhibited no hydraulic insufficiencies. Since it is within an urban section, it should have a DSL of 100 years. The cross drain was analyzed hydraulically and this analysis determined that you could extend the cross drain with no adverse upstream effects.

Specific environmental data were obtained at the site of the two cross drains as follows:

Table 8.5-2: Soil Corrosivity Data Obtained for Two Cross Drains

| Station | | Boring # | pH | Resistivity | Chlorides | Sulfates |
|---------|-------|----------|-----|-------------|-----------|----------|
| 505+00 | Rural | A-4 | 5.2 | 17,000 | 51 | 6 |
| 589+00 | Urban | A-5 | 6.9 | 18,000 | 42 | 6 |

The CSLE program was used to find culvert materials that meet the DSL and structural requirements for the 54-inch culvert. The depth from finished grade to flow line of pipe is 96 inches. The CSLE output file is shown in Figure 8.5-8.

Drainage Design Guide
Chapter 8: Optional Pipe Material



Florida Department of Transportation

Culvert Service Life Estimator - Version 2.0

(Generated Wednesday, May 18th 2022, 1:58:44 pm)

| Job Information | | | |
|-----------------|------------|-------------------------|----------|
| Project Name: | Road Widen | FM Number: | 00000000 |
| Section Number: | 1 | Structure Number: | CD-1 |
| County: | Hollywood | Boring Number/Location: | A-4 |
| Station | 505+00 | Designer | TH |

| Environmental/Structural Data | | | | |
|-------------------------------|----------|--|-----------------------|-------|
| Design Life (Years) | 50 | | pH | 5.2 |
| Max Allowable Manning's n | >= 0.017 | | Resistivity (Ohms-cm) | 17000 |
| Diameter (Inches) | 54 | | Chlorides (ppm) | 51 |
| Depth to Invert 'd' (Inches) | 96 | | Sulphates (ppm) | 6 |
| Pavement Thickness (Inches) | 3 | | | |

| Gage | Type of Culvert | Service Life | Environmental | Structural |
|---------------|--|--------------|---------------|------------|
| Passed | | | | |
| | (RCP) Steel-Reinforced Concrete Round, CL I | 360 | Pass | Pass |
| 10 | (CAP) Aluminum - 2-2/3x1/2 in. corrugations. | 169 | Pass | Pass |
| 12 | (SRAP) Aluminum - Spiral Rib | 132 | Pass | Pass |
| 14 | (SRASP) Aluminized Steel - Spiral Rib | 107 | Pass | Pass |
| 10 | (CAGP) Aluminized Steel - 3x1 in. corrugations. | 82 | Pass | Pass |
| 16 | (CAP) Aluminum - 3x1 in. corrugations | 75 | Pass | Pass |
| 10 | (CSP) Galvanized Steel - 2-2/3x1/2 in. corrugations. | 61 | Pass | Pass |
| 10 | (CSP) Galvanized Steel - 3x1 in. corrugations. | 61 | Pass | Pass |
| 10 | (SRGP) Galvanized Steel - Spiral Rib | 61 | Pass | Pass |
| Failed | | | | |
| | (CASP) Aluminized Steel - 2-2/3x1/2 in. corrugations. | | Pass | Fail |
| | (HDPE) High Density Polyethylene, CL I - Unavailable in this size or not suitable for use | | Fail | Fail |
| | (HDPE) High Density Polyethylene, CL II - Unavailable in this size or not suitable for use | | Fail | Fail |
| | (NRCP) Non-Reinforced Concrete - Unavailable in this size or not suitable for use | | Fail | Fail |
| | (PP) Polypropylene - Class I - Unavailable in this size or not suitable for use | | Fail | Fail |
| | (PP) Polypropylene - Class II - Unavailable in this size or not suitable for use | | Fail | Fail |
| | (PVC) Polyvinyl Chloride, ASTM F-949 - Unavailable in this size or not suitable for use | | Fail | Fail |
| | (SRPE) Steel Reinforced Polyethylene Pipe - Corrugated | | Fail | Pass |
| | (SRPE) Steel Reinforced Polyethylene Pipe - Ribbed | | Fail | Pass |

Figure 8.5-8

So, there are 9 options for CD-1 at station 505+00. There are elliptical and metal pipe arch options that you also could include. However, the elliptical or arch options may not be economical to construct. Generally, round pipe is easier to construct, so only the round options need to be shown. If there were utility conflicts, then they could be avoided with a maximum pipe height of 48 inches; then the Steel-Reinforced Concrete Elliptical, 3" x 1" Corrugated Aluminum Pipe Arch, 16 gage pipe; the Corrugated Steel Pipe Arch, 10 gage in both the 2-2/3" x 1/2" and 3" x 1" corrugations; and the Aluminized Corrugated Steel Pipe Arch, 12 gage, would be acceptable alternates.

You can extend the second cross drain and still meet the hydraulic requirements. Check to verify that this cross drain still will have the required DSL. The corrosion data obtained for this location were input to the CSLE program, along with the depth of cover. The results, shown in Figure 8.5-9, show that the RCP has a service life of 360 years. However, Table M-4 of Appendix M indicates that you should adjust the service life of 360 years by multiplying by 0.54 for 36-inch diameter pipe. This results in 194 years. This pipe has been in service only 40 years, so the DSL of 100 years is met.

When extending cross drains, use the same existing pipe materials. If, upon inspection, the existing pipe shows corrosion or has structural cracking, then you should replace or line the existing pipe. When the extension of an existing pipe results in a minor exceedance of the structural clearance criteria, consider providing additional structural support for the pipe extension rather than replacing the entire cross drain. Encasing the extension in flowable fill typically provides the needed additional support.

Drainage Design Guide
Chapter 8: Optional Pipe Material

Environmental Check

Design Life: 100 Years

Max Allowable Manning's (n) Value: < 0.017 >= 0.017

pH: 6.9

Resistivity: 18000 Ohm-cm

Chlorides: 42 ppm

Sulfates: 6 ppm

Diameter: 36 Inches

Structural Check

Cover Type: Flexible Pavement

Cover thickness (d) measured from flow line of pipe: 72 Inches

Cover thickness measured from the bottom inside radius of the pipe:

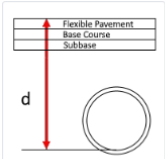

Asphalt Pavement Thickness: 3 Inches

Jack and Bore

[Reset Form](#) [Calculate](#)

Pipe Results Add Job Information and Generate PDF

| Gage | Type of Culvert | Service Life | Environmental Check | Structural Check |
|------|---|--------------|---------------------|------------------|
| Pass | | | | |
| | (NRCP) Non-Reinforced Concrete , CL HE I | 360 | Pass | Pass |
| | (RCP) Steel-Reinforced Concrete Round, CL I | 360 | Pass | Pass |
| | 16 (SRAP) Aluminum - Spiral Rib | 255 | Pass | Pass |
| | 16 (SRASP) Aluminized Steel - Spiral Rib | 120 | Pass | Pass |
| | (HDPE) High Density Polyethylene, CL II | 100 | Pass | Pass |
| | (PP) Polypropylene - Class II | 100 | Pass | Pass |
| | (PVC) Polyvinyl Chloride, ASTM F-949 | 100 | Pass | Pass |
| | (SRPE) Steel Reinforced Polyethylene Pipe - Ribbed | 100 | Pass | Pass |
| Fail | | | | |
| | (HDPE) High Density Polyethylene, CL I - Unavailable in this size or not suitable for use | | Fail | Fail |
| | (PP) Polypropylene - Class I - Unavailable in this size or not suitable for use | | Fail | Fail |
| | (SRPE) Steel Reinforced Polyethylene Pipe - Corrugated - Unavailable in this size or not suitable for use | | Fail | Fail |
| | (SRSP) Galvanized Steel - Spiral Rib - Unavailable in this size or not suitable for use | | Pass | Fail |

Figure 8.5-9

8.5.1.3 Storm Drain

Referring to Table 6-1 in the *Drainage Manual*, we find that storm drains require either 50-year or 100-year DSL. A combination of the two DSLs could exist within a project. An example would be where the main storm drain has to be designed to meet the 100-year DSL and you could design the outfall to meet the 50-year DSL.

When choosing the appropriate DSL, use the same steps as those previously stated. Remember, storm drains do not always require the 100-year DSL criteria. Refer to the notes on Table 6-1 for guidance on the selection of DSL.

The 100-year DSL is required for our example project because the storm drain system is located within a curb-and-gutter section (see Note 2, Table 6-1). The corrosion data produced by the geotechnical survey were correlated to the field review observations and these values are not suspect. The corrosion data values are from the most aggressive test site (not the most aggressive parameter value from all test sites) along the applicable subsection of the project.

Table 8.5-3: Soil Corrosivity Data for the Storm Drain Example

| Station | To Station | Boring # | pH | Resistivity | Chlorides | Sulfates |
|---------|------------|--------------|-----|-------------|-----------|----------|
| 550+00 | 630+00 | B-1 thru B-5 | 5.2 | 17,000 | 51 | 6 |

Because this is a storm drain system, only the smooth wall pipe options may be considered. The corrosion test data were input to the CSLE program for pipe sizes of 18, 24, 30, and 36 inches. Minimum cover is 25 inches and maximum cover is 11 feet. The CSLE program provided the materials described below for both 18-inch and 24-inch pipe sizes (Figure 8.5-10). For 30-inch and 36-inch, 12-gage SRAP is an additional option. A thicker gage of SRAP is needed because of the low pH and 12 gage is not available in diameters of less than 30 inches. See Figure 8.5-11 for a screen shot of the CSLE program for 36-inch pipe.

Drainage Design Guide
Chapter 8: Optional Pipe Material

Environmental Check

Design Life: Years

Max Allowable Manning's (n) Value: < 0.017 >= 0.017

pH:

Resistivity: Ohm-cm

Chlorides: ppm

Sulfates: ppm

Diameter: Inches

Structural Check

Cover Type:

Cover thickness (d) measured from flow line of pipe: Inches

Asphalt Pavement Thickness: Inches

Cover thickness measured from the bottom inside radius of the pipe.

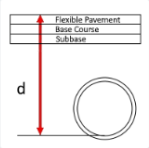

Jack and Bore

[Reset Form](#) [Calculate](#)

Pipe Results [Add Job Information and Generate PDF](#)

| Gage | Type of Culvert | Service Life | Environmental Check | Structural Check |
|----------------------------------|---|--------------|---------------------|------------------|
| Pass | | | | |
| <input type="button" value="Q"/> | (NRCP) Non-Reinforced Concrete, CL HE I | 360 | Pass | Pass |
| <input type="button" value="Q"/> | (RCP) Steel-Reinforced Concrete Round, CL I | 315 | Pass | Pass |
| <input type="button" value="Q"/> | 14 (SRASP) Aluminized Steel - Spiral Rib | 107 | Pass | Pass |
| <input type="button" value="Q"/> | (HDPE) High Density Polyethylene, CL II | 100 | Pass | Pass |
| <input type="button" value="Q"/> | (PP) Polypropylene - Class II | 100 | Pass | Pass |
| <input type="button" value="Q"/> | (PVC) Polyvinyl Chloride, ASTM F-949 | 100 | Pass | Pass |
| Fail | | | | |
| <input type="button" value="Q"/> | (CSP/SRSP) Galvanized Steel - cannot be used | | Fail | Fail |
| <input type="button" value="Q"/> | (HDPE) High Density Polyethylene, CL I - Unavailable in this size or not suitable for use | | Fail | Fail |
| <input type="button" value="Q"/> | (PP) Polypropylene - Class I - Unavailable in this size or not suitable for use | | Fail | Fail |
| <input type="button" value="Q"/> | (SRAP) Aluminum - Spiral Rib - Unavailable in this size or not suitable for use | | Pass | Fail |
| <input type="button" value="Q"/> | (SRPE) Steel Reinforced Polyethylene Pipe - Corrugated - Unavailable in this size or not suitable for use | | Fail | Fail |
| <input type="button" value="Q"/> | (SRPE) Steel Reinforced Polyethylene Pipe - Ribbed - Unavailable in this size or not suitable for use | | Fail | Fail |

Figure 8.5-10

Drainage Design Guide
Chapter 8: Optional Pipe Material

Environmental Check

Design Life: Years

Max Allowable Manning's (n) Value: < 0.017 >= 0.017

pH:

Resistivity: Ohm-cm

Chlorides: ppm

Sulfates: ppm

Diameter: Inches

Structural Check

Cover Type:

Cover thickness (d) measured from flow line of pipe: Inches

Asphalt Pavement Thickness: Inches

Cover thickness measured from the bottom inside radius of the pipe.

Jack and Bore

[Reset Form](#) [Calculate](#)

Pipe Results [Add Job Information and Generate PDF](#)

| Gage | Type of Culvert | Service Life | Environmental Check | Structural Check |
|-------------|---|--------------|---------------------|------------------|
| Pass | | | | |
| | (NRCP) Non-Reinforced Concrete, CL HE I | 360 | Pass | Pass |
| | (RCP) Steel-Reinforced Concrete Round, CL I | 360 | Pass | Pass |
| | 12 (SRAP) Aluminum - Spiral Rib | 132 | Pass | Pass |
| | 14 (SRASP) Aluminized Steel - Spiral Rib | 107 | Pass | Pass |
| | (HDPE) High Density Polyethylene, CL II | 100 | Pass | Pass |
| | (PP) Polypropylene - Class II | 100 | Pass | Pass |
| | (PVC) Polyvinyl Chloride, ASTM F-949 | 100 | Pass | Pass |
| Fail | | | | |
| | (CSP/SRSP) Galvanized Steel - cannot be used | | Fail | Fail |
| | (HDPE) High Density Polyethylene, CL I - Unavailable in this size or not suitable for use | | Fail | Fail |
| | (PP) Polypropylene - Class I - Unavailable in this size or not suitable for use | | Fail | Fail |
| | (SRPE) Steel Reinforced Polyethylene Pipe - Corrugated - Unavailable in this size or not suitable for use | | Fail | Fail |
| | (SRPE) Steel Reinforced Polyethylene Pipe - Ribbed | | Fail | Pass |

Figure 8.5-11

8.5.1.4 Wall Zone Pipe

The example project contains an area of elevated, MSE-walled embankment for a divided highway with median barrier wall in super-elevation. The roadway profile is at 0.5 percent and the storm drain piping will follow the slope of the roadway. The roadway storm drain system outfalls under the wall to a shoulder gutter inlet (SGI) within a parallel storm drain system. To ensure that all piping meets the Wall Zone Pipe material restrictions and requirements, sketch the wall zones on the drainage structure sections (see Figure 8.5-12). You can see that the longitudinal pipe coming into the median barrier inlet is within Zone A. The 18-inch lateral pipe from the barrier wall inlet along the MSE wall goes through Zone B transversely and through Zone A.

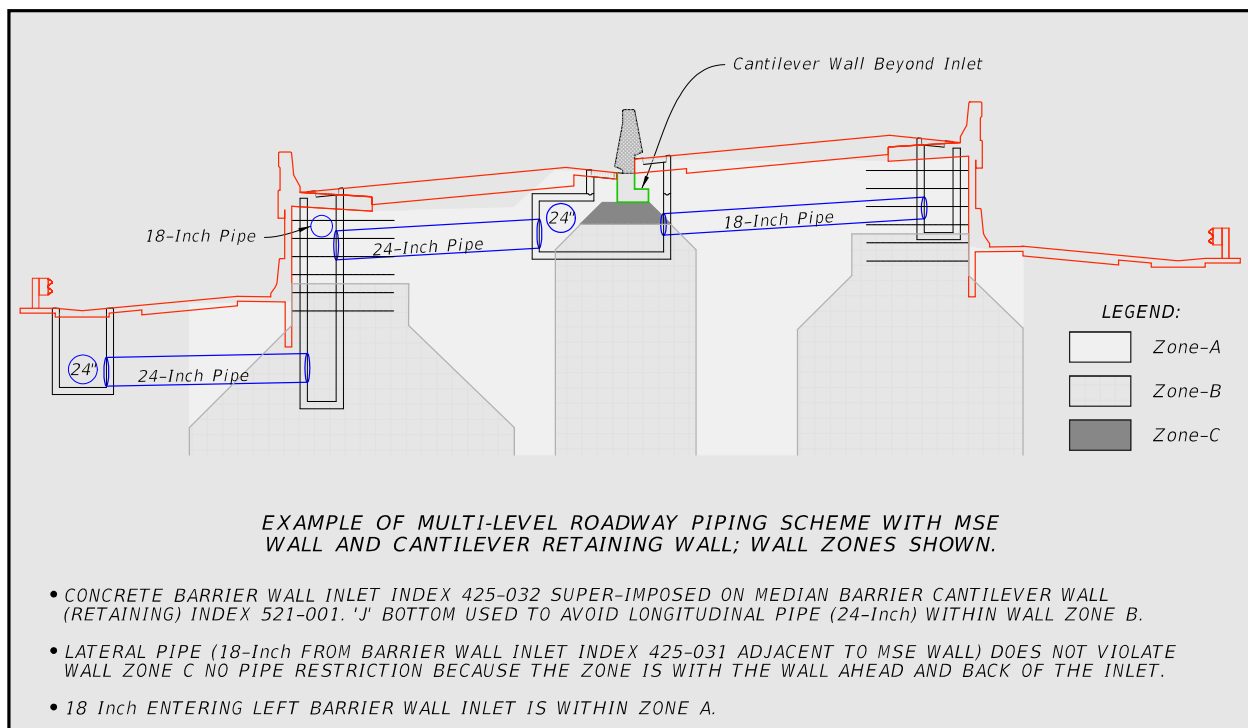

Figure 8.5-12

Zone C is below the median barrier cantilever wall, which is back and ahead of the median barrier inlet. The pipe options, as shown in the *Drainage Manual*, Table 6-1, are: polypropylene, PVC, and J&B Steel. The steel pipe will cost substantially more than the PVC or polypropylene, so it would be included as an option only if structurally necessary. In this case, the 24-inch pipe from the barrier wall inlet to the SGI has 13.5 feet of cover, so polypropylene may be acceptable. However, because this pipe is under the wall with roadway on both sides of the wall, you are encouraged to use the methodology in the AASHTO LRFD (Load Reduction Factor Design) *Bridge Design Specifications*, Chapter

12, to ensure that the pipe installation will withstand the load conditions. Consider the need for resilient connections at structures, particularly where there may be some differential settlement.

8.5.1.5 Gutter Drain

From Table 6-1 in the *Drainage Manual*, you identify a required DSL of 25 years for the gutter drain. The process is the same as for performing the analysis for the side drain application discussed previously. However, when sizing gutter drain and choosing materials, only use materials having an N-value of > 0.020 . A gutter drain is defined as a pipe used along steep slopes to convey stormwater from shoulder gutter inlets on elevated roadways to drainage conveyance systems at a much lower elevation. These pipes should be configured so that they can be replaced without disturbing the roadway and so that they are not placed too deep within the embankment to prohibit future excavation. Minimize joints where possible. See Figure 8.5-13 for an illustration of gutter drains.

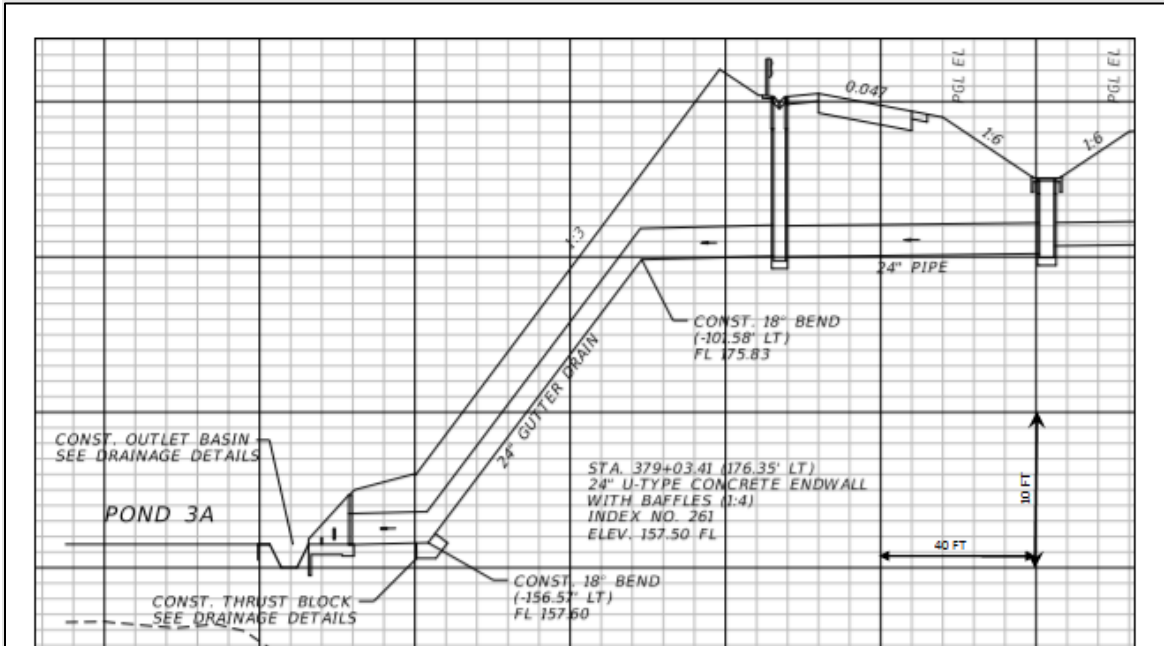

ABOVE, THE GUTTER DRAIN WAS PLACED AT SHALLOW DEPTH TO ALLOW REPLACEMENT. PIPE TO THE RIGHT OF THE GUTTER DRAIN IS STORM DRAIN (100-YEAR DSL).

THE EXAMPLE BELOW HAS A DEEP INLET (>16 FT) AND THE PIPE WOULD BE DIFFICULT TO REPLACE; THIS WOULD MORE APPROPRIATELY BE CLASSIFIED AS STORM DRAIN.

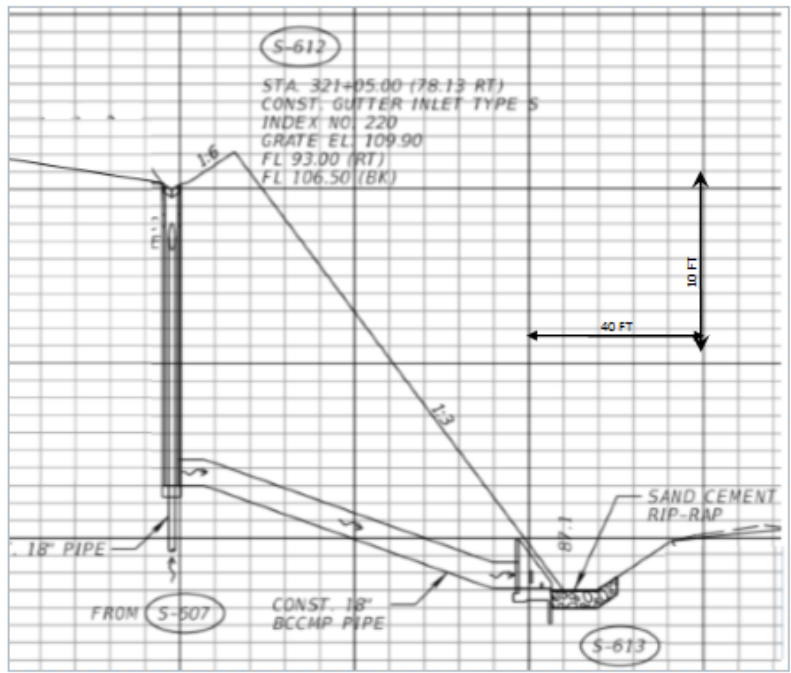

Figure 8.5-13

8.5.1.6 French Drain

A French drain is used for stormwater treatment and/or attenuation. The *Drainage Manual*, Table 6-1, shows that either a 50-year or a 100-year DSL is used for French drains. The location of the French drain system determines which DSL to use. See Figure 8.5-14. Consider a case where you place a French drain in an urban location along the trunk line located under the sidewalk, parallel and adjacent to the roadway. The French drain is not under the roadway, but replacement of the French drain would require reconstruction of the outside lane due to the depth of cut and angle of repose of the soil. Even though the French drain reconstruction might be performed using sheeting to avoid impacting the roadway, the cost of the sheeting makes this installation expensive enough to elevate the service life to 100 years. A similar situation occurs when a pipe installation is adjacent to buildings. In these cases, sheeting required during replacement is costly; thus, the pipe should have a longer, 100-year DSL. Conversely, if the French drain is located in a swale along a rural roadway, the lower DSL may be appropriate.

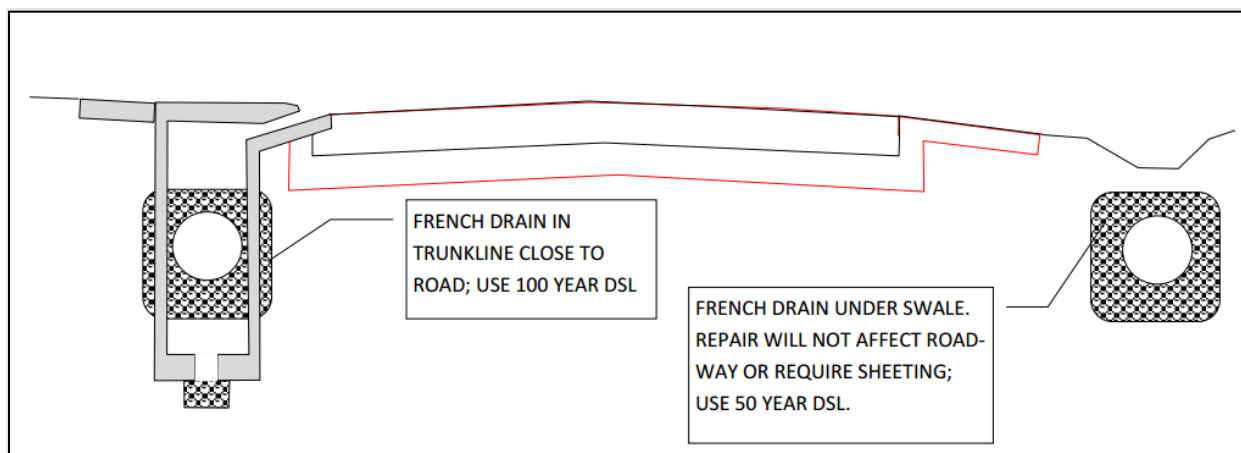

Figure 8.5-14

For these applications, consider whether a roughness coefficient ≥ 0.020 will result in a hydraulically acceptable design. Where the French drain also is the primary storm conveyance system, only materials with N-value = 0.012 need to be considered. Where the French drain is “offline” or is a secondary conveyance, analyses should consider N value ≥ 0.020 . After ascertaining the hydraulic needs, use the CSLE program or the figures and tables in Appendix M to select materials that meet the required DSL based upon the corrosion data and pipe size. Then determine minimum and maximum cover and use the CSLE program or Appendix C of the *Drainage Manual* to select pipe materials that meet the structural requirements.

8.6 SPECIFYING OPTIONAL PIPE MATERIALS IN THE CONTRACT PLANS

Show the optional pipe materials for cross drains, storm drains, French drains, and gutter drains in the project plans, as illustrated in the *FDM*. The Optional Pipe Tabulation Sheet includes: the size; class of concrete; gage, corrugation, and type of metal; and type of plastic pipe that may be applicable to particular pipes within the project.

Side drains are listed in a Summary of Side Drains table. The two formats within *Basis of Estimates*, Chapter 8, have columns for five round and five “other” pipe sizes with corresponding MES widths; one has additional columns for offset and flowline. You shouldn’t modify the tables except to “hide” columns not used or to change pipe sizes as needed. As noted in the side drain example in Section 8.5, you should place notes stating allowable side drain options below the table. Include any particular exceptions in the Design Notes column. Do not use the Construction Remarks column since that is reserved for the construction phase of the project. The two Summary of Side Drain tables are shown in Figure 8.6-1. See the current version of *Basis of Estimates* for the most current form of these tables.

Figure 8.6-1

French drains also may be listed in a Summary Table; however, that table form has only the actual limits of pipe/French drain and does not have a column for the structures or the non-perforated pipe without the gravel envelope that extends a minimum of four feet on each side of the drainage structure. If you decide to use this Summary Table, then the Summary of Drainage Structures (SDS) tabulation should include the drainage structure and non-perforated pipe and a separate column for the French drain segment. You can note the pipe options allowable for French drains below the French Drain Summary Table or within the Design Notes Column. You cannot use dissimilar types of pipe within a

continuous run of pipe, and the non-perforated pipe should be of the same material as the perforated pipe.

All other pipes that are listed in the SDS tabulation should have options listed in the Optional Materials table. When elliptical pipe or arch pipe are the only allowed options, these are listed in the Summary of Drainage Structures under the column heading “Other” with the round equivalent size. The Optional Materials tabulation for these pipes should include elliptical or arch pipe configurations that meet the DSL and structural requirements. There are two Optional Materials tabulation formats; one includes flowlines and one does not. Generally, flowlines for all options will be the same. However, in some cases, minimum cover will control storm drain flowlines and it will be necessary to list the required alternate flow lines. If round pipes meet the required clearances, there is no need to even list elliptical and arch pipes as options since they usually are more expensive than their round equivalents. For instance, where a round concrete pipe and arch metal pipe meet all requirements, it is not necessary to list elliptical concrete as an option.

You can group pipe options by size and, if necessary, by location (station to station) or by structure numbers. The structure numbers are listed as “Exceptions” in the “STR No.” column next to the corresponding pipe size column. If the exceptions all have the same limited options, the options can be listed with that group; otherwise, show the exceptions individually with allowable material. Ideally, you can group the options by pipe size and you can use the suitable materials for a spectrum of sizes. The intent of allowing options is for the contractor to choose acceptable materials from a fair, competitive pipe supply market, not to have numerous materials installed within a particular storm drain system. In general, if you group material options by pipe size, one Optional Pipe Tabulation Sheet is sufficient to describe allowable options for most projects.

Figure 8.6-2 is a spreadsheet format of the Optional Pipe Tabulation sheet containing the optional materials determined for the examples in Section 8.5.

Drainage Design Guide
Chapter 8: Optional Pipe Material

| STRUCTURE | SIZE (Inches) | MATERIAL | PLOTTED | AS BUILT | REMARKS |
|-------------------------------------|---------------|--|---------|----------|-------------------------|
| STORM DRAIN | 18,24 | NRCP, CL I | X | | |
| | | RCP, CL I | | | |
| EXCEPT S-100 THROUGH S-105 | | SRASP (14 ga.) | | | |
| | | HDPE, CL II | | | |
| | | POLYPROPYLENE | | | |
| | | PVC ASTM F-949 | | | |
| S-100 THRU S-104 WALL ZONE PIPE | 18,24 | POLYPROPYLENE | | | |
| | | PVC ASTM F-99 | X | | |
| S-105 WALL ZONE PIPE | 24 | PVC ASTM F-949 | X | | |
| CROSS DRAINS CD-1, CD-2, CD-3, CD-4 | 24 | RCP, CL I | X | | |
| | | NRCP, CL I | | | |
| | | SRAP (16 ga.) | | | |
| | | SRASP (16 ga.) | | | |
| | | SRSP (10 ga.) | | | |
| STORM DRAINS | 30, 36 | NRCP, CL I | X | | |
| | | RCP, CL I | | | |
| | | SRASP (14 ga.) | | | |
| | | SRAP (12 ga.) | | | |
| | | HDPE, CL II | | | |
| | | POLYPROPYLENE | | | |
| | | PVC ASTM F-949 | | | |
| CD-5 | 36 | RCP | X | | |
| CD-6 | 54 | RCP CL I, SRAP (12 ga.) | X | | |
| | | SRSP (10 ga.), SRASP(14 ga.) | | | |
| | | 2-2/3 x 1/2 corr-CAP, CSP, both 10 ga. | | | |
| | | 3 x 1 corr-CAP, CASP, both 16 ga. | | | |
| | | 3 x 1 corr-CSP, 10 ga. | | | |
| GUTTER DRAIN | 18,24 | 2-2/3 x 1/2 corr-CAP, 14 ga. | X | | |
| | | 2-2/3 x 1/2 corr-CASP, 14 ga. | | | |
| | | 2-2/3 x 1/2 corr-CSP, 14 ga. | | | FULLY BITUMINOUS COATED |

Figure 8.6-2

Note that both of the Optional Materials Tabulation forms have a “PLOTTED” column. It is important to check the material used for determining clearances at drainage structures. If spiral rib pipe was assumed/used to determine clearances at structures and concrete is listed as a pipe option, then the thicker wall of concrete pipe may not fit into the structure. Structure fit may be another rationale for choice of pipe material. For example, pipes with thinner walls would allow for smaller precast openings, which in turn allows for smaller angle between pipes entering a round structure.

For design/build projects, you still need to create materials analyses to demonstrate suitability of the pipe to be installed, and then you can include the analyses in project documentation. You can include either an optional materials tabulation sheet in the construction plans or make sure that the pipe material to be installed is noted somewhere in the plans, such as on the plan sheets or on the Summary of Drainage Structures.

CHAPTER 9: STORMWATER MANAGEMENT FACILITY

| | |
|--|-------------|
| 9. STORMWATER MANAGEMENT FACILITY | 9-1 |
| 9.1 Selecting a Pond Site | 9-1 |
| 9.1.1 Estimating Right-of-Way Requirements | 9-3 |
| 9.1.1.1 Typical Factors Controlling Surface Area Requirements | 9-3 |
| 9.1.2 Access and Conveyance | 9-7 |
| 9.1.3 Joint-Use (Regional) Facilities | 9-8 |
| 9.1.4 Facilities on Forest Lands | 9-8 |
| 9.1.5 Coordination with Property Owners | 9-9 |
| 9.1.6 A Suggested Evaluation Process | 9-10 |
| 9.1.6.1 Start Final Design | 9-16 |
| 9.2 Maintenance, Construction, Aesthetics, and Other Concerns | 9-20 |
| 9.2.1 Maintenance | 9-20 |
| 9.2.1.1 Pond Configurations | 9-20 |
| 9.2.1.2 Diversion Structures | 9-21 |
| 9.2.1.3 Conveyance to and from the Pond | 9-22 |
| 9.2.1.4 Vehicle Access | 9-23 |
| 9.2.1.5 NPDES Permits | 9-23 |
| 9.2.2 Construction | 9-23 |
| 9.2.2.1 Structure Tolerances | 9-24 |
| 9.2.2.2 Earthwork Tolerances | 9-24 |
| 9.2.3 Aesthetics | 9-25 |
| 9.2.3.1 Fence | 9-26 |
| 9.2.3.2 Debris Collection | 9-27 |
| 9.2.4 Aviation Safety Requirements | 9-27 |
| 9.3 Stormwater Quality | 9-29 |
| 9.3.1 Design Criteria | 9-29 |
| 9.3.1.1 Treatment Volumes | 9-30 |
| 9.3.1.2 Special Conditions | 9-30 |
| 9.3.2 Concerns of Off-Line Systems | 9-31 |
| 9.3.3 Seasonal High Water Table | 9-32 |
| 9.3.4 Treatment Methods | 9-32 |
| 9.3.4.1 Wet Detention Systems | 9-33 |
| 9.3.4.2 Pond Liners | 9-36 |
| 9.3.4.3 Retention Systems | 9-37 |

| | | |
|------------|--|-------------|
| 9.3.4.4 | Filtration/Underdrain Systems | 9-37 |
| 9.3.4.5 | Stormwater Re-Use Systems | 9-44 |
| 9.3.4.6 | Regional Stormwater Pond Systems | 9-44 |
| 9.3.4.7 | Harper (2007) Methodology for Nutrient Loadings Computation | 9-44 |
| 9.3.4.8 | Protection of Springsheds from Nitrates | 9-46 |
| 9.4 | Stormwater Quantity Control | 9-53 |
| 9.4.1 | The Department's Design Storms | 9-53 |
| 9.4.1.1 | Critical Duration | 9-54 |
| 9.4.1.2 | Storm Frequencies | 9-57 |
| 9.4.2 | Estimating Attenuation Volume | 9-57 |
| 9.4.2.1 | Pre Versus Post Runoff Volume | 9-58 |
| 9.4.2.2 | Simple Pond Model Procedure | 9-61 |
| 9.4.2.3 | Other Techniques | 9-63 |
| 9.4.3 | Tailwater Conditions | 9-63 |
| 9.4.4 | Routing Calculations | 9-64 |
| 9.4.5 | Discharges to Watersheds with Positive Outlet (Open Basins) Using Chapter 14-86 | 9-65 |
| 9.4.6 | Discharges to Watersheds without Positive Outlet (Closed Basins) Using Chapter 14-86 | 9-74 |
| 9.4.6.1 | Retention System Groundwater Flow Analysis | 9-75 |
| 9.4.7 | Off-Site Inflows | 9-92 |
| 9.4.8 | Commingling of Untreated Onsite Runoff | 9-93 |
| 9.5 | Outlet Control Structures | 9-93 |
| 9.5.1 | Weirs | 9-93 |
| 9.5.2 | Discharge Coefficients | 9-94 |
| 9.5.2.1 | Submerged Control Devices | 9-96 |
| 9.5.3 | Skimmers | 9-97 |
| 9.5.4 | Miscellaneous | 9-97 |

9. STORMWATER MANAGEMENT FACILITY

9.1 SELECTING A POND SITE

Selecting the most appropriate pond site for a stormwater management facility requires the work of many different offices and professionals within the Department. You, as a drainage designer, will provide critical information, but because of the many factors to consider, a team approach is essential.

There are numerous design features (depth, size, shape, treatment method, landscaping, etc.) that you can modify to accommodate a pond site. However, hydraulic constraints may preclude the use of some sites. Alternate sites and their different design features usually will result in different costs and impacts. As a result, an evaluation of alternates must be made to select the most appropriate pond site. The purpose of the evaluation is twofold: (1) it will show that alternate sites were considered and that the selected site was the most appropriate, and (2) when you combine the evaluation with the final design details, they become the documentation that justifies the need to acquire property rights.

In the case where one person owns all the property in the area and that person is agreeable to any pond location proposed by the Department, evaluating alternates may not seem necessary. In these situations, the evaluation will not be as extensive as in other situations; nevertheless, you should perform some amount of evaluation to show that the site selected results in the lowest total cost.

The evaluation should weigh and balance numerous factors, such as cost; maintainability; constructability; public opinion; aesthetics; and environmental, social, and cultural impacts. The costs associated with right of way, environmental impacts, construction, and long-term maintenance usually are the easiest factors to estimate and compare. Other factors are more subjective and qualitative.

Because the evaluation involves a broad range of subjects, you should put together a multi-functional team to select the most appropriate pond site. Teams should have representatives from right of way, design, drainage, landscape architecture, environmental management, maintenance, construction, and eminent domain. At times, other units may provide critical information to the evaluation process. Although all of the team members may not participate in the entire process, they will likely provide critical information at some stage. The project manager, with support from the Drainage and Right-of-Way offices, will be responsible for coordinating the team effort and ensuring that the appropriate personnel participate.

Consider the value of existing vegetation during site selection and pond siting. In some cases, the need to preserve existing vegetation for aesthetic purposes may justify additional project expenses (retaining walls, acquisition of additional right of way, etc.).

Perform pond site evaluations during the Project Development Phase. Often, you will re-evaluate pond sites during the Design Phase. Before doing a design reevaluation, check what commitments have been made and what work has been done during the Project Development Phase.

| CONSIDERATIONS WHEN SELECTING A POND SITE | |
|--|---|
| <ol style="list-style-type: none"> 1. Use existing FDOT properties or other state-owned property, if feasible. 2. Minimize the number of parcels required. For example, avoid using parts of two parcels when the pond will fit within one parcel. 3. Generally, property owners prefer to place ponds toward the rear of their property. For parcels that abut the roadway right-of-way, the portion of the parcel next to the road usually is the most expensive. 4. Avoid splitting a parcel, thus creating two independent parcel remainders. 5. Consider the parcels identified by the right-of-way office. Even if a parcel is not large enough to provide all the stormwater management, it may be large enough to provide the treatment for stormwater quality. Or it could replace treatment and attenuation for parcels adjacent to the road that will have their ponds removed because of the road improvements. | <ol style="list-style-type: none"> 6. Avoid wetlands. 7. Avoid archaeological sites and historic structures listed on or eligible for listing on the National Register of Historic Places. 8. Consider a joint-use facility (on the Department and another entity share) as an alternate, if one is feasible. 9. Generally, do not consider an option that requires water quality monitoring. Historically, this has been very expensive. 10. Stormwater treatment systems must be at least 30 meters (100 feet) from any public water supply well. (Chapter 62-555, F.A.C.). 11. Locations with billboards usually are expensive. 12. Locations with mature, attractive trees that will fit into the pond design increase the aesthetic value of the pond site. |

9.1.1 Estimating Right-of-Way Requirements

The right of way required for a pond site varies with the amount of additional impervious area and associated additional runoff, the ground line and groundwater elevations at the pond, the proposed road elevations, the existing on-site natural features, and sometimes the soil conditions and other factors. During the pond site evaluation stage, the accuracy to which you estimate these items and the resulting pond size varies with several factors.

Sometimes the acquisition schedule dictates that results of the pond site evaluation form the basis for the final pond site right-of-way requirements. For these projects, you should determine the pond size as accurately as if doing the final detailed design.

There are other projects where the determination of the final right-of-way requirements occurs shortly after the pond site evaluation. After establishing the final right-of-way requirements, the acquisition process starts. For these projects, you would perform a pond site evaluation only to compare alternate sites or drainage schemes. Make your size estimates accurate enough to minimize changes to the right-of-way requirements during the final design.

In a third category of projects the right-of-way acquisition is scheduled for several years after the pond site evaluation, or the acquisition is not even funded in the Department's work program. For these projects, changes in pond size and location from that established in the original evaluation will not affect production schedules or the right-of-way acquisition process substantially. Therefore, your pond size estimates need not be very accurate. For these projects, you typically would perform a pond site re-evaluation shortly before right-of-way acquisition.

Other factors that affect the level of accuracy for pond size estimates are property costs and the existing and anticipated development of the project area. In a rural area with relatively large tracts of land, changes to pond size and location will have less impact to property owners and the Department than in an expensive urban area that is rapidly developing and has relatively small parcels. As a result, the pond size estimates you use for these evaluations in rural areas do not need to be as accurate as in urban, rapidly developing areas.

9.1.1.1 Typical Factors Controlling Surface Area Requirements

Typically, the need to fit storage volumes within upper and lower constraints dictates the amount of surface area required for a pond. The following items could control the surface area requirements for a pond:

- The ground line at the pond (or the berm elevation) minus the freeboard dictates the top of the treatment and attenuation volume.

- For urban projects, the low point in the gutter minus the hydraulic gradient clearance dictates the hydraulic gradient of the storm drain. This constraint often is critical in flat terrain but not in steep terrain.
- High groundwater elevations or sometimes discharge tailwater elevations can constrain storage volumes. The groundwater elevation constraint will vary with the method of treatment used and the requirements of the regulatory agency.
- Retention ponds must recover a certain volume in a certain time. The size of the pond bottom area sometimes controls the recovery or drawdown time. This may be particularly critical for ponds discharging to closed basins.
- For wet detention facilities, most regulatory agencies limit the treatment volume depth to 18 inches and you must provide the required permanent pool volume.
- To contain a substantial portion of the pond volume in rolling or steep terrain, you would berm the low side of the pond site. The horizontal distance of the embankment from the berm top to natural ground dictates how much right of way you will need in this direction. The embankment slope must be flat enough to be stable. For example, a 1 (vertical) to 2 (horizontal) slope in sandy soil with seepage may not be stable. In this case, it would be appropriate for you to conduct a slope stability analysis. Discuss these situations with the geotechnical engineer to establish an acceptable slope and thus a reasonable estimate of the surface area requirements.
- You might adjust the shape of the pond—and, therefore, the surface area—due to existing on-site natural features (mature vegetation, a significant stand of vegetation on a slope, a visual landscape barrier, etc).

Example 9.1-1. Estimating Pond Right-of-Way Requirements

Given:

- Flat terrain, approximately 1-percent slope
- Proposed pond discharges to open basin
- Proposed curb and gutter section with gutter elevation at the low point in profile = 59.9 ft
- Ground elevation at pond site = approx. 59 ft
- Estimated seasonal high water table (SHWT) = 2.5 ft – 3.6 ft below ground (based on NRCS soil survey)
- Treatment volume = 10,950 ft³
- Estimated peak attenuation volume = 19,567 ft³ (from Example 9.4-1)
- Estimated 3-year attenuation volume = 10,243 ft³ (storm drain design frequency)

Find: Estimated surface area requirements for a pond

1. Since the SHWT is so close to the surface, you choose a wet detention pond.

For these conditions, one of two requirements typically control the surface area. Both involve spreading the treatment and attenuation volumes over a large enough area to keep the height of the volume within limits. The height (H) of the treatment and peak attenuation volume is constrained on the top, by the ground elevation minus the freeboard, and on the bottom, by the controlling groundwater elevation. Although some Water Management Districts (WMDs) allow treatment below the SHWT, this example will assume that treatment is above the SHWT. First, determine the surface area necessary to meet these constraints. The other requirement that may control the surface area is discussed after Step 5.

2. Conservatively, assume the SHWT is 2.5 feet below ground. The standard freeboard is given in Section 5.4.4.2 of the *Drainage Manual*. The treatment and peak attenuation volume are constrained to the following height (H).

$H = \text{Depth to SHWT} - \text{Freeboard}$

$H = 2.5 - 1.0$

$H = 1.5 \text{ ft.}$

3. The total peak storage volume required is:

$\text{Volume}_{\text{PEAK}} = \text{Treatment Volume} + \text{Est. Peak Attenuation Volume}$

$\text{Volume}_{\text{PEAK}} = 10,950 + 19,957 = 30,907 \text{ ft}^3$

You will need to make assumptions about the pond configuration.

Shape: Assume the shape of the pond will be rectangular. Irregular shapes usually can be approximated by a rectangular shape so this is a reasonable assumption and it greatly simplifies estimating the surface area.

Length to Width Ratio (L/W): The property lines may suggest a preferred ratio to make best use of a parcel. Without other guidance, assume $L/W = 2$.

Side Slopes: Assume flat slopes, such as 1 (vertical) to 5 or 6 (horizontal) for sites required to be aesthetically pleasing. Assume 1 (vertical) to 4 (horizontal) for most other conditions.

4. Use the formula for a rectangular box to determine the water surface area of a pond with vertical sides.

$$\text{Volume} = L_{\text{RECT}} W_{\text{RECT}} H$$

where:

H = Height (m) = 1.5 ft for the above condition

L_{RECT} = Length (ft) of vertical-sided pond

W_{RECT} = width (ft) of vertical-sided pond

Assume for this example that $L/W = 2$, then

$$30,907 \text{ ft}^3 = L_{\text{RECT}} \times (0.5 L_{\text{RECT}}) \times 1.5 \text{ ft, then}$$

$$L_{\text{RECT}} = 203 \text{ ft}$$

$$W_{\text{RECT}} = 101.5 \text{ ft}$$

5. Increase these dimensions to account for sloped sides by adding: $2 \times (0.5 \times H \times \text{Side Slope})$.

For this example, assume side slope = 5, thus adding 7.5 ft to each dimension.

$$\text{Length @ top of slope} = 210.5 \text{ ft}$$

$$\text{Width @ top of slope} = 109 \text{ ft}$$

Then,

$$\text{Water Surface at Peak Design Stage} = 210.5 \times 109 = 22,944.5 \text{ ft}^2 = 0.53 \text{ ac}$$

The other requirement that may control the surface area in flat terrain is the requirement to maintain the clearance between the low point in the gutter and the hydraulic gradient in the storm drain system. On the top, the low point in the gutter minus both the hydraulic gradient clearance and the energy losses in the storm drain system constrain the treatment volume and three-year attenuation volume. On the bottom, the groundwater elevations (SHWT for this example) constrains these volumes. The standard hydraulic gradient clearance is given in the *Drainage Manual*.

You can estimate the energy losses in the storm drain system in two ways. Assume a hydraulic gradient slope. Slopes of 0.05 percent to 0.1 percent are common in flat terrain. Multiply the length between the pond and the low point by the assumed slope to obtain the losses. Another approach is to assume a fixed energy loss, ignoring the length between pond and low point. In flat terrain, a reasonable value for this purpose is two feet.

6. The SHWT elevation is 56.5 feet (59 – 2.5). For this example, you can assume the energy loss in the storm drain to be 0.7 ft. Then, the treatment and three-year attenuation volume are constrained to the following height (H):

$$H = \text{Low Point in Gutter} - \text{Clearance} - \text{Estimated Energy Losses} - \text{SHWT Elevation}$$

$$H = 59.9 - 1.0 - 0.7 - 56.5$$

$$H = 1.7 \text{ ft}$$

This is greater than the height (1.5 feet) available to “stack” the peak attenuation volume (Step 2). Since the three-year attenuation volume is less than the peak attenuation volume, this constraint will not control the water surface area. If the height was less than determined in Step 2, you would estimate the water surface area as done in Step 4 except using different values for H and the total volume.

The water surface area dimensions determined in Step 4 apply.

7. Add the maintenance berms to the water surface dimensions. The standard maintenance berm width is given in Section 5.4.4.2 of the *Drainage Manual*.

$$\text{Length} = L_{\text{TOP}} + 2 (\text{berm width}) = L_{\text{TOP}} + 2(20) = 210.5 + 40 = 250.5 \text{ ft}$$

$$\text{Width} = W_{\text{TOP}} + 2 (\text{berm width}) = W_{\text{TOP}} + 2(20) = 109 + 40 = 149 \text{ ft}$$

$$\text{Area} = 250.5 \times 149 = 37,324.5 \text{ ft}^2 = 0.86 \text{ acre}$$

8. Increase the value by 10 percent to 20 percent to account for the preceding information being preliminary. For this example, we will increase it by 10 percent.

$$\text{Area} = 0.86 \times 1.1 = 0.95 \text{ ac}$$

Realize that this is only the pond size estimate. You also must make estimates for access and conveyance, as discussed in the next section.

9.1.2 Access and Conveyance

The right of way required to convey the project’s runoff to and from a pond and to provide access can affect which alternate pond site is the most appropriate. Determine these requirements for each alternate and include the costs and impacts in the evaluation.

Sites placed far from the project will require more right of way to get stormwater to the pond than sites adjacent to the project. Similarly, different pond sites can have different right-of-way requirements for the outfall (discharge) from the pond. Guidelines for establishing the width or “footprint” of the right-of-way requirements for conveyance are provided in Section 9.2 of this document.

The Department often provides access through the same property obtained for conveying the project's runoff. For pond sites placed far from the project, providing access from a local road closer to the pond is sometimes more reasonable.

Usually, the Department will obtain the right of way required for access and conveyance as a perpetual easement. Fee simple right of way may be appropriate sometimes. The opinion of the District Maintenance Office, balanced with property owner preference and right-of-way costs, is the primary factor for determining which type of right of way is appropriate.

Refer to Appendix B of the Drainage Manual and the FDM113. Both contain additional information about acquisition of property rights.

9.1.3 Joint-Use (Regional) Facilities

Sometimes the Department and other entities can share a stormwater management facility. Both the Department and the other entities receive the stormwater management benefits of the facility and share in its construction, operation, or both. The Department and the other entities create a written agreement describing the responsibilities of each party. Typically, these agreements are made with local governments, but sometimes private entities enter joint-use agreements. For example, the Department shares several facilities with golf course owners.

Advantages of a joint-use or regional facility are that: (1) the Department often can relieve itself of the maintenance requirements, (2) water quality improves downstream, and (3) stormwater re-use is incentivized when a larger volume of water is available. A joint-use facility can have disadvantages, such as affecting production schedules, a more complex permitting process, and resolving any non-complying discharges, if they occur.

When developing a joint-use agreement, avoid commitments that hold the Department to completing construction of the site by a certain date because there often are unforeseen delays in permitting and funding. Developing an acceptable joint-use agreement often requires an extensive coordination effort involving the project manager and representatives from numerous other offices. Discuss this option with the project manager or District Drainage Engineer.

9.1.4 Facilities on Forest Lands

Occasionally, projects are bounded by state and/or national forest lands and ponds must be located within these public preserves. In such cases, advanced coordination with the owning agency and the WMD can result in cost-effective designs that will not degrade the public purpose of the forest lands. This cooperative process can sometimes take longer to complete and should, therefore, be started early in the PD&E phase.

9.1.5 Coordination with Property Owners

Often, contacting the property owner to get his or her preference regarding the shape and location of the pond and location of the access road is beneficial from a right of way standpoint. This coordination is especially important where the Department needs only part of a parcel for a pond.

Consider contacting the owner during the evaluation of alternate sites. A situation where contacting the owner during the evaluation may be appropriate is where one person owns all the property in the area. If a contact is not made during the evaluation process, it is recommended that a contact be made shortly afterward and before starting final design. For example, perhaps the property owner may prefer a shallower pond although it would require more right of way, or the owner may be interested in re-acquiring and maintaining the pond. A certain pond shape could give the owner better use of the remainder of the parcel. This is important information to know before starting final design. In some instances, contacting homeowner's associations or abutting property owners may be beneficial to find out if a negative perception of the proposed pond exists.

Sometimes, contacting the owner may not be appropriate. Where the Department needs an entire parcel, there is no need to obtain the owner's preference about pond location.

The project manager, with participation from the right-of-way office, should decide whether to contact the property owner based on individual circumstances.

The Department's project manager or a right-of-way specialist or both could make the contact. As a drainage designer, you are the best source to answer technical questions and will likely be asked to be present when the contact is made. You cannot provide specifics early in the design process, but you can speak about general principles of stormwater management facilities.

When obtained in writing, you should accommodate the property owner's preference to the greatest degree possible. The Department may not be able to accommodate all of the owner's preferences in the design of the pond due to hydraulic constraints or other limitations. However, after weighing and balancing the owner's requests with other factors, it is likely that some aspects of the owner's preference can be satisfied, thus improving relations during the right-of-way acquisition process.

If a commitment is made to a property owner, follow through or notify the owner that the Department cannot meet the commitment. Usually, you will not have enough information to commit to anything during the first contact with the owner. Remember that the purpose of the initial contact is to learn the owner's preference regarding the shape and location of the pond and location of the access road. The most that you can commit to is to try to

accommodate the owner's requests. If, during any discussion, the property owner is told about the operation, shape, or location of the pond, this is a commitment. If you subsequently design the pond differently, you should notify the property owner. If the owner is not notified, the right-of-way specialist is placed in the difficult situation of approaching the owner with a proposed pond configuration that is different than what was discussed previously.

This holds true for changes that occur through the detailed design phase. The owner must be notified if the shape, size, and location of the pond are going to be different than what was discussed previously.

9.1.6 A Suggested Evaluation Process

An outline for evaluating alternate sites follows, and a flow chart is provided in Figure 9.1-5. The process is divided into seven main steps of work, as follows:

- | | |
|--------|---|
| Step 1 | Coordinate with the right-of-way office |
| Step 2 | Identify alternate drainage schemes |
| Step 3 | Estimate the right of way required for each alternate |
| Step 4 | Get team buy-in on the proposed alternates |
| Step 5 | Estimate costs and assess impacts |
| Step 6 | Summarize findings |
| Step 7 | Select site |

The steps listed below are directed toward you, the drainage designer, but there also is information about activities that team members from other offices should perform. Normally, you should proceed through the steps in order, but, often, doing certain steps earlier in the process or doing several steps concurrently will be reasonable and prudent. The most important issue is to maintain the coordination necessary to ensure that pond sites are selected using a multi-functional team.

The degree of detail will vary with individual projects and between FDOT districts. It is essential that you discuss this with the project manager or the District Drainage Engineer before starting the evaluation.

Step One Coordinate with the Right-of-Way Office

The purpose of this coordination is to provide a preliminary pond size and a general location to the right-of-way office and to ask the right-of-way office to identify potential sites.

Shortly after the roadway typical section is set, provide the right-of-way office with a preliminary estimate of the size and a general location of the pond. Use aerial contour maps, old construction plans, available surveys, and other data to identify the primary basins and the general outfall locations (discharge points). Identifying the high points along the project usually separates the primary basins. At this stage, assume that the pond site will be near the lows in the terrain and will be close to the existing outfalls. As a preliminary size estimate, use 20 percent of the roadway right of way draining to the outfall. The area identified for the general location should be large enough to allow for several alternates to be developed. Refer to Figure 9.1-1. The project manager should relay this information to the right-of-way office so it can include the preliminary costs for pond sites in the cost estimates.

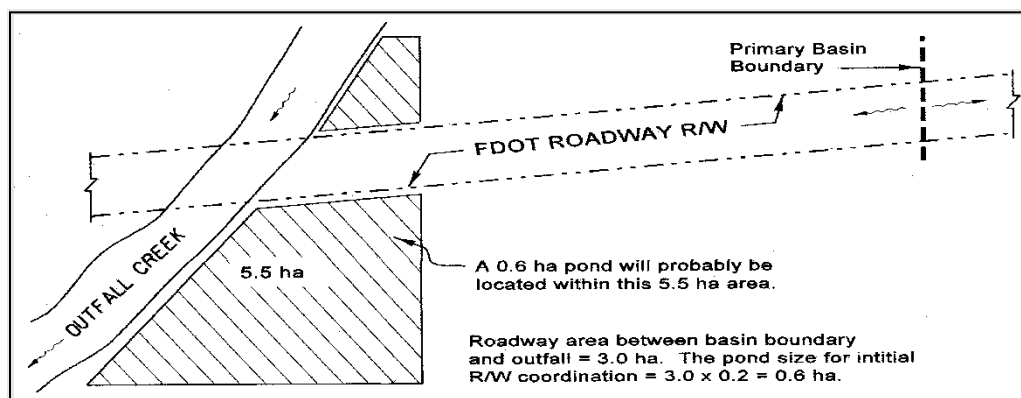

Figure 9.1-1: Size and Location for Initial Coordination with the Right-of-Way Office

When the corridor and alignment (left, right, or center) are set, the project manager should request the right-of-way office to identify parcels along the roadway that could be economical for a pond, due to the impacts of the roadway footprint. The right-of-way office also should identify existing excess property in the area.

At this stage, impacts of the roadway footprint at intersections and interchanges may be uncertain still simply because the geometry has not been set. These areas may warrant discussions with the right-of-way office at a later time.

When the right-of-way office completes this task, the project manager should arrange a meeting with the team to discuss all potential pond sites, aesthetic concerns, and possible contacts with property owners. Representatives from right of way, drainage, landscape, and environmental management should attend.

Refer to tax maps while discussing potential pond sites. The project manager should have these; if not, the local government should.

Step Two Identify alternate drainage schemes

Before developing the alternates, familiarize yourself with soils and groundwater conditions in the area and with the various stormwater quality treatment methods. Use the Natural Resources Conservation Service (NRCS) (formerly Soil Conservation Service) soil surveys to obtain the soil information. The treatment methods are discussed in Section 9.3, below.

It may be reasonable to start this step by qualitatively eliminating areas that are not hydraulically feasible. For example, some areas may be too high in elevation, or may be at the beginning of the drainage system rather than at the end.

For projects in developing areas, consider contacting the Planning (or Development) Department of the local government to find out the zoning for the area, the planned land use, and if proposed developments exist. Although this information should not automatically eliminate a site from being evaluated, it may help you to identify viable alternatives, such as a joint pond use with future land developers.

Identify two or three alternate drainage schemes for each primary basin. If two or three vacant sites are not available, then consider developed sites. Familiarize yourself with the list of considerations in Section 9.1 when identifying your drainage schemes. Also consider the sites identified by the right-of-way office in Step One. This is not to say that these sites need to be evaluated as alternates, but all of the alternates evaluated must be viable. You should consider these sites during the evaluation.

The alternates may be as simple as two different locations for a wet detention pond, or a wet detention pond compared with a dry pond with underdrain at the same location. A system using two ponds, one for off-line quality treatment and one for attenuation, could be compared with a single pond designed for both quality treatment and attenuation. In areas with expensive right of way, identifying an alternate that uses a non-standard approach—such as sand box filters or pumping stations—may be prudent. Check with the District Drainage Engineer before doing so. See Figure 9.1-2.

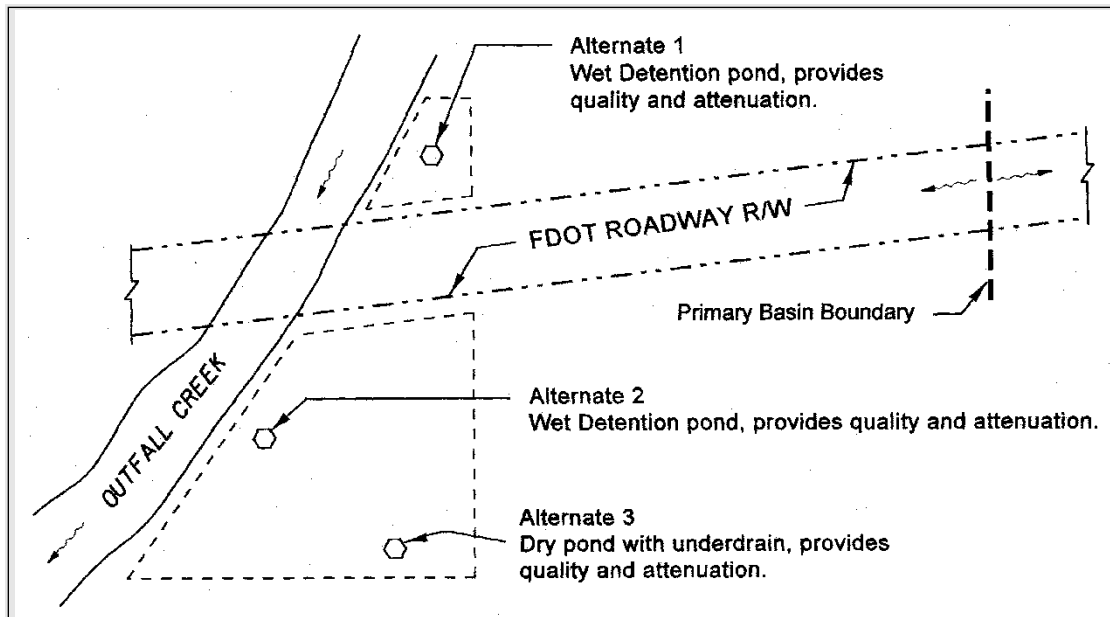

Figure 9.1-2: Alternate Drainage Schemes

Step Three Estimate the right of way required for each alternate

- A. Consider the need for additional soils and groundwater information. Most of the Department's districts accept the NRCS soil surveys for pond site evaluations. For alternates using retention or exfiltration in areas where there are poor soils and for projects discharging to a closed basin, site-specific data may be appropriate. If you feel that additional information is warranted, discuss this with the District Drainage Engineer.

Steps B through G apply to ponds discharging to open basins. Ponds discharging to closed basins have the additional complication of assuring that the drawdown requirements are met (see Section 9.4).

- B. Determine the required treatment (quality) volume. See the discussion of treatment volumes in Section 9.3. Refer to the appropriate regulatory agency's rules or meet with the agency at this time.
- C. Estimate the required attenuation volume. See the discussion of Estimating Attenuation Volume in Section 9.4.2.
- D. Coordinate with the Landscape Architect to perform a preliminary identification of existing landscape, natural and aesthetic features, and opportunities and constraints that could impact the placement and design of the pond.
- E. Estimate the low point in the proposed roadway. Discuss the grade with the roadway designer as necessary.

- F. Obtain ground elevations around each alternate site. Using a contour map with one-foot intervals usually is sufficient. In flat terrain where one-foot contour maps are not available, obtaining a survey of the ground elevations around each alternate site may be appropriate.
- G. Determine the pond surface area necessary to satisfy all applicable criteria. Refer to the typical controlling factors in Section 9.1.1.1. If you know of aesthetic preferences that will affect the surface area, such as shape, side slopes, landscaping, or preserving existing vegetation, account for them in the surface area determination. Example 9.1-1 goes through this and the following two steps.
- H. Add the maintenance berms to the above area.
- I. Increase this area by 10 percent to 20 percent to account for the preceding information being preliminary.
- J. Place these surface area requirements within parcel boundaries in a way that minimizes the number of parcels required. For example, avoid using part of two parcels when the pond will fit within one.
- K. Determine the right-of-way requirements for access to the pond and for conveyance to and from the pond.
- L. Sketch each alternate site and its requirements for conveyance and access on the tax maps (preferably on aerial background). Refer to Figure 9.1-3.

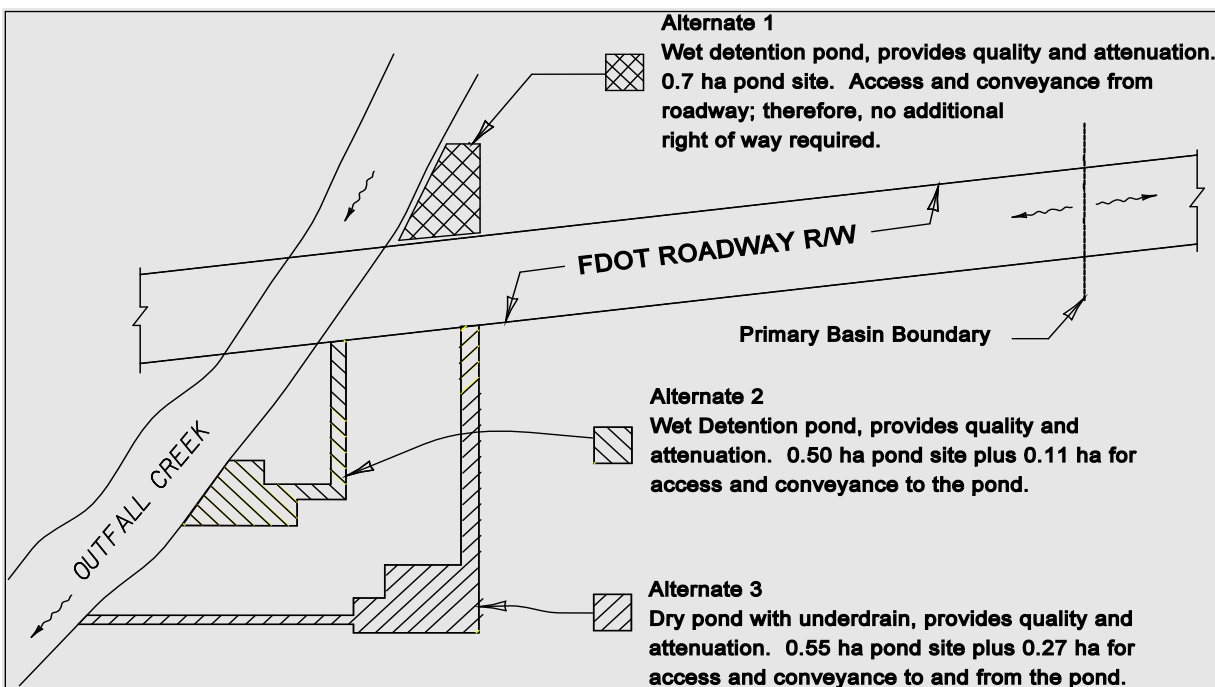

Figure 9.1-3: Sketch of Each Alternate's Estimate Requirements

Check with the project manager or District Drainage Engineer to see if they want to review the above work before proceeding to the next step.

Step Four Get team buy-in on the proposed alternates

The project manager should arrange a meeting with the team to discuss the alternates. The meeting has several purposes: (1) discuss how the right-of-way requirements fit within parcel boundaries, (2) confirm that alternates being considered are viable, (3) consider the need to contact property owners to obtain their preference of pond shape and location, (4) confirm that the access and conveyance requirements are reasonable, and (5) discuss social, cultural, and environmental impacts, including the existing landscape, natural and aesthetic features, and opportunities and constraints of each alternate.

If the property owners are contacted, their preferences should be discussed among the appropriate team members, and the sites appropriately adjusted before proceeding to the next step.

Step Five Estimate costs and assess impacts

When the team agrees on the alternate drainage schemes, the project manager should request environmental assessments, right-of-way cost estimates, and utility impact assessments for each alternate site. The purpose of the environmental assessments is to determine potential hazardous material contamination and potential impacts to environmental resources such as threatened, endangered or significant species and cultural resources. Environmental specialists from the Environmental Management Office usually do the assessments, which should include cost estimates associated with any mitigation and environmental cleanup.

The purpose of the utility assessment is to determine the existence of utility corridors through each alternate site.

You, as the drainage designer, should estimate the construction cost of each alternate, including the conveyance requirements to and from the pond. Usually, the largest costs are associated with earthwork, pond liner (when required), and pipe. Statewide average unit prices for the standard pay items are provided in the publication *Item Average Report*, which is available for download at:

<https://fdotwp1.dot.state.fl.us/wTWebgateReports/login.aspx> (note: the user must have a login and password for a specific project). For alternates that are similar, estimating construction cost differences rather than total construction costs may be reasonable. If different alternates are expected to have substantially different maintenance costs, estimate these as well. Since maintenance costs will be spread over time, it will be

necessary to equate these to initial costs using a life cycle analysis. Contact the District Maintenance Office to obtain the latest unit prices for routine maintenance activities.

Each alternate should have, at a minimum, cost estimates for right of way. When the estimates and assessments are complete, the various offices should furnish their findings to you via the project manager.

Step Six Summarize findings

For each basin, combine the findings of the other offices with your construction cost estimates. Use a summary table similar to Figure 9.1-4 to compare the alternates. The *Drainage Manual* lists the minimum documentation requirements.

Check with the project manager to see if the district staff wants to review the summary before proceeding to the next step.

Step Seven Select site

The team should meet to discuss all alternates and select the most appropriate site. Cost, maintainability, constructability, public opinion, aesthetics, and environmental (social, cultural, natural, and physical) impacts will affect the selection of a pond site. The team should weigh and balance all factors in their decision. Include documentation of the decision with the summarized findings of the previous step.

9.1.6.1 Start Final Design

For most projects, the actual right-of-way requirements will be determined during the final design of the pond. The acquisition of the pond site occurs during the process of acquiring any additional right of way for the roadway corridor. You should revisit the site evaluation process if the final right-of-way requirements are substantially different from those originally estimated. Pond locations frequently change as the final design progresses. Sometimes additional sites are evaluated, and occasionally the originally selected site is not used. Any additional evaluations of pond sites should be documented as required by the District Drainage Engineer. All changes in right-of-way requirements must be coordinated with the right-of-way office.

| Alternate Pond Site Evaluation | | | | | | | |
|---|--|-------------|-------|----------------------|-------|-------------|-------|
| Project Description _____ | | | | Project Number _____ | | | |
| Basin Description _____ | | | | | | | |
| | | | | | | | |
| | | Alternate 1 | | Alternate 2 | | Alternate 3 | |
| Brief Description of Alternate ▶ | | | | | | | |
| | | Comments | Costs | Comments | Costs | Comments | Costs |
| Right of Way | | | | | | | |
| Construction | | | | | | | |
| Hazardous Materials | | | | | | | |
| Utilities | | | | | | | |
| TES ¹ Species | | | | | | | |
| Maintenance | | | | | | | |
| Cultural Resources | | | | | | | |
| Public Opinion | | | | | | | |
| Aesthetics | | | | | | | |
| Other | | | | | | | |
| Total Costs | | | | | | | |
| Comments, Advantages, Disadvantages, etc. | | | | | | | |

1. Threatened, Endangered, or Significant

Figure 9.1-4: Summary Table to Compare Alternates

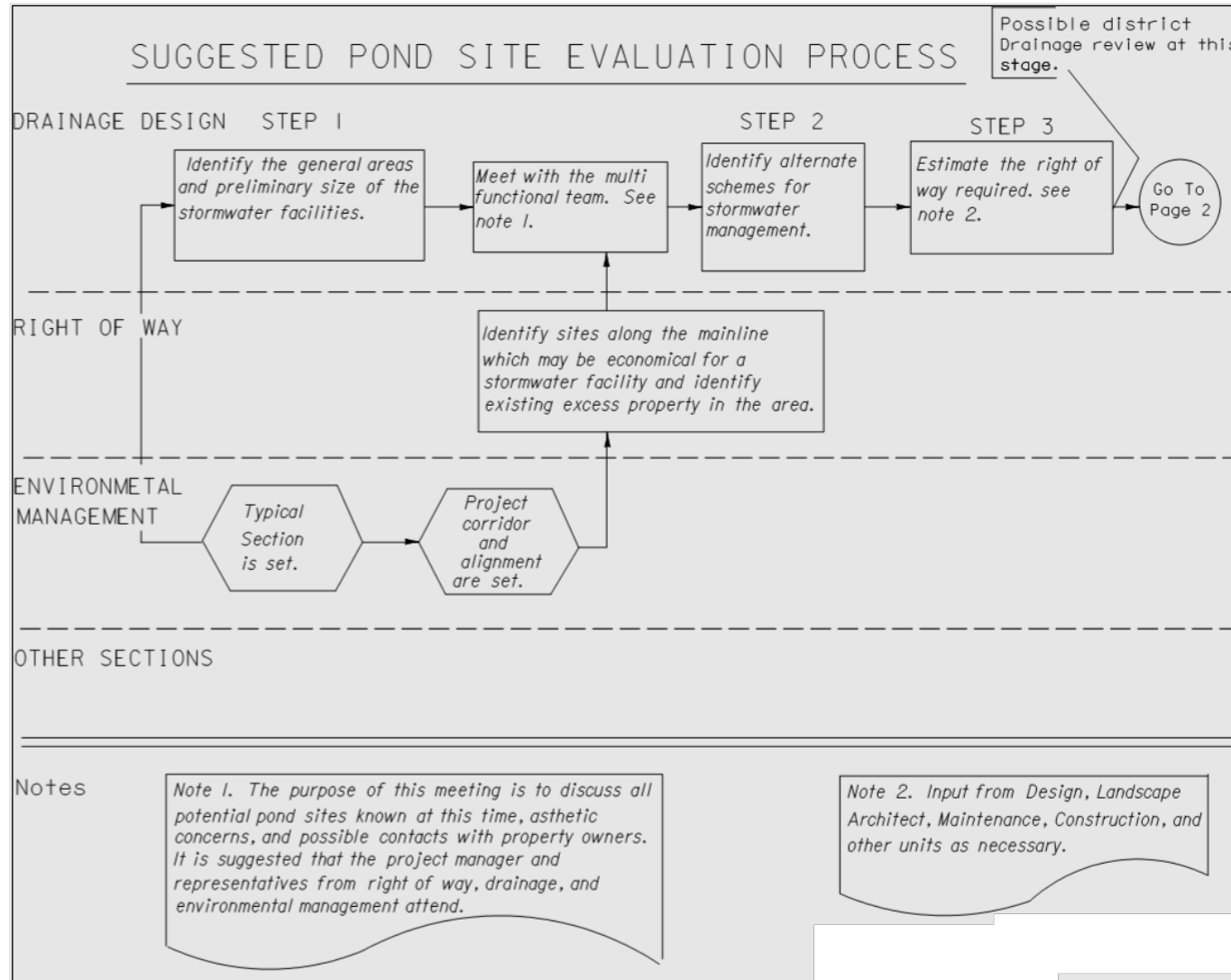

Figure 9.1-5: Pond Site Evaluation Process

Drainage Design Guide
Chapter 9: Stormwater Management Facility

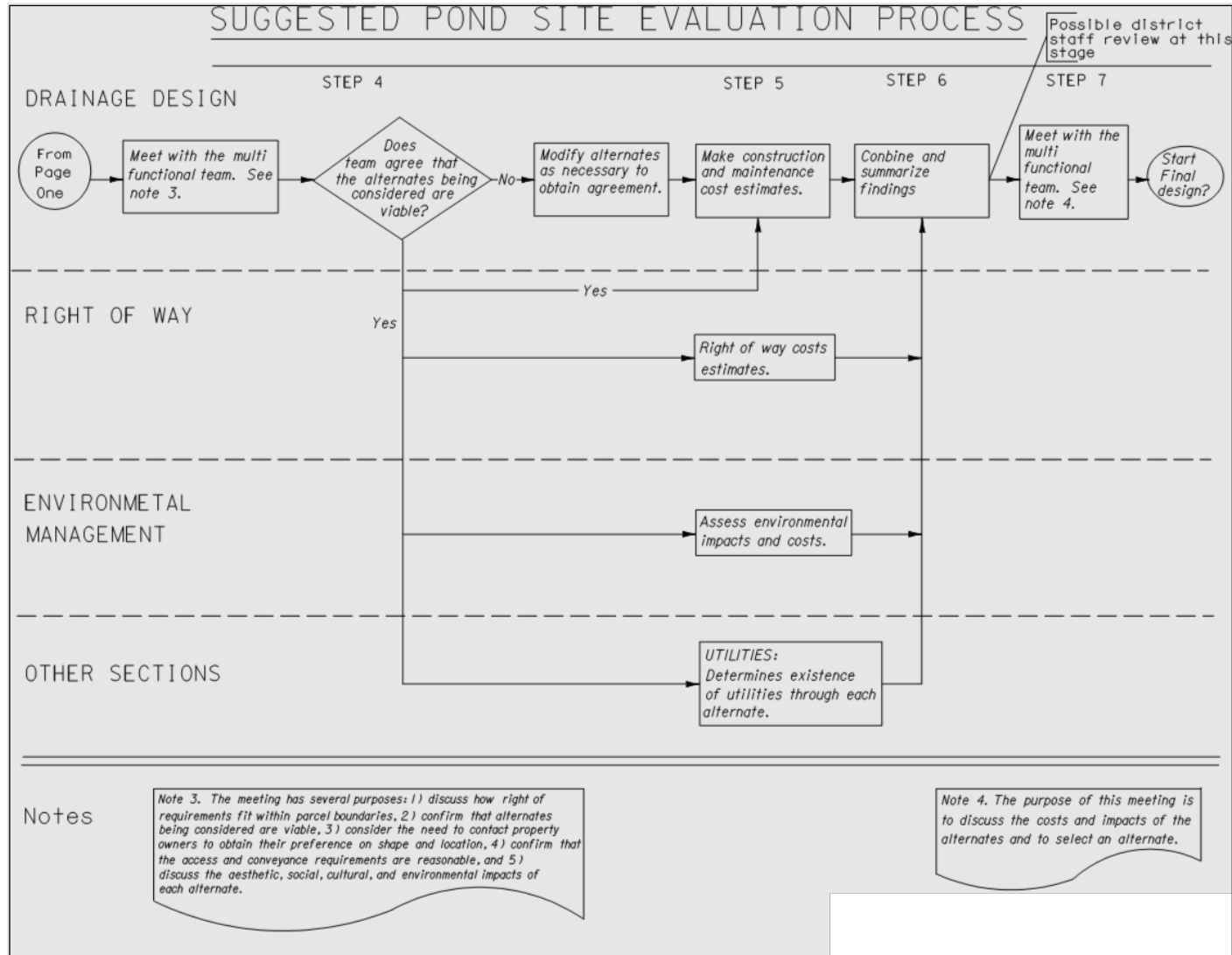

Figure 9.1-5 (continued)

9.2 MAINTENANCE, CONSTRUCTION, AESTHETICS, AND OTHER CONCERNS

9.2.1 Maintenance

Maintenance must be a consideration throughout the process of designing a stormwater facility. Long-term maintenance costs are inevitable, but they can be minimized by appropriate consideration during the design of a facility. The difference between a maintainable design and a design that is difficult and expensive to maintain often will be the difference between an attractive operating facility and a neglected, non-functioning facility generating frequent public complaints.

9.2.1.1 Pond Configurations

Side slopes:

Use a slope of 1 (vertical) to 4 (horizontal) or flatter. Steep slopes are harder to mow and are more susceptible to erosion than flat slopes. Slopes steeper than 1:3 must be mowed with special equipment. This is generally more expensive than using regular mowers.

Where possible, conserve established slope vegetation to increase stability and add an aesthetic feature to the pond.

Maintenance berms:

The *Drainage Manual* gives the minimum widths and slopes. These are acceptable for most situations, but discuss site-specific concerns with the local maintenance staff.

For ponds that will maintain a permanent or normal pool, keep the lowest point of the maintenance berm at least one foot above the top of the treatment volume. This will minimize saturation of the maintenance berm.

Corners:

Use a radius of 30 feet or larger for the inside edge of the maintenance berm. This is based on the largest piece of normal maintenance equipment. Several maintenance vehicles were modeled using the AUTOTURN program (Transoft Solution, Inc.). The GRADALL 880 requires the largest turning radius and gate opening.

Benchmark:

Have a benchmark constructed in or near all ponds. It will be used to check critical elevations of the pond and outlet control structure. Avoid installing benchmarks in areas subject to settlement such as high fill sections and areas subject to vehicle loads. An outside corner of the maintenance berm in a minimal fill section would be an appropriate location.

Sediment buildup:

Design the pond with a three-foot deep sediment sump near the inlet. In retention ponds (described in Section 9.3.4.2) where the groundwater is close to the pond bottom, the depth of the sump may need to be reduced to avoid exposing the groundwater. The area of the sump should be approximately 20 percent of the pond bottom area.

In retention ponds, the sediment is visible, but often it accumulates so slowly that it is difficult to see how much exists. A staff gage placed near the inlet allows the buildup to be measured.

Permanent (Normal) Pool Depth:

The main body (not the littoral shelf) of the permanent or normal pool should be deep enough to minimize aquatic growth, but shallow enough to maintain an aerobic environment throughout the water column. The regulatory agencies usually will specify the maximum depth for water quality credit, but this depth may be exceeded for harvesting fill needed for the project or to preclude future maintenance cleaning; in such cases, the extra pond depth will not be credited toward the regulatory permanent pool requirement. If the minimum depth is not specified, use five feet to minimize aquatic growth.

Side Bank Underdrain Filters:

Do not construct these around the entire pond. Design the pond to have at least 20 feet of the side slope without underdrains so that maintenance vehicles can get to the pond bottom without running over the underdrain.

9.2.1.2 Diversion Structures

Diversion structures of off-line systems must have a manhole for access on each side of the weir (refer to Section 3.10 of the *Drainage Manual*). Furthermore, the manholes should be located out of the roadway pavement to allow access without blocking traffic. Off-line systems are discussed in Section 9.3.

9.2.1.3 Conveyance to and from the Pond

The right of way obtained for conveyance to and from the pond must be sufficient to maintain the conveyance. This is true for either piped or open-ditch conveyance systems. Figure 9.2-2 provides typical sections for establishing the width of the right-of-way requirements.

Where the pond discharges to something other than an existing storm drain system, obtain right of way from the pond to a receiving surface water body (lake, wetland, ditch, canal, etc.) even if there are no physical changes proposed to the conveyance path. This assures that the Department will have the right to maintain the flow path.

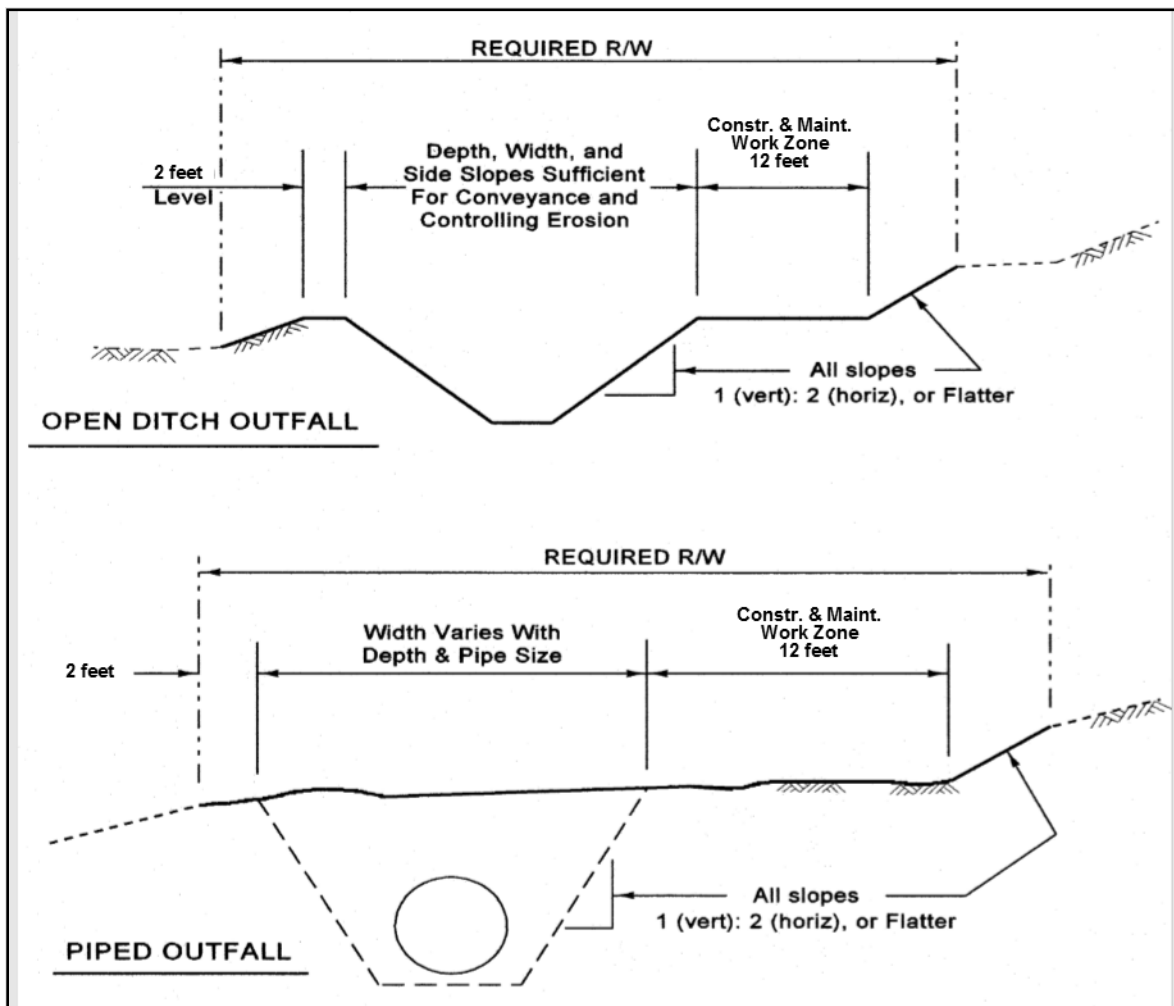

Figure 9.2-2: Required Right of Way Widths

9.2.1.4 Vehicle Access

Roads:

Sometimes, you can use the right of way available for conveyance to provide maintenance access to the pond. For pond sites located far from the project, it may be more reasonable to reach the pond from a local road. In flat terrain, an ideal width of right of way for access only (not including conveyance) is 15 feet. Larger widths may be necessary for turns. In irregular terrain, consider the distance to tie into natural ground. Concentrated flows crossing the access road may require a culvert crossing. If the vertical clearance is restricted, discuss it with maintenance personnel.

The roadway designer should design and incorporate curb cuts and driveways in the plans where the access road joins the public road.

Gates:

If you plan to fence the pond, use a 24-foot or two 12-foot sliding cantilever gates (Standard Plans, Index 550-003). This will allow the largest piece of normal maintenance equipment to enter and exit without having to back out along the access road. If you must use a swinging gate, pave the area under the arc of the gate swing. Show the gate type, location, and size in the plans.

9.2.1.5 NPDES Permits

Active National Pollutant Discharge Elimination System (NPDES) permits may cover the limits of proposed construction. The District NPDES Coordinator needs to review the proposed project to ensure compliance with any active permits.

9.2.2 Construction

Consider the right of way needed to construct the facility. The right of way needed to maintain the facility, i.e., the permanent right of way, may be, but is not always, sufficient to construct the facility. If the construction area is outside the permanent right of way, you should use temporary construction easement documents to obtain sufficient area for the contractor to construct the facility.

Some water management districts require a professional land surveyor to lay out final placement of drainage structures. Some of the Department's districts are directing the contractor to do this. Discuss this with the project manager or district construction personnel. If they want to have the contractor survey the final placement, include the requirement in the contract documents, as directed by the district.

Often, the regulatory agencies place special requirements on the Department's projects as "conditions of the permit." Requirements that will affect the contractor's work must be incorporated into the plans or specifications for bidding and payment purposes. It is not sufficient that the permits will become part of the contract documents.

9.2.2.1 Structure Tolerances

Unless otherwise dictated, the tolerance for drainage structures is controlled by Section 5-3 of the Standard Specifications, which reads: "reasonably close conformity with the lines, grades, . . . specified in the contract documents." The tolerance is particularly important for weirs, orifices, and other flow control openings of outlet control structures. You can calculate weir dimensions quite precisely, but it is not reasonable to construct concrete structures to that same precision. Complicating this in the past, the regulatory agencies' inspectors sometimes have expected the dimensions to be exactly as shown in the plans.

During design, if you realize that the designed discharge is sensitive to small changes in weir dimensions, you should conservatively account for the tolerance in the calculations. For example, to maintain the discharge rate at or below the allowable rate, specify a weir width that is 0.05 feet smaller than the width required to discharge at the allowable rate. And include the tolerance mentioned above. If the contractor constructs the weir 0.05 feet wider than specified, it will match the designed width. If the weir is constructed 0.05 feet narrower than specified, the discharge rate still will be less than the 0.05 feet maximum allowed. In the last condition, you should check that stage has not increased to a point where the pond is now discharging through the overflow point.

Although not often used, another option is to use "bolt on weir plates" with slotted bolt holes. The plate elevation then can be adjusted to exact elevations after the structure is set.

9.2.2.2 Earthwork Tolerances

By Standard Specifications, the tolerance for earthwork within a stormwater management facility is 0.3 feet above or below plan cross section (Section 120-12). For some retention ponds, having a bottom 0.3 feet higher than anticipated may substantially reduce the treatment volume and somewhat affect the attenuation capacity. Conversely, having a bottom 0.3 feet lower than anticipated may substantially increase the retention (or treated) volume and affect the recovery time. This tolerance will not affect wet detention facilities.

Do not specify a tolerance that may conflict with the Standard Specifications. If the standard tolerance will substantially reduce the retention or treatment volume—as in a shallow retention pond—design the pond to allow for the bottom being 0.3 feet higher or lower than shown in the plans. In other words, specify a pond bottom that is 0.3 feet lower

than necessary to retain the minimum volume. For example, the pond bottom may need to be 0.7 feet below the weir to provide the treatment volume. Specify the bottom to be 1.0 foot below the weir to allow for the earthwork tolerance. Determine the recovery time assuming that the pond bottom is 1.25 feet below the weir, i.e., 0.3 feet below the specified bottom elevation.

You should reserve this extra effort for facilities where the earthwork tolerance could substantially reduce the retention or treatment volume.

9.2.3 Aesthetics

The Florida Department of Transportation has adopted a Highway Beautification Policy to include aesthetic considerations in the design aspects of highways. Chapter 5 of the *Project Development & Environmental Manual* summarizes the requirements and provides direction in applying them to Department projects. Aesthetic considerations are cited in Section 5.4.4.2 of the *Drainage Manual* as an integral part of sound pond design. Often, programmatic or aesthetic commitments are made during the project development phase. If so, the environmental document will contain a discussion of visual impacts and aesthetic requirements for stormwater ponds. Discuss this with the Landscape Architect and Environmental Management Office project manager.

The location, size, shape, side slopes, fencing, and landscaping all affect the aesthetic quality of a pond. In general, irregular shapes, gradual slopes, and no fence are more aesthetically pleasing and have less visual impact than rectangular shapes and steep slopes with a chain link fence. For this reason, the *Drainage Manual* mandates that the default pond design should not include fencing, and that fencing must be justified within the design documentation. You can use irregular side slopes for permanently wet ponds to create an undulating water edge even when the perimeter of the site is rectangular. Preservation of existing vegetation and inclusion of native and wetland vegetation can greatly improve the visual appearance of a pond. Typically, this will require that you design and construct physical barriers to protect the existing vegetation from construction equipment.

In urban areas, ponds designed with a park-like appearance will encourage the local government to undertake the maintenance. If you design a pond site to be landscaped, a memorandum of agreement (MOA) for maintenance may be executed with the local government. In the absence of an MOA, the Department may undertake the landscape maintenance of a pond. The District Landscape Architect is familiar with the MOA procedure. Any landscape projects should be coordinated by the project manager with support from the District Landscape Architect.

The shape, depth, and side slopes will affect how much right of way is required for a pond. Therefore, you must evaluate and weigh aesthetics among the other factors during the site selection process (see Section 9.1). The Department has determined that pond aesthetics is an acceptable design objective that would justify acquisition of additional right of way, including eminent domain acquisition, when appropriate. Seek out the District Landscape Architect to coordinate and develop appropriate aesthetic features. Your responsibility is to ensure that the design constraints (volumes, depths, littoral shelves) are met while accommodating the aesthetic features. Coordinate with the District Landscape Architect to establish the quantity of right of way needed to meet aesthetic and design constraints.

9.2.3.1 Fence

The *Drainage Manual* mandates that the default pond design does not include fencing and that use of fencing must be justified within the design documentation. Design stormwater ponds to avoid the need for fence, if feasible. Typically, the flow velocities within a stormwater pond are low and, therefore, the velocities do not create a hazard. Unexpected deep standing water—such as an immediate 1:2 drop off at the water's edge—should be avoided or fenced. Under the Statewide Environmental Resource Permit (ERP Ch. 62-330) Rule, the *Drainage Manual*, Florida Department of Environmental Protection (FDEP), and all the water management districts allow for unfenced facilities if the slopes are 1 (vertical) to 4 (horizontal) or flatter. Refer to Section 2.6.1 of the *Drainage Manual* for further discussion of protective treatment.

When it is necessary to provide a fence, one that fits the surrounding community is ideal. The style (wood, block, chain link, wrought iron, etc.) will vary from community to community. Pay item 0550-10 series covers special fencing; however, special details and specifications will need to be included in the contract documents. Because of the extra work, special fencing has not been commonly used. Another complication with special fencing is that the Department's maintenance units do not normally have the materials to repair them; therefore, confer with the local maintenance engineer anytime you are considering special fencing.

If it is not feasible to provide a special fence, the next option is to use standard FDOT fence. In rural areas, the Type A fence, Standard Plans, Index 550-001 usually is appropriate. In urban areas, Type B fence (chain link), Standard Plans, Index 550-002 usually is appropriate.

Fence Color:

One of the simplest things you can do to reduce the visual impact of chain link fence is to specify that it be color coated. Standard Plans, Index 550-002 offers an option for PVC (vinyl) coated fence fabric that is a soft gray color; however, you can specify the color to

be medium green, dark green, or black as allowed by AASHTO M 181. The posts, rails, and fittings also can be color coated. To specify color-coated fence, use a pay item footnote (0550-102x2 thru 0550-102x2, as applicable to the fence height required) similar to the following:

Color coat the fence fabric, posts, rails, and fittings around the stormwater facilities with xxx (state the desired color) PVC. Apply the PVC coating of the posts and rails in addition to the standard metallic coating and ensure that it meets the requirements of ASTM F 1043. The PVC coating of the fittings must meet the requirements of ASTM F 626. Include the cost of the coating in the cost of these items.

Fence Height and Barbed Wire Attachments:

The Department has no requirement for the height of the fence surrounding a stormwater facility, nor does it require the use of barbed wire attachments on a fence surrounding a stormwater facility. Other regulatory agencies may have applicable requirements regarding fence height and barbed wire attachments.

9.2.3.2 Debris Collection

Discuss with maintenance personnel and the District Landscape Architect the need to collect debris near the inflow pipe to the pond to prevent the debris from spreading. If it is possible to collect the debris, direct it to one location where maintenance personnel can easily remove it. Figure 9.2-3 shows some possible configurations.

Do not locate inflows and outlets near preserved existing vegetation or planted landscape areas that have the potential to shed leaves, limbs, etc., that may clog pipes and structures.

9.2.4 Aviation Safety Requirements

Per the *Drainage Manual*, when a prospective pond—wet or dry—is located within five miles of an airport, the drainage designer must contact the District Aviation Coordinator to ascertain any relevant airport design restrictions. The FAA requirements are targeted to minimize the potential for bird strikes and are specific to the types of aircraft using the airport and to the layout of the airport's runways. The district aviation coordinators are familiar with these requirements and will provide guidance to the drainage designer.

The best choice, in responding to FAA requirements, is to move the proposed pond outside the glide paths of the air traffic. If this is imprudent, dry ponds are less attractive to birds than wet ponds. Additionally, several design approaches are routinely used in wet ponds to minimize attracting birds:

- Use steep, rocked slopes, typically 1:2, without littoral zones, to discourage the presence of food sources for birds.
- Suspend nets over the surface of the pond to make the area less hospitable for ducks, geese, and other waterfowl.
- Other options may be available through consultation with the airport manager and Qualified Airport Wildlife Biologist.
- Ask districts for other techniques

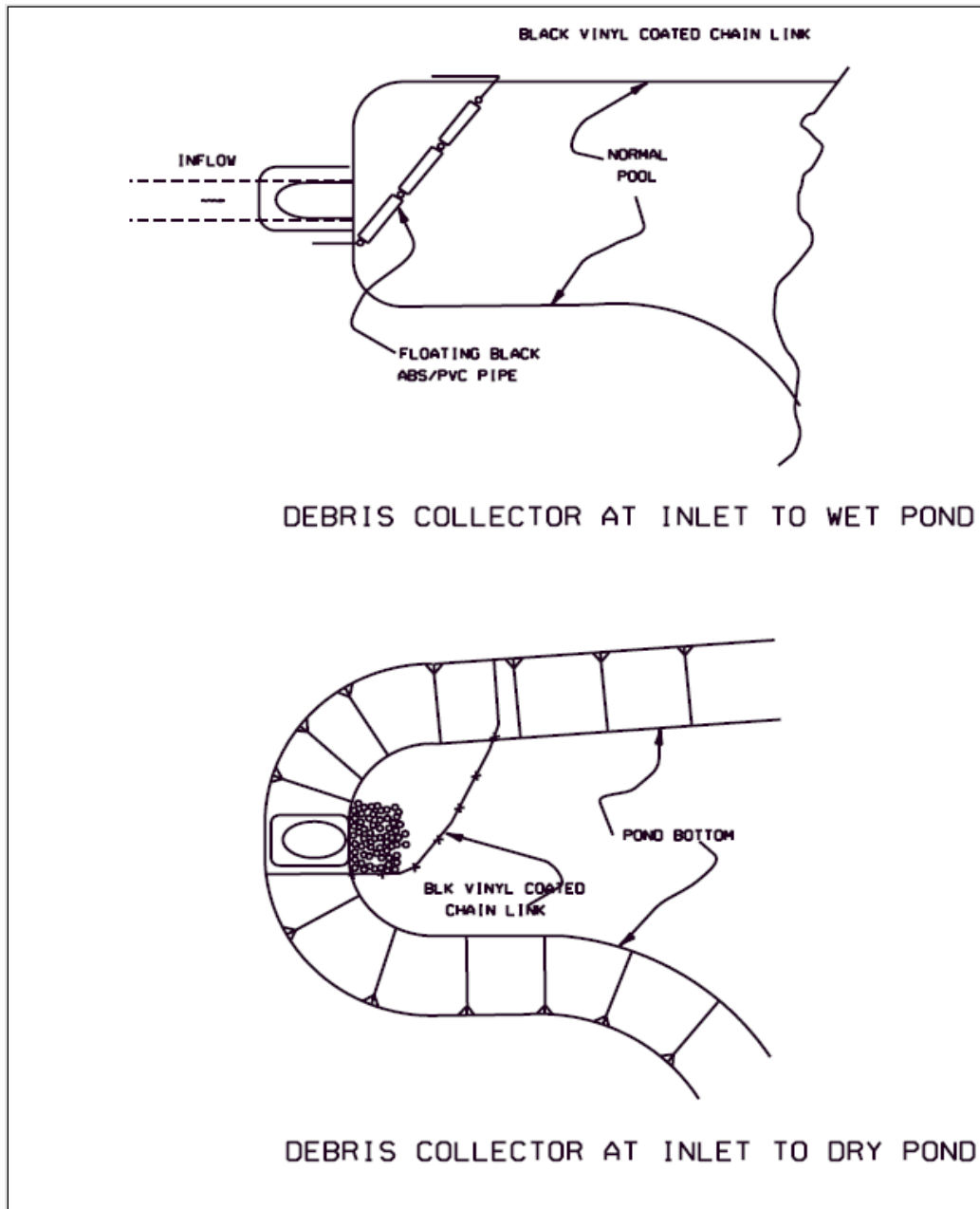

Figure 9.2-3: Possible Configurations to Collect Debris

9.3 STORMWATER QUALITY

9.3.1 Design Criteria

FDEP, the WMDs, and the delegated local governments have established design criteria for the operations of stormwater management facilities. There are two main categories of

criteria: (1) water quality, and (2) water quantity (see Section 9.4). The criteria related to water quality are based on research of rainfall and runoff in Florida and were established to meet state water quality standards. See Appendix N for a discussion of the development of the typical criteria.

Although the criteria are similar around the state, there is some variation. It is essential that you become familiar with the applicable agency's criteria. Read their manuals and coordinate as necessary. Arrange a pre-application meeting to review the status of applicable rules and to identify potential problems and concerns to be addressed during design. Agencies usually have checklists and standard forms to be completed for a stormwater permit. Review these forms and address the items relating to stormwater management.

9.3.1.1 Treatment Volumes

Pollutants in stormwater runoff from urbanized areas generally exhibit a "first flush" effect. This is a phenomenon where the concentrations of pollutants in stormwater runoff are highest during the early part of the storm with concentrations declining as the runoff continues. Substantial reductions in pollutant loads to the state's waters will occur when this first flush is captured and treated. Therefore, each method of treatment requires that a volume of runoff be captured and treated before discharging to surface or groundwater. This volume is called the treatment volume.

In general, the treatment volume will vary depending on the classification of the receiving water body and whether the volume is captured on-line or off-line. Sensitive water bodies such as shellfish harvesting waters (Class II) and Outstanding Florida Waters require a larger treatment volume. The classification of the receiving water body should be identified in the Project Development phase as a part of the water quality impact evaluation. FDEP includes a list of sensitive water bodies in Rule 62-302, F.A.C.

9.3.1.2 Special Conditions

Some of the Department's districts have agreements with regulatory agencies regarding treatment requirements for certain types of highway improvements, such as bridge widening and intersection improvements. Check with the District Drainage Engineer to see if your project is covered by an agreement.

Compensatory treatment may be an option when trying to meet water quality regulations. Sometimes, limited or very expensive right of way creates hardship conditions in which it is unrealistic to provide the standard treatment. Sometimes, the Department can arrange to provide compensatory treatment for an area that currently does not receive any treatment. Providing this treatment compensates for not providing the standard treatment in the area where the hardship condition exists. Treating a larger volume of runoff at

another location (drainage area) on the project usually is not considered replacement treatment.

Nutrient-Impaired Basins

When designing stormwater systems that discharge to basins verified for nutrient impairment, state law requires the applicant to demonstrate that there will be no net increase of the pollutant of concern. To satisfy this requirement, all WMDs require a pre- vs. post-development comparison of annual nutrient loading, using the Harper (2007) Methodology, to demonstrate that the post-development annual loading is not greater than the pre-development loading for the pollutant of concern. Guidance on this analysis is contained in Section 9.3.4.6 of this document.

The BMPTRAINS software, developed by the UCF Stormwater Management Academy (<https://stormwater.ucf.edu/>), can be used to analyze best management practice (BMP) nutrient removal from different land uses. See Section 4.5.1 for an example. Software results are readily accepted by permitting agencies around the state.

9.3.2 Concerns of Off-Line Systems

Although off-line treatment systems are preferred from a water quality standpoint and sometimes require less treatment volume, they can complicate the design. You would design off-line systems to bypass essentially all additional stormwater runoff volumes greater than the treatment volume to the receiving water or an attenuation basin. The bypass flow must pass over the weir of the diversion structure. This can present design problems in that the weir may need to be very long to keep the hydraulic gradient at an acceptable level. Skimmers need to be constructed in front of these weirs, further complicating the practicality of long weirs.

Another concern is that there will be some additional attenuation storage in the off-line basin associated with the hydraulic gradient of the peak flow passing over the weir. When there is significant attenuation storage above the treatment volume, there is a concern that the system will function more as an on-line system than as an off-line system due to mixing. You could use metal or rubberized flap gates to address this concern, but they can be a maintenance problem and a noncompliance issue if not carefully designed.

The outlet control structures of off-line systems are difficult to maintain simply because they normally are placed in junction boxes. They are neither seen nor reached as easily as the outlet control structures of on-line systems.

9.3.3 Seasonal High Water Table

Frequently, the first parameter considered in the design of a retention or detention BMP is the location of the water table. Define the depth to the normal high water table and the seasonal high water table (SHWT) to establish the appropriate type of BMP and the needed treatment volume. The SHWT is critical to the operation of all of the treatment methods described below. The control (or normal) water elevation of wet detention systems is related to, and sometimes set at, the SHWT. The SHWT is a critical factor in calculating the recovery time of the treatment volume in a retention system. For filtration systems, the lowest point of the underdrain pipe should be at least one foot above the SHWT.

Use the NRCS soil surveys, project-specific soil investigations, and field observations (vegetative indicators, observation wells, etc.) to estimate the SHWT. Recognize, however, that soil staining may denote a relic or historic water table that has since been lowered by other drainage features in the region.

9.3.4 Treatment Methods

The treatment methods most commonly used by the Department are wet detention, retention, filtration, and exfiltration. Refer to Chapter 7 of this document for exfiltration system BMPs. The type of soil and the SHWT control the selection of the treatment method. The following figure provides qualitative guidance for the selection.

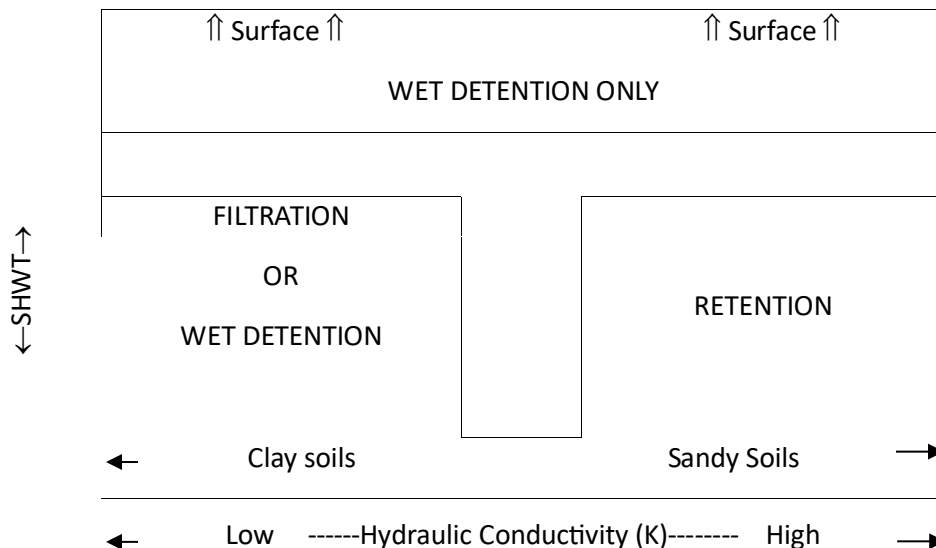

As shown, wet detention is the only option in areas where the SHWT is near the surface. However, wet detention also may be appropriate in areas where the SHWT is far from the surface and clay soils exist. The use of retention requires that the SHWT be far from the

surface and that sandy soils exist. Filtration requires that the SHWT be far from the surface unless impermeable liners are used.

You cannot apply specific values to this figure because site-specific factors—such as pond shape, groundwater boundary conditions, and drainage basin characteristics—need to be considered. Situations exist where both filtration and wet detention are suitable. In these cases, the Department should weigh and balance other factors—such as right-of-way costs, property owner preference, and long-term maintenance costs—to select the most appropriate treatment method.

9.3.4.1 Wet Detention Systems

These systems are permanently wet ponds that are designed to slowly release the treatment volume through the outlet control structure. The pollutants are removed by physical, biological, and chemical assimilation. Specifically, pollutant removal processes that occur within the permanent pool include uptake of nutrients by algae and wetland vegetation, adsorption of nutrients and heavy metals onto bottom sediments, biological oxidation of organic materials, and sedimentation.

Advantages

1. Very effective at removing dissolved and suspended pollutants.
2. High probability to function as designed.
3. Recovery of treatment volume is easily predicted.
4. Easy and low-cost long-term maintenance.
5. Produces on-site fill material for project needs

Disadvantages

1. Treatment requirements are typically double the requirements for retention and filtration.
2. Depth of the treatment volume is sometimes limited to 1.5 feet.
3. Because of the above items, right-of-way requirements are greater than other methods.
4. Sometimes requires planting of the littoral zone.
5. Creates a potential mosquito habitat.

Despite the disadvantages, the Department encourages the use of wet detention.

The average length-to-width ratio of the pond should be at least 2:1. Maximize the flow path of water from the inlet to the outlet to promote good mixing and avoid “dead” storage areas. If you cannot avoid short flow paths, use the littoral shelf to increase the effective

flow path, provided this is acceptable to the regulatory agency. Figure 9.3-1 shows examples of pond configurations.

Per the regulatory agency requirements, you may need to plant the littoral shelf. If so, consult with the District Landscape Architect.

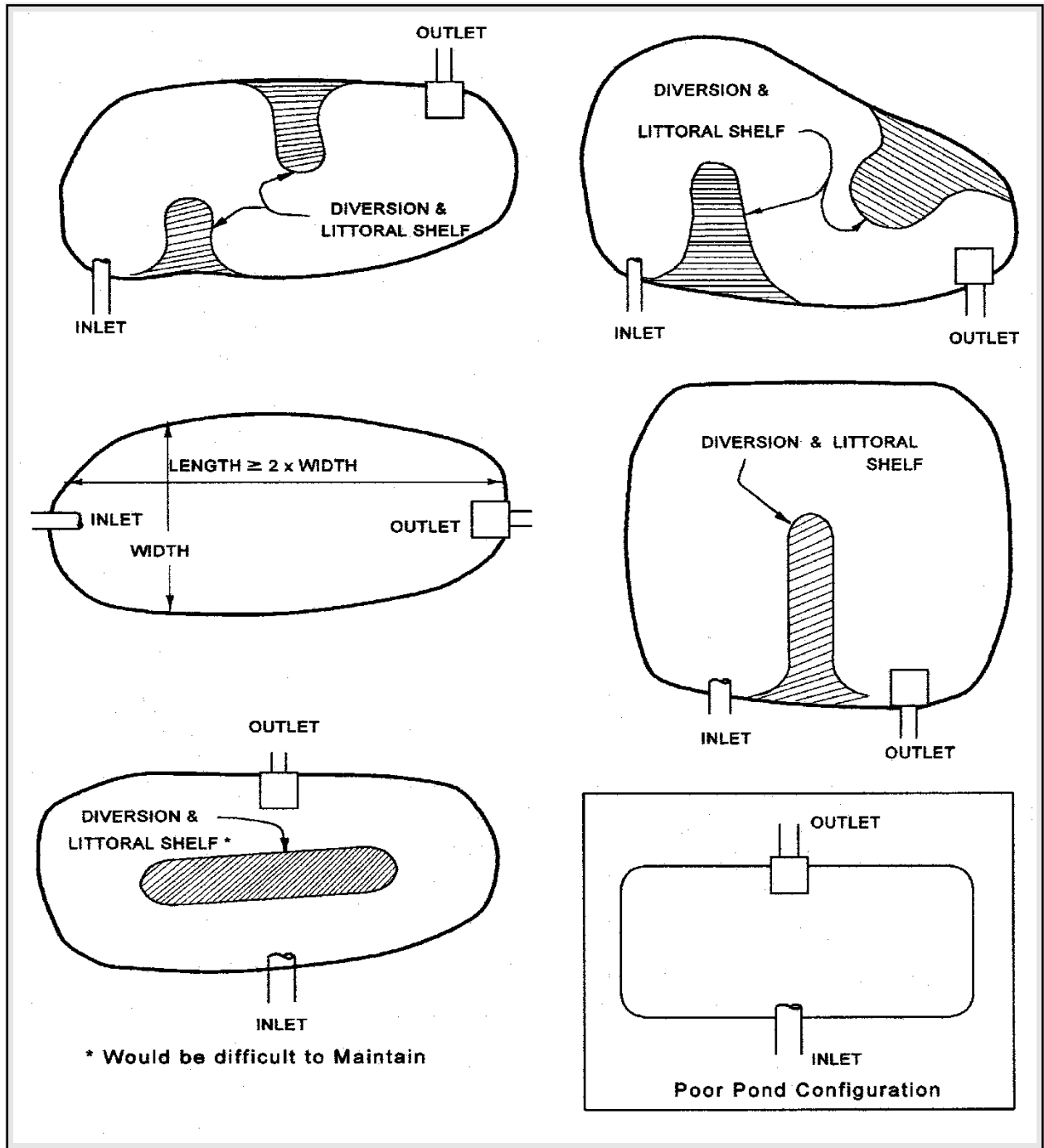

Figure 9.3-1: Wet Detention Configurations

9.3.4.2 Pond Liners

Pond Liner Applications

Due to the challenges around pond liners, there is an increased risk of failure. Using a pond liner should be thoroughly vetted and the design should be well supported by the unique environmental conditions, survey and geotechnical data. Some typical causes of failure can be inadequate cover, insufficient de-watering activities and lack of groundwater modeling.

Consult the District or State Drainage Office for Technical Specifications. While the Department does not encourage the use of liners, the following are design scenarios where the consideration of a pond liner is appropriate:

1. The stormwater facility is located within a Sensitive Karst Area Basin or the surrounding geography is susceptible to sinkholes due to excessive stormwater runoff.
2. If the stormwater facility is in proximity to hazardous environmental conditions, and water seeping from the pond risks mobilizing existing contaminants in the soil or groundwater.
3. When there is a need to preserve groundwater flows into the facility from adjacent wetlands.

Design Considerations

When designing an impermeable pond liner, a groundwater model is recommended to ensure the proposed liner does not negatively impact subsurface groundwater flows (i.e. a 20-acre wetland adjacent to a 1-acre pond or a 5-acre pond adjacent to a 1-acre wetland, will have differing impacts to pond water levels.) Factor in the Seasonal High Groundwater Elevations of existing wetland / depressional areas adjacent to the pond. If elevations in such areas are higher than the proposed top of impermeable liner, seepage into the new facility could occur. Additionally, temporary barriers may be required to protect wetland / depressional areas from being impacted by the de-watering activities necessary to construct the liner.

Installation of pond liners can be challenging and require an experienced contractor. Pond liners in facilities adjacent to right-of-way limits may require sheet piles or other temporary structural measures to stabilize the trench during the liner installation. Construction sequencing details may be needed to address the construction activities required to accomplish the grading and pond liner construction. This could include sheet piles, dewatering, excavation, seam welding, battens, perimeter anchoring and liner penetration methods.

Before a pond liner may be implemented on a project, perform a cost benefit analysis to compare the costs related to pond liner construction versus an expanded pond footprint. Examine the material within the pond footprint to see if it's worth-while fill (embankment) material. If the material can be used on the project, this could justify the cost associated with excavation and de-watering needed to complete the installation.

Materials Information

Impermeable pond liners come in many different materials: High Density Polyethylene (HDPE), Polyvinyl Chloride (PVC), Reinforced Polyethylene and clay. Below are material minimums for using a pond liner, however, always consult your District Drainage Engineer and District Geotechnical Engineer for project specific considerations.

1. PVC, use a minimum of 30 mil
2. Reinforced Polyethylene Geomembrane, use a minimum of 30 mil
3. HDPE, use a minimum of 60 mil
4. Clay liners, use a minimum thickness of two feet or an in-place hydraulic conductivity of 1×10^{-7} centimeters per second (cm/s) or less

9.3.4.3 Retention Systems

A retention system is designed to store the treatment volume, allowing it to infiltrate into the soil. Soil permeability, water table conditions, and the depth to any confining layer must be such that the retention system can infiltrate the treatment volume within a specified time following a storm event. After the pond completes the drawdown, the basin does not hold water; thus, the system is normally "dry." Unlike wet detention systems and filtration systems, the retention system will discharge the treatment volume into the ground, not to surface waters.

Most regulatory agencies require that the treatment volume be available within 72 hours after a storm. See Section 9.4.6.1 on the subject of groundwater flow from retention systems and a recommended approach to modeling recovery of the treatment volume.

9.3.4.4 Filtration/Underdrain Systems

A filtration system is designed to treat the water quality volume, allowing it to pass through a sand filter. It differs from a retention system in that the treatment volume is not infiltrated into the soil, but instead discharges to surface water. After passing through the sand filter, the water collects in perforated pipes that discharge to surface water. The Department's standard underdrain is shown in Standard Plans, Index 440-001.

Compared with the previous two treatment methods discussed, underdrains are the least reliable. They are subject to clogging during and after construction and are difficult to

maintain. Vehicle loads can crush the underdrain pipes. Filtration systems also do not remove dissolved constituents, such as nitrogen and phosphorus, and therefore do not count toward load reduction credit in impaired basins. The Department realizes that using underdrains is sometimes necessary due to clayey soils but encourages a thorough evaluation of other treatment methods first.

Configuration:

When you use side bank underdrain (Standard Plans, Index 440-001, Type Va), slope the pond bottom up from the underdrain. This will reduce the saturated soil condition and localized ponding associated with a flat pond bottom. It also increases the chances of sustaining a stand of grass on the bottom. See Figure 9.3-2.

If feasible, construct underdrains out of the primary flow path to avoid directing debris and sediments there.

To account for construction tolerances, the underdrain pipe should be placed on a slope. Specify flow lines for the pipe at the beginning, at bends, and at the end of the underdrain. In all but very short runs of underdrain, the flow line should drop six inches or more to account for construction tolerances.

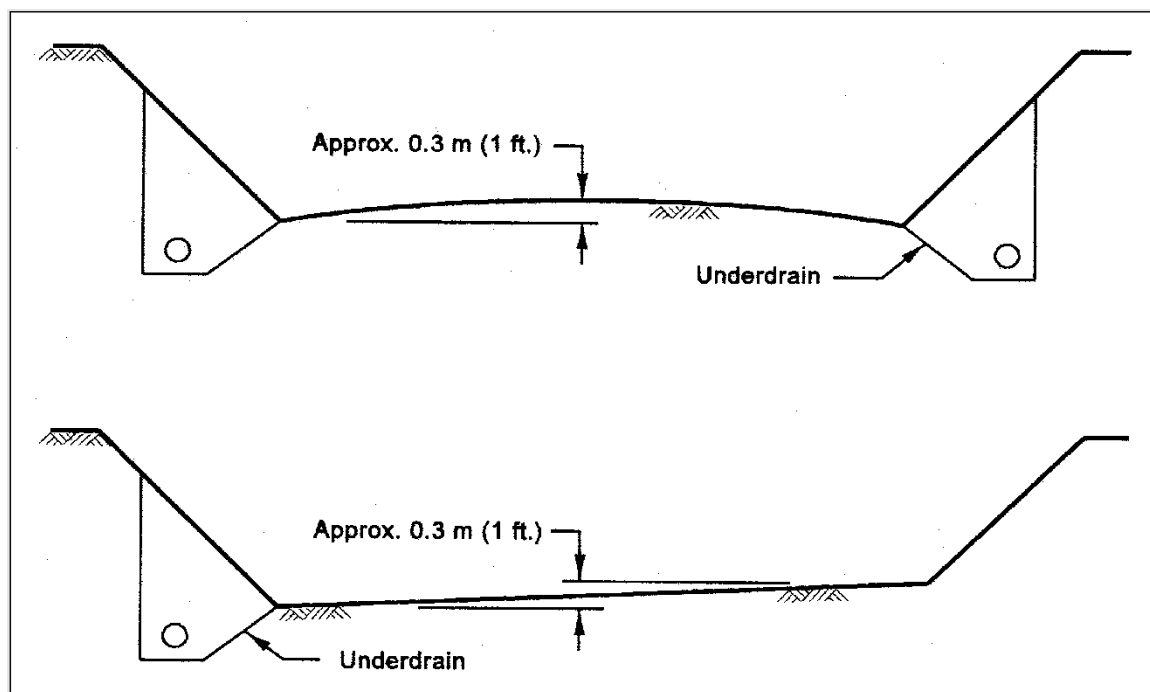

Figure 9.3-2: Bottom Configurations with Side Bank Underdrains

Design Technique

Hydraulic Conductivity of the Fine Aggregate Media:

For design purposes, use $K = 0.5$ ft/hr as the hydraulic conductivity of the fine aggregate media. This does not include the factor of safety of two required by the regulatory agencies. You do not have to apply that factor of safety to the hydraulic conductivity. It is sometimes applied to the length of the underdrain or to the time to draw down the treatment volume. You could refine the above value by experience from permeability testing of locally available fine aggregate media meeting the requirements of the standard specifications for underdrain filter material.

Determining the length of underdrain required is a trial-and-error process and can be accomplished by using the following procedure with Table 9.3-2.

1. Develop incremental storage volumes from the maximum elevation of retention storage (i.e., lowest elevation of the outlet control structure) down to the pond bottom. Record these in Column 1 through Column 3 of Table 9.3-2.

2. Determine the effective head (H_E), the average flow length (L_{AVG}), and the average width (W_{AVG}) for flow paths through the underdrain. Determine these for each water surface elevation considered in Step 1. See the discussion following Step 10 for a suggested approach to determining these values. Record these in Column 4 through Column 6.
3. Calculate the hydraulic gradient (i) for each water surface elevation considered in Step 1 using the values determined in Step 3, and record the results in Column 7. Hydraulic gradient (i) = H_E/L_{AVG} .
4. Assume an underdrain pipe length (L) and calculate the area of filter (A) for each water surface elevation considered in Step 1. Record results in Column 8.
5. Calculate the Darcy flow (Q) using the hydraulic conductivity (K), the hydraulic gradient, and the filter area for each water surface elevation considered in Step 1. Record results in Column 9.
6. Calculate the average flow rate for each depth interval and record results in Column 10.
7. Divide the incremental storage volume (ΔV) from Column 3 by the average flow rate from Column 10 to obtain the incremental time (ΔT) to draw down that storage volume. Record results in Column 11.
8. Sum the incremental drawdown times recorded in Column 11 to obtain the drawdown time (ΣT). Record results in Column 12.
9. If the total computed drawdown is longer than required, increase the underdrain length and return to Step 5.
10. Size the underdrain pipe to handle the design flow rate.

Determining the Effective Head, Average Flow Length, and Average Width:**Bottom Underdrain (Type Vb):**

To determine the effective head (H_E) at a given water surface, use the vertical distance from the water surface to the bottom of the fine aggregate material. For the average flow length (L_{AVG}) through the filter, use the depth of fine aggregate, 2.0 feet. For the average width (W_{AVG}) of filter normal to flow, use the standard width of 1.5 feet unless you use non-standard geometry.

Side Bank Underdrains (Type Va):

The standard plans index shows the upper and lower limit to side bank underdrain. Try to avoid using the upper limit configuration because of its limited flow capacity in low head

conditions. There is very little head and the length of the filter material through which the water must pass is long, resulting in a very small hydraulic gradient.

1. Make a scaled drawing of the average cross section geometry. One is shown in Figure 9.3-3. The average should represent the midpoint between the high end and low end of the underdrain.
2. For the effective head (H_E) at a given water surface elevation, use the vertical distance from the water surface to the pipe centerline. At high heads, this is non-conservative because the free draining effect of the course aggregate reduces the head. At low heads, this is a reasonable assumption.

The combined effect of using H_E & L_{AVG} as described here should result in conservative flow rates in low head conditions and reasonable rates in high head conditions. At high heads, the non-conservatism of using the effective head (H_E) to the center line of the pipe is offset by using an average length (L_{AVG}) that is longer than the actual distance through the fine aggregate. At low heads, the conservatism of using a longer-than-actual average length (L_{AVG}) is justified because this zone of the filter is most likely to receive sediment and clog.

3. For the average flow length (L_{AVG}) through the filter at a given water surface, use the average of several straight-line distances from the outside of the pipe to the top of the fine aggregate. This is conservative because it ignores the course aggregate, which is relatively free draining. Refer to Figure 9.3-3 and Table 9.3-1 for an example.
4. For the average width (W_{AVG}) of filter normal to flow, use the average of the saturated fine aggregate area. Due to the complex transition between vertical and horizontal flow, this is best determined by “visually” estimating the average width based on your scaled drawing. Refer to Figure 9.3-3 and Table 9.3-1 for an example.

Table 9.3-1: Average Flow Length and Average Width through Side Bank Underdrain

| Water Surface Elevation | L_{AVG} Avg. Flow Length through Filter | W_{AVG} Avg. Width of Filter Normal to Flow |
|-------------------------|--|--|
| WSE-5 or above | $(L5 + L4 + L3 + L2 + L1 + L0) / 6$ | W to W5 |
| WSE-4 | $(L4 + L3 + L2 + L1 + L0) / 5$ | W to W4 |
| WSE-3 | $(L3 + L2 + L1 + L0) / 4$ | W to W3 |
| WSE-2 | $(L2 + L1 + L0) / 3$ | W2A to W2B |
| WSE-1 | $(L1 + L0) / 2$ | W1A to W1B |
| Refer to Figure 9.3-3. | | |

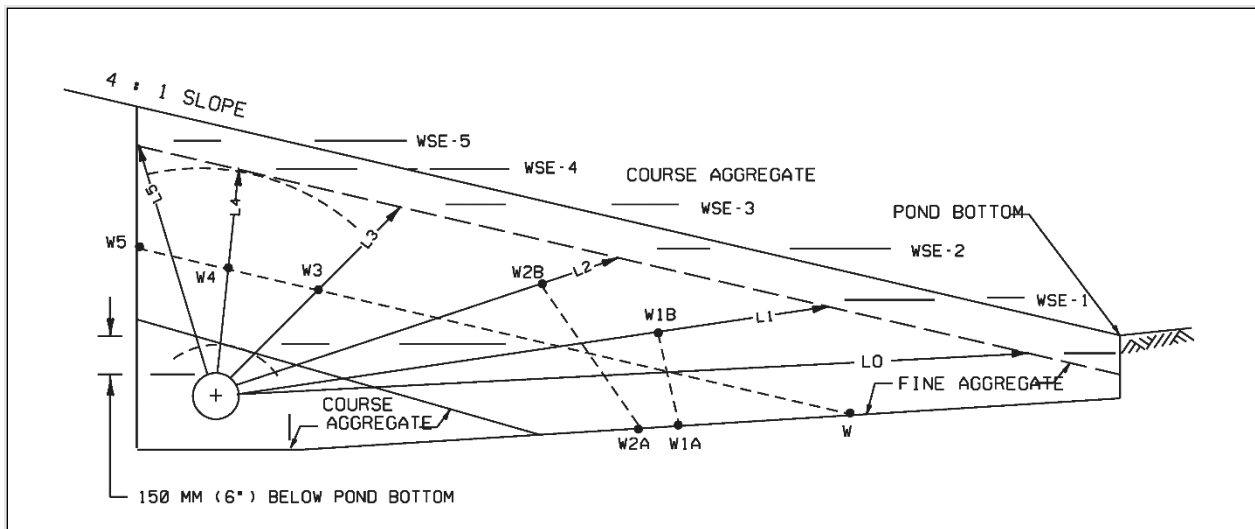

Figure 9.3-3: Side Bank Underdrain (Shown 6" Below Upper Limit)

9.3.4.5 Stormwater Re-Use Systems

These systems represent wet ponds that provide water for re-use—either for irrigation, alternative water supply, or supplemental water for reclaimed wastewater lines. A wet detention pond can be converted to a re-use pond simply by plugging the bleeder and pumping the treatment volume to its designated re-use. Since there is less discharge volume compared to a standard wet detention pond, there is less mass of pollutant being released from the stormwater re-use pond.

9.3.4.6 Regional Stormwater Pond Systems

Regional stormwater ponds, by definition, provide water quality treatment for a significant portion of the upstream basin, not just the onsite FDOT project. These ponds often are located downstream of the FDOT project, avoiding the more expensive land adjacent to the state highway. Typically, this approach includes the cooperation of a local government that assumes ownership and perpetual maintenance of the pond. FDOT holds a storage easement, prescribing a needed storage volume below a certain design elevation. Multiple gains result from this cooperative approach:

1. FDOT is relieved of ongoing property liability and maintenance responsibility.
2. The downstream waterway enjoys improved water quality.
3. Property adjacent to the state highway, previously targeted for usage as a pond, is available for development.
4. Oftentimes, stormwater re-use is facilitated by a single, larger stormwater pond.

Regional treatment facilities can be difficult to permit because of the Class III treatment requirements of conveyance facilities between the FDOT site and the location of the regional pond. These intermediate waterway requirements sometimes can be eliminated by classifying the manmade, intermediate conveyance waterways as part of the stormwater system, thereby severing jurisdiction. The cooperation of the WMD will be essential in such efforts.

9.3.4.7 Harper (2007) Methodology for Nutrient Loadings Computation

The 2007 Harper Methodology was the computational foundation for the 2009 Statewide Stormwater Rule. The rule was not implemented, but the Harper Methodology has been accepted by the WMDs and FDOT as a best practice for estimating annual nutrient loadings. Details of the methodology are outlined in the March 2010 draft of the Stormwater Quality Applicant's Handbook posted on the state drainage website, under Design Aids: <http://www.fdot.gov/roadway/Drainage/ManualsandHandbooks.shtm>

The above draft publication is referenced **ONLY** for its helpful outline of the background rationale and computational steps involved in the Harper Methodology, **NOT** for regulatory requirements.

Since 2010, event mean concentrations (EMCs) for different land uses have changed as additional data have become available. Current general EMCs are tabulated below:

Table 9.3-3: Example EMC Values for Different Land Uses

| LAND USE CATEGORY* | Event Mean Concentration (EMC) | |
|----------------------------------|--------------------------------|------------------|
| | mg/L | |
| | Total Nitrogen | Total Phosphorus |
| Single-Family | 2.07 | 0.327 |
| Multi-Family | 2.32 | 0.520 |
| High-Intensity Commercial | 2.40 | 0.345 |
| Light Industrial | 1.20 | 0.260 |
| Highway | 1.64 | 0.220 |
| Agricultural—Citrus | 2.24 | 0.183 |
| Agricultural—Row Crops | 2.65 | 0.593 |
| Agricultural—General Agriculture | 2.79 | 0.431 |
| Undeveloped | 1.15 | 0.055 |

*Numbers may vary as more information becomes available or for specific locations.

The BMPTRAINS computer program was developed to employ the latest policy and methodology for assessing nutrient loadings and BMP performance related to nutrient removal. The program is available on-line at the UCF Stormwater Management Academy website: <http://stormwater.ucf.edu/>

The program includes helpful tutorials and a user's manual.

Additional helpful tools sponsored by the Academy are available under the title Stormwater Management and Design Aids (<http://stormwater.ucf.edu/>). A partial list of programs in the SMADA online package is below:

1. BMPTRAINS "Light"—Used to select one BMP with an estimate of nutrient pollutant removal and in the selection of BMPs for net improvement or pre/post analysis.
2. BMP performance evaluation
3. Rainfall distributions and IDF curves

4. Statistical analyses such as regression and frequency distributions
5. Time of concentration
6. Hydrograph generation
7. Unit hydrograph generation
8. Transport pipe and channel flow and sizing
9. Pollutant load calculations
10. Storm sewer design and analysis

9.3.4.8 Protection of Springsheds from Nitrates

The Harper Methodology targets annual loadings of nutrients to surface waters, making the assumption that nutrients infiltrated into the ground via retention systems are “removed.” For springsheds, nitrates infiltrated into the ground are the critical transport mechanism for springshed impairment. Nitrate-removing retention BMPs currently are under development using bio-activated media (BAM). Until design methodology is released, contact your local District Drainage Engineer for guidance when designing retention ponds within Karst springshed geology.

Examples Illustrating the Use of BMPTRAINS for Nutrient Loading Analysis

FDOT has extracted relevant design criteria and combined them into one reference publication and computer program, named BMPTRAINS. The design engineer should verify the design criteria at a pre-meeting with the WMD or FDEP, since newer regulations may exist. The BMPTRAINS model provides the option to over-ride existing criteria and assumptions. An example of an assumption is the event mean concentration (EMC) data.

Example Problem 9.3-1: Wet detention, net improvement

A wet detention pond serves a section of a two-lane highway that is about 1,100 feet long and the right-of-way width is about 200 feet. The catchment area is five acres and is part of a larger watershed that may impact the design. The existing portion of highway was not served by any treatment system. The existing and proposed portion of the highway will be treated in the post-development condition. The site is located in West Palm Beach, Florida, on Hydrologic Soil Group D. The existing land use condition is assumed to be a highway with a non-DCIA Curve Number of 80 and 40 percent DCIA. The post-development land use condition is assumed to be a highway with a non-DCIA Curve Number of 80 and 85 percent DCIA. The area needs net improvement using a wet detention pond with a littoral zone (assumed 10 percent removal efficiency credit for the

littoral zone) in the design. The area and depth for the pond allowed an average annual pond residence time of 50 days.

First, identify the meteorological zone, which is Zone 5, and the mean annual rainfall, which is 61 inches, as shown below.

General Site Information for Example Problem 9.3-1

| GENERAL SITE INFORMATION: | GO TO INTRODUCTION PAGE |
|--|---|
| STEP 1: Select the appropriate Meteorological Zone, input the appropriate Mean Annual Rainfall amount and select the type of analysis | |
| Meteorological Zone (Please use zone map): | <div style="border: 1px solid black; padding: 2px;">CLICK ON CELL BELOW TO SELECT</div> <div style="border: 1px solid black; padding: 2px; text-align: center;">Zone 5</div> |
| Mean Annual Rainfall (Please use rainfall map): | <div style="border: 1px solid black; padding: 2px;">61.00</div> Inches |
| Type of analysis: | <div style="border: 1px solid black; padding: 2px;">CLICK ON CELL BELOW TO SELECT</div> <div style="border: 1px solid black; padding: 2px; text-align: center;">Net improvement</div> |
| Treatment efficiency (leave empty if net improvement analysis is used): | <div style="border: 1px solid black; width: 100px; height: 15px;"></div> % |

Next, the catchment site information data are summarized below.

Watershed Characteristics for Example Problem 9.3-1

| WATERSHED CHARACTERISTICS | STORMWATER TREATMENT ANALYSIS |
|--|---|
| CATCHMENT NO.1 CHARACTERISTICS: | |
| Pre-development land use: | <div style="border: 1px solid black; padding: 2px;">CLICK ON CELL BELOW TO SELECT</div> <div style="border: 1px solid black; padding: 2px; text-align: center;">Highway</div> |
| Post-development land use: | <div style="border: 1px solid black; padding: 2px;">CLICK ON CELL BELOW TO SELECT</div> <div style="border: 1px solid black; padding: 2px; text-align: center;">Highway</div> |
| Total pre-development catchment area: | 5.00 AC |
| Total post-development catchment area: | 5.00 AC |
| Pre-development Non DCIA CN: | 80.00 |
| Pre-development DCIA percentage: | 40.00 % |
| Post-development Non DCIA CN: | 80.00 |
| Post-development DCIA percentage: | 85.00 % |

| | |
|--|-----------------------|
| | Pre-development Annu |
| | Pre-development Annu |
| | Post-development Annu |
| | Post-development Annu |

Using the BMPTRAINS program, the net improvement expected with the wet detention design is 71.5 percent removal of total phosphorus and 46.2 percent removal of total nitrogen, as shown in the BMPTRAINS program screenshot below. Note that, for the wet detention option, a residence time greater than 50 days will only marginally improve removal. Thus, a design criterion of 50 days annual residence time is above the minimum required by the water management district (21 days x 1.5 = 31.5 days) and can fit within the existing right of way.

Wet Detention Pond Effectiveness for Example Problem 9.3-1

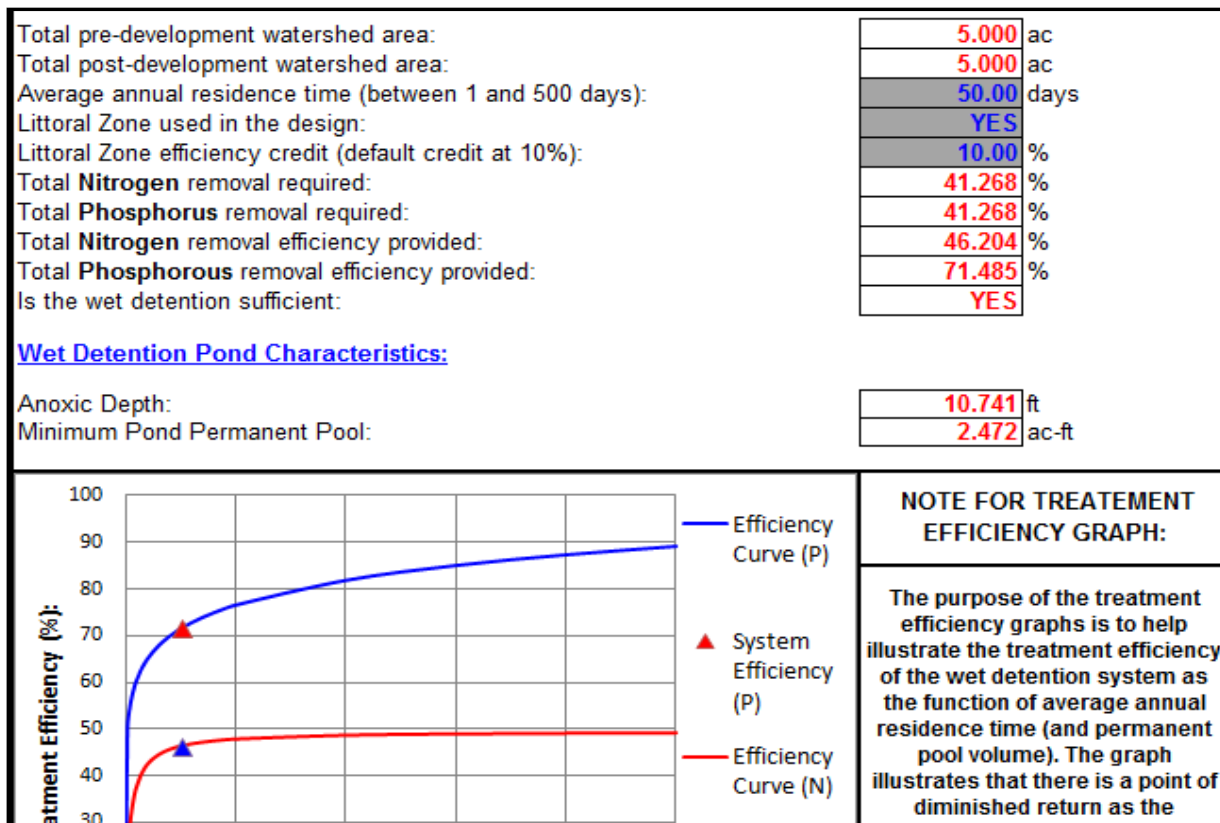

Example Problem 9.3-2: A highway receiving runoff from an industrial park that will have retention systems in a series—a pre- vs. post-development loading analysis is required

The water table conditions in this area are suitable for retention systems. An exfiltration trench in series with a retention basin can serve a five-acre light-intensity commercial site. The catchment also can contain 10 tree wells along the road. The tree wells are designed to be three feet deep with a six-inch depth above soil column. The length and width of the tree wells are designed to be four feet each. Use a 0.2 sustainable water storage capacity of the soil. Treat the tree wells as retention systems. The site is located in Orlando, Florida, on Hydrologic Soil Group C. The existing land use condition is assumed to be undeveloped-dry prairie with a non-DCIA Curve Number of 79 and 0.0 percent DCIA. The post-development land use condition is a low-intensity commercial area with a non-DCIA Curve Number of 85 and 65 percent DCIA. The combination of treatment systems is to provide treatment sufficient to match the post-development annual nutrient loads with the pre-development annual nutrient loads.

First identify the meteorological zone and annual rainfall for the project.

General Site Information for Example Problem 9.3-2

| GENERAL SITE INFORMATION: | GO TO INTRODUCTION PAGE |
|--|--|
| STEP 1: Select the appropriate Meteorological Zone, input the appropriate Mean Annual Rainfall amount and select the type of analysis | |
| Meteorological Zone (Please use zone map): | <div style="border: 1px solid black; padding: 2px; display: inline-block;"> CLICK ON CELL BELOW TO SELECT Zone 2 </div> |
| Mean Annual Rainfall (Please use rainfall map): | <div style="border: 1px solid black; padding: 2px; display: inline-block;"> 51.00 </div> Inches |
| Type of analysis: | <div style="border: 1px solid black; padding: 2px; display: inline-block;"> CLICK ON CELL BELOW TO SELECT Net improvement </div> |
| Treatment efficiency (leave empty if net improvement analysis is used): | <div style="border: 1px solid black; width: 100px; height: 20px; display: inline-block;"></div> % |

A summary of the catchment characteristic data is shown below. Note that the catchment is highly developed, leaving no feasible space for a retention basin or other land-intensive BMP. You need to consider BMPs that are more useful for ultra-urban environments.

To meet pre/post conditions, the required phosphorus removal is calculated as 70.3 percent and the required nitrogen removal is 89.3 percent. These are calculated knowing the Event Mean Concentrations and the pre- and post-runoff volumes.

Catchment Characteristics Data for Example Problem 9.3-2

| WATERSHED CHARACTERISTICS | | STORMWATER TREATMENT ANALYSIS | |
|--|---|-------------------------------|-------------------------|
| CATCHMENT NO.1 CHARACTERISTICS: | | | |
| Pre-development land use: | CLICK ON CELL BELOW TO SELECT Undeveloped - Dry Prairie | | |
| Post-development land use: | CLICK ON CELL BELOW TO SELECT Low-Intensity Commercial | | |
| Total pre-development catchment area: | 5.00 | AC | |
| Total post-development catchment area: | 5.00 | AC | |
| Pre-development Non DCIA CN: | 79.00 | | Pre-development Annual |
| Pre-development DCIA percentage: | 0.00 | % | Pre-development Annual |
| Post-development Non DCIA CN: | 85.00 | | Post-development Annual |
| Post-development DCIA percentage: | 65.00 | % | Post-development Annual |

The tree wells receive runoff water first and, thus, the effectiveness associated with a design is examined first. The capture effectiveness is low (1.3 percent) because of the number and size of the catchment. The results are shown below.

Effectiveness of 10 Tree Wells in the Catchment or Watershed of Example Problem 9.3-2

Note: As the BMPTRAINS model is improved, output screens may change.

| VEGETATED AREAS (Example Tree Wells): | | | | | |
|--|----------------------------------|-------------|------------|-------------|----|
| Vegetated Areas (tree wells or similar) for: | Facility handbook example 2 | | | | |
| | Catchment 1 | Catchment 2 | Catchment3 | Catchment 4 | |
| Contributing catchment area: | 5.000 | 0.000 | 0.000 | 0.000 | ac |
| Required treatment efficiency (Nitrogen): | 70.300 | | | | % |
| Required treatment efficiency (Phosphorus): | 89.257 | | | | % |
| Vegetated Area (Tree Well) depth | 3.00 | | | | ft |
| Vegetated Area (Tree Well) water depth above soil column: | 0.50 | | | | ft |
| Vegetated Area (Tree Well) length: | 4.00 | | | | ft |
| Vegetated Area (Tree Well) width: | 4.00 | | | | ft |
| Sustainable water storage capacity of the soil: | 0.20 | | | | |
| Number of similar Areas within watershed: | 10.00 | | | | |
| Retention depth for provided hydraulic capture efficiency: | 0.010 | 0.000 | 0.000 | 0.000 | in |
| Is this a retention or detention system? | Retention | | | | |
| Type of soil augmentation: | View Media Mixes | | | | |
| Provided treatment efficiency (Nitrogen): | 1.307 | 0.000 | 0.000 | 0.000 | % |
| Provided treatment efficiency (Phosphorus): | 1.307 | 0.000 | 0.000 | 0.000 | % |
| Is/are the vegetated areas sufficient? | NO | | | | |

Next, you can use an exfiltration system to collect some of the runoff water. Using the geometric design for the exfiltration, the retention storage volume is calculated as 0.55 inches. The effectiveness of using the exfiltration design is shown below.

Exfiltration Trench Design and Effectiveness for Example Problem 9.3-2

| EXFILTRATION TRENCH: | |
|---|--------------------|
| EXFILTRATION TRENCH SERVING ENTIRE CONTRIBUTING WATERSHED: | |
| Contributing watershed area: | 5.000 ac |
| Required Treatment Eff (Nitrogen): | 70.300 % |
| Required Treatment Eff (Phosphorus): | 89.257 % |
| Required retention for the entire watershed to meet required efficiency: | 1.756 in |
| Required water quality retention volume: | 0.732 ac-ft |
| EXFILTRATION TRENCH FOR MULTIPLE TREATMENT SYSTEMS (use only if other BMP method is oversized or undersized) : | |
| Provided retention depth: | 0.550 in |
| Provided treatment efficiency (Nitrogen): | 56.620 % |
| Provided treatment efficiency (Phosphorus): | 56.620 % |
| Remaining treatment efficiency needed (Nitrogen): | 31.535 % |
| Remaining treatment efficiency needed (Phosphorus): | 31.535 % |
| Remaining retention depth needed if retention: | 1.206 in |

Finally, you can use a retention basin at the discharge from the watershed. The land for the retention basin within the watershed is part of the industrial park but did not provide sufficient removal by itself to meet post-equal-pre average annual mass loading. The retention basin can hold 0.50 inches of runoff and, thus, was limited to the removal effectiveness associated with that volume of storage. Using a combination of retention basin, tree wells, and an exfiltration trench provided by the roadway was sufficient to meet the post-equal-pre requirements.

The retention options are in a series. The first flush of water is captured by the tree wells and what is not captured is routed to the inlets for the exfiltration trench. The exfiltration trench can handle a fraction of that runoff, so the bypassed water is routed to the retention basin. All of these retention BMPs are designed to be off-line BMPs. Summary results of the tree well, exfiltration, and retention basin designs with the overall effectiveness removal are shown below.

Summary Loadings and Removal Effectiveness for Example 9.3-2

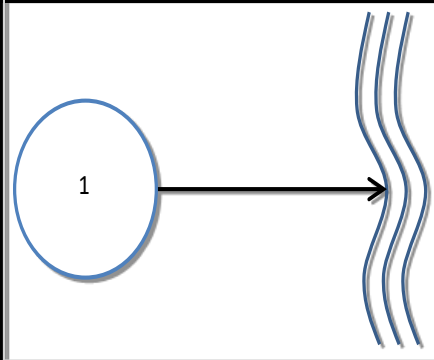
| Summary Performance | | | |
|-------------------------------------|----------------------|-------|--|
| Catchment Configuration | A - Single Catchment | | 3/25/2014 |
| Nitrogen Pre Load (kg/yr) | 5.35 | |  |
| Phosphorus Pre Load (kg/yr) | 0.29 | | |
| Nitrogen Post Load (kg/yr) | 18.00 | | |
| Phosphorus Post Load (kg/yr) | 2.73 | | |
| Target Load Reduction (N) % | 70 | | |
| Target Load Reduction (P) % | 89 | | |
| Target Discharge Load, N (kg/yr) | 5.35 | | |
| Target Discharge Load, P (kg/yr) | 0.29 | | |
| Provided Overall Efficiency, N (%): | 57 | | |
| Provided Overall Efficiency, P (%): | 57 | | |
| Discharged Load, N (kg/yr & lb/yr): | 7.72 | 17.00 | |
| Discharged Load, P (kg/yr & lb/yr): | 1.17 | 2.58 | |
| Load Removed, N (kg/yr & lb/yr): | 10.28 | 22.65 | |
| Load Removed, P (kg/yr & lb/yr): | 1.56 | 3.44 | |

For additional example problems, see the User's Manual to be used with the BMPTRAINS model (www.stormwater.ucf.edu) located at:



What's New

BMPTRAINS Stormwater Best Management Practices Analysis Model (Latest Version; <https://stars.library.ucf.edu/bmptrains/>) and User's Manual (<https://stars.library.ucf.edu/bmptrains/25/>).

9.4 STORMWATER QUANTITY CONTROL

9.4.1 The Department's Design Storms

A problem with developing a design storm distribution is that actual storms have an unlimited combination of durations and intensity patterns. What should the duration of the design storm be? Should the peak rainfall occur near the beginning, in the middle, or near the end of the storm? Should there be multiple peaks?

Most of the current widely used rainfall distributions address this by nesting short-duration, high-intensity storms in the middle of a long duration storm, although very intense peaks do not usually occur in long storms. You usually would place the largest intensity value in the middle of the storm pattern, then place the remaining values alternately before and after this point, in order of decreasing intensity. The various NRCS distributions, the South Florida Water Management District (SFWMD) three-day distributions, and the St. Johns River Water Management District (SJRWMD) four-day distributions are examples of design storm distributions created using this approach. These “nested” distributions are not indicative of actual rainfall patterns and subsequently may produce inaccurate representations of actual runoff characteristics.

You may have used these distributions in the past for the design of conveyance systems because they give conservatively high runoff estimates. But, when you use these distributions to determine the pre-developed discharge, they can overestimate it. In the developed condition, the outlet control structure would be designed to pass the “overestimated pre-developed discharge,” thereby discharging more in the post-developed condition.

Another problem with these distributions is that different drainage areas will react differently to the same rainfall pattern. Small basins with short times of concentration and little storage will have higher runoff rates from short, intense storms than from long-duration, low-intensity storms. Long-duration, low-intensity storms usually do not generate peak discharges from small basins. The opposite is true for large basins. Very large basins with large amounts of storage will have less runoff from short, intense storms than from long-duration, low-intensity storms. Large river systems and static water bodies such as lakes reach peak stages when extreme antecedent conditions exist and variations in intensity usually do not affect their stages.

To overcome the concerns of a single design storm distribution, the Suwannee River Water Management District (SRWMD) developed a series of design distributions to better reflect actual rainfall patterns. They developed distributions for 1-, 2-, 4-, and 8-hour storms and for 1-, 3-, 7-, and 10-day storms using National Oceanic and Atmospheric Administration (NOAA) hourly and sub-hourly data. SRWMD requires the use of these distributions for projects within the district.

Chapter 14-86, Florida Administrative Code

In 1986, the Department established Chapter 14-86 of the F.A.C., requiring adjacent developments to maintain discharges at or below pre-developed discharges using a multiple storm approach. In the Department's Drainage Connection Handbook (February 1987), the SRWMD design distributions mentioned above were accepted as appropriate for the entire state. These distributions can be found at the Department's website, listed below:

<https://fdotwww.blob.core.windows.net/sitefinity/docs/default-source/roadway/drainage/files/fdotrainfalldistributions.pdf>.

In a July 1988 memorandum, the State Roadway Design Engineer directed the districts to design the Department's stormwater management systems to Chapter 14-86. In October 1992, the *Drainage Manual* was revised to require the design of the Department's stormwater management systems to comply with Chapter 14-86. In 2013, the *Drainage Manual* was amended to require the application of Chapter 14-86 on FDOT stormwater designs only for closed basins and areas where downstream historical flooding is documented.

9.4.1.1 Critical Duration

Since the time the Department developed Chapter 14-86, there have been two interpretations of the critical duration and how to apply the multiple storm concept. The definition of critical duration (shown below), as defined in Chapter 14-86, lends itself to two interpretations.

“Critical Duration” means the duration of a specific storm event (i.e., 100-year storm) that creates the largest volume or highest rate of net stormwater runoff (post-development runoff less pre-development runoff) for typical durations up through and including the 10-day duration event. The critical duration is determined by comparing various durations of the specified storm and calculating the peak rate and volume of runoff from each. The duration resulting in the highest peak rate or largest total volume is the “critical duration” storm.

(A) Peak Discharge Approach

This interpretation of critical duration and the multiple storm concept allows a post-developed runoff rate, for a given frequency, that is equal to or less than the highest pre-developed runoff rate of any duration. For example, given the pre-developed runoff rates shown in the table below, the allowable runoff rate would be 70, regardless of the duration associated with the peak post-developed runoff rate. The post-developed runoff rates shown are acceptable because none are greater than 70. You need only run enough durations in the post-developed condition to be assured that runoff rates of the other durations do not exceed the allowable.

| Duration | Pre-Dev Runoff XX Year Event | Acceptable Post- Dev Runoff XX Year Event |
|----------|---------------------------------|---|
| 1-hour | 65 | |
| 2-hour | 70 | 60 |
| 4-hour | 66 | 70 |
| 8-hour | 60 | 65 |
| 24-hour | 30 | 35 |
| 3-day | 25 | |
| 7-day | 24 | |
| 10-day | 21 | |

This approach is consistent with the last sentence of the definition of critical duration. *“The duration resulting in the highest peak rate . . . is the critical duration.”* With this approach, the pre-developed critical duration can be different from the post-developed critical duration, as shown in the values above. Also, the pre-developed runoff rate could be calculated with the rational method ($Q = CIA$) for small basins; therefore, it would not be directly associated with any of the eight durations. The examples in the *Drainage Connection Handbook* follow this interpretation.

The above discussion pertains to discharges to open basins only with historical flooding documented. For discharges to closed basins, a similar approach is used with an additional constraint on the runoff volume. For a given frequency, the allowable post-developed runoff volume is the largest pre-developed runoff volume of any duration. When using the NRCS technique for computing runoff, the 10-day duration event will always produce the largest runoff volume and, therefore, be the critical duration. But, for other more-refined approaches to modeling infiltration, the critical duration could be something other than the 10-day duration.

(B) Storm for Storm Approach (Preferred)

This interpretation of critical duration and the multiple storm concept requires, for a given frequency, that the post-developed runoff rate for each duration be less than or equal to the pre-developed runoff rate of corresponding duration. For example, in the table below, the allowable runoff rate for each duration is the pre-developed runoff rate. The post-developed runoff rates shown are acceptable because they are all less than or equal to the pre-developed runoff rate of corresponding duration. The 4-hour duration is critical because it most closely matches the pre-developed runoff rate.

| Duration | Pre-Dev Runoff XX Year Event | Acceptable Post- Dev Runoff XX Year Event |
|----------|---------------------------------|---|
| 1-hour | 65 | 60 |
| 2-hour | 70 | 68 |
| 4-hour | 66 | 66 |
| 8-hour | 60 | 57 |
| 24-hour | 30 | 26 |
| 3-day | 25 | 23 |
| 7-day | 24 | 22 |
| 10-day | 21 | 20 |

This approach is consistent with the first sentence of the definition of critical duration. “Critical Duration means the duration . . . that creates the . . . highest rate of net stormwater runoff (post-development runoff less pre-development runoff). . . .” In the example above, when you subtract the pre-development runoff rate from the corresponding post-development runoff rate, all the “net stormwater runoff” values are negative except the 4-hour duration, which has zero “net stormwater runoff.” So, the 4-hour duration has the highest rate of net stormwater runoff; therefore, it is the critical duration. This approach is better than the peak discharge approach, where the release timing of the facility is critical. FHWA’s Hydraulic Engineering Circular No. 22 (HEC 22) contains a discussion of the concern for release timing.

The above discussion pertains to discharges to open basins only with historical flooding documented. For discharges to closed basins, a similar approach is used with an additional constraint on the runoff volume. For a given frequency, the post-developed runoff volumes for each duration cannot exceed the pre-developed runoff volumes of corresponding duration.

Although both the Peak Discharge Approach and the Storm for Storm Approach have been applied to FDOT projects in the past, the Department prefers that you use the Storm for Storm Approach on its projects. The examples in Section 9.4 are based on the Storm for Storm Approach.

9.4.1.2 Storm Frequencies

The previous sections primarily discuss durations and the multiple storm concept. Chapter 14-86 [14-86.003 (3)(c) 2 & 3] requires that we consider various rainfall event frequencies up to and including the 100-year event. The rule does not say that all frequencies must be evaluated.

The more frequent FDOT design storms (2-year to 50-year) do not usually control the size of the pond because the runoff from these storms is less than the runoff for the 100-year storm. The purpose of evaluating the less frequent storms is to ensure that the pre-developed discharges are not exceeded. And so it becomes a check of the operation of the outlet control structure under various rainfall event frequencies.

Where the discharge is controlled by a simple rectangular weir (one with a constant width), it may be reasonable to run only the 2-year, 25-year, and 100-year events. Where the discharge is controlled by a complex weir (width varies with elevation), an orifice, a pipe, tailwater conditions, or any combination of these, evaluate all frequencies (2-year, 5-year, 10-year, 25-year, 50-year, and 100-year). Some software programs can run all the frequencies at once. If these programs are available to you, run all the frequencies, regardless of the outlet control structure configuration.

9.4.2 Estimating Attenuation Volume

A first step in estimating attenuation volume is identifying outfalls and their associated drainage basins. At this stage, consider if it will be necessary to divert runoff from one basin to another. Although the Department does not encourage diverting runoff, doing so sometimes allows the Department to provide stormwater management (treatment and attenuation) in more economical locations. For example, an economical parcel for a pond site may be available in one drainage basin while the parcels in an adjacent basin are very expensive. Diverting some roadway runoff to the economical parcel basin from the expensive parcel basin may be more economical even when other costs, such as construction and maintenance, are considered. Before you propose diverting runoff, be sure it is acceptable to the regulatory agency.

When diverting runoff, be careful how you calculate the allowable discharge. Base your allowable (pre-developed) discharge calculations on the pre-developed drainage area that discharges to the proposed outfall. If an area does not drain to the proposed outfall in the pre-developed condition, do not include that area in the allowable (pre-developed)

discharge calculations. Therefore, in a basin you divert runoff to, the pre-developed drainage area is smaller than the post-developed drainage area. Conversely, in a basin you divert runoff from, the pre-developed drainage area is larger than the post-developed drainage area.

The actual attenuation volume cannot be determined until you “route” the design storms and design the pond. There are several methods for estimating the attenuation volume. The methods more commonly used on the Department’s projects are discussed below.

9.4.2.1 Pre Versus Post Runoff Volume

A common technique for estimating attenuation volume is to calculate the difference in runoff volume between the post-developed conditions and the pre-developed conditions using the NRCS equation for runoff.

$$Q_R = \frac{(P - 0.2S)^2}{P + 0.8S}$$

As written, this assumes the initial abstraction (I_a) = 0.2S & $S = (1000/CN) - 10$

where:

- Q_R = Runoff depth (in inches)
- P = Rainfall depth (in inches); Use the 100-year, 24-hour depth for evaluating alternate drainage schemes or pond sites
- S = Maximum retention or soil storage (in inches)
- CN = Watershed curve number

The runoff volume is determined from: $VOL = (Q_R) (\text{Drainage Area})$

A similar approach can be taken using the Rational Equation Method.

$$VOL = (C_{POST} - C_{PRE}) (P) (\text{Drainage Area})$$

An advantage of this technique is that it does not involve any design storm distributions. So there is no concern for which storm duration is critical. On the other hand, this technique ignores the timing differences between the pre-developed and post-developed hydrographs. As a result, it may underestimate the attenuation volume.

Example 9.4-1: Estimating attenuation volume using differences in runoff volume

Given:

- Pre-developed roadway pavement = 2 10-foot lanes
- Drainage area: includes roadway right of way & off-site drainage to the roadway = 10.4 ac

For preliminary pond sizing, use the information from the old drainage map unless you have reason not to.

- Offsite land use = Residential lots averaging 1/2 ac
- Proposed typical section = 5-lane urban section; Combined roadway, curb, and sidewalk width = 83 ft
- Proposed right-of-way width = 100 ft
- Length of roadway within drainage area = 1,706 ft
- Offsite runoff draining to the project will be taken through the pond, not bypassed around.
- Project located in Somewhere City, Florida, flat terrain <1 percent grade, Hydrologic Soil Group B/D, project drains to open basin.

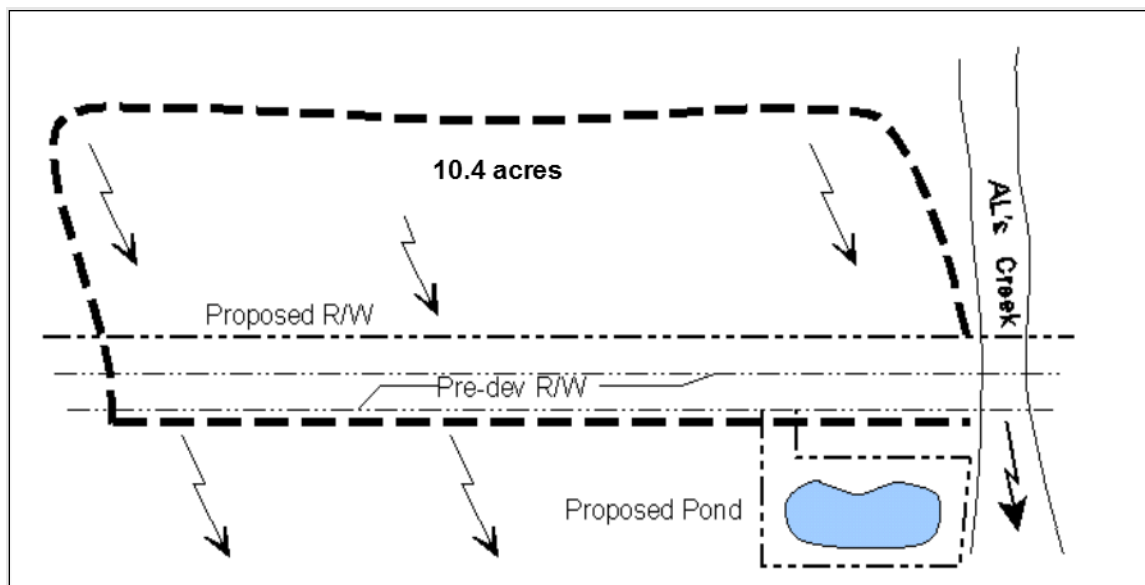

Example 9.4-1

Find: The estimated attenuation volume.

1. Pre-developed area & curve number:

| | | |
|--------------------|-----------------------|---------------------|
| Roadway pavement: | = 0.79 ac @ CN = 98 | (20 ft x 1,706 ft) |
| Pervious area | = 9.61 ac @ CN = 85 | (10.4 ac – 0.79 ac) |
| Proposed pond area | = 0.77 ac @ CN = 85 | |
| Total | = 11.2 ac @ CN = 85.9 | |

Assume the pond area is 20 percent of the roadway right of way (0.2 x 1,706 ft x 98 ft = 0.77 ac). For this example, the proposed pond is located outside the area draining to the roadway; thus, the pond must be added to the other areas.

For this example, the roadway right of way to be acquired is within the area draining to the roadway. For your project, the acquired right of way may be outside the area draining to the road, thereby requiring that the additional right of way be added to the other areas.

2. Post-developed area and curve number:

| | | |
|------------------------------|-----------------------|----------------------|
| Roadway, curb, and sidewalk: | = 3.24 ac @ CN = 98 | (82.7 ft x 1,706 ft) |
| Pervious area | = 7.17 ac @ CN = 85 | (10.4 ac – 3.24 ac) |
| Pond area | = 0.77 ac @ CN = 98 | |
| Total | = 11.2 ac @ CN = 89.7 | |
3. Calculate the difference in runoff volume between the pre-developed conditions and post-developed conditions for the 100-year, 24-hour storm using the NRCS equation for runoff.

Refer to the NOAA website link in Section 1.4 of the *Drainage Manual* to obtain location-specific precipitation data for the 100-year, 24-hour volume. For this example, the 100-year, 24-hour volume for Somewhere City, Florida, is 10.7 inches.

$$Q = (P - 0.2S)^2 / (P + 0.8S) \quad \text{where: } S = (1,000 / CN) - 10$$

| | <u>Pre</u> | <u>Post</u> |
|-----------------------------|------------|-------------|
| Potential abstraction (S) = | 1.64 | 1.15 |
| Runoff depth (Q) in inches | 8.95 | 9.44 |
| Runoff volume (ac-ft) = | 8.36 | 8.81 |

Volume difference = 0.45 ac-ft

The estimated attenuation volume is this volume difference of 0.45 ac-ft.

9.4.2.2 Simple Pond Model Procedure

Another technique for estimating attenuation volume is to route a design storm through a simple pond model. It works best with a routing program that allows a rating curve for the stage-discharge relationship and a stage-storage (not area) relationship for the pond configuration. The model should be set up as follows:

- Arbitrarily select pond bottom and top elevations.
- Use two points for the stage-discharge relationship:
(1) Zero discharge @ pond bottom, and (2) Allowable discharge @ pond top
- Use two points for the stage-storage relationship:
(1) Zero storage @ pond bottom, and (2) Estimated storage @ pond top

As with any routing, this is an iterative process. During each iteration, the estimated storage volume is changed to bring the routed peak stage close to the top of the pond. The storage volume that causes the peak pond stage to match the top of the pond is the estimated attenuation storage.

This approach is useful when the discharge rate is limited to something other than the pre-developed rate. It is complicated when working with the Department's multiple design storms. Which design storm do you route? The following suggestions will help to simplify working with the multiple design storms:

- Determine the pre-developed discharges for the 100-year, 1-hour design storm through the 100-year, 8-hour design storm. Use the smallest of these calculations as the allowable discharge rate. For the Storm for Storm Approach to critical duration, the post-developed discharge rate will be limited to all of the corresponding pre-developed rates, so using the rate for estimating purposes is reasonable. The basis for running only the 1-hour through the 8-hour design storm is that one of these design storms usually is critical to sizing ponds discharging to open basins.
- Route the post-developed conditions using a "nested" design storm such as the NRCS Type 2 Florida modified or the applicable WMD design storm. These distributions often are as severe as or more severe than the Department's distributions.

Example 9.4-2: Estimating attenuation volume using a simple pond model

Given:

- The same conditions as in Example 9.4-1
- Pre-developed time of concentration = 29 min.
- Post-developed time of concentration = 21 min.

Find: The estimated attenuation volume

1. Pre-developed runoff:

Determine the pre-developed discharge rates for the 100-year FDOT 1-hour and 8-hour design storms. Using a typical program based on the NRCS unit hydrograph approach, you should obtain values similar to these when using a peak shape factor of 256. The rainfall volumes for Somewhere City, Florida, are tabulated in Step 1 of Example 9.4-3.

| Pre-Developed Peak Runoff Rates (cfs) | | | |
|---------------------------------------|----------------|----------------|----------------|
| 1-hour, 100-yr | 2-hour, 100-yr | 4-hour, 100-yr | 8-hour, 100-yr |
| 33.2 | 30.1 | 25.5 | 27.8 |

The discharge associated with the 4-hour, 100-year design storm is the smallest and will be used as the allowable discharge.

2. Develop a simplified pond model as follows.

| | Elevation | Discharge (cfs) | Storage |
|-------------|-----------|-----------------|-----------------|
| Pond Bottom | 0 | 0 | 0 |
| Top of Pond | 10 | 25.5 | Trial and Error |

3. Route a nested design storm through the pond using post-developed conditions. For this example, we will route the 25-year, SFWMD 72-hour storm. Adjust the storage as necessary to have the routed peak stage match the top of pond. After numerous iterations, a storage value of 1.3 ac-ft was found acceptable, so:

The estimated attenuation volume is 1.3 ac-ft.

9.4.2.3 Other Techniques

FHWA's HEC 22 provides several methods to estimate attenuation volume, including examples and comparisons. Although most of these techniques are reasonably accurate, they—like the previous method—are complicated when working with the Department's multiple design storms.

9.4.3 Tailwater Conditions

Tailwater conditions can affect the design of the outfall structure, the size of the pond, and even the evaluation of alternate pond sites. The pond must meet the attenuation requirements during the tailwater conditions expected to occur coincident with the design storms. Predicting the tailwater condition sometimes can be difficult. Our facilities usually discharge to points associated with watersheds that are much larger than the drainage area of our facility. It may be appropriate to model the larger watershed and apply design storms to both the road project and the larger watershed simultaneously. This method will help to address any timing-related effects.

Tailwater conditions can become more challenging when discharging at or close to the confluence of two streams, as shown in the figure below. Depending on the relative size of each basin, it may be overly conservative to use the combined (or coincident) 100-year probability for each stream. National Cooperative Highway Research Program (NCHRP) conducted Project 15-36: *Estimating Joint Probabilities of Design Coincident Flows at Stream Confluences* (<http://www.trb.org/Publications/Blurbs/169456.aspx>) to develop practical procedures for estimating joint probabilities of coincident flows at stream confluences. This paper focuses on two practical design methods and provides a step-by-step application guide for designers in Appendix H of the document.



A simpler approach is to estimate the worst-case tailwater condition and see if it submerges the control point of the outlet control structure. If it does not, the tailwater condition can be ignored in the design of the weir/orifice of the outlet control structure.

Placing a pond in a 100-year riverine floodplain can complicate the design due to high tailwater conditions that may be coincident with the design storm. Other complications

such as flood plain compensation and changes to floodway conveyances may exist as well. Chapter 5 (Bridge Hydraulics) addresses impacts to floodway conveyances.

9.4.4 Routing Calculations

Most engineers currently use computer programs to route hydrographs through stormwater facilities. The majority of computer programs use the storage indication method for this process. HEC 22 contains a discussion of the storage indication method, with an example. The *Drainage Connection Handbook* also discusses this method.

Although the computer reduces the effort, it does not eliminate the iterative process of modifying the pond and outlet control structure after each run. To design an acceptable pond and outlet control structure, you usually will run numerous iterations. You can adjust six items to meet the discharge requirements: (1) weir width (or orifice size), (2) weir crest (or orifice invert) elevation, (3) pond surface area, (4) pond depth, (5) pond length to width ratio, and (6) outlet pipe size. Although some of these items may be constrained by regulatory requirements, the following provides general guidance for making adjustments during the iterative process.

| If the only change made is: | The results are: |
|---|--|
| Increasing weir width (or orifice size) | Increases discharge and lowers stage. |
| Lowering weir crest (or orifice invert) ¹ | Increases discharge (volume more than rate) and lowers peak stage. |
| Increasing pond surface area (increases storage above and below weir crest) | Decreases discharge and lowers peak stage. For retention systems, increases infiltration and shortens recovery time. |
| Lowering pond depth ¹ (increases storage below the weir only) | Decreases discharge and lowers peak stage. For retention systems, decreases infiltration and lengthens recovery time when saturated groundwater flow conditions exist. |
| Increasing length to width ratio | Increases discharge and raises peak stage, due to slight reduction in storage area for the same surface area. For retention systems, increases infiltration and shortens recovery time when saturated groundwater flow conditions exist. |
| Decreasing outlet pipe size | Increases discharge and raises peak stage due to additional friction losses in the pipe. Increases outlet velocity in discharge pipe. |

1. Normally applicable to only retention systems.

9.4.5 Discharges to Watersheds with Positive Outlet (Open Basins) Using Chapter 14-86

Using the Storm for Storm Approach, the Department's criterion for discharges to open basins requires that—for a given frequency—the post-developed discharge rate for each duration must be less than or equal to the pre-developed discharge rate of corresponding duration. Most of the regulatory agencies also have requirements for post-developed discharge rates. You must meet these requirements and the Department's criterion.

Example 9.4-3: Discharge to watershed with positive outlet (open basin)

This example uses information developed in Examples 9.1-1, 9.4-1, and 9.4-2.

Given:

The following information has been verified since the time of the pond site evaluation.

- SHWT elevation at pond site: = 56.1 ft Agreed to by regulatory agency
- Lowest ground elev. around pond site = 59.1 ft From design survey

Find:

The required pond configuration to meet the FDOT criterion. For this example, the pond also will be designed to meet SWFWMD and SFWMD criteria.

1. Determine the location-specific rainfall volumes using the NOAA website link in Section 1.4 of the *Drainage Manual*.

| Rainfall Volumes: Somewhere City, Florida | | | | | | |
|---|------|------|-------|-------|-------|--------|
| | 2-yr | 5-yr | 10-yr | 25-yr | 50-yr | 100-yr |
| 1-hr | 2.4 | 2.95 | 3.25 | 3.75 | 4.1 | 4.5 |
| 2-hr | 2.8 | 3.5 | 3.9 | 4.5 | 5.0 | 5.5 |
| 4-hr | 3.3 | 4.0 | 4.6 | 5.4 | 6.0 | 6.6 |
| 8-hr | 3.8 | 4.9 | 5.6 | 6.5 | 7.3 | 8.0 |
| 1-day | 4.8 | 6.3 | 7.7 | 8.7 | 9.7 | 10.7 |
| 3-day | 6.1 | 7.9 | 9.1 | 10.8 | 12.2 | 14.1 |
| 7-day | 7.5 | 9.4 | 11.5 | 13 | 14.8 | 16.8 |
| 10-day | 8.5 | 11 | 13 | 15 | 17 | 19 |

First Round of Iterations

- 2. Determine the pre-developed runoff rates: This will establish the allowable discharge rates.

Time of concentration = 29 min (from Ex. 9.4-2)
 Pre-developed CN:
 Roadway pavement: = 0.79 ac @ CN = 98 (from Ex. 9.4-1)
 Pervious area: = 9.61 ac @ CN = 85 (from Ex. 9.4-1)
 Proposed pond area: = 0.94 ac @ CN = 85
 Total: = 11.3 ac @ CN = 85.9

The proposed pond size is from Example 9.1-1, Pond Siting Stage. This is a reasonable assumption for the first iteration.

To simplify this problem, we have used the time of concentration, roadway pavement area, and offsite land use from prior examples. Actually, you should use the latest information from the design surveys and field reviews of the proposed project to establish the pre-developed conditions. Using a typical program, which uses the NRCS unit hydrograph approach, you should obtain values similar to these when using a peak shape factor of 256. This peak shape factor is used throughout this example.

For the first round of iterations for a pond discharging to an open basin (with documented flooding history), it is usually sufficient to run the 100-year FDOT 1-hour to 8-hour duration design storms and the regulatory agency design storm.

| Pre-Developed Runoff (cfs) | | | | | |
|----------------------------|---------------------|---------------------|---------------------|------------------|-------------|
| DOT 1-hr, 100-yr | DOT 2-hr, 100-yr | DOT 4-hr, 100-yr | DOT 8-hr, 100-yr | FLT2M, 25- yr | SF72, 25-yr |
| 33.6 | 30.4 | 25.8 | 28.1 | 30.6 | 36.3 |

- 3. Post-developed runoff:

In urban sections, the time of concentration is best determined from the storm sewer design tabulations. For this example, assume the storm sewer tabs have a $T_c = 21$ min.

Time of concentration: = 21 min
 Post-developed area & CN:
 Roadway, curb, and sidewalk: = 3.24 ac @ CN = 98 (from Ex. 9.4.1)
 Pervious area: = 7.17 ac @ CN = 85 (from Ex. 9.4.1)

Pond: = 0.94 ac @ CN = 98
Total: = 11.3 ac @ CN = 89.7

4. Develop a stage-storage relation (pond configuration) for the first round of iterations.

Dimensions at peak stage = 210.5 ft by 109 ft (from Ex. 9.1-1)

For the first iteration, use the configuration estimated in the pond siting evaluation unless you have reasons not to.

Peak stage = 58.1 ft to maintain freeboard between ground line of 59 ft.

Although some WMDs allow treatment below SHWT, this example assumes that treatment is above SHWT. Then, the pond length and width at SHWT elevation (for routing purposes, the SHWT elevation is considered pond bottom) are:

Bottom length = Top length – 2 [side slope (peak stage – elev_{SHWT})]
= 210.5 m – 2 [5 (58.1 ft – 56.1 ft)] (1:5 side slopes)
= 191 ft

Similarly, Bottom width = 90 ft

Using these dimensions and side slopes, develop a stage-storage relationship. The values below were obtained using the equation for the volume of a frustum of a pyramid.

| Stage (ft) | Storage (ac-ft) |
|------------|-----------------|
| 56.10 | 0.00 |
| 56.50 | 0.16 |
| 56.90 | 0.34 |
| 57.30 | 0.52 |
| 57.70 | 0.72 |
| 58.10 | 0.92 |

5. Develop an outfall structure for the first round of iterations. Do so using the maximum allowable stage and discharge. For this example, the maximum allowable stage is the ground elevation minus the freeboard [59.1 ft – 1.0 ft = 58.1 feet]. The maximum allowable discharge is the largest pre-developed

discharge, which, for this example, is the SFWMD 72-hour, 25-year design storm (see Step 2).

Weir crest elevation = 56.7 ft The treatment volume (10,950 ft³, given in Ex. 9.1-1) stacks 0.59 ft high.

$$\begin{aligned} \text{Weir width (L)} &= Q / (C \times H^{1.5}) && \text{from } Q = C \times L \times H^{1.5} \\ &= 36.3 \text{ cfs} / (3.1 \times 1.37^{1.5}) \end{aligned}$$

The max head = 58.1 ft – 56.7 ft = 1.37 ft = 7.3 ft

For this example, we have assumed no tailwater effects. For your projects, you will need to consider the effects of the tailwater conditions on the outfall control structure.

During this round of iterations, ignore the effects of the water quality bleed down orifice and start the routings at the top of the treatment volume.

- Route the selected design storms. Using a typical routing program, you should obtain values similar to the following.

Table 9.4-1

| Pond configuration: Pond dimensions at SHWT = 191 ft x 90 ft SHWT elev. = 56.1 ft Avg side slope = 1:5 Weir crest elev. = 56.7 ft Weir width = 7.3 ft Starting WS = 56.7 ft Allowable Stage = 58.1ft | Design Storm | Discharge (cfs) | Peak Pond Stage (ft) |
|---|-------------------|-----------------|----------------------|
| | FDOT 1-hr, 100-yr | Pre Post | 33.6 38.2 |
| FDOT 2-hr, 100-yr | Pre Post | 30.4 35.0 | 58.1 |
| FDOT 4-hr, 100-yr | Pre Post | 25.8 28.8 | 57.9 |
| FDOT 8-hr, 100-yr | Pre Post | 28.1 30.6 | 57.9 |
| SCS-T2FLM, 25-yr | Pre Post | 30.6 33.0 | 58.0 |
| SFWMD 72-hr, 25-yr | Pre Post | 36.3 38.0 | 58.1 |

From this table, it appears that the 100-year, 1-hour or 2-hour may be critical because they exceed the pre-developed discharge more than the others. Overall, the configuration used in the first iteration is close to meeting the requirements. Shorten the weir length to decrease the peak discharge. Doing so will cause the stage of the 1-hour, the 2-hour, and the SFWMD design storm to exceed the allowable stage, so the pond size needs to be increased also.

After making several runs, the stage-storage relationship shown below and a weir width of 6.0 ft is close to meeting the requirements of the design storms modeled. The second row in the table is the weir crest elevation sufficient to store the treatment volume.

| Stage (ft) | Storage (ac-ft) |
|------------|-----------------|
| 56.10 | 0.00 |
| 56.40 | 0.27 |
| 56.50 | 0.36 |
| 56.90 | 0.73 |
| 57.30 | 1.11 |
| 57.70 | 1.52 |
| 58.10 | 1.94 |

Using this configuration, you should obtain values as shown below.

Table 9.4-2

| Pond configuration: Pond dimensions at SHWT = 288.7 ft x 131.2 ft SHWT elev. = 56.1 ft Average side slope = 1:5 Weir crest elev. = 56.4 ft Weir width = 6.0 ft Starting WS = 56.4 ft Allowable Stage = 58.1 | Design Storm | Discharge cfs | Peak Pond Stage ft |
|---|-------------------|------------------|--------------------------|
| | FDOT 1-hr, 100-yr | Pre Post | 33.6 27.1 |
| FDOT 2-hr, 100-yr | Pre Post | 30.4 27.3 | 57.7 |
| FDOT 4-hr, 100-yr | Pre Post | 25.8 26.4 | 57.7 |
| FDOT 8-hr, 100-yr | Pre Post | 28.1 27.4 | 57.7 |
| SCS-T2FLM, 25-yr | Pre Post | 30.6 27.5 | 57.7 |
| SFWMD, 72-hr, 25-yr | Pre Post | 36.3 30.7 | 57.8 |

From this table, it appears that the FDOT 4-hour is critical since it is the only duration for which the post-developed discharge is not less than the pre-developed discharge. The SFWMD design storm creates the highest stage of the storms modeled.

Second Round of Iterations

- Adjust the drainage basin characteristics due to the pond size being increased in the previous step. Remember that, for this example, the pond is outside the area draining to the pond so increasing the pond size also increases the total area. See Example 9.4-1. During the first iteration, we assumed the entire pond area had a CN = 98. A more refined estimate of the pond area curve number can be made at this time.

Pond Area:

| | |
|-------------------------------------|---------------------|
| Water surf dims at peak stage | = 308 ft. x 150 ft. |
| Water surface area at peak stage | = 1.06 ac @ CN = 98 |
| Total pond area (incl maint berms) | = 1.53 ac |
| Grassed area within total pond area | = 0.47 ac @ CN = 85 |

Total Project Area and Curve Number:

Pre-developed CN:

| | |
|---------------------|--------------------------------------|
| Roadway pavement: | = 0.79 ac @ CN = 98 (same as Step 2) |
| Pervious area: | = 9.61 ac @ CN = 85 (same as Step 2) |
| Proposed pond area: | = 1.53 ac @ CN = 85 |
| Total: | = 11.9 ac @ CN = 85.9 |

Post-developed CN:

| | |
|------------------------------|--|
| Roadway, curb, and sidewalk: | = 3.24 ac @ CN = 98 (same as Step 3) |
| Pervious area: | = 7.64 ac @ CN = 85 [7.17 ac (Step 3) + 0.47 ac] |
| Pond: | = 1.06 ac @ CN = 100 |
| Total | = 11.9 ac @ CN = 89.9 |

- Calculate the pre-developed runoff and then route the design storms. For this example, we will add the FDOT 24-hour, 100-year design storm at this time. The results are shown in the following table.

Table 9.4-3

| Pond configuration: (Same as previous table) Pond Dimensions at SHWT = 288.7 ft x 131.2 ft SHWT El. =56.1ft Avg Side Slope = 1: 5 Weir Crest El. = 56.40 ft Weir Width = 6.0 ft Starting WS = 56.4 ft Allowable Stage = 58.1ft | Design Storm | Discharge (cfs) | Peak Pond Stage (ft) |
|---|------------------------------------|-----------------|----------------------|
| | FDOT 1-hr, 100-yr Pre Post | 35.2 28.7 | 57.8 |
| | FDOT 2-hr, 100-yr Pre Post | 31.9 28.9 | 57.8 |
| | FDOT 4-hr, 100-yr Pre Post | 27.0 27.9 | 57.7 |
| | FDOT 8-hr, 100-yr Pre Post | 29.5 28.9 | 57.8 |
| | FDOT 24-hr, 100-yr Pre Post | 11.2 11.1 | 57.2 |
| | SCS-T2FLM, 250-yr Pre Post | 32.1 29.0 | 57.8 |
| | SFWMD, 72-hr, 25-yr Pre Post | 38.1 32.5 | 57.9 |

From this table, we can see the discharge for the 4-hour needs to be reduced and the stage of the SFWMD storm can still be increased, so the weir width can be reduced. After several iterations, a weir 4.5 ft wide works. The results are as follows.

Table 9.4-4

| Pond configuration: Pond dimensions at SHWT = 288.7 ft x 131.2 ft SHWT elev. = 56.1 ft Avg. side slope = 1:5 Weir crest elev. = 56.4 ft Weir width = 4.5 ft Starting WS = 56.4 ft Allowable stage = 58.1 | Design Storm | | Discharge (cfs) | Peak Pond Stage (ft) |
|--|-------------------|-------------|--------------------|----------------------------|
| | FDOT 1-hr, 100-yr | | Pre Post | 35.2 25.8 |
| FDOT 2-hr, 100-yr | | Pre Post | 31.9 26.7 | 57.9 |
| FDOT 4-hr, 100-yr | | Pre Post | 27.0 26.8 | 57.9 |
| FDOT 8-hr, 100-yr | | Pre Post | 29.5 27.6 | 58.0 |
| FDOT 24-hr, 100-yr | | Pre Post | 11.2 10.9 | 57.3 |
| SCS-T2FLM, 25-yr | | Pre Post | 32.1 27.5 | 58.0 |
| SFWMD, 72-hr, 25-yr | | Pre Post | 38.1 30.3 | 58.0 |

Since this configuration meets the requirements for these design storms, the pond size is probably adequate. We need to make sure that the discharges are not exceeded for the less frequent (2-year through 50-year) DOT design storms. We also will check the longer-duration storms, though it appears that the long duration storms (24-hour to 240-hour) will not control the size of the pond, since the stages and discharges of the 24-hour are much less than the 1-hour through 8-hour duration storms.

- Check the size of the bleed down orifice. For this example, you will need a 1.5-inch diameter orifice or less to meet the typical wet detention criteria [discharge no more than half of the treatment volume in 60 hours and discharge the total treatment volume in no less than 120 hours]. At maximum pond stage, the discharge through this orifice is less than 0.1 cfs. This is insignificant for this problem. The orifice flow will be ignored and the routing calculations will be started at the weir crest, as done in previous iterations.

If the discharge through the bleed down orifice at peak stage is small, ignore it. If not, model the orifice in the routing. If the orifice is modeled, the starting water surface should reflect some amount of drawdown. The average inter-event period between storms is 72 hours. Most wet detention systems hold at least half of the treatment volume for 60 hours. Therefore, for most wet ponds, starting the water surface at an elevation associated with half of the treatment volume would be reasonable. If the regulatory requirements allow for a quicker drawdown, it may be reasonable to start the water surface at the bleed down orifice.

10. Run the other design storms. The other design storms were routed through the above pond configuration and all the post-developed rates were less than the pre-developed rates, except one. A summary of these is shown below.

Table 9.4-5 (Example 9.4-3)

| Pond Config. as in Table 5.3-4 | 100-yr | 50-yr | 25-yr | 10-yr | 5-yr | 2-yr | |
|--------------------------------------|--------------------|--------------------|--------------------|--------------------|--------------------|--------------------|------|
| | Discharge (cfs) | Discharge (cfs) | Discharge (cfs) | Discharge (cfs) | Discharge (cfs) | Discharge (cfs) | |
| 1-hr | Pre | 35.2 | 31.0 | 27.4 | 22.3 | 19.3 | 14.0 |
| | Post | 25.8 | 22.3 | 19.4 | 15.3 | 13.0 | 9.1 |
| 2-hr | Pre | 31.9 | 28.0 | 24.2 | 19.8 | 16.9 | 11.9 |
| | Post | 26.7 | 23.3 | 20.0 | 16.1 | 13.7 | 9.6 |
| 4-hr | Pre | 27.0 | 24.0 | 21.1 | 17.1 | 14.2 | 10.8 |
| | Post | 26.8 | 23.7 | 20.7 | 16.8 | 13.8 | 10.5 |
| 8-hr | Pre | 29.5 | 26.5 | 23.0 | 19.0 | 16.0 | 11.3 |
| | Post | 27.6 | 24.5 | 21.1 | 17.3 | 14.3 | 9.9 |
| 24-hr | Pre | 11.2 | 10.0 | 8.9 | 7.7 | 6.0 | 4.3 |
| | Post | 10.9 | 9.7 | 8.6 | 7.4 | 5.8 | 4.1 |
| 3-day | Pre | 8.2 | 7.1 | 6.2 | 5.2 | 4.5 | 3.4 |
| | Post | 8.2 | 7.1 | 6.2 | 5.2 | 4.4 | 3.3 |
| 7-day | Pre | 5.9 | 5.2 | 4.5 | 4.0 | 3.2 | 2.5 |
| | Post | 5.9 | 5.2 | 4.5 | 4.0 | 3.2 | 2.6 |
| 10-day | Pre | 7.8 | 6.9 | 6.1 | 5.3 | 4.4 | 3.4 |
| | Post | 7.8 | 6.9 | 6.1 | 5.3 | 4.4 | 3.4 |

The 7-day, 2-year post-developed discharge rate is greater than the pre-developed rate. If carried to three significant digits, the increase is 0.02 cfs (2.56-2.54). This is within the accuracy of these calculations and would be acceptable for most projects. If you or your project reviewers are concerned about an increase like this,

you could modify the weir configuration slightly, as is done in Step 8 of Example 9.4-4.

11. Fine tune pond dimensions.

The stage-storage values used in this example are based on length and width dimensions applied to a frustum of a pyramid. When you apply the radii to the corners, you would reduce the storage using the same pond dimensions, so use an equivalent stage-area relationship when working with the contours within the CADD file. Doing so also will allow you to configure the pond for aesthetic purposes while maintaining the necessary stage-storage relationship.

9.4.6 Discharges to Watersheds without Positive Outlet (Closed Basins) Using Chapter 14-86

Using the Storm for Storm Approach, the Department's criterion for projects discharging to a closed basin is that—for a given frequency—the post-developed discharge (rate and volume) for each duration must be less than or equal to the pre-developed discharge (rate and volume) of corresponding duration.

Ensure the retention volume is large enough that the post-developed discharge volumes do not exceed the pre-developed discharge volumes. The retention volume is the volume between the pond bottom and lowest discharge elevation of outlet control structure.

When using the NRCS runoff methodology, you can conservatively calculate the retention volume as the difference between the pre-developed and post-developed discharge volume for the 100-year, 10-day event. Some of this volume is infiltrated into the soil during the storm, so the actual retention volume is sometimes less than this. During long-duration design storms, such as the 3-day through 10-day durations, the volume infiltrated during the storm can be substantial. You can account for this by using a program that models the infiltration while routing the storm hydrograph. When you do this, you will not know the required retention volume until you have routed the storms and know how much volume infiltrates during the storm event.

The retention volume must recover at a rate such that half of the volume is available in seven days and the total volume is available in 30 days. When measuring the recovered volume, the pond is instantly (or over a very short time) filled with a runoff volume equal to the retention volume. Then, the water can infiltrate with no inflow to the pond.

9.4.6.1 Retention System Groundwater Flow Analysis

The approach described below is based on the current approach to modeling the recovery of the treatment volume in retention systems. You can apply the same techniques to the infiltration of retention systems discharging to closed basins.

The next several pages summarize the critical information contained in the following documents. We suggest that you read these documents before designing a retention system.

- a) *Stormwater Retention Pond Infiltration Analyses in Unconfined Aquifers*. Prepared by Jammal and Associates, Inc., 1989 (Revised 1991), for the SWFWMD, Brooksville, Florida. See web link below:

http://publicfiles.dep.state.fl.us/dworm/stormwater/stormwater_rule_development/docs/retpond_infil_analys.pdf

- b) *Full-Scale Hydrologic Monitoring of Stormwater Retention Ponds and Recommended Hydro-Geotechnical Design Methodologies*. Prepared by PSI, Jammal and Associates Division, for the SJRWMD, August 1993, Special Publication SJ93-SP10. See web link below:

<http://static.sjrwmd.com/sjrwmd/secure/technicalreports/SP/SJ93-SP10.pdf>

During a storm event, runoff from the drainage basin enters the pond and infiltrates the pond bottom. At the beginning of a storm, the groundwater beneath the pond moves primarily vertically downward through unsaturated soil. If runoff to the pond exceeds the infiltration, the water depth in the pond increases as the wetting front continues to move down. Although the soil between the wetting front and the pond bottom is wet, it is not totally saturated due to entrapped air. After the wetting front reaches the water table, the vertical infiltration adds water to the water table aquifer. At this time, the groundwater moves primarily horizontally within the saturated aquifer while the water table begins to mound and saturate the soil beneath the pond. If infiltration continues, the mound rises to and above the pond bottom. When the mound reaches the pond bottom, the area beneath the bottom is fully saturated and flow moves primarily horizontally. See Figure 9.4-1.

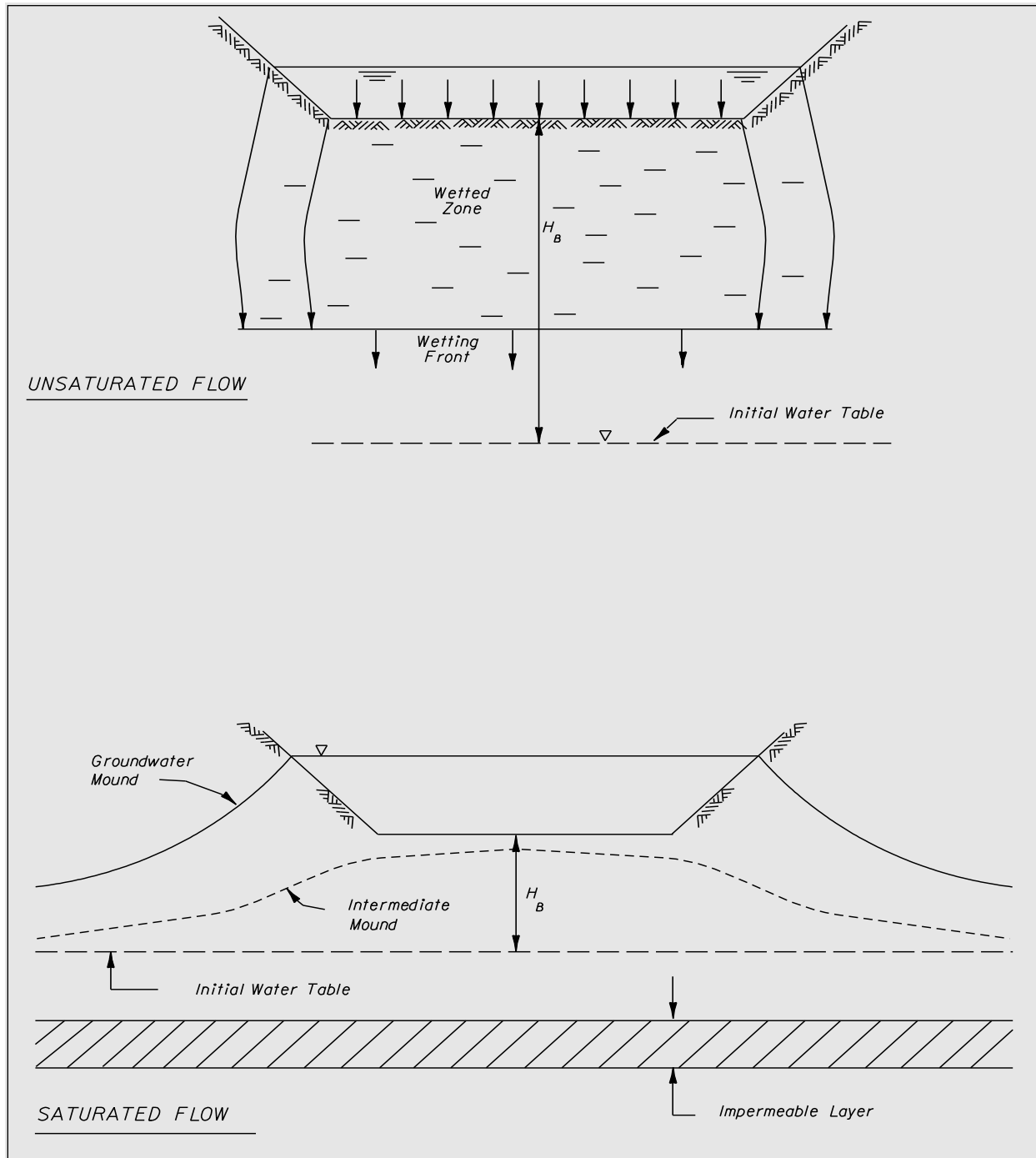

Figure 9.4-1: Groundwater Flow Characteristics during Infiltration

Determining the drawdown characteristics and the recovery time may involve modeling the downward vertical flow through unsaturated soil, or the horizontal saturated flow of the groundwater mound, or both.

(C) Unsaturated Flow

The design infiltration rate is:

$$I_D = \frac{K_{VU}}{FS}$$

The time necessary to saturate the soil below the pond is:

$$T = \frac{f H_B}{I_D}$$

The source for the above equations is the modified Green and Ampt infiltration equation. Their derivation is presented in *Stormwater Retention Pond Infiltration Analyses in Unconfined Aquifers* (Jammal and Associates, 1991).

The total volume of water required to saturate the voids in the soil below the pond bottom is:

$$VOL_{VOIDS} = (A_{PB}) (H_B) (f)$$

where:

H_B = Height of pond bottom above groundwater (see Figure 9.4-1)

I_D = Design infiltration rate

K_{VU} = Unsaturated vertical hydraulic conductivity
You can obtain this typically from a Double Ring Infiltration (DRI) test. Although infiltration is occurring during the test, the soil is not fully saturated due to entrapped air. The unsaturated K is less than the saturated K. Unsaturated K ranges from one-half to two-thirds saturated K (Bouwer 1978, ASTM D 5126, & Jammal and Assoc., 1991).

f = Fillable porosity. See description in following pages.

A_{PB} = Area of pond bottom

FS = Factor of safety, usually 2.0.

You can use this factor of safety to account for the variability of the measurements and for the sediment that inevitably will enter the pond and clog the bottom surface.

(D) Saturated Flow

In most areas of the state, except the high sandy ridges, the groundwater mound likely will rise to the pond bottom, forcing the groundwater into a saturated horizontal flow. The most common approach to analyzing saturated flow conditions is to assume flow to be purely horizontal and uniformly distributed across the thickness of the receiving aquifer.

Model the aquifer as having a single homogeneous layer of uniform thickness and a horizontal initial water table.

Several computer models are available to analyze saturated flow. Most use a form of the USGS program MODFLOW. A simplified approach was developed by Jammal and is discussed in the SJRWMD's, "*Applicant's Handbook for Regulation of Stormwater Management Systems.*" Regardless of which program or technique is used, four parameters are needed to model saturated flow: (1) the thickness of the aquifer, (2) the groundwater table elevation, (3) the fillable porosity, and (4) the horizontal saturated hydraulic conductivity of the aquifer.

- Thickness (or Elevation of the Base) of Mobilized Aquifer:

This is the thickness of soil through which the horizontal flow will occur. You usually will measure this depth to the top of a confining or very dense layer, such as hardpan, that will restrict the downward vertical movement of groundwater. Use the lesser of the depth of the soil boring or the width of the pond as the maximum value in the analysis. (The maximum depth of the mobilized aquifer is about equal to the width of the pond. [Bouwer, 1978]).

- Groundwater Elevation:

For modeling the recovery of the treatment volume, you usually will use the SHWT elevation. For modeling the infiltration of a pond discharging to a closed basin, this groundwater elevation should represent the groundwater elevation during an extreme event like the 100-year, 10-day design storm. Currently, there is no standard procedure for determining this elevation; nevertheless, it could be substantially higher than the SHWT. For example, where the pond is located near the low in the watershed (lake or flood plain at the low), it may be reasonable to use the 100-year lake or floodplain elevation as the extreme event groundwater elevation. Where the pond is located higher in the watershed, the extreme event groundwater elevation may be closer to the SHWT. Use your judgment and handle these situations on a case-by-case basis.

- Fillable Porosity:

This is sometimes called specific yield, storage coefficient, effective storage coefficient, or effective porosity. It is the difference between volumetric water content of soil before and after wetting. The total porosity of a soil is the percentage of the total volume of the material occupied by pores or interstices. The fillable porosity is less than the total porosity because some water exists in soils above the water table; therefore, not all of the unsaturated void space is available for filling. In the zone immediately above the groundwater, capillary rise causes the

voids to be substantially filled with water. In fine sands, the distance saturated due to capillary rise is roughly six inches. Therefore, the fillable porosity varies with the depth to the water table.

Specific field or laboratory testing usually is not required for determining the fillable porosity. For most calculations associated with fine sands, the fillable porosity will vary from 0.1 to 0.3 (10 percent to 30 percent). The SFWMD has produced soil storage curves that you can use to estimate the fillable porosity. For fine sand aquifers, the SJRWMD recommends using a fillable porosity in the range of 20 percent to 30 percent in infiltration calculations. The higher values of fillable porosity will apply to the well-to-excessively-drained, hydrologic group "A" fine sands, which generally are deep and contain less than 5 percent by weight passing the No. 200 sieve.

With all other dimensional and aquifer factors being the same, the predicted recovery time decreases as the assumed value of fillable porosity increases. Increasing the fillable porosity from 0.2 (20 percent) to 0.3 (30 percent) decreases the recovery time by 15 percent to 30 percent.

- Horizontal Saturated Hydraulic Conductivity of the Aquifer:

Since you assume horizontal flow for the saturated analysis, the hydraulic conductivity should represent that direction. This should represent the weighted value of the soil above the confining layer. There are numerous techniques for measuring this value, and they are briefly described below. The Department recommends applying a safety factor of 1.5 to 2.0 to the measured values. You can apply this factor of safety to account for the variability in the elevation of the impermeable layer, measurement of the conductivity, and the estimate of fillable porosity.

Cased hole tests:

Generally, measure horizontal hydraulic conductivity if the casing bottom is below the water table during the test. Generally, measure vertical hydraulic conductivity if the casing bottom is above the water table during the test. Use the results with caution if the bottom of the casing is near an impermeable or confining layer.

Uncased hole tests:

This also applies to cased holes that use screen, perforated pipe, or rock bottom to maintain borehole shape. These generally measure horizontal hydraulic conductivity K .

Double Ring Infiltration (DRI) test:

Generally, the DRI measures the vertical unsaturated hydraulic conductivity. Although the Department does not encourage the use of the DRI to obtain the weighted horizontal saturated hydraulic conductivity, if it is the only test information you have, the saturated horizontal hydraulic conductivity could be estimated by applying two adjustment factors as follows:

$$KVS = 1.5 KVV$$

$$KHS = 1.5 KVS \text{ (conservative SWFWMD guideline)}$$

or

$$KHS = 1.5 \times 1.5 KVV$$

Pumping tests:

These tests generally are expensive and should be reserved for highly sensitive projects. They can overestimate hydraulic conductivity if the bore holes extend into a highly permeable layer which is below a confining layer and the proposed pond bottom is above the confining layer.

(E) Special Saturated Analysis

If you cannot model the aquifer as having the characteristics discussed above, you may need to use a more complicated, fully three-dimensional model with multiple layers, such as MODFLOW.

(F) Coordination with the Geotechnical Engineer

When requesting the soils investigation, provide the Geotechnical Engineer with the following information:

- Pond location
- Approximate pond shape (length, width, plan area configuration)
- Estimated pond bottom elevation
- Your estimate of SHWT
- The ideal functional characteristics of the pond, such as: "This pond will be designed to retain a volume of stormwater for flood control purposes. It should

infiltrate half the retention volume in no more than seven days and all of the volume in no more than 30 days.”

- The anticipated groundwater flow conditions/analysis you expect to model based on your preliminary review of the soil and groundwater conditions.

The Geotechnical Engineer needs to know the information listed above because the soils investigation can vary depending on the groundwater flow condition anticipated during your design conditions. Refer to Table 9.4-6

Table 9.4-6: Typical Soil Investigations

| Anticipated Groundwater Flow Conditions/Analysis | Soil Investigation ¹ |
|--|---|
| Saturated | 1) Thickness of mobilized aquifer. 2) Determine SHWT elevation. 3) Determine weighted saturated horizontal hydraulic conductivity of mobilized aquifer. |
| Unsaturated (Probably limited to high, sandy ridges) | 1) Obtain unsaturated vertical hydraulic conductivity at or near pond bottom. 2) Determine SHWT or confirm that SHWT is at least as low as drainage engineer estimated. 3) Confirm that no confining layer exists between pond bottom and SHWT. |
| Karst Areas | See discussion in this section. |
| 1 Preliminary results of the soil investigation may dictate that a different soil investigation is necessary. For example, you may have estimated sandy conditions down to a deep water table, planned on doing an unsaturated analysis, and requested appropriate soil information. Then the initial soil borings could indicate a confining layer close enough to the pond bottom to warrant a saturated analysis. | |

If the groundwater elevation is within two feet of the pond bottom, you can assume that horizontal saturated flow will occur. If the groundwater is farther from the pond bottom, you should compare the volume of the voids under the pond to the volume of runoff that must be infiltrated.

For estimating the groundwater flow conditions, the volume to be infiltrated should be the treatment volume for retention systems discharging to open basins with known historical flooding. It should be the difference between the 100-year, 10-day runoff volume for ponds discharging to closed basins. If the volume to be infiltrated is larger than the volume of the voids under the pond, the groundwater mound will rise to the pond bottom, thus forcing saturated horizontal flow.

Karst Areas:

The WMDs and FDEP have identified known Karst areas and usually have special requirements for stormwater facilities in these areas to assure that water quality of the aquifer is maintained. Sink holes can present problems during or after construction, so it is important that you are aware of potential sink hole locations.

Some sink holes can be only a meter or two in diameter, thus making it difficult to identify their potential as a hazard. Sometimes potential sink holes can be identified in the field by localized depressions in the ground surface. You may find it useful to try ground penetrating radar in some situations, but this tool has a disadvantage in that it does not penetrate clay layers. Work closely with the Geotechnical Engineer to identify potential sink holes.

As a preventive measure, you could place a permeable geotextile strong enough to span a small opening several feet below the pond bottom. This would allow small sink holes to develop without requiring any maintenance work. Doing this will add substantial costs and may not be warranted for all facilities in Karst areas. You and the Geotechnical Engineer should make a joint decision to follow this approach.

Example 9.4-4: Discharge to watershed without positive outlet (closed basin)

Given:

- Pre-developed roadway pavement = 2 10-foot lanes
- Drainage area: includes roadway right of way and
offsite draining to the roadway: = 13.0 ac
- Offsite land use = Residential lots averaging 1/2 ac
- Proposed typical section = 4-lane urban section
- Combined roadway, curb, and
sidewalk width = 73 ft
- Length of roadway within drainage
area = 2,313 ft
- Treatment volume = 17,600 ft³
- Maximum allowable pond stage = 104 ft
- Offsite runoff draining to the project will be taken through the pond, not bypassed around.

- Project located near Somewhere City, Florida; rolling terrain, approx. 2 percent grades, Hydrologic Soil Group B
- A confining or impermeable layer exists at approximately elevation 92 ft
- The saturated horizontal hydraulic conductivity was estimated to be 8 ft/day
- The SHWT was estimated at approximately elevation 93 ft

Find: Pond size and outlet control structure configuration.

1. Pre-developed runoff:
 Time of concentration = 21 min (given)
 Area & curve number:
 Roadway pavement: = 1.06 ac @ CN = 98 (20 ft x 2,313 ft)
 Pervious area: = 11.94 ac @ CN = 70 (13 ac – 1.06 ac)
 Proposed pond area: = 1.50 ac @ CN = 70 (preliminary size)
 Total: = 14.5 ac @ CN = 72.1

As in Example 9.4-1, the proposed pond is outside the area draining to the roadway; thus, the pond area must be added to the other areas.

Also, as in Example 9.4-1, the roadway right of way to be acquired is within the area draining to the roadway. For your project, the acquired right of way may be outside the area draining to the road, thereby requiring that the additional right of way be added to the other areas.

2. Post-developed runoff:
 Time of concentration = 16 min. (given)
 Area and curve number:
 Roadway, curb, and
 sidewalk: = 3.88 ac @ CN = 98 (72.8 ft x 2,313 ft)
 Pervious area: = 9.12 ac @ CN = 70 (13 ac – 3.88 ac)
 Pond: = 1.50 ac @ CN = 98
 Total: = 14.5 ac @ CN = 80.4

3. Determine the location-specific rainfall volumes using the NOAA website link in Section 1.4 of the *Drainage Manual*.

| Rainfall Volumes (inches): Somewhere City, FL | | | | | | |
|---|------|------|-------|-------|-------|--------|
| | 2-yr | 5-yr | 10-yr | 25-yr | 50-yr | 100-yr |
| 1-hr | 2.2 | 2.7 | 3.0 | 3.5 | 3.8 | 4.1 |
| 2-hr | 2.7 | 3.3 | 3.7 | 4.2 | 4.6 | 5.1 |
| 4-hr | 3.1 | 3.9 | 4.4 | 5.0 | 5.6 | 6.1 |
| 8-hr | 3.6 | 4.6 | 5.1 | 5.9 | 6.6 | 7.3 |
| 1-day | 4.4 | 5.8 | 6.8 | 7.8 | 8.7 | 9.6 |
| 3-day | 5.6 | 7.2 | 8.3 | 9.9 | 11 | 12.4 |
| 7-day | 7.0 | 8.9 | 10 | 12 | 13.4 | 15 |
| 10-day | 7.6 | 9.5 | 11.2 | 13.7 | 15.2 | 16 |

For this example, we will use peak shape factor = 323 for all NRCS hydrograph runs.

4. Assumptions:
- Unsaturated vertical hydraulic conductivity: A DRI could not be performed because of the depth of the pond bottom. The unsaturated vertical hydraulic conductivity was estimated from the saturated horizontal conductivity ($K_{HS} = 8$ ft/day)

 $8 \text{ ft/day} \times (1.5 - 1.5) = 3.6 \text{ ft/day}$ (see discussion of DRI)

 A factor of safety of 2 was applied to both values; thus, the modeled values are $K_{HS} = 4$ ft/day, and $K_{VU} = 1.8$ ft/day
 - Groundwater elevation: The extreme event groundwater elevation is assumed to be 3 feet above the SHWT. Then, extreme event groundwater elevation = 96.0 feet.
 - Fillable porosity is assumed = 0.1 (10 percent), worst case for fine sands

First Round of Iterations

5. Develop a starting-size pond.

You can take any approach to develop the starting trial size for the pond. Perhaps you found a preliminary estimate in the pond siting stage, or you can make an educated guess or a guess based on experience from a similar project. The following approach could be used:

- Assume the retention volume will be the difference in runoff volume for the 100-year, 10-day design storm. Using the approach of Example 9.4-1, the volume difference is 66,588 ft³ for this example.

- Assume a height of the peak stage over the weir crest. For this example, we will use 1 foot. With a peak pond stage of 104 feet, this puts the weir crest at approximately 103 feet.
 - Assume a pond bottom elevation, staying several feet above the estimated extreme event groundwater elevation. For this example, we will start 4 feet above the groundwater elevation with a pond bottom of 100 feet maintaining 4 feet between estimated peak groundwater and pond bottom.
 - Determine a pond size and shape that will fit the retention volume between the pond bottom and the weir crest. For this example, a pond with a 200 foot x 100 foot bottom and 1:4 side slopes meets these constraints and will be used as a starting size.
6. Calculate the pre-developed discharge rates and volumes, and route the post-developed runoff through the pond. The weir width was arbitrarily selected for this iteration. Using a typical routing program that models infiltration during the storm, you should obtain values similar to the following.

For the first round of iterations for a pond discharging to a closed basin, it is usually sufficient to run the 100-year, FDOT 8-hour through 10-day duration storms.

Table 9.4-7

| Pond Configuration: Pond bottom dimensions = 200 ft x 100 ft Pond bottom elevation = 100 ft Avg side slope = 1: 4 Weir crest elevation = 102.9 ft Weir width = 5 ft Volume below weir crest = 68,585 ft ³ Allowable stage = 104 ft Modeled Soil Conditions: Aquifer base elevation = 92 ft Saturated horizontal condition (K _{HS}) = 4 ft/day Water table elevation = 96 ft Fillable porosity = 0.1(10%) Unsat Vert Cond. (K _{VU}) = 1.8 ft/day | Design Storm | | Disch. Volume (ft ³ x 10 ³) | Disch. Rate (cfs) | Peak Pond Stage (ft) |
|---|-----------------------------------|---------------------|--|---------------------------|----------------------|
| | | FDOT 8-hr, 100-year | Pre Post | 216 182 | 29.1 27.3 |
| | FDOT 24-hr, 100-year | Pre Post | 323 289 | 10.4 10.9 | 103.7 |
| | FDOT 3-day, 100-year | Pre Post | 459 422 | 8.2 8.4 | 103.6 |
| | FDOT 7-day, 100-year | Pre Post | 589 543 | 6.1 6.2 | 103.5 |
| | FDOT 10-day, 100-year | Pre Post | 639 589 | 7.5 7.7 | 103.5 |
| | Quantity Control Retention Volume | | | | |
| | Total recovered in 28 days | | 7-Day (ft ³) | 30-Day (ft ³) | |
| | Vol. Req'd. to be Recovered = | | 33,300 | 66,590 | |
| | Vol. Recovered (infiltrated) = | | 30,600 | 53,400 | |

All the post-developed discharge volumes are substantially less than the pre-developed discharge volumes of corresponding duration, so the pond retains more volume than needed. That is, the post-developed discharge volumes could be increased. This is done by lowering the weir. Although most of the post-developed discharge rates exceed the pre-developed rates, they are close to the pre-developed rates. To maintain similar post-developed rates, we will need to reduce the weir width as it is lowered. After making several iterations of weir adjustments, the following configuration produces the results in the following table.

For this example, we will add the 1-hour, 2-hour, and 4-hour duration storms.

Table 9.4-8

| Pond Configuration: Pond bottom dimension = 200 ft x 100 ft Pond bottom elevation = 100 ft Avg side slope = 1:4 Weir crest elevation = 101.5 ft Weir width = 1.5 ft Volume below weir crest = 32,768 ft ³ Allowable stage = 104 ft Modeled Soil Conditions: Aquifer base elevation = 92 ft Saturated horizontal cond. (K _{HS}) = 4 ft/day Water table elevation = 96 ft Fillable porosity = 0.1(10%) Unsat vertical cond. (K _{VU}) = 1.8 ft/day | Design Storm | | Disch. Volume (ft ³ x 10 ³) | Disch. Rate (cfs) | Peak Pond Stage (ft) |
|---|--------------------------------|---------------------|--|---------------------------|----------------------|
| | | FDOT 1-hr, 100-year | Pre Post | 83.3 64.3 | 33.8 16.8 |
| | FDOT 2-hr, 100-year | Pre Post | 122 109 | 31.1 19.9 | 103.7 |
| | FDOT 4-hr, 100-year | Pre Post | 164 155 | 25.4 22.6 | 103.9 |
| | FDOT 8-hr, 100-year | Pre Post | 217 212 | 29.1 24.0 | 104.0 |
| | FDOT 24-hr, 100-year | Pre Post | 323 322 | 10.5 10.2 | 103.0 |
| | FDOT 3-day, 100-year | Pre Post | 459 458 | 8.2 8.3 | 102.8 |
| | FDOT 7-day, 100-year | Pre Post | 588 581 | 6.1 6.2 | 102.6 |
| | FDOT 10-day, 100-year | Pre Post | 638 631 | 7.6 7.7 | 102.8 |
| | Retention Volume | | | | |
| | Total recovered in 17 days | | 7-Day (ft ³) | 30-Day (ft ³) | |
| | Vol. Reqd. to be Recovered = | | 16,390 | 32,770 | |
| | Vol. Recovered (infiltrated) = | | 24,200 | 32,770 | |

This pond configuration meets the drawdown and discharge volume requirements. The rate requirements are close to being met as the 3-day through 10-day storms at only 0.1 cfs above the pre-developed discharge rates.

Second Round of Iterations

- Adjust the drainage basin characteristics due to the pond size being smaller than estimated in Step 1. Remember that, for this example, the pond is located outside the area draining to the road, so changing the pond size also changes the total area. In Step 2, we assumed the entire pond area had a CN = 98. A more-refined estimate of the pond area curve number can be made at this time.

Pond Area:

| | |
|--|-------------------|
| Water surface dimension at peak stage | = 232 ft x 132 ft |
| Water surface area at peak stage | = 0.70 ac |
| Total pond area (including maintenance berms & slopes) | = 1.1 ac |
| Grassed area within total pond area | = 0.40 ac |

Total Project Area and CN:

Pre-developed area & curve number:

Roadway pavement: = 1.06 ac @ CN = 98 (from Step 1)
 Pervious area: = 11.94 ac @ CN = 70 (from Step 1)
 Proposed pond area: = 1.11 ac @ CN = 70
 Total: = 14.1 ac @ CN = 72.1

Post-developed area and curve number:

Roadway, curb, and sidewalk: = 3.88 ac @ CN = 98 (from Step 2)
 Pervious area: = 9.54 ac @ CN = 70 (9.12 ac (from Step 2) + 0.42 ac)
 Pond: = 0.70 ac @ CN = 100
 Total: = 14.1 ac @ CN = 79.2

- Calculate the pre-developed discharge rates and volumes and route the post-developed runoff through the pond. Using the same pond/weir configuration as in the previous table produces the following results.

Table 9.4-9

| Pond Configuration: Pond bottom dimensions = 200 ft x 100 ft Pond bottom elevation = 100 ft Avg side slope = 1: 4 Weir crest elevation = 101.5 ft Weir width = 1.5 ft Volume below weir crest = 32,768 ft ³ Allowable stage = 104 ft Modeled Soil Conditions: Aquifer base elevation = 92 ft Saturated horizontal cond.(K _{HS}) = 4 ft/day Water table elevation = 96 ft Fillable porosity = 0.1(10%) Unsaturated vertical cond. (K _{VU}) = 0.8 ft/day | Design Storm | | Disch. Volume (ft ³ x 10 ³) | Disch. Rate cfs | Peak Pond Stage ft |
|--|---------------------|------|--|-----------------|---------------------------|
| | FDOT 1-hr, 100-year | Pre | Post | 81.2 | 32.9 |
| FDOT 2-hr, 100-year | Pre | Post | 119 | 30.3 | 103.6 |
| FDOT 4-hr, 100-year | Pre | Post | 160 | 24.7 | 103.8 |
| FDOT 8-hr, 100-year | Pre | Post | 211 | 28.4 | 103.9 |
| FDOT 24-hr, 100-year | Pre | Post | 315 | 10.1 | 103.0 |
| FDOT 3-day, 100-year | Pre | Post | 447 | 7.9 | 102.8 |
| FDOT 7-day, 100-year | Pre | Post | 572 | 5.9 | 102.6 |
| FDOT 10-day, 100-year | Pre | Post | 621 | 7.3 | 102.8 |
| Retention Volume | | | | | |
| Total recovered in 17 days | | | 7-Day (ft ³) | | 30-Day (ft ³) |
| Vol. Req'd. to be Recovered = | | | 16,390 | | 32,770 |
| Vol. Recovered (infiltrated) = | | | 24,,200 | | 32,770 |

This essentially meets all the requirements. The 24-hour and 3-day are critical durations for discharge volume. The 8-hour duration creates the highest stage. The 3-day through 7-day are critical durations for discharge rate and they exceed the pre-developed discharge rates by less than 2 percent. This may be acceptable. For this example, several more iterations could be made to bring these rates down without increasing the pond size.

Notice that the retention volume recovered in 7 days was more than necessary and the total volume was recovered in only 17 days. This indicates that we can lower the pond bottom. We can lower the weir crest the same amount that the pond bottom is lowered and maintain similar discharge volumes, which we need to do. As we lower the weir crest, we can reduce the weir width to reduce the discharge rate, which is the primary intent. So after several iterations, the following configuration using two weirs seems to do the trick. Notice it involves a compound weir.

Table 9.4-10

| | | | | | | |
|---|-----------------------------------|-------------|--|--------------------------|---------------------------|--|
| <p><u>Pond Configuration:</u> Pond bottom dimension: = 192 ft x 92 ft</p> <p>Pond bottom elevation = 99 ft Avg side slope = 1:4 #1 weir crest elevation = 100.5 ft #1 weir width = 0.5 ft Volume below #1 weir crest = 29,120 ft³ #2 weir crest elevation = 103.3 ft #2 weir width = 12 ft Allowable stage = 104 ft</p> <p><u>Modeled Soil Conditions:</u> Aquifer base elevation = 92 ft Saturated horizontal cond. (K_{HS}) = 4 ft/day Water table elevation = 96 ft Fillable porosity = 0.1(10%) Unsat vertical cond. (K_{VU}) = 1.8 ft/day</p> | Design Storm | | Disch. Volume (ft ³ x 10 ³) | Disch. Rate (cfs) | Peak Pond Stage (ft) | |
| | FDOT 1-hr, 100-year | Pre Post | 81.2 38.9 | 32.9 8.2 | 103.0 | |
| | FDOT 2-hr, 100-year | Pre Post | 119 78.5 | 30.3 13.8 | 103.5 | |
| | FDOT 4-hr, 100-year | Pre Post | 160 124 | 24.7 21.1 | 103.7 | |
| | FDOT 8-hr, 100-year | Pre Post | 211 185 | 28.4 21.7 | 103.7 | |
| | FDOT 24-hr, 100-year | Pre Post | 315 299 | 10.1 8.1 | 103.0 | |
| | FDOT 3-day, 100-year | Pre Post | 447 436 | 7.9 7.4 | 102.9 | |
| | FDOT 7-day, 100-year | Pre Post | 572 556 | 5.9 5.9 | 102.6 | |
| | FDOT 10-day, 100-year | Pre Post | 621 610 | 7.3 7.3 | 102.9 | |
| | Quantity Control Retention Volume | | | | | |
| | Total recovered in 28 days | | | 7-Day (ft ³) | 30-Day (ft ³) | |
| | Vol. Req'd. to be Recovered = | | | 14,560 | 29,120 | |
| | Vol. Recovered (infiltrated) = | | | 17,590 | 29,120 | |

This configuration meets all the requirements for the storms modeled. The 7-day and 10-day durations are critical for discharge rate. The 3-day and 10-day durations are critical for discharge volume, and the 4-hour and 8-hour durations create the highest stage. The total retention volume is recovered in 28 days, just under the 30-day requirement. Although it appears that the pond size could be reduced slightly, remember that the earthwork tolerance will slightly affect characteristics of this pond. A slightly lower pond bottom will reduce the aquifer thickness, thus reducing the recovery time. A slightly higher pond bottom will reduce the retention volume and increase the discharge. So, when considering the construction tolerance, this configuration looks good.

9. Run the other design storms.

The other storm frequencies should be calculated to check that the pre-developed discharges are not exceeded. The results are in Table 9.4-1.

10. The stage-storage values used in this example have been based on length and width dimensions applied to a frustum of a pyramid. When you apply the radii to the corners, you would reduce the storage using the same pond dimensions, so use an equivalent stage-area relationship when working with the contours within a CADD file. Doing so will allow you to configure the pond for aesthetic purposes while maintaining the necessary stage-storage relationship.

9.4.7 Off-Site Inflows

In 2013, House Bill 599 (2012), enacted as Chapter 2012 174, Laws of Florida, amended Chapter 373, F.S. to create provision Section 373.413(6). This provision states that “FDOT is responsible for treating stormwater generated from state transportation projects but is not responsible for the abatement of pollutants and flows entering its stormwater management systems from off-site sources; however, this subsection does not prohibit the Department of Transportation from receiving and managing such pollutants and flows when cost effective and prudent. Further, in association with right-of-way acquisition for state transportation projects, the Department of Transportation is responsible for providing stormwater treatment and attenuation for the acquired right-of-way but is not responsible for modifying permits for adjacent lands affected by right-of-way acquisition when it is not the permittee.”

FDOT generally has four options when dealing with offsite flows that would be intercepted by a linear transportation project:

- 1) Bypass offsite flows around the project's treatment system
- 2) Accept offsite flows and direct them to a treatment system that is designed to treat the transportation project and the offsite flow
- 3) Accept offsite flows and direct them to a treatment system that is designed to treat only the project
- 4) Accept offsite flows and direct them to a treatment system that is designed to treat the project and partially treat the off-site property

Empirical nutrient loading model results (Harper Methodology) show that—in all cases involving wet detention treatment, even when the treatment facility is designed for only the project area—there is an overall environmental benefit achieved by commingling (i.e., the net pollutant reduction is greater).

The same modeling shows that—for retention-type treatment systems, when the offsite lands provide equal or greater nutrient loading when compared to the FDOT project—there is also an overall environmental benefit achieved by commingling, even when the treatment facility is designed for only the project area. Thus, in these cases, the water quality at downstream points of discharge from the commingled system will be equal to or better than those systems that bypass offsite flows. Based on these results, FDEP and the WMDs support allowing commingling in these cases without requiring further analysis as long as the proposed treatment pond meets the ERP design requirements for the runoff from the project area and results in an overall environmental benefit.

The same empirical nutrient loading model results (Harper Methodology) show that—where undeveloped or unimproved offsite lands flow into onsite FDOT dry retention

ponds—the water quality at downstream points of discharge from the commingled system may, in some cases, be worse than those systems that bypass offsite flows. As such, these designs should be evaluated on a case-by-case basis to ensure that environmental protection is not diminished.

In summary:

- For wet detention:
 - ✓ Comingle offsite inflows unless cost or hydraulic issues lead to bypassing
- For dry retention:
 - ✓ Comingle developed offsite inflows unless cost or hydraulic issues lead to bypassing
 - ✓ For inflows from lower EMC areas, consult the District Drainage Engineer
 - Calculate change in nutrient removal
 - If reduction in treatment, evaluate B/C

9.4.8 Commingling of Untreated Onsite Runoff

When you are adding new lanes to an existing roadway that has no formal water quality treatment, if you leave the drainage system for the existing roadway untouched, water quality treatment does not need to be provided for the existing unchanged lanes. Regardless, as a matter of good environmental stewardship, attempt, if economically prudent, to bring the runoff from the existing roadway into the treatment system for the new lanes. Just as in the section above for offsite inflows, commingling of existing onsite runoff will always result in improved downstream water quality, even if the stormwater management system is sized only for the new lanes. If economically prudent, consider increasing the pond sizes to treat the old system, even though not required.

9.5 OUTLET CONTROL STRUCTURES

9.5.1 Weirs

The most common form of flow control is a weir notched into the side of a concrete structure. To maximize the predictability of the flow, the weir should be smaller than the distance between the inside edges of the walls. This smaller size will allow air to get under the nappe. Using a weir size equal to the inside edges of the walls would create an unstable condition when the flow is attempting to spring free from the leading edge of the weir.

Sometimes outlet control structures contain multiple (or staged) weirs, such as a small weir at a low elevation with a larger weir at a higher elevation. These compound weirs can be handled in one of two ways. SWFWMD recommends treating the lower slot as an orifice, with head (H) measured to the centroid when the opening is submerged. Then you can model the upper portion with standard weir formulas and the two flows are added. Alternatively, you can extend the lower slot computations to the water surface. Then you model the flows from the sides of the upper slot as a separate weir and add the flows. In either case, a totally smooth transition in the performance curve at the stage of the upper weir crest cannot be expected. Some amount of manipulation of the curve should be made to smooth it at the transition.

9.5.2 Discharge Coefficients

The following coefficients are recommended for the typical concrete box outlet control structure. You will find these values documented in a report titled “Performance and Design Standards for Control Weirs, An Investigation of Discharge Through Slotted Weirs,” based on a study by the University of South Florida, March 1993; WPI nos. 0510610, & 0510522. Contact the FDOT Research Center at (850) 414-4615 to obtain a copy.

The first two tables apply to control devices formed into the wall of the outlet control structure. As a result, the thickness of the structure wall will affect the discharge coefficient. The discharge coefficient first rises with increasing head and then remains constant. This behavior is observed for both orifices and weirs and is caused by attachment of the flow at the sides of the opening. The wall thickness of the typical FDOT structure can vary depending on whether the structure is precast or “cast in place.” Unless you specify “cast in place,” assume that the structure will be precast. The Roadway and Traffic Design Standards specify the wall thickness.

Table 9.5-1: Orifice Discharge Coefficients

| ORIFICE | Discharge Coefficient, C_D | |
|---|------------------------------|-------------|
| | $H/b < 0.6$ | $H/b > 0.7$ |
| Condition of upstream edge | | |
| Concrete edge ¹ | $0.276 (H/b) + 0.491$ | 0.709 |
| 90° elbow fitting | $0.620 (H/b) + 0.284$ | 0.645 |
| ¹ These values account for edge imperfections, chipping, wear, and some amount of bevel. | | |
| C_D is dimensionless, to be used with the equation: $Q = C_D A_o (2gH)^{1/2}$ A_o = area of opening H = distance of water surface above orifice center b = thickness of the structure wall | | |

Table 9.5-2: Weir Discharge Coefficients

| RECTANGULAR WEIR | Weir Coefficient, C_w | |
|---|-------------------------|---------------|
| | $0.25 < H/b < 2.0^1$ | $H/b > 2.0^1$ |
| Condition of upstream edge | | |
| Concrete edge ² | $0.468(H/b) + 2.45$ | 3.45 |
| ¹ A typographical error exists in the original report, which shows this value to be 2.5 instead of 2.0. ² These values account for edge imperfections, chipping, wear, and some amount of bevel. | | |
| C_w is dimensional and calculated from $C_w = (2g)^{1/2} C_D$ C_w is to be used in the equation: $Q = C_w L H^{1.5}$ L = width of weir H = distance of water surface above the weir crest b = thickness of the structure wall | | |

Thin plate weirs fabricated from metal and bolted over a larger opening in the wall provide a more-uniform, predictable performance. Install the metal weir plate over an opening of sufficient size to ensure that the flow passing over the weir encounters no interference from the headwall. The plate's thickness should be 0.25 inch or less to approximate a sharp edge. If you construct it as discussed here, the weir coefficient is as follows and is independent of height.

| | Metric | US Customary |
|--|--------|--------------|
| Weir Coefficient C_w for Thin Plates | 1.73 | 3.13 |
| | | |

9.5.2.1 Submerged Control Devices

For weirs, use the Villemonte relationship to compute the ratio of flow under submerged conditions to flow under free discharge.

$$\frac{Q_S}{Q_F} = (1 - S^n)^{0.385}$$

where:

Q_S = Flow under submerged conditions

Q_F = Flow under free discharge

S = H_2/H_1 = Submergence ratio

H_1 = Upstream headwater

H_2 = Downstream headwater

n = 1.5 for rectangular weirs, & 2.5 for triangular weirs

Use the following similar relationship for orifices.

$$\frac{Q_S}{Q_F} = (1 - S)^{0.5}$$

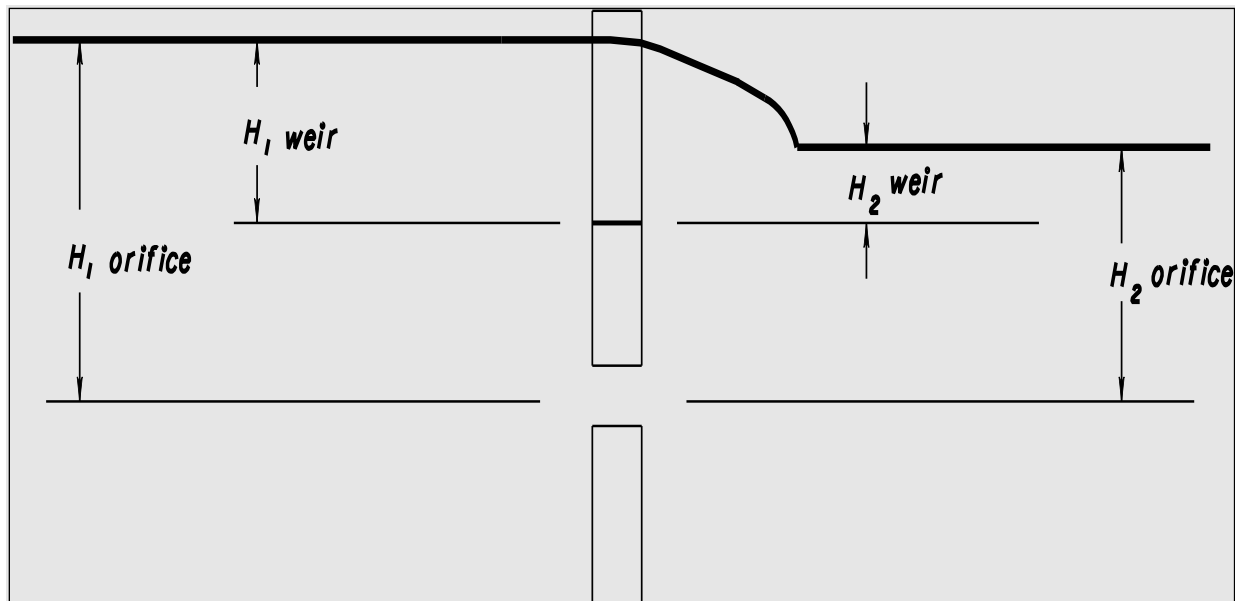

9.5.3 Skimmers

Regulatory agencies commonly require skimmers to prevent oil and grease from leaving the pond. The head loss due to skimmers is minimized if the flow area under the skimmer is three times larger than the flow area of the weir. If this area is provided, you need not calculate the head loss associated with the skimmer.

If it is impossible to provide the flow area mentioned above, the head loss across the skimmer can be calculated using this formula:

$$H_L = k V^2/2g$$

where:

k = Loss coefficient

V = Velocity under the skimmer

A loss coefficient, k, of 0.2 is recommended based on a May 25, 1988, SWFWMD Technical Memorandum by R.E. Benson Jr., P.E., Ph.D.

9.5.4 Miscellaneous

To minimize plant growth, construct a concrete apron around the outlet control structure. You should extend it five feet from the structure.

In wet detention facilities, the outlet control structure generally includes a drawdown device, such as an orifice or a v-notch weir, to establish the normal water level and to slowly release the treatment volume. If the drawdown device is smaller than three inches wide or less than 20 degrees for v-notches, include a device to eliminate clogging. Examples of such devices include baffles, grates, screens, and pipe elbows.

It is not necessary to use the ditch bottom inlet type grates on outlet control structures unless needed for safety. If the structure is accessible to the public or maintenance vehicles will traverse it, grates are recommended.

Always consider the effects of storms that are more severe than what was designed for. Sometimes an overflow spillway can be built into the berm. Or additional flow can sometimes pass through the top of the outlet control structure while using the freeboard to store more volume and create additional head.

CHAPTER 10: TEMPORARY DRAINAGE DESIGN

| | |
|---|-------------|
| CHAPTER 10: TEMPORARY DRAINAGE DESIGN | 10-I |
| 10. TEMPORARY DRAINAGE DESIGN | 10-1 |
| 10.1 Purpose | 10-1 |
| 10.2 Criteria | 10-1 |
| 10.3 Method | 10-2 |
| 10.4 Detours | 10-2 |
| 10.4.1 On Existing Streets | 10-2 |
| 10.4.2 Constructed Detours | 10-3 |
| 10.5 Construction of the Proposed Facility | 10-3 |
| 10.5.1 Milling and Drop-Offs | 10-3 |
| 10.5.2 Driveways | 10-4 |
| 10.5.3 Temporary Drains and Curb Inlets | 10-4 |
| 10.5.4 Box-Culvert Extensions | 10-5 |
| 10.5.5 Temporary Barrier Wall | 10-5 |
| 10.5.5.1 Flow under Temporary Barrier Walls | 10-6 |

10. TEMPORARY DRAINAGE DESIGN

10.1 PURPOSE

The primary purposes for designing temporary drainage are to:

- Minimize travel lane flooding
- Prevent damage to property adjacent to a project during construction
- Facilitate construction activities by temporarily rerouting or altering drainage conveyances

The information covered in this chapter offers practical considerations and solutions to physical conditions that affect drainage efficiency at roadway construction sites. This is intended for the drainage system engineer and designer and indirectly for other technical personnel. Proper use of this information includes ongoing communication and collaboration with engineers responsible for roadways, structures, and traffic control plans.

10.2 CRITERIA

Consult the *Drainage Manual* for hydraulic and hydrologic criteria that apply to the design of temporary drainage systems. Specifically, refer to Section 2.2 in the *Drainage Manual* for design frequencies at temporary roadside and median ditches, swales, and side drains. Refer to Section 3.3 in the *Drainage Manual* under “General Design” for design frequencies of temporary storm drain systems. Refer to Section 4.3.2 in the *Drainage Manual* for design frequencies at temporary culverts, bridge culverts, and bridges.

Some drainage situations are much more common in temporary conditions than in permanent conditions. For example, in temporary MOT scenarios, a temporary traffic lane ultimately will become a paved shoulder; thus, the shoulder area, proposed to carry spread in the permanent condition, now has traffic flowing with little room before being confined by a barrier wall. Thus, stormwater may pool along the temporary barrier wall or curbing near an inside high-speed lane.

Be aware that criteria can be different for permanent and temporary conditions on the same section of roadway, primarily because the two conditions can have differing design speeds. Consult Section 3.9 of the *Drainage Manual* to determine spread criteria.

10.3 METHOD

Carefully consider the temporary conditions that could arise during the construction or rehabilitation of a permanent transportation facility. Safety of travelers and workers, cost of construction, and the time required to complete construction tasks all are affected adversely when temporary drainage is not adequately addressed during design. You can reduce construction delays resulting from inclement weather conditions by creating a well-designed temporary drainage system. Further, unsafe traveling conditions and construction delays increase the cost of projects. Provide temporary drainage features where and when they are needed.

Design temporary drainage for construction sites with emphasis on the following:

- (1) Drain detours efficiently, whether on existing streets or temporary lanes.
- (2) Prevent drainage problems caused by construction staging. Examine detour designs in the light of construction staging to determine whether construction activities might divert or trap water and compromise safety and efficiency.
- (3) Provide details for box culvert extensions that require a temporary rerouting of water away from work areas.
- (4) Provide emergency relief that will convey storm events without substantial risk of flooding travel lanes.

10.4 DETOURS

The term “detour” is defined in FDM 240. Detours may be either located on existing streets or constructed with temporary paved or graded lanes. Design the drainage for detours on existing streets by using the existing street drainage system while preventing overtaxing of the system on those streets. When temporary lanes or roads must be constructed, provide design for temporary drainage systems.

10.4.1 On Existing Streets

Concentrate on construction site ingress and egress points when designing drainage for detours routed over existing streets or roads. Ensure that the construction site does not divert drainage onto the detour route in excess of the capacity of the existing street drainage systems. Conversely, ingress and egress locations cannot be allowed to divert excessive water onto the travel lanes or to accommodate surface drainage that causes erosion of the construction site.

10.4.2 Constructed Detours

Refer to Figures 10.5-1 and 10.5-2. When constructing detours, provide designs for temporary drainage systems that prevent stormwater from pooling or backing up on lanes where traffic will travel. Detour lanes, whether constructed in a median or off an outside edge of pavement, often are built on fill that can disrupt the flow of stormwater unless you design temporary measures to carry the water through or around the fill area.

Include directional flow arrows in the plans when a swale is used between fill for a temporary road and fill for a permanent road. See Figure 10.5-1.

Consider every temporary low area created when a detour road interrupts a proposed ditch gradient as a possible location for temporary drainage structures.

Temporary detours sometimes have vertical curvature or gradients that are independent of the main project. Be careful not to overlook these areas when locating temporary drainage structures. See the temporary pipe shown in Figure 10.5-1.

10.5 CONSTRUCTION OF THE PROPOSED FACILITY

Provide a design for temporary drainage of construction features, such as milled lanes, drop-offs between lanes, turnout construction, and construction operations for new side drains, cross drains, and box culverts. Examine areas where traffic control items, especially temporary barrier walls, might cause water to pond.

10.5.1 Milling and Drop-Offs

A drainage problem can occur where the natural sheet flow across the roadway surface is curbed by an adjacent lane; this problem will be most evident in sag vertical curves where curbed water is directed to the low point and then flows in concentrated form across an adjacent lane. The best way to avoid this is to schedule construction phasing so that an adjacent lane does not curb natural sheet flow across the roadway surface. It is difficult to avoid this curbing effect when adding lanes to the median side of a divided highway, or to the high side of a section in super-elevation.

Where you cannot avoid this curbing effect with construction phasing, provide temporary measures to prevent flooding of adjacent travel lanes. Sandbags or temporary asphalt curb can be effective in directing runoff away from travel lanes. Prevent overtopping flow at drop-offs by calling for sandbags or temporary asphalt curb to be placed along the drop-off to force water away from travel lanes. Refer to Figures 10.5-3, 10.5-4 and 10.5-5.

If the speed limit in a work zone is 45 mph or less, you can use intermittent transverse saw-cuts in travel lanes to allow water to flow through the travel area without overtopping.

10.5.2 Driveways

Constructing driveways can cause water to pond in the turnout area and subsequently flood adjacent lanes on the roadway. Include details in the plans for placing sandbags or temporary asphalt curb along outside edges of pavement adjacent to turnout construction to prevent water in the turnout site from flowing across the travel lanes. Provide details for temporary flumes and inlets, where needed, to direct water at turnout sites into the storm drain system, thus preventing water from collecting in low areas and/or causing erosion.

10.5.3 Temporary Drains and Curb Inlets

In accordance with Standard Plans, Index 425-001, provide a note in the plans requiring “temporary drains for subgrade and base” at inlets, or include a similar detail in the plans. Either detail will require construction of temporary drains for water that is trapped on base and subsequent paving layers around inlets during construction.

10.5.4 Box-Culvert Extensions

Furnish a temporary drainage design that will provide dry work areas for box culvert extensions during common storms and provide flood protection during severe storms. When standing or flowing water occupies box culverts that are to be extended, divert this water away from work areas for the duration of required work. Refer to Figures 10.5-6 through 10.5-10 for examples of details for inclusion in plans. Include details and notes in the plans that provide, at a minimum, the following information:

1. Provide sizes for diversion pipes that are to be inserted into existing box culverts.
2. Show the configuration requirements for sandbagging.
3. Include measures for stabilization and erosion control.
4. List any items that must be removed prior to final grading.
5. List descriptions and quantities for items not included in the cost of the structure.

10.5.5 Temporary Barrier Wall

The temporary barrier wall most commonly used on Department projects is the Type K Temporary Concrete Barrier System detailed in Standard Plans, Index 102-110. The concrete units are configured with two 27-inch drainage slots.

When needed, perform spread calculations for temporary precast concrete barrier wall, based on rainfall of four inches per hour.

10.5.5.1 Flow under Temporary Barrier Walls

For barrier walls placed on a longitudinal grade, an approach to calculating spread that is similar to the approach used for curb inlets is summarized as follows.

1. Determine the flow approaching the slot.
2. Assume normal depth of flow at the slot and use the modified Manning's Equation for shallow channel flow to determine the spread and associated depth of flow (y) at the edge of the barrier wall.

$$Q = \left(\frac{0.56}{n} \right) S_x^{5/3} S_L^{1/2} T^{8/3}$$

where:

- Q = Gutter flow rate, in ft³/sec
- n = Manning's roughness coefficient (see Table B-2, Appendix B)
- S_x = Pavement cross slope, in ft/ft
- S_L = Longitudinal slope, in ft/ft
- T = Spread, in ft

3. Using the depth of flow (y) at the edge of the barrier wall, determine the flow through the slot using the capture equations in HEC 22, and assuming that the two 27-inch slots operate independently. The Department suggests that the slot flow be reduced to 75 percent of the equation value to account for 25 percent blockage.
4. Subtract the flow through the slot from the flow approaching the slot to determine the flow bypassing the slot.
5. Add the bypass flow to the surface runoff for the next slot.
6. Repeat steps 1 through 5 for the length of the barrier wall or until equilibrium is achieved.

Table 10.5-1 provides the spread values for several pavement widths and slopes using the approach described above.

For sag vertical curves, you will likely need a more complicated approach. Several items change with changing (y) values. As the depth of ponding increases, the length of roadway draining directly (not including the bypass from approach grades) to the ponded area increases, as does the number of slots that operate in sump condition.

Table 10.5-1: Spread at Temporary Barrier Walls (27") Slots

| Pavement Width | Cross Slope | Longitudinal Slope = 0.3% | Longitudinal Slope = 1% | Longitudinal Slope = 3% |
|----------------|-------------|---------------------------|-------------------------|-------------------------|
| | ft/ft | Spread (ft) | Spread (ft) | Spread (ft) |
| 12 feet | 0.01 | 3.00 | 2.39 | 1.95 |
| | 0.02 | 1.94 | 1.55 | 1.26 |
| | 0.03 | 1.51 | 1.20 | 0.98 |
| 24 feet | 0.01 | 3.74 | 2.98 | 2.43 |
| | 0.02 | 2.42 | 1.93 | 1.57 |
| | 0.03 | 1.88 | 1.5 | 1.22 |
| 36 feet | 0.01 | 4.33 | 3.45 | 2.81 |
| | 0.02 | 2.8 | 2.24 | 1.82 |
| | 0.03 | 2.18 | 1.74 | 1.41 |

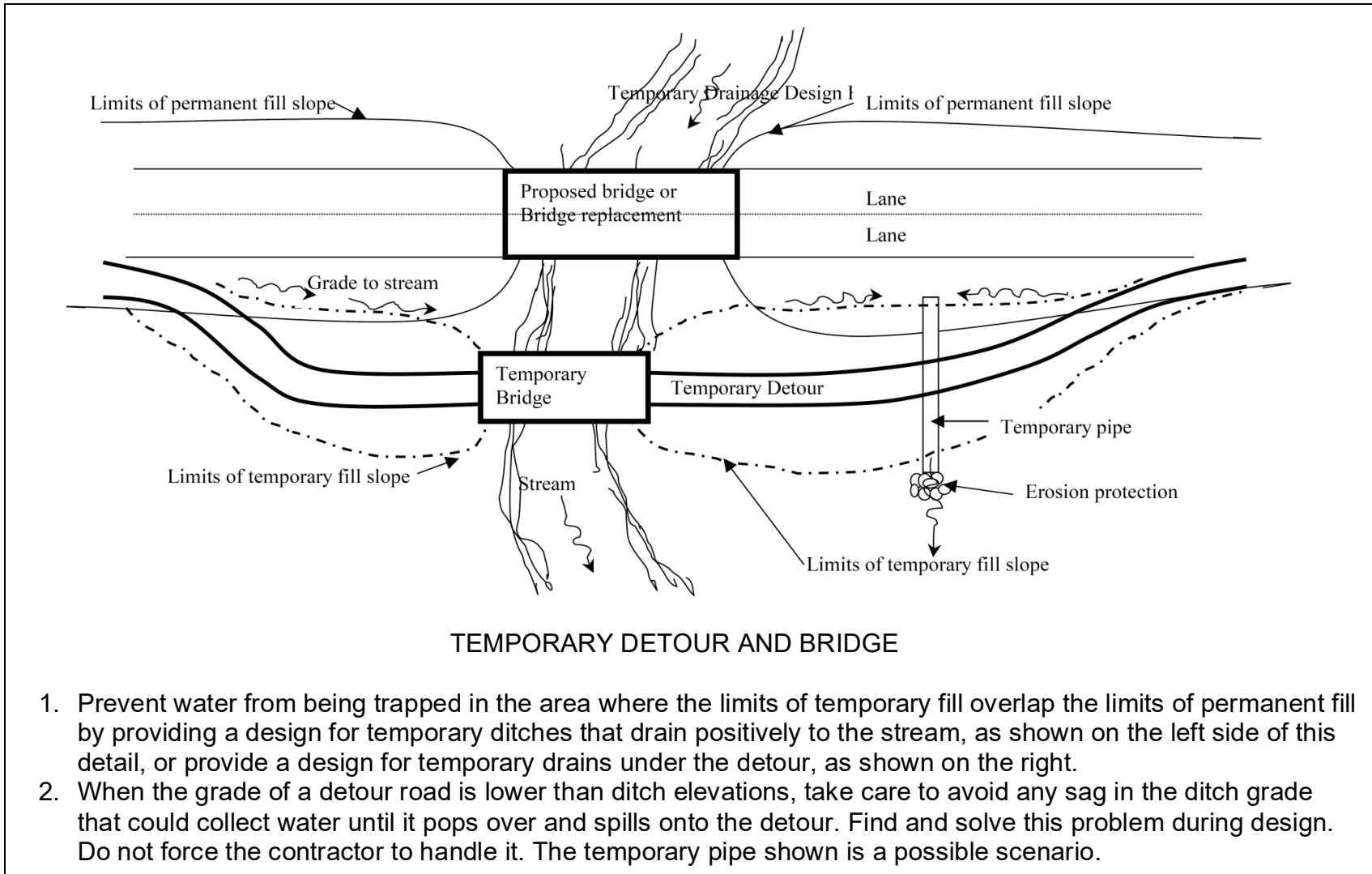
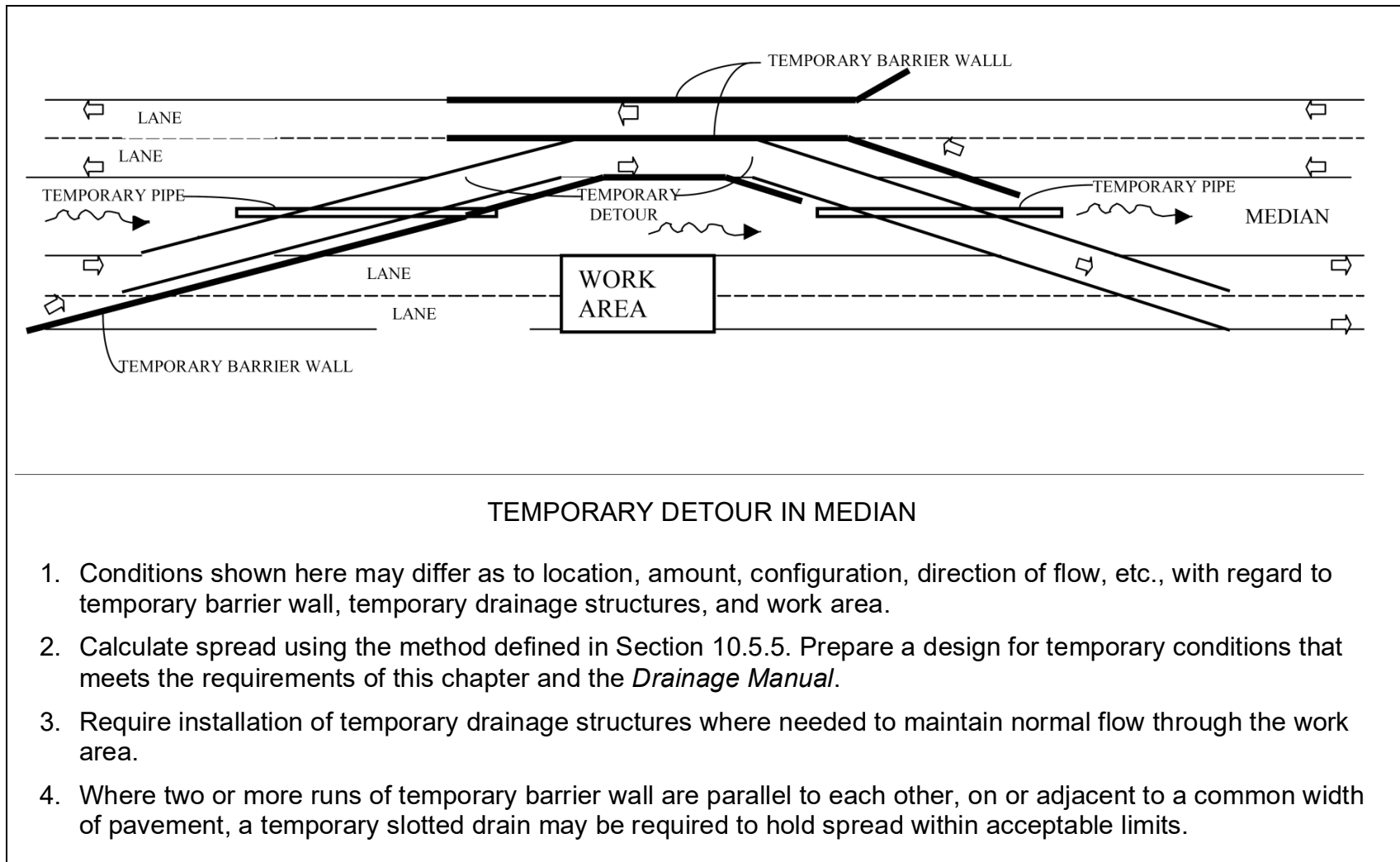

Figure 10.5-1: Temporary Detour and Bridge

**Figure 10.5-2: Temporary Detour in Median**

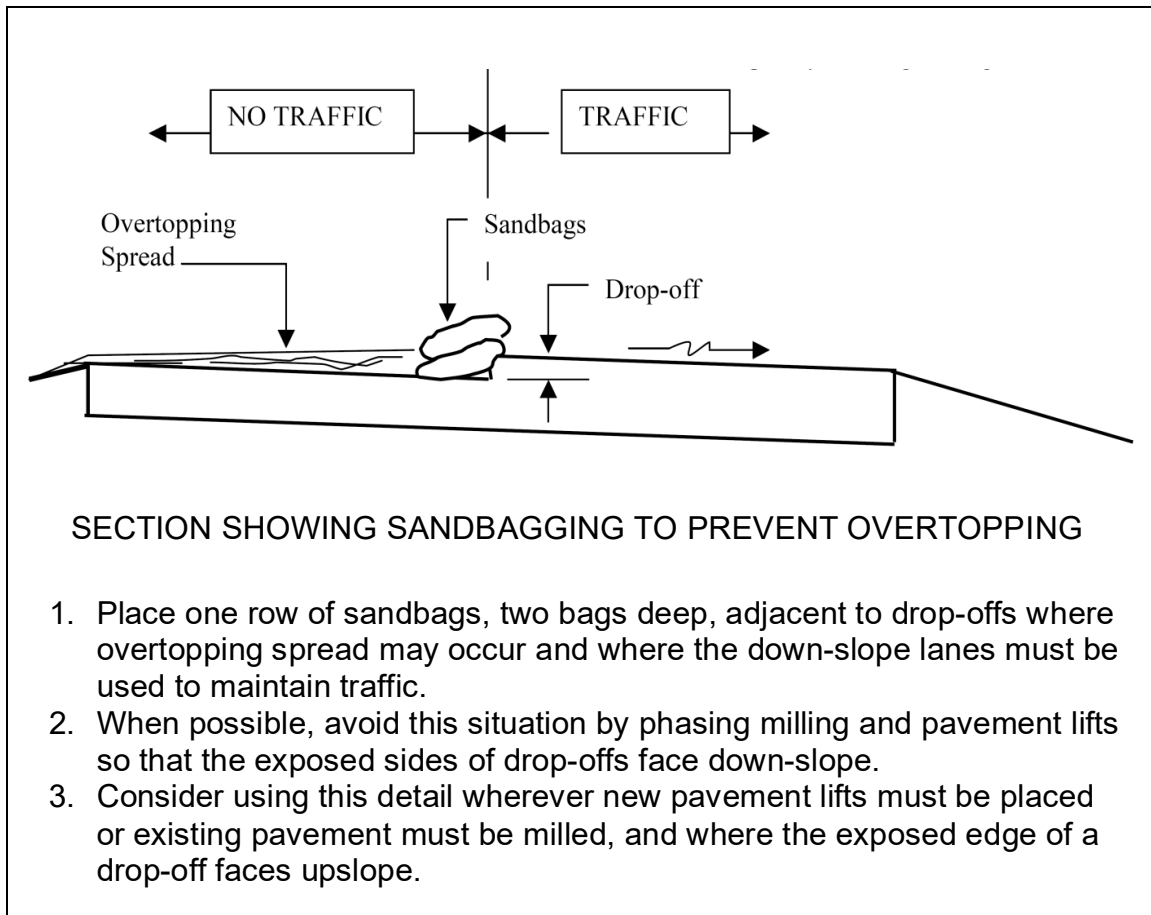

Figure 10.5-3: Section Showing Sandbagging to Prevent Overtopping

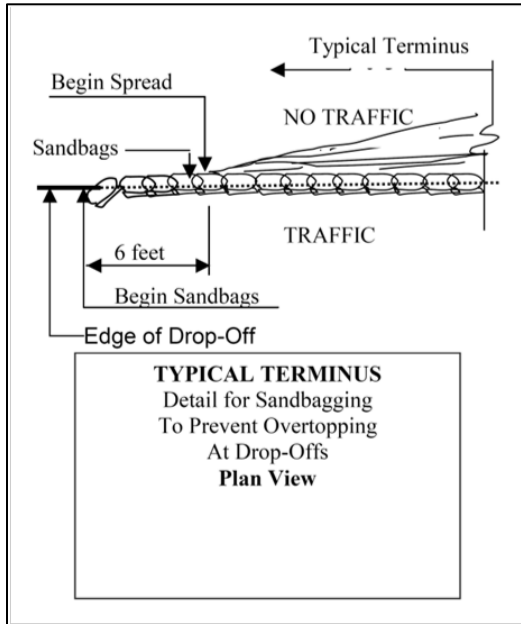

Figure 10.5-4: Typical Terminus

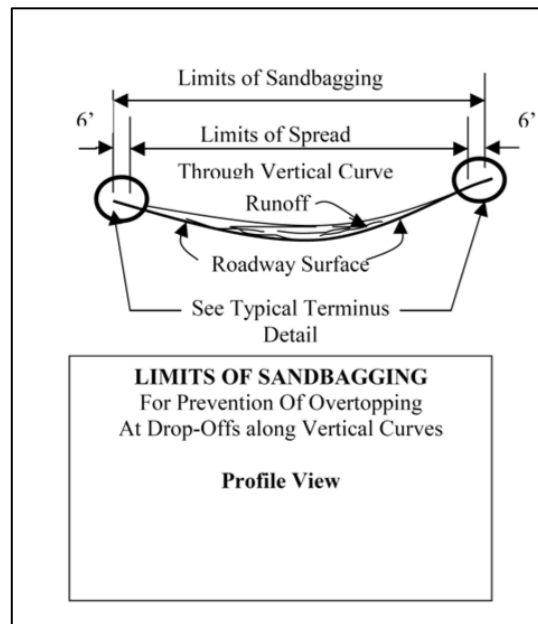

Figure 10.5-5: Limits of Sandbagging

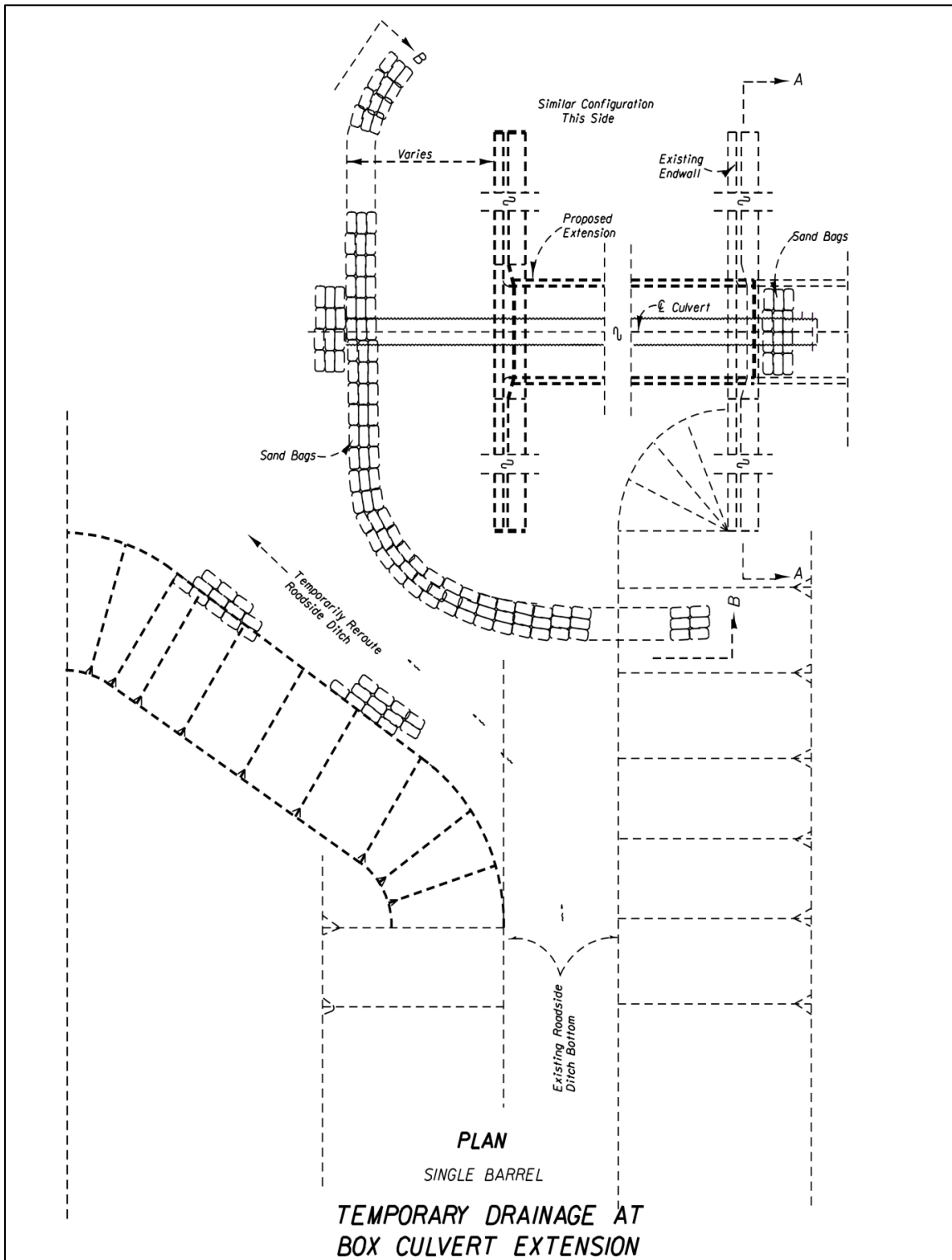

Figure 10.5-6: Temporary Drainage at Box Culvert Extension

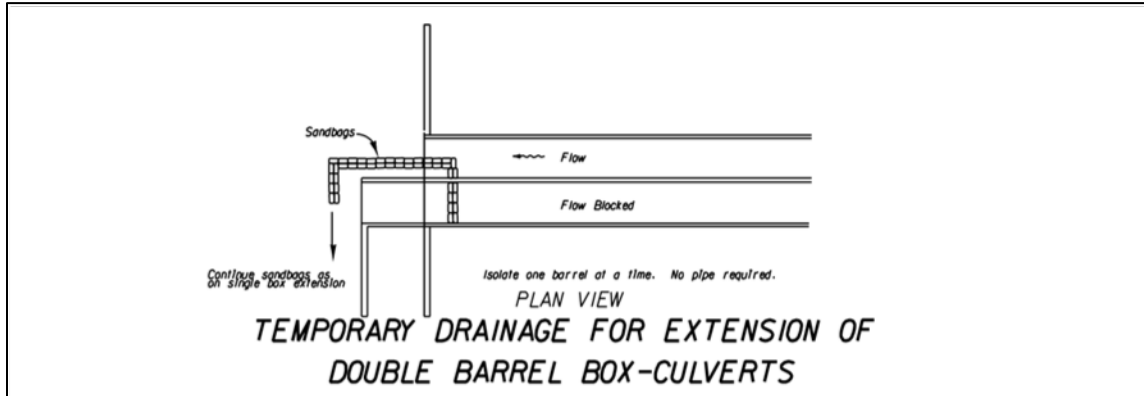

Figure 10.5-7: Temporary Drainage for Extension of Double Barrel Box-Culverts

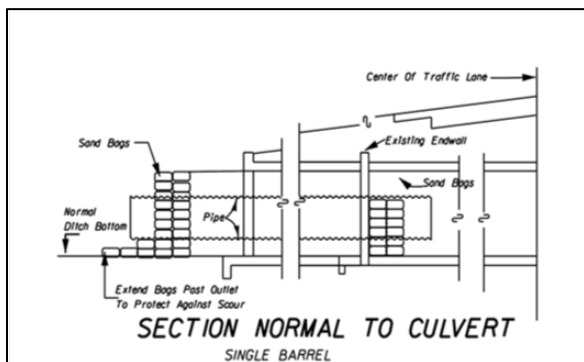

Figure 10.5-8: Section Normal to Culvert (Single Barrel)

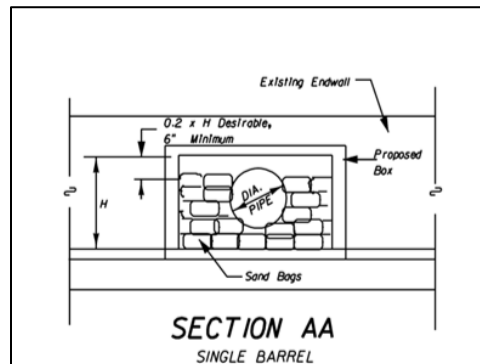

Figure 10.5-9: Section AA (Single Barrel)

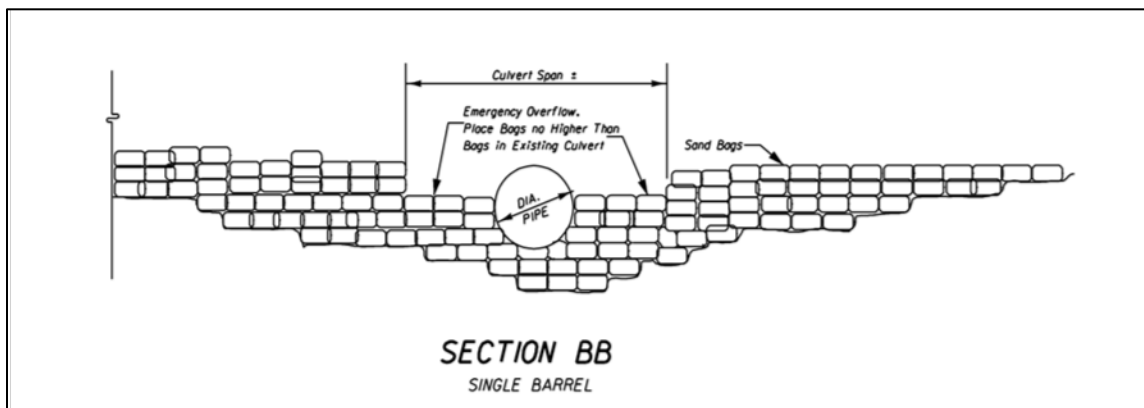

Figure 10.5-10: Section BB (Single Barrel)

APPENDIX

A. DATA COLLECTION/PUBLISHED DATA

TABLE OF CONTENTS

| | |
|--|------------|
| A. Data Collection/Published Data | A-1 |
| A.1 Data Collection | A-1 |
| A.2 Published Data | A-5 |
| A.2.1 Soils | A-5 |
| A.2.2 Land Use | A-5 |
| A.2.3 Precipitation | A-6 |
| A.2.4 Topography and Contour Information | A-7 |
| A.2.5 Streamflow and Flood History | A-7 |
| A.3 Field Investigations and Surveys | A-8 |
| A.3.1 Drainage Areas | A-8 |
| A.3.2 High-Water Information | A-9 |

A. DATA COLLECTION/PUBLISHED DATA

A.1 DATA COLLECTION

All of the information presented in this section may not be required to address the needs of each project.

Table A-1, below, lists examples of data, along with typical sources and uses, for three data categories, including:

- Completed or ongoing studies
- Natural resource base
- Manmade features

Drainage projects typically require numerous potential sources of data. Identifying these sources can be difficult and making the subsequent necessary contacts can be time-consuming. To assist in this process, Table A-1, below, includes typical data sources. In many cases, the local community or Water Management District in which the drainage project is being conducted is either the best source of data or the most logical starting point.

The primary use of drainage data is to quantify the hydrologic/hydraulic characteristics of the watershed to evaluate stormwater runoff discharge and volume. Quantification of watershed characteristics is a must for both existing and future conditions. Table A-1, below, presents examples of data uses.

Before initiating calculations, collect drainage data using the following general guidelines:

1. Identify data needs, sources, and uses, using Table A-1 as a checklist. Much of this information will have to be provided in the environmental document and supporting files.
2. Collect published data, based on sources identified in Step 1 and information presented in Section A.2.
3. Compile and document the results of Step 2, and compare data needs and uses with the availability of published data. Identify any additional field data needs.
4. Collect field data based on needs identified in Steps 1 and 3, using information presented in Section A.3.
5. Compile and document the results of Step 4.

Table A-1: Data Needs, Sources, and Uses

| Data Needs | Examples | Typical Sources | Examples of Uses |
|---------------------------------|-------------------------|--|--|
| 1. Completed or ongoing studies | Storm Master Plan | County, City, or Water Management District | Establish type and configuration of future stormwater control facilities |
| | 208 Plan | <ul style="list-style-type: none"> • U.S. Environmental Protection Agency • Regional Planning Agency | Delineate watersheds and subbasins |
| | SCS PI 566 Plan | U.S. Environmental Protection Agency | Establish flood flows, stages, and area of inundation on principle streams |
| | Flood Plain Information | U.S. Army Corps of Engineers | Establish flood flows, stages, and area of inundation on principle streams |
| | Special Studies | <ul style="list-style-type: none"> • City or County • U.S. Geological Survey • Regional Planning Agency | Varies with Study |
| | Flood Insurance Study | <ul style="list-style-type: none"> • U.S. Federal Emergency Management Agency/Department of Housing and Urban Development • City or County | Establish flood flows, stages, and area of inundation of principle streams |
| | Topographic Map | <ul style="list-style-type: none"> • U.S. Geological Survey • Regional Planning Agency • Water Management District • Field Survey • FL. Dept. of Environmental Protection | <ul style="list-style-type: none"> • Delineate watersheds and subbasins • Identity potential detention sites • Determine land slope |

Drainage Design Guide
Appendix A: Data Collection/Published Data

| Data Needs | Examples | Typical Sources | Examples of Uses |
|---------------------------------|---|---|---|
| <p>2. Natural Resource Base</p> | Soils | <ul style="list-style-type: none"> • U.S. Natural Resources Conservation Service • Construction Logs | <ul style="list-style-type: none"> • Determine the runoff coefficients, curve numbers, and other runoff factors |
| | Historic Inundation Areas and High Waters | <ul style="list-style-type: none"> • U.S. Geological Survey • City or County • Water Management District • Regional Planning Agency • News Media – Newspapers, Radio, T.V. • Museums, Historical Societies • Residents • Field Survey | <ul style="list-style-type: none"> • Evaluate erosion potential • Project construction condition |
| | Precipitation Intensity-Soils Duration-Frequency Data | <ul style="list-style-type: none"> • National Weather Service • Water Management District | <ul style="list-style-type: none"> • Document location and severity of historic inundation and other problems |
| | Historic Stage and Discharge | <ul style="list-style-type: none"> • National Weather Service • Water Management District | <ul style="list-style-type: none"> • Develop design storms • Assess severity of historic floods |
| <p>3. Manmade Features</p> | Stream Stage and Discharge | <ul style="list-style-type: none"> • U.S. Geological Survey • Water Management District | <ul style="list-style-type: none"> • Develop discharge-probability relationships • Assess severity of historic floods |
| | Existing Land Use Areas and High Waters | <ul style="list-style-type: none"> • Regional Planning Agency • Field Survey | <ul style="list-style-type: none"> • Determine runoff coefficients, curve numbers, and other factors |
| | Land Use Plan | <ul style="list-style-type: none"> • Regional Planning Agency • City or County | <ul style="list-style-type: none"> • Determine runoff coefficients, curve numbers, and other factors |
| | Zoning Map and Ordinance | City or County | <ul style="list-style-type: none"> • Project future land use |
| Subdivision Plats | City or County | <ul style="list-style-type: none"> • Project future land use • Established type and configuration of future stormwater control facilities | |

Drainage Design Guide
 Appendix A: Data Collection/Published Data

| Data Needs | Examples | Typical Sources | Examples of Uses |
|------------|---|--|--|
| | Agricultural and Other Land Management Measures | <ul style="list-style-type: none"> • U.S. Natural Resources Conversation Services • Regional Planning Agency • Field Survey | Determine runoff coefficients, curve numbers, and other factors |
| | Transportation, Sewage and Other Public Facility-Systems and Plans | <ul style="list-style-type: none"> • Regional Planning Agency • City or County • Department of Transportation | <ul style="list-style-type: none"> • Establish future watershed and sub-basin divides • Project future land use |
| | Stormwater Systems Maps, Plans, Profiles; As-Builts | <ul style="list-style-type: none"> • Regional Planning Agency • City or County | <ul style="list-style-type: none"> • Delineate existing/future watershed and sub-basin divides • Develop hydraulic characteristics |
| | Bridge, Culverts, Channels, and Other Hydraulic Structure As-Builts or Plans Subdivisions Plats | <ul style="list-style-type: none"> • Water Management District • Department of Transportation • Field Survey | <ul style="list-style-type: none"> • Delineate existing/future watershed and sub-basin divides • Develop hydraulic characteristics |
| | Land Ownership—Public vs. Private | City or County | Identify potential sites for detention and other facilities |

A.2 PUBLISHED DATA

Published data include soils, land use, precipitation, topography and contour, streamflow and flood history, and groundwater. A good basic reference for water resources data in Florida is the *Water Resources Atlas of Florida* (Florida State University, 1984). Of particular relevance to drainage projects are data on weather and climate, surface water, groundwater, water quality, drainage, flood control, navigation, and ecosystems.

A.2.1 Soils

Collect published soils data by following this procedure:

1. Identify soils data needed to evaluate runoff, soil erosion, slope and foundation stabilities, and hydraulic conductivity.
2. Obtain soils data from the U.S. Natural Resources Conservation Service (formerly the U.S. Soil Conservation Service [SCS]) in the form of detailed soils reports for the county area being considered. Old plans, construction logs, and soil boring results can provide additional site-specific data. Specific project information usually is available during the final design stage.

When a project involves a channel in which storm tide surge conditions may be expected to result in erosion of the channel, the geology in the area of the channel is important in analyzing the nature of the potential erosion enlargement. More detailed and extensive borings may be important, which would not be the case where channel stability is reasonably assured. You may need to make a preliminary assessment of the potential for enlargement to specify the extent of the geotechnical study required.

A.2.2 Land Use

Collect published land use data by following this procedure:

1. Determine historical land use from older land use maps or aerials.
2. Determine current land use from sources such as land use maps, aerial photographs, and field reconnaissance. Contact appropriate county and municipal governments. Regional Planning Councils and Water Management Districts also may have existing land use data. Compare historical (from Step 1) and current land use to identify areas undergoing rapid growth and an approximate rate of change. Establishing land use at the time of design can be crucial to project success.

3. Determine future land use based on projections of existing land use, land use plans, and site-specific layouts of proposed development, zoning maps, and discussions with public officials. County and municipal governments as well as Regional Planning Councils and Water Management Districts also may be good sources of future land use data.
4. Ascertain the existence of master drainage plans, stormwater management plans, and similar plans that may designate or restrict land use.

A.2.3 Precipitation

Collect published precipitation data by following this procedure:

1. Select an appropriate procedure for hydrologic calculations using information presented in this handbook.
2. Determine the type of precipitation data needed. Generally, either intensity-duration-frequency (IDF) curves or hyetographs for historic or design storm conditions are used.
3. Collect published precipitation data. The primary source is the National Weather Service. Additional data may be available from Water Management Districts. Sources of published precipitation data are briefly discussed below.

A series of publications by the National Weather Service (formerly the U.S. Weather Bureau) presents precipitation depth-duration-frequency data developed from observed precipitation data across the United States. *HYDRO-35*, by Frederick *et al.* (1977), is particularly useful for small drainage areas, since rainfall depths for durations of 5, 10, 15, 30, and 60 minutes are presented for return periods of 2, 5, 10, 25, 50, and 100 years. *Technical Paper No. 40*, by Hershfield (1961), commonly known as TP-40, is a standard reference for obtaining hydrologic design rainfall depths for durations of 30 minutes and one, 2, 3, 6, 12, or 24 hours, and for return periods of one, 2, 5, 10, 25, 50, and 100 years. *Technical Paper No. 49*, by Miller (1964), extends the depth-duration-frequency data presented by Hershfield (1961) to include rainfall depths for durations of 2, 4, 7, and 10 days at return periods of 2, 5, 10, 25, 50, and 100 years. The Department has developed rainfall curves based on these references.

Data for statistical rainfall depth and rainfall intensity for Florida is found in the National Oceanic and Atmospheric Administration's (NOAA's) [Hydrometeorological Design Studies Center](#).

A.2.4 Topography and Contour Information

Collect topographic data by using the following procedure:

1. Obtain published topographic data. The Florida Department of Environmental Protection (FDEP) may have contour information at one- or two-foot contours developed from LIDAR, Water Management Districts, and municipal or county government agencies. The U.S. Geological Survey (USGS) has maps with five-foot or 10-foot contour intervals, which often are not detailed enough for design.
2. If published data are either unavailable or inadequate for project needs, the Department can develop contours from aerial photographs for large-scale projects or by survey for small areas.

A.2.5 Streamflow and Flood History

Collect streamflow and flood history data by using the following procedure:

1. Obtain published data. The principal source of published streamflow data is the USGS. Additional sources include Water Management Districts and municipal or county government agencies.
2. Because published streamflow data may not be available for a specific project site, an evaluation of flood history may require researching news media sources, making field survey observations, and interviewing local residents and other knowledgeable persons.

Groundwater

Data on groundwater levels and movements can be obtained from information on existing detention ponds and other ponds in the area; existing non-pumping wells or wells that could be temporarily shut off to determine the static groundwater level; observations made by inspectors and others during construction of sanitary sewers, storm drains, and major buildings; and regional or area-wide reports prepared by the USGS or similar state agencies. If existing data sources are not sufficient to define the position of the groundwater table, it may be necessary to construct special observation wells, particularly at potential sites of detention facilities. These wells could be installed in the boreholes used to take soil samples during a site-specific subsurface exploration.

A.3 FIELD INVESTIGATIONS AND SURVEYS

A.3.1 Drainage Areas

If sufficient topographic information for a project site is readily available, a field determination of drainage area may not be necessary, but it is always advisable to spot-check selected control elevations. For those project sites for which detailed information is not available, perform field survey work. In all cases, a site visit is highly recommended to confirm drainage area conditions.

Depending on District preference, drainage areas may be outlined by field survey or drainage personnel on county maps, aerial photographs, USGS contour maps, or specially prepared maps. Drainage area boundaries should connect with the job centerline, typically at high points in grade or at other locations where there is a definite division in the direction of stormflow runoff. After the overall areas are plotted, the Drainage Engineer should subdivide the drainage area to show how the various sections contribute to the structures in the proposed drainage or storm drain system.

Follow all drainage area boundaries from the project centerline, around the area being covered, and close again at the centerline. There is no need to show ridges that do not drain to the project unless this information is pertinent to determine runoff concentration points or flow path segments. Clearly indicate by notation on the map all exceptions to the rule for closing all drainage area boundaries. These notes should show location and elevation of break-over or diversion to or from the drainage area.

Typically, a drainage area should close to each existing culvert along the project and for each probable cross drain location. As an exception, note flow distribution information where two or more structures operate together to drain a single area.

For municipal-type construction surveys, mark appropriate city maps or specially prepared maps to show the boundaries of total areas contributing to the project. Mark streets or other drainage facilities in these areas with flow arrows. In many instances, elevations may have to be determined to accurately delineate direction of flow in gutters.

Show all areas contributing to existing storm drains, which drain to or across the project. In very flat terrain, as is found in South Florida, it often is necessary to develop profiles for cross streets and parallel streets to make a definite determination of drainage areas. In flat terrain, consider collecting additional field data about agricultural ditches to confirm flow patterns.

Specially flown aerial photography is available for most new construction projects. Ridge lines usually can be indicated on the photographs. When using photographs, the field survey party should verify questionable points and supplement the information with structure sizes, elevations, and high water marks as required. Determine drainage areas by stereo interpretation with spot field survey work as appropriate.

A.3.2 High-Water Information

To evaluate flood elevations and establish roadway grades, you will need reliable high-water information. Show high-water elevation locations upstream of the proposed project, upstream of significant existing structures, and at some point along or at the end of outfall ditch surveys. Clearly record the location at which a high-water elevation is taken in the field notes, along with the date and time if available.

At many locations, it is not possible to obtain documented information on high water. In such cases, estimate elevation by observing natural growth or by other means; the survey crew should provide complete information on the methods used. The crew chief should attempt to obtain information from local residents, maintenance personnel (both state and county), and rural mail carriers, school bus drivers, police officers, and school board officials.

The soils crew usually supplies water table information within the right of way; however, the survey crew should note information pertaining to standing water, areas of heavy seepage, or springs within the basin area.

APPENDIX

B. HYDROLOGY DESIGN AIDS

TABLE OF CONTENTS

Tables

| | |
|---|------|
| Table B-1: Overland Flow Manning's n Values | B-1 |
| Table B-2: Manning's n Values for Street and Pavement Gutters | B-5 |
| Table B-3: Recommended Manning's n Values for Artificial Channels..... | B-6 |
| Table B-4: Runoff Coefficients for Storm Return Period ≤ 10 Years | B-7 |
| Table B-5: Design Storm Frequency Factors for Pervious Area Runoff Coefficients ... | B-8 |
| Table B-6: Definitions of Four SCS Hydrologic Soil Groups..... | B-9 |
| Table B-7: SCS Runoff Curve Numbers – Agricultural, Suburban, and Urban Land.. | B-10 |
| Table B-8: SCS Runoff Curve Numbers for Agricultural Use | B-11 |
| Table B-9: SCS Classifications of Vegetative Covers by Hydrologic Properties | B-12 |
| Table B-10: USGS Regression Equations – Natural Flow Conditions - Region 1 | B-13 |
| Table B-11: USGS Regression Equations – Natural Flow Conditions - Region 2 | B-15 |
| Table B-12: USGS Regression Equations – Natural Flow Conditions - Region 3 | B-16 |
| Table B-13: USGS Regression Equations – Natural Flow Conditions - Region 4 | B-17 |
| Table B-14: USGS Nationwide Regression Equations for Urban Conditions | B-18 |
| Table B-15: Urban Watershed Regression Equations for Tampa Bay Area..... | B-19 |
| Table B-16: Urban Watershed Regression Equations for Leon County, Florida | B-20 |
| Table B-17: USGS Watershed Regression Equations for West Central Florida..... | B-21 |
| Table B-18: USGS Watershed Regression Equations' Range of Applicability for West Central Florida | B-23 |

Figures

Figure B-1: Kinematic Wave Formula for Determining Overland Flow Travel TimeB-2
Figure B-2: Overland Flow Velocities for Various Land Use Types.....B-3
Figure B-3: Velocity versus slope for Shallow Concentrated FlowB-4
Figure B-4: Regions for USGS Regression Equations – Natural Flow ConditionsB-13
Figure B-5: Regions for USGS Regression Equations for Natural Flow Conditions in West
Central FloridaB-21

Table B-1: Overland Flow Manning's n Values

| | <u>Value</u> | <u>Recommended Range of Values</u> |
|---|--------------|--|
| Concrete | 0.011 | 0.010 - 0.013 |
| Asphalt | 0.012 | 0.010 - 0.015 |
| Bare sand ^a | 0.010 | 0.010 - 0.016 |
| Graveled surface ^a | 0.012 | 0.012 - 0.030 |
| Bare clay-loam (eroded) ^a | 0.012 | 0.012 - 0.033 |
| Fallow (no residue) ^b | 0.05 | 0.006 - 0.16 |
| Chisel plow (<1/4 tons/acre residue) | 0.07 | 0.006 - 0.17 |
| Chisel plow (1/4 - 1 tons/acre residue) | 0.18 | 0.070 - 0.34 |
| Chisel plow (1 - 3 tons/acre residue) | 0.30 | 0.190 - 0.47 |
| Chisel plow (>3 tons/acre residue) | 0.40 | 0.340 - 0.46 |
| Disk/Harrow (<1/4 tons/acre residue) | 0.08 | 0.008 - 0.41 |
| Disk/Harrow (1/4 - 1 tons/acre residue) | 0.16 | 0.100 - 0.25 |
| Disk/Harrow (1 - 3 tons/acre residue) | 0.25 | 0.140 - 0.53 |
| Disk/Harrow (>3 tons/acre residue) | 0.30 | -- -- |
| No till (<1/4 tons/acre residue) | 0.04 | 0.030 - 0.07 |
| No till (1/4 - 1 tons/acre residue) | 0.07 | 0.010 - 0.13 |
| No till (1 - 3 tons/acre residue) | 0.30 | 0.160 - 0.47 |
| Plow (Fall) | 0.06 | 0.020 - 0.10 |
| Coulter | 0.10 | 0.050 - 0.13 |
| Range (natural) | 0.13 | 0.010 - 0.32 |
| Range (clipped) | 0.08 | 0.020 - 0.24 |
| Grass (bluegrass sod) | 0.45 | 0.390 - 0.63 |
| Short grass prairie ^a | 0.15 | 0.100 - 0.20 |
| Dense grass ^c | 0.24 | 0.170 - 0.30 |
| Bermuda grass ^c | 0.41 | 0.300 - 0.48 |
| Woods | 0.45 | -- -- |

All values are from Engman (1983), unless noted otherwise.

^aWoolhiser (1975).

^bFallow has been idle for one year and is fairly smooth.

^cPalmer (1946). Weeping love grass, bluegrass, buffalo grass, blue gamma grass, native grass mix (OK), alfalfa, lespedeza.

Note: These values were determined specifically for overland flow conditions and are not appropriate for conventional open channel flow calculations. See Chapter 3, for open channel flow procedures.

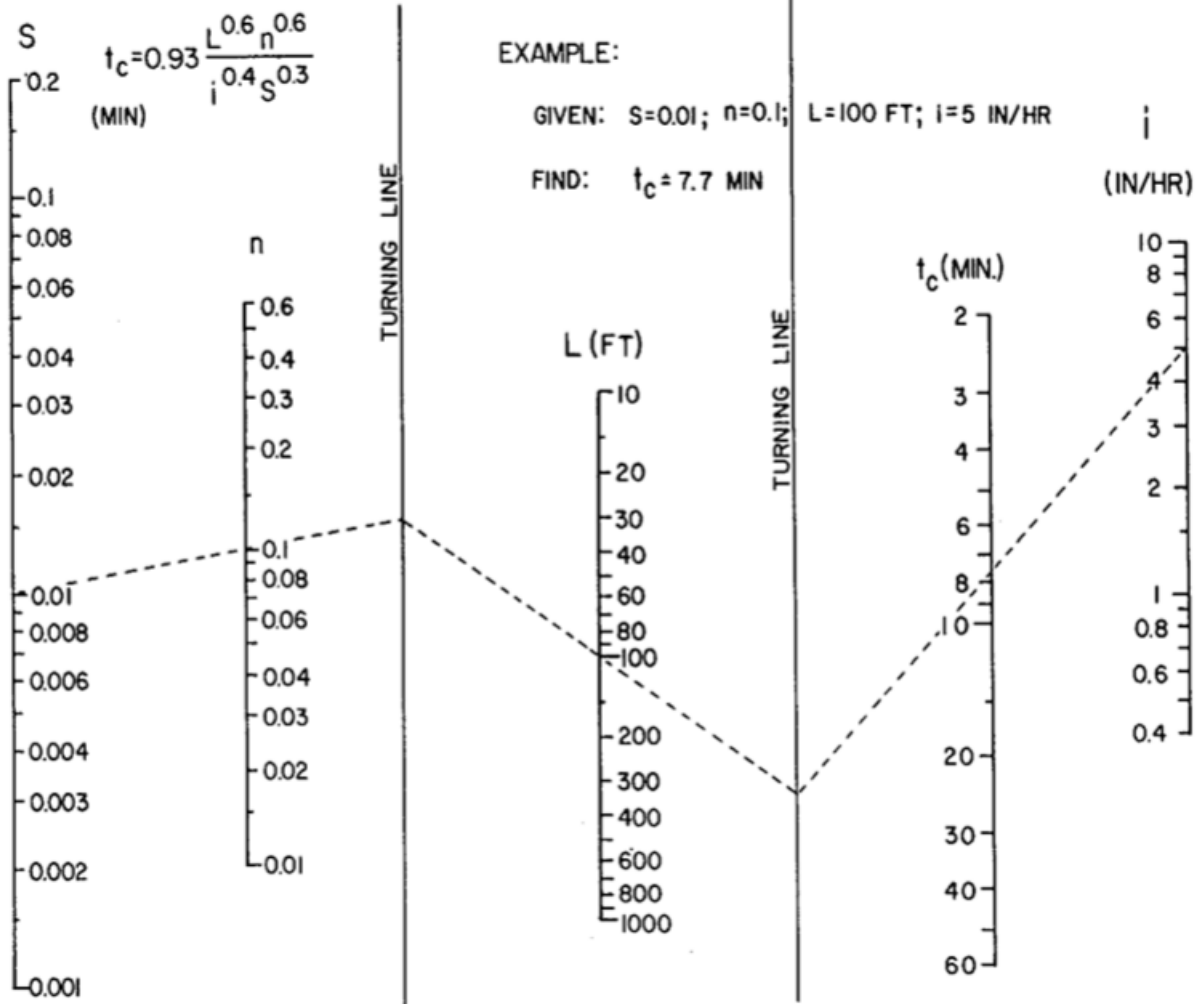

Figure B-1: Kinematic Wave Formula for Determining Overland Flow Travel Time

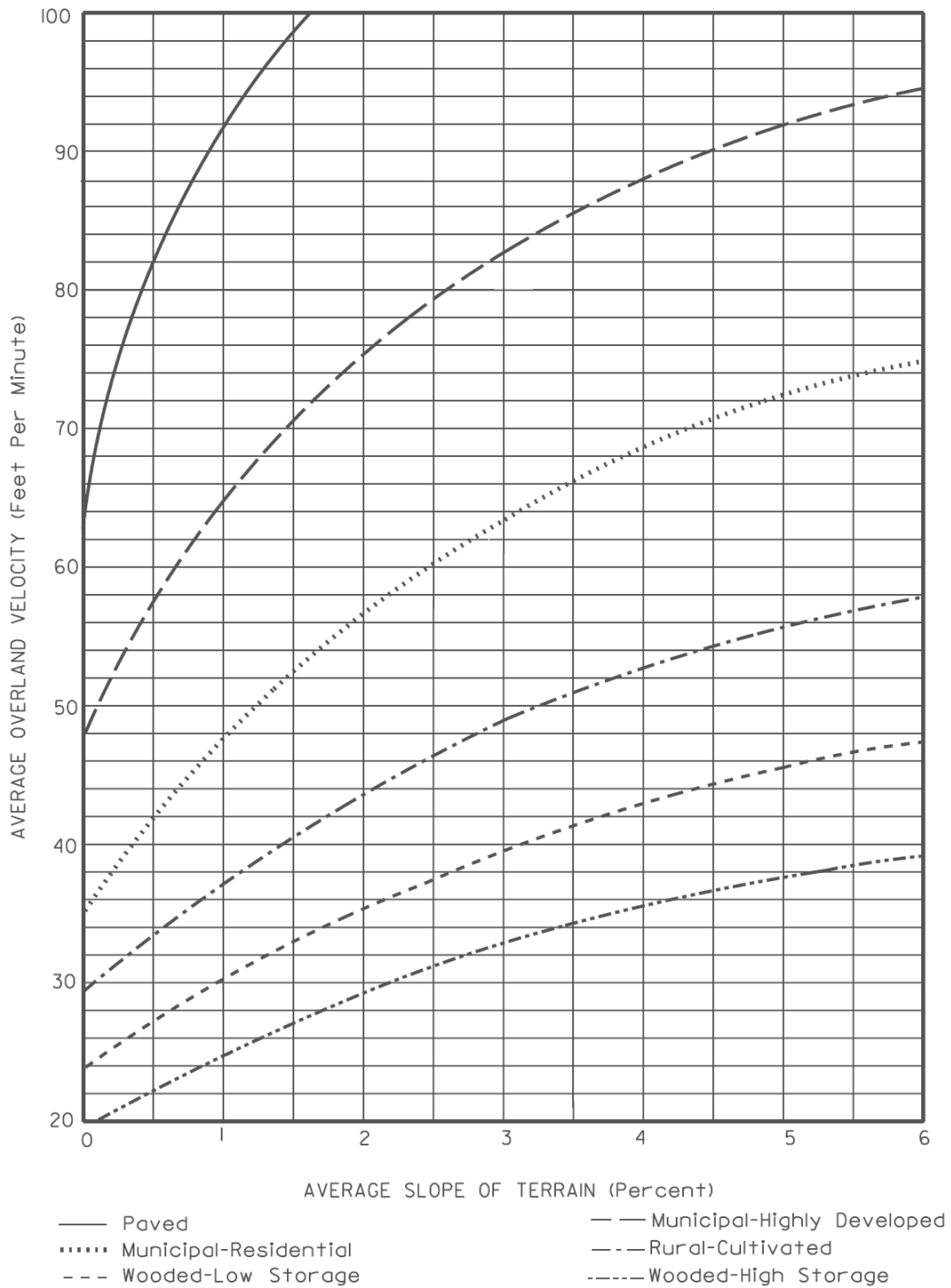
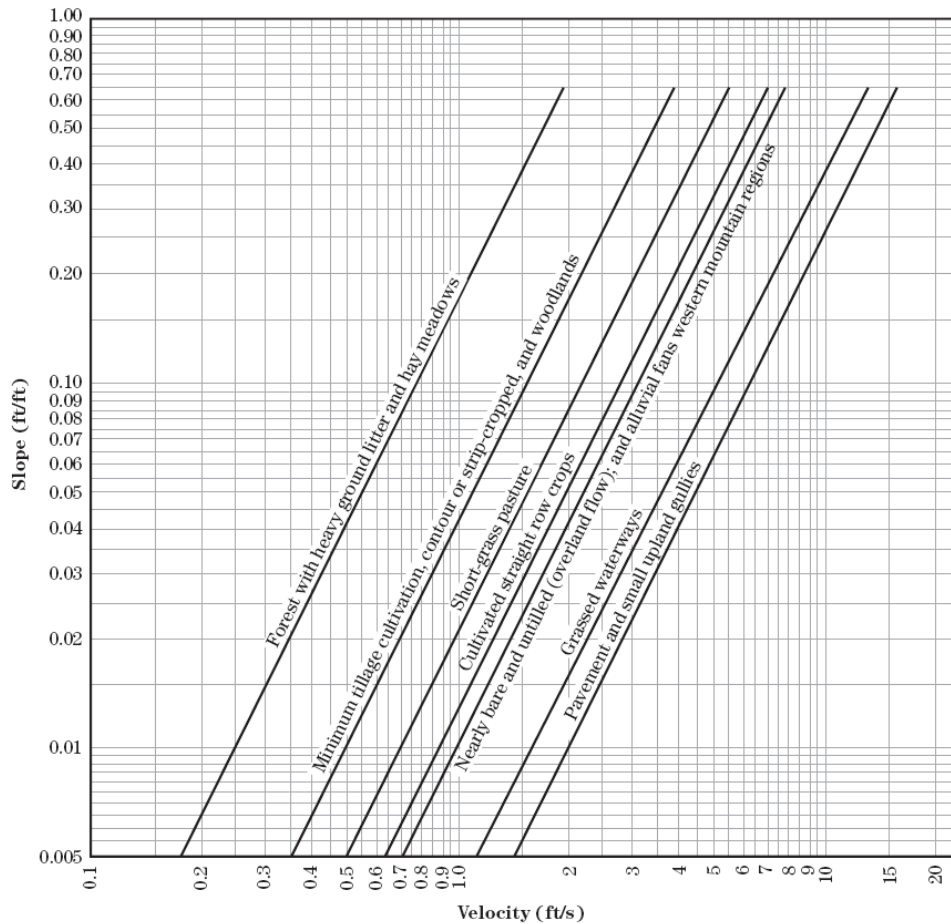

Figure B-2: Overland Flow Velocities for Various Land Use Types



Equations and assumptions from Figure B-3

| Flow type | Depth (ft) | Manning's <i>n</i> | Velocity equation (ft/s) |
|---|------------|--------------------|--------------------------|
| Pavement and small upland gullies | 0.2 | 0.025 | $V = 20.328(s)^{0.5}$ |
| Grassed waterways | 0.4 | 0.050 | $V = 16.135(s)^{0.5}$ |
| Nearly bare and untilled (overland flow); and alluvial fans in western mountain regions | 0.2 | 0.051 | $V = 9.965(s)^{0.5}$ |
| Cultivated straight row crops | 0.2 | 0.058 | $V = 8.762(s)^{0.5}$ |
| Short-grass pasture | 0.2 | 0.073 | $V = 6.962(s)^{0.5}$ |
| Minimum tillage cultivation, contour or strip-cropped, and woodlands | 0.2 | 0.101 | $V = 5.032(s)^{0.5}$ |
| Forest with heavy ground litter and hay meadows | 0.2 | 0.202 | $V = 2.516(s)^{0.5}$ |

Ref: Chapter 15, Part 630, National Engineering Handbook, May 2010

Figure B-3: Velocity versus slope for Shallow Concentrated Flow

Table B-2: Manning's n Values for Street and Pavement Gutters

| <u>Type of Gutter or Pavement</u> | <u>Range of Manning's n</u> |
|---|-----------------------------|
| Concrete gutter, troweled finish | 0.012 |
| Asphalt pavement: | |
| Smooth texture | 0.013 |
| Rough texture [2] | 0.016 |
| Concrete gutter with asphalt pavement: | |
| Smooth | 0.013 |
| Rough | 0.015 |
| Concrete pavement: | |
| Float finish | 0.014 |
| Broom finish [3] | 0.016 |
| For gutters with small slopes, where sediment may accumulate increase above values of n by | 0.002 |

Reference: FHWA HEC-22

Notes:

- 1) Estimates are by the Federal Highway Administration.
- 2) The Department's friction course is rough texture asphalt.
- 3) The Department's standard is brush (broom) finish for concrete curb.
[Specification Section 520]

Table B-3: Recommended Manning's n Values for Artificial Channels

| <u>Channel Lining</u> | <u>Lining Description</u> | <u>Design Manning's n Value</u> |
|---|-------------------------------------|---------------------------------|
| <u>Bare Earth or Vegetative Linings</u> | | |
| Bare earth, fairly uniform | Clean, recently completed | 0.022 |
| Bare earth, fairly uniform | Short grass and some weeds | 0.028 |
| Dragline excavated | No vegetation | 0.030 |
| Dragline excavated | Light brush | 0.040 |
| Channels not maintained | Dense weeds to flow depth | 0.100 |
| Channels not maintained | Clear bottom, brush sides | 0.080 |
| Maintained grass or sodded ditches | Good stand, well maintained 2" - 6" | 0.060* |
| Maintained grass or sodded ditches | Fair stand, length 12" - 24" | 0.200* |
| <u>Rigid Linings</u> | | |
| Concrete paved | Broomed** | 0.016 |
| Concrete paved | "Roughened" - standard | 0.020 |
| Concrete paved | Gunite | 0.020 |
| Concrete paved | Over rubble | 0.023 |
| Asphalt concrete | Smooth | 0.013 |
| Asphalt concrete | Rough | 0.016 |

* Decrease 30% for flows > 0.7' (maximum flow depth 1.5').

** Because this is not the standard finish, it must be specified.

Table B-4: Runoff Coefficients for Storm Return Period \leq 10 Years ^a

| Slope | Land Use | Sandy Soils | | Clay Soils | |
|---------------------------|--|-------------|------|------------|------|
| | | Min. | Max. | Min. | Max. |
| Flat (0-2%) | Woodlands | 0.10 | 0.15 | 0.15 | 0.20 |
| | Pasture, grass, and farmland ^b | 0.15 | 0.20 | 0.20 | 0.25 |
| | Bare Earth | 0.30 | 0.50 | 0.50 | 0.60 |
| | Rooftops and pavement | 0.95 | 0.95 | 0.95 | 0.95 |
| | Pervious pavements ^c | 0.75 | 0.95 | 0.90 | 0.95 |
| | SFR: 1/2-acre lots and larger | 0.30 | 0.35 | 0.35 | 0.45 |
| | Smaller lots | 0.35 | 0.45 | 0.40 | 0.50 |
| | Duplexes | 0.35 | 0.45 | 0.40 | 0.50 |
| | MFR: Apartments, townhouses, and condominiums | 0.45 | 0.60 | 0.50 | 0.70 |
| Commercial and Industrial | 0.50 | 0.95 | 0.50 | 0.95 | |
| Rolling (2-7%) | Woodlands | 0.15 | 0.20 | 0.20 | 0.25 |
| | Pasture, grass, and farmland ^b | 0.20 | 0.25 | 0.25 | 0.30 |
| | Bare Earth | 0.40 | 0.60 | 0.60 | 0.70 |
| | Rooftops and pavement | 0.95 | 0.95 | 0.95 | 0.95 |
| | Pervious pavements ^c | 0.80 | 0.95 | 0.90 | 0.95 |
| | SFR: 1/2-acre lots and larger | 0.35 | 0.50 | 0.40 | 0.55 |
| | Smaller lots | 0.40 | 0.55 | 0.45 | 0.60 |
| | Duplexes | 0.40 | 0.55 | 0.45 | 0.60 |
| | MFR: Apartments, townhouses, and condominiums | 0.50 | 0.70 | 0.60 | 0.80 |
| Commercial and Industrial | 0.50 | 0.95 | 0.50 | 0.95 | |
| Steep (7%+) | Woodlands | 0.20 | 0.25 | 0.25 | 0.30 |
| | Pasture, grass, and farmland ^b | 0.25 | 0.35 | 0.30 | 0.40 |
| | Bare Earth | 0.50 | 0.70 | 0.70 | 0.80 |
| | Rooftops and pavement | 0.95 | 0.95 | 0.95 | 0.95 |
| | Pervious pavements ^c | 0.85 | 0.95 | 0.90 | 0.95 |
| | SFR: 1/2-acre lots and larger | 0.40 | 0.55 | 0.50 | 0.65 |
| | Smaller lots | 0.45 | 0.60 | 0.55 | 0.70 |
| | Duplexes | 0.45 | 0.60 | 0.55 | 0.70 |
| | MFR: Apartments, townhouses, and condominiums | 0.60 | 0.75 | 0.65 | 0.85 |
| Commercial and Industrial | 0.60 | 0.95 | 0.65 | 0.95 | |

^a Weighted coefficient based on percentage of impervious surfaces and green areas must be selected for each site.

^b Coefficients assume good ground cover and conservation treatment.

^c Depends on depth and degree of permeability of underlying strata.

Note: SFR = Single Family Residential
MFR = Multi-Family Residential

Table B-5: Design Storm Frequency Factors for Pervious Area Runoff Coefficients*

| <u>Return Period (years)</u> | <u>Design Storm Frequency Factor, X_T</u> |
|------------------------------|--|
| 2 to 10 | 1.0 |
| 25 | 1.1 |
| 50 | 1.2 |
| 100 | 1.25 |

Reference: Wright-McLaughlin Engineers (1969).

* DUE TO THE INCREASE IN THE DURATION TIME THAT THE PEAK OR NEAR PEAK DISCHARGE RATE IS RELEASED FROM STORMWATER MANAGEMENT SYSTEMS, THE USE OF THESE SHORT DURATION PEAK RATE DISCHARGE ADJUSTMENT FACTORS IS NOT APPROPRIATE FOR FLOOD ROUTING COMPUTATIONS.

Table B-6: Definitions of Four SCS Hydrologic Soil Groups

| <u>Hydrologic Soil Group</u> | <u>Definition</u> |
|------------------------------|--|
| A | <p><u>Low Runoff Potential</u> Soils having high infiltration rates even when thoroughly wetted, consisting chiefly of deep, well-to-excessively-drained sands or gravels. These soils have a high rate of water transmission.</p> |
| B | <p><u>Moderately Low Runoff Potential</u> Soils having moderate infiltration rates when thoroughly wetted and consisting chiefly of moderately deep, to deep, moderately fine to moderately coarse textures. These soils have a moderate rate of water transmission.</p> |
| C | <p><u>Moderately High Runoff Potential</u> Soils having slow infiltration rates when thoroughly wetted and consisting chiefly of soils with a layer that impedes downward movement of water, soils with moderate fine to fine texture, or soils with moderate water tables. These soils have a slow rate of water transmission.</p> |
| D | <p><u>High Runoff Potential</u> Soils having very slow infiltration rates when thoroughly wetted and consisting chiefly of clay soils with high swelling potential, soils with a permanent high water table, soils with a clay pan or clay layer at or near the surface, and shallow soils over nearly impervious material. These soils have a very slow rate of water transmission.</p> |

Reference: USDA, SCS, NEH-4 (1972).

Table B-7: SCS Runoff Curve Numbers – Agricultural, Suburban, and Urban Land

| Land Use Description | Hydrologic Soil Group | | | |
|---|-----------------------|----|----|----|
| | A | B | C | D |
| Cultivated Land ^a : | | | | |
| Without conservation treatment | 72 | 81 | 88 | 91 |
| With conservation treatment | 62 | 71 | 78 | 81 |
| Pasture or range land: | | | | |
| Poor condition | 68 | 79 | 86 | 89 |
| Good condition | 39 | 61 | 74 | 80 |
| Meadow: good condition | 30 | 58 | 71 | 78 |
| Wood or Forest Land: | | | | |
| Thin stand, poor cover, no mulch | 45 | 66 | 77 | 83 |
| Good cover ^b | 25 | 55 | 70 | 77 |
| Open Spaces, Lawns, Parks, Golf Courses, Cemeteries: | | | | |
| Good condition: grass cover on 75% or more of the area | 39 | 61 | 74 | 80 |
| Fair condition: grass cover on 50% to 75% of the area | 49 | 69 | 79 | 84 |
| Poor condition: grass cover on 50% or less of the area | 68 | 79 | 86 | 89 |
| Commercial and Business Areas (85% impervious ^d) | 89 | 92 | 94 | 95 |
| Industrial Districts (72% impervious ^d) | 81 | 88 | 91 | 93 |
| Residential ^c | | | | |
| Average lot size Average % Impervious ^d | | | | |
| 1/8 acre or less 65 | 77 | 85 | 90 | 92 |
| 1/4 acre 38 | 61 | 75 | 83 | 87 |
| 1/3 acre 30 | 57 | 72 | 81 | 86 |
| 1/2 acre 25 | 54 | 70 | 80 | 85 |
| 1 acre 20 | 51 | 68 | 79 | 84 |
| Paved Parking Lots, Roofs, Driveways ^e : | 98 | 98 | 98 | 98 |
| Streets and Roads: | | | | |
| Paved with curbs and storm sewers ^e | 98 | 98 | 98 | 98 |
| Gravel | 76 | 85 | 89 | 91 |
| Dirt | 72 | 82 | 87 | 89 |
| Paved with open ditches | 83 | 89 | 92 | 93 |
| Newly graded area (no vegetation established) ^f | 77 | 86 | 91 | 94 |

^a For a more detailed description of agricultural land use curve numbers, refer to Table B-8.

^b Good cover is protected from grazing and litter and brush cover soil.

^c Curve numbers are computed assuming the runoff from the house and driveway is directed toward the street with a minimum of roof water directed to lawns where additional infiltration could occur, which depends on the depth and degree of the permeability of the underlying strata.

^d The percent impervious is presumed to be directly connected impervious area (DCIA). The remaining pervious areas (lawn) are considered to be in good pasture condition for these curve numbers. Reference TR-55 from USDA SCS Urban Hydrology Manual Figure 2-3 if the DCIA differs from the average percent used in this CN table, and Figure 2-4 if the impervious area is not directly connected to develop site specific CN for the project.

^e In some warmer climates of the country, a curve number of 96 may be used.

^f Use for temporary conditions during grading and construction.

Note: These values are for Antecedent Moisture Condition II, and $I_a = 0.2S$.

Reference: USDA, SCS, TR-55 (1984).

Table B-8: SCS Runoff Curve Numbers for Agricultural Use

| <u>Land Use</u> | <u>Treatment or Practice</u> | <u>Hydrologic Condition</u> | <u>Hydrologic Soil Group</u> | | | |
|---|------------------------------|-----------------------------|------------------------------|----------|----------|----------|
| | | | <u>A</u> | <u>B</u> | <u>C</u> | <u>D</u> |
| Fallow | Straight row | ---- | 77 | 86 | 91 | 94 |
| Row Crops | Straight row | Poor | 72 | 81 | 88 | 91 |
| | Straight row | Good | 67 | 78 | 85 | 89 |
| | Contoured | Poor | 70 | 79 | 84 | 88 |
| | Contoured | Good | 65 | 75 | 82 | 86 |
| | and terraced and terraced | Poor Good | 66 62 | 74 71 | 80 78 | 82 81 |
| Small grain | Straight row | Poor | 65 | 76 | 84 | 88 |
| | Straight row | Good | 63 | 75 | 83 | 87 |
| | Contoured | Poor | 63 | 74 | 82 | 85 |
| | Contoured | Good | 61 | 73 | 81 | 84 |
| | Contoured | Good | 55 | 69 | 78 | 83 |
| | and terraced and terraced | Poor Good | 61 59 | 72 70 | 79 78 | 82 81 |
| Close seeded legumes ^a or rotation meadow | Straight row | Poor | 66 | 77 | 85 | 89 |
| | Straight row | Good | 58 | 72 | 81 | 85 |
| | Contoured | Poor | 64 | 75 | 83 | 85 |
| | Contoured | Good | 55 | 69 | 78 | 83 |
| | and terraced and terraced | Poor Good | 63 51 | 73 67 | 80 76 | 83 80 |
| Pasture or range | | Poor | 68 | 79 | 86 | 89 |
| | | Fair | 49 | 69 | 79 | 84 |
| | | Good | 39 | 61 | 74 | 80 |
| | Contoured | Poor | 47 | 67 | 81 | 88 |
| | Contoured | Fair | 25 | 59 | 75 | 83 |
| | Contoured | Good | 6 | 35 | 70 | 79 |
| Meadow | | Good | 30 | 58 | 71 | 78 |
| Woods | | Poor | 45 | 66 | 77 | 83 |
| | | Fair | 36 | 60 | 73 | 79 |
| | | Good | 25 | 55 | 70 | 77 |
| Farmsteads | | ---- | 59 | 74 | 82 | 86 |
| Road (dirt) ^b | | ---- | 72 | 82 | 87 | 89 |
| (hard surface) ^b | | ---- | 74 | 84 | 90 | 92 |

^a Closed-drilled or broadcast.^b Including right-of-way.Note: These values are for Antecedent Moisture Condition II, and $I_a = 0.2S$.

Reference: USDA, SCS, NEH-4 (1972)

Table B-9: SCS Classifications of Vegetative Covers by Hydrologic Properties

| <u>Vegetative Cover</u> | | <u>Hydrologic Condition</u> |
|-------------------------|-------|--|
| Crop rotation | Poor: | Contains a high proportion of row crops, small grain, and fallow. |
| | Good: | Contains a high proportion of alfalfa and grasses. |
| Native pasture or range | Poor: | Heavily grazed or having plant cover on less range than 50% of the area. |
| | Fair: | Moderately grazed; 50 - 75% plant cover. |
| | Good: | Lightly grazed; more than 75% plant cover. |
| | | Permanent Meadow: 100% plant cover. |
| Woodlands | Poor: | Heavily grazed or regularly burned so that litter, small trees, and brush are destroyed. |
| | Fair: | Grazed but not burned; there may be some litter. |
| | Good: | Protected from grazing so that litter and shrubs cover the soil. |

Reference: USDA, SCS, NEH-4 (1972).

Drainage Design Guide
Appendix B: Hydrology Design Aids



Figure B-4: Regions for USGS Regression Equations – Natural Flow Conditions

Table B-10: USGS Regression Equations – Natural Flow Conditions - Region 1

| <u>Peak Runoff Equation</u> | | Standard Error of Prediction (%) |
|-----------------------------|------------------------------------|----------------------------------|
| Q_2 | $= 127 A^{0.656} (ST+1)^{-0.098}$ | 43 |
| Q_5 | $= 248 A^{0.662} (ST+1)^{-0.189}$ | 40 |
| Q_{10} | $= 357 A^{0.666} (ST+1)^{-0.239}$ | 42 |
| Q_{25} | $= 528 A^{0.671} (ST+1)^{-0.293}$ | 47 |
| Q_{50} | $= 684 A^{0.675} (ST+1)^{-0.328}$ | 52 |
| Q_{100} | $= 864 A^{0.679} (ST+1)^{-0.362}$ | 57 |
| Q_{200} | $= 1072 A^{0.683} (ST+1)^{-0.392}$ | 62 |
| Q_{500} | $= 1395 A^{0.688} (ST+1)^{-0.430}$ | 70 |

Q_T = Peak runoff rate for return period of T-years, in cfs

A = Drainage area, in miles²

ST = Basin storage, the percentage of the drainage basin occupied by lakes, reservoirs, swamps, and wetland. In-channel storage of a temporary nature, resulting from detention ponds or roadway embankments, is not included in the computation of ST

Basin Characteristic

Range of Applicability

Drainage Area (A)
Storage Area (ST)

0.14 miles² (89.6 acres) to 4,385 miles²
0% to 44.29%

Reference: Verdi (2006)

See Figure B-4 for region delineation.

Table B-11: USGS Regression Equations – Natural Flow Conditions - Region 2

| <u>Peak Runoff Equation</u> | <u>Standard Error of Prediction (%)</u> |
|---|---|
| $Q_2 = 101 A^{0.617} (ST+1)^{-0.211}$ | 58 |
| $Q_5 = 184 A^{0.620} (ST+1)^{-0.212}$ | 53 |
| $Q_{10} = 253 A^{0.621} (ST+1)^{-0.215}$ | 52 |
| $Q_{25} = 353 A^{0.621} (ST+1)^{-0.221}$ | 53 |
| $Q_{50} = 435 A^{0.621} (ST+1)^{-0.226}$ | 54 |
| $Q_{100} = 525 A^{0.621} (ST+1)^{-0.231}$ | 56 |
| $Q_{200} = 622 A^{0.621} (ST+1)^{-0.236}$ | 59 |
| $Q_{500} = 764 A^{0.620} (ST+1)^{-0.244}$ | 63 |

Q_T = Peak runoff rate for return period of T-years, in cfs

A = Drainage area, in miles²

ST = Basin storage, the percentage of the drainage basin occupied by lakes, reservoirs, swamps, and wetland. In-channel storage of a temporary nature, resulting from detention ponds or roadway embankments, is not included in the computation of ST

Basin Characteristic

Range of Applicability

Drainage Area (A)

0.06 miles² (38.4 acres) to 2,647 miles²

Storage Area (ST)

0% to 74.33%

Reference: Verdi (2006)

See Figure B-4 for region delineation.

Table B-12: USGS Regression Equations – Natural Flow Conditions - Region 3

| <u>Peak Runoff Equation</u> | <u>Standard Error of Prediction (%)</u> |
|--|---|
| $Q_2 = 72.7 A^{0.741} (ST+1)^{-0.589}$ | 87 |
| $Q_5 = 164 A^{0.704} (ST+1)^{-0.587}$ | 62 |
| $Q_{10} = 250 A^{0.686} (ST+1)^{-0.592}$ | 56 |
| $Q_{25} = 390 A^{0.668} (ST+1)^{-0.601}$ | 53 |
| $Q_{50} = 517 A^{0.656} (ST+1)^{-0.608}$ | 53 |
| $Q_{100} = 664 A^{0.646} (ST+1)^{-0.616}$ | 54 |
| $Q_{200} = 833 A^{0.638} (ST+1)^{-0.625}$ | 56 |
| $Q_{500} = 1094 A^{0.629} (ST+1)^{-0.638}$ | 59 |

Q_T = Peak runoff rate for return period of T-years, in cfs

A = Drainage area, in miles²

ST = Basin storage, the percentage of the drainage basin occupied by lakes, reservoirs, swamps, and wetland. In-channel storage of a temporary nature, resulting from detention ponds or roadway embankments, is not included in the computation of ST

Basin Characteristic

Range of Applicability

Drainage Area (A)

0.41 miles² (262.4 acres) to 3,244 miles²

Storage Area (ST)

0.18% to 48.04%

Reference: Verdi (2006)

See Figure B-4 for region delineation.

Table B-13: USGS Regression Equations – Natural Flow Conditions - Region 4

| <u>Peak Runoff Equation</u> | <u>Standard Error of Prediction (%)</u> |
|--|---|
| $Q_2 = 171 A^{0.628} (ST+1)^{-0.401}$ | 36 |
| $Q_5 = 321 A^{0.618} (ST+1)^{-0.395}$ | 39 |
| $Q_{10} = 447 A^{0.614} (ST+1)^{-0.396}$ | 43 |
| $Q_{25} = 636 A^{0.610} (ST+1)^{-0.401}$ | 48 |
| $Q_{50} = 797 A^{0.609} (ST+1)^{-0.406}$ | 53 |
| $Q_{100} = 975 A^{0.608} (ST+1)^{-0.411}$ | 57 |
| $Q_{200} = 1171 A^{0.608} (ST+1)^{-0.416}$ | 62 |
| $Q_{500} = 1461 A^{0.609} (ST+1)^{-0.424}$ | 69 |

Q_T = Peak runoff rate for return period of T-years, in cfs

A = Drainage area, in miles²

ST = Basin storage, the percentage of the drainage basin occupied by lakes, reservoirs, swamps, and wetland. In-channel storage of a temporary nature, resulting from detention ponds or roadway embankments, is not included in the computation of ST

Basin Characteristic

Range of Applicability

Drainage Area (A)
Storage Area (ST)

0.20 miles² (120 acres) to 2,833 miles²
0% to 34.12%

Reference: Verdi (2006)

See Figure B-4 for region delineation.

Table B-14: USGS Nationwide Regression Equations for Urban Conditions

| Peak Runoff Equation | R^2 | Standard Error (%) |
|--|-------|--------------------|
| $UQ_2 = 2.35A^{0.41} SL^{0.17} (i_2 + 3)^{2.04} (ST + 8)^{-0.65} (13 - BDF)^{-0.32} IA^{0.15} RQ_2^{0.47}$ | 0.93 | 38 |
| $UQ_5 = 2.70A^{0.35} SL^{0.16} (i_2 + 3)^{1.86} (ST + 8)^{-0.59} (13 - BDF)^{-0.31} IA^{0.11} RQ_5^{0.54}$ | 0.93 | 37 |
| $UQ_{10} = 2.99A^{0.32} SL^{0.15} (i_2 + 3)^{1.75} (ST + 8)^{-0.57} (13 - BDF)^{-0.30} IA^{0.09} RQ_{10}^{0.58}$ | 0.93 | 38 |
| $UQ_{25} = 2.78A^{0.31} SL^{0.15} (i_2 + 3)^{1.76} (ST + 8)^{-0.55} (13 - BDF)^{-0.29} IA^{0.07} RQ_{25}^{0.60}$ | 0.93 | 40 |
| $UQ_{50} = 2.67A^{0.29} SL^{0.15} (i_2 + 3)^{1.74} (ST + 8)^{-0.53} (13 - BDF)^{-0.28} IA^{0.06} RQ_{50}^{0.62}$ | 0.92 | 42 |
| $UQ_{100} = 2.50A^{0.29} SL^{0.15} (i_2 + 3)^{1.76} (ST + 8)^{-0.52} (13 - BDF)^{-0.28} IA^{0.06} RQ_{100}^{0.63}$ | 0.92 | 44 |
| $UQ_{500} = 2.27A^{0.29} SL^{0.16} (i_2 + 3)^{1.86} (ST + 8)^{-0.54} (13 - BDF)^{-0.27} IA^{0.05} RQ_{500}^{0.63}$ | 0.90 | 49 |

UQ_T = Peak discharge, in cfs, for the urban watershed for recurrence interval T.

SL = Main channel slope, in ft/mile, measured between points which are 10 and 85 percent of the main channel length upstream from the study site. For sites where SL is greater than 70 ft/mile, 70 ft/mile is used in the equations.

A = Contributing drainage area, in miles².

i_2 = Rainfall intensity, in inches, for the 2-hour 2-year occurrence.

ST = Basin storage, the percentage of the drainage basin occupied by lakes, reservoirs, swamps, and wetland. In-channel storage of a temporary nature, resulting from detention ponds or roadway embankments, is not included in the computation of ST.

BDF = Basin development factor, an index of the prevalence of the drainage aspects of (a) storm sewers, (b) channel improvements, (c) impervious channel linings, and (d) curb and gutter streets. The range of BDF is 0-12. A value of zero for BDF indicates the above drainage aspects are not prevalent, but does not necessarily mean the basin is non-urban. A value of 12 indicates full development of the drainage aspects throughout aspects throughout the basin. See Chapter 2, Section 2.2.3 & Example 2.2-2 of this document for details of computing BDF.

IA = Percentage of the drainage basin occupied by impervious surfaces, such as houses, buildings, streets, and parking lots.

RQ_T = Peak discharge, in cfs, for an equivalent rural drainage basin in the same hydrologic area as the urban basin, and for recurrence interval T.

Reference: Sauer et al. (1983).

Table B-15: Urban Watershed Regression Equations for Tampa Bay Area

| d | | | | Standar |
|----------------------|---|---|----------------|------------|
| Peak Runoff Equation | | | R ² | Error in % |
| Q ₂ | = | 3.72 A ^{1.07} BDF ^{1.05} SL ^{0.77} (DTENA + 0.01) ^{-0.11} | 0.92 | 33 |
| Q ₅ | = | 7.94 A ^{1.03} BDF ^{0.87} SL ^{0.81} (DTENA + 0.01) ^{-0.10} | 0.90 | 32 |
| Q ₁₀ | = | 12.9 A ^{1.04} BDF ^{0.75} SL ^{0.83} (DTENA + 0.01) ^{-0.10} | 0.88 | 35 |
| Q ₂₅ | = | 214 A ^{1.13} (13 - BDF) ^{-0.59} SL ^{0.73} | 0.85 | 37 |
| Q ₅₀ | = | 245 A ^{1.14} (13 - BDF) ^{-0.55} SL ^{0.74} | 0.83 | 39 |
| Q ₁₀₀ | = | 282 A ^{0.918} (13- BDF) ^{-0.51} SL ^{0.76} | 0.83 | 42 |

Q_T = Peak runoff rate for return period of T-years, in cfs

A = Drainage area, in miles²

BDF = Basin development factor, dimensionless; see Example 2.2-2 and the discussion on Nationwide Regression Equations in Chapter 2, Section 2.2.3 of this document.

SL = Channel slope, in ft/mile, measured between points at 10 and 85 percent of the distance from the design point to the watershed boundary.

DTENA = Surface area of lakes, ponds, and detention and retention basins, expressed as a percentage of drainage area.

| Watershed Characteristic | Range of Applicability |
|---|--|
| Drainage Area | 0.34 miles ² (220 acres) to 3.45 miles ² |
| Noncontributing internal drainage | 0 to 0.3 percent of watershed area |
| Soil-infiltration index | 2.05 to 3.89 inches |
| Total impervious area | 19 to 61 percent of watershed area |
| Hydraulically connected impervious area | 5.5 to 53 percent of watershed area |
| Effective impervious area | 5.5 to 40 percent of watershed area |
| Channel slope | 4.6 to 23.6 ft/mile |
| Lake and detention basin area | 0 to 3.5 percent of watershed area |
| Basin development factor | 3 to 12 (dimensionless) |

Reference: Lopez and Woodham (1983).

Table B-16: Urban Watershed Regression Equations for Leon County, Florida

| <u>Peak Runoff Equation</u> | | <u>R²</u> | <u>Standard Error in %</u> |
|--------------------------------------|--|----------------------|----------------------------|
| <u>Outside Lake Lafayette Basin</u> | <u>Inside Lake Lafayette Basin</u> | | |
| $Q_2 = 10.7 A^{0.766} IA^{1.07}$ | $Q_2 (LL) = 1.71 A^{0.766} IA^{1.07}$ | 0.99 | 18 |
| $Q_5 = 24.5 A^{0.770} IA^{0.943}$ | $Q_5 (LL) = 4.51 A^{0.770} IA^{0.943}$ | 0.98 | 18 |
| $Q_{10} = 39.1 A^{0.776} IA^{0.867}$ | $Q_{10} (LL) = 7.98 A^{0.776} IA^{0.867}$ | 0.98 | 20 |
| $Q_{25} = 63.2 A^{0.787} IA^{0.791}$ | $Q_{25} (LL) = 14.6 A^{0.787} IA^{0.791}$ | 0.98 | 22 |
| $Q_{50} = 88.0 A^{0.797} IA^{0.736}$ | $Q_{50} (LL) = 22.1 A^{0.797} IA^{0.736}$ | 0.97 | 24 |
| $Q_{100} = 118 A^{0.808} IA^{0.687}$ | $Q_{100} (LL) = 32.4 A^{0.808} IA^{0.687}$ | 0.97 | 25 |
| $Q_{500} = 218 A^{0.834} IA^{0.589}$ | $Q_{500} (LL) = 71.7 A^{0.834} IA^{0.589}$ | 0.97 | 30 |

- Q_T = Peak runoff rate outside Lake Lafayette Basin for return period T, in cfs.
- A = Drainage area, in miles²
- IA = Impervious area, in percentage of drainage area.
- $Q_T (LL)$ = Peak runoff rate inside Lake Lafayette Basin for return period T, in cfs.

Watershed Characteristic

Range of Applicability

| | |
|--|--|
| Drainage Area | 0.26 miles ² (166 acres) to 15.9 miles ² |
| Impervious area | 5.8 to 54 % |
| Channel slope | 11.9 to 128 ft/mile |
| Basin development factor | 0 to 8 (dimensionless) |
| Main Channel Length | 0.58 to 6.50 miles |
| Storage (area of ponds, lakes, swamps) | 0 to 4.26 percent |

Reference: Franklin and Losey (1984).

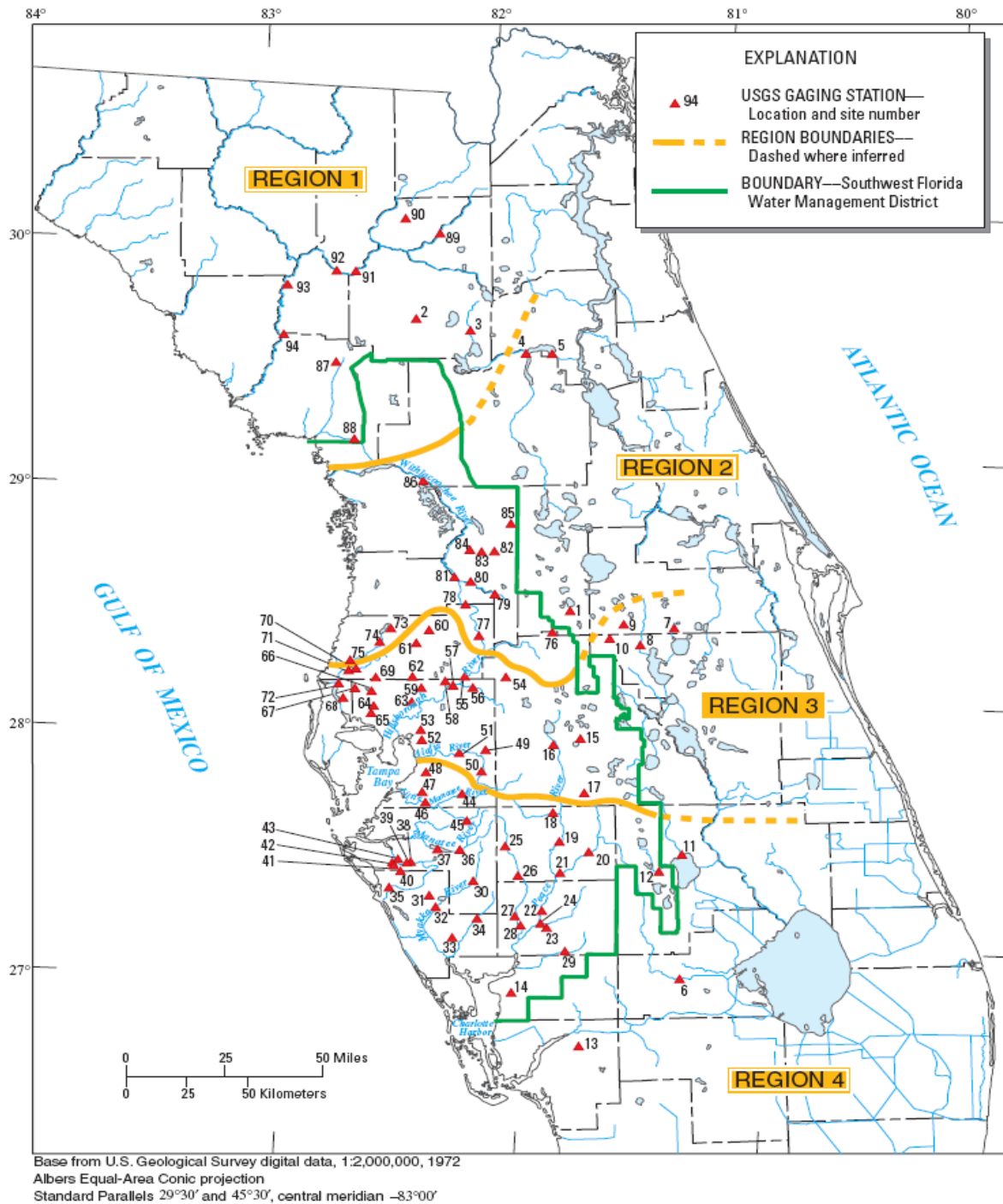

Reference: Hammett and DelCharco (2001).

Figure B-5: Regions for USGS Regression Equations for Natural Flow Conditions in West Central Florida

Table B-17: USGS Watershed Regression Equations for West Central Florida

| Regression equations | Standard error of model, SE _m (percent) | SE _m (+ percent) | SE _m (- percent) | Average standard error of prediction (ASEP) (percent) | Equivalent length of record (years) |
|--|--|-----------------------------|-----------------------------|---|-------------------------------------|
| Region 1 | | | | | |
| $Q_2 = 132 (DA)^{0.528} (LK+0.6)^{-0.542}$ | 57.9 | 71.2 | -41.6 | 69 | 1.35 |
| $Q_5 = 267 (DA)^{0.510} (LK+0.6)^{-0.534}$ | 50.3 | 60.8 | -37.8 | 60 | 2.29 |
| $Q_{10} = 389 (DA)^{0.500} (LK+0.6)^{-0.535}$ | 48.3 | 58.0 | -36.7 | 58 | 3.27 |
| $Q_{25} = 583 (DA)^{0.489} (LK+0.6)^{-0.540}$ | 47.1 | 56.5 | -36.1 | 57 | 4.64 |
| $Q_{50} = 760 (DA)^{0.481} (LK+0.6)^{-0.545}$ | 46.9 | 56.2 | -36.0 | 58 | 5.64 |
| $Q_{100} = 965 (DA)^{0.474} (LK+0.6)^{-0.550}$ | 47.0 | 56.4 | -36.1 | 58 | 6.58 |
| $Q_{200} = 1,200 (DA)^{0.467} (LK+0.6)^{-0.557}$ | 47.4 | 56.9 | -36.3 | 59 | 7.43 |
| $Q_{500} = 1,562 (DA)^{0.460} (LK+0.6)^{-0.566}$ | 48.4 | 58.2 | -36.8 | 61 | 8.41 |
| Region 2 | | | | | |
| $Q_2 = 2.03 (DA)^{1.065} (LK+3.0)^{-0.259} (SL)^{-0.017}$ | 57.3 | 70.3 | -41.3 | 68 | 1.98 |
| $Q_5 = 5.82 (DA)^{1.023} (LK+3.0)^{-0.339} (SL)^{0.149}$ | 54.9 | 67.1 | -40.1 | 65 | 2.58 |
| $Q_{10} = 9.84 (DA)^{0.999} (LK+3.0)^{-0.371} (SL)^{0.226}$ | 54.7 | 66.7 | -40.0 | 65 | 3.34 |
| $Q_{25} = 17.0 (DA)^{0.972} (LK+3.0)^{-0.398} (SL)^{0.298}$ | 54.3 | 66.3 | -39.9 | 66 | 4.48 |
| $Q_{50} = 24.1 (DA)^{0.953} (LK+3.0)^{-0.412} (SL)^{0.339}$ | 54.0 | 65.8 | -39.7 | 66 | 5.39 |
| $Q_{100} = 32.7 (DA)^{0.936} (LK+3.0)^{-0.423} (SL)^{0.372}$ | 53.5 | 65.2 | -39.5 | 66 | 6.34 |
| $Q_{200} = 42.8 (DA)^{0.921} (LK+3.0)^{-0.432} (SL)^{0.400}$ | 52.9 | 64.4 | -39.2 | 66 | 7.31 |
| $Q_{500} = 58.7 (DA)^{0.903} (LK+3.0)^{-0.440} (SL)^{0.428}$ | 52.3 | 63.5 | -38.8 | 66 | 8.59 |
| Region 3 | | | | | |
| $Q_2 = 21.0 (DA)^{0.890} (LK+3.0)^{-0.601} (SL)^{0.452}$ | 54.6 | 66.7 | -40.0 | 60 | 1.99 |
| $Q_5 = 54.0 (DA)^{0.841} (LK+3.0)^{-0.593} (SL)^{0.374}$ | 49.1 | 59.1 | -37.2 | 54 | 3.02 |
| $Q_{10} = 87.2 (DA)^{0.819} (LK+3.0)^{-0.594} (SL)^{0.338}$ | 49.9 | 60.2 | -37.6 | 56 | 3.85 |
| $Q_{25} = 140 (DA)^{0.799} (LK+3.0)^{-0.593} (SL)^{0.308}$ | 52.6 | 63.9 | -39.0 | 59 | 4.74 |
| $Q_{50} = 186 (DA)^{0.789} (LK+3.0)^{-0.591} (SL)^{0.294}$ | 55.2 | 67.4 | -40.3 | 62 | 5.27 |
| $Q_{100} = 236 (DA)^{0.782} (LK+3.0)^{-0.588} (SL)^{0.284}$ | 57.9 | 71.3 | -41.6 | 66 | 5.69 |
| $Q_{200} = 289 (DA)^{0.776} (LK+3.0)^{-0.584} (SL)^{0.278}$ | 60.9 | 75.4 | -43.0 | 69 | 6.02 |
| $Q_{500} = 364 (DA)^{0.771} (LK+3.0)^{-0.578} (SL)^{0.274}$ | 64.9 | 80.9 | -44.7 | 74 | 6.36 |
| Region 4 | | | | | |
| $Q_2 = 62.3 (DA)^{0.661} (LK+3.0)^{-0.367} (SL)^{0.497}$ | 36.3 | 42.1 | -29.6 | 40 | 3.86 |
| $Q_5 = 127 (DA)^{0.669} (LK+3.0)^{-0.435} (SL)^{0.493}$ | 35.9 | 41.7 | -29.4 | 40 | 5.44 |
| $Q_{10} = 182 (DA)^{0.678} (LK+3.0)^{-0.474} (SL)^{0.495}$ | 37.0 | 43.1 | -30.1 | 42 | 6.91 |
| $Q_{25} = 262 (DA)^{0.691} (LK+3.0)^{-0.514} (SL)^{0.502}$ | 38.9 | 45.6 | -31.3 | 45 | 8.65 |
| $Q_{50} = 326 (DA)^{0.701} (LK+3.0)^{-0.538} (SL)^{0.508}$ | 40.7 | 47.9 | -32.4 | 47 | 9.74 |
| $Q_{100} = 394 (DA)^{0.712} (LK+3.0)^{-0.559} (SL)^{0.513}$ | 42.6 | 50.5 | -33.5 | 50 | 10.62 |
| $Q_{200} = 465 (DA)^{0.722} (LK+3.0)^{-0.576} (SL)^{0.519}$ | 44.7 | 53.2 | -34.7 | 52 | 11.33 |
| $Q_{500} = 562 (DA)^{0.736} (LK+3.0)^{-0.595} (SL)^{0.527}$ | 47.6 | 57.1 | -36.4 | 56 | 12.04 |

Reference: Hammett and DelCharco (2001).
See Figure B-5 for Region delineation.

Table B-18: USGS Watershed Regression Equations' Range of Applicability for West Central Florida

| Basin characteristic | Region 1 | Region 2 | Region 3 | Region 4 |
|------------------------------|--------------|--------------|------------|-------------|
| Drainage area (square miles) | 18.5 – 9,640 | 28.6 – 2,100 | 4.43 – 390 | 0.94 – 330 |
| Slope (feet per mile) | 0.51 – 23.5 | 0.09 – 3.6 | 0.41 – 9.8 | 1.02 – 7.52 |
| Lake area (percent) | 0.03 – 8.67 | 0 – 26.35 | 0 – 27.5 | 0 – 19.3 |

Reference: Hammett and DelCharco (2001).

APPENDIX

C. OPEN CHANNEL FLOW DESIGN AIDS

TABLE OF CONTENTS

| | |
|--|------------|
| C. Open Channel Flow Design Aids..... | C-1 |
| Example C.1 – Geometric Elements..... | C-1 |
| Example C.2 – Geometric Elements..... | C-2 |
| Figure C-1: Trapezoidal Channel Geometry | C-4 |
| Figure C-2: Nomographs for the Solution of Manning’s Equation | C-5 |
| Figure C-3: Trapezoidal Channel Capacity Chart..... | C-6 |
| Figure C-4: Open Channel Geometric Relationships for Various Cross Sections .. | C-7 |

C. OPEN CHANNEL FLOW DESIGN AIDS

The nomographs in Figures C-1 through C-3 can be used as desktop aides for open channel flow calculations. The purpose of each nomograph is:

Figure C-1 Area, Hydraulic Radius, and Top Width of Trapezoidal Channels

Figure C-2 Normal Depth Velocity for a General Cross Section

Normal Depth Velocity in a Circular Pipe

Figure C-3 Normal Depth in a Trapezoidal Channel

Figure C-1 can be used to solve Example C.1 below and the Geometry of Examples 3.1-1 through 3.1-4 in Chapter 3 of this document.

EXAMPLE C.1 – GEOMETRIC ELEMENTS

Given: Depth = 1.0 ft
Trapezoidal Cross Section shown below

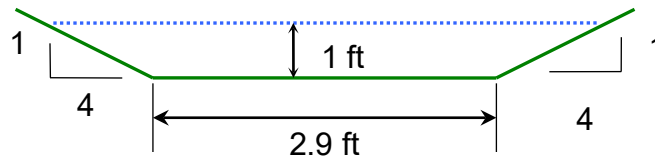

Calculate: Area, Wetted Perimeter, Hydraulic Radius, Top Width, and Hydraulic Depth

Water Area

$$A = a = bd + zd^2$$

$$a = (2.9 \times 1) + 4(1)^2 = 6.9 \text{ ft}^2$$

Wetted Perimeter

$$P = b + 2d\sqrt{z^2 + 1}$$

$$P = 2.9 + (2 \times 1)\sqrt{4^2 + 1} = 11.146 = 11.1 \text{ ft}$$

Hydraulic Radius

$$R = r = \frac{bd + zd^2}{b + 2d\sqrt{z^2 + 1}}$$

$$r = \frac{(2.9 \times 1) + 4(1)^2}{2.9 + (2 \times 1)\sqrt{4^2 + 1}} = 0.619 = 0.62 \text{ ft}$$

Top Width

$$T = b + 2zd$$

$$T = 2.9 + (2 \times 4 \times 1) = 10.9 \text{ ft}$$

Hydraulic Depth

$$D = \frac{A}{T} = \frac{6.9}{10.9} = 0.63 \text{ ft}$$

This problem can also be solved using nomographs

This example is solved in the lower right hand corner of Figure C-1

EXAMPLE C.2 – GEOMETRIC ELEMENTS

Determine Normal Depth for Standard Ditch and Narrow Ditch given in Chapter 3, Example 3.1-4 using Figure C-3.

Standard Ditch:

$$\text{Solve for } \frac{Qn}{b^{8/3}S^{1/2}} = \frac{(25)(0.04)}{5^{8/3}(0.005)^{1/2}} = 0.193$$

The average value of z is $(6 + 4) / 2 = 5$

From Figure C-3, $\frac{d}{b} = 0.22$

$$d = 0.43b = 0.22(5) = 1.1 \text{ ft.}$$

Using a trial and error procedure to solve Manning's Equation, normal depth = 1.12'

Narrow Ditch:

$$\text{Solve for } \frac{Qn}{b^{8/3}S^{1/2}} = \frac{(25)(0.04)}{3.5^{8/3}(0.005)^{1/2}} = 0.501$$

The average value of z is $(6 + 4) / 2 = 5$

From Figure C-3, $\frac{d}{b} = 0.34$

$$d = 0.34b = 0.34(3.5) = 1.2 \text{ ft.}$$

Using a trial and error procedure to solve Manning's Equation, normal depth = 1.25'

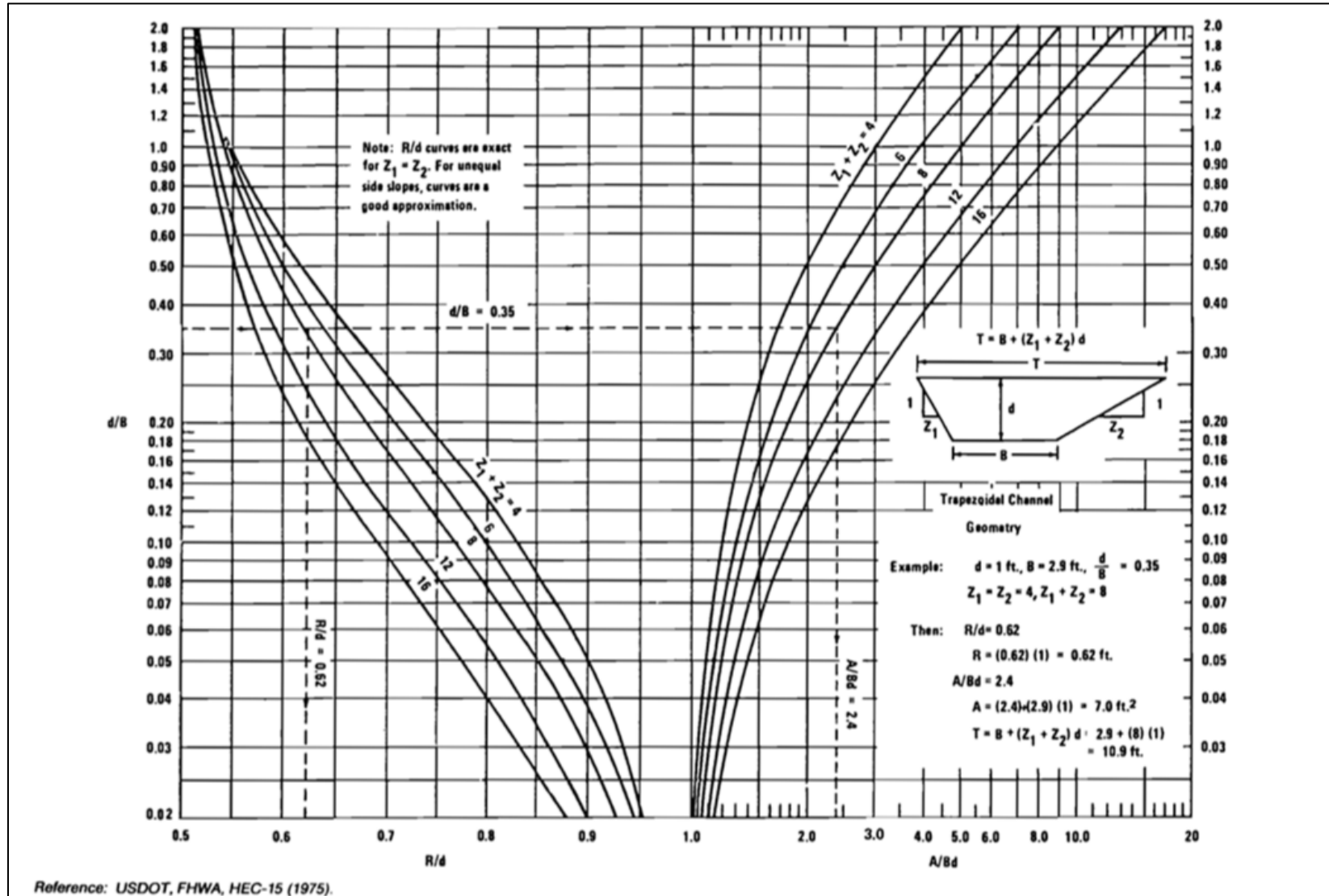

Figure C-1: Trapezoidal Channel Geometry

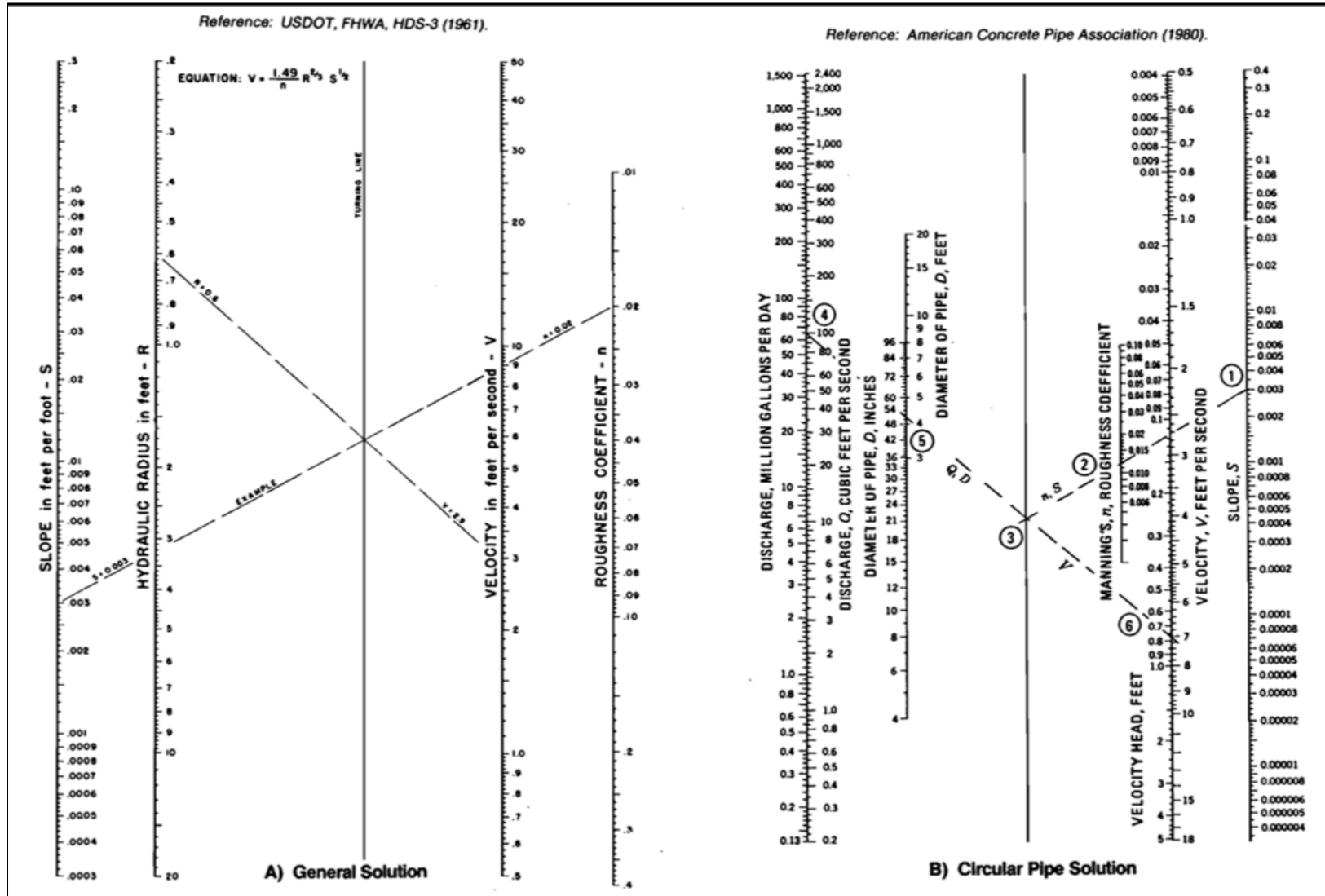

Figure C-2: Nomographs for the Solution of Manning's Equation

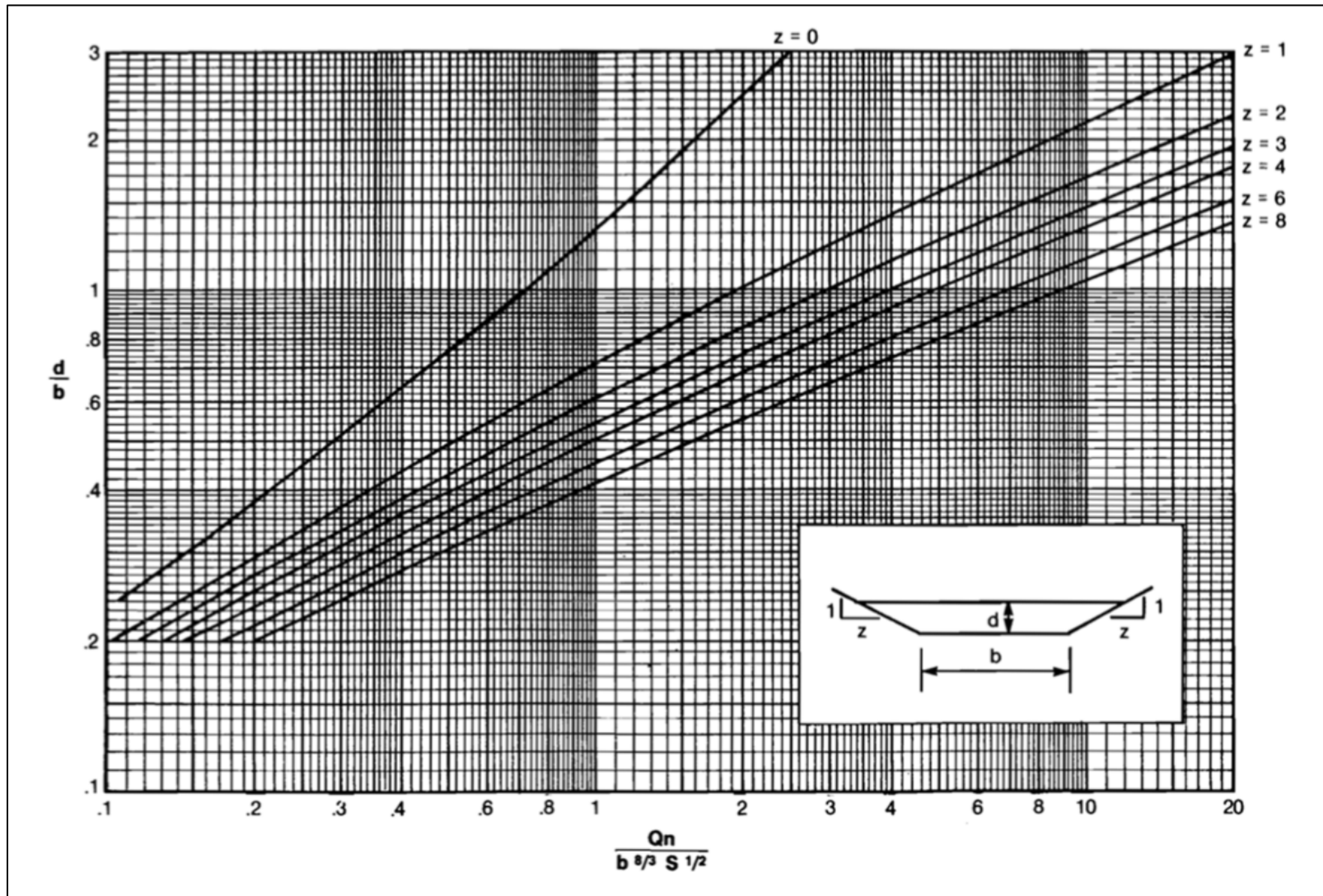

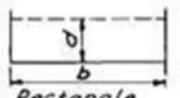

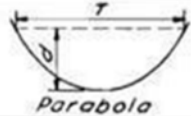



Figure C-3: Trapezoidal Channel Capacity Chart

| Section | Area a | Wetted Perimeter p | Hydraulic Radius r | Top Width T |
|--|--|-----------------------------------|--|--|
|  Trapezoid | $bd + zd^2$ | $b + 2d\sqrt{z^2 + 1}$ | $\frac{bd + zd^2}{b + 2d\sqrt{z^2 + 1}}$ | $b + 2zd$ |
|  Rectangle | bd | $b + 2d$ | $\frac{bd}{b + 2d}$ | b |
|  Triangle | zd^2 | $2d\sqrt{z^2 + 1}$ | $\frac{zd}{2\sqrt{z^2 + 1}}$ | $2zd$ |
|  Parabola | $\frac{2}{3}dT$ | $T + \frac{8d^2}{3T}$ \perp | $\frac{2dT^2}{3T^2 + 8d^2}$ \perp | $\frac{3a}{2d}$ |
|  Circle - < 1/2 full $\perp 2$ | $\frac{D^2}{8}(\frac{\pi\theta}{180} - \sin\theta)$ | $\frac{\pi D\theta}{360}$ | $\frac{45D}{\pi\theta}(\frac{\pi\theta}{180} - \sin\theta)$ | $D \sin \frac{\theta}{2}$ or $2\sqrt{d(D-d)}$ |
|  Circle - > 1/2 full $\perp 3$ | $\frac{D^2}{8}(2\pi - \frac{\pi\theta}{180} + \sin\theta)$ | $\frac{\pi D(360 - \theta)}{360}$ | $\frac{45D}{\pi(360 - \theta)}(2\pi - \frac{\pi\theta}{180} + \sin\theta)$ | $D \sin \frac{\theta}{2}$ or $2\sqrt{d(D-d)}$ |
| $\perp 1$ Satisfactory approximation for the interval $0 < \frac{d}{T} \leq 0.25$ When $\frac{d}{T} > 0.25$, use $p = \frac{1}{2}\sqrt{6d^2 + T^2} + \frac{T^2}{8d} \sinh^{-1} \frac{4d}{T}$ $\perp 2$ $\theta = 4 \sin^{-1} \sqrt{d/D}$ } Insert θ in degrees in above equations $\perp 3$ $\theta = 4 \cos^{-1} \sqrt{d/D}$ | | | | |

Reference: USDA, SCS, NEH-5 (1956)

Figure C-4: Open Channel Geometric Relationships for Various Cross Sections

APPENDIX

D. GUTTER FLOW USING HEC-RAS

TABLE OF CONTENTS

| | | |
|-----------|--|------------|
| D. | Gutter Flow Using HEC-RAS | D-1 |
| D.1 | Introduction | D-1 |
| D.2 | Example of Gutter Flow Using HEC-RAS | D-2 |

D. GUTTER FLOW USING HEC-RAS

D.1 INTRODUCTION

Gutter flow is a form of open channel flow. Most gutter flow is associated with pavement drainage and storm drain design, and is, therefore, discussed in Storm Drain Design, Chapter 6 of this document. Some situations may warrant a more detailed approach to gutter flow than presented in the Storm Drain Chapter. The gutter flow equation is:

$$Q = \frac{0.56}{n} S_x^{5/3} T^{8/3} S^{1/2}$$

where:

Q = Discharge, in ft³/sec

n = Manning's roughness coefficient

S_x = Cross Slope, in ft/ft

T = Spread, in ft

S = Slope of the energy gradient, in ft/ft

The gutter flow equation is a normal depth equation that can be used in a manner similar to Manning's Equation. The slope of the energy gradient is the same as the longitudinal slope of the gutter for normal depth of flow in the gutter. The equation cannot be solved if the slope is zero or negative. While zero and negative slope conditions should be avoided when designing a project, you will sometimes encounter these conditions when analyzing existing or retrofit situations.

You can use the HEC-RAS model to analyze open channels with flat or reverse slopes, so HEC-RAS is applicable to analyzing gutter flow with zero or negative slopes. In HEC-RAS, the friction losses between cross sections are estimated using Manning's Equation. The Manning's roughness coefficient can be adjusted, in effect, to make HEC-RAS use the gutter flow equation to determine the friction losses.

If the gutter has a typical triangular cross section, such as a gutter against a curb or barrier wall, the area and the hydraulic radius can be solved using the cross slope, S_x, and the spread, T:

$$A = \frac{S_x T^2}{2}$$

$$P \approx T$$

where:

P = Wetted perimeter, in ft

Note that T is an approximation of P when the cross slope is relatively small.

$$R = \frac{A}{P} = \frac{S_x T^2}{2T} = \frac{S_x T}{2}$$

Substituting into Manning's Equation:

$$Q = \frac{1.486}{n} \left(\frac{S_x T^2}{2} \right) \left(\frac{S_x T}{2} \right)^{2/3} S^{1/2} = \frac{1.486}{(2)2^{2/3}n} S_x^{5/3} T^{8/3} S^{1/2} = \frac{0.47}{n} S_x^{5/3} T^{8/3} S^{1/2}$$

Therefore, Manning's Equation can be manipulated to solve the gutter flow equation if the Manning's roughness coefficient is reduced by a ratio of $0.47/0.56 = 0.84$. The roughness value normally used in gutter analysis is 0.016 (see Appendix B, Table B-2). The reduced value that should be used in HEC-RAS is 0.0134 or 0.013.

D.2 EXAMPLE OF GUTTER FLOW USING HEC-RAS

An existing four-lane divided rural highway with zero percent grade will be widened to six lanes by adding lanes in the median. The new inside lanes will slope toward the median. A barrier wall will be erected in the median to prevent cross-over accidents. The inside shoulder will be 12 feet wide with a 0.06 ft/ft cross slope.

The shoulder will not be warped to provide a grade along the barrier wall. Instead, the water collecting against the barrier will be allowed to seek out the nearest inlet despite the flat grade. Pipe will be installed parallel to the barrier wall to connect the inlets. Occasionally, a pipe will be jacked and bored under the existing lanes to outfall the flow from the median storm drain systems. The maximum distance between inlets will be 500 feet. Analyze the maximum spread next to the barrier wall.

D.2.1 Solution

The flow is assumed to divide halfway between the two inlets and flow in both directions. So the flow from one side of the inlet comes from 250 feet away. Table D-1 shows the flow rate at each cross section that will be used in the HEC-RAS analysis. Calculate the flow rates using the rational equation. Calculate the drainage area by multiplying the width of 36 feet by the distance from the midway point between the inlets. The rainfall intensity used is four inches per hour. The runoff coefficient is 0.95.

Table D-1: Discharges

| Location (distance from inlet) | Area (acres) | Q (cfs) |
|-----------------------------------|-----------------|------------|
| 0 | 0.2066 | 0.785 |
| 1 | 0.2058 | 0.782 |
| 4 | 0.2033 | 0.773 |
| 10 | 0.1983 | 0.754 |
| 25 | 0.1860 | 0.707 |
| 50 | 0.1653 | 0.628 |
| 100 | 0.1240 | 0.471 |

The total flow into the inlet is $2 \times 0.785 = 1.67$ cfs. The capacity chart for a Type D DBI from Appendix I (Inlet Efficiencies) shows that the depth above the inlet is less than 0.1 feet (which is a conservative estimate of the capacity of a barrier wall inlet). This depth will be lower than critical depth, so the profile in HEC-RAS will start at critical depth. Critical depth is not affected by the adjustment to Manning's "n" because critical depth is independent of the channel roughness.

The geometry of the shoulder next to the barrier wall is entered into HEC-RAS at Station 0, which will be next to the inlet. See Figure D-1, below:

Drainage Design Guide
Appendix D: Gutter Flow Using HEC-RAS

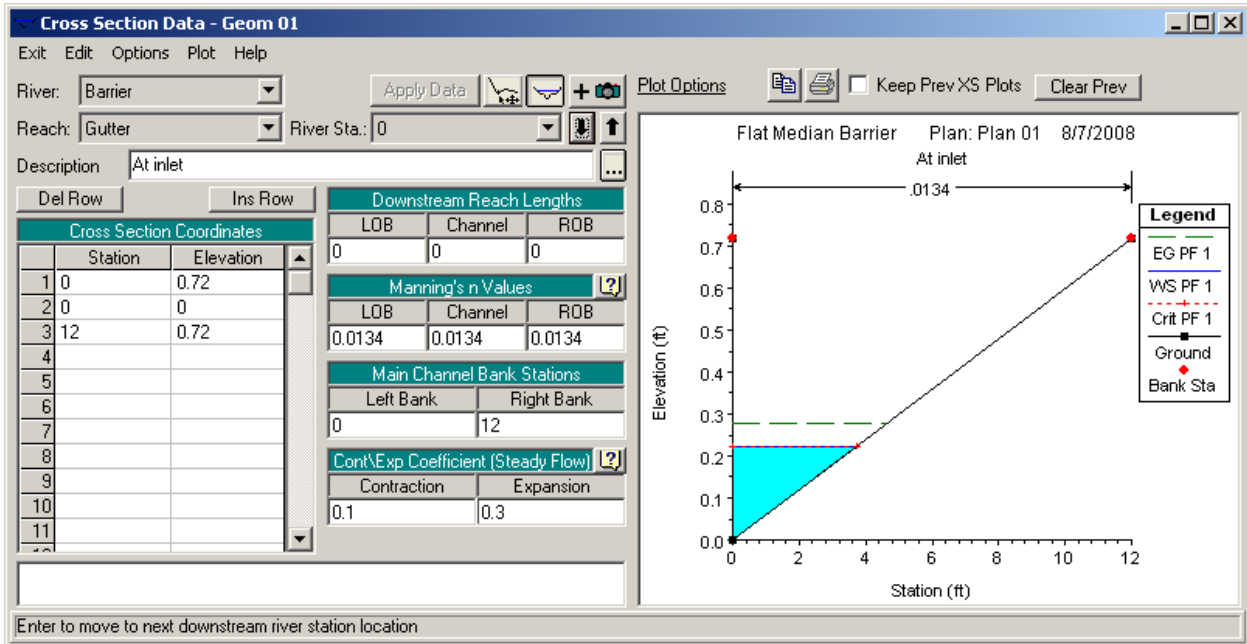

Figure D-1: HEC-RAS Input

The geometry is copied to the other desired cross section locations. Since the profile begins at critical depth, the first few cross sections should be located close to each other. The first cross section had to be located only one foot away to avoid a conveyance ratio warning.

The flow data is entered. A flow of 0.01 cfs is entered at Station 250 because HEC-RAS cannot use a value of zero when analyzing Steady State conditions. The downstream boundary condition is set at critical depth. Figure D-2, below, shows the computed profile:

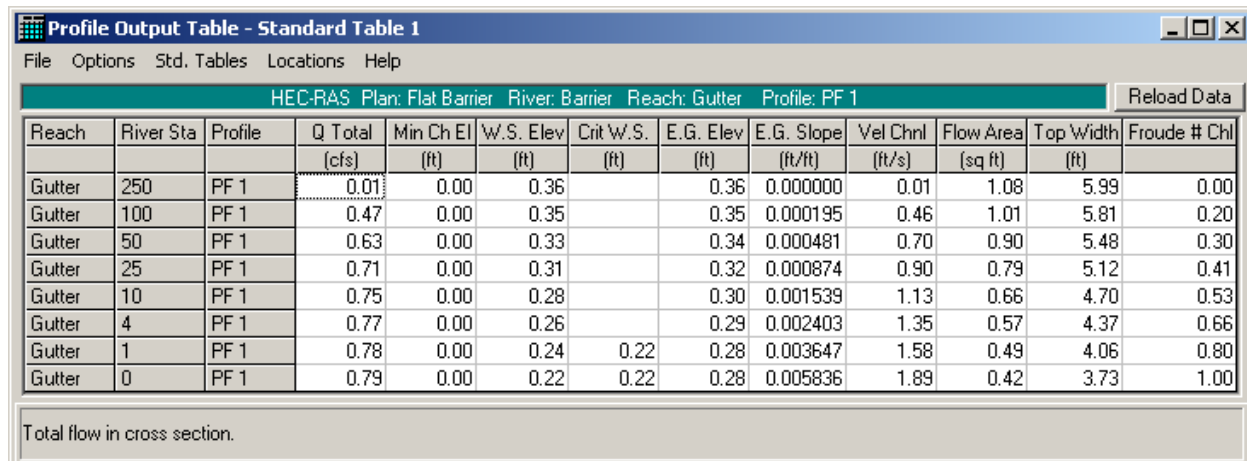

Figure D-2: Computed Profile

The top width, which is equivalent to the spread, does not exceed six feet. Therefore, the inlets prevent spread onto the travel lanes with a considerable safety factor.

Although spread will not be a problem, nuisance ponding will probably develop since the elevation along the barrier will not be perfectly level. Although this will not be a hazard, silt will collect next to the barrier and may require more maintenance.

APPENDIX

E. PARTIAL DEPTH PIPE FLOW GRAPHS

TABLE OF CONTENTS

| | |
|---|-----|
| Figure E-1: Circular Pipe Partial Flow Capacity Chart | E-1 |
| Figure E-2: Circular Pipe Relative Flow, Area, Hydraulic Radius, and Velocity | E-2 |
| Figure E-3: Horizontal Elliptical Pipe Relative Flow, Area, and Velocity | E-2 |
| Figure E-4: Vertical Elliptical Pipe Relative Flow, Area and Velocity | E-3 |
| Figure E-5: Pipe-Arch Relative Flow, Area, and Velocity | E-3 |

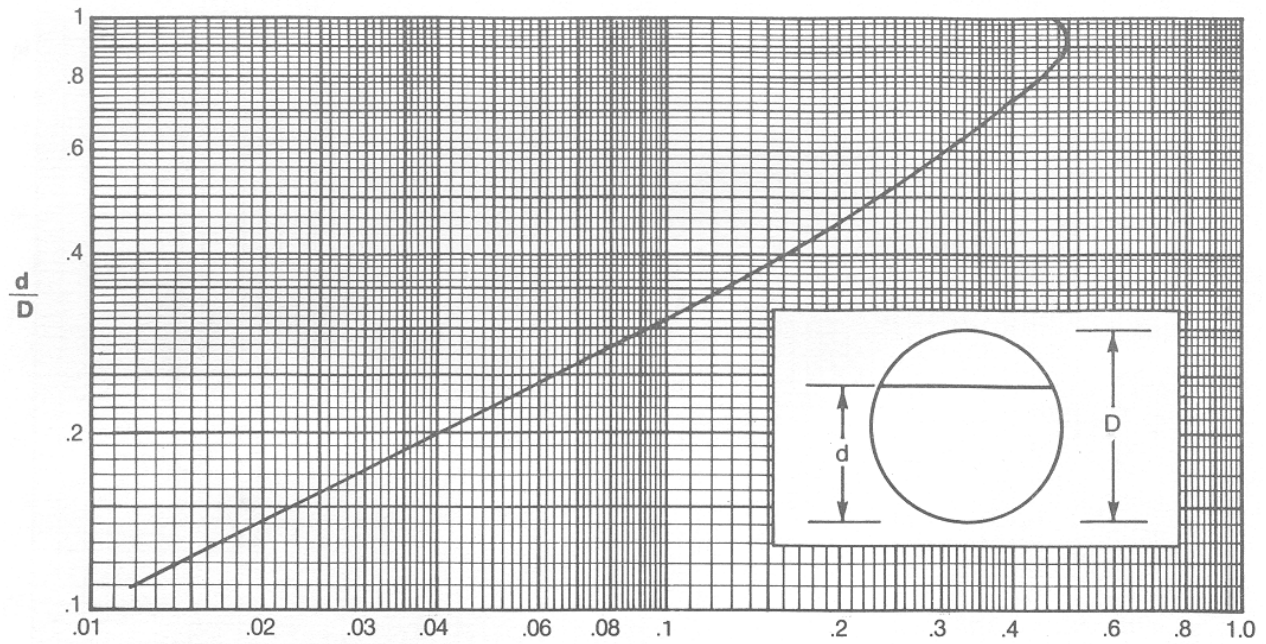

$$\frac{Qn}{D^{8/3} S^{1/2}}$$

Q = Flow Rate (cfs)

D = Pipe Diameter (ft)

S = Pipe Slope (ft/ft)

d = Normal Depth (ft)

Ref 1987 FDOT Drainage Manual

Figure E-1: Circular Pipe Partial Flow Capacity Chart

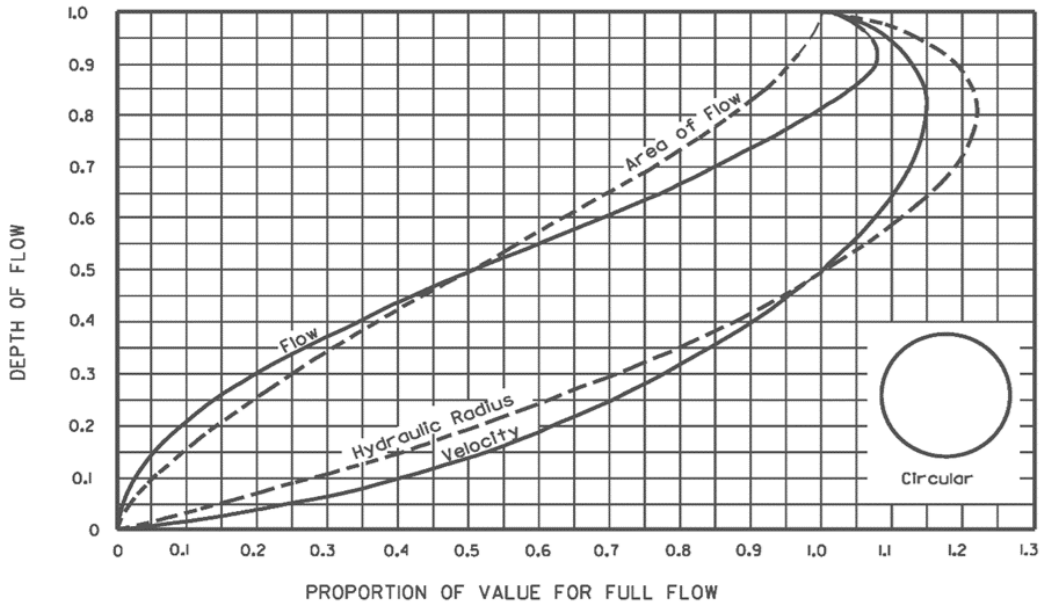

Reference: American Concrete Pipe Association (1980).

Figure E-2: Circular Pipe Relative Flow, Area, Hydraulic Radius, and Velocity

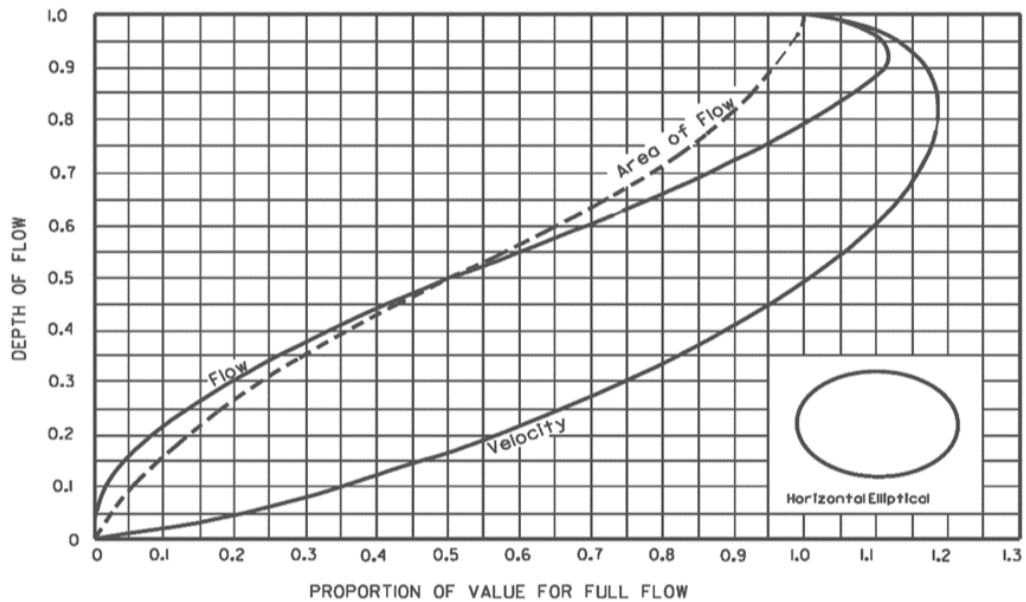

Reference: American Concrete Pipe Association (1980).

Figure E-3: Horizontal Elliptical Pipe Relative Flow, Area, and Velocity

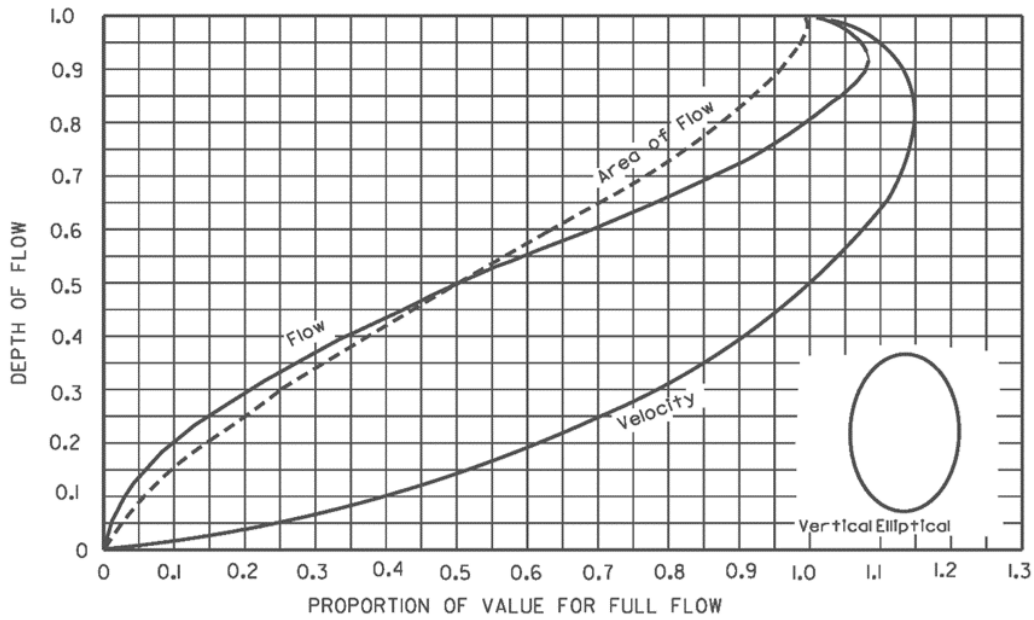

Reference: American Concrete Pipe Association (1980).

Figure E-4: Vertical Elliptical Pipe Relative Flow, Area and Velocity

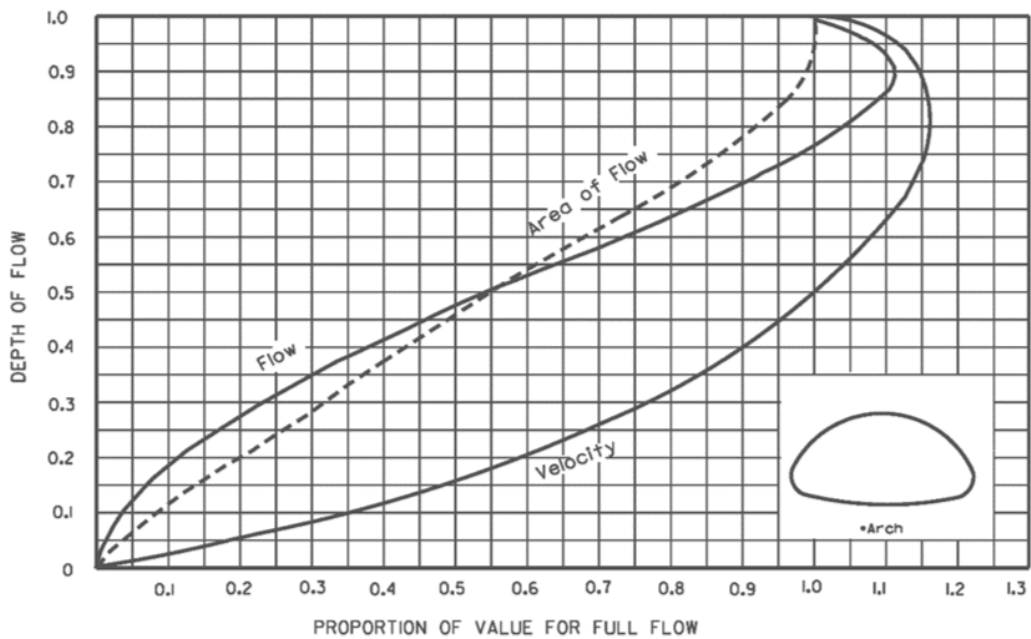

Reference: American Concrete Pipe Association (1980).

Figure E-5: Pipe-Arch Relative Flow, Area, and Velocity

APPENDIX

F. APPLICATION GUIDELINES FOR PIPE END TREATMENTS

TABLE OF CONTENTS

Table F-1: Application Guidelines for Pipe End Treatments - Part AF-1
Table F-2: Application Guidelines for Pipe End Treatments - Part BF-2

Table F-1: Application Guidelines for Pipe End Treatments - Part A

(see page F-3 for notes)

| Standard Plan Index | Description | | Application | | | Inlet End | | |
|---------------------|---------------------------------|--------------------------------|-------------|------------|---------|-------------|-----------------------|-----------------------|
| | Type | Pipe Size | Cross Drain | Side Drain | Median | Application | Hydraulic Performance | K_e |
| 430-010 | U Type Concrete With Grate | Single 15" thru 30" | Limited | Limited | Yes | Yes | Fair | 0.7 |
| 430-011 | U Type Concrete | Single 15" thru 30" | Limited | No | Yes | Limited | Good | 0.5 to 0.7 |
| 430-012 | Concrete Energy Dissipater | Single 30" thru 72" | Limited | No | No | No | NA | NA |
| 430-020 | Flared End Section Concrete | Single 12" thru 72" | Yes | No | Yes | Yes | Good | 0.5 |
| 430-021 | Cross Drain Mitered End Section | Single & Multiple 15" thru 72" | Yes | No | Yes | Yes | Fair | 0.7 |
| 430-022 | Side Drain Mitered End Section | Single & Multiple 15" thru 60" | No | Yes | No | Yes | Fair | 0.7 w/o, 1.0 w/ grate |
| 430-030 | Straight Concrete | Single & Multiple 15" thru 54" | (a) Yes | No | Limited | Yes | Excellent | 0.2 |
| 430-031 | Straight Concrete | Single & Double 60" | Yes | No | Limited | Yes | Excellent | 0.2 |
| 430-032 | Straight Concrete | Single & Double 66" | Yes | No | Limited | Yes | Excellent | 0.2 |
| 430-033 | Straight Concrete | Single & Double 72" | Yes | No | Limited | Yes | Excellent | 0.2 |
| 430-034 | Straight Concrete | Single 84" | Yes | No | Limited | Yes | Excellent | 0.2 |
| 430-040 | Winged Concrete | Single 12" thru 48" | Yes | No | Yes | Yes | Very Good | 0.3 |

Table F-2: Application Guidelines for Pipe End Treatments - Part B

(see page F-3 for notes)

| Standard Plans Index | Description | | Outlet End | | Safety | | Economic Rating |
|----------------------|---------------------------------|--------------------------------|------------|-------------------|--------------------------|------------------------------|-----------------|
| | Type | Pipe Size | Applicable | Erosion Tolerance | Permitted Location | Traffic-Safe Grate Available | |
| 430-010 | U Type Concrete With Grate | Single 15" thru 30" | Yes | Very Good | Inside CZ | Required | Good |
| 430-011 | U Type Concrete | Single 15" thru 30" | Yes | Good | Grate Required Inside CZ | Yes | Fair |
| 430-012 | Concrete Energy Dissipater | Single 30" thru 72" | Yes | Excellent | Outside CZ | No | NA |
| 430-020 | Flared End Section Concrete | Single 12" thru 72" | Yes | (c) Very Good | (c) Outside CZ | No | Very Good |
| 430-021 | Cross Drain Mitered End Section | Single & Multiple 15" thru 72" | Yes | Good | (d) Outside CZ | No | Very Good |
| 430-022 | Side Drain Mitered End Section | Single & Multiple 15" thru 60" | Yes | Good | (e) Inside CZ | Yes | Good |
| 430-030 | Straight Concrete | Single & Multiple 15" thru 54" | Limited | Good | Outside CZ | No | Fair |
| 430-031 | Straight Concrete | Single & Double 60" | Limited | Good | Outside CZ | No | Fair |
| 430-032 | Straight Concrete | Single & Double 66" | Limited | Good | Outside CZ | No | Fair |
| 430-033 | Straight Concrete | Single & Double 72" | Limited | Good | Outside CZ | No | Fair |
| 430-034 | Straight Concrete | Single 84" | Limited | Good | Outside CZ | No | Fair |
| 430-040 | Winged Concrete | Single 12" thru 48" | Yes | Good | Outside CZ | No | Good |

LEGEND:

- (a) For back of sidewalk location, see Standard Plans, Index 425-060.
- (b) For temporary construction or use on a minor facility.
- (c) Construction of optional toewall and concrete jacket may be necessary. Flared end section sizes 12 inch and 15 inch may be located as close as 8 feet beyond the outside edge of the shoulder.
- (d) Mitered end section sizes 15 inch, 18 inch, and 24 inch may be located as close as 8 feet beyond the outside edge of the shoulder.
- (e) Mitered end section size 30 inch and larger does not require a grate if pipe is located outside CZ and is offset from approach ditch alignment.

NOTES:

- 1. All end treatments must be selected to satisfy hydraulic suitability with proper consideration given to safety and economics.
- 2. CZ denotes clear zone; it was formerly CRA, denoting clear recovery area.
- 3. Grates should not be placed on outlet ends unless positive debris protection is provided at inlet end.
- 4. Additional notes concerning application restrictions may be shown on individual indexes.
- 5. Economic ratings are based on statewide average costs.
- 6. End treatments with a K_e of 0.5 or greater should be used only in areas of low design velocities and negligible debris.
- 7. Pipe sizes are circular, Class III B wall, concrete pipe. Elliptical pipe and corrugated pipe are to be checked for fit. Metal pipe sizes should be reviewed using 2 $\frac{3}{8}$ -inch x $\frac{1}{2}$ -inch corrugation up to 30 inches and 3-inch x 1-inch corrugation for larger sizes.

APPENDIX

G.RISK EVALUATIONS

TABLE OF CONTENTS

| | |
|--|------------|
| G. Risk Evaluations | G-1 |
| G.1 Risk Evaluation | G-1 |
| G.1.1 Risk Assessment | G-1 |
| G.1.2 Economic Analysis | G-2 |
| G.2 Sample Risk Analysis | G-3 |
| G.2.1 Alternatives Considered | G-3 |
| G.2.1.1 Calculations for Alternative 1 | G-4 |
| G.2.1.2 Calculations for Alternative 2 | G-7 |
| G.2.1.3 Calculations for Alternative 3 | G-8 |

G. RISK EVALUATIONS

G.1 Risk Evaluation

All designs with floodplain encroachments should include an evaluation of the inherent flood-related risks to the highway facility and to the surrounding property. In the traditional design process, the level of risk is seldom quantified, but is instead implied through the application of predetermined design standards. For example, the design frequency, backwater limitations, and limiting velocity are parameters for which design standards can be set.

Two other approaches, however, are available that quantify risk on projects involving highway facilities designed to encroach within the limits of a floodplain. These are risk assessment and economic analysis.

Consideration of capital costs and risks should include, as appropriate, a risk analysis or risk assessment that includes:

- The overtopping flood or the base flood, whichever is greater
- The greatest flood that must pass through the highway drainage structure(s), where overtopping is not practicable

G.1.1 Risk Assessment

A risk assessment is a subjective analysis of the risks engendered by various design alternatives, without detailed quantification of flood risks and losses. It may consist of developing the construction costs for each alternative and subjectively comparing the risks associated with each alternative. A risk assessment usually is more appropriate for small structures or for structures whose size is highly influenced by non-hydraulic constraints. There are no well-defined procedures or criteria for performing risk assessments. However, an attempt should be made to screen projects and determine the level of analysis required. Some items to consider are:

- Backwater
 - a. Is the overtopping flood greater than the design flood (100-year)?
 - b. Is the overtopping flood greater than the check flood (500-year)?
 - c. Is there potential for major flood damage from the overtopping flood?
 - d. Could flood damage occur even if the roadway crossing wasn't there?
 - e. Could flood damage be significantly increased by the backwater caused

-
- by the proposed structure?
- f. Could flood damage occur to offsite property owners?
- Traffic-Related Losses
 - a. If the design flood is exceeded and the roadway is overtopped, is there a detour available?
 - Roadway and/or Structure Repair Costs
 - a. Is the overtopping flood greater or less than the design flood (100-year)?
 - b. Is the embankment constructed from erosion-resistant material, such as a clay type soil?
 - c. Does the embankment have good erosion-resistant vegetation cover?
 - d. How long will the duration of overtopping be?
 - e. Will the cost of protecting the roadway and/or structure from damage exceed the cost of providing a relief structure?
 - f. Is there damage potential to the structure caused by scour, debris, or other means during the lesser of the overtopping flood or the design flood (100-year)?

If the risk assessment indicates the risks warrant additional study, a detailed analysis of alternative designs and associated costs is necessary to determine the design with the least total expected cost (LTEC) to the public.

G.1.2 Economic Analysis

An economic analysis (sometimes called risk analysis) encompasses a complete evaluation of all quantifiable flood losses and the costs associated with them for each structure alternative. This can include damage to structures, embankments, surrounding property, traffic-related losses, and scour or stream channel change.

The level of expense and effort required for an economic analysis is considerably higher than for a risk assessment, and selection of the process to be used should be based on the size of the project and the potential risk involved.

Further details of the economic analysis process and procedures for using it have been documented in HEC-17 (USDOT, FHWA, 1981). The full-scale detailed risk analysis described in HEC-17 would not be necessary for normal stream crossings, but would apply to unusual, complex, or high-cost encroachments involving substantial flood losses.

An example of a simple risk analysis follows.

G.2 SAMPLE RISK ANALYSIS

An existing double 10-foot x 4-foot concrete box culvert (CBC) crossing is the subject for this analysis.

G.2.1 Alternatives Considered

Alternative 1: Extend existing double 10-foot x 4-foot CBC (60 feet total length) with no change to road. Overtops at about a 17-year frequency; flooding at the site has not caused any accidents.

Alternative 2: New quad 10-foot x 5-foot CBC (60 feet total length). Raise road to meet FDOT 50-year HW (Headwater) criteria and closely match existing 100-year HW. Overtops at frequencies greater than 50 years.

Alternative 3: Bridge

Table G-1: Alternatives Data

| | Alternative 1 | Alternative 2 | Alternative 3 |
|--|---------------|---------------|---------------|
| Annual Capital Costs \$ (i.e., Construction Costs) | | | |
| Annual Risks Costs \$ | | | |
| Total Costs \$ | | | |

G.2.1.1 Calculations for Alternative 1

(A) Capital Costs

Quantities are from the Department’s Culvert Design Program.

| | | | | |
|----------------------|----------|----------------|----------|------------------|
| Extend 20 feet right | Concrete | 43.1 CY | Steel | 6,622 lbs |
| Extend 8 feet left | | <u>23.5 CY</u> | | <u>3,283 lbs</u> |
| Total quantity | Concrete | 66.6 CY | Steel | 9,905 lbs |
| Unit prices | | | \$477/CY | \$0.53/lb |

Total capital cost = \$37,018 = \$31,768 + \$5,250
 To convert to annual capital cost, use capital recovery factor (CRF) based on a discount rate of 7 percent and a 20-year design life.

$$CRF = \frac{i}{1 - (1+i)^{-n}} \quad \text{where: } n = 20 \text{ and } i = 0.07$$

Annual capital costs = \$37,018 x 0.0944 = \$3,494

(B) Additional Economic Costs

The following discussion estimates the additional losses associated with extending the existing culvert and allowing the road to overtop. The losses usually consist of embankment (and pavement), backwater, and traffic.

No embankment losses are expected. The existing road and culvert overtop, but there is no history of embankment or pavement loss.

There will not be any additional backwater losses compared to Alternative 2. Both Alternative 1 and Alternative 2 have essentially the same backwater characteristics.

There may be additional traffic losses associated with Alternative 1 when compared with Alternative 2, which would raise the road to reduce overtopping potential. Traffic-related costs consist of running time costs, lost time costs, and accident costs. Running time costs were estimated, lost time costs were ignored (detour length added only 1 mile to the travel distance), and accident costs were estimated but were found to be insignificant.

Assume traffic would have to be detoured:

- 1 day for 25-year storm event (roadway tops at about a 17-year event)
- 2 days for 50-year storm event
- 3 days for 100-year storm event
- 4 days for 200-year storm event

The additional detour distance is 0.5 mile on a two-lane undivided roadway and 0.5 mile on a four-lane divided roadway.

Additional running costs = Cost per mile x ADT x additional detour length (miles)
Assume cost per mile = \$0.35/mile

$$\$_{25 \text{ yr}} = \$0.35 \times 27250 \text{ vpd} \times 1.0 \text{ mi} \times 1 \text{ day} = \$9,538$$

$$\$_{50 \text{ yr}} = \$0.35 \times 27250 \text{ vpd} \times 1.0 \text{ mi} \times 2 \text{ days} = \$19,075$$

$$\$_{100 \text{ yr}} = \$0.35 \times 27250 \text{ vpd} \times 1.0 \text{ mi} \times 3 \text{ days} = \$28,615$$

$$\$_{200 \text{ yr}} = \$0.35 \times 27250 \text{ vpd} \times 1.0 \text{ mi} \times 4 \text{ days} = \$38,150$$

Additional accident costs: These are additional costs due to increased travel distance due to the need to detour.

Additional detour length is 0.5 mi on a two-lane undivided roadway and 0.5 mi on a four-lane divided roadway.

Accident cost = crash rate x vehicle miles x cost per crash

Vehicle miles = ADT x additional detour distance x number of days of detour

Get the crash rate and the cost per crash from the FDOT Safety Office.

Crash rate = 1.9 crashes/million vehicle miles for urban, two-lane, undivided roadways
0.8 crashes/million vehicle miles for urban, four-lane, divided roadways

Cost per crash = \$28,000 for urban, two-lane, undivided roadways
\$26,000 for urban, four-lane, divided roadways

$$\$_{25} = (\$28,000 \times [27,250 \times 0.5 \times 1] \times 1.9) + (\$26,000 \times [27,250 \times 0.5 \times 1] \times 0.8)$$

$$\$_{25} = \$1,008.25$$

Using the same method, with 50-year detour = 2 days, 100-year detour = 3 days, and 200-year detour = 4 days:

\$₅₀ = \$2,016.50
 \$₁₀₀ = \$3,024.75
 \$₂₀₀ = \$4,033.00

Traffic losses in the following table are the sum of increased running costs and increased accident losses.

Table G-2: Summary of Economic Losses

| Frequency (yr) | Losses (\$) | | | Total Losses (\$) |
|----------------|-----------------------|-----------|---------------------------------|-------------------|
| | Embankment & Pavement | Backwater | Traffic | |
| 5 | 0 | 0 | 0 | 0 |
| 10 | 0 | 0 | 0 | 0 |
| 15 | 0 | 0 | 0 | 0 |
| 25 | 0 | 0 | 9,538 + 1,008.25 = 10,546.25 | 10, 546.25 |
| 50 | 0 | 0 | 21,091.50 | 21,091.50 |
| 100 | 0 | 0 | 31,639.75 | 31,639.75 |
| 200 | 0 | 0 | 42,183.00 | 42,183.00 |

Table G-3: Summary of Annual Risk Costs

| Freq. (yr) | Exceed. Prob. | Losses (\$) | Average Loss (\$) | Delta Prob. | Annual Risk Costs (\$) |
|--------------------------------|---------------|-------------|-------------------|-------------|------------------------|
| 5 | 0.2 | 0 | | | |
| 10 | 0.1 | 0 | | | |
| 15 | 0.07 | 0 | | | |
| | | | 5,273.13 | 0.03 | 158.19 |
| 25 | 0.04 | 10,546.25 | | | |
| | | | 15,818.88 | 0.02 | 316.38 |
| 50 | 0.02 | 21,091.50 | | | |
| | | | 26,365.63 | 0.01 | 263.66 |
| 100 | 0.01 | 31,639.75 | | | |
| | | | 36,911.38 | 0.005 | 184.56 |
| 200 | 0.005 | 42,183.00 | | | |
| | | | 42,183.00 | 0.005 | 210.92 |
| | 0 | 42,183.00 | | | |
| Total Annual Risk Costs | | | | | 1,133.71 |

G.2.1.2 Calculations for Alternative 2

Replace with quad 10' x 5' CBC

(A) Capital Costs

Concrete (from box culvert program) = 219.7 CY @ \$477/CY = \$104,797

Steel (from box culvert program) = 42,251 lbs @ \$0.53/lb = \$22,393

(B) Rebuild 400' of Roadway

Structural Course (2' x 24') = 1,067 SY @ \$3.40/SY = \$3,628

Base group 9 = 1,067 SY @ \$6.16/SY = \$6,573

Neglect earthwork costs

Total Capital Costs = \$137,391

Annual Capital Cost = Total x CRF = \$12,970

This alternative would overtop at frequencies greater than the 50-year storm event and would, therefore, have some annual risk costs. These risks were not calculated because the annual cost alone is greater than the total cost for Alternative 1. If the capital costs for Alternative 2 were less than the total cost for Alternative 1, it would be necessary to calculate the other costs associated with this alternative.

G.2.1.3 Calculations for Alternative 3

57-foot-long x 44-foot-wide flat slab bridge

(A) Capital Costs

$$57 \text{ feet} \times 44 \text{ feet} \times \$40/\text{sf} = 2,508 \text{ sf} \times \$40/\text{sf} = \$100,320$$

$$\text{Annual cost using CRF} = 0.0944 = \$9,470$$

(B) Costs Not Estimated

Roadway fill and new base and asphalt. At a minimum, 900 feet of roadway would have to be rebuilt to raise the grade to meet the bridge. (Bridge would be raised to meet FDOT drift clearance requirements.)

Standard 1H:2V front slopes encroach into roadside ditches. Since the upstream roadside ditch conveys substantial flow, it may not be possible or wise to reduce its capacity. Vertical walls and/or additional right of way may be necessary.

Miscellaneous factors include driveway connections within the raised roadway section, and the aesthetics of the raised road and bridge.

Table G-4: Cost Comparisons

| Cost Item | Alternative 1 | Alternative 2 | Alternative 3 |
|---|---------------|---------------|---------------|
| Annual Capital Costs (i.e., Construction Costs) | \$3,494 | \$12,970 | \$9,740 |
| Annual Risks Costs | \$1,134 | >0 | >0 |
| Total Costs | \$4,628 | >\$12,970 | >\$9,740 |

Alternative 1 is the most economical alternative and the most desirable when considering other impacts.

APPENDIX

H. SHOULDER GUTTER TRANSITION SLOPE AT BRIDGES

H. SHOULDER GUTTER TRANSITION SLOPE AT BRIDGES

H.1 SLOPE CREATED BY THE SHOULDER/GUTTER TRANSITION

If the profile grade line (PGL) of the road is flat, there will be a slope away from the bridge created by the shoulder/gutter transition. The degree of slope will depend on the width of the shoulder and the cross slopes of the bridge deck and the roadway shoulder. Figure H.1 shows a transition with a 10-foot shoulder and standard cross slopes for the bridge deck and roadway shoulder.

The drop from the edge of the travel lane to the bottom of the gutter at the end of the bridge barrier wall is:

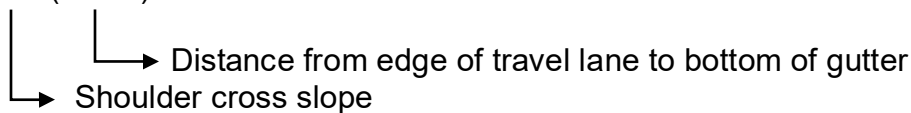
$$0.02 (10.33) = 0.206 \text{ feet}$$

Shoulder cross slope

Distance from edge of travel lane to bottom of gutter

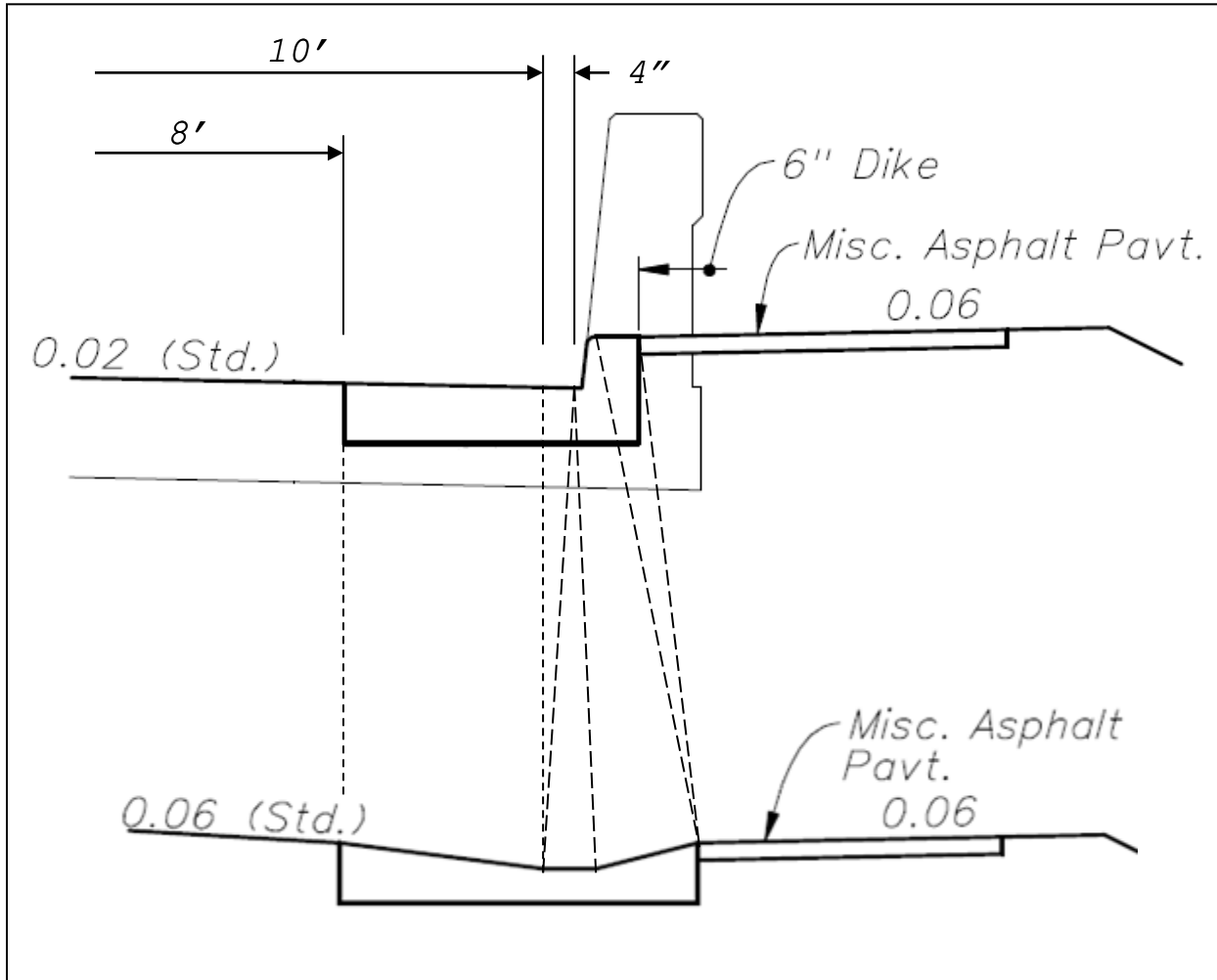

Figure H-1: Shoulder/Gutter Transition at Bridge End

The drop from the edge of the travel lane to the bottom of the gutter at the end of the transition is:

$$0.06 (8) + 0.25 = 0.730 \text{ feet}$$

↳ 3-inch drop from lip of gutter to bottom of gutter
 ↳ Distance from edge of travel lane to lip of gutter
 ↳ Shoulder cross slope

The drop of the gutter bottom in the transition is $0.730 - 0.206 = 0.524$ feet. The length of the transition is 25 feet. The slope of the bottom of the gutter is $0.524/25 = 0.0210$, or 2.10%.

APPENDIX

I. INLET EFFICIENCIES

TABLE OF CONTENTS

| | |
|--|------|
| Figure I-1: Type 1, $S_x = 0.02$ | I-1 |
| Figure I-2: Type 1, $S_x = 0.03$ | I-1 |
| Figure I-3: Type 1, $S_x = 0.04$ | I-2 |
| Figure I-4: Type 1, $S_x = 0.05$ | I-2 |
| Figure I-5: Type 1, $S_x = 0.06$ | I-3 |
| Figure I-6: Type 3, $S_x = 0.02$ | I-3 |
| Figure I-7: Type 3, $S_x = 0.03$ | I-4 |
| Figure I-8: Type 3, $S_x = 0.04$ | I-4 |
| Figure I-9: Type 3, $S_x = 0.05$ | I-5 |
| Figure I-10: Type 3, $S_x = 0.06$ | I-5 |
| Figure I-11: Type 5, $S_x = 0.02$ | I-6 |
| Figure I-12: Type 5, $S_x = 0.03$ | I-6 |
| Figure I-13: Type 5, $S_x = 0.04$ | I-7 |
| Figure I-14: Type 5, $S_x = 0.05$ | I-7 |
| Figure I-15: Type 5, $S_x = 0.06$ | I-8 |
| Figure I-16: Type S (Shoulder Gutter Inlet), $S_x = 0.06$ | I-8 |
| Figure I-17: Sump Conditions for Types 2, 4 & 6; $S_x = 0.02$ | I-9 |
| Figure I-18: Sump Conditions for Types 2, 4 & 6; $S_x = 0.04$ | I-10 |
| Figure I-19: Sump Conditions for Types 2, 4, 6 & S; $S_x = 0.06$ | I-11 |
| Figure I-20: Type 9 Inlet..... | I-12 |
| Figure I-21: Type 10 Inlet..... | I-12 |
| Figure I-22: Closed Flume Inlet, $S_x = 0.02$ | I-13 |
| Figure I-23: Closed Flume Inlet, $S_x = 0.03$ | I-13 |
| Figure I-24: Closed Flume Inlet, $S_x = 0.04$ | I-14 |
| Figure I-25: Closed Flume Inlet, $S_x = 0.05$ | I-14 |
| Figure I-26: Closed Flume Inlet, $S_x = 0.06$ | I-15 |
| Figure I-27: Ditch Bottom Inlets..... | I-16 |

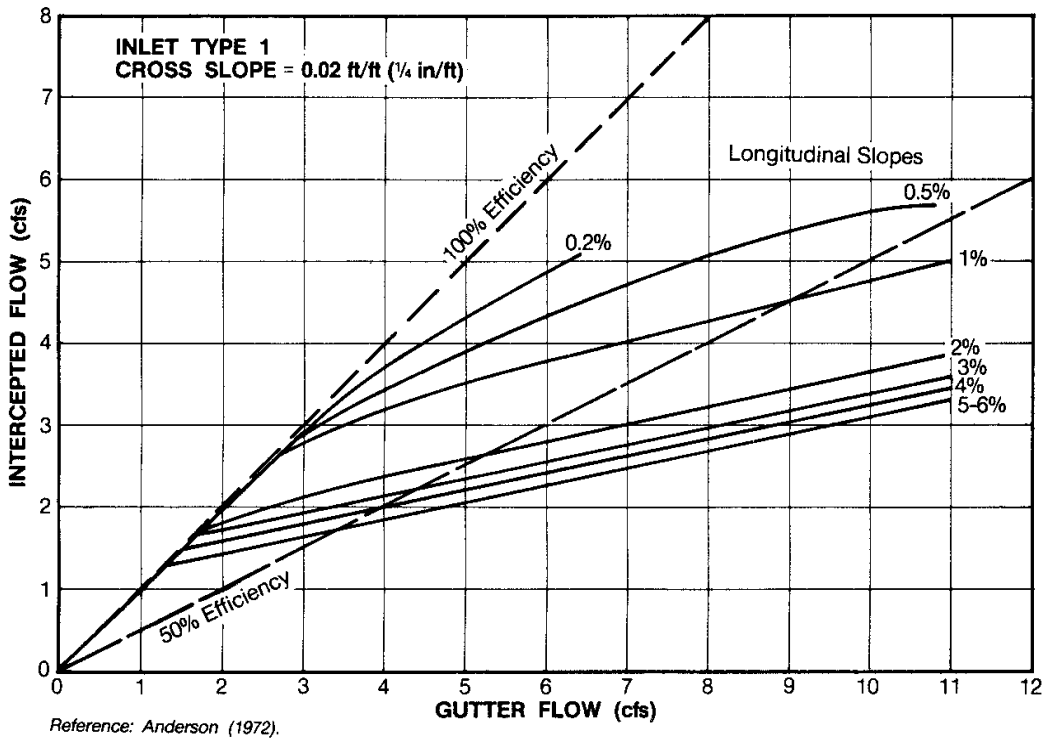

Figure I-1: Type 1, $S_x = 0.02$

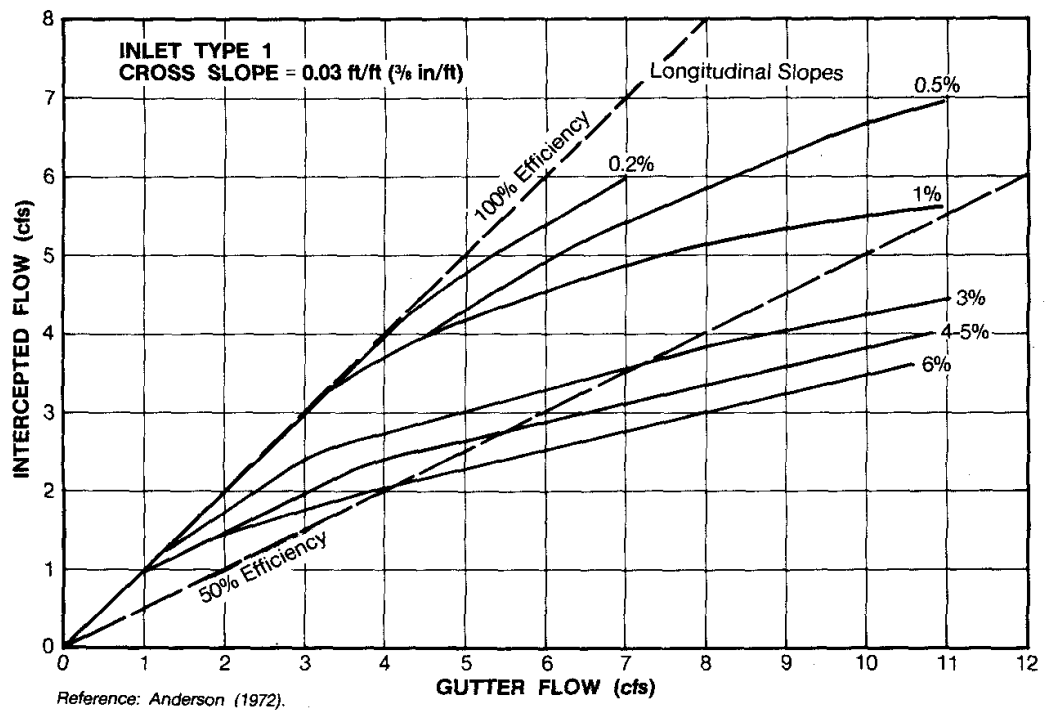

Figure I-2: Type 1, $S_x = 0.03$

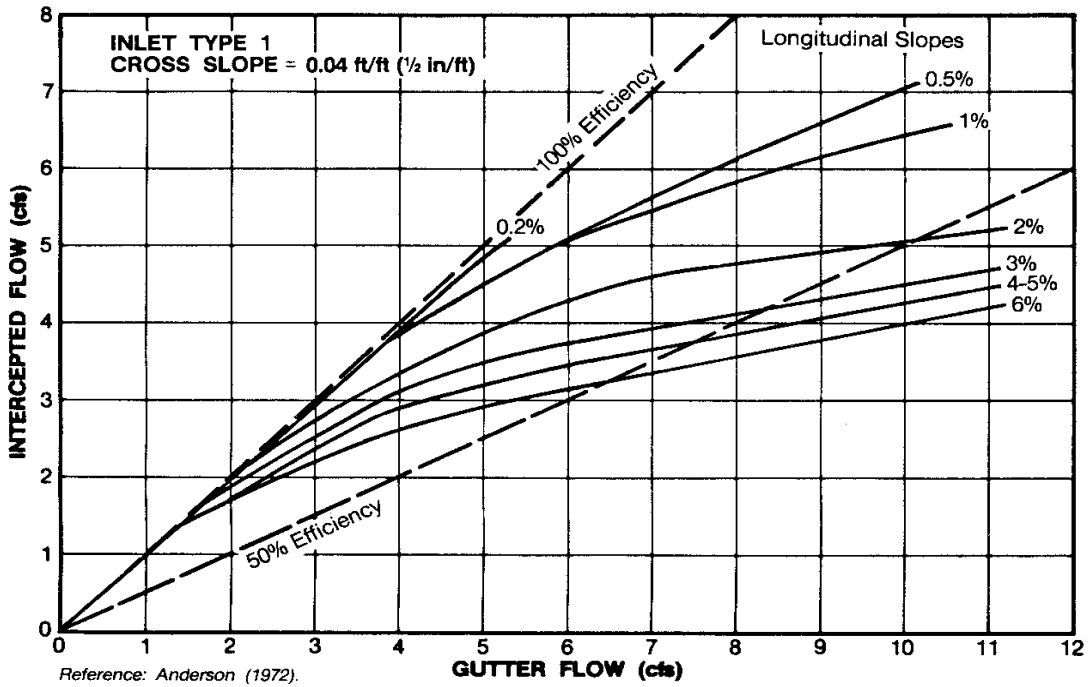

Figure I-3: Type 1, $S_x = 0.04$

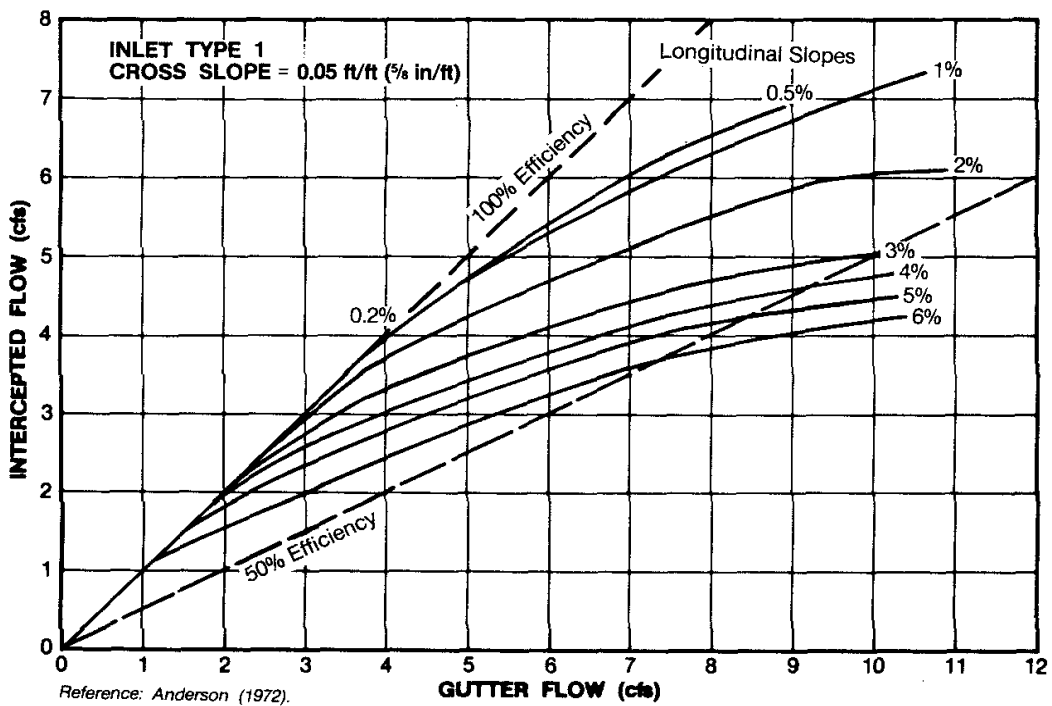

Figure I-4: Type 1, $S_x = 0.05$

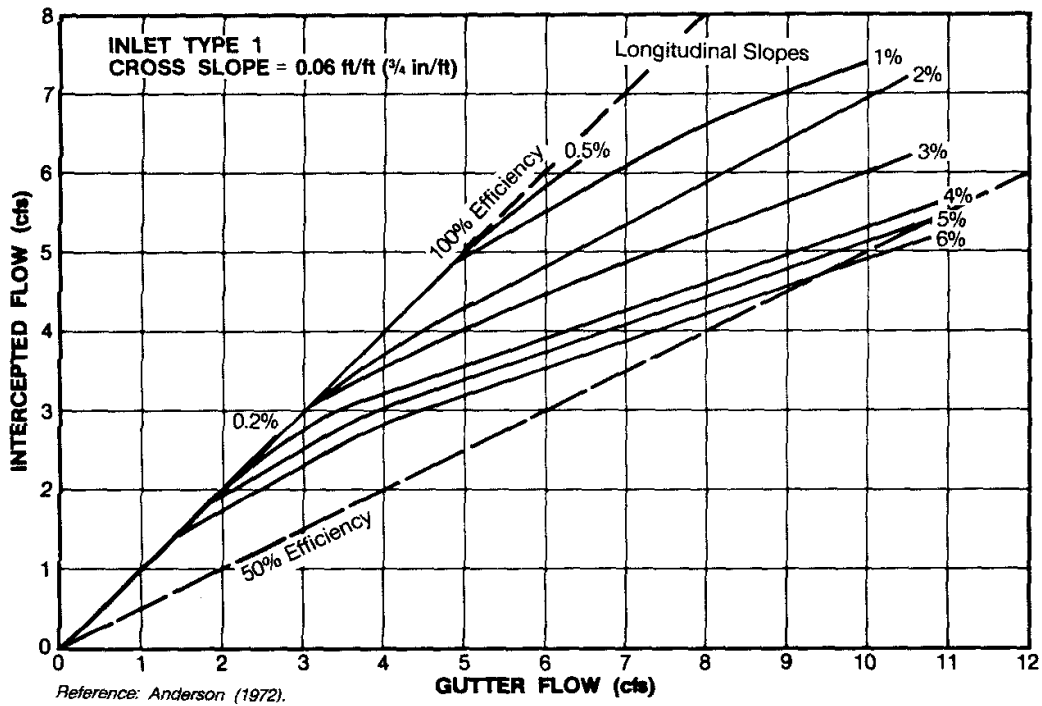

Figure I-5: Type 1, $S_x = 0.06$

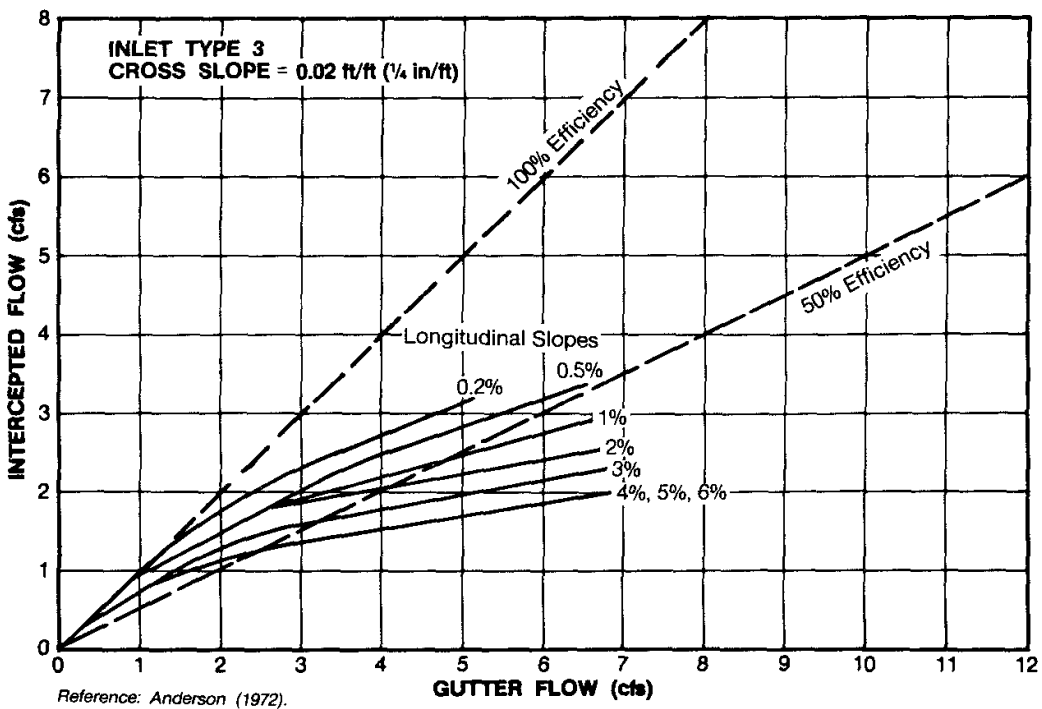

Figure I-6: Type 3, $S_x = 0.02$

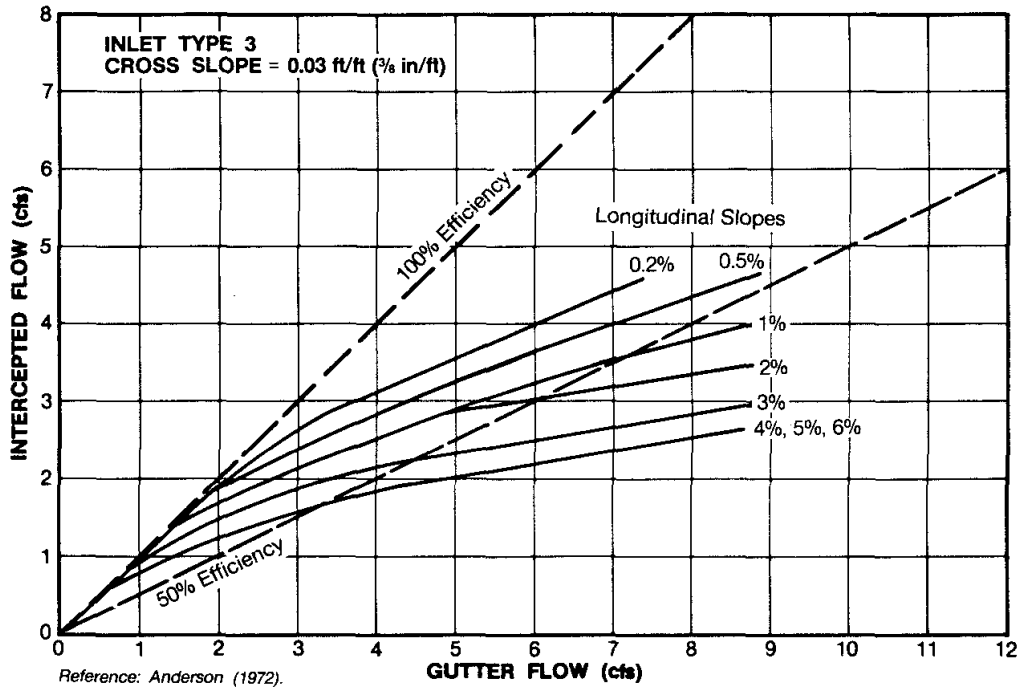

Figure I-7: Type 3, $S_x = 0.03$

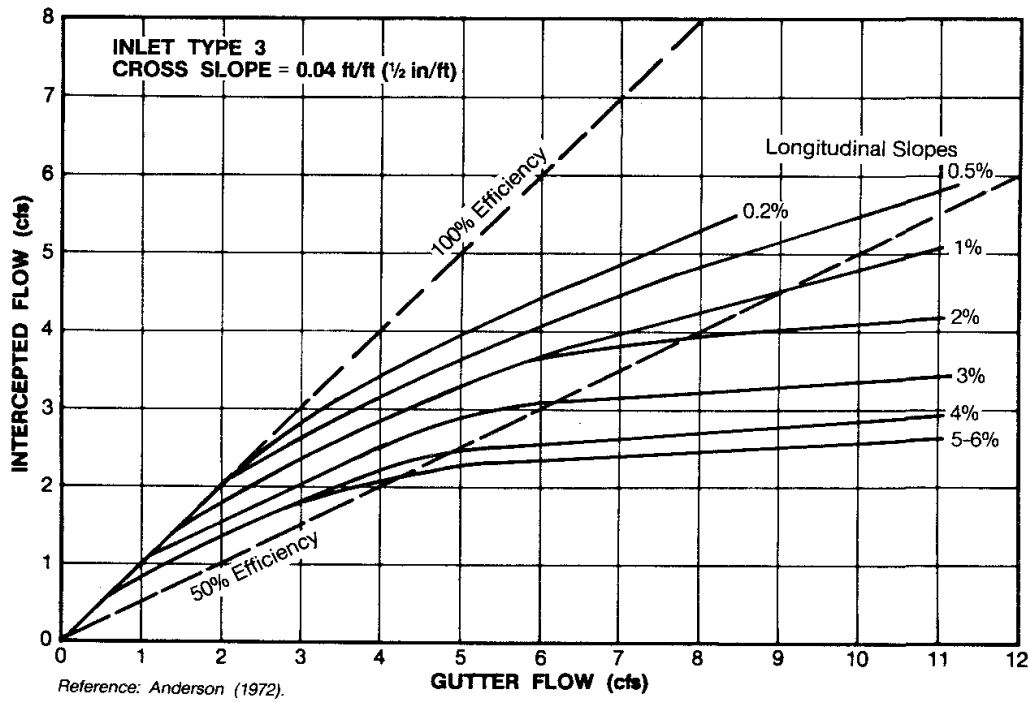

Figure I-8: Type 3, $S_x = 0.04$

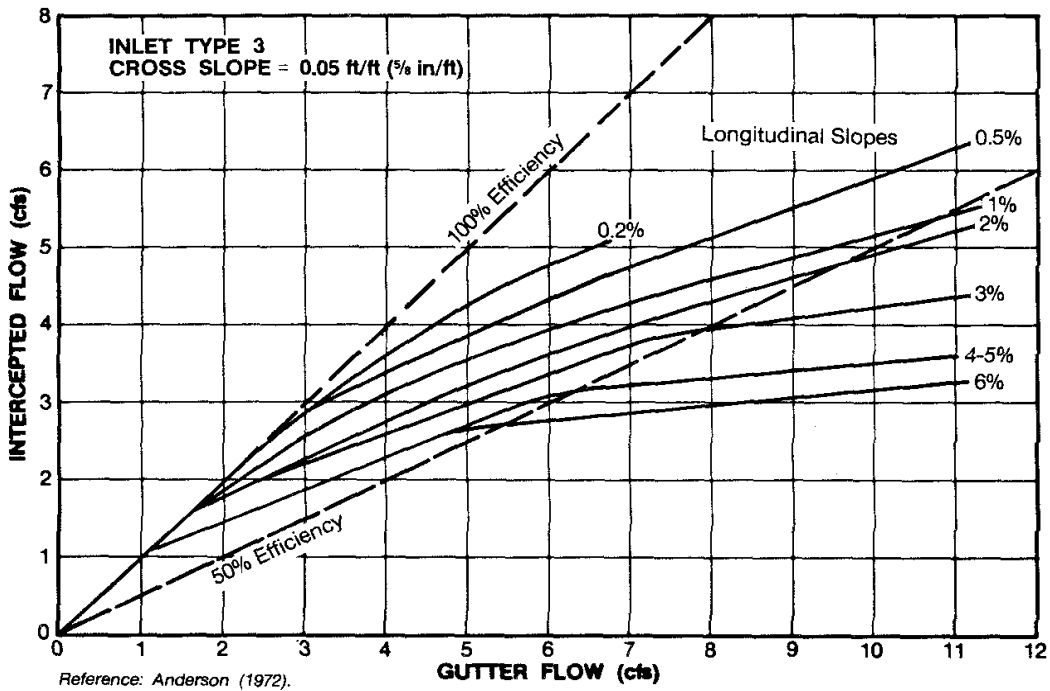

Figure I-9: Type 3, $S_x = 0.05$

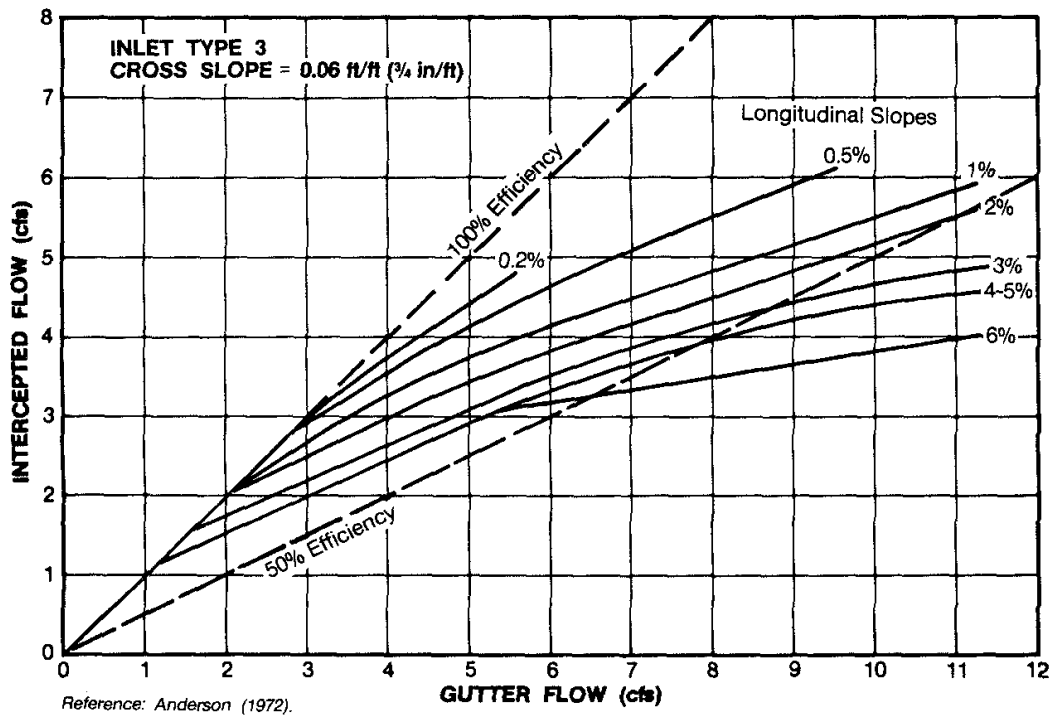

Figure I-10: Type 3, $S_x = 0.06$

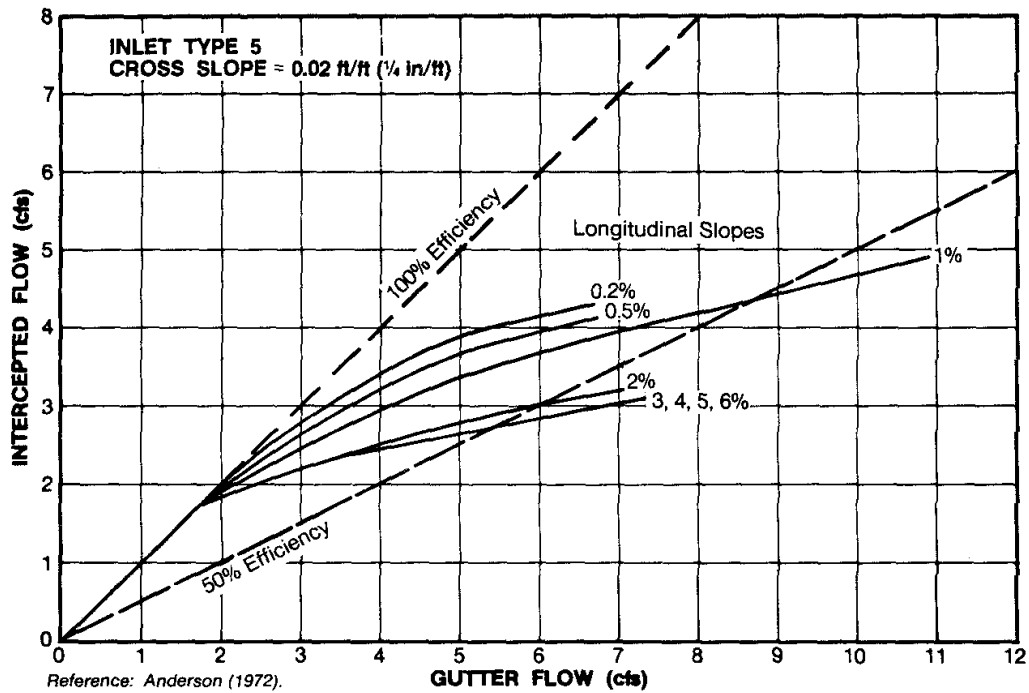

Figure I-11: Type 5, $S_x = 0.02$

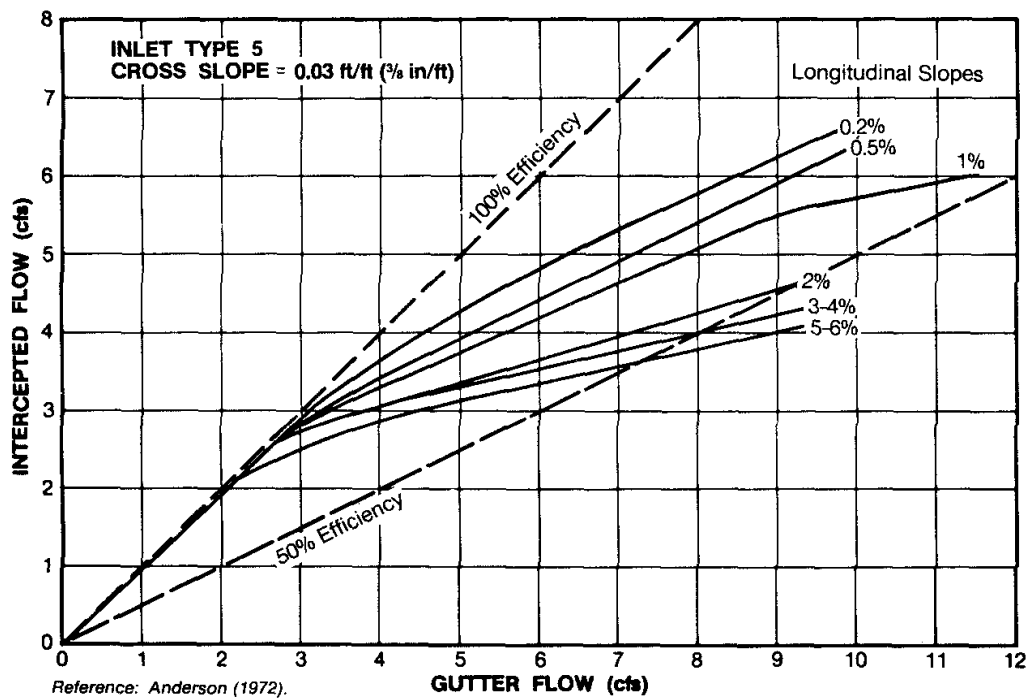

Figure I-12: Type 5, $S_x = 0.03$

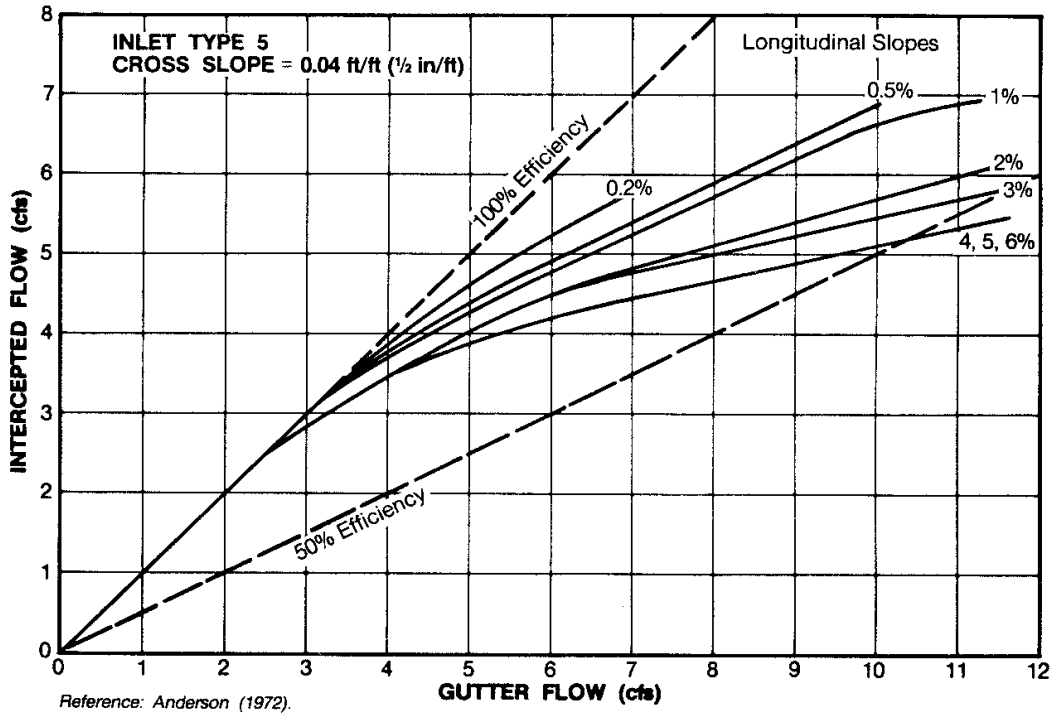

Figure I-13: Type 5, $S_x = 0.04$

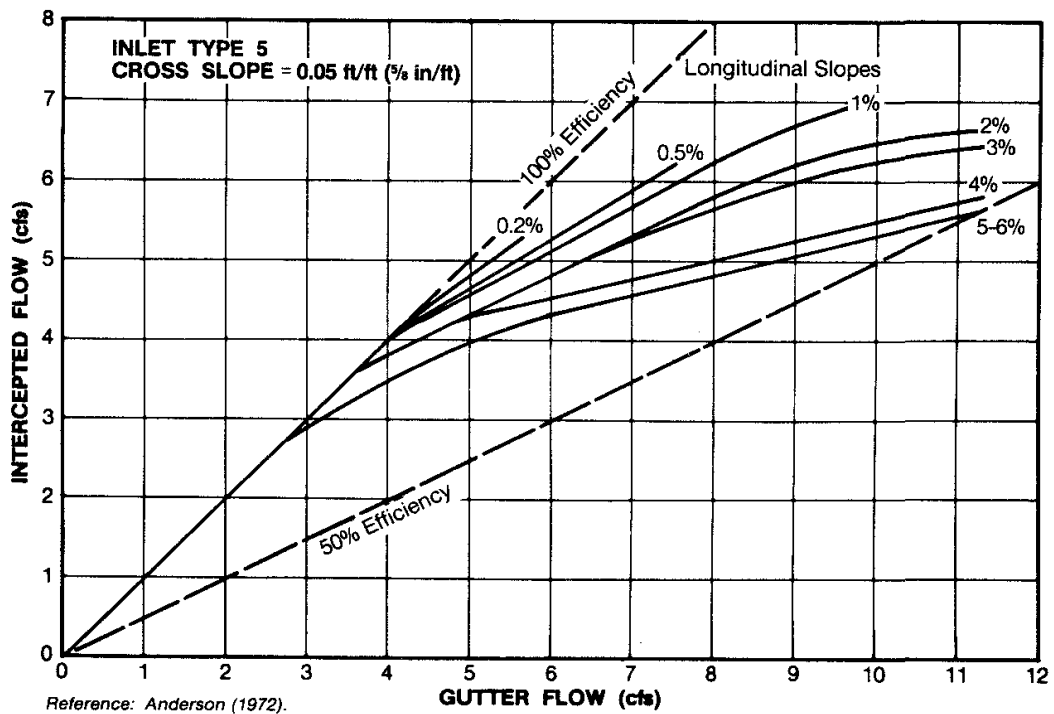

Figure I-14: Type 5, $S_x = 0.05$

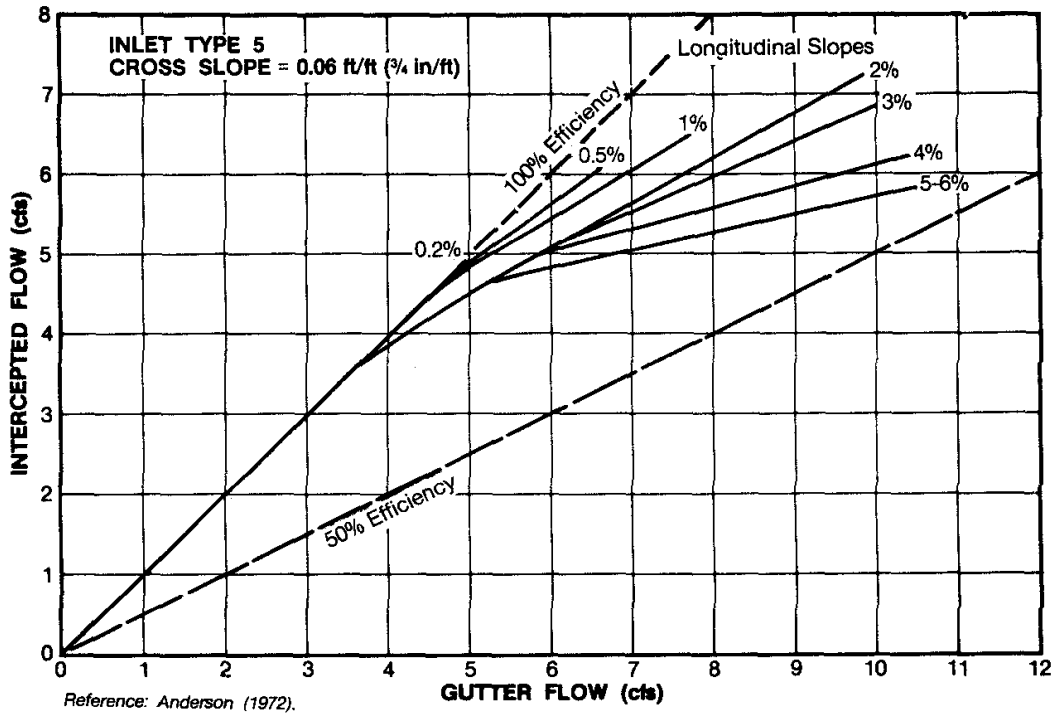

Figure I-15: Type 5, $S_x = 0.06$

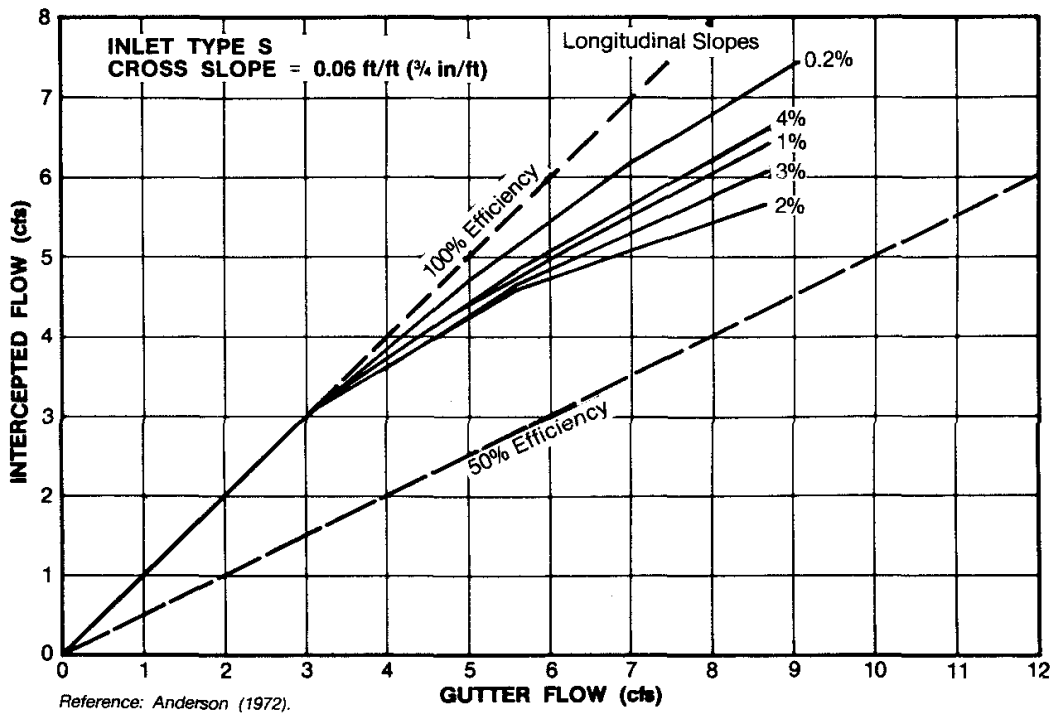

Figure I-16: Type S (Shoulder Gutter Inlet), $S_x = 0.06$

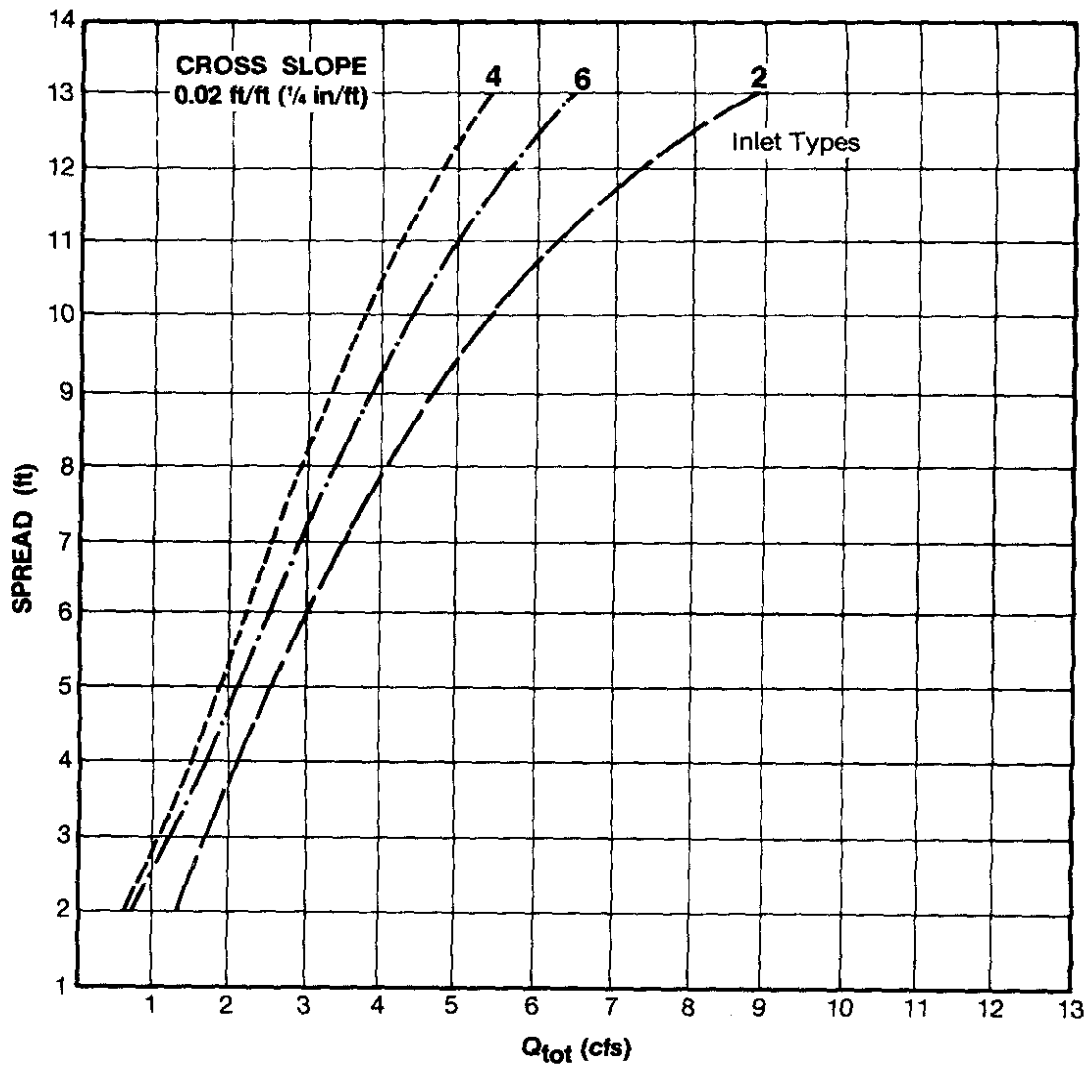

Figure I-17: Sump Conditions for Types 2, 4 & 6; $S_x = 0.02$

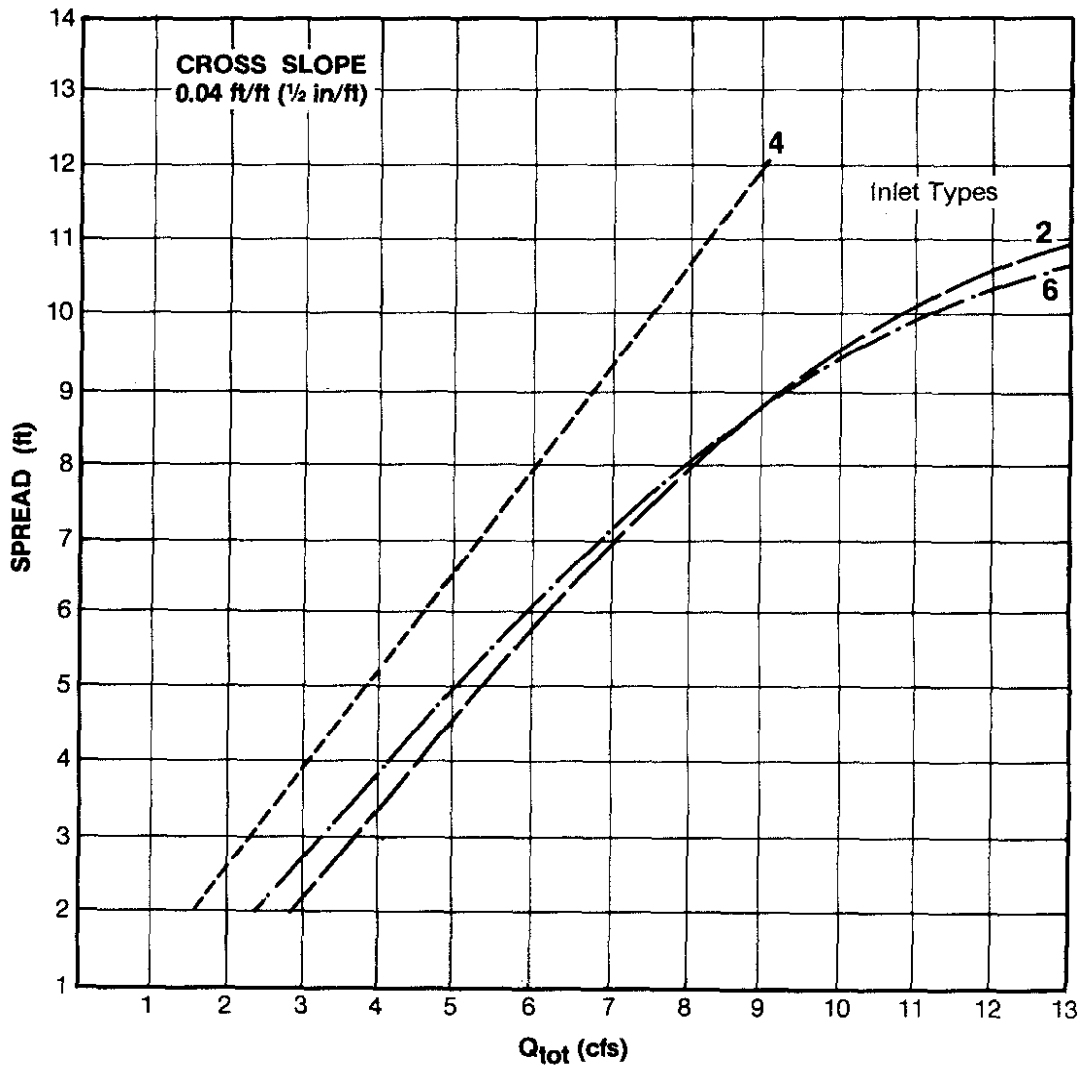

Figure I-18: Sump Conditions for Types 2, 4 & 6: $S_x = 0.04$

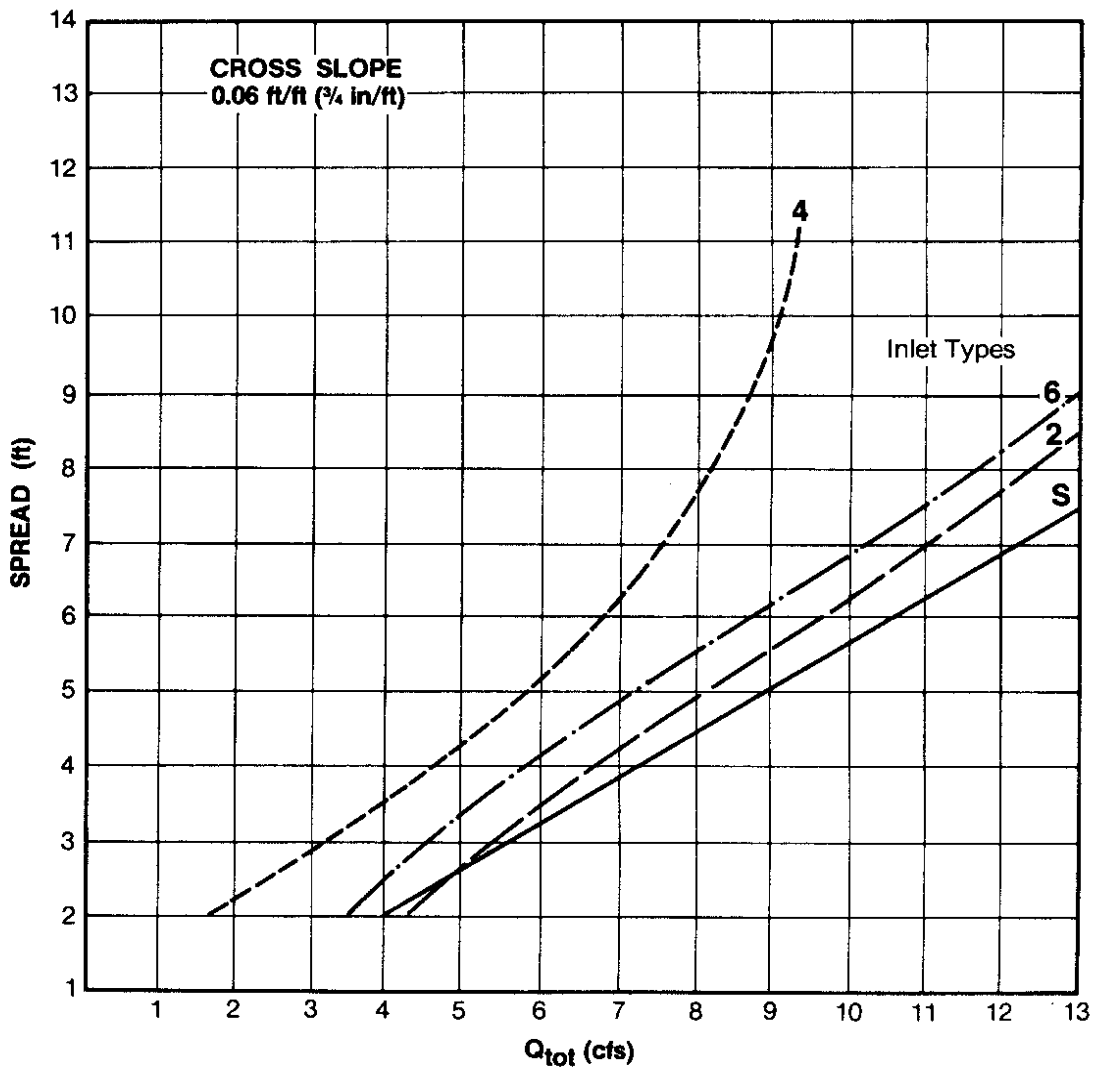

Figure I-19: Sump Conditions for Types 2, 4, 6 & S; $S_x = 0.06$

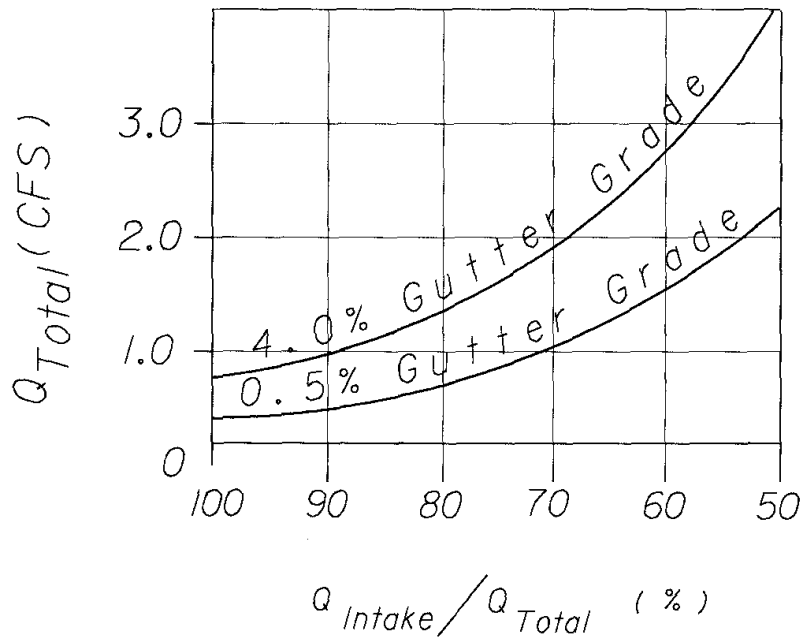

Figure I-20: Type 9 Inlet

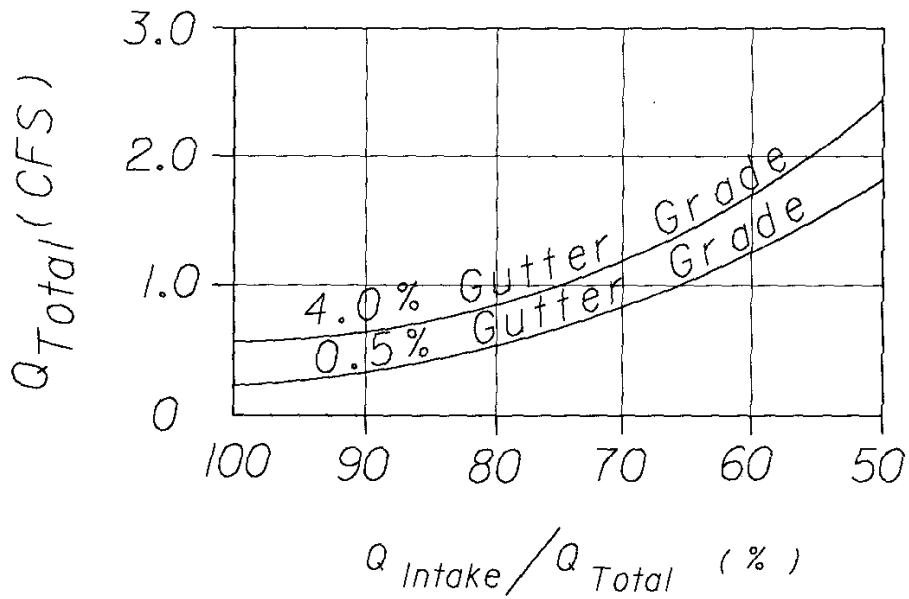
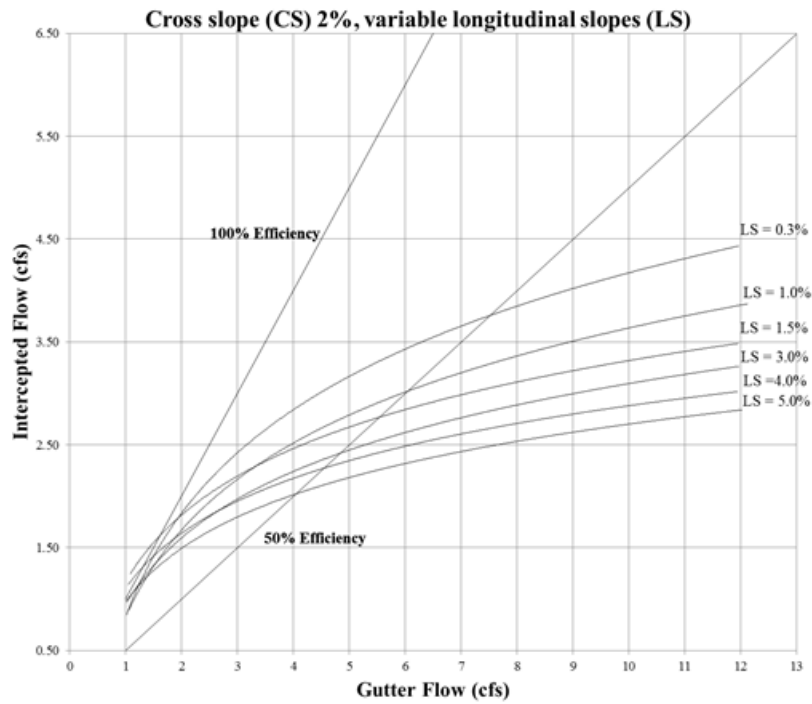
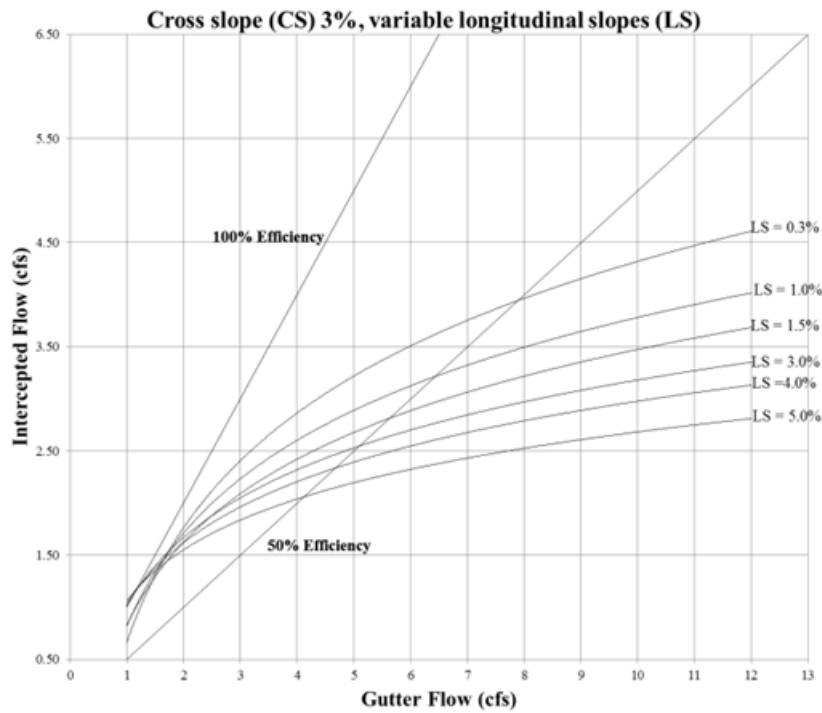

Figure I-21: Type 10 Inlet



Reference: Muste, Craig, Bayraktar

Figure I-22: Closed Flume Inlet, $S_x = 0.02$



Reference: Muste, Craig, Bayraktar

Figure I-23: Closed Flume Inlet, $S_x = 0.03$

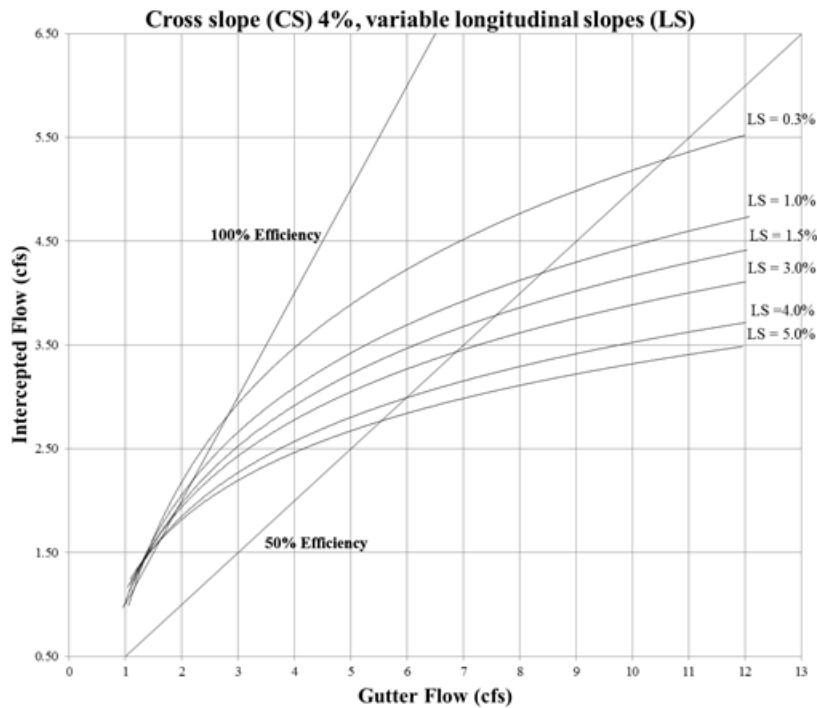

Reference: Muste, Craig, Bayraktar

Figure I-24: Closed Flume Inlet, $S_x = 0.04$

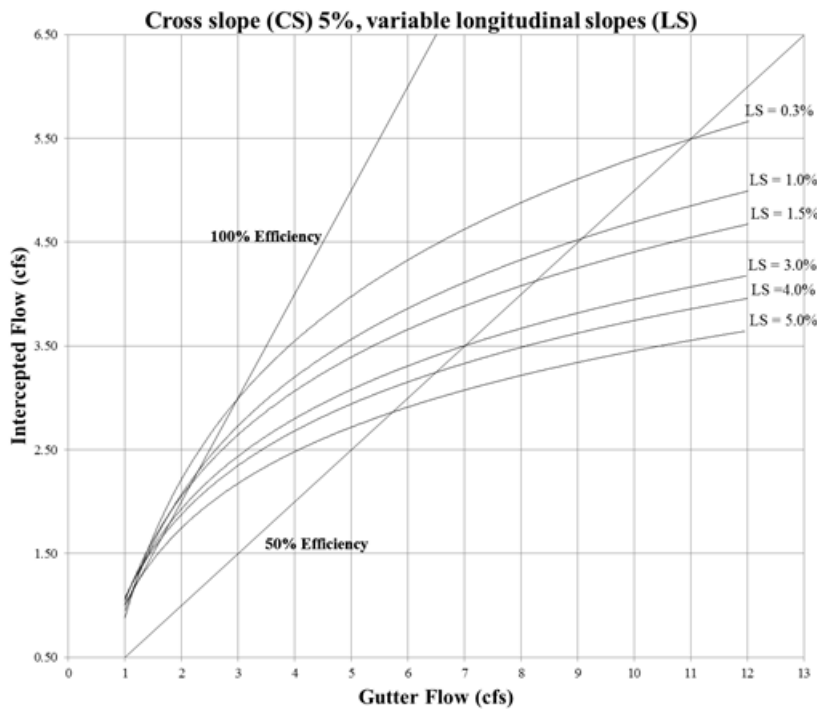

Reference: Muste, Craig, Bayraktar

Figure I-25: Closed Flume Inlet, $S_x = 0.05$

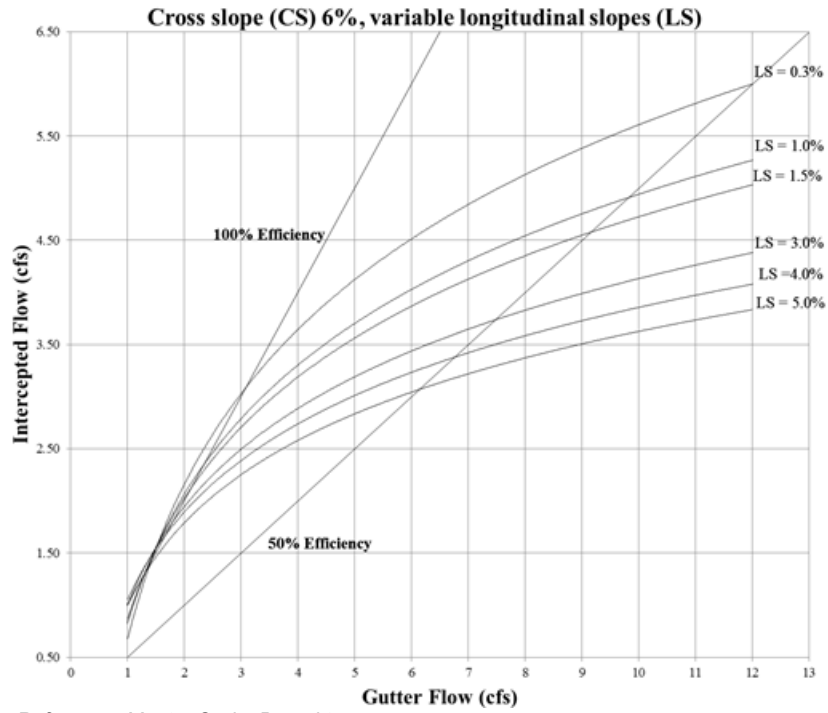
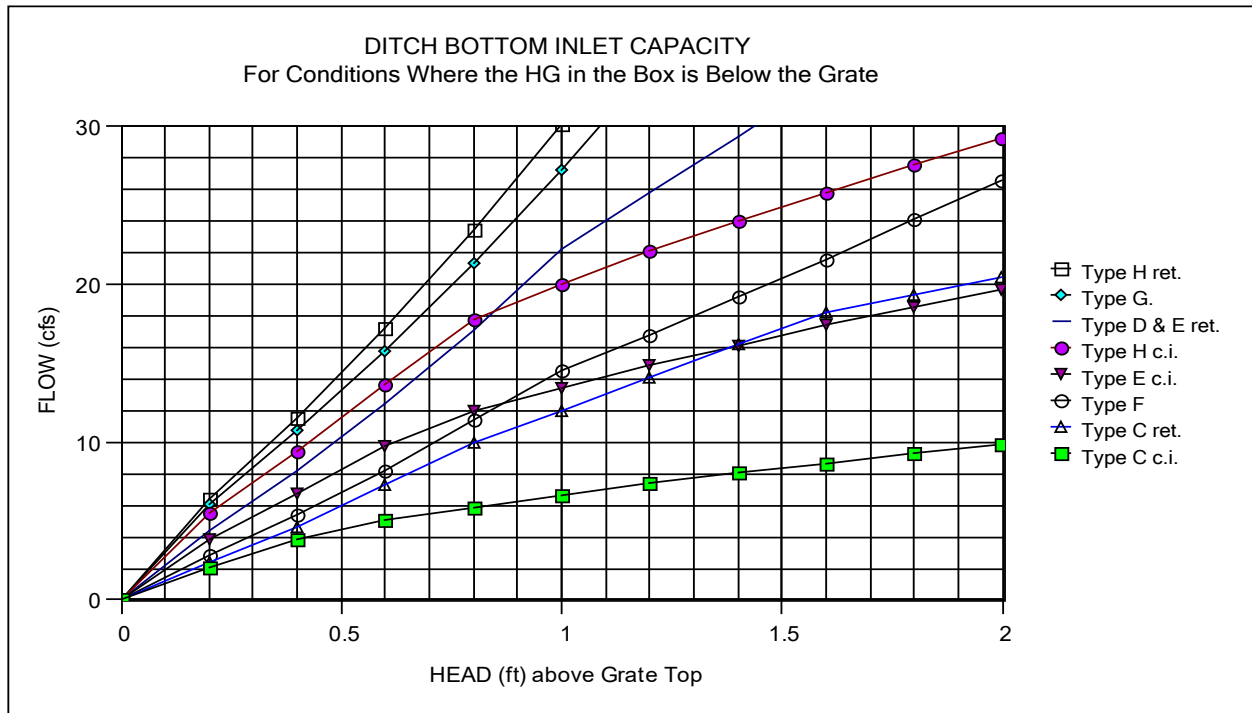

Figure I-26: Closed Flume Inlet, $S_x = 0.06$



1. The above graph should be used where the hydraulic gradient in the inlet box is below the top of the grate. For other conditions, see the discussion below.
2. The above is based on 50% debris blockage and inlets without slots.
3. The symbols on the curves do not represent-measured data points. They are calculated points from the equation and coefficients in the research report by the University of South Florida titled "Investigation of Discharge through Grated Inlets", February 1993, WPI No. 0510611. Contact the FDOT Research Center at 850-414-4615 to obtain a copy. The grate flow areas used in the equations are from U.S. Foundry & Mfg. Corp.

Figure I-27: Ditch Bottom Inlets

Where the hydraulic gradient is above the top of the grate, the system capacity may control the flow through the grate. The total system loss is a sum of friction losses and various minor losses, including the loss across the grate. In this situation, the loss across the grate is typically small but can be calculated from:

$$\text{Head Loss [feet]} = K \frac{V_g^2}{2g}$$

Where $K = 0.46$ for reticuline grates; 3.2 for cast iron grates
 $V_g =$ velocity [fps] across the grate based on the grate full face area
 (grate width x grate length)
 $g =$ acceleration of gravity

Example:

A DBI is needed to capture 5 cfs in a depressed area behind the sidewalk. The hydraulic gradient due to friction loss in the system is estimated to be 0.8 ft above the grate.

Try a Type C DBI:

$$\text{Full Face Area} = 2.33' \times 3.0' = 7.0 \text{ ft}^2,$$

$$\text{then } V_g = Q / A = 5 / 7 = 0.7 \text{ fps}$$

Assume a Cast iron grate is used. Then $K = 3.2$

$$\text{Then: Head loss} = K \times V_g^2 / 2g = 3.2 \times (0.7)^2 / 64.4 = 0.02 \text{ ft}$$

This is an insignificant amount of head loss and is typical of most design situations. Where a DBI accepts high flow rates (usually under high head conditions) as perhaps in a stormwater pond, the additional loss could be substantial and may dictate a larger inlet (large grate area.)

APPENDIX

J. EXFILTRATION DESIGN - HYDRO-GEOTECHNICAL AIDS - K FOR SATURATED AND COMPACTED LAB SOIL SPECIMENS

Table J-1: Coefficient of Permeability (k) for Saturated and Compacted Laboratory Soil Specimens

| SOIL TYPICAL NAME | SOIL CLASSIFICATION | | PERMEABILITY (ft/day) |
|--|---------------------|--------|---|
| | UNIFIED | AASHTO | |
| Well-graded gravels or gravel-sand mixtures with little or no fines | GW | A-3 | 300 to 0.3 Pervious |
| Poorly graded gravels or gravel-sand mixtures with little or no fines | GP | A-3 | 3×10^4 to 30 Very pervious |
| Silty gravels, gravel-sand-silt mixtures | GM | A-2-4 | 3 to 3×10^{-3} Semi-pervious to pervious |
| Clayey gravels, gravel-sand-clay mixtures | GC | A-2-6 | 3×10^{-3} to 3×10^{-5} Impervious |
| Well-graded sands or gravelly sands with little or no fines | SW | A-3 | 30 to 0.3 Pervious |
| Poorly graded sands or gravelly sands with little or no fines | SP | A-3 | 300 to 3 Pervious |
| Silty sands, sand-silt mixtures | SM | A-2-4 | 3 to 3×10^{-3} Semi-pervious to pervious |
| Clayey sands, sand-clay mixtures | SC | A-6 | 3×10^{-3} to 3×10^{-5} Impervious |
| Inorganic silts and very fine sands, rock flour, silty or clayey fine sands or clayey silts with slightly plasticity | ML | A-6 | 3 to 3×10^{-3} Semi-pervious to pervious |
| Inorganic clays of low to medium plasticity, gravelly clays, sandy clays, silty clays, lean clays | CL | A-7 | 3×10^{-3} to 3×10^{-5} Impervious |
| Organic silts and organic silty clays of low plasticity | OL | A-6 | 0.3 to 3×10^{-3} Semi-pervious to pervious |
| Inorganic silts, micaceous or diatomaceous fine sandy or silty soils, elastic silts | MH | A-6 | 0.03 to 3×10^{-4} Semi-pervious to pervious |
| Organic clays of high plasticity, fat clays | CH | A-8 | 3×10^{-3} to 3×10^{-6} Impervious |

NOTE: Table adapted from Drainage Manual Volume 2, FDOT 1987.

Table J-2: Coefficient of Permeability (k) for SCS Hydrological Soils

| HYDROLOGICAL SOIL CLASSIFICATION | | PERMEABILITY (ft/day) |
|----------------------------------|--|--------------------------|
| TYPE | CHARACTERISTICS | |
| A | Soils that have high infiltration rates even when thoroughly wetted and a high rate of water transmission | 60 |
| B | Soils that have moderated infiltration rates when thoroughly wetted and a moderated rate of water transmission | 48 |
| C | Soils that have slow infiltration rates when thoroughly wetted and a slow rate of water transmission | 24 |
| D | Soils having very slow infiltration rates when thoroughly wetted and a very slow rate of water transmission | 12 |
| A/D | Soils Type A under saturated natural conditions that can be adequately drained, considering that drainage is feasible and practical. | 60 |
| B/D | Soils Type B under saturated natural conditions that can be adequately drained, considering that drainage is feasible and practical. | 36 |
| C/D | Soils Type C under saturated natural conditions that can be adequately drained, considering that drainage is feasible and practical. | 12 |

NOTE: Table adapted from Applicant's Handbook: Regulation of Stormwater Management Systems. SJRWMD, 2005

APPENDIX

K. DRAINAGE WELL DESIGN – REASONABLE ASSURANCE REPORT

K. DRAINAGE WELL DESIGN – REASONABLE ASSURANCE REPORT

K.1 REASONABLE ASSURANCE REPORT

Submit a Reasonable Assurance Statement, in a report form, to the Department for review and approval.

1) The report should provide a reasonable assurance that the buoyant stormwater discharge into a Class G-III aquifer (total dissolved solids **greater** than 10,000 mg/L) via the drainage well(s) has a minimum potential to:

- i) Due to buoyancy, rise into a preferential pathway in a Class G-II aquifer system [Underground Source of Drinking Water (USDW) total dissolved solids less than 10,000 mg/L]
- ii) Impact any surface water bodies in the vicinity of the project via groundwater discharge
- iii) Cause mounding that may rise into USDW and/or manifest on a land surface as a spring due to pressurization of the wells that are located nearby or receive stormwater flow from a building roof at elevation + XXX feet.

The report should be signed and sealed by a Florida Licensed Professional Geologist/Engineer with hydro-geological expertise to:

- Document the existence of sufficient confining strata above the base of the well casing, to minimize the potential of injected buoyant stormwater to rise into a G-II aquifer system.
- Show the injected stormwater has minimum potential to impact any surface water bodies in the vicinity of the project that may be affected via groundwater discharge.
- Show the pressurization of the well due to its location at elevation + XXX feet or receiving stormwater flow from a building roof elevation + XXX feet will not cause mounding that may rise into USDW and/or manifest as a spring on a land surface.

2) The report may be submitted at this time or its submission may be deferred until the stormwater drainage well(s) construction permit has been issued. However, it must be submitted for Department review and approval prior to the Department's authorization to use the stormwater drainage well(s).

3) Indicate whether you wish to submit this report before or subsequent to Department issuance of a stormwater drainage well construction permit. The Department strongly advises the former option to most efficiently achieve the operational authorization of the well(s).

4) Note that no fluid should be discharged into the stormwater drainage well(s) without written authorization from the Department to use the well(s).

5) Issuance of a well construction permit does not obligate the Department to authorize the use of well(s), unless the well(s), information required by the permit, and this report qualifies for an authorization.

APPENDIX

L. EXFILTRATION DESIGN - SAMPLE PLANS

Drainage Design Guide
Appendix L: Exfiltration Design - Sample Plans

COMPONENTS OF CONTRACT PLANS SET

- ROADWAY PLANS
- SIGNING AND PAVEMENT MARKING PLANS
- LIGHTING PLANS
- STRUCTURE PLANS

A DETAILED INDEX APPEARS ON THE KEY SHEET OF EACH COMPONENT

INDEX OF ROADWAY PLANS

| SHEET NO. | SHEET DESCRIPTION |
|-----------|--------------------------------------|
| 1 | KEY SHEET |
| 2 - 3 | SUMMARY OF PAY ITEMS |
| 4 - 6 | DRAINAGE MAP |
| 7 - 9 | TYPICAL SECTIONS |
| 10 - 11 | SUMMARY OF QUANTITIES |
| 12 | OPTIONAL MATERIALS TABULATION |
| 13 | SUMMARY OF DRAINAGE STRUCTURES |
| 14 | GENERAL NOTES |
| 15 | LANDSCAPE RELOCATION NOTES |
| 16 - 17 | PROJECT NETWORK CONTROL PLAN |
| 18 - 24 | PROFILE (SR-9A) |
| 25 - 31 | SPECIAL PROFILE (RAMP "A") |
| 32 - 36 | DRAINAGE STRUCTURES |
| 37 | MISCELLANEOUS DRAINAGE DETAILS |
| 38 - 40 | MISCELLANEOUS DETAILS |
| 41 | ROADWAY SOIL SURVEY |
| 42 | CROSS SECTION PATTERN |
| 43 - 56 | CROSS SECTIONS |
| 57 - 59 | STORMWATER POLLUTION PREVENTION PLAN |
| 60 - 72 | TRAFFIC CONTROL PLANS |
| 73 - 79 | UTILITY ADJUSTMENTS |

GOVERNING STANDARDS AND SPECIFICATIONS:
FLORIDA DEPARTMENT OF TRANSPORTATION,
DESIGN STANDARDS DATED JANUARY 2004,
AND STANDARD SPECIFICATIONS FOR ROAD
AND BRIDGE CONSTRUCTION DATED 2004,
AS AMENDED BY CONTRACT DOCUMENTS.

APPLICABLE DESIGN STANDARDS MODIFICATIONS: 7-1-06

For Design Standards Modifications click on
"Design Standards" at the following web site:
<http://www.dot.state.fl.us/roads/pln/>

REVISIONS

STATE OF FLORIDA
DEPARTMENT OF TRANSPORTATION

CONTRACT PLANS

FINANCIAL PROJECT ID 251669-3-52-01
(FEDERAL FUNDS)
MIAMI-DADE COUNTY (87270000)
STATE ROAD NO. 9A (I-95)

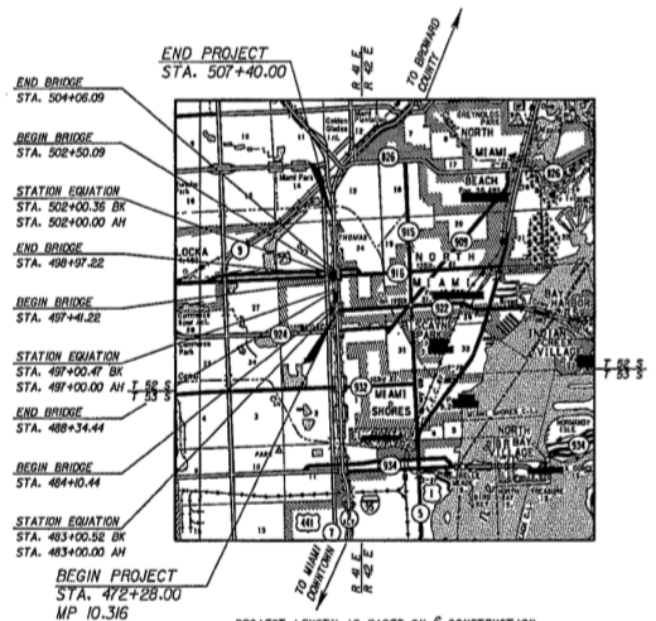
END PROJECT
STA. 507+40.00

BEGIN BRIDGE
STA. 504+06.09

BEGIN BRIDGE
STA. 502+50.09

STATION EQUATION
STA. 502+00.36 BK
STA. 502+00.00 AH

END BRIDGE
STA. 498+97.22

BEGIN BRIDGE
STA. 497+41.22

STATION EQUATION
STA. 497+00.47 BK
STA. 497+00.00 AH

END BRIDGE
STA. 488+34.44

BEGIN BRIDGE
STA. 484+10.44

STATION EQUATION
STA. 483+00.52 BK
STA. 483+00.00 AH

BEGIN PROJECT
STA. 472+28.00
MP 10.316

PROJECT LENGTH IS BASED ON E CONSTRUCTION

| LENGTH OF PROJECT | | |
|--------------------------------|----------------|--------------|
| | LINEAR FEET | MILES |
| ROADWAY | 2774.65 | 0.526 |
| BRIDGES | 736.00 | 0.139 |
| NET LENGTH OF PROJECT | 3510.65 | 0.665 |
| EXCEPTIONS | | |
| GROSS LENGTH OF PROJECT | 3510.65 | 0.665 |

KEY SHEET REVISIONS

| DATE | BY | DESCRIPTION |
|------|----|-------------|
| | | |

ROADWAY PLANS
ENGINEER OF RECORD: ROBERT T. CARBALLO, P.E.
P.E. NO. 42502

| FISCAL YEAR | SHEET NO. |
|-------------|-----------|
| 07 | 1 |

FDOT PROJECT MANAGER: JASON CHANG, P.E.

ROADWAY SHOP DRAWINGS TO BE SUBMITTED TO:

ROBERT T. CARBALLLO, P.E.
P.E. NO. 42502
CORZO CASTELLA CARBALLLO THOMPSON SALMAN, P.A.
90 PONCE DE LEON BLVD., SUITE 900
CORAL GABLES, FLORIDA 33134

PLANS PREPARED BY:



CSTB, PA
801 PONCE DE LEON BLVD., SUITE 900
CORAL GABLES, FLORIDA 33134
MIAMI (305) 448-3900 FLORIDA (800) 448-0227
CERTIFICATION OF AUTHORIZATION NO. 0004022
MEMBER IN CHARGE: ROBERT T. CARBALLLO
CONSULTANT CONTRACT NO. C-8485

NOTE: THE SCALE OF THESE PLANS MAY HAVE CHANGED DUE TO REPRODUCTION.

Drainage Design Guide
Appendix L: Exfiltration Design - Sample Plans

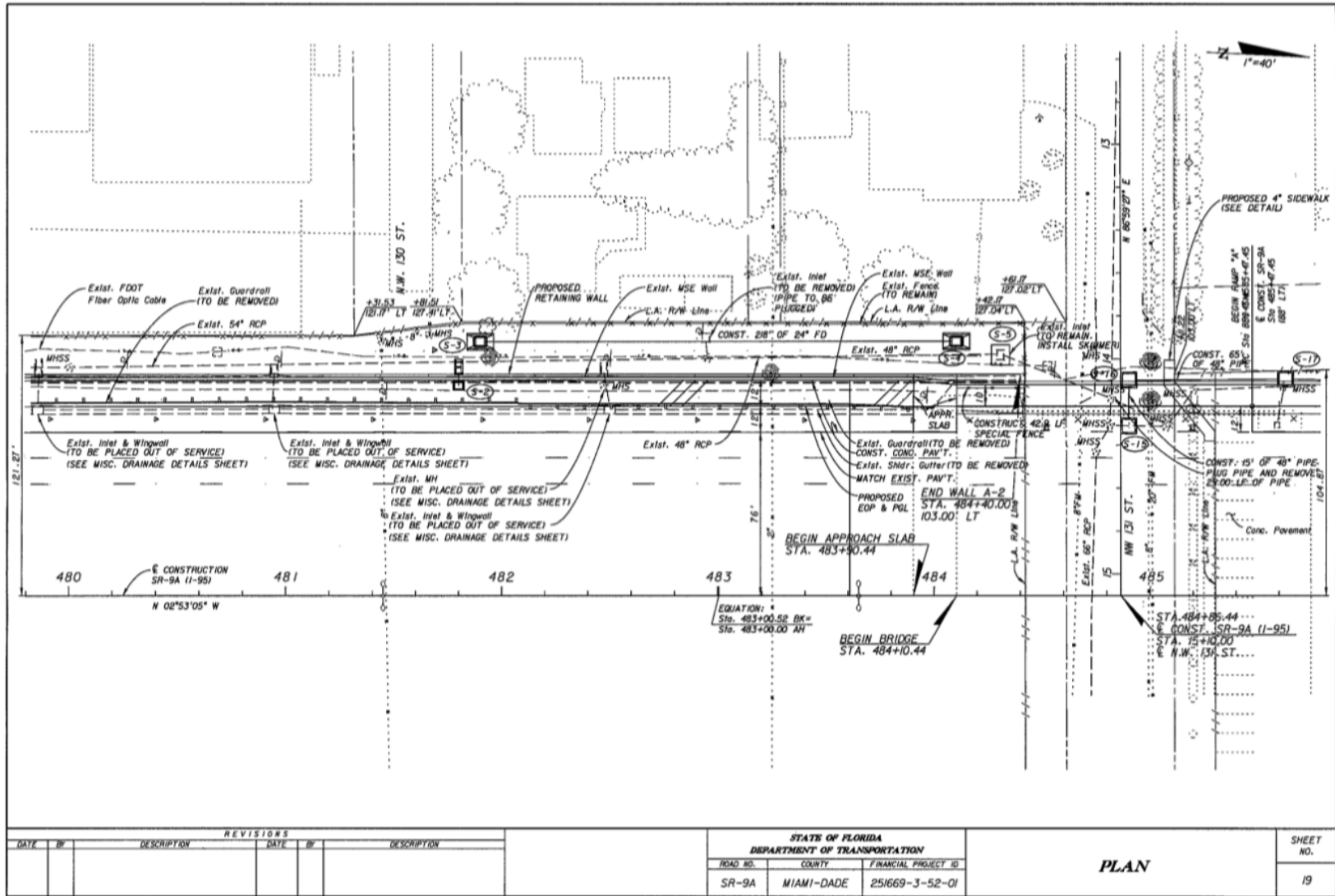

Drainage Design Guide
Appendix L: Exfiltration Design - Sample Plans

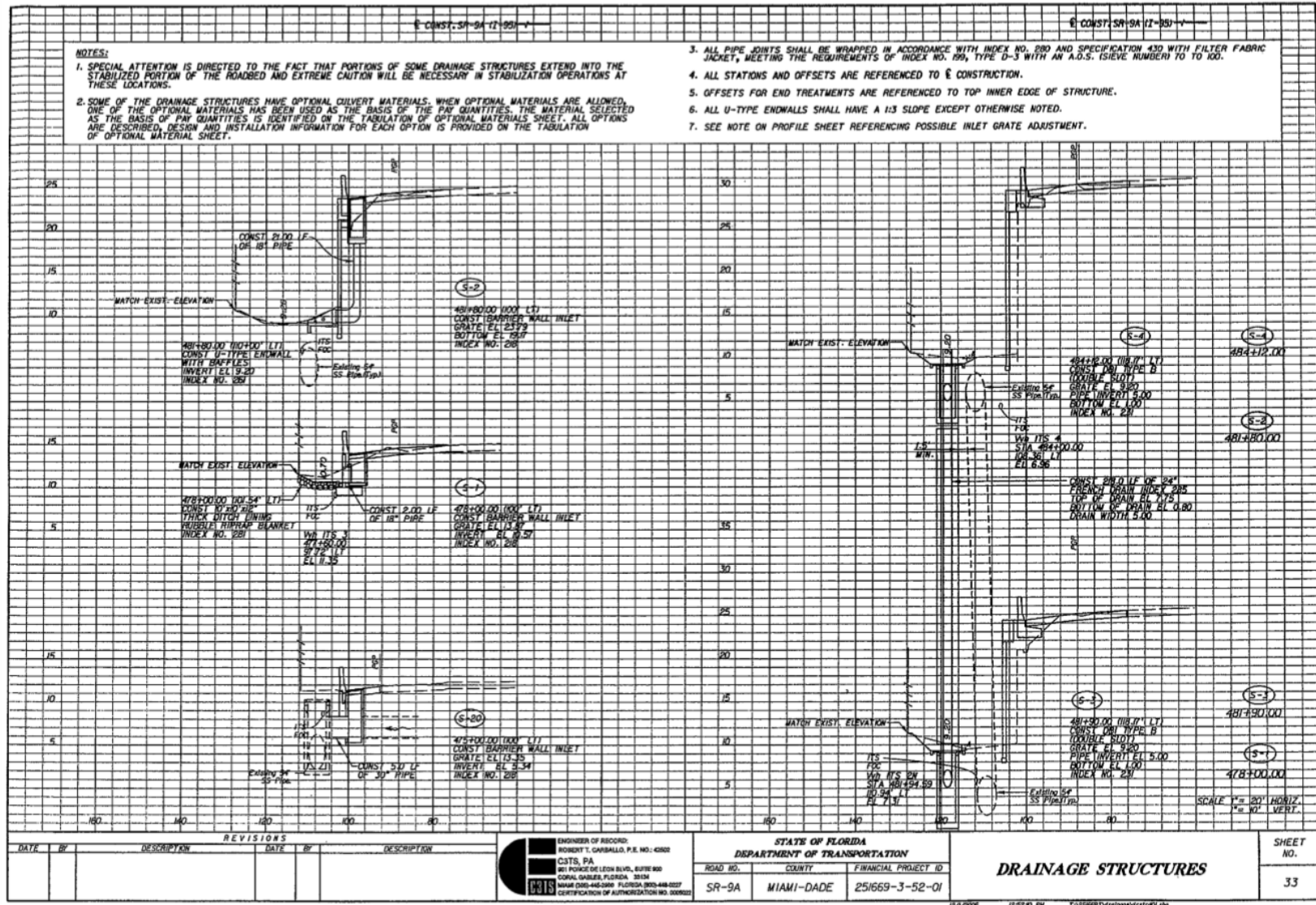

APPENDIX

M. PIPE CORROSION TABLES AND CHARTS

TABLE OF CONTENTS

| | |
|--|-----|
| Figure M-1: Estimated Service Life – 16 ga. Galvanized Steel Pipe | M-1 |
| Table M-1: Estimated Service Life – 16 ga. Galvanized Steel Pipe | M-2 |
| Figure M-2: Estimated Service Life – 16 ga. Aluminized Steel Pipe | M-3 |
| Table M-2: Estimated Service Life – 16 ga. Aluminized Steel Pipe | M-4 |
| Figure M-3: Estimated Service Life – 16 ga. Aluminum Pipe | M-5 |
| Table M-3: Estimated Service Life – 16 ga. Aluminum Pipe | M-6 |
| Figure M-4: Estimated Service Life – 60" Dia. Reinforced Concrete Pipe, S = 1500 ... | M-7 |
| Table M-4: Estimated Service Life – 60" Dia. Reinforced Concrete Pipe, S = 1500 | M-8 |

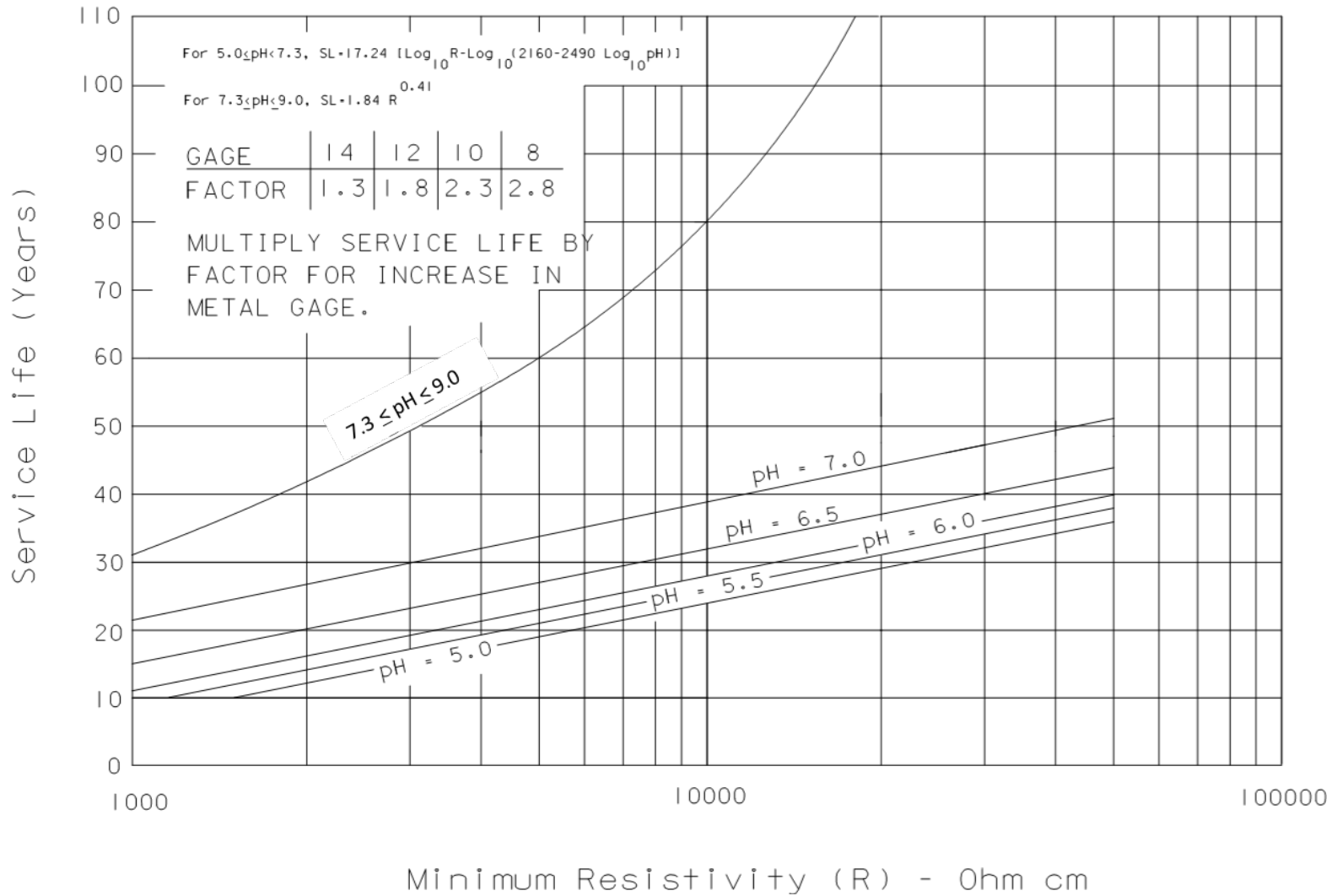

Figure M-1: Estimated Service Life – 16 ga. Galvanized Steel Pipe

Table M-1: Estimated Service Life – 16 ga. Galvanized Steel Pipe

| pH | Resistivity | | | | | | | | | | | | |
|-----------|-------------|------|------|------|------|------|------|-------|-------|-------|-------|-------|--------|
| | 1000 | 1500 | 2000 | 3000 | 4000 | 5000 | 7000 | 10000 | 15000 | 20000 | 30000 | 40000 | ≤50000 |
| 5.0 | 7 | 10 | 12 | 15 | 17 | 19 | 21 | 24 | 27 | 29 | 32 | 34 | 36 |
| 5.1 | 7 | 10 | 12 | 15 | 17 | 19 | 21 | 24 | 27 | 29 | 32 | 34 | 36 |
| 5.2 | 8 | 10 | 13 | 16 | 18 | 19 | 22 | 25 | 28 | 30 | 33 | 35 | 37 |
| 5.3 | 8 | 11 | 13 | 16 | 18 | 20 | 22 | 25 | 28 | 30 | 33 | 35 | 37 |
| 5.4 | 8 | 11 | 13 | 16 | 19 | 20 | 23 | 25 | 28 | 31 | 34 | 36 | 37 |
| 5.5 | 9 | 12 | 14 | 17 | 19 | 21 | 23 | 26 | 29 | 31 | 34 | 36 | 38 |
| 5.6 | 9 | 12 | 14 | 17 | 19 | 21 | 24 | 26 | 29 | 32 | 35 | 37 | 38 |
| 5.7 | 10 | 13 | 15 | 18 | 20 | 22 | 24 | 27 | 30 | 32 | 35 | 37 | 39 |
| 5.8 | 10 | 13 | 15 | 18 | 21 | 22 | 25 | 27 | 30 | 32 | 36 | 38 | 39 |
| 5.9 | 11 | 14 | 16 | 19 | 21 | 23 | 25 | 28 | 31 | 33 | 36 | 38 | 40 |
| 6.0 | 11 | 14 | 16 | 20 | 22 | 23 | 26 | 28 | 32 | 34 | 37 | 39 | 41 |
| 6.1 | 12 | 15 | 17 | 20 | 22 | 24 | 26 | 29 | 32 | 34 | 37 | 40 | 41 |
| 6.2 | 13 | 16 | 18 | 21 | 23 | 25 | 27 | 30 | 33 | 35 | 38 | 40 | 42 |
| 6.3 | 13 | 16 | 19 | 22 | 24 | 25 | 28 | 31 | 34 | 36 | 39 | 41 | 43 |
| 6.4 | 14 | 17 | 19 | 22 | 24 | 26 | 29 | 31 | 34 | 36 | 40 | 42 | 43 |
| 6.5 | 15 | 18 | 20 | 23 | 25 | 27 | 30 | 32 | 35 | 37 | 40 | 43 | 44 |
| 6.6 | 16 | 19 | 21 | 24 | 26 | 28 | 31 | 33 | 36 | 38 | 41 | 44 | 45 |
| 6.7 | 17 | 20 | 22 | 25 | 27 | 29 | 32 | 34 | 37 | 39 | 42 | 45 | 46 |
| 6.8 | 18 | 21 | 23 | 26 | 29 | 30 | 33 | 36 | 39 | 41 | 44 | 46 | 48 |
| 6.9 | 20 | 23 | 25 | 28 | 30 | 32 | 34 | 37 | 40 | 42 | 45 | 47 | 49 |
| 7.0 | 22 | 25 | 27 | 30 | 32 | 34 | 36 | 39 | 42 | 44 | 47 | 49 | 51 |
| 7.1 | 24 | 27 | 29 | 32 | 34 | 36 | 39 | 41 | 44 | 46 | 50 | 52 | 53 |
| 7.2 | 28 | 31 | 33 | 36 | 38 | 40 | 42 | 45 | 48 | 50 | 53 | 55 | 57 |
| 7.3 | 34 | 37 | 39 | 42 | 45 | 46 | 49 | 52 | 54 | 57 | 60 | 61 | 64 |
| 7.4 - 9.0 | 34 | 37 | 42 | 49 | 55 | 60 | 69 | 80 | 95 | 107 | 126 | 142 | 155 |

Estimated Service Life: $(SL) = 17.24\{\text{Log}_{10}R - \text{Log}_{10}[2160-2490(\text{Log}_{10}\text{pH})]\}$ for $5 \leq \text{pH} \leq 7.3$
 $(SL) = 1.84 R^{0.41}$ for $7.3 \leq \text{pH} \leq 9$

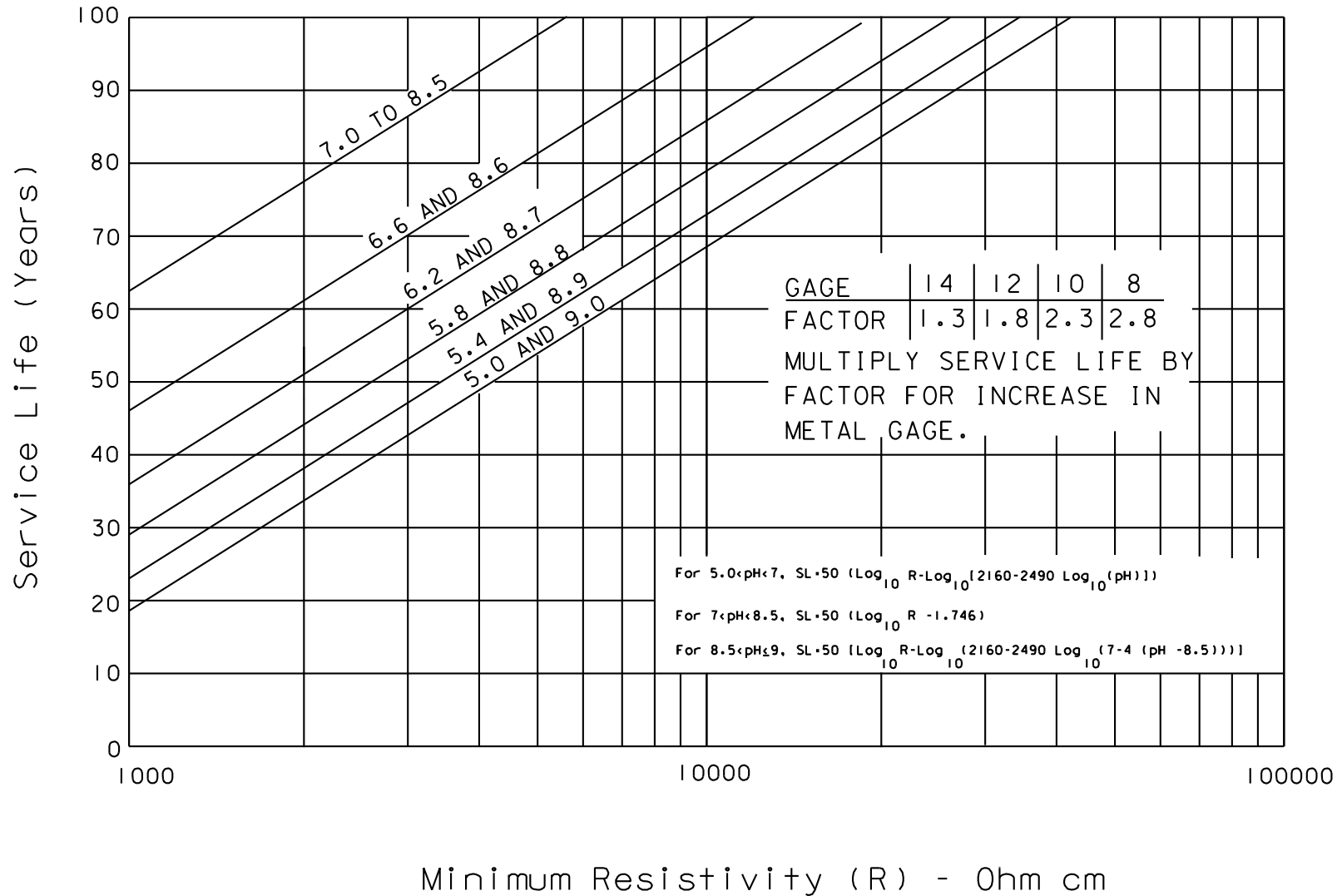

Figure M-2: Estimated Service Life – 16 ga. Aluminized Steel Pipe

Table M-2: Estimated Service Life – 16 ga. Aluminized Steel Pipe

| pH | Resistivity | | | | | | | | | | | | |
|------------|-------------|------|------|------|------|------|------|-------|-------|-------|-------|-------|--------|
| | 1000 | 1500 | 2000 | 3000 | 4000 | 5000 | 7000 | 10000 | 15000 | 20000 | 30000 | 40000 | ≤50000 |
| 5.0 | 19 | 28 | 34 | 43 | 49 | 54 | 61 | 69 | 78 | 84 | 93 | 99 | 104 |
| 5.1 | 20 | 29 | 35 | 44 | 50 | 55 | 62 | 70 | 79 | 85 | 94 | 100 | 105 |
| 5.2 | 21 | 30 | 36 | 45 | 51 | 56 | 63 | 71 | 80 | 86 | 95 | 101 | 106 |
| 5.3 | 22 | 31 | 37 | 46 | 52 | 57 | 65 | 72 | 81 | 87 | 96 | 102 | 107 |
| 5.4 | 24 | 32 | 39 | 48 | 54 | 59 | 66 | 74 | 82 | 89 | 98 | 104 | 109 |
| 5.5 | 25 | 34 | 40 | 49 | 55 | 60 | 67 | 75 | 84 | 90 | 99 | 105 | 110 |
| 5.6 | 26 | 35 | 41 | 50 | 56 | 61 | 69 | 76 | 85 | 91 | 100 | 106 | 111 |
| 5.7 | 28 | 37 | 43 | 52 | 58 | 63 | 70 | 78 | 87 | 93 | 102 | 108 | 113 |
| 5.8 | 29 | 38 | 44 | 53 | 59 | 64 | 72 | 79 | 88 | 94 | 103 | 109 | 114 |
| 5.9 | 31 | 40 | 46 | 55 | 61 | 66 | 73 | 81 | 90 | 96 | 105 | 111 | 116 |
| 6.0 | 33 | 41 | 48 | 56 | 63 | 68 | 75 | 83 | 91 | 98 | 106 | 113 | 118 |
| 6.1 | 34 | 43 | 50 | 58 | 65 | 69 | 77 | 84 | 93 | 100 | 108 | 115 | 119 |
| 6.2 | 36 | 45 | 51 | 60 | 67 | 71 | 79 | 86 | 95 | 101 | 110 | 116 | 121 |
| 6.3 | 38 | 47 | 54 | 62 | 69 | 73 | 81 | 88 | 97 | 104 | 112 | 119 | 123 |
| 6.4 | 41 | 50 | 56 | 65 | 71 | 76 | 83 | 91 | 100 | 106 | 115 | 121 | 126 |
| 6.5 | 43 | 52 | 58 | 67 | 73 | 78 | 86 | 93 | 102 | 108 | 117 | 123 | 128 |
| 6.6 | 46 | 55 | 61 | 70 | 76 | 81 | 88 | 96 | 105 | 111 | 120 | 126 | 131 |
| 6.7 | 49 | 58 | 64 | 73 | 79 | 84 | 92 | 99 | 108 | 114 | 123 | 129 | 134 |
| 6.8 | 53 | 62 | 68 | 77 | 83 | 88 | 95 | 103 | 112 | 118 | 127 | 133 | 138 |
| 6.9 | 57 | 66 | 72 | 81 | 87 | 92 | 100 | 107 | 116 | 122 | 131 | 137 | 142 |
| 7.0 to 8.5 | 63 | 72 | 78 | 87 | 93 | 98 | 105 | 113 | 122 | 128 | 137 | 143 | 148 |
| 8.6 | 46 | 55 | 61 | 70 | 76 | 81 | 88 | 96 | 105 | 111 | 120 | 126 | 131 |
| 8.7 | 36 | 45 | 51 | 60 | 67 | 71 | 79 | 86 | 95 | 101 | 110 | 116 | 121 |
| 8.8 | 29 | 38 | 44 | 53 | 59 | 64 | 72 | 79 | 88 | 94 | 103 | 109 | 114 |
| 8.9 | 24 | 32 | 39 | 48 | 54 | 59 | 66 | 74 | 82 | 89 | 98 | 104 | 109 |
| 9.0 | 19 | 28 | 34 | 43 | 49 | 54 | 61 | 69 | 78 | 84 | 93 | 99 | 104 |

Estimated Service Life (SL) = 50{Log₁₀R - Log₁₀[2160 - 2490(Log₁₀pH)]} for 5.0 ≤pH<7.0
 (SL) = 50(Log₁₀R - 1.746) for 7.0 ≤pH ≤8.5
 (SL) = 50{Log₁₀R - Log₁₀{2160 - 2490 Log₁₀[7 - 4(pH - 8.5)]}} for 8.5<pH ≤9.0

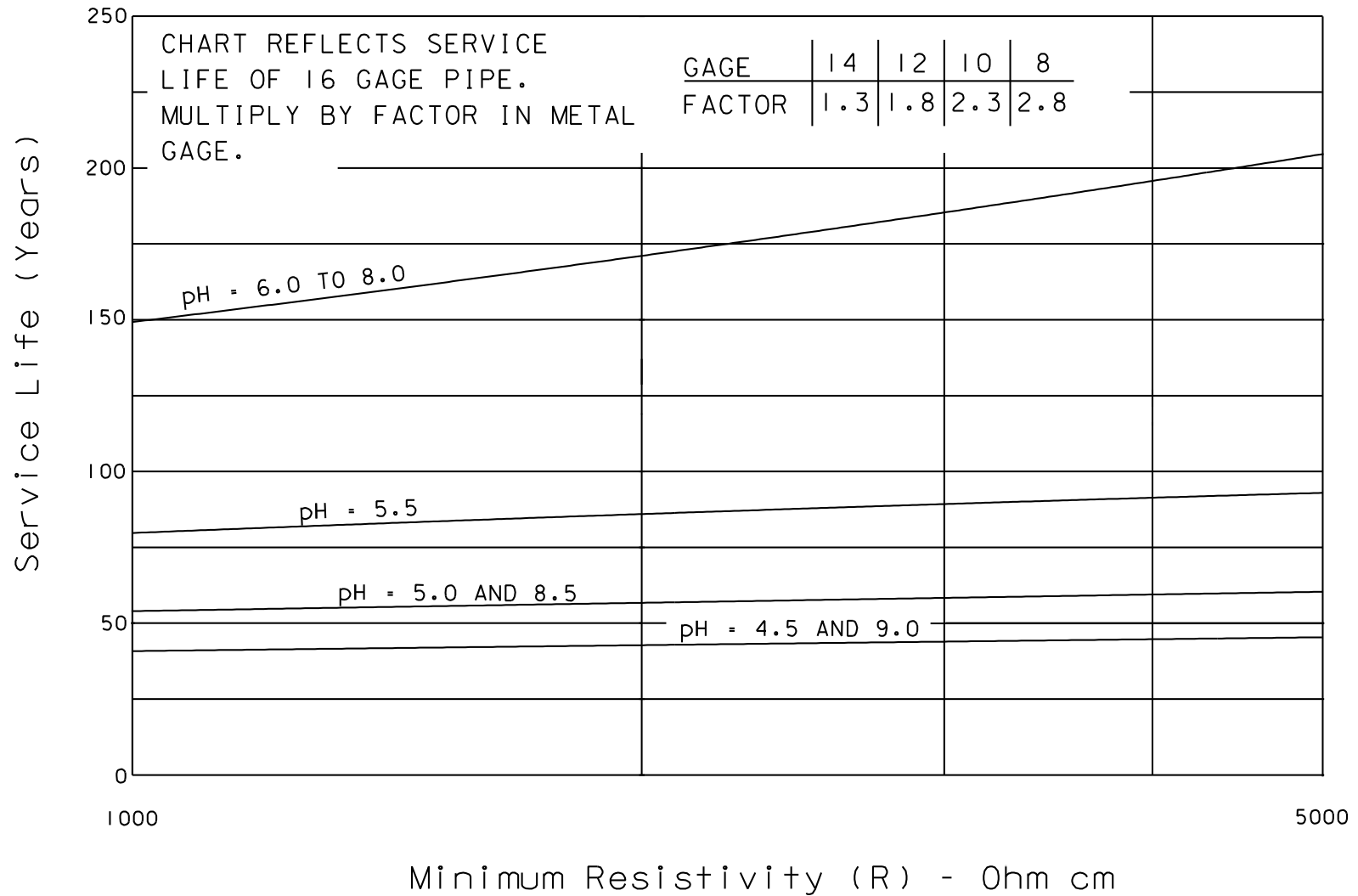

Figure M-3: Estimated Service Life – 16 ga. Aluminum Pipe

Table M-3: Estimated Service Life – 16 ga. Aluminum Pipe

| pH | Resistivity | | | | | | | | | | | | | | | |
|-------------|-------------|-----|-----|-----|------|------|------|------|------|------|------|------|------|------|------|-------|
| | ≥200 | 400 | 600 | 800 | 1000 | 1200 | 1400 | 1600 | 1800 | 2000 | 2300 | 2700 | 3200 | 3800 | 4500 | ≤5000 |
| 4.5 & 9.0 | 36 | 39 | 40 | 41 | 41 | 42 | 42 | 42 | 43 | 43 | 43 | 43 | 44 | 44 | 44 | 45 |
| 4.6 & 8.9 | 38 | 41 | 42 | 43 | 43 | 44 | 44 | 45 | 45 | 45 | 45 | 46 | 46 | 47 | 47 | 48 |
| 4.7 & 8.8 | 40 | 43 | 44 | 45 | 46 | 46 | 47 | 47 | 47 | 48 | 48 | 48 | 49 | 49 | 50 | 51 |
| 4.8 & 8.7 | 42 | 45 | 46 | 48 | 48 | 49 | 49 | 50 | 50 | 50 | 51 | 51 | 52 | 52 | 53 | 54 |
| 4.9 & 8.6 | 44 | 48 | 49 | 50 | 51 | 52 | 52 | 53 | 53 | 54 | 54 | 55 | 55 | 56 | 56 | 57 |
| 5.0 & 8.5 | 46 | 50 | 52 | 53 | 54 | 55 | 56 | 56 | 57 | 57 | 58 | 58 | 59 | 59 | 60 | 61 |
| 5.1 | 49 | 53 | 56 | 57 | 58 | 59 | 60 | 60 | 61 | 61 | 62 | 62 | 63 | 64 | 65 | 66 |
| 5.2 & 8.4 | 52 | 57 | 59 | 61 | 62 | 63 | 64 | 65 | 65 | 66 | 67 | 67 | 68 | 69 | 70 | 71 |
| 5.3 | 55 | 61 | 64 | 66 | 67 | 68 | 69 | 70 | 71 | 71 | 72 | 73 | 74 | 75 | 76 | 77 |
| 5.4 & 8.3 | 59 | 66 | 69 | 71 | 73 | 74 | 75 | 76 | 77 | 78 | 79 | 80 | 81 | 82 | 83 | 84 |
| 5.5 | 63 | 71 | 75 | 78 | 80 | 81 | 83 | 84 | 85 | 86 | 87 | 88 | 90 | 91 | 92 | 93 |
| 5.6 & 8.2 | 68 | 78 | 82 | 85 | 88 | 90 | 91 | 93 | 94 | 95 | 97 | 98 | 100 | 102 | 104 | 105 |
| 5.7 | 74 | 85 | 91 | 95 | 98 | 100 | 102 | 104 | 106 | 107 | 109 | 111 | 113 | 116 | 118 | 119 |
| 5.8 & 8.1 | 81 | 95 | 102 | 107 | 110 | 114 | 116 | 119 | 121 | 122 | 125 | 128 | 131 | 134 | 137 | 138 |
| 5.9 | 89 | 107 | 115 | 122 | 127 | 131 | 134 | 138 | 140 | 143 | 146 | 150 | 154 | 158 | 163 | 165 |
| ≥6.0 & ≤8.0 | 100 | 122 | 133 | 142 | 149 | 154 | 159 | 164 | 168 | 171 | 176 | 182 | 188 | 194 | 200 | 204 |

Where:

SL = Years to first perforation

T_p = Thickness of pipe (inches)

R_{pH} = Corrosion rate for pH (inches/year)

R_r = Corrosion rate for resistivity (inches/year)

$$\text{Service Life (SL)} = T_p / (R_{pH} + R_r)$$

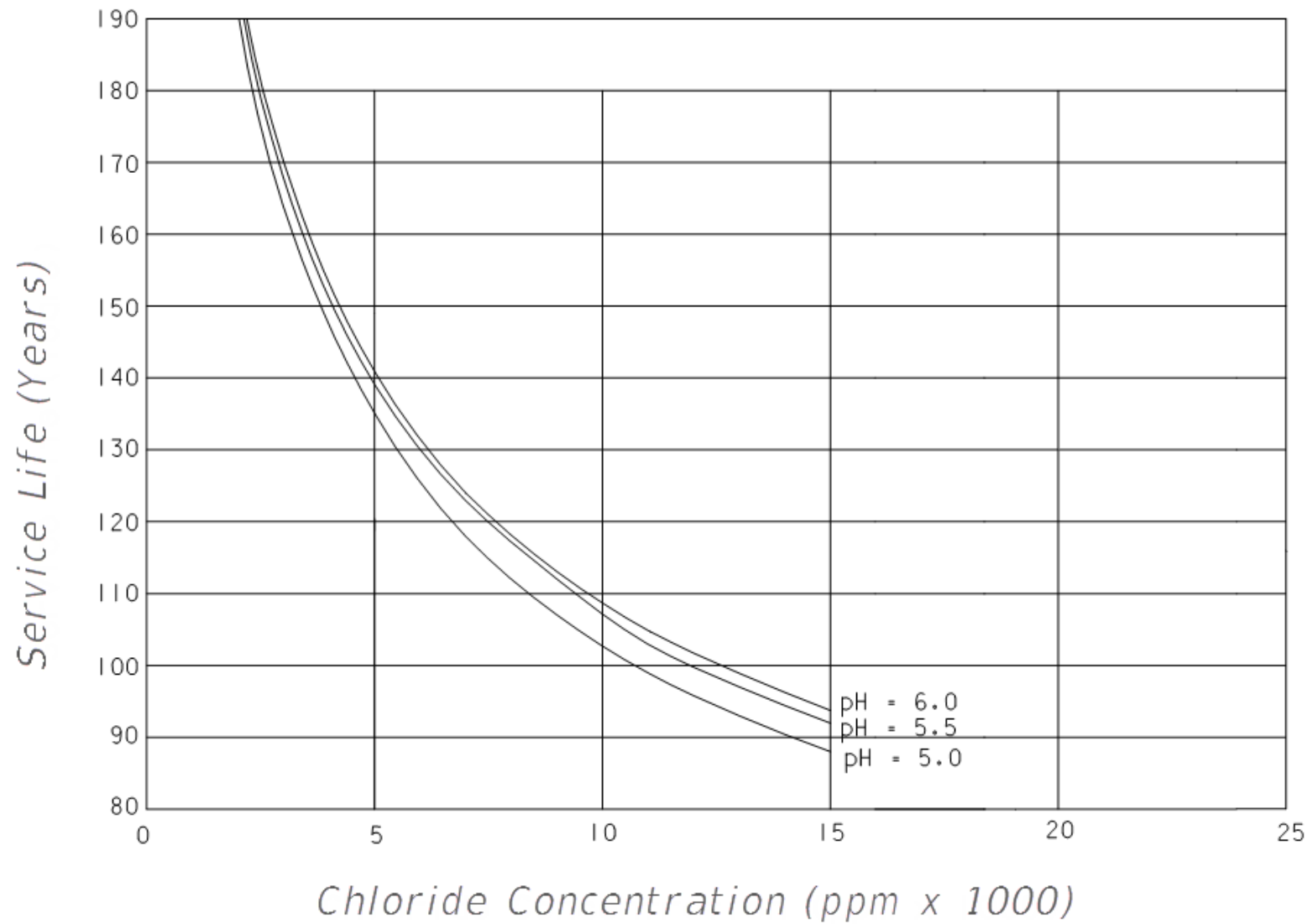

Figure M-4: Estimated Service Life – 60” Dia. Reinforced Concrete Pipe, S = 1500

Table M-4: Estimated Service Life – 60" Dia. Reinforced Concrete Pipe, S = 1500

| pH | Chlorides | | | | | | | | | | | |
|------|-----------|-------|-------|------|------|------|------|------|------|-----|-----|-----|
| | 15000 | 13000 | 11000 | 9000 | 7000 | 5000 | 3000 | 2000 | 1000 | 750 | 500 | 250 |
| 5.0 | 88 | 93 | 99 | 107 | 118 | 135 | 164 | 192 | 250 | 278 | 324 | 360 |
| 5.1 | 89 | 94 | 101 | 109 | 119 | 136 | 165 | 193 | 251 | 279 | 325 | 360 |
| 5.2 | 90 | 95 | 102 | 110 | 121 | 137 | 167 | 194 | 252 | 281 | 327 | 360 |
| 5.3 | 91 | 96 | 102 | 111 | 122 | 138 | 167 | 195 | 253 | 282 | 327 | 360 |
| 5.4 | 92 | 97 | 103 | 111 | 122 | 139 | 168 | 196 | 253 | 282 | 328 | 360 |
| 5.5 | 92 | 97 | 103 | 112 | 123 | 139 | 168 | 196 | 254 | 282 | 328 | 360 |
| 5.6 | 93 | 98 | 104 | 112 | 123 | 140 | 169 | 196 | 254 | 283 | 329 | 360 |
| 5.7 | 93 | 98 | 104 | 112 | 123 | 140 | 169 | 197 | 254 | 283 | 329 | 360 |
| 5.8 | 93 | 98 | 104 | 113 | 124 | 140 | 169 | 197 | 255 | 283 | 329 | 360 |
| 5.9 | 93 | 98 | 105 | 113 | 124 | 140 | 170 | 197 | 255 | 284 | 330 | 360 |
| ≥6.0 | 94 | 99 | 105 | 113 | 124 | 141 | 170 | 197 | 255 | 284 | 330 | 360 |

| Pipe Dia. | Mult. By | Pipe Dia. | Mult. By |
|-----------|----------|-----------|----------|
| 12" | 0.36 | 48" | 0.76 |
| 18" | 0.36 | 60" | 1.00 |
| 24" | 0.41 | 72" | 1.25 |
| 30" | 0.48 | 84" | 1.51 |
| 36" | 0.54 | 96" | 1.77 |
| 42" | 0.65 | 108" | 2.04 |

| Sulfate Content | Subtract from SL |
|-----------------|------------------|
| 1500 | 0 |
| 3200 | 5 |
| 4900 | 10 |
| 6600 | 15 |
| 8300 | 20 |
| 10000 | 25 |

Note: Sulfate derating not applicable when Type V cement is used.

$$\text{Service Life (SL)} = 1000(1.107^C C^{0.717} D^{1.22} K^{-0.37} W^{-0.631}) - 4.22 \times 10^{10} (\text{pH}^{-14.1}) - 2.94 \times 10^{-3} (S) + 4.41$$

Where: C = Sacks of cement per cubic yard D = Steel depth in concrete K = Environmental chloride concentration in ppm
 W = Total percentage of water in the mix S = Environmental sulfate content in ppm

APPENDIX

N. A Rationale for Stormwater Rule Standards

N. A RATIONALE FOR STORMWATER RULE STANDARDS

The following is an excerpt from a paper titled “The Evolution of Florida’s Stormwater / Watershed Management Program” by Eric H. Livingston, FDEP.

The overriding standards of the Stormwater Rule are the state’s water quality standards and appropriate regulations established in other FDEP rules. Therefore, an application for a stormwater discharge permit must provide reasonable assurance that stormwater discharges will not violate state water quality standards. Because of the potential number of discharge facilities and the difficulties of determining the impact of any facility on a waterbody or the latter’s assimilative capacity, the Department decided that the Stormwater Rule should be based on design and performance standards.

The performance standards established a technology-based effluent limitation against which an applicant can measure the proposed treatment system. Compliance with the rule’s design criteria created a presumption that the desired performance standards would be met which, in turn, provided a rebuttable presumption that water quality standards would be met. If an applicant wanted to use Best Management Practices (BMPs) other than those described in the rule, then a demonstration must be made that the BMP provides treatment that achieves the desired pollutant removal performance standard. The actual design and performance standards are based on a number of factors which will subsequently be discussed.

1. **Stormwater Management Goals** - Stormwater management has multiple objectives including water quality protection, flood protection (volume, peak discharge rate), erosion and sediment control, water conservation and reuse, aesthetics and recreation. The basic goal for new development is to assure that the post-development peak discharge rate, volume, timing and pollutant load does not exceed pre- development levels. However, BMPs are not 100% effective in removing stormwater pollutants while site variations can also make this goal unachievable at times. Therefore, for the purposes of stormwater regulatory programs, the Department (water quality) and the state’s regional Water Management Districts (flood control) have established performance standards based on risk analysis and implementation feasibility.
2. **Rainfall Characteristics** - An analysis of long term rainfall records was undertaken to determine statistical distribution of various rainfall characteristics such as storm intensity and duration, precipitation volume, time between storms, etc. It was found that nearly 90% of a year’s storm events occurring anywhere in Florida produce a total of 1 inch of rainfall or less. Also, 75% of the total annual volume of rain falls in storms of 1-inch or less. Finally, the average inter-event time between storms is approximately 80 hours (5).

3. **Runoff Pollutant Loads** - The first flush of pollutants refers to the higher concentrations of storm water pollutants that characteristically occur during the early part of the storm with concentrations decaying as the runoff continues. Concentration peaks and decay functions vary from site to site depending on land use, the pollutants of interest, and the characteristics of the drainage basin. Florida studies (6, 7) indicated that for a variety of land uses the first .5 inch of runoff contained 80-95 percent of the total annual loading of most stormwater pollutants. However, first flush effects generally diminish as the size of the drainage basin increases and the percent impervious area decreases because of the unequal distribution of rainfall over the watershed and the additive phasing of inflows from numerous small drainages in the larger watershed. In fact, as the drainage area increases in size above 100 ac the annual pollutant load carried in the first flush drops below 80% because of the diminishing first flush effect.
4. **BMP Efficiency and Cost Data** - Numerous studies conducted in Florida during the Section 208 program generated information about the pollutant removal effectiveness of various BMPs and the costs of BMP construction and operation. Analysis of this information revealed that the cost of treatment increased exponentially after “secondary treatment” (removal of 80% of the annual load) (8).

Selection of Minimum Treatment Levels - After review and analysis of the above information, and after extensive public participation, the Department set a stormwater treatment objective of removing at least 80% of the average annual pollutant load for stormwater discharges to Class III (fishable/swimmable) waters. A 95% removable level was set for storm water discharges to sensitive waters such as potable supply waters (Class I), shellfish harvesting waters (Class II) and Outstanding Florida Waters. The Department believed that these treatment levels would protect beneficial users and thereby establish a relationship between the rule’s BMP performance standards and water quality standards.

References:

Wanielista, M.P., et. al. Precipitation, Inter-event Dry Periods, and Reuse Design Curves for Selected Area of Florida. Final report submitted to Florida Department of Environmental Regulation, 1991.

Wanielista, M.P., et. al. Stormwater Management Practices Evaluations. Reports submitted to East Central Florida Regional Planning Council, 1977.

Miller, R.A. Percentage Entrainment of Constituent Loads in Urban Runoff, South Florida, USGS WRI Report 84-4329, 1985.

Wanielista, M.P., et. al. Stormwater Management Manual. Prepared for Florida Department of Environmental Regulation, 1982.