

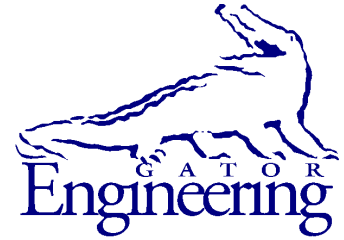

University of Florida  
Civil and Coastal Engineering

Structures Research  
Report 2023/P0171699



University of Florida  
Civil and Coastal Engineering

---

Final Report

February 2023

# Update of Commercial Vessel Past Point Data for Designing Bridges across Navigable Florida Waterway

*Principal investigator:*

Gary R. Consolazio, Ph.D.

*Co-Principal investigator:*

Michael T. Davidson, Ph.D., P.E.

*Graduate research assistant:*

Saul Licon

---

Department of Civil and Coastal Engineering  
University of Florida  
P.O. Box 116580  
Gainesville, Florida 32611

**Sponsor:**

Florida Department of Transportation (FDOT)  
Alex Randell, P.E., S.E. – Project manager  
Matt Kosar, P.E. – Project manager

**Contract:**

UF Project Nos. P0171699, P0171698, P0172693  
FDOT Contract No. BDV31-977-134

## **DISCLAIMER**

The opinions, findings, and conclusions expressed in this publication are those of the authors and not necessarily those of the State of Florida Department of Transportation.

**SI (MODERN METRIC) CONVERSION FACTORS**  
*APPROXIMATE CONVERSIONS TO SI UNITS*

SYMBOL	WHEN YOU KNOW	MULTIPLY BY	TO FIND	SYMBOL
<b>LENGTH</b>				
<b>in</b>	inches	25.4	millimeters	mm
<b>ft</b>	feet	0.305	meters	m
<b>yd</b>	yards	0.914	meters	m
<b>mi</b>	miles	1.61	kilometers	km
<b>AREA</b>				
<b>in<sup>2</sup></b>	square inches	645.2	square millimeters	mm <sup>2</sup>
<b>ft<sup>2</sup></b>	square feet	0.093	square meters	m <sup>2</sup>
<b>yd<sup>2</sup></b>	square yard	0.836	square meters	m <sup>2</sup>
<b>ac</b>	acres	0.405	hectares	ha
<b>mi<sup>2</sup></b>	square miles	2.59	square kilometers	km <sup>2</sup>
<b>VOLUME</b>				
<b>fl oz</b>	fluid ounces	29.57	milliliters	mL
<b>gal</b>	gallons	3.785	liters	L
<b>ft<sup>3</sup></b>	cubic feet	0.028	cubic meters	m <sup>3</sup>
<b>yd<sup>3</sup></b>	cubic yards	0.765	cubic meters	m <sup>3</sup>
NOTE: volumes greater than 1000 L shall be shown in m <sup>3</sup>				
<b>MASS</b>				
<b>oz</b>	ounces	28.35	grams	g
<b>lb</b>	pounds	0.454	kilograms	kg
<b>T</b>	short tons (2,000 lb)	0.907	Megagrams	Mg (or "t")
<b>TEMPERATURE (exact degrees)</b>				
<b>°F</b>	Fahrenheit	5(F-32)/9 or (F-32)/1.8	Celsius	°C
<b>FORCE and PRESSURE or STRESS</b>				
<b>kip</b>	1,000 pound force	4.45	kilonewtons	kN
<b>lbf</b>	pound force	4.45	newtons	N
<b>lbf/in<sup>2</sup></b>	pound force per square inch	6.89	kilopascals	kPa
<b>ksi</b>	kips force per square inch	6.89	Megapascals	MPa

## TECHNICAL REPORT DOCUMENTATION PAGE

1. Report No.	2. Government Accession No.	3. Recipient's Catalog No.	
4. Title and Subtitle  Update of Commercial Vessel Past Point Data for Designing Bridges across Navigable Florida Waterway		5. Report Date <b>February 2023</b>	
		6. Performing Organization Code	
		8. Performing Organization Report No.  2023/P0171699	
7. Author(s)  Gary R. Consolazio, Michael T. Davidson, Saul Licon Mendez, Jr.		10. Work Unit No. (TRAIS)	
9. Performing Organization Name and Address  University of Florida Department of Civil and Coastal Engineering 365 Weil Hall, P.O. Box 116580 Gainesville, FL 32611-6580		11. Contract or Grant No.  BDV31-977-134	
		13. Type of Report and Period Covered  Final Report Jun. 2020 – Feb. 2023	
12. Sponsoring Agency Name and Address  Florida Department of Transportation Research Management Center 605 Suwannee Street, MS 30 Tallahassee, FL 32399-0450		14. Sponsoring Agency Code	
		15. Supplementary Notes	
16. Abstract  <p>When designing a bridge that spans over a navigable waterway, the risk associated with potential vessel collisions must be evaluated to ensure that the structure possesses sufficient impact resistance. Typically, the probability-based risk assessment procedure specified by AASHTO is employed for this purpose. The procedure requires collection of data that characterize vessel traffic that is relevant to bridge design. In the late 1990s, the Florida Department of Transportation (FDOT) funded a study that utilized commercial vessel data to develop a practical database of vessel traffic information for Florida past points. The data were synthesized into a form that corresponded to calendar year (CY) 2000. However, in the more than twenty (20) years that have since passed, significant changes in vessel traffic have occurred. Furthermore, innovations in maritime technology have produced new sources of vessel data that may be used to quantify characteristics such as operational vessel speeds near bridges.</p> <p>In this study, vessel data were obtained from the U.S. Army Corps of Engineers (USACE) Waterborne Commerce Statistics Center (WCSC), automatic identification system (AIS) records were obtained from Marine Cadastre, and interviews with maritime professionals from around Florida were conducted. Analysis of historical USACE WCSC vessel traffic data collected for the years 2010 to 2019 indicated that traffic levels increased at many locations around Florida, but decreased or completely disappeared at other locations. Such differences necessitated the development of both growth and decay projection models for estimating future vessel traffic. The historical data further revealed the presence of deep draft (&gt;15 ft) barge traffic at multiple Florida past point locations. Importantly, the bow characteristics (and thus impact forces) of deep draft barges are more similar to those of ships than to shallow draft barges. Information provided by maritime professionals indicated that the majority of shallow draft (≤15 ft) barges in Florida waterways are used for construction purposes and that a bow rake angle of 45 degrees is common for such barges. Analysis of AIS data indicated that, on a statewide basis, average ship speed was approximately 7 knots, and average barge speed was approximately 6 knots. However, local vessel speeds at select locations can be significantly faster.</p> <p>Outcomes from this study included (1) an updated vessel past point database that characterizes modern vessel traffic in Florida and (2) updated models of future vessel traffic projection. Additional outcomes included (1) procedures for assessing bridge pier column vulnerability to direct impact by shallow draft barges and (2) illustrative examples of the calculation of the AASHTO protection factor for scenarios where adjacent protection structures may provide a partial level of shielding against vessel collisions.</p>			
17. Key Words  Vessel-bridge impact, collision, barge, ship, pier, risk, past point traffic data, design specifications, protection factor		18. Distribution Statement  No restrictions.	
19. Security Classif. (of this report)  Unclassified	20. Security Classif. (of this page)  Unclassified	21. No. of Pages  242	22. Price

Form DOT F 1700.7 (8-72). Reproduction of completed page authorized

## ACKNOWLEDGEMENTS

The authors thank the Florida Department of Transportation (FDOT) for providing the funding that made this research possible. The authors thank the United States Army Corps of Engineers (USACE) for providing the extensive collection of past point data that was necessary to complete this work. Special thanks are extended to Amy Tujague (USACE Waterborne Commerce Statistics Center) and her team for providing assistance in data acquisition and data interpretation. The authors thank MOBRO Marine, and Mike Rodriguez in particular, for granting a site visit and for providing technical insights and information related to barges. The authors thank Great Lakes Dredge & Dock Company, including Lynn Nietfeld Holt Hartung in particular, for providing technical insights and information related to barges. Special thanks are extended to Laura DiBella (Florida Harbor Pilots Association), Captain Nathan Cook (St. Johns Bar Pilot Association), Captain Sam Stephenson (Port Everglades Pilots Association), Captain Geoffrey Pool (Biscayne Bay Pilots), Captain Bob Maguire (Key West Bar Pilots Association), Terry Fluke (Tampa Bay Pilots Association), Captain Bryan McGee (Pensacola Bay Pilots Association), and Captain Gary Bryan (Portside Marine & Towing) for sharing their time, expertise, and technical insights regarding Florida vessel traffic (past and present).

## EXECUTIVE SUMMARY

When designing a bridge that spans over a navigable waterway, the risk associated with potential vessel collisions must be evaluated to ensure that the structure possesses sufficient impact resistance. Typically, the probability-based risk assessment procedure specified by AASHTO is employed to assess such risk, and to quantify the required resistances of individual bridge components such as piers. Carrying out an AASHTO vessel collision risk analysis requires the collection of data that characterize the different types of vessel traffic (e.g., ships, barges) that are relevant to both the bridge and the waterway. In the late 1990s, the Florida Department of Transportation (FDOT) funded a study that utilized commercial vessel data to develop a practical database of vessel traffic information for geographic locations distributed throughout Florida. The data were synthesized and tabulated for prominent Florida past point locations into a form that corresponded to calendar year (CY) 2000. In the more than twenty (20) years that have since passed, significant changes in commercial vessel traffic have occurred at locations throughout Florida. Furthermore, innovations in maritime technology have produced new sources of vessel data that may be used to quantify characteristics such as operational vessel speeds near bridges.

In this study, vessel-related data were collected, processed, analyzed, and interpreted for the purpose of developing updated parameters and guidance relevant to the design of highway bridges that span across navigable Florida waterways. Data relating to vessel characteristics and vessel traffic frequency (trip counts) were obtained primarily from the U.S. Army Corps of Engineers (USACE) Waterborne Commerce Statistics Center (WCSC). Automatic identification system (AIS) records, which contain vessel position and speed data, were obtained primarily from Marine Cadastre, a partnership between the Bureau of Ocean Energy Management (BOEM) and the National Oceanic and Atmospheric Administration (NOAA). Additionally, interviews were conducted with maritime professionals from around the state of Florida to obtain data and insights regarding vessel operational procedures, vessel characteristics, and historic trends in Florida vessel traffic.

Analysis of historical USACE WCSC vessel traffic data collected for the years 2010 to 2019 indicated that traffic levels increased (growth trends) at many locations around Florida, but decreased (decay trends), or completely disappeared, at other locations. Such differences necessitated the development of both growth and decay projection models for estimating future vessel traffic. The historical data further revealed the presence of deep draft (>15 ft) barge traffic at multiple Florida past point locations. Importantly, the bow characteristics (and thus impact forces) of deep draft barges are more similar to those of ships than to shallow draft barges. Information provided by maritime professionals indicated that the majority of shallow draft ( $\leq 15$  ft) barges in Florida waterways are used for construction purposes and that a bow rake angle of 45 degrees is common for such barges. Analysis of historical AIS data indicated that, on a statewide basis, average ship speed was approximately 7 knots, and average barge speed was approximately 6 knots. However, local vessel speeds at select locations can be significantly faster.

Outcomes from this study included an (1) updated vessel past point database that characterizes modern vessel traffic throughout navigable waterways in Florida and (2) updated models of future vessel traffic projection. Additional outcomes included (1) procedures for assessing bridge pier column vulnerability to direct impact by shallow draft barges and (2) illustrative examples of the calculation of the AASHTO protection factor (*PF*) for scenarios where adjacent protection structures may provide a partial level of shielding against vessel collisions.

## TABLE OF CONTENTS

DISCLAIMER .....	ii
SI (MODERN METRIC) CONVERSION FACTORS .....	iii
TECHNICAL REPORT DOCUMENTATION PAGE .....	iv
ACKNOWLEDGEMENTS .....	v
EXECUTIVE SUMMARY .....	vi
LIST OF FIGURES .....	x
LIST OF TABLES .....	xiv
CHAPTER 1 INTRODUCTION .....	1
1.1 Background.....	1
1.2 Objectives .....	1
1.3 Scope of work .....	2
CHAPTER 2 LITERATURE REVIEW .....	3
2.1 AASHTO Guide Specifications and Commentary for Vessel Collision Design of Highway Bridges.....	3
2.1.1 Vessel frequency ( $N$ ) .....	4
2.1.2 Probability of aberrancy ( $PA$ ).....	5
2.1.3 Geometric probability ( $PG$ ).....	5
2.1.4 Probability of collapse ( $PC$ ) .....	6
2.1.5 Protection factor ( $PF$ ).....	7
2.2 Vessel Traffic Characteristics.....	7
2.2.1 Overview .....	7
2.2.2 Geometry .....	8
2.2.3 Hydrodynamic characteristics .....	9
2.2.4 Vessel group and vessel fleet .....	10
2.2.5 Role of vessel traffic characteristics in evaluating annual frequency of collapse ( $AF$ ).....	11
2.3 Literature Review of the Protection Factor ( $PF$ ).....	12
2.3.1 Protection structures and systems.....	13
2.3.2 Quantifying the protection to bridge components provided by protective systems .....	17
2.4 Past Characterizations of Vessel Traffic.....	18
2.4.1 Review of Wang and Liu (1999).....	18
2.4.2 Review of Liu and Wang (2001).....	25
2.4.3 Texas Department of Transportation.....	26
2.4.4 Eurocode.....	30
2.5 FDOT Structures Design Guidelines.....	32

CHAPTER 3 DATA COLLECTION .....	34
3.1 Data Collection .....	34
3.1.1 Commercial past point traffic data .....	34
3.1.2 Vessel speed data.....	36
3.1.3 Barge rake geometry data.....	36
3.1.4 Supplementary data and information collected from interviews with maritime professionals .....	40
CHAPTER 4 DATA ANALYSIS .....	42
4.1 Introduction.....	42
4.2 Vessel Traffic Trip Counts .....	42
4.2.1 Interpretation of barge traffic data.....	42
4.2.2 Model of future traffic estimation .....	43
4.2.3 Outlier detection and removal .....	44
4.2.4 Future projection: Growth at statewide level .....	47
4.2.5 Future projection: Growth at past point level.....	48
4.2.6 Future projection: Decay at past point level.....	52
4.3 Vessel Groups.....	53
4.3.1 Barges and tugboats.....	54
4.3.2 Ships and small self-propelled vessels .....	58
4.3.3 Foreign and other vessels .....	58
4.3.4 Invalid data .....	59
4.3.5 Synthesizing vessel groups.....	59
4.4 Design Vessel Speeds.....	60
4.4.1 Introduction .....	60
4.4.2 Data collection and processing.....	60
4.4.3 Computing vessel transit speeds.....	61
4.4.4 Verification of computed speeds using independent data source.....	63
4.4.5 Typical speeds in Florida waterways .....	65
CHAPTER 5 UPDATES TO FDOT STRUCTURES DESIGN GUIDELINES.....	69
5.1. Overview.....	69
5.2. FDOT SDG 2.11.1 – General .....	69
5.3. FDOT SDG 2.11.2 – Research and Information Assembly .....	69
5.4. FDOT SDG 2.11.9 – Application of Impact Forces.....	70
5.4.1 Typical geometric characteristics of shallow draft barge bows .....	71
5.4.2. Guidance for selecting pile cap thickness .....	72
5.4.3. Guidance for selecting pier column horizontal offset .....	73
5.4.4. Guidance for minimum barge impact load conditions .....	74
5.5. Guidance on Calculating Protection Factor ( <i>PF</i> ) Values .....	75
5.5.1. Calculation of <i>PF</i> in the presence of a single protective structure .....	75
5.5.2. Calculation of <i>PF</i> in the presence of multiple protective structures.....	77
5.6. FDOT SDG 3.14 – Fender Systems .....	78
5.6.1. Minimum energy absorption capacity ( <i>EAC</i> ) for fender design.....	79



CHAPTER 6 FINDINGS, IMPLEMENTATION, AND FUTURE RECOMMENDATIONS.....	80
6.1. Summary and Key Findings .....	80
6.2. Implementation .....	81
6.3. Future Recommendations .....	81
REFERENCES .....	83
APPENDIX A Plots of Collected Past point Data.....	86
APPENDIX B Past Point Future Traffic Projections .....	139
APPENDIX C Past Point Vessel Groups .....	167
APPENDIX D Example Calculation of Protection Factor, <i>PF</i> .....	220
APPENDIX E Supporting Data Relating to Minimum Energy Absorption Capacity (EAC) For Fender Design .....	227

## LIST OF FIGURES

<u>Figure</u>	<u>Page</u>
Figure 2.1 Determining the geometric probability, $PG$ , of a bridge pier (AASHTO 2009).....	6
Figure 2.2 General barge vessels characteristics (AASHTO 2009) .....	8
Figure 2.3 Typical ship bow structure (Larsen 1993).....	9
Figure 2.4 Effects of ballasted conditions on ship draft (AASHTO 2009) .....	10
Figure 2.5 Barge group characteristics (2x2 configuration) (AASHTO 2009) .....	11
Figure 2.6 Timber fender systems analyzed using FEA: (a) Wuttrich et al. (2001); (b) Consolazio and Wilkes (2013).....	14
Figure 2.7 Pile-supported system protecting an off-shore transmission tower (Zhu et al. 2011): (a) plan view; (b) foundation (pile) drawing .....	15
Figure 2.8 Flexible floating protection system installed in Zhanjiang Bay Bridge, China (Wang et al. 2019).....	15
Figure 2.9 The Bridge of the Americas stands on artificial islands made to protect the piers from ships transiting the Panama Canal (Wikipedia) .....	16
Figure 2.10 Example scenario for computing $PF$ as given in AASHTO (2009): (a) Plan view of protection; (b) Normal distribution of possible impact angles ( $\sigma = 30^\circ$ assumed).....	17
Figure 2.11 Computation of $PF$ based on adjacent land masses or structures (Consolazio et al. 2014; $\sigma = 10^\circ$ assumed).....	18
Figure 2.12 Map of fifty-two past point locations in Florida (Wang and Liu 1999).....	19
Figure 2.13 Barge and tug classification for forming vessel groups (Wang and Liu 1999): (a) Barge groups with the assigned tug sizes; (b) Tug groups by size and displacement .....	20
Figure 2.14 Typical characteristics of different types of ships utilized to compute foreign vessel information (Wang and Liu 1999) .....	21
Figure 2.15 Description of vessel traffic in past point 5 (Wang and Liu 1999) .....	21
Figure 2.16 Summary of vessel transit velocities based on interviews with vessel companies (Wang and Liu 1999).....	22
Figure 2.17 Recommended design velocities and corrections (Wang and Liu 1999) .....	22
Figure 2.18 Increased traffic rate for past points 19, 38, and 39 (Wang and Liu 1999).....	23

Figure 2.19 Bridge tender log data from past points compared with WCSC data (Wang and Liu 1999).....	24
Figure 2.20 Composition of self-propelled vessel traffic (Wang and Liu 1999).....	24
Figure 2.21 Risk analysis results obtained using the VIOB software (Manuel et al. 2006).....	27
Figure 2.22 Barge group characteristics (Manuel et al. 2006): (a) By length categories; (b) By type sub-categories.....	28
Figure 2.23 Reported number of vessel trips and the assumed traffic densities.....	29
Figure 2.24 Eurocode vessel classification: (a) Static forces for inland waterway vessels; (b) Static forces for seagoing vessels (CEN 2006).....	31
Figure 2.25 CEMT vessel classification by waterway class (CEMT Resolution No. 92/2).....	32
Figure 3.1 Example raw data records provided by the USACE WCSC.....	36
Figure 3.2 Example set of transmitted GPS positions in AIS records.....	37
Figure 3.3 Risk of direct impact to pier column by a barge with rake angle of (a) 45 deg. at empty draft, (b) 25 deg. at empty draft, (c) 45 deg. at loaded draft, and (d) 25 deg. at loaded draft.....	37
Figure 3.4 Photographs of the bow of MOBRO 1705: (a) rake geometry; (b) bow shape.....	38
Figure 3.5 Schematic diagram of MOBRO 1705 bow dimensions.....	38
Figure 3.6 Sketch of MOBRO 1007 bow dimensions.....	39
Figure 3.7 Photographs of MOBRO 1202: (a) rake geometry; (b) bow shape.....	39
Figure 3.8 Examples of bow shapes from barge fleet serviced by MOBRO Marine: (a) MB 303; (b) MB 1704; (c) MB 150; (d) MB 204.....	40
Figure 3.9 Locations throughout Florida of maritime professionals that were interviewed.....	41
Figure 4.1 Detection and removal of outlier data: (a) Original data; (b) Best-fit power model; (c) Residuals between data and power model; (d) Residuals in sorted order; (e) Quartiles parameters, limits, and outlier detection; (f) Updated power model fit to non-outlier data.....	46
Figure 4.2 Illustration of the ‘box-and-whiskers’ outlier detection approach.....	47
Figure 4.3 Statewide traffic growth model.....	48
Figure 4.4 Past point with growth trend: (a) 10-year future projection; (b) 75-year future projection.....	50

Figure 4.5 Power model fits through non-outlier data and 75-year target point: (a) Growth permitted at 75 years; (b) Growth ceases at 75 years; (c) Average curve .....	51
Figure 4.6 Past point with growth: final power model for future projection of traffic .....	52
Figure 4.7 Past point with decay trend: (a) Unconstrained power fit; (b) Power fit with 75-year minimum value constrained to the 10-year mean trip count.....	53
Figure 4.8 Shallow draft barges and deep draft barges: (a) Flotilla of 3 shallow draft barges (Apalachicola Bay, FL); (b) Flotilla of 2 shallow draft barges, showing bow (Apalachicola Bay, FL); (c) Deep draft articulated tug barge (Source: Crowley); (d) Deep draft articulated tug barge, showing bow (Source: Crowley).....	57
Figure 4.9 Distribution of length overall ( <i>LOA</i> ) for ships with detected bridge crossings (2016 to 2020).....	61
Figure 4.10 AIS vessel transit segments crossing past point bridges: (a) Within or near to Tampa Bay; (b) Inset of the Sunshine Skyway Bridge (base map imagery courtesy of U.S. Census Bureau).....	62
Figure 4.11 Illustrative uses of procedure for accepting or removing AIS segments: (a) Accepted AIS segments with $6 \times LOA90$ region centered at bridge crossing; (b) Removed AIS segments with $6 \times LOA90$ region centered at bridge crossing; (c) Accepted AIS segments with $6 \times LOA90$ region centered at an offset distance of $3 \times LOA90$ ; (d) Removed AIS segments with $6 \times LOA90$ region centered at an offset distance of $3 \times LOA90$ (Map data © 2022 Google).....	64
Figure 5.1 Illustrative schematic of shallow draft barge bow geometry.....	72
Figure 5.2 Fully loaded barge impact scenario with considerations for selection of pile cap thickness.....	73
Figure 5.3 Empty barge impact scenario with considerations for selection of pier column offset .....	74
Figure 5.4 Illustrative schematic of vessel collision in the presence of a protective structure: (a) Relative positioning; (b) Geometric parameters of the protective structure .....	76
Figure 5.5 Illustrative schematic of vessel collision in the presence of multiple protective structures .....	78
Figure D.1 Schematic for example calculation of protection factor, <i>PF</i> , involving a single protective structure: (a) Relative positioning; (b) Geometric parameters of the protective structure.....	221
Figure D.2 Calculation of protection factor, <i>PF</i> , when a single protective structure is present..	222

Figure D.3 Normal distribution of transit angles (and protected area) for calculating protection factor, $PF$ , value when a single protective structure is present .....	222
Figure D.4 Schematic for example calculation of protection factor, $PF$ , involving two protective structures: (a) Relative positioning; (b) Geometric parameters of the protective structures .....	224
Figure D.5 Calculation of protection factor, $PF$ , when two protective structures are present ....	225
Figure D.6 Normal distribution of transit angles (and protected areas) for calculating protection factor, $PF$ , value when two protective structures are present.....	226

## LIST OF TABLES

<u>Table</u>	<u>Page</u>
Table 3.1. Collected past point data locations .....	35
Table 4.1 FDOT design tug dimensions and tonnages (FDOT 2019) .....	55
Table 4.2 FDOT relationships between barge draft and tug size (FDOT 2019).....	55
Table 4.3 Marine Traffic characteristic vessel transit speeds in Florida waterways .....	65
Table 4.4 Average barge tow speed determined from AIS data for past point locations .....	67
Table 4.5 Average ship speed determined from AIS data for past point locations .....	68
Table 4.6 Characteristic vessel transit speeds by region.....	68
Table 4.7 Characteristic vessel transit speeds by channel depth at the statewide level.....	68
Table 4.8 Characteristic vessel transit speeds by vessel type at the statewide level .....	68
Table 4.9 Recommended design vessel speed for barges and ships .....	68
Table 5.1. Past points and associated minimum energies.....	79
Table B.1 Parameters of traffic projection power model curves .....	140
Table E.1. Supporting data for calculation of energy absorption capacity values.....	228

# CHAPTER 1 INTRODUCTION

## 1.1 Background

When designing a bridge that spans over a navigable waterway, the risk associated with potential vessel collisions must be evaluated to ensure that the structure possesses sufficient impact resistance. Typically, the probability-based risk assessment procedure specified in AASHTO (2009, 2020) is employed to assess such risk and to quantify the required resistances of individual bridge components (e.g., piers). Carrying out an AASHTO vessel collision risk analysis requires the collection of data that characterize the different types of vessel traffic (e.g., ships, barges) that are relevant to both the bridge and the waterway.

In the late 1990s, the Florida Department of Transportation (FDOT) funded a study (Wang and Liu 1999) that utilized commercial vessel data to develop a practical database of vessel traffic information for geographic locations distributed throughout Florida. Use of this database enables engineers to efficiently conduct vessel collision risk assessments for bridge design. As part of the study, 52 past point locations were selected from among the inland and intracoastal waterways throughout Florida, and one- to three-year waterborne data were obtained from the U.S. Army Corps of Engineers (USACE) Waterborne Commerce Statistics Center (WCSC). The acquired data were synthesized and tabulated for the 52 Florida past point locations into a form that corresponded to calendar year (CY) 2000. Estimations of future vessel traffic increase rates were also developed.

In the more than 20 years that have passed since Wang and Liu developed their vessel database, significant changes in commercial vessel traffic (type of vessels, frequency of trips) have occurred at locations throughout the state of Florida. Such changes have necessitated that an updated vessel database be developed for use by bridge designers. Innovations in maritime technology have also produced new sources of vessel data (e.g., automatic identification systems [AIS]) that may be used to quantify vessel characteristics (e.g., typical operational speeds near bridges).

Furthermore, over this same time period, the need for updated design guidance in various areas relating to the assessment of vessel impacts on bridge piers has been identified. For example, guidance and equations are needed for evaluating whether shallow draft barge bows can directly impact (contact) columns of a bridge pier, and if so, what changes in pier geometry can be made to prevent such impacts. Guidance is additionally needed to illustrate how the level of protection afforded by protection structures adjacent to bridge piers can be quantified through computation of an appropriate protection factor.

## 1.2 Objectives

The primary objectives of the study were to develop an updated vessel past point database that characterizes modern vessel traffic throughout navigable waterways in Florida and to develop updated models of future traffic projection. Additional objectives were to develop and provide design guidance in the areas of shallow draft barge bow impact assessment, and the calculation of protection factors for protection structures adjacent to bridge piers. Implementation components of the research included updating the FDOT vessel collision risk assessment tool (Mathcad program) and conducting a critical analysis of the past point data to identify potential updates to collision-related provisions within the FDOT Structures Design Guidelines (SDG).

### 1.3 Scope of work

The scope of work included in this study was organized into the following key phases:

- Collection of data: Vessel-related data were collected from the United States Army Corps of Engineers (USACE) Waterborne Commerce Statistics Center (WCSC), multiple sources of automatic identification systems (AIS) data, a site visit to a barge fabrication facility, and from interviews with maritime professionals. The collected data included waterway commercial passage records, vessel characteristics, real-time and historical AIS dynamic route data, on-site physical vessel measurements, and qualitative descriptions of local traffic characteristics.
- Analysis of past point data: Algorithms were developed and implemented to process the collected raw data into a form that characterized Florida waterway vessel traffic in a manner suitable for use in bridge design. Analysis of the statewide data resulted in the development of future vessel traffic projections, vessel groups, typical barge and ship speeds, and guidance regarding computation of the AASHTO vessel collision protection factor.
- Update of past point data in FDOT Vessel Collision Risk Assessment tool: The past point database maintained by the FDOT was updated with the processed vessel traffic data (vessel groups, and trip frequencies), and the risk assessment program was modified to adopt new findings related to deep draft barges.
- Identification of updates to FDOT SDG provisions for vessel collision: A review of the FDOT SDG was conducted to identify provisions that may warrant changes as a result of collection, processing, and updating of Florida vessel traffic data for use in bridge design. Guidance was developed for relevant sections of the FDOT SDG that warrant consideration for revision.



## CHAPTER 2 LITERATURE REVIEW

The following sections summarize a review of literature related to the present study. The literature review was conducted with a focus on the design guidelines, relevant research, and existing collision risk assessment resources.

### 2.1 AASHTO Guide Specifications and Commentary for Vessel Collision Design of Highway Bridges

When designing bridges against vessel collision events, AASHTO (2009, 2020) provides three alternatives (Method I, Method II, and Method III). These procedures vary with regard to selection of design vessel characteristics to be used in a risk assessment analysis. Method I provides a simplified semi-deterministic procedure that selects a single (bridge-wide) design vessel to produce impact loads. The Method I procedure is less accurate (but more conservative) than Method II. Method II entails a relatively extensive probability-based risk assessment procedure, and requires the collection of vessel traffic data to determine the different categories of vessels relevant to a given bridge and waterway. The engineer is required to develop a database that represents the characteristics of vessel traffic surrounding the location of the proposed bridge. Method II is the recommended design procedure for critical structures and the method that is focused upon in the present study. Method III is a cost-effective procedure that considers the probability of a bridge being struck by a vessel, the potential disruption cost of such a collision, and the cost of strengthening or protecting the bridge elements at risk of collision.

As mentioned above, Method II is focused upon in the present study, where emphasis is placed on updating the existing commercial vessel traffic database that is utilized in conjunction with the probability-based risk assessment. Commercial vessel traffic characteristics for inland and intracoastal waterways throughout Florida are maintained by the FDOT and made available as part of the Vessel Collision Risk Analysis Software (FDOT 2019).

Method II consists of a combination of various relationships (some empirical in nature) that are intended to minimize subjectivity when performing risk analyses. Method II consists of computing the annual frequency of bridge collapse ( $AF$ ) for bridge components susceptible to vessel collision and for all waterborne vessel categories. The general form of the annual frequency of collapse for a specific element of a bridge (typically a pier) is:

$$AF = N(PA)(PG)(PC)(PF) \quad (2.1)$$

where  $N$  is the annual total of vessel trips per vessel group (vessel frequency);  $PA$  is the probability, per trip, that a vessel will become aberrant (deviate from the intended vessel transit path);  $PG$  is the geometric probability that a vessel will collide with a bridge pier or span once the vessel becomes aberrant;  $PC$  is the probability of bridge collapse due to collision with the aberrant vessel; and,  $PF$  is an adjustment factor that accounts for any waterway obstructions or protective structures (e.g., sandbars, fenders, adjacent structures) that may partially or completely block a vessel from colliding with a bridge component.

Computation of the annual frequency of collapse requires the creation of a database that synthesizes a large body of data into a form that can be efficiently utilized in risk assessment. The designer must gather information related to the characteristics of the waterway such as nautical charts; type and geometry of the bridge; preliminary plans of the bridge (including elevations, sizes and locations of piers, and navigation channel width); and, the average current velocity. Additional items of information that must be gathered include characteristics of the vessel traffic that operates near the bridge, such as:

- Size (overall length, width, and height),
- Displacement (vessel and cargo),
- Deadweight tonnage (*DWT*),
- Draft,
- Speed, and
- Number of passages.

Each vessel transit (or trip) is then assigned to representative categories and subcategories that classify the traffic based on the vessel types, lengths, widths, drafts, and tonnages, ultimately creating groups that elicit similar structural demand upon impact. Developing a modern vessel traffic database, encompassing the characteristics mentioned above, is the primary focus of the present study. Details regarding how the vessel characteristics and traffic data are obtained, assembled, and utilized during the risk assessment analysis will be described later in this document.

The annual frequency of collapse is computed as:

$$AF = \sum_{i=1}^{N_v} \sum_{j=1}^{N_e} N_i (PA_i) (PG_{i,j}) (PC_{i,j}) (PF_{i,j}) \quad (2.2)$$

where  $i$  represents vessel group ( $i = 1 \dots N_v$ );  $N_v$  is the total number of vessel groups;  $j$  is the bridge element ( $j = 1 \dots N_e$ ); and,  $N_e$  is the number of bridge elements susceptible to collision. Note that the bridge elements that should be considered when computing  $AF$  are piers within three times the overall length of the vessel from the centerline of the navigable channel and spans at a height lower than the exposed height of the vessel category. In the following sections, discussion is provided for each term within the annual frequency of collapse ( $AF$ ) expression (Equation 2.2)

Determining whether the computed  $AF$  value is acceptable or not requires the that designer assign importance and operational classifications of the bridge (critical/essential, or typical). Within the Strategic Highway Network (STRAHNET), bridges deemed critical/essential are those that provide a continuous route for police, emergency response, civil defense, or public health agencies to respond to an emergency. Also taken into account in determining bridge criticality are the average annual daily motorist traffic and evacuation routes. The acceptable level of risk based on bridge classification is specified by AASHTO. For critical/essential bridges, the maximum acceptable value of annual frequency of collapse (summed across all individual risks associated with each element and each vessel group, see Equation 2.2) is given as 0.0001/yr (i.e., a 1 in 10,000 probability of failure each year). For typical bridges, the maximum acceptable value of annual frequency of collapse is given as 0.001/yr (i.e., a 1 in 1000 probability of failure each year).

### 2.1.1 Vessel frequency ( $N$ )

The vessel frequency,  $N$ , is the number of vessel trips (transits) per year that cross the alignment of the bridge. Vessel trips are considered either non-self-propelled or self-propelled and are quantified per vessel group. The first category encompasses inland non-self-propelled vessels (typically barges), tugs, and tows. Self-propelled vessels (typically ships) are assigned to discrete groups based on deadweight tonnage (DWT). The direction of the traffic in the channel (upbound or downbound) must also be recorded to account for directional traffic variances and changes in loading.

The bridge designer must be aware of vessel drafts and displacements, and must be familiar with limitations due to the water depths in the channel. Understanding these factors is crucial when determining the relevant vessel groups to be used in the risk analysis. For example, vessels possessing drafts deeper than the available water depth in the vicinity of a bridge component can be neglected as such vessels would run aground before striking said bridge component.

Additionally, vessels transiting with commercial cargo of less than 1,000 DWT are neglected in the risk analysis (where such vessels are found to have little to no effect on bridge pier design, (Wang and Liu 1999).

Vessel transit frequencies may be determined from sources such as the *Waterborne Commerce Statistics Center (WCSC)*, *Waterborne Commerce of the United States (WCUS)* publications, *United States Coast Guard* records, or with the assistance of technologies such as Automatic Identification Systems (AIS).

### 2.1.2 Probability of aberrancy (*PA*)

The probability of aberrancy, *PA*, is defined as the probability that a vessel will deviate from the intended course as a result of human error, strong currents, and/or mechanical malfunction. The probability of aberrancy is computed as:

$$PA = (BR)(R_B)(R_C)(R_{XC})(R_D) \quad (2.3)$$

where *BR* is the base rate of aberrancy ( $6.0 \times 10^{-5}$  for ships and  $1.2 \times 10^{-4}$  for barges, per AASHTO), *R<sub>B</sub>* is the bridge location correction factor, *R<sub>C</sub>* and *R<sub>XC</sub>* are correction factors that account for currents parallel and perpendicular to the intended vessel transit path, and *R<sub>D</sub>* is a traffic density correction factor. Expressions for these factors are provided in the AASHTO provisions. The *BR* value for ships was developed from historical data, and the *BR* value for barges was conservatively taken as double the value for ships. In a recent study, Consolazio and Kantrales (2016) developed a recalibrated base rate of aberrancy for barges, *BR*, based on barge traffic and collision data collected specifically within the state of Florida. Results from this study yielded an updated barge *BR* value of  $5.4 \times 10^{-5}$ , representing a 55% decrease relative to the value presently listed in AASHTO.

### 2.1.3 Geometric probability (*PG*)

The geometric probability, *PG*, is a conditional probability that measures the likelihood that an aberrant vessel will strike a component of the bridge. This probability is dependent on factors such as the geometry of the waterway and water depths. However, *PG* is mainly a function of the geometry of the bridge (locations of the piers) in relation to the channel centerline (Figure 2.1).

It is assumed that possible locations of aberrant vessels will be normally distributed (i.e., Gaussian) about the centerline of the channel. The mean ( $\mu$ ) of the normal distribution is taken as the centerline of the transit path, and the standard deviation ( $\sigma$ ) is taken as the length overall (LOA) of the vessel group being considered. The value of *PG* is computed as the area under the normal distribution curve integrated over the width of the vessel impact zone. This width is taken as the outermost projected width of the pier (*B<sub>p</sub>*) plus the beam width of the vessel being considered ( $B_M = 2 \times (B_M/2)$ ) (Figure 2.1). Note that a value of *PG* is computed for each bridge member, and for each vessel group. Bridge piers that lie beyond the distance of  $3 \times LOA$  from the channel centerline are neglected from the computation of *PG* (and therefore do not contribute to *AF*) as it is unlikely that such piers will be struck by a vessel (AASHTO 2009).

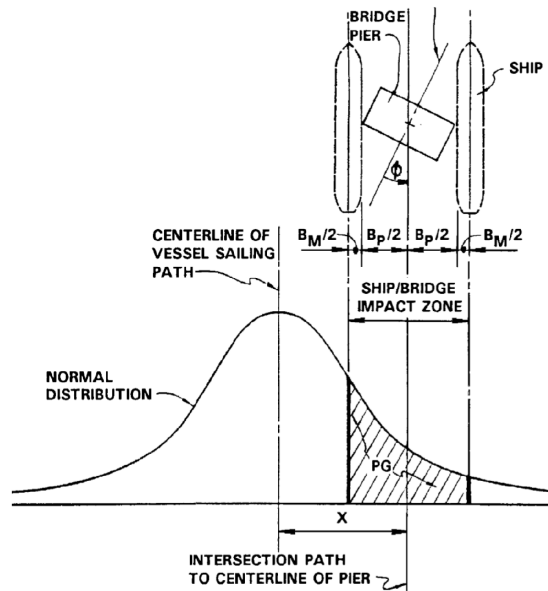

Figure 2.1 Determining the geometric probability,  $PG$ , of a bridge pier (AASHTO 2009)

The AASHTO  $PG$  expression was formulated as a simplified combination of different models proposed in studies by researchers including Fujii and Shiobara (1978), and Modjeski and Masters (1985).

#### 2.1.4 Probability of collapse ( $PC$ )

The probability of bridge collapse,  $PC$ , is calculated for each bridge pier (and vessel group) in the waterway based on the condition that vessel impact will occur. The AASHTO  $PC$  expression was derived from a study of ship-ship collision damage rates (AASHTO 2009; Fujii and Shiobara, 1978). In this derivation, ship-bridge collision damage rates were assumed (for the purposes of bridge design) to be correlated to the ratio of bridge resistance to ship impact force ( $H/P$ ). Furthermore, because of a lack of data for barge (as opposed to ship) collisions, the AASHTO  $PC$  expression was assumed to be applicable to both ship-bridge collisions and barge-bridge collisions.

The  $PC$  expression thus developed and incorporated into AASHTO is:

$$PC = \begin{cases} 0.1 + 9(0.1 - H/P) & 0.0 \leq H/P < 0.1 \\ 0.111 \times (1 - H/P) & 0.1 \leq H/P < 1.0 \\ 0.0 & H/P > 1.0 \end{cases} \quad (2.4)$$

where  $H$  is the bridge member ultimate capacity (typically taken as bridge pier static pushover capacity), and  $P$  is the static vessel impact load. Note that when  $H/P > 1$ , the AASHTO  $PC$  expression gives a 0% probability of pier collapse.

Following the publication of the original AASHTO provisions, research has been conducted to develop an updated  $PC$  expression for barge impact conditions to take into account dynamic amplification effects and directly incorporate barge-bridge collision data (Davidson 2010). In line with these efforts, barge impact load models have been developed that account for the impact-related dynamic amplification of member demands (Consolazio et al. 2009; Getter and Consolazio 2011). Subsequently, in Davidson et al. (2013), a rational framework for determining the probability of bridge collapse (failure), in the event of a barge-bridge collision, was used to form an updated  $PC$  expression.

### 2.1.5 Protection factor (*PF*)

The AASHTO protection factor, *PF*, facilitates modification of the annual frequency of collapse to account for full or partial protection of the substructure or superstructure. Other structures (e.g., fenders, dolphins, adjacent bridges and wharfs) or elements of the waterway (e.g., shallow water depths, land masses, the shoreline) may act as shields against vessel impact. The *PF* term varies from pier-to-pier and also varies in the upbound and downbound directions since protection elements may differ depending on direction of travel. The following expression is used to compute the protection factor:

$$PF = 1 - (\text{protection}) \quad (2.5)$$

This expression is interpreted in the following manner: if the bridge element is fully protected,  $PF = 0.0$ ; if no protection is present,  $PF = 1.0$ . For example, if a bridge element is 70% protected (i.e., protection=0.7), then  $PF = 0.3$ . The greater the protection afforded to a bridge element, the smaller the value of *PF*. A more detailed discussion of the *PF* term, alternative proposed *PF* expressions, and details on the design and construction of protection structures will be discussed later in Section 2.3.

## 2.2 Vessel Traffic Characteristics

### 2.2.1 Overview

Collection of vessel characteristics and vessel traffic data is critical for the accuracy of the Design Method II risk analysis. Terminology and descriptions of vessels that transit navigable waterways are provided below. Relevant vessel terms and descriptors include passages, vessel types, geometry, hydrodynamic characteristics, and transit direction, among others. In addition, the role of each descriptor with respect to the evaluation of the annual frequency of collapse, *AF*, is subsequently reviewed in Section 2.2.5 .

#### 2.2.1.1 Passages

The United States Coast Guard (USCG 1947) defines navigable waterways as all waters that are (1) territorial seas of the US; (2) internal waters that are subjected to tidal influence; or (3) non-tidal waters that are or have been used, or are susceptible for use to transport commerce. Vessels may navigate a waterway in either the upstream (upbound) or downstream (downbound) direction; upstream being against the flow, and downstream being with the flow. Inbound and outbound can also be used to describe the direction of vessel traffic and such directions may not coincide with the upstream/downstream notations. An example is when a vessel is exiting (outbound) the waterway of a port but going against the stream of the channel (upstream). It is important to note this as multiple publications (e.g., USACE 2017) use both notations. Vessel traffic may have different characteristics depending on direction. Such differences may be due to conditions such as strong currents and variations in water depths; or, due to changes in speed and/or tonnages of vessels transiting in one direction versus when returning in the opposite direction (additional details are provided in Section 2.2.3.2).

#### 2.2.1.2 Vessel types and purposes

The United States Coast Guard (USCG 2010) defines vessels as any craft used as a means of transportation in water. Based on this definition, vessels can range from recreational vessels such as sailboats and racing boats to commercial ships. However, only vessels with commercial

purposes are typically considered for impact-resistant bridge design. Commercial vessel types (ships, barges) have distinct characteristics in matters of geometry, capacity, and hydrodynamics. According to the WCSC, classification of inland and sea-going vessels includes: self-propelled dry cargo, self-propelled tanker, non-self-propelled dry cargo, non-self-propelled tanker, and others. The AASHTO design provisions provide vessel sub-classifications based on the purpose of the vessel. Barges are divided into hopper, deck, and tanker, whereas ships are classified into product carriers/tankers, bulk carriers, or freighter/container vessels.

## 2.2.2 Geometry

### 2.2.2.1 Dimensions

The widest and longest possible dimensions of a vessel (ship, or barge flotilla) are referred to as the beam (width) and length overall (LOA). The vertical distance between the bottom of the vessel and the waterline is called draft. The vertical clearance from the waterline to the highest point on the vessel is called air draft. Vertical clearances of barge-tug flotillas are usually controlled by the air draft of the tug boat. The minimum vertical clearance between a bridge and vessels is based on the tallest vessel transiting the waterway. For waterways that are navigable by deep draft ships, the minimum bridge-to-vessel clearance distance is controlled by ships. For waterways that are navigable only by barges, minimum clearance distance is typically controlled by the height of tug/push boats.

### 2.2.2.2 Bow shape

The characteristics of the bow are of relevance when computing the vessel impact location and when considering the effects of bow crushing and energy dissipation during collision (Consolazio et al. 2010). The rake dimensions of a barge describe the shape of the cross-section of the bow. The schematic in Figure 2.2 depicts one such typical barge geometry (as excerpted from AASHTO 2009).

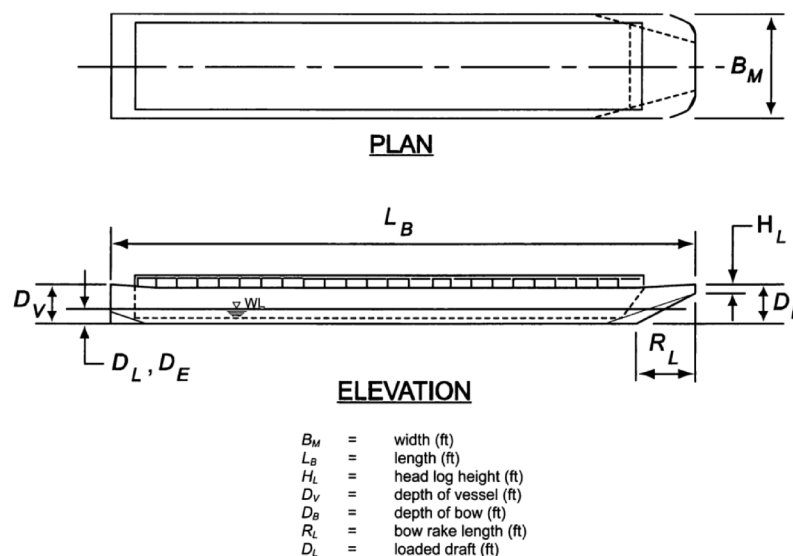

Figure 2.2 General barge vessels characteristics (AASHTO 2009)

With regard to ships, the shape of the bow overhang, as well as the loading condition, determine the location at which impact force will be applied to a bridge and should therefore be taken into account in bridge design. Typical examples of bow shape for commercial ships

(container, bulk carriers, and tankers) are presented in Figure 2.3. Generally, the bow of ships will have cylindrical or bulbous shapes, and the rise of the bow will vary depending on the rake (the angle at which the bow intersects the waterline). The shape of the bow of ships not only influences the location of the impact force, but also the distribution of the load along the impact surface(s).

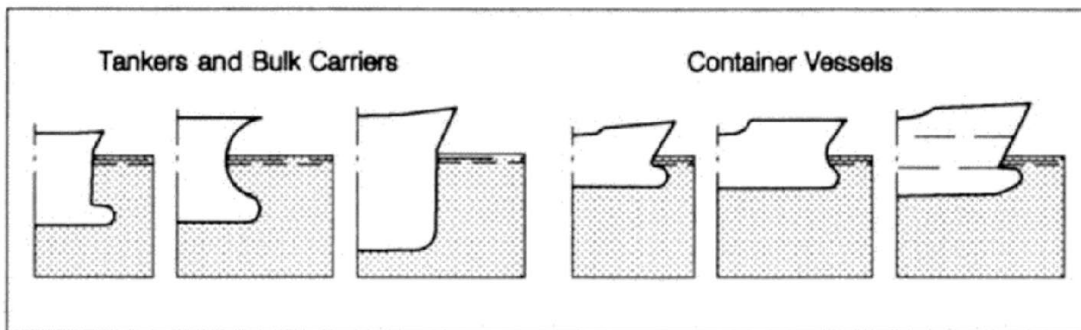

Figure 2.3 Typical ship bow structure (Larsen 1993)

## 2.2.3 Hydrodynamic characteristics

### 2.2.3.1 Displacement and draft

The weight of a vessel can be expressed in terms of water displacement, often called the displacement tonnage ( $W$ ). Vessel displacement tonnage ( $W$ ) differs from deadweight tonnage ( $DWT$ ). The latter,  $DWT$ , represents the weight carrying capacity of the vessel, but does not account for the weight of the vessel itself. Also, the  $DWT$  may account for cargo, supplies, fuel, passengers, fresh water, and ballast water. The  $DWT$  measure of a ship is important as maritime institutions often classify vessels based on this parameter. Displacement tonnage ( $W$ ) and deadweight tonnage ( $DWT$ ) are often measured in metric tons (or tonnes), where 1 tonne equals 1000 kg of mass. The weight associated with 1 tonne (of mass), expressed in US customary units, is 2205 lbf. Alternate measures used to describe vessel and cargo weights include: short tons (1 short ton = 2000 lbf), and long tons (1 long ton = 2240 lbf).

### 2.2.3.2 Loading condition

Vessel displacement and draft vary based on the loading condition of the vessel. Therefore, distinction between empty/loaded displacement and draft is required when collecting traffic data. Barges may transit along a waterway in either loaded or empty conditions. Loaded barges are often defined in terms of cargo-carrying capacity, expressed in short tons. Ships can also transit in fully, partially, and ballasted loading conditions with varying drafts. The displacement of ships may be computed as a function of the draft (see AASHTO 2009, Equation C3.5.2-1). However, doing so for ballasted ships can be problematic in that such ships may draft differently at the bow versus at the stern (Figure 2.4). The technique of ballasting, which involves pumping water into chambers near the bottom of a ship, is used to increase ship stability when carrying light payloads.

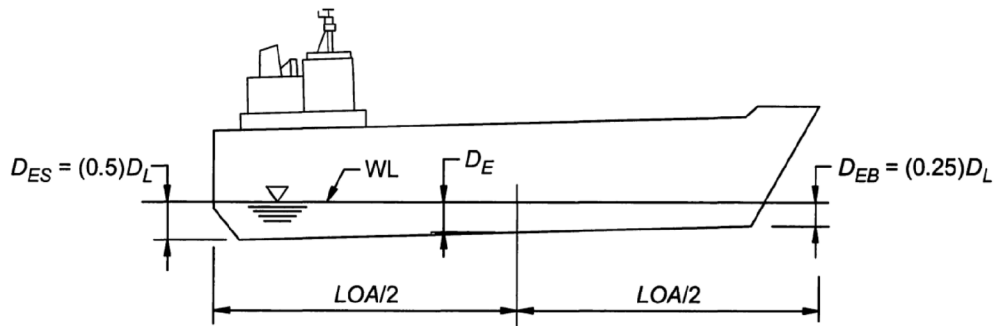

Figure 2.4 Effects of ballasted conditions on ship draft (AASHTO 2009)

### 2.2.3.3 Vessel speed

Design impact speeds are computed individually for upbound and downbound directions. The computation of the design impact speed should reflect typical transit velocities and typical environmental conditions. The vessel velocities can be estimated by interviewing barge and freight companies, contacting relevant institutions (e.g., USACE for velocities between locks and ports; FDOT for speeds recommended for use in design), or by implementing Automatic Identification Systems (AIS) methodologies.

### 2.2.4 Vessel group and vessel fleet

For bridge design purposes, vessels of similar characteristics are grouped together. Characteristics used in establishing groups range from, but are not limited to, draft, displacement, deadweight tonnage, length, speed, and flotilla configuration (for barge-tug flotillas). As some of these characteristics may vary depending on the direction the vessel is heading, a single type of vessel can often form part of multiple vessel groups. An example of this is when bulk carriers and tankers transit a waterway fully loaded in one direction and return in ballasted conditions subsequent to unloading the cargo. In this case, the ship is classified in two different vessel groups (one for each direction) that are described by (1) fully loaded conditions and the associated speed; and (2) ballasted conditions with the associated speed, draft, and *DWT*.

Generally, ships and other self-propelled vessels are classified into vessel groups based on deadweight tonnage. It is recommended in AASHTO (2009) that ships be grouped in intervals of no more than 20,000 *DWT* (i.e., 20,000 tonnes) for vessels smaller than 100,000 *DWT*, and not exceeding 50,000 *DWT* for larger ships. Additionally, ships should be categorized by size, draft, and loading condition, as these factors affect the computed annual frequency of collapse (*AF*).

Barge groups, which are typically non-self-propelled, are comprised of barge(s) and a tug/tow boat that propels the barge flotilla. Barge groups are defined by size, draft, loading condition, and the number and configuration of barges. If a tug is transporting multiple barges, the dimensions and mass (or weight) of the vessel group are computed as a summation of the overall width, length, and deadweight tonnage of the barge-tug configuration (Figure 2.5). Free tugs are collected into distinct vessel groups.

The combination of all vessel groups that cross a point in a navigable waterway at a particular time is referred to as a vessel fleet. A vessel fleet is described in terms of a combination of vessel characteristics and the frequency at which a point is crossed (e.g., transit under a bridge; past a mile-marker).



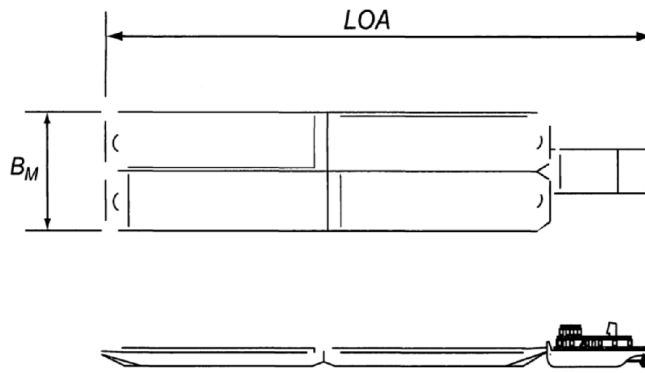

Figure 2.5 Barge group characteristics (2x2 configuration) (AASHTO 2009)

### 2.2.5 Role of vessel traffic characteristics in evaluating annual frequency of collapse ( $AF$ )

Differences in vessel characteristics play an important role in collision risk analysis because the annual frequency of collapse is not only computed for individual bridge components but also for individual vessel groups. The number of vessel groups determines the number of iterations (summations) that are needed in order to account for contributions from all vessels to the annual frequency of collapse. Moreover, vessel characteristics such as length and type also influence the probability that a collision event occurs (Fujii and Shiobara 1978).

The bridge designer is responsible for drawing together information related to the characteristics of the waterway as well as the characteristics of the vessel fleet so that the annual frequency of collapse ( $AF$ ) can be determined. These characteristics and their effects are discussed in subsequent subsections.

#### 2.2.5.1 Vessel frequency ( $N$ )

The number of vessel trips crossing directly beneath a bridge structure directly affects the likelihood that collision with a given a bridge component may occur. The vessel frequency,  $N$ , acts as a direct magnitude multiplier of the contribution of a vessel group to the total annual frequency of collapse. Alternatively stated, the greater the number of vessel transits, the higher the probability of vessel-bridge collision.

To properly determine the number of vessels ( $N$ ) that pass beneath a bridge, the draft of the vessel group must be compared with the available water depth. If it is determined that vessels making up the group will run aground prior to reaching the bridge, it can be assumed that the vessel group poses no risk to the associated bridge element(s). The same approach can be taken for bridge spans with vertical clearances significantly higher than the tallest vessel in the waterway. The water depth of both sides (upstream, downstream) of a bridge must be accounted for, as varying water depths may permit a vessel group to contribute to only one direction. The analysis must also include the potential risks that a ship poses when transiting in a ballasted condition. When considering shallow waterways, it must be determined if differences between the bow draft and the stern draft are enough for the ship to impact a bridge element before it runs aground. Moreover, the physical ability of a vessel to plow through underlying soft soils when running aground may also require consideration.

Once the vessel frequency data are determined, future traffic must be estimated. Traffic growth must be estimated for the service lifetime of the structure. Ideally, not only the increase in trips but also the change in vessel characteristics would be accounted for in the growth rate analysis. However, given the challenges inherent in predicting future changes to vessel

characteristics, the AASHTO vessel collision bridge design provisions do not require consideration of such changes when computing growth rates.

#### 2.2.5.2 Probability of aberrancy ( $PA$ )

The size and type of the vessel, use of modern navigation technologies, loading condition, and other vessel characteristics influence the probability that a vessel will deviate from its intended path; however, the current AASHTO  $PA$  expression (recall Section 2.1.2) accounts for these factors only in an overall (average) sense. The effect of traffic density corresponds to one of four correction factors found in the computation of probability of aberrancy ( $PA$ ). The traffic density factor,  $R_D$ , represents the likelihood that a vessel will encounter another vessel transiting in the immediate vicinity of a bridge. The AASHTO LRFD (AASHTO 2020) bridge design specifications categorize traffic into low, medium, and high density levels. For waterways in which vessels rarely encounter one another (low density) a value of  $R_D = 1.0$  is assigned; if vessel encounters occur occasionally, a value of  $R_D = 1.3$  is assigned; and, for waterways where vessels routinely encounter one another,  $R_D = 1.6$  is assigned.

#### 2.2.5.3 Probability of geometry ( $PG$ )

the AASHTO  $PG$  expression (recall Section 2.1.3) is calculated as the area under a normal distribution curve with the standard deviation of the distribution taken as the length overall (LOA) of the vessel group being analyzed. Any bridge element located at a distance from the channel centerline that is greater than three times the vessel LOA (i.e.,  $3 \cdot LOA$ ) is not considered to be at risk of impact, and therefore is not further considered in the analysis.

#### 2.2.5.4 Probability of collapse ( $PC$ )

Given that the AASHTO  $PC$  expression (recall Section 2.1.4) is in part a function of the static vessel impact force ( $P$ ), it is heavily reliant on vessel characteristics as such as dimension, type, bow shape, speed, and weight. Specifically, impact loads for barges ( $P_B$ ) and ships ( $P_S$ ) are correlated to vessel speed and weight. The vessel bow damage depth ( $a$ ) is a function of the kinetic energy ( $KE$ ) imparted at collision, which in turn is related to the weight and speed of the vessel. Additionally, the shape of the vessel bow should be considered when determining the point of application of impact loads. For the design of substructures, the following criteria are stated in AASHTO 2009, Section 3.15.1:

1. For assessment of overall stability, the design impact force should be applied at the mean high-water level .
2. For assessment of localized collision force effects, the design impact force should be transformed into a uniformly distributed load applied along the height of the vessel bow. If the vessel analyzed is a barge, then the distributed load should be applied over the height of the headlog.

### **2.3 Literature Review of the Protection Factor ( $PF$ )**

As noted in Section 2.1.5, the AASHTO protection factor ( $PF$ ) adjusts the probability of bridge collapse to account for any protection provided by elements that may: prevent a vessel from reaching the structure; or reduce the kinetic energy of an impacting vessel. A  $PF$  value should be determined for protection provided by land masses, protective structures (e.g., fenders, protective dolphins, artificial islands, other bridges), and shallow water levels that shield bridge elements from possible vessel impact. AASHTO (2009) provides a brief definition of  $PF$ , a recommended procedure for estimating  $PF$  values for protective dolphin structures, and an example of the

computation of  $PF$  for the LA-1 Bridge case study (see Appendix I AASHTO 2009). However, the document does not supply an explicit methodology for consistently computing  $PF$  values for all possible cases. The current implementation recommended by AASHTO relies on a singular variable, ‘percent protection provided.’ However, AASHTO does not detail how to quantify the percent protection provided. Thus, the task of assigning values of  $PF$  is commonly left to the judgement of the design engineer. This approach is undesirably non-uniform since it depends somewhat on the subjective perspective of the engineer. Hence, additional review was undertaken of typical protection measures, protection systems, and factors that could constitute protection.

### **2.3.1 Protection structures and systems**

In Larsen (1993), it is explained that an engineer, when designing a bridge over a navigable waterway, has the option of deciding between two approaches: designing bridge elements capable of withstanding vessel impact loads, or alternatively, constructing a protective structure system. The first option may not always be cost effective due to the material energy absorption characteristics that will be required during collision events. Hence, protective systems are implemented to prevent, redirect, or reduce impact forces such that the associated structural demands remain below destructive levels. Moreover, protection systems must also be designed to minimize damage of an impacting vessel; otherwise, there is the potential for negative environmental effects to occur within the waterway (e.g., cargo spills).

As summarized by Geng et al. (2016), two different approaches can be taken when designing protection for bridges against waterway vessel collision: (1) the plastic deformation of the protective system should dissipate the impact energy and ensure shielding of the pier, or (2) the elastic deformation of the protective system can be relied upon to absorb impact energy. The latter approach can increase the duration of impact, and consequently, decrease both the force level and damage to the colliding vessel. The main types of protective structures are fender systems (pile-supported and floating devices), dolphins, and artificial islands.

#### 2.3.1.1 Fender systems

Fenders are designed as guide walls to aid with vessel navigation, but also to shield (protect) piers from ship and barge impact. Fender systems can be constructed from timber, polymer composites (e.g., high density polyethylene [HDPE]), concrete, steel, or elastomers. Moreover, fender systems are commonly constructed from a combination of materials to provide protection characteristics adequate to the design requirements, as proposed by, for example, Fan et al. (2015) and Manohar et al. (2020). The energy absorption capacities of fender systems are critically dependent upon the strengths of the pile connections, as the connections are typically the weakest elements in the system (Wuttrich et al. 2001). Timber and composite fenders (Figure 2.6) are often constructed as a beam grillage consisting of interconnected horizontal and vertical members and supported by piles.

Due to the prohibitive cost and logistics associated with conducting full-scale collision testing, vessel impact loads and expected damage levels for fenders are typically investigated using methods such as finite element analysis (FEA). For example, Wuttrich et al. (2001), investigated the structural performance of Florida fender systems under a variety of different impact conditions, and also investigated potential methods for retrofitting such systems. Consolazio and Wilkes (2013) used dynamic finite element (FE) impact simulations to quantify design impact loads for fender guide walls that were constructed from timber and composite-material elements.

### 2.3.1.2 Protective systems that surround and protect piers (pile-supported systems)

Design configurations commonly associated with pile-supported protection systems consist of a group of piles connected by a rigid cap in the form of a “ring” (Figure 2.7). All protective structures are designed to absorb impact energy and reduce the consequences of vessel impact. Similarly, pile-supported bridge protection is designed to absorb energy through large deformations and yielding (Zhu et al. 2011). Such systems are typically constructed out of concrete, steel, or timber. Depending on cost considerations, site conditions, and impact loads, the pile system should be designed to either prevent the vessel from impacting a pier or decrease the impact loads below destructive levels. Free-standing piles are also considered as protective elements.

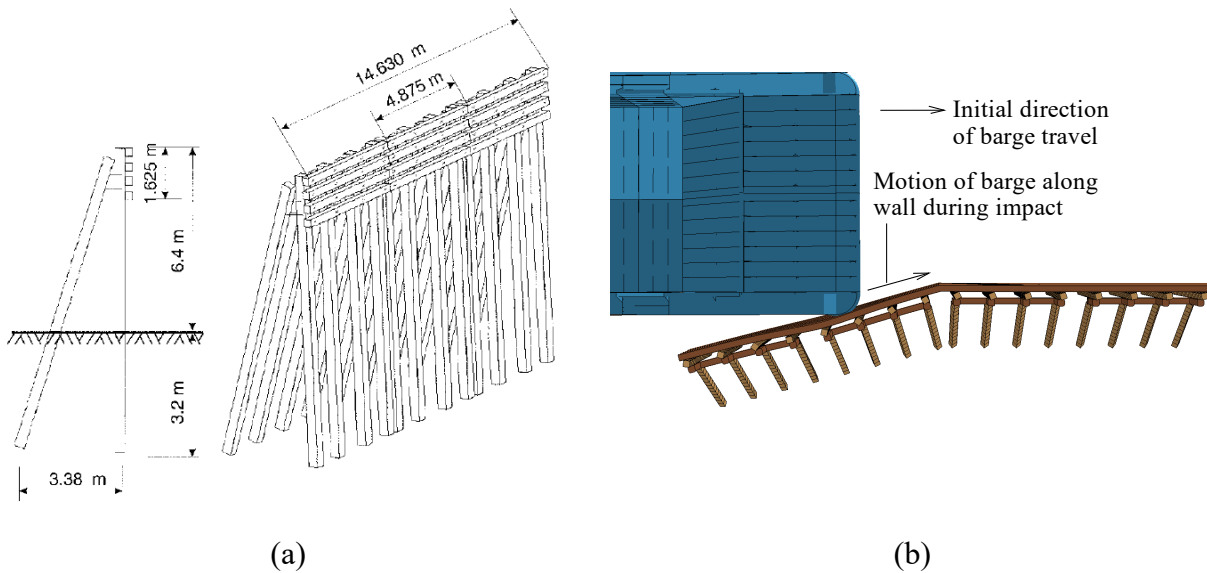

Figure 2.6 Timber fender systems analyzed using FEA:  
(a) Wuttrich et al. (2001); (b) Consolazio and Wilkes (2013)

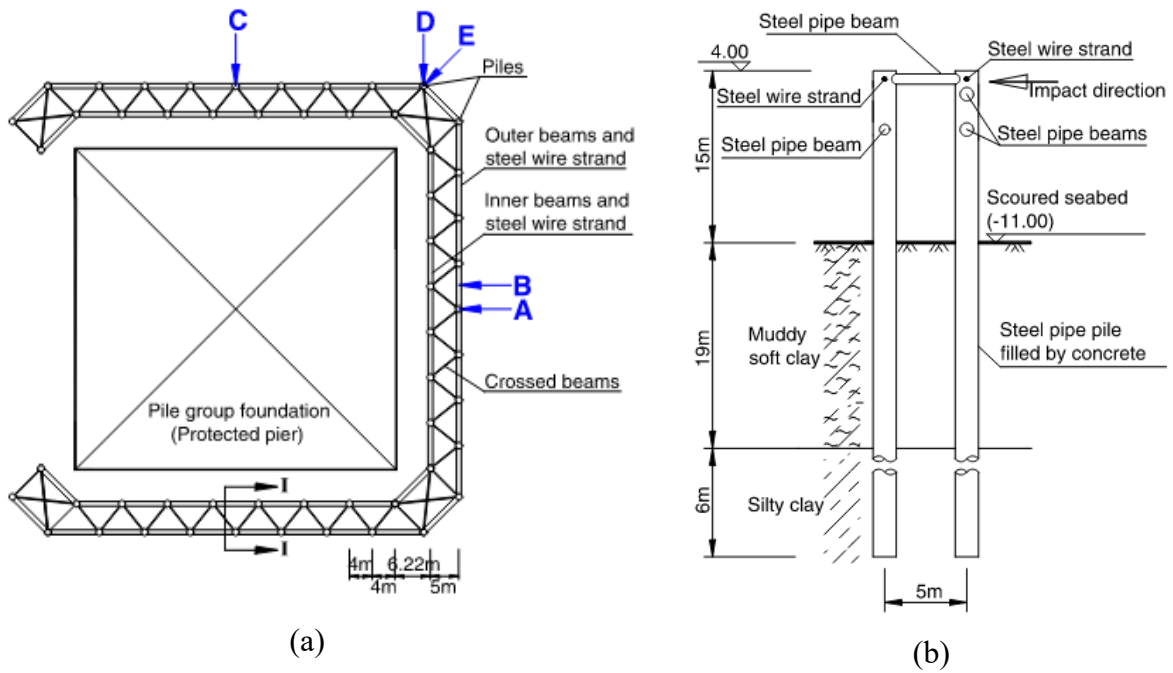

Figure 2.7 Pile-supported system protecting an off-shore transmission tower (Zhu et al. 2011):  
 (a) plan view; (b) foundation (pile) drawing

### 2.3.1.3 Protective systems that surround and protect piers (floating systems)

Bridge designers also have the option to use floating protective systems. The systems may be anchored to the bottom of the channel, secured to the coastline, or attached to the bridge piers. Examples of floating protective systems are floating islands, anchored pontoons, floating shear booms, and cable net systems. These types of systems can be constructed from various materials, including fiber-reinforced polymer and steel wire-rope coil (Figure 2.8), all characterized by the associated energy absorption characteristics. Cable net systems may be at risk for being pulled down by the bow of vessels and being run over, thus the bow geometry of the vessel fleet transiting below the structure is of importance when choosing floating protection systems (Svensson 2009). When compared to other protection systems, a floating protection system can protect the bridge structure and otherwise avoid (or limit) damage to the ship (Wang et al. 2019).



Figure 2.8 Flexible floating protection system installed in Zhanjiang Bay Bridge, China (Wang et al. 2019)

#### 2.3.1.4 Dolphin protection

Dolphin structures may be designed based on an estimate of the energy that can be absorbed through plastic deformation (Geng et al. 2016). Deformation paths can be developed for each potential vessel-dolphin impact condition in accordance with energy dissipation mechanisms. Larsen (1993) recommended that maximum dolphin deformation be limited to less than one-half the diameter of the structure. Dolphins tend to be constructed as circular cells made from concrete with steel pilings and a reinforced concrete cap. Alternatively, dolphins can be constructed off-site as precast concrete structures. Dolphin structures can be designed to withstand low-energy impacts without damage, while repair or replacement may be necessary following high-energy head-on impacts (Consolazio et al. 2014). It is known that dolphins and land masses can entirely shelter a pier from impact and provide a protection factor of  $PF=0.0$  (AASHTO 2009).

#### 2.3.1.5 Artificial Islands or reef protection

Designing an artificial island at the bases of bridge piers, or around the piers, can provide effective protection against vessel collisions. However, this type of protection is non-optimal as it reduces the channel width and increases the waterway current velocities (Svensson 2009). The design of artificial islands should prevent penetration of the bow and, in turn, prevent contact between the vessel bow and a structural element of the bridge. Artificial islands are usually constructed with a sand or rock core and with an outer layer of heavier rocks to prevent erosion from currents and waves (Figure 2.9). Islands also provide a high degree of safety in that a colliding vessel is stopped gradually, not suddenly, where more rapid decelerations of vessels may occur during collisions involving other types of protective structures (Svensson 2009).



Figure 2.9 The Bridge of the Americas stands on artificial islands made to protect the piers from ships transiting the Panama Canal (Wikipedia)

#### 2.3.1.6 Existing structures that shield bridge elements

Existing structures that are located near a bridge, and which have the ability to shield the bridge from vessel impact should also be considered when computing protection factor values. The influence of nearby bridges, wharfs, towers, etc. may be taken into account when analyzing the probabilities that a bridge will be struck by a vessel. The protection factor ( $PF$ ) can be used to account for the degree of shielding protection that is afforded by a nearby structure. Wei and Li (2019) performed a study where the annual frequency of collapse ( $AF$ ) was computed for an existing bridge. The researchers computed the protection factor ( $PF$ ) for two scenarios: with and without consideration of protection from a nearby bridge. It was found that by including the influence of protection afforded by columns of the nearby structure, the  $AF$  for the upstream direction decreased by 68% (Wei and Li 2019).

### 2.3.2 Quantifying the protection to bridge components provided by protective systems

In AASHTO (2009), selected elements (Figure 2.10) of an approach for computing the protection factor (recall Equation 2.5) are outlined. The conceptual example presented in AASHTO involves a dolphin structure partially protecting a bridge pier. For vessel approach angles between  $-\theta$  and  $+\theta$ , it is assumed that the pier is protected (shielded) from vessel impact. The magnitude (absolute value) of the angle  $\theta$  (degrees) is:

$$\theta = \sin^{-1}(D_E/(2L)) \quad (2.6)$$

Where  $L$  (ft) is the distance from the pier to the dolphin (Figure 2.10a), and  $D_E$  (ft) is the effective dolphin diameter:

$$D_E = D + 0.75B \quad (2.7)$$

In the above expression,  $D$  is the diameter of the protective structure,  $B$  is the beam (i.e., width) of the vessel. The range of all possible vessel impact angles is assumed to be represented by a normal (i.e., Gaussian) distribution (Figure 2.10b). In the example presented in AASHTO (2009), the standard deviation of possible impact angles is assumed to be  $\sigma = 30^\circ$ . [Note that differing values of  $\sigma$  have been utilized in other works, e.g., Kunz (1998), Consolazio et al. (2014)]. Considering angles between  $-\theta$  and  $+\theta$ , the hatched area under the normal distribution in Figure 2.10b then represents the probability ( $R$ ) that the pier is protected from vessel impact. Although not stated in AASHTO (2009), the protection factor is then computed as  $PF = (1 - R)$ . Note that a protection factor ( $PF$ ) must be computed for both directions of each vessel group and for every bridge element.

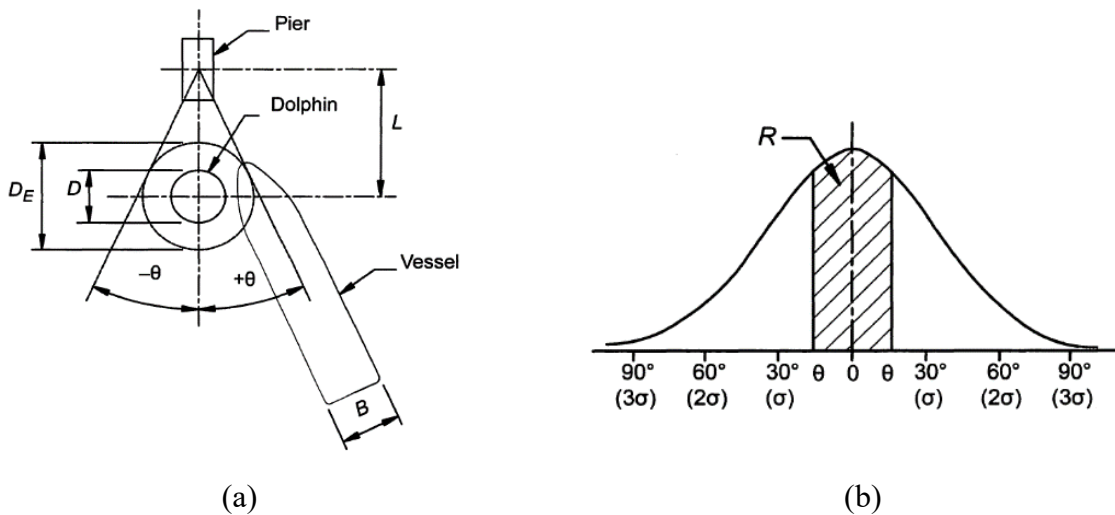

Figure 2.10 Example scenario for computing  $PF$  as given in AASHTO (2009): (a) Plan view of protection; (b) Normal distribution of possible impact angles ( $\sigma = 30^\circ$  assumed)

In Consolazio et al. (2014), a similar procedure was utilized to quantify the levels of protection afforded by land masses and structures that were located adjacent to bridge piers under consideration. Possible vessel approach angles (Figure 2.11) were assumed to be represented by Gaussian distributions, but the standard deviation was assumed to be  $\sigma = 10^\circ$  as per Kunz (1998). The probability of grounding against a land mass ( $P_{Gr}$ ), or shielding by another structure, was then computed by integrating (finding the area under) the Gaussian distribution over approach angles

that would be blocked by the land mass or structure. The resulting protection factor was computed as  $PF = (1 - P_{Gr})$ . A similar approach was presented in Knott and Winters (2018), where the protection provided by a land mass is calculated, assuming a standard deviation of 30 degrees ( $\sigma = 30^\circ$ ).

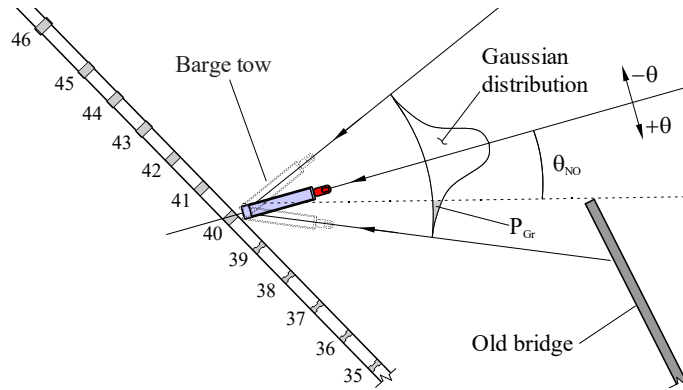

Figure 2.11 Computation of  $PF$  based on adjacent land masses or structures (Consolazio et al. 2014;  $\sigma = 10^\circ$  assumed)

Whereas the above approaches apply to the calculation of  $PF$  for individual piers, an alternative approach was employed in Consolazio and Kantrales (2016) in which a protection factor  $PF_{br}$  for an entire bridge site was computed as:

$$PF_{br} = 1 - \left( \frac{\sum_{i=1}^n (PG_p)_i}{PG_{br}} \right) \quad (2.8)$$

In Equation 2.8,  $PG_{br}$  is the geometric probability for the bridge;  $(PG_p)_i$  is the geometric probability associated with *protected* pier  $i$ ; and  $n$  = number of protected piers.

In each of the approaches noted above, the source of protection (adjacent structure, land mass, or shallow water) is assumed to be physically separate from the bridge. Publications providing explicit guidance for situations where a bridge and adjacent structure are physically connected, and thus share in resisting applied impact loads, were not located in the literature.

## 2.4 Past Characterizations of Vessel Traffic

### 2.4.1 Review of Wang and Liu (1999)

In 1999, the FDOT funded a research project called “Synthesizing Commercial Shipping (Barge/Tug Trains) From Available Data For Vessel Collision Design”. The purpose of the 1999 study was to collect and organize vessel traffic data in Florida, and further, to synthesize the data for use in risk analysis of vessel collisions against bridges (Wang and Liu 1999). The researchers selected fifty-two locations, referred to as “past points”, to represent vessel traffic in inland and intracoastal waterways. For each past point, one-year or three-year data sets were collected from the United States Army Corps of Engineers (USACE) WCSC for calendar years (CY) 1994 to 1996. A Fortran program was developed to process the collected data. The past point data were synthesized, and the results were presented in the form of calendar year 2000 information, coupled with future traffic growth rates. A computer database file containing the data reported by Wang and Liu (1999) was created by the FDOT. This database serves as the vessel traffic data source for



the FDOT Vessel Collision Risk Analysis Mathcad program, which allows engineers to perform the AASHTO Design Method II procedures (FDOT 2019).

#### 2.4.1.1 Selecting past point locations

Wang and Liu selected a group of fifty-two (52) past points to represent 540 bridges with navigation control in Florida (Figure 2.12). The past points were intended to describe vessel traffic in Florida waterways such as the Gulf Intracoastal Waterway (GIWW) and the Atlantic Intracoastal Waterway (AIWW) and inland channels such as the Okeechobee Waterway, the Miami River, and the St. Johns River system. The selection of the past points was based on the following criteria:

- Each major navigable river, canal, channel, and waterway of every county possesses one past point;
- When present, movable bridges are preferably taken as past points.

The commercial vessel traffic obtained from the past points can be utilized for new bridge sites contiguous to the past points as long as only one navigable waterway connects the past points and there are no intermediate exits. Wang and Liu (1999) presented the past point coordinates, the bridge numbers associated with the past points, and the surrounding county.

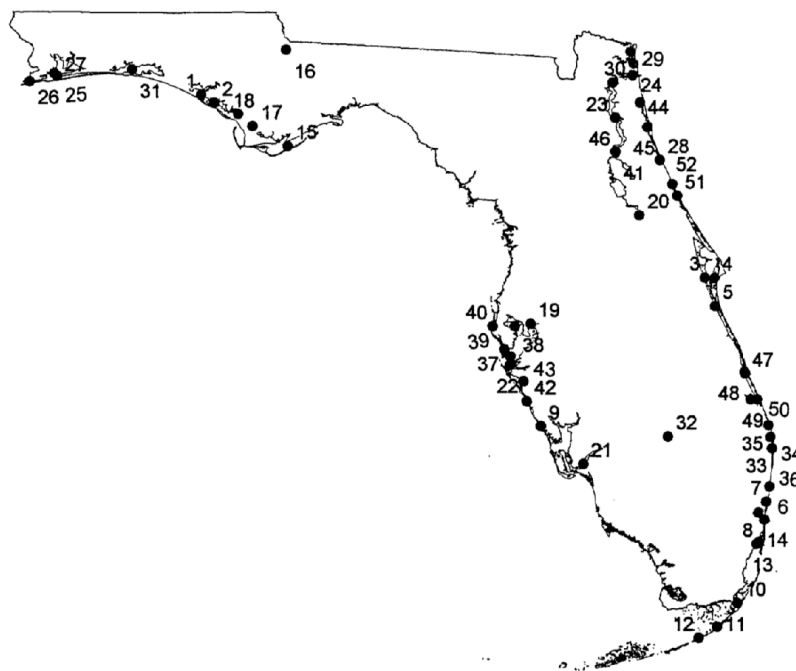

Figure 2.12 Map of fifty-two past point locations in Florida (Wang and Liu 1999)

#### 2.4.1.2 Data collection and classification

Wang and Liu (1999) reported that after reviewing a time frame of ten years, the *WCUS 1997* (parts 1-5) indicated that the annual tonnage varied significantly in some Florida waterways. To account for the traffic variance, three-year data were collected for waterways with fluctuating traffic (32 past points), and one-year data were collected for waterways with approximately constant traffic (20 past points). The commercial vessel traffic data were requested from the USACE WCSC, which maintains the U.S. waterborne commerce and vessel database. A Fortran program was developed to process the data. Collected data were synthesized into the form of

weighted averages for vessel draft, width, length, and displacement, and vessel groups were formed with the resulting information.

Barges were placed into groups based on draft intervals of 3 ft each. As the data provided by WCSC did not include sufficient information to determine the tugs associated with each individual barge train trip, a simplified method was adopted. Tugs were categorized as small, medium, or large, and then associated with barge groups based on barge draft. An additional vessel group was assigned for the special case of tugs transiting alone.

**Barge Classification and Assigned Tug**

Group No.	Draft	Tug
1	<=3 ft	SMALL
2	>3 ft <=6 ft	MED
3	>6 ft <=9 ft	MED
4	>9 ft <=12 ft	LARGE
5	>12 ft	LARGE

(a)

**Tug Size and Displacement**

Tug size	Draft (ft)	Displacement (ton)	Width (ft)	Length (ft)
SMALL	4	65	20	50
MED	7	130	30	100
MED	7	130	30	100
LARGE	9	220	35	120
LARGE	9	220	35	120

(b)

Figure 2.13 Barge and tug classification for forming vessel groups (Wang and Liu 1999):

(a) Barge groups with the assigned tug sizes; (b) Tug groups by size and displacement

The synthesized data of self-propelled vessels (ships) were also grouped by draft. It was found that keeping the same draft intervals for ship groups as for barge groups would have produced minimal effects in the design, thus providing unrealistic results. Consequently, self-propelled vessels were instead classified by draft intervals of 2 ft. As the data provided by WCSC did not directly indicate *DWT* information, the deadweight tonnage (*DWT*) of ships was approximated as:

$$DWT = 0.447 \cdot (length) \cdot (width) \cdot (draft) \cdot \left(\frac{63}{2205}\right); \text{tonnes} \quad (2.9)$$

which was derived, in part, from data presented in Figure 2.14. When reviewing the processed data, significant foreign vessel traffic was found at 9 past points; however, size and displacement information were not provided by the WCSC for these types of vessels. It was determined that foreign vessels traversing Florida waterways possessed a 2-ft light draft and a 20-ft loaded draft. These values were compared with typical characteristics of similar bulk, tanker, and container ships described in *1991 Guide Specification and Commentary for Vessel Collision Design of Highway Bridges* (Tables 3.5.2-1, 3.5.2-2, 3.5.2-3). Figure 2.14 presents a summary of the information found in AASHTO (2009). As a simplification, the researchers computed weighted averages of similar ships, for each type, and thus established the size and displacement values for the foreign vessel group.

Summary of Relationship between Sizes and DWT of Typical Ships

Length (ft) (a)	Width (ft) (b)	Fully Loaded Draft (ft) (c)	DWT (tonne) (d)	Eq. (6)/1.03 (tonne) (e)	Ratio of (d) divided by (e) (f)	Note (g)
200	29.2	14.1	1000	2358	0.424	Bulk Carrier
289	41.7	22.3	3000	7696	0.390	Bulk Carrier
341	48.9	21.3	5000	10171	0.492	Bulk Carrier
459	61.4	26.6	10,000	21468	0.466	Bulk Carrier
515	70.5	29.5	15,000	30672	0.489	Bulk Carrier
558	77.8	31.5	20,000	39160	0.511	Bulk Carrier
187	30.8	13.8	1000	2276	0.439	Product Carrier/Tanker
279	42.0	19.4	3000	6510	0.461	Product Carrier/Tanker
335	48.2	22.6	5000	10450	0.479	Product Carrier/Tanker
456	62.3	26.6	10,000	21640	0.462	Product Carrier/Tanker
515	71.2	29.5	15,000	30976	0.484	Product Carrier/Tanker
561	78.1	32.2	20,000	40401	0.495	Product Carrier/Tanker
190	31.2	13.8	1000	2343	0.427	Freighter/Container
282	43.3	19.4	3000	6784	0.442	Freighter/Container
338	50.5	22.3	5000	10900	0.459	Freighter/Container
472	63.6	26.9	10,000	23124	0.433	Freighter/Container
617	84.3	30.8	16,000	45876	0.349	Freighter/Container
643	90.6	34.4	20,000	57387	0.349	Freighter/Container
					Average 0.447	

Figure 2.14 Typical characteristics of different types of ships utilized to compute foreign vessel information (Wang and Liu 1999)

Example results synthesized from this averaging process are presented in Figure 2.15 for past point 5. The figure demonstrates how vessel groups were divided by draft intervals, and how a separate group for free tugs was established. Columns B, F, G, and H show weighted averages for each vessel group (where the weighting values are the numbers of trips). Column C lists the total number of barges in each group. Column D (number of barges per trip) was calculated by dividing the total number of barges by the total number of tug trips for a given direction. Column H presents the weighted average of the results of computing displacements for every vessel trip. Finally, Column I assigns a tug type (small, medium, large) to barge groups following Figure 2.13-b, and lists deadweight tonnages for self-propelled vessel groups following Eq. 2.9. Note that no international vessel traffic data were reported for past point 5.

GROUP	A VESSEL DRAFT <i>D</i> (FT)	B AVE. DRAFT (FT)	C NUMBER OF BARGES	D NUMBER OF BARGES PER TRIP	E NUMBER OF TRIPS	F AVE. WIDTH (FT)	G AVE. LENGTH (FT)	H AVE. SINGLE UNIT DISPLACEMENT (TON)	I TUG TYPE Or DWT (TONNE)
1	$3 \geq D$	2.05	21.30	1.	21.30	46.61	176.19	611.57	SMALL
2	$6 \geq D > 3$	4.87	18.82	1.	18.82	64.55	246.30	2659.30	MED
3	$9 \geq D > 6$	7.62	4.62	1.	4.62	42.23	199.38	2081.49	MED
4	$12 \geq D > 9$	11.31	10.30	1.	10.30	46.90	199.79	3441.79	LARGE
5	Free Tugs	7.00			28.05	23.52	68.91	411.85	
6	Self Propelled $4 \geq D > 2$	3.67			1.07	19.83	79.97	222.54	139.67
7	Self Propelled $6 \geq D > 4$	5.56			3.20	31.50	135.67	826.33	360.56
8	Self Propelled $10 \geq D > 8$	9.00			1.78	38.00	179.20	1988.44	1037.27
Σ			55.04		89.12				

Figure 2.15 Description of vessel traffic in past point 5 (Wang and Liu 1999)

As an additional effort in characterizing vessel traffic for bridge design, the researchers took on the task of estimating vessel speeds in Florida waterways. Eight vessel companies associated with Florida waterways were chosen from the book *Waterborne Transportation Lines*

of the United States, Calendar year 1995 (WTLUS) and contacted to obtain information about transit velocities. Wang and Liu (1999) provided a table with transcripts of phone interviews along with additional information regarding the commodities transported by the companies and the waterways where such companies operate. Figure 2.16 shows an example summary of data that were obtained from the responses. Figure 2.17 shows values recommended by the authors for empty vessel transit velocities, and also provides instructions on velocity corrections to account for operating conditions such as traffic density, loading condition, current velocities, and channel geometry. Superscript 'A' in Figure 2.17 indicates the following corrections:

- For loaded barge trains, reduce the velocity by one knot;
- For barge trains transiting on narrow canals or restricted intracoastal waterways, reduce the velocity by one knot;
- For loaded ships, do not adjust the velocity;
- For ships transiting on narrow canals or restricted intracoastal waterways, reduce the velocity by two knots;
- The annual mean water current velocity is taken as 0.4 knots. For upbound traffic, reduce the vessel velocity by 0.4 knots, and increase by 0.4 knots for downbound traffic.

On River & Good Operation Condition	≅ 6.4 knots
On Intracoastal Waterway or Canal & Average Operation Condition	≅ 5 knots

Figure 2.16 Summary of vessel transit velocities based on interviews with vessel companies (Wang and Liu 1999)

Vessel Type	Operation Condition	Recommended Velocity (knot)
Barge/Tug Train	Straight Navigation Channel and Clear Traffic	7 <sup>A</sup>
	Curve Navigation Channel and/or Crowded Traffic	6 <sup>A</sup>
Self-propelled Vessel (majority: passenger vessels)	Straight Navigation Channel and Clear Traffic	10 <sup>A</sup>
	Curve Navigation Channel and/or Crowded Traffic	8 <sup>A</sup>
Free Tug	Straight Navigation Channel and Clear Traffic	10 <sup>A</sup>
	Curve Navigation Channel and/or Crowded Traffic	8 <sup>A</sup>

Figure 2.17 Recommended design velocities and corrections (Wang and Liu 1999)

Once the vessel traffic data were collected, synthesized, and classified, future projections of traffic growth were developed. First, waterborne traffic increase rates were computed for every past point by collecting annual tonnage data from the WCUS 1997 for an average period of 12 years. Growth rates were then developed based on the assumption that vessel characteristics would remain unchanged in the future, but that trip counts would increase in a linear manner. Figure 2.18 shows an example of the computation of the growth rate for Tampa Harbor, which contains past points 19, 38, and 39.

TAMPA HARBOR, FL  
 Past the points: 19, 38 and 39

Year	Annual total
1985	50921
1986	44522
1987	47,311
1988	54,071
1989	54,047
1990	51,578
1991	49,548
1992	46,434
1993	44,993
1994	51,905
1995	51,911
1996	49,293

One Year Period Increase Rate  
 Based on CY2000  
 0.000733

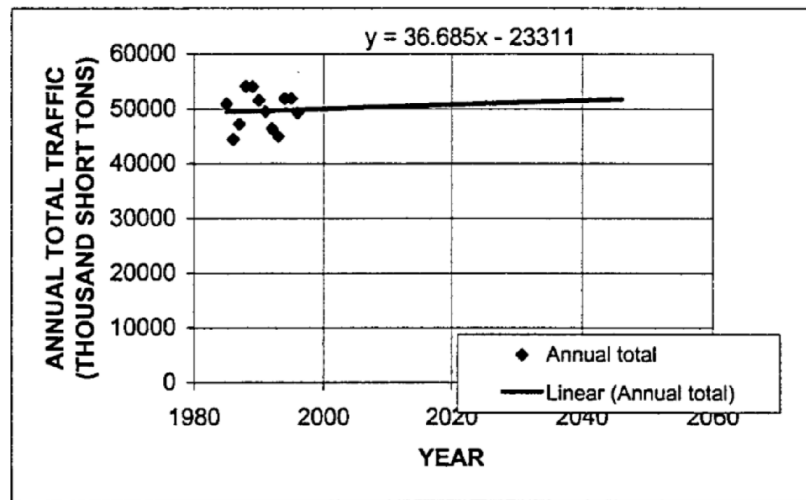

Figure 2.18 Increased traffic rate for past points 19, 38, and 39 (Wang and Liu 1999)

For locations where either negative growth (i.e., traffic reduction) was found, or where the data for a waterway were not located, the statewide average for traffic increase rate was adopted instead.

For all locations, Wang and Liu (1999) recommended that vessel trips for a target year of interest ‘y’ be predicted as:

$$\text{Future value} = \text{Base value} \cdot [1.0 + \text{increase rate} \cdot (y - 2000)] \quad (2.10)$$

where *Base value* was the original CY2000 traffic data, *increase rate* was the growth rate documented in Appendix III of Wang and Liu (1999), and *y* was the target year.

#### 2.4.1.3 Data verification

The data obtained from the WCSC were verified by making comparisons with bridge tender logs from movable bridges and with summaries of annual trips found in the report *WCUS 1997*.

Tender logs were requested from the FDOT for the fourteen movable bridge locations that were selected as past points. Most of the bridge tender logs were not useful in terms of verifying the WCSC data as the logs were in the form of annual accumulations, or in other cases, the format used to record vessel type was different from the standard (i.e., “Power”, “Trawler”, and “Fish” instead of “P”, “C”, “T”, and “G”). Traffic data that were able to be utilized are summarized in Figure 2.19 where it is noted that different sources of data were rarely in accordance with each other. Discrepancies between the two data sources were attributed to differences in the approaches used to acquire data, and to barge companies providing incorrect data to the WCSC.

Past the Points	Bridge Number	Direction	Tug & Barge Trips by Tender Logs	Tug & Barge Trips by WCSC	Commercial Trips by Tender Logs	Commercial Trips by WCSC	Note
20	110063	Upbound	184	227	53	422	
		Downbound	182	227	45	422	
10	900047	Upbound	27	7	-	1532	can not be processed due to no standard vessel types as "P", "C", "T", and "G".
		Downbound	30	7	-	1532	
37	150049	Upbound	1 (from 7/1-12/31)	57	-	3566	can not be processed due to no standard vessel types as "P", "C", "T", and "G".
		Downbound	3 (from 7/1-12/31)	80	-	3566	
6	860034	Upbound	-	52	-	489	Only yearly log summary
		Downbound	-	73	-	490	
43	170021	Upbound	65 (from 1/1-6/30)	77	-	4808	
		Downbound	71 (from 1/1-6/30)	96	-	4808	

Note: UPBOUND: NORTH OR EAST; DOWNBOUND: SOUTH OR WEST

Figure 2.19 Bridge tender log data from past points compared with WCSC data (Wang and Liu 1999)

After processing the tender log data, it was found that vessel traffic of 12 past points was primarily comprised of self-propelled vessels. Additional data were requested from the WCSC to study this finding. The annual trips per type of self-propelled vessel are summarized in Figure 2.20, where trips of passenger type vessels constitute the majority of the traffic. Passenger vessels consisted of pleasure craft, crew boats, and excursion vessels.

Point	Direction	Passenger	Fish	Shellfish	Machinery	Foreign	Total Trips
6	Downbound	2+17+455+1+1+4+ = 480	-	-	-	10	490
6	Upbound	2+15+455+1+5 = 478	-	-	2	9	489
9	Downbound	187+206+48+504+1619+1379 +1 = 3944	0	0	1	-	3945
9	Upbound	187+206+48+504+1619+1379 = 3943	-	0	2	-	3945
11	Downbound	56+292+37+320+827 = 1532	0	0	-	-	1532
11	Upbound	56+292+37+320+827 = 1532	-	-	-	-	1532
22	Downbound	187+157+706+48+504+1619+1379+1 = 4601	0	0	1	-	4602
22	Upbound	187+0+706+48+504+1619+1379 = 4443	0	0	157+2 = 159	-	4602
37	Downbound	62+504+1619+1379+1 = 3565	-	-	1 (empty)	-	3566
37	Upbound	62+504+1619+1379 = 3564	0	-	2 (empty)	-	3566
43	Downbound	187+206+706+48+504+1619+1379+1 = 4650	0	0	157+1 = 158	-	4808
43	Upbound	187+206+706+48+504+1619+1379 = 4649	0	-	157+2 = 159	-	4808
36	Downbound	3+1+1+2 = 7	-	-	-	10	17
36	Upbound	2+1+4 = 7	-	-	2	9	18
47	Downbound	3+1+2 = 6	0	-	3	-	9
47	Upbound	4+1+1 = 6	0	-	6	-	12
48	Downbound	2+1+2 = 5	-	-	1	-	6
48	Upbound	3+1+1 = 5	-	-	4	-	9

Figure 2.20 Composition of self-propelled vessel traffic (Wang and Liu 1999)

As noted previously, another data source used by Wang and Liu (1999) to verify the WCSC data was the report *WCUS 1997*. Section 2 of the *WCUS 1997* report includes a summary of annual vessel trips per vessel type in most Florida waterways. Trip summary data were extracted for the locations where past points corresponded to a high percentage of self-propelled vessels. Eleven of the twelve past points with high densities of self-propelled vessels were located in the AIWW (Jacksonville to Miami). Information obtained from the *WCUS* indicated that this intracoastal waterway recorded 3026 upbound self-propelled vessel trips, in comparison to 373 non-self-propelled trips. This trend in traffic data was similar to trends observed from the WCSC data, and indicated that certain past points are predominately associated with self-propelled

vessels. Wang and Liu (1999) indicated that such a finding was sufficient to verify the data provided by the WCSC.

#### 2.4.1.4 Findings and applications

Wang and Liu (1999) presented a design example to illustrate the implementation of the synthesized data, recommended vessel speeds, and traffic increase rates in the AASHTO Design Method II procedures. The structure selected for the analysis was a bridge associated with past point 3, which spans over the Indian River in Brevard County. Annual vessel trip data 50 years into the future (CY2050) were computed and applied to past point 3. A risk analysis using the FDOT Vessel Collision Risk Analysis Mathcad program was then demonstrated. An annual frequency of collapse ( $AF$ ) of  $8.984 \cdot 10^{-5}/\text{yr}$  was determined for the entire bridge structure, including both upbound and downbound traffic. This  $AF$  corresponded to a return period of  $(1/8.984 \cdot 10^{-5}/\text{yr}) = 11,131$  yrs. which was (acceptably) more than the 10,000 yrs. required for critical bridges.

The synthesized data also revealed that past points with predominantly self-propelled vessels were comprised primarily of small ships with less than 1000- $DWT$ , and, recalling that AASHTO provisions do not apply for this type of vessels, the researchers decided to investigate the effects of the small vessels. Past point 3 data were used for the analysis. Two separate analyses were performed due to differences in tonnages in the upbound self-propelled traffic (522.73 tonnes  $DWT$ ) and downbound self-propelled traffic (1479.69 tonnes  $DWT$ ). For each direction, four different cases were investigated: total annual trip counts of small self-propelled vessels equaling 0 trips (none), 6 trips, 600 trips, and 6000 trips. Trip counts for all other vessel types at past point 3 were held constant. Results from the analyses indicated that the increase (from 0 trips to 6000 trips) in self-propelled vessels trips for upbound traffic (<1000 tonnes) had no noticeable effect on the computed annual frequency of collapse, whereas differences were observed due to downbound (>1000 tonnes) self-propelled traffic. The researchers concluded that self-propelled vessels with deadweight tonnages ( $DWT$ ) less than 1000 tonnes would not appreciably affect impact resistant bridge design procedures, and therefore, can be neglected.

#### **2.4.2 Review of Liu and Wang (2001)**

In Liu and Wang (2001), the authors proposed a methodology for statewide implementation of the AASHTO Design Method II for vessel collision design of bridges. As noted earlier, traffic increase rates were developed in Wang and Liu (1999) using linear regression analysis under the assumption that traffic rates would increase linearly and that vessel characteristics would remain constant. In Liu and Wang (2001), an alternative approach was presented. Namely, a model was created to account for the increase in vessel trips and sizes based on the following assumptions:

1. Future traffic growth (trip counts) is the same as loaded cargo tonnage growth;
2. Barge dimensions remain constant, yet ship dimensions gradually increase with time;
3. For loaded barge trains, traffic growth applies to both trips and cargo tonnage, while for empty barge trains, growth applies only to trips counts; and,
4. For ships, the traffic growth is equally applied to both trips and deadweight tonnage ( $DWT$ ).

Data collected by Liu and Wang (2001) indicated that cargo tonnage for barges, and  $DWT$  for ships, tend to increase at the same rate as vessel trips. The increase in tonnage, owing to the form of Equation 2., will consequently increase barge and ship dimensions. When compared with the 'simple' model that only considered growth in the number of trips (from Wang and Liu 1999), it was found that using the more 'comprehensive' trip and tonnage growth model (from Liu and Wang 2001) produced results which could potentially reduce the required lateral ultimate strength

of piers. However, as noted in Section 2.2.5.1, given the challenges inherent in predicting future changes to vessel characteristics, the AASHTO (and FDOT) vessel collision bridge design provisions do not consider such vessel dimensional changes when computing growth rates.

### **2.4.3 Texas Department of Transportation**

To implement and semi-automate the AASHTO provisions for bridge design against vessel collision, the Texas Department of Transportation (TxDOT) funded a study that was carried out by the University of Texas at Austin (Manuel et al. 2006). The study resulted in the creation of a database of vessel traffic in the state of Texas, and the development of a stand-alone computer program for performing the Design Method II procedures for vessel collision risk analysis. The program, referred to as Vessel Impact on Bridges (VIOB), included an accompanying database (containing vessel traffic data) and facilitated vessel collision risk analysis and computation of annual frequency of collapse (*AF*).

#### 2.4.3.1 Brief overview of the Vessel Impact on Bridges (VIOB) program

The VIOB program featured a preprocessing component, a solver component, and a post-processing component. In the preprocessing component, key data items were collected from the user regarding bridge geometry (e.g., pier height, vertical pier profile, cross-sectional properties, strengths), and channel characteristics (e.g., width, turn angle, region type, high water line, normal water line). Once these data items were entered, the program would—based on the chosen waterway—access the accompanying database to collect information such as: waterway currents, vessel fleet characteristics, minimum impact speed, and vessel traffic density. A vessel traffic growth factor of 1.2 was conservatively assumed as the default value, however, the user had the opportunity to override this value. After running the risk analysis calculations in the solver component, the post-processing component would report output such as the annual frequency of collapse and associated return period (Figure 2.21)



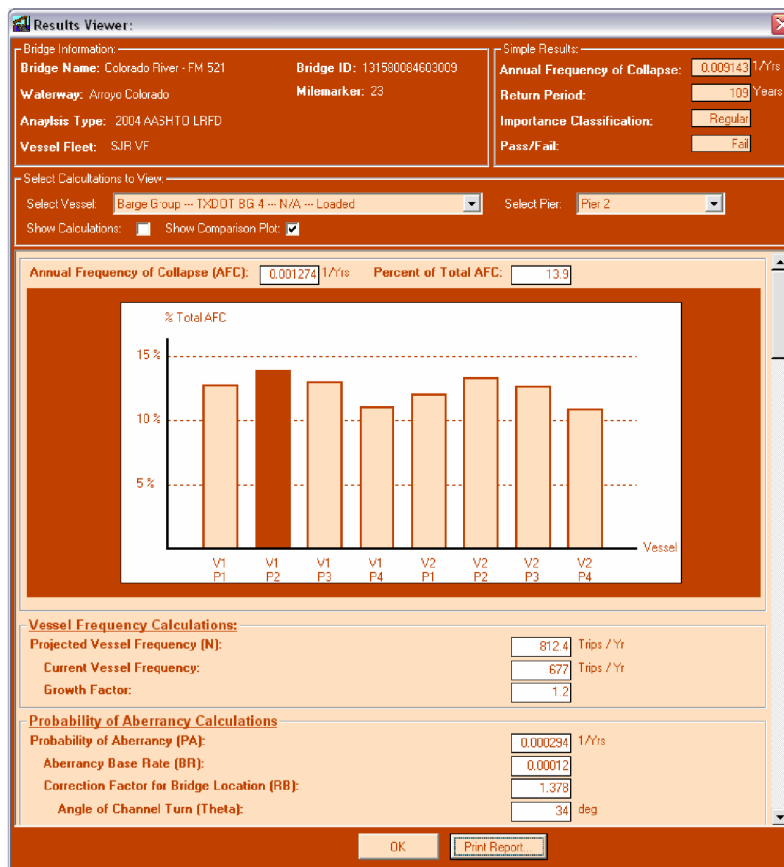

Figure 2.21 Risk analysis results obtained using the VIOB software (Manuel et al. 2006)

#### 2.4.3.2 Description of the VIOB database

Manuel et al. (2006) recognized the difficulties that can be associated with accumulating the necessary vessel traffic data to perform Design Method II and noted that obtaining accurate traffic data was a key component of the AASHTO provisions. To address this issue, a vessel traffic database was developed for the state of Texas. To create the database, 31 bridge locations were selected to represent the Gulf Intracoastal Waterway (GIWW), as well as a number of inland waterways, such as the Houston Ship Channel, the Neches River, and the Victoria Barge Canal. Commercial traffic data were requested from the WCSC. For the GIWW, data were requested for every mile marker; however, the entire requested dataset was not provided as some data were not available. Moreover, data were not available for some bridge locations as WCSC did not record traffic data for some waterway locations with low traffic. Data collected from this process were organized into a form that was similar to the FDOT database.

Barge groups were categorized by type (Dry Cargo or Tanker), and further sub-classified by length. For each category, weighted averages were assigned for the cargo capacity, empty and loaded draft, and empty and loaded displacements. Since the displacements of vessels were not regularly recorded, the values had to be estimated based on the AASHTO provisions, similar to the procedure followed by Wang and Liu (1999). Also, based on interviews with industry experts, a typical barge operating speed was estimated to be 5 mph (4.3 knots, 7.3 ft/sec). It was reported that the WCSC was not able to provide information that made possible the determination of rake dimensions; therefore, this characteristic was not included in the database.

Barge Type	Barge Size	Barge Length		Barge Type	Barge Size	Barge Length
Dry Cargo	Small	62' to 174'		Tanker	Small	62' to 174'
Dry Cargo	Standard	175' to 194'		Tanker	Standard	175' to 194'
Dry Cargo	Jumbo	195' to 199'		Tanker	Jumbo	195' to 199'
Dry Cargo	Oversize	200' or more		Tanker	Oversize	200' or more

(a)

Type	Size	FEET				TONNAGE	
		Length	Width	Empty Draft	Loaded Draft	Empty Displacement	Loaded Displacement
Dry Cargo	Small	67	32	2	9	105	530
Dry Cargo	Standard	178	48	2	10	428	2,458
Dry Cargo	Jumbo	198	35	2	9	337	2,350
Dry Cargo	Oversize	272	53	2	11	720	4,076
Tanker	Small	149	47	2	9	352	2,023
Tanker	Standard	181	49	2	9	449	2,212
Tanker	Jumbo	196	36	2	9	346	1,904
Tanker	Oversize	284	53	2	11	830	5,096

(b)

Figure 2.22 Barge group characteristics (Manuel et al. 2006):

(a) By length categories; (b) By type sub-categories

For towboats, vessel horsepower was estimated by cataloging all towboats operating in Texas, and for all towboat operators on record. A database was developed which stored tug length and grouped tugs by power capacity. A Monte Carlo-based statistical simulation program was developed to estimate the configuration of barge trains. Given barge and towboat traffic data, the program produced simulated barge-tow configurations based on the following rules:

3. All barges in a train are of the same type (either dry cargo or tanker);
4. All barges are in the same length sub-category;
5. All barges are either loaded or empty;
6. Barge train configurations are one of:
  - 1x1: single barge,
  - 2x1: two barges side by side,
  - 1x2: two barges end to end, or
  - 2x2: four barges, two by two;
7. Towboats must possess the minimum horsepower required to move the barge train

Additional details regarding assumptions and limitations of the Monte-Carlo simulation procedure are provided in Manuel et al. (2006). Output from the Monte-Carlo program consisted of a file describing the barge train traffic characteristics and individual towboat traffic characteristics.

Manuel et al. (2006) reported that most of the ship fleet in Texas consisted of foreign flagged vessels. Since the WCSC does not record detailed information for foreign vessels, a simplified approach was adopted wherein ship characteristics found in the AASHTO provisions were employed. Specifically, each foreign ship was assigned the characteristics of the largest vessel that was identified in the *DWT*-classification range.

Values for water current velocities and traffic densities were also determined. Recall that both water current velocities and traffic densities are used as correction factors to accurately determine the probability that a vessel will divert from the intended vessel transit path (i.e., probability of aberrancy, *PA*, recall Equation 2.3). To determine water current velocities, the Texas Water Development Board (TWDB) was contacted and water current data were requested.

Average values were computed to determine the current velocities for each waterway; parallel and/or crossing components of velocity were also determined.

In terms of traffic density factors,  $R_D$ , Manuel et al. (2006) noted that AASHTO provides little guidance as to what constitutes light, medium, and heavy traffic. The basis for choosing  $R_D$  values was described as:

“Most of the bridges in the study have either high volumes of barge traffic, many thousands of trips like the Houston Ship Channel, or very light vessel traffic, only few barges per week, month, or year like the San Jacinto River. Mile markers that fell somewhere in between these extremes were considered medium” (Manuel et al. 2006, Part IV, pg 11)

Values of  $R_D$  were assumed as listed in the rightmost column of Figure 2.23.

Bridge No.	Roadway	Water Body	Barge Group	Tugs	Domestic Ship	Assumed Traffic Density
3	S.H. 332	GIWW	7,422	866	1,558	1.6
4	F.M. 1495	GIWW	6,616	1,734	506	1.6
6	F.M. 521	San Bernard River	248	112	0	1.0
7	F.M. 2611	San Bernard River	248	112	0	1.0
8	S.H. 124	GIWW	10,170	551	587	1.6
10	I.H. 45	GIWW	7,203	2,134	491	1.6
11	U.S. 90-A	Houston Ship Channel	218	97	0	1.0
12	Loop 610	Houston Ship Channel	10,705	4,023	705	1.6
14	S.H. 146	Houston Ship Channel	14,634	1,431	578	1.6
16	Beltway 8	Houston Ship Channel	14,474	6,069	778	1.6
18	F.M. 2031	GIWW	6,338	907	574	1.6
19	F.M. 457	GIWW	6,338	907	574	1.6
22	P.R. 22	GIWW	1,204	347	150	1.0
23	S.H. 361	GIWW	4,186	321	791	1.3
24	I.H. 10	Trinity River	2	4	0	1.0
25	S.H. 73	Neches River	8,003	417	143	1.6
26	S.H. 87	GIWW	14,390	1,338	704	1.6
27	S.H. 82	GIWW	14,390	1,338	0	1.6
30	Queen Isabella Memorial Causeway	GIWW	2,101	119	323	1.3
31	F.M. 106	Arroyo Colorado	295	32	0	1.0

Source: U.S. Army Corps of Engineers Waterborne Commerce Statistics Center, 2002.

Figure 2.23 Reported number of vessel trips and the assumed traffic densities

Use of the traffic density factor,  $R_D$ , was included in a step-by-step example of the computation of annual frequency of collapse for the Colorado River – FM 521 Bridge. Selection of  $R_D$  was indicated as being based on references to guidance provided in the AASHTO provisions. Elsewhere in the report, selection of  $R_D$  was mentioned within the context of features provided by the VIOB software. Specifically, it was noted that the program automatically selected a value of  $R_D$  that was previously assigned to the waterway. However, once again, Manuel et al. (2006) refer to the recommendations found in the AASHTO provisions when explaining how the  $R_D$  values were assigned.

## 2.4.4 Eurocode

Provided in the following is a brief review of the classification, collection, and processing of vessel traffic data for bridge design in Europe. In the Eurocode, accidental actions, including vessel-to-bridge collisions, are found in *Eurocode 1: Actions on structures – Part 1-7: General actions – Accidental actions* (CEN 2006). Similar to the AASHTO provisions, the Eurocode suggests that bridge design to resist vessel impact should be conducted within the context of a comprehensive risk assessment. In §B.9.3.3 of CEN (2006), a risk analysis expression specific to vessel impacts on bridge piers is provided, where emphasis is given to dynamic structural analysis:

$$P_f(T) = n \lambda T (1 - p_a) \int P(F_{dyn}(x) > R) dx \quad (2.11)$$

In Equation 2.11,  $P_f(T)$  is the probability of structural failure within a given time period ( $T$ ),  $n$  is the vessel traffic intensity,  $\lambda$  is the probability of navigation failure per unit traveling distance,  $p_a$  is the probability that collision can be avoided by human intervention,  $F_{dyn}$  is the dynamic impact force as a function of the distance ( $x$ ) where navigation failure occurred, and  $R$  is the structural resistance. Note that  $x$  is the distance between the structure and the point in the waterway where a navigation failure occurred. If  $T = 1$ , then  $P_f(T)$  is the annual frequency of collapse.

In general, vessel impact is defined in CEN (2006) as ‘hard impact’, in that the impacted pier is assumed to be rigid and all kinetic energy is absorbed by elastic or plastic deformation of the vessel. In the absence of conducting a dynamic analysis of design force ( $F_{dyn}$ ) a set of tables (Figure 2.24) provides indicative values of static design forces ( $F_{dx}$  and  $F_{dy}$ ), which correspond to impacts by inland vessels or seagoing vessels.

The Eurocode table presented in Figure 2.24a contains 7 classes of navigable waterways described by the European Conference of Ministers of Transport (CEMT) classifications of 1992 (see Figure 2.8). Each classification gives the maximum size of vessel that is suited for transiting a given type of waterway. Vessel types presented in the table are self-propelled vessels and barge trains. The 1992 CEMT classification was developed to include provisions for multi-unit barge trains because the 1952 CEMT classification did not categorize such vessels. However, since 1992, significant developments have been made in the size, maneuvering capabilities, and configuration of barge trains, resulting in vessels currently navigating outside the provisions of the CEMT classifications (Koedijk 2015). For this reason, ongoing research is being conducted by the World Association for Waterborne Transport Infrastructure (commonly referred to as PIANC, the Permanent International Association of Navigation Congresses) with the objective of creating an updated CEMT classification (PIANC 2015).

Vessel characteristics that are required to be considered in the risk analysis are taken from the tables in Figure 2.24 and Figure 2.8. The impact load is taken as a horizontal force, which is positioned depending on the geometry of the structure and the bow dimensions of the impacting vessel. CEN (2006) states that as a general rule, the impact load should be applied within a vertical distance that extends both  $0.05 \cdot \ell$  below and  $0.05 \cdot \ell$  above the design water line (where  $\ell$  is the vessel length).

CEMT <sup>a</sup> Class	Reference type of ship	Length $\ell$ (m)	Mass $m$ (ton) <sup>b</sup>	Force $F_{dx}$ <sup>c</sup> (kN)	Force $F_{dy}$ <sup>c</sup> (kN)
I		30-50	200-400	2 000	1 000
II		50-60	400-650	3 000	1 500
III	"Gustav König"	60-80	650-1 000	4 000	2 000
IV	Class „Europe“	80-90	1 000-1 500	5 000	2 500
Va	Big ship	90-110	1 500-3 000	8 000	3 500
Vb	Tow + 2 barges	110-180	3 000-6 000	10 000	4 000
Vla	Tow + 2 barges	110-180	3 000-6 000	10 000	4 000
Vlb	Tow + 4 barges	110-190	6 000-12 000	14 000	5 000
Vlc	Tow + 6 barges	190-280	10 000-18 000	17 000	8 000
VII	Tow + 9 barges	300	14 000-27 000	20 000	10 000

<sup>a</sup> CEMT: European Conference of Ministers of Transport, classification proposed 19 June 1992, approved by the Council of European Union 29 October 1993.

<sup>b</sup> The mass  $m$  in tons (1 ton = 1 000 kg) includes the total mass of the vessel, including the ship structure, the cargo and the fuel. It is often referred to as the displacement tonnage.

<sup>c</sup> The forces  $F_{dx}$  and  $F_{dy}$  include the effect of hydrodynamic mass and are based on background calculations, using expected conditions for every waterway class.

(a)

Class of ship	Length $\ell$ = (m)	Mass $m^a$ (ton)	Force $F_{dx}^{b,c}$ (kN)	Force $F_{dy}^{b,c}$ (kN)
Small	50	3 000	30 000	15 000
Medium	100	10 000	80 000	40 000
Large	200	40 000	240 000	120 000
Very large	300	100 000	460 000	230 000

<sup>a</sup> The mass  $m$  in tons (1 ton = 1 000 kg) includes the total mass of the vessel, including the ship structure, the cargo and the fuel. It is often referred to as the displacement tonnage. It does not include the added hydraulic mass.

<sup>b</sup> The forces given correspond to a velocity of about 5,0 m/s. They include the effects of added hydraulic mass.

<sup>c</sup> Where relevant the effect of bulbs should be accounted for.

(b)

Figure 2.24 Eurocode vessel classification: (a) Static forces for inland waterway vessels; (b) Static forces for seagoing vessels (CEN 2006)

**CLASSIFICATION OF EUROPEAN INLAND WATERWAYS**

Type of inland waterways	Classes of navigable waterways	Motor vessels and barges					Pushed convoys					Minimum height under bridges <sup>2/</sup>	Graphical symbols on maps
		Type of vessel: General characteristics					Type of convoy: General characteristics						
		Designation	Maximum length	Maximum beam	Draught <sup>2/</sup>	Tonnage	Length	Beam	Draught <sup>2/</sup>	Tonnage			
	L(m)	B(m)	d(m)	T(t)		L(m)	B(m)	d(m)	T(t)	H(m)			
OF REGIONAL IMPORTANCE To West of Elbe	I	Barge	38.5	5.05	1.80-2.20	250-400					4.0	=====	
	II	Kampine-Barge	50-55	6.6	2.50	400-650					4.0-5.0	=====	
	III	Gustav Koenigs	67-80	8.2	2.50	650-1,000					4.0-5.0	=====	
	To East of Elbe	I	Gross Finow	41	4.7	1.40	180					3.0	=====
		II	BM-500	57	7.5-9.0	1.60	500-630					3.0	=====
		III	g/	67-70	8.2-9.0	1.60-2.00	470-700		118-132	8.2-9.0	1.60-2.00	1,000-1,200	4.0
OF INTERNATIONAL IMPORTANCE	IV	Johann Welker	80-85	9.5	2.50	1,000-1,500		85	9.5 g/	2.50-2.80	1,250-1,450	5.25 or 7.00 g/	=====
	Va	Large Rhine vessels	95-110	11.4	2.50-2.80	1,500-3,000		95-110 1/	11.4	2.50-4.50	1,600-3,000	5.25 or 7.00 or 9.10 g/	=====
	Vb							172-185 1/	11.4	2.50-4.50	3,200-6,000	g/	=====
	Vla							95-110 1/	22.8	2.50-4.50	3,200-6,000	7.00 or 9.10 g/	=====
	Vlb	g/	140	15.0	3.90			185-195 1/	22.8	2.50-4.50	6,400-12,000	7.00 or 9.10 g/	=====
	Vlc							270-280 1/	22.8	2.50-4.50	9,600-18,000	9.10 g/	=====
								195-200 1/	33.0-34.2 1/	2.50-4.50	9,600-18,000	g/	=====
VII							285	33.0-34.2 1/	2.50-4.50	14,500-27,000	9.10 g/	=====	

Figure 2.25 CEMT vessel classification by waterway class (CEMT Resolution No. 92/2)

**2.5 FDOT Structures Design Guidelines**

The FDOT *Structures Design Guidelines* (SDG) (FDOT 2023) cover the engineering standards, criteria, and norms for designers and detailers who design bridge structures for the FDOT. Note that complex structure types (e.g., cable-stayed structures) are not intended to be addressed as part of the FDOT SDG. Within the SDG, Section 2 – *Loads and Load Factors*, Subsection 11 – *Vessel Collision* addresses the minimum design requirements for accidental vessel collision events. The section specifies that a risk analysis is required for design of all bridges that span navigable waterways and that the Vessel Collision Risk Analysis software maintained by the FDOT (FDOT 2019) may be used for the purpose of conducting such a risk analysis. The guidelines recognize the available vessel data and growth factors documented in Wang and Liu (1999), where such data are implemented in the Vessel Collision Risk Analysis software. The SDG provisions include a recommendation that engineers check traffic values for accuracy by comparing data with USACE databases. Further, within the SDG, the AASHTO LRFD specifications (2020) are identified as the procedures by which engineers and designers must abide. A review of the guidelines was conducted with the intent of identifying potential changes as result of re-collecting and reprocessing updated vessel traffic data in Florida.

Section 2.11 of the FDOT SDG includes commentary on the AASHTO risk assessment design procedure, and in addition, contains supplemental requirements to be included as part of analyses that are conducted for design. The section also addresses aspects of vessel collision design such as assembly of data, data sources, damage permitted on the structure, and the effects of scour. Additional items of note include the following:

- Section 2.11.2 – *Research and Information Assembly*. Listings of pertinent vessel traffic data sources are given in this section. However, updated and additional data sources were

identified during the present study. The updated listings are provided later in the present report.

- Section 2.11.4 – *Design Methodologies*. This section provides required design procedures that supplement the AASHTO provisions. Section 2.11.4 may serve as an appropriate location for supplying contextual information with respect to procedures for calculating protection factor values (*PF*). Later in the present report, guidance and example calculations are provided for calculation of protection factor values (*PF*). The guidance and example calculations may serve to inform future updates to Section 2.11.4.
- Section 2.11.9 – *Application of Impact Forces*. This section provides summary information related to application (positioning) of barge impact loads on bridge substructure components. Information gathered as part of the present study included geometric characteristics such as typical rake angles of barge bows. Schematics and discussion regarding sizing of pier foundation components (e.g., pile caps) and positioning of barge impact loads are presented later in the present report. Such content may serve to inform future updates to Section 2.11.9.
- Section 3.14 – *Fender Systems*. This section addresses the utilization and structural requirements of fender systems. More specifically, Table 3.14.2-1 presents the Minimum Energy Absorption Capacity (EAC) associated with the fifty-two (52) past points distributed throughout Florida. The EAC values were computed following AASHTO (2009) and are utilized for vessel collision analysis of fender systems. Based on updated determinations of barge traffic characteristics (tonnage, transit velocity), updates to the table, as well as the associated methodology, are presented later in the present report.

## **CHAPTER 3 DATA COLLECTION**

### **3.1 Data Collection**

Based on information collected during the literature review process, and on discussions with FDOT regarding present-day bridge design data requirements in the state of Florida, several types of vessel-related data were identified for collection: (1) commercial past point traffic data, (2) vessel speed data, (3) barge rake geometry data, and (4) data and insights sought from maritime professionals. These areas of data collection are described in the following sections.

#### **3.1.1 Commercial past point traffic data**

Of primary importance, in terms of conducting a vessel collision risk analysis of a bridge, is the characterization of commercial vessel traffic (typical vessel sizes, trip counts, etc.). Commercial vessel traffic data were collected for selected locations (namely, past points) throughout inland and intracoastal waterways in Florida. A data request was issued to the Army Corps of Engineers (USACE) Waterborne Commerce of Statistics Center (WCSC), given that the WCSC maintains information on vessel characteristics and commercial movement across navigable U.S. waters. The WCSC provided digital records of available commercial traffic data for 10 years (i.e., from 2010 to 2019) with consideration of 52 past points locations (Table 3.1). The 52 past points were adopted from the current FDOT past points (Wang and Liu 1999) with the exception of past point 16, where the new location of past point 16 was proposed to be modified to correspond to New River, FL. Note that zero trips (no commercial traffic) were reported by the WCSC for several of the past point locations. These included past points located within segments of the Atlantic Intracoastal Waterway (AIWW), the Gulf Intracoastal Waterway (GIWW), and Hillsborough Bay.

Data delivered by the WCSC included trips and commodity datasets for each past point that had commercial transits recorded between 2010 and 2019. Trip counts were provided for each unique set of vessel dimensions (vs. each unique vessel ID), and each transit direction, within a given year. The commodity data included corresponding tonnage and commodity types for uniquely sized vessels. Each record of data supplied by the WCSC included the following fields:

- Vessel transit direction (upbound, downbound)
- Vessel origin (domestic, foreign)
- Vessel type (self-propelled dry, tanker, towboat, cargo barge, liquid barge, and other)
- Overall vessel dimensions (length, beam)
- Vessel draft (loaded, light, and actual)
- Number of trips
- Commodity type
- Tonnage

An example excerpt of raw data records provided by the WCSC is provided in Figure 3.1. Documented in Appendix A are traffic data in the form of total upbound and downbound trip counts per year. Detailed analysis of the vessel trip data is discussed in the following chapter.



Table 3.1. Collected past point data locations

Past point No.	Waterway Name	Channel Name	Coordinates (deg.)
1	GIWW	Saint Andrew Bay-West Bay	30.1875, -85.7367
2	GIWW	Saint Andrew Bay-East Bay	30.1073, -85.6056
3	AIWW	Indian River	28.4033, -80.7317
4	Port Canaveral Canal	Banana River	28.4094, -80.6329
5	AIWW	Indian River	28.1339, -80.6139
6	AIWW	Stranahan River	26.0122, -80.1181
7	AIWW	Stranahan River	26.1898, -80.1029
8 <sup>†</sup>	AIWW	Stranahan River	26.0816, -80.1140
9*	GIWW	Lemon Bay	26.9350, -82.3541
10*	AIWW	Jewfish Creek	25.1833, -80.3883
11*	AIWW	Snake Creek	24.9517, -80.5917
12*	AIWW	Channel #5 - Florida Bay	24.8400, -80.7800
13	Miami River	Miami River	25.7692, -80.1980
14	AIWW	Biscayne Bay	25.7899, -80.1808
15	GIWW	St George Sound	29.6849, -84.8756
16 <sup>‡</sup>	New River	New River	26.1180, -80.1371
17	GIWW	Jackson River	29.8797, -85.2221
18	GIWW	Wetapp Creek	29.9976, -85.3703
19*	Hillsborough Bay	Hillsborough River	27.9433, -82.4583
20	St. Johns River	St. Johns River	29.0086, -81.3823
21	Okeechobee Waterway	Caloosahatchee River	26.5617, -81.9333
22	GIWW	Anna Maria Sound	27.4973, -82.6948
23	St. Johns River	St. Johns River	30.3217, -81.6567
24	AIWW	Clapboard Creek	30.3940, -81.4595
25	Pensacola Bay	Escambia River/Escambia Bay	30.3946, -87.1843
26	GIWW	Perdido Bay	30.3131, -87.4264
27	GIWW	Santa Rosa Sound	30.3453, -87.1494
28	AIWW	Matanzas River	29.5736, -81.1890
29*	AIWW	Nassau Sound/Amelia River	30.5133, -81.4500
30	AIWW	Amelia River	30.6279, -81.4836
31	GIWW	Choctawhatchee Bay	30.4326, -86.4178
32	Okeechobee Waterway	Caloosahatchee Canal/Rim River	26.8331, -81.0887
33	AIWW	Boca Raton Inlet to Palm Beach Inlet	26.7182, -80.0434
34	AIWW	Palm Beach Inlet to Jupiter Inlet	26.8321, -80.0602
35	AIWW	Jupiter Inlet to St. Lucie Inlet	26.9460, -80.0847
36	AIWW	Hillsboro Inlet to Boca Raton Inlet	26.3394, -80.0772
37	GIWW	Tampa Bay Main Channel	27.6917, -82.7167
38	Tampa Bay	Old Tampa Bay	27.9167, -82.6150
39	Tampa Bay	Tampa Bay	27.6209, -82.6556
40	GIWW	St. Joseph Sound to Tampa Bay	27.9167, -82.8333
41	St. Johns River	St. Johns River	29.6450, -81.6250
42*	GIWW	Dryman Bay to South Venice	27.1800, -82.4953
43*	GIWW	Sarasota Bay	27.3301, -82.5582
44	AIWW	St. Augustine Inlet to Jacksonville Harbor	30.1333, -81.3850
45	AIWW	Matanzas River to St. Augustine River	29.8917, -81.3067
46	St. Johns River	St. Johns River	29.9800, -81.6283
47	AIWW	St. Lucie to Fort Pierce Inlet	27.4597, -80.3149
48	AIWW	Fort Pierce Inlet to Sebastian Inlet	27.4727, -80.3225
49	Okeechobee Waterway	St. Lucie River	27.2035, -80.2613
50	AIWW	St. Lucie to Fort Pierce Inlet	27.2059, -80.1941
51	AIWW	North of Ponce de Leon Inlet (Halifax River)	29.2096, -81.0117
52	AIWW	South of Ponce de Leon Inlet (Indian River North)	29.0388, -80.9063

<sup>†</sup> Only data for years 2010, 2013, 2017, and 2019 were delivered by USACE

\* No commercial data recorded by USACE

<sup>‡</sup> The location of past point 16 was modified to correspond to New River, FL

DIRECTION	TTYPE	VTYPE	CAP_TONS	OVER_LENGTH	OVER_BREADTH	ACTUAL_DRAFT	LOAD_DRAFT	LIGHT_DRAFT	YEAR	TRIPS
Upbound	Domestic	1	6000	317.0	72.0	2	28.0	2.0	2018	1
Upbound	Domestic	1	55	50.0	14.7	4	5.0	3.5	2015	1
Upbound	Domestic	1	2200	110.0	24.0	5	5.5	4.5	2010	5
Upbound	Domestic	1	160	77.0	33.0	6	8.0	6.0	2017	3
Upbound	Domestic	1	160	77.0	33.0	6	8.0	6.0	2016	1
Upbound	Domestic	1	65	47.0	14.0	6	6.0	5.0	2014	32

Figure 3.1 Example raw data records provided by the USACE WCSC

### 3.1.2 Vessel speed data

Commercial vessel traffic data provided by the USACE WCSC did not contain information regarding vessel transit speeds. To assess representative vessel transit speeds in areas adjacent to bridge structures, automatic identification system (AIS) data were collected for all inland and intracoastal waterways in Florida. AIS is a technology employed in maritime activities to track vessel activity by means of exchanging navigation data between vessels and receiver stations (terrestrial and satellite). AIS data consist of GPS (global positioning system) positional coordinates (Figure 3.23.2), time, and speed of the vessel at the time when the signal was transmitted. In order to characterize representative vessel transit speeds in Florida waterways, the following data were collected:

- Historical AIS records for U.S. waters were obtained from Marine Cadastre, a partnership between the Bureau of Ocean Energy Management (BOEM) and the National Oceanic and Atmospheric Administration (NOAA). Approximately 1.2 billion historical AIS records (individual transmissions from vessels) were collected for the years 2016 through 2020.
- Real-time AIS records were purchased for one month (September 2021) from ‘MarineTraffic’, a commercial provider of ship tracking and maritime intelligence data collected through AIS networks of terrestrial and satellite stations.
- Interviews with maritime professionals.

Automated software tools were developed to process the collected AIS datasets and to characterize typical vessel transit speeds in Florida waterways, particularly at locations adjacent to bridge structures. Analysis of the vessel speed data is discussed in the following chapter.

### 3.1.3 Barge rake geometry data

Collection of key geometric characteristics of barges operating in Florida waterways was carried out to enable assessment of potential risks for direct impact between aberrant barges and bridge pier columns (Figure 3.3), and to develop corresponding design guidance for assessing such risks (discussed later in this report). The data collection effort included characterizing typical barge bow geometries and determining if typical barge bow lengths and rake angles could lead to direct contacts with bridge pier columns.



Figure 3.2 Example set of transmitted GPS positions in AIS records

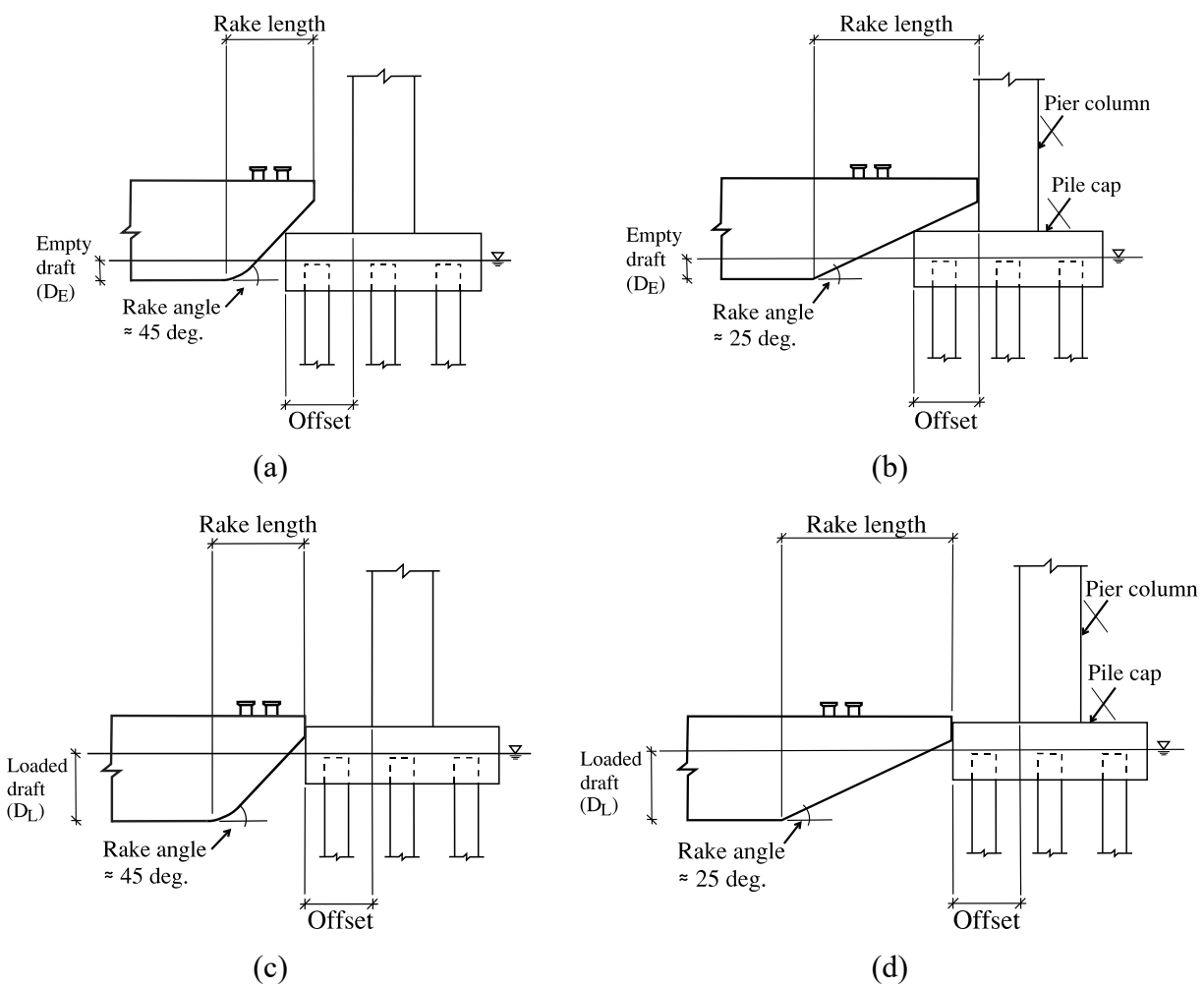

Figure 3.3 Risk of direct impact to pier column by a barge with rake angle of (a) 45 deg. at empty draft, (b) 25 deg. at empty draft, (c) 45 deg. at loaded draft, and (d) 25 deg. at loaded draft

Datasets obtained from the USACE WCSC did not include information pertaining to barge bow geometries (e.g., rake lengths, bow shapes) as such characteristics are rarely recorded by governmental or commercial maritime entities. Therefore, as one component of barge rake data collection process, a site visit was conducted on 2022-02-15 to the facilities of MOBRO Marine (Green Cove Springs, FL), a maritime transportation company that routinely engages in inland and (offshore) oceangoing towing of barges. During the site visit, typical barge bow shapes were photographed, direct barge rake measurements were taken, and an on-site maritime professional (with decades of experience in the field) was consulted regarding typical barge bow geometries.

Measurements of deck barges MOBRO 1705 and MOBRO 1007 (referred to as MB 1705 and MB 1007) were recorded, where photographs of MOBRO 1705 are presented in Figure 3.4. Schematics of pertinent bow dimensions of the barges are presented in Figure 3.5 and Figure 3.6, respectively. For the vessel MOBRO 1705, with a length overall (*LOA*) of 150 ft and a beam (i.e., width) of 54 ft, the angle of the rake was estimated to be (approximately) 45 deg.



Figure 3.4 Photographs of the bow of MOBRO 1705: (a) rake geometry; (b) bow shape

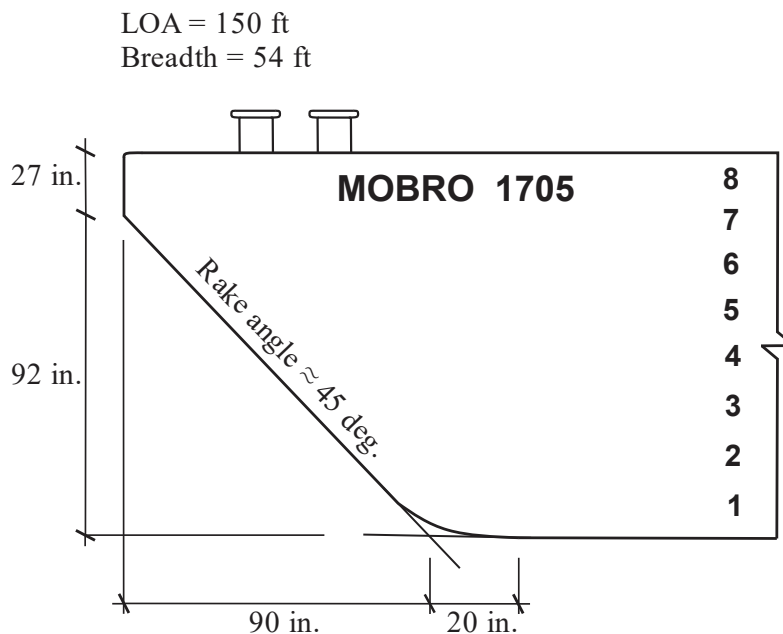

Figure 3.5 Schematic diagram of MOBRO 1705 bow dimensions

For vessel MOBRO 1007, with a *LOA* of 150 ft and a beam of 45 ft, the rake angle was measured to be approximately 25 deg. It was not feasible to directly measure the total rake length as the barge was in the water at the time of the site visit and measurements to the bottom of the hull were (in turn) not feasible.

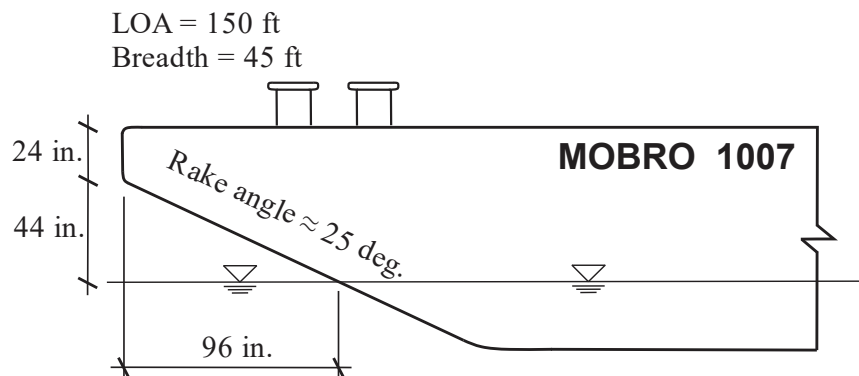

Figure 3.6 Sketch of MOBRO 1007 bow dimensions

Further input was elicited during the site visit through conversations with a maritime industry professional. The consulted professional indicated that a rake angle of 45 deg. is typical for construction barges. It was also indicated that barges making up the fleet for MOBRO Marine are used primarily for construction purposes. The noted prevalence of construction barges was consistent with comments made during interviews with other maritime professionals (discussed in the next section), who pointed out that the majority of barges present in Florida inland waterways are for construction purposes. With regard to tonnage, it was indicated that construction barges serviced by MOBRO Marine rarely exceed 1,000 *DWT*. This is relevant in that the American Association of State Highway and Transportation Officials (AASHTO) provisions are applicable to waterway vessels exceeding 1,000 *DWT*.

Regarding offshore (oceangoing) barges, it was indicated by the maritime professional that offshore barges typically possess rounded bow geometries (for improved hydrodynamic efficiency). As an example, consider the vessel MOBRO 1202 (Figure 3.7), where the shape of the bow region possesses notable curvature.



Figure 3.7 Photographs of MOBRO 1202: (a) rake geometry; (b) bow shape

Barges in the MOBRO Marine vessel fleet transit across inland waters, intracoastal waters, offshore waters, and foreign waters. Spud barges are present within the vessel fleet, as are American Bureau of Shipping (ABS) barges, equipment and material hauling barges, hopper barges, and sectional barges. Additional examples of barges that were located onsite (during the site visit) are depicted in Figure 3.8.



(a)



(b)



(c)



(d)

Figure 3.8 Examples of bow shapes from barge fleet serviced by MOBRO Marine:  
(a) MB 303; (b) MB 1704; (c) MB 150; (d) MB 204

### 3.1.4 Supplementary data and information collected from interviews with maritime professionals

In a separate data collection effort, maritime professionals from around the state (Figure 3.9) were interviewed to gain insights into typical characteristics of the commercial vessels operating in Florida waterways. Among other topics, interviewees were asked a series of questions related to barge traffic and typical rake geometry. Consulted professionals included pilot association executives, port captains, and professional pilots navigating in regions such as the Florida AIWW and GIWW, St. Johns River, and Tampa Bay. The topics discussed were related to local vessel traffic frequency, typical barge bow characteristics, operating speeds, and AIS reporting protocols. Primary takeaways from these interviews are summarized below:

- Rake lengths and angles vary depending on the type of barge. Generally, smaller inland barges (e.g., construction and dredge barges) have short bows with sharp angles, whereas offshore barges tend to have longer (and rounded) rakes.

- A sharp-angle bow is more prevalent than a rounded shape in Florida waterways. The most common rake angle for barges transiting Florida waterways is 45 deg. with a vertical headlog extending up from the rake at angle of 90 deg.
- In many Florida inland waterways, a majority of the barges present are shallow draft and are used for construction purposes.
- Operating vessel speeds when transiting under a bridge are a function of multiple factors, including: crossing clearance dimensions, environmental conditions, channel restrictions, and loading conditions. There is no explicit, common practice of decreasing the vessel speed prior crossing under a bridge.
- Among maritime professionals, it is common knowledge that the accuracy of AIS records is limited, especially for tugs that are used for towing barges. AIS systems will almost always reflect the dimensions of the towing vessel rather than dimensions of the barge(s).
- Vessel traffic in the inland and intracoastal channels of Florida has changed significantly since the 1990s due to the relocation or decommission of facilities that used to utilize maritime transport, particularly in the energy sector. Other contributors to the change in traffic include environmental and social factors.
- The maneuverability of barge tows is affected by channel conditions and the loading conditions of the barges. Empty barges are harder to maneuver (in a controlled manner) than fully-loaded barges as empty barges rise higher out of the water, resulting in greater exposed port and starboard surface areas, and greater susceptibility to transverse wind loads. Empty barges also possess greater rake lengths above the waterline, resulting in less fluid drag. Transit maneuvers are performed by tow operators at bridge crossings to counter winds and currents.
- Most frequently, barge tow configurations in Florida correspond to one barge and one towboat. It is not unusual for barge tows in Florida waterways to transit with two barges, but almost never with more than three barges. When a tow consists of more than one barge, the constituent barges are typically aligned lengthwise.

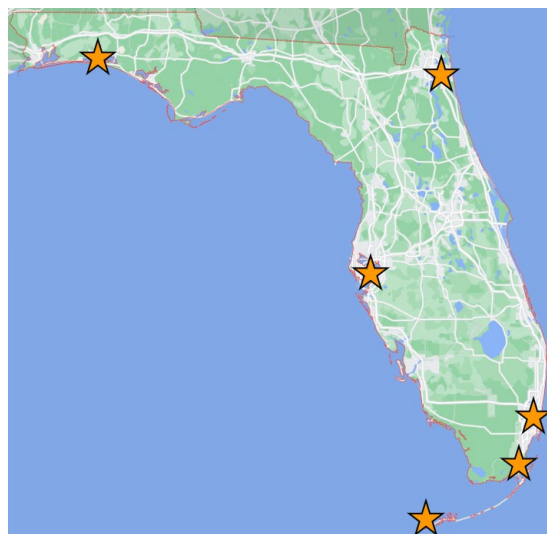

Figure 3.9 Locations throughout Florida of maritime professionals that were interviewed

## CHAPTER 4 DATA ANALYSIS

### 4.1 Introduction

Processing algorithms were developed to analyze traffic data which were collected from the USACE Waterborne Commerce Statistics Center (WCSC). The processing algorithms were used to transform the raw USACE data into the types of vessel information that are required to conduct the AASHTO vessel collision risk analysis. Vessel traffic data obtained from USACE were processed to remove non-representative outlier values and to estimate parameters that are needed for bridge design but which are not specifically quantified in the USACE data (e.g., trips counts of barge tows versus trip counts of individual barges). Estimations of anticipated future changes in vessel traffic were made through the development of future projection models and the use of USACE historical data. Additionally, representative vessel characteristics were determined by categorizing past point data into vessel groups and synthesizing the results. Finally, design values of vessel speeds (for barges and ships) were derived from AIS data after applying data filtering and error handling procedures.

### 4.2 Vessel Traffic Trip Counts

Processing the raw vessel trip data provided by USACE into parameters that are usable in bridge design involved several steps, as described in the following sections.

#### 4.2.1 Interpretation of barge traffic data

One or more barges connected to, and propelled by, a tugboat (or push boat) is referred to as a barge flotilla (or barge tow). To conduct a vessel collision risk analysis of a bridge structure, trip counts for barge flotillas (rather than individual barges) must be available because potential collision risk is quantified for each transiting flotilla (not each individual barge). In the data provided by USACE for barge traffic, the configurations of barge flotillas were not directly identified. That is, the number of individual barges (1, 2, 3) that were connected to, and propelled by, a tugboat was not directly reported in the USACE data.

Consequently, barge flotilla trip counts were estimated from individual barge trip counts and tug trip counts contained within the USACE data. For past points and/or years where the number of individual barge trips exceeded the number of tug trips, multi-barge flotillas were known to be present in the vessel traffic data. For such situations (past points and/or years), it was assumed that a single tug propelled each multi-barge flotilla. The average barge-to-tug ratio was then computed as:

$$r = N_{barge}/N_{tug} \quad (4.1)$$

where  $N_{barge}$  was the total (annual) number of individual barge trips, and  $N_{tug}$  was the total (annual) number of individual tug trips. Information collected during interviews with maritime professionals confirmed that multi-barge flotillas in Florida waterways frequently involve two barges ( $r=2$ ), less frequently involve three barges ( $r=3$ ), and rarely, if ever, involve more than three barges ( $r > 3$ ). Despite this fact, for a small subset of past points and years,  $r$  values computed from the USACE data exceeded practical limits for Florida waterways, indicating questionable tug trip counts. To address this issue, a practical upper limit on the number of barges per tug ( $r_{max}$ ) was established to ensure that barge flotilla trip counts were not significantly underestimated.

For a particular number of individual barge trips reported in the USACE data, a larger value of  $r_{max}$  (e.g., 3) would yield a smaller number of computed flotilla trips and correspond to reduced



(computed) risk. In contrast, a smaller value of  $r_{max}$  (e.g., 2) would yield a larger number of flotilla trips (and increased computed risk). While flotillas involving  $r_{max} = 3$  barges are found in Florida waterways, to provide a moderate degree of conservatism in the computed flotilla trip counts, a value of  $r_{max} = 2.5$  was instead selected (i.e., the average of 2 and 3) as the maximum ‘average’ flotilla configuration size. For past points and years where  $r$ , computed per Equation 4.1, exceeded  $r_{max} = 2.5$ , the number of barge flotilla trips was then computed as:

$$\text{If: } r > r_{max} \text{ ; then: } N_{flotilla} = N_{barge}/r_{max} \quad (4.2)$$

Enforcement of  $r_{max} = 2.5$  only affected data interpretation for three past points (17, 18, and 20) and a small number of years. For past points 17 and 18, maximum average computed  $r$  values were approximately 2.6, so that enforcement of  $r_{max} = 2.5$  increased the computed flotilla trip counts by less than 5%. For past point 20, however,  $r$  values computed from the USACE data were unrealistically large ( $r \approx 8.4$ ) for a small number of years. For this past point, enforcing  $r_{max} = 2.5$  approximately doubled the computed number of flotilla trip counts.

Note that for past points and/or years where the barge-to-flotilla ratio was less than one ( $r < 1$ ), a flotilla configuration of one barge and one tug was assumed and the remainder of the tug trips were treated as trips of free (unconnected) tugs.

#### 4.2.2 Model of future traffic estimation

Commercial vessel traffic may vary due to factors such as changes in environmental policies, regional economic circumstances, modifications to the capacity of channels, or maritime industry innovations. For example, during interviews with maritime professionals it was noted that over the past decades, barge traffic in certain areas of the GIWW and Tampa Bay decreased substantially after several coal-based power plants closed (or were converted to utilize alternative sources of fuel) thereby eliminating the need for barge-based coal delivery. Other examples of traffic fluctuation include: the reduction of traffic through the Apalachicola River due to low water levels; and an overall increase in cruise ship traffic due to the expansion of the industry.

Acknowledging that vessel traffic can be affected by a variety of factors, the historical data collected from USACE (2010 to 2019) were used to estimate future traffic trends at each past point for the next 75 years. Future projection models of anticipated changes in vessel traffic were developed that consisted of: total annual trip count determination; an outlier detection method; and a multi-pass power model curve fit with constraints on growth and/or decay (discussed in detail later).

For purposes of characterizing changes in future vessel traffic relative to the collected historical (2010 to 2019) data, regression data sets were formed which consisted of aggregated total annual vessel trip counts. That is, vessel trip counts were determined by aggregating (adding together) the upbound and downbound trips corresponding to all vessel types (ships, barge flotillas, free tugs, etc.). The data aggregation process was employed to help attenuate fluctuations (transient, directional, or otherwise) in the collected data, and to provide a more robust overall estimation of future traffic changes. However, note that while upbound and downbound trip counts were aggregated for purposes of determining *relative* changes in traffic, separate upbound and downbound vessel trip counts were still maintained in the final traffic database that will be used for future bridge design.

Analysis of the USACE data indicated decaying trends in vessel traffic at some locations in Florida (e.g., portions of Tampa Bay), but growth trends at other locations. For past points where the historical data indicated a growth trend, the data aggregation approach noted above was implemented at two levels: 1) past point level, and 2) statewide level. The past point level

aggregation noted above—wherein traffic for both directions and for all vessel types were added together for each year—was used to project the ten years of collected historical data (2010 to 2019) forward another ten years into the future. To further project from that point in time out to a time 75 years from present, a statewide level of data aggregation was employed. In the latter approach, data for all past points, in all directions, and for all vessel types were aggregated together to form a statewide future projection model. Aggregation of data at the statewide level helped reduce (via averaging) transient fluctuations of traffic that occurred at local past points, and thus provided a more robust long-term future projection approach. Further details of the future projection models—for growth and decay cases—are provided in later sections.

To model anticipated future changes in vessel traffic, a power model functional form was applied consistently, regardless of the trend being represented (growth, decay), or the scope of data aggregation being implemented (past point level, statewide level). Specifically, a three parameter (or three ‘degree of freedom’) power model was utilized:

$$N(t) = N(y - y_0) = a_0 \cdot t^{a_1} + a_2 ; \text{ where } y_0 = 2009 \quad (4.3)$$

where the fitting parameters (degrees of freedom) consisted of:  $a_0$ , a linear coefficient;  $a_1$ , a power exponent; and,  $a_2$ , an offset. The time parameter  $t$  was defined as the number of years that had elapsed since the reference (datum) year  $y_0$ . In this study, the reference year ( $y_0$ ) was defined as  $y_0 = 2009$ . The time parameter  $t$  for a particular year of interest ( $y$ ) was then  $t = (y - y_0)$ . Using this definition, the year 2010 (i.e., the first year for which data were collected from USACE) corresponded to time  $t=1$ . For a particular year ( $y$ ) of interest,  $t = (y - y_0)$ , and  $N(t)$  is evaluated to estimate the number of vessel trips.

In addition to the power model, other functional forms (e.g., linear, low-order polynomial) were considered for adoption. However, the power model was found to offer flexibility in terms of representing both growth and decay cases. Also the power model was found to be robust to (or able to mitigate) undesirable rapid changes in future traffic estimation, particularly for locations (past points) with decaying traffic trends. Additionally, for locations where vessel trip counts exhibited an essentially linear trend over time, the power model contained within itself the ability to represent a linear trend (where  $a_0$ =slope,  $a_2$ =offset, and  $a_1=0$ ).

### 4.2.3 Outlier detection and removal

Even with aggregation of vessel traffic data across multiple directions (upbound, downbound) and across multiple vessel types (ship, barge flotilla, etc.), which helped to attenuate fluctuations, outliers remained present in some of the historical past point data sets. A representative example is illustrated in Figure 4.1. In Figure 4.1a, the aggregated annual vessel trip counts from 2010 to 2019 are shown for PP-3 (past point 3). Contrary to an overall trend of moderate growth of annual trip counts, the data point for one year (2018) exhibits a very high trip count, lies well outside the overall trend, and skews future traffic projections upward. Such points are referred to as outliers and may result from short-term, non-representative vessel traffic patterns (e.g., construction projects or special cargo deliveries), or from errors in data reporting processes.

Regardless of cause, outliers must be detected (identified) and removed before models of future traffic projection are formed. An outlier detection methodology was therefore developed and implemented to detect years in which the aggregated annual trip counts were significantly higher or lower than the overall trends. A summary of key steps involved in the outlier detection and removal process is as follows:

- Form the aggregate annual vessel trip count data for past point (Figure 4.1a)
- Compute the least square error power model curve fit (Figure 4.1b)
- Compute residuals between the data and the power model fit curve (Figure 4.1b-c)

- Sort residuals (Figure 4.1d), then compute median-based quartiles ( $Q_1, Q_2, Q_3$ ) and the interquartile range ( $IQR = Q_3 - Q_1$ ) (Figure 4.1e)
- Select an  $IQR$  scaling coefficient ( $coef_{IQR}$ ) based on the type of outliers to be detected
- Compute lower residual limit for non-outlier data,  $Q_1 - coef_{IQR} \cdot IQR$  (Figure 4.1e)
- Compute upper residual limit for non-outlier data,  $Q_3 + coef_{IQR} \cdot IQR$  (Figure 4.1e)
- Detect outliers as points with residuals outside the range:  $[Q_1 - coef_{IQR} \cdot IQR, Q_3 + coef_{IQR} \cdot IQR]$  (Figure 4.1e)
- Remove detected outliers from data set and recompute best fit power model (Figure 4.1f)

Using the aggregated USACE trip count data for each past point (Figure 4.1a), a best fit (least square error) power model (Equation 4.6) was computed (Figure 4.1b) using an iterative error minimization process. Residual differences ( $R$ ) between the USACE trip counts ( $N_{trip}$ ) and the best fit power model were then computed (Figure 4.1b-c) at each year  $y$ :

$$R(y) = N_{trip}(y) - (a_0 \cdot (y - y_0)^{a_1} + a_2) \quad (4.4)$$

The vector of computed residuals  $\{R\}$  was then sorted from minimum to maximum (Figure 4.1d), and the following median-based quartile parameters computed (Figure 4.1e):

- Third (upper) quartile,  $Q_3 = median(\{R_{top}\})$ , where  $\{R_{top}\}$  is the ‘top’ half of the sorted residual vector  $\{R\}$  consisting of all entries  $> Q_2$
- Second (median) quartile,  $Q_2 = median(\{R\})$
- First (lower) quartile,  $Q_1 = median(\{R_{btm}\})$ , where  $\{R_{btm}\}$  is the ‘bottom’ half of the sorted residual vector  $\{R\}$  consisting of all entries  $< Q_2$
- Interquartile range,  $IQR = Q_3 - Q_1$

Identification of outliers then followed the so-called ‘box-and-whiskers’ approach (Figure 4.2) originally published by Tukey (1977).

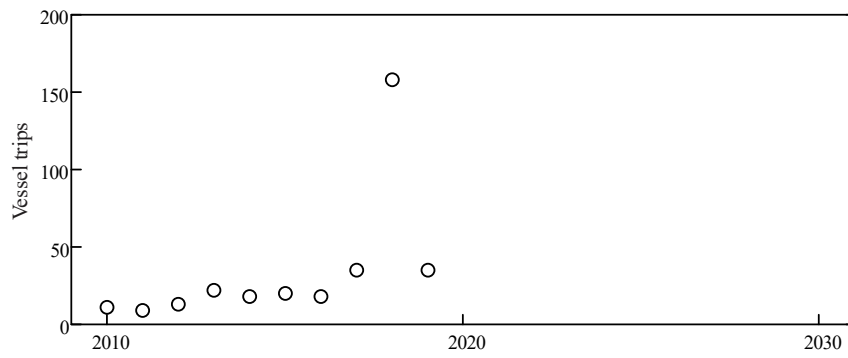

(a)

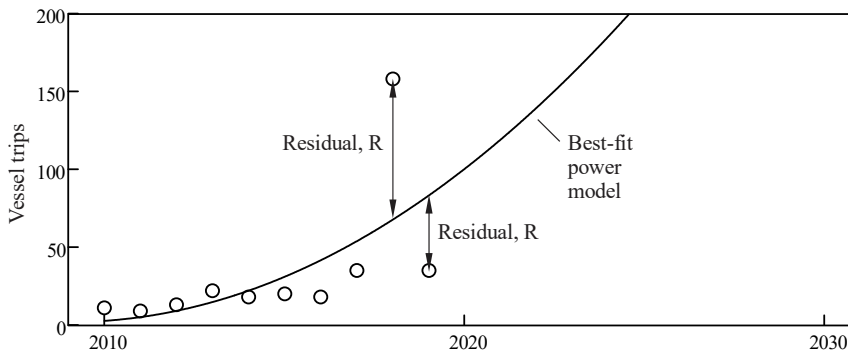

(b)

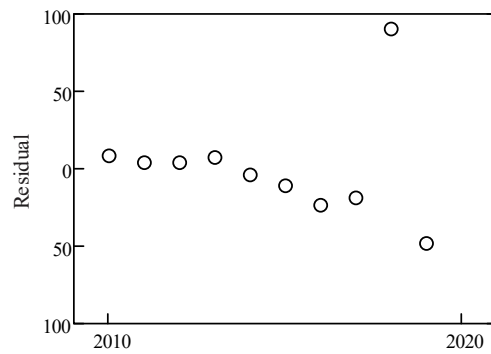

(c)

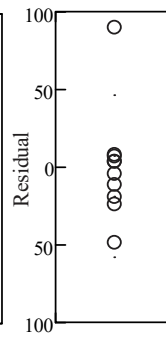

(d)

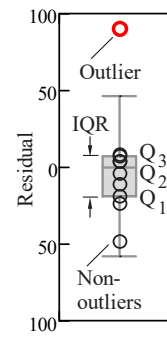

(e)

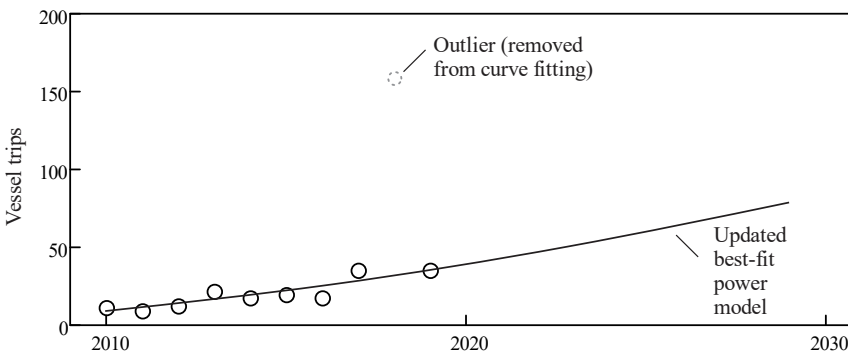

(f)

Figure 4.1 Detection and removal of outlier data: (a) Original data; (b) Best-fit power model; (c) Residuals between data and power model; (d) Residuals in sorted order; (e) Quartiles parameters, limits, and outlier detection; (f) Updated power model fit to non-outlier data

The inter-quartile range ( $IQR$ ), bounded by the first ( $Q_1$ ) and third quartiles ( $Q_3$ ), is commonly referred to as the ‘box’ (Figure 4.2) portion of the plot. Lower (minimum) and upper (maximum) limits, commonly referred to as the ‘whiskers’ (Figure 4.2), define the separation levels between non-outlier data and outlier data:

- Upper ‘whisker’, maximum limit:  $Q_3 + coef_{IQR} \cdot IQR$
- Lower ‘whisker’, minimum limit:  $Q_1 - coef_{IQR} \cdot IQR$

To identify outliers, the interquartile scaling coefficient ( $coef_{IQR}$ ) was typically chosen as one of:

- Extreme outliers:  $coef_{IQR} = 3.0$
- Outliers:  $coef_{IQR} = 1.5$

Given that formation of the initial fitted power curve, i.e., the curve used to compute the residuals (Figure 4.1a), would be influenced by any outlier points present in the data set, the outlier detection and removal process was performed in two passes. In the first pass, outlier detection was performed using a scaling coefficient  $coef_{IQR} = 3.0$  to identify and remove ‘extreme outlier’ points. Next, an updated least square error power model curve fit was formed using the remaining (‘non-extreme-outlier’) data points. A second pass of outlier detection was then performed using a reduced scaling coefficient  $coef_{IQR} = 1.5$  to detect additional ‘outlier’ points. Any outliers newly detected during this second pass were omitted from all subsequent steps taken to form future vessel traffic projections models (described in the following sections).

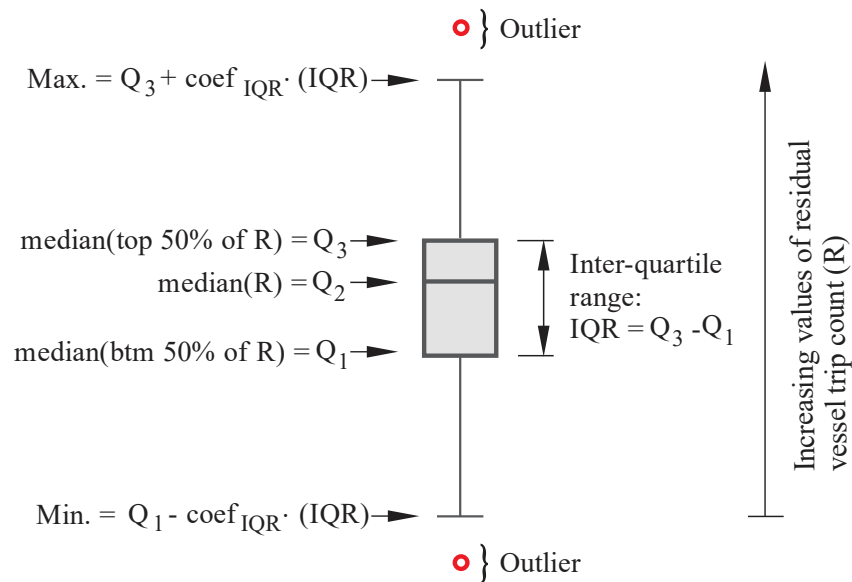

Figure 4.2 Illustration of the ‘box-and-whiskers’ outlier detection approach

#### 4.2.4 Future projection: Growth at statewide level

As noted earlier, aggregation and analysis of the USACE data were performed at both the statewide level and the past point level. At the statewide level, data for all past points, in all directions, and for all vessel types (relevant to bridge design) were aggregated together at each of the 10 years for which data were collected (2010-2019). As an exception, four years (rather than 10 years) of data were obtained from the USACE for PP-8. Due to this inconsistency, data

associated with PP-8 were not merged together with other past points in forming the statewide model. However, the influence of this omission is considered minor as trends at the statewide level and for PP-8 data were found to be similar. Data aggregation at the statewide level helped to attenuate transient fluctuations of vessel traffic that occurred at local past points, and thereby provided a reasonable basis for long-term (75-year) estimation of future changes in vessel traffic. Least square error curve fitting of a power model to the 10 years of aggregated USACE trip data at the statewide level indicated a gradual overall trend of growth in vessel traffic (Figure 4.3).

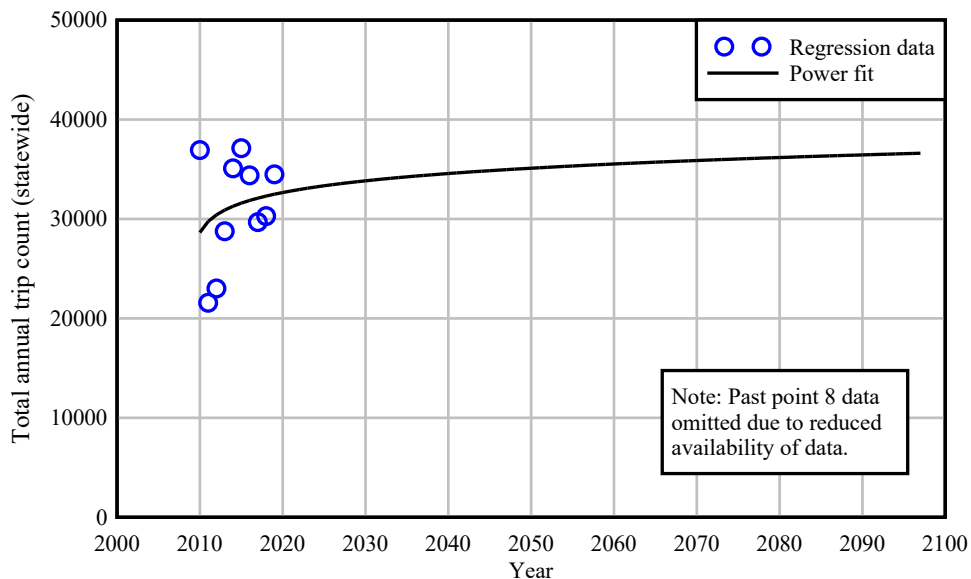

Figure 4.3 Statewide traffic growth model

Specific parameters of the statewide growth power model, following the general form of Equation 4.6, were:

$$a_0 = 27912.56 ; a_1 = 0.0561 ; a_2 = 729.03 \quad (4.5)$$

Although an overall trend of growth was observed at the statewide level, aggregation and analysis of data at the individual past point levels indicated mixed conditions. At some past point locations, the data indicated decaying (decreasing) trends in traffic (for reasons noted earlier), whereas at other locations, growth trends were observed. To provide reasonable levels of conservatism in the future traffic projections for both types of trends, separate approaches were implemented, as described in the following sections.

#### 4.2.5 Future projection: Growth at past point level

When aggregation and analysis of data at the past point level indicated a growth trend, a multi-step process was implemented to estimate (i.e., project) future anticipated traffic. In broad terms, two distinct time frames of future projection were integrated together:

- 10-year: Past point data collected at 10 years from 2010-2019 were used to project 10 years beyond the end of the collected data, to 2029 (i.e., 2019+10 years)
- 75-year: The statewide growth model was applied to the past point data to project 75 years beyond the present, to 2097 (i.e., 2022 + 75 years)

This general approach allowed near-term future projection to be primarily influenced by recently observed trends (as indicated by the 2010-2019 data), while longer-term future projection was based on the broader statewide trend.

For near-term projection, a least square error power model curve fit was formed (Figure 4.4a) to estimate traffic 10 years beyond the end of collected data set, at 2029 (i.e., 2019+10 years). To mitigate against the potential for unreasonably rapid growth, a constraint was introduced into the curve fitting process. Specifically, the maximum permissible increment of growth in traffic over the future 10-year time span 2019-2029 (offset relative to a linear fit through non-outlier data) was limited to the maximum observed increment of traffic from 2010-2019, excluding any influence from rejected outliers. That is, maximum growth permitted in the 10-year future projection was limited to maximum growth observed in the 10-year historical record. If an unconstrained power model fit through the historical data indicated a trip count at 2029 that was larger than the maximum permissible limit (Figure 4.4a), then a new (updated) least square error power model fit through the data was formed, but subject to the constraint that the traffic count at 2029 be no larger than the permissible limit. Note that if an unconstrained power model fit through the historical data indicated a trip count at 2029 that was smaller than the maximum permissible limit, then no enforcement of the constraint was necessary, nor applied. Constraints on growth, to levels consistent with the historical data trends, were only applied (enforced) when necessary to mitigate excessive growth in the 10-year projection process.

Long-term (75-year) growth was estimated by starting at the projected 2029 traffic count, then projecting further forward (Figure 4.4b) based on a scaled version of the statewide growth model (Figure 4.3). To apply the statewide growth model to a given past point, the statewide model was scaled by the following ratio:

$$\mu_{past\ point,10\ yr} / \mu_{statewide,10\ yr} \quad (4.6)$$

where  $\mu_{past\ point,10\ yr}$  was the mean value of trips per year at the past point, computed over 10 years, and  $\mu_{statewide,10\ yr}$  was the mean value of trips per year, computed over 10 years, at the statewide level. Employing the mean-scaled statewide growth model, traffic at the past point was computed at 2097 (i.e., 2022+75 years). This point is referred to as the long-term traffic target point.

To enable calculation of past point traffic counts at points in time between the present (2022) and 75 years into the future (2097), additional steps were necessary. A least square error power model fit through the collected historical data (2010-2019) was formed (Figure 4.5a), but subject to the constraint that the future projection at 2097 pass through the long-term target point. At 2097, the slope of such a fit will naturally be positive and non-zero, indicating continued growth of traffic at 75 years into the future. To account for the contrasting condition where growth has ceased 75 years in the future, and traffic counts have reached a plateau level, a second power model curve fit was performed (Figure 4.5b). This second fit was formed in an identical manner to the first, but subject to the additional constraint that the slope of the curve at 2097 be zero (or negligibly small, i.e., not more than 1/1000<sup>th</sup> of the mean annual trip count for the past point). These two bounding curves, with unconstrained slope at 2097 and (essentially) zero slope at 2097, were then averaged together (Figure 4.5c).

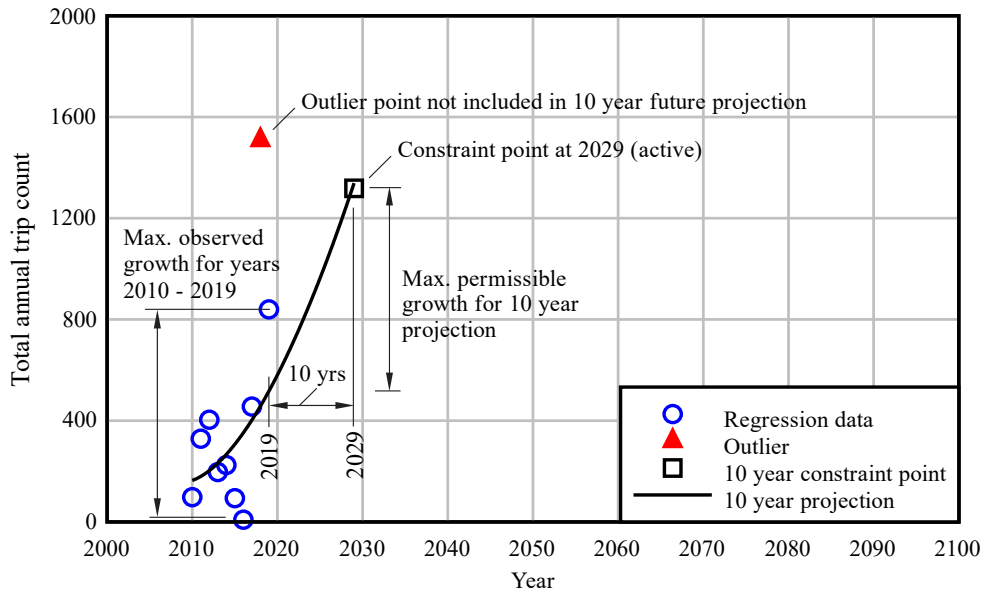

(a)

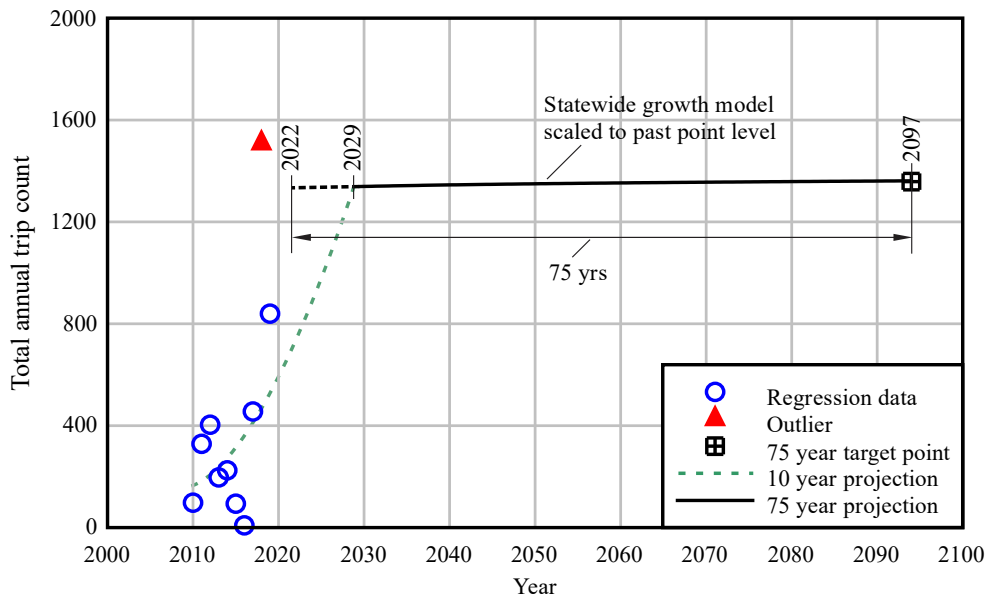

(b)

Figure 4.4 Past point with growth trend:  
 (a) 10-year future projection; (b) 75-year future projection



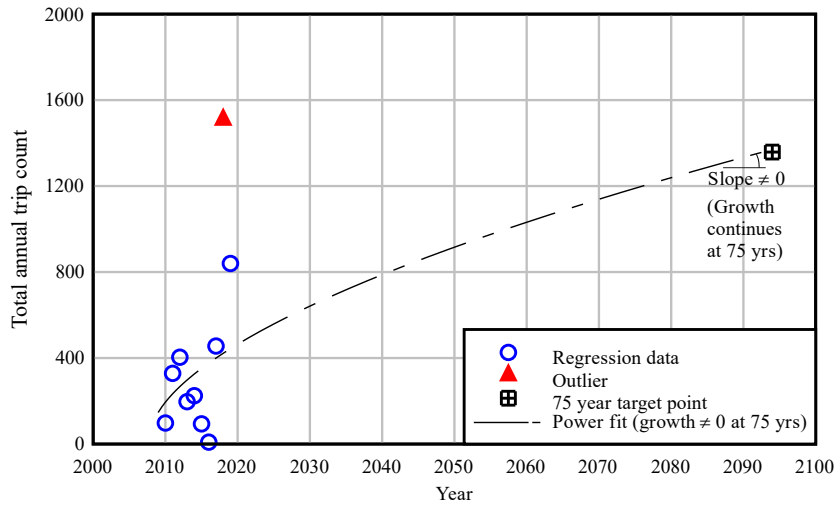

(a)

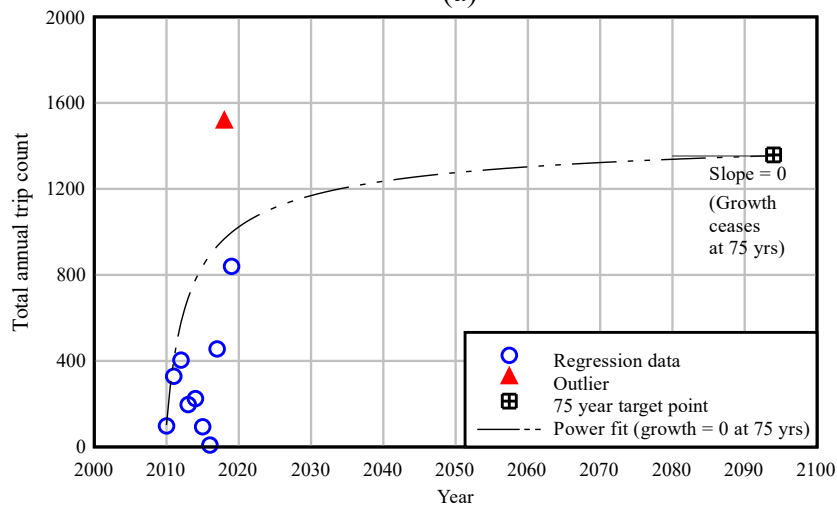

(b)

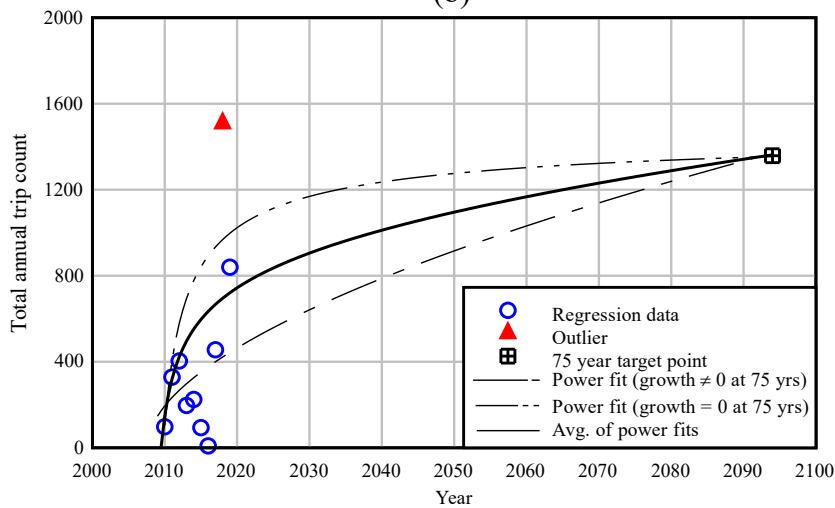

(c)

Figure 4.5 Power model fits through non-outlier data and 75-year target point: (a) Growth permitted at 75 years; (b) Growth ceases at 75 years; (c) Average curve

The final future traffic projection curve for the past point was then formed by computing the least square error unconstrained power model fit to the average of the bounding curves

(Figure 4.6). The results produced by this procedure for past points exhibiting trends of growth are presented in Appendix B.

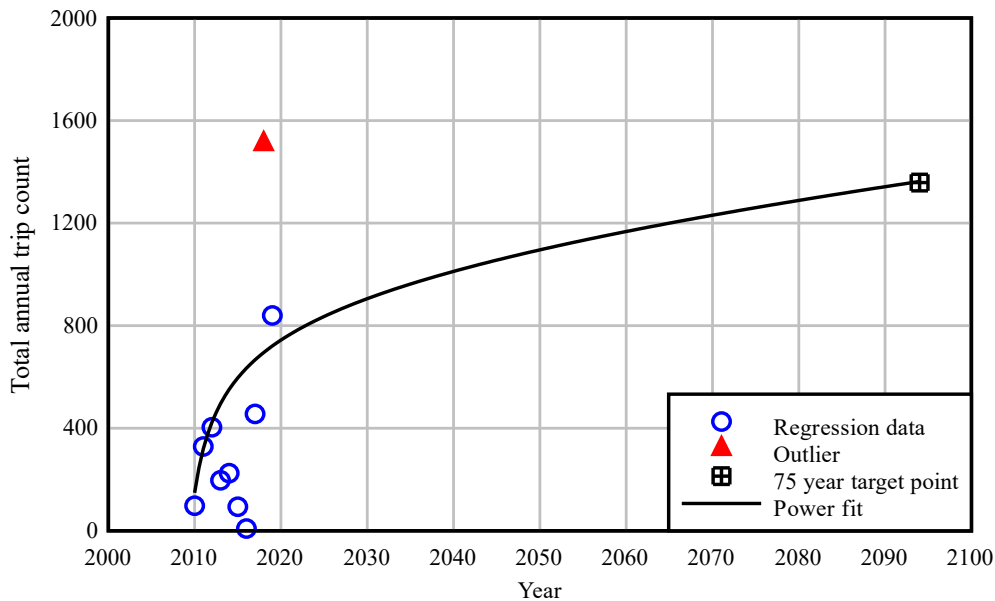

Figure 4.6 Past point with growth: final power model for future projection of traffic

#### 4.2.6 Future projection: Decay at past point level

When aggregation and analysis of data at the past point level indicated a trend of decay, mitigating against potentially unconservative underestimation of future traffic was deemed important. Given that vessel traffic can be affected by a variety of factors, particularly over the long-term (e.g., 75 years), the possibility of future reversals in trends, from decay to growth, had to be taken into consideration in the formation of traffic projection models. As noted earlier, power model curve fitting was used consistently in this study for future traffic projection, both for locations that exhibited growth (statewide, past point), as well as locations (past points) that exhibited decay.

For many of the past points that exhibited a trend of decay in the collected 2010-2019 traffic data, the rate of decay was quite pronounced. Fitting an unconstrained power model to such a data set could lead to potentially unconservative long-term future projections (Figure 4.7a). Examples of potentially unconservative future projections included future projected trip counts of zero, or minimal projected trip counts, even in the near-term (e.g., at 2029).

Therefore, to promote conservatism in the development of future projection models, a constraint was placed on the power model curve fitting process. For each past point that exhibited a decaying traffic trend, a least square error power model was fit to the data, but subject to the constraint that the projected long-term traffic at 2097 (i.e., 2022+75 years) be no smaller than the mean annual trip count from 2010-2019 (Figure 4.7b). That is, a minimum level, or ‘floor’, was enforced on the curve fitting process.

The results produced by this procedure for past points exhibiting trends of decay are presented in Appendix B.

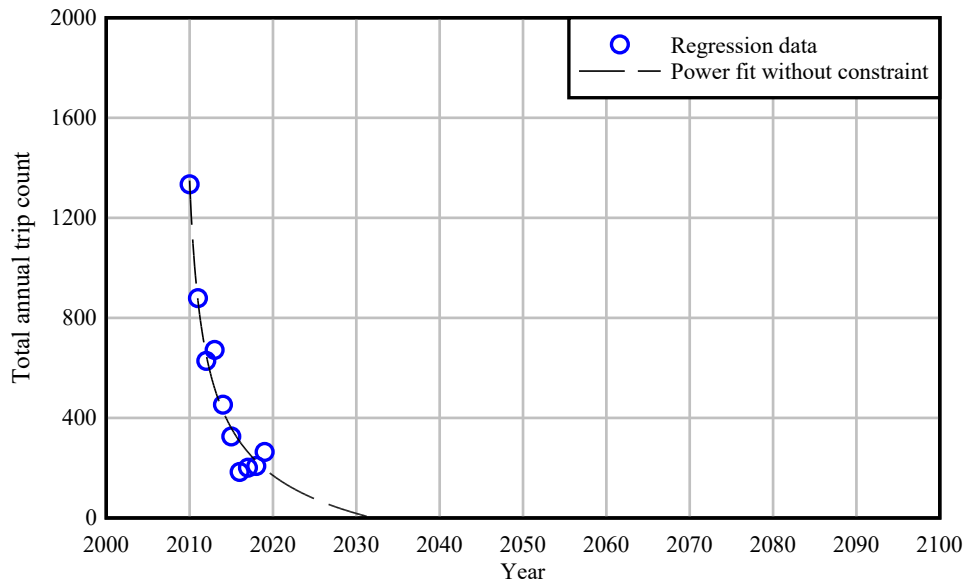

(a)

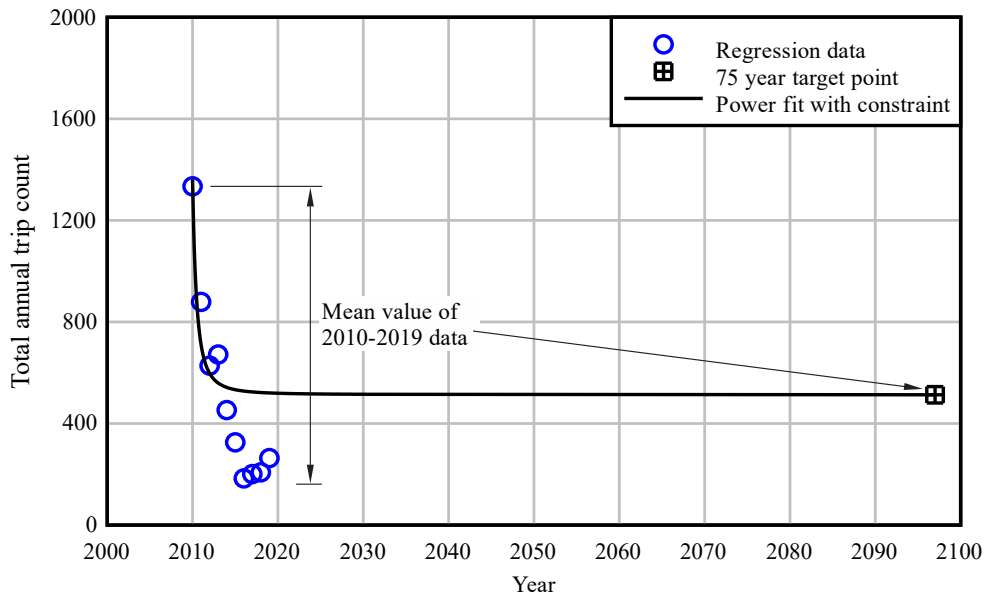

(b)

Figure 4.7 Past point with decay trend: (a) Unconstrained power fit; (b) Power fit with 75-year minimum value constrained to the 10-year mean trip count

### 4.3 Vessel Groups

Given the wide variety of vessel types and configurations that may operate at a given past point location, the process of characterizing representative vessel traffic that is relevant to bridge design typically involves aggregating vessels into a manageable number of groups. In this study, formation of vessel groups was achieved by analyzing the collected USACE data to identify vessels of relatively similar characteristics. Vessel draft (at transit) was selected as the metric by which vessels of the same type were grouped together, as this metric determines the vessel size that can reach a bridge pier given an available water depth. The groups defined to categorize vessels in this study included: ship, barge flotilla, small self-propelled vessel, free tug, and other.

Every traffic record collected from USACE for a particular past point location and direction (upbound, downbound) was assigned to a vessel group. Representative vessel characteristics were computed for each group in the form of weighted averages, with trip counts used as the weighting factors. Data assigned to the vessel groups corresponded to the vessel characteristics that are required to perform the vessel collision risk analysis: length overall (*LOA*), beam (width), draft, tonnage, and vessel frequency. Typical vessel speed, also required when conducting a vessel collision risk analysis, is discussed in later sections.

#### 4.3.1 Barges and tugboats

Analysis of barge trip records in the collected USACE traffic data indicated wide-ranging characteristics (type, draft depth, dimensions, tonnage, etc.) for barges operating in Florida waterways. To condense the data down into a manageable number of vessel groups, barges were aggregated together based on similarities of draft depth. Specifically, groups were formed by aggregating barges into intervals of draft depth that were no smaller than 3 ft (e.g., 0-3 ft, 3-6 ft, 6-9 ft).

After forming barge groups in this manner, the number of associated barge *flotilla* trips for each group was determined by analyzing both individual barge trip counts and tug trip counts. As previously discussed in Section 4.2.1, the barge-to-tug ratio  $r$  for each past point (with an upper limit of  $r=2.5$ ) was used to estimate the number of flotilla trips based on barge and tug trips. The quantity (count) of flotilla trips estimated in this manner was then assigned to each barge (flotilla) group.

Also as previously noted, when  $r < 1$  (i.e., the number of individual barge trips was less than the number of tug trips) for a given past point and/or year, a flotilla configuration of one barge and one tug was assumed. Subsequently, all residual tug trips (those exceeding the number of recorded barge trips) were treated as trips of free (unconnected) tugs. Trip counts for ‘one-barge and one-tug flotillas’ ( $r=1$ ) were assigned a barge flotilla vessel group (based on draft depth), while the remaining trip counts for free tugs were assigned to a separate vessel group.

Note that while trip counts determined for the formed barge groups corresponded to trips counts of barge flotillas (whether  $r=1$ , or  $r>1$ ), other key barge characteristics (e.g., dimensions, tonnage) assigned to each barge group corresponded instead to *individual* barges, not flotillas. The cause for this difference lies in the manner in which the FDOT vessel collision risk analysis program (FDOT 2019) and associated database of past point information function. Key items of information read into the risk assessment program from the database include barge *flotilla* counts, *individual* barge characteristics (averaged for each group, as discussed below), and the number of barges per flotilla trip (i.e., the parameter  $r$  defined in Section 4.2.1). Using these and other items of information, barge *flotilla* characteristics are formed inside the risk assessment program by multiplying individual barge characteristics by  $r$  and then adding appropriate tug contributions (e.g., to length, weight). Flotilla characteristics computed by the program in this manner are then used to compute various quantities needed for risk analysis. For example, the characteristic of length overall (*LOA*) of a barge *flotilla* group is used in computing  $PG$ , the geometric probability parameter of the AASHTO risk assessment procedure. Similarly, the characteristic of weight ( $W$ , tonnage) of a barge flotilla group is used in computing impact forces. Thus, to maintain consistency with the FDOT vessel collision risk analysis program, barge characteristics that were (1) assigned to each barge group, (2) reported in Appendix C of this report, and (3) stored in the updated past point database, consisting of individual (averaged) barge characteristics.

Consistent with the AASHTO vessel collision risk analysis, displacement tonnage for individual barges was taken as the key characteristic measure of weight for barge vessels. Displacement tonnage was calculated for individual barges by adapting and applying AASHTO (2009) C3.5.2-1:

$$W = L \cdot B \cdot D \cdot C_b / W_w \quad (4.7)$$

where  $W$  was the displacement tonnage (short tons, for barges),  $L$  was the length overall ( $LOA$ , ft),  $B$  was the beam (width, ft) of the vessel,  $D$  was the actual draft (ft) at transit,  $C_b$  was the block coefficient, and  $W_w$  was the specific volume of water (adapted from the ft<sup>3</sup>/tonne values provided in AASHTO to ft<sup>3</sup>/ton). Consistent with the FDOT vessel collision risk analysis program,  $C_b$  was assigned values of 0.85 for empty barges (drafts  $\leq 2$  ft) and 1.0 otherwise.

For each barge flotilla group, trip-weighted average values of individual barge characteristics were computed and assigned. For example, the vessel length assigned to a given barge flotilla group corresponded to the trip-weighted average length of all individual barges contained within the group. Using trip counts as ‘weighting factors’ in forming such average values produced vessel characteristics that were strongly influenced by frequently occurring barges (high reported trip counts) and weakly influenced by infrequently occurring barges (low reported trip counts). Barge characteristics computed using the trip-weighted averaging approach included: average draft; average length; average width; average tonnage (weight).

As noted above, in the FDOT vessel collision risk analysis program, average individual barge characteristics are combined with appropriate contributions (e.g., to length, weight) from tugs to form overall flotilla characteristics. Interviews conducted with maritime professionals indicated that typical barge flotilla configurations in Florida involve one or more barges aligned lengthwise and with a single tugboat. Since the tug and barges in a flotilla navigate as a single connected unit, flotilla characteristics (e.g.,  $LOA$ , tonnage), must account for both the contributions from the barges as well as the connected tug.

Therefore, the USACE data were analyzed to investigate typical tug dimensions and tug weights, across the entire set of towing vessel records that were collected from USACE for Florida. Based on a review of the USACE tug records, it was determined that the design tug (towing vessel) sizes currently employed by the FDOT constitute a reasonable representation of typical characteristics of towing vessels found in navigable Florida waterways. These design tug sizes are denoted by FDOT as TUG 1 and TUG 2, with characteristics as shown in Table 4.1. Discussions with maritime professionals further indicated that unique relationships associating tug size with corresponding barge size are not easily identifiable. That is, the sizes of tugs employed to move barges are not selected based solely on barge size, but instead may also be influenced by other considerations (e.g., availability; or applicability to multiple, varied trips). Given that no clearly contradictory information was identified in this study, the existing FDOT designated relationship between barge size (barge draft) and associated tug size was adopted and maintained (Table 4.2) for consistency with current design practice.

Table 4.1 FDOT design tug dimensions and tonnages (FDOT 2019)

Tug Size	Draft (ft)	Length (ft)	Beam (ft)	Displacement (tons)
TUG 1	8	75	25	260
TUG 2	9	120	30	560

Table 4.2 FDOT relationships between barge draft and tug size (FDOT 2019)

Barge draft	Assigned tug size
$0 \text{ ft} < D \leq 9 \text{ ft}$	TUG 1
$D > 9 \text{ ft}$	TUG 2

#### 4.3.1.1 Model of future traffic estimation

Barges transiting navigable waterways are commonly associated with configurations such as jumbo hopper barges, oversize tank barges, and special deck barges (Figure 4.8a-b). Respectively, these three common barge types possess typical (loaded) draft depths of 8.7 ft, 8.7 ft, and 12.5 ft (AASHTO 2009). However, still other barge types were found to transit Florida waterways, where such barges possessed significantly larger dimensions and greater draft depths. For example, articulated tug barges (ATBs) have been introduced into the wider region of the Gulf Intracoastal Waterway (GIWW), with carrying capacities that are ten times those of the aforementioned barge types (Harrison 2015). For example, operating along the US Gulf Coast is a class of ATBs with *LOA* values of 674 ft and loaded draft depths of 57 ft (Crowley 2020). This latter type of barge (Figure 4.8c-d) possesses lengths, loaded drafts, and bow characteristics that are more aligned with those of ships, and further, ATBs visibly resemble ships (Harrison 2015).

In AASHTO (2020), a distinction is made between shallow and deep draft waterways, where shallow draft waterways are defined as those used primarily by barge vessels with loaded drafts of less than 9-10 ft. Deep draft waterways are defined in AASHTO (2020) as those used by merchant ships with loaded drafts of 14-60 ft (or greater). Furthermore, the USACE defines deep draft navigation as waterways (or channels) with depths exceeding 15 ft (USACE 2006).

In processing the USACE barge traffic data, a distinction was therefore made between shallow-draft barges (Figure 4.8a-b) and deep-draft barges (Figure 4.8c-d) for the purposes of characterizing vessel groups. All barges possessing loaded drafts greater than 15 ft were categorized as deep draft barges, and shallow draft barges were separated from (i.e., not aggregated together with) deep draft barges when forming barge groups. Furthermore, given that the bow characteristics of deep draft barges (such as ATBs, Figure 4.8d) are more similar to those of ships than to the bow characteristics of shallow draft barges (e.g., hoppers, tankers, Figure 4.8b), it is recommended that the AASHTO empirical force-deformation relationship associated with ships be utilized when computing impact forces for deep draft barges.



(a)



(b)



(c)



(d)

Figure 4.8 Shallow draft barges and deep draft barges:  
(a) Flotilla of 3 shallow draft barges (Apalachicola Bay, FL); (b) Flotilla of 2 shallow draft barges, showing bow (Apalachicola Bay, FL); (c) Deep draft articulated tug barge (Source: Crowley); (d) Deep draft articulated tug barge, showing bow (Source: Crowley)

### 4.3.2 Ships and small self-propelled vessels

In a manner similar to that used to form barge groups, the USACE data were processed to form a manageable number of vessel groups corresponding to ships for each past point. Groups were formed by aggregating ships into intervals of draft depth that were no smaller than 2 ft (e.g., 0-2 ft, 2-4 ft, 4-6 ft). Deadweight tonnage (*DWT*, tonnes), i.e., the cargo capacity of ships, was taken as the measure of mass for ships following AASHTO C3.5.2-1 (2009) and FDOT procedures:

$$DWT = L \cdot B \cdot D_L \cdot C_b / W_w \quad (4.8)$$

where  $D_L$  was the loaded draft, and  $W_w$  was the specific volume of water. The value of  $W_w$  used in Equation 4.8 for ships was the average of the values provided in AASHTO (i.e., the average of 34.4 ft<sup>3</sup>/tonne of saltwater and 35.4 ft<sup>3</sup>/tonne of freshwater). An investigation was conducted to verify the parameter  $C_b$  used by the FDOT (2019) for ships. Values of  $C_b$  were derived by substituting typical characteristics of fully loaded ships into Equation 4.8 (AASHTO 2009). Additionally, tabulated values of ship weights were excerpted from Table 3.5.2 in AASHTO (2009). It was found that the resulting  $C_b$  values exhibited low to moderate variance, with an average value of 0.638, consistent with the value of 0.6 used by the FDOT (2019). Therefore, when using Equation 4.8 to compute deadweight tonnage (*DWT*) of ships,  $C_b=0.6$  was used.

After analyzing the collected USACE ship records, the distribution of computed *DWT* values revealed that a significant portion of the commercial vessel fleet corresponded to small ships. For purposes of bridge design, small ships (categorized as self-propelled vessels) with a capacity smaller than 1,000 *DWT* are not applicable when performing vessel collision risk analyses (AASHTO 2020). Moreover, the influence of small ships (<1,000 *DWT*) has been proven negligible to the vessel impact risk in previous studies (Wang and Liu 1999, Liu and Wang 2001). Even so, as a measure of comprehensiveness, an individual vessel group, without draft intervals, was created to contain small ships at past points that had reported traffic of this vessel type.

All characteristics that were: 1) assigned to each ship group, 2) reported in Appendix C of this report, and 3) stored in the updated past point database, consisted of trip-weighted averages computed from individual ship records. These characteristics included: average draft; average length; average width; average tonnage (*DWT*).

### 4.3.3 Foreign and other vessels

Approximately 18% of all recorded trips collected from USACE corresponded to vessels that were associated with foreign commercial exchange (referred to as ‘foreign vessels’). Further, nearly all (>98%) of these foreign vessel trips were found to be concentrated at past points 6, 7, 8, 13, 14, 30, 33, 36, and 39. Although most of the foreign vessel trip records were found to correspond to ships, a small portion indicated barges, tugs, and even ‘other’ vessel types. In terms of vessel characteristics that are relevant to bridge design, information contained within the foreign vessel trip records were limited, providing only vessel type and actual in-transit draft. Vessel characteristics such as length, width, and tonnage, which are necessary for collision risk analysis, were not reported. This issue of missing information was addressed by one of various means, depending on the extent of foreign vessel traffic that was present in the past point data.

For past points with relatively small amounts of foreign traffic (<3% of all trips), a mapping approach was used to estimate missing vessel characteristics. For each unique type of vessel contained within the *domestic* past point data, average vessel characteristics were correlated to draft depth. Then, the missing *foreign* vessel characteristics were estimated by mapping—based on draft depth—from the average characteristics of domestic vessels to the foreign vessels. When possible, the data used to map average vessel characteristics was limited (in scope) to the individual



past point to maintain consistency with the local fleet characteristics. However, in some cases, the local past point data were not sufficiently populated with domestic vessel types and/or drafts to enable mapping onto foreign vessels. For these cases, the broader statewide data set of average domestic vessel characteristics was used. That is, the foreign vessel characteristics were mapped from the average statewide characteristics of corresponding domestic vessels of the same vessel type and draft.

For past points with significant levels of foreign traffic, and where there was also a lack of adequate corresponding domestic data available for mapping purposes (i.e., past points 7, 8, 13, 14, 33, 36), a different approach was used. In these situations, supplementary information regarding foreign vessel characteristics was sought from local maritime data sources located near the past points in question. This information was used to relate draft to other characteristics (length, width, tonnage) for each type of foreign vessel. These relationships were then used to estimate the characteristics of foreign vessels that were present in the USACE data for the past points in question.

After incorporating the influences of foreign vessels (trips counts, characteristics) into the overall Florida vessel traffic data set, the trip-weighted averaging approach discussed in earlier sections was used to form average characteristics (length, width, tonnage) for each vessel group. Finally, it should be noted that foreign vessels reported by USACE as type ‘other’ were categorized into groups of 2-ft draft intervals.

#### **4.3.4 Invalid data**

Among the data records provided by USACE, invalid dimensional data (e.g., 999.99-ft width or 9999.99-ft length) were identified in approximately 10% of the recorded trips. However, these same records contained valid information regarding capacity tonnage, and light-, loaded-, and actual-drafts (as confirmed with USACE). Therefore, to avoid discarding these records, an approach similar to that described above for foreign vessels was implemented. Relationships were developed between average width and draft depth (for each type of vessel, and each past point), and between average length and draft depth (for each type of vessel, and each past point). These relationships were then used to estimate width and/or length dimensions of vessels when invalid data were encountered. Also, similar to the treatment of foreign vessels, the approach of using local past point vessel characteristics when available, and statewide characteristics when needed, was implemented for records with invalid dimensional data.

#### **4.3.5 Synthesizing vessel groups**

All vessel records collected from USACE for a given past point were distributed into vessel groups, primarily based on the draft intervals described above. The average annual number of trips for each vessel group was determined by dividing the total number of trips for the vessels in the group, throughout the entire dataset, by the number of years reported in the dataset (i.e., 4 years for past point 8; and 10 years for all other past points). After processing the data in this manner, vessel groups that indicated less than one average trip per year were identified. Such vessel groups typically contribute low overall risk as compared to vessel groups with larger quantities of annual trips. A synthesizing approach was therefore developed to reduce the number of vessel groups that corresponded to small annual average trip counts.

If a vessel group involved less than one trip per year, then the data compiled for said group were aggregated into an adjacent—in terms of draft depth—group of the same vessel type and same transit direction. When feasible, such records were aggregated into the group corresponding to the next largest draft interval. However, when no deeper draft vessel group existed, the data records were instead aggregated into the adjacent group with smaller draft. Vessel groups were

iteratively synthesized (aggregated) until the average number of trips for each group was equal to or more than one per year, or until there was only one vessel group remaining (for a particular type and direction). Once the synthesizing procedure was complete, trip-weighted average vessel characteristics were computed for each group. Characteristics of the vessel groups synthesized for each past point are reported in Appendix C.

## **4.4 Design Vessel Speeds**

### **4.4.1 Introduction**

Vessel speed plays an essential role in the evaluation of risk for bridge structures that are vulnerable to vessel impact. Design speeds must be established to determine collision energy, which is then used along with empirical expressions given in design provisions to determine impact force for each vessel category and pier location. With the development of vessel traffic technologies and automated data delivery methods, AIS data have evolved into an important source of information relating to vessel transit paths and operating speeds. In the present study, AIS data were collected from Marine Cadastre and processed for the purpose of characterizing typical vessel transit speeds throughout navigable Florida waterways. The methodology used to process and interpret the collected AIS data is discussed in the next sections. Additionally, representative vessel speeds, aggregated together in various ways (e.g., statewide, by vessel type, by waterway type) are summarized.

### **4.4.2 Data collection and processing**

Marine Cadastre data files containing Florida AIS records spanning from 2016 to 2020 were collected and processed. Marine Cadastre provides AIS records that are sampled and reported at time intervals of 1 minute. The AIS records contain static descriptions of vessel characteristics as well as dynamic (trip-specific) information, such as geographical position and speed over ground (SOG). Using such data, it was feasible to determine vessel speeds in two different, and independent, ways: 1) directly, by reading the SOG data as reported by the vessel, and 2) indirectly, by reading GPS positional data at different points in time, and subsequently computing speeds from the distances traveled.

Directly reported vessel speeds (SOG) were quantified in nautical units of knot with a resolution of  $\pm 0.1$  knot (0.169 ft/s). The GPS positional data were reported in units of decimal degrees (i.e., latitude and longitude) with a resolution of  $\pm 0.00001^\circ$ . Two independent approaches for determining speed were undertaken because prior studies (e.g., Meyer et al. 2020) indicated the frequent presence of gaps in Marine Cadastre data (i.e., irregular reporting intervals between AIS points). The use of independent speed determination approaches was deemed to be more robust than simply collecting and summarizing AIS SOG data.

For the five (5) year time span ranging from 2016 to 2020, hundreds of millions of AIS records were collected from Marine Cadastre. Automated data processing procedures were implemented to process the bulk data. Data filters were implemented to remove AIS records for vessels that were not relevant to vessel collision risk analysis. For example, fishing and pleasure craft/sailing vessel types were excluded from analysis. Military vessels were also excluded since AIS transponders are not required by the U.S. Coast Guard for such vessels. Moreover, the scarce number of AIS records pertinent to military vessels contained no usable information; records typically included null Maritime Mobile Service Identity (MMSI) values, missing vessel names, and incomplete vessel dimensions. Overall barge tow characteristics (e.g., dimensions, draft) were also not able to be robustly determined from AIS data because the information contained in AIS

records related to the characteristics of the towing vessel on which the AIS transponder was installed.

For bridge design, it is of particular interest to characterize the vessel speeds of large barge tows and commercial ships as they pose the greatest impact risk. The size of barge tows could not be determined from the AIS records as meaningful data were not available (e.g., *DWT*, *LOA*). Ships that contributed the greatest risk were deemed to be those above the 90<sup>th</sup> percentile, based on size (e.g., mass, dimensions). In AASHTO (2009), *DWT* is recommended for characterizing size, which relates to impact energy. However, only a relatively small fraction (approximately 19%) of ship AIS records contained sufficient information to calculate *DWT* (recall Eqn. 4.8). The vessel characteristic that was present in the greatest portion of AIS records was the length overall (*LOA*) of the vessel, with more than 95% of records containing non-zero *LOA* values.

For purposes of estimating typical vessel operating speeds, a filter was implemented to cull out (i.e., retain) only AIS data corresponding to records of large vessels navigating near bridge crossings. Specifically, the minimum *LOA* for AIS data retention (filtering) was set to the 90<sup>th</sup> percentile of length overall ( $LOA_{90}$ ) of ships with recorded bridge crossings from 2016 to 2020 (Figure 4.9). Only ships larger than  $LOA_{90} = 738 \text{ ft}$  were considered during the characterization of large vessel speeds.

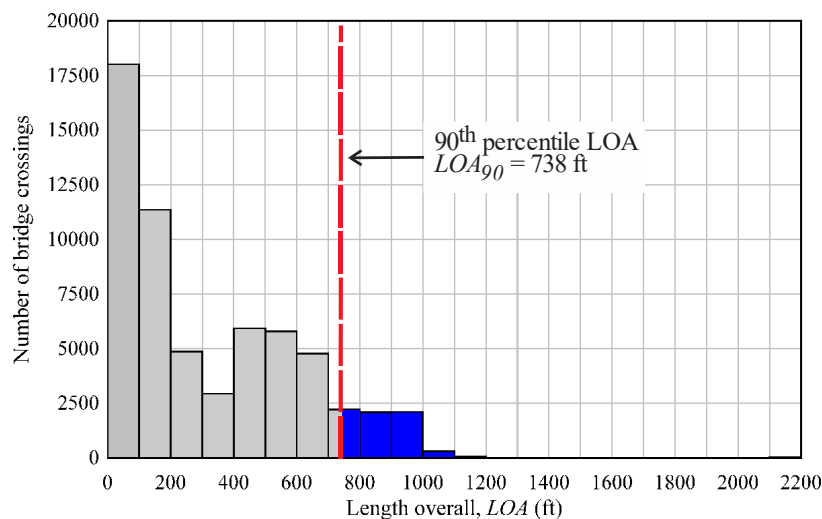

Figure 4.9 Distribution of length overall (*LOA*) for ships with detected bridge crossings (2016 to 2020)

### 4.4.3 Computing vessel transit speeds

#### 4.4.3.1 Methodology

Positional AIS data consisted of latitude and longitude values. To facilitate the calculation of linear distances, the positional data were projected to Universal Transverse Mercator (UTM) format. Then, individual vessel transit paths were constructed by creating straight line segments between sequential AIS data points for each vessel. The distance and time differences between the sequential points were then used to compute vessel speeds.

Considering that it is of interest to determine typical transit speeds in the vicinity of structures, vessels transiting under bridges associated with past points were identified. The spans of past point bridges were constructed in a piecewise linear manner. Line segments defining vessel paths that intersected the spans were considered as crossings, and the associated transit data were cataloged.

To illustrate the methodology, vessel crossings pertaining to six bridges within (or near to) Tampa Bay (Figure 4.10) are discussed in the following. More specifically, depicted in Figure 4.10a are approximately 25,535 reported vessel trip portions and piecewise linear traces of the past point bridge spans. Note that error handling of, for example, vessel trip portions indicating passage over land is discussed later. Also depicted in Figure 4.10a are vessel transit segments that intersected the bridge spans. For all relevant vessel trips, computed speeds were recorded at the point of (span) crossing and at a span offset distance of  $3 \times LOA_{90}$  from the bridge. Here, the span offset distance was taken in direction that was opposite to the vessel transit direction (i.e., at a prior time in the vessel trip). The  $LOA_{90}$  referenced in Figure 4.9 was designated as the span offset distance. For example, Figure 4.10b illustrates the piecewise linear trace of the Sunshine Skyway Bridge span, and the offset distance ( $3 \times LOA_{90}$ ) in both directions. The value of  $LOA_{90}$  computed from ship data was used to characterize barge speeds given that no reliable information was available for barge tows. The objective was to gain insight regarding the difference in speed near the vicinity of the bridge as compared to the speed at the actual crossing. The offset distance was selected to be broadly consistent with the design-relevant distance specified in the AASHTO (2009) provisions (e.g., as specified therein for the purposes of identifying impact-susceptible piers, and further, establishing vessel impact speeds for each impact-susceptible pier).

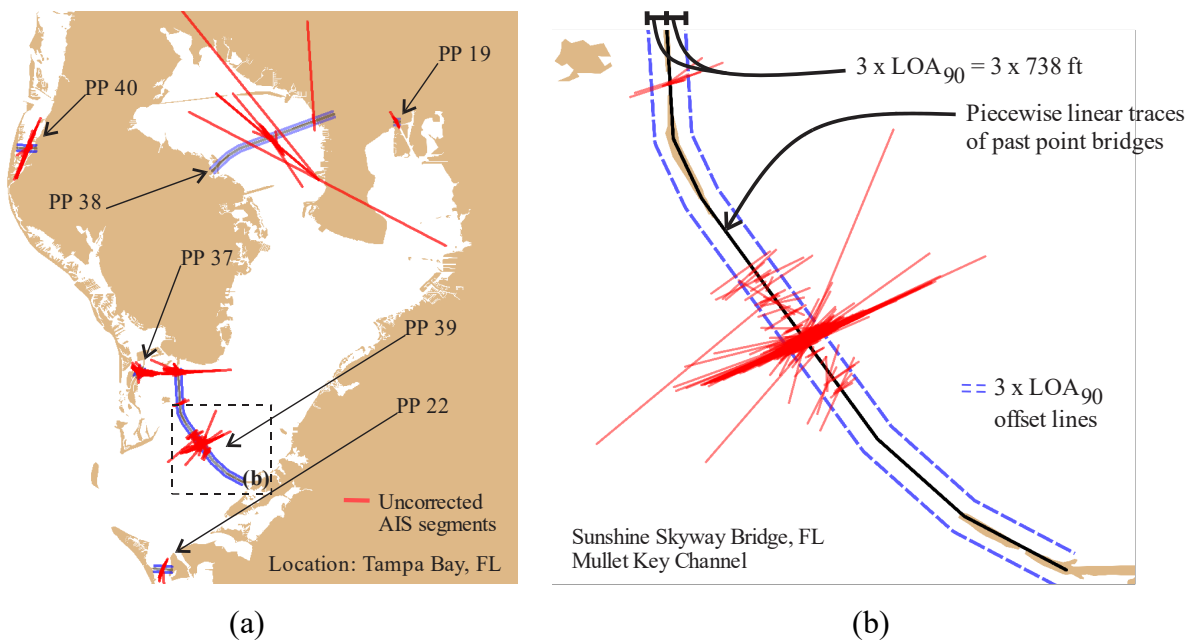

Figure 4.10 AIS vessel transit segments crossing past point bridges: (a) Within or near to Tampa Bay; (b) Inset of the Sunshine Skyway Bridge (base map imagery courtesy of U.S. Census Bureau)

#### 4.4.3.2 Error Handling

Examples of errors found in the AIS data set included missing or zero dimensions, drafts deeper than the control channel depth, duplicate MMSI numbers, greater than realistic reported SOG values, unreported vessel types, impractical navigational status values, and inconsistent time steps between AIS signals. The latter of these variables significantly influences the computation of speed. Therefore, an error handling algorithm was developed to mitigate the effects of using linear segments connected by points with inconsistent time steps when defining vessel transit paths. Further, only those segments located within a region bounded by  $3 \times LOA_{90}$  on both sides

of a past point bridge were accepted for analysis (Figure 4.11a). (The  $LOA_{90}$  was taken as the 90<sup>th</sup> percentile  $LOA$  of ships with reported bridge crossings.) This error prevention procedure filtered out non-physical transit data wherein the vessel was indicated as passing over land or cutting out bends of channels (Figure 4.11b).

A similar procedure was followed for the characterization of speeds at specified offset distances from the bridge. As illustrated in Figure 4.11c, a region with length of  $6 \times LOA_{90}$  was centered at a  $3 \times LOA_{90}$  offset distance and opposite to the vessel transit direction. If any point of a crossing segment fell outside of the  $6 \times LOA_{90}$  region, then the computed SOG and vessel data were removed from the analysis (Figure 4.11d).

Detection of possible redundant trips, such as those attributable to tethered tugs escorting commercial vessels in restricted channels, was also incorporated into the overall methodology. Tugs are commonly assumed to be towing one or more barges; however, tugs can also aid in maneuvering ships, especially tanker vessels. For these instances, separate crossings and speeds would be computed for both vessels. To avoid introducing redundant results, the algorithm detected redundant situations where a combination of tugs and ships were travelling in the same direction and with a crossing time difference of less than a minute; in these situations, only the ship data were retained for determining transit speeds.

To further ensure the quality of vessel data carried forward into the speed determination methodology, the sensitivity of computed SOG values with respect to noisy AIS data was assessed. Specifically, data smoothing methods were applied to the positional data, and speeds were computed based on the post-smoothed positional data. Based on sensitivity studies, numerical noise within AIS positional data was judged to have negligible effect on the computation of vessel speeds.

#### **4.4.4 Verification of computed speeds using independent data source**

Historical vessel transit speeds produced by the methodology described above were verified to ensure that the results were reasonable and representative of current traffic conditions. As discussed below, data verification was achieved by comparing vessel speeds produced from the historical Marine Cadastre AIS data to independently recorded vessel transit data. Namely, the vessel data service, Marine Traffic, was utilized to collect real-time AIS records throughout a one-month period of time for all vessels in Florida, via terrestrial and satellite stations. An automated data polling procedure was developed to collect real-time AIS data for vessels transiting throughout Florida inland and intracoastal waterways from Sept. 1, 2021, to Sept. 30, 2021.

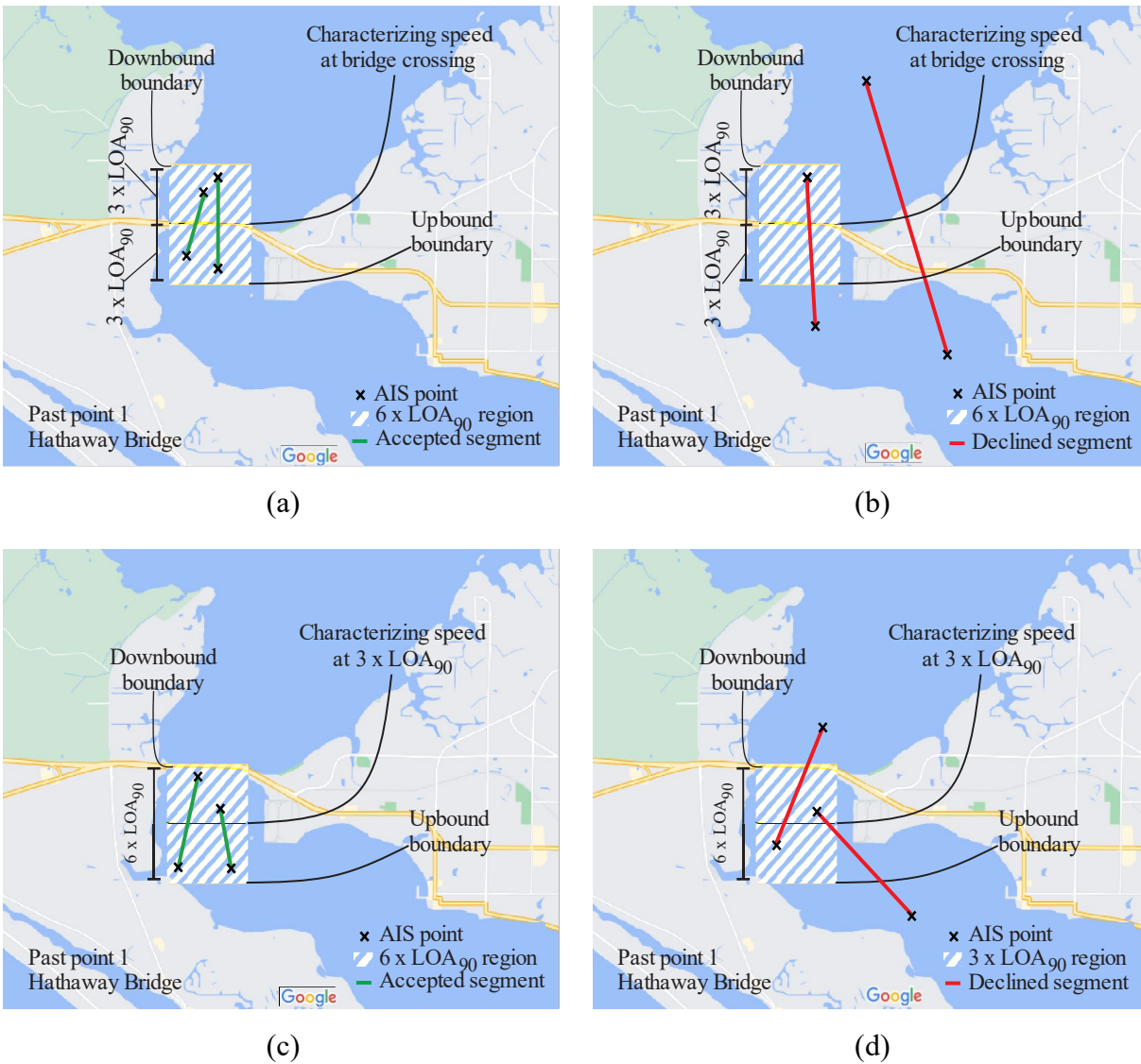

Figure 4.11 Illustrative uses of procedure for accepting or removing AIS segments: (a) Accepted AIS segments with  $6 \times LOA_{90}$  region centered at bridge crossing; (b) Removed AIS segments with  $6 \times LOA_{90}$  region centered at bridge crossing; (c) Accepted AIS segments with  $6 \times LOA_{90}$  region centered at an offset distance of  $3 \times LOA_{90}$ ; (d) Removed AIS segments with  $6 \times LOA_{90}$  region centered at an offset distance of  $3 \times LOA_{90}$  (Map data © 2022 Google)

For the specific Marine Traffic data collection service that was utilized, the shortest permissible time duration between AIS data queries was 1 hour. The 1-hour time duration between queries limited the ability to compute vessel speeds from consecutive GPS positional points since vessel transit paths along waterways over a 1-hour duration could potentially involve complex geometries (i.e., not follow a straight line between two positional points). Moreover, using Marine Traffic data points separated by a 1-hour duration would not permit computation of vessel speeds using average segment speeds (as described in the sections above), would not account for changes in speed introduced by channel bends, high density traffic areas, or bridge crossings. Therefore, an alternative methodology was developed to compute vessel transit speeds from the Marine Traffic data.

Similar to the method illustrated above in Figure 4.11, only AIS points within a distance of  $3 \times LOA_{90}$  away from both sides of a given bridge were considered during analysis. However,

instead of computing speeds from positional data, the directly transmitted SOG was used to quantify vessel speeds from the Marine Traffic data. This methodology provided the best approximation of the vessel speed at bridge crossing given limitations in the frequency of sampling (polling) of the Marine Traffic AIS data. It was found that most of AIS records detected by the modified methodology corresponded to one of three locations. Specifically, past points 8, 19, and 39 contributed to 94% of AIS points identified as being in the vicinity of past point bridges. As emphasis, given that barge tows could not be identified from AIS data, only the speed of ships were considered during the analysis.

Vessel speeds at the noted past points were averaged separately (one average speed per past point) and compared with results obtained from use of Marine Cadastre data (Table 4.3). The decreased sample size of the Marine Traffic data, relative to the larger sample size of the Marine Cadastre data, was not amenable to use of the 90<sup>th</sup> percentile method of characterizing large vessels. Therefore, values reported in Table 4.3 that are associated with Marine Traffic corresponded to the average speed of all ships crossing the past point. Sample sizes (i.e., quantities of bridge crossings of relevant vessels) are also shown. Impact speeds determined from the two data sources (Marine Cadastre historical; Marine Traffic real time) differed by values between 0.4 knot and 1.0 knot. These observed differences were judged to be acceptably small for the purposes of the present study. Given that a much larger and richer set of AIS data was available from Marine Cadastre, the historical Marine Cadastre data (rather than the Marine Traffic data) were used to characterize typical vessel speeds, as reported in the next section.

Table 4.3 Marine Traffic characteristic vessel transit speeds in Florida waterways

Past point	Marine Cadastre		Marine traffic	
	Average speed (knot)	Sample size	Average speed (knot)	Sample size
8	5.6	24488	5.2	11
19	3.8	5863	3.4	46
39	12.8	11201	12.4	7

#### 4.4.5 Typical speeds in Florida waterways

For each individual past point location, average values of computed speed were determined for ships and barges at the point of bridge crossing and at an offset distance of  $3 \times LOA$ . The detailed results for each past point are reported in Table 4.4 (barges) and Table 4.5 (ships). The differences in speed at bridge crossings as compared to the speed at an approach distance of  $3 \times LOA$  from each bridge were judged to be relatively small for purposes of this study. Consequently, the speed at crossing was used for the purpose of characterizing vessel design speeds.

In order to synthesize the detailed per-past-point results into more generalized speed estimates, the computed past point speeds were grouped and averaged by: region, channel depth, and at the statewide level. Note that, in this context, the speeds were averaged using vessel trip counts as a weighing factor. To investigate possible variations of average speed by region, data were grouped into the following regional waterways: AIWW-North, AIWW-Central, AIWW-South, GIWW-Panhandle, GIWW-Tampa Bay, GIWW-South, St. Johns River, Okeechobee Waterway, Miami River, and Port Canaveral. The average speeds for these regions (Table 4.6) varied from 4 to 11 knot. Possible variations of average speed were also investigated with respect to waterway channel depth. For this purpose, waterways with controlling depths of less than 15 ft were considered as shallow draft channels, and those with depths equal to or greater than 15 ft were considered deep draft channels. Controlling depths were sourced from National Oceanic and Atmospheric Administration (NOAA) nautical charts. It was found that the average

vessel speed navigating through deep draft channels was 7.6 knot, which is greater than the speed of 5.8 knot for shallow channels (Table 4.7). Note that transit speeds at specific locations with significant amounts of traffic data (e.g., past point 39) were greater than the respective speeds of surrounding past points.

A more general characterization was established by characterizing vessel speeds separately for barges and ships at the statewide level (Table 4.8). These results indicated that the average transit speed of vessels crossing under bridges throughout Florida waterways was 5.8 knot for barges and 7.1 knot for ships. As simplification to the characterization of vessel speeds for design purposes, recommended speeds were rounded to the nearest 1 knot. Accordingly, at the statewide level, the recommended design speeds for vessels at bridge crossings in Florida waterways are 6 knot for barge tows and 7 knot for ships (Table 4.9).



Table 4.4 Average barge tow speed determined from AIS data for past point locations

PP	Vessel type	Sample size	Avg. speed @ $3 \times LOA$ (knot)	Avg. speed @ crossing (knot)	Difference (%)
1	Barge	2418	6.0	6.0	0
2	Barge	931	6.0	5.4	-11
3	Barge	466	6.0	5.6	-7
4	Barge	250	5.0	3.6	-39
5	Barge	449	6.0	5.9	-3
6	Barge	175	5.8	4.7	-22
7	Barge	186	6.4	4.6	-40
8	Barge	17341	6.4	6.0	-6
9	Barge	87	5.7	4.6	-26
10	Barge	31	5.3	4.4	-20
12	Barge	3	6.9	4.6	-52
13	Barge	5488	5.1	4.0	-28
14	Barge	225	5.9	4.7	-27
15	Barge	444	5.9	5.7	-2
16	Barge	13	4.1	4.3	5
17	Barge	1029	5.1	4.4	-16
18	Barge	1109	5.1	4.3	-18
19	Barge	97	5.6	4.9	-16
21	Barge	37	7.0	6.6	-5
22	Barge	137	8.4	8.5	1
23	Barge	2034	6.4	5.5	-15
24	Barge	1904	6.6	6.0	-10
25	Barge	7194	6.5	5.4	-21
26	Barge	9235	5.8	5.1	-13
27	Barge	4163	6.2	6.1	-2
28	Barge	162	5.7	5.5	-3
30	Barge	1873	6.7	6.0	-11
31	Barge	3570	6.4	6.3	-2
32	Barge	37	4.9	4.5	-10
33	Barge	847	4.9	4.4	-11
34	Barge	289	5.6	4.7	-21
35	Barge	238	5.8	4.2	-38
36	Barge	209	5.5	4.5	-24
37	Barge	612	12.7	8.5	-51
38	Barge	509	13.8	13.8	0
39	Barge	6931	9.9	9.9	-1
40	Barge	1756	17.5	12.2	-44
41	Barge	55	6.5	6.2	-4
42	Barge	85	5.8	3.5	-68
43	Barge	128	5.9	6.0	1
44	Barge	494	5.9	5.4	-9
45	Barge	513	5.9	4.7	-26
46	Barge	227	7.0	6.3	-13
47	Barge	351	5.3	5.1	-3
48	Barge	171	6.2	5.0	-24
49	Barge	54	5.1	4.2	-21
50	Barge	57	5.6	6.0	7
51	Barge	493	6.1	3.5	-74
52	Barge	373	5.6	4.5	-25

Table 4.5 Average ship speed determined from AIS data for past point locations

PP	Vessel type	Sample size	Avg. speed @ $3 \times LOA$ (knot)	Avg. speed @ crossing (knot)	Difference (%)
8	Ship	4331	5.3	4.8	-11
13	Ship	81	3.9	3.7	-5
14	Ship	4	6.9	5.6	-23
16	Ship	4	7.1	5.8	-22
24	Ship	1	1.6	1.3	-23
39	Ship	2095	12.1	12.2	1

Table 4.6 Characteristic vessel transit speeds by region

Region Names	Avg. Speed @ $3 \times LOA$ (knot)	Avg. Speed @ Crossing (knot)	Difference (%)
AIWW-North and Central	7.7	4.7	-63
AIWW-South	5.5	5.2	-5
GIWW-Panhandle	7.3	7.0	-4
GIWW-Tampa Bay	11.9	11.3	-6
GIWW-South	7.5	7.2	-3
St. Johns River	6.3	6.1	-3
Okeechobee Waterway	4.7	4.2	-10
Miami River	4.9	3.9	-20
Port Canaveral	5.0	3.6	-28

Table 4.7 Characteristic vessel transit speeds by channel depth at the statewide level

Channel depth	Typical speed @ $3 \times LOA$ (knot)	Typical speed @ crossing (knot)	Difference (%)
Shallow draft channel (< 15 ft)	6.1	5.8	-5
Deep draft channel ( $\geq 15$ ft)	9.3	7.6	-22

Table 4.8 Characteristic vessel transit speeds by vessel type at the statewide level

Vessel type	Typical speed @ $3 \times LOA$ (knot)	Typical speed @ crossing (knot)	Difference (%)
All vessel types	6.9	6.1	-13
Barges	6.0	5.8	-4
Ships	7.3	7.1	-3

Table 4.9 Recommended design vessel speed for barges and ships

Vessel type	Recommended design vessel speed (knot)
Barges	6
Ships	7

## **CHAPTER 5 UPDATES TO FDOT STRUCTURES DESIGN GUIDELINES**

### **5.1. Overview**

Documented in the FDOT Structures Design Guidelines (SDG) are the engineering standards, criteria, and norms for designers and detailers who design bridge structures (FDOT 2022). In turn, the AASHTO LRFD bridge design specifications (AASHTO 2020) are identified within the FDOT SDG as being the procedures by which engineers and designers must abide, unless otherwise indicated. Addressed within Sec. 2.11 of the FDOT SDG are the minimum design requirements for accidental vessel collision events, including loads and load factors. Also, Sec. 2.11 of the FDOT SDG specifies that a risk analysis is required when designing bridges that span navigable waterways (using the vessel collision risk assessment procedure delineated in AASHTO 2020).

As part of Task 1 of the present study, a review of the FDOT SDG was conducted to identify provisions that may warrant changes as a result of collecting, processing, and updating Florida vessel traffic data for use in bridge design. Based on the literature review of Task 1, and implementation of the updated risk assessment tool in Task 4, provisions were identified that may warrant updates within the FDOT SDG, as pertaining to vessel collision. Presented in the following is documentation of guidance for each relevant section, where such guidance may serve to inform content changes in future editions of the FDOT SDG. Provided in the appendices of the current report is additional documentation (e.g., illustrative calculation sets) for subtopics that entail engineering calculations.

### **5.2. FDOT SDG 2.11.1 – General**

It is indicated in Sec. 2.11.1 of the FDOT SDG that data are based on the year 2000. It is proposed that the following statement:

*The vessel traffic provided is based on the year 2,000 and an automatic traffic escalation factor is provided by the software for the various past points which one selects.*

Be modified to:

*The vessel traffic provided is based on the years 2010-2019 and traffic escalation factors are provided by the software for the various past points which one selects.*

### **5.3. FDOT SDG 2.11.2 – Research and Information Assembly**

Indicated in Sec. 2.11.2 Part A of the FDOT SDG are the resources that may be used to assemble data required for vessel collision risk assessment. The required data are listed in Part B of Sec. 2.11.2 in the FDOT SDG. It is proposed that Section 2.11.2 be updated to include additional data sources and data points found during the current project in the following way (updates in italics):

#### **A. Data Sources:**

1. U.S. Army Corps of Engineers, Waterborne Commerce Statistics Center, P.O. Box 61280, New Orleans, LA 70161. Telephone: (504) 862-1472.
2. U.S. Army Corps of Engineers, Navigation Data Center (<http://www.navigationdatacenter.us/publications.htm>)
3. U.S. Army Corps of Engineers, “Waterborne Commerce of the United States (WCUS), Parts 1 & 2,” Water Resources Support Center (WRSC), Fort Belvoir, VA.
4. U.S. Army Corps of Engineers, “Waterborne Transportation Lines of the United States,” WRSC, Fort Belvoir, VA.

5. U.S. Army Corps of Engineers (COE), District Offices.
6. U.S. Coast Guard, Marine Safety Office (MSO).
7. Port Authorities and Water Dependent Industries.
8. Pilot Associations and Merchant Marine Organizations.
9. National Oceanic and Atmospheric Administration (NOAA), “Tidal Current Tables; Tidal Current Charts and Nautical Charts,” National Ocean Service, Rockville, Maryland.
10. Bridge tender record for bascule bridge at the District Maintenance Office.
11. Local tug and barge companies.
12. *Bureau of Ocean Energy Management (BOEM) and NOAA, Marine Cadastre Automatic Identification System (AIS) data.* (<https://www.marinecadastre.gov/ais/>)
13. *Providers of Automatic Identification System (AIS) data, (Marine Cadastre, <https://www.marinecadastre.gov/ais/>, and private providers).*

B. Assembly of Information:

The EOR must assemble the following information:

1. Characteristics of the waterway including:
  - a. Nautical chart of the waterway.
  - b. Type and geometry of bridge.
  - c. Preliminary plan and elevation drawings depicting the number, size and location of the proposed piers, navigation channel, width, depth and geometry.
  - d. Average current velocity across the waterway.
2. Characteristics of the vessels and traffic including:
  - a. Ship, tug, and barge sizes (length, width, and height)
  - b. Number of passages for ships, tugs, and barges per year (last 5 years and prediction to end of 25 years in the future).
  - c. Vessel displacements.
  - d. Cargo displacements (deadweight tonnage).
  - e. Draft (depth below the waterline) of ships, tugs and barges.
  - f. The overall length and speed of tow.
3. Accident reports.
4. Bridge Importance Classification

#### **5.4. FDOT SDG 2.11.9 – Application of Impact Forces**

When designing bridge piers for vessel collision resistance, engineering judgement is required regarding the locations (and associated bridge components) at which impacting vessels may make direct contact. With respect to barge-bridge collision, the intention is for pier configurations within navigable waterways to be configured such that direct contact from an impacting barge would occur on the pile cap (as opposed to direct contact with other structural members such as pier columns). To size the various bridge components so that direct contact occurs on the pile caps of bridge piers, geometric characteristics of typical barges bows must be known. However, guidance is not generally available regarding typical barge bow geometries. Furthermore, waterway vessel traffic data obtained from the USACE WCSC did not include bow geometry data associated with barges transiting throughout Florida.

As described in the Task 3 report, the geometric bow configurations of shallow draft barges (draft  $\leq 15$  ft) differ significantly from those of deep draft barges (draft  $> 15$  ft). Shallow draft barges often possess a bow that gradually decreases (tapers) in depth, reaching a minimum vertical dimension at the headlog. This configuration poses the greatest threat to direct impact against

bridge elements such as pier columns because the raked section can extend over and above bridge elements such as pile caps. In contrast, the bow of a deep draft barge typically extends approximately the full vertical depth of the vessel, similar to the bow of a ship. Deep draft barges are therefore more likely than shallow draft barges to make direct contact with bridge elements such as pile caps, thus reducing the likelihood of direct contact with pier columns. Given the limited availability of guidance for sizing of bridge pier components to prevent direct impacts of shallow draft barges on components such as pier columns, an investigation was conducted to ascertain key geometric bow characteristics of shallow draft barges operating in Florida waterways.

The investigation included a site visit to a barge manufacturer in northeast Florida, as well as taking direct measurements of shallow draft barge dimensions. Additionally, separate discussions were held with several maritime professionals, encompassing barge transits throughout the state (reflecting insights along areas such as the AIWW, GIWW, St. Johns River, Tampa Bay, Miami, and the Florida Keys). Of particular interest was characterization of typical shallow draft barge bow geometric components such as bow shapes, rake lengths, and rake angles. These vessel components were identified as being of interest to practicing engineers when making determinations of whether a given pier configuration would be (undesirably) susceptible to impacts occurring directly on the pier columns. Provided below is illustrative guidance for establishing dimensions of bridge pier components to reduce the likelihood that shallow draft barge impacts occur directly on the columns of bridge piers. The illustrative scenarios presented below may serve to inform the future addition of content to FDOT SDG Sec. 2.11.9.

#### **5.4.1 Typical geometric characteristics of shallow draft barge bows**

Shallow draft barges manufactured at the visited site were indicated to be commonly used for construction purposes, which is consistent with indications given during interviews with other maritime professionals. Shown in Figure 5.1 is a schematic denoting pertinent shallow draft barge bow components and geometric parameters. The leading portions of the barge bow include the headlog, rake, and bitts. Bitts are fitted with cables (wire-rope lashings) when joining together several barges into a flotilla. The headlog typically possesses a vertical face, with dimension  $H_H$ . The overall rake height and length are denoted respectively as  $H_R$  and  $L_R$  in Figure 5.1.

While barge rakes can either be rounded or adhere to an approximately constant angle, it was consistently indicated by maritime professionals that construction barges along Florida waterways typically possess a constant angle and a relatively sharp-angle transition from the bow rake to the barge bottom, and furthermore, that a rake angle ( $\theta_R$ ) of  $45^\circ$  is common. To contextualize the phrasing “sharp-angle transition,” note that the overall rake length is divided into two components in Figure 5.1: the horizontal distance ( $L_{R1}$ ) at which the projection of the constant rake angle coincides with the plane of the barge bottom surface; and the horizontal distance encompassing the transition from the constant-angle rake portion to the barge bottom surface ( $L_{R2}$ ). Per the maritime professionals interviewed,  $L_{R2}$  is typically small relative to  $L_{R1}$ . Therefore, for simplicity in the following, the overall rake length ( $L_R$ ) is utilized. While a common rake angle of approximately  $45^\circ$  was consistently indicated among the various maritime professionals, other geometric parameters such as headlog heights, rake heights, and rake lengths were indicated to be of varying magnitudes.

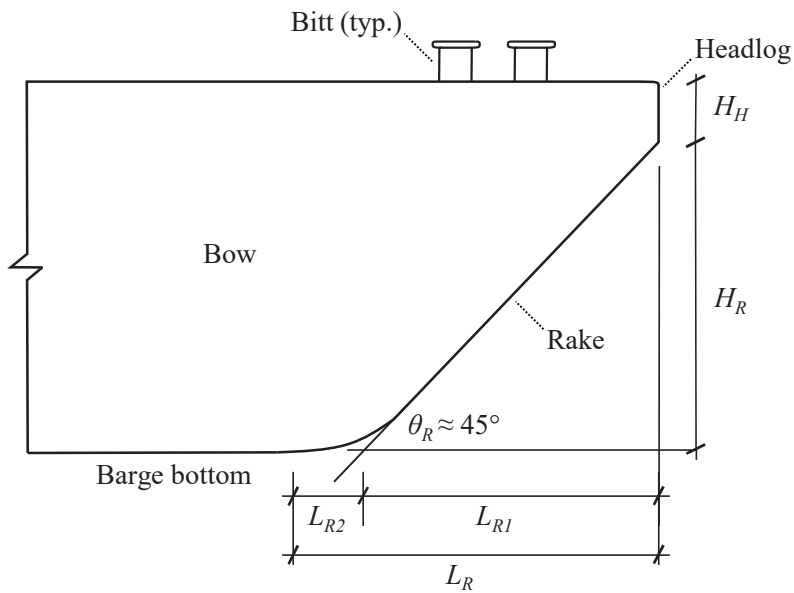

Figure 5.1 Illustrative schematic of shallow draft barge bow geometry

Based on the prevalence of construction barges throughout Florida waterways—as well as indications of common geometric characteristics such as 45° rake angles and sharp-angle rake transitions—the following presents guidance for sizing of selected pier member dimensions with respect to preventing direct, head-on barge impact of pier columns. Among the considerations are those given to selection of a pile cap thickness. Separately, considerations are given for sizing of the horizontal offset from the vertical face of the pile cap to the nearest pier column face.

#### 5.4.2. Guidance for selecting pile cap thickness

Under certain collision conditions, selection of an adequate pile cap thickness may be sufficient to preclude additional considerations for preventing direct shallow draft barge impacts on bridge pier columns. As illustration for scenarios where it is of interest to only modify the pile cap thickness, consider the schematic shown in Figure 5.2, which consists of a fully loaded barge colliding with the pile cap of a bridge pier. Note that the approach detailed below for modifying the pile cap thickness ( $H_C$ ) is not necessarily limited to scenarios involving collisions by loaded barges.

Parameters of relevance for this barge collision scenario include the barge overall height, ( $H_B$ ); loaded draft depth ( $D_L$ ); and, headlog height ( $H_H$ ). Given the waterline elevation,  $E_W$ , the elevation at the top of the bow for the fully loaded barge can be calculated as:

$$E_B = E_W - D_L + H_B \quad (5.1)$$

Similarly, the elevation corresponding to the top of the pile cap can be calculated based on a trial value of the pile cap thickness ( $H_C$ ); the depth below the waterline elevation to the cap bottom surface ( $D_C$ ); and, the waterline elevation ( $E_W$ ). Namely, the elevation corresponding to the top surface of the pile cap can be calculated as:

$$E_C = E_W - D_C + H_C \quad (5.2)$$

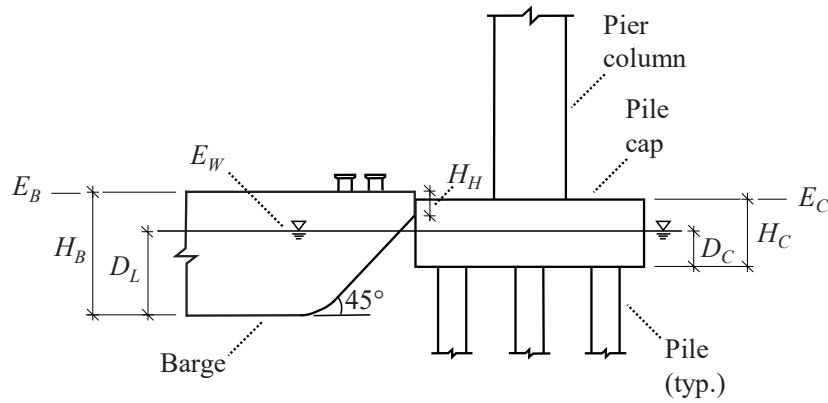

Figure 5.2 Fully loaded barge impact scenario with considerations for selection of pile cap thickness

The pile cap thickness ( $H_C$ ), required to prevent direct impact on the column from the fully loaded barge, can then be assessed by evaluating the following inequality:

$$E_C > E_B - H_H/2 \quad (5.3)$$

where use of the term  $H_H/2$  ensures that at least half of the headlog height makes direct contact with the pile cap thus preventing further forward motion of the barge subsequent to initial impact. If the inequality in Equation 5.3 is satisfied, then the pile cap is of adequate thickness to ensure that the barge headlog will make direct contact with the pile cap (i.e., direct contact with the pier column will not occur). Otherwise, an increased magnitude for the trial value of the pile cap thickness ( $H_C$ ) can be selected, which will correspond to an updated value of  $D_C$  as well. Then, Equation 5.2 can be re-evaluated, followed by assessment of the inequality in Equation 5.3. This process can be repeated as necessary by iterating on trial values of the pile cap thickness ( $H_C$ ), updating the value of  $D_C$ , evaluating Equation 5.2, and then checking whether the inequality in Equation 5.3 is satisfied.

#### 5.4.3. Guidance for selecting pier column horizontal offset

For design scenarios where it is either undesirable to adjust the pile cap thickness, or where a relevant collision scenario would necessitate impractical increases in the pile cap thickness, the horizontal offset between the vertical face of the pile cap and the nearest pier column face can be adjusted. As illustration, consider a collision scenario involving impact between an empty barge and a bridge pier (Figure 5.3). Increasing the pile cap thickness to preclude direct contact with the pier column may be impractical for this case, and so, consideration is given to modifying the horizontal offset ( $L_O$ ). The illustrative collision scenario consists of an empty barge, where the parameters of interest include the barge overall height, ( $H_B$ ); empty draft depth ( $D_E$ ); rake length ( $L_R$ ); and, headlog height ( $H_H$ ).

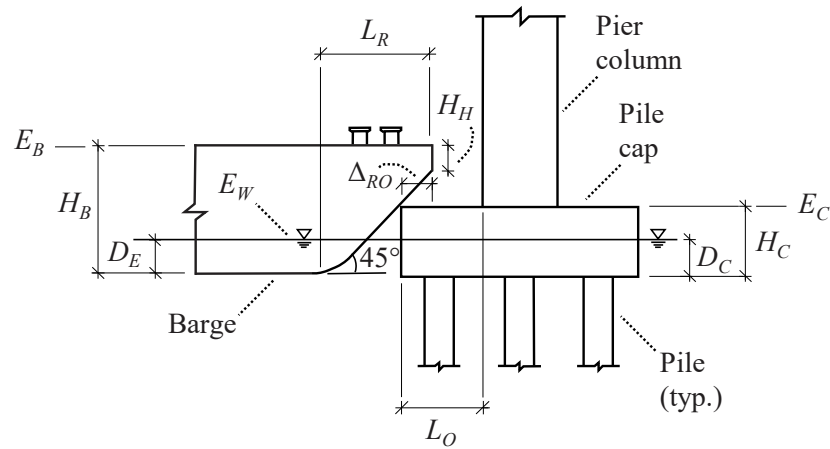

Figure 5.3 Empty barge impact scenario with considerations for selection of pier column offset

Given the waterline elevation,  $E_W$ , the elevation at the top of the bow for the empty barge can be calculated similar to Equation 5.1, but where (for the current illustrative scenario) the draft for the empty barge is utilized:

$$E_B = E_W - D_E + H_B \quad (5.4)$$

The elevation corresponding to the top of the pile cap ( $E_C$ ) can then be calculated using Equation 5.2. Next, the horizontal rake overhang distance, at which the barge bow horizontally extends beyond the vertical face of the pile cap, can be calculated as:

$$\Delta_{RO} = \frac{E_B - E_C - H_H}{\tan 45^\circ} \quad (5.5)$$

where  $\tan 45^\circ$  (which is equal to unity) is included in Equation 5.5 to emphasize the role of the rake angle. For scenarios where the rake angle is not  $45^\circ$ , then  $\theta_R$  (recall Figure 5.1) can be substituted for  $45^\circ$  in Equation 5.5.

To prevent direct impact on the pier column, the following must be satisfied:

$$L_O > \Delta_{RO} + a_B \quad (5.6)$$

where the horizontal offset from the edge of the pile cap to the face of the pier column ( $L_O$ ) must be greater than the summation of  $\Delta_{RO}$  and the empirical prediction of the barge bow crush depth,  $a_B$ . The barge bow crush depth can be estimated based on the design vessel weight and initial impact velocity, and use of empirical expressions given in Ch. 3 of AASHTO (2020). Note that the approach described above for modifying the horizontal offset distance ( $L_O$ ) is not necessarily limited to scenarios involving collisions by empty barges.

#### 5.4.4. Guidance for minimum barge impact load conditions

From among the 52 past points distributed throughout Florida, no commercial traffic data were recorded for past points 9-12, 19, 29, 42, and 43. Furthermore, for the revised past point 16 (located on the New River, Ft. Lauderdale), no barge traffic data were reported (only free tug trips were reported), and only a single barge trip was reported over a ten-year period (2010-2019) for past point 38. For all of these past points, given the lack of statistically meaningful (or null) data sets, minimum barge impact conditions can be incorporated into design procedures. Here, minimum



barge impact conditions correspond to an empty barge (shallow draft, weighing 200 ton, AASHTO 2020) with initial impact velocity equal to the annual mean waterway velocity.

Minimum impact loads on impacted bridge structures for analysis purposes are additionally dependent on other vessel characteristics such as barge draft and barge rake configuration. For waterways for which no commercial traffic data were recorded by the USACE (or, zero-valued barge trips were recorded), it is assumed that any vessel trips that may occur would entail passages of shallow draft construction barges. As discussed in Sec. 5.4.1, a typical rake angle for shallow draft construction barges in Florida is approximately 45°. Additional quantities such as empty barge draft are given in AASHTO (2020), which lists an empty barge draft of 1.7 ft.

## 5.5. Guidance on Calculating Protection Factor (*PF*) Values

A key outcome of performing vessel collision risk assessment is estimation of the overall bridge risk of collision-induced failure, expressed as the annual frequency of collapse, *AF*, (AASHTO 2020). For bridge piers requiring considerations for vessel collision design, the presence of protective bodies (whether naturally occurring or man-made) may also be taken into account. Examples of such bodies include natural landmasses that extend into the waterway, artificial islands, protective dolphin structures, and piers of immediately adjacent bridges.

As documented in the AASHTO provisions (AASHTO 2020)—and as part of conducting vessel collision risk assessment—considerations for protective bodies are packaged into values of quantitative scale factors, referred to as protection factor values, *PF*. More broadly, values of *PF* are used to scale contributing values of risk that accumulate into the overall value of *AF*. When conducting risk assessments, values of the protection factor (*PF*) are assigned: 1) on a per-pier basis; 2) based on the overall dimensions of the impacting vessel; and, 3) with respect to (i.e., unique to) upbound and downbound vessel transit directions. For instances where a given bridge pier is wholly shielded from vessel collision with respect to a given transit direction (and type of vessel), values of *PF* are assigned as 0.0. Stated alternatively, the presence of complete shielding yields a zero-valued contribution of vessel collision risk that is attributed to a bridge pier, with respect to one transit direction and a specific vessel. In contrast, for instances where a bridge pier is not shielded from vessel collision (for a given transit direction and vessel), the corresponding value of *PF* is taken as 1.0. In this latter instance, the value of *PF* (1.0) has no effect on the contribution of risk attributed to a bridge pier (with respect to one transit direction and a given vessel). As emphasis, values of the protection factor (*PF*) are computed for both upbound and downbound directions of each vessel group and for every bridge element.

Resources and guidance for calculating values of *PF* between 0.0 and 1.0 are relatively limited. One available resource is that of AASHTO (2009), which includes a brief discussion pertaining to the estimation of the *PF* values. Furthermore, a recommended procedure for estimating *PF* values, specific to a design scenario involving the presence of dolphin structures, is given in Appendix I of AASHTO (2009). Examples of calculating *PF* are additionally found in Consolazio et al. (2014). To offset the relatively limited, existing resources available for estimating *PF* values as part of vessel collision design, illustrative guidance is provided in the following discussion. Stated alternatively, presented in the following are discussion and illustrative collision conditions that may inform future population of content, related to *PF*, within the FDOT SDG. Additionally, example calculations of the protection factor (*PF*) are documented in Appendix D.

### 5.5.1. Calculation of *PF* in the presence of a single protective structure

For the scenario illustrated in Figure 5.4, an aberrant vessel (with beam, or width, *B*) is situated parallel to the intended vessel transit path, and such that the vessel would (in the absence of any protective bodies) strike the bridge pier of interest. As situated, the centerline of the aberrant

vessel is collinear with the centerline of the pier of interest. Also, a normal probability distribution,  $p(\theta)$ , of alternative (yet aberrant) transit paths is superimposed on the schematic of Figure 5.4. The distribution of aberrant vessel transit paths differ by approach angle,  $\theta$ , and all paths meet at the centerline of the pier of interest. Note that in forming the distribution of aberrant vessel transit angles,  $p(\theta)$ , engineering judgment is required for selecting the standard deviation ( $\sigma$ ). In AASHTO (2009),  $\sigma$  was set equal to  $30^\circ$ . In Kunz (1998), the value of  $\sigma$  was estimated as  $10^\circ$ .

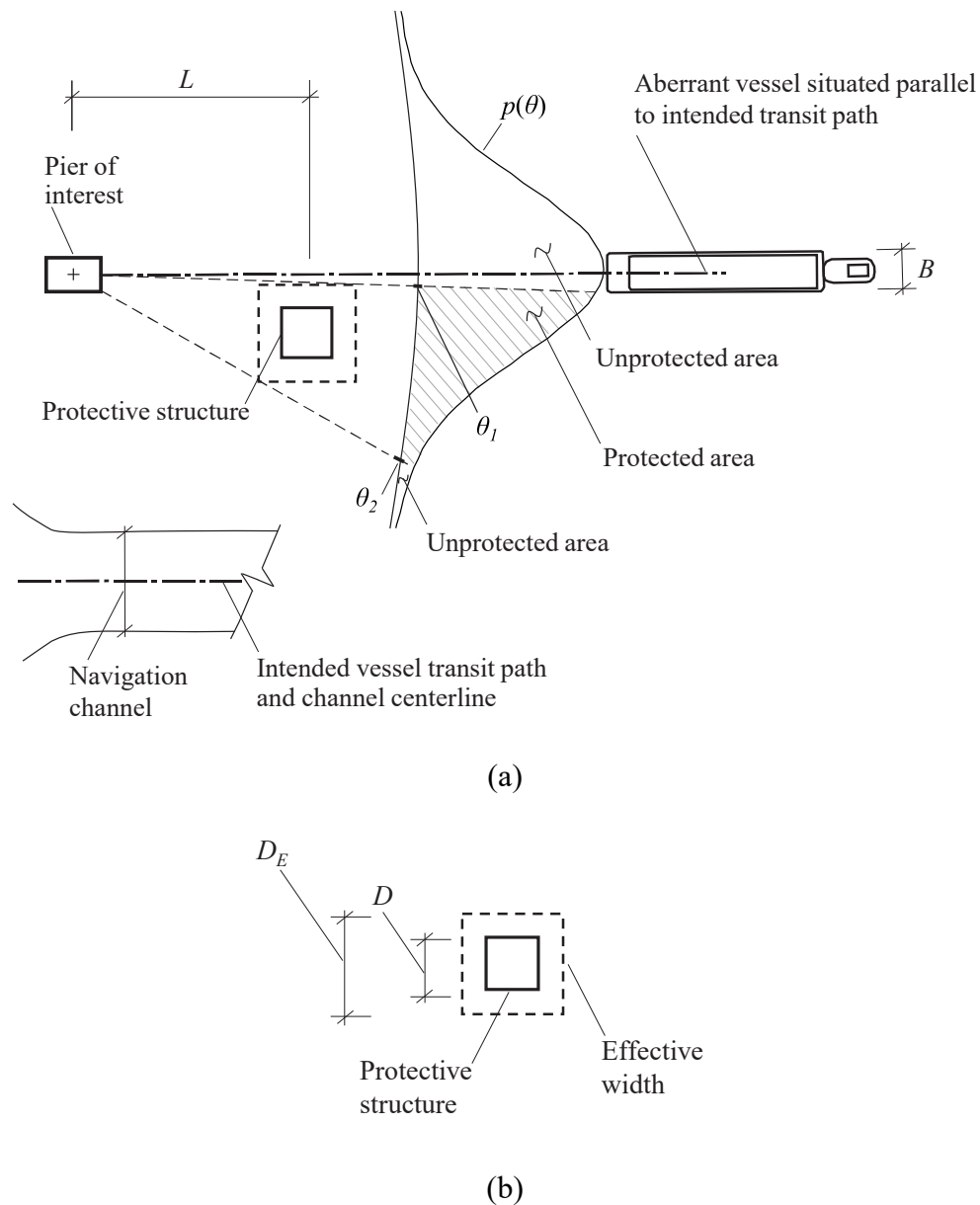

Figure 5.4 Illustrative schematic of vessel collision in the presence of a protective structure: (a) Relative positioning; (b) Geometric parameters of the protective structure

Additionally depicted in Figure 5.4 is a protective structure (which might consist of a dolphin, a pier from an adjacent bridge, a natural formation, etc.). For scenarios where one or more protective structures lie within the angle-dependent distribution of aberrant vessel transit paths, a value of  $PF$  less than unity is estimated (again, specific to upstream and downstream directions,

and impacting vessel). Each protective structure possesses a physical plan-view width,  $D$ , and effective width,  $D_E$ , (Figure 5.4b). In AASHTO (2009), a moderately conservative definition of  $D_E$  is utilized:

$$D_E = D + 0.75B \quad (5.1)$$

Based on the relative positioning of the pier of interest and the protective structure, the effective width ( $D_E$ ), and the distribution,  $p(\theta)$ , the range of approach angles that would lead to impact with the protective structure can then be determined using routine trigonometry. For the schematic shown in Figure 5.4, the range of angles associated with the protective structure corresponds to those bounded between  $\theta_1$  and  $\theta_2$ . That is, vessel transits bounded between  $\theta_1$  and  $\theta_2$  are categorized as protected. All other vessel transits of the distribution are categorized as unprotected. Given that the total area under the probability distribution function,  $p(\theta)$ , is unity:

$$\int_{-\infty}^{\infty} p(\theta)d\theta = 1 \quad (5.2)$$

the value of the protection factor,  $PF$ , for the particular transit direction and vessel is then estimated as one minus the protected area under the distribution:

$$PF = 1 - \int_{\theta_1}^{\theta_2} p(\theta)d\theta \quad (5.3)$$

### 5.5.2. Calculation of PF in the presence of multiple protective structures

To provide further potential content for inclusion within the FDOT SDG, consider the schematic shown in Figure 5.5, which involves the presence of multiple (two) protective structures. Here, the aberrant vessel is again situated parallel to the intended vessel transit path, and such that the aberrant vessel passes through the centerline of the pier of interest. Vessel dimensions such as width,  $B$ , are utilized in the same manner as that discussed above. A normal probability distribution,  $p(\theta)$ , of aberrant transit paths is superimposed (Figure 5.5) such that all potential paths, regardless of approach angle ( $\theta$ ), also pass through the centerline of the pier of interest.

To characterize the protection offered by a given protection structure, the geometric variables  $D$  and  $L$  are defined in the same manner as that shown previously in Figure 5.4. For simplicity in this second illustrative scenario, the same values of  $B$ ,  $D$ , and  $L$  are applied to both protective structures in Figure 5.5. In general, however, the unique geometry of each protective structure should be considered. Subsequent to selection of the geometric parameters ( $B$ ,  $D$ , and  $L$ ) for each protective structure, Equation 5.1 is then employed to calculate values of  $D_E$ .

For the relative positioning of the pier of interest, protective structures, and impacting vessel in Figure 5.5, the distribution of aberrant vessel transit paths,  $p(\theta)$ , is divided into five subregions. An unprotected subregion exists for transit paths with transit angles that fall outside of (i.e., are more negative than)  $\theta_1$ . A second region is bounded between  $\theta_1$  and  $\theta_2$ , and is protected by the topmost protective structure shown in Figure 5.5. Aberrant vessel transit paths falling between angles  $\theta_2$  and  $\theta_3$  are designated as unprotected. For transits bounded between  $\theta_3$  and  $\theta_4$ , the bottommost protective structure in Figure 5.5 shields the pier of interest from collision, and therefore, this subregion is categorized as being protected. The fifth subregion, extending beyond (i.e., more positive than)  $\theta_4$  is unprotected. The protection factor,  $PF$ , value is then estimated based on one minus the protected areas under the distribution:

$$PF = 1 - \int_{\theta_1}^{\theta_2} p(\theta)d\theta + \int_{\theta_3}^{\theta_4} p(\theta)d\theta$$

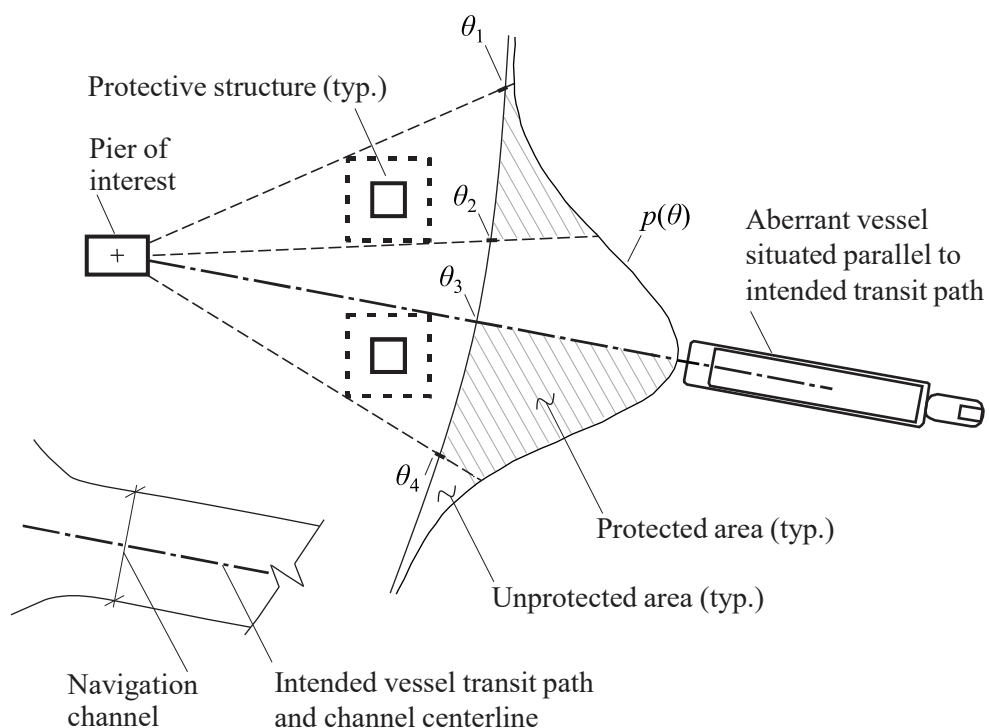

Figure 5.5 Illustrative schematic of vessel collision in the presence of multiple protective structures

### 5.6. FDOT SDG 3.14 – Fender Systems

Fender systems are one form of protection that can be installed adjacent to bridges that span navigable waterways. Fenders are typically constructed parallel to, and just to either side of, the navigation channel beneath the channel span of the bridge. Accordingly, fenders act as guide walls to aid in navigating in-transit waterway vessels while also protecting bridge piers from impact during vessel transit in the vicinity of the channel span. Being comprised of a series of piles and multiple, interconnected horizontal structural members (e.g., wales), materials used for the structural members of fenders include timber, polymer composites, concrete, and steel. Moreover, fender systems are typically constructed to be flexible under impact loading to such an extent that energy-based design methods are employed as part of fender design for vessel collision loads. For example, the energy absorption capacity of a fender system, as it undergoes significant levels of deflection, may be subtracted from the initial kinetic energy of a vessel to quantify the residual impact energy that is imparted to an adjacent bridge pier. Importantly, capacities of fender systems are dependent upon the strengths of the pile connections, as these connections typically constitute the weakest components (Wuttrich et al. 2001).

For design of fenders associated with bridges spanning navigable waterways in Florida, provisions are given in Section 3.14 of the FDOT SDG. The content of Section 3.14 includes establishment of decision-making regarding when fenders are to be utilized (i.e., the FDOT makes this determination in concurrence with the US Coast Guard), and delineation of the design procedures for both the engineer-of-record (EOR) and the contractor. Included among the

provisions pertaining to the design procedure for the EOR are location-specific (i.e., past-point specific) listings of the minimum energy absorption capacities (EACs), which stipulate the minimum vessel impact energy for which a given fender must be designed to resist without undergoing collapse.

### 5.6.1. Minimum energy absorption capacity (EAC) for fender design

Provided below is an updated listing of minimum EAC values for fender design at past point locations throughout Florida. Namely, the listings presented in Table 5.1 may serve to inform future updates to Section 3.14 of the FDOT SDG. To facilitate such updates, Table 5.1 is formatted consistent with Table 3.14.2-1 in the current edition of the FDOT SDG (FDOT 2022). The updated values reflect findings from data synthetization efforts (e.g., recommended transit velocities for design, maximum barge tonnages per past point) that were carried out as part of the present study. In addition, note that the past points listed in Table 5.1 are those that were recommended as part of the present study. The basis and underlying data pertaining to the calculations of updated EAC values per past point are given in Appendix E.

Table 5.1. Past points and associated minimum energies

Past point	Minimum energy (kip-ft)	Past point	Minimum energy (kip-ft)	Past point	Minimum energy (kip-ft)	Past point	Minimum energy (kip-ft)
1	770	14	1971	27	770	40	1277
2	879	15	1089	28	2233	41	483
3	2233	16	38	29	38	42	38
4	1623	17	1041	30	2493	43	38
5	2233	18	1022	31	770	44	2233
6	1971	19	38	32	1033	45	2233
7	1072	20	484	33	2264	46	483
8	1971	21	1076	34	1016	47	1275
9	38	22	423	35	1061	48	2233
10	38	23	688	36	2349	49	1084
11	38	24	2233	37	511	50	1257
12	38	25	770	38	38	51	2233
13	1214	26	770	39	17627	52	2233

## CHAPTER 6 FINDINGS, IMPLEMENTATION, AND FUTURE RECOMMENDATIONS

### 6.1. Summary and Key Findings

In this study, vessel-related data were collected, processed, analyzed, and interpreted for the purpose of developing updated parameters and guidance relevant to the design of highway bridges that span across navigable Florida waterways. Data relating to vessel characteristics and vessel traffic frequency (trip counts) were obtained primarily from the U.S. Army Corps (USACE) Waterborne Commerce Statistics Center (WCSC). Automatic identification system (AIS) records, which contain vessel position and speed data, were obtained primarily from Marine Cadastre, a partnership between the Bureau of Ocean Energy Management (BOEM) and the National Oceanic and Atmospheric Administration (NOAA). Additionally, interviews were conducted with maritime professionals from around the state of Florida to obtain data and insights regarding vessel operational procedures, vessel characteristics, and historic changes and trends in waterway vessel traffic throughout the state. Primary outcomes from this research were as follows:

- Estimation of future vessel traffic  
Data collected: Vessel trip counts, vessel travel directions  
Data source(s): USACE WCSC commercial past point data  
Outcome(s): Projection models for estimating future vessel traffic growth or decay
- Vessel characterization and formation of vessel groups  
Data collected: Type (ship, barge), dimensions, draft, tonnage, origin, travel direction  
Data source(s): USACE WCSC commercial past point data  
Outcomes(s): Formation of past point vessel groups for risk assessment
- Vessel speeds for bridge design  
Data collected: Historic and recent (2021) vessel positional and velocity data  
Data source(s): AIS (automatic identification system) records, maritime professionals  
Outcome(s): Representative vessel speeds (ships, barges) for bridge design
- Barge bow rake geometry  
Data collected: Typical barge bow rake dimensions, angles  
Data source(s): Photographs, physical measurements, maritime professionals  
Outcome(s): Design guidance for assessing pier column vulnerability to direct impact
- Protection factor (PF)  
Reviewed: Procedures for estimating bridge protection factors  
Data source(s): AASHTO bridge design provisions for vessel collision risk assessment  
Outcome(s): Illustrative examples of the calculation of PF for varying scenarios

Findings from this study included:

- Changes in vessel traffic  
Commercial vessel traffic may vary over time due to factors such as changes in regional economic circumstances, energy production, environmental conditions (e.g., water levels); changes in environmental policies; modifications to the capacities of channels; or maritime industry innovations. An analysis of vessel traffic data collected for the years 2010 to 2019 indicated that vessel traffic levels have increased (growth trends) at many locations around Florida, but have decreased (decay trends), or completely disappeared, at other locations. Projection models for estimating future vessel traffic growth or decay at each Florida past point location have thus been proposed. At ten past point locations there were either no commercial vessel trips recorded by the US Army Corps of

Engineers (Past points 9, 10, 11, 12, 19, 29, 42, 43), or no statistically meaningful commercial vessel trips recorded (Past points 16, 38). For these past points, minimum barge impact conditions correspond to an empty barge (shallow draft, weighing 200 ton, AASHTO 2020) with initial impact velocity equal to the annual mean waterway velocity.

- Deep draft barges  
The historical vessel traffic data collected for the years 2010 to 2019 recorded the presence of deep draft (>15 ft) barge traffic at multiple past point locations in Florida. Importantly, the bow characteristics (and thus impact forces) of deep draft barges are more similar to those of ships than to shallow draft barges.
- Shallow draft barges  
In many Florida inland waterways, the majority of the barges present are shallow draft ( $\leq 15$  ft) and are used for construction purposes. Further, a rake angle of 45 degrees is common for construction barges.
- Vessel speeds  
In order to maintain navigational control, pilots do not generally reduce vessel speed when in the immediate vicinity of a bridge. Vessel speeds that were determined from historical AIS records indicated variabilities (e.g., with respect to geographic location, water depth), however, clearly identifiable correlations were not evident. On a statewide basis, average ship speed was found to be approximately 7 knots, and average barge speed was found to be approximately 6 knots. However, local vessel speeds at select locations (e.g., at past point 39, the Sunshine Skyway Bridge in Tampa Bay) can be significantly faster.

## 6.2. Implementation

To implement key findings from this study and to utilize the updated vessel past point data that have been developed herein, the following implementation items are available:

- Updated vessel collision risk assessment software  
The FDOT Vessel Collision Risk Analysis Mathcad program has been revised to incorporate the results of this study. The revised program utilizes updated vessel groups (containing average vessel characteristics) and updated vessel traffic estimation parameters (including future projection of trips). Additionally, the revised program implements the AASHTO ship force-deformation model when computing impact loads for deep draft (>15 ft) barges.
- Updated design guidance  
In Chapter 5 of this report, provisions in the FDOT Structures Design Guidelines (SDG) have been identified that may warrant updates pertaining to vessel collision risk assessment of bridges. Procedures and equations for assessing bridge pier column vulnerability to direct barge impact have also been provided. Additionally, in Appendix D, illustrative examples of the calculation of the AASHTO protection factor (*PF*) have been provided for various scenarios. Any or all of these items may serve to inform updates to future editions of the FDOT SDG.

## 6.3. Future Recommendations

As noted in the present report, a variety of different factors may influence the type and frequency of vessel traffic that operates near bridges in Florida. These factors include, but are not

limited to, changes in economic conditions, changes in environmental policies, waterway changes (channel modifications, water depth), and maritime industry innovations. Time frames associated with these changes can also vary significantly. Consequently, it is recommended that the FDOT consider updating the vessel traffic characterization components (vessel groups, future traffic projection) that are used in bridge risk assessment approximately once every ten (10) years. Performing such an update once per decade would help reduce the gap between implemented design requirements and observable trends in Florida vessel traffic. If ten (10) year long records are to be obtained from the USACE WCSC as part of such an update process, advance coordination with the USACE WCSC may aid in ensuring that adequate personnel resources are available to service such data requests in an efficient manner.



## REFERENCES

- American Association of State Highway and Transportation Officials (AASHTO). (2009). *Guide specification and commentary for vessel collision design of highway bridges*. 2nd Ed., Washington, D.C., 2009.
- American Association of State Highway and Transportation Officials (AASHTO). (2020). *LRFD Bridge Design Specifications*, 9th Ed., Washington, D.C., 2020.
- Consolazio, G. R., Getter, and D. J., Kantrales, G. C. (2014). *Validation and Implementation of Bridge Design Specifications for Barge Impact Loading*. University of Florida, Gainesville.
- Consolazio, G. R., and Kantrales, G. C. (2016). *Determination of Barge Impact Probabilities for Bridge Design*, University of Florida, Gainesville.
- Consolazio, G. R., Davidson, M. T., and Cowan, D. R. (2009). “Barge bow force-deformation relationships for barge-bridge collision analysis.” *Transportation Research Record* 2131, Transportation Research Board, Washington, D.C., 3–14.
- Consolazio, G. R., Davidson, M. T., and Getter, D. J. (2010). “*Development and Support of Dynamic Numerical Modeling of Aberrant Rake Barges Impacting Hurricane Protection Structures Subjected to Forces from a Hurricane Environment*.” Structures Research Report No. 83710, University of Florida, Department of Civil and Coastal Engineering, Gainesville, Florida.
- Consolazio, G. R., Wilkes, J. R. (2013). *Determination of Multi-Barge Flotilla Impact Loads on Bullnose Structures and Flexible Timber Guide Walls*. Structures Research Report 2013/96918, University of Florida, Department of Civil and Coastal Engineering, Gainesville, Florida.
- Crowley Shipping. (2020). 750 Class Articulated Tug Barge Fleet (ATB). Crowley Shipping, Jacksonville, FL.
- Davidson, M. T. (2010). *Probability Assessment of Bridge Collapse Under Barge Collision Loads*. Doctorate Dissertation, University of Florida, Gainesville.
- Davidson, M. T., Consolazio, G. R., and Getter, D. J. (2010). “Dynamic Amplification of Pier Column Internal Forces Due to Barge-Bridge Collision.” *Transportation Research Record* 2172, Transportation Research Board, Washington, DC, 11–22.
- Davidson, M. T., Consolazio, G. R., Getter, D. J., and Shah, F. D. (2013). “Probability of collapse expression for bridges subject to barge collision.” *J. Bridge Eng.*, 18(4), 287-296.
- European Committee for Standardization (CEN). (2006). *Eurocode 1: Actions on structures – Part 1-7: General actions – Accidental actions (EN 1991-1-7:2006)*, Brussels, Belgium.
- Fan, W., Yuan, W., Chen, B. (2015). “Steel Fender Limitations and Improvements for Bridge Protection in Ship Collisions.” *Journal of Bridge Engineering*, Vol. 20, Issue 12.

- Florida Department of Transportation (FDOT 2023). “Structures Design Guidelines, Structures Manual, Vol. 1”, January 2023.
- Florida Department of Transportation (FDOT) (2021). Fender Systems – Prestressed Concrete Piles & FRP Wales, FDOT Index 471-030, Tallahassee, FL.
- Florida Department of Transportation (FDOT). (2019). “Vessel Collision Risk Analysis v4.1.” Structures Design Programs Library. <<https://www.fdot.gov/structures/proglib.shtm>>.
- Fujii, Y., and Shiobara, R. (1978). “The estimation of losses resulting from marine accidents.” *J. Navig.*, 31(1), 117–125.
- Geng, B., Songlin, L., Zheng, Z. (2016). “Research on the Reasonable Stiffness of Bridge Anti-Collision Devices.” *International Collaboration in Lifeline Earthquake Engineering*, American Society of Civil Engineers.
- Getter, D. J., and Consolazio, G. R. (2011). “Relationships of barge bow force-deformation for bridge design: Probabilistic consideration of oblique impact scenarios.” *Transportation Research Record 2251*, Transportation Research Board, Washington, DC, 3-15.
- Harrison, R., (2015). *Impact of the Gulf Intracoastal Waterway (GIWW) on Freight Flows in the Texas-Louisiana Megaregion*, Center for Transportation Research, Report 600451-00080-1, University of Texas at Austin, Austin, TX.
- Knott, M. and Winters, M. (2018). “Ship and Barge Collisions with Bridges Over Navigable Waterways”. *PIANC – World Congress*, Panama City, Panama, 2018.
- Koedijk, O. C. (2015), “The role of classification and reference vessels in the design of inland fairways for commercial vessels – contribution to the Workshop of WG 141 Design Guidelines for Inland Waterways”, *PIANC*, Buenos Aires, Argentina, 2015.
- Kunz, C. U. (1998). “Ship bridge collision in river traffic, Analysis and design practice.” *Ship Collision Analysis* (H. Gluver and D. Olsen, eds.), Balkema, Rotterdam, Netherlands, 13-22.
- Larsen, O.D. (1993). “Ship collision with bridges: interaction between vessel traffic and bridge structures.” *Structural Engineering Documents*, SED 4, International Association for Bridge and Structural Engineering (IABSE), Switzerland.
- Liu, C., and Wang, T. L. (2001). “Statewide vessel collision design for bridges.” *J. Bridge Eng.*, 6(3), 213–219.
- Manohar, T., Suribabu, C. R., Murali, G., Salaimanimagudam, M. P. (2020). “A novel steel-PAFRC composite fender for bridge pier protection under low velocity vessel impacts.” *School of Civil Engineering, SASTRA Deemed to be University, Thanjavur, India*.
- Manuel, L., Kallivokas, L. F., Williamson, E. B., Bomba, M., Berlin, K. B., Cryer, A., and Henderson, W. R. (2006). “A Probabilistic Analysis of the Frequency of Bridge Collapses due to Vessel Impact.” *University of Texas Center for Transportation Research Report No. 0 4650 1*, University of Texas, Austin, TX.

- Meyer, S. D., Ringuet, M. E., Raulerson, G., Sherwood, E., Conrad, K., Basili, G. (2020). "Characterizing Vessel Traffic Using the AIS: A Case Study in Florida's Largest Estuary". *Journal of Waterway, Port, Coastal, and Ocean Engineering*, American Society of Civil Engineering (ASCE).
- Modjeski and Masters Consulting Engineers. (1985). "Criteria for the Design of Bridge Piers with Respect to Vessel Collision in Louisiana Waterways". The Louisiana Department of Transportation and Development and the Federal Highway Administration.
- Permanent International Association of Navigation Congresses (PIANC). (2015), "How to deal with new ships in the CEMT '92 classification - towards a new CEMT (ITF) classification", InCom WG 179, World Association for Waterborne Transport Infrastructure.
- Svensson, H. (2009). "Protection of bridge piers against ship collision." *Steel Construction* 2, No. 12: 21-32. DOI: 10.1002/stco.200910004.
- Tukey, J. (1977). "Exploratory Data Analysis", Pearson, New York, NY.
- United States Army Corps of Engineers (USACE). (2017). *Waterborne Commerce of the United States, Part 2—Waterways and Harbors, Gulf Coast, Mississippi River System, Antilles*, Institute for Water Resources, U.S. Army Corps of Engineers, Alexandria, VA.
- United States Coast Guard (USCG). (1947). *Federal Statutes, July 30, 1947. Title 1, Chapter 388, Statute 633 - Vessel* as including all means of water transportation. 1 U.S. Code §3.
- United States Coast Guard (USCG). (2010). *Federal Statutes. July 1, 2010. Title 33, Chapter 1, Subchapter A, Part 2, Subpart B, Section 2.36 – Navigable Waters of the United States. 33 U.S. Codes §1322.*
- USACE. (2006). *Hydraulic Design of Deep-Draft Navigation Projects, EM 1110-2-1613*, USACE, Washington, DC.
- Wang, J. J., Song, Y. C., Wang, W., Chen, C. J. (2019). "Evaluation of flexible floating anti-collision device subjected to ship impact using finite-element method." *Ocean Engineering* 178 (2019) 321-330.
- Wang, T. L., and Liu C. (1999). *Synthesizing commercial shipping (barge/tug trains) from available data for vessel collision design*. Florida International Univ., Miami, FL.
- Wei, S., Li, S. (2019). "Study on the Probabilities of Vessel-Bridge Collision Considering the Influence of Existing Structures." 4<sup>th</sup> International Conference of Energy Equipment Science and Engineering, 242 (2019) 032068.
- Wuttrich, R., Wekezer J., Yazdani, N., Wilson, C. (2001). "Performance Evaluation of Existing Bridge Fenders for Ship Impact." *Journal of Performance of Constructed Facilities*, American Society of Civil Engineers (ASCE).
- Zhu, B., Chen, R, Chen, Y., Zhang, Z. (2011). "Impact Model Tests and Simplified Analysis for Flexible Pile-Supported Protective Structures Withstanding Vessel Collisions." *Journal of Waterway, Port, Coastal, and Ocean Engineering*, ASCE. March 2012.

**APPENDIX A**  
**PLOTS OF COLLECTED PAST POINT DATA**

Presented on the following pages are plots of the total number of upbound and downbound trips of vessels that are relevant to bridge design. Plot points are included for every past point and every year for which data were available.

### Past point 1

Upbound

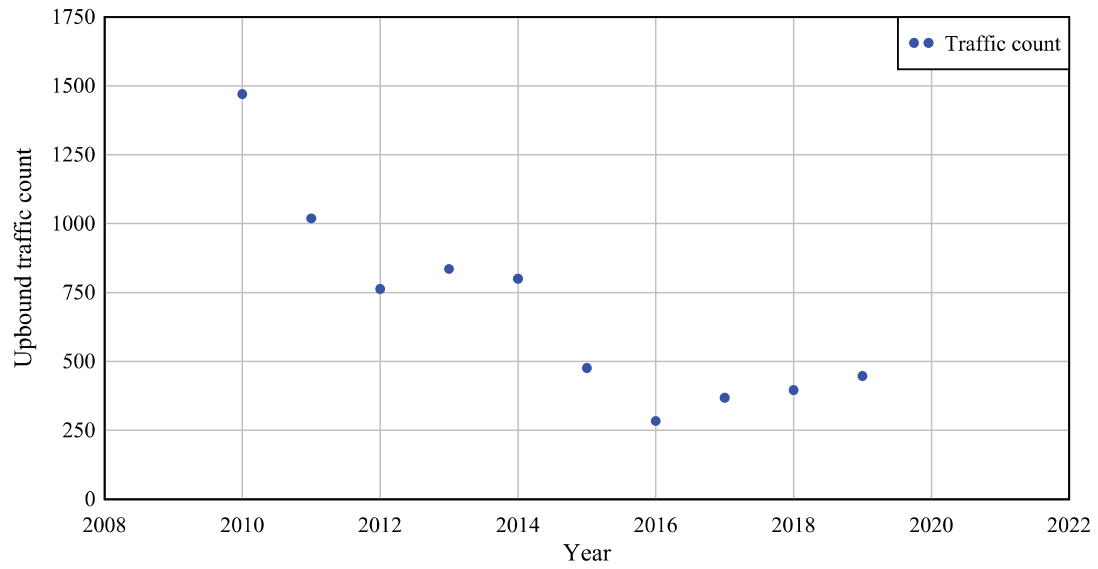

### Past point 1

Downbound

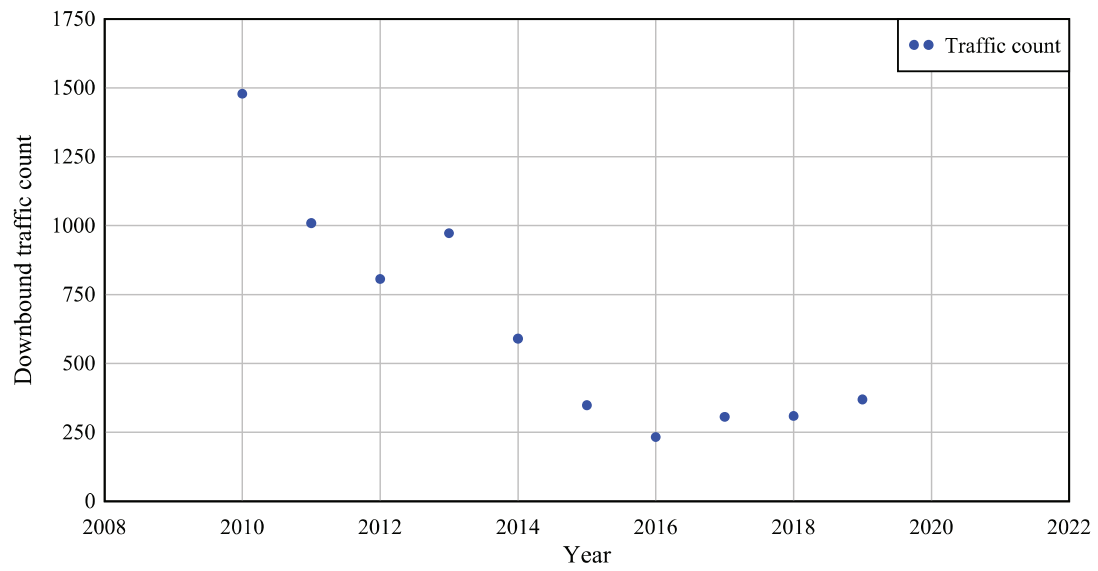

**Past point 2**  
Upbound

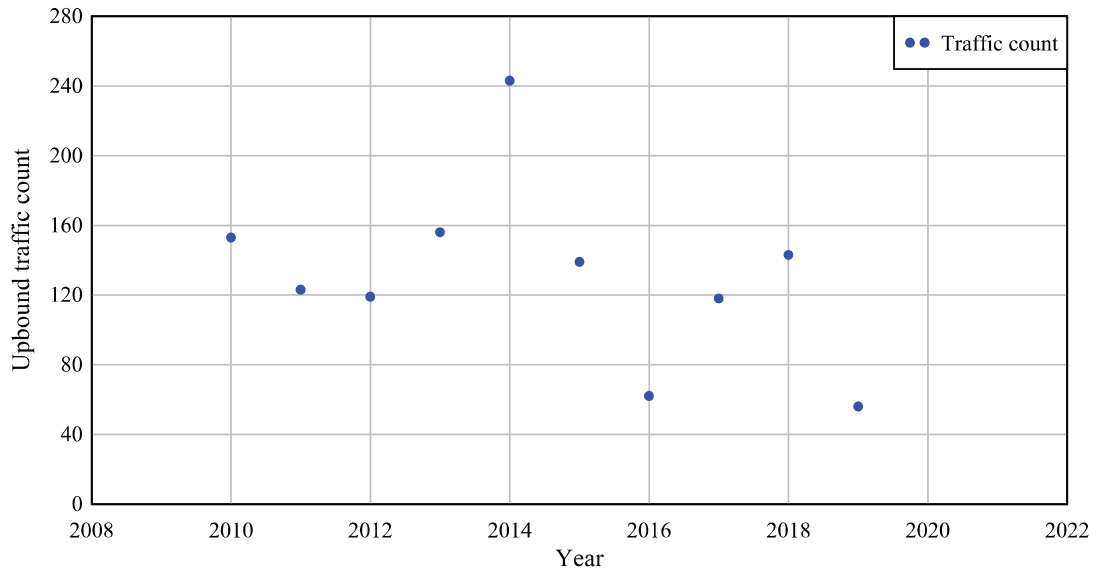

**Past point 2**  
Downbound

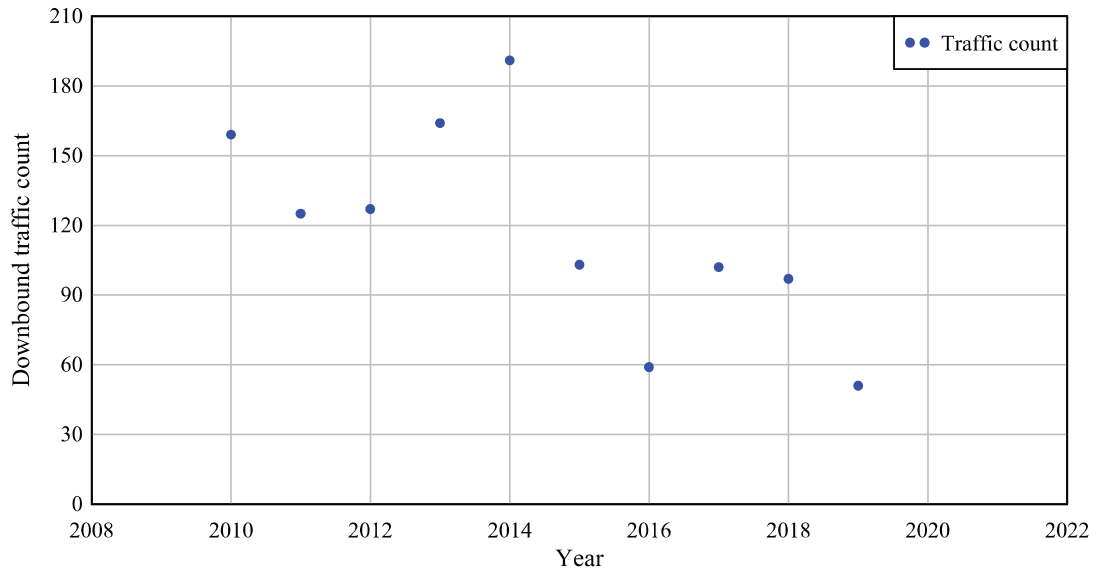

**Past point 3**  
Upbound

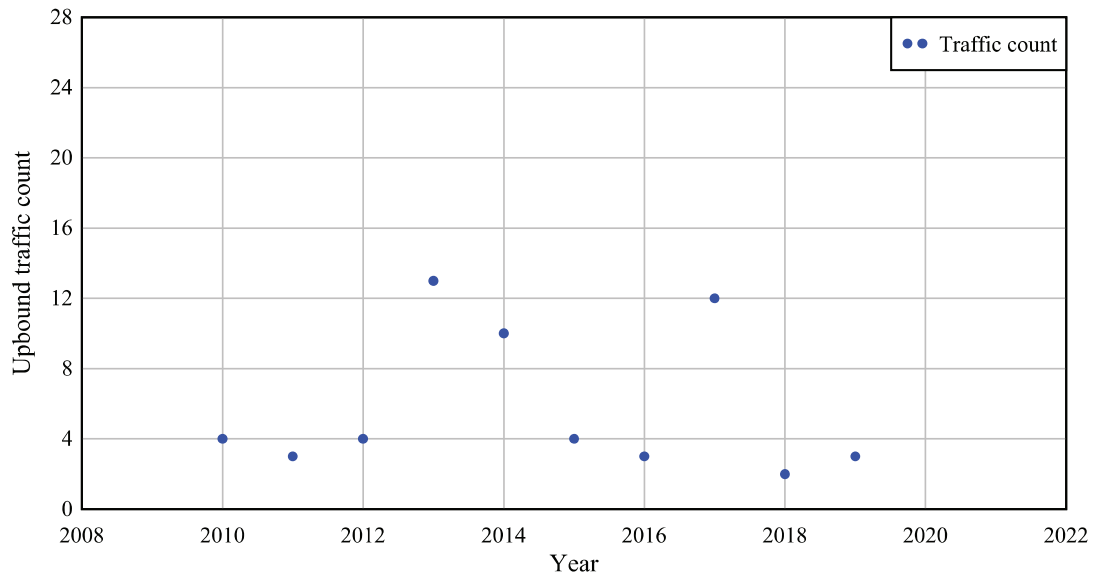

**Past point 3**  
Downbound

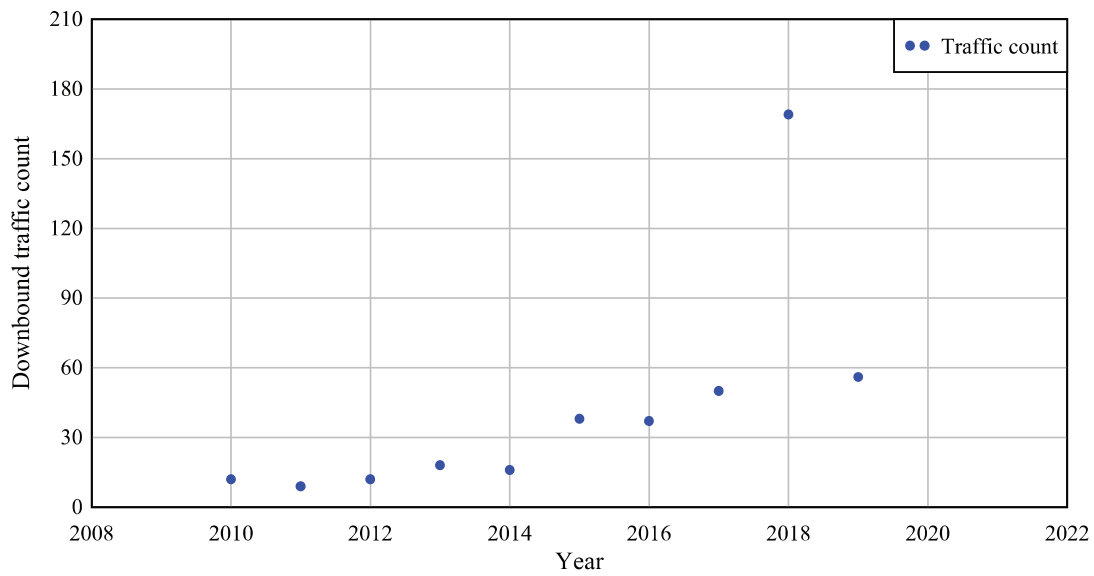

**Past point 4**  
Upbound

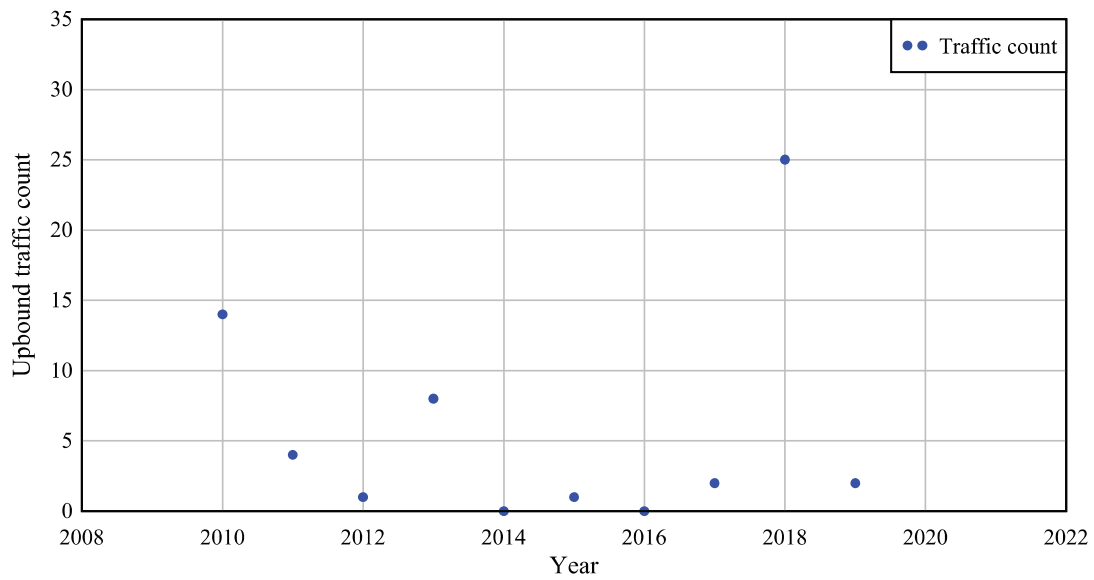

**Past point 4**  
Downbound

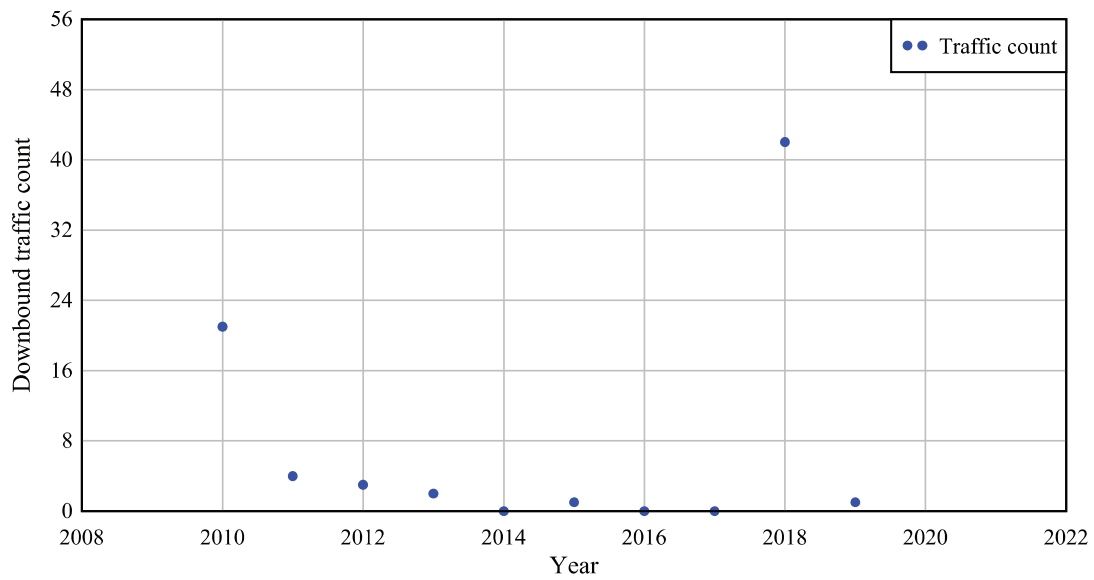



### Past point 5

Upbound

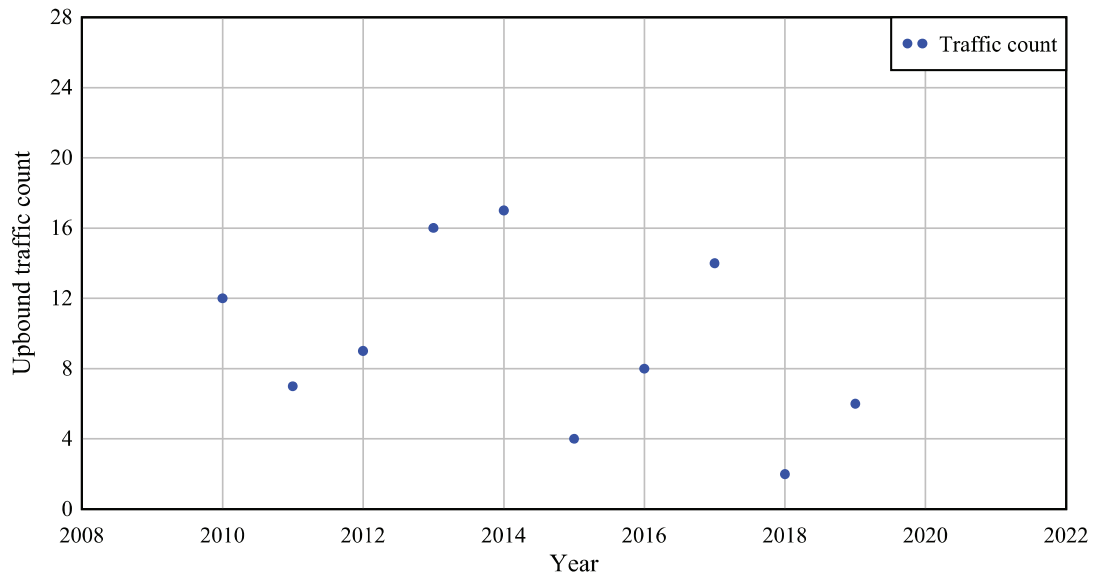

### Past point 5

Downbound

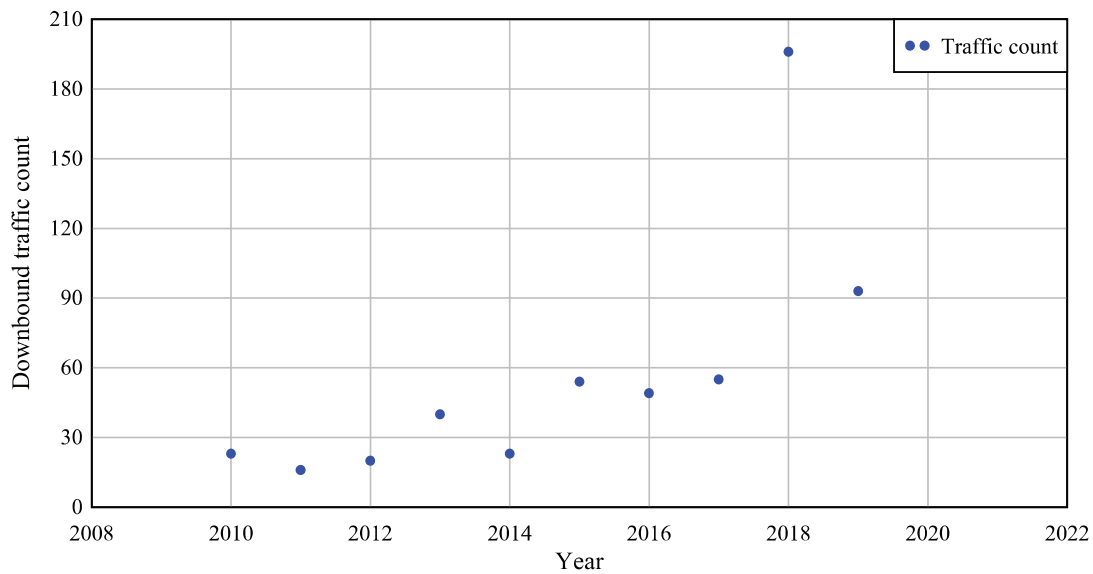

### Past point 6 Upbound

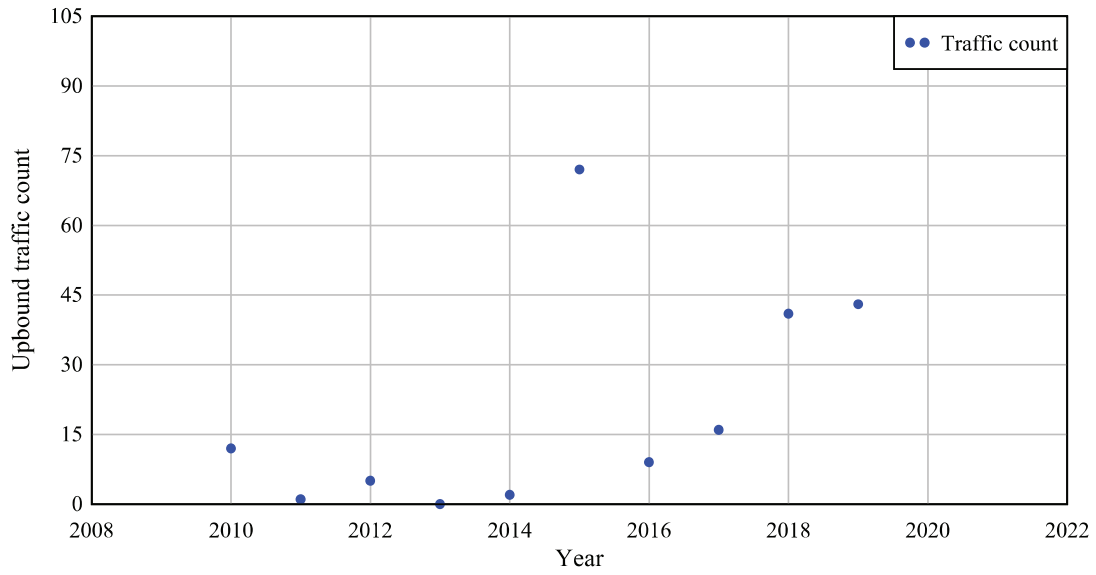

### Past point 6 Downbound

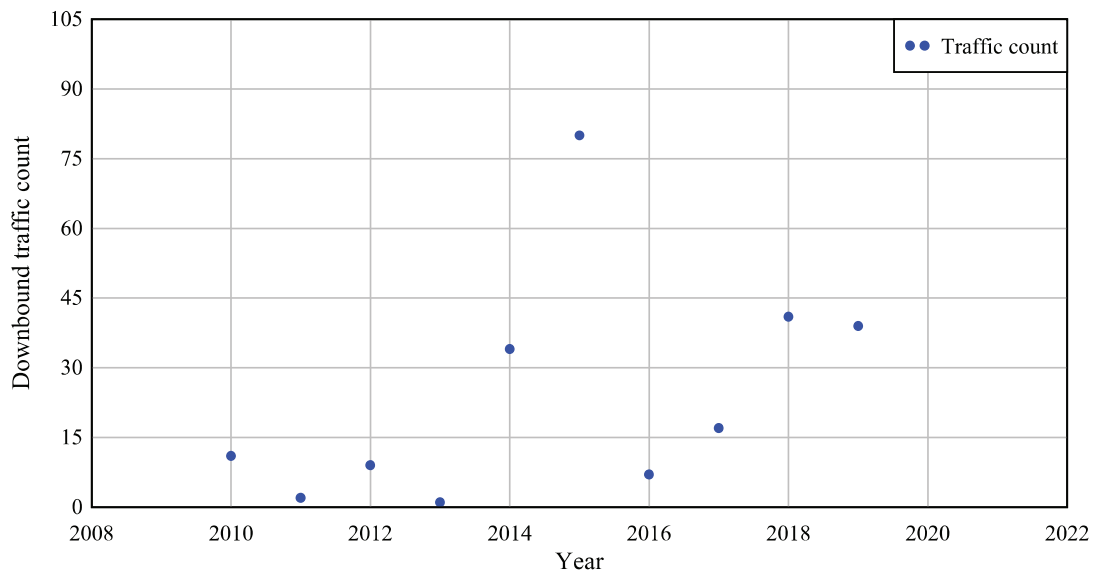

**Past point 7**  
Upbound

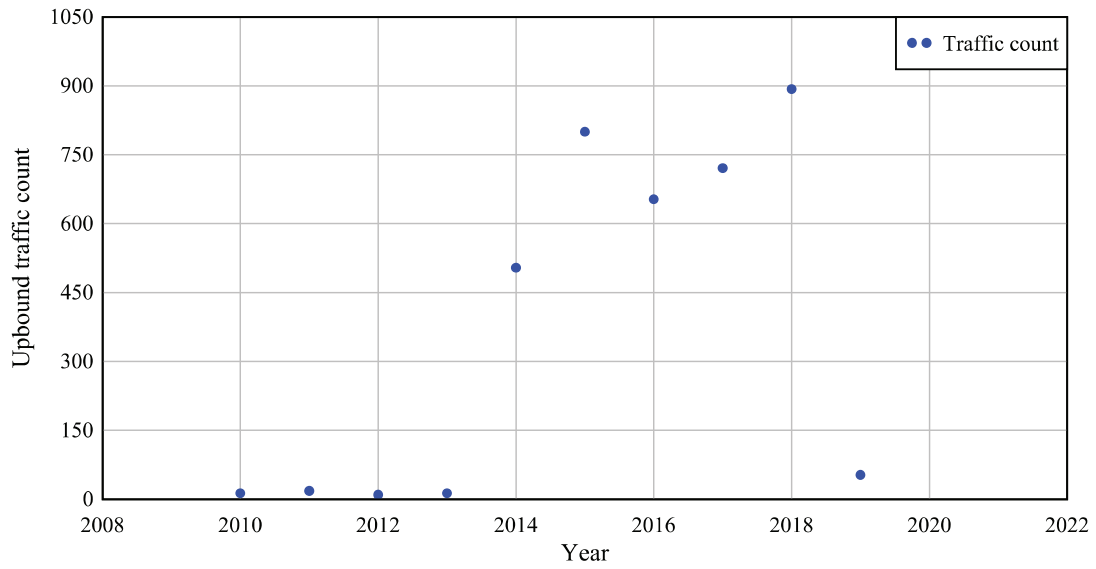

**Past point 7**  
Downbound

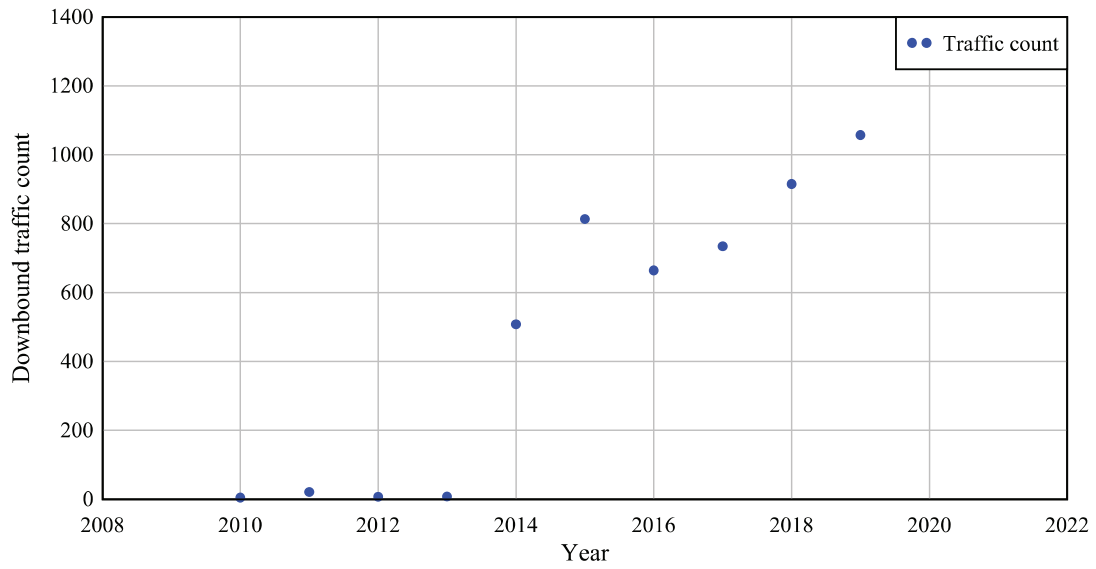

**Past point 8**  
Upbound

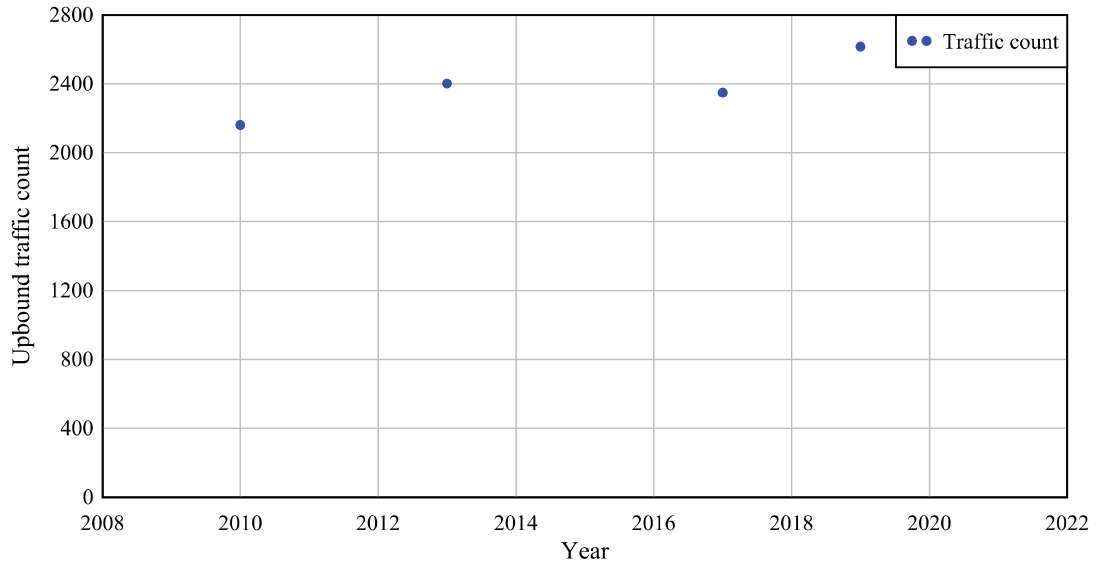

**Past point 8**  
Downbound

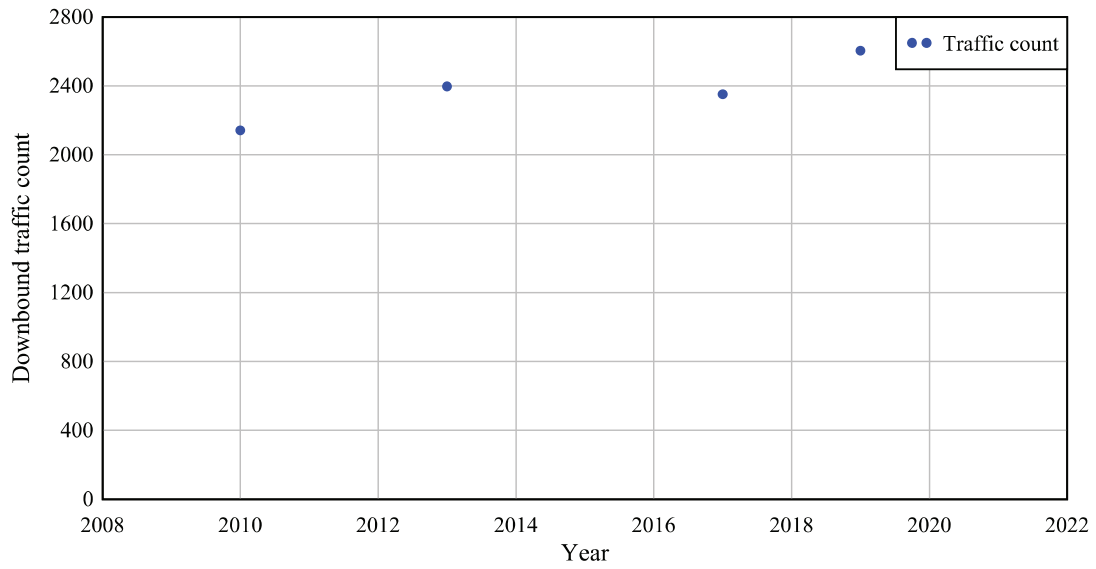

[No data for Past point 9 Upbound]

[No data for Past point 9 Downbound]

[No data for Past point 10 Upbound]

[No data for Past point 10 Downbound]

[No data for Past point 11 Upbound]

[No data for Past point 11 Downbound]

[No data for Past point 12 Upbound]

[No data for Past point 12 Downbound]



**Past point 13**  
Upbound

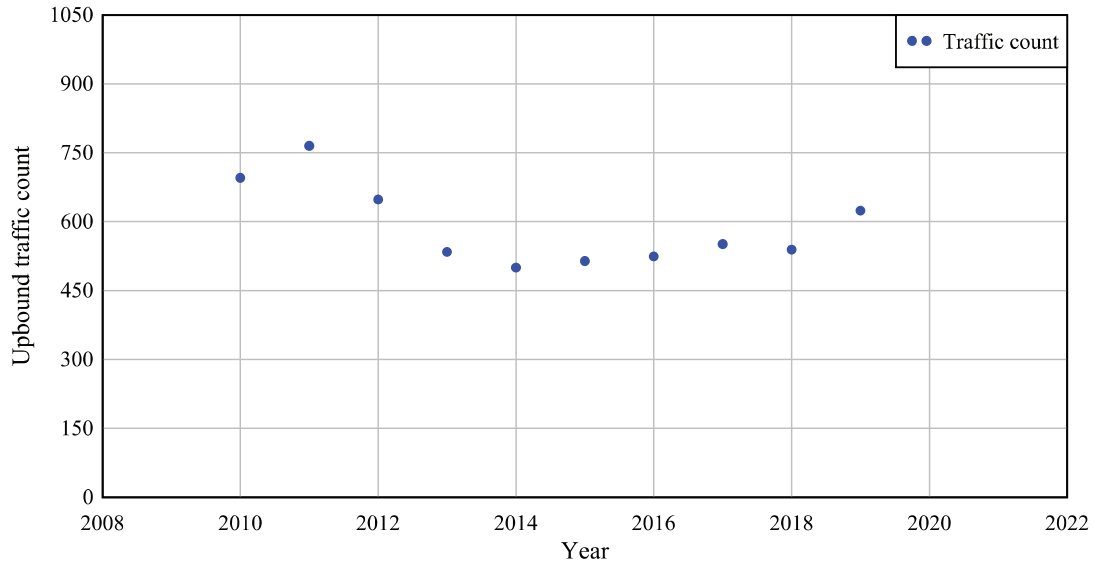

**Past point 13**  
Downbound

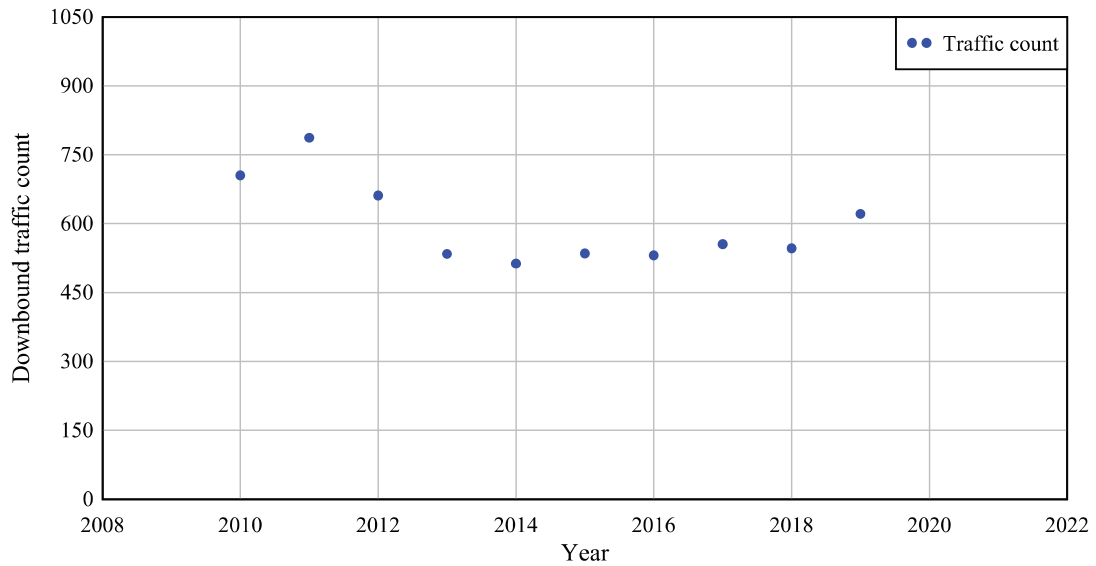

**Past point 14**  
Upbound

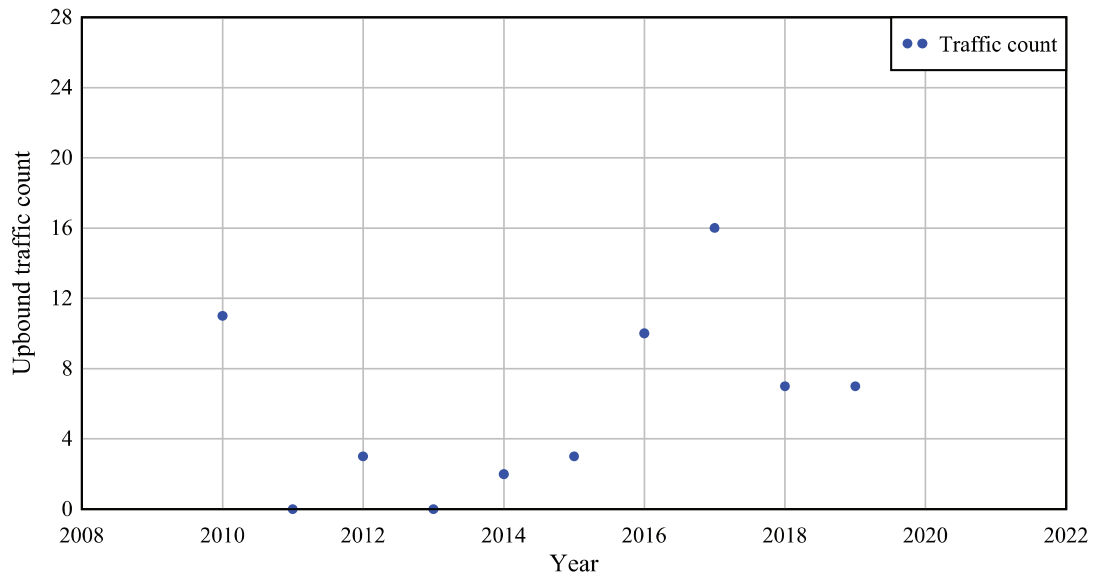

**Past point 14**  
Downbound

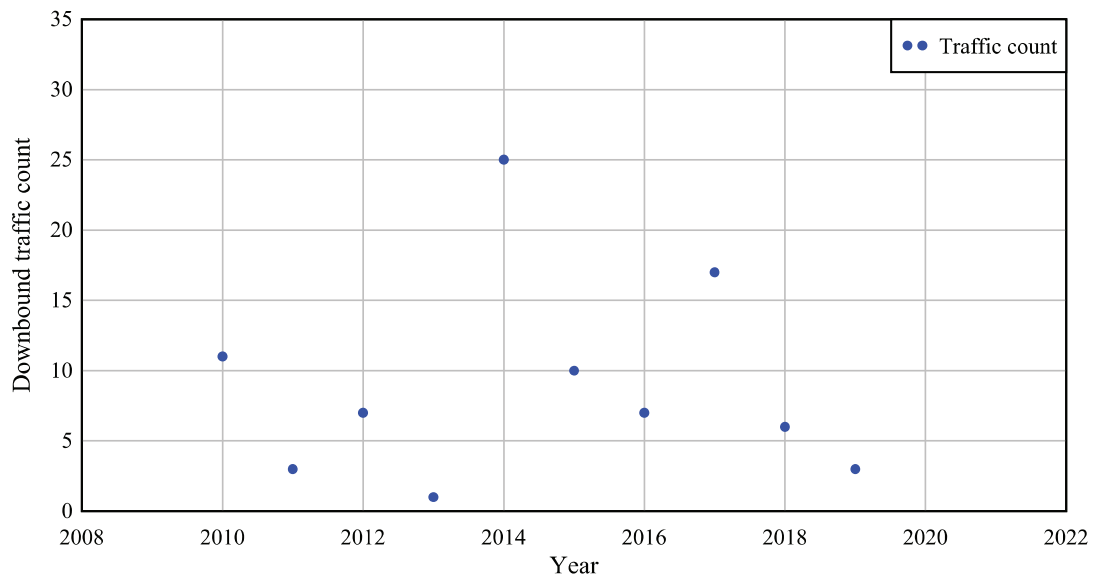

**Past point 15**  
Upbound

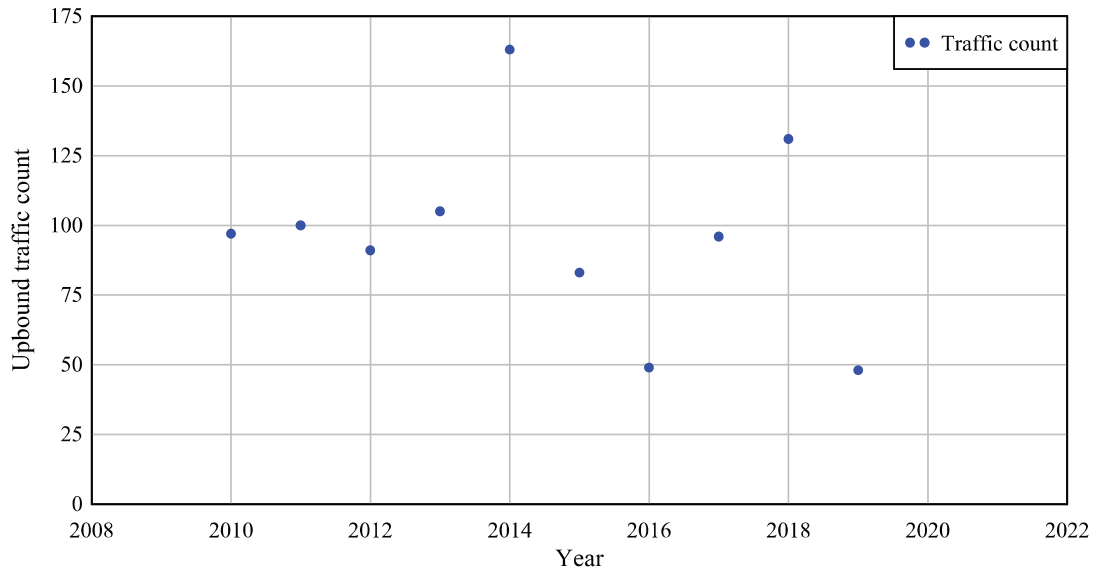

**Past point 15**  
Downbound

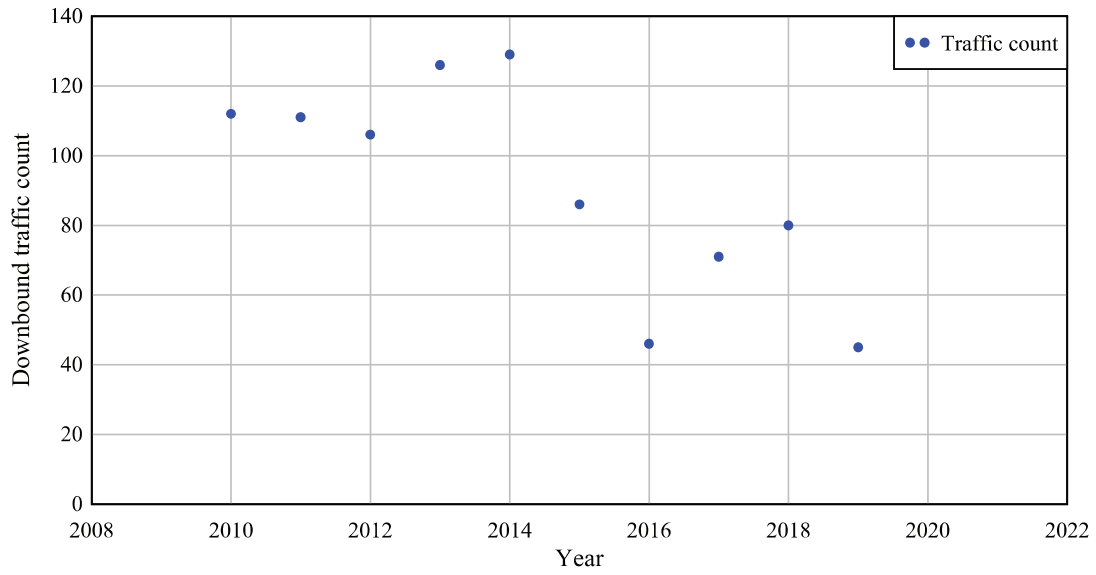

**Past point 16**  
Upbound

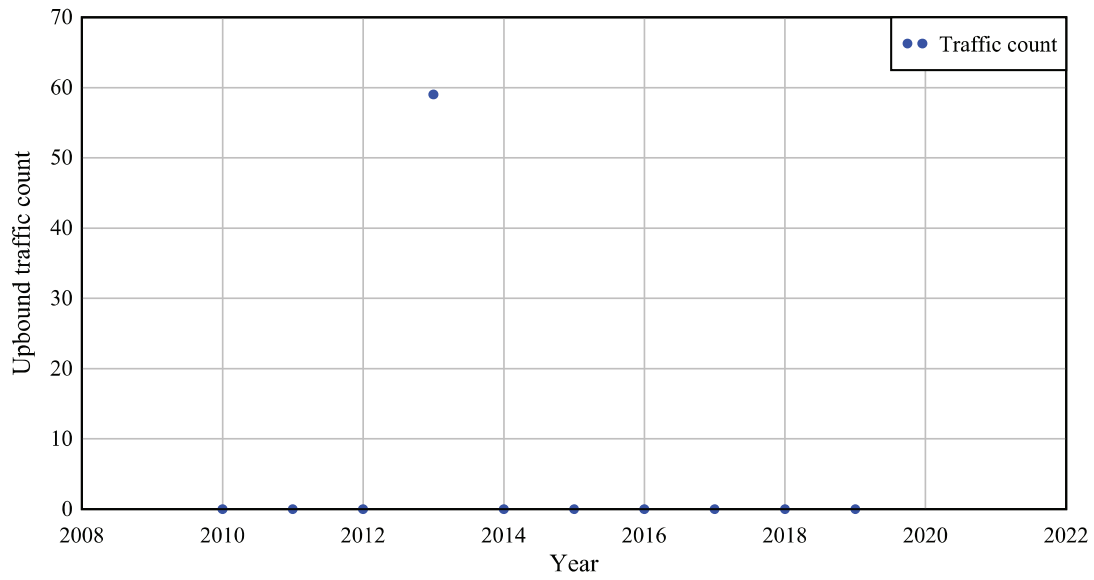

**Past point 16**  
Downbound

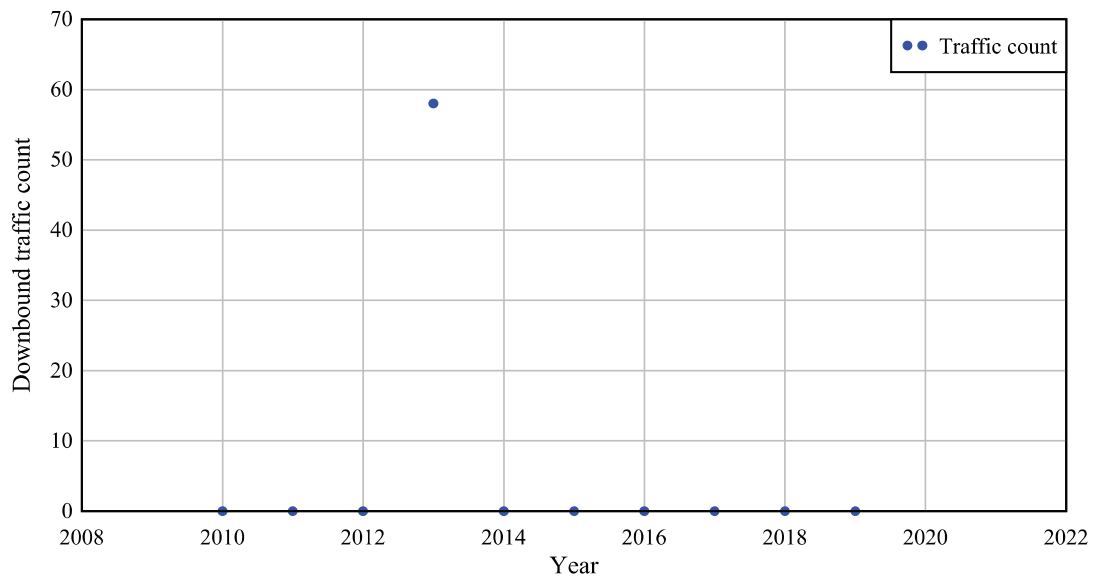

**Past point 17**  
Upbound

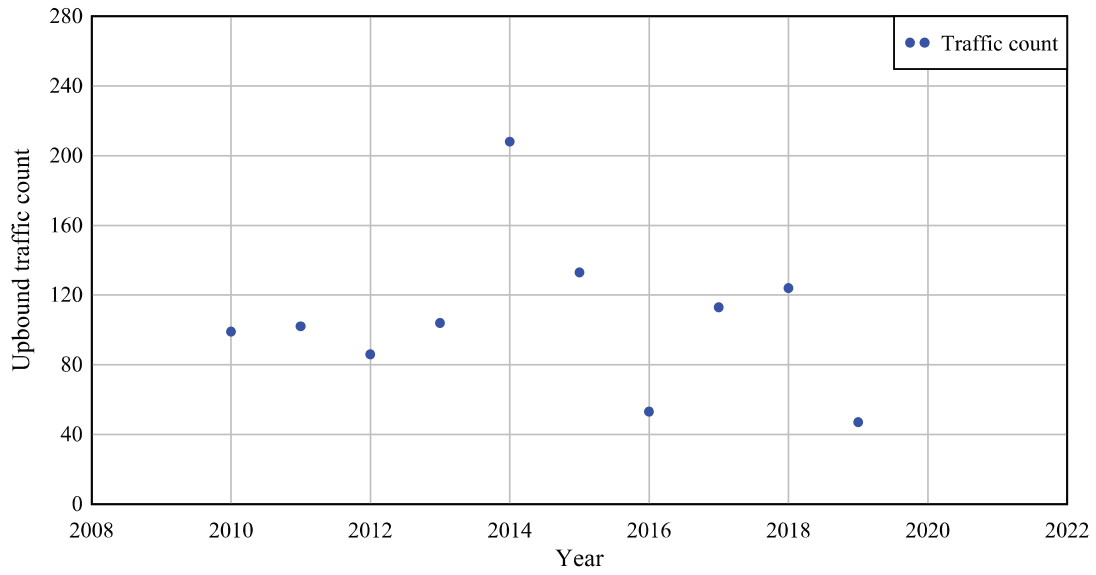

**Past point 17**  
Downbound

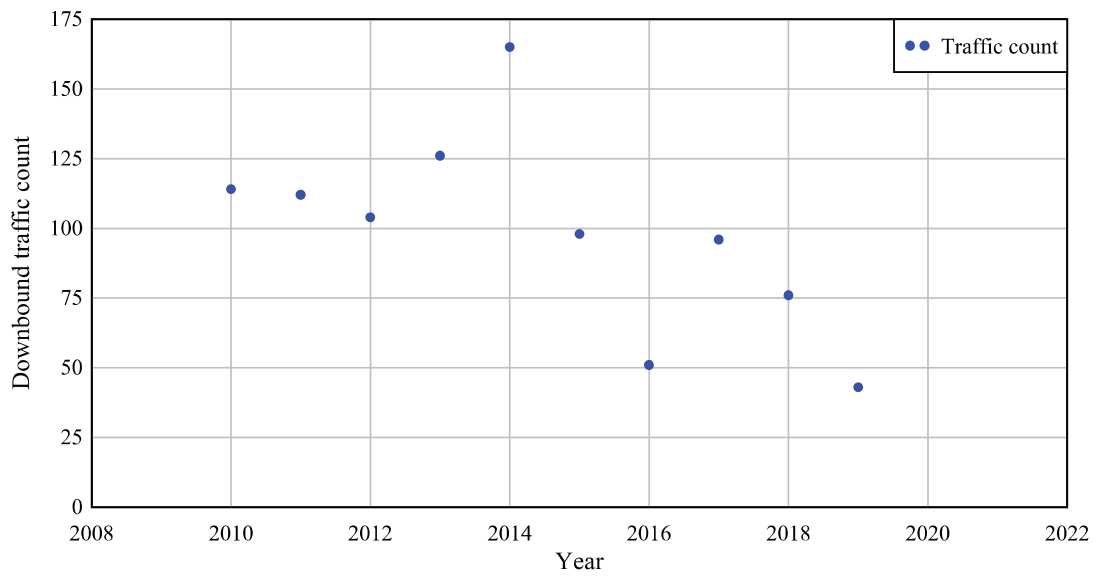

**Past point 18**  
Upbound

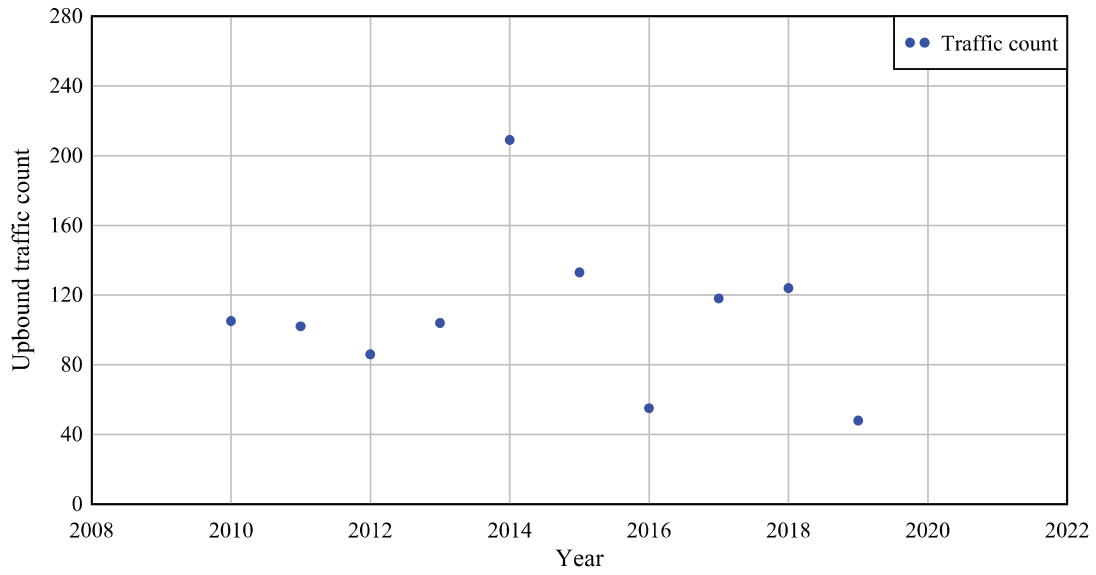

**Past point 18**  
Downbound

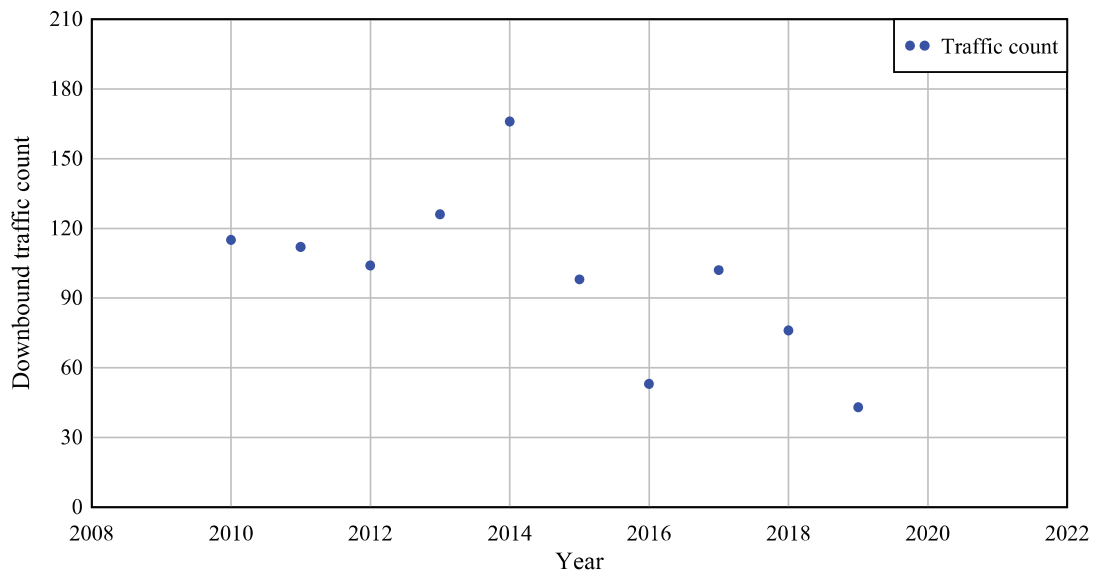

[No data for Past point 19 Upbound]

[No data for Past point 19 Downbound]

### Past point 20

Upbound

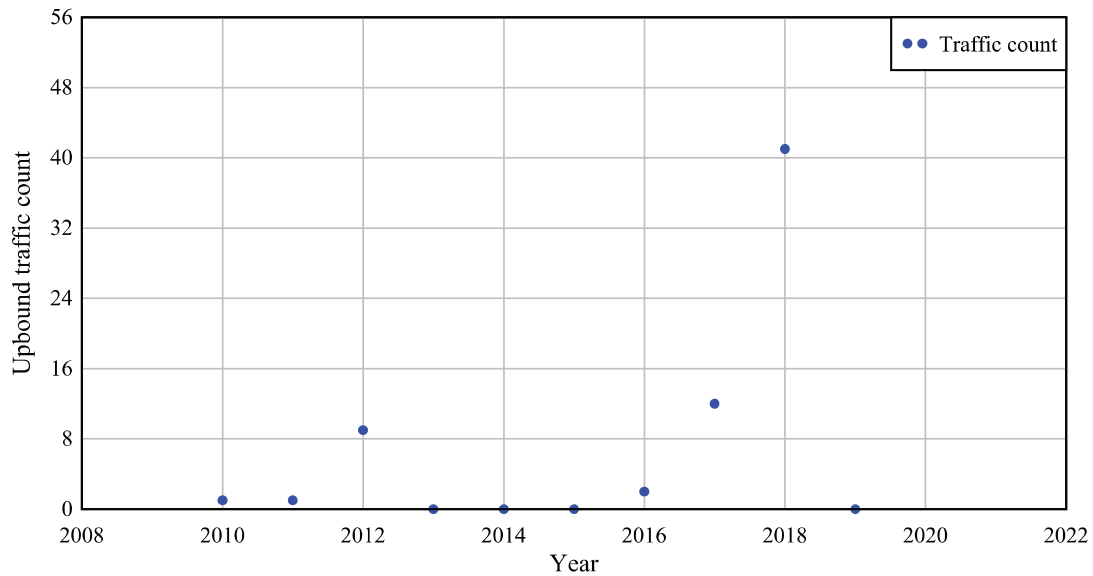

### Past point 20

Downbound

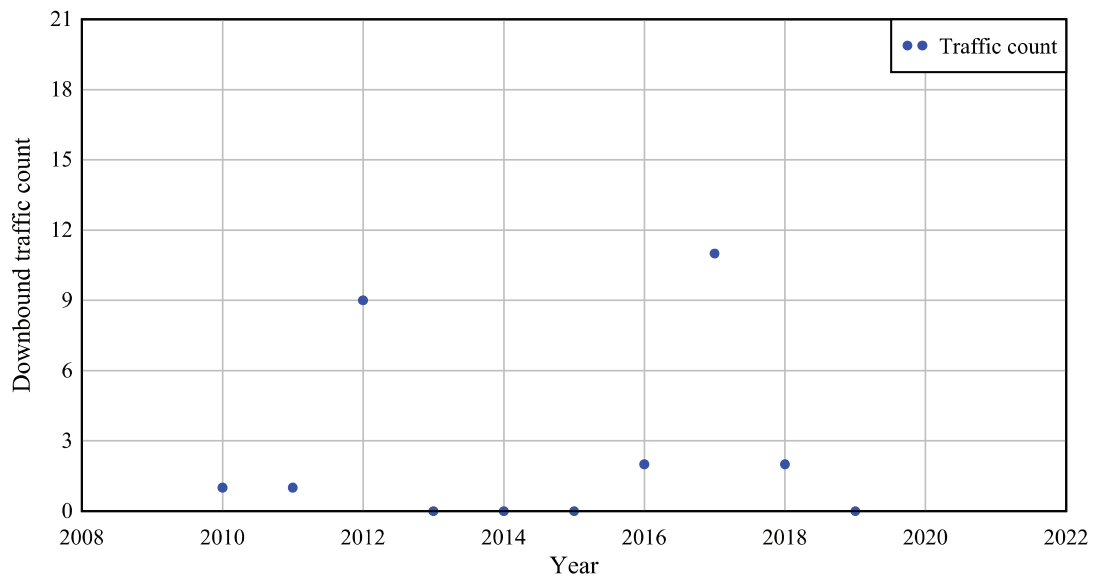



**Past point 21**  
Upbound

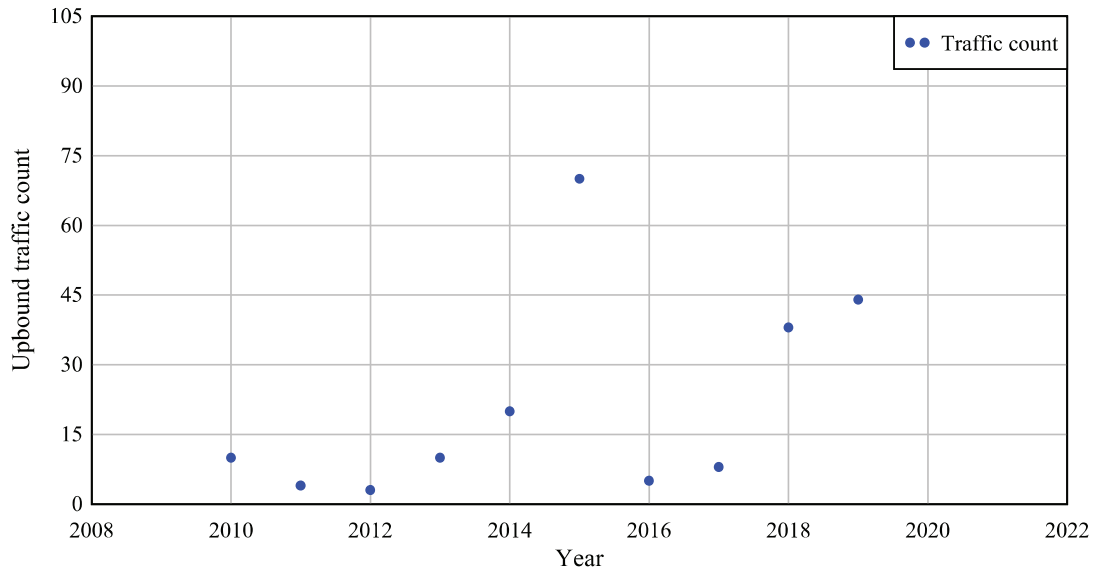

**Past point 21**  
Downbound

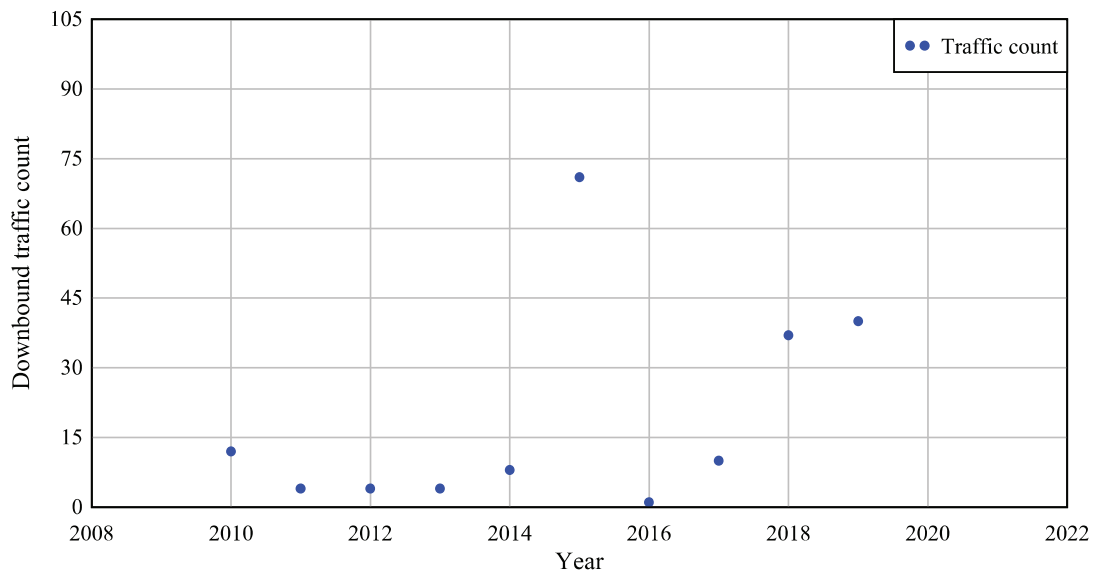

**Past point 22**  
Upbound

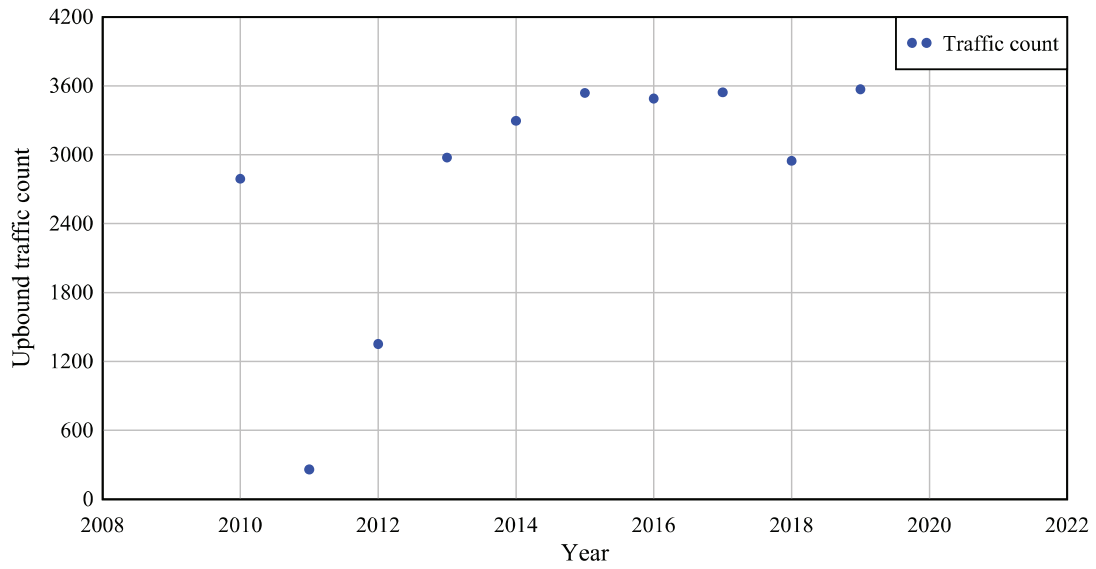

**Past point 22**  
Downbound

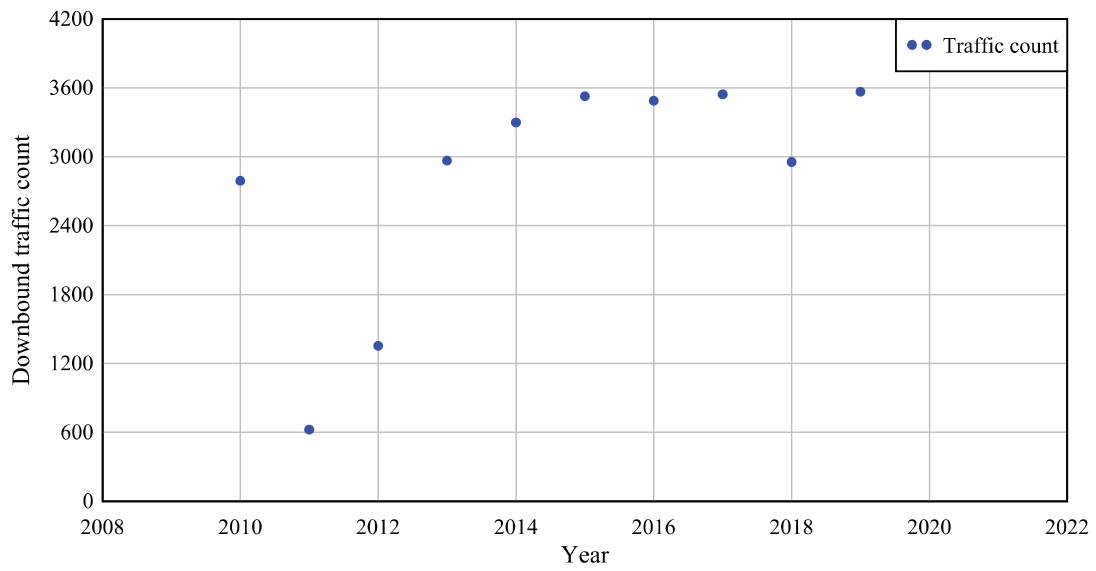

**Past point 23**  
Upbound

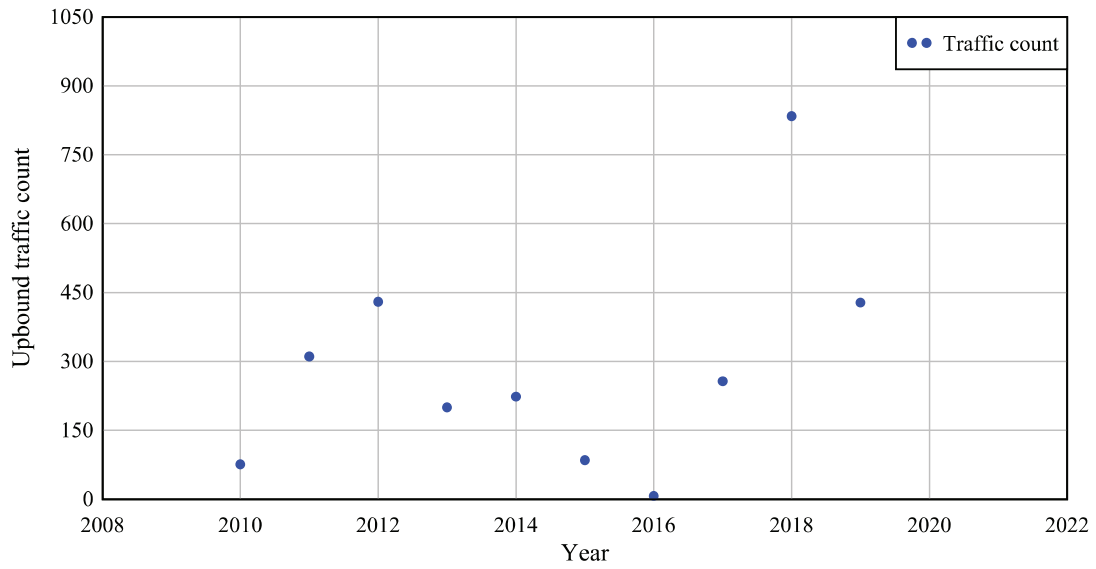

**Past point 23**  
Downbound

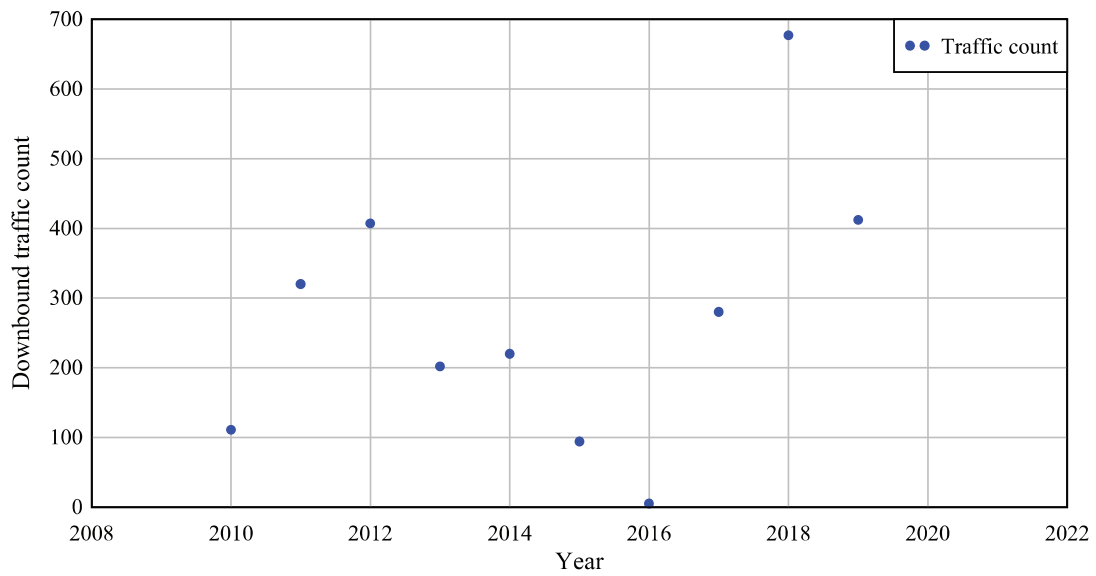

**Past point 24**  
Upbound

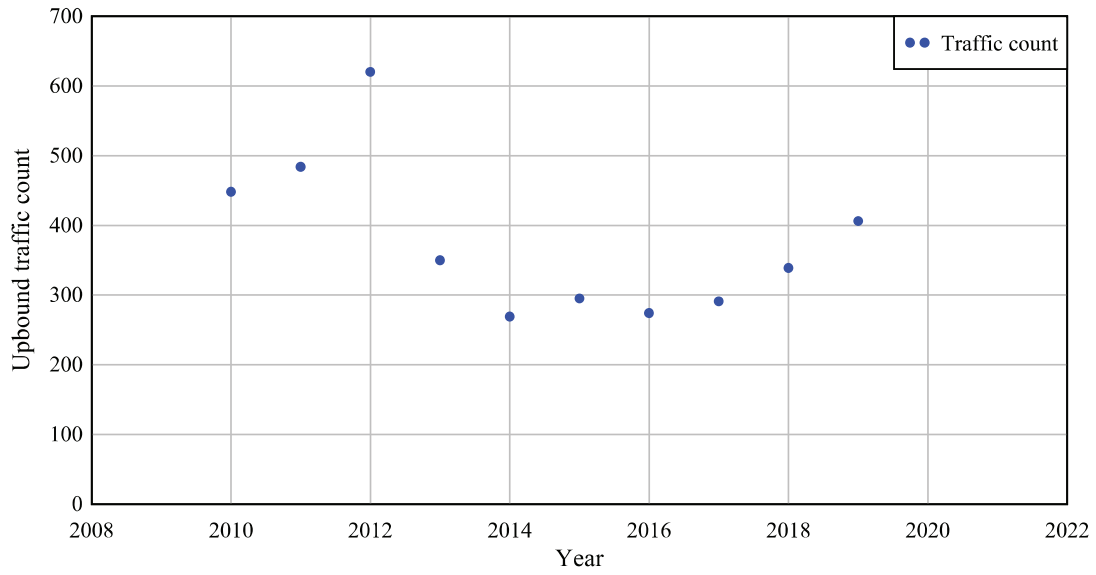

**Past point 24**  
Downbound

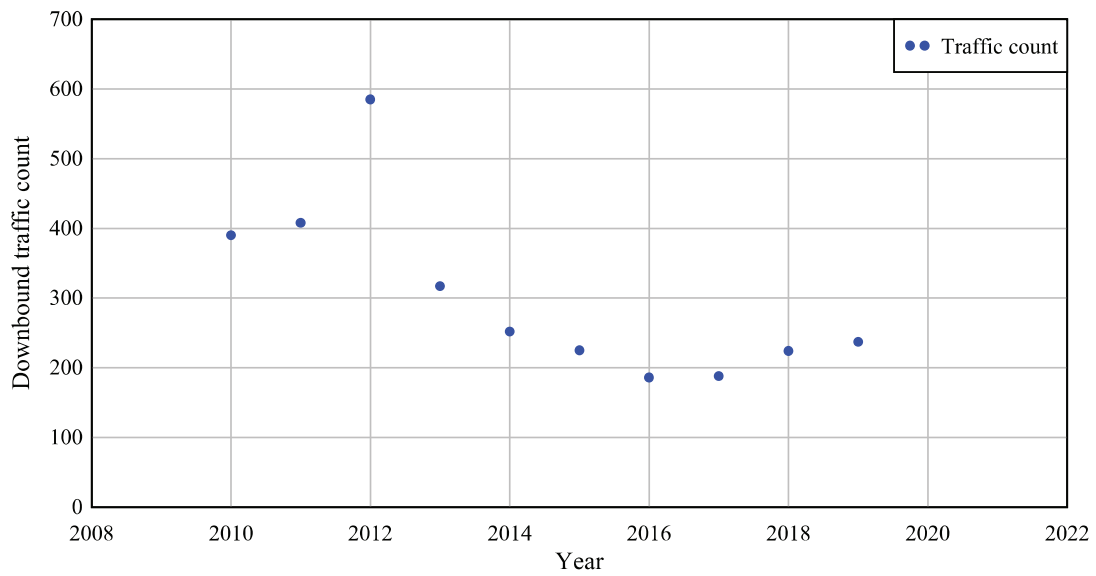

**Past point 25**  
Upbound

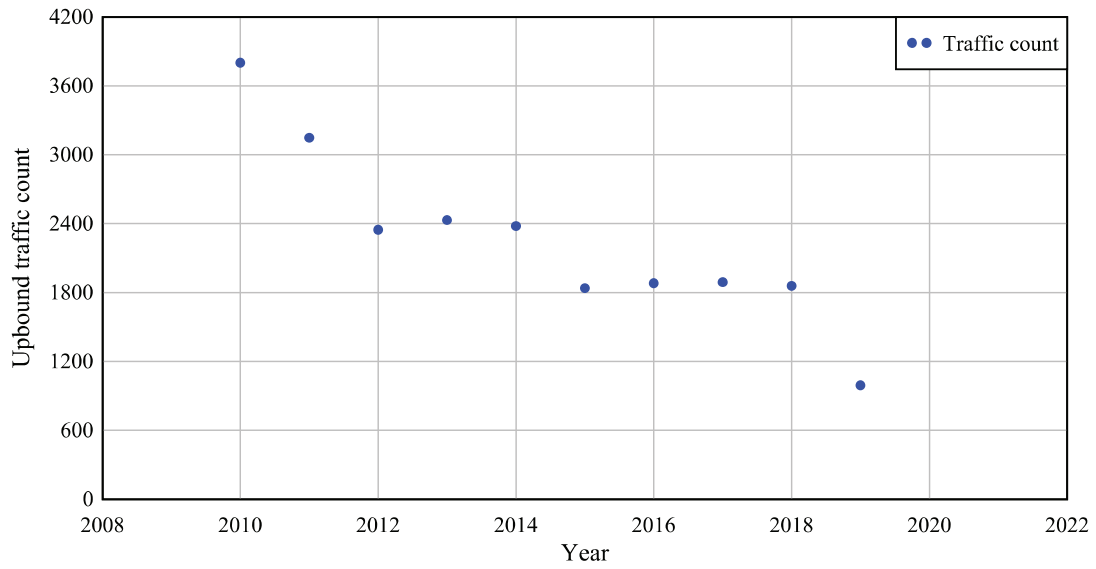

**Past point 25**  
Downbound

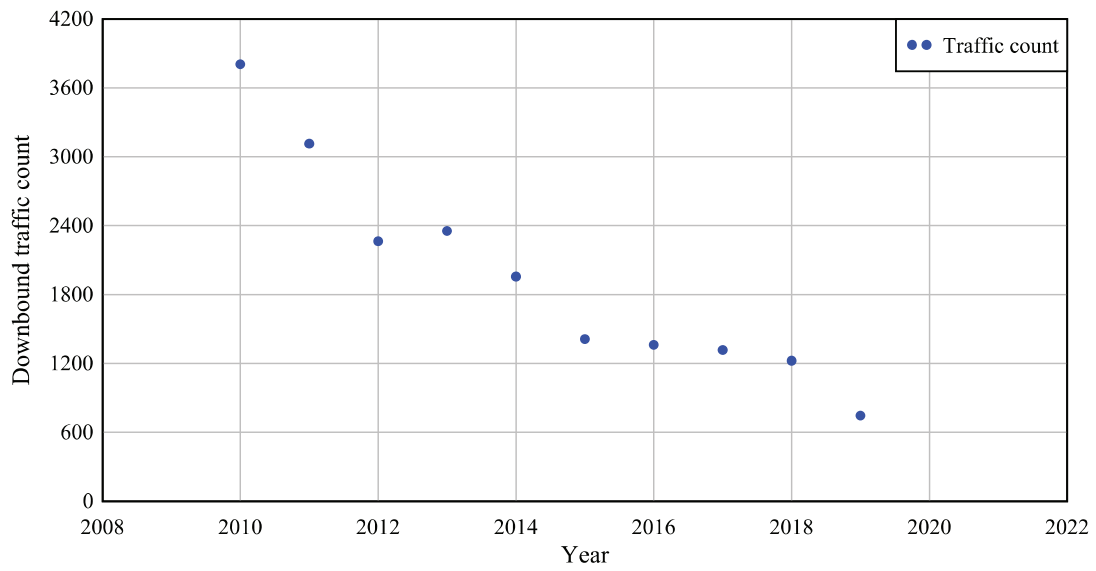

**Past point 26**  
Upbound

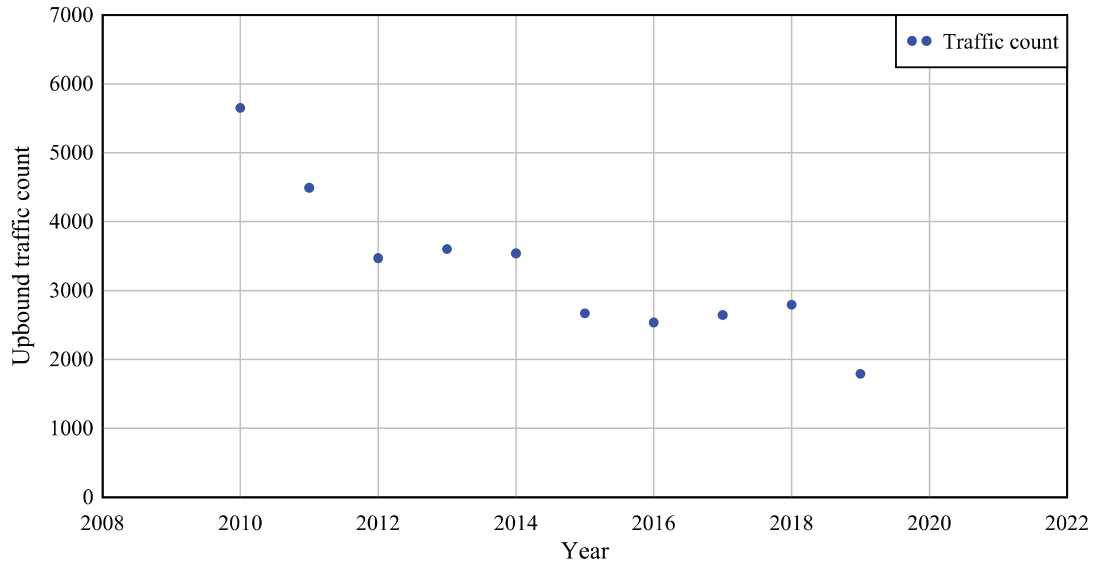

**Past point 26**  
Downbound

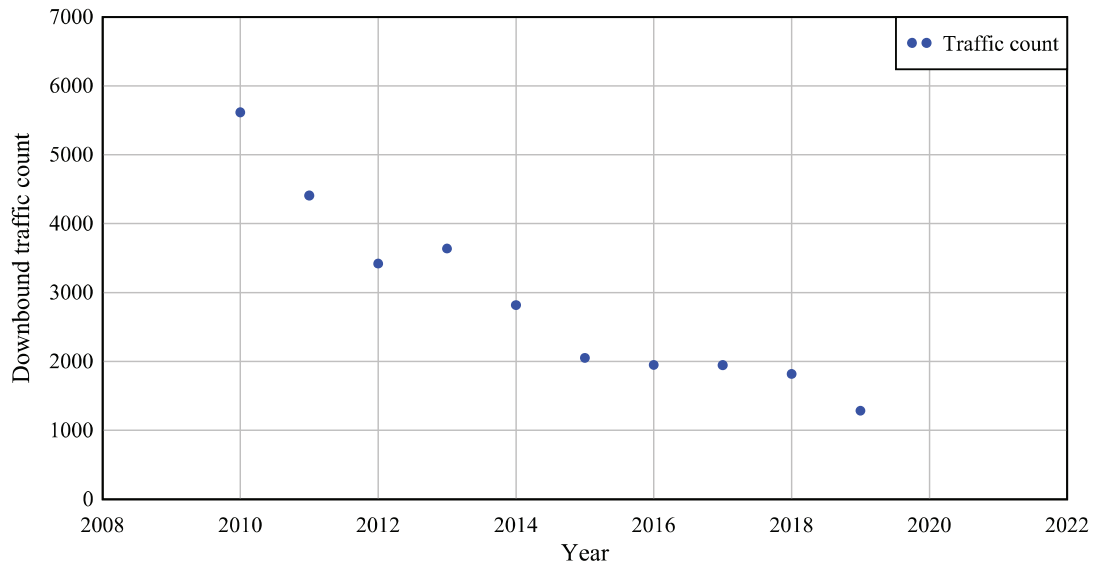

**Past point 27**  
Upbound

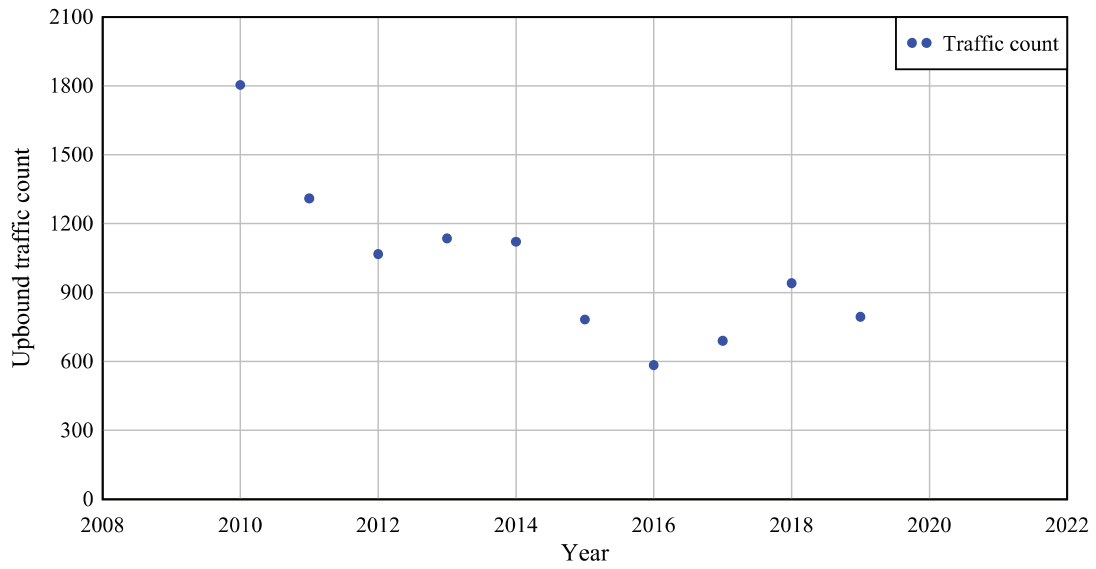

**Past point 27**  
Downbound

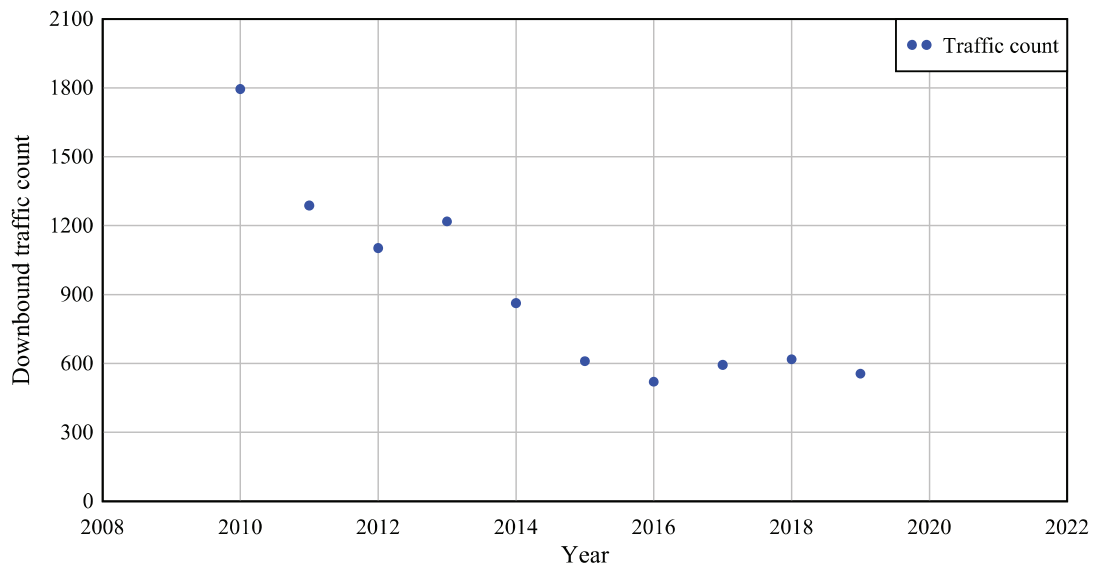

### Past point 28

Upbound

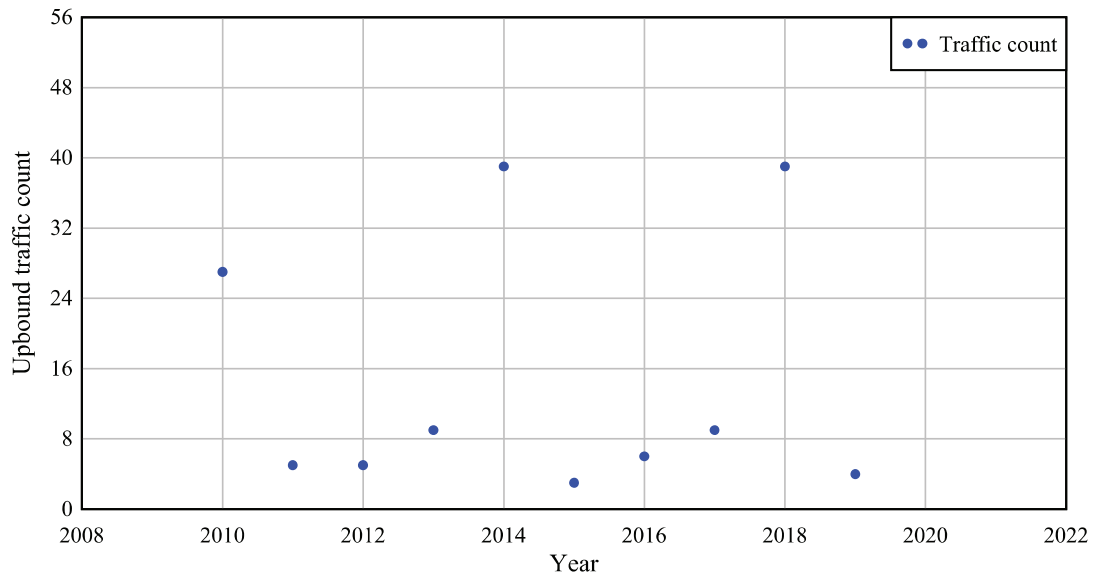

### Past point 28

Downbound

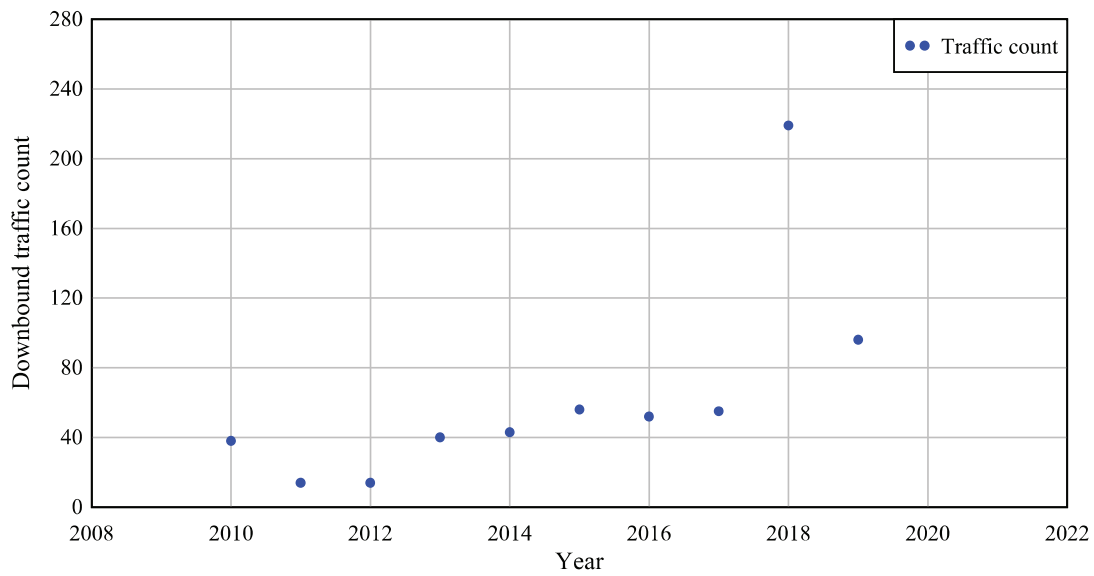



[No data for Past point 29 Upbound]

[No data for Past point 29 Downbound]

**Past point 30**  
Upbound

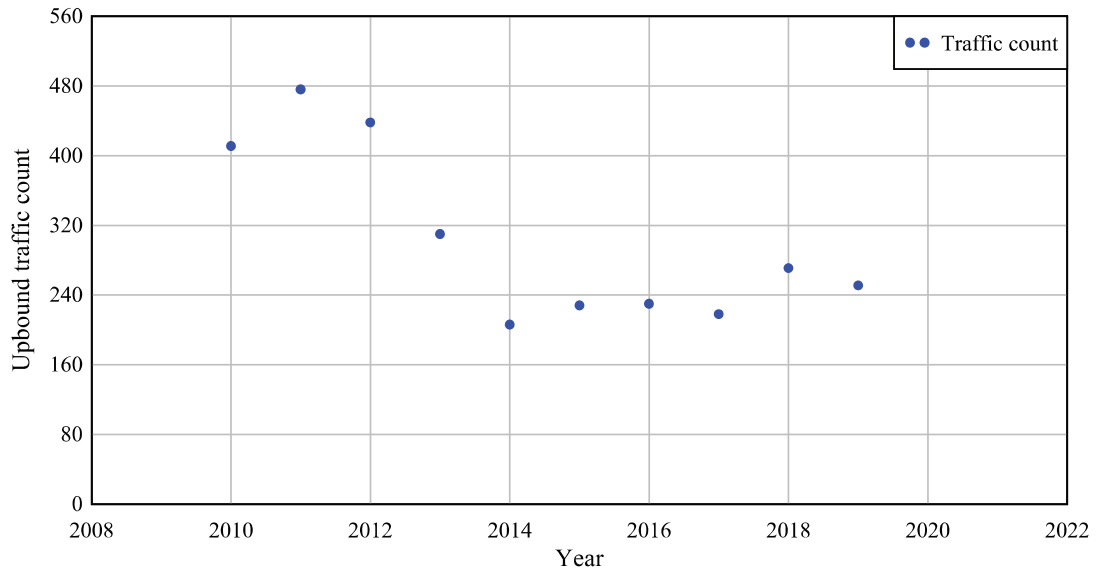

**Past point 30**  
Downbound

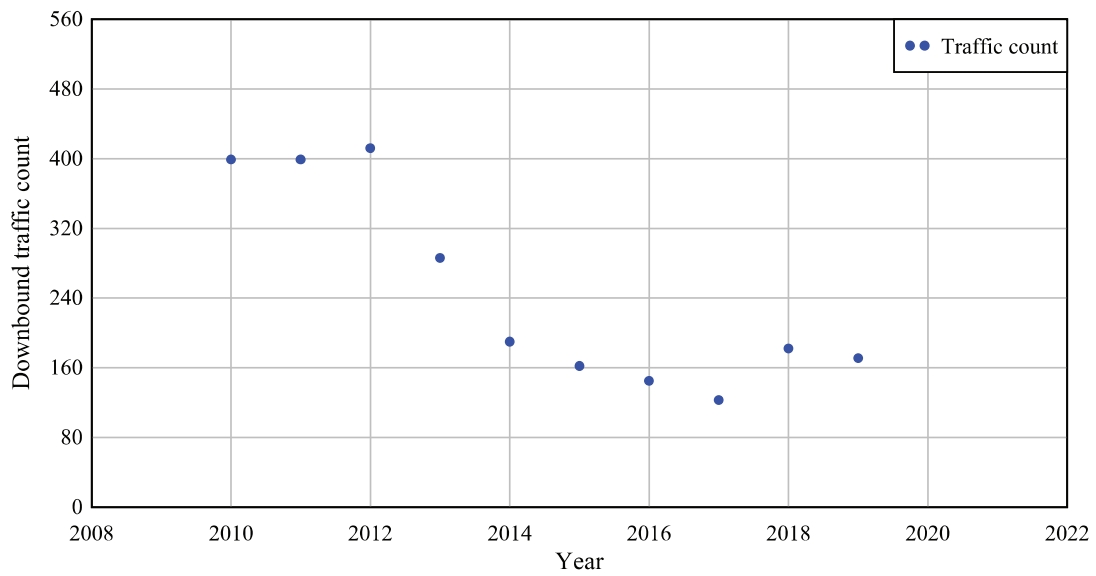

**Past point 31**  
Upbound

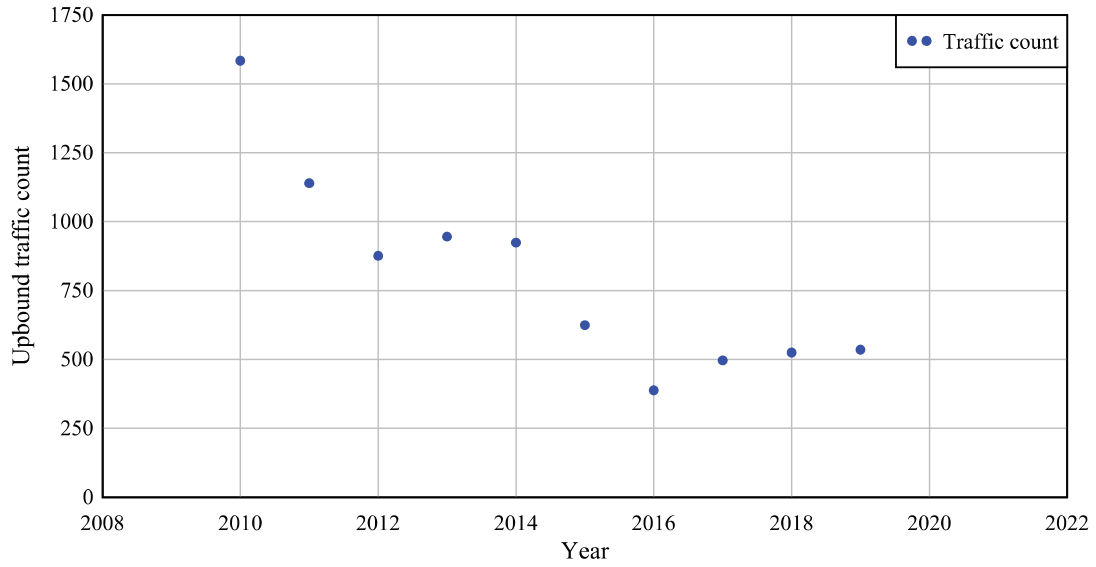

**Past point 31**  
Downbound

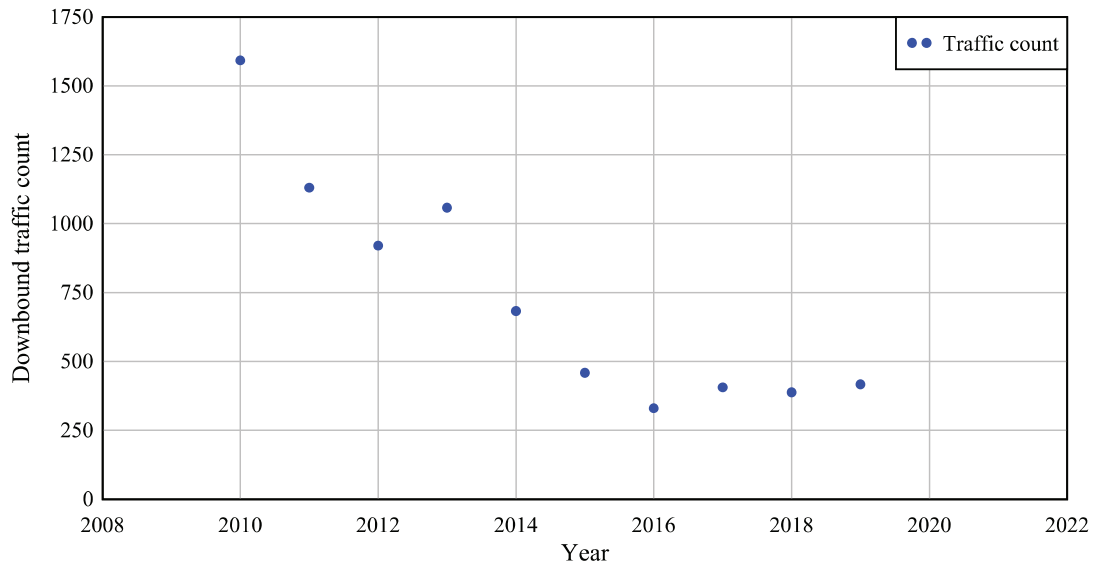

**Past point 32**  
Upbound

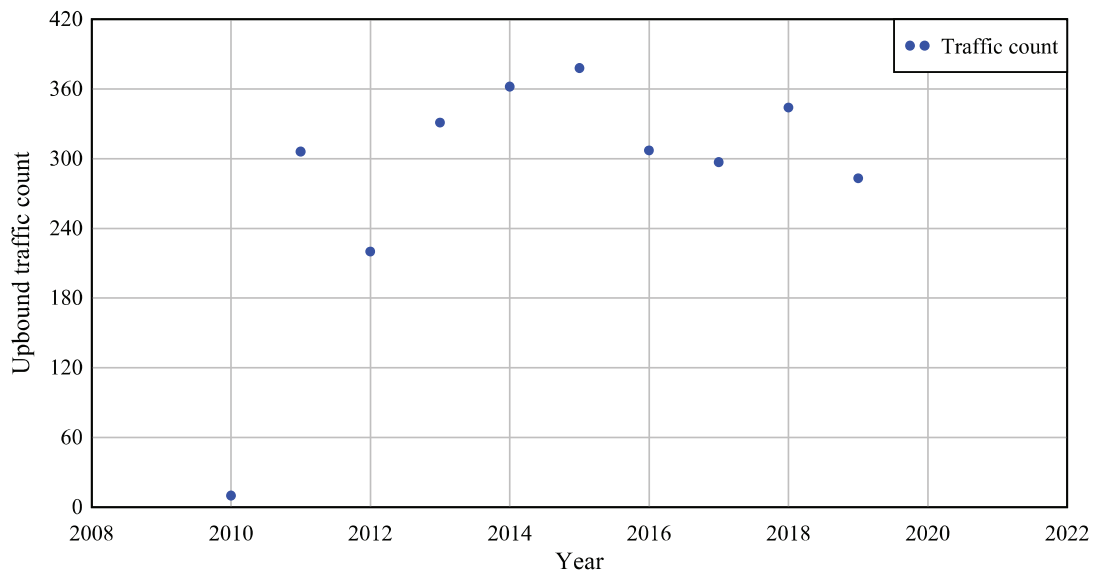

**Past point 32**  
Downbound

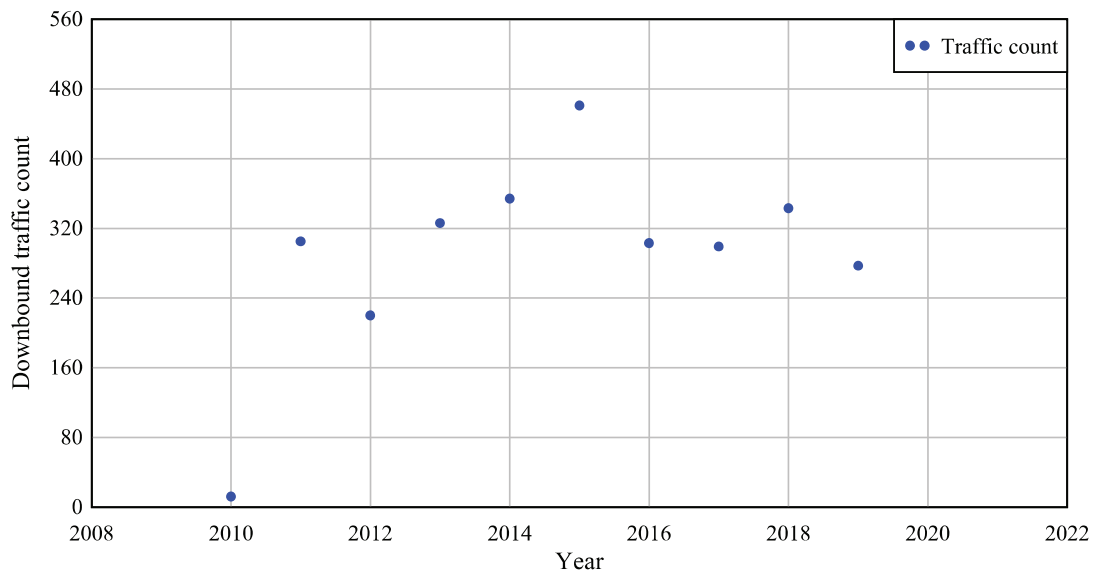

**Past point 33**  
Upbound

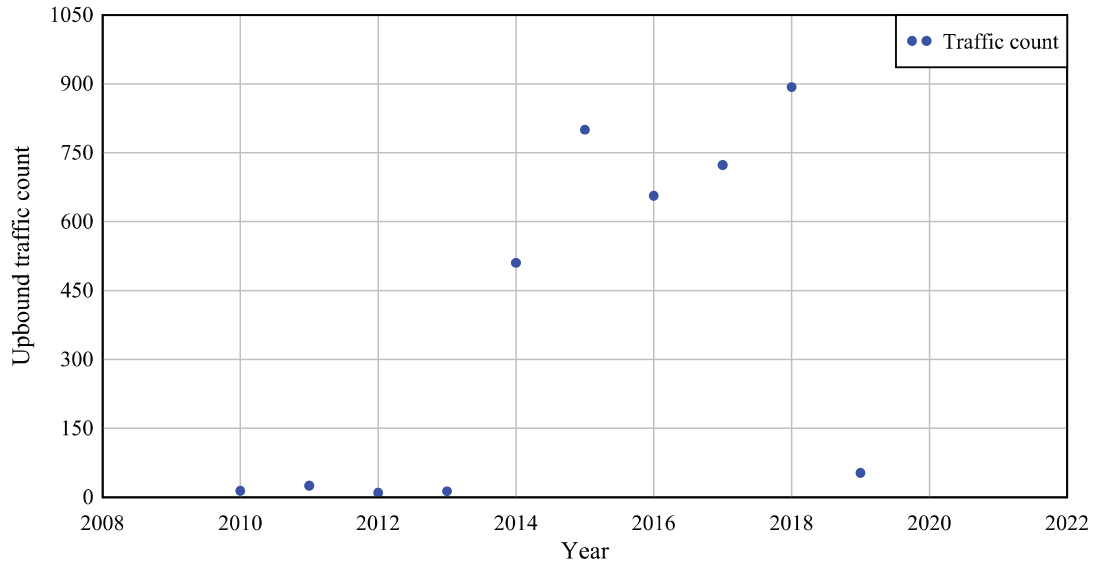

**Past Point 33**  
Downbound

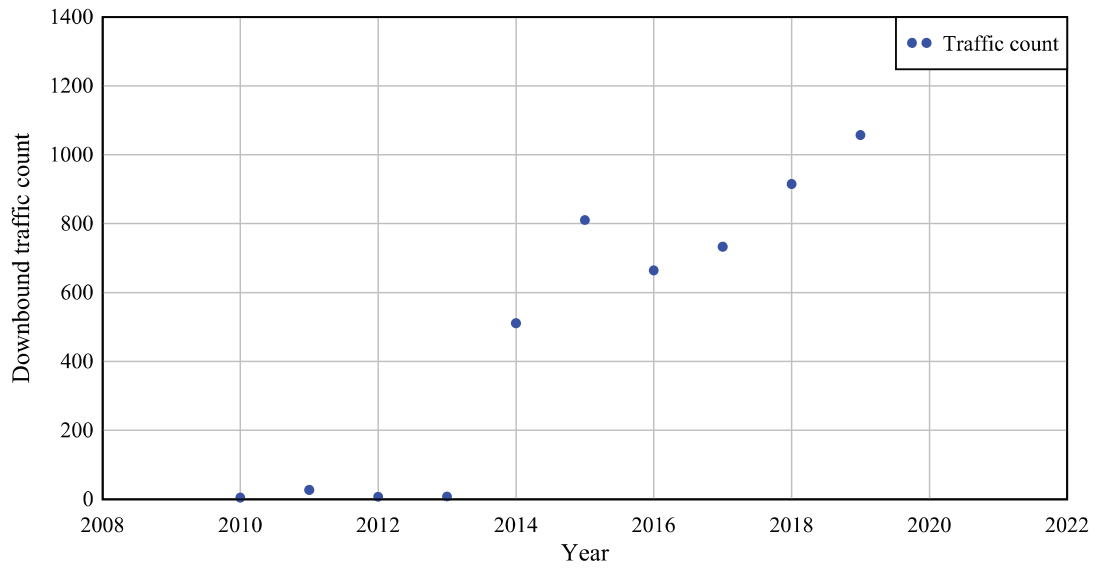

**Past point 34**  
Upbound

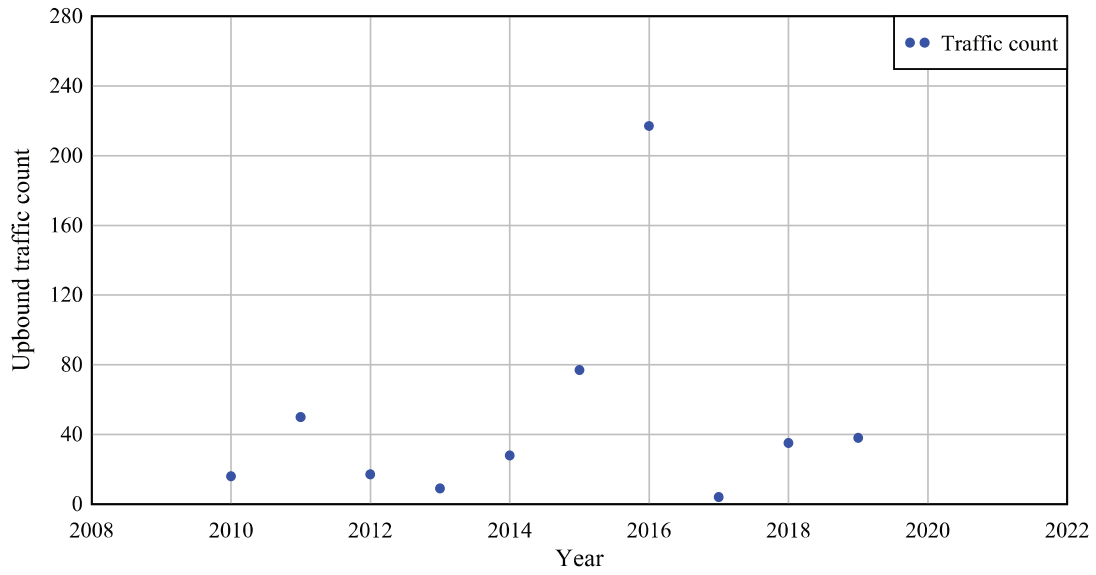

**Past point 34**  
Downbound

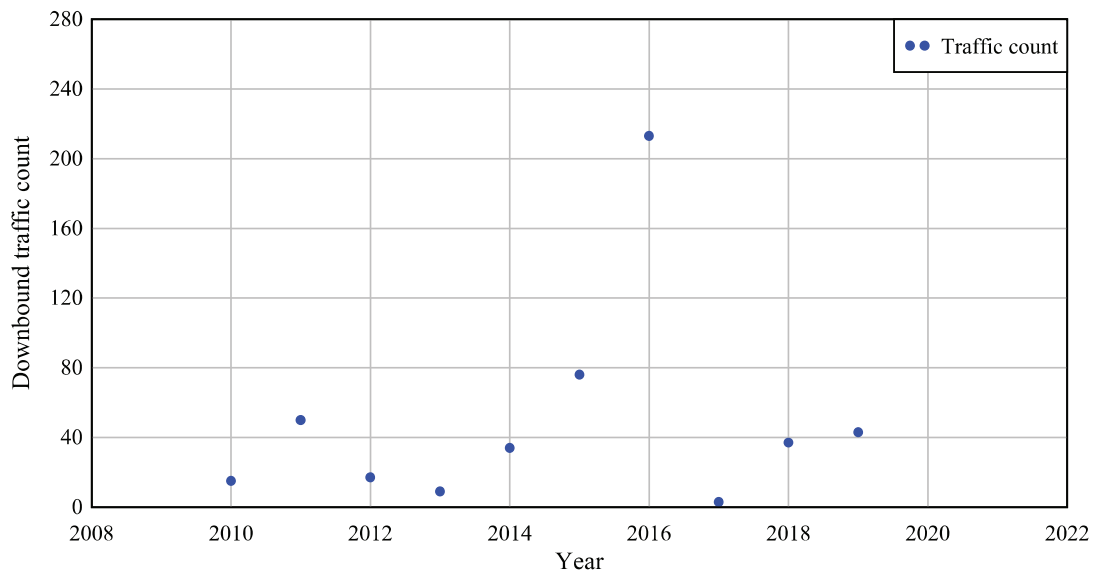

**Past point 35**  
Upbound

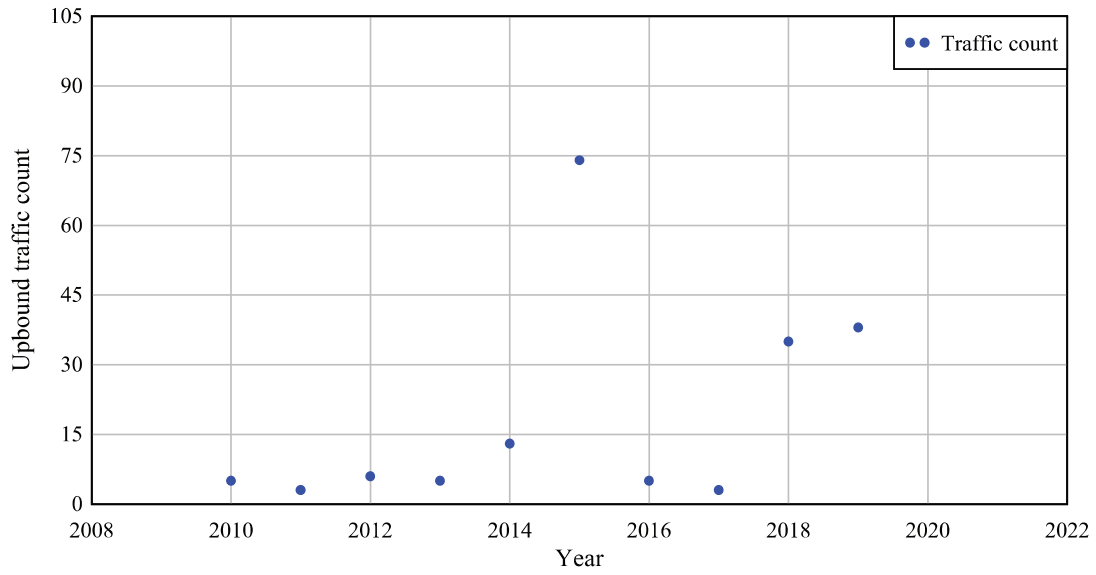

**Past point 35**  
Downbound

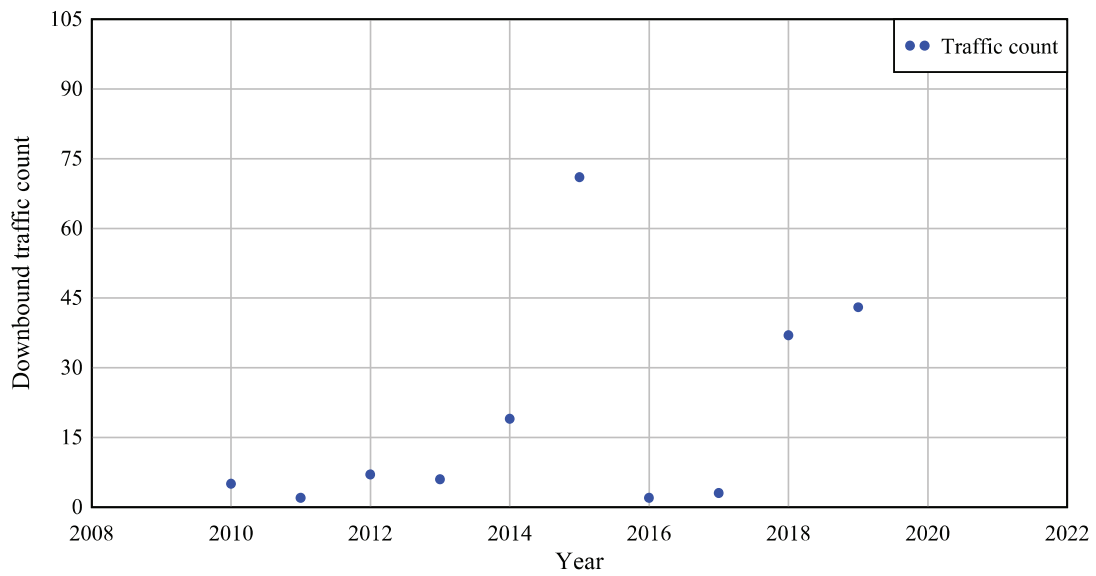

**Past point 36**  
Upbound

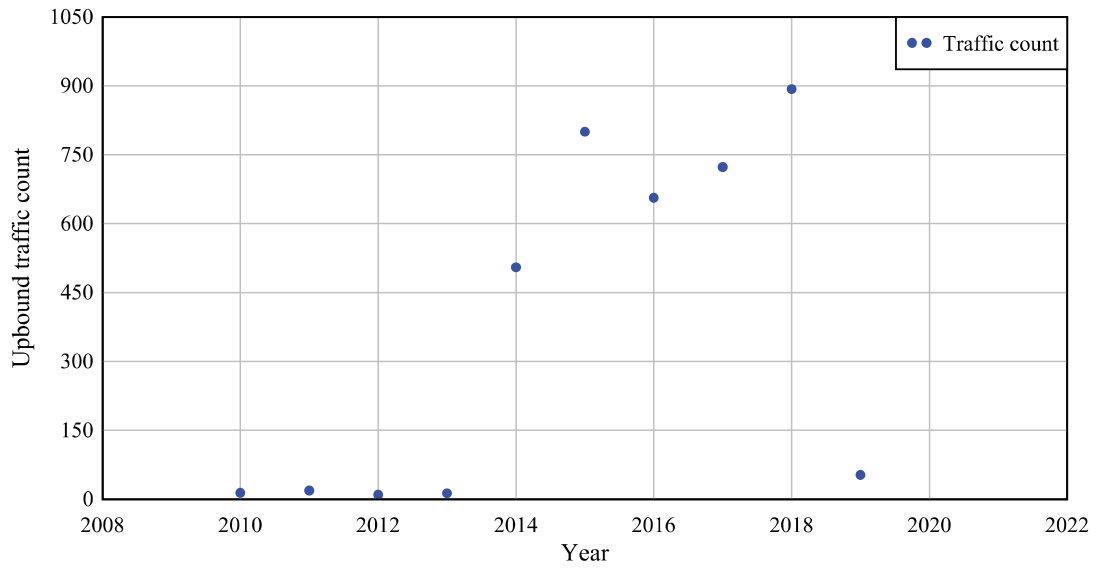

**Past point 36**  
Downbound

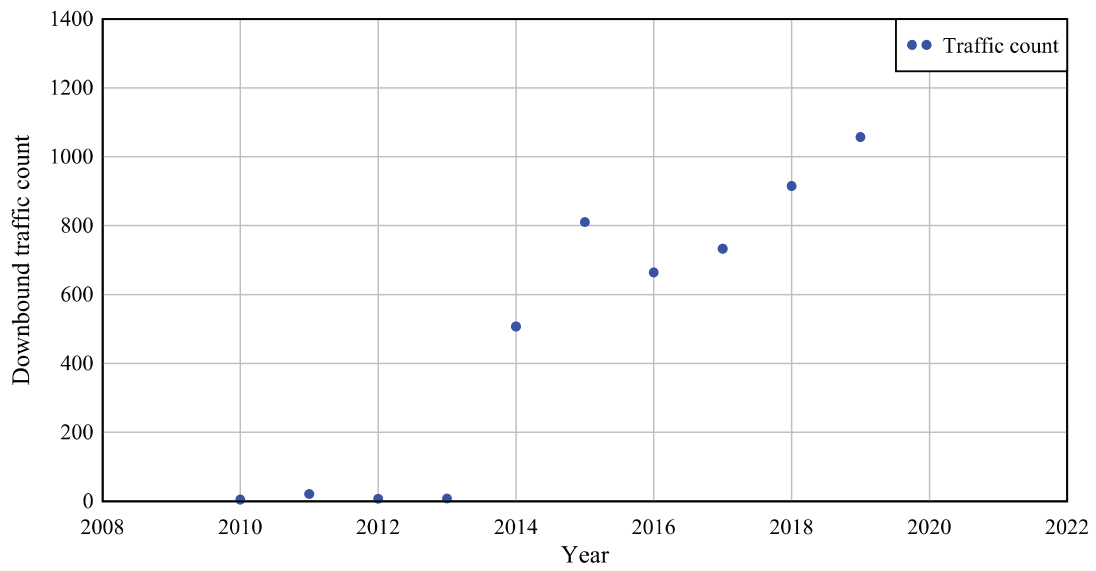



**Past point 37**  
Upbound

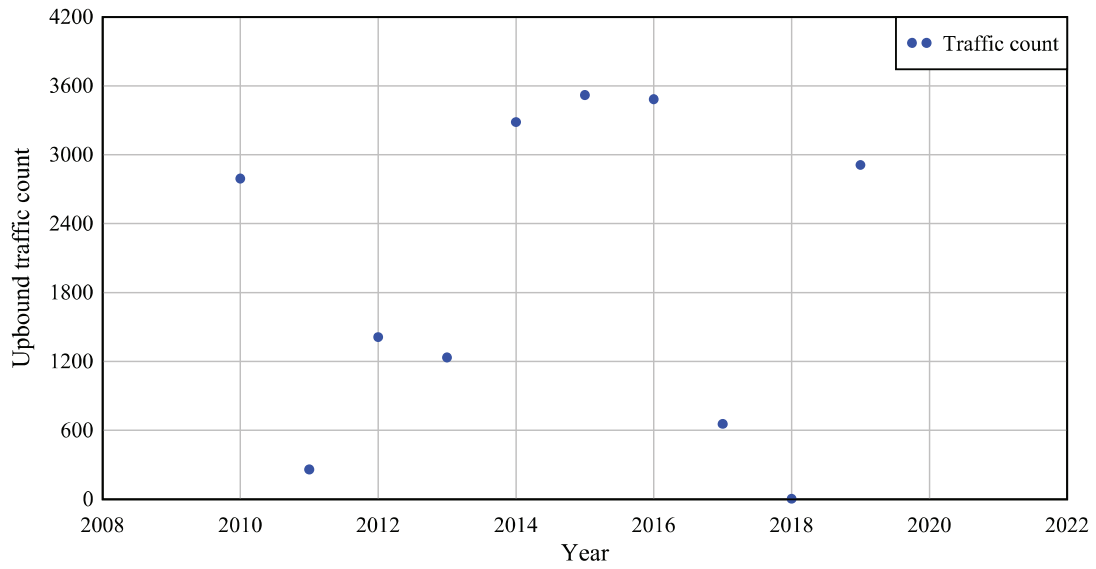

**Past point 37**  
Downbound

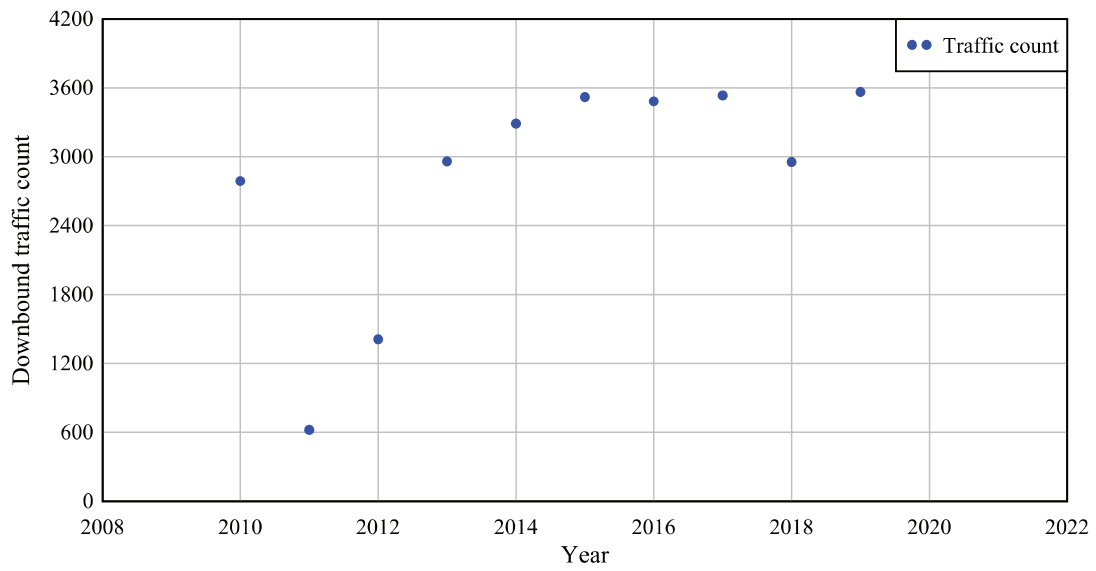

**Past point 38**  
Upbound

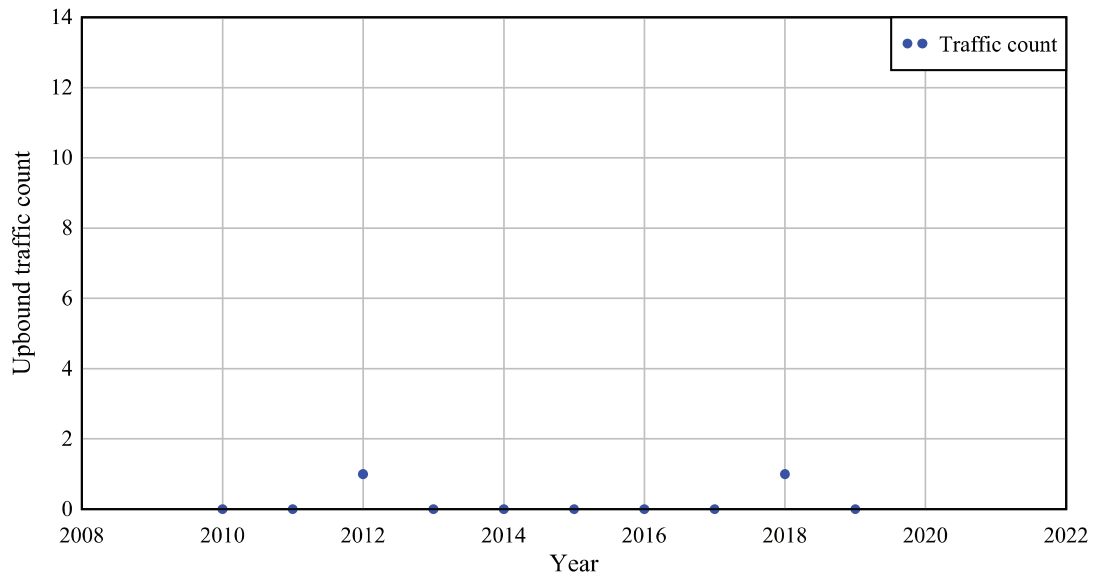

**Past point 38**  
Downbound

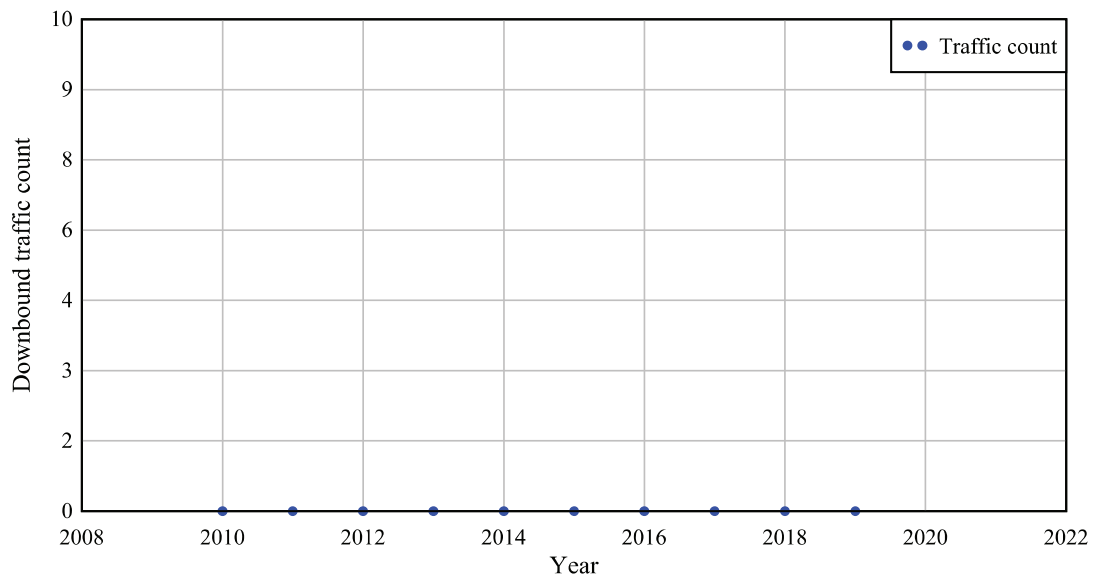

**Past point 39**  
Upbound

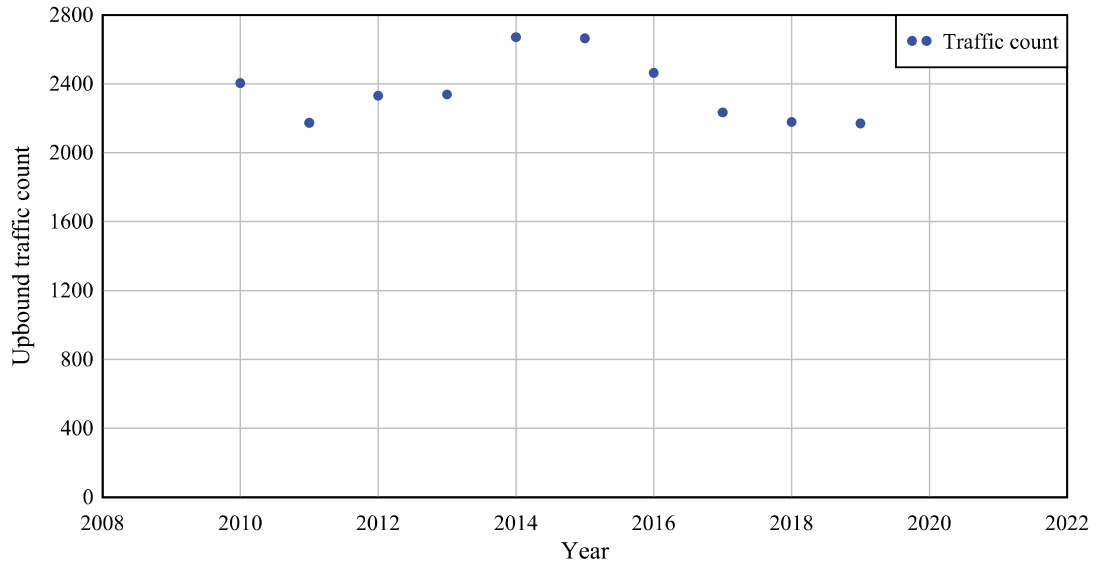

**Past point 39**  
Downbound

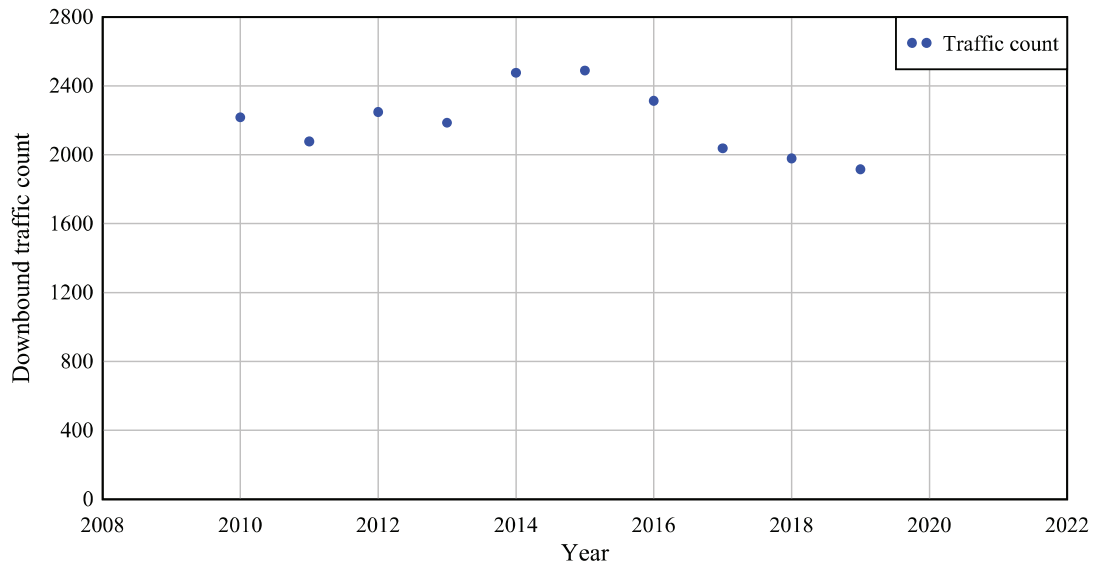

**Past point 40**  
Upbound

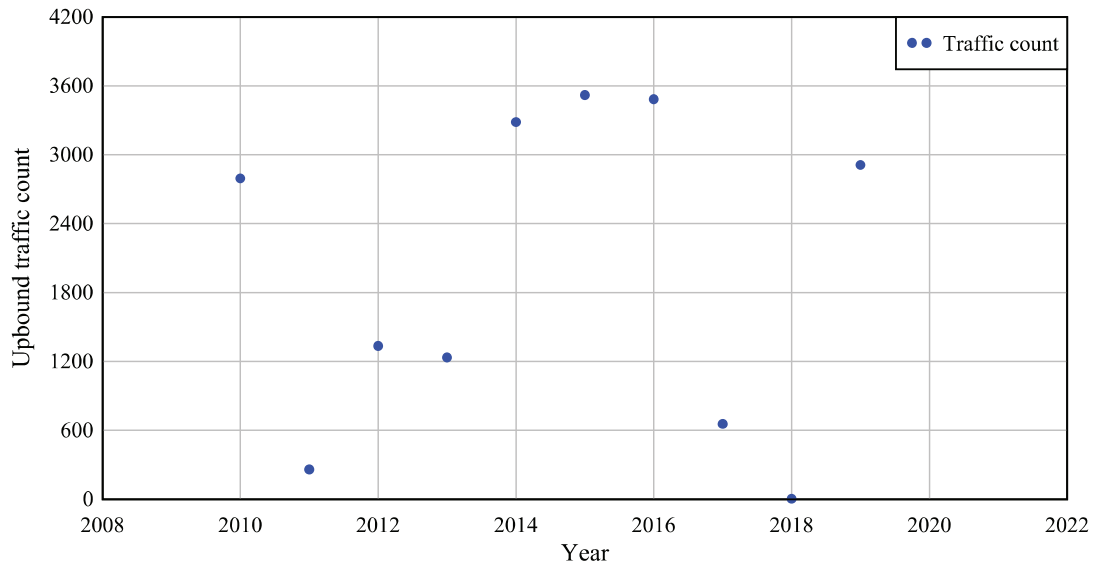

**Past point 40**  
Downbound

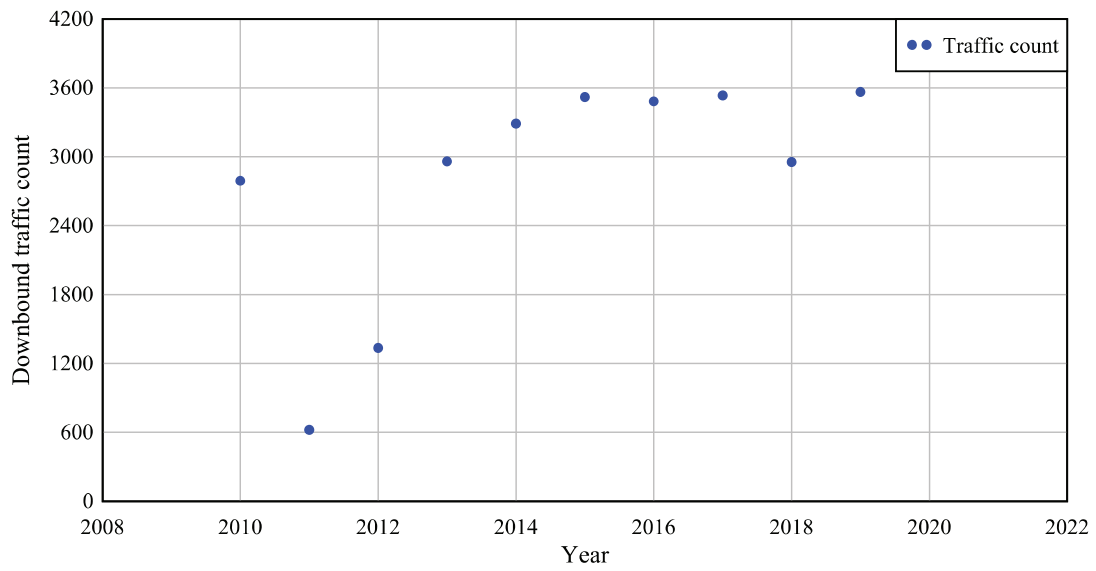

**Past point 41**  
Upbound

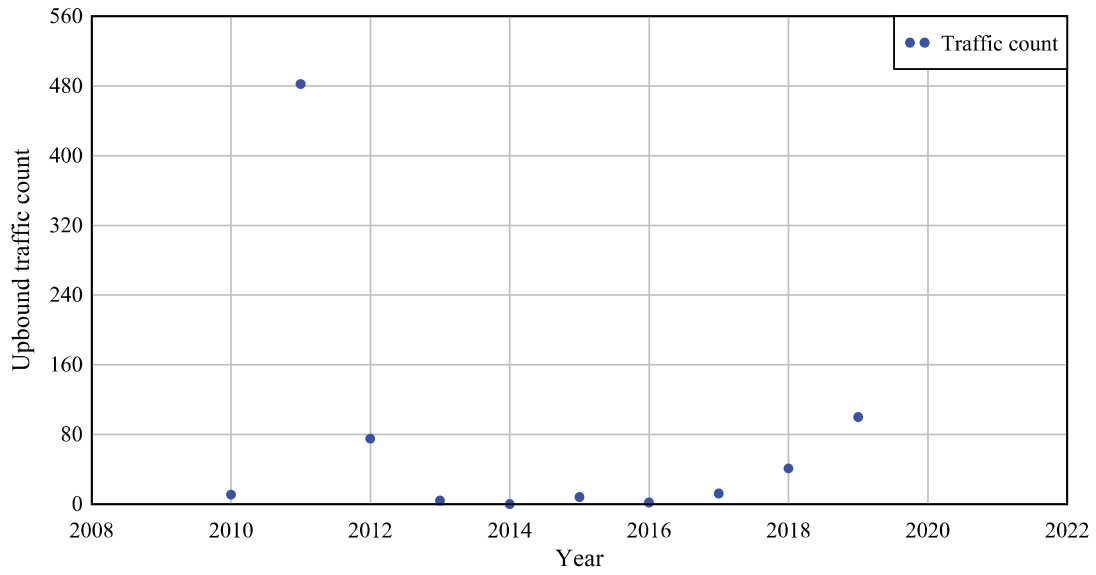

**Past point 41**  
Downbound

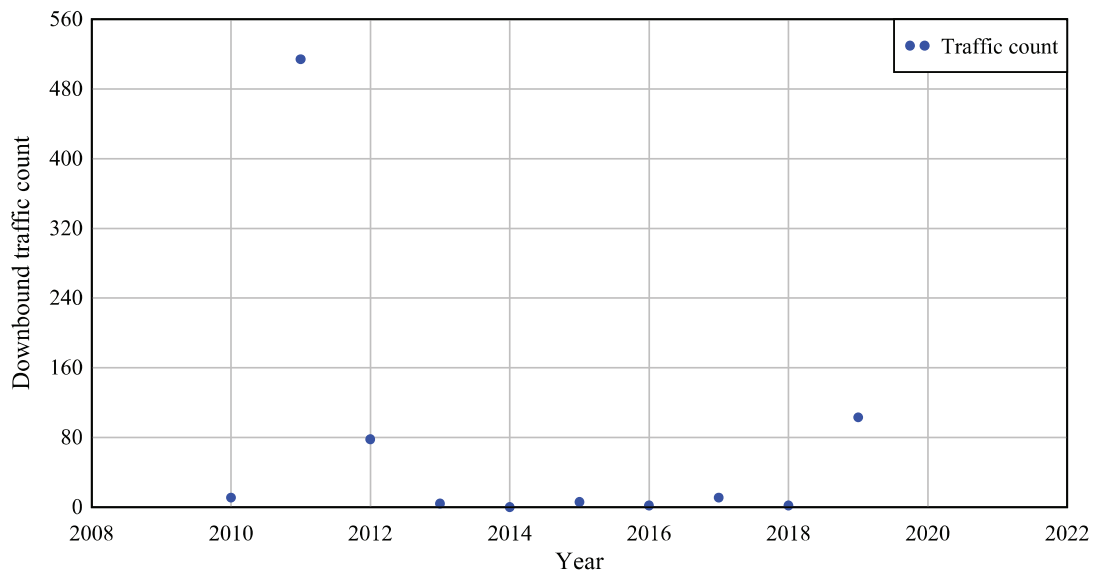

[No data for Past point 42 Upbound]

[No data for Past point 42 Downbound]

[No data for Past point 43 Upbound]

[No data for Past point 43 Downbound]

**Past point 44**  
Upbound

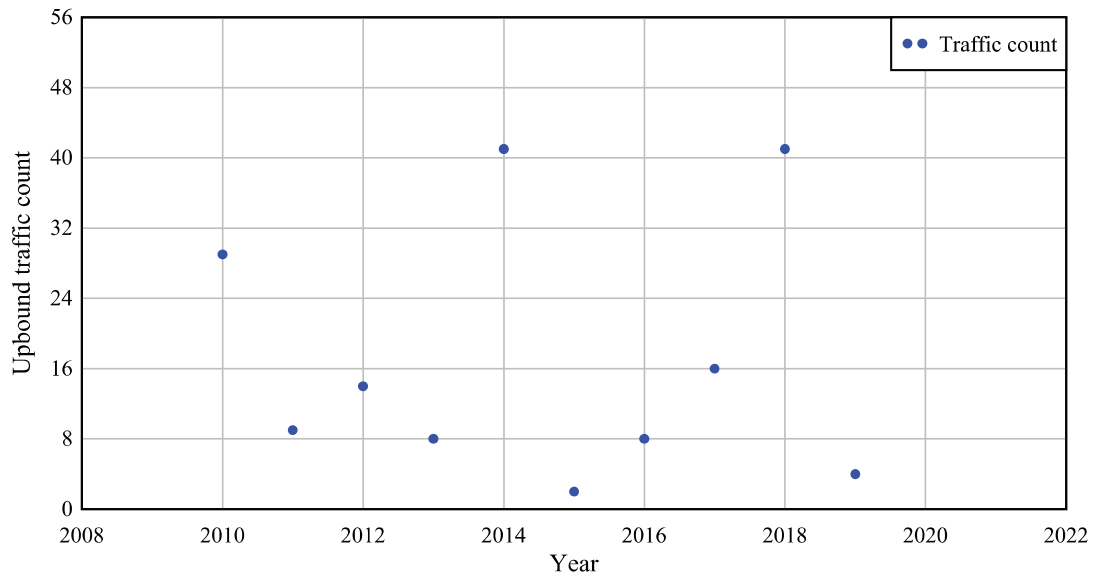

**Past point 44**  
Downbound

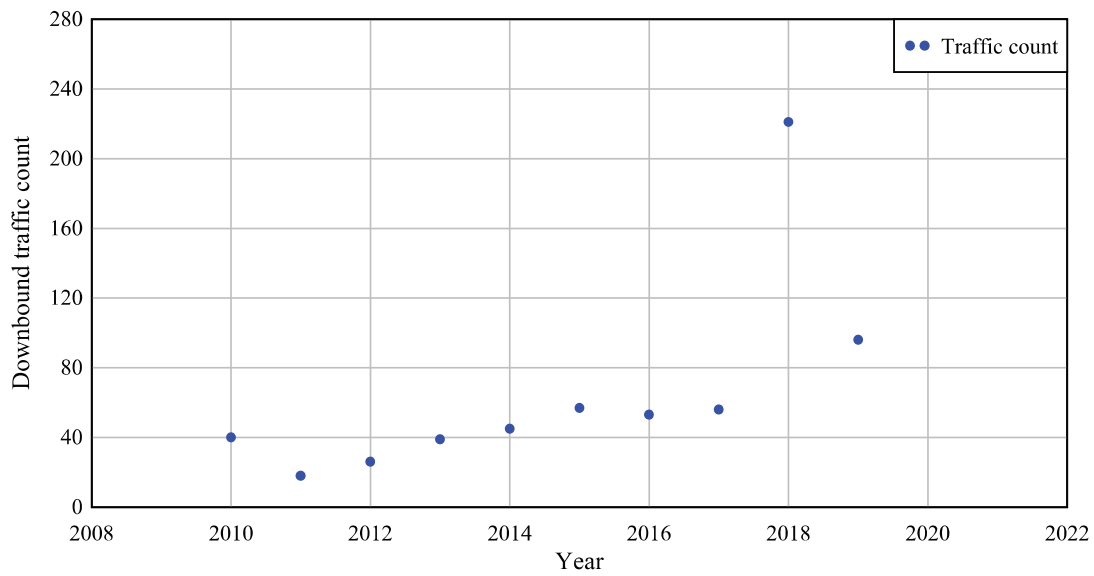



**Past point 45**  
Upbound

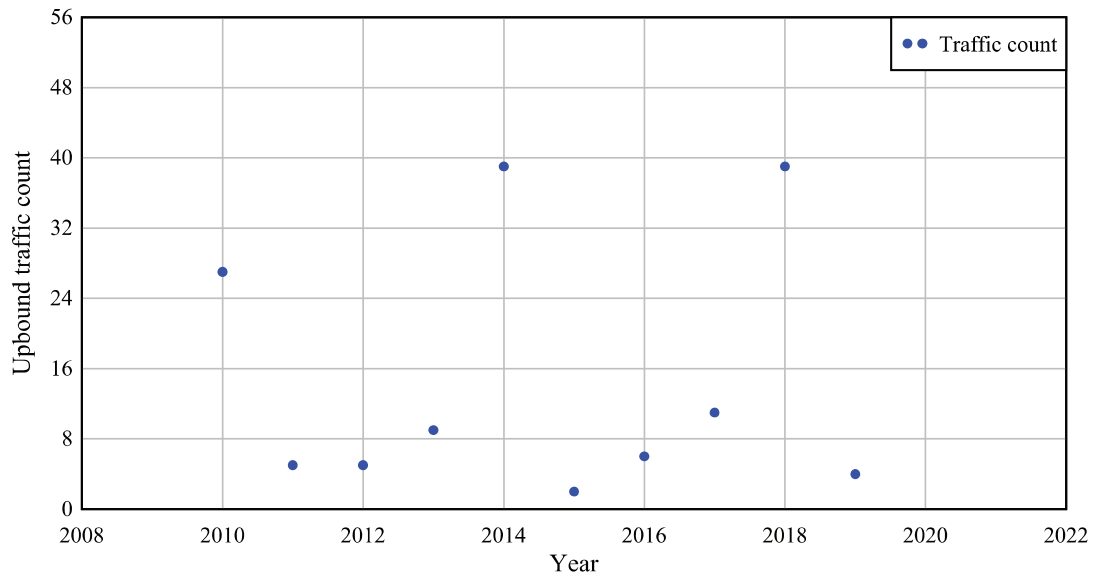

**Past point 45**  
Downbound

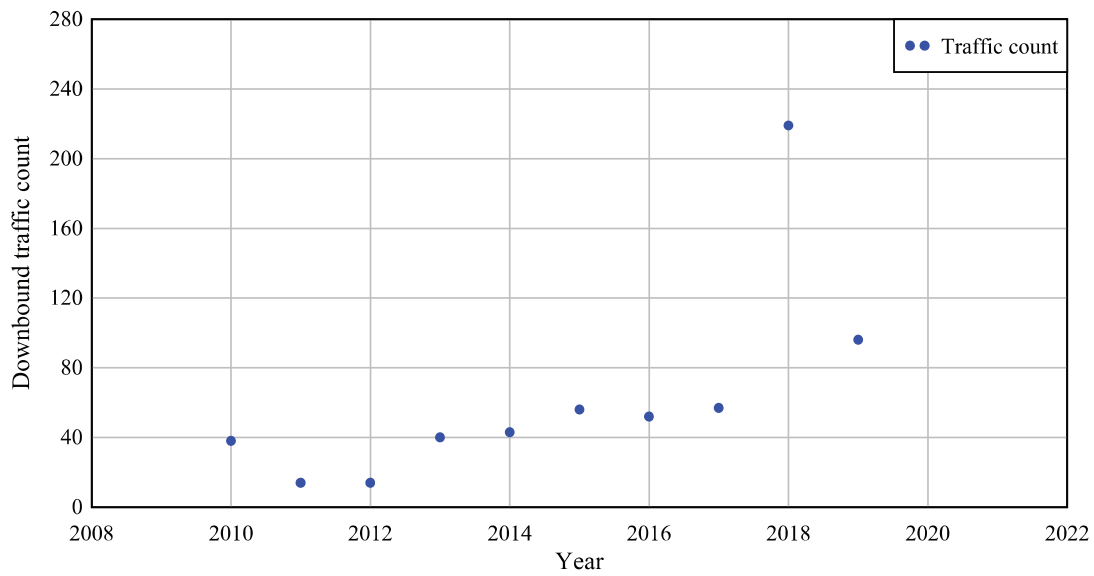

**Past point 46**  
Upbound

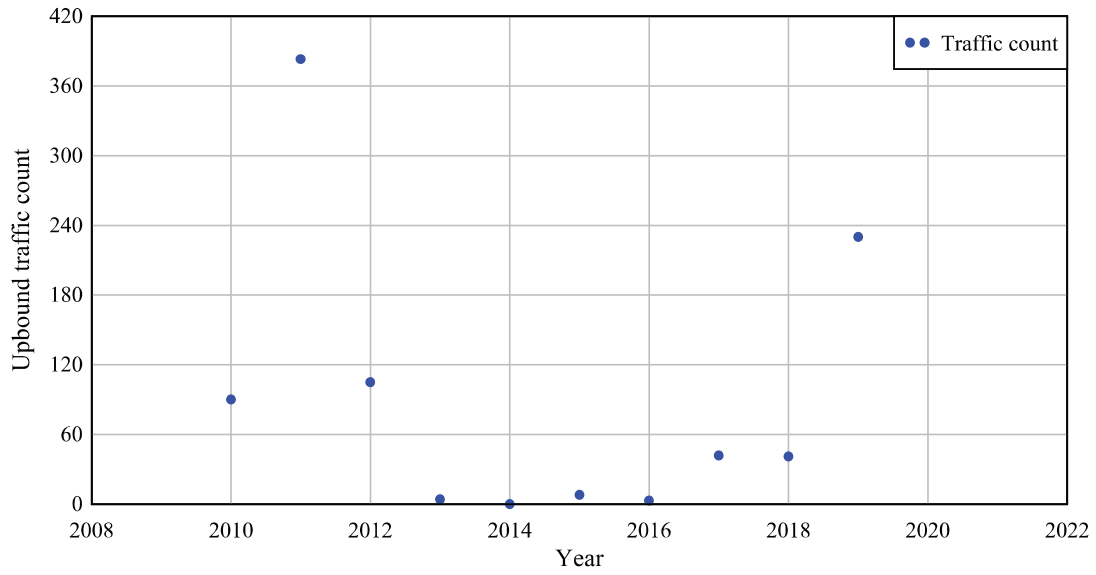

**Past point 46**  
Downbound

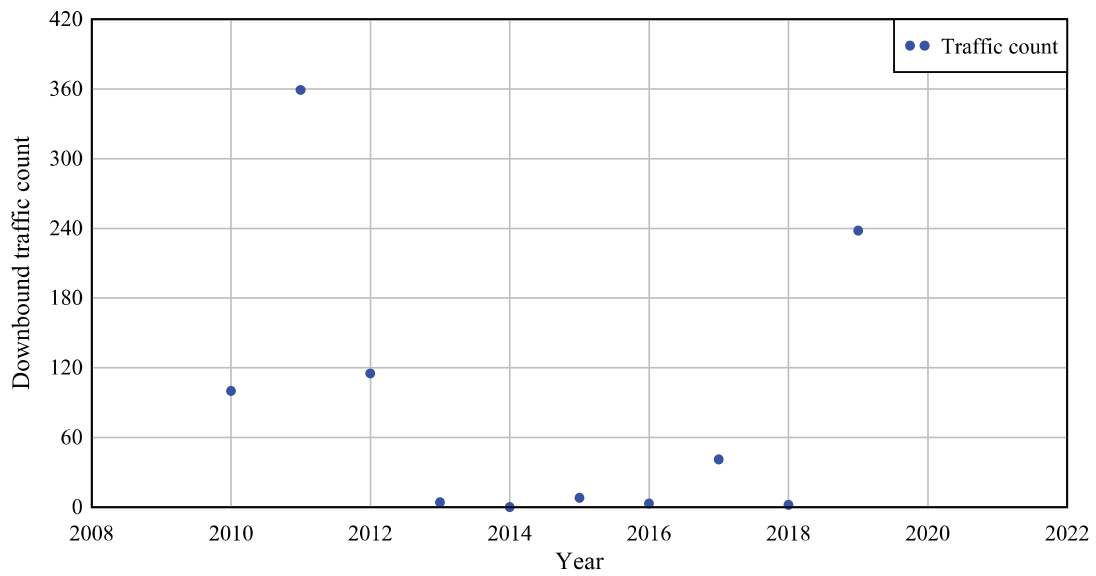

**Past point 47**  
Upbound

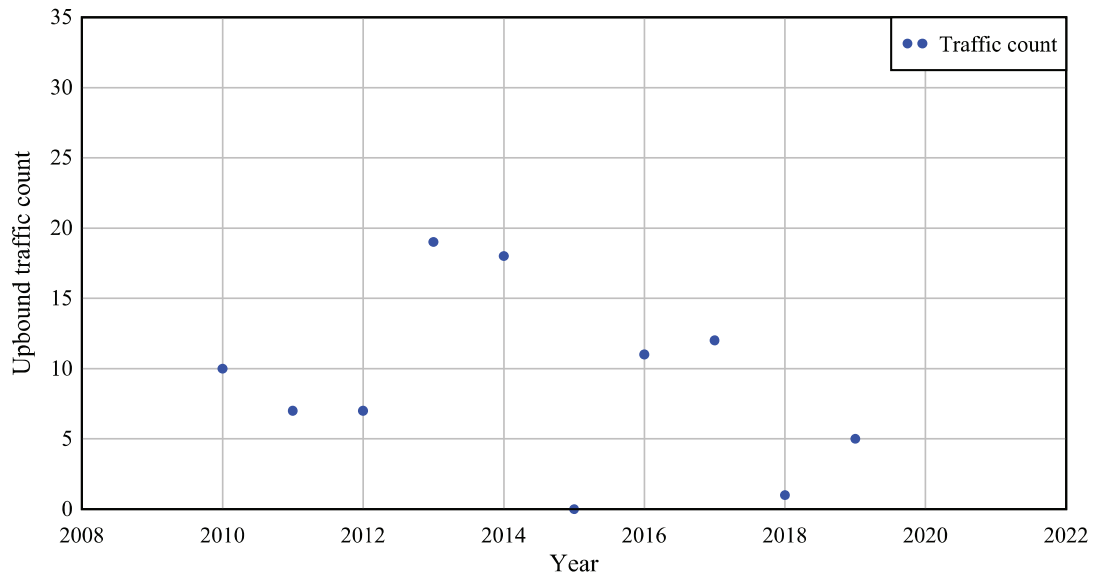

**Past point 47**  
Downbound

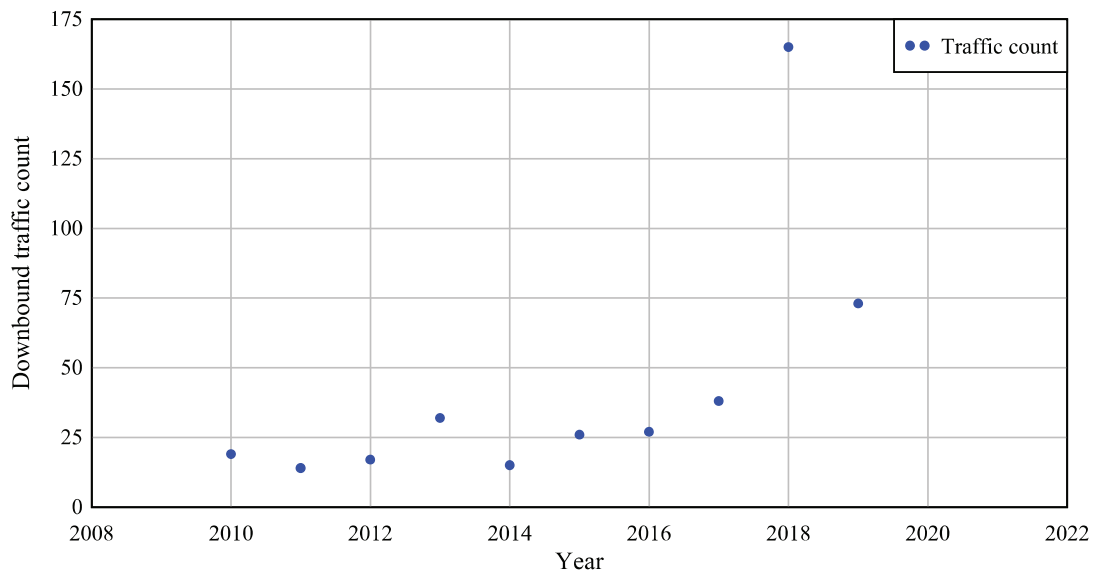

**Past point 48**  
Upbound

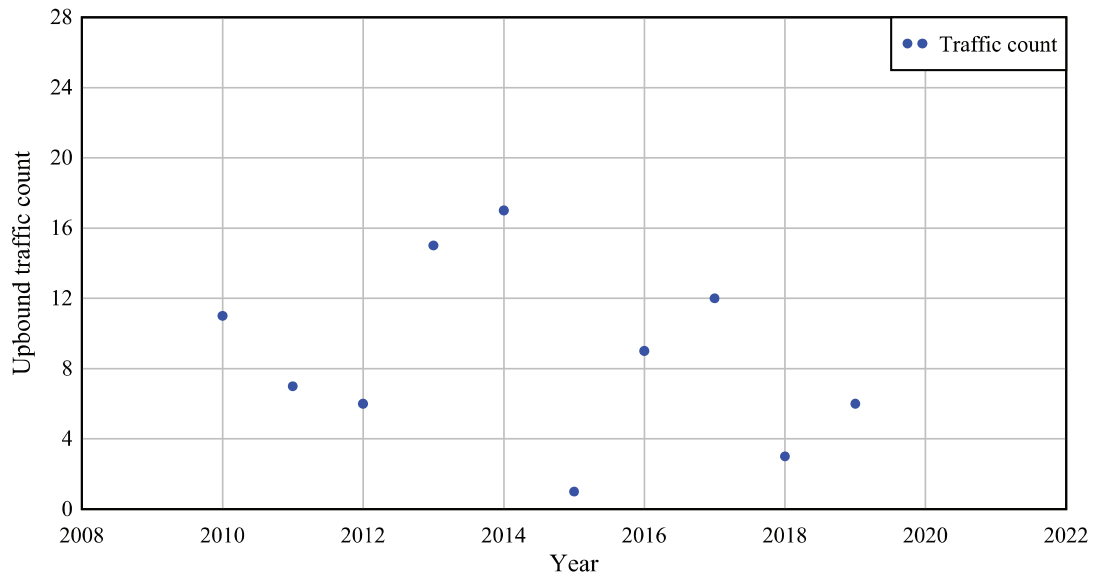

**Past point 48**  
Downbound

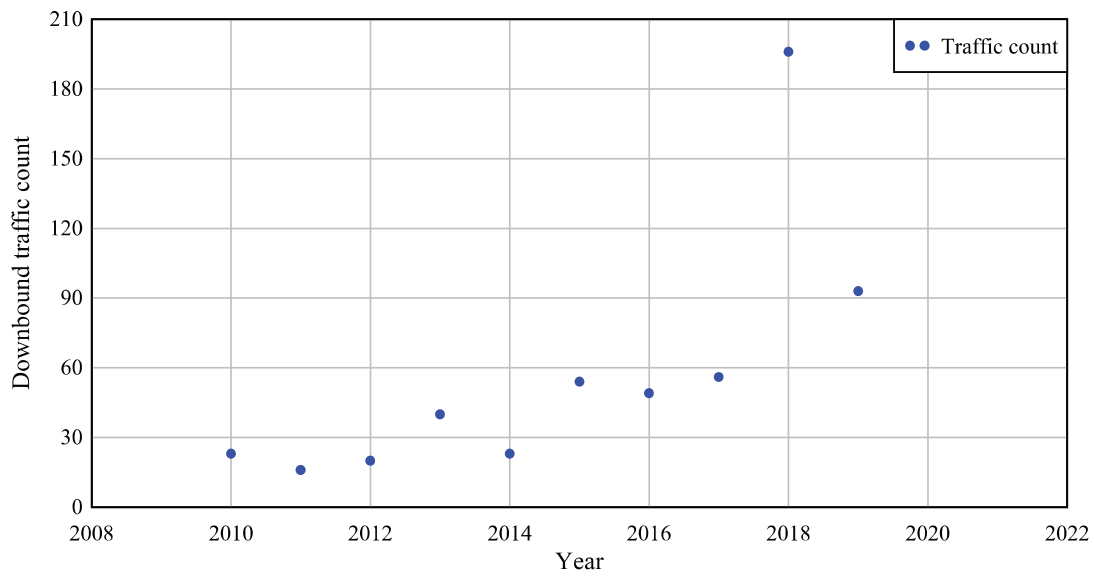

**Past point 49**  
Upbound

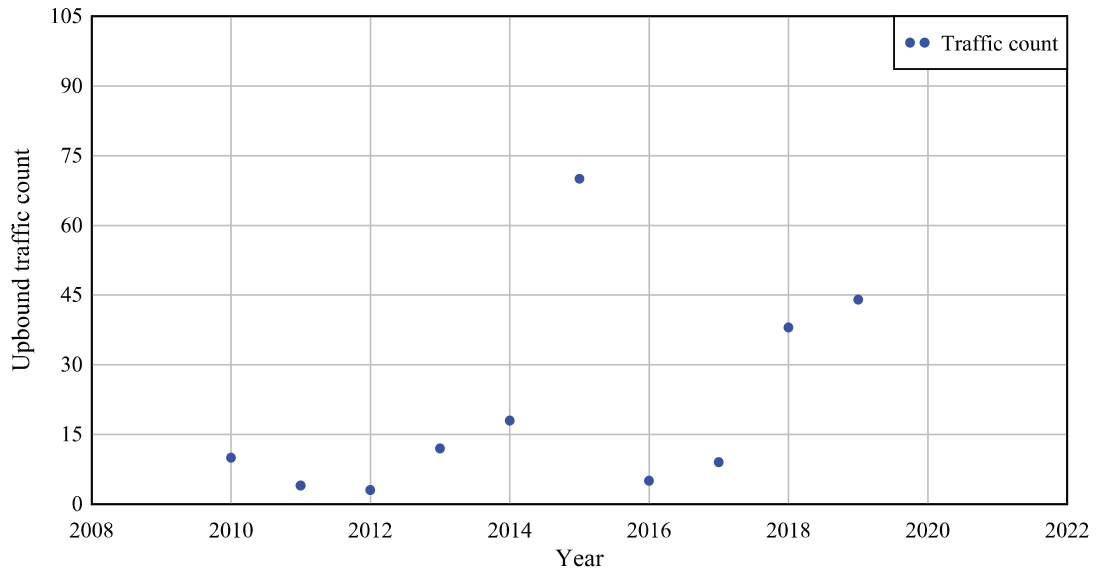

**Past point 49**  
Downbound

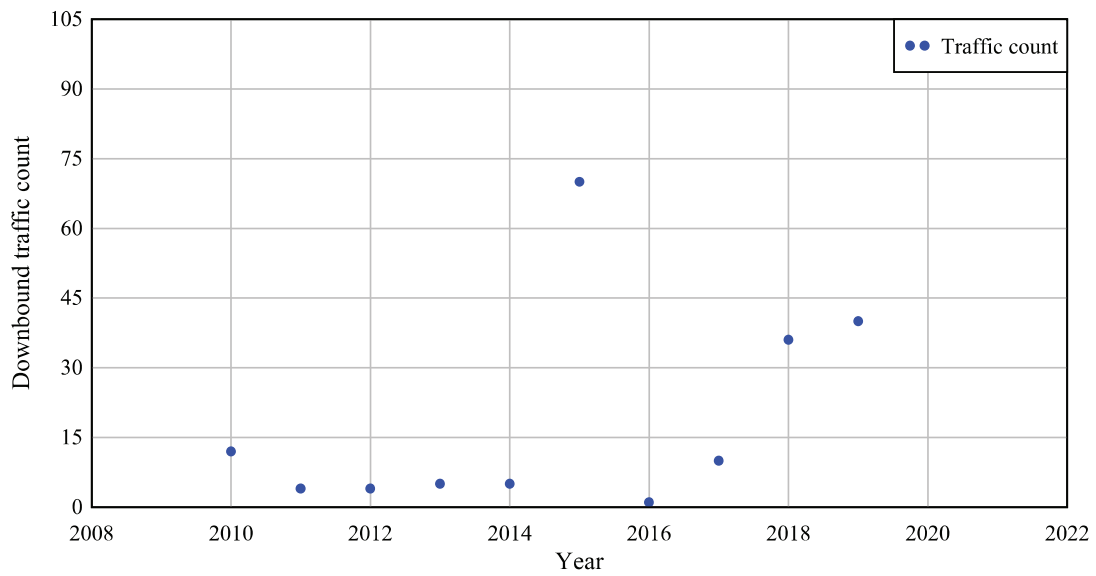

**Past point 50**  
Upbound

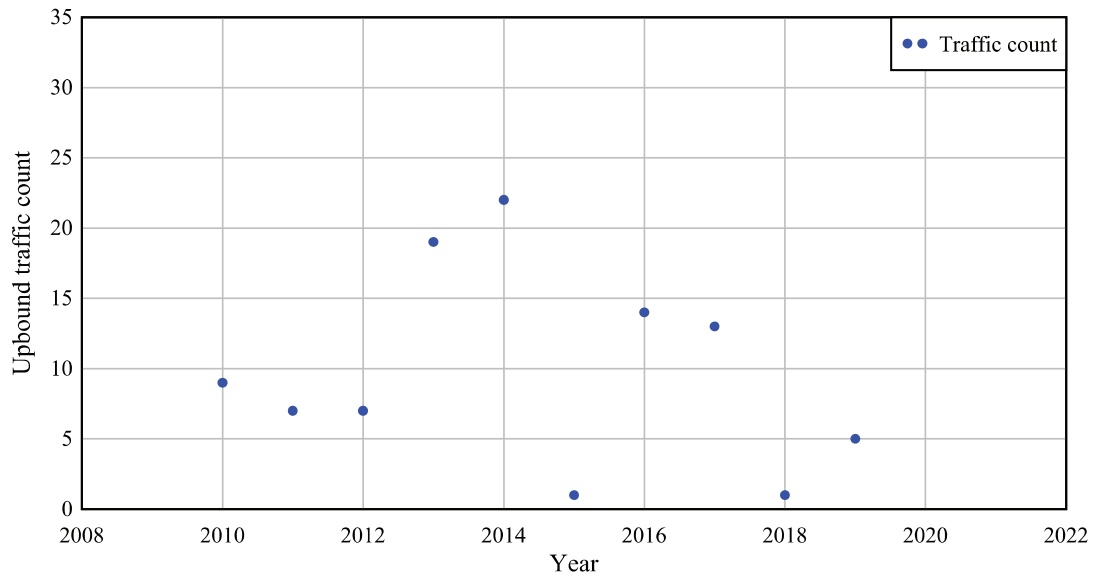

**Past point 50**  
Downbound

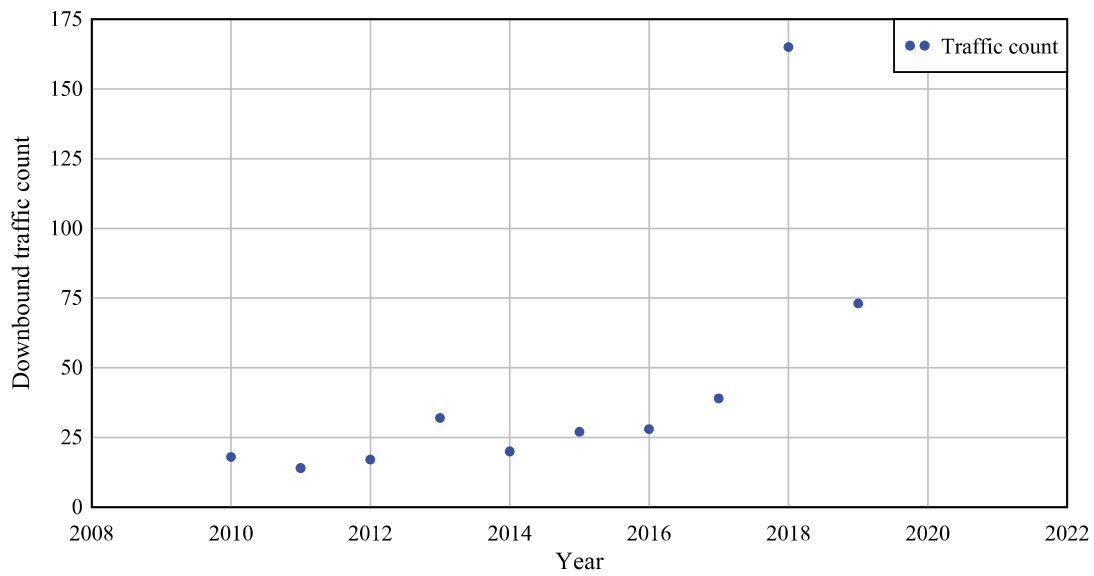

### Past point 51

Upbound

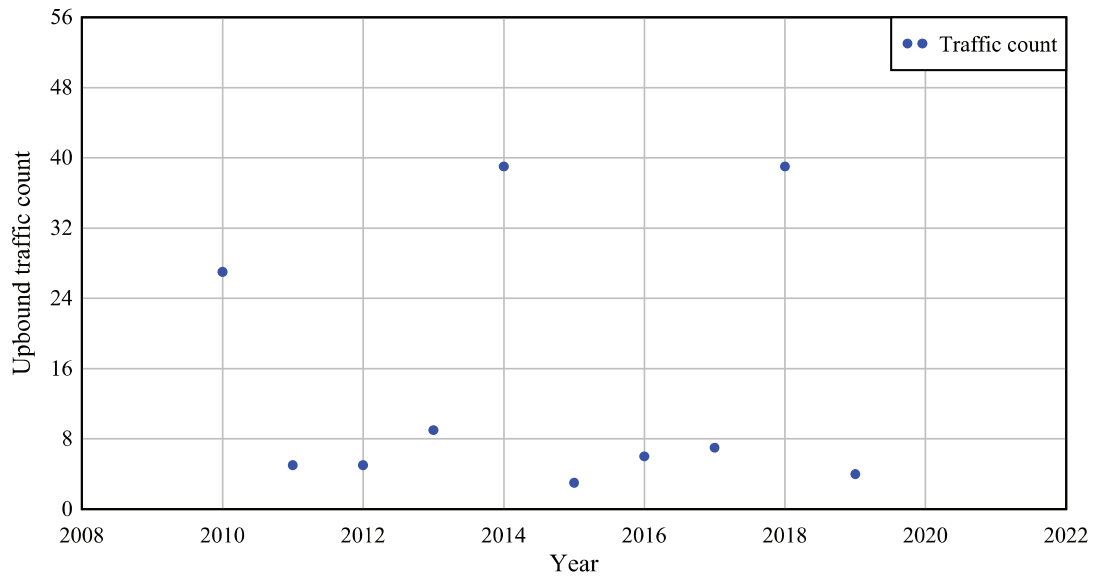

### Past point 51

Downbound

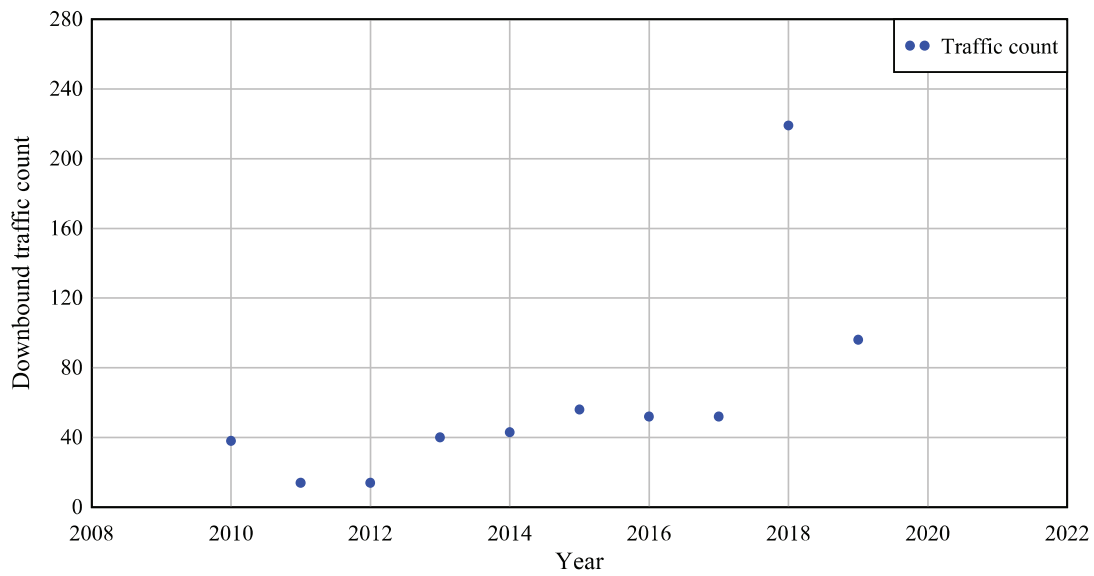

**Past point 52**  
Upbound

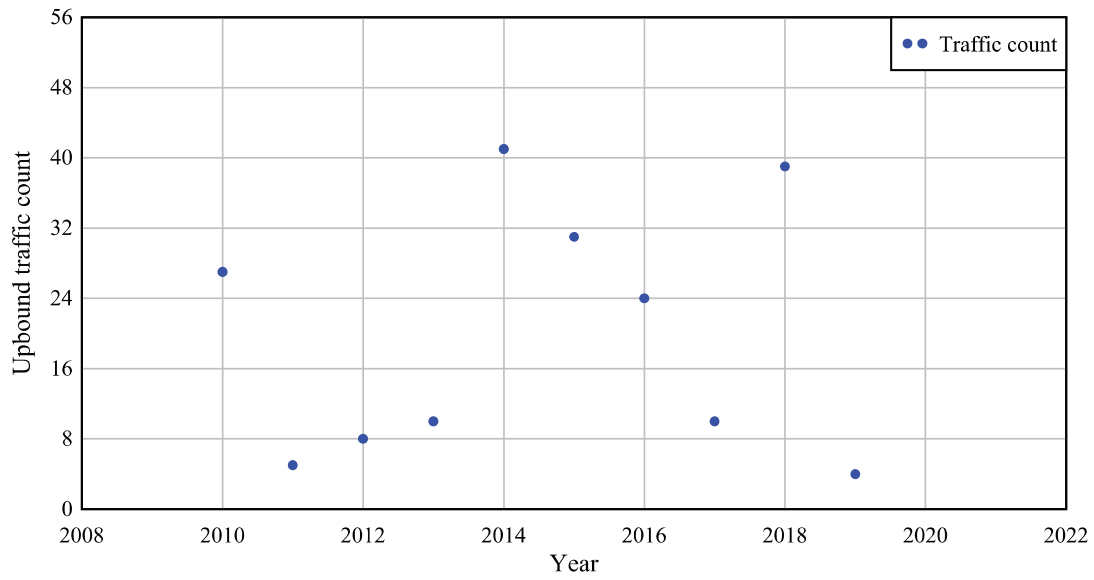

**Past point 52**  
Downbound

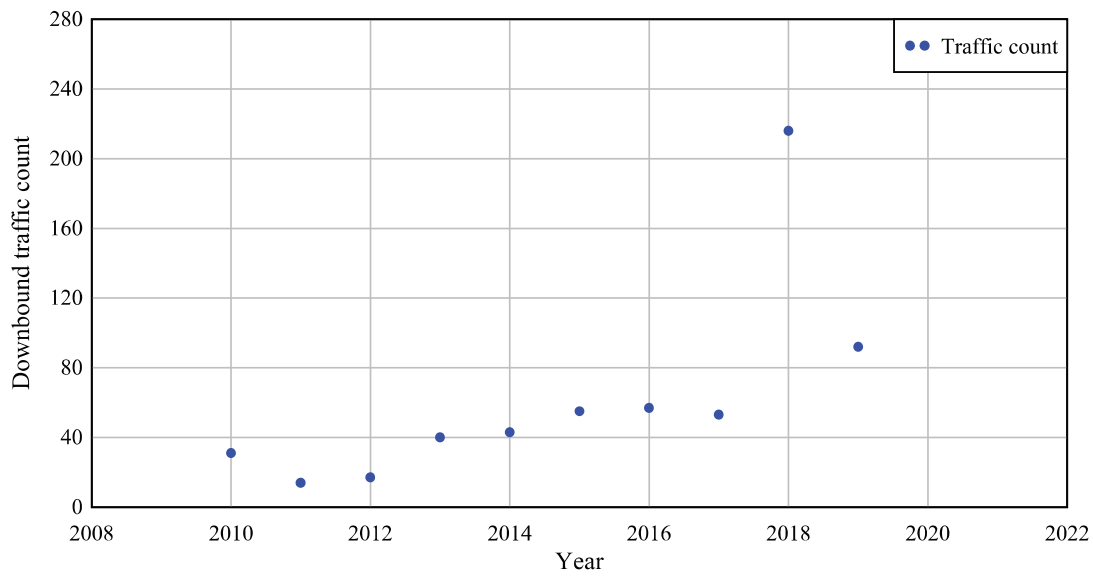



## APPENDIX B PAST POINT FUTURE TRAFFIC PROJECTIONS

To model the anticipated future traffic at each past point, a three parameter power model was utilized:

$$N(t) = N(y - y_0) = a_0 \cdot t^{a_1} + a_2 ; \text{ where } y_0 = 2009 \quad (\text{B-1})$$

where the fitting parameters (degrees of freedom) consisted of:  $a_0$ , a linear coefficient;  $a_1$ , a power exponent; and,  $a_2$ , an offset. For a particular year ( $y$ ) of interest,  $t = (y - y_0)$ , and  $N(t)$  is evaluated to estimate the number of annual vessel trips. Numeric values of  $a_0$ ,  $a_1$ , and  $a_2$  determined for each past point are provided in Table B-1. Note that the number of trips,  $N$ , computed using Equation B-1 corresponds to the total number of annual trips for both the upbound and downbound traffic directions, and for all vessel groups. To determine the number of annual trips for a particular direction (upbound, downbound) and particular vessel group, the scale factors documented in Appendix C are utilized.

Graphical plots of the future traffic projection models for all past points are provided after Table B-1.

Table B.1 Parameters of traffic projection power model curves

Past point	a0	a1	a2
1	847.821	-2.085	513.257
2	135.550	-0.019	-26.900
3	-76.754	-0.318	79.454
4	11.236	-2.169	3.983
5	-109.681	-0.304	118.741
6	-204.143	-0.399	182.894
7	872.908	0.231	626.047
8	3149.926	0.087	1154.631
9	[No data recorded by USACE]	N/A	N/A
10	[No data recorded by USACE]	N/A	N/A
11	[No data recorded by USACE]	N/A	N/A
12	[No data recorded by USACE]	N/A	N/A
13	313.524	-1.279	1124.919
14	-31.005	-0.418	32.697
15	-5.483	0.168	81.064
16	[No statistically meaningful data]	N/A	N/A
17	0.000	0.000	84.200
18	0.000	0.000	85.600
19	[No data recorded by USACE]	N/A	N/A
20	-35.567	-0.468	27.411
21	-307.390	-0.130	299.318
22	3081.644	0.182	3346.969
23	7998.852	0.030	-7820.152
24	177.008	-1.271	312.671
25	2026.778	-1.740	1763.848
26	2984.452	-1.846	2416.763
27	898.019	-2.128	698.470
28	-113.584	-0.275	126.191
29	[No data recorded by USACE]	N/A	N/A
30	287.663	-1.676	352.800
31	860.358	-2.045	579.518
32	-666.798	-1.822	696.155
33	763.232	0.252	720.182
34	-83.458	-0.679	94.898
35	-181.795	-0.356	165.221
36	580.899	0.304	809.763
37	3111.015	0.140	1853.078
38	[No statistically meaningful data]	N/A	N/A
39	208.773	-1.492	3345.386
40	2873.731	0.151	2064.967
41	120.425	-0.736	109.704
42	[No data recorded by USACE]	N/A	N/A
43	[No data recorded by USACE]	N/A	N/A
44	-89.437	-0.345	106.858
45	-106.083	-0.351	115.813
46	27.567	0.648	104.183
47	-94.745	-0.407	96.114
48	-107.025	-0.447	104.310
49	-190.576	-0.436	155.982
50	-117.088	-0.518	93.720
51	-114.787	-0.334	117.602
52	-81.262	-0.388	99.765

Past point 1

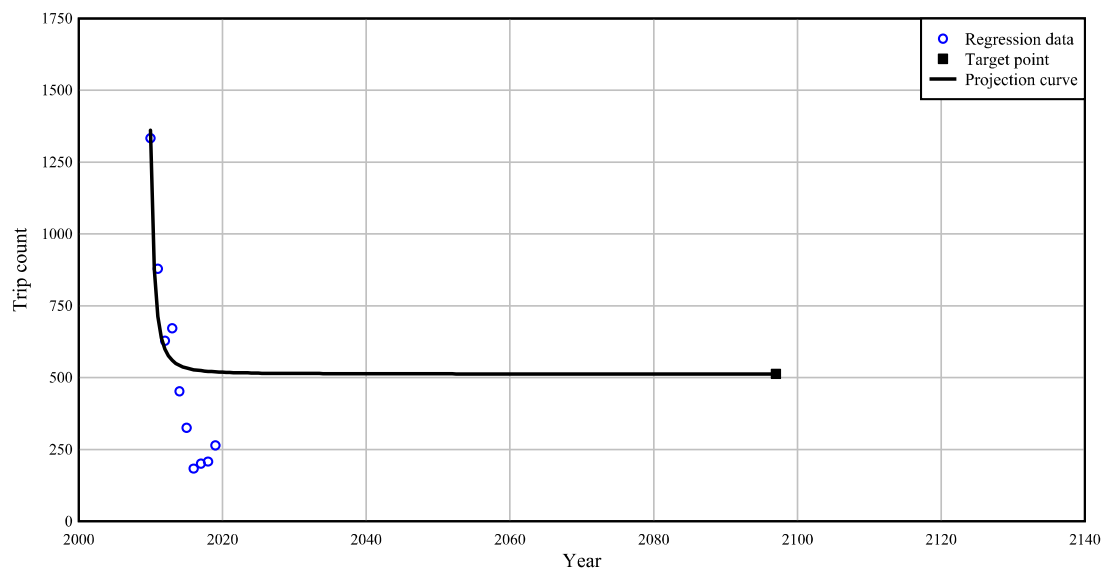

Past point 2

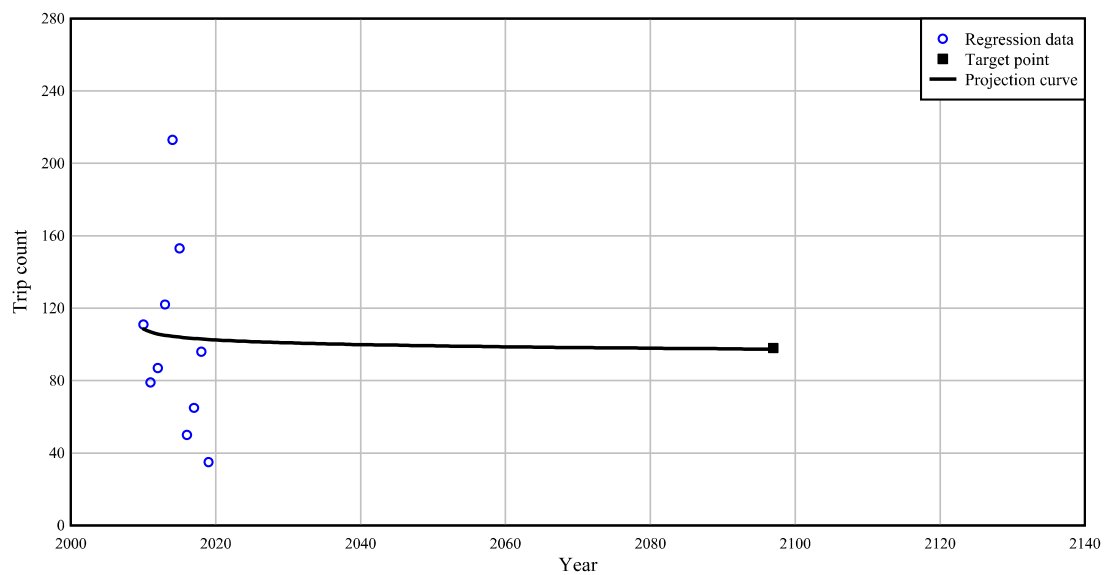

### Past point 3

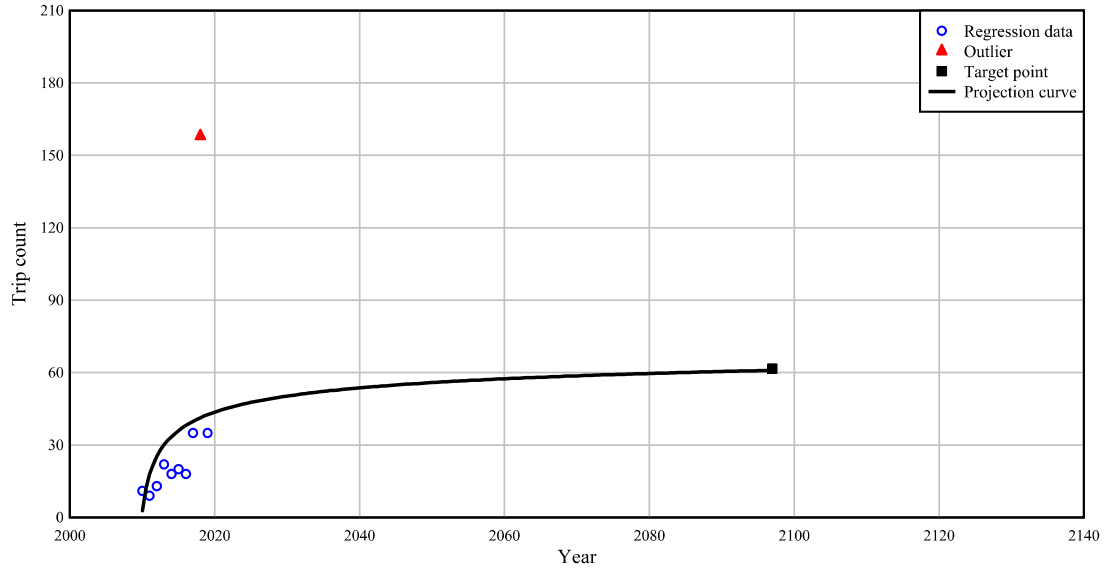

### Past point 4

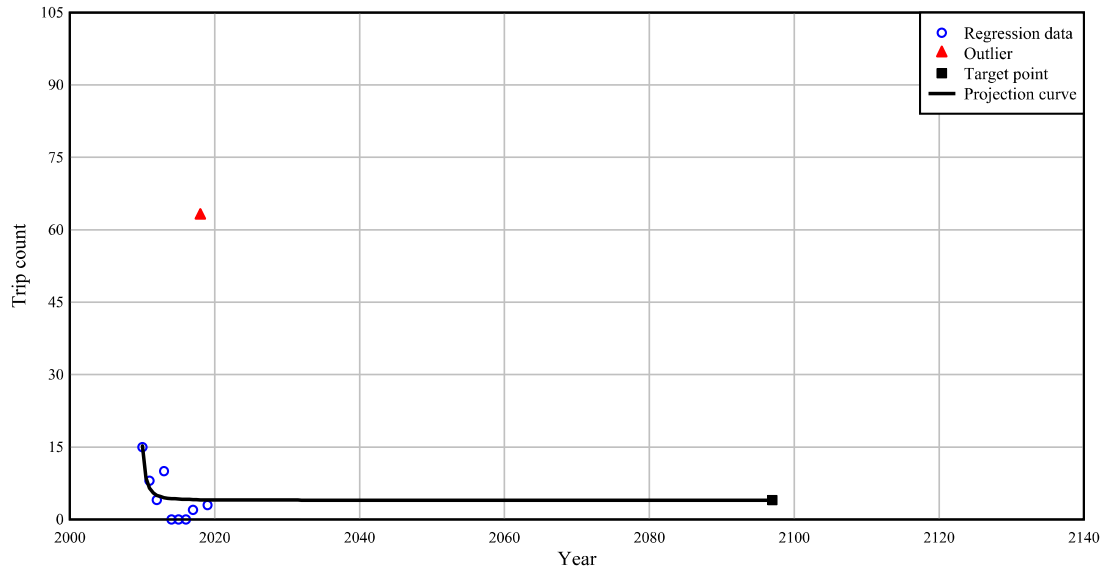

Past point 5

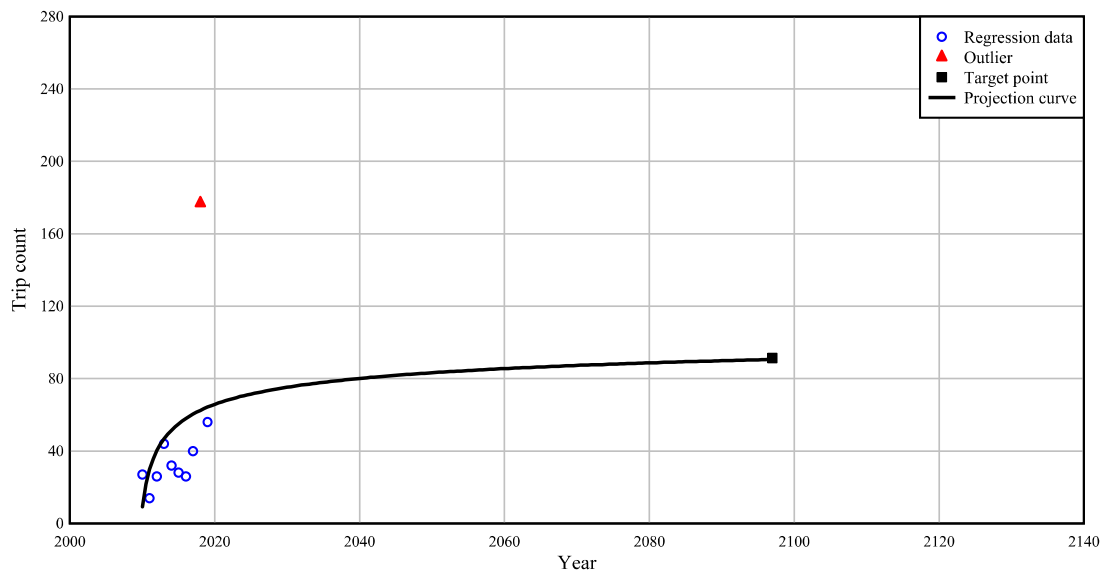

Past point 6

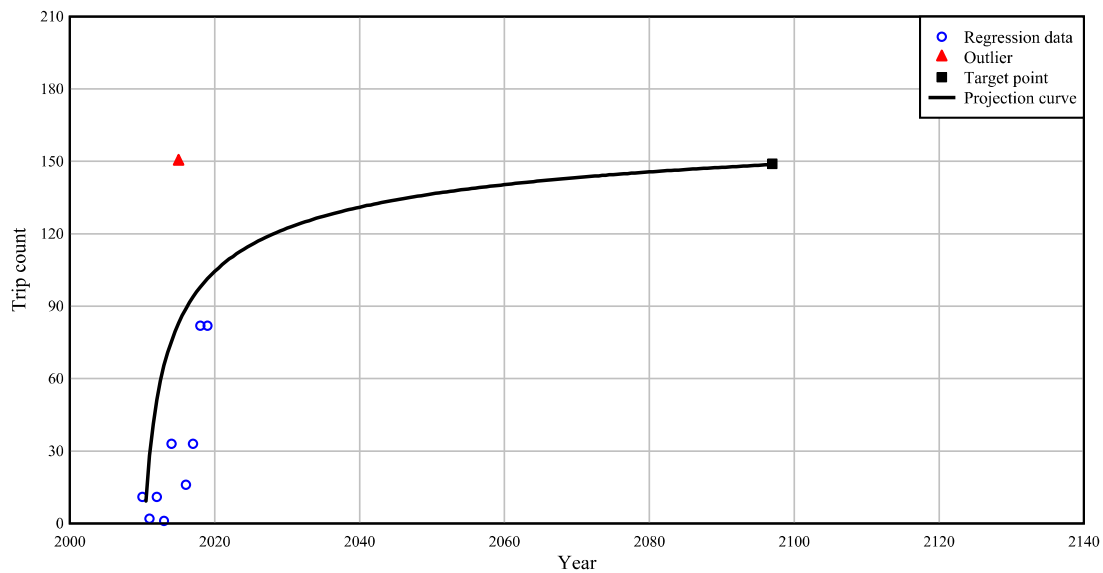

Past point 7

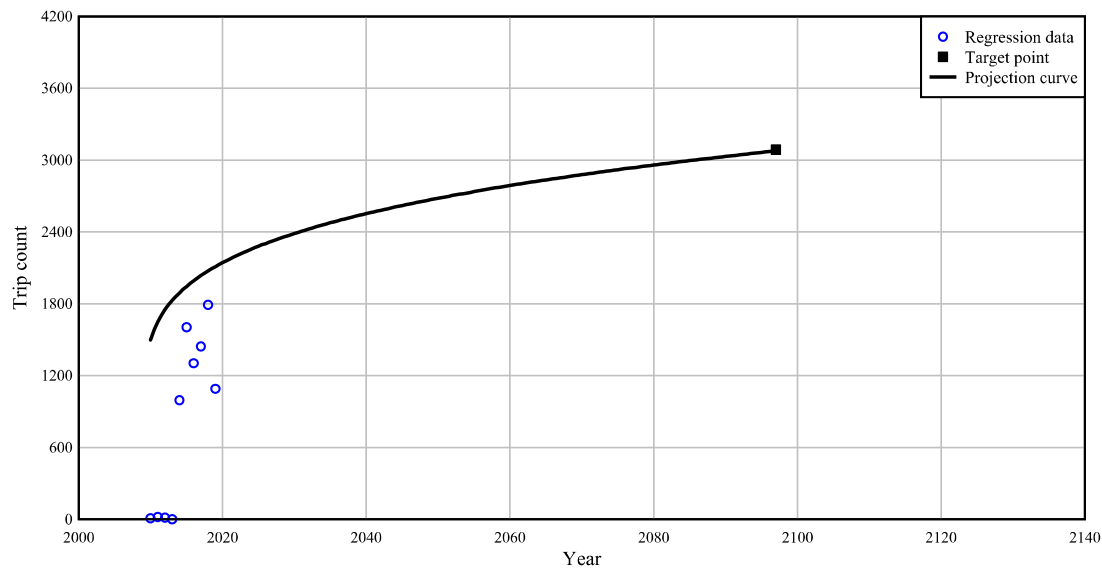

Past point 8

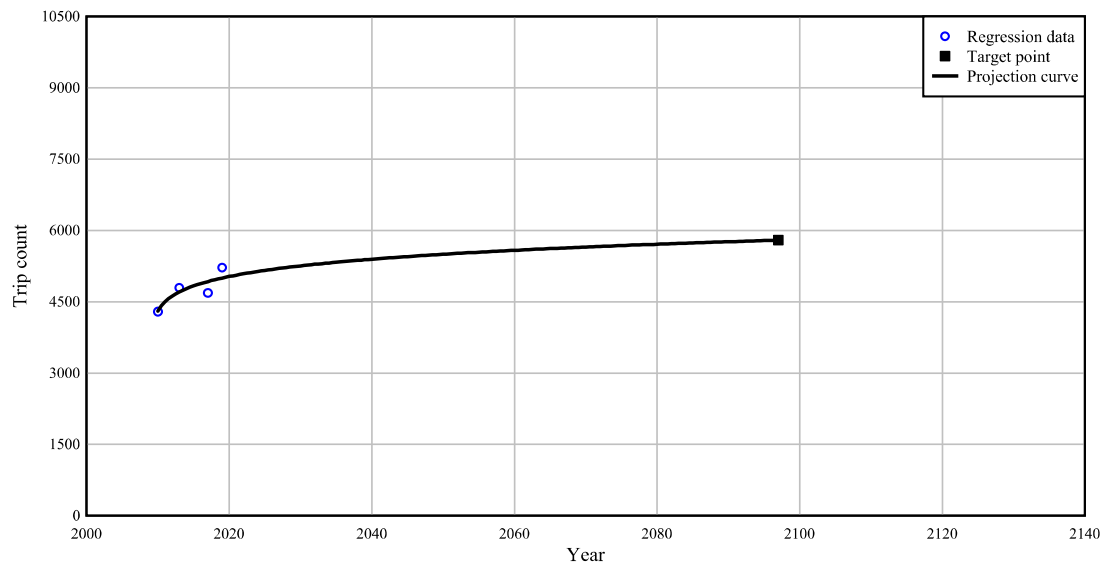

[No data for Past point 9]

[No data for Past point 10]

[No data for Past point 11]

[No data for Past point 12]



Past point 13

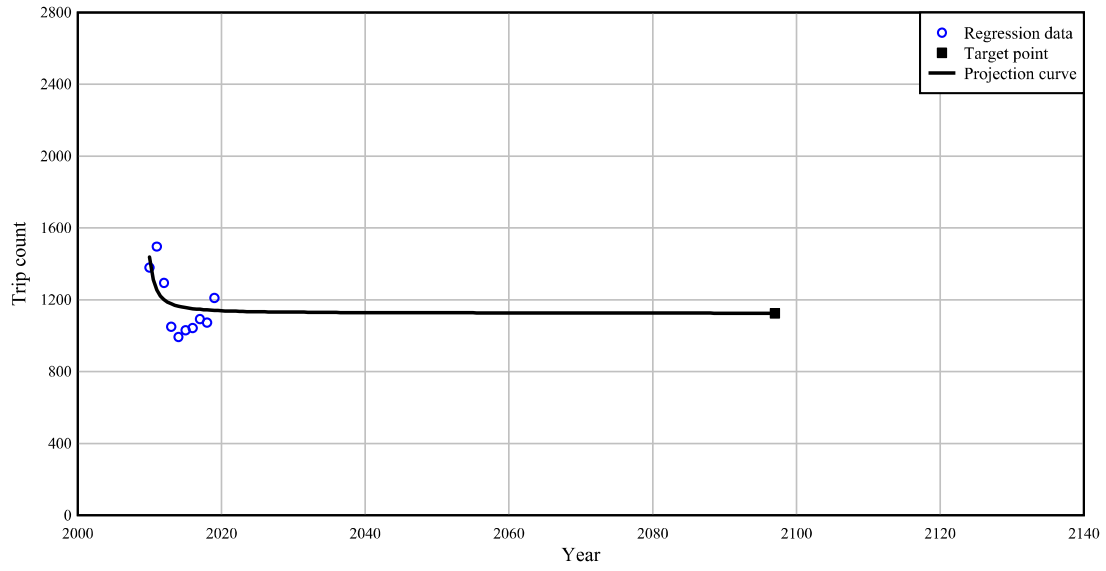

Past point 14

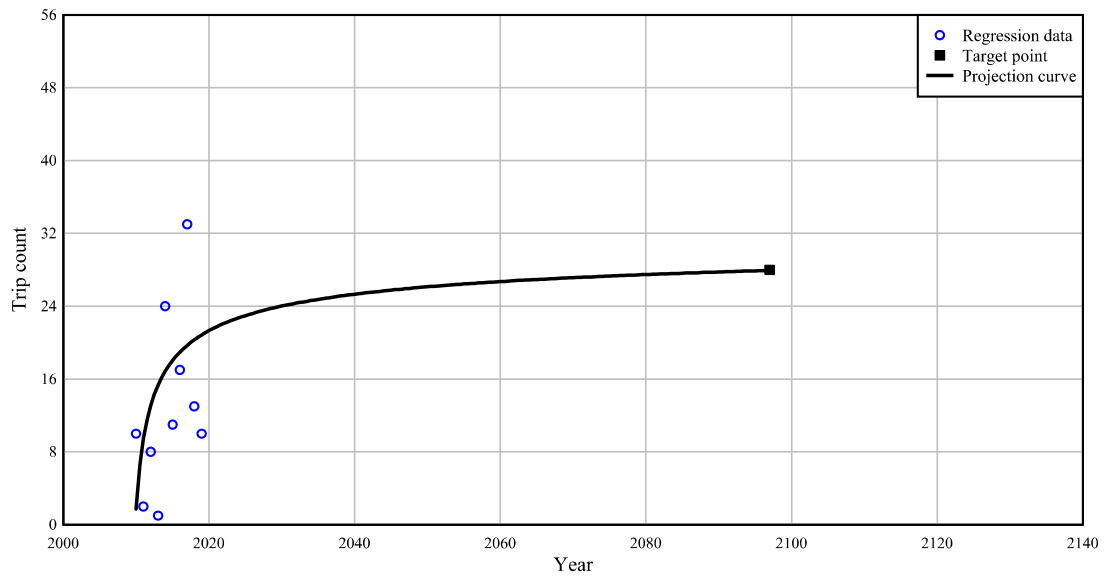

Past point 15

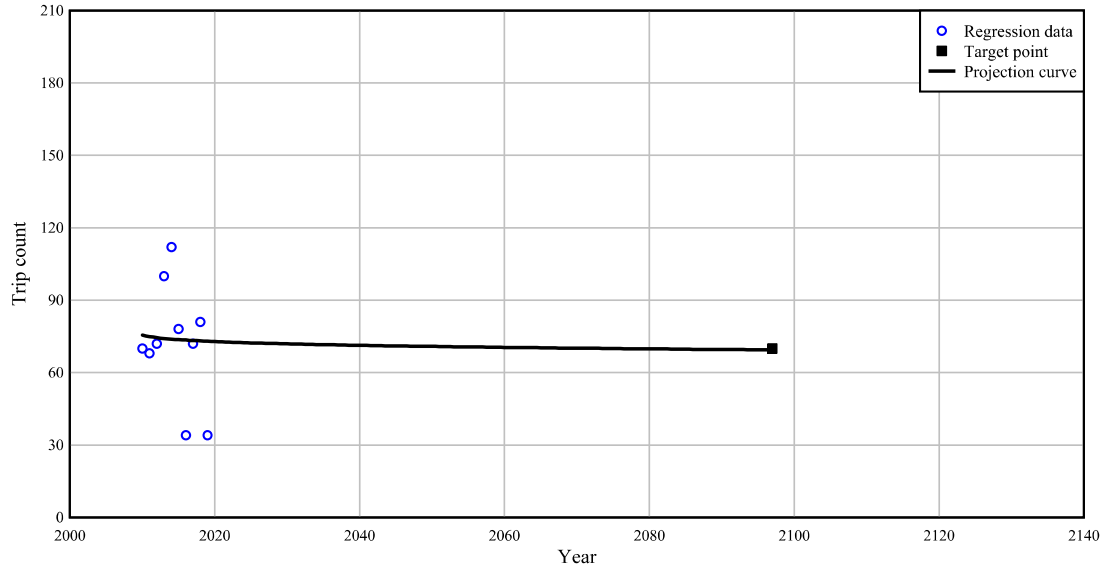

Past point 16

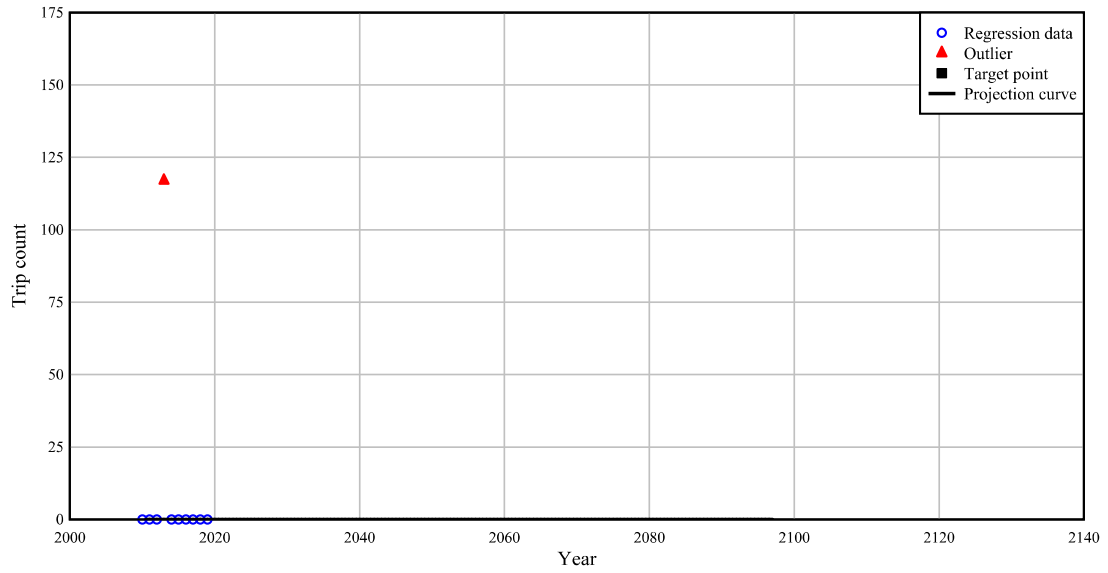

### Past point 17

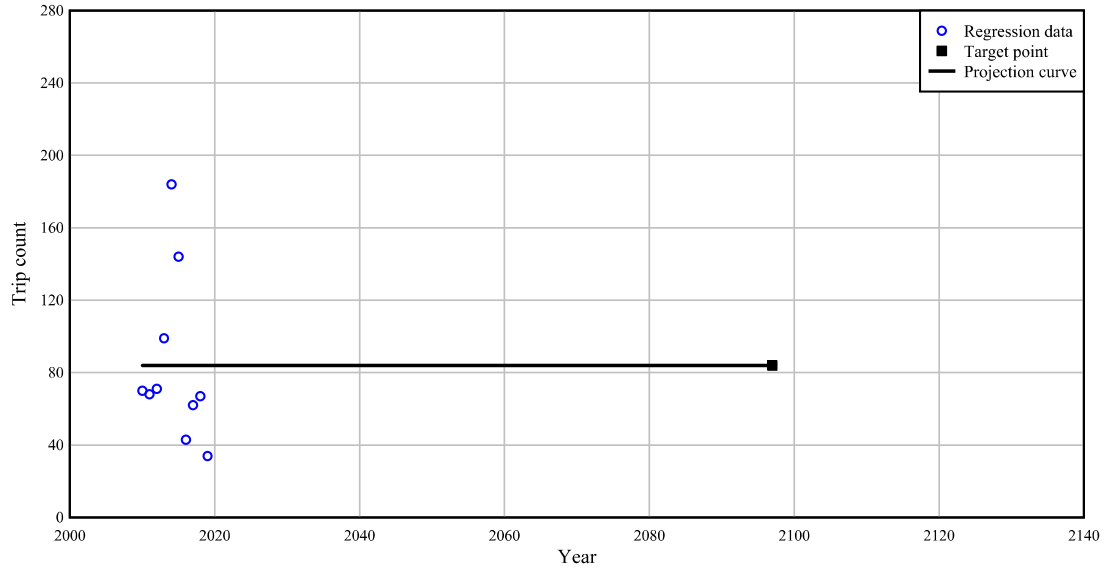

### Past point 18

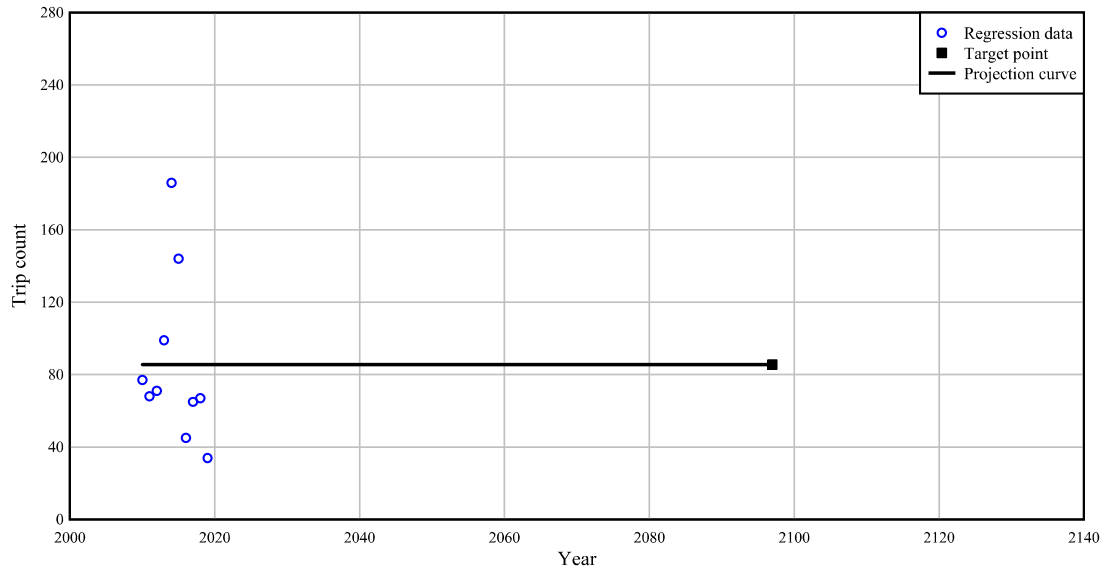

[No data for Past point 19]

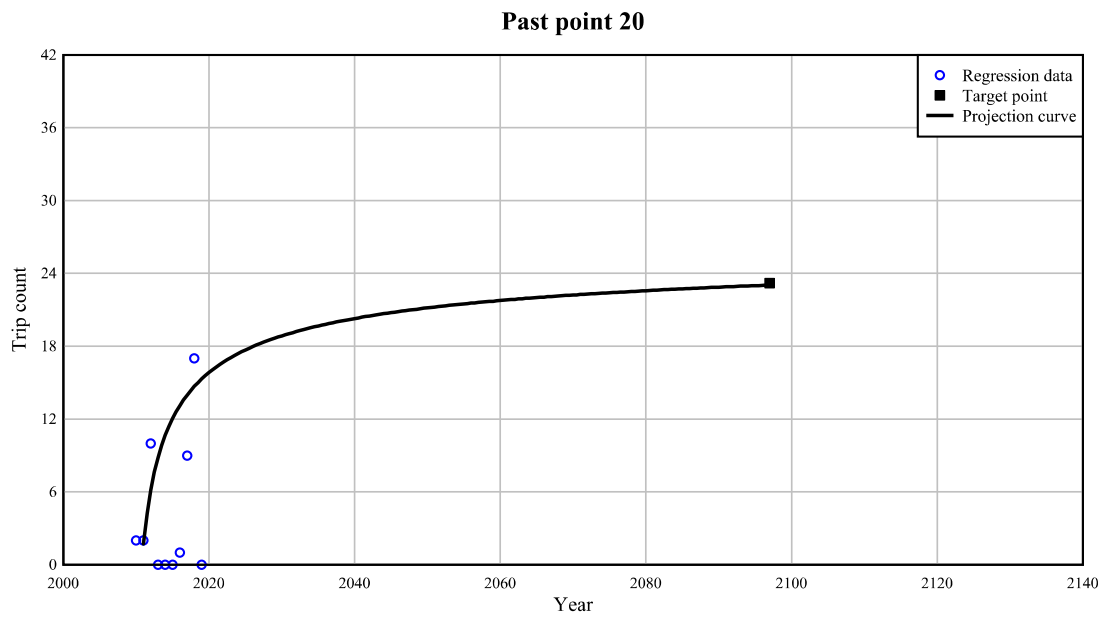

Past point 21

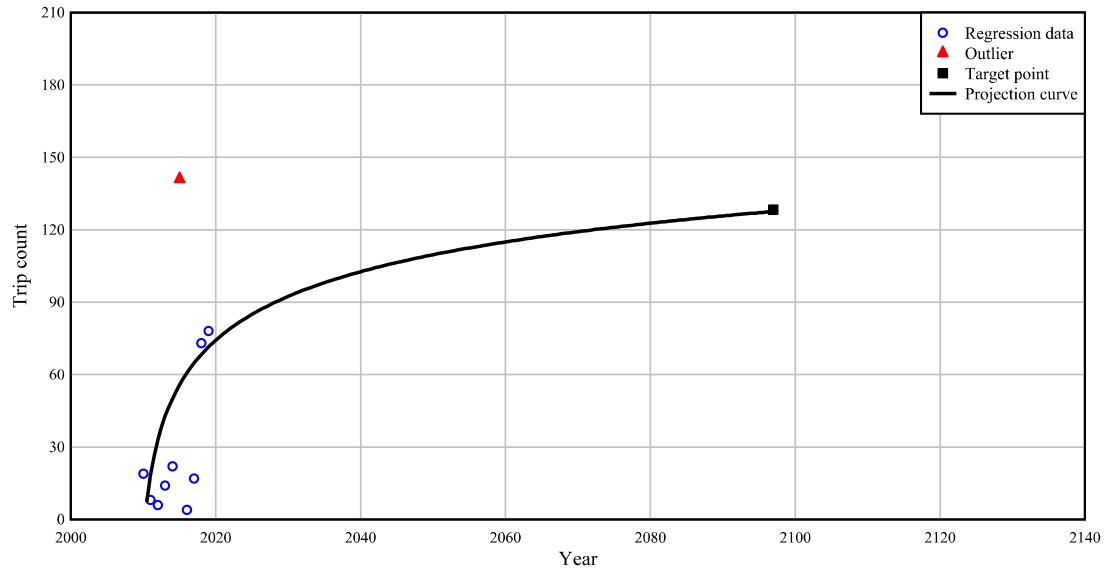

Past point 22

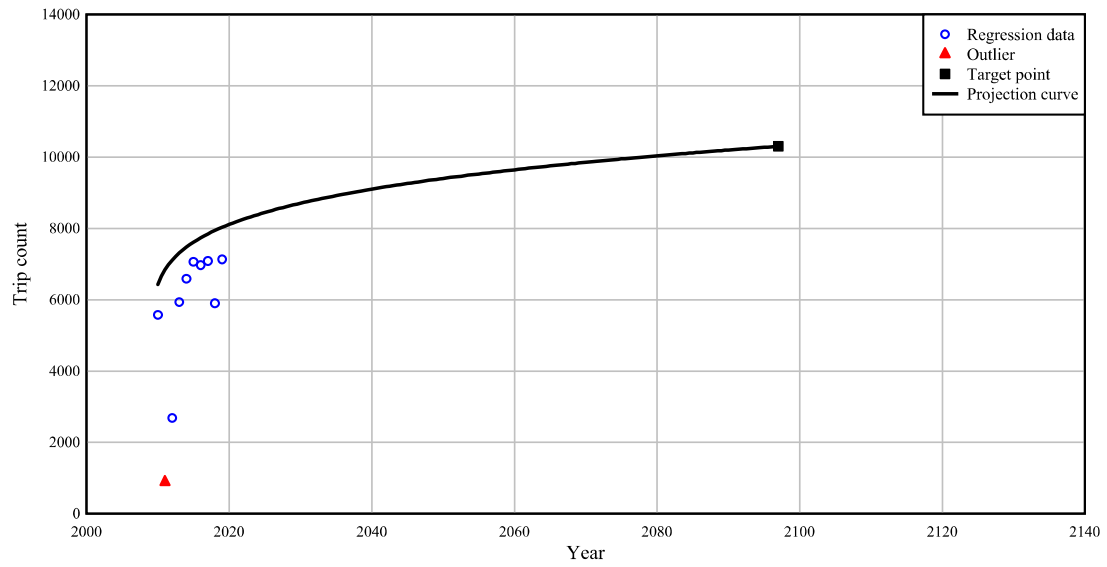

### Past point 23

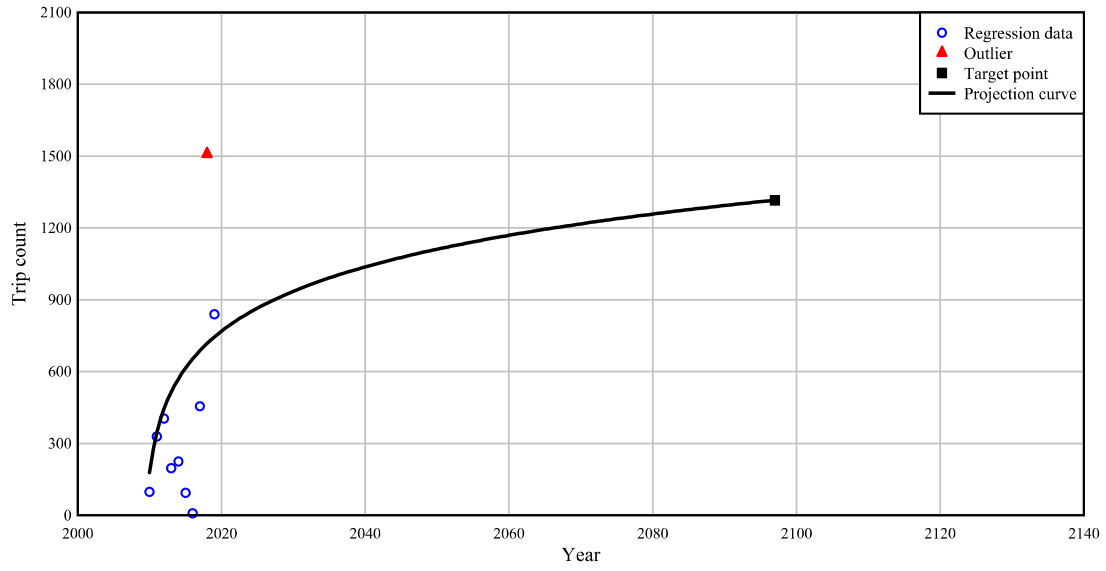

### Past point 24

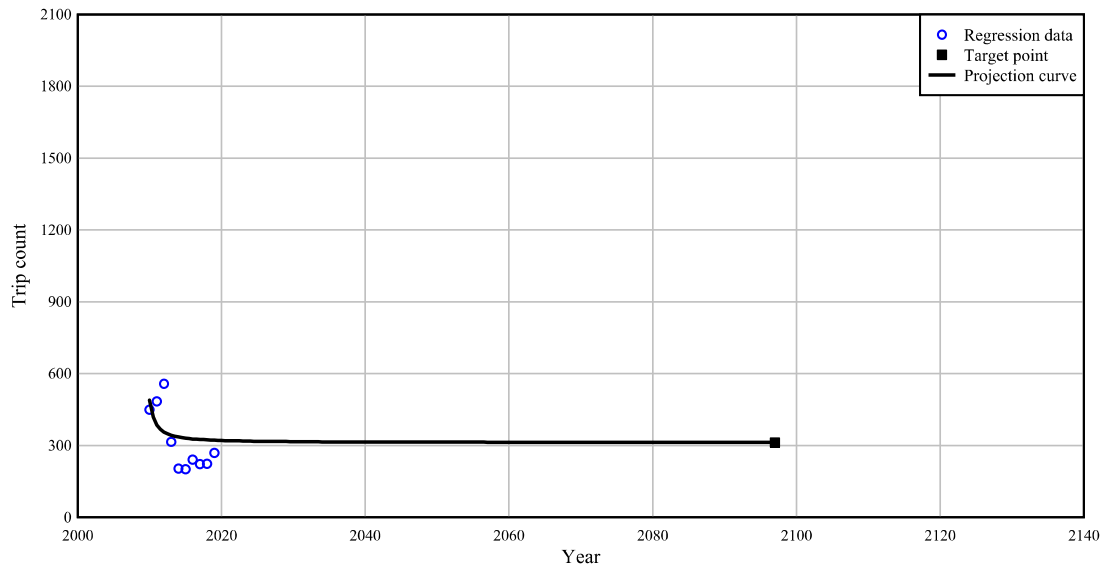

### Past point 25

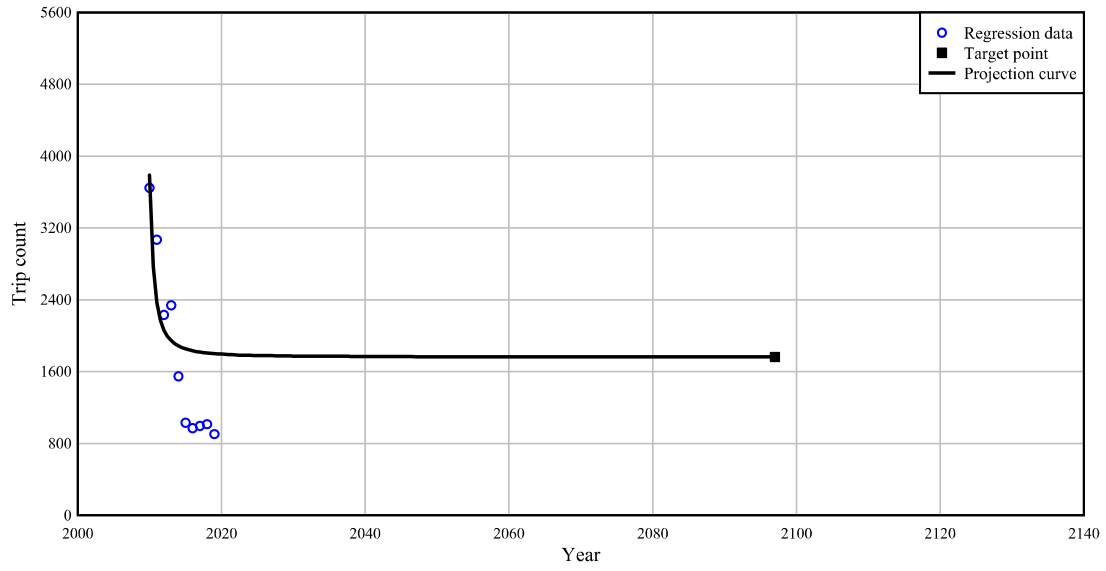

### Past point 26

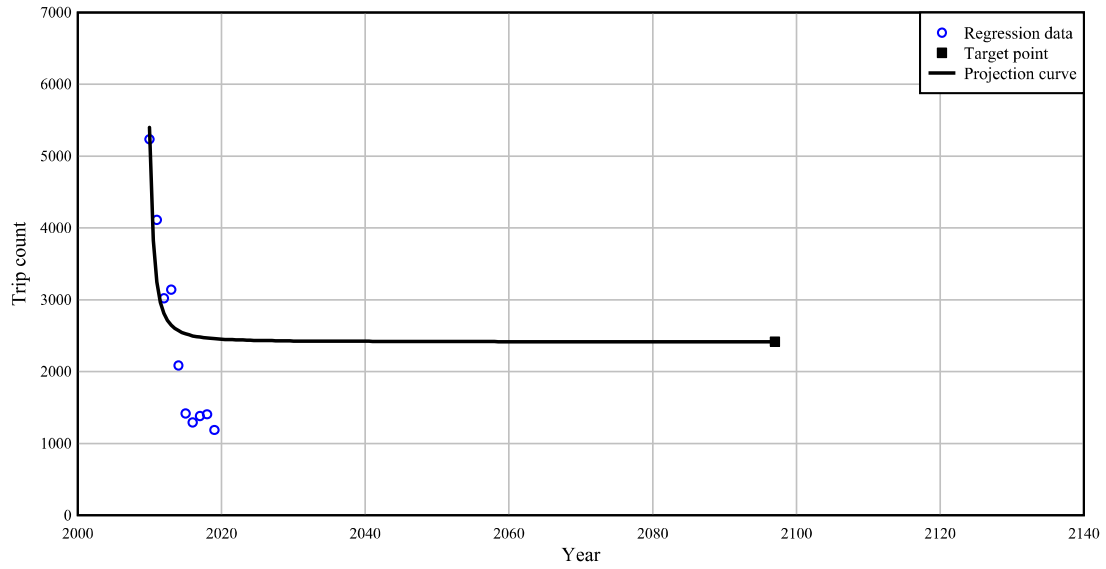

### Past point 27

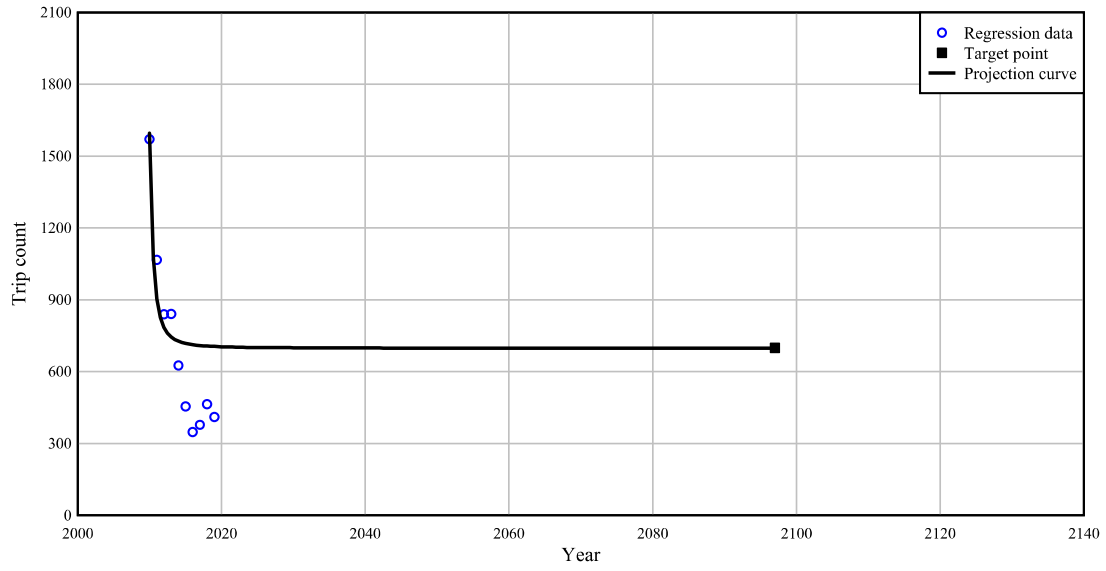

### Past point 28

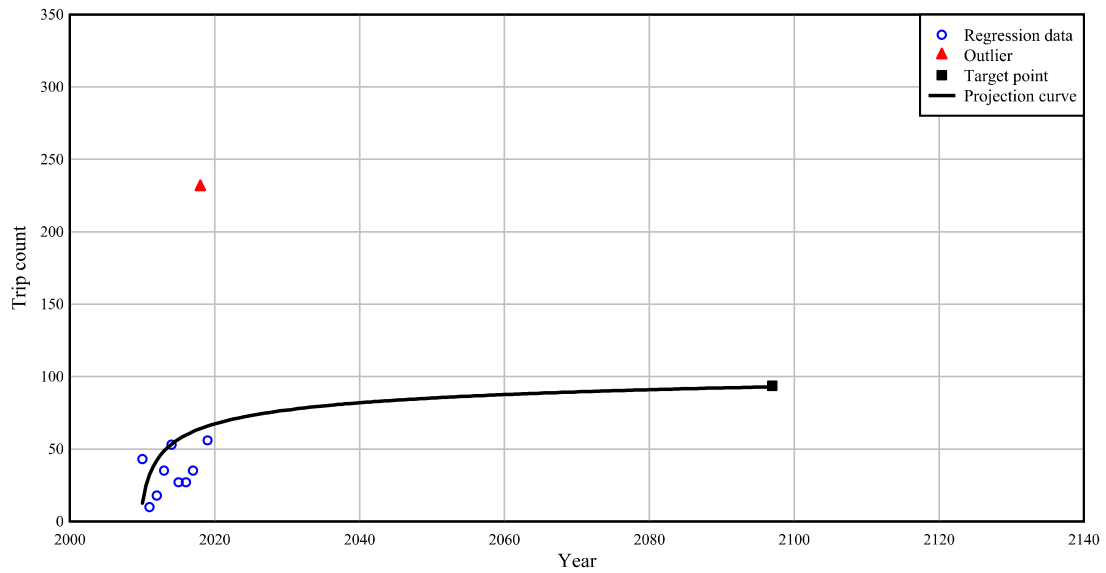



[No data for Past point 29]

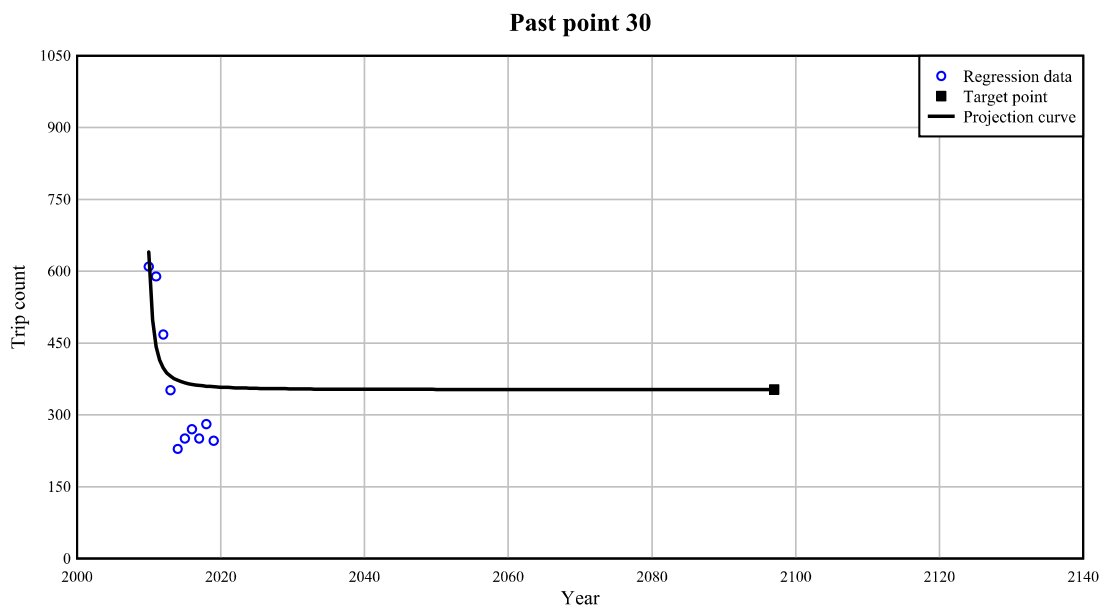



Past point 33

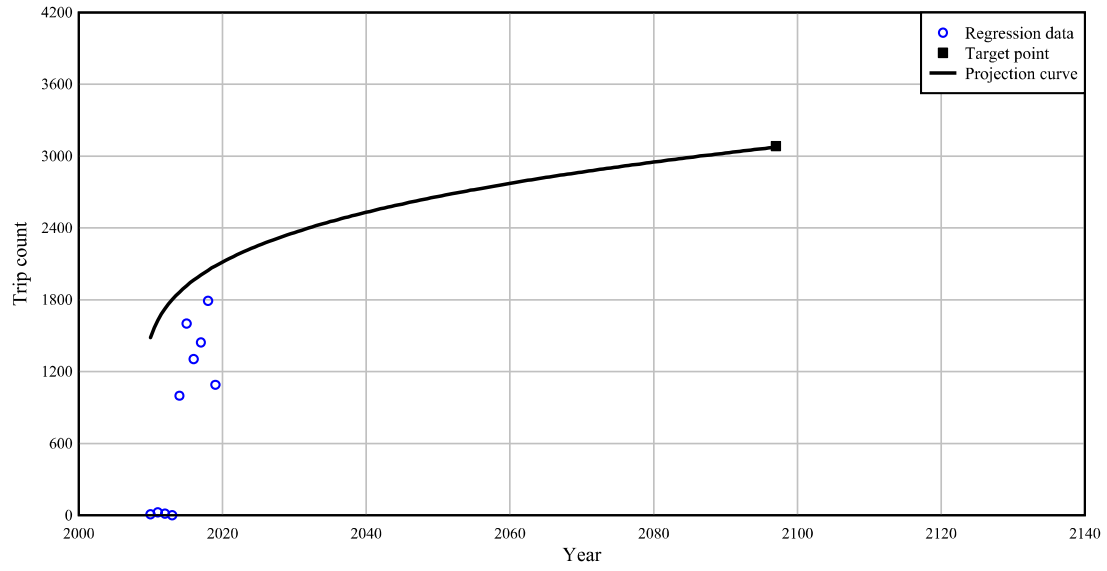

Past point 34

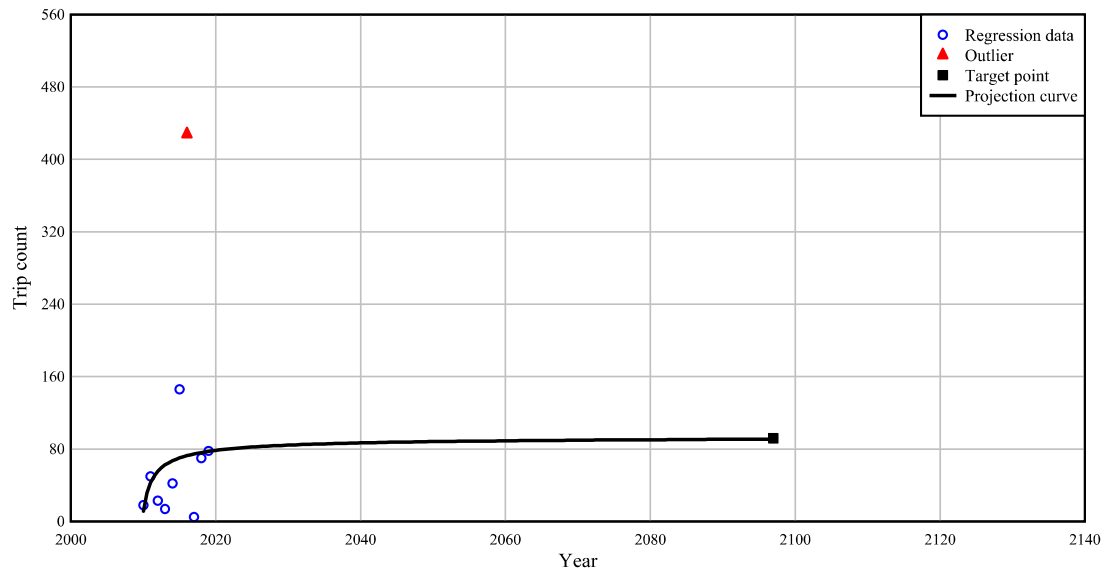

Past point 35

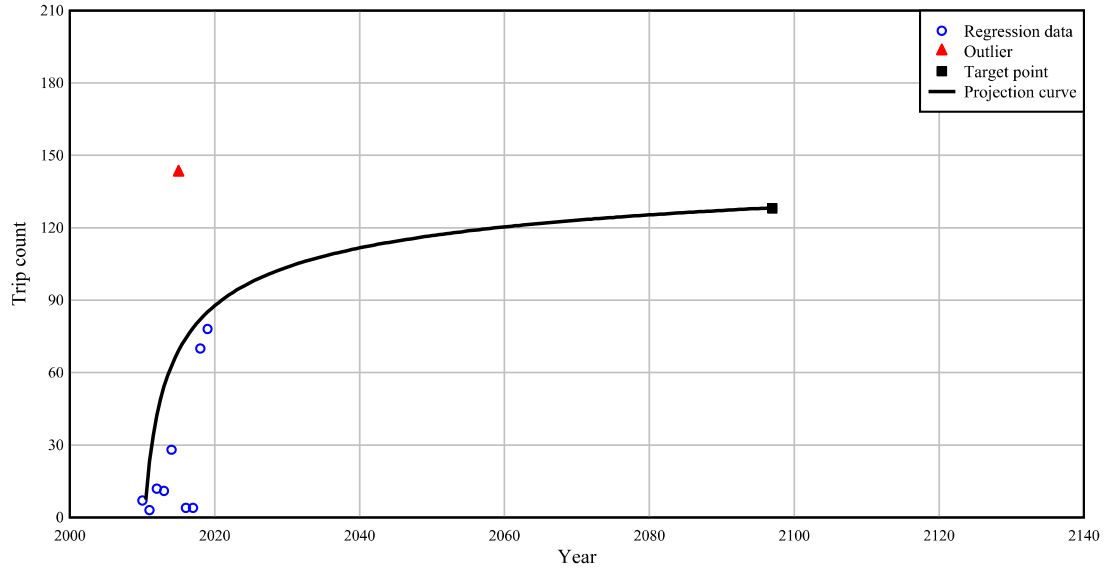

Past point 36

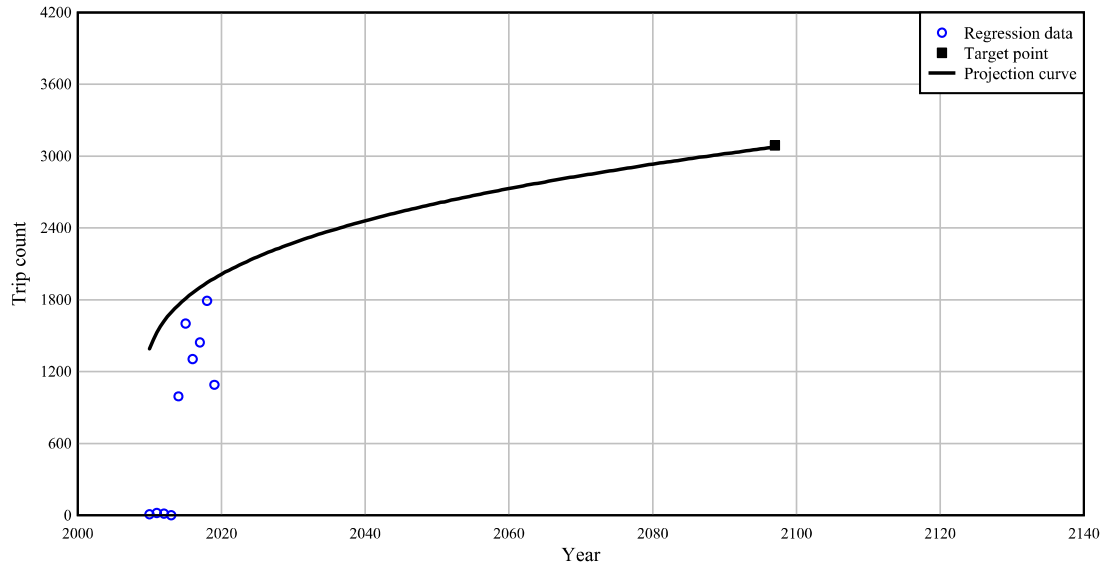

Past point 37

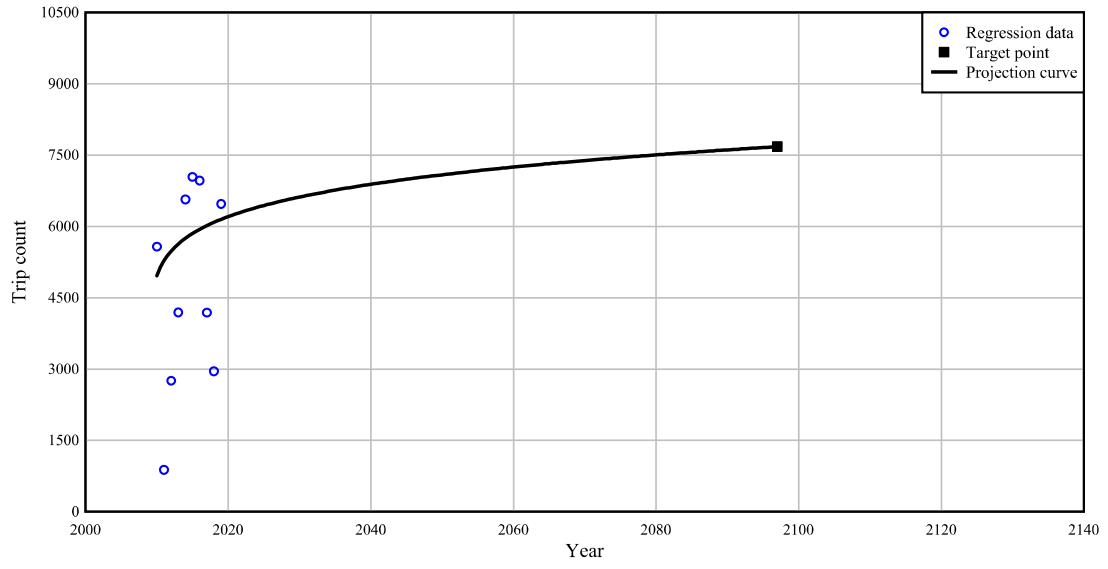

Past point 38

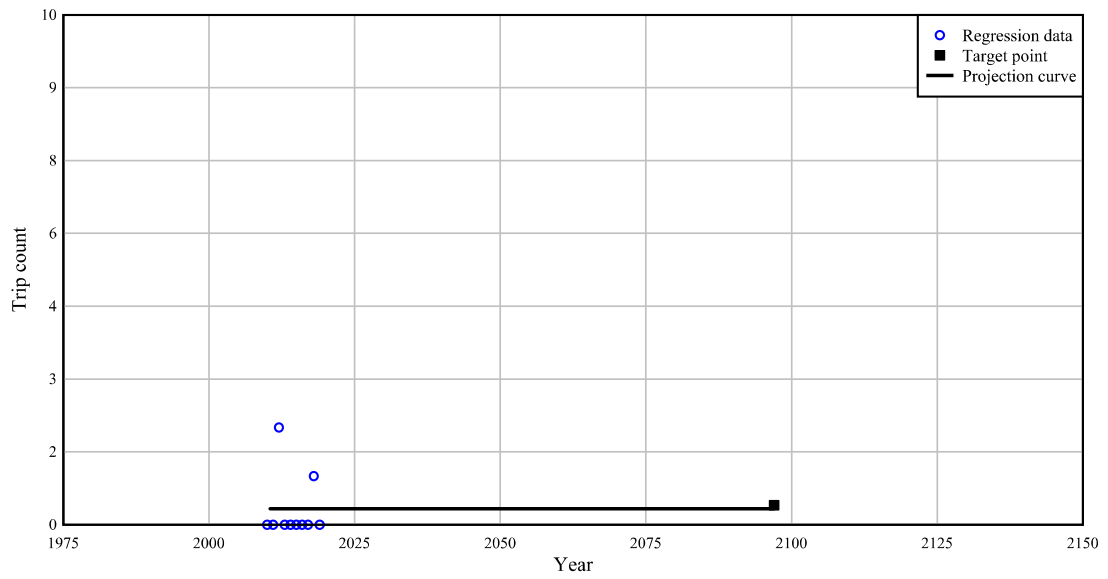

### Past point 39

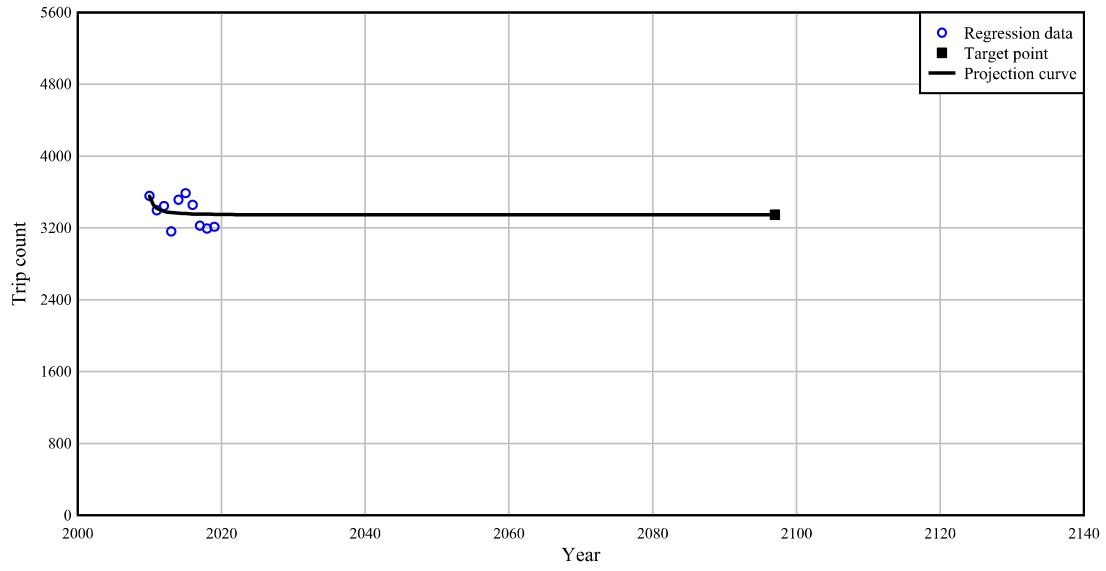

### Past point 40

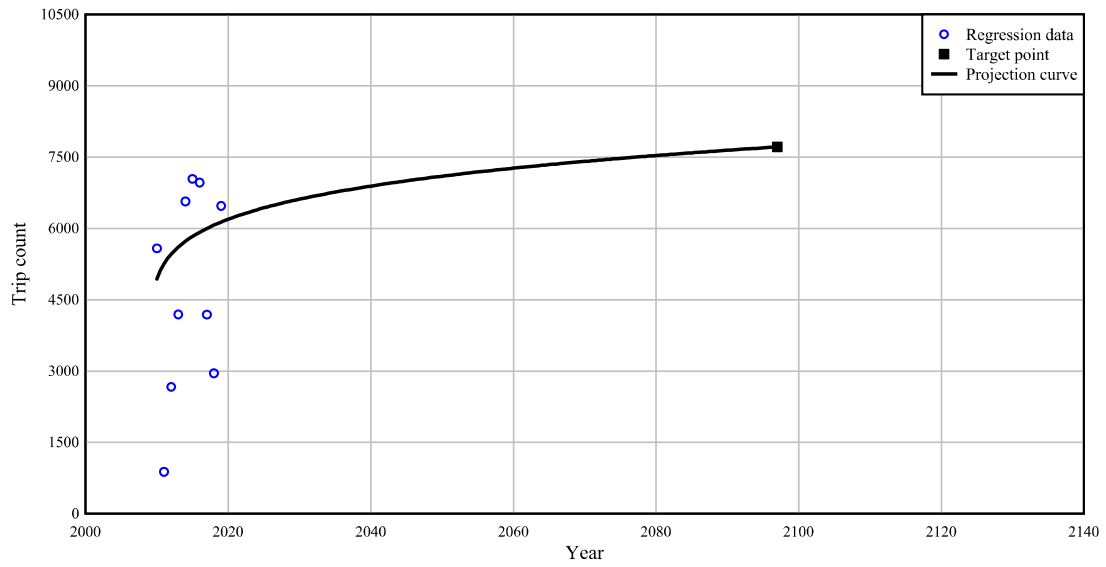

### Past point 41

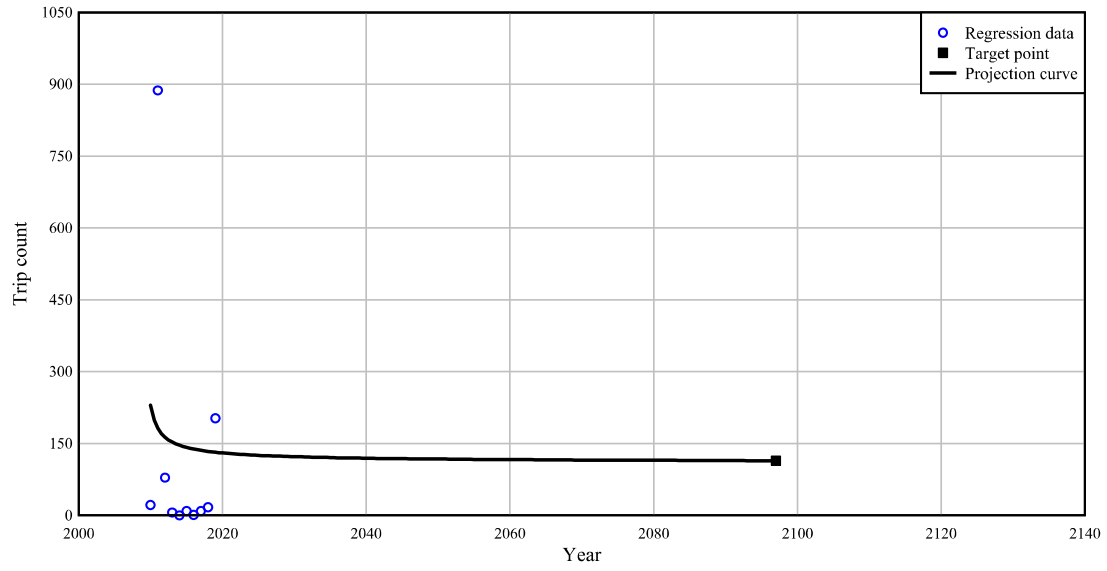

[No data for Past point 42]

[No data for Past point 43]

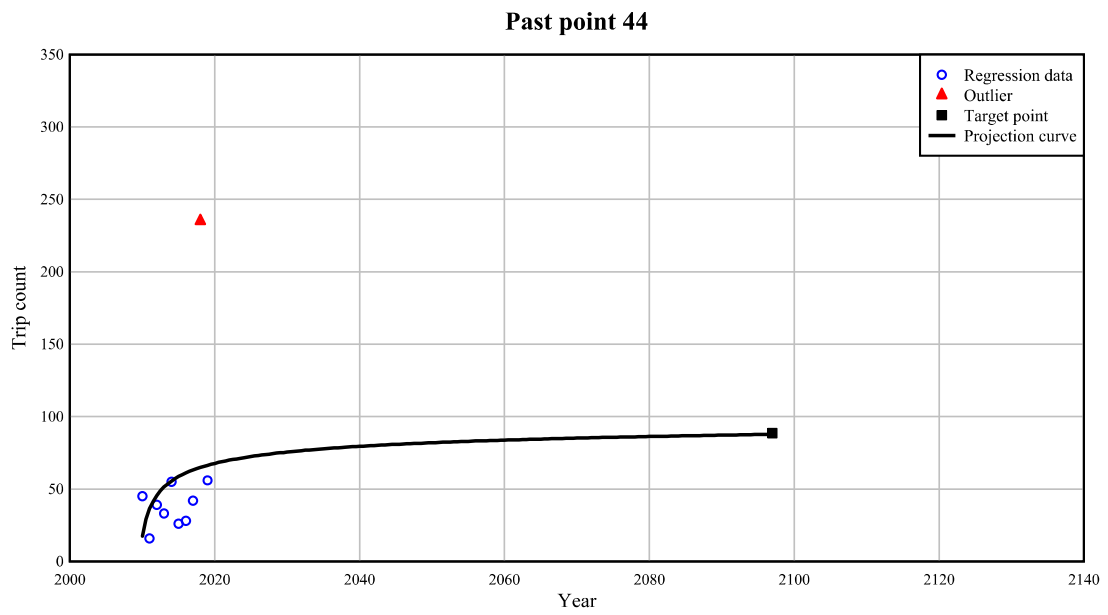



### Past point 45

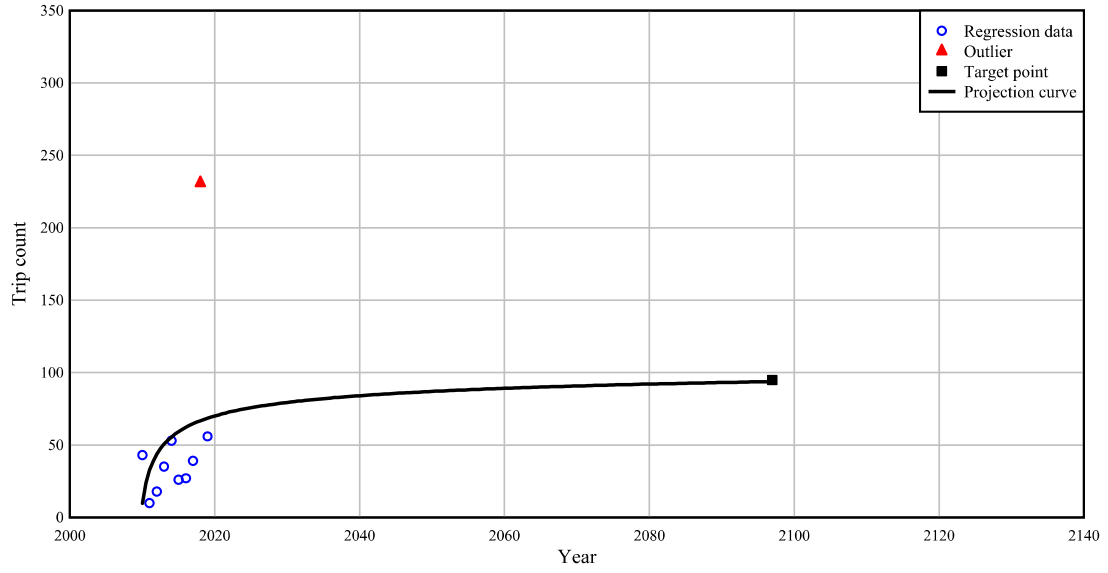

### Past point 46

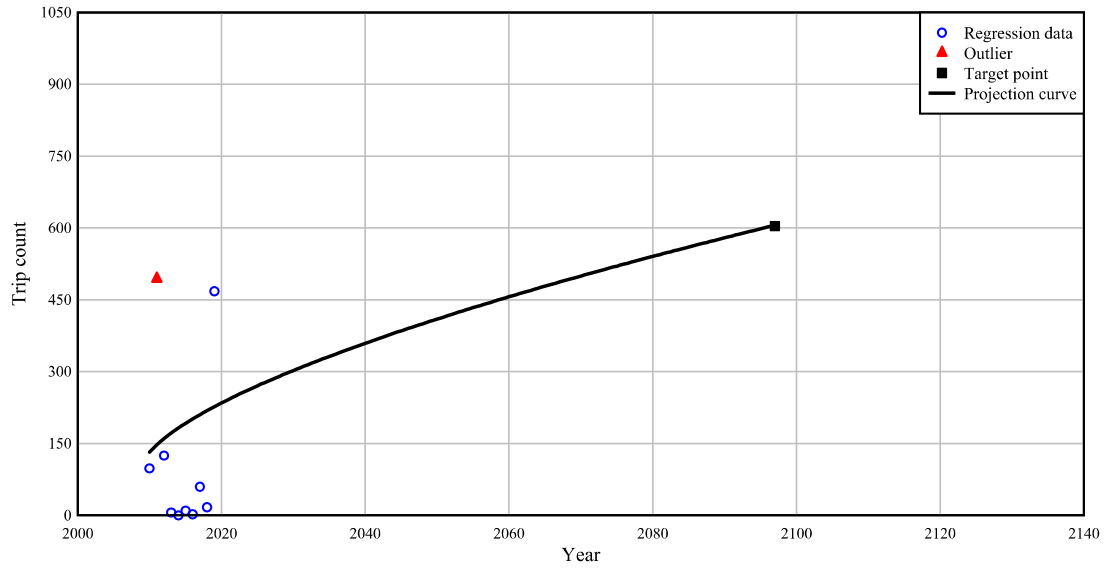

### Past point 47

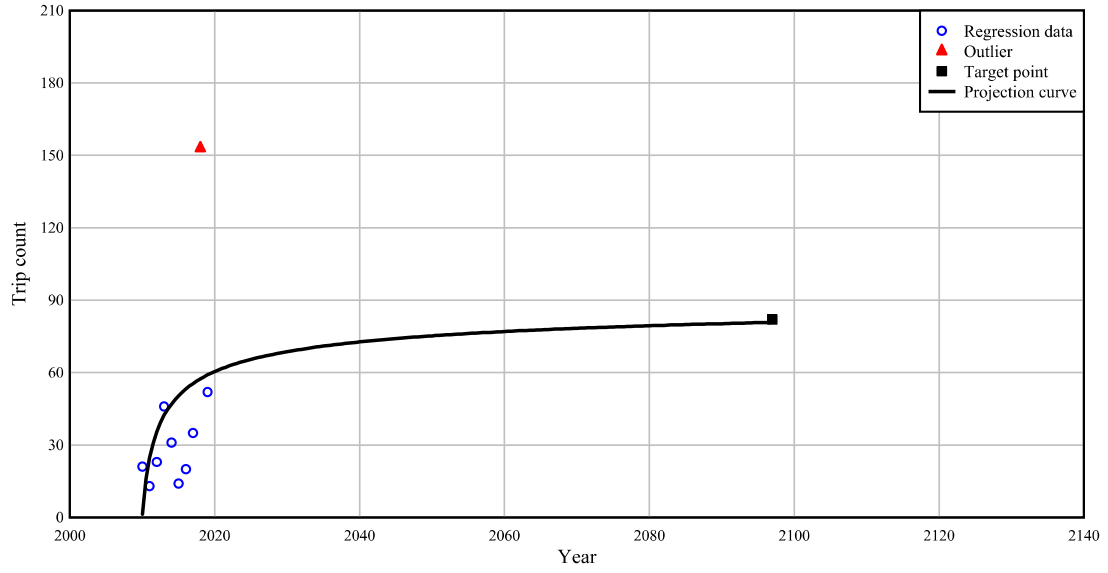

### PP-48

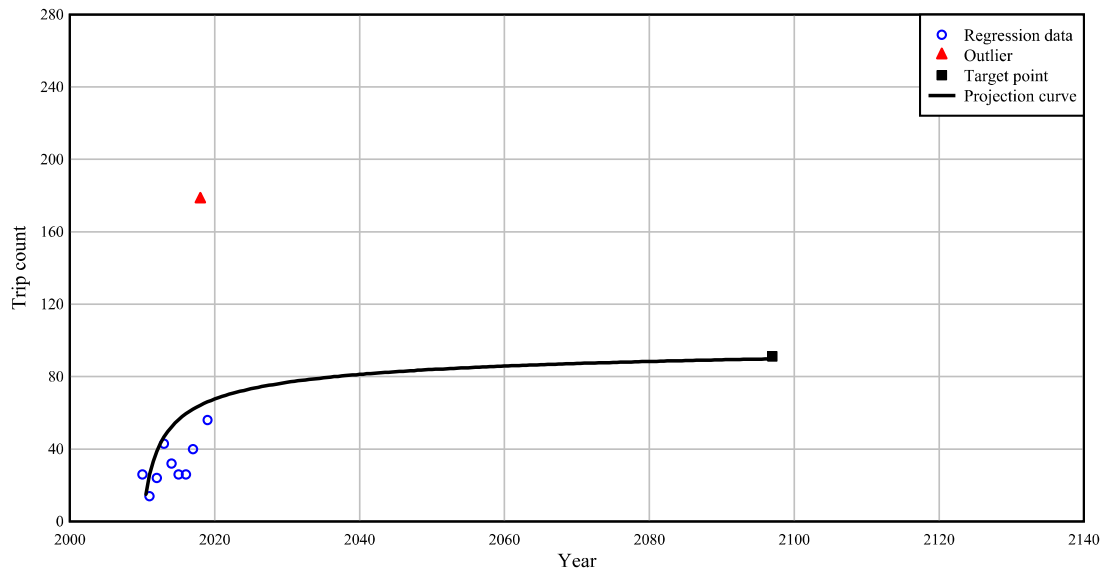

### PP-49

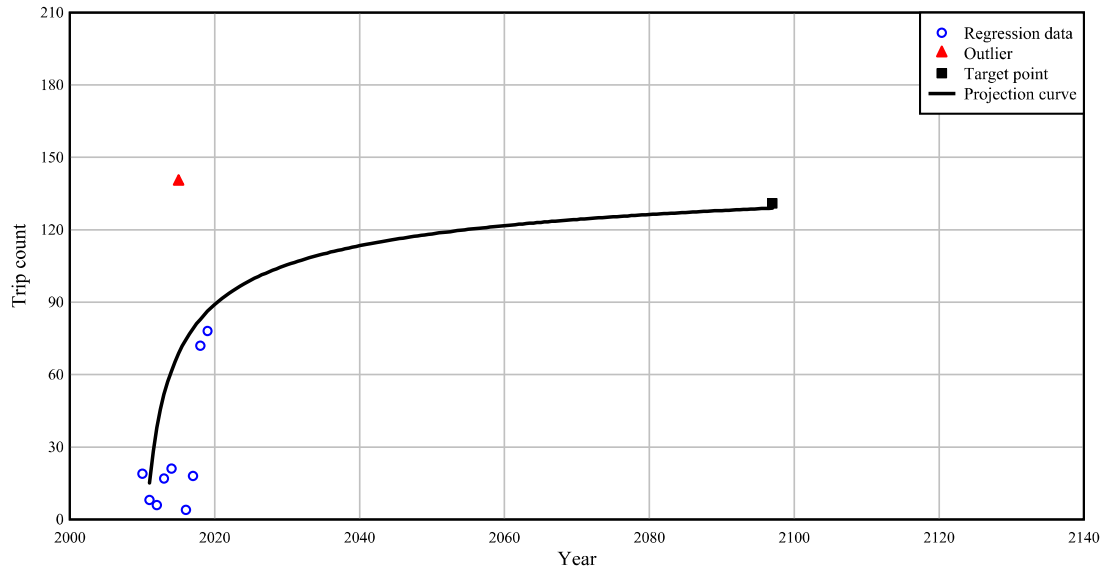

### Past point 50

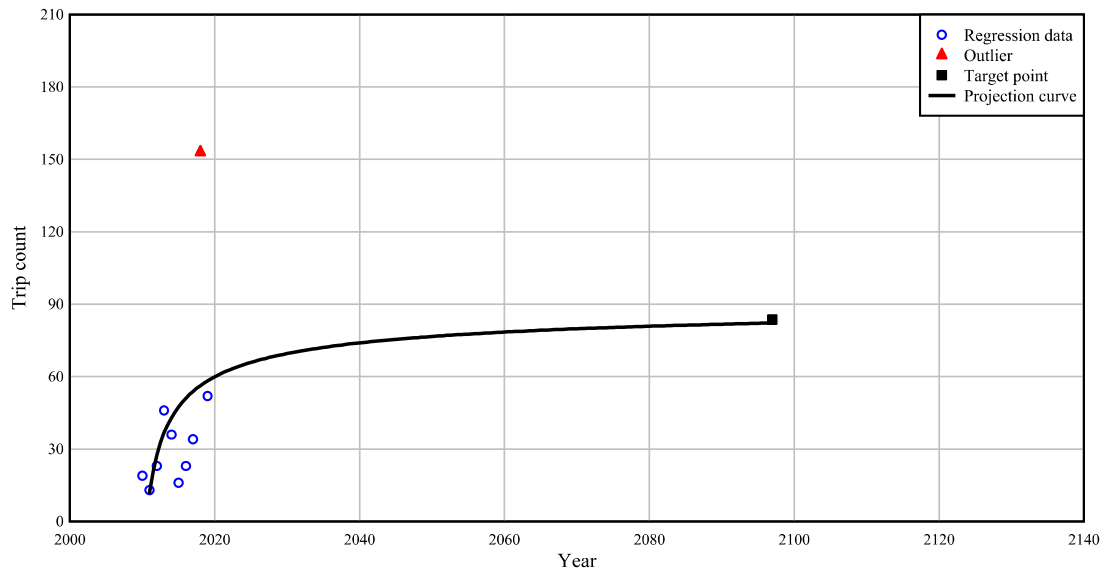

Past point 51

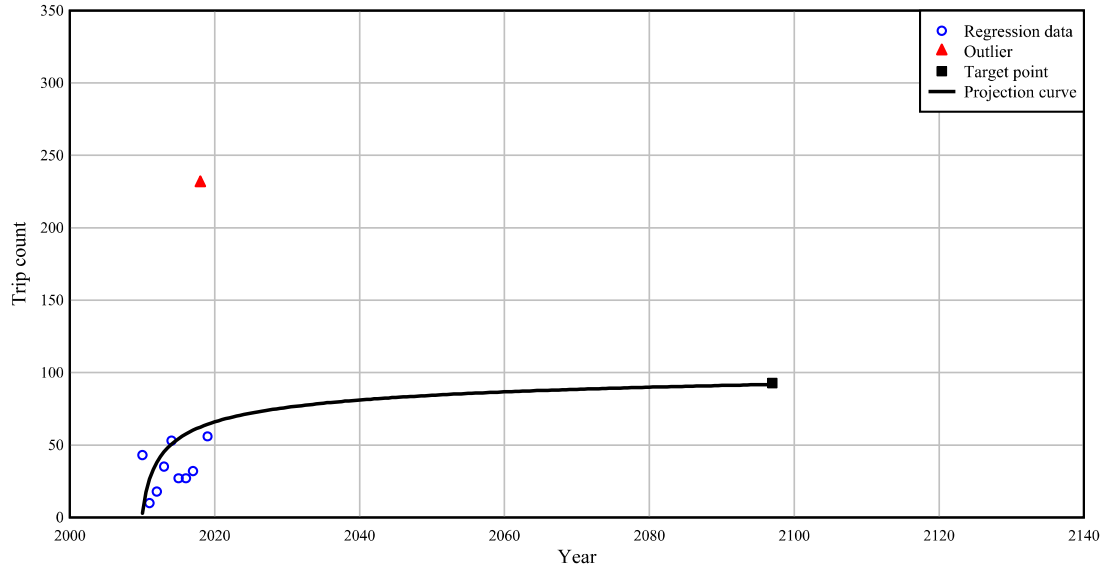

Past point 52

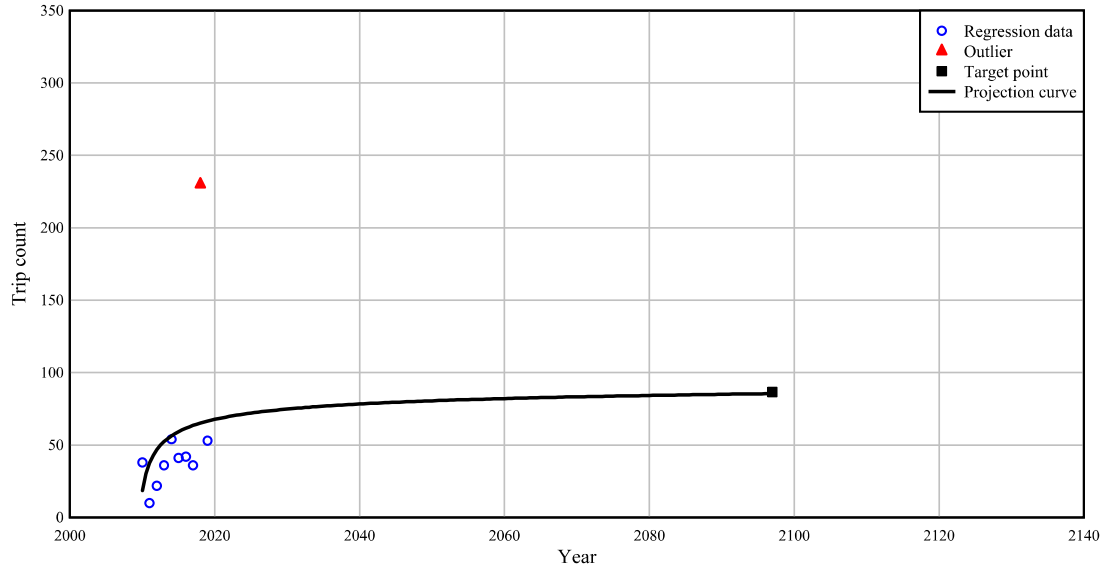

## APPENDIX C PAST POINT VESSEL GROUPS

On the following pages, vessel groups formed for each past point are documented. Average vessel characteristics (draft, length, width, tonnage, number of barges) for each vessel group are also provided.

To determine the number of annual trips for a particular: past point; vessel direction (upbound, downbound); and vessel group, the past point parameters  $a_0$ ,  $a_1$ , and  $a_2$  provided in Appendix B re combined with vessel group scale factors:

$$N(t) = N(y - y_0) = TrpScl \cdot (a_0 \cdot t^{a_1} + a_2) ; \text{ where } y_0 = 2009 \quad (C-1)$$

where  $TrpScl$  is the trip scaling factor for each vessel group. Numeric values of the trip scaling factors are provided on the following pages for each past point and each vessel group.

Past point 1

Group	Direction	Vessel Type	Draft group	Avg. Draft (ft)	Num. of barges	Num. of barges per trip	Trips (per year)	Avg. Length (ft)	Avg. Breadth (ft)	Avg. Tonnage (tons, tonnes)	Tug Type	Trip Scaling Factor
1	Upbound	Barge	0 < draft =< 3	2.3	537	1.6	32.9	242.3	42.5	772	Tug1	0.0643
2	Upbound	Barge	3 < draft =< 6	4.9	766	1.6	47.0	310.8	53.1	2581	Tug1	0.0917
3	Upbound	Barge	6 < draft =< 9	8.5	2562	1.6	157.1	223.9	41.1	2514	Tug1	0.3067
4	Upbound	Barge	9 < draft =< 15	10.8	289	1.6	17.7	255.6	48.0	4585	Tug2	0.0346
5	Upbound	Ship	0 < draft =< 8	7.6	-	-	1.7	295.7	75.7	5501	Vessel	0.0033
6	Upbound	Ship	8 < draft =< 12	10.0	-	-	0.3	389.5	82.5	18096	Vessel	0.0006
7	Upbound	Small ship	-	7.0	-	-	13.4	63.1	19.1	182	Vessel	0.0262
8	Upbound	Other	2 < draft =< 4	3.0	-	-	0.2	332.0	65.0	6610	Vessel	0.0006
9	Downbound	Barge	0 < draft =< 3	2.1	3841	1.7	221.6	236.9	42.8	631	Tug1	0.4324
10	Downbound	Barge	3 < draft =< 6	5.0	95	1.7	5.5	270.9	52.8	2454	Tug1	0.0107
11	Downbound	Barge	6 < draft =< 12	8.6	60	1.7	3.5	269.2	46.6	3856	Tug1	0.0068
12	Downbound	Ship	0 < draft =< 8	7.6	-	-	2.4	317.9	79.4	6905	Vessel	0.0047
13	Downbound	Ship	8 < draft =< 12	9.5	-	-	0.4	358.4	74.8	14812	Vessel	0.0008
14	Downbound	Small ship	-	7.2	-	-	8.7	66.9	21.1	215	Vessel	0.0170

Past point 2

Group	Direction	Vessel Type	Draft group	Avg. Draft (ft)	Num. of barges	Num. of barges per trip	Trips (per year)	Avg. Length (ft)	Avg. Breadth (ft)	Avg. Tonnage (tons, tonnes)	Tug Type	Trip Scaling Factor
1	Upbound	Barge	0 < draft =< 3	1.9	78	1.9	4.1	212.2	44.6	521	Tug1	0.0440
2	Upbound	Barge	3 < draft =< 6	5.2	76	1.9	4.0	307.6	55.7	2889	Tug1	0.0429
3	Upbound	Barge	6 < draft =< 9	8.1	424	1.9	22.5	206.6	47.8	2550	Tug1	0.2391
4	Upbound	Barge	9 < draft =< 15	11.0	202	1.9	10.7	263.2	50.3	5097	Tug2	0.1139
5	Upbound	Ship	6 < draft =< 8	8.0	-	-	1.5	299.0	77.5	5245	Vessel	0.0160
6	Upbound	Ship	8 < draft =< 12	10.0	-	-	0.2	444.3	93.8	24754	Vessel	0.0021
7	Upbound	Small ship	-	6.3	-	-	10.0	59.8	16.2	131	Vessel	0.1065
8	Upbound	Other	2 < draft =< 4	3.0	-	-	0.2	332.0	65.0	6610	Vessel	0.0021
9	Downbound	Barge	0 < draft =< 3	2.2	691	2.3	29.6	218.1	47.4	625	Tug1	0.3150
10	Downbound	Barge	3 < draft =< 6	4.7	39	2.3	1.7	373.5	75.4	4223	Tug1	0.0178
11	Downbound	Barge	6 < draft =< 12	8.8	41	2.3	1.8	299.4	51.6	4771	Tug1	0.0187
12	Downbound	Ship	4 < draft =< 10	7.9	-	-	2.3	333.2	82.1	8380	Vessel	0.0245
13	Downbound	Small ship	-	6.5	-	-	5.4	62.4	16.7	152	Vessel	0.0575

Past point 3

Group	Direction	Vessel Type	Draft group	Avg. Draft (ft)	Num. of barges	Num. of barges per trip	Trips (per year)	Avg. Length (ft)	Avg. Breadth (ft)	Avg. Tonnage (tons, tonnes)	Tug Type	Trip Scaling Factor
1	Upbound	Barge	0 < draft =< 12	3.0	5	1.0	0.5	133.0	46.0	727	Tug1	0.0148
2	Upbound	Ship	4 < draft =< 10	7.9	-	-	1.5	306.6	79.5	5463	Vessel	0.0445
3	Upbound	Free Tugs	-	7.5	-	-	2.9	79.6	27.1	568	TugOnly	0.0861
4	Upbound	Other	2 < draft =< 12	7.0	-	-	0.2	279.5	53.0	5869	Vessel	0.0059
5	Downbound	Barge	0 < draft =< 3	2.0	25	1.0	2.5	239.7	46.6	927	Tug1	0.0742
6	Downbound	Barge	3 < draft =< 6	4.5	19	1.0	1.9	373.5	72.3	3990	Tug1	0.0564
7	Downbound	Barge	6 < draft =< 12	10.3	38	1.0	3.8	483.6	77.3	12324	Tug2	0.1128
8	Downbound	Barge	12 < draft =< 15	14.1	48	1.0	4.8	455.6	73.3	14886	Tug2	0.1424
9	Downbound	Barge	18 < draft =< 21	21.0	1	1.0	0.1	326.5	74.0	15983	Tug2	0.0030
10	Downbound	Ship	4 < draft =< 8	6.8	-	-	3.1	504.7	90.4	25121	Vessel	0.0920
11	Downbound	Ship	8 < draft =< 18	12.2	-	-	0.5	601.7	102.6	42436	Vessel	0.0148
12	Downbound	Free Tugs	-	8.4	-	-	11.5	78.1	28.1	572	TugOnly	0.3412
13	Downbound	Other	4 < draft =< 12	9.2	-	-	0.4	343.1	65.9	3961	Vessel	0.0119



Past point 4

Group	Direction	Vessel Type	Draft group	Avg. Draft (ft)	Num. of barges	Num. of barges per trip	Trips (per year)	Avg. Length (ft)	Avg. Breadth (ft)	Avg. Tonnage (tons, tonnes)	Tug Type	Trip Scaling Factor
1	Upbound	Barge	0 < draft =< 9	4.1	11	1.0	1.1	287.7	56.8	2163	Tug1	0.1048
2	Upbound	Ship	6 < draft =< 10	8.1	-	-	1.4	312.6	82.0	5713	Vessel	0.1333
3	Upbound	Free Tugs	-	8.2	-	-	2.1	103.7	30.8	1128	TugOnly	0.2000
4	Downbound	Barge	0 < draft =< 9	5.1	12	1.0	1.2	269.4	54.4	2358	Tug1	0.1143
5	Downbound	Barge	9 < draft =< 15	11.7	3	1.0	0.3	415.2	73.3	11200	Tug2	0.0286
6	Downbound	Ship	6 < draft =< 8	8.0	-	-	1.0	312.6	82.0	5713	Vessel	0.0952
7	Downbound	Free Tugs	-	7.7	-	-	3.4	102.9	30.1	1126	TugOnly	0.3238

Past point 5

Group	Direction	Vessel Type	Draft group	Avg. Draft (ft)	Num. of barges	Num. of barges per trip	Trips (per year)	Avg. Length (ft)	Avg. Breadth (ft)	Avg. Tonnage (tons, tonnes)	Tug Type	Trip Scaling Factor
1	Upbound	Barge	0 < draft =< 12	2.6	8	1.0	0.8	188.5	51.2	803	Tug1	0.0171
2	Upbound	Ship	4 < draft =< 8	7.8	-	-	1.4	306.2	79.3	5445	Vessel	0.0299
3	Upbound	Ship	8 < draft =< 12	10.0	-	-	0.2	287.8	67.0	5232	Vessel	0.0043
4	Upbound	Small ship	-	7.0	-	-	0.1	96.0	24.0	395	Vessel	0.0021
5	Upbound	Free Tugs	-	7.3	-	-	5.8	78.6	26.7	535	TugOnly	0.1239
6	Upbound	Other	2 < draft =< 12	7.0	-	-	0.2	279.5	53.0	5869	Vessel	0.0043
7	Downbound	Barge	0 < draft =< 3	2.0	27	1.0	2.7	244.2	47.8	936	Tug1	0.0577
8	Downbound	Barge	3 < draft =< 6	5.0	48	1.0	4.8	394.3	73.3	4752	Tug1	0.1026
9	Downbound	Barge	6 < draft =< 9	7.2	32	1.0	3.2	436.4	74.0	7320	Tug1	0.0684
10	Downbound	Barge	9 < draft =< 12	11.1	30	1.0	3.0	499.6	78.3	13679	Tug2	0.0641
11	Downbound	Barge	12 < draft =< 15	14.1	48	1.0	4.8	455.6	73.3	14886	Tug2	0.1026
12	Downbound	Barge	18 < draft =< 21	21.0	1	1.0	0.1	326.5	74.0	15983	Tug2	0.0021
13	Downbound	Ship	4 < draft =< 8	6.8	-	-	3.1	504.7	90.4	25121	Vessel	0.0662
14	Downbound	Ship	8 < draft =< 18	12.2	-	-	0.5	601.7	102.6	42436	Vessel	0.0107
15	Downbound	Small ship	-	6.5	-	-	0.2	72.4	19.5	233	Vessel	0.0043
16	Downbound	Free Tugs	-	7.9	-	-	15.5	81.9	28.4	588	TugOnly	0.3312
17	Downbound	Other	4 < draft =< 12	9.2	-	-	0.4	343.1	65.9	3961	Vessel	0.0085

Past point 6

Group	Direction	Vessel Type	Draft group	Avg. Draft (ft)	Num. of barges	Num. of barges per trip	Trips (per year)	Avg. Length (ft)	Avg. Breadth (ft)	Avg. Tonnage (tons, tonnes)	Tug Type	Trip Scaling Factor
1	Upbound	Barge	0 < draft =< 12	5.1	7	1.0	0.7	313.9	65.1	4667	Tug1	0.0167
2	Upbound	Ship	8 < draft =< 10	9.0	-	-	0.2	576.0	105.6	43794	Vessel	0.0048
3	Upbound	Small ship	-	5.8	-	-	14.1	132.1	35.5	695	Vessel	0.3357
4	Upbound	Free Tugs	-	7.8	-	-	4.3	186.2	37.2	2340	TugOnly	0.1024
5	Downbound	Barge	0 < draft =< 12	4.7	11	1.0	1.1	232.0	47.0	4042	Tug1	0.0262
6	Downbound	Ship	8 < draft =< 12	10.5	-	-	0.2	580.5	104.5	42441	Vessel	0.0048
7	Downbound	Small ship	-	5.8	-	-	15.0	131.9	35.5	711	Vessel	0.3571
8	Downbound	Free Tugs	-	8.1	-	-	6.4	167.3	34.9	2167	TugOnly	0.1524

Past point 7

Group	Direction	Vessel Type	Draft group	Avg. Draft (ft)	Num. of barges	Num. of barges per trip	Trips (per year)	Avg. Length (ft)	Avg. Breadth (ft)	Avg. Tonnage (tons, tonnes)	Tug Type	Trip Scaling Factor
1	Upbound	Barge	0 < draft =< 6	2.2	19	1.0	1.9	179.4	50.3	865	Tug1	0.0023
2	Upbound	Ships	8 < draft =< 12	11.6	-	-	10.8	256.1	51.6	2613	Vessel	0.0131
3	Upbound	Small ship	-	7.0	-	-	344.4	179.5	33.3	697	Vessel	0.4174
4	Upbound	Free Tugs	-	6.7	-	-	2.4	73.5	25.3	482	TugOnly	0.0029
5	Downbound	Barge	0 < draft =< 3	1.9	14	1.0	1.4	102.9	43.6	241	Tug1	0.0017
6	Downbound	Barge	6 < draft =< 12	11.3	6	1.0	0.6	297.9	62.6	6597	Tug2	0.0007
7	Downbound	Ships	8 < draft =< 10	9.8	-	-	14.2	240.5	62.5	2539	Vessel	0.0172
8	Downbound	Ships	10 < draft =< 14	11.7	-	-	11.2	257.8	53.4	2734	Vessel	0.0136
9	Downbound	Small ship	-	6.9	-	-	437.0	181.5	33.3	704	Vessel	0.5296
10	Downbound	Free Tugs	-	7.7	-	-	1.3	61.8	23.0	465	TugOnly	0.0016

Past point 8

Group	Direction	Vessel Type	Draft group	Avg. Draft (ft)	Num. of barges	Num. of barges per trip	Trips (per year)	Avg. Length (ft)	Avg. Breadth (ft)	Avg. Tonnage (tons, tonnes)	Tug Type	Trip Scaling Factor
1	Upbound	Barge	0 < draft =< 9	4.2	16	1.0	4.0	227.9	49.1	1477	Tug1	0.0008
2	Upbound	Barge	9 < draft =< 15	13.3	3	1.0	0.8	200.0	48.4	5040	Tug2	0.0006
3	Upbound	Deep barge	15 < draft =< 33	23.5	2	1.0	0.5	125.3	37.2	3619	Tug2	0.0000
4	Upbound	Ship	8 < draft =< 16	12.0	-	-	136.0	268.4	54.4	3008	Vessel	0.0288
5	Upbound	Ship	16 < draft =< 18	18.0	-	-	336.8	379.5	61.0	7126	Vessel	0.0711
6	Upbound	Ship	18 < draft =< 22	20.4	-	-	247.5	430.3	68.1	10325	Vessel	0.0522
7	Upbound	Ship	22 < draft =< 28	25.7	-	-	332.9	691.6	96.2	26270	Vessel	0.0704
8	Upbound	Ship	28 < draft =< 34	31.4	-	-	329.5	783.2	110.7	42276	Vessel	0.0695
9	Upbound	Ship	34 < draft =< 42	37.0	-	-	214.5	743.5	110.4	52749	Vessel	0.0452
10	Upbound	Small ship	-	7.0	-	-	769.5	188.9	33.9	765	Vessel	0.1624
11	Downbound	Barge	0 < draft =< 3	2.8	4	1.0	1.0	343.8	69.8	2410	Tug1	0.0002
12	Downbound	Barge	3 < draft =< 12	9.0	5	1.0	1.2	311.8	56.3	7757	Tug2	0.0003
13	Downbound	Deep barge	30 < draft =< 33	31.0	1	1.0	0.2	135.8	39.3	5205	Tug2	0.0001
14	Downbound	Ship	8 < draft =< 16	12.5	-	-	161.1	280.4	55.6	3371	Vessel	0.0340
15	Downbound	Ship	16 < draft =< 20	18.6	-	-	296.5	400.7	63.6	8177	Vessel	0.0625
16	Downbound	Ship	20 < draft =< 24	22.4	-	-	353.3	495.0	81.4	9361	Vessel	0.0745
17	Downbound	Ship	24 < draft =< 28	26.3	-	-	244.8	739.6	96.9	32648	Vessel	0.0516
18	Downbound	Ship	28 < draft =< 32	30.7	-	-	222.5	822.4	112.1	48656	Vessel	0.0469
19	Downbound	Ship	32 < draft =< 42	36.1	-	-	314.1	732.7	109.9	45428	Vessel	0.0661
20	Downbound	Small ship	-	7.0	-	-	772.8	188.1	34.1	775	Vessel	0.1631

[No vessel groups for Past point 9]

[No vessel groups for Past point 10]

[No vessel groups for Past point 11]



[No vessel groups for Past point 12]

Past point 13

Group	Direction	Vessel Type	Draft group	Avg. Draft (ft)	Num. of barges	Num. of barges per trip	Trips (per year)	Avg. Length (ft)	Avg. Breadth (ft)	Avg. Tonnage (tons, tonnes)	Tug Type	Trip Scaling Factor
1	Upbound	Barge	0 < draft =< 3	2.4	10	1.0	1.0	61.8	24.5	125	Tug1	0.0004
2	Upbound	Barge	3 < draft =< 9	7.0	17	1.0	1.7	192.8	41.5	2570	Tug1	0.0007
3	Upbound	Barge	9 < draft =< 12	11.2	15	1.0	1.5	169.3	35.0	435	Tug2	0.0006
5	Upbound	Ship	7 < draft =< 10	10.0	-	-	131.0	195.9	40.0	1263	Vessel	0.0554
6	Upbound	Ship	10 < draft =< 14	13.0	-	-	721.0	274.5	43.5	2052	Vessel	0.3049
7	Upbound	Ship	14 < draft =< 25	17.1	-	-	103.0	232.4	41.6	1548	Vessel	0.0436
4	Upbound	Small ship	-	7.4	-	-	218.0	169.3	35.0	435	Vessel	0.0922
8	Upbound	Free Tugs	-	7.0	-	-	1.5	177.7	36.5	1665	TugOnly	0.0006
9	Upbound	Other	4 < draft =< 6	5.0	-	-	3.7	222.7	43.9	1972	Vessel	0.0016
10	Downbound	Barge	0 < draft =< 3	2.4	12	1.0	1.2	96.7	29.6	243	Tug1	0.0005
11	Downbound	Barge	3 < draft =< 9	6.9	13	1.0	1.3	217.5	44.1	3124	Tug1	0.0005
12	Downbound	Barge	9 < draft =< 12	11.2	16	1.0	1.6	91.3	30.8	996	Tug2	0.0007
14	Downbound	Ship	7 < draft =< 10	10.0	-	-	131.0	195.9	40.0	1263	Vessel	0.0554
15	Downbound	Ship	10 < draft =< 14	13.0	-	-	721.0	274.5	43.5	2052	Vessel	0.3049
16	Downbound	Ship	14 < draft =< 25	17.1	-	-	103.0	232.4	41.6	1548	Vessel	0.0436
13	Downbound	Small ship	-	7.4	-	-	218.0	169.3	35.0	435	Vessel	0.0922
17	Downbound	Free Tugs	-	7.0	-	-	1.8	192.2	38.4	2141	TugOnly	0.0008
18	Downbound	Other	4 < draft =< 6	5.0	-	-	3.7	222.7	43.9	1972	Vessel	0.0016

Past point 14

Group	Direction	Vessel Type	Draft group	Avg. Draft (ft)	Num. of barges	Num. of barges per trip	Trips (per year)	Avg. Length (ft)	Avg. Breadth (ft)	Avg. Tonnage (tons, tonnes)	Tug Type	Trip Scaling Factor
1	Upbound	Barge	0 < draft =< 12	5.7	6	1.0	0.6	316.7	67.0	5301	Tug1	0.0469
2	Upbound	Ship	0 < draft =< 10	6.0	-	-	0.5	434.7	80.9	18515	Vessel	0.0391
3	Upbound	Free Tugs	-	7.8	-	-	4.1	193.2	38.1	2463	TugOnly	0.3203
4	Downbound	Barge	0 < draft =< 12	4.7	11	1.0	1.1	232.0	47.0	4042	Tug1	0.0859
5	Downbound	Ship	8 < draft =< 12	10.5	-	-	0.2	580.5	104.5	42441	Vessel	0.0156
6	Downbound	Free Tugs	-	8.1	-	-	6.3	169.3	35.3	2198	TugOnly	0.4922

Past point 15

Group	Direction	Vessel Type	Draft group	Avg. Draft (ft)	Num. of barges	Num. of barges per trip	Trips (per year)	Avg. Length (ft)	Avg. Breadth (ft)	Avg. Tonnage (tons, tonnes)	Tug Type	Trip Scaling Factor
1	Upbound	Barge	0 < draft =< 3	2.0	34	1.9	1.8	194.4	43.8	486	Tug1	0.0279
2	Upbound	Barge	3 < draft =< 9	8.0	387	1.9	20.4	207.7	49.0	2586	Tug1	0.3172
3	Upbound	Barge	9 < draft =< 15	11.1	188	1.9	9.9	261.5	50.3	5132	Tug2	0.1541
4	Upbound	Ship	6 < draft =< 8	8.0	-	-	1.5	299.0	77.5	5245	Vessel	0.0233
5	Upbound	Ship	8 < draft =< 12	10.0	-	-	0.2	444.3	93.8	24754	Vessel	0.0031
6	Upbound	Small ship	-	8.0	-	-	1.5	109.1	25.7	428	Vessel	0.0233
7	Upbound	Other	2 < draft =< 4	3.0	-	-	0.1	296.0	54.0	6987	Vessel	0.0016
8	Downbound	Barge	0 < draft =< 3	2.3	549	2.5	22.3	207.9	47.0	611	Tug1	0.3467
9	Downbound	Barge	3 < draft =< 6	4.7	39	2.5	1.6	373.5	75.4	4223	Tug1	0.0246
10	Downbound	Barge	6 < draft =< 12	8.9	35	2.5	1.4	316.6	54.4	5276	Tug1	0.0221
11	Downbound	Ship	4 < draft =< 10	7.9	-	-	2.3	333.2	82.1	8380	Vessel	0.0358
12	Downbound	Small ship	-	8.0	-	-	1.3	105.3	24.4	381	Vessel	0.0202

[No vessel groups for Past point 16]

Past point 17

Group	Direction	Vessel Type	Draft group	Avg. Draft (ft)	Num. of barges	Num. of barges per trip	Trips (per year)	Avg. Length (ft)	Avg. Breadth (ft)	Avg. Tonnage (tons, tonnes)	Tug Type	Trip Scaling Factor
1	Upbound	Barge	0 < draft =< 3	2.0	45	2.0	2.2	198.8	41.8	462	Tug1	0.0293
2	Upbound	Barge	3 < draft =< 9	8.0	406	2.0	20.0	207.4	48.4	2546	Tug1	0.2640
3	Upbound	Barge	9 < draft =< 15	11.1	190	2.0	9.4	261.0	50.1	5099	Tug2	0.1236
4	Upbound	Ship	6 < draft =< 8	8.0	-	-	1.5	299.0	77.5	5245	Vessel	0.0198
5	Upbound	Ship	8 < draft =< 12	10.0	-	-	0.2	444.3	93.8	24754	Vessel	0.0026
6	Upbound	Small ship	-	6.4	-	-	9.4	56.2	15.7	119	Vessel	0.1240
7	Upbound	Other	2 < draft =< 4	3.0	-	-	0.1	296.0	54.0	6987	Vessel	0.0013
8	Downbound	Barge	0 < draft =< 3	2.2	580	2.5	23.2	207.5	46.5	599	Tug1	0.2967
9	Downbound	Barge	3 < draft =< 6	4.7	39	2.5	1.6	373.5	75.4	4223	Tug1	0.0200
10	Downbound	Barge	6 < draft =< 12	9.0	36	2.5	1.4	313.2	53.9	5195	Tug2	0.0184
11	Downbound	Ship	4 < draft =< 10	7.9	-	-	2.3	333.2	82.1	8380	Vessel	0.0303
12	Downbound	Small ship	-	6.5	-	-	5.3	61.3	16.5	145	Vessel	0.0699

Past point 18

Group	Direction	Vessel Type	Draft group	Avg. Draft (ft)	Num. of barges	Num. of barges per trip	Trips (per year)	Avg. Length (ft)	Avg. Breadth (ft)	Avg. Tonnage (tons, tonnes)	Tug Type	Trip Scaling Factor
1	Upbound	Barge	0 < draft =< 3	2.0	49	2.0	2.4	198.9	41.3	461	Tug1	0.0314
2	Upbound	Barge	3 < draft =< 9	8.0	406	2.0	20.1	207.4	48.4	2546	Tug1	0.2602
3	Upbound	Barge	9 < draft =< 15	11.1	190	2.0	9.4	261.0	50.1	5099	Tug2	0.1218
4	Upbound	Ship	6 < draft =< 8	8.0	-	-	1.5	299.0	77.5	5245	Vessel	0.0194
5	Upbound	Ship	8 < draft =< 12	10.0	-	-	0.2	444.3	93.8	24754	Vessel	0.0026
6	Upbound	Small ship	-	6.3	-	-	10.0	59.8	16.2	131	Vessel	0.1292
7	Upbound	Other	2 < draft =< 4	3.0	-	-	0.2	332.0	65.0	6610	Vessel	0.0026
8	Downbound	Barge	0 < draft =< 3	2.2	580	2.5	23.2	207.5	46.5	599	Tug1	0.2929
9	Downbound	Barge	3 < draft =< 6	4.7	39	2.5	1.5	373.5	75.4	4223	Tug1	0.0197
10	Downbound	Barge	6 < draft =< 12	8.8	41	2.5	1.6	299.4	51.6	4771	Tug1	0.0207
11	Downbound	Ship	4 < draft =< 10	7.9	-	-	2.3	333.2	82.1	8380	Vessel	0.0297
12	Downbound	Small ship	-	6.5	-	-	5.4	62.4	16.7	152	Vessel	0.0698

[No vessel groups for Past point 19]



Past point 20

Group	Direction	Vessel Type	Draft group	Avg. Draft (ft)	Num. of barges	Num. of barges per trip	Trips (per year)	Avg. Length (ft)	Avg. Breadth (ft)	Avg. Tonnage (tons, tonnes)	Tug Type	Trip Scaling Factor
1	Upbound	Barge	0 < draft =< 12	4.1	59	2.5	2.3	200.6	35.2	866	Tug1	0.5000
2	Downbound	Barge	0 < draft =< 12	2.5	19	2.5	0.8	202.0	35.3	500	Tug1	0.5000

Past point 21

Group	Direction	Vessel Type	Draft group	Avg. Draft (ft)	Num. of barges	Num. of barges per trip	Trips (per year)	Avg. Length (ft)	Avg. Breadth (ft)	Avg. Tonnage (tons, tonnes)	Tug Type	Trip Scaling Factor
1	Upbound	Barge	0 < draft =< 12	6.1	11	1.0	1.1	226.2	56.7	3262	Tug1	0.0288
2	Upbound	Ship	6 < draft =< 10	8.1	-	-	1.4	312.6	82.0	5713	Vessel	0.0366
3	Upbound	Small ship	-	5.8	-	-	15.1	131.2	35.3	702	Vessel	0.3953
4	Upbound	Free Tugs	-	7.0	-	-	2.4	78.6	26.6	541	TugOnly	0.0628
5	Upbound	Other	2 < draft =< 4	3.0	-	-	0.1	296.0	54.0	6987	Vessel	0.0026
6	Downbound	Barge	0 < draft =< 6	3.4	10	1.0	1.0	245.0	57.6	1807	Tug1	0.0262
7	Downbound	Ship	6 < draft =< 8	8.0	-	-	1.0	312.6	82.0	5713	Vessel	0.0262
8	Downbound	Small ship	-	5.8	-	-	14.2	131.0	35.2	684	Vessel	0.3717
9	Downbound	Free Tugs	-	7.3	-	-	1.9	76.3	25.6	500	TugOnly	0.0497

Past point 22

Group	Direction	Vessel Type	Draft group	Avg. Draft (ft)	Num. of barges	Num. of barges per trip	Trips (per year)	Avg. Length (ft)	Avg. Breadth (ft)	Avg. Tonnage (tons, tonnes)	Tug Type	Trip Scaling Factor
1	Upbound	Barge	0 < draft =< 3	2.0	15	1.0	1.5	191.0	47.8	529	Tug1	0.0003
2	Upbound	Barge	3 < draft =< 9	5.9	7	1.0	0.7	257.3	57.2	2709	Tug1	0.0001
3	Upbound	Ship	6 < draft =< 8	8.0	-	-	2.0	312.6	82.0	5713	Vessel	0.0004
4	Upbound	Ship	10 < draft =< 12	12.0	-	-	196.6	585.0	103.3	12436	Vessel	0.0352
5	Upbound	Small ship	-	3.0	-	-	2568.6	40.0	12.0	43	Vessel	0.4602
6	Upbound	Free Tugs	-	7.4	-	-	3.6	73.1	25.1	488	TugOnly	0.0006
7	Downbound	Barge	0 < draft =< 3	2.2	12	1.0	1.2	171.2	48.4	531	Tug1	0.0002
8	Downbound	Barge	3 < draft =< 12	7.8	8	1.0	0.8	185.0	49.3	2663	Tug1	0.0001
9	Downbound	Ship	6 < draft =< 8	8.0	-	-	1.3	312.6	82.0	5713	Vessel	0.0002
10	Downbound	Ship	8 < draft =< 12	12.0	-	-	197.7	584.8	103.3	12449	Vessel	0.0354
11	Downbound	Small ship	-	3.0	-	-	2604.5	40.0	12.0	43	Vessel	0.4666
12	Downbound	Free Tugs	-	6.9	-	-	3.1	69.5	24.5	427	TugOnly	0.0006
13	Downbound	Other	2 < draft =< 4	3.0	-	-	0.1	296.0	54.0	6987	Vessel	0.0000

Past point 23

Group	Direction	Vessel Type	Draft group	Avg. Draft (ft)	Num. of barges	Num. of barges per trip	Trips (per year)	Avg. Length (ft)	Avg. Breadth (ft)	Avg. Tonnage (tons, tonnes)	Tug Type	Trip Scaling Factor
1	Upbound	Barge	0 < draft =< 3	2.0	601	1.0	60.1	236.4	51.2	651	Tug1	0.1444
2	Upbound	Barge	3 < draft =< 9	7.0	63	1.0	6.3	200.5	36.1	1596	Tug1	0.0151
3	Upbound	Barge	9 < draft =< 12	11.6	23	1.0	2.3	215.8	39.7	3171	Tug2	0.0055
4	Upbound	Barge	24 < draft =< 27	27.0	1	1.0	0.1	124.2	38.0	4012	Tug2	0.0002
5	Upbound	Free Tugs	-	8.3	-	-	98.7	68.3	27.2	479	TugOnly	0.2371
6	Upbound	Other	2 < draft =< 4	3.0	-	-	48.8	296.0	54.0	6987	Vessel	0.1173
7	Downbound	Barge	0 < draft =< 3	2.0	650	1.0	65.0	230.5	50.1	627	Tug1	0.1562
8	Downbound	Barge	3 < draft =< 6	4.6	10	1.0	1.0	229.6	41.6	1412	Tug1	0.0024
9	Downbound	Barge	6 < draft =< 12	10.7	61	1.0	6.1	241.7	44.0	3589	Tug2	0.0147
10	Downbound	Barge	12 < draft =< 15	13.0	7	1.0	0.7	274.0	50.0	5610	Tug2	0.0017
11	Downbound	Barge	15 < draft =< 27	22.0	2	1.0	0.2	124.0	37.1	3207	Tug2	0.0005
12	Downbound	Ship	6 < draft =< 12	10.0	-	-	0.2	481.8	93.7	25983	Vessel	0.0005
13	Downbound	Free Tugs	-	8.1	-	-	92.1	68.4	27.2	482	TugOnly	0.2213
14	Downbound	Other	2 < draft =< 6	3.0	-	-	34.5	295.9	54.0	6982	Vessel	0.0829
15	Downbound	Other	4 < draft =< 6	5.0	-	-	0.1	259.3	54.0	5281	Vessel	0.0002

Past point 24

Group	Direction	Vessel Type	Draft group	Avg. Draft (ft)	Num. of barges	Num. of barges per trip	Trips (per year)	Avg. Length (ft)	Avg. Breadth (ft)	Avg. Tonnage (tons, tonnes)	Tug Type	Trip Scaling Factor
1	Upbound	Barge	0 < draft =< 3	2.3	337	1.2	28.2	215.2	43.7	608	Tug1	0.0891
2	Upbound	Barge	3 < draft =< 6	4.9	376	1.2	31.5	268.1	63.5	2984	Tug1	0.0994
3	Upbound	Barge	6 < draft =< 9	7.6	1140	1.2	95.4	321.8	58.5	6049	Tug1	0.3013
4	Upbound	Barge	9 < draft =< 12	11.7	177	1.2	14.8	220.6	39.2	3299	Tug2	0.0468
5	Upbound	Barge	12 < draft =< 15	13.5	20	1.2	1.7	330.9	56.3	8788	Tug2	0.0053
6	Upbound	Ship	4 < draft =< 12	7.7	-	-	0.7	553.1	90.9	31998	Vessel	0.0022
7	Upbound	Small ship	-	6.0	-	-	0.2	62.0	17.0	210	Vessel	0.0006
8	Upbound	Other	2 < draft =< 4	3.0	-	-	0.1	296.0	54.0	6987	Vessel	0.0003
9	Downbound	Barge	0 < draft =< 3	2.0	995	1.1	89.0	188.3	40.9	423	Tug1	0.2812
10	Downbound	Barge	3 < draft =< 6	5.0	116	1.1	10.4	469.4	89.6	6921	Tug1	0.0328
11	Downbound	Barge	6 < draft =< 9	7.8	342	1.1	30.6	552.8	97.7	13694	Tug1	0.0966
12	Downbound	Barge	9 < draft =< 12	11.7	53	1.1	4.7	255.3	45.6	4870	Tug2	0.0150
13	Downbound	Barge	12 < draft =< 15	14.0	64	1.1	5.7	432.3	71.2	13698	Tug2	0.0181
14	Downbound	Barge	18 < draft =< 21	21.0	1	1.1	0.1	326.5	74.0	15983	Tug2	0.0003
15	Downbound	Ship	14 < draft =< 16	15.0	-	-	0.2	629.3	105.8	49878	Vessel	0.0006
16	Downbound	Small ship	-	6.0	-	-	3.2	63.7	18.3	126	Vessel	0.0101
17	Downbound	Other	2 < draft =< 4	3.0	-	-	0.1	296.0	54.0	6987	Vessel	0.0003

Past point 25

Group	Direction	Vessel Type	Draft group	Avg. Draft (ft)	Num. of barges	Num. of barges per trip	Trips (per year)	Avg. Length (ft)	Avg. Breadth (ft)	Avg. Tonnage (tons, tonnes)	Tug Type	Trip Scaling Factor
1	Upbound	Barge	0 < draft =< 3	2.0	2975	1.5	202.6	206.6	36.5	414	Tug1	0.1178
2	Upbound	Barge	3 < draft =< 6	5.7	523	1.5	35.6	231.8	49.0	2074	Tug1	0.0207
3	Upbound	Barge	6 < draft =< 9	8.5	8238	1.5	561.1	218.8	39.0	2365	Tug1	0.3263
4	Upbound	Barge	9 < draft =< 12	10.7	1388	1.5	94.5	246.3	48.5	4113	Tug2	0.0550
5	Upbound	Ship	0 < draft =< 16	16.1	-	-	6.7	537.9	91.3	31174	Vessel	0.0039
6	Upbound	Ship	16 < draft =< 20	19.1	-	-	11.6	614.9	99.2	39406	Vessel	0.0067
7	Upbound	Ship	20 < draft =< 22	21.3	-	-	7.0	603.2	102.3	44286	Vessel	0.0041
8	Upbound	Ship	22 < draft =< 26	24.4	-	-	7.6	584.7	102.0	40319	Vessel	0.0133
9	Upbound	Ship	26 < draft =< 34	29.4	-	-	6.5	588.8	99.0	38987	Vessel	0.0038
10	Upbound	Small ship	-	8.8	-	-	10.8	72.9	27.4	308	Vessel	0.0063
11	Downbound	Barge	0 < draft =< 3	2.0	11450	1.6	710.2	218.3	39.5	477	Tug1	0.4030
12	Downbound	Barge	3 < draft =< 12	6.1	283	1.0	17.5	240.2	41.9	1936	Tug1	0.0102
13	Downbound	Ship	0 < draft =< 18	13.9	-	-	5.4	489.2	84.6	26337	Vessel	0.0031
14	Downbound	Ship	18 < draft =< 20	19.8	-	-	5.3	623.7	99.3	39992	Vessel	0.0040
15	Downbound	Ship	20 < draft =< 22	21.5	-	-	6.8	587.4	100.2	40949	Vessel	0.0040
16	Downbound	Ship	22 < draft =< 24	23.6	-	-	6.6	590.2	103.1	40889	Vessel	0.0038
17	Downbound	Ship	24 < draft =< 26	25.3	-	-	5.3	577.7	101.5	40291	Vessel	0.0031
18	Downbound	Ship	26 < draft =< 32	28.4	-	-	5.1	585.2	96.6	36728	Vessel	0.0030
19	Downbound	Small ship	-	7.0	-	-	11.2	74.2	27.3	315	Vessel	0.0065
20	Downbound	Other	2 < draft =< 32	23.0	-	-	4.1	577.4	96.0	36248	Vessel	0.0024

Past point 26

Group	Direction	Vessel Type	Draft group	Avg. Draft (ft)	Num. of barges	Num. of barges per trip	Trips (per year)	Avg. Length (ft)	Avg. Breadth (ft)	Avg. Tonnage (tons, tonnes)	Tug Type	Trip Scaling Factor
1	Upbound	Barge	0 < draft =< 3	2.0	4025	1.6	252.7	215.9	38.0	485	Tug1	0.1067
2	Upbound	Barge	3 < draft =< 6	5.2	1592	1.6	100.0	281.8	51.7	2374	Tug1	0.0422
3	Upbound	Barge	6 < draft =< 9	8.5	12631	1.6	793.1	229.8	41.3	2638	Tug1	0.3349
4	Upbound	Barge	9 < draft =< 15	10.7	1959	1.6	123.0	254.8	49.3	4345	Tug2	0.0519
5	Upbound	Ship	0 < draft =< 8	7.2	-	-	1.9	285.0	72.8	5103	Vessel	0.0008
6	Upbound	Ship	8 < draft =< 12	10.2	-	-	0.4	365.1	77.4	15069	Vessel	0.0002
7	Upbound	Small ship	-	7.5	-	-	26.2	63.2	21.5	213	Vessel	0.0111
8	Upbound	Other	2 < draft =< 4	3.0	-	-	0.3	344.0	68.7	6484	Vessel	0.0001
9	Downbound	Barge	0 < draft =< 3	2.0	17505	1.7	1004.3	231.2	41.7	555	Tug1	0.4241
10	Downbound	Barge	3 < draft =< 6	4.9	297	1.7	17.0	254.8	45.9	1890	Tug1	0.0072
11	Downbound	Barge	6 < draft =< 9	8.2	299	1.7	17.2	213.3	37.6	2155	Tug1	0.0072
12	Downbound	Barge	9 < draft =< 15	11.1	133	1.7	7.6	217.4	38.3	3088	Tug2	0.0032
13	Downbound	Ship	0 < draft =< 8	7.3	-	-	2.6	308.4	77.0	6506	Vessel	0.0011
14	Downbound	Ship	8 < draft =< 12	9.8	-	-	0.5	345.1	72.2	13048	Vessel	0.0002
15	Downbound	Small ship	-	7.8	-	-	21.3	64.9	22.8	235	Vessel	0.0090
16	Downbound	Other	2 < draft =< 4	3.0	-	-	0.1	368.0	76.0	6233	Vessel	0.0000

Past point 27

Group	Direction	Vessel Type	Draft group	Avg. Draft (ft)	Num. of barges	Num. of barges per trip	Trips (per year)	Avg. Length (ft)	Avg. Breadth (ft)	Avg. Tonnage (tons, tonnes)	Tug Type	Trip Scaling Factor
1	Upbound	Barge	0 < draft =< 3	2.2	736	1.9	39.5	259.8	45.5	812	Tug1	0.0576
2	Upbound	Barge	3 < draft =< 6	4.9	1053	1.9	56.5	306.4	52.9	2515	Tug1	0.0824
3	Upbound	Barge	6 < draft =< 9	8.5	4181	1.9	224.3	248.4	45.2	3109	Tug1	0.3270
4	Upbound	Barge	9 < draft =< 15	10.5	574	1.9	30.8	272.9	50.3	4776	Tug2	0.0449
5	Upbound	Ship	0 < draft =< 8	7.6	-	-	1.7	295.7	75.7	5501	Vessel	0.0025
6	Upbound	Ship	8 < draft =< 12	10.2	-	-	0.4	365.1	77.4	15069	Vessel	0.0006
7	Upbound	Small ship	-	6.8	-	-	15.0	60.7	18.3	168	Vessel	0.0219
8	Upbound	Other	2 < draft =< 4	3.0	-	-	0.2	332.0	65.0	6610	Vessel	0.0003
9	Downbound	Barge	0 < draft =< 3	2.1	5825	2.0	296.3	254.9	45.9	696	Tug1	0.4321
10	Downbound	Barge	3 < draft =< 6	5.0	95	2.0	4.8	270.9	52.8	2454	Tug1	0.0070
11	Downbound	Barge	6 < draft =< 12	8.5	62	2.0	3.2	268.6	46.6	3808	Tug1	0.0046
12	Downbound	Ship	0 < draft =< 8	7.6	-	-	2.4	317.9	79.4	6905	Vessel	0.0035
13	Downbound	Ship	8 < draft =< 12	9.8	-	-	0.5	345.1	72.2	13048	Vessel	0.0007
14	Downbound	Small ship	-	6.9	-	-	10.3	62.9	19.5	189	Vessel	0.0150



Past point 28

Group	Direction	Vessel Type	Draft group	Avg. Draft (ft)	Num. of barges	Num. of barges per trip	Trips (per year)	Avg. Length (ft)	Avg. Breadth (ft)	Avg. Tonnage (tons, tonnes)	Tug Type	Trip Scaling Factor
1	Upbound	Barge	0 < draft =< 3	1.5	19	1.0	1.9	157.5	49.1	371	Tug1	0.0356
2	Upbound	Barge	6 < draft =< 15	8.6	9	1.0	0.9	311.7	59.5	5744	Tug1	0.0169
3	Upbound	Ship	4 < draft =< 12	8.0	-	-	0.2	242.9	48.0	3361	Vessel	0.0037
4	Upbound	Small ship	-	7.0	-	-	0.1	96.0	24.0	395	Vessel	0.0019
5	Upbound	Free Tugs	-	7.4	-	-	8.3	87.0	27.5	760	TugOnly	0.1554
6	Upbound	Other	2 < draft =< 12	7.7	-	-	0.3	389.0	68.0	4253	Vessel	0.0056
7	Downbound	Barge	0 < draft =< 3	1.9	44	1.0	4.4	220.6	48.3	753	Tug1	0.0824
8	Downbound	Barge	3 < draft =< 6	5.0	53	1.0	5.3	387.1	71.6	4564	Tug1	0.0993
9	Downbound	Barge	6 < draft =< 9	7.1	34	1.0	3.4	432.0	74.3	7223	Tug1	0.0637
10	Downbound	Barge	9 < draft =< 12	11.1	30	1.0	3.0	499.6	78.3	13679	Tug2	0.0562
11	Downbound	Barge	12 < draft =< 15	14.1	48	1.0	4.8	455.6	73.3	14886	Tug2	0.0899
12	Downbound	Barge	18 < draft =< 21	21.0	1	1.0	0.1	326.5	74.0	15983	Tug2	0.0019
13	Downbound	Ship	4 < draft =< 8	6.2	-	-	2.1	596.1	94.4	34363	Vessel	0.0393
14	Downbound	Ship	8 < draft =< 18	12.2	-	-	0.5	601.7	102.6	42436	Vessel	0.0094
15	Downbound	Small ship	-	6.5	-	-	0.2	72.4	19.5	233	Vessel	0.0037
16	Downbound	Free Tugs	-	8.0	-	-	17.5	82.8	28.3	623	TugOnly	0.3277
17	Downbound	Other	4 < draft =< 12	9.2	-	-	0.4	343.1	65.9	3961	Vessel	0.0075

[No vessel groups for Past point 29]

Past point 30

Group	Direction	Vessel Type	Draft group	Avg. Draft (ft)	Num. of barges	Num. of barges per trip	Trips (per year)	Avg. Length (ft)	Avg. Breadth (ft)	Avg. Tonnage (tons, tonnes)	Tug Type	Trip Scaling Factor
1	Upbound	Barge	0 < draft =< 6	3.5	352	1.3	27.0	292.5	60.6	2617	Tug1	0.0801
2	Upbound	Barge	6 < draft =< 9	7.7	581	1.3	44.6	481.0	81.7	10755	Tug1	0.1322
3	Upbound	Barge	9 < draft =< 15	12.1	151	1.3	11.6	260.4	45.1	5238	Tug2	0.0343
4	Upbound	Ship	4 < draft =< 16	14.9	-	-	24.7	615.6	102.3	9315	Vessel	0.0732
5	Upbound	Ship	16 < draft =< 18	17.3	-	-	14.2	595.8	94.4	33616	Vessel	0.0420
6	Upbound	Ship	18 < draft =< 22	20.8	-	-	17.3	600.6	99.0	40179	Vessel	0.0513
7	Upbound	Ship	22 < draft =< 26	24.8	-	-	27.3	583.3	100.8	39390	Vessel	0.0809
8	Upbound	Ship	26 < draft =< 28	27.5	-	-	13.3	579.6	89.1	31348	Vessel	0.0394
9	Upbound	Ship	28 < draft =< 36	30.0	-	-	8.3	592.8	104.8	43070	Vessel	0.0246
10	Upbound	Small ship	-	6.0	-	-	0.2	62.0	17.0	210	Vessel	0.0006
11	Downbound	Barge	0 < draft =< 6	3.1	325	1.3	22.9	306.7	57.5	2781	Tug1	0.0676
12	Downbound	Barge	6 < draft =< 9	7.8	341	1.4	24.0	559.4	98.5	13850	Tug1	0.0709
13	Downbound	Barge	9 < draft =< 15	13.1	116	1.3	8.2	366.4	61.7	10422	Tug2	0.0241
14	Downbound	Ship	8 < draft =< 14	12.3	-	-	5.0	592.0	101.2	30533	Vessel	0.0148
15	Downbound	Ship	14 < draft =< 18	15.8	-	-	28.1	612.0	100.8	16966	Vessel	0.0832
16	Downbound	Ship	18 < draft =< 20	19.5	-	-	12.7	620.5	95.9	37903	Vessel	0.0375
17	Downbound	Ship	20 < draft =< 24	22.7	-	-	18.7	590.0	101.9	41135	Vessel	0.0554
18	Downbound	Ship	24 < draft =< 26	25.3	-	-	15.8	577.7	101.5	40329	Vessel	0.0468
19	Downbound	Ship	26 < draft =< 33	28.2	-	-	10.7	583.9	94.1	35099	Vessel	0.0317
20	Downbound	Small ship	-	6.0	-	-	3.2	63.7	18.3	126	Vessel	0.0095

Past point 31

Group	Direction	Vessel Type	Draft group	Avg. Draft (ft)	Num. of barges	Num. of barges per trip	Trips (per year)	Avg. Length (ft)	Avg. Breadth (ft)	Avg. Tonnage (tons, tonnes)	Tug Type	Trip Scaling Factor
1	Upbound	Barge	0 < draft =< 3	2.3	528	1.7	31.1	245.5	42.6	786	Tug1	0.0544
2	Upbound	Barge	3 < draft =< 6	4.9	824	1.7	48.5	308.9	52.9	2546	Tug1	0.0849
3	Upbound	Barge	6 < draft =< 9	8.5	3050	1.7	179.7	233.3	42.7	2733	Tug1	0.3144
4	Upbound	Barge	9 < draft =< 15	10.5	557	1.7	32.8	272.7	50.3	4780	Tug2	0.0574
5	Upbound	Ship	0 < draft =< 8	7.6	-	-	1.7	295.7	75.7	5501	Vessel	0.0030
6	Upbound	Ship	8 < draft =< 12	10.0	-	-	0.3	389.5	82.5	18096	Vessel	0.0005
7	Upbound	Small ship	-	7.0	-	-	13.4	63.1	19.1	182	Vessel	0.0235
8	Upbound	Other	2 < draft =< 4	3.0	-	-	0.2	332.0	65.0	6610	Vessel	0.0004
9	Downbound	Barge	0 < draft =< 3	2.1	4583	1.9	243.7	245.1	44.2	660	Tug1	0.4266
10	Downbound	Barge	3 < draft =< 6	5.0	95	1.9	5.1	270.9	52.8	2454	Tug1	0.0088
11	Downbound	Barge	6 < draft =< 12	8.5	64	1.9	3.4	265.9	46.4	3760	Tug1	0.0060
12	Downbound	Ship	0 < draft =< 8	7.6	-	-	2.4	317.9	79.4	6905	Vessel	0.0042
13	Downbound	Ship	8 < draft =< 12	9.5	-	-	0.4	358.4	74.8	14812	Vessel	0.0007
14	Downbound	Small ship	-	7.2	-	-	8.7	66.9	21.1	215	Vessel	0.0152

Past point 32

Group	Direction	Vessel Type	Draft group	Avg. Draft (ft)	Num. of barges	Num. of barges per trip	Trips (per year)	Avg. Length (ft)	Avg. Breadth (ft)	Avg. Tonnage (tons, tonnes)	Tug Type	Trip Scaling Factor
1	Upbound	Barge	0 < draft =< 12	5.3	13	1.0	1.3	209.8	53.7	2778	Tug1	0.0023
2	Upbound	Ship	4 < draft =< 6	6.0	-	-	190.8	150.7	37.6	1165	Vessel	0.3341
3	Upbound	Ship	6 < draft =< 8	7.2	-	-	7.8	181.3	45.2	1959	Vessel	0.0137
4	Upbound	Ship	8 < draft =< 10	9.0	-	-	6.8	312.6	82.0	5280	Vessel	0.0119
5	Upbound	Small ship	-	6.1	-	-	68.8	140.3	35.9	503	Vessel	0.1205
6	Upbound	Free Tugs	-	6.8	-	-	6.9	69.9	24.3	410	TugOnly	0.0121
7	Upbound	Other	2 < draft =< 4	3.0	-	-	0.1	296.0	54.0	6987	Vessel	0.0002
8	Downbound	Barge	0 < draft =< 6	3.1	13	1.0	1.3	216.1	53.5	1456	Tug1	0.0023
9	Downbound	Ship	4 < draft =< 6	6.0	-	-	197.8	150.7	37.6	1165	Vessel	0.3463
10	Downbound	Ship	6 < draft =< 8	7.1	-	-	7.5	176.0	43.8	1808	Vessel	0.0131
11	Downbound	Ship	8 < draft =< 10	9.0	-	-	6.7	312.6	82.0	5273	Vessel	0.0117
12	Downbound	Small ship	-	6.1	-	-	69.0	140.0	35.8	501	Vessel	0.1208
13	Downbound	Free Tugs	-	7.1	-	-	6.3	68.2	23.7	383	TugOnly	0.0110

Past point 33

Group	Direction	Vessel Type	Draft group	Avg. Draft (ft)	Num. of barges	Num. of barges per trip	Trips (per year)	Avg. Length (ft)	Avg. Breadth (ft)	Avg. Tonnage (tons, tonnes)	Tug Type	Trip Scaling Factor
1	Upbound	Barge	0 < draft =< 3	2.2	23	1.0	2.3	165.6	48.3	757	Tug1	0.0028
2	Upbound	Barge	3 < draft =< 15	13.2	6	1.0	0.6	413.1	76.7	16948	Tug2	0.0007
3	Upbound	Ships	8 < draft =< 16	11.7	-	-	10.9	259.1	52.1	2979	Vessel	0.0132
4	Upbound	Small ship	-	7.0	-	-	344.3	179.5	33.3	697	Vessel	0.4167
5	Upbound	Free Tugs	-	7.0	-	-	2.3	71.6	24.7	500	TugOnly	0.0028
6	Downbound	Barge	0 < draft =< 3	2.2	17	1.0	1.7	100.6	42.4	254	Tug1	0.0021
7	Downbound	Barge	6 < draft =< 12	11.3	6	1.0	0.6	297.9	62.6	6597	Tug2	0.0007
8	Downbound	Ships	8 < draft =< 10	9.8	-	-	14.2	240.5	62.5	2539	Vessel	0.0172
9	Downbound	Ships	10 < draft =< 14	11.7	-	-	11.2	257.8	53.4	2734	Vessel	0.0136
10	Downbound	Small ship	-	6.9	-	-	436.8	181.5	33.3	704	Vessel	0.5286
11	Downbound	Free Tugs	-	7.2	-	-	1.4	58.9	22.2	422	TugOnly	0.0017

Past point 34

Group	Direction	Vessel Type	Draft group	Avg. Draft (ft)	Num. of barges	Num. of barges per trip	Trips (per year)	Avg. Length (ft)	Avg. Breadth (ft)	Avg. Tonnage (tons, tonnes)	Tug Type	Trip Scaling Factor
1	Upbound	Barge	0 < draft =< 6	2.2	56	1.0	5.6	118.0	41.4	357	Tug1	0.0641
2	Upbound	Ship	8 < draft =< 12	10.0	-	-	0.2	218.3	47.5	3318	Vessel	0.0023
3	Upbound	Small ship	-	5.8	-	-	14.1	132.1	35.5	695	Vessel	0.1613
4	Upbound	Free Tugs	-	5.5	-	-	2.3	47.0	18.8	222	TugOnly	0.0263
5	Upbound	Other	2 < draft =< 4	3.0	-	-	21.3	368.0	76.0	6233	Vessel	0.2437
6	Downbound	Barge	0 < draft =< 3	2.1	51	1.0	5.1	104.7	41.3	245	Tug1	0.0584
7	Downbound	Barge	3 < draft =< 12	10.3	7	1.0	0.7	272.5	60.1	5752	Tug2	0.0080
8	Downbound	Small ship	-	5.8	-	-	15.0	131.9	35.5	711	Vessel	0.1716
9	Downbound	Free Tugs	-	5.0	-	-	1.8	42.5	18.0	177	TugOnly	0.0206
10	Downbound	Other	2 < draft =< 4	3.0	-	-	21.3	368.0	76.0	6233	Vessel	0.2437

Past point 35

Group	Direction	Vessel Type	Draft group	Avg. Draft (ft)	Num. of barges	Num. of barges per trip	Trips (per year)	Avg. Length (ft)	Avg. Breadth (ft)	Avg. Tonnage (tons, tonnes)	Tug Type	Trip Scaling Factor
1	Upbound	Barge	0 < draft =< 6	2.5	10	1.0	1.0	193.8	45.6	916	Tug1	0.0278
2	Upbound	Ship	10 < draft =< 12	11.0	-	-	0.1	263.0	52.1	4750	Vessel	0.0028
3	Upbound	Small ship	-	5.8	-	-	14.1	132.1	35.5	695	Vessel	0.3917
4	Upbound	Free Tugs	-	6.6	-	-	2.5	75.5	25.5	482	TugOnly	0.0694
5	Downbound	Barge	0 < draft =< 12	7.3	12	1.0	1.2	217.3	53.8	3591	Tug1	0.0333
6	Downbound	Small ship	-	5.8	-	-	15.0	131.9	35.5	711	Vessel	0.4167
7	Downbound	Free Tugs	-	6.2	-	-	2.1	68.8	24.6	422	TugOnly	0.0583



Past point 36

Group	Direction	Vessel Type	Draft group	Avg. Draft (ft)	Num. of barges	Num. of barges per trip	Trips (per year)	Avg. Length (ft)	Avg. Breadth (ft)	Avg. Tonnage (tons, tonnes)	Tug Type	Trip Scaling Factor
1	Upbound	Barge	0 < draft =< 3	2.1	18	1.0	1.8	185.4	51.8	898	Tug1	0.0022
2	Upbound	Barge	3 < draft =< 15	13.2	6	1.0	0.6	413.1	76.7	16948	Tug2	0.0007
3	Upbound	Ships	8 < draft =< 16	11.7	-	-	10.9	259.1	52.1	2979	Vessel	0.0132
4	Upbound	Small ship	-	7.0	-	-	344.3	179.5	33.3	697	Vessel	0.4173
5	Upbound	Free Tugs	-	7.4	-	-	2.2	76.1	25.9	557	TugOnly	0.0027
6	Downbound	Barge	0 < draft =< 3	2.0	13	1.0	1.3	103.1	45.0	254	Tug1	0.0016
7	Downbound	Barge	6 < draft =< 12	11.3	6	1.0	0.6	297.9	62.6	6597	Tug2	0.0007
8	Downbound	Ships	8 < draft =< 10	9.8	-	-	14.2	240.5	62.5	2539	Vessel	0.0172
9	Downbound	Ships	10 < draft =< 14	11.7	-	-	11.2	257.8	53.4	2734	Vessel	0.0136
10	Downbound	Small ship	-	6.9	-	-	436.8	181.5	33.3	704	Vessel	0.5294
11	Downbound	Free Tugs	-	8.1	-	-	1.2	63.2	23.5	492	TugOnly	0.0015

Past point 37

Group	Direction	Vessel Type	Draft group	Avg. Draft (ft)	Num. of barges	Num. of barges per trip	Trips (per year)	Avg. Length (ft)	Avg. Breadth (ft)	Avg. Tonnage (tons, tonnes)	Tug Type	Trip Scaling Factor
1	Upbound	Barge	0 < draft =< 3	1.9	30	1.0	3.0	155.4	42.8	401	Tug1	0.0006
2	Upbound	Barge	3 < draft =< 6	4.5	10	1.0	1.0	191.7	51.3	1562	Tug1	0.0002
3	Upbound	Barge	6 < draft =< 12	8.7	7	1.0	0.7	379.2	68.3	7618	Tug1	0.0001
4	Upbound	Ship	6 < draft =< 12	12.0	-	-	65.5	583.7	103.2	12405	Vessel	0.0138
5	Upbound	Small ship	-	2.9	-	-	1879.1	40.0	12.0	38	Vessel	0.3949
6	Upbound	Free Tugs	-	6.4	-	-	1.3	56.9	20.5	244	TugOnly	0.0003
7	Downbound	Barge	0 < draft =< 9	2.3	41	1.0	4.1	162.0	44.7	700	Tug1	0.0009
8	Downbound	Ship	10 < draft =< 12	12.0	-	-	197.5	585.0	103.3	12436	Vessel	0.0415
9	Downbound	Small ship	-	3.0	-	-	2604.3	40.0	12.0	43	Vessel	0.5473
10	Downbound	Free Tugs	-	6.5	-	-	1.7	58.6	20.9	254	TugOnly	0.0004
11	Downbound	Other	2 < draft =< 4	3.0	-	-	0.1	296.0	54.0	6987	Vessel	0.0000

[No vessel groups for Past point 38]

Past point 39

Group	Direction	Vessel Type	Draft group	Avg. Draft (ft)	Num. of barges	Num. of barges per trip	Trips (per year)	Avg. Length (ft)	Avg. Breadth (ft)	Avg. Tonnage (tons, tonnes)	Tug Type	Trip Scaling Factor
1	Upbound	Barge	0 < draft =< 6	4.0	546	1.7	32.9	335.1	63.0	3298	Tug1	0.0122
2	Upbound	Barge	6 < draft =< 15	11.2	999	1.7	60.3	346.7	61.6	8259	Tug2	0.0224
3	Upbound	Deep barge	15 < draft =< 21	19.3	1353	1.7	81.6	423.9	70.8	18239	Tug2	0.0302
4	Upbound	Deep barge	21 < draft =< 27	25.5	1405	1.7	84.7	516.2	75.9	31471	Tug2	0.0315
5	Upbound	Deep barge	27 < draft =< 42	31.8	1944	1.7	117.2	529.5	83.9	44859	Tug2	0.0436
6	Upbound	Ship	2 < draft =< 20	13.0	-	-	173.3	616.2	100.8	4507	Vessel	0.0642
7	Upbound	Ship	20 < draft =< 28	23.6	-	-	233.1	594.5	102.2	7110	Vessel	0.0866
8	Upbound	Ship	28 < draft =< 30	29.6	-	-	207.1	589.2	105.1	6108	Vessel	0.0770
9	Upbound	Ship	30 < draft =< 34	32.8	-	-	161.9	606.2	103.5	12303	Vessel	0.0602
10	Upbound	Ship	34 < draft =< 44	36.9	-	-	259.3	93.5	16.6	3440	Vessel	0.0964
11	Downbound	Barge	0 < draft =< 6	4.2	2179	1.7	130.1	392.4	66.3	3983	Tug1	0.0484
12	Downbound	Barge	6 < draft =< 15	9.6	1088	1.7	65.0	470.9	74.7	10813	Tug2	0.0241
13	Downbound	Deep barge	15 < draft =< 21	19.0	692	1.7	41.3	463.4	78.8	21890	Tug2	0.0154
14	Downbound	Deep barge	21 < draft =< 27	25.3	583	1.7	34.8	498.4	77.6	30836	Tug2	0.0130
15	Downbound	Deep barge	27 < draft =< 42	32.5	871	1.7	51.9	553.2	82.8	47137	Tug2	0.0193
16	Downbound	Ship	0 < draft =< 18	11.8	-	-	142.2	595.1	100.7	23914	Vessel	0.0530
17	Downbound	Ship	18 < draft =< 22	21.1	-	-	147.9	594.5	99.9	21236	Vessel	0.0550
18	Downbound	Ship	22 < draft =< 28	27.8	-	-	296.8	584.5	105.1	4901	Vessel	0.0937
19	Downbound	Ship	28 < draft =< 32	30.1	-	-	238.8	590.6	104.9	2701	Vessel	0.0888
20	Downbound	Ship	34 < draft =< 42	37.2	-	-	98.6	589.0	103.5	23804	Vessel	0.0651

Past point 40

Group	Direction	Vessel Type	Draft group	Avg. Draft (ft)	Num. of barges	Num. of barges per trip	Trips (per year)	Avg. Length (ft)	Avg. Breadth (ft)	Avg. Tonnage (tons, tonnes)	Tug Type	Trip Scaling Factor
1	Upbound	Barge	0 < draft =< 12	6.3	12	1.0	1.2	346.6	63.0	5225	Tug1	0.0003
2	Upbound	Ship	6 < draft =< 12	12.0	-	-	65.5	583.7	103.2	12405	Vessel	0.0138
3	Upbound	Small ship	-	2.9	-	-	1879.1	40.0	12.0	38	Vessel	0.3956
4	Upbound	Free Tugs	-	6.6	-	-	0.7	84.2	27.8	567	TugOnly	0.0001
5	Downbound	Barge	0 < draft =< 9	4.9	7	1.0	0.7	256.9	52.1	2597	Tug1	0.0001
6	Downbound	Ship	10 < draft =< 12	12.0	-	-	197.5	585.0	103.3	12436	Vessel	0.0416
7	Downbound	Small ship	-	3.0	-	-	2604.3	40.0	12.0	43	Vessel	0.5483
8	Downbound	Free Tugs	-	6.8	-	-	1.1	87.7	28.6	574	TugOnly	0.0002
9	Downbound	Other	2 < draft =< 4	3.0	-	-	0.1	296.0	54.0	6987	Vessel	0.0000

Past point 41

Group	Direction	Vessel Type	Draft group	Avg. Draft (ft)	Num. of barges	Num. of barges per trip	Trips (per year)	Avg. Length (ft)	Avg. Breadth (ft)	Avg. Tonnage (tons, tonnes)	Tug Type	Trip Scaling Factor
1	Upbound	Barge	0 < draft =< 3	2.0	123	1.0	12.3	233.4	46.4	589	Tug1	0.1020
2	Upbound	Barge	6 < draft =< 12	9.0	21	1.0	2.1	201.2	35.3	2028	Tug2	0.0174
3	Upbound	Small ship	-	14.0	-	-	35.5	48.0	18.0	207	Vessel	0.2944
4	Upbound	Free Tugs	-	7.3	-	-	9.2	68.1	27.2	477	TugOnly	0.0763
5	Downbound	Barge	0 < draft =< 12	2.2	116	1.0	11.6	241.5	48.2	674	Tug1	0.0962
6	Downbound	Small ship	-	14.0	-	-	39.2	48.0	18.0	207	Vessel	0.3250
7	Downbound	Free Tugs	-	7.3	-	-	10.7	68.3	27.3	488	TugOnly	0.0887

[No vessel groups for Past point 42]

[No vessel groups for Past point 43]



Past point 44

Group	Direction	Vessel Type	Draft group	Avg. Draft (ft)	Num. of barges	Num. of barges per trip	Trips (per year)	Avg. Length (ft)	Avg. Breadth (ft)	Avg. Tonnage (tons, tonnes)	Tug Type	Trip Scaling Factor
1	Upbound	Barge	0 < draft =< 3	1.6	24	1.0	2.4	139.3	47.2	348	Tug1	0.0418
2	Upbound	Barge	6 < draft =< 15	8.6	9	1.0	0.9	311.7	59.5	5744	Tug1	0.0157
3	Upbound	Ship	10 < draft =< 12	11.0	-	-	0.1	263.0	52.1	4750	Vessel	0.0017
4	Upbound	Small ship	-	6.0	-	-	0.2	62.0	17.0	210	Vessel	0.0035
5	Upbound	Free Tugs	-	7.1	-	-	10.1	83.9	26.5	681	TugOnly	0.1760
6	Upbound	Other	2 < draft =< 4	3.0	-	-	0.1	296.0	54.0	6987	Vessel	0.0017
7	Downbound	Barge	0 < draft =< 3	1.8	49	1.0	4.9	203.1	47.4	693	Tug1	0.0854
8	Downbound	Barge	3 < draft =< 6	5.0	53	1.0	5.3	387.1	71.6	4564	Tug1	0.0923
9	Downbound	Barge	6 < draft =< 9	7.1	34	1.0	3.4	432.0	74.3	7223	Tug1	0.0592
10	Downbound	Barge	9 < draft =< 12	11.1	30	1.0	3.0	499.6	78.3	13679	Tug2	0.0523
11	Downbound	Barge	12 < draft =< 15	14.1	48	1.0	4.8	455.6	73.3	14886	Tug2	0.0836
12	Downbound	Barge	18 < draft =< 21	21.0	1	1.0	0.1	326.5	74.0	15983	Tug2	0.0017
13	Downbound	Ship	4 < draft =< 8	6.2	-	-	2.1	596.1	94.4	34363	Vessel	0.0366
14	Downbound	Ship	8 < draft =< 18	12.2	-	-	0.5	601.7	102.6	42436	Vessel	0.0087
15	Downbound	Small ship	-	6.0	-	-	0.3	57.6	16.3	164	Vessel	0.0052
16	Downbound	Free Tugs	-	7.9	-	-	19.1	82.4	28.1	609	TugOnly	0.3328
17	Downbound	Other	4 < draft =< 6	5.0	-	-	0.1	259.3	54.0	5281	Vessel	0.0017

Past point 45

Group	Direction	Vessel Type	Draft group	Avg. Draft (ft)	Num. of barges	Num. of barges per trip	Trips (per year)	Avg. Length (ft)	Avg. Breadth (ft)	Avg. Tonnage (tons, tonnes)	Tug Type	Trip Scaling Factor
1	Upbound	Barge	0 < draft =< 3	1.5	19	1.0	1.9	157.5	49.1	371	Tug1	0.0354
2	Upbound	Barge	6 < draft =< 15	8.6	9	1.0	0.9	311.7	59.5	5744	Tug1	0.0168
3	Upbound	Ship	4 < draft =< 12	8.0	-	-	0.2	242.9	48.0	3361	Vessel	0.0037
4	Upbound	Small ship	-	7.0	-	-	0.1	96.0	24.0	395	Vessel	0.0019
5	Upbound	Free Tugs	-	7.3	-	-	8.5	87.2	27.4	754	TugOnly	0.1583
6	Upbound	Other	2 < draft =< 10	6.0	-	-	0.2	452.0	75.9	4004	Vessel	0.0037
7	Downbound	Barge	0 < draft =< 3	1.9	44	1.0	4.4	220.6	48.3	753	Tug1	0.0819
8	Downbound	Barge	3 < draft =< 6	5.0	53	1.0	5.3	387.1	71.6	4564	Tug1	0.0987
9	Downbound	Barge	6 < draft =< 9	7.1	34	1.0	3.4	432.0	74.3	7223	Tug1	0.0633
10	Downbound	Barge	9 < draft =< 12	11.1	30	1.0	3.0	499.6	78.3	13679	Tug2	0.0559
11	Downbound	Barge	12 < draft =< 15	14.1	48	1.0	4.8	455.6	73.3	14886	Tug2	0.0894
12	Downbound	Barge	18 < draft =< 21	21.0	1	1.0	0.1	326.5	74.0	15983	Tug2	0.0019
13	Downbound	Ship	4 < draft =< 8	6.2	-	-	2.1	596.1	94.4	34363	Vessel	0.0391
14	Downbound	Ship	8 < draft =< 18	12.2	-	-	0.5	601.7	102.6	42436	Vessel	0.0093
15	Downbound	Small ship	-	6.5	-	-	0.2	72.4	19.5	233	Vessel	0.0037
16	Downbound	Free Tugs	-	8.0	-	-	17.7	82.9	28.3	622	TugOnly	0.3296
17	Downbound	Other	4 < draft =< 12	9.2	-	-	0.4	343.1	65.9	3961	Vessel	0.0074

Past point 46

Group	Direction	Vessel Type	Draft group	Avg. Draft (ft)	Num. of barges	per trip	Trips (per year)	Avg. Length (ft)	Avg. Breadth (ft)	Avg. Tonnage (tons, tonnes)	Tug Type	Trip Scaling Factor
1	Upbound	Barge	0 < draft =< 3	2.0	172	1.0	17.2	234.9	46.9	599	Tug1	0.1362
2	Upbound	Barge	3 < draft =< 9	7.3	76	1.0	7.6	200.0	35.8	1653	Tug1	0.0602
3	Upbound	Barge	9 < draft =< 12	11.6	16	1.0	1.6	201.6	35.9	2652	Tug2	0.0127
4	Upbound	Ship	4 < draft =< 6	5.0	-	-	5.2	259.3	54.0	5281	Vessel	0.0412
5	Upbound	Free Tugs	-	7.6	-	-	32.6	76.0	27.6	612	TugOnly	0.2581
6	Downbound	Barge	0 < draft =< 12	2.1	249	1.0	24.9	231.2	45.2	591	Tug1	0.1971
7	Downbound	Ship	4 < draft =< 6	5.0	-	-	5.2	259.3	54.0	5281	Vessel	0.0412
8	Downbound	Free Tugs	-	7.6	-	-	32.0	77.2	27.8	636	TugOnly	0.2534

Past point 47

Group	Direction	Vessel Type	Draft group	Avg. Draft (ft)	Num. of barges	Num. of barges per trip	Trips (per year)	Avg. Length (ft)	Avg. Breadth (ft)	Avg. Tonnage (tons, tonnes)	Tug Type	Trip Scaling Factor
1	Upbound	Barge	0 < draft =< 12	3.9	7	1.0	0.7	266.8	55.3	1742	Tug1	0.0172
2	Upbound	Ship	4 < draft =< 8	7.8	-	-	1.4	306.2	79.3	5445	Vessel	0.0344
3	Upbound	Ship	8 < draft =< 12	10.0	-	-	0.2	287.8	67.0	5232	Vessel	0.0049
4	Upbound	Small ship	-	7.0	-	-	0.1	96.0	24.0	395	Vessel	0.0025
5	Upbound	Free Tugs	-	7.1	-	-	5.7	76.4	25.8	489	TugOnly	0.1400
6	Upbound	Other	2 < draft =< 4	3.0	-	-	0.1	296.0	54.0	6987	Vessel	0.0025
7	Downbound	Barge	0 < draft =< 3	2.0	25	1.0	2.5	235.9	45.6	760	Tug1	0.0614
8	Downbound	Barge	3 < draft =< 6	5.2	43	1.0	4.3	396.9	72.5	4894	Tug1	0.1057
9	Downbound	Barge	6 < draft =< 9	7.2	33	1.0	3.3	427.4	72.9	7141	Tug1	0.0811
10	Downbound	Ship	4 < draft =< 8	6.8	-	-	3.1	504.7	90.4	25121	Vessel	0.0762
11	Downbound	Ship	8 < draft =< 18	12.0	-	-	0.3	597.3	100.6	39929	Vessel	0.0074
12	Downbound	Small ship	-	6.5	-	-	0.2	72.4	19.5	233	Vessel	0.0049
13	Downbound	Free Tugs	-	6.6	-	-	18.7	77.4	27.4	460	TugOnly	0.4595
14	Downbound	Other	4 < draft =< 6	5.0	-	-	0.1	259.3	54.0	5281	Vessel	0.0025

Past point 48

Group	Direction	Vessel Type	Draft group	Avg. Draft (ft)	Num. of barges	Num. of barges per trip	Trips (per year)	Avg. Length (ft)	Avg. Breadth (ft)	Avg. Tonnage (tons, tonnes)	Tug Type	Trip Scaling Factor
1	Upbound	Barge	0 < draft =< 12	4.3	6	1.0	0.6	291.3	57.0	2008	Tug1	0.0130
2	Upbound	Ship	4 < draft =< 8	7.8	-	-	1.4	306.2	79.3	5445	Vessel	0.0302
3	Upbound	Ship	8 < draft =< 12	10.0	-	-	0.2	287.8	67.0	5232	Vessel	0.0043
4	Upbound	Small ship	-	7.0	-	-	0.1	96.0	24.0	395	Vessel	0.0022
5	Upbound	Free Tugs	-	7.5	-	-	5.4	81.2	27.0	565	TugOnly	0.1166
6	Upbound	Other	2 < draft =< 12	7.0	-	-	0.2	279.5	53.0	5869	Vessel	0.0043
7	Downbound	Barge	0 < draft =< 3	2.0	27	1.0	2.7	244.2	47.8	936	Tug1	0.0583
8	Downbound	Barge	3 < draft =< 6	5.0	48	1.0	4.8	394.3	73.3	4752	Tug1	0.1037
9	Downbound	Barge	6 < draft =< 9	7.2	32	1.0	3.2	436.4	74.0	7320	Tug1	0.0691
10	Downbound	Barge	9 < draft =< 12	11.1	30	1.0	3.0	499.6	78.3	13679	Tug2	0.0648
11	Downbound	Barge	12 < draft =< 15	14.1	48	1.0	4.8	455.6	73.3	14886	Tug2	0.1037
12	Downbound	Barge	18 < draft =< 21	21.0	1	1.0	0.1	326.5	74.0	15983	Tug2	0.0022
13	Downbound	Ship	4 < draft =< 8	6.8	-	-	3.1	504.7	90.4	25121	Vessel	0.0670
14	Downbound	Ship	8 < draft =< 18	12.2	-	-	0.5	601.7	102.6	42436	Vessel	0.0108
15	Downbound	Small ship	-	6.5	-	-	0.2	72.4	19.5	233	Vessel	0.0043
16	Downbound	Free Tugs	-	7.9	-	-	15.6	81.8	28.4	587	TugOnly	0.3369
17	Downbound	Other	4 < draft =< 12	9.2	-	-	0.4	343.1	65.9	3961	Vessel	0.0086

Past point 49

Group	Direction	Vessel Type	Draft group	Avg. Draft (ft)	Num. of barges	Num. of barges per trip	Trips (per year)	Avg. Length (ft)	Avg. Breadth (ft)	Avg. Tonnage (tons, tonnes)	Tug Type	Trip Scaling Factor
1	Upbound	Barge	0 < draft =< 12	8.2	9	1.0	0.9	257.0	59.8	4262	Tug1	0.0235
2	Upbound	Ship	6 < draft =< 10	8.1	-	-	1.4	312.6	82.0	5713	Vessel	0.0366
3	Upbound	Small ship	-	5.8	-	-	15.1	131.2	35.3	702	Vessel	0.3943
4	Upbound	Free Tugs	-	7.0	-	-	2.9	77.4	26.3	523	TugOnly	0.0757
5	Upbound	Other	2 < draft =< 4	3.0	-	-	0.1	296.0	54.0	6987	Vessel	0.0026
6	Downbound	Barge	0 < draft =< 6	3.4	8	1.0	0.8	276.2	60.8	2120	Tug1	0.0209
7	Downbound	Ship	6 < draft =< 8	8.0	-	-	1.0	312.6	82.0	5713	Vessel	0.0261
8	Downbound	Small ship	-	5.8	-	-	14.2	131.0	35.2	684	Vessel	0.3708
9	Downbound	Free Tugs	-	7.2	-	-	1.9	76.3	25.7	495	TugOnly	0.0496

Past point 50

Group	Direction	Vessel Type	Draft group	Avg. Draft (ft)	Num. of barges	Num. of barges per trip	Trips (per year)	Avg. Length (ft)	Avg. Breadth (ft)	Avg. Tonnage (tons, tonnes)	Tug Type	Trip Scaling Factor
1	Upbound	Barge	0 < draft =< 12	3.0	11	1.0	1.1	211.6	50.2	1174	Tug1	0.0266
2	Upbound	Ship	4 < draft =< 8	7.8	-	-	1.4	306.2	79.3	5445	Vessel	0.0338
3	Upbound	Ship	8 < draft =< 12	10.0	-	-	0.2	287.8	67.0	5232	Vessel	0.0048
4	Upbound	Small ship	-	7.0	-	-	0.1	96.0	24.0	395	Vessel	0.0024
5	Upbound	Free Tugs	-	6.9	-	-	5.7	74.8	25.4	466	TugOnly	0.1377
6	Upbound	Other	2 < draft =< 4	3.0	-	-	0.1	296.0	54.0	6987	Vessel	0.0024
7	Downbound	Barge	0 < draft =< 3	2.0	28	1.0	2.8	222.1	45.5	706	Tug1	0.0676
8	Downbound	Barge	3 < draft =< 6	5.1	44	1.0	4.4	390.6	71.9	4798	Tug1	0.1063
9	Downbound	Barge	6 < draft =< 9	7.2	33	1.0	3.3	427.4	72.9	7141	Tug1	0.0797
10	Downbound	Ship	4 < draft =< 8	6.8	-	-	3.1	504.7	90.4	25121	Vessel	0.0749
11	Downbound	Ship	8 < draft =< 18	12.0	-	-	0.3	597.3	100.6	39929	Vessel	0.0072
12	Downbound	Small ship	-	6.5	-	-	0.2	72.4	19.5	233	Vessel	0.0048
13	Downbound	Free Tugs	-	6.5	-	-	18.6	77.0	27.2	455	TugOnly	0.4493
14	Downbound	Other	4 < draft =< 6	5.0	-	-	0.1	259.3	54.0	5281	Vessel	0.0024

Past point 51

Group	Direction	Vessel Type	Draft group	Avg. Draft (ft)	Num. of barges	Num. of barges per trip	Trips (per year)	Avg. Length (ft)	Avg. Breadth (ft)	Avg. Tonnage (tons, tonnes)	Tug Type	Trip Scaling Factor
1	Upbound	Barge	0 < draft =< 3	1.4	18	1.0	1.8	157.9	48.8	348	Tug1	0.0339
2	Upbound	Barge	6 < draft =< 15	8.6	9	1.0	0.9	311.7	59.5	5744	Tug1	0.0169
3	Upbound	Ship	4 < draft =< 12	8.0	-	-	0.2	242.9	48.0	3361	Vessel	0.0038
4	Upbound	Small ship	-	7.0	-	-	0.1	96.0	24.0	395	Vessel	0.0019
5	Upbound	Free Tugs	-	7.4	-	-	8.3	87.3	27.5	764	TugOnly	0.1563
6	Upbound	Other	2 < draft =< 12	7.7	-	-	0.3	389.0	68.0	4253	Vessel	0.0056
7	Downbound	Barge	0 < draft =< 3	1.8	43	1.0	4.3	222.3	48.2	752	Tug1	0.0810
8	Downbound	Barge	3 < draft =< 6	5.0	53	1.0	5.3	387.1	71.6	4564	Tug1	0.0998
9	Downbound	Barge	6 < draft =< 9	7.1	34	1.0	3.4	432.0	74.3	7223	Tug1	0.0640
10	Downbound	Barge	9 < draft =< 12	11.1	30	1.0	3.0	499.6	78.3	13679	Tug2	0.0565
11	Downbound	Barge	12 < draft =< 15	14.1	48	1.0	4.8	455.6	73.3	14886	Tug2	0.0904
12	Downbound	Barge	18 < draft =< 21	21.0	1	1.0	0.1	326.5	74.0	15983	Tug2	0.0019
13	Downbound	Ship	4 < draft =< 8	6.2	-	-	2.1	596.1	94.4	34363	Vessel	0.0395
14	Downbound	Ship	8 < draft =< 18	12.2	-	-	0.5	601.7	102.6	42436	Vessel	0.0094
15	Downbound	Small ship	-	6.5	-	-	0.2	72.4	19.5	233	Vessel	0.0038
16	Downbound	Free Tugs	-	8.0	-	-	17.4	83.0	28.4	625	TugOnly	0.3277
17	Downbound	Other	4 < draft =< 12	9.2	-	-	0.4	343.1	65.9	3961	Vessel	0.0075



Past point 52

Group	Direction	Vessel Type	Draft group	Avg. Draft (ft)	Num. of barges	Num. of barges per trip	Trips (per year)	Avg. Length (ft)	Avg. Breadth (ft)	Avg. Tonnage (tons, tonnes)	Tug Type	Trip Scaling Factor
1	Upbound	Barge	0 < draft =< 3	2.2	42	1.0	4.2	136.3	46.6	415	Tug1	0.0749
2	Upbound	Barge	6 < draft =< 15	8.7	10	1.0	1.0	299.0	58.6	5461	Tug1	0.0178
3	Upbound	Ship	4 < draft =< 12	8.0	-	-	0.2	242.9	48.0	3361	Vessel	0.0036
4	Upbound	Small ship	-	7.0	-	-	0.1	96.0	24.0	395	Vessel	0.0018
5	Upbound	Free Tugs	-	7.3	-	-	8.8	81.5	26.6	666	TugOnly	0.1569
6	Upbound	Other	2 < draft =< 12	7.7	-	-	0.3	389.0	68.0	4253	Vessel	0.0053
7	Downbound	Barge	0 < draft =< 3	1.8	41	1.0	4.1	216.0	48.0	727	Tug1	0.0731
8	Downbound	Barge	3 < draft =< 6	5.0	51	1.0	5.1	388.2	72.2	4618	Tug1	0.0909
9	Downbound	Barge	6 < draft =< 9	7.1	32	1.0	3.2	436.4	74.4	7305	Tug1	0.0570
10	Downbound	Barge	9 < draft =< 12	11.1	30	1.0	3.0	499.6	78.3	13679	Tug2	0.0535
11	Downbound	Barge	12 < draft =< 15	14.1	48	1.0	4.8	455.6	73.3	14886	Tug2	0.0856
12	Downbound	Barge	18 < draft =< 21	21.0	1	1.0	0.1	326.5	74.0	15983	Tug2	0.0018
13	Downbound	Ship	4 < draft =< 8	6.2	-	-	2.1	596.1	94.4	34363	Vessel	0.0374
14	Downbound	Ship	8 < draft =< 18	12.2	-	-	0.5	601.7	102.6	42436	Vessel	0.0089
15	Downbound	Small ship	-	6.5	-	-	0.2	72.4	19.5	233	Vessel	0.0036
16	Downbound	Free Tugs	-	7.9	-	-	18.0	82.3	28.2	613	TugOnly	0.3209
17	Downbound	Other	4 < draft =< 12	9.2	-	-	0.4	343.1	65.9	3961	Vessel	0.0071

## APPENDIX D

### EXAMPLE CALCULATION OF PROTECTION FACTOR, $PF$

Presented in Figure D.1 is a schematic for use in performing an example calculation of the value of the protection factor ( $PF$ ). Note that one value of  $PF$  is required as part of the vessel collision risk assessment for each of the upbound and downbound directions of each vessel group, and for every bridge element. In this example, the bridge crosses over a channel that is perpendicular to (i.e., aligned at a 90-degree angle relative to) the spans of the bridge. A single tug and barge (with width,  $B$ , equal to 35 ft) is situated parallel to the intended vessel transit path, but such that aberrant vessel path passes through the centerline of the pier of interest (i.e., under consideration for collision design). A single protective structure possesses a plan-view dimension,  $D$ , of 50 ft (Figure D.1b) and is offset from the pier of interest at a centerline distance,  $L$ , of 152.5 ft. Note that the y-distances between the pier of interest and points on the protective structure (e.g.,  $y_1, y_2$ ) are measured perpendicular to the centerline of the pier of interest. The normal probability distribution of approach angles for the aberrant vessel is assumed to possess a standard deviation ( $\sigma$ ) of  $10^\circ$  (Kunz 1998). Calculations of the effective width of the protective structure ( $D_E$ ); relative geometry between the pier of interest and protective structure (e.g.,  $x_1, y_1$ ); relevant approach angles; and, the  $PF$  value are documented below in Figure D.2.

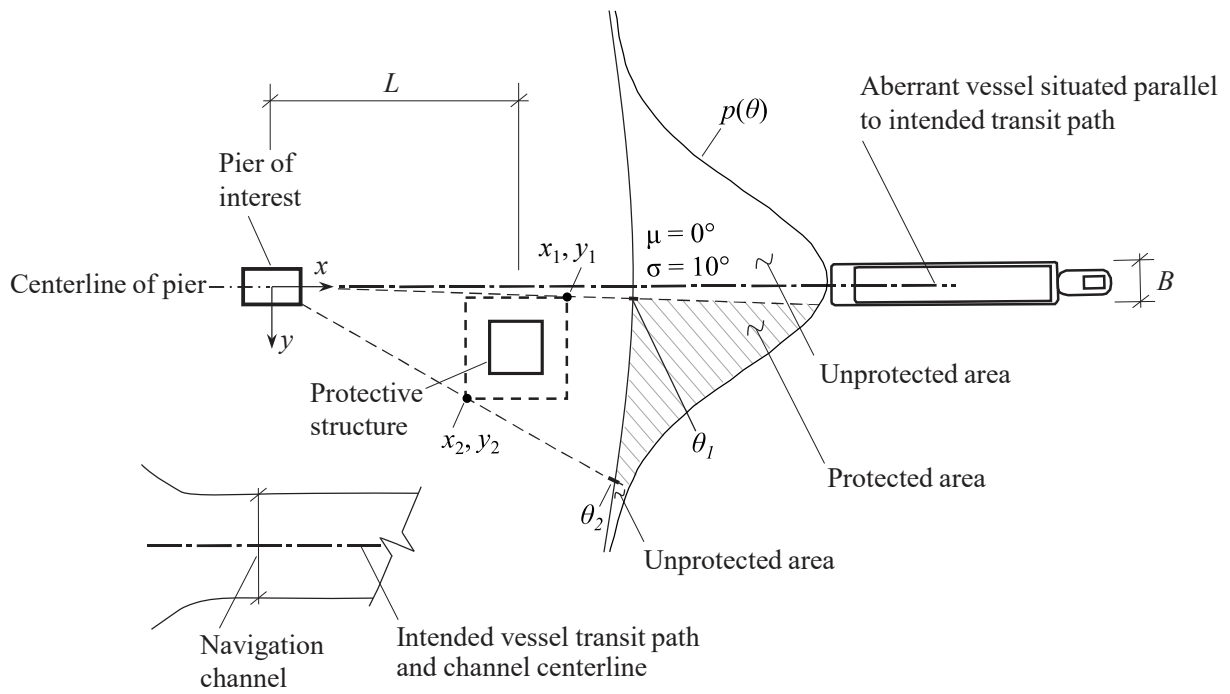

(a)

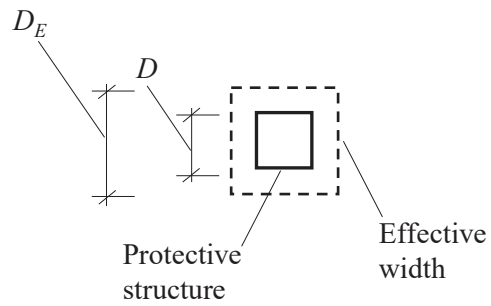

(b)

Figure D.1 Schematic for example calculation of protection factor,  $PF$ , involving a single protective structure: (a) Relative positioning; (b) Geometric parameters of the protective structure

Parameter definitions ...	
$D := 50$	(ft) ... width of protective structure
$B := 35$	(ft) ... width ('beam') of aberrant vessel
$L := 152.5$	(ft) ... x-distance between pier of interest and protective structure
$D_E := D + 0.75B = 76.25$	(ft) ... effective width of protective structure (per AASHTO)
$\theta_{\text{transit}} := 0$	(deg) ... transit approach angle of vessel
$\mu := \theta_{\text{transit}}$	(deg) ... mean approach angle of aberrant vessel transit paths
$\sigma := 10$	(deg) ... standard deviation of approach angle of aberrant transit paths
Coordinates of points on protective structure ...	
Defined ...	
$y_1 := 5$	(ft)
Computed ...	
$y_2 := y_1 + D_E = 81.25$	(ft)
$x_1 := L + (D_E \div 2) = 190.6$	(ft)
$x_2 := L - (D_E \div 2) = 114.4$	(ft)
Calculations ...	
$\theta_1 := \text{atan}(y_1 \div x_1) \cdot (180 \div \pi) = 1.5$	(deg)
$\theta_2 := \text{atan}(y_2 \div x_2) \cdot (180 \div \pi) = 35.4$	(deg)
$p(\mu, \sigma, \theta) := \frac{1}{\sigma\sqrt{2\pi}} \cdot e^{-0.5 \left( \frac{\theta - \mu}{\sigma} \right)^2}$	... normal probability distribution of approach angles
$\text{protection} := \int_{\theta_1}^{\theta_2} p(\mu, \sigma, \theta) d\theta = 0.44$	... level of protection provided by protective structure
$\text{PF} := 1 - \text{protection} = 0.56$	... value of AASHTO protection factor (PF)

Figure D.2 Calculation of protection factor,  $PF$ , when a single protective structure is present

The normal distribution and protected area are plotted in Figure D.3.

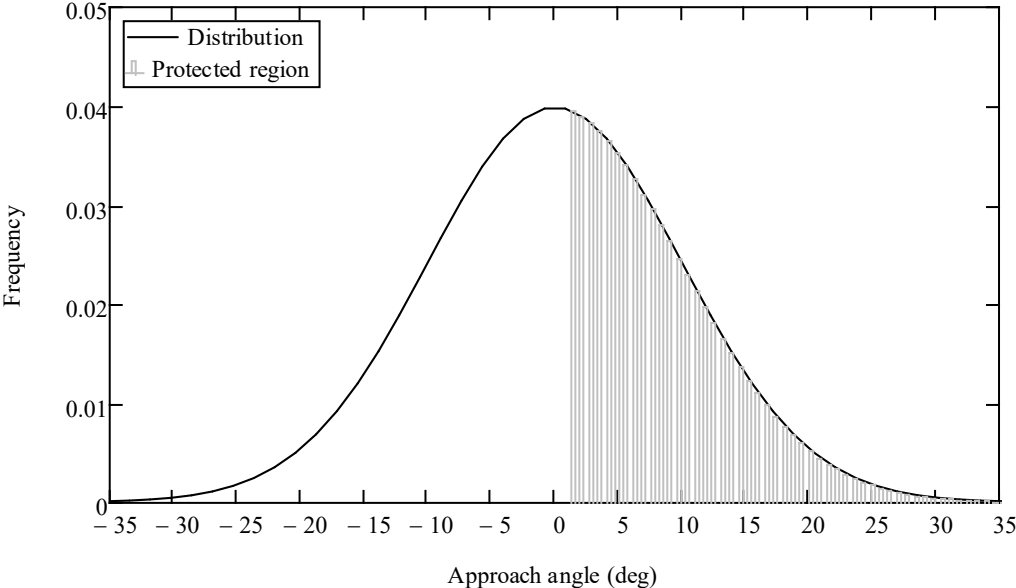

Figure D.3 Normal distribution of transit angles (and protected area) for calculating protection factor, *PF*, value when a single protective structure is present

A second example is presented in Figure D.4 for the calculation of the value of the protection factor ( $PF$ ). The example below considers two protective structures in the vicinity of a pier. In this example, the bridge crosses over a channel that is non-perpendicular to (i.e., not aligned at a 90-degree angle relative to) the spans of the bridge. The dimensions of the protective structures ( $D$ ) and the offset distance away from the piers ( $L$ ) are set equal to those from the previous example. Additionally, the same dimensions of the tug and barge are utilized. In Figure D.4, the aberrant vessel is situated parallel to the channel centerline, but such that the aberrant vessel would strike the pier of interest (i.e., under consideration for collision design). Note that y-distances between the pier of interest and points on protective structures (e.g.,  $y_1, y_2$ ) are measured perpendicular to the centerline of the pier of interest. The normal distribution of approach angles for the aberrant vessel is assumed to possess a standard deviation ( $\sigma$ ) of  $10^\circ$ . Calculations of the effective width of the protective structure ( $D_E$ ); relevant approach angles; and, the  $PF$  value are documented below in Figure D.5.

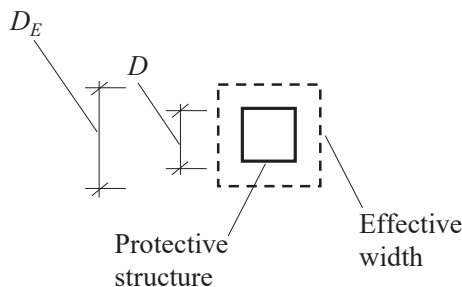
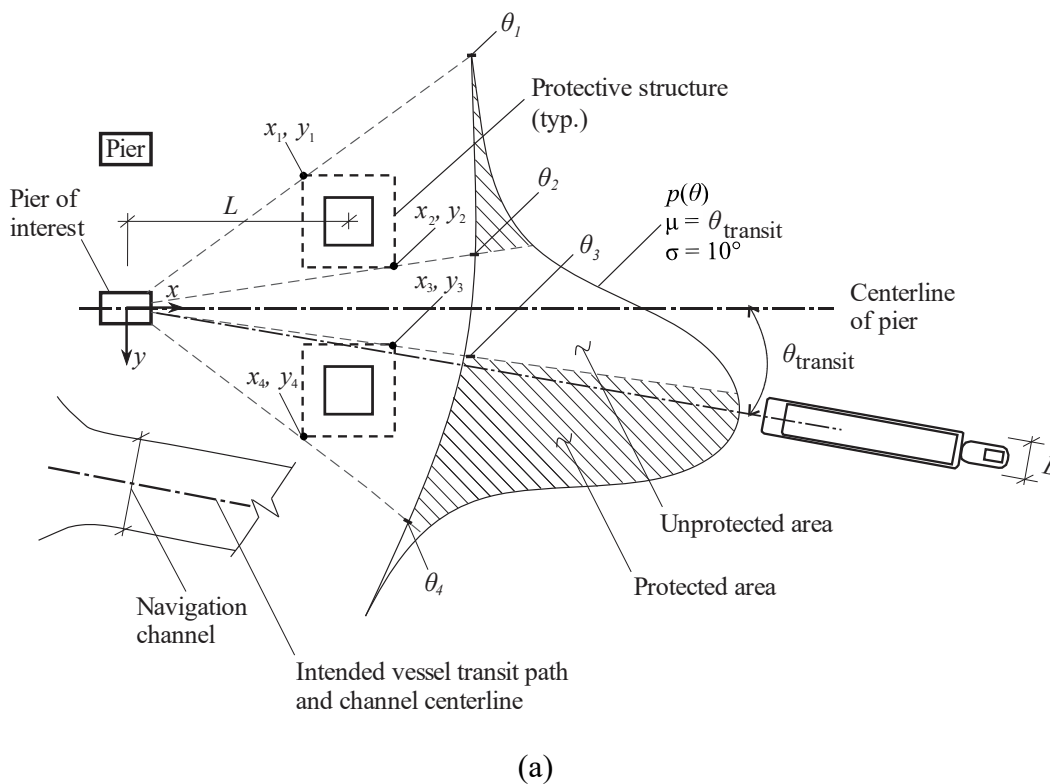

Figure D.4 Schematic for example calculation of protection factor,  $PF$ , involving two protective structures: (a) Relative positioning; (b) Geometric parameters of the protective structures

Parameter definitions ...

$D := 50$	(ft)	... width of protective structures
$B := 35$	(ft)	... width ('beam') of aberrant vessel
$L := 152.5$	(ft)	... x-distance between pier of interest and protective structures
$D_E := D + 0.75B = 76.25$	(ft)	... effective width of protective structures (per AASHTO)
$\theta_{\text{transit}} := 10$	(deg)	... transit approach angle of vessel
$\mu := \theta_{\text{transit}}$	(deg)	... mean approach angle of aberrant vessel transit paths
$\sigma := 10$	(deg)	... standard deviation of approach angle of aberrant transit paths

Coordinates of points on protective structures ...

Defined ...

$y_1 := -103.75$	(ft)
$y_3 := 27.5$	(ft)

Computed ...

$y_2 := y_1 + D_E = -27.5$	(ft)
$y_4 := y_3 + D_E = 103.75$	(ft)
$x_1 := L - (D_E \div 2) = 114.4$	(ft)
$x_2 := L + (D_E \div 2) = 190.6$	(ft)
$x_3 := L + (D_E \div 2) = 190.6$	(ft)
$x_4 := L - (D_E \div 2) = 114.4$	(ft)

Calculations ...

$\theta_1 := \text{atan}(y_1 \div x_1) \cdot (180 \div \pi) = -42.2$	(deg)
$\theta_2 := \text{atan}(y_2 \div x_2) \cdot (180 \div \pi) = -8.2$	(deg)
$\theta_3 := \text{atan}(y_3 \div x_3) \cdot (180 \div \pi) = 8.2$	(deg)
$\theta_4 := \text{atan}(y_4 \div x_4) \cdot (180 \div \pi) = 42.2$	(deg)

$$p(\mu, \sigma, \theta) := \frac{1}{\sigma\sqrt{2\pi}} \cdot e^{-0.5\left(\frac{\theta-\mu}{\sigma}\right)^2} \quad \dots \text{normal probability distribution of approach angles}$$

$$\text{protection} := \int_{\theta_1}^{\theta_2} p(\mu, \sigma, \theta) d\theta \dots = 0.60 \quad \dots \text{level of protection provided by protective structures}$$

$$+ \int_{\theta_3}^{\theta_4} p(\mu, \sigma, \theta) d\theta$$

$\text{PF} := 1 - \text{protection} = 0.40$	... value of AASHTO protection factor (PF)
---	--

Figure D.5 Calculation of protection factor, *PF*, when two protective structures are present

The normal distribution and protected areas are plotted in Figure D.6.

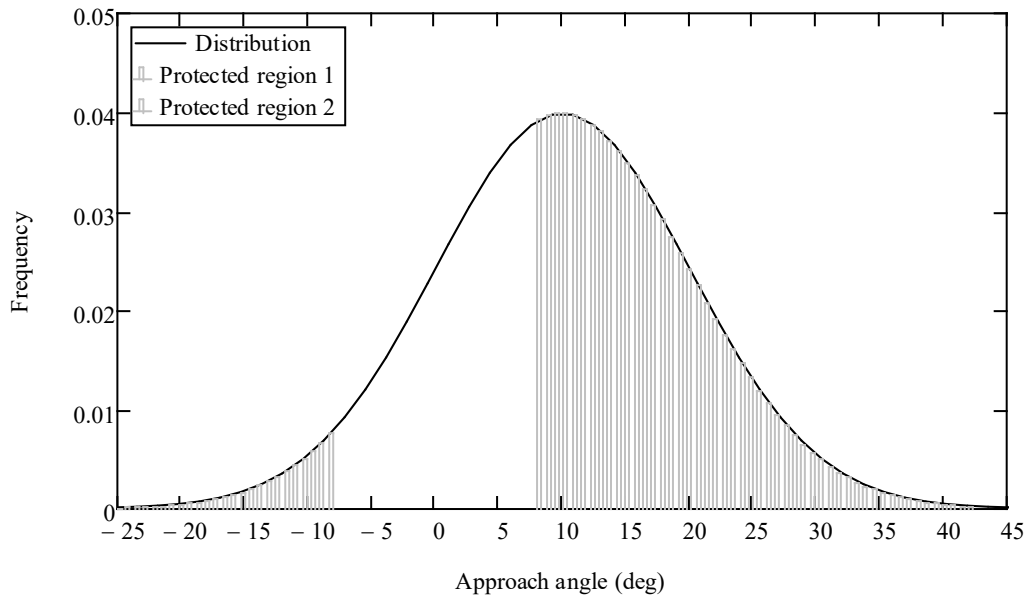

Figure D.6 Normal distribution of transit angles (and protected areas) for calculating protection factor,  $PF$ , value when two protective structures are present



## APPENDIX E

### SUPPORTING DATA RELATING TO MINIMUM ENERGY ABSORPTION CAPACITY (EAC) FOR FENDER DESIGN

Briefly summarized here are the types of data, procedure, assumptions, and key resources that were utilized in developing updated listings of minimum energy absorption capacities (EACs), which in turn, are needed for design of fender systems along navigable Florida waterways. Regarding pertinent types of data: efforts carried out as part of the present study included historical and real-time collection of vessel transit velocities (e.g., as obtained from the vessel data service, Marine Cadastre). Additionally, vessel traffic data obtained from the USACE Waterborne Commerce Statistics Center (WCSC) facilitated characterization of tonnages for the types of vessels transiting in proximity to a given past point location. For developing updated listings of EAC values per past point, statewide values of vessel transit velocities, past-point specific transit velocities, and estimates of maximum tonnages were utilized.

The procedure utilized to develop updated listings of EAC values was consistent with the procedure FDOT previously used to form the existing Table 3.14.2-1 in the FDOT Structures Design Guidelines (SDG), FDOT (2022). The procedure consists of calculating a value of kinetic energy (i.e., initial kinetic energy associated with an impacting vessel) based on values of typical transit velocity and maximum vessel tonnage. Kinetic energy ( $KE$ ) is calculated per past point, where the procedure makes use of the tonnage ( $W$ ) associated with a barge (or barge flotilla) and a tug, as well as a transit velocity ( $V$ ):

$$KE = \frac{C_H \cdot W \cdot V^2}{29.2} \quad (E.1)$$

where  $C_H$  is the hydrodynamic mass coefficient, which is assumed to correspond to fully loaded conditions and is set equal to 1.05. Regarding units that are specific to evaluating  $KE$ , the vessel weight ( $W$ ) is given in tonne, transit velocity ( $V$ ) is given in ft/s, and the calculated value of  $KE$  is given in units of kip-ft.

The EAC for the past point (denoted here as  $E_{AC}$ ) is then calculated by applying a scale factor ( $\eta$ ) to the calculated value of kinetic energy,  $KE$ . The value of the scale factor utilized in the present study is adopted from AASHTO (2009), consistent with values listed in Table 3.14.2-1 in the FDOT SDG. As additional context, the scale factor is based on an assumption of the frictional coefficient associated with vessel-fender impact. Namely, a steel-steel contact interface is assumed and vessel-fender impact is assumed to occur at an angle of  $15^\circ$ . Based on these assumptions, the value of  $\eta$  is stated by AASHTO to be 0.045, and the EAC value ( $E_{AC}$ ) is calculated as:

$$E_{AC} = \eta \cdot KE \quad (E.2)$$

where  $E_{AC}$  is expressed in units of kip-ft.

Listed in Table E.1 are the underlying data used for each past point to calculate values of  $E_{AC}$ . Note that generally, the statewide barge velocity (6 knot, 10.1 ft/s) was utilized. As an exception, past point 39 (PP39) corresponds to the Sunshine Skyway bridge in Tampa Bay, Florida. For this past point, the localized (i.e., past-point specific) velocity was utilized in calculating the corresponding value of  $E_{AC}$ . Regarding selection of tonnage, when data were available, the 90<sup>th</sup> percentile maximum barge weight (plus tug) was utilized on a past point basis.

Table E.1. Supporting data for calculation of energy absorption capacity values

Past point	Source for Velocity	$V$ (ft/s)	Source for Weight	$W$ (ton)	$E_{AC}$ (kip-ft)
1	Statewide	10.1	PP1	5114	770
2	Statewide	10.1	PP2	5840	879
3	Statewide	10.1	PP3	14833	2233
4	Statewide	10.1	PP4	10778	1623
5	Statewide	10.1	PP5	14835	2233
6	Statewide	10.1	PP6	13091	1971
7	Statewide	10.1	PP7	7123	1072
8	Statewide	10.1	PP8	13091	1971
9	N/A	N/A	N/A	N/A	38
10	N/A	N/A	N/A	N/A	38
11	N/A	N/A	N/A	N/A	38
12	N/A	N/A	N/A	N/A	38
13	Statewide	10.1	PP13	8061	1214
14	Statewide	10.1	PP14	13091	1971
15	Statewide	10.1	PP15	7235	1089
16	N/A	N/A	N/A	N/A	38
17	Statewide	10.1	PP17	6917	1041
18	Statewide	10.1	PP18	6789	1022
19	N/A	N/A	N/A	N/A	38
20	Statewide	10.1	PP20	3212	484
21	Statewide	10.1	PP21	7146	1076
22	Statewide	10.1	PP22	2807	423
23	Statewide	10.1	PP23	4572	688
24	Statewide	10.1	PP24	14833	2233
25	Statewide	10.1	PP25	5114	770
26	Statewide	10.1	PP26	5114	770
27	Statewide	10.1	PP27	5114	770
28	Statewide	10.1	PP28	14833	2233
29	N/A	N/A	N/A	N/A	38
30	Statewide	10.1	PP30	16563	2493
31	Statewide	10.1	PP31	5114	770
32	Statewide	10.1	PP32	6864	1033
33	Statewide	10.1	PP33	15040	2264
34	Statewide	10.1	PP34	6752	1016
35	Statewide	10.1	PP35	7047	1061
36	Statewide	10.1	PP36	15604	2349
37	Statewide	10.1	PP37	3397	511
38	N/A	N/A	N/A	N/A	38
39	PP39	16.7	PP39	43049	17627
40	Statewide	10.1	PP40	8480	1277
41	Statewide	10.1	PP41	3206	483
42	N/A	N/A	N/A	N/A	38
43	N/A	N/A	N/A	N/A	38
44	Statewide	10.1	PP44	14833	2233
45	Statewide	10.1	PP45	14833	2233
46	Statewide	10.1	PP46	3206	483
47	Statewide	10.1	PP47	8471	1275
48	Statewide	10.1	PP48	14833	2233
49	Statewide	10.1	PP49	7202	1084
50	Statewide	10.1	PP50	8350	1257
51	Statewide	10.1	PP51	14833	2233
52	Statewide	10.1	PP52	14833	2233

For past points 9-12, 19, 29, 42, and 43, commercial vessel traffic data were not available for directly calculating  $E_{AC}$  values (i.e., USACE reported no commercial traffic). In addition, for past point 16, no barge traffic data were reported (only free tug trips were reported). Still further, for past point 38, only a single barge trip was reported over the ten-year period of 2010-2019. For these past points, the required  $E_{AC}$  value was set equal to the minimum required kinetic energy of 38 kip-ft, as listed in FDOT index 471-030 (FDOT 2021).