

Final Report  
Contract BDV24-977-27

# **Evaluation of Innovative Alternative Intersection Designs in the Development of Safety Performance Functions and Crash Modification Factors**

Mohamed A. Abdel-Aty, Ph.D., P.E.

Jaeyoung Lee, Ph.D.

Jinghui Yuan, Ph.D.

Lishengsa Yue, Ph.D.

Ma'en Al-Omari, Ph.D. Student

Ahmed Abdelrahman, Ph.D. Student

University of Central Florida  
Department of Civil, Environmental & Construction Engineering  
Orlando, FL 32816-2450



May 2020

## **DISCLAIMER**

“The opinions, findings, and conclusions expressed in this publication are those of the authors and not necessarily those of the State of Florida Department of Transportation.”

## UNITS CONVERSION

### APPROXIMATE CONVERSIONS TO SI UNITS

SYMBOL	WHEN YOU KNOW	MULTIPLY BY	TO FIND	SYMBOL
<b>LENGTH</b>				
<b>in</b>	inches	25.4	millimeters	mm
<b>ft</b>	feet	0.305	meters	m
<b>yd</b>	yards	0.914	meters	m
<b>mi</b>	miles	1.61	kilometers	km
SYMBOL	WHEN YOU KNOW	MULTIPLY BY	TO FIND	SYMBOL
<b>AREA</b>				
<b>in<sup>2</sup></b>	square inches	645.2	square millimeters	mm <sup>2</sup>
<b>ft<sup>2</sup></b>	square feet	0.093	square meters	m <sup>2</sup>
<b>yd<sup>2</sup></b>	square yard	0.836	square meters	m <sup>2</sup>
<b>ac</b>	acres	0.405	hectares	ha
<b>mi<sup>2</sup></b>	square miles	2.59	square kilometers	km <sup>2</sup>
SYMBOL	WHEN YOU KNOW	MULTIPLY BY	TO FIND	SYMBOL
<b>VOLUME</b>				
<b>fl oz</b>	fluid ounces	29.57	milliliters	mL
<b>gal</b>	gallons	3.785	liters	L
<b>ft<sup>3</sup></b>	cubic feet	0.028	cubic meters	m <sup>3</sup>
<b>yd<sup>3</sup></b>	cubic yards	0.765	cubic meters	m <sup>3</sup>
NOTE: volumes greater than 1000 L shall be shown in m <sup>3</sup>				
SYMBOL	WHEN YOU KNOW	MULTIPLY BY	TO FIND	SYMBOL
<b>MASS</b>				
<b>oz</b>	ounces	28.35	grams	g
<b>lb</b>	pounds	0.454	kilograms	kg

<b>T</b>	short tons (2000 lb)	0.907	megagrams (or "metric ton")	Mg (or "t")
<b>SYMBOL</b>	<b>WHEN YOU KNOW</b>	<b>MULTIPLY BY</b>	<b>TO FIND</b>	<b>SYMBOL</b>
<b>TEMPERATURE (exact degrees)</b>				
<b>°F</b>	Fahrenheit	5(F-32)/9 or (F-32)/1.8	Celsius	°C
<b>SYMBOL</b>	<b>WHEN YOU KNOW</b>	<b>MULTIPLY BY</b>	<b>TO FIND</b>	<b>SYMBOL</b>
<b>ILLUMINATION</b>				
<b>fc</b>	foot-candles	10.76	lux	lx
<b>fl</b>	foot-Lamberts	3.426	candela/m <sup>2</sup>	cd/m <sup>2</sup>
<b>SYMBOL</b>	<b>WHEN YOU KNOW</b>	<b>MULTIPLY BY</b>	<b>TO FIND</b>	<b>SYMBOL</b>
<b>FORCE and PRESSURE or STRESS</b>				
<b>lbf</b>	poundforce	4.45	newtons	N
<b>lbf/in<sup>2</sup></b>	poundforce per square inch	6.89	kilopascals	kPa
<b>SYMBOL</b>	<b>WHEN YOU KNOW</b>	<b>MULTIPLY BY</b>	<b>TO FIND</b>	<b>SYMBOL</b>
<b>LENGTH</b>				
<b>mm</b>	millimeters	0.039	inches	in
<b>m</b>	meters	3.28	feet	ft
<b>m</b>	meters	1.09	yards	yd
<b>km</b>	kilometers	0.621	miles	mi
<b>SYMBOL</b>	<b>WHEN YOU KNOW</b>	<b>MULTIPLY BY</b>	<b>TO FIND</b>	<b>SYMBOL</b>
<b>AREA</b>				
<b>mm<sup>2</sup></b>	square millimeters	0.0016	square inches	in <sup>2</sup>
<b>m<sup>2</sup></b>	square meters	10.764	square feet	ft <sup>2</sup>
<b>m<sup>2</sup></b>	square meters	1.195	square yards	yd <sup>2</sup>
<b>ha</b>	hectares	2.47	acres	ac
<b>km<sup>2</sup></b>	square kilometers	0.386	square miles	mi <sup>2</sup>

SYMBOL	WHEN YOU KNOW	MULTIPLY BY	TO FIND	SYMBOL
<b>VOLUME</b>				
<b>mL</b>	milliliters	0.034	fluid ounces	fl oz
<b>L</b>	liters	0.264	gallons	gal
<b>m<sup>3</sup></b>	cubic meters	35.314	cubic feet	ft <sup>3</sup>
<b>m<sup>3</sup></b>	cubic meters	1.307	cubic yards	yd <sup>3</sup>
SYMBOL	WHEN YOU KNOW	MULTIPLY BY	TO FIND	SYMBOL
<b>MASS</b>				
<b>g</b>	grams	0.035	ounces	oz
<b>kg</b>	kilograms	2.202	pounds	lb
<b>Mg (or "t")</b>	megagrams (or "metric ton")	1.103	short tons (2000 lb)	T
SYMBOL	WHEN YOU KNOW	MULTIPLY BY	TO FIND	SYMBOL
<b>TEMPERATURE (exact degrees)</b>				
<b>°C</b>	Celsius	1.8C+32	Fahrenheit	°F
SYMBOL	WHEN YOU KNOW	MULTIPLY BY	TO FIND	SYMBOL
<b>ILLUMINATION</b>				
<b>lx</b>	lux	0.0929	foot-candles	fc
<b>cd/m<sup>2</sup></b>	candela/m <sup>2</sup>	0.2919	foot-Lamberts	fl
SYMBOL	WHEN YOU KNOW	MULTIPLY BY	TO FIND	SYMBOL
<b>FORCE and PRESSURE or STRESS</b>				
<b>N</b>	newtons	0.225	poundforce	lbf
<b>kPa</b>	kilopascals	0.145	poundforce per square inch	lbf/in <sup>2</sup>

## TECHNICAL REPORT DOCUMENTATION PAGE

1. Report No.	2. Government Accession No.	3. Recipient's Catalog No.	
4. Title and Subtitle Evaluation of Innovative Alternative Intersection Designs in the Development of Safety Performance Functions and Crash Modification Factors		5. Report Date March 2020	
		6. Performing Organization Code	
7. Author(s) Mohamed A. Abdel-Aty, Ph.D., P.E.; Jaeyoung Lee, Ph.D.; Jinghui Yuan, Ph.D.; Lishengsa Yue, Ph.D. Student; Ma'en Al-Omari, Ph.D. Student; Ahmed Abdelrahman, Ph.D. Student		8. Performing Organization Report No.	
9. Performing Organization Name and Address Department of Civil, Environmental & Construction Engineering University of Central Florida 12800 Pegasus Drive, Suite 211 Orlando, FL 32816-2450		10. Work Unit No. (TRAIS)	
		11. Contract or Grant No. BDV24-977-31	
12. Sponsoring Agency Name and Address Florida Department of Transportation		13. Type of Report and Period Covered Final Deliverable 2018-2020	
		14. Sponsoring Agency Code	
15. Supplementary Note			
16. Abstract Many alternative intersections aim to reduce conflict points by separating turning vehicles (left-turning vehicles in most cases) at intersections. In order to investigate the safety effects of alternative intersections, data were collected from 27 states, including Arizona, Colorado, Florida, Georgia, Idaho, Indiana, Iowa, Kansas, Kentucky, Louisiana, Michigan, Minnesota, Missouri, North Carolina, New Jersey, New Mexico, New York, Nevada, Ohio, Oregon, Pennsylvania, Tennessee, Texas, Virginia, Utah, Wisconsin, and Wyoming. The ten alternative intersections that were investigated in this project included continuous green T-intersections, median U-turn intersections (Types A, B, and partial), continuous flow intersections, jughandle intersections (Types 1-3), restricted crossing U-turn intersections, and diverging diamond interchanges. It was shown that the restricted crossing U-turn intersections are the most effective to minimize the equivalent property damage only (EPDO), fatal-and-injury, and angle crashes. The median U-turn intersections (Type A and Type B) are the best for reducing total and rear-end crashes, respectively. For minimizing left-turn crashes, implementing jughandle (Type 1) is the most effective, and the continuous flow intersection is the most effective for minimizing non-motorized crashes. It was also shown that converting conventional diamond interchanges to diverging diamond interchanges could significantly decrease the total, fatal-and-injury, PDO, rear-end, and angle crashes by 14%, 44%, 8%, 11%, and 55%, respectively. Fifty intersections were identified as the top 1% intersections with the highest crash risk in FL. It was found that rear-end crashes are the most frequent, 'most problematic' crash type, followed by left-turn crashes. For each hotspot intersection, two different alternative intersections were suggested to minimize (1) the most problematic crash type and (2) overall EPDO. In addition to exploring the safety effects of the alternative intersections, it was shown that signalization is effective in reducing severe crash types (e.g., angle, left-turn); whereas it significantly increases rear-end crashes by 66% to 195%. Also, it was found that signalization significantly increased the number of rear-end crashes for elderly drivers.			
17. Key Word alternative intersections; intersection safety; safety performance functions; crash modification factors; crash modification functions; hotspot identification		18. Distribution Statement	
19. Security Classif. (of this report)	20. Security Classif. (of this page) Unclassified	21. No. of Pages 455	22. Price

## EXECUTIVE SUMMARY

Intersections have been of major interest to traffic engineers because there are many conflicts between road users and they pose considerable exposure to safety risk and traffic congestion. In order to alleviate the safety and congestion problems, several types of alternative intersection designs have been suggested and implemented in some states. It would be useful and important to evaluate the alternative intersections that have been implemented in other states and predict their effects when they are implemented in Florida.

Many alternative intersections aim to reduce conflict points by separating turning vehicles (left-turning vehicles in most of the cases) at intersections. In order to investigate the safety effects of alternative intersections, data were collected from 27 states, including Arizona, Colorado, Florida, Georgia, Idaho, Indiana, Iowa, Kansas, Kentucky, Louisiana, Michigan, Minnesota, Missouri, North Carolina, New Jersey, New Mexico, New York, Nevada, Ohio, Oregon, Pennsylvania, Tennessee, Texas, Virginia, Utah, Wisconsin, and Wyoming. The ten alternative intersections that were investigated in this project include continuous green T-intersections, median U-turn intersections (Types A, B, and partial), continuous flow intersections, jughandle intersections (Types 1-3), restricted crossing U-turn intersections, and diverging diamond interchanges. It was shown that the restricted crossing U-turn intersections are the most effective to minimize the equivalent property damage only (EPDO), fatal-and-injury, and angle crashes. The median U-turn intersections (Type A and Type B) are the best for reducing total and rear-end crashes, respectively. For minimizing left-turn crashes, implementing jughandle (Type 1) is the most effective, and the continuous flow intersection is the most effective for minimizing non-motorized crashes.

Fifty intersections were identified as the top 1% intersection with the highest crash risk. It was found that rear-end crashes are the most frequent, ‘most problematic’ crash type, and left-turn crashes follow. For each hotspot intersection, two different alternative intersections were suggested to minimize (1) the most problematic crash type and (2) overall EPDO. In addition to exploring the safety effects of the alternative intersections, it was shown that the signalization is effective in reducing severe crash types (e.g., angle, left-turn); whereas it significantly increases rear-end crashes by 66% to 195%. Also, it was found that signalization significantly increased the number of rear-end crashes for elderly drivers.

This study also evaluated the safety benefits of diverging diamond interchanges (DDIs) in comparison to the conventional diamond interchanges. Three methods were adopted to estimate the crash modification factors (CMFs), which are before-and-after with comparison group (CG), Empirical Bayes before-and-after (EB), and the cross-sectional analysis. The studied sample included 80 DDIs and 240 conventional diamond interchanges as comparison sites located in 24 states. Different data types were collected to conduct the analysis. First, multi-year crash data were acquired from the various states. Then, traffic and geometric features were collected, including annual average daily traffic (AADT), speed limits, and the distance between crossovers or ramp terminals. Since the AADT of the freeway exit ramp was not available for all interchanges, two modeling strategies were considered for the EB method and the cross-sectional analysis. The first strategy included all DDIs and their comparison sites, while the second one only included the DDIs with available ramp traffic volumes and their comparison sites.

The before-and-after analysis with CG showed that converting the conventional diamond interchange to DDI can decrease the total, fatal-and-injury, property damage only (PDO), rear-end and angle crashes by 26%, 49%, 19%, 18%, and 68%, respectively. On the other hand, the



Empirical Bayes method showed that the conversion could decrease them by 14%, 44%, 8%, 11%, and 55%, respectively. It is obvious that the two methods provided similar trends; however, the CMFs of the Empirical Bayes method are slightly higher than those of the before-after with CG method. This difference may be due to the regression to the mean effect that was considered in the Empirical Bayes approach.

The cross-sectional method was used to develop safety performance functions that describe the relationship between crash frequency and various explanatory variables. The developed safety performance functions (SPFs) showed that converting the diamond interchange to DDI can decrease the total, fatal-and-injury, PDO, rear-end, and angle crashes, which is consistent with the before-and-after methods. Moreover, the distance between crossover or ramp terminals was found to have a negative effect on the crash frequency, which means that the longer distance lowers crash frequency. Furthermore, the interchanges with the underpass configuration were found to have more non-motorized and single-vehicle crashes than those of the interchanges with the overpass configuration. In addition, both variables of “Arterial Speed Limit” and “Freeway Exit Speed Limit” were found to have positive effects on the crash frequency. In other words, increasing the speed limit of the freeway exit ramp can significantly increase the total crashes as well the angle crashes, while the increase of the arterial’s speed limit can significantly increase the total crashes. The SPFs also revealed that the variable of “Freeway Exit Right-turn Control Type” is significantly associated with the safety performance of DDI, where the signalized exit has significantly lower frequency of PDO crashes.

The cross-sectional analysis can also provide CMFs by exponentiating the parameter of the dummy variable “DDI” (1 if DDI, 0 if diamond interchange). It showed that converting the diamond interchange to DDI can reduce the total, fatal-and-injury, PDO, rear-end, and angle

crashes by 24%, 38%, 18%, 2%, and 55%, respectively. The results are quite similar to those of the before-and-after methods. However, the before-and-after methods provide more reliable CMFs because they consider the observed crash frequencies before and after the treatment's effect, while the cross-sectional analysis only considers the crash counts after implementing the treatment.

# TABLE OF CONTENTS

DISCLAIMER .....	ii
UNITS CONVERSION .....	iii
TECHNICAL REPORT DOCUMENTATION PAGE .....	vi
EXECUTIVE SUMMARY .....	vii
LIST OF FIGURES .....	xiv
LIST OF TABLES .....	xxiv
1. BACKGROUND.....	29
2. LITERATURE REVIEW OF ALTERNATIVE INTERSECTIONS .....	32
2.1. CONTINUOUS FLOW INTERSECTION .....	32
2.2. MEDIAN U-TURN INTERSECTION .....	43
2.3. RESTRICTED CROSSING U-TURN INTERSECTION .....	51
2.4. DIVERGING DIAMOND INTERCHANGE .....	58
2.5. CONTINUOUS GREEN T-INTERSECTIONS .....	65
2.6. PARALLEL FLOW INTERSECTION .....	68
2.7. JUGHANDLE INTERSECTIONS .....	71
2.8. QUADRANT ROADWAY .....	74
2.9. HAMBURGER INTERSECTION .....	78
2.10. SYNCHRONIZED SPLIT-PHASING INTERSECTION .....	79
2.11. SUMMARY .....	79
3. LITERATURE REVIEW OF REAR-END CRASHES AT INTERSECTIONS.....	80
3.1. REAR-END CRASH CHARACTERISTICS .....	80
3.2. EFFECTS OF SIGNALIZATION ON REAR-END CRASHES.....	83
3.3. PROHIBITION OF RIGHT-TURN-ON-RED ON REAR-END CRASHES.....	84
3.4. EFFECTS OF RED LIGHT RUNNING CAMERAS ON REAR-END CRASHES ...	84
3.5. REAR-END CRASH PREVENTION TECHNOLOGIES .....	85
3.6. SUMMARY.....	87
4. LITERATURE REVIEW OF ELDERLY DRIVERS' SAFETY AT INTERSECTIONS ..	89
4.1. CRASH CHARACTERISTICS OF ELDERLY DRIVERS.....	89
4.2. RISK EVALUATION FOR ELDERLY DRIVERS AT INTERSECTIONS.....	91
4.3. COUNTERMEASURES.....	91
4.4. ELDERLY DRIVERS AND REAR-END CRASHES AT INTERSECTIONS.....	93
4.5. SUMMARY.....	94
5. QUESTIONNAIRE SURVEY ANALYSIS AND DATA COLLECTION .....	95

5.1.	IMPLEMENTATION OF ALTERNATIVE INTERSECTIONS .....	96
5.2.	PLANS TO IMPLEMENT ALTERNATIVE INTERSECTIONS IN THE FUTURE	106
5.3.	CAMPAIGNS TO INFORM DRIVERS ABOUT HOW TO NAVIGATE THROUGH ALTERNATIVE INTERSECTIONS .....	108
5.4.	ALTERNATIVE INTERSECTIONS' CONSTRUCTION COSTS .....	110
5.5.	DATA COLLECTION.....	111
5.6.	SUMMARY AND CONCLUSIONS .....	112
6.	DEVELOPMENT OF SAFETY PERFORMANCE FUNCTIONS AND CRASH MODIFICATION FACTORS .....	114
6.1.	METHODOLOGIES .....	114
6.1.1.	Before-and-After Study with the Comparison Group.....	114
6.1.2.	Before-and-After Study using the Empirical Bayes Approach.....	116
6.1.3.	Cross-Sectional Method.....	120
6.2.	CONTINUOUS GREEN T-INTERSECTION .....	122
6.2.1.	Data Processing for Continuous Green T-Intersections.....	122
6.2.2.	Estimating CMFs for Continuous Green T-Intersections .....	132
6.2.3.	Summary .....	138
6.3.	MEDIAN U-TURN INTERSECTION .....	140
6.3.1.	Data Processing for Median U-Turn Intersections .....	141
6.3.2.	Developing SPFs for Median U-Turn Intersections .....	157
6.3.3.	Estimating CMFs for Median U-Turn Intersections.....	165
6.3.4.	Before-and-After Analysis for Partial MUTs.....	169
6.3.5.	Summary .....	171
6.4.	CONTINUOUS FLOW INTERSECTIONS.....	173
6.4.1.	Data Processing for Continuous Flow Intersections.....	173
6.4.2.	Developing SPFs for Continuous Flow Intersections.....	183
6.4.3.	Estimating CMFs for Continuous Flow Intersections .....	186
6.4.4.	Before-and-After Analysis for Continuous Flow Intersections .....	188
6.4.5.	Summary .....	189
6.5.	JUGHANDLE INTERSECTIONS.....	191
6.5.1.	Data Processing for Jughandle Intersections.....	193
6.5.2.	Developing SPFs for Jughandle Intersections.....	213
6.5.3.	Estimating CMFs for Jughandle Intersections .....	217
6.5.4.	Summary .....	222
6.6.	RESTRICTED CROSSING U-TURN INTERSECTION .....	223

6.6.1. Data Processing for RCUT Intersections .....	224
6.6.2. Before-and-After Analysis for RCUT Intersections .....	231
6.6.3. Summary .....	232
6.7. SUMMARY AND CONCLUSIONS .....	233
7. TRAFFIC SAFETY DIAGNOSIS FOR REAR-END CRASHES .....	240
7.1. METHODOLOGIES .....	240
7.2. DATA COLLECTION AND PREPARATION .....	245
7.3. INTRODUCTION OF DATABASES .....	245
7.4. CRASH FEATURES AT INTERSECTIONS IN FLORIDA .....	258
7.5. EFFECTS OF SIGNALIZATION AT URBAN INTERSECTIONS .....	276
7.6. EFFECTS OF SIGNALIZATION AT RURAL INTERSECTIONS .....	294
7.7. COMPARISON BETWEEN RURAL AND URBAN AREAS .....	327
7.8. SUMMARY AND CONCLUSIONS .....	331
8. HOTSPOT INTERSECTION IDENTIFICATION AND RECOMMENDATIONS .....	334
8.1. METHODOLOGIES .....	334
8.2. RESULTS .....	341
8.3. SUMMARY AND CONCLUSIONS .....	394
9. SAFETY EVALUATION OF DIVERGING DIAMOND INTERCHANGES .....	395
9.1. DATA PROCESSING FOR DIVERGING DIAMOND INTERCHANGES .....	396
9.2. BEFORE-AND-AFTER ANALYSIS FOR DDIS .....	408
9.3. CROSS-SECTIONAL METHOD .....	413
9.4. SUMMARY .....	419
10. CONCLUSIONS .....	422
REFERENCES .....	427
APPENDIX .....	437

## LIST OF FIGURES

Figure 2-1: Left-turn crossover movement at a three-legged partial CFI in Shirley, New York (Hughes et al., 2010).....	33
Figure 2-2: Left-turn crossover movement at a partial CFI in Baton Rouge, Louisiana (Hughes et al., 2010).....	34
Figure 2-3: Illustration of left-turn cross movements at full CFI (Hughes et al., 2010).....	35
Figure 2-4: Explanation of how a CFI works (Hughes et al., 2010).....	36
Figure 2-5: Conflict points for a conventional intersection (Steyn et al., 2014).....	37
Figure 2-6: Conflict points for a CFI with two displaced left turns (Steyn et al., 2014).....	37
Figure 2-7: Conflict points for a CFI with four displaced left-turns (Steyn et al., 2014).....	38
Figure 2-8: MUT intersection in Michigan (Levinson et al., 2000).....	43
Figure 2-9: Illustration of typical MUT design (Hughes et al., 2010).....	44
Figure 2-10: Illustration of MUT left-turn traffic movements (Hughes et al., 2010).....	45
Figure 2-11: MUT intersection with water retention ponds in median in New Orleans, Louisiana (Reid et al., 2014).....	46
Figure 2-12: Vehicle-to-vehicle conflict points at MUT intersection (Reid et al., 2014).....	47
Figure 2-13: Divided highway level of service and throughput comparison (Reid et al., 2014).....	49
Figure 2-14: RCUT intersection in Troy, Michigan (Hughes et al., 2010).....	51
Figure 2-15: RCUT intersection configuration with direct left turns from the major road (Hughes et al., 2010).....	52
Figure 2-16: Basic RCUT intersection with no direct left turns (Hughes et al., 2010).....	52
Figure 2-17: Vehicular conflict points at four-approach RCU intersection (Hummer et al., 2014).....	54
Figure 2-18: Typical DDI configuration (Hughes et al., 2010).....	58
Figure 2-19: DDI in Sarasota (Courtesy of Mr. Kevin Ingle).....	59
Figure 2-20: Comparison of conflict points at DDI (left) and conventional diamond interchange (Schroeder et al., 2014).....	60
Figure 2-21: Typical geometry of CGT (Hughes et al., 2010).....	65
Figure 2-22: Example of a CGT in Charlotte, North Carolina (Hughes et al., 2010).....	66
Figure 2-23: Example of typical geometry of a parallel flow intersection (Parsons, 2007).....	68

Figure 2-24: Conflict points of parallel flow intersection (left) and conventional intersection (right) (Parsons, 2007).....	69
Figure 2-25: Jughandle intersections: Types 1, 2, and 3 (from top to bottom) .....	72
Figure 2-26: Illustration of left-turn movements at a QR intersection (Hughes et al., 2010) .....	74
Figure 2-27: QR intersection in Fairfield, Ohio .....	75
Figure 2-28: QR intersection in Bend, Oregon (Hughes et al., 2010) .....	75
Figure 2-29: Vehicle-to-vehicle conflict points at a QR intersection (Hughes et al., 2010).....	76
Figure 2-30: Typical hamburger intersection movements (Hughes et al., 2010) .....	78
Figure 2-31: Hamburger intersection in Fairfax, Virginia (Hughes et al., 2010).....	78
Figure 2-32: Typical synchronized split-phase intersection movements (Hughes et al., 2010)...	79
Figure 5-1: Survey responses from states.....	97
Figure 5-2: Parallel flow intersection with median U-turn intersection .....	99
Figure 5-3: Reverse jughandle intersection .....	100
Figure 5-4: Number of states having alternative intersections by type.....	101
Figure 5-5: Number of implemented alternative intersections by type.....	102
Figure 5-6: Number of alternative intersections implemented by type and state .....	104
Figure 5-7: Alternative intersections by type .....	105
Figure 5-8: Results of inquiry about plans to deploy alternative intersections .....	107
Figure 5-9: The states where the data were collected .....	111
Figure 6-1: Locations of treated and comparison sites .....	123
Figure 6-2: Sideswipe (left) and angle crashes (right) between a vehicle on the CGT through lane and a left-turning vehicle from the minor road.....	124
Figure 6-3: Yearly crash counts per site by crash type .....	130
Figure 6-4: Crash trends of statewide and comparison sites .....	131
Figure 6-5: Illustration of MUT left-turn traffic movements (Hughes et al., 2010).....	140
Figure 6-6: MUT: Type A at US-24 & W Warren St., Detroit, Michigan.....	141
Figure 6-7: MUT Type B at E 10 Mile Rd & Gratiot Ave., Michigan, Michigan .....	141
Figure 6-8: Influence areas of intersections for the safety analysis for MUT intersections .....	143
Figure 6-9: Percentage of crashes by injury severity at MUT and conventional intersections ..	151
Figure 6-10: Percentages of crashes by types at MUT and conventional intersections.....	152
Figure 6-11: Distribution of crash types in HSM and this study .....	154

Figure 6-12: Distribution of crash types in this study and Florida 4SG crash data.....	155
Figure 6-13: Distribution of crash types in NCHRP 17-62 and this study (MUT Study-FDOT) .....	156
Figure 6-14: Distribution of severity levels in NCHRP 17-62 and this study (MUT Study-FDOT) .....	157
Figure 6-15: Influence areas of intersections for the safety analysis for CFIs .....	174
Figure 6-16: Percentages of crashes by types at CFI and conventional intersections .....	179
Figure 6-17: Percentage of crashes by injury severity at CFI and conventional intersections...	180
Figure 6-18: Distribution of crash types in NCHRP 17-62, this study (CFI-FDOT), and Florida 4SG data .....	181
Figure 6-19: Distribution of severity level in NCHRP 17-62, this study (CFI-FDOT), and Florida 4SG data .....	182
Figure 6-20: Crash modification functions for fully-specified SPFs by crash type (significant CMFunctions only) .....	187
Figure 6-21: Forward/forward jughandle intersection, New Jersey .....	192
Figure 6-22: Reverse/reverse jughandle intersection, New Jersey .....	192
Figure 6-23: Forward/reverse jughandle intersection, New Jersey .....	193
Figure 6-24: Influence areas of jughandle intersections for the safety analysis.....	195
Figure 6-25: Percentage of crashes by severity at Type 1 jughandle and conventional intersections .....	205
Figure 6-26: Percentage of crashes by severity at Type 2 jughandle and conventional intersections .....	206
Figure 6-27: Percentage of crashes by severity at Type 3 jughandle and conventional intersections .....	207
Figure 6-28: Percentages of crashes by types at Type 1 jughandle and conventional intersections .....	208
Figure 6-29: Percentages of crashes by types at Type 2 jughandle and conventional intersections .....	209
Figure 6-30: Percentages of crashes by types at Type 3 jughandle and conventional intersections .....	210
Figure 6-31: Distribution of crash types in HSM and this study (Jughandle-FDOT) .....	211



Figure 6-32: Distribution of crash types in NCHRP 17-62 and this study (Jughandle-FDOT) .	212
Figure 6-33: Distribution of severity levels in NCHRP 17-62 and this study (Jughandle-FDOT)	
.....	212
Figure 6-34: CMF values by DVMT for jughandle: Type 1 (significant types only) .....	219
Figure 6-35: CMF values by DVMT for jughandle: Type 2 (significant types only) .....	219
Figure 6-36: CMF values by DVMT for jughandle: Type 3 (significant type only) .....	220
Figure 6-37: RCUT intersection in Hamilton, Ohio .....	223
Figure 6-38: Influence areas of intersections for the safety analysis for RCUT intersections ...	225
Figure 6-39: Percentage of crashes by severity at RCUT and conventional intersections .....	229
Figure 6-40: Percentages of crashes by types at RCUT and conventional intersections .....	230
Figure 7-1: Using K-nearest neighbors and K-means to select similar stop-controlled	
intersections and signalized intersections.....	242
Figure 7-2: Flowchart of quasi-induced exposure method for the crash data .....	244
Figure 7-3: Annual trends in crash frequencies in the before period for urban 3-leg treatment	
sites and reference sites .....	251
Figure 7-4: Annual trends in crash frequencies in the before period for urban 4-leg treatment	
sites and reference sites .....	251
Figure 7-5: Total crashes: proportions of crash types at different rural intersections .....	260
Figure 7-6: Total crashes: proportions of crash types at different urban intersections.....	260
Figure 7-7: Crashes involving elderly drivers: proportions of crash types at different rural	
intersections .....	262
Figure 7-8: Crashes involving elderly drivers: proportions of crash types at different urban	
intersections .....	262
Figure 7-9: Crashes not involving elderly drivers: proportions of crash types at different rural	
intersections .....	263
Figure 7-10: Crash not involving elderly drivers: proportions of crash types at different urban	
intersections .....	264
Figure 7-11: Rural 4-leg intersections: signalized vs. minor-road stop-controlled (rear-end	
crashes).....	305
Figure 7-12: Rural 4-leg intersections: signalized vs. all-way stop-controlled (rear-end crashes)	
.....	306

Figure 7-13: Rural 3-leg intersections: signalized vs. minor-road stop-controlled (rear-end crashes).....	307
Figure 7-14: CMFs for rear-end KAB crashes at the rural 4-leg stop controlled intersections ..	309
Figure 7-15: CMFs for rear-end PDO crashes at the rural 4-leg stop controlled intersections ..	309
Figure 7-16: Rural 4-leg intersections: signalized vs. minor-road stop-controlled (angle crashes) .....	311
Figure 7-17: Rural 4-leg intersections: signalized vs. minor-road stop-controlled (total crashes) .....	314
Figure 7-18: Rural 4-leg intersections: signalized vs. all-way stop-controlled (total crashes) ..	315
Figure 7-19: Rural 4-leg intersections: signalized vs. minor-road stop-controlled (KAB crashes) .....	318
Figure 7-20: Rural 4-leg intersections: signalized vs. minor-road stop-controlled (PDO crashes) .....	321
Figure 7-21: Rural 3-leg intersections: signalized vs. minor-road stop-controlled (PDO-Total) .....	322
Figure 8-1: Procedure of suggesting alternative intersections.....	340
Figure 8-2: Locations of the fifty most dangerous intersections in Florida .....	341
Figure 8-3: Satellite image of intersection 1 .....	344
Figure 8-4: Crash distribution by severity and EPDO distribution by crash type for intersection 1 .....	344
Figure 8-5: Satellite image of intersection 2 .....	345
Figure 8-6: Crash distribution by severity and EPDO distribution by crash type for intersection 2 .....	345
Figure 8-7: Satellite image of intersection 3 .....	346
Figure 8-8: Crash distribution by severity and EPDO distribution by crash type for intersection 3 .....	346
Figure 8-9: Satellite image of intersection 4 .....	347
Figure 8-10: Crash distribution by severity and EPDO distribution by crash type for intersection 4.....	347
Figure 8-11: Satellite image of intersection 5 .....	348

Figure 8-12: Crash distribution by severity and EPDO distribution by crash type for intersection 5.....	348
Figure 8-13: Satellite image of intersection 6 .....	349
Figure 8-14: Crash distribution by severity and EPDO distribution by crash type for intersection 6.....	349
Figure 8-15: Satellite image of intersection 7 .....	350
Figure 8-16: Crash distribution by severity and EPDO distribution by crash type for intersection 7.....	350
Figure 8-17: Satellite image of intersection 8 .....	351
Figure 8-18: Crash distribution by severity and EPDO distribution by crash type for intersection 8.....	351
Figure 8-19: Satellite image of intersection 9 .....	352
Figure 8-20: Crash distribution by severity and EPDO distribution by crash type for intersection 9.....	352
Figure 8-21: Satellite image of intersection 10.....	353
Figure 8-22: Crash distribution by severity and EPDO distribution by crash type for intersection 10.....	353
Figure 8-23: Satellite image of intersection 11.....	354
Figure 8-24: Crash distribution by severity and EPDO distribution by crash type for intersection 11.....	354
Figure 8-25: Satellite image of intersection 12.....	355
Figure 8-26: Crash distribution by severity and EPDO distribution by crash type for intersection 12.....	355
Figure 8-27: Satellite image of intersection 13.....	356
Figure 8-28: Crash distribution by severity and EPDO distribution by crash type for intersection 13.....	356
Figure 8-29: Satellite image of intersection 14.....	357
Figure 8-30: Crash distribution by severity and EPDO distribution by crash type for intersection 14.....	357
Figure 8-31: Satellite image of intersection 15.....	358

Figure 8-32: Crash distribution by severity and EPDO distribution by crash type for intersection 15.....	358
Figure 8-33: Satellite image of intersection 16.....	359
Figure 8-34: Crash distribution by severity and EPDO distribution by crash type for intersection 16.....	359
Figure 8-35: Satellite image of intersection 17.....	360
Figure 8-36: Crash distribution by severity and EPDO distribution by crash type for intersection 17.....	360
Figure 8-37: Satellite image of intersection 18.....	361
Figure 8-38: Crash distribution by severity and EPDO distribution by crash type for intersection 18.....	361
Figure 8-39: Satellite image of intersection 19.....	362
Figure 8-40: Crash distribution by severity and EPDO distribution by crash type for intersection 19.....	362
Figure 8-41: Satellite image of intersection 20.....	363
Figure 8-42: Crash distribution by severity and EPDO distribution by crash type for intersection 20.....	363
Figure 8-43: Satellite image of intersection 21.....	364
Figure 8-44: Crash distribution by severity and EPDO distribution by crash type for intersection 21.....	364
Figure 8-45: Satellite image of intersection 22.....	365
Figure 8-46: Crash distribution by severity and EPDO distribution by crash type for intersection 22.....	365
Figure 8-47: Satellite image of intersection 23.....	366
Figure 8-48: Crash distribution by severity and EPDO distribution by crash type for intersection 23.....	366
Figure 8-49: Satellite image of intersection 24.....	367
Figure 8-50: Crash distribution by severity and EPDO distribution by crash type for intersection 24.....	367
Figure 8-51: Satellite image of intersection 25.....	368

Figure 8-52: Crash distribution by severity and EPDO distribution by crash type for intersection 25.....	368
Figure 8-53: Satellite image of intersection 26.....	369
Figure 8-54: Crash distribution by severity and EPDO distribution by crash type for intersection 26.....	369
Figure 8-55: Satellite image of intersection 27.....	370
Figure 8-56: Crash distribution by severity and EPDO distribution by crash type for intersection 27.....	370
Figure 8-57: Satellite image of intersection 28.....	371
Figure 8-58: Crash distribution by severity and EPDO distribution by crash type for intersection 28.....	371
Figure 8-59: Satellite image of intersection 29.....	372
Figure 8-60: Crash distribution by severity and EPDO distribution by crash type for intersection 29.....	372
Figure 8-61: Satellite image of intersection 30.....	373
Figure 8-62: Crash distribution by severity and EPDO distribution by crash type for intersection 30.....	373
Figure 8-63: Satellite image of intersection 31.....	374
Figure 8-64: Crash distribution by severity and EPDO distribution by crash type for intersection 31.....	374
Figure 8-65: Satellite image of intersection 32.....	375
Figure 8-66: Crash distribution by severity and EPDO distribution by crash type for intersection 32.....	375
Figure 8-67: Satellite image of intersection 33.....	376
Figure 8-68: Crash distribution by severity and EPDO distribution by crash type for intersection 33.....	376
Figure 8-69: Satellite image of intersection 34.....	377
Figure 8-70: Crash distribution by severity and EPDO distribution by crash type for intersection 34.....	377
Figure 8-71: Satellite image of intersection 35.....	378

Figure 8-72: Crash distribution by severity and EPDO distribution by crash type for intersection 35.....	378
Figure 8-73: Satellite image of intersection 36.....	379
Figure 8-74: Crash distribution by severity and EPDO distribution by crash type for intersection 36.....	379
Figure 8-75: Satellite image of intersection 37.....	380
Figure 8-76: Crash distribution by severity and EPDO distribution by crash type for intersection 37.....	380
Figure 8-77: Satellite image of intersection 38.....	381
Figure 8-78: Crash distribution by severity and EPDO distribution by crash type for intersection 38.....	381
Figure 8-79: Satellite image of intersection 39.....	382
Figure 8-80: Crash distribution by severity and EPDO distribution by crash type for intersection 39.....	382
Figure 8-81: Satellite image of intersection 40.....	383
Figure 8-82: Crash distribution by severity and EPDO distribution by crash type for intersection 40.....	383
Figure 8-83: Satellite image of intersection 41.....	384
Figure 8-84: Crash distribution by severity and EPDO distribution by crash type for intersection 41.....	384
Figure 8-85: Satellite image of intersection 42.....	385
Figure 8-86: Crash distribution by severity and EPDO distribution by crash type for intersection 42.....	385
Figure 8-87: Satellite image of intersection 43.....	386
Figure 8-88: Crash distribution by severity and EPDO distribution by crash type for intersection 43.....	386
Figure 8-89: Satellite image of intersection 44.....	387
Figure 8-90: Crash distribution by severity and EPDO distribution by crash type for intersection 44.....	387
Figure 8-91: Satellite image of intersection 45.....	388

Figure 8-92: Crash distribution by severity and EPDO distribution by crash type for intersection 45.....	388
Figure 8-93: Satellite image of intersection 46.....	389
Figure 8-94: Crash distribution by severity and EPDO distribution by crash type for intersection 46.....	389
Figure 8-95: Satellite image of intersection 47.....	390
Figure 8-96: Crash distribution by severity and EPDO distribution by crash type for intersection 47.....	390
Figure 8-97: Satellite image of intersection 48.....	391
Figure 8-98: Crash distribution by severity and EPDO distribution by crash type for intersection 48.....	391
Figure 8-99: Satellite image of intersection 49.....	392
Figure 8-100: Crash distribution by severity and EPDO distribution by crash type for intersection 49.....	392
Figure 8-101: Satellite image of intersection 50.....	393
Figure 8-102: Crash distribution by severity and EPDO distribution by crash type for intersection 50.....	393
Figure 9-1: Different traffic movements at a typical DDI design (I-77 & Catawba Ave, Cornelius, North Carolina) .....	395
Figure 9-2: Example of irregular DDI (Baltimore-Washington Pkwy & Arundel Mills Blvd, Maryland) .....	396
Figure 9-3: The distribution of used and unused DDIs over the states.....	397
Figure 9-4: Example of not-junction facility before a DDI implementation (I-65 & Worthsville Road, Greenwood, Indiana).....	400
Figure 9-5: Different proposed crash influence areas.....	401
Figure 9-6: Example of a DDI with a relatively short crossovers' distance (I-29 & Tiffany Springs Pkwy, Kansas City, Missouri) .....	403
Figure 9-7: Percentage of crashes by injury severity at MUT and conventional intersections ..	407
Figure 9-8: Example of overpass and underpass interchanges (Google Earth).....	417
Figure 9-9: Effect of crossovers' distance on average crash frequency.....	419

## LIST OF TABLES

Table 1-1: Installations and examples of alternative intersection design treatments.....	30
Table 1-2: Summary of counts of alternative intersections by state .....	31
Table 2-1: Comparison of conflict points: CFI vs. conventional intersections (Hughes and Jagannathan, 2009).....	38
Table 2-2: Summary of CMF for CFI.....	39
Table 2-3: Comparison of conflict points: MUT intersection vs. conventional intersection (Reid et al., 2014) .....	47
Table 2-4: Crash modification factor for MUT .....	48
Table 2-5: Comparison of conflict points: RCUT intersection vs. conventional intersection (Hummer et al., 2014) .....	54
Table 2-6: Comparison of conflict points by interchange type (Schroeder et al., 2014) .....	61
Table 2-7: Summary of CMFs for DDI.....	62
Table 2-8: Summary of CMFs for CGTs .....	67
Table 2-9: Comparison of conflict points: PFI vs. conventional intersections (Parsons, 2007) ..	69
Table 3-1: Summary of contributing factors to rear-end crashes .....	88
Table 5-1: Alternative intersection designs implemented by alternative intersection type .....	98
Table 5-2: Instruction campaign about alternative intersections .....	109
Table 5-3: Construction costs .....	110
Table 6-1: Summary of crash counts by type by year (Florida) .....	126
Table 6-2: Comparison of AADT in treated and comparison sites (Florida) .....	126
Table 6-3: Descriptive statistics of data for the cross-sectional analysis .....	127
Table 6-4: CMFs for the conversion of CGTs back to the conventional design by crash type (before-and-after study with the comparison group) .....	129
Table 6-5: Safety performance functions for CGTs and non-CGTs using data of Florida, Nevada, Texas, and Colorado (N=41) .....	134
Table 6-6: CMFs of non-CGTs (vs. CGTs) (cross-sectional method).....	135
Table 6-7: Combined effects of CGT and other features .....	137
Table 6-8: Average crash frequency by different influence area of intersections .....	144
Table 6-9: Estimated CMFs by different influence area of intersections .....	145



Table 6-10: Descriptive statistics of the prepared data for MUTs.....	148
Table 6-11: Fully-specified SPFs for MUTs .....	160
Table 6-12: Simple SPFs for MUTs .....	163
Table 6-13: CMFs from fully-specified SPFs .....	166
Table 6-14: CMFs from simple SPFs.....	168
Table 6-15: Comparison of AADT of partial MUTs and comparison sites .....	170
Table 6-16: CMFs for partial MUTs (before-and-after study with the comparison group).....	171
Table 6-17: Annual average crash frequency by different influence area of intersections .....	175
Table 6-18: Estimated CMFs by different influence area of intersections.....	176
Table 6-19: Descriptive statistics of the conventional intersections and CFIs.....	176
Table 6-20: Fully-specified SPFs for CFIs.....	184
Table 6-21: Simple SPFs for CFIs .....	185
Table 6-22: CMFunctions from the fully-specified SPFs .....	186
Table 6-23: CMFs from the simple SPFs .....	186
Table 6-24: CMFs for CFIs (before-and-after study with the comparison group).....	188
Table 6-25: Average crash frequency by different influence area of intersections .....	196
Table 6-26: Estimated CMFs by different influence area of intersections.....	197
Table 6-27: Descriptive statistics of conventional and jughandle Intersections .....	198
Table 6-28: Fully-specified SPFs for jughandle intersections.....	214
Table 6-29: Simple SPFs for Jughandle intersections.....	216
Table 6-30: CMFunctions from the fully-specified SPFs .....	218
Table 6-31: CMFs for Jughandle intersections from simple SPFs .....	221
Table 6-32: Average crash frequency by different influence areas of intersection .....	226
Table 6-33: Estimated CMFs by different influence area of intersections.....	227
Table 6-34: Descriptive statistics of conventional and RCUT intersections.....	227
Table 6-35: CMFs for RCUTs (before-and-after study with the comparison group).....	231
Table 6-36: Comparison of CMFs of RCUT and MUT intersections .....	232
Table 6-37: Suggested CMFs for Safety Performance for Intersection Control Evaluation (SPICE) .....	239
Table 7-1: Intersection-related variables collected and corresponding data source .....	248
Table 7-2: Proportion of 3-leg and 4-leg urban intersections.....	250

Table 7-3: Sample odds ratios for treatment and reference groups .....	252
Table 7-4: Descriptive statistics for reference sites (urban 3-leg) .....	253
Table 7-5: Descriptive statistics for reference sites (urban 4-leg) .....	253
Table 7-6: Descriptive statistics for treated sites (urban 3-leg) .....	254
Table 7-7: Descriptive statistics for treated sites (urban 4-leg) .....	254
Table 7-8: Proportions of 3-leg and 4-leg rural intersections.....	255
Table 7-9: Descriptive statistics for sampled intersections (rural 3-leg) .....	256
Table 7-10: Descriptive statistics for sampled intersections (rural 4-leg).....	257
Table 7-11: Intersection proportions for analysis .....	258
Table 7-12: Total crashes: proportions of crash severities at different rural intersections .....	266
Table 7-13: Total crashes: proportions of crash severities at different urban intersections.....	267
Table 7-14: Crashes involving elderly drivers: proportions of crash severities at different rural intersections .....	269
Table 7-15: Crashes involving elderly drivers: proportions of crash severities at different urban intersections .....	270
Table 7-16: Crashes not involving elderly drivers: proportions of crash severities at different rural intersections.....	272
Table 7-17: Crashes not involving elderly drivers: proportions of crash severities at different urban intersections .....	273
Table 7-18: CMFs for signalization on total rear-end crashes at urban intersections .....	278
Table 7-19: CMFs for signalization on rear-end crash severities at urban intersections .....	280
Table 7-20: CMFs for signalization on angle crashes at urban intersections.....	282
Table 7-21: CMFs for signalization on total crashes at urban intersections .....	284
Table 7-22: CMFs for signalization on KAB crashes at urban intersections .....	286
Table 7-23: CMFs for signalization on KABC crashes at urban intersections .....	288
Table 7-24: CMFs for signalization on PDO crashes at urban intersections .....	290
Table 7-25: SPFs of signalization for rear-end crashes at rural intersections .....	296
Table 7-26: SPFs of signalization for different crash severity levels of rear-end crashes at rural intersections .....	298
Table 7-27: SPF of signalization for angle crashes at rural intersections .....	299
Table 7-28: SPF of signalization for total crashes at rural intersections.....	300

Table 7-29: SPF of signalization for KAB crashes at rural intersections .....	301
Table 7-30: SPF of signalization for PDO crashes at rural intersections .....	302
Table 7-31: Crash modification function of signalization on rear-end crashes at different rural intersections .....	304
Table 7-32: Crash modification function of signalization on different crash severity levels of rear-end crashes at different rural intersections .....	308
Table 7-33: Crash modification function of signalization on angle crashes at different rural intersections .....	310
Table 7-34: Crash modification function of signalization on total crashes at different rural intersections .....	313
Table 7-35: Crash modification function of signalization on KAB Crashes at different rural intersections .....	317
Table 7-36: Crash modification function of signalization on PDO crashes at different rural intersections .....	320
Table 8-1: SPFs for crash severity .....	335
Table 8-2: List of counties by the number of identified top 1% hot intersections .....	342
Table 8-3: Characteristics of the most problematic intersections .....	343
Table 9-1: DDI frequency and available crash data by state .....	398
Table 9-2: Configuration type of the treated sites before being converted to DDI .....	399
Table 9-3: Comparison between the different scenarios of crash influence area .....	402
Table 9-4: Crash data descriptive statistics .....	404
Table 9-5: Explanatory variables descriptive statistics .....	406
Table 9-6: Before-after with CG calculations (full sample size) .....	409
Table 9-7: Empirical Bayes before-after calculations (full sample size: arterial AADT only) .....	409
Table 9-8: Empirical Bayes before-after calculations (partial sample size: TEV) .....	410
Table 9-9: SPFs for Empirical Bayes' expected crash frequency calculation (full sample size: arterial AADT only) .....	411
Table 9-10: SPFs for Empirical Bayes' expected crash frequency calculation (partial sample size: TEV= arterial+ramps) .....	411
Table 9-11: CMFs for DDIs resulting from the before-and-after methods .....	412

Table 9-12: Safety performance functions from the cross-sectional analysis (full sample size: arterial AADT only) .....	415
Table 9-13: Safety performance functions from the cross-sectional analysis (partial sample size: TEV).....	416
Table 9-14: CMFs resulting from the cross-sectional analysis (full sample size: arterial AADT only) .....	418

## **1. BACKGROUND**

Intersections have been of major interest to traffic engineers because approximately half of severe crashes occur at intersections. In the last decade, several alternative intersection designs have been suggested for improving safety and efficiency by reducing conflict points. Some of these types of intersections are also valuable since they have lower construction cost, less right-of-way, and shorter construction duration than interchanges. In this report, we reviewed all relevant studies of the major types of alternative intersections in the United States (and beyond), including their known safety and operation considerations. Moreover, we also reviewed the research on rear-end crashes at intersections and safety issues about elderly drivers at intersections.

Table 1-1 summarizes the safety benefits of alternative intersections. Table 1-2 lists the currently operational alternative intersections by state. The data were mainly collected from the FHWA report (Hughes et al., 2010) and informational guides (Schroeder et al., 2014; Steyn et al., 2014; Reid et al., 2014; Hummer et al., 2014).

**Table 1-1: Installations and examples of alternative intersection design treatments**

No	Intersection type	State	Safety effects (vs. conventional)
1	Continuous Flow Intersection (CFI) /Displaced Left Turn (DLT)	MD, NY, LA, UT, MO	- Total crashes decreased by 24% - Fatal-and-injury crashes reduced by 19 % (Hughes et al., 2010)
2	Michigan U-Turn (MUT)	MI, FL, LA	- Total crashes decreased between 20% and 50% (Jagannathan, 2007) -Conflict points reduced by half (32 to 16) (Jagannathan, 2007)
3	Restricted crossing U-turn (RCUT) intersection	MD, NC, TN, MO	-Total crashes decreased between 28% and 44% (Inman and Haas, 2012)
4	Diverging diamond interchange (DDI)	MO, NC, MN, UT	-Reduced signal phase -Fewer conflict points
5	Quadrant roadway (QR) intersection	NC, UT, OR	-Conflict points reduced from 32 to 28 (Hughes et al., 2010)
6	Jughandle intersections	NJ, WI	-Conflict points reduced from 32 to 24-26 (Jagannathan et al., 2006)
7	Hamburger or Through-About intersection	VA, MD, NJ	-Slightly reduces the conflict point compared to a conventional roundabout
8	Continuous Green T-Intersection (CGT)	FL, MD, VA, MI, OH	-No reduction in the number of conflict points; provides capacity benefits (Boone and Hummer, 1995)
9	Parallel Flow intersection (PFI)	NJ, OH, NY, MD, LA	-Can reduce vehicle delay by as much as 90% -2- or 3-phases per signal cycle for shorter cycle lengths and less lost time -Fewer conflict points -Removes unsafe ‘permitted’ left turns -Channelizing islands create pedestrian refuge (Parsons, 2007)

**Table 1-2: Summary of counts of alternative intersections by state**

State	CFI	MUT	RCUT	DDI	QR	Jughandle	CGT	PFI	Hamburger
AL	0	1	2	0	0	0	0	0	0
AZ	0	2	0	0	0	0	0	0	0
CO	2	0	0	3	0	0	8	0	0
DE	0	0	0	1	0	0	0	0	0
FL	0	0	0	1	0	0	30*	0	0
GA	2	0	0	5	0	0	0	0	0
IA	0	0	0	1	0	0	0	0	0
ID	0	0	0	1	0	0	0	0	0
IL	0	0	0	3	0	0	0	3	0
IN	0	1	0	3	0	0	0	0	0
KS	0	0	0	5	0	0	0	0	0
KY	0	0	0	1	0	0	0	0	0
LA	2	0	0	0	0	0	0	0	0
MD	2	1	2	1	0	0	0	0	0
MI	0	73	2	2	1	0	0	0	0
MN	0	0	0	6	0	0	0	0	0
MO	1	0	0	18	0	0	0	0	0
MS	2	0	0	1	0	0	0	0	0
NC	0	1	11	11	2	0	0	0	0
NE	0	0	0	1	0	0	0	0	0
NJ	2	0	0	0	0	68	0	1	0
NM	0	0	0	1	0	0	0	0	0
NV	0	0	0	2	0	0	6	0	0
NY	0	0	0	1	0	0	0	0	0
OH	3	1	3	1	1	0	0	0	0
OR	0	0	0	1	1	0	0	0	0
PA	0	0	0	1	0	0	0	0	0
SC	0	0	2	0	0	0	16	0	0
TN	0	0	0	2	0	0	0	0	0
TX	3	5	5	3	0	0	5	0	1
UT	11	3	0	8	1	0	0	0	0
VA	2	1	0	3	1	1	0	0	0
WI	0	0	0	1	0	0	0	0	0
WY	0	0	0	1	0	0	0	0	0
Total	32	89	27	89	7	69	65	4	1

## **2. LITERATURE REVIEW OF ALTERNATIVE INTERSECTIONS**

### **2.1. CONTINUOUS FLOW INTERSECTION**

#### **Introduction**

Continuous flow intersections (CFIs) are also known as displaced left-turn intersections (DLTs), or crossover displaced left-turn intersections (XDLs). At conventional intersections, left-turn movements are frequently made from separate left-turn lanes directly onto the crossroad. Drivers turning left must cross the path of the oncoming through traffic from the opposite direction. At CFIs, left-turn traffic is laterally displaced. In other words, left-turning traffic crosses over the opposing through movement at a location that is several hundred feet upstream of the major intersection. This upstream crossover location is typically controlled by a signal. The left-turning traffic then travels on a separated roadbed, which is on the outside of the opposing through lanes, as those vehicles proceed toward the major intersection. When these left-turning motorists reach the major intersection, they can proceed without conflict concurrently with the opposing through traffic.

The main feature of the CFIs is the relocation of the left-turn movement on an approach to the other side of the opposing roadway, which consequently eliminates the left-turn phase for this approach at the main intersection. As shown in Figure 2-1, traffic that would normally turn left at the main intersection first crosses the opposing through lanes at a signalized intersection, several hundred feet upstream of the main intersection.

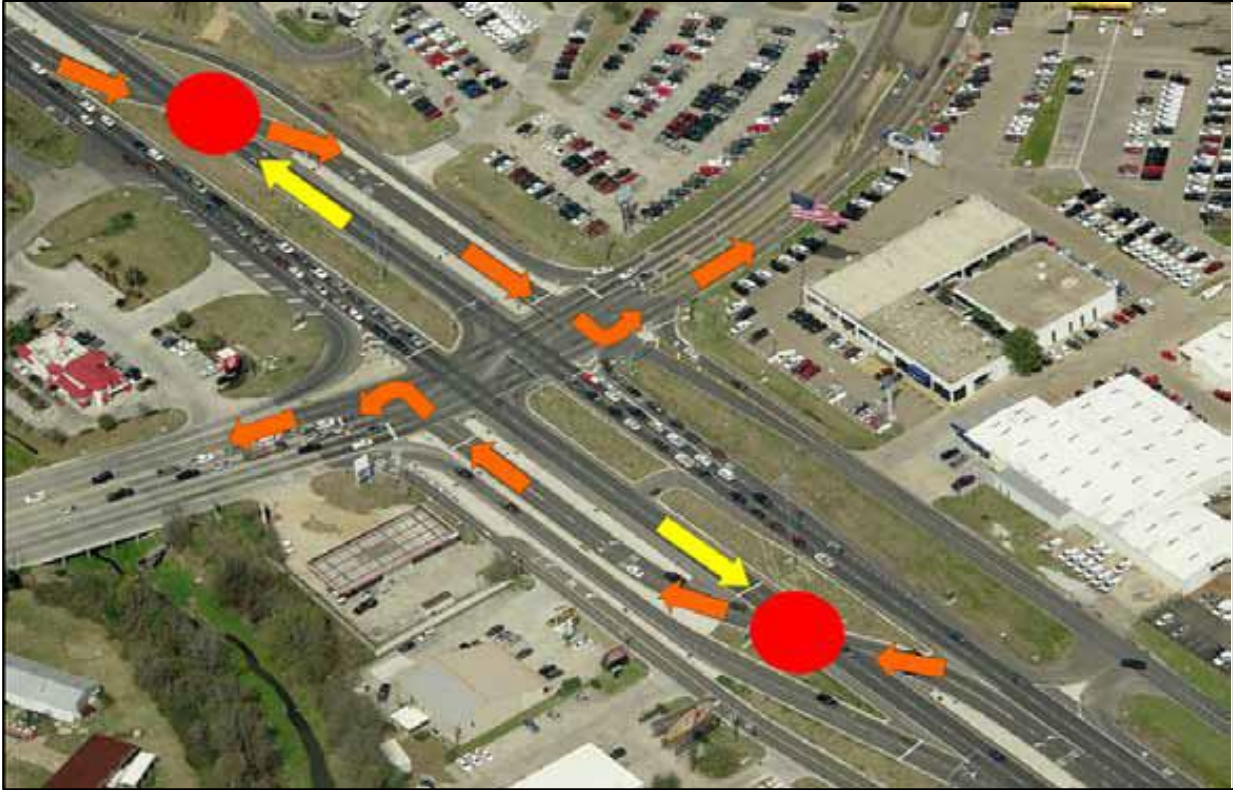
Figure 2-2 shows a partial CFI where the CFI movement provisions have been implemented on two opposing approaches on the major road in this case. In most cases, the CFIs are on the major roadway. The left-turn movements of the minor road continue to take place at the main intersection.



For the full CFI intersection, the left-turn movements are relocated to crossovers on all four approaches, as shown in Figure 2-3. In the figure, the red circle indicates a signal-controlled crossover, the orange arrows indicate left-turn crossover movements, and the yellow arrows indicate opposing through movements at a crossover controlled by a signal. There are five junctions with traffic signal control at a full CFI- the main intersection and the four left-turn crossovers.



**Figure 2-1: Left-turn crossover movement at a three-legged partial CFI in Shirley, New York (Hughes et al., 2010)**



**Figure 2-2: Left-turn crossover movement at a partial CFI in Baton Rouge, Louisiana (Hughes et al., 2010)**

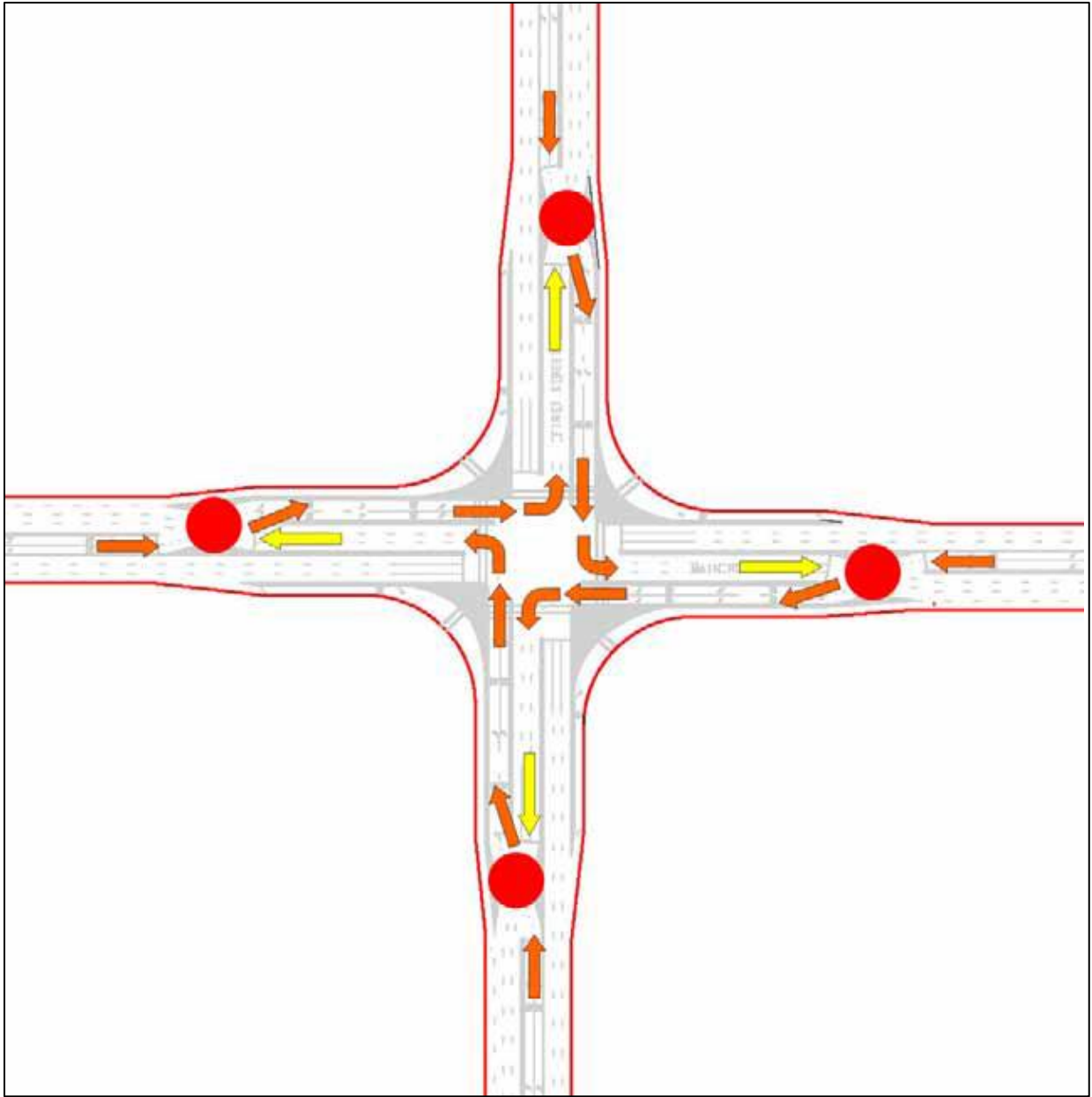
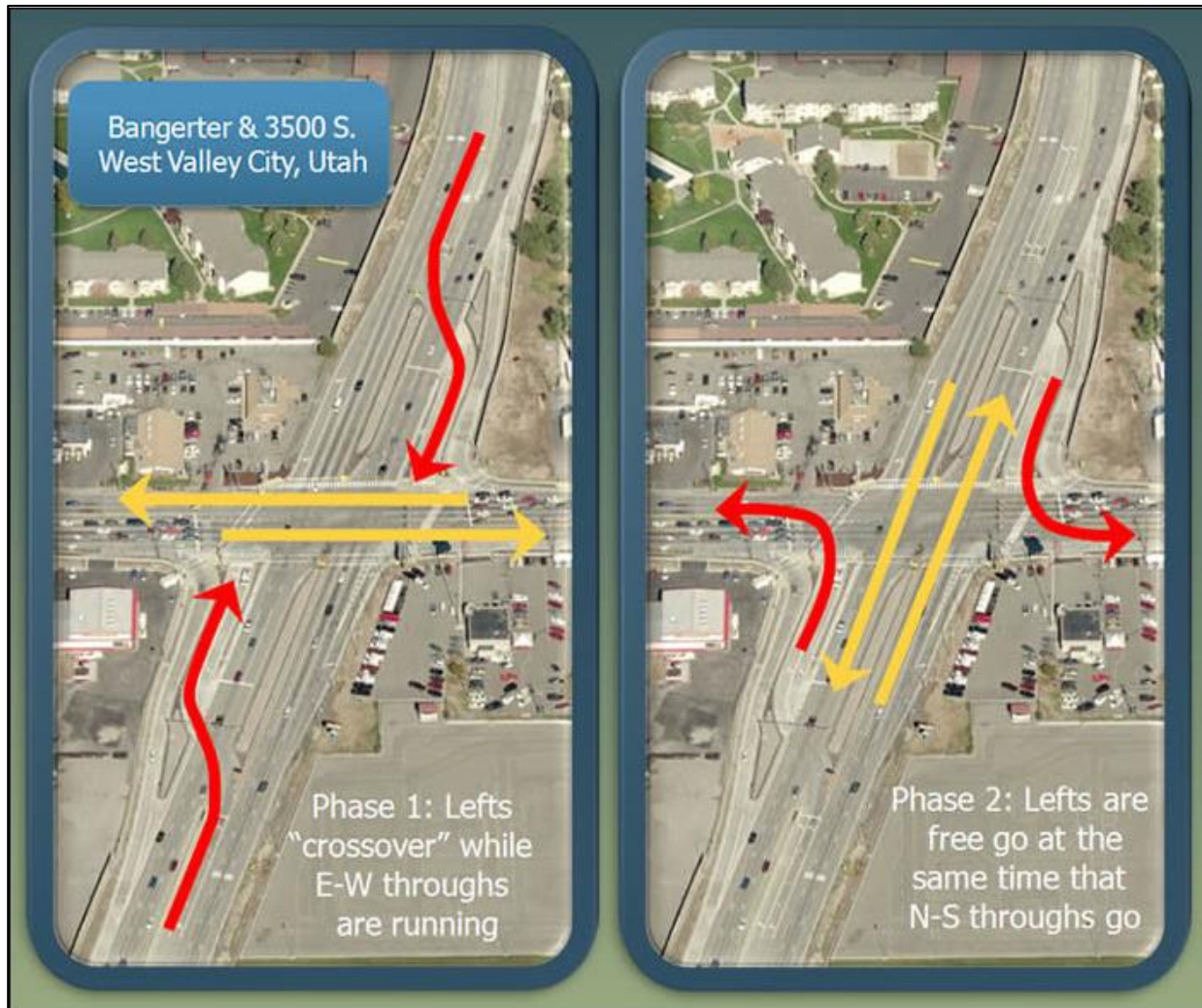


Figure 2-3: Illustration of left-turn cross movements at full CFI (Hughes et al., 2010)

The following Figure 2-4 shows how a CFI is operated.

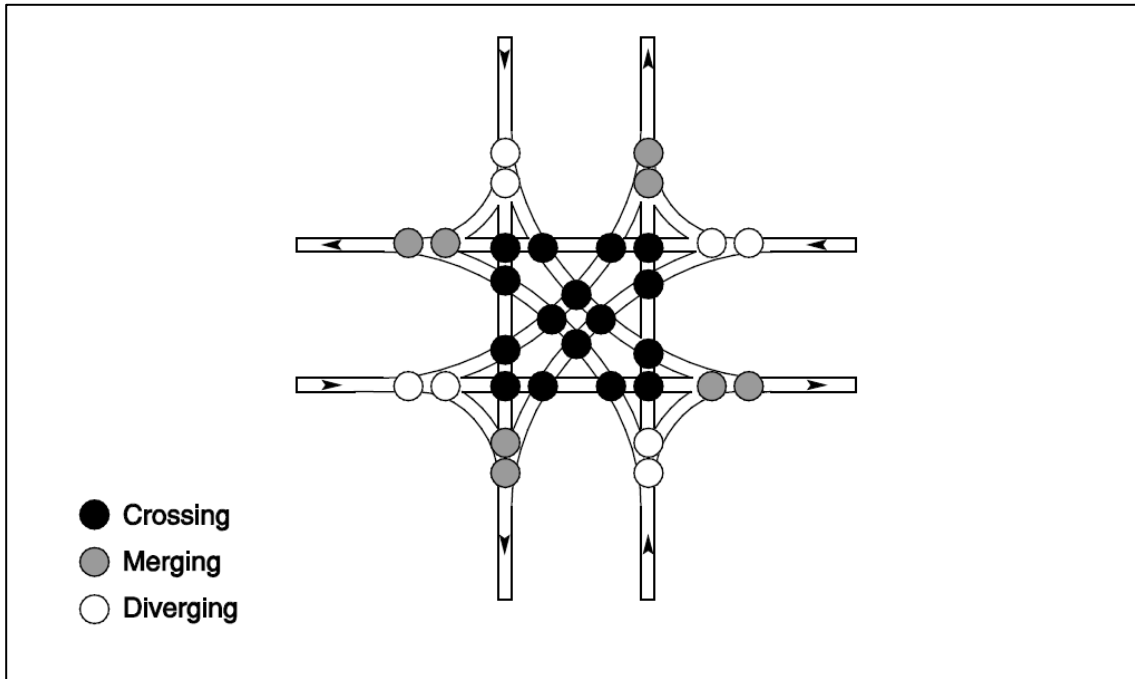


**Figure 2-4: Explanation of how a CFI works (Hughes et al., 2010)**

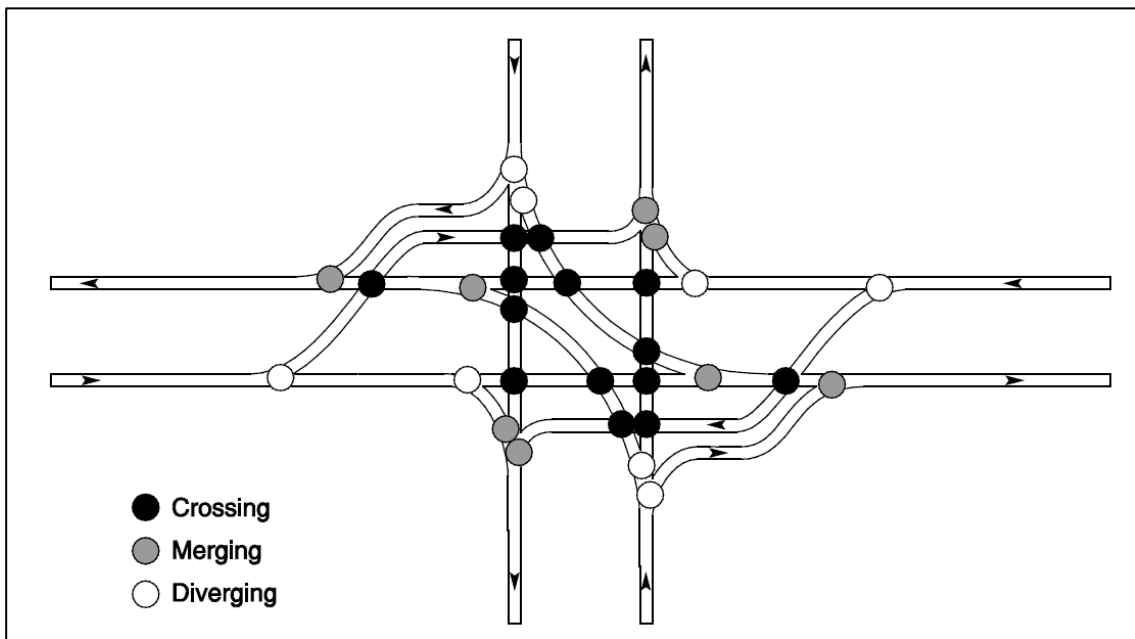
### **Safety Performance**

The total number of conflict points at a CFI is 30 compared to the 32 conflict points at a conventional intersection (Hughes et al., 2010). Inman (2009) analyzed the conflict points' diagram of a conventional four-leg at-grade intersection and a CFI. The results showed that a CFI has two fewer crossing points than the conventional four-leg at-grade intersection. Steyn et al.

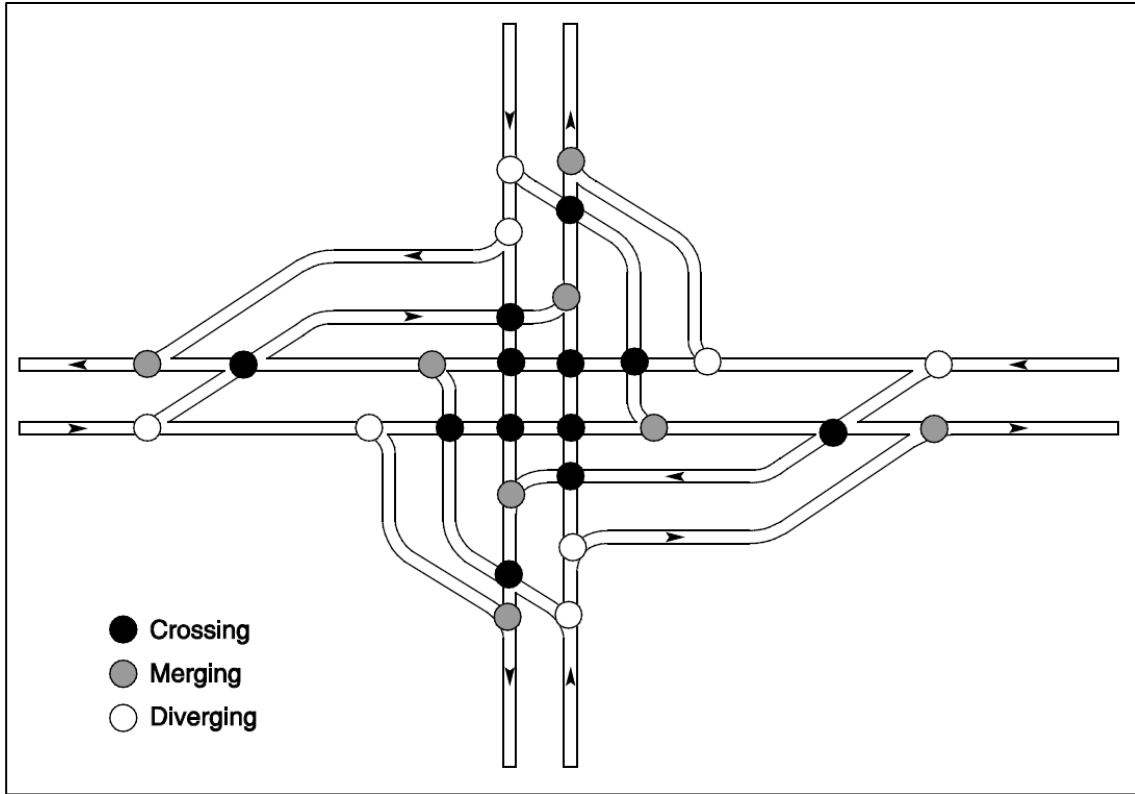
(2014) compared the conflict points of a CFI (on major roads) to those of a typical four-leg intersection (Figures 2-5 to 2-7). The results showed that there was a 6% to 12% decrease in conflict points for a four-leg signalized intersection.



**Figure 2-5: Conflict points for a conventional intersection (Steyn et al., 2014)**



**Figure 2-6: Conflict points for a CFI with two displaced left turns (Steyn et al., 2014)**



**Figure 2-7: Conflict points for a CFI with four displaced left-turns (Steyn et al., 2014)**

Table 2-1 compares the number of conflict points of CFI and conventional intersections. In case of three-legged intersections, the number of conflict points are nine in both types. On the other hand, CFIs have less conflict points compared with conventional intersections at four-legged intersections.

**Table 2-1: Comparison of conflict points: CFI vs. conventional intersections (Hughes and Jagannathan, 2009)**

Number of Intersection Legs	Number of Crossovers on a CFI	Conflict Points	
		Conventional	CFI
3	1	9	9
4	2	32	30
4	4	32	28

Abramson et al. (1995) conducted a human factor study to examine a CFI in New York State. They found that ~80% of the first-time users of the CFI expressed positive comments about the design, with that figure increasing to 100% after a week of driving. Park and Rakha (2010) presented the field experiments to analyze the before-and-after driving behaviors using video data from the two existing CFIs in Utah and Louisiana. Their results showed that the total number of events, such as improper lane change, decreased significantly after opening the CFI. Yahl (2013) found that fatal, injury, rear end and sideswipe collisions increased, while angle and other collisions decreased.

**Crash Modification Factor**

Zlatkovic (2015) developed a crash modification factor (CMF) for the CFI using the empirical Bayes (EB) methodology based on 6 years’ data from 8 CFI in Utah. The CMF was computed to be 0.877 as shown in Table 2-2.

**Table 2-2: Summary of CMF for CFI**

Crash Type	Severity	CMF	Standard error	No. of Intersections	Location	Reference
All	All	0.877***	0.045	8	UT	Zlatkovic, 2015

\*\*\*Significance level 99%

**Safety Considerations**

The FHWA’s information guide (Hughes and Jagannathan, 2009) provided safety considerations, which introduces some unique operational qualities, not present in a conventional signalized intersection.

- a. Pedestrian and bicyclist right-turn movements

b. Potential for wrong-way movements



## **Operational Characteristics**

CFIs are often used in locations where overall demand approaches the capacity of a conventional signalized intersection. Maintaining or providing access to homes and businesses near a CFI can be accomplished by using frontage roads and other access management treatments. However, this can result in the following operational impacts:

- Weaving movements into and out of driveways
- A need for U-turns at the main intersection or adjacent intersections
- Driver confusion related to wayfinding

CFI implementation typically restricts access to parcels situated in the quadrants of the main intersection. Access to these parcels can be accommodated via right-in/right-out configurations from the channelized right-turn lanes. U-turn movements are typically prohibited at the main intersection of a CFI due to conflicts with other movements. To facilitate egress and easy movement of traffic from driveways in either direction of the approach, roadway agencies may deploy U-turn crossovers between the main intersection and the left-crossovers.

Some advantages and disadvantages of the CFI are listed as follows:

### Advantages

- Improves capacity
- Reduces delay and travel time
- Lower cost than alternatives

- Fits with driver expectancy
- Initial step for freeway interchange
- Reduces intersection delay by 20-90%.
- Increases capacity or throughput by 15-30%

#### Disadvantages

- Other alternatives may be safer for pedestrians
- Requires additional room for construction
- May lead to driver confusion

## 2.2. MEDIAN U-TURN INTERSECTION

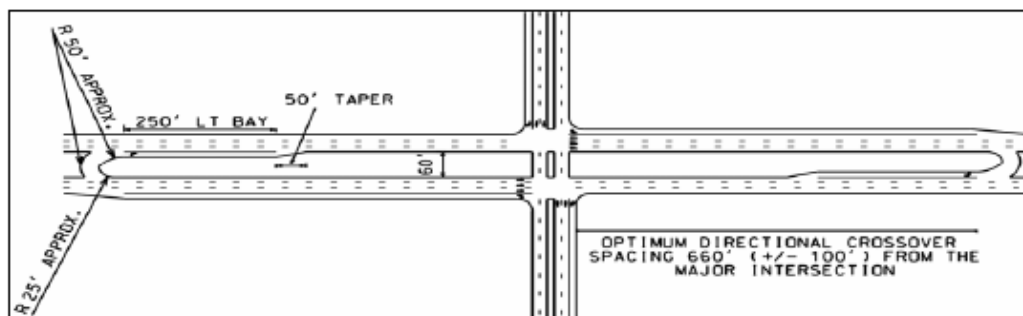
### Introduction

Median U-turn (MUT) intersections are the most common type of alternative intersections in the nation, with many existing implementations in Michigan while some are in Florida and Louisiana. Figure 2-8 presents an MUT intersection in Michigan.

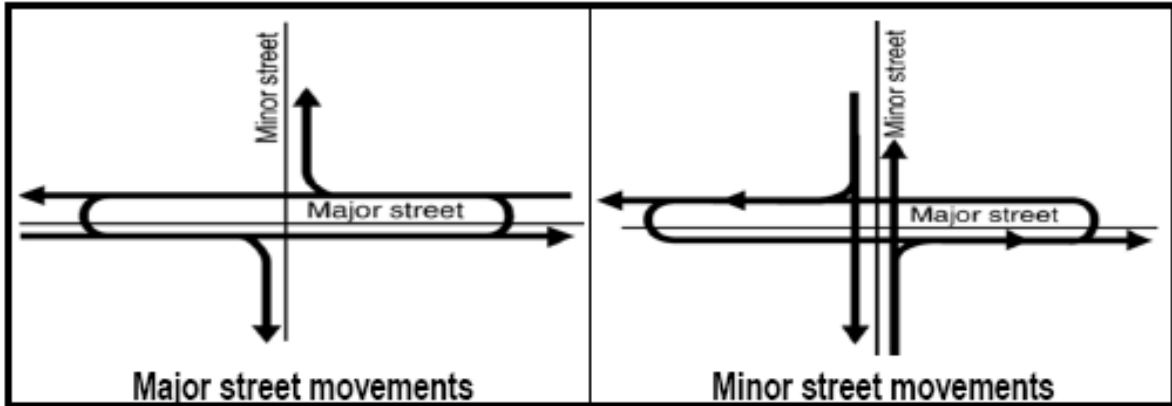


**Figure 2-8: MUT intersection in Michigan (Levinson et al., 2000)**

The MUT intersection involves the elimination of direct left turns from major and/or minor approaches (usually both). Drivers desiring to turn left from the major road onto an intersecting cross street must first travel through the at-grade main intersection and then execute a U-turn at the median opening downstream of the intersection. These drivers then turn right at the cross street. Drivers on the minor street desiring to turn left onto the major road must first turn right at the main intersection, execute a U-turn at the downstream median opening and proceed back through the main intersection. Figure 2-9 provides a schematic sketch of a typical MUT's geometric design, while Figure 2-10 shows the left-turn movements. Elimination of left-turning traffic from the main intersection simplifies the signal operation at the intersection, which accounts for most of the benefits.



**Figure 2-9: Illustration of typical MUT design (Hughes et al., 2010)**



**Figure 2-10: Illustration of MUT left-turn traffic movements (Hughes et al., 2010)**

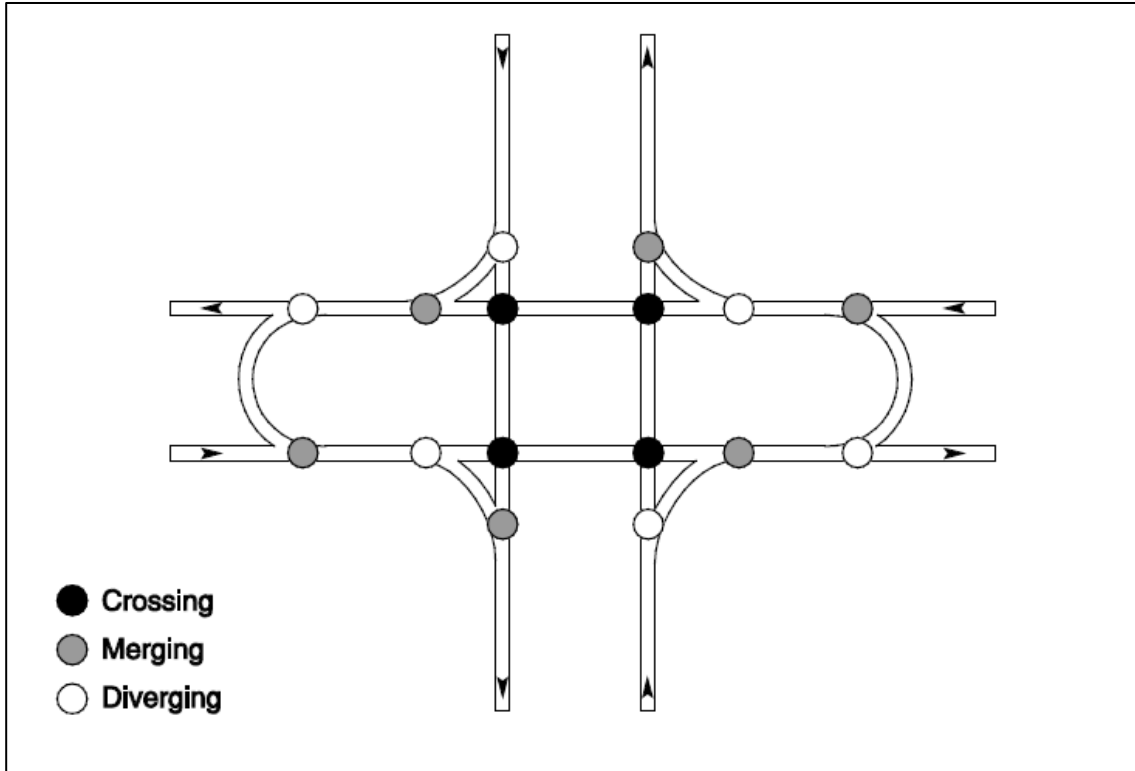
There are several ways to accommodate these MUT intersections if sufficient right-of-way is not available to accommodate a wide median. One method is to provide pavement outside the travel lane to allow the design vehicle to complete the U-turn maneuver and merge back into the traffic stream (Figure 2-11).



**Figure 2-11: MUT intersection with water retention ponds in median in New Orleans, Louisiana (Reid et al., 2014)**

### **Safety Performance**

MUTs have fewer conflict points compared to conventional intersections with dual-left turning lanes (Bared and Kaisar, 2002). The informational guide from FHWA shows the number of conflict points at a four-leg signalized intersection (32 total) as compared to the MUT intersection (16 total). The MUT intersection, compared to a conventional intersection, reduces crossing conflict points by 75% (Figure 2-12 & Table 2-3).



**Figure 2-12: Vehicle-to-vehicle conflict points at MUT intersection (Reid et al., 2014)**

**Table 2-3: Comparison of conflict points: MUT intersection vs. conventional intersection (Reid et al., 2014)**

Type	Conventional 4-leg	MUT
Diverging	8	6
Crossing	16	4
Merging	8	6
Total	32	16

An FHWA report (Reid et al., 2014) indicated the MUT could lead to a 60% reduction in total crash frequencies and a 75% reduction in total injuries. Moreover, reductions of 17%, 96%, and 61% were observed for rear-end crashes, angle crashes, and sideswipe crashes, respectively.

Liu et al. (2008) evaluated the safety effects of the separation distances between driveway exits and downstream U-turn locations. The results showed that the separation distances significantly affected safety performance. A 10 percent increase in separation distance resulted in a 3.3 percent decrease in total crashes and a 4.5 percent decrease in total crashes.

### Crash Modification Factor

A research team from Iran (Azizi and Sheikholeslami, 2012) discovered that there was an increase of approximately 13.22% in crashes after converting conventional signalized intersections to MUT intersections. The result from the study is summarized in Table 2-4.

**Table 2-4: Crash modification factor for MUT**

Crash Type	Severity	CMF	Standard Error	No. of Intersections	Location	Reference
All	All	1.132**	0.06	6	Iran	Azizi and Sheikholeslami, 2013

\*\*Significance level 95%

### Safety Considerations

FHWA’s information guide (Reid et al., 2014) provided safety considerations, which introduced some unique operational qualities, not present in a conventional signalized intersection.

- a. Right-turn / U-turn conflicts
- b. Potential for wrong-way movements
- c. Weaving on the major street
- d. Potential for violating left turn prohibitions
- e. Truck navigation of crossovers
- f. Intersection sight distance



## Operational Characteristics

The combination of reduced clearance intervals, reduced cycle lengths and improved corridor signal progression with MUT intersections enables greater corridor throughput compared to a corridor with conventional signalized intersections. Figure 2-13 illustrates a compilation showing how the MUT intersection design improves performance by a level of service (LOS) grade on average compared to a comparable conventional signalized intersection. The major street through movement receives a greater portion of green time at an MUT intersection than at a conventional intersection. Therefore, the chances of a vehicle arriving during the green phase at an MUT intersection are greater than under a conventional intersection. In general, an MUT corridor provides a wider green band for progression.

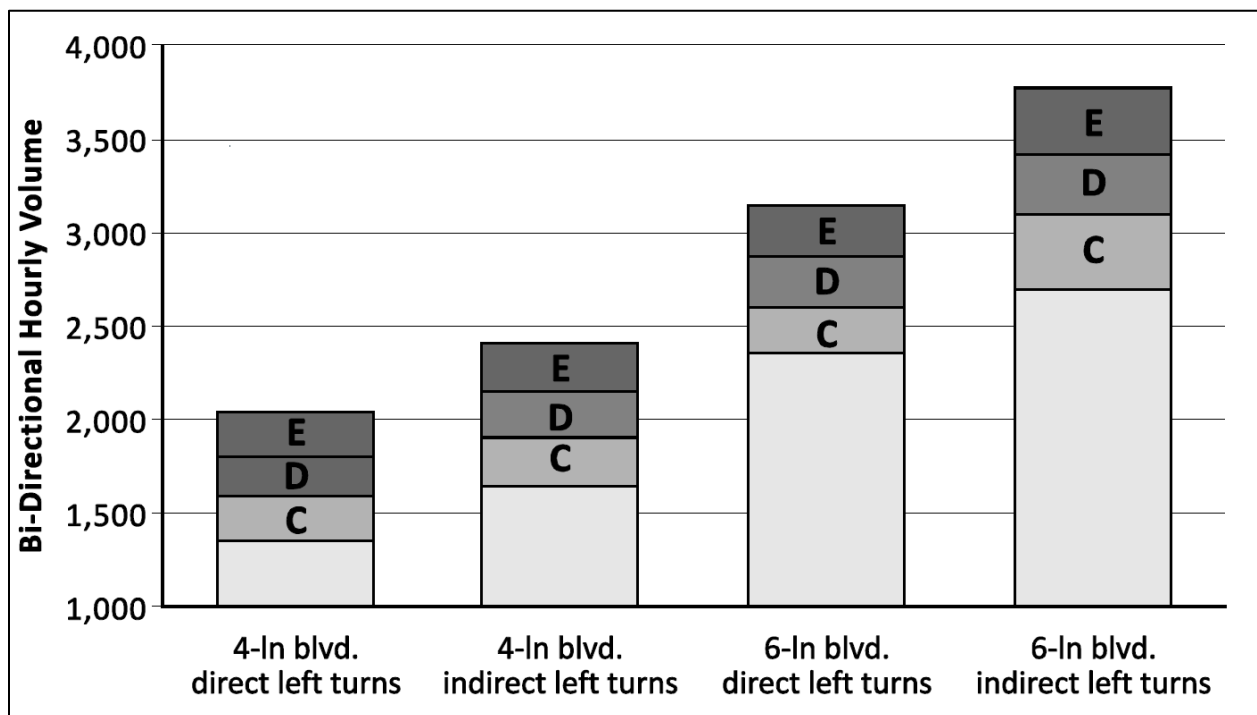


Figure 2-13: Divided highway level of service and throughput comparison (Reid et al., 2014)

Hummer (1998) concluded the advantages and disadvantages when comparing the MUT intersection and the conventional intersection.

#### Advantages

- Through arterial traffic delay is reduced
- Through arterial traffic progression is more efficient
- Through traffic has fewer stops
- Crossing pedestrians encounter fewer conflicts
- Traffic conflict points are reduced

#### Disadvantages

- Left turning traffic delay is increased
- Left turning traffic travel distance is increased
- Left turning traffic stops are increased
- Driver confusion
- Drivers may neglect the prohibition of left turns on the main intersection
- Right of way must be larger along the arterial
- Increase in operational cost due to extra signalization needed
- Cross-street minimum green times may need to be longer

## 2.3. RESTRICTED CROSSING U-TURN INTERSECTION

### Introduction

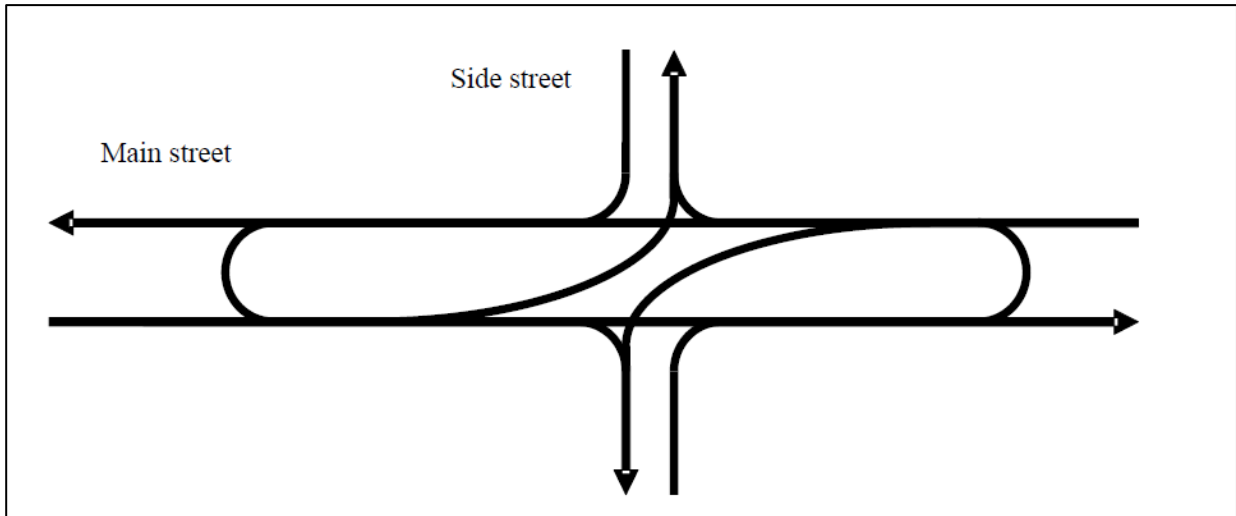
A restricted crossing U-turn (RCUT) intersection is also known as a superstreet or J-turn intersection. A typical RCUT intersection is displayed in Figure 2-14.



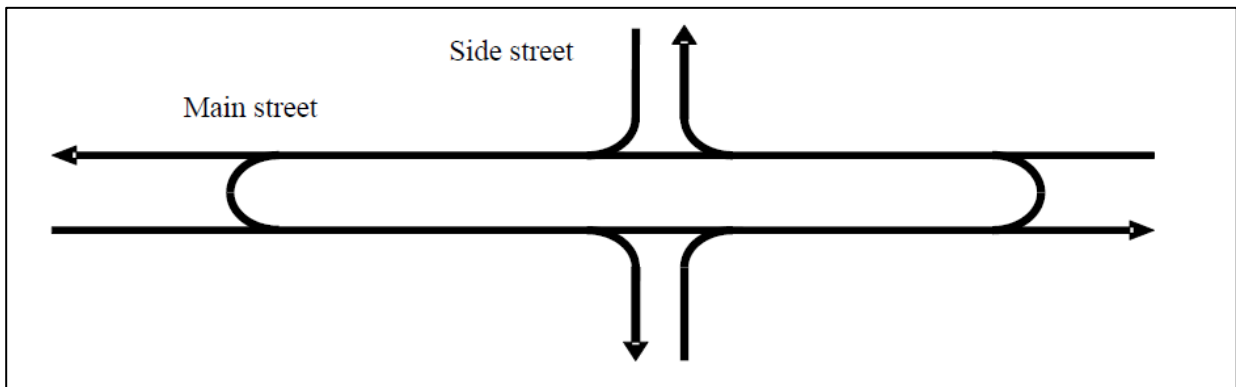
**Figure 2-14: RCUT intersection in Troy, Michigan (Hughes et al., 2010)**

RCUT intersection has been implemented in both the signalized and unsignalized junction designs in North Carolina. In Maryland, such RCUT junctions are unsignalized and are referred to as J-turns. The RCUT intersection is a promising solution for arterials with dominant flows on the major road. It has the potential to discharge vehicles safely and more efficiently than a counterpart signalized at-grade intersection with minimal disruptions to adjacent development. The RCUT intersection operates by redirecting left-turn and through movements from the side street approaches. Instead of allowing those movements to be made directly through the intersection, as in a conventional design, an RCUT intersection accommodates those movements by requiring drivers to turn right onto the main road and then execute a U-turn at a one-way median opening 400 to 1,000 ft downstream.

Figure 2-15 shows an RCUT intersection's configuration with direct left turns from the major road and Figure 2-16 presents an illustration of the basic RCUT intersection (without direct left turns).



**Figure 2-15: RCUT intersection configuration with direct left turns from the major road (Hughes et al., 2010)**

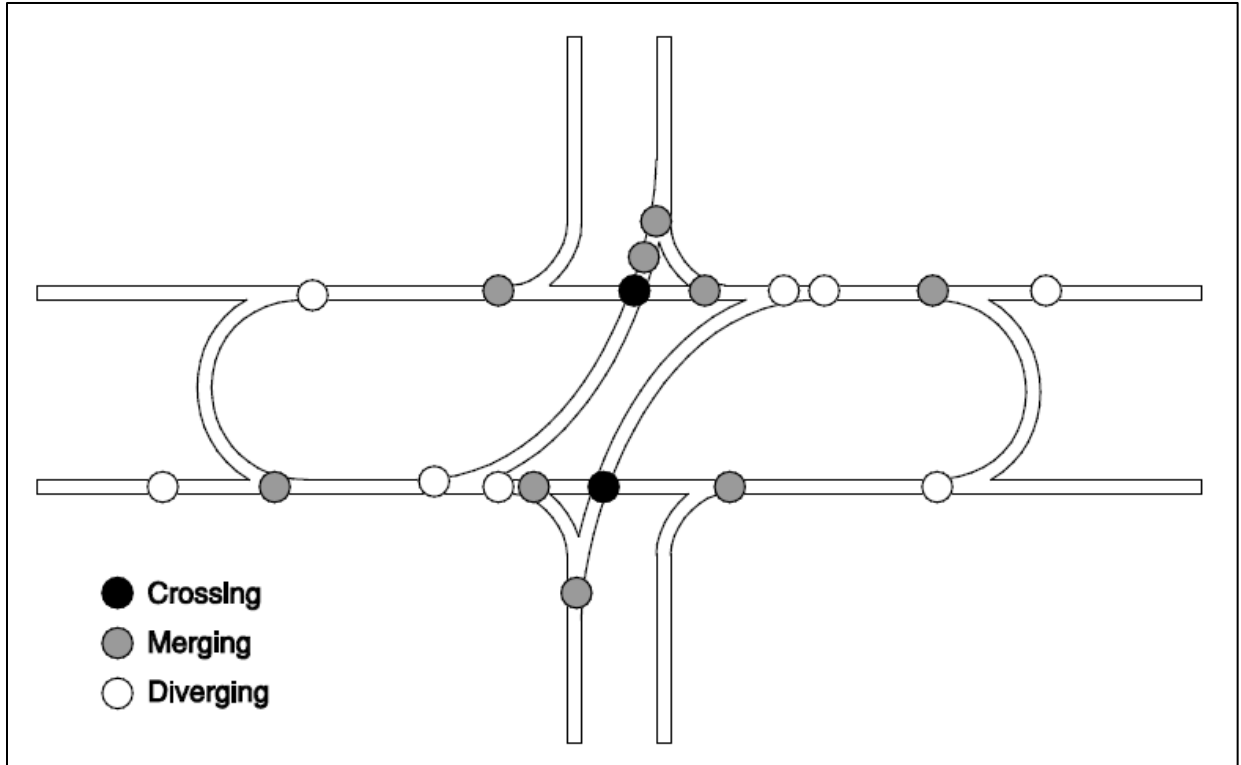


**Figure 2-16: Basic RCUT intersection with no direct left turns (Hughes et al., 2010)**

## **Safety Performance**

According to a FHWA report (Hughes et al., 2010), a four-legged RCUT intersection has 14 conflict points while a conventional intersection has 32 conflict points. In addition to reducing total conflict points, RCUT intersections reduce crossing conflict points. Crossing maneuvers can result in angle crashes, which are generally more severe than other types of crashes.

The information guide from FHWA (Hummer et al., 2014) showed that installing unsignalized RCUT intersections in conditions similar to those of North Carolina, Maryland, and Missouri would likely result in a one-third reduction in total crashes and a one-half reduction in injury crashes. Ott et al. (2012) investigated safety effects of unsignalized superstreets (RCUT) in North Carolina. The results indicated the unsignalized superstreet countermeasure would lead to a significant reduction in total, angle, right turn, and left turn collisions. The summary statistics of the RCUT intersections' study of North Carolina showed that there was a 17-percent decrease in total crashes, a 31 percent decrease in the total crash rate, a 41 percent decrease in fatal-and-injury crashes, and a 51 percent decrease in the fatal injury crash rate (Bared, 2009). Additional information on RCUT intersections is provided in Figure 2-17 and Table 2-5.



**Figure 2-17: Vehicular conflict points at four-approach RCU intersection (Hummer et al., 2014)**

**Table 2-5: Comparison of conflict points: RCUT intersection vs. conventional intersection (Hummer et al., 2014)**

Number of Intersection Legs	Conflict Points	
	Conventional	RCUT
3	9	7
4	32	14

Hochstein et al. (2009) compared the before-and-after crash data of the junction at US-23/74 and SR-1527/1449 that was converted to an RCUT intersection. The results demonstrated there was a 53 percent reduction in total crashes with a 100 percent reduction in right-angle collisions after the RCUT intersection was completed. The researchers also conduct a naïve before-and-after crash data comparison for the junction at US-64 and Mark’s Creek Road that was converted to

an RCUT intersection. Overall, there was a 48 percent reduction in total crashes with reduced crash frequency for all severity levels. Right-angle collisions, which made up 57 percent of the crashes in the before period, were reduced by 92 percent with the complete elimination of far-side right-angle crashes.

Hummer et al. (2010) undertook a naïve and comparison group (CG) analyses of signalized and unsignalized superstreets and an EB method analysis of unsignalized superstreets. They selected 19 intersections in North Carolina for the analysis. The CG results showed that unsignalized superstreets reduced total collisions by 46 percent, fatal-and-injury collisions by 63 percent. Angle and right turn collisions were reduced the most by 75 percent. The naïve EB results for unsignalized superstreets as a group indicated that the superstreet significantly reduced total crashes by 27 percent and fatal and injury crashes by over 50 percent. Unsignalized superstreets had a tremendous impact on turning collisions with a reduction of 86 percent on angle and right turn crashes. Left turn crashes diminished by 76 percent.

Inman and Haas (2012) conducted a before-and-after crash analysis for 8 intersections converted from conventional signalized intersections to RCUT intersections on two Maryland highway corridors. The results indicated the number of crashes cumulatively decreased by about 44 percent after the treatment. Moreover, there was a 70 percent reduction in fatal crashes and a 42 percent reduction in injury crashes between the analysis periods, which was 3 years.

Edara et al. (2013) used simple comparison and the EB method to compare before and after crash frequency and severity of five treatment intersections in Missouri. As per the analysis results of the simple comparison, the total number of crashes reduced was 51 percent, and disabling injury crashes reduced by 86 percent. Regarding the results of the EB method, the J-

turn countermeasure reduced total crash frequency by 53.7, and it was statistically significant at the 95 percent confidence level.

### **Safety Considerations**

The RCUT design was found to be more efficient than that of a conventional signalized intersection, primarily for the one U-turn lane design and the RCUT intersection's ability to accommodate high volumes (Kim et al., 2006b). According to the findings of a study in Michigan, during peak conditions, travel time on the corridor with RCUT crossovers decreased 10 percent (Reid and Hummer, 2001). Furthermore, Hummer et al. (2014) summarized the operational advantages and disadvantages of the RCUT intersection design as follows.

Advantages:

- Creates the possibility for the largest possible progression bands in both directions of the arterial at any speed with any signal spacing
- Provides potential to reduce overall travel time at signalized sites
- Provides potential to reduce delay and travel time for arterial through traffic at signalized sites
- Provides potential for shorter signal cycle lengths
- Allows larger portion of signal cycle to be allocated to the arterial through movement
- Reduces the need for signalization of intersections along rural high-speed divided highways

Disadvantages:



- Increases travel distance (and potentially travel time) for minor street left turn and through movements
- Experiences a high demand
- Creates potential for spillback out of crossover storage lane
- Minor street left turn and through drivers must make unusual maneuvers and may need additional guidance

## 2.4. DIVERGING DIAMOND INTERCHANGE

### Introduction

A diverging diamond interchange (DDI) is also called a double crossover diamond (DCD) interchange. The DDI is a new interchange design that is slowly gaining recognition as a viable interchange form that can improve traffic flow and reduce congestion. Similar to the design of a conventional diamond interchange, the DDI differs in the way that the left and through movements navigate between the ramp terminals. The purpose of this interchange design is to accommodate left-turning movements onto arterials and limited-access highways while eliminating the need for a left-turn bay and a signal phase at the signalized ramp terminals. Figure 2-18 shows the typical movements that are accommodated in a DDI. The highway is connected to the arterial cross street by two on-ramps and two off-ramps in a manner similar to that of a conventional diamond interchange. However, on the cross street, the traffic moves to the left side of the roadway between the ramp terminals. This allows the vehicle drivers on the cross street who need to turn left onto the ramps to continue to the on-ramps without conflicting with the opposing through traffic. Recently, the first DDI of Florida has been operational on I-75 in Sarasota (Figure 2-19).

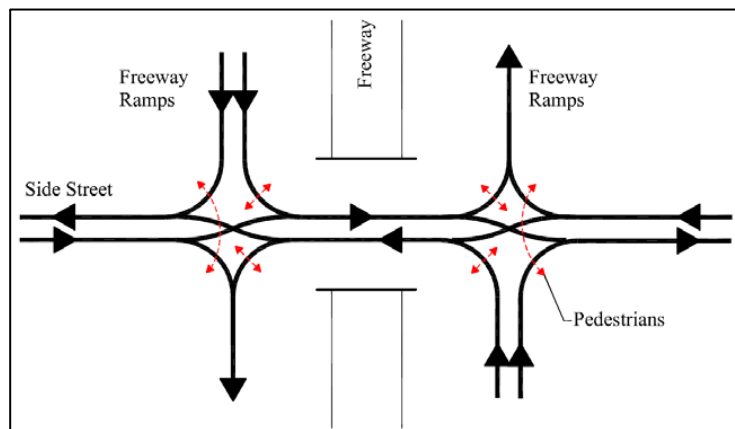


Figure 2-18: Typical DDI configuration (Hughes et al., 2010)

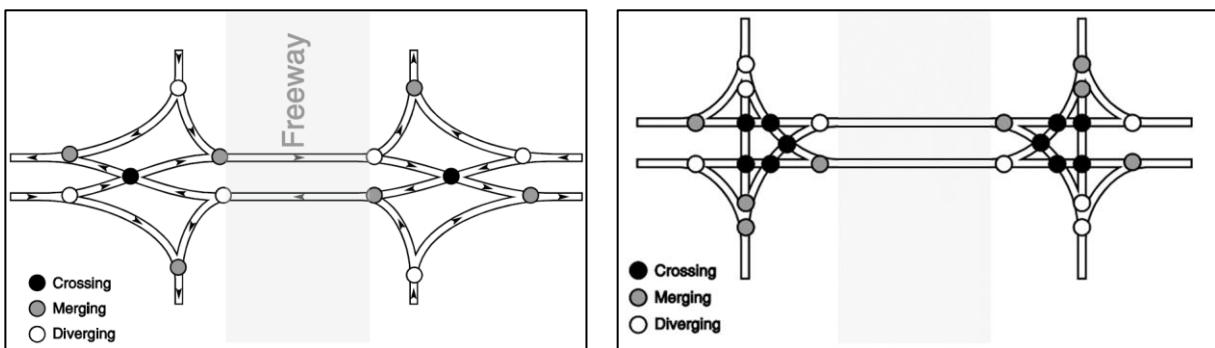


**Figure 2-19: DDI in Sarasota (Courtesy of Mr. Kevin Ingle)**

## Safety Performance

The information guide from FHWA (Schroeder et al., 2014) compared the count of conflict points of the DDI and the conventional diamond interchange. The conventional diamond interchange has 26 conflict points, while the DDI has only 14. The DDI offers a safety benefit due to reduced conflicts especially crossing conflicts.

One of the common concern is wrong-way driving. Vaughan et al. (2015) monitored five DDIs for 6 months using video camera footage data. The analysis showed that wrong-way maneuvers tended to occur more often when vehicles were first entering the DDI. Wrong-way maneuvers were found to occur more frequently at night than during the day. However, no crashes could be identified from safety data that were associated with these wrong-way driving events. DDIs have generally proved to be safe and efficient movers of traffic when designed appropriately. Safety information on the DDI is presented in Figure 2-20 and Table 2-6.



**Figure 2-20: Comparison of conflict points at DDI (left) and conventional diamond interchange (Schroeder et al., 2014)**

**Table 2-6: Comparison of conflict points by interchange type (Schroeder et al., 2014)**

<b>Type</b>	<b>Crossing</b>	<b>Merging</b>	<b>Diverging</b>	<b>Total</b>
Conventional diamond	10	8	8	26
Diverging diamond	2	6	6	14

### **Crash Modification Factors**

Hummer et al. (2016) estimated a CMF for six interchanges in Missouri, Kentucky, New York, and Tennessee based using the before-and-after with comparison group method. The results showed that total crashes reduced, and the CMF was computed as 0.67. The reduction in injury crashes was even larger, and the CMF was 0.59.

Claros et al. (2015) estimated a CMF for 10 operational DDI's in Missouri using naïve, EB, and comparison group (CG) methods. The highest crash reduction was observed for fatal and injury crashes. Total crashes and injury crashes reduced considerably as well. Claros et al. (2015) found that the DDI ramp terminals were safer than those of the conventional diamond signalized terminals. CMFs of 0.45 for fatal and injury crashes, 0.686 for no injury crashes, and 0.625 for total crashes were obtained.

Claros et al. (2016) estimated a CMF for 20 ramp terminals of DDI's in Missouri using the CG and the EB methods. The fatal and injury crashes were reduced by 73.3 percent as computed using the CG method. The EB method's results indicate that such crashes diminished by 63.4 percent. No injury crashes were reduced by 21.0 percent and 51.2 percent as calculated by the CG and EB methods respectively. The total crash frequency also decreased by 42.7 percent and 54.0 percent as computed via the CG method and the EB method respectively.

Claros et al. (2017a) used the EB method to estimate the safety effect of the DDI on adjacent facilities. For signalized intersections near DDI ramp terminals, the EB analysis showed a 6.5

percent decrease in fatalities and injuries, 19.5 percent increase in no injury crashes and a 12 percent increase in total crashes. Summaries of CMFs by study are listed in Table 2-7.

More recently, Nye et al. (2019) evaluated the safety performance of DDI based on 26 DDIs in 11 states by using the observational before-and-after with comparison group method. They recommended CMF values for the total, angle, and rear-end crashes of 0.633, 0.441, 0.549, respectively. They also found that fatal-and-injury crashes were reduced by 54%. However, they provided statistical significance measures for the total crashes only.

**Table 2-7: Summary of CMFs for DDI**

Crash Type	Severity	CMF	Standard Error	Number of intersections	Location	Reference
All	All	0.67(CG)***	0.04(CG)	6	MO, TN, KY, NY	Hummer et al., 2016
All	KABC	0.59(CG)***	0.07(CG)	7	MO, TN, KY, NY	
All	All	0.521(CG)*** 0.592(EB)***	0.027(CG) 0.029(EB)	6	MO	Claros et al., 2015
All	KABC	0.407(CG)*** 0.374(EB)***	0.048(CG) 0.041(EB)	6	MO	
All	O	0.552(CG)*** 0.649(EB)***	0.034(CG) 0.037(EB)	6	MO	
All	All	0.573(CG)*** 0.46(EB)***	0.036(CG) 0.027(EB)	10	MO	Claros et al., 2016
All	KABC	0.267(CG)*** 0.366(EB)***	0.036(CG) 0.047(EB)	10	MO	
All	O	0.79(CG)*** 0.488(EB)***	0.056(CG) 0.033(EB)	10	MO	
All	All	0.625(EB)***	0.037(EB)	12	MO	Claros et al., 2017b
All	KABC	0.45(EB)***	0.059(EB)	12	MO	
All	O	0.686(EB)***	0.047(EB)	12	MO	
All	All	0.633(CG)***	0.041	26	GA, ID, KS, KY, MN, MO, NC, NY, UT, VA, WY	(Nye et al., 2019)
Angle	All	0.441(CG) <sup>1</sup>	--	26		
Rear-end	All	0.549(CG) <sup>1</sup>	--	26		
All	FI	0.461(CG) <sup>1</sup>	--	26		

\*\*Significance level 95%

\*\*\*Significance level 99%

-- = the standard error is not provided

<sup>1</sup> Statistical Significance is not specified

Note: EB = empirical Bayes, CG = comparison group.

Severity levels: K (fatal injury), A (incapacitating injury), B (non-incapacitating injury), C (possible injury), O (no injury); combinations of designations denote crashes from multiple severity levels

### **Safety Considerations**

The FHWA informational Guide (Schroeder et al., 2014) provided some safety concerns. The most common ones perceived by transportation professionals are associated with exit ramp movements, heavy vehicles, bicyclists, pedestrians, and emergency vehicles.

- a. Right Turn at Exit Ramp
- b. Left Turn at Exit Ramp
- c. Heavy Vehicles
- d. Wrong-way Maneuvers
- e. Pedestrians
- f. Bicyclists

### **Operational Characteristics**

Abou-Senna et al. (2015) summarized the operational advantages and disadvantages of the DDI.

#### Advantages

- Fewer signal phases
- Fewer conflict points
- Left turns without crossing over roads
- Capability of combining lane assignments without changing the signal's phase
- Efficient when there are heavy left and/or right turns

#### Disadvantages

- Driver confusion especially in the presence of inadequate signage
- Poor performance when ramp volumes exceed mainline through volumes
- Extra cost for rights of ways: Widened median to avoid confusion, wider bridges, ramp bends
- Concerns with driveway access for residents and businesses near the interchange



## 2.5. CONTINUOUS GREEN T-INTERSECTIONS

### Introduction

A continuous green T-intersection (CGT) is also known as a seagull intersection, or turbo T-intersection. The basic difference between a continuous green T-intersection and a normal signalized T-intersection is the channelized left-turn movement from the stem of the minor street to the mainline, which enables the mainline through movement to be executed at the same time (Figure 2-21). The signal system at a continuous green T-intersection operates with three signal phases. The through movement in one direction can flow continuously. Figure 2-22 presents an aerial illustration of a CGT intersection in Charlotte, North Carolina.

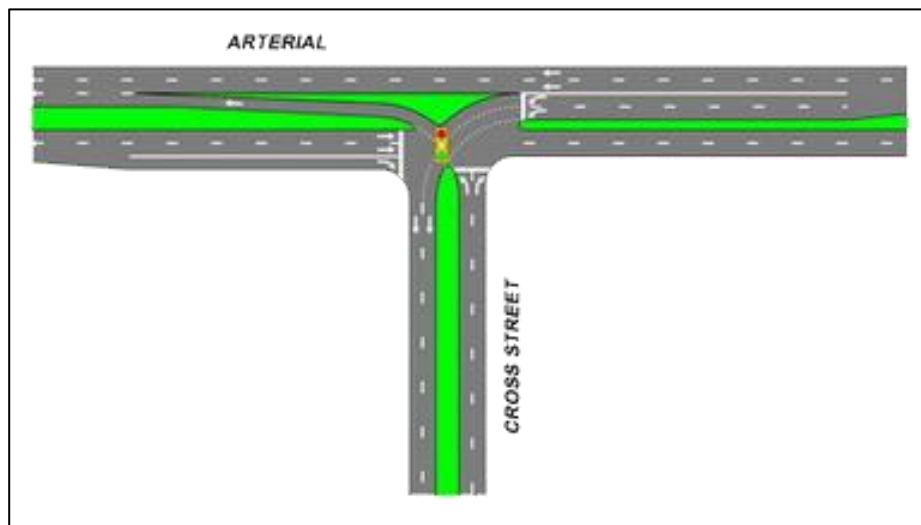


Figure 2-21: Typical geometry of CGT (Hughes et al., 2010)



**Figure 2-22: Example of a CGT in Charlotte, North Carolina (Hughes et al., 2010)**

**Safety Performance**

A technical report from FHWA (Hughes et al., 2010) summarized the crash reduction after converting three-leg intersections to CGT intersections in Colorado. The results indicated that the total crashes, injury crashes and angle crashes decreased significantly after the conversion.

Sando et al. (2012) examined safety characteristics of CGT intersections using paired-t tests and an ordered probit model. The authors summarized the characteristics of three common types of crashes that occur at CGT intersections: sideswipe crashes, angle crashes and rear-end crashes.

Angle crashes and crashes involving lane changing maneuvers were significantly more severe compared to rear-end crashes.

**Crash Modification Factors**

Wood and Donnell (2016) estimated the CMF for 46 CGT intersections in Florida and South Carolina. The expected total (CMF = 0.958), fatal-and-injury (CMF = 0.846), and target (rear-end, angle, and sideswipe; CMF=0.920) crash frequencies were lower at CGT intersections relative to the conventional signalized intersections. Nevertheless, the estimated CMFs are quite close to one and not statistically significant from the safety performance functions. Table 2-8 illustrates CMF results of previous studies about CGT intersections.

**Table 2-8: Summary of CMFs for CGTs**

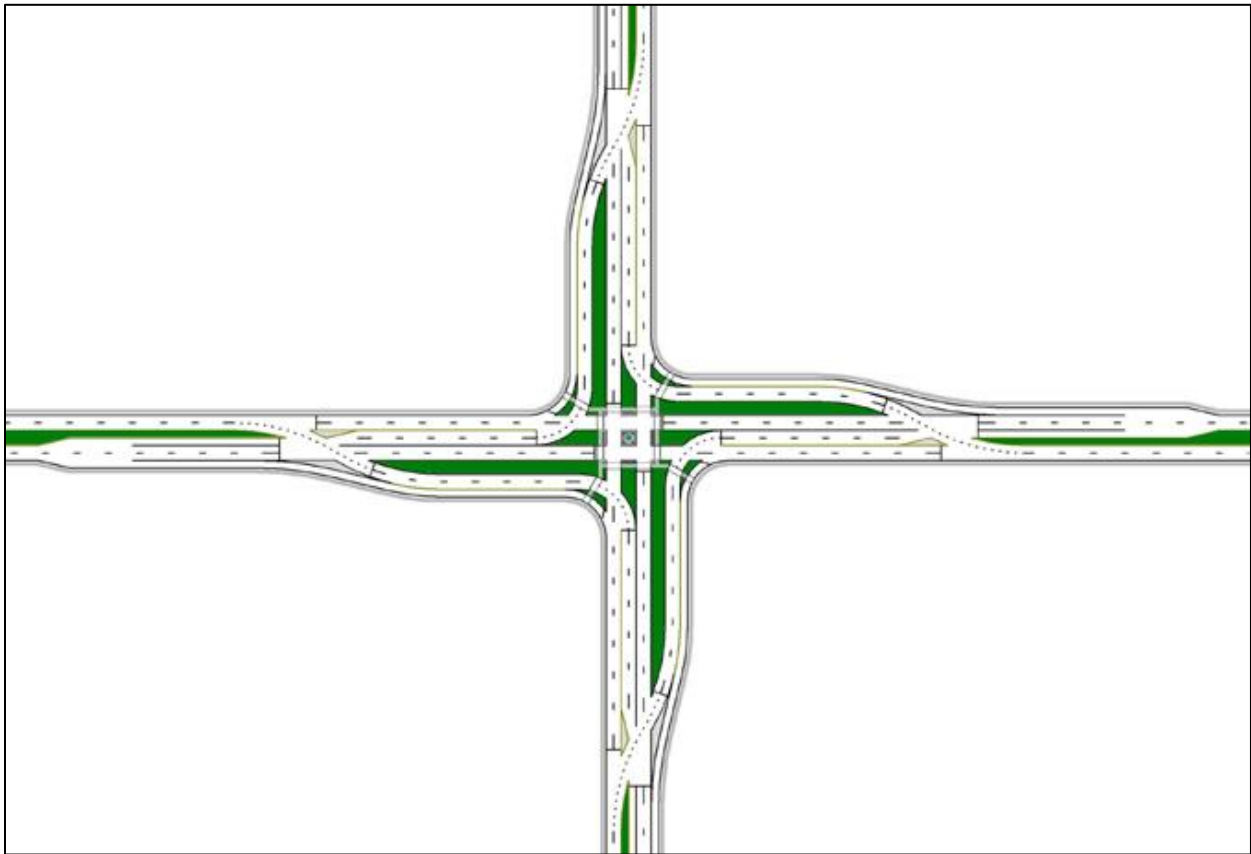
Crash Type	Severity	CMF	Standard Error	No. of Intersections	Location	Reference
All	All	0.958	N/A <sup>#</sup>	46	FL&SC	Wood and Donnell, 2016
All	KABC	0.846	N/A <sup>#</sup>	46	FL&SC	
Angle, Rear-end, Sideswipe	All	0.92	N/A <sup>#</sup>	46	FL&SC	

<sup>#</sup>: Not available because a cross-sectional method was used.

## 2.6. PARALLEL FLOW INTERSECTION

### Introduction

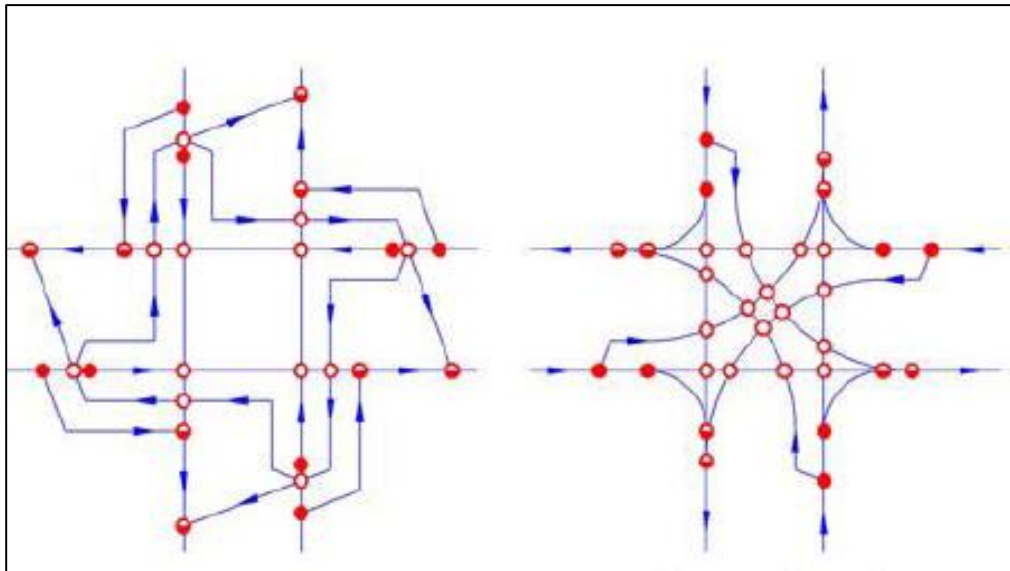
A parallel flow intersection (PFI) is a variant of the CFI. It is also called a paraflow intersection. Figure 2-23 illustrates a typical PFI (Parsons, 2007). The left-turning traffic crosses over opposing through lanes and travels on bypass lanes. The bypass roadway is located parallel to the cross street and merges to the main road at the crossover or bypass. After the left-turn traffic accomplishes the left-turn movement at the main intersection, it merges to the main traffic on the receiving lanes with the help of bypass lanes and the crossover on the receiving approach.



**Figure 2-23: Example of typical geometry of a parallel flow intersection (Parsons, 2007)**

### Safety Performance

PFI have four fewer conflict points than the conventional signalized intersection as in Figure 2-24 and Table 2-9 (Parsons, 2007). Without left-turns at the major intersection, the PFI can make pedestrian and bicycle movements even safer, theoretically.



**Figure 2-24: Conflict points of parallel flow intersection (left) and conventional intersection (right) (Parsons, 2007)**

**Table 2-9: Comparison of conflict points: PFI vs. conventional intersections (Parsons, 2007)**

Type	PFI	Conventional
Diverging	8	8
Crossing	12	16
Merging	8	8
Total	28	32

### **Operational Characteristics**

Parsons's study (2007) showed that the PFI is efficient compared to other intersection types based on capacity analyses. This feature presents the results of one such analysis expressed in terms of LOS and average vehicle delay for an intersection with a total approach volume of 6,375 vph and 30 percent left-turn volume. The intersection analyzed had four approaches with two through lanes on each approach and 55-percent directional volume distribution on the major road.

## **2.7. JUGHANDLE INTERSECTIONS**

### **Introduction**

A jughandle intersection is defined by the NJDOT Roadway Design Manual (NJDOT, 2016 ) as an at-grade ramp provided at or between intersections to permit motorists to make indirect left turns and/or U-turns. There are three different types of jughandle intersections by jughandle ramp type. The first type is “forward ramp”. With forward ramps, both left and right turning traffic exit onto a jughandle ramp to the right, upstream of the intersection. Drives making a U-turn should exit on to the ramp and turn left from the cross street. The second ramp type is “reverse ramp”. With reverse ramps, left-turning vehicles use the rightmost lane downstream of the intersection into a loop ramp. Three types of jughandle intersections are shown in Figure 2-25. In this project, we call them Types 1, 2, and 3 (from top to bottom). Jughandle Type 1 is with forward/forward ramps, Type 2 is with reverse/reverse ramps, and Type 3 is reverse/forward ramps.

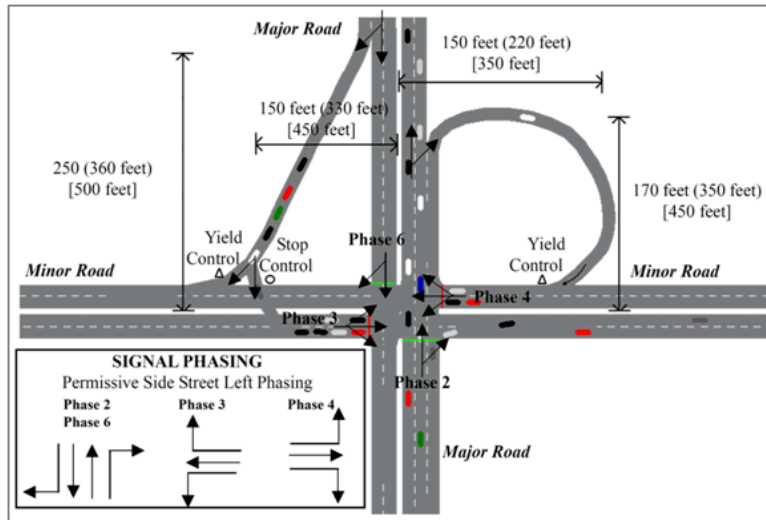
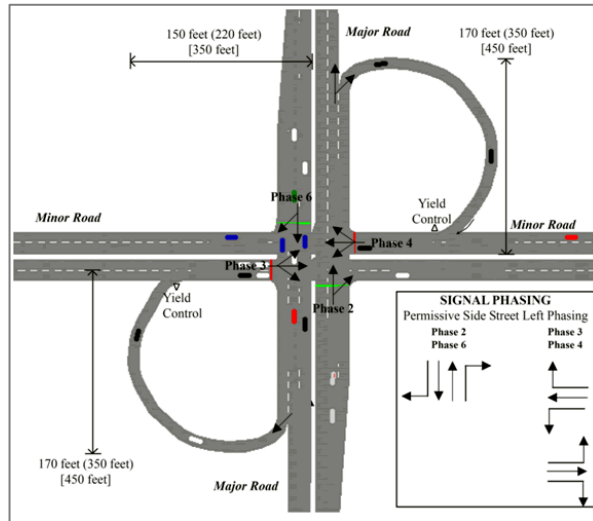
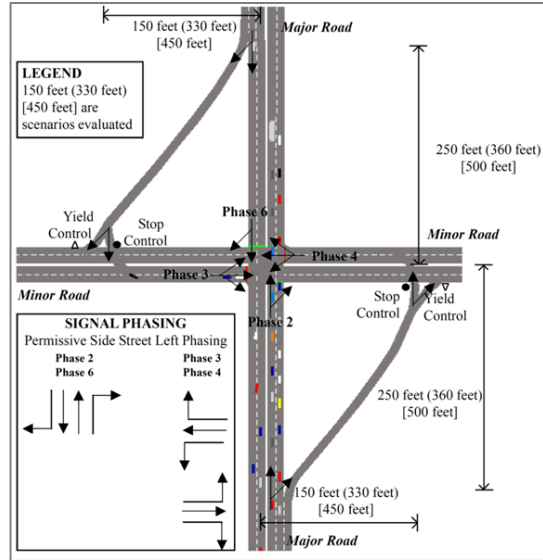


Figure 2-25: Jughandle intersections: Types 1, 2, and 3 (from top to bottom)



## **Safety Performance**

Compared to conventional intersections, jughandle intersections have less conflict points (Smith, 2013). According to a study involving a comparative analysis between jughandle and conventional intersections, jughandles had lower rates of head-on crashes. Also, more jughandle intersection crashes were rear-end or property-damage-only than left-turn crashes (Jagannathan, 2006).

## **Operational Characteristics**

The advantages and disadvantages of the jughandle intersection are listed as follows.

### Advantages

- Reduces left turn crashes
- Reduces travel time and stops

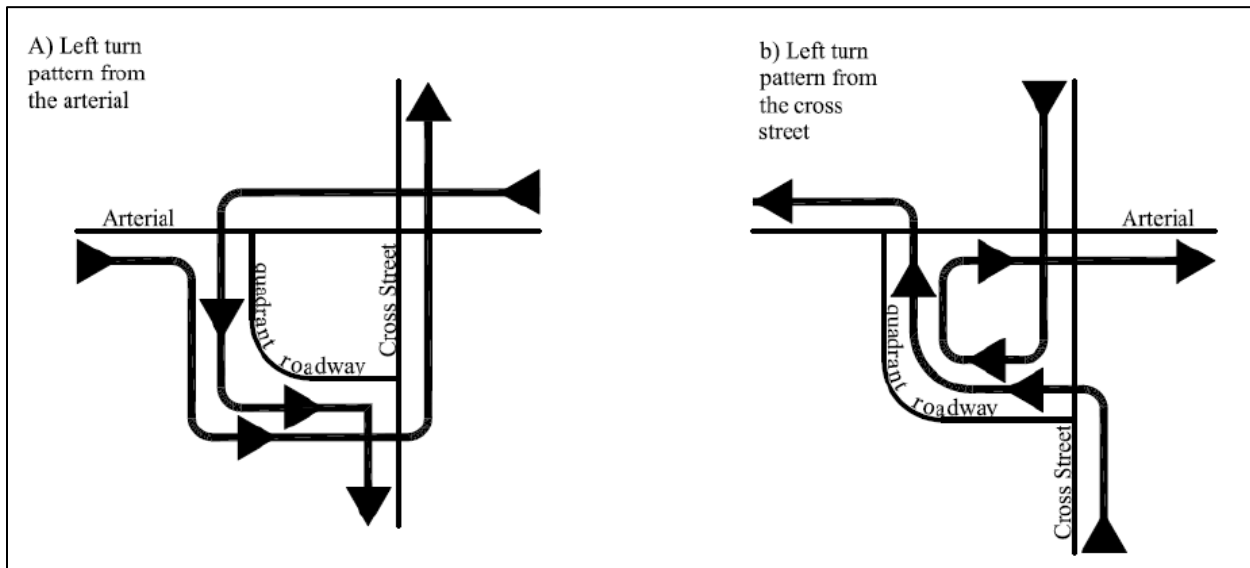
### Disadvantages

- Left -turning vehicles have more stops and longer travel time
- Additional right of way may be required
- Transit stops are required to be relocated outside the influence area of the intersection
- Increases exposure for pedestrians crossing the ramp terminal.

## 2.8. QUADRANT ROADWAY

### Introduction

A quadrant roadway (QR) intersection is a promising design for an intersection of two busy suburban or urban roadways. The primary objective of a QR intersection is to reduce delay at a severely congested intersection and to reduce overall travel time by removing left-turn movements. A QR intersection can provide other benefits as well, including enhanced pedestrian safety. A QR intersection can be among the least costly of the alternative intersections to construct and maintain. Figure 2-26 shows the connector road and how all four of the left-turning movements are re-routed to use it. Left turns from all approaches are prohibited at the main intersection, which consequently allows a simple two-phase signal operation at the main intersection. Each terminus of the connector road is typically signalized. These two secondary signalized intersections usually require three phases.



**Figure 2-26: Illustration of left-turn movements at a QR intersection (Hughes et al., 2010)**

Examples of QR intersections are shown in Figures 2-27 and 2-28.



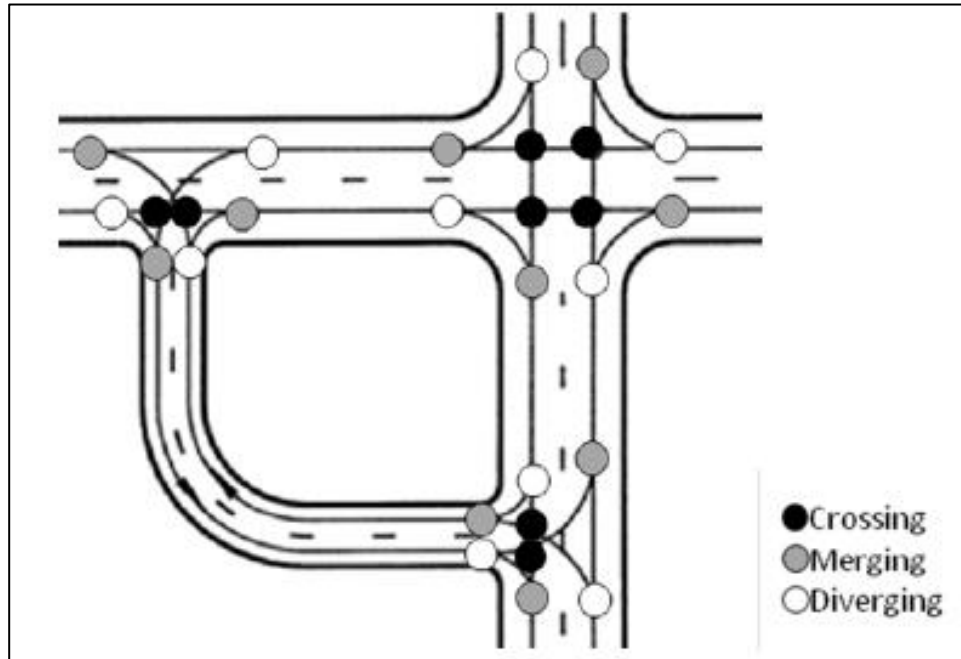
**Figure 2-27: QR intersection in Fairfield, Ohio**



**Figure 2-28: QR intersection in Bend, Oregon (Hughes et al., 2010)**

**Safety Performance**

A QR has 28 conflict points, which is four less compared to those of a conventional intersection (Figure 2-29).



**Figure 2-29: Vehicle-to-vehicle conflict points at a QR intersection (Hughes et al., 2010)**

### **Operational Characteristics**

Abou-Senna et al. (2015) inferred advantages and disadvantages of the QR when compared to the conventional intersection. They are listed as follows:

Advantages:

- Ease of progression in the main intersection because of the two phase signal
- reduces total system delay
- Shortens queues
- fewer conflict points
- Possibly reduces head on collision as a result of left turns

- reduces vehicle clearance and pedestrian crossing times due to narrower intersection widths
- Connector roads can accommodate up to 5-lanes

Disadvantages:

- Increases left turn travel distance
- Possibly increases left turn stops and travel time
- Driver confusion
- Unacceptance of the new alternative and left turn options
- Additional signalization
- Extra right of way requirements
- Access to local parcels is affected by the location and design of the connector
- U-turns are prohibited at the main intersection

There are two other drawbacks of the QR intersection.

- 1) It is costly because of the extra of right-of-way and the additional signals
- 2) Signal timing complexity for the signals at the multiple quadrants.

## 2.9. HAMBURGER INTERSECTION

A hamburger intersection or through-about intersection design is a variant of the signalized roundabout. The primary difference is that the mainline through movements are permitted in the intersection. The through and left-turn movements from the minor street are executed by following the circulatory movement around the semicircular islands at the main intersection. This type of configuration allows the main intersection to operate on a two-phase signal. The typical configuration is shown in Figure 2-30 and a photograph of a hamburger intersection in Virginia is shown in Figure 2-31.



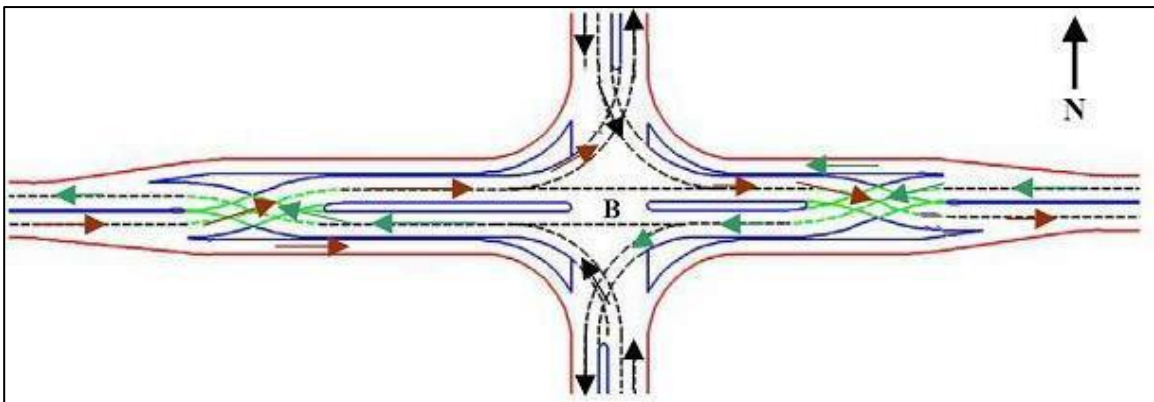
**Figure 2-30: Typical hamburger intersection movements (Hughes et al., 2010)**



**Figure 2-31: Hamburger intersection in Fairfax, Virginia (Hughes et al., 2010)**

## 2.10. SYNCHRONIZED SPLIT-PHASING INTERSECTION

Figure 2-32 shows vehicular movements in a synchronized split-phasing intersection, also known as a double crossover intersection (Chlewicki, 2003). In this design, the through and left-turn movements on the mainline cross over before the main intersection. This helps disperse the turning traffic before the main intersection. At the main intersection, the through and the opposing left turning movements can proceed concurrently during the same signal phase.



**Figure 2-32: Typical synchronized split-phase intersection movements (Hughes et al., 2010)**

## 2.11. SUMMARY

From the literature review, we can conclude that almost all the alternative intersection designs would reduce the traffic conflicts. In addition, based on the CMF related research studies, we can conclude that most of the alternative intersection designs would improve safety, especially by reducing severe crashes.

### **3. LITERATURE REVIEW OF REAR-END CRASHES AT INTERSECTIONS**

#### **3.1. REAR-END CRASH CHARACTERISTICS**

There have been many studies analyzing rear-end crashes at intersections because they are the most common crash type. Abdel-Aty et al. (2005) employed the regression tree methodology to analyze the types of crashes at signalized intersections. Their results showed that factors contributing to injuries in rear-end, right-turn, and sideswipe crashes are generally the same as those that contribute to crashes involving possible or no injury. In addition, the number of exclusive left-turn lanes on the major road was also the most important factor for rear-end crashes. Yan et al. (2005) applied the quasi-induced exposure concept and the multiple logistic regression modeling framework to investigate intersection crash propensity. The analysis results indicated that the risk of rear-end crashes for 6-lane highways is greater than that of 2-lane and 4-lane highways. Rear-end crashes were more likely to occur at divided highways than at undivided highways. It was also found that crashes were less likely to occur during nighttime conditions than during daytime conditions. In addition, compared to a dry road surface, wet and slippery road surfaces could greatly contribute to rear-end crashes. Inferences were also made on the drivers in rear-end crashes. Rear-ended drivers were more likely to be middle-aged females while rear-end crashes with a relatively larger accident propensity tended to be young (< 26 years old) or old (> 75 years old) males. Das and Abdel-Aty (2010) applied linear genetic programming (LGP) to explore the relationship between injury-related crashes and geometric and environmental factors. According to the findings, rear-end crashes at intersections were more likely to be injury crashes as well as those at paved and curbed median segments of the roadways.



Yan and Radwan (2006) used the classification tree method and the quasi-induced exposure concept to perform the statistical analysis based on 2001 Florida intersection crash data. The results showed that the rear-end crashes were over-represented in high posted speed limit locations (45–55 mph). The rear-end crash propensity at daytime was apparently larger than that at nighttime. In addition, the reduction of braking capacity due to wet and slippery road surface conditions would have contributed to rear-end crashes, especially at intersections with high posted speed limits. The authors recommended that at signalized intersections with high speed limits, reducing the speed limit to 40 mph would efficiently contribute to a lower crash rate.

Harb et al. (2007) investigated the contribution of light truck vehicles (LTVs) to rear-end collisions resulting from horizontal visibility using driving simulator experiments. According to the findings, LTVs contributed to more rear-end collisions at unsignalized intersections due to horizontal visibility blockage and drivers' behavior when driving behind an LTV.

Retting et al. (2003) investigated crashes at stop sign-controlled intersections during 1996–2000 in four U.S. cities. They found among crashes not involving stop violations, rear-end crashes were most common, accounting for about 12% of all crashes.

Poch and Mannering (1996) estimated a negative binomial regression model to examine the frequency of rear-end crashes at intersection approaches. They found that the approach right-turn volume, 2-phase signal, 8-phase signal, approach posted speed limit and greater than 3% grade, uphill and downhill, variables increased rear-end crashes.

Kim et al. (2006a) employed Poisson and negative binominal models to predict motor vehicle crashes in Georgia. Average annual daily traffic, the presence of turning lanes, and the number of driveways increased the crash risk of multiple types of crashes, whereas median widths and the presence of lighting had the

opposite effect on crash risk. Wang and Abdel-Aty (2006) implemented generalized estimating equations with the negative binomial link function to model rear-end crash frequencies at signalized intersections to account for the temporal or spatial autocorrelation. The results showed that intersections with heavier traffic, more right-turn and left-turn lanes on the major roadway, a larger number of phases per cycle, higher posted speed limits on the major roadway, and higher population areas had a propensity of experiencing more frequent rear-end crashes. On the other hand, intersections with three legs, channelized or exclusive right-turn lanes on the minor roadway, protected left-turning on the major roadway, medians on the minor roadway and longer signal spacing had lower counts of rear-end crashes.

Ni and Li (2014) applied a microscopic modeling approach to estimate the rear-end crash probability for signalized intersections with and without green signal countdown devices (GSCDs). It was found that GSCDs increased the crash risk during the flashing green interval. In addition, GSCDs were effective in reducing rear-end crashes during the yellow interval. Similarly, Chiou and Chang (2010) also found GSCD will create a potential risk of rear-end crashes. Montella (2011) investigated the crash contributing factors in 15 urban roundabouts located in Italy and examined the interdependences between these factors. The results demonstrated that the radius of deflection of the entering approach was associated with rear-end crashes at roundabout entry points.

### **3.2. EFFECTS OF SIGNALIZATION ON REAR-END CRASHES**

Pernia et al. (2002) evaluated the impacts of signalization on crashes at newly constructed signalized intersections in Florida based on a before and after analysis. The crash data were collected within a ten-year period from 1989 to 1998. The results showed that rear-end crashes increased by 48 percent. McGee (2003) investigated the safety effect after installation of a traffic signal on four-leg urban intersections. Rear-end crashes rose by 38 percent. Davis and Aul (2007) estimated CMFs associated with different left-turn phasing schemes at intersections where the major approach's posted speed limit exceeded 40 mph. For installation of signals at junctions that were previously unsignalized, rear-end crashes increased by 143 percent, while right-angle crashes decreased. Harkey et al. (2008) undertook a study to examine the safety impacts of converting rural intersections from stop-controlled operation to signal controlled operation. The crash data were collected from California, Minnesota and Iowa. Rear-end crash increased by 58 percent after installation of the traffic signals as per the study's findings.

Jensen (2010) conducted a before-and-after crash and injury study of 54 intersections in Copenhagen, Denmark. The author discovered that signalization increased rear-end crashes by 37 percent. Srinivasan et al. (2014) conducted a before-and-after study using the EB method to determine the safety effect of signalization with and without left-turn lanes using data about 117 intersections demarcating two lane roads in rural and suburban areas in North Carolina. The research team found that rear-end crashes increased by 42.7 percent after signalization without addition of left turn lanes. However, if the traffic signals were installed with the addition of at least one left turn lane rear-end crashes would've decrease by 28.9 percent. Abdel-Aty et al. (2014) estimated CMFs for signalization of stop-controlled intersections in Florida. The results

indicated that rear-end crashes at rural and urban three-leg intersections rose by 95 percent and 126 percent, respectively, while rear end crashes at four-leg urban intersections reduced by 29 percent after signalization. Wang et al. (2015) estimated CMFs for converting a stop-controlled intersection to a signalized intersection in Florida. As per the results, rear-end crashes increased by 58 percent during a 29-month period after signalization.

### **3.3. PROHIBITION OF RIGHT-TURN-ON-RED ON REAR-END CRASHES**

According to the FHWA (Hummer et al., 2014), prohibiting right-turn-on-red can reduce rear-end crashes by 20%. It is important to provide safe and appropriate alternative locations to make the right-turn in close locations near the intersection where the prohibition is applied.

### **3.4. EFFECTS OF RED LIGHT RUNNING CAMERAS ON REAR-END CRASHES**

Based on the Highway Safety Manual (AASHTO, 2010), the installation of red light running cameras (RLRCs) contributed to the rise of rear-end crashes by 18 percent. Ross and Sperley (2011) discovered that RLRCs were likely to result in fewer angle crashes, which were often severe, and more rear-end crashes, for which injuries tend to be less severe. Erke (2009) conducted meta-analyses on the effects of RLRCs on intersection crashes. As per the findings, rear-end collisions increased by 43 percent. Ko et al. (2013) investigated the effectiveness of RLRCs in reducing crashes at intersections using before-and-after evaluation methods focusing on data from 254 signalized intersections in 32 jurisdictions across Texas. A significant increase of 37% of rear-end crashes as a result of installation of RLRCs was discovered. Retting and Kyrychenko (2002) estimated the impact of red light camera enforcement on motor vehicle crashes in one of the first US communities to employ such cameras—Oxnard, California. They

found a nonsignificant 3% increase in rear-end crashes at signalized intersections. Shin and Washington (2007) conducted a study to estimate the safety impacts of RLCs on traffic crashes at signalized intersections in the cities of Phoenix and Scottsdale, Arizona. The frequency of rear-end crashes increases at RLCs intersections, while the severity of rear-end crashes is reduced as a result of RLCs

Høyve (2013) reviewed previous RLRC related traffic crash research, and found that only rear-end collisions increased after installation of RLRCs. Vanlaar et al. (2014) evaluated the impact of Winnipeg's photo enforcement safety program on red-light running behavior at intersections. The ARIMA time series analyses were used to investigate the safety impact. The results demonstrated that there was a 46% decrease in right-angle crashes at intersections with RLRCs but that there was also an initial 42% increase in rear-end crashes. However, Hallmark et al. (2010) employed a Bayesian statistical before-and-after analysis method to evaluate the effectiveness of RLRCs in Davenport, Iowa. It was concluded that rear-end crashes dropped by 2 percent after installation of RLRC's. Ahmed and Abdel-Aty (2015) examined the safety impacts of RLRC's on traffic crashes at signalized intersections using the EB method. They found that RLRCs contributed significantly to rear-end crashes.

### **3.5. REAR-END CRASH PREVENTION TECHNOLOGIES**

Tang and Yip (2010) used dedicated short-range communication (DSRC) systems in test vehicles to investigate the use of vehicle-to-vehicle (V2V) communication in preventing crashes, some of which were rear-end crashes. The authors found that the driver's reaction and deceleration rate among other factors affect the design of the system intended to warn about

impending collision. The authors proposed what they referred to as the critical and preferred times to prevent crashes. Brännström et al. (2010) presented a model-based algorithm that estimated how the driver of a vehicle can either steer, brake, or accelerate to avoid colliding with an arbitrary object. The results indicated that the authors' algorithm significantly improved the timing of autonomous brake activation in rear-end collision situations in comparison with conventional threat assessment algorithms. Chen et al. (2011) proposed a protocol with reduced infrastructure designed to prevent rear-end crashes. It only relied on vehicles' onboard sensors. The research team's strategy was shown to perform better than those in the current literature in preventing rear-end crashes. Milanés et al. (2012) developed a collision warning system (CWS) and a collision avoidance system (CAS) to avoid rear-end crashes. The CWS warns the driver of an imminent rear-end crash while the CAS transmits a signal to override steering wheel to avoid the rear-end crash. The time to collision was used as an input in developing both systems. Kusano and Gabler (2012) examined the efficacy of the combination of the three rear-end collision prevention system: forward collision warning, brake assist, and autonomous braking. The results indicated that the collision prevention system could reduce the severity of the collision, defined by the authors as the change in the vehicle's travel speed at the condition of the crash, between 14% and 34%. Also, the number of moderately to fatally injured drivers who wore their seat belts could have been reduced by 29% to 50%.

Li et al. (2013) designed an advanced driver assistance system (ADAS) that warns drivers of potential rear-end collision scenarios using mobile devices. An et al. (2014) proposed a collision warning system for rear-end collision situations using linear discriminant analysis (LDA). Fildes et al. (2015) evaluated the effectiveness of low speed ( $< 30 \text{ kph} \approx 18.64 \text{ mph}$ ) autonomous

emergency braking (AEB) systems in reducing rear-end crashes. The authors' results indicated that vehicles with low speed AEB systems reduced rear-end crashes by 38% when compared to control vehicles not equipped with such systems. Isaksson-Hellman and Lindman (2015) evaluated the potential of the system of forward collision warning and brake support combined with adaptive cruise control (CWB+ACC) in preventing rear-end crashes. The research team's results showed that rear-end crashes with frontal impacts were reduced by 38% for cars with CWB+ACC. Chen et al. (2017) proposed a method for predicting rear-end crash probability for conditions of vehicles connected in an internet of vehicles using back propagation neural network optimized by a genetic algorithm.

### **3.6. SUMMARY**

Rear-end crashes are of a major concern when it comes to intersection traffic safety. From the review discussed previously, we can infer specific trends. Road geometric characteristics can potentially contribute to rear-end crashes at intersections, such as the median divider and uphill or downhill grade. Environmental characteristics including adverse weather, absence of street lighting during nighttime conditions and slippery road surface can also contribute to rear-end crash risk. Young drivers and elderly drivers are also more likely to be involved in rear-end crashes at intersections. Signalization and RLRCs also increase rear-end crash risk. We summarized the factors that contribute to rear-end crashes in Table 3-1.

**Table 3-1: Summary of contributing factors to rear-end crashes**

<b>Contributing Factor</b>	<b>Reference(s)</b>
No of left-turn lanes on the major road	Abdel-Aty et al. (2005); Wang and Abdel-Aty (2006)
Divided highways	Yan et al. (2005)
Daytime conditions	Yan et al. (2005); Yan and Radwan (2006)
Wet and slippery road surfaces	Yan et al. (2005); Yan and Radwan (2006)
Middle-aged females	Yan et al. (2005)
Paved and curbed median segments	Das and Abdel-Aty (2010)
High posted speed limit	Yan and Radwan (2006); Wang and Abdel-Aty (2006)
Proportion of light truck vehicles	Harb et al. (2007)
Approach right-turn volume	Poch and Mannering (1996)
2-phase signal	Poch and Mannering (1996)
8-phase signal	Poch and Mannering (1996)
Larger number of phases per cycle	Wang and Abdel-Aty (2006)
Greater than 3% grade	Poch and Mannering (1996)
AADT	Kim et al. (2006a)
Presence of turning lanes	Kim et al. (2006a)
Number of driveways	Kim et al. (2006a)
Intersections with heavier traffic	Wang and Abdel-Aty (2006)
More right-turn lanes on the major roadway	Wang and Abdel-Aty (2006)
GSCDs	Ni and Li (2014)
Signalization	Pernia et al. (2002); McGee (2003); Davis and Aul (2007); Harkey et al. (2008); Jensen (2010); Srinivasan et al. (2014); Wang et al. (2015)
Installation of RLRCs	AASHTO (2010); Ross and Sperley (2011); Erke (2009); Ko et al. (2013); Høye (2013); Vanlaar et al. (2014); Ahmed and Abdel-Aty (2015)

In addition, state of the art technologies offer more possibilities to reduce rear-end crashes at intersections. Advanced driver assistance systems, connected and autonomous vehicles are the main research areas that are capable of addressing rear-end crashes.



#### **4. LITERATURE REVIEW OF ELDERLY DRIVERS' SAFETY AT INTERSECTIONS**

The United States is an aging nation. In 2050, the population aged 65 and above is projected to be 83.7 million, almost double its estimated population of 43.1 million in 2012 (Ortman et al., 2014). The elderly people are more dependent on automobiles for mobility in the United States. Elderly drivers are more likely to be involved in fatal crashes than those of all other age groups except for drivers under 25 (Cobb and Coughlin, 1998). In the United States, fatal crashes at intersections account for more than 20 percent of all motor vehicle traffic fatalities every year (Subramanian and Lombardo, 2007). Hauer (1988) inferred that about half of the safety problems of senior drivers occur at intersections. A research team from Australia (Langford and Koppel, 2006) indicated that one in every two fatal crashes involving elderly drivers occurred at intersections. Thus, it is important to design intersections such that the risk and severity of crashes are reduced.

##### **4.1. CRASH CHARACTERISTICS OF ELDERLY DRIVERS**

Preusser et al. (1998) found that drivers aged 65 to 69 were 2.26 times more at risk for being involved in multiple-vehicle crashes at intersections, and drivers aged 85 and older were 10.62 times more. The authors also found that the crash risk was particularly high for older drivers at uncontrolled and stop-controlled junctions when traveling straight or when entering the junction. Another factor was the failure to yield. Mayhew et al. (2006) found that senior drivers have particularly high rates of involvement in intersection crashes when turning, especially left (Abdel-Aty et al., 1998, 1999). Furthermore, elderly drivers were more likely to be at fault than younger drivers. A plausible explanation is that the major factors were failure to yield the right-of-way, disregarding of the traffic signal or other traffic violations. Compared with younger drivers, elderly drivers are over-represented in situations involving overtaking (passing) another

vehicle, merging crashes, and angle crashes. Chen et al. (2016) discovered that elderly drivers aged 64 and above are more susceptible to be severely injured than younger drivers when conducting a study to examine the influence of crashes, some of which were rear-end crashes, on driver's injury severity. Additionally, in another study undertaken by Ma and Yan (2014), it was found that male drivers older than 55 were less at risk of being the rear-enders in rear-end crashes than female drivers assuming the same age. Horswill et al. (2008) undertook a video experiment study to test the perception-reaction time of drivers aged 65 and older when detecting to an impending hazard. As per the results, the time to respond increases as age increases. Yet, adjusting the video's contrast and the field of view can mitigate the effect of the longer time to respond. Nishida's (1999) evaluation results are consistent with those of Horswill et al. (2008) in that elderly drivers' response times are longer than those of younger drivers. However, Nishida (1999) also observed that elderly drivers drove at slower speeds than younger drivers, a remedy for the prolonged response time. Ou and Liu (2017) conducted a driving simulator experiment and a survey to assess the participants' awareness of the surroundings when driving. It was found that drivers aged 66 to 78 were less aware of the driving situation than drivers aged between 20 and 25. That was possibly because elderly drivers are prone to be overcome by observable surroundings to be recognized such as the signage, traffic signals and pedestrians. Eberhard (2008) reviewed recent crash, injury, and exposure trends from the National Household Travel Survey. As per the study's findings, older drivers had a higher crash risk per mile driven due to the physiological functional limitations that accompany aging. Moreover, older drivers were not a risk to drivers belonging to other road user age groups but primarily to themselves.

## **4.2. RISK EVALUATION FOR ELDERLY DRIVERS AT INTERSECTIONS**

Braitman et al. (2007)'s research indicated that crashes where drivers failed to yield the right-of-way increased with age and occurred mostly at stop-controlled intersections, generally when drivers were turning left. Protected left turn lanes at signalized intersections may help reduce failure-to-yield crashes at intersections, especially among older drivers. Yan and Radwan (2006) founded that older subjects tended to select larger gaps to make left-turns at intersections. In particular, older female drivers exhibited a conservative driving attitude as a compensation for reduced driving ability. Uchida et al. (1999) found that elderly drivers had a greater risk of late detection of a vehicle on a collision course if they used peripheral vision only. Yonekawa et al. (2014) undertook a study involving a driving simulator experiment in which elderly drivers navigate through a stop-controlled intersection and found elderly drivers did not check the road adequately before proceeding through the intersection and suggested elderly driver aid systems.

## **4.3. COUNTERMEASURES**

Elderly drivers were more prone to violate traffic rules when yielding to opposing traffic is necessary as opposed to other age groups. Garber and Srinivasan (1991) suggested several countermeasures. First, the provision of a protected left-turn phase with left-turn lanes helps in reducing the crash rates of the elderly at signalized intersections. Second, longer yellow times are beneficial to the elderly. Oxley et al. (2006) reviewed age-related performance deficits that affect driving. The authors also analyzed high crash risk locations, known as "black spots" to examine the relationship between intersection design features and the crash contributing factors related to older driver characteristics in Australasia. The top three design features that increased the older driver crash risk were lack of separate traffic control signals, limited or restricted sight

distance at right turns, and a perception-reaction time (PRT) design value less than 2.5 seconds. Classen et al. (2007) tested the effectiveness of the FHWA guidelines for intersection design based on driving performances of young and senior adults. It was found that older drivers committed fewer errors on the FHWA improved intersections that are more forgiving. Lord et al. (2007) recommended advance warning signs, guide signs, yield treatments, directional signs and exit treatments at intersections to reduce the crash risk for old drivers.

Davidse (2006) summarized advanced driver assistance systems (ADAS) that have the highest potential to reduce the crash involvement rates of older drivers. The author pin-pointed the following systems to support older drivers at intersections: 1) collision warning systems deployed at intersections, 2) automated lane changing and merging systems, 3) reversing aids, 4) in-vehicle signing systems, 5) intelligent cruise control, and 6) a system that gives information on the characteristics of complex intersections the driver is about to cross. Caird et al. (2008) conducted a driving experimental study to determine if drivers benefited from advanced in-vehicle signs presented to older and younger drivers in a head-up display (HUD). The results indicated that older drivers experienced a greater deal of difficulty in searching for and using road signs. It was implied that the in-vehicle signage system, the HUD, might have assisted elderly drivers in intersection navigation.

#### **4.4. ELDERLY DRIVERS AND REAR-END CRASHES AT INTERSECTIONS**

According to the road safety literature, elderly drivers were more likely to be involved in rear-end intersection crashes (Villalba et al., 2001). Elderly drivers were more likely to be the at-fault drivers instead of the victims (Stamatiadis et al., 1990; Staplin et al., 1998). Braitman et al. (2007) identified the factors that led to intersection crashes involving older drivers. The authors found that drivers in their 80s and older were less likely to be involved in rear-end crashes than drivers aged 35 to 54 and 70 to 79. This conclusion was consistent with those of other studies. Senior drivers were also less susceptible than middle-age drivers to be involved in rear-end crashes at intersections (Knoblauch et al., 1995).

Yan et al. (2005) indicated that older drivers' higher rear-end crash risk may result from deteriorated physical conditions, impaired judgment and vision problems. Drivers with cognitive impairment, such as Alzheimer's disease and Parkinson's disease may be more prone to be involved in crashes. Uc et al. (2006) examined responses of drivers, with Alzheimer's disease, to a stopped lead vehicle at an intersection using a rear-end collision avoidance scenario in driving simulator experiments. The authors found that that the drivers with Alzheimer's disease tended to take longer times to respond to the stopped lead vehicles at intersections translating to an increase in the odds of rear-end crashes.

#### **4.5. SUMMARY**

In general, due to the deterioration of body functions with age, the elderly are more likely to be involved in crashes at intersections. Particularly, this holds when elderly drivers need to yield the right-of-way, turn or pass other vehicles. Countermeasures may be implemented to reduce the crash risk for elderly drivers. Such countermeasures are longer yellow time, advanced warning signs, guide signs, in-vehicle driver assistance technologies and special forgiving designs.

Moreover, elderly drivers are more likely to cause rear-end crashes. Cognitive impairment may also be a contributing factor to rear-end crashes. Florida has a large and growing senior population. In order to protect the elderly drivers, roadway agencies ought to implement protective and forgiving intersection designs, such as protected left turn phases. The alternative intersection designs have great potential for addressing the elderly drivers' safety.

## **5. QUESTIONNAIRE SURVEY ANALYSIS AND DATA COLLECTION**

The survey analysis involves disseminating a survey to traffic engineers, primarily state DOT representatives across the country, to receive feedback about the alternative intersections implemented in the engineers' jurisdictions to determine the types of alternative intersections that are preferred. Following are a discussion about the survey and an extensive section about the analysis of the survey's results.

A survey is prepared in multiple forms: Google Forms, Google Sheets, Microsoft (MS) Word and MS Excel. The survey was circulated to traffic engineers in several counties in Florida and many states in the country. Originally, the survey was intended to be prepared in Google Forms and Google Sheets only. However, some respondents had a problem to access Google Forms and Google Sheets because of cyber-security concerns, the survey was also prepared on MS Word and MS Excel. It was prepared to ask (1) what alternative intersection types are implemented, (2) why did the jurisdictions decide to deploy the intersections, (3) what course of action is taken to educate the drivers on how to navigate through such unconventional intersections, (4) whether the jurisdictions plan to deploy alternative intersections in the future and why. Respondents were also asked for additional information regarding the type of alternative intersections implemented such as the location, construction start/completion dates, construction cost and maintenance cost in a separate spreadsheet accompanying the survey. The survey and an altered form of the accompanying spreadsheet are included in the Appendix.

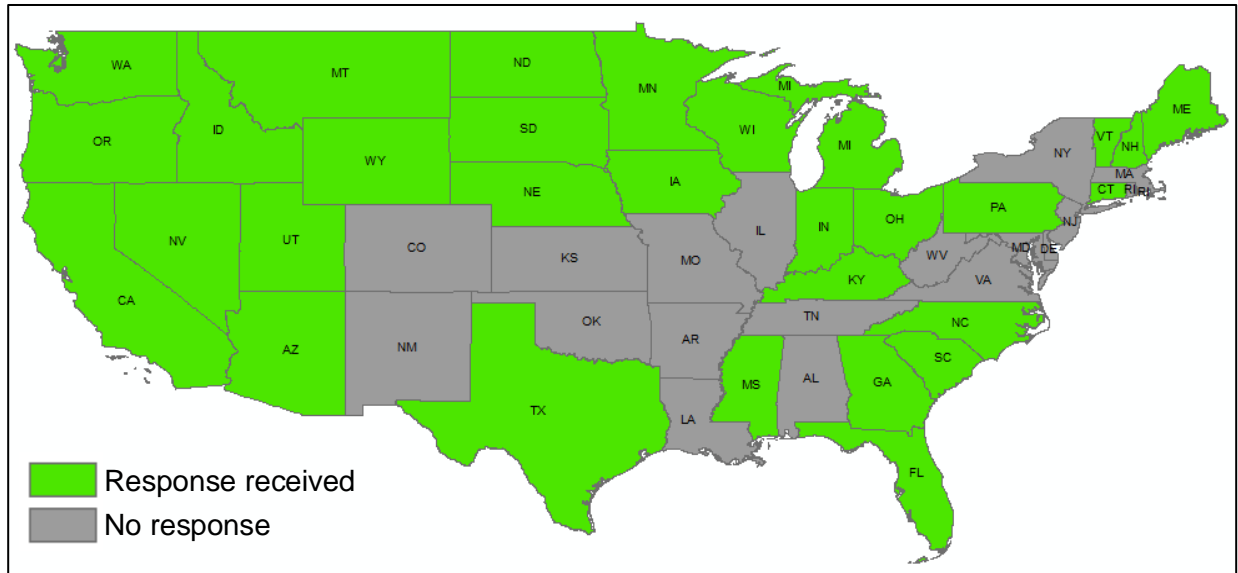
This section pertains to the analysis of the survey's responses and is divided into four subsections. One is about the implementation of the alternative intersections. The others are

about plans to deploy alternative intersections in the future, campaigns to educate the drivers regarding how to navigate through the alternative intersections and costs of implementing the alternative intersections respectively. The costs are those of construction and maintenance.

### **5.1. IMPLEMENTATION OF ALTERNATIVE INTERSECTIONS**

The survey was distributed to traffic engineers in a multitude of states and 49 state representatives from 30 states responded. The survey responses by state are depicted in Figure 5-1. The alternative intersections, implemented by type in each state, are illustrated in Table 5-1. As shown in the table, all types of alternative intersections, listed, deployed in the country except for hamburger intersections. It should be noted that respondents from California, Kentucky, Mississippi, Pennsylvania and Washington mentioned that their states implemented roundabouts. However, roundabouts are not considered alternative intersections in the context of this project. It is critical to note that information entered into the survey may be inaccurate. For instance, a respondent may claim that his or her state has RCUT intersections where in fact they are two-way left-turn lanes with channelization.





**Figure 5-1: Survey responses from states**

**Table 5-1: Alternative intersection designs implemented by alternative intersection type**

<b>Junction Type</b>	<b>State(s)</b>
<b>Hamburger Intersection</b>	None
<b>Synchronized Split Phasing Intersection</b>	South Carolina
<b>PFI</b>	Michigan
<b>Parallel Flow with MUT Intersection</b>	Michigan
<b>Paired Intersection</b>	California, Michigan
<b>Double Wide Intersection</b>	California, Utah
<b>Bowtie Intersection</b>	Nebraska, Utah
<b>QR Intersection</b>	Michigan, North Carolina, Utah, Wisconsin
<b>CFI</b>	Georgia, Mississippi, Ohio, Texas, Utah
<b>Split Intersection</b>	Florida, Michigan, Mississippi, Pennsylvania, Texas, Utah
<b>MUT Intersection</b>	Arizona, Florida, Michigan, North Carolina, Nebraska, Texas, Utah
<b>MUT with RCUT Intersection</b>	North Carolina
<b>Jughandle</b>	Connecticut, Georgia, Michigan, North Carolina, Nebraska, Oregon, Pennsylvania, South Carolina, Vermont, Wisconsin
<b>RCUT</b>	Georgia, Indiana, Kentucky, Michigan, Minnesota, North Carolina, Nebraska, Ohio, Texas, Utah, Washington, Wisconsin
<b>Offset T-Intersection</b>	California, Florida, Georgia, Indiana, Kentucky, Michigan, Minnesota, Mississippi, Pennsylvania, South Carolina, Texas, Utah, Vermont
<b>CGT Intersection</b>	California, Florida, Georgia, Kentucky, Maine, Michigan, Minnesota, Mississippi, North Carolina, Nevada, Pennsylvania, South Carolina, Utah, Washington
<b>DDI</b>	Arizona, California, Florida, Georgia, Iowa, Idaho, Indiana, Kentucky, Michigan, Minnesota, Mississippi, North Carolina, Nebraska, Nevada, Ohio, Oregon, Pennsylvania, South Carolina, Texas, Utah, Wisconsin, Wyoming
<b>Roundabout Interchange</b>	Mississippi, Missouri

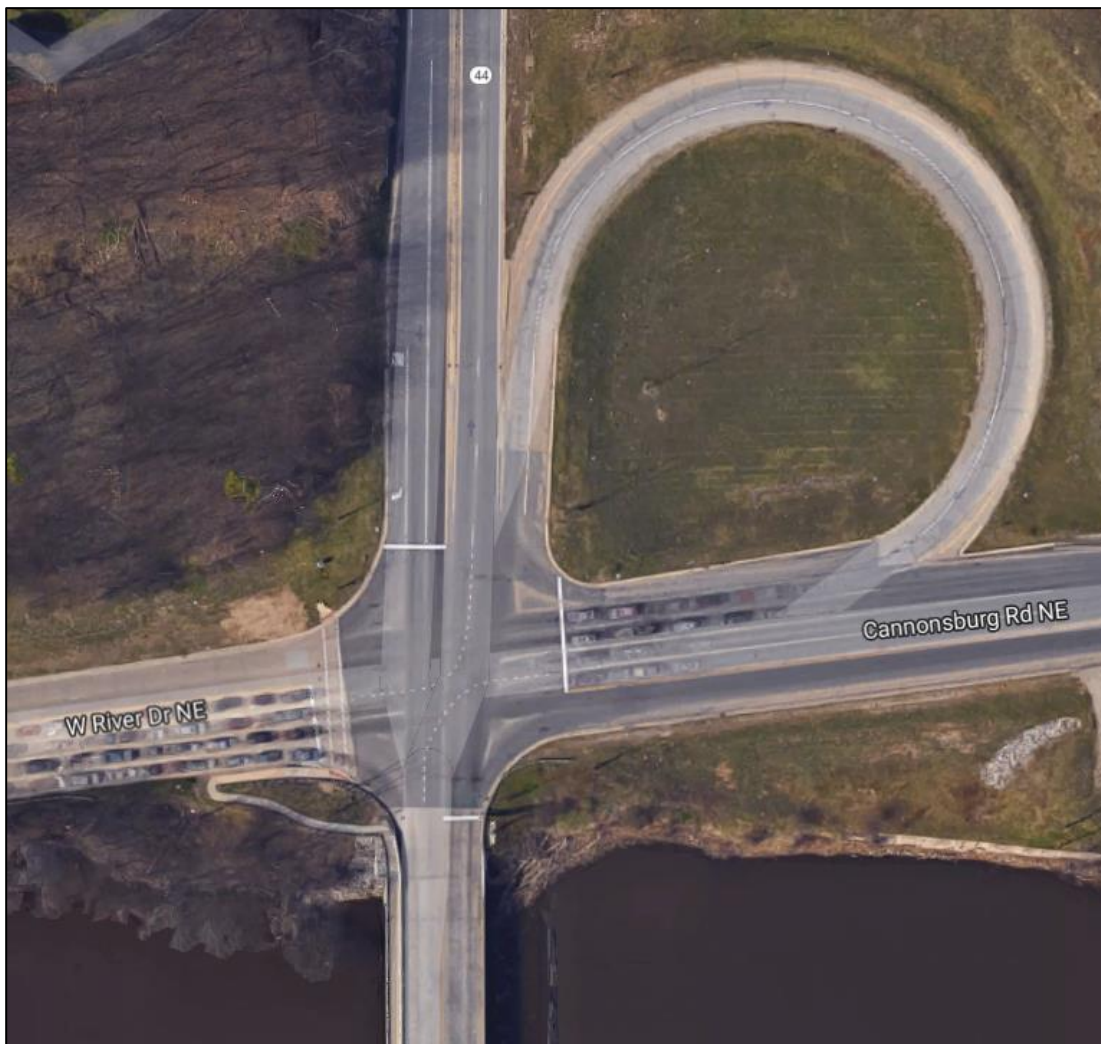
The parallel flow with MUT intersection, deployed in Michigan as per the results of Table 5-1, is one with a combination of the parallel flow design and the MUT design as shown in Figure 5-2.



**Figure 5-2: Parallel flow intersection with median U-turn intersection**

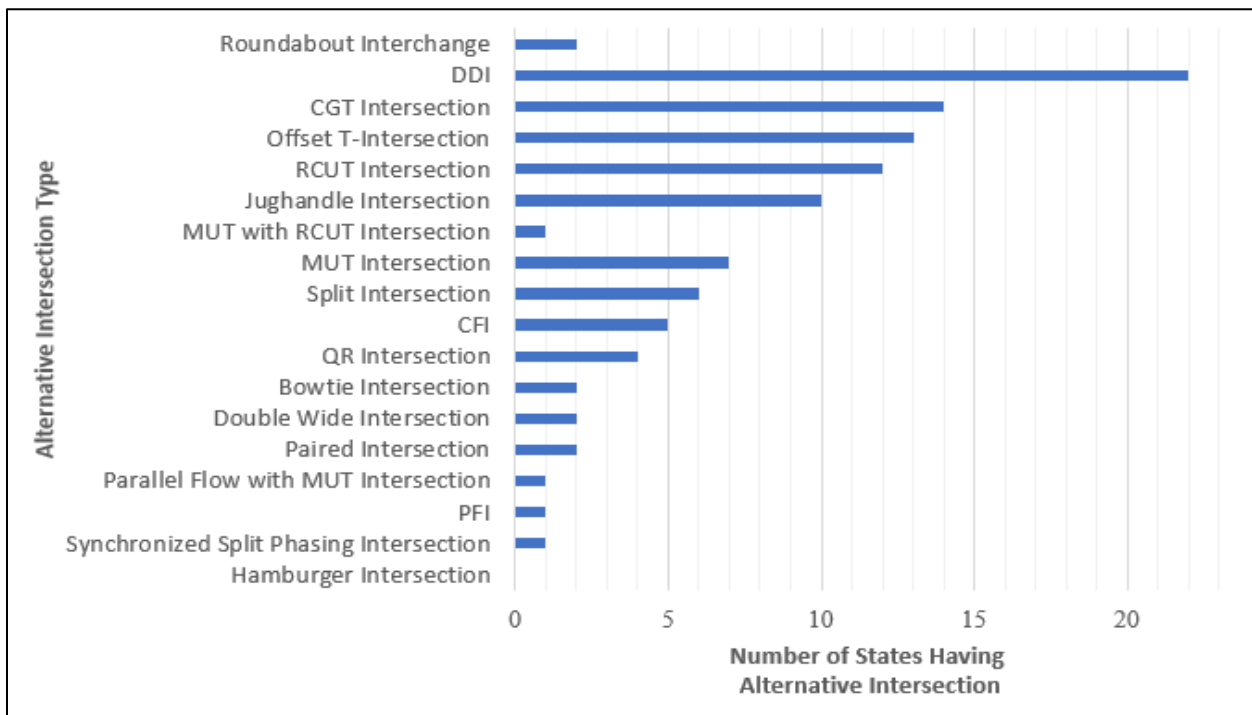
Likewise, the MUT with RCUT intersection design, implemented in North Carolina as per the survey's results, is a combination of the MUT intersection and the RCUT intersection designs.

The jughandle intersection may be an atypical one with a reverse handle. For such junction, left turners, traveling northbound, may proceed through the intersection, enter the loop, resembling the handle after the intersection, and arrive at through lanes of the cross street to make their desired movement as shown in Figure 5-3.



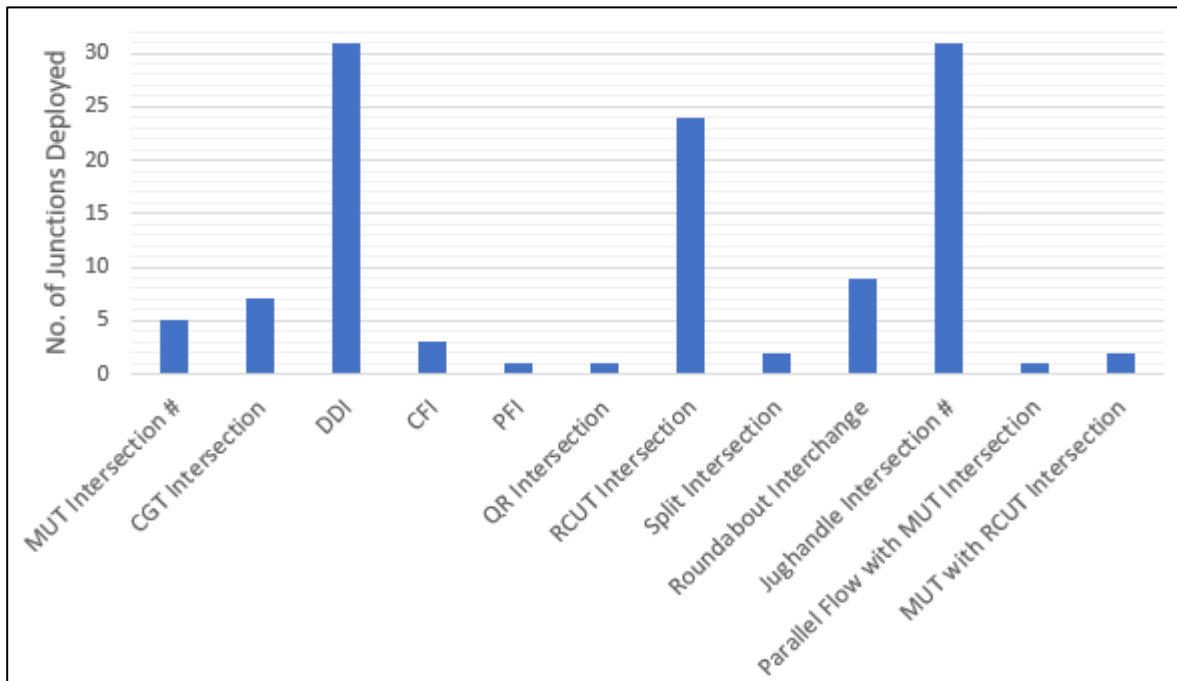
**Figure 5-3: Reverse jughandle intersection**

When it comes to the analysis of the survey’s results, the number of states implementing alternative intersections, by type, is depicted in Figure 5-4. The DDI is the most preferred junction type. A total of 22 states adopted this type of design. The CGT, offset T- and RCUT intersections rank the second (14 states), third (13 states) and fourth (12 states) places respectively for the number of states implementing them. Following the RCUT intersection in rank are the jughandle intersection, MUT intersection, split intersection, CFI and QR intersection. Few states implemented the bowtie intersection, double wide intersection, paired intersection, or roundabout interchange. The PFI and parallel flow with MUT intersection are only deployed in Michigan as per the survey’s results. Likewise, the synchronized split phasing intersection is only implemented in South Carolina.



**Figure 5-4: Number of states having alternative intersections by type**

As previously mentioned, the survey included a spreadsheet for the respondents to input the locations of the alternative intersections, construction costs, maintenance costs, construction start dates and construction end dates. Not all respondents entered the information into the spreadsheet. Overall, the spreadsheet of 117 intersections were processed. The total counts of alternative intersections implemented by type in all states, of which respondents entered the information required in the spreadsheet, are depicted in Figure 5-5. The deployments of the intersections are verified using Google Maps. It should be noted that the respondent from Michigan entered information about an MUT intersection and simply stated that there are many other MUT intersections in his state. Similarly, the number of jughandle intersections in Pennsylvania is unknown as mentioned by the respondent. As shown in the figure, the jughandle intersection and the DDI are the most abundant ones. Pennsylvania’s jughandle intersections comprise the majority of them. The RCUT intersection, roundabout interchange, CGT intersection and MUT intersection are the also popular to a considerably less extent.



**Figure 5-5: Number of implemented alternative intersections by type**

The number of junctions, deployed by type and state, are presented in Figure 5-6. The jughandle intersection is implemented in more than 23 locations in Pennsylvania, 5 locations in Connecticut, 2 locations in Michigan and 1 location in Oregon. Also, a variety of the jughandle intersections in Pennsylvania are unsignalized. The DDI design is deployed the most in North Carolina. According to the survey's results, there are 18 DDIs in North Carolina including the ones being planned and the ones under construction. Most of the other states have at least one DDI. The RCUT intersection is also the most popular in North Carolina while three RCUT intersections are operational in Ohio. The roundabout interchange is preferred in Missouri and Mississippi has a roundabout interchange as well. Furthermore, Florida has three CGT intersections while Nevada, North Carolina, Pennsylvania and Washington have one each. In addition, Michigan has more than two MUT intersections deployed as the Michigan DOT representative stated while the number of MUT intersections in Arizona and North Carolina are one and two, respectively. The other junction types are implemented in few states. Note that representatives from North Carolina and Indiana reported that their states have unsignalized RCUT intersections. However, the operating characteristics of such intersection are similar to a two-way left-turn lane or a mid-block location with channelized turning bays on both directions. Hence, they are not considered alternative intersections. A map depicting the states having alternative intersections, verified, is presented in Figure 5-7. The specific locations of the alternative intersections are listed in Appendix.

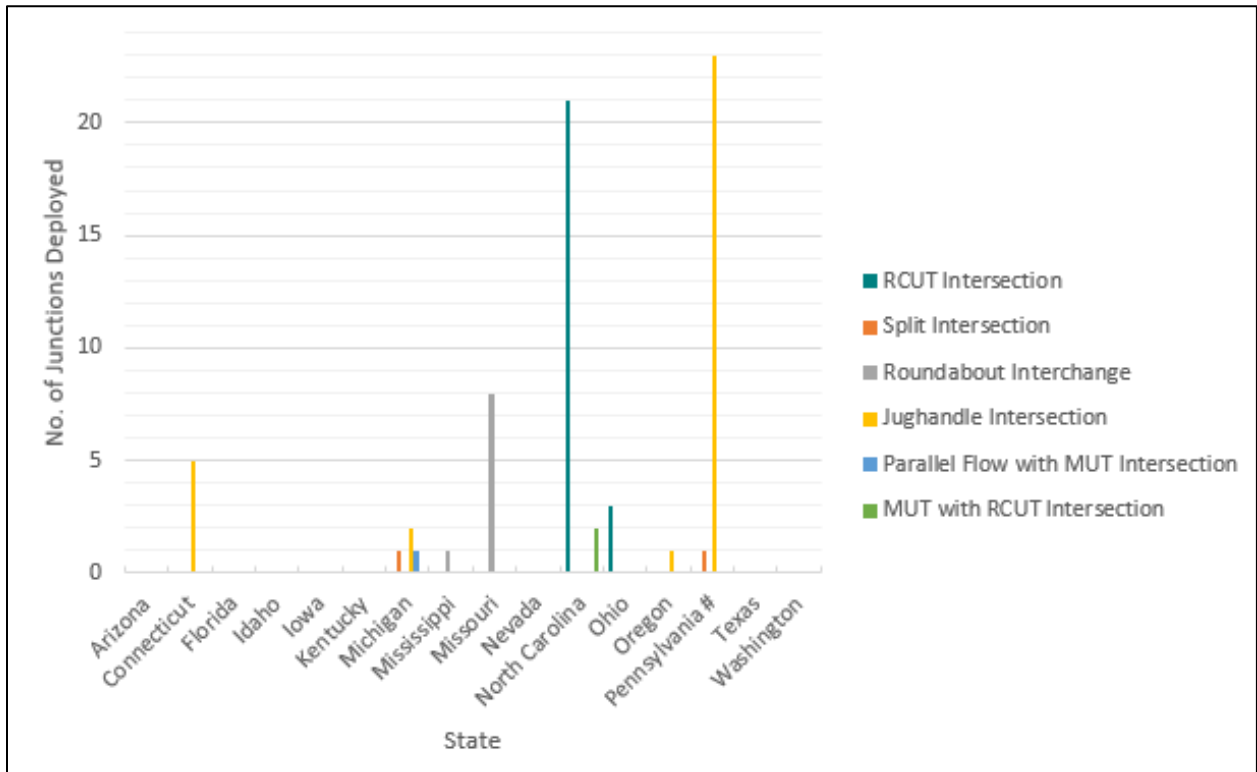
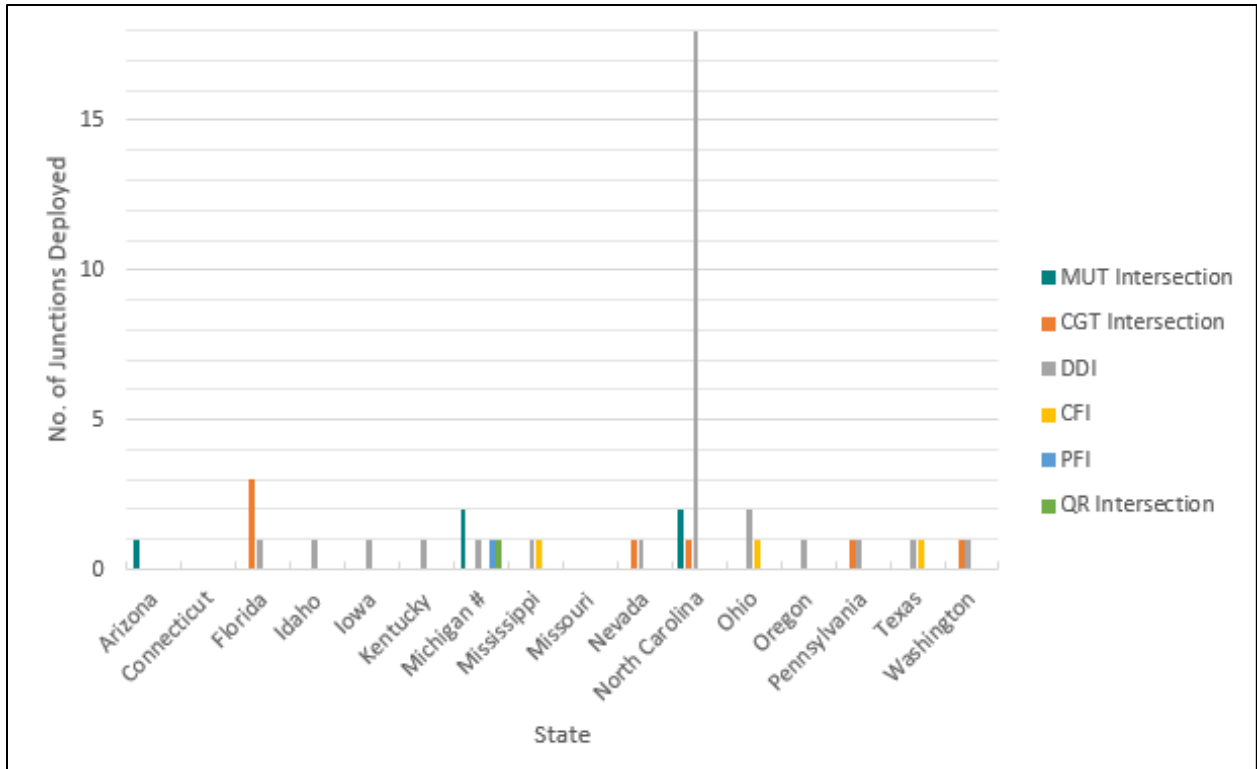
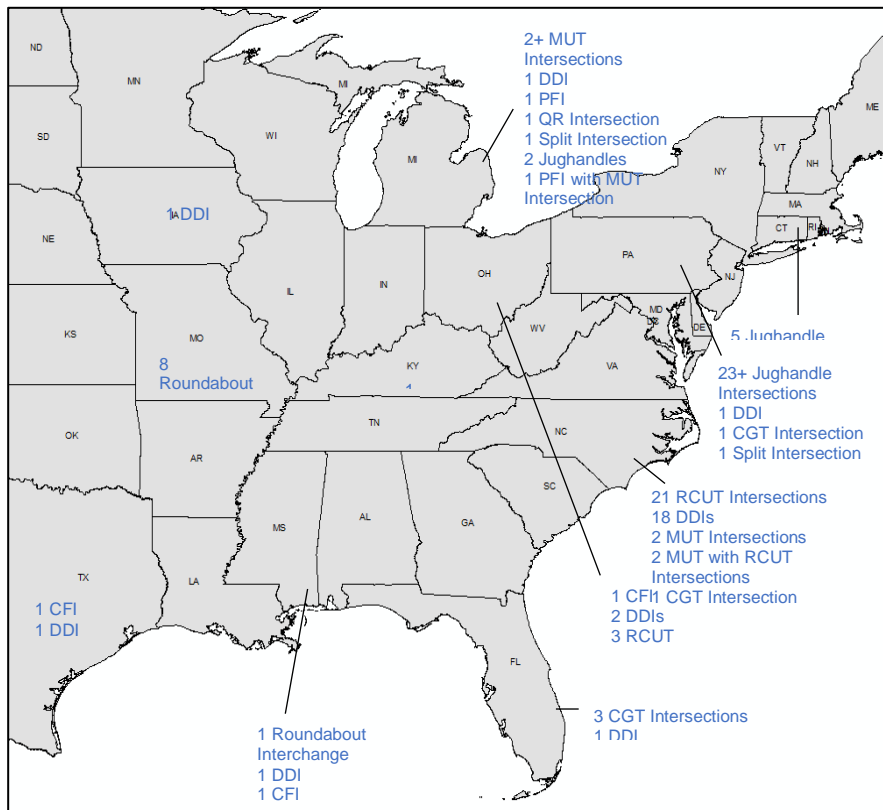
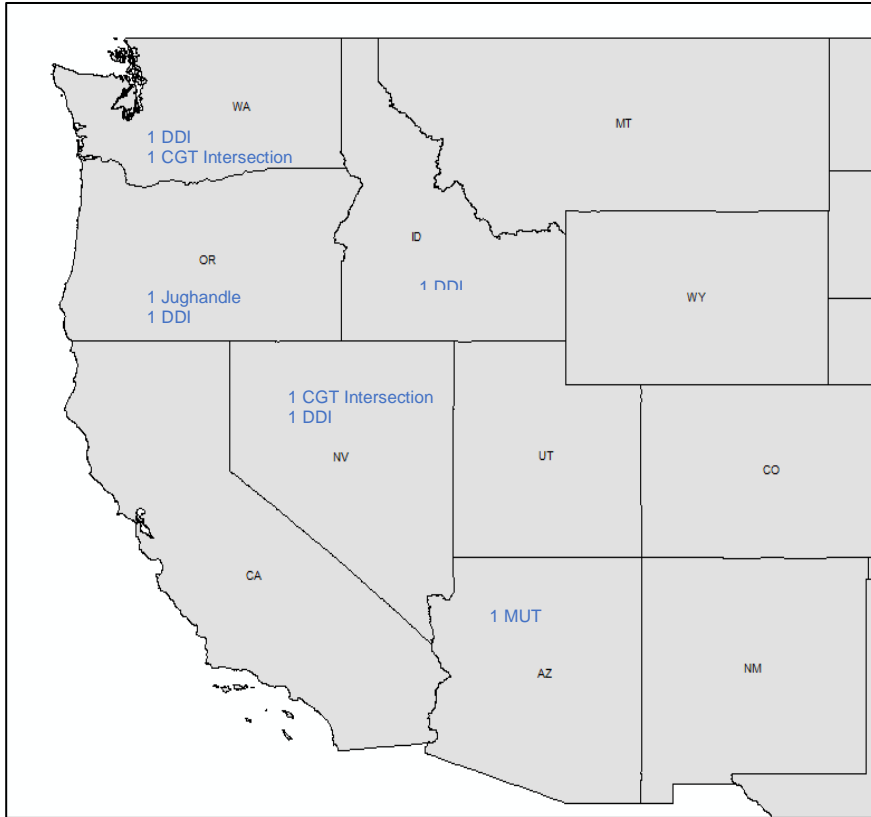


Figure 5-6: Number of alternative intersections implemented by type and state





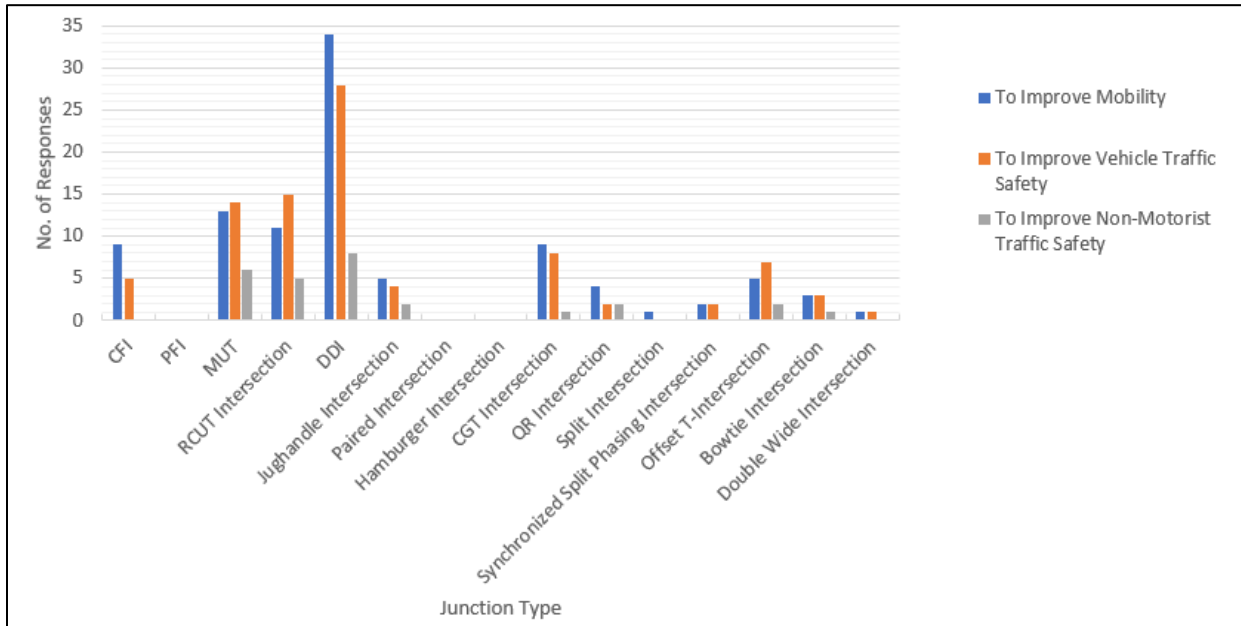
**Figure 5-7: Alternative intersections by type**

## **5.2. PLANS TO IMPLEMENT ALTERNATIVE INTERSECTIONS IN THE FUTURE**

As the survey's main inquiry is about the alternative intersections that are already deployed, another critical component is to ask about plans to implement alternative intersection designs in the future. The question is specifically asking what types of alternative intersections are planned to be deployed and why. Three reasons are provided and the respondent may check more than one. They are to enhance mobility, to improve vehicle traffic safety, to improve non-motorized users' traffic safety and other(s). If the respondent selects other(s), he or she would have to specify the reason in writing.

When it comes to the results of responses about the plans to implement alternative intersections, 13 types of such junctions are planned to be deployed in the future. The results of the responses are shown in Figure 5-8. Interestingly, no state is planning to deploy paired intersections, hamburger intersections and PFIs. In addition, the main reason jurisdictions are planning to deploy DDIs is to enhance mobility. As shown in the figure, there are 34 responses indicating that DDIs are planned to be deployed to improve traffic throughput. Regarding CFIs, CGT intersections, jughandle intersections, split intersections and QR intersections, respondents also claimed that such intersections are being planned for implementation to improve mobility. However, the number of responses for those intersections is much fewer than that of the DDI. The MUT, RCUT and offset T- intersections are planned for deployment mainly to improve vehicle traffic safety even though respondents indicated that the intersections are preferred to enhance mobility as well. The synchronized split phasing, bowtie and double wide intersections, are considered for design in the future chiefly because of enhancing both traffic throughput and vehicle traffic safety. Additionally, it should be highlighted that non-motorist safety is one of the key factors for planning for the implementation of MUT intersections, RCUT intersections,

DDIs, jughandle intersections, CGT intersections, QR intersections, offset T-intersections and bowtie intersections.



**Figure 5-8: Results of inquiry about plans to deploy alternative intersections**

Other reasons specific alternative intersections are to be implemented are posited. One respondent from South Carolina stated that the synchronized split phasing intersection is being planned to avoid encroachment beyond the right-of-way. In Washington State, plans for the construction of a DDI are being devised to cut back cost by using an existing bridge. In Utah, multiple CGT intersections are considered for deployment because each project, involving the implementation of the CGT intersection design, has its exclusive objectives.

### **5.3. CAMPAIGNS TO INFORM DRIVERS ABOUT HOW TO NAVIGATE THROUGH ALTERNATIVE INTERSECTIONS**

Since the operating characteristics of the alternative intersections are different from those of the conventional intersections, drivers, especially those unfamiliar with the roads, may be confused when approaching the alternative intersections and experience difficulty navigating their way. Thus, many states adopted various ways to educate the public about how to proceed through the alternative intersections. Out of the 30 states from which responses were received, there are only 15 with information available about the education and/or awareness campaign to instruct the drivers in navigating through the alternative intersections. The responses, verbatim, are listed in Table 5-2. In Maine, special instructional campaigns are not conducted. Regarding the other 14 states, the most preferred approach to drivers' education regarding alternative intersections' guidance is via TV, radio, or social media. Public outreach programs, press releases, brochure distributions, and educational video releases are other approaches undertaken. Presenting information about guidance of alternative intersections on official DOT websites is also a common approach. Drivers' education manuals may include content about how to traverse alternative intersections as well. Efficient use of traffic control devices at and near the alternative intersections is also critical.

**Table 5-2: Instruction campaign about alternative intersections**

<b>State</b>	<b>Campaign</b>
<b>California</b>	Awareness campaign during project development and approximately two years after construction.
<b>Georgia</b>	most of the alternative intersections we use are in our driver’s license manual; we have also done public outreach for specific projects implementing alternative designs
<b>Indiana</b>	Press releases, news stories, information in the Driver Manual.  Public information events/meetings, brochures, media releases, agency web site content.
<b>Kentucky</b>	Variable message boards may be placed in advance of the alternative intersection design relaying information to motorists. Signing and markings should be clear for the motorist to understand how to navigate through the intersection regardless of the alternative intersection design that is used. Media
<b>Maine</b>	We have implemented unsignalized continuous-green T intersections without special educational campaigns.
<b>Michigan</b>	Many have been around for decades, the newer ones we do public outreach via meeting, TV and radio, sometimes creating 3D models
<b>Mississippi</b>	MDOT's Public Affairs division has launched a new website as well as staying active in social media to help try and educate drivers about new intersections. <a href="https://drivesmart.mdot.ms.gov/">https://drivesmart.mdot.ms.gov/</a>
<b>North Carolina</b>	PR campaign before they open; good traffic control devices; limited enforcement within the first few weeks of opening.
<b>Nevada</b>	NDOT website and the local TV/news outlets.
<b>Oregon</b>	Our regional Public Information staff produced YouTube videos, maintained a project website with explanatory information, worked with local media to provide added explanations and frequent updates as the project progressed to completion.
<b>Pennsylvania</b>	Jughandles – None or minimal Diverging Diamond – Project specific brochure, project website, project specific public meetings with video simulation. Roundabouts – In Drivers Manual, Brochures, Information on our website, project specific public meetings with video simulation. Others – Varies
<b>Texas</b>	Public meetings, driver education campaigns are proved to be helpful.
<b>Utah</b>	Instruction included in driver's education manual. Training videos provided on line and in social media.  Local media, public meetings, YouTube videos or advertisement at adjacent movie theaters
<b>Washington</b>	WSDOT blog, website, social media outreach
<b>Wisconsin</b>	Developed print materials, You Tube videos and held lots of public meetings with stakeholders and media outlets.

#### 5.4. ALTERNATIVE INTERSECTIONS' CONSTRUCTION COSTS

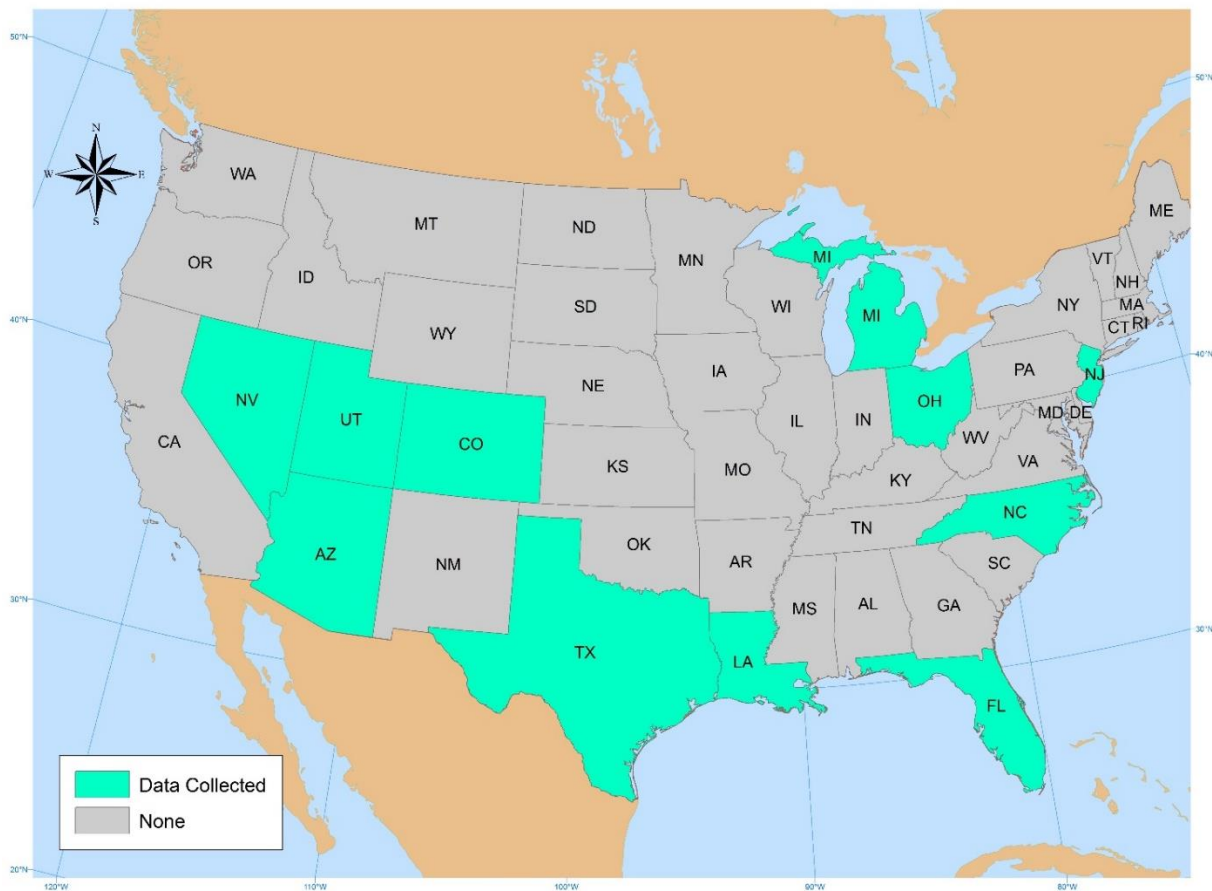
Limited data were provided regarding the construction costs of the alternative intersections, let alone the annual maintenance costs. The construction costs are presented in Table 5-3. The DDI is the most expensive junction to construct followed by the CGT intersection. Yet, the DDI's construction cost may vary tremendously as indicated by the standard deviation. That is plausible because the cost of constructing a new DDI is different from that of converting an existing interchange to a DDI. On the other hand, the split intersection is the least expensive junction to construct. Also, only one response contains data about the annual maintenance costs. It is from Pennsylvania. As per the response, roughly \$6,000 per year are required to maintain a split intersection.

**Table 5-3: Construction costs**

Junction Type	State	Latitude	Longitude	Construction Cost (\$)	Average Construction Cost (\$)	Standard Deviation of Construction Cost (\$)
CFI	Ohio	39.59665	-84.2291	895,000	5,447,500	6,438,207
CFI	Ohio	39.59665	-84.2291	10,000,000		
CGT	Pennsylvania	40.285731	-76.649904	13,353,582	13,353,582	0
DDI	Ohio	40.002545	-83.1182	10,652,444	19,745,665	18,009,162
DDI	Ohio	41.532595	-83.636	7,990,728		
DDI	Iowa	41.569211	-93.853597	18,000,000		
DDI	Pennsylvania	40.184061	-80.227345	51,268,386		
RCUT	Ohio	39.343893	-84.502091	6,838,219	7,644,027	3,035,195
RCUT	Ohio	39.363001	-84.504277	11,000,812		
RCUT	Ohio	39.378832	-84.506847	5,093,049		
Split	Pennsylvania	41.266391	-75.864390	1,000,000	1,000,000	0

## 5.5. DATA COLLECTION

Considering the number and the type of alternative intersections and crash data availability, the research team decided to use the data from eleven states. Those states include Arizona, Colorado, Florida, Louisiana, Michigan, North Carolina, New Jersey, Nevada, Ohio, Texas, and Utah (Figure 5-9).



**Figure 5-9: The states where the data were collected**

## 5.6. SUMMARY AND CONCLUSIONS

This chapter involves the preparation and dissemination of a survey inquiring about the alternative intersection designs. The questionnaires were distributed to many states in the country. The questions, asked, are (1) what types of alternative intersections are implemented, (2) whether there are any plans to deploy alternative intersections in the future, (3) why are the alternative intersections being planned for implementation, (4) what are the campaigns that are conducted to educate the drivers' population on how to navigate through the alternative intersections, (5) what are the locations of the intersections, (6) what are the intersections' construction costs, and (7) what are the annual maintenance costs.

Feedbacks were received from 30 states. According to the responses, the jughandle intersection, DDI, and RCUT intersection are the most preferred alternative junction designs. Furthermore, the jughandle intersection design, is planned for deployment in the future in multiple states mainly to improve traffic throughput even though improving motorist and non-motorist safety are other important factors. Similarly, plans for implementing DDIs are devised chiefly to enhance mobility as well. Safety improvement, in general, is also considered. On the other hand, jurisdictions are planning to deploy RCUT intersections primarily to improve vehicle traffic safety while mobility and non-motorist safety are considered less of a concern. In addition, the safety of non-motorists is considered for implementing MUT, CGT, QR, offset T- and bowtie intersections. Regarding the construction and annual maintenance costs of the alternative intersections, the data are quite limited. According to the responses, the DDI is the most expensive to construct followed by the CGT intersection. Also, only one response was received regarding annual maintenance cost which is about that of a split intersection.



Also, data from eleven states were collected for evaluating the safety effects of the alternative intersections. Those states include Arizona, Colorado, Florida, Louisiana, Michigan, North Carolina, New Jersey, Nevada, Ohio, Texas, and Utah. The collected data were processed for the analysis.

## **6. DEVELOPMENT OF SAFETY PERFORMANCE FUNCTIONS AND CRASH MODIFICATION FACTORS**

### **6.1. METHODOLOGIES**

A crash modification factor (CMF) is defined as the relative change in crash count due to a change in one particular condition when all other conditions are without any change (AASHTO, 2010). If the estimated CMF is significantly less than one, it indicates such change results in reduction of the expected number of crashes. Likewise, the CMF significantly greater than one shows the increase of the expected number of crashes. If a change has no effect, its CMF is not statistically significantly different from one. In the current research, two methods are adopted: a before-and-after study with the comparison group method and a cross-sectional method. The first approach estimates safety effects of the design change not only using crash data from the treated sites, but also from the comparison sites without a change. The method compensates for the external causal factors that could affect the change in the number of crashes (Hauer, 1997). On the other hand, the second method applied when we do not have the sufficient numbers of crashes in the before or after the treatment. The cross-sectional method can compare the safety level between alternative intersections and conventional ones and identify the factors that affect safety at alternative intersections.

#### **6.1.1. Before-and-After Study with the Comparison Group**

According to Hauer (1997), the expected number of crashes for the treated sites that would have occurred in the ‘after’ period had experienced no changes ( $N_{expected, T,A}$ ) can be calculated using Equation (1):

Equation (1):

$$N_{expected, T, A} = N_{observed, T, B} \times \frac{N_{observed, C, A}}{N_{observed, C, B}} \quad (1)$$

where,  $N_{expected, T, A}$  is the expected number of crashes in the treated sites in the after period,  $N_{observed, T, B}$  is the observed number of crashes in the treated sites in the before period,  $N_{observed, C, A}$  is the observed number of crashes in the comparison sites in the after period, and  $N_{observed, C, B}$  is the observed number of crashes in the comparison sites in the before period.

If the similarity between the comparison and treated sites in the yearly trends is ideal, the variance of  $N_{expected, T, A}$  can be estimated from Equation (2):

$$Var(N_{expected, T, A}) = N_{expected, T, A}^2 \left( \frac{1}{N_{observed, T, B}} + \frac{1}{N_{observed, C, B}} + \frac{1}{N_{observed, C, A}} \right) \quad (2)$$

CMF and its variance can be estimated using Equations (3) and (4):

$$CMF = \left( \frac{N_{observed, T, A}}{N_{expected, T, A}} \right) / \left( 1 + \frac{Var(N_{expected, T, A})}{N_{expected, T, A}^2} \right) \quad (3)$$

$$Var(CMF) = \frac{CMF^2 \left[ \left( \frac{1}{N_{observed, T, A}} \right) + \left( \frac{Var(N_{expected, T, A})}{N_{expected, T, A}^2} \right) \right]}{\left[ 1 + \left( \frac{Var(N_{expected, T, A})}{N_{expected, T, A}^2} \right) \right]^2} \quad (4)$$

In this study, we explore whether a conversion has any effect on the number of crashes. In other words, we want to know if the estimated CMFs are significantly different from one. Thus, the hypothesis test for the estimated CMFs is as follows:

$$H_0: CMF = 1 \quad (5)$$

$$H_1: CMF \neq 1 \quad (6)$$

p-values are calculated using the following formulae:

$$p = 1 - 2 \times F(\widehat{CMF}) \quad (7)$$

$$F(\widehat{CMF}) = \Phi\left(\frac{\widehat{CMF}-1}{SE}\right) \quad (8)$$

CMFs with the p-value smaller than 0.1 were considered significant in this study.

### 6.1.2. Before-and-After Study using the Empirical Bayes Approach

For the before-and-after study with empirical Bayes method (i.e. EB method), the expected number of crashes for a treated site that would have occurred in the ‘after’ period is estimated based on the crash history of the treated site and the crash history of a group of reference sites with similar yearly traffic trend, physical characteristics, and land use. The EB method can account for the regression to the mean issue by introducing an estimate for the mean crash frequency of similar untreated sites using SPFs. Since the SPFs use AADT and sometimes other characteristics of the site, these SPFs also account for traffic volume changes, which provides a real safety effect of the treatment (Hauer, 1997).

The method is based on three fundamental assumptions (Hauer, 1997):

1. The number of crashes at any site follows a Poisson distribution.
2. The means for a population of systems can be approximated by a Gamma distribution.
3. Changes from year to year from sundry factors are similar for all reference sites.

One of the main advantages of the before-and-after study with EB is that it accurately accounts for changes in crash frequencies in the ‘before’ and in the ‘after’ periods at the treatment sites that may be due to regression-to-the-mean bias. It is also a better approach than the comparison group for accounting for influences of traffic volumes and time trends on safety. The estimation

of the expected crashes at treatment sites is based on a weighted average of information from treatment and reference sites as given in (Hauer, 1997):

$$\hat{E}_i = (\gamma_i * y_i * n) + (1 - \gamma_i) * \eta_i \quad (9)$$

Where  $\gamma_i$  is a weight factor estimated from the over-dispersion parameter of the negative binomial regression relationship and the expected ‘before’ period crash frequency for the treatment site as shown in equation (9):

$$\gamma_i = \frac{1}{1 + k * y_i * n} \quad (10)$$

where,

$y_i$  = Number of average expected crashes of given type per year estimated from the SPF (represents the ‘evidence’ from the reference sites).

$\eta_i$  = Observed number of crashes at the treatment site during the ‘before’ period

$n$  = Number of years in the before period

$k$  = Over-dispersion parameter, is the parameter which determines how widely the crash frequencies are dispersed around the mean.

The ‘evidence’ from the reference sites is obtained as the output from the SPF. SPF is a regression model which provides an estimate of crash occurrences on a given roadway section.

In the study, the negative binomial model is used as the form of the SPF and is used to fit the before period crash data of the reference sites with their geometric and traffic parameters. A typical SPF will be of the following form:

$$y_i = e^{(\beta_0 + \beta_1 x_1 + \beta_2 x_2 + \dots + \beta_n x_n)} \quad (11)$$

Where,

$\beta_i$  = Regression Parameters,

$x_1$  is the logarithmic value of AADT, and  $x_i$  ( $i > 1$ ) are other traffic and geometric parameters of interest.

It should be noted that the estimates obtained from equation (9) are the estimates for number of crashes in the before period. Since, it is required to get the estimated number of crashes at the treatment site in the after period; the estimates obtained from equation (9) are to be adjusted for traffic volume changes and different before and after periods (Hauer, 1997; Noyce et al., 2006).

The adjustment factors for which are given as below:

$$\rho_{AADT} = \frac{AADT_{after}^{\alpha_I}}{AADT_{before}^{\alpha_I}} \quad (12)$$

Where,

$AADT_{after}$  = AADT in the after period at the treatment site.

$AADT_{before}$  = AADT in the before period at the treatment site.

$\alpha_I$  = Regression coefficient of AADT from the SPF.

Adjustment for different before-after periods ( $\rho_{time}$ ):

$$\rho_{time} = \frac{m}{n} \quad (13)$$

Where,

$m$  = Number of years in the after period.

$n$  = Number of years in the before period.

Final estimated number of crashes at the treatment location in the after period ( $\hat{\pi}_i$ ) after adjusting for traffic volume changes and different time periods is given by:

$$\hat{\pi}_i = \hat{E}_i * \rho_{AADT} * \rho_{time} \quad (14)$$

The index of effectiveness ( $\hat{\theta}_i$ ) of the treatment is given by:

$$\hat{\theta}_i = \frac{\hat{\lambda}_i / \hat{\pi}_i}{1 + (\hat{\sigma}_i^2 / \hat{\pi}_i^2)} \quad (15)$$

where,

$\hat{\lambda}_i$  = Observed number of crashes at the treatment site during the after period.

$$\hat{\sigma}_i = \sqrt{(1 - \gamma_i) * \hat{E}_i} \quad (16)$$

The percentage reduction ( $\tau_i$ ) in crashes of particular type at each site  $i$  is given by:

$$\hat{\tau}_i = (1 - \hat{\theta}_i) * 100\% \quad (17)$$

The Crash Reduction Factor or the safety effectiveness ( $\hat{\theta}$ ) of the treatment averaged over all sites would be given by (Persaud et al., 2004):

$$\hat{\theta} = \frac{\sum_{i=1}^m \hat{\lambda}_i / \sum_{i=1}^m \hat{\pi}_i}{1 + (var(\sum_{i=1}^m \hat{\pi}_i) / (\sum_{i=1}^m \hat{\pi}_i)^2)} \quad (18)$$

Where,

m=total number of treated sites;

$$var(\sum_{i=1}^k \hat{\pi}_i) = \sum_{i=1}^k \rho_{AADT}^2 * \rho_{AADT}^2 * var(\hat{E}_i) \quad (\text{Hauer, 1997}) \quad (19)$$

The standard deviation ( $\hat{\sigma}$ ) of the overall effectiveness can be estimated using information on the variance of the estimated and observed crashes, which is given by Equation

$$\hat{\sigma} = \sqrt{\frac{\theta^2 \left[ \frac{var(\sum_{i=1}^k \hat{\pi}_i)}{(\sum_{i=1}^k \hat{\pi}_i)^2} + \frac{var(\sum_{i=1}^k \hat{\lambda}_i)}{(\sum_{i=1}^k \hat{\lambda}_i)^2} \right]}{[1 + (var(\sum_{i=1}^m \hat{\pi}_i) / (\sum_{i=1}^m \hat{\pi}_i)^2)]^2}} \quad (20)$$

where,

$$var(\sum_{i=1}^k \hat{\lambda}_i) = \sum_{i=1}^k \lambda_i \quad (\text{Hauer, 1997}) \quad (21)$$

### 6.1.3. Cross-Sectional Method

A negative binomial model is the most widely used for estimating the safety performance functions, of which the functional form is as follows:

$$\lambda_i = \exp(\beta_0 + \beta X_i + \ln(year) + \varepsilon_i) \quad (22)$$

where,  $\lambda_i$  is the Poisson distribution for intersection  $i$ ,  $\beta_0$  is the intercept,  $X_i$  is a set of independent variables,  $\beta$  is the corresponding parameters, year is the number of crash-years, and  $\exp(\varepsilon_i)$  is gamma-distributed with mean 1 and variance  $\alpha$  so that the variance of crash count distribution becomes  $\lambda_i(1 + \alpha\lambda_i)$  that is capable of handling over-dispersion.



A CMF from the cross-sectional method is calculated by exponentiating the coefficient of the variable of interest (i.e., alternative intersections/conventional intersections, other possible factors that might affect safety at alternative intersections), and its confidence interval is determined as follows:

$$\text{Confidence Interval of CMF} = \exp(\text{coef} \pm z \text{ score} \times S.E. (\text{coef})) \quad (23)$$

where,  $\text{coef}$  is the estimated coefficient of a variable of interest and  $S.E. (\text{coef})$  is the standard error of the coefficient.  $z$  scores for 99%, 95%, and 90% are 2.576, 1.96, and 1.645, respectively.

A CMF for combined two effects and its confidence interval are estimated using the following equations:

$$CMF = \exp(\text{coef}_1) \times \exp(\text{coef}_2) = CMF_1 \times CMF_2 \quad (24)$$

Confidence Interval of CMF

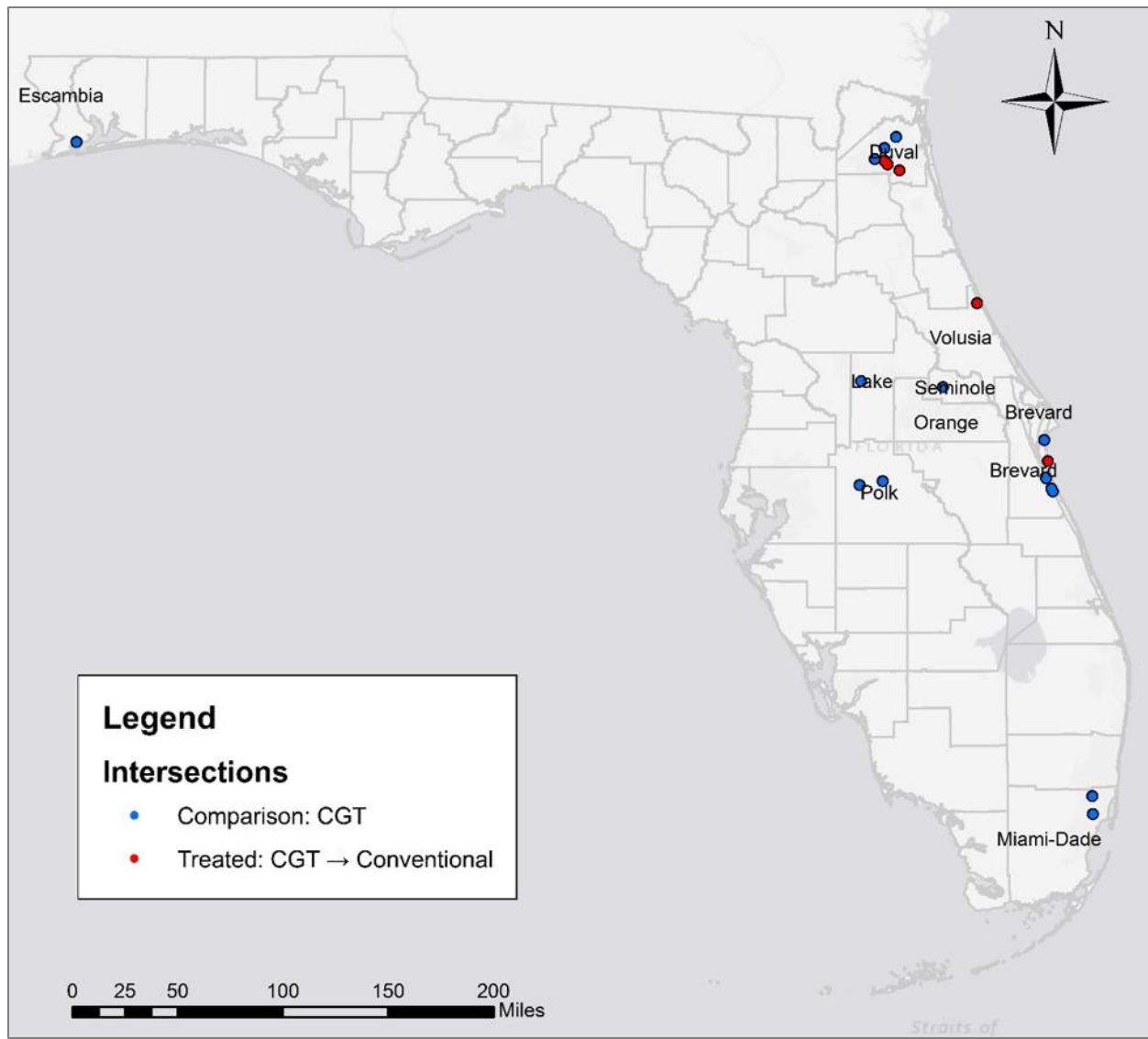
$$[\min(\exp(\text{coef}_1) \pm z \text{ score} \times S.E. (\text{coef}_1) \times \exp(\text{coef}_2) \pm z \text{ score} \times S.E. (\text{coef}_2)), \max(\exp(\text{coef}_1) \pm z \text{ score} \times S.E. (\text{coef}_1) \times \exp(\text{coef}_2) \pm z \text{ score} \times S.E. (\text{coef}_2))] \quad (25)$$

where,  $\text{coef}_1$  and  $\text{coef}_2$  are the estimated coefficient of two variables of interest and  $S.E. (\text{coef}_1)$  and  $S.E. (\text{coef}_2)$  are the standard errors of the coefficients.

## **6.2. CONTINUOUS GREEN T-INTERSECTION**

### **6.2.1. Data Processing for Continuous Green T-Intersections**

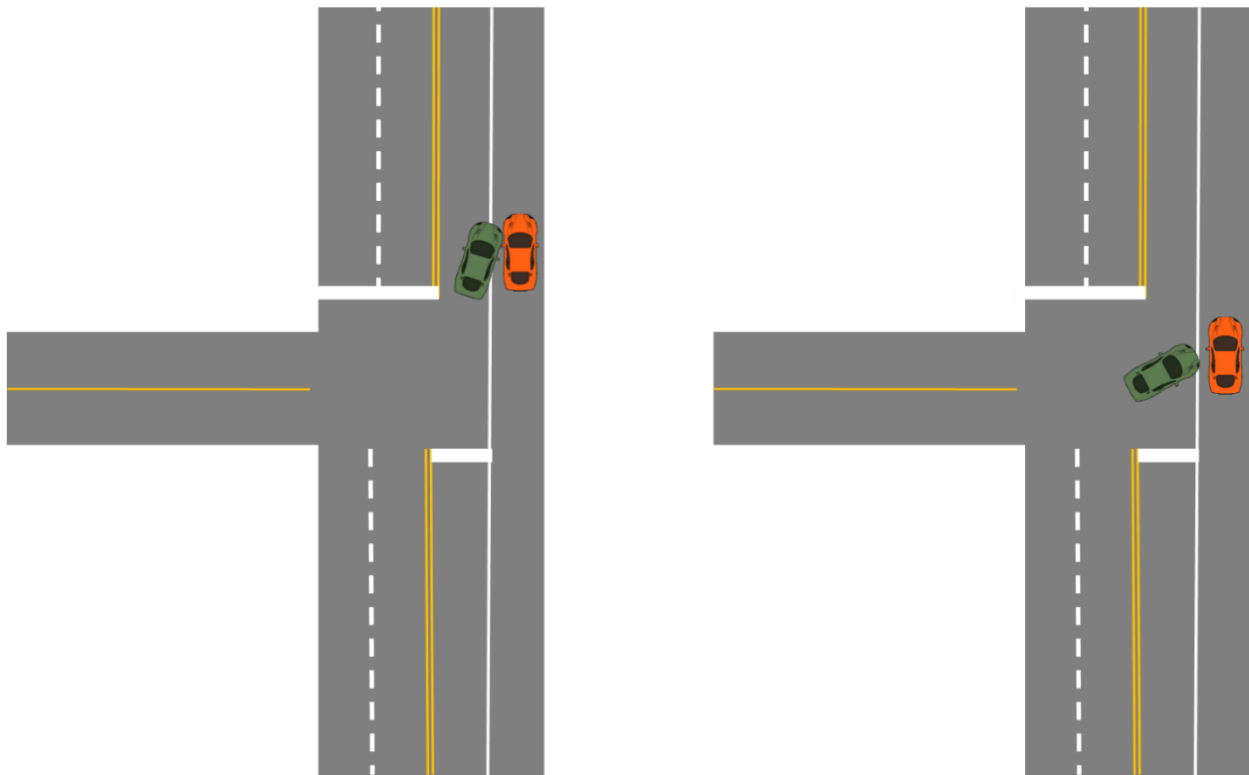
In order to explore the safety effects of continuous green T-intersections (CGTs), two methods were employed: a before-and-after method using the comparison group and cross-sectional method. For the before-and-after study, the research team used Google Earth and Google Street View, and confirmed that six intersections in Duval, Brevard, and Volusia Counties have been converted from the CGT design back to the conventional T-intersection design between 2014 and 2015. Those intersections were used for the treated group in this study while CGTs without any change in the design in the study period were used for the comparison group. The locations of the identified treated sites (i.e., conversion from CGTs to non-CGT) and comparison sites (i.e., CGTs) are shown in Figure 6-1. Crash data of 2012-2017 were collected from Signal Four Analytics managed by the University of Florida GeoPlan Center. The collected crash data were classified by injury severity (i.e., fatal, injury, and no injury (i.e., property damage only or PDO)), crash type (rear-end, CGT-related, single-vehicle, non-motorized user involved, and elderly driver involvement).



**Figure 6-1: Locations of treated and comparison sites**

A CGT-related crash is defined as any collision (e.g., angle, left-turn, sideswipe) between a through vehicle on the flat side (top) of T-intersection and a left-turning vehicle from the minor road. We defined the CGT-related crashes because many angle, left-turn, and sideswipe crashes are not relevant to the CGT operation. Also, the same type of CGT-related crashes is often coded differently (i.e., angle, left-turn, and sideswipe) as they are difficult to distinguish. Figure 6-2 shows sideswipe and angle crashes that occurred between a vehicle on the CGT through lane and

a left-turning vehicle from the minor road. Both cases could be identified as either angle, left-turn, or sideswipe crashes by police officers. It is considered that those crashes are the most relevant to the CGT operation. Thus, we decided to define a CGT-related crash in this study. That of course in addition to the traditional crash types and severities.



**Figure 6-2: Sideswipe (left) and angle crashes (right) between a vehicle on the CGT through lane and a left-turning vehicle from the minor road**

Please note that CGT-related crashes could happen at non-CGT intersections, they are called CGT-related crashes in this study. The yearly number of crashes by type are summarized in Table 6-1. The crashes of 2012-2013 and those of 2016-2017 were used for the before and after periods, respectively. However, the crash data of 2014-2015 were excluded from the analysis as it is the transition period.

In addition, annual average daily traffic (AADT) of 2013 and 2016 were collected from the Florida Department of Transportation (FDOT) Roadway Characteristics Inventory (RCI), which represent the traffic level in the before and after periods, respectively. The collected traffic volume is summarized in Table 6-2. In order to ensure that there is no significant difference in traffic volumes between treated and comparison sites, two t-tests were conducted for each period. For both before and after periods, there is no evidence that the traffic volumes between treated and comparison sites are statistically significantly different.

For the cross-sectional analysis, new additional data were collected from Florida (2016), Colorado (2014-2015), Nevada (2016) and Texas (2011-2012). The summary of the collected data are shown in Table 6-3. Several possible characteristics that might affect traffic safety at the CGTs were obtained from Google Earth. They include whether there is a physical separation between the acceleration lane for the merging vehicles and the CGT lane; the length of separation of an acceleration lane for merging vehicles from the minor road on the flat side of the CGT intersection (i.e., separation length) - either pylons, barriers, or solid line marking; the roughness index (or IRI); and the number of CGT through lanes.

**Table 6-1: Summary of crash counts by type by year (Florida)**

Crash Type	Site	2012	2013	2014	2015	2016	2017	Before Total	After Total
<b>Total (KABCO)</b>	Treated	67	78	64	67	54	52	145	106
	Comparison	115	148	150	141	160	187	263	347
<b>Fatal-and-injury (KABC)</b>	Treated	25	28	21	22	17	11	53	28
	Comparison	35	50	51	44	45	50	85	95
<b>No injury (PDO)</b>	Treated	42	50	43	44	36	41	92	77
	Comparison	80	97	98	96	114	137	177	251
<b>Rear-end</b>	Treated	35	50	37	29	25	23	85	48
	Comparison	55	48	59	55	66	75	103	141
<b>CGT-related</b>	Treated	3	6	2	5	2	3	9	5
	Comparison	16	15	26	15	18	16	31	34
<b>Single-vehicle</b>	Treated	13	8	14	16	16	10	21	26
	Comparison	21	34	26	29	28	29	55	57
<b>Non-motorized</b>	Treated	0	1	0	2	2	1	1	3
	Comparison	0	3	0	1	2	2	3	4
<b>Elderly driver involved (65+)</b>	Treated	15	16	11	11	14	8	31	22
	Comparison	36	36	50	28	52	32	72	84

**Table 6-2: Comparison of AADT in treated and comparison sites (Florida)**

Statistics	Before Period (2013)		After Period (2016)	
	Treated	Comparison	Treated	Comparison
<b>Sample size</b>	6	15	6	15
<b>Mean</b>	41,040.4	33,510.2	44,148.9	37,166.1
<b>Std. Dev.</b>	8,969.2	10,288.8	9,570.0	11,010.8
<b>Minimum</b>	28,900	18,300	32,250	19,300
<b>Maximum</b>	50,800	56,900	58,850	64,300

**Table 6-3: Descriptive statistics of data for the cross-sectional analysis**

Variables		Mean	S.D.	Min	Max
<i>Pooled Data (N=41), Florida=22, Nevada=6, Texas=5, Colorado=8</i>					
<b>Major AADT</b>		27,847.073	10,233.100	6,000	50,500
<b>Minor AADT</b>		9,155.561	6,219.976	18	29,500
<b>Total entering vehicles (TEV)</b>		32,424.829	11,089.918	6,650	54,350
<b>CGT (yes=1, no=0)</b>		0.585	0.499	0	1
<b>Pedestrian crossing (yes=1, no=0)</b>		0.415	0.499	0	1
<b>Railroad crossing (yes=1, no=0)</b>		0.049	0.218	0	1
<b>Total lanes on the major road</b>		5.805	1.123	3	8
<b>Left-turn lanes on the major road</b>		1.049	0.312	0	2
<b>Total lanes on the minor road</b>		3.537	0.897	2	5
<b>Left-turn lanes on the minor road</b>		1.244	0.435	1	2
<b>CGT intersections only (N=24)</b>	<b>Physical separation</b>	0.542	0.509	0	1
	<b>Separation length (feet)</b>	635.000	292.158	300	1400
	<b>International roughness index (IRI)</b>	97.458	52.755	41	247
	<b>CGT through lanes</b>	1.667	0.637	1	3
<b>Total crashes (KABCO)</b>		9.634	7.074	1	32
<b>Fatal-and-injury crashes (KABC)</b>		3.537	2.785	0	10
<b>No injury crashes (PDO)</b>		6.098	4.888	0	22
<b>Rear-end crashes</b>		4.463	4.063	0	13
<b>CGT-related crashes</b>		2.415	4.093	0	25
<b>Single-vehicle crashes</b>		1.171	1.642	0	6
<b>Non-motorized crashes</b>		0.171	0.442	0	2

## **Before-and-After Analysis of Continuous Green T-Intersections**

Table 6-4 summarizes the results of the safety analyses using the before-and-after method with the comparison group. The statistical significant reductions are shown. The relative numbers of crashes have been decreased for total, injury, PDO, rear-end, sideswipe, and left-turning and angle crashes after the CGT were removed. Overall, about 46% of crashes have been reduced, and 56% and 44% of injury and PDO crashes have been decreased, respectively, after the CGT removal. Moreover, 61% of rear-end crashes have been reduced. The most significant reduction was observed (64%) in CGT-related crashes. However, no significant change for single-vehicle, non-motorized, and elderly driver involved crashes were found. The results showed that there are significant reductions in total, injury, PDO, rear-end, CGT-related crashes after the conversion of the CGTs back to the conventional T-intersections. Even though the CMF for single-vehicle crashes was insignificant ( $p=0.283$ ), it is the only CMF that is greater than one. Thus, it is still possible that there is a potential that single crashes could be increased after the conversion.

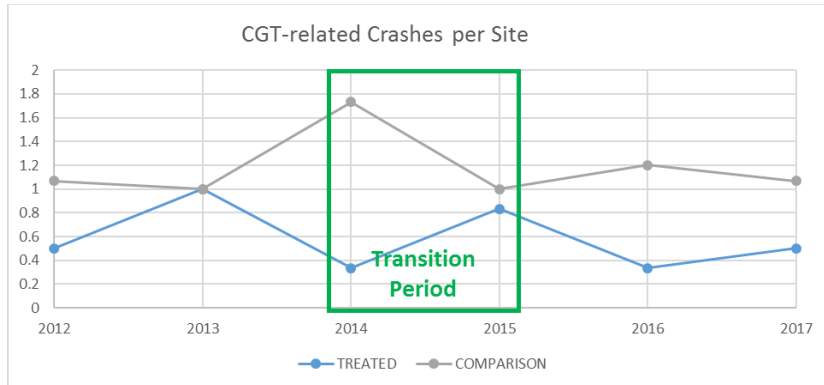
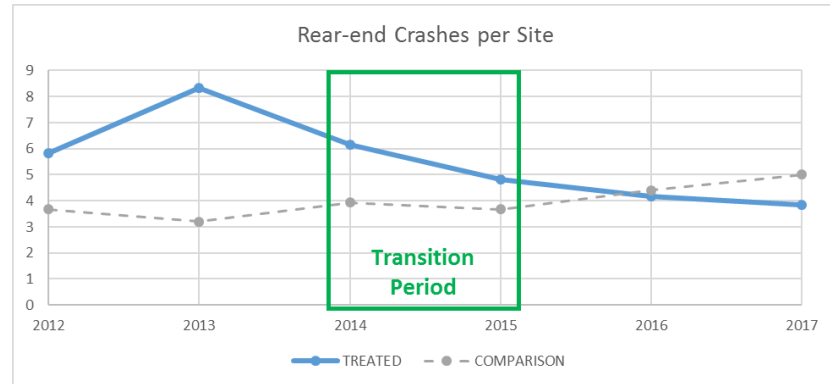
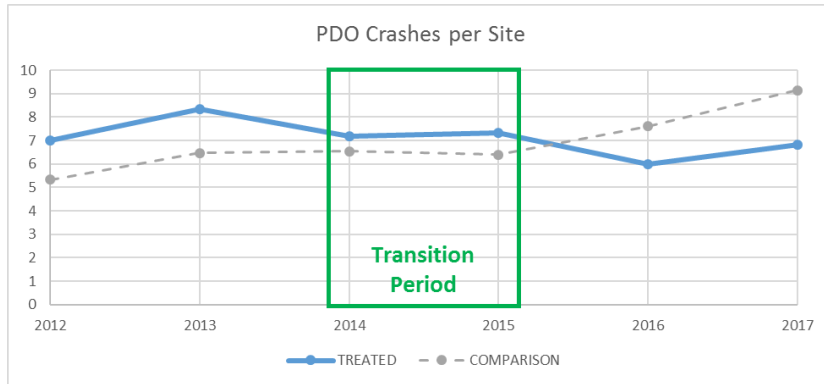
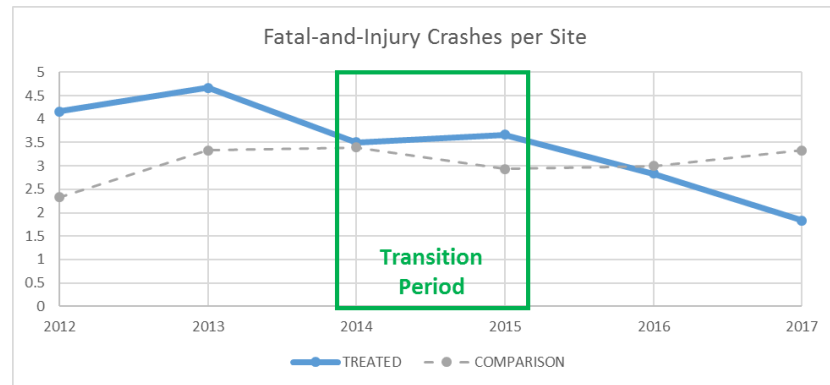
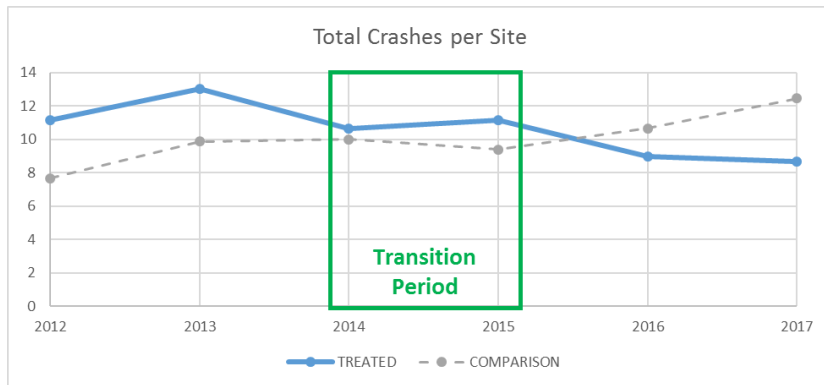


**Table 6-4: CMFs for the conversion of CGTs back to the conventional design by crash type (before-and-after study with the comparison group)**

Crash Type	Before-and-After with the Comparison Group		
	CMF	S.E.	p
Total (KABCO)	<b>0.539<sup>***</sup></b>	0.108	0.000
Fatal-and-Injury (KABC)	<b>0.444<sup>***</sup></b>	0.164	0.001
No injury (PDO)	<b>0.564<sup>***</sup></b>	0.137	0.001
Rear-end	<b>0.393<sup>***</sup></b>	0.136	0.000
CGT-related	<b>0.362<sup>*</sup></b>	0.115	0.340
Single-vehicle	1.307	0.286	0.283
Non-motorized	0.281	0.507	0.156
Elderly driver involved (65+)	0.793	0.230	0.368

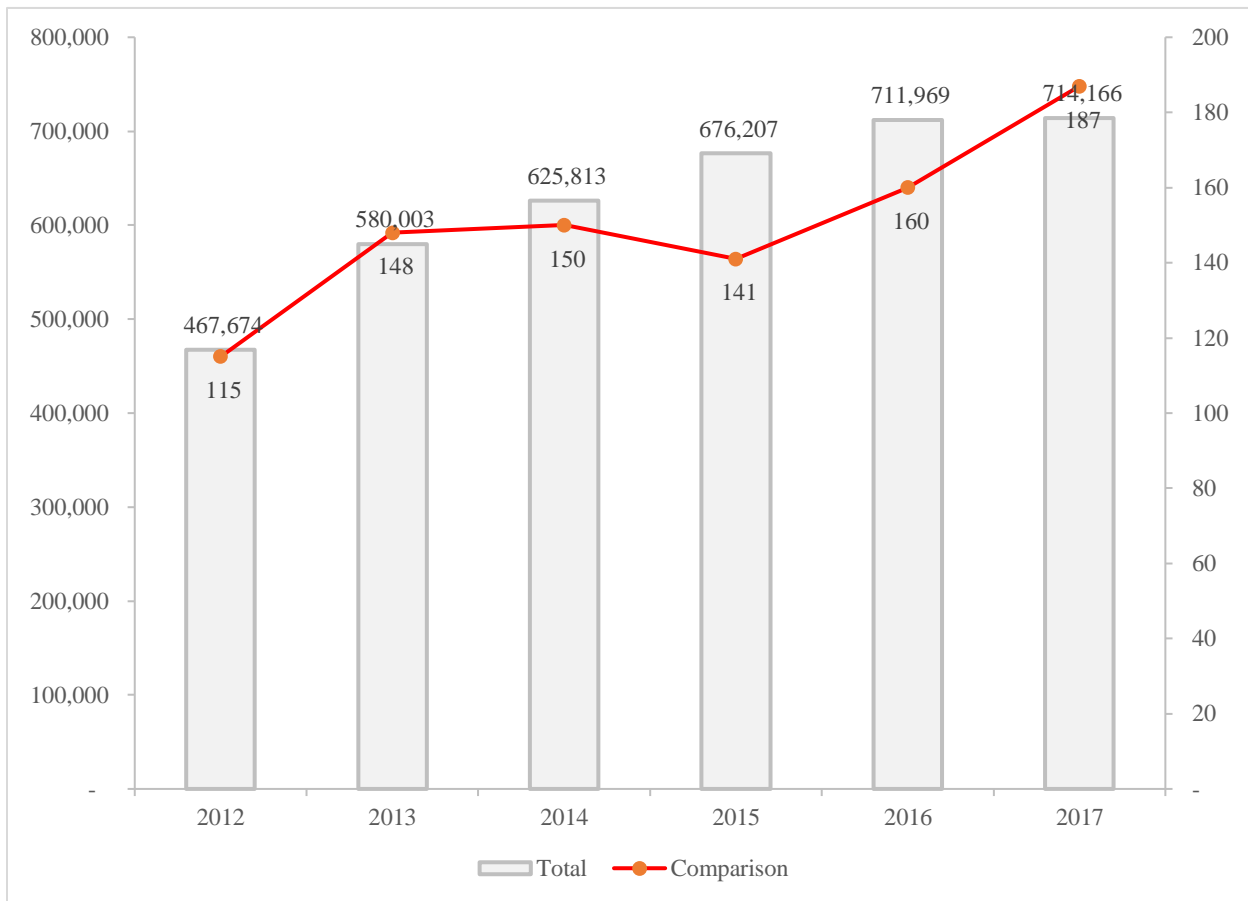
<sup>\*\*\*</sup> significant at 99% confidence level, <sup>\*\*</sup> significant at 95% confidence level, and <sup>\*</sup> significant at 90% confidence level.

Figure 6-3 presents the crash counts per site by year by type. In most of the cases, gradual decreases in crashes at the treated sites and increases at the comparison sites are observed before and after the transition period. It is generally assumed that there is no considerable change in the comparison sites; otherwise, those comparison sites might have been affected by unexplainable external factors, which is not desirable. Nevertheless, the increasing trends of total, fatal-and-injury, PDO, and rear-end crashes were observed in the comparison sites in Figure 6-3. Thus, the research team checked the total number of crashes in Florida by year if the increasing trend is statewide in order to ensure that the comparison sites were properly selected (Figure 6-4).



**Figure 6-3: Yearly crash counts per site by crash type**

Figure 6-4 displays the total number of crashes by year in Florida and the comparison sites. As seen in the figure, the number of crashes in the comparison sites have a similar increasing trend as the statewide crash count. A Chi-square test was conducted to ensure the equality of proportions by year, and the result shows that there is no evidence for a significant difference between the crash counts in statewide and comparison sites ( $\chi^2=0.553$ , d.f.=5,  $p=0.645$ ). In other words, the increasing crash counts in the comparison sites because of the statewide trend. As shown in Table 6-2, traffic volume has increased from 2013 to 2016, possibly due to the economic growth. Thus, it appears that the statewide increasing crash trend is because of the increased traffic volume.



**Figure 6-4: Crash trends of statewide and comparison sites**

### 6.2.2. Estimating CMFs for Continuous Green T-Intersections

Subsequently, a cross-sectional analysis was conducted to validate the results of the before-and-after study with the comparison group and identify factors that could increase (or decrease) crashes at CGTs. Safety performance functions were developed to estimate CMFs. The modeling results are shown in Table 6-5. State dummy variables of Nevada and Colorado were significant for total, fatal-and-injury, and no-injury. It indicates that Nevada has more and Colorado has less number of crashes compared to other two states: Florida and Texas. TEV was positively associated with the crashes except for single-vehicle crashes. For fatal-and-injury, the ratio of the minor AADT to the major AADT has a positive association with crashes.

International Roughness Index (IRI) values were obtained from the Highway Performance Monitoring System of the Federal Highway Administration (FHWA). Although the research team thinks that the IRI values change throughout the time period it was used only used for the cross-sectional method, which compares the different site with one time period), and the team found that the pavement roughness has some effect on safety. The previous research also showed that the pavement conditions plays an important role in safety (Lee et al., 2015; Lee and Abdel-Aty, 2019).

A dummy variable indicating CGTs has a significant positive coefficient in total, fatal-and-injury, no injury, and CGT-related crashes, which implies that CGTs have higher crash risks for those crash types. Nevertheless, physical separation was found significant to reduce the negative safety effects of CGTs for total, fatal-and-injury, no injury, and CGT-related crashes. An increase of separation length has a significant effect to reduce CGT-related crashes. It was also

shown that a good pavement condition at CGTs could reduce fatal-and-injury crashes and longer separation could decrease the number of CGT-related crashes. In the case of rear-end crashes, its non-CGT dummy variable has a significant negative coefficient in Table 6-5, the interaction term of CGT and CGT through lanes (i.e., CGT\*CGT through lanes) cancelled out the effect. Even with only one CGT through lane, the non-CGT dummy variable became insignificant. Therefore, it is concluded that CGTs do not have significantly more rear-end crashes compared to conventional intersections.

**Table 6-5: Safety performance functions for CGTs and non-CGTs using data of Florida, Nevada, Texas, and Colorado (N=41)**

Variable		Total (KABCO)	Fatal-and- injury (KABC)	No injury (PDO)	Rear-end	CGT-related	Single-vehicle
Intercept		-5.4249** (2.4885)	-7.1700** (3.0198)	-6.6588** (3.1005)	-9.3631** (3.6412)	-15.8272*** (6.0479)	-3.6881# (5.6583)
Nevada		0.9483*** (0.2354)	1.1685*** (0.2634)	1.0015*** (0.2853)	1.4091*** (0.2672)		
Colorado		-1.0387*** (0.2898)	-1.0159*** (0.3776)	-0.9438*** (0.3581)	-1.1514*** (0.4028)		
Log (TEV)		0.7611*** (0.2383)	0.7901*** (0.2896)	0.8358*** (0.2970)	1.1882** (0.3599)	1.7954*** (0.5684)	0.3507# (0.5480)
Ratio of the minor AADT to the major AADT			0.4871* (0.2951)				
<b>CGT</b>		<b>0.6308*** (0.2170)</b>	<b>0.6180** (0.2518)</b>	<b>0.5841** (0.2625)</b>	<b>2.0790*** (0.4437)</b>	<b>2.3987** (0.9419)</b>	
Interaction terms	CGT*physical separation	-0.6219*** (0.2336)	-0.6904** (0.2823)	-0.7456*** (0.2869)		-1.5756*** (0.5771)	
	CGT*separation length					-0.0022* (0.0011)	
	CGT*(1-IRI/100)		-0.3445* (0.2040)				
	CGT*CGT through lanes				-1.0189*** (0.2302)		
Over-dispersion		0.1587 (0.0653)	0.0000 (0.0026)	0.2228 (0.0975)	0.1583 (0.1032)	0.7940 (0.3238)	1.0922 (0.5047)
LL (null)		-139.05	-100.29	-122.66	-112.33	-88.003	-61.981
LL (full)		-117.9868	-78.3973	-106.0728	-90.9492	-78.49	-61.7827
McFadden's rho-squared		0.151	0.218	0.135	0.190	0.108	0.003
AIC		249.9735	174.7946	226.1455	195.8985	168.98	129.5655
BIC		261.9685	190.2167	238.1405	207.8935	179.261	134.7062

The numbers in parentheses are the standard error.

\*\*\* significant at 99% confidence level, \*\* significant at 95% confidence level, \* significant at 90% confidence level, and # not significant at 90% level.

Table 6-6 shows a series of CMFs of non-CGT (vs. CGT) that were calculated to be consistent with the results from the before-and-after study. Compared to the CMFs estimated from the before-and-after study with the comparison group (Table 6-4), the CMF values from the two methods and different data are quite consistent for total, fatal-and-injury, and no injury crashes. Nevertheless, the CMF for rear-end crashes using the cross-sectional method is not significant. The CMF for CGT-related crashes estimated from the before-and-after method is larger than that from the cross-sectional method (0.362 vs. 0.091); but both still indicate the reduction in CGT-related crashes without CGTs.

**Table 6-6: CMFs of non-CGTs (vs. CGTs) (cross-sectional method)**

Variables	Crash Type	CMF	Confidence Interval					
			Lower 99%	Lower 95%	Lower 90%	Upper 90%	Upper 95%	Upper 99%
Non-CGT (without other factors)	Total (KABCO)	<b>0.5322</b> ***	0.3043	0.3478	0.3724	0.7605	0.8143	0.9307
	Fatal-and-injury (KABC)	<b>0.5390</b> **	0.2818	0.3291	0.3562	0.8156	0.8830	1.0311
	No injury (PDO)	<b>0.5576</b> **	0.2836	0.3333	0.3621	0.8587	0.9328	1.0965
	CGT-related	<b>0.0908</b> **	0.0080	0.0143	0.0193	0.4277	0.5755	1.0280

\*\*\* significant at 99% confidence level, \*\* significant at 95% confidence level, and \* significant at 90% confidence level

Table 6-7 presents the combined effects of CGT and other features, including CMFunctions when appropriate. The CMFs of first combination (i.e., CGT and physical separation) shows they are insignificant even at 90% confidence level. It implies that if CGT is operated with the physical separation between the acceleration lane for the merging vehicles and the CGT lane, CGTs would not have more total injury, no injury, and CGT-related crashes than non-CGTs. The

three interaction terms have variable factors (i.e., separation length, IRI, and the number of CGT through lanes), and their CMF are expressed as a functional form (as known as crash modification function). The CMFs of the second combination (i.e., CGT and separation length) for CGT-related crashes are significantly greater than one if the separation length is shorter than 300 feet. It suggests that such CGT-related crashes at CGTs could be minimized with a sufficient separation length. The CMFs of the third combination (CGT and  $1-IRI/100$ ) for fatal-and-injury crashes are insignificant until the IRI value reaches 80, which suggests the IRI needs to be lower than 80 and the number of fatal-and-injury crashes at CGTs are not significantly different from that at non-CGTs. Lastly, the CMFs for the combination of CGT and the number of CGT through lanes are all insignificant regardless of the number of CGT through lanes. However, as Jarem (2004) pointed out, it is still possible that out-of-town drivers who are not familiar with the CGT design might be confused, and they are more likely to cause a rear-end crash. Our results might suggest a tendency that the number of rear-end crashes could be smaller at the CGTs with more number of CGT through lanes. It is possible that the CGTs with more CGT through lanes might be less confusing to drivers on CGT through lanes whether they need to stop or go, and the number of rear-end crashes are less likely to occur.



**Table 6-7: Combined effects of CGT and other features**

Combination	Crash Type	Crash Modification Function	CMF	Confidence Interval						
				Lower 99%	Lower 95%	Lower 90%	Upper 90%	Upper 95%	Upper 99%	
CGT and physical separation	Total (KABCO)	N/A	1.0089	0.3161	0.4172	0.4808	2.1173	2.4402	3.2209	
	Fatal-and-injury (KABC)		0.9302	0.2350	0.3265	0.3864	2.2394	2.6497	3.6819	
	No injury (PDO)		0.8509	0.2066	0.2899	0.3446	2.1007	2.4976	3.5035	
	CGT-related		2.2775	0.0455	0.1160	0.1872	27.7117	44.7164	113.9824	
CGT and separation length (unit: feet)	CGT-related	$\exp(2.3987) \times \exp(-0.0022)^{\text{length}}$	<b>100</b>	<b>8.8348</b> **	0.5880	1.1241	1.5657	49.8528	69.4373	132.7403
			<b>200</b>	<b>7.0901</b> *	0.3555	0.7271	1.0485	47.9436	69.1324	141.4229
			300	5.6899	0.2149	0.4704	0.7022	46.1075	68.8289	150.6734
			400	4.5663	0.1299	0.3043	0.4702	44.3417	68.5267	160.5290
			500	3.6645	0.0785	0.1968	0.3149	42.6435	68.2259	171.0292
			1000	1.2198	0.0063	0.0223	0.0424	35.0798	66.7413	234.7766
			1500	0.1352	0.0000	0.0003	0.0008	23.7391	63.8684	442.4088
CGT and (1-IRI/100) (unit: inch per mile)	Fatal-and-injury (KABC)	$\exp(0.6180) \times \exp(-0.3445)^{(1-\frac{\text{IRI}}{100})}$	50	1.5617	0.6277	0.7806	0.8726	2.7948	3.1243	3.8851
			60	1.6164	0.6848	0.8409	0.9340	2.7973	3.1070	3.8154
			70	1.6731	0.7470	0.9059	0.9998	2.7998	3.0899	3.7469
			<b>80</b>	<b>1.7317</b> *	0.8149	0.9759	1.0701	2.8023	3.0728	3.6797
			<b>90</b>	<b>1.7924</b> **	0.8890	1.0513	1.1454	2.8048	3.0559	3.6137
			<b>100</b>	<b>1.8552</b> **	0.9698	1.1326	1.2260	2.8073	3.0390	3.5489
			<b>150</b>	<b>2.2039</b> ***	1.4984	1.6432	1.7226	2.8198	2.9561	3.2418
			<b>200</b>	<b>2.6182</b> ***	2.3149	2.3841	2.4202	2.8324	2.8754	2.9613
<b>250</b>	<b>3.1104</b> ***	3.5764	3.4590	3.4005	2.8451	2.7969	2.7051			
CGT and CGT through lanes	Rear-end	$\exp(2.0790) \times \exp(-1.0189)^{\text{CGT thru lanes}}$	1	2.8867	0.5087	0.7705	0.9527	8.7466	10.8151	16.3801
			2	1.0421	0.1015	0.1771	0.2355	4.6110	6.1303	10.6991
			3	0.3762	0.0202	0.0407	0.0582	2.4308	3.4748	6.9884

\*\*\* significant at 99% confidence level, \*\* significant at 95% confidence level, and \* significant at 90% confidence level

### 6.2.3. Summary

In the last decades, many alternative intersection designs have been proposed for improving efficiency and safety. Among the alternative intersection designs, continuous green T-intersections (CGTs) have been popularly implemented in many states in the United States. Nevertheless, several CGTs in Florida have been converted back to the conventional T-intersection design in the last half decade. Traffic engineers decided to stop CGT operations at these locations because of traffic safety concerns, conversion to four-legged intersection due to the adjacent development (not used in this study), non-compliance with the latest Manual on Uniform Traffic Control Devices (MUTCD), etc. The main objective of this research project is to develop SPFs and CMF. In this chapter, we evaluated the safety effects of the conversion of the CGT, and validated using the cross-sectional method. The research team identified six sites with the conversion back to conventional design, and fifteen CGTs without any change (remained CGT), and they were used as the treated group and the comparison group, respectively. A before-and-after study design with a comparison group was employed. A series of crash modification factors (CMFs) were estimated for various crash types. The results showed that there was about 40% reduction in total and no injury crashes after the conversion and approximately 60% of fatal-and-injury, rear-end, and CGT-related crashes were reduced.

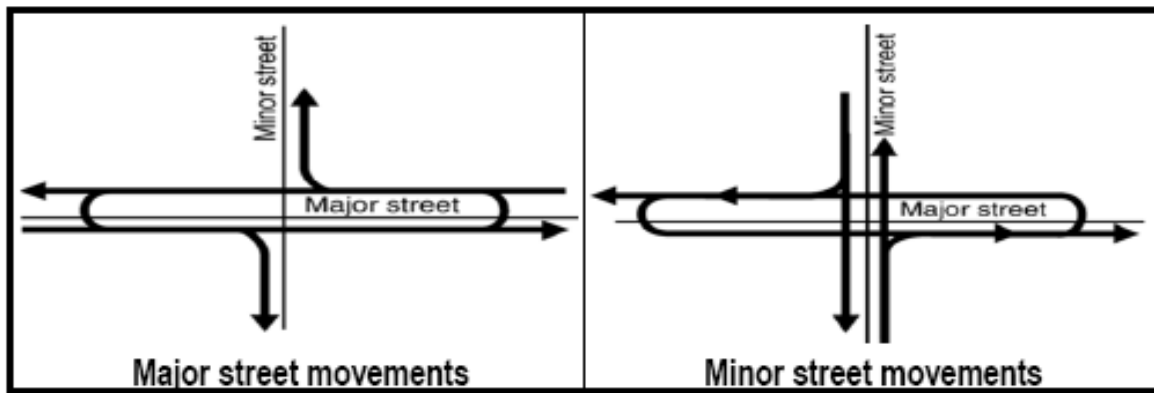
In order to validate the results from the before-and-after study with the comparison group, a cross-sectional analysis was conducted with new data from Florida, Nevada, Texas, and Colorado. The results are consistent for total, fatal-and-injury, no injury, and CGT-related crashes compared to those from the before-and-after study. The results also suggested effective countermeasures to minimize the number of crashes at CGTs. First, a physical separation between the acceleration lane for the merging vehicles and the CGT lane could result in no

significant difference in the numbers of total, injury, no injury, and CGT-related crashes between CGT and non-CGT. Second, provide a separation length longer than 300 feet (either solid pavement marking and/or physical separation) for reducing CGT-related crashes. Third, keep IRI at CGTs less than 80 to minimize fatal-and-injury crashes.

At Florida's T-intersections that were converted to the conventional design from the CGT in 2014-2015, which were used as the treated group in the before-and-after study, the CGT through lanes were not physically separated, and the results showed a significant safety improvement after the conversion. Therefore, this study supports the decision to stop CGT operation at Florida's study sites from a safety perspective, but also points to the needed improvements to retain the other CGT sites if they are providing better traffic efficiency. In conclusion, it is strongly recommended for policy makers and practitioners to consider providing a physical separation, sufficient separation length, and good pavement condition at CGTs, or stopping CGT operations if the current CGTs have experienced traffic safety problems, especially with total, fatal-and-injury, no injury, or CGT-related crashes. Although no significant increase was observed for single-vehicle, non-motorized users (although non-motorized activity could violate the justification to having CGTs), and elderly driver-involved crashes, it is possible that their insignificance resulted from the limited sample size. Because both Sando et al. (2010) and Tang and Levett (2010) showed that elderly drivers are more vulnerable to CGTs, further investigation is needed with a larger sample size, and possible alternative solutions in areas with larger elderly driver population. The analysis from this section was presented at the Transportation Research Board Annual Meeting in January, 2019 (Lee and Abdel-Aty, 2019).

### 6.3. MEDIAN U-TURN INTERSECTION

Median U-turn (MUT) intersection is the most common type of alternative intersections in the United States, especially in Michigan. The MUT intersections prohibit direct left-turns from major and minor approaches. Drivers who need to make a left-turn from the major road onto an intersecting cross-street must first pass the main intersection and then make a U-turn at the median opening located at the downstream of the intersection, and turn right. Drivers on the minor turning who wish to go left onto the major road must first turn right at the main intersection, then make a U-turn at the downstream median opening (Figure 6-5).



**Figure 6-5: Illustration of MUT left-turn traffic movements (Hughes et al., 2010)**

There are two types of MUTs. Type A have two U-turn lanes at the downstream (Figure 6-6) whereas Type B has additional two reverse U-turn lanes near the main intersection (Figure 6-7). Because the two types have different geometric characteristics and traffic movement that might affect traffic safety, SPFs and CMFs were developed separately for the two types. In addition, partial MUT intersections has only one U-turn.



**Figure 6-6: MUT: Type A at US-24 & W Warren St., Detroit, Michigan**



**Figure 6-7: MUT Type B at E 10 Mile Rd & Gratiot Ave., Michigan, Michigan**

**6.3.1. Data Processing for Median U-Turn Intersections**

Many MUTs in Michigan, which were investigated in this analysis were implemented in the 1960s, thus before-and-after methods could not be adopted due to the lack of crash data before the implementation. Thus, cross-sectional methods were used to develop the SPFs and estimating the CMFs for MUTs.

Since the MUTs consist of both main intersection and U-turn lanes at downstream, different influence areas of intersections were considered. In the analysis, the following influence areas of intersections were studied:

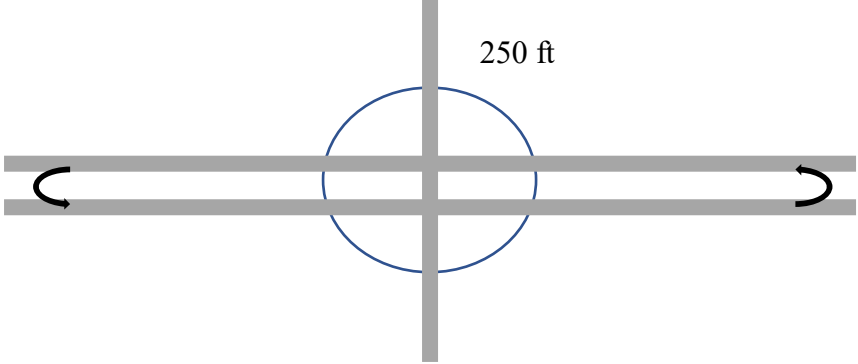
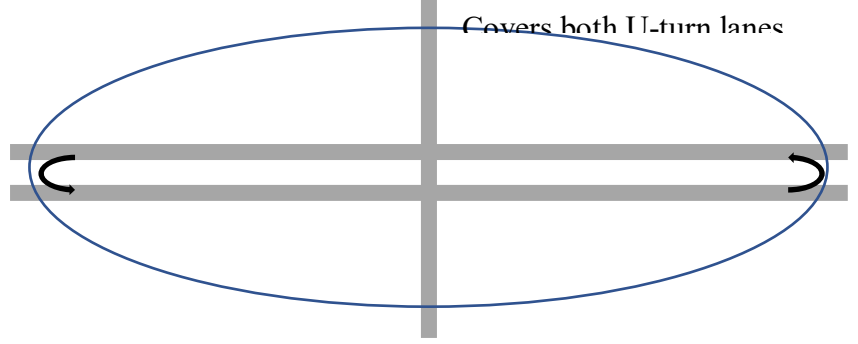
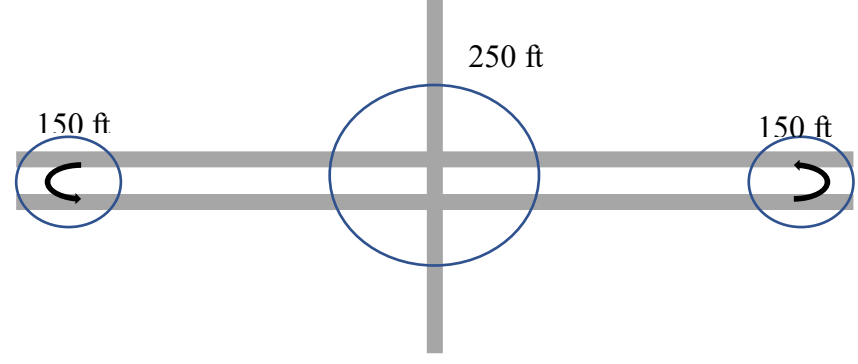
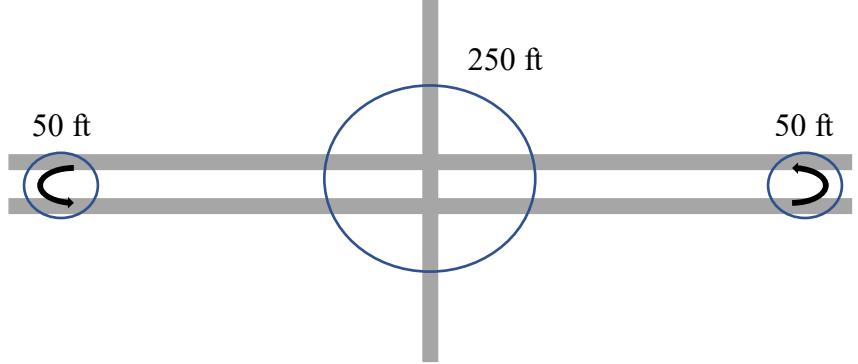
- (1) 250 feet buffers from the center of the main intersection (same as the traditional approach) using TEV as an exposure
- (2) Large buffers that would cover both U-turn lanes and the main intersection using DVMT as an exposure
- (3) 250 feet buffers from the center of the main intersection and 150 feet buffer from the center of both U-turn lanes using DVMT as an exposure
- (4) 250 feet buffers from the center of the main intersection and 50 feet buffer from the center of both U-turn lanes using DVMT as an exposure

The abovementioned influence areas of intersections are displayed in Figure 6-8.

From Michigan, data from 53 MUT: Type A and 20 MUT: Type B intersections were collected. In addition, data from 151 conventional intersections were acquired and they were used to compare with the MUTs.

Approximately two conventional intersections were chosen for one MUT (2:1 ratio). The selected conventional intersections are very close to the MUTs. A MUT and its two conventional intersections for the comparison have comparable AADT. Both MUTs and compared conventional intersections are four-legged, signalized and located in urban areas.

Concerning the sample size, the Highway Safety Manual (HSM) recommends using minimum 30 sites with 100 crashes. In order to secure the sufficient sample size, the team used multiple years of data. The majority of MUTs are located in Michigan and the team used 73 MUTs and 151 conventional intersections from Michigan, and the total number of crashes is over 20,000. Thus, the team believes that the sample size is acceptable from the statistical point of view.

Influence areas of intersections	Schematic Diagrams
(1)	 <p>250 ft</p>
(2)	 <p>Covers both T-turn lanes</p>
(3)	 <p>250 ft</p> <p>150 ft</p> <p>150 ft</p>
(4)	 <p>250 ft</p> <p>50 ft</p> <p>50 ft</p>

**Figure 6-8: Influence areas of intersections for the safety analysis for MUT intersections**

Crash and traffic data were prepared for each influence area. The average crash frequencies by different influence area of intersections for all crash types are presented in Table 6-8. As seen in the table, the average crash frequency values in (1) Main 250 feet, (3) Main 250 feet + U-turn 150 feet, and (4) Main 250 feet + U-turn 50 feet were not significantly different from each other. For conventional intersections, 250 feet was used as the influence area of intersection (i.e., same as (1)). Nevertheless, the average crash frequency values in (2) Covering both U-turn lanes are quite larger than those in other influence areas of intersections are, as it covers excessively wider area.

**Table 6-8: Average crash frequency by different influence area of intersections**

Variables	(1) Main 250 ft	(2) Covering both U-turn lanes	(3) Main 250 ft + U-turn 150 ft	(4) Main 250 ft + U-turn 50 ft
Total	127.522	279.009	140.938	128.951
Injury	26.504	57.871	29.661	26.763
Fatal	0.174	0.482	0.214	0.183
Single-vehicle	5.179	18.022	6.121	5.254
Head-on	0.857	2.504	0.879	0.862
Head-on Left-turn	6.388	9.616	6.424	6.402
Angle	26.018	58.549	28.496	26.290
Rear-end	59.228	116.879	65.473	59.875
Rear-end Left-turn	1.335	2.371	1.469	1.371
Rear-end Right-turn	1.817	3.272	2.009	1.826
Same-direction Sideswipe	19.098	44.893	21.777	19.402
Opposite-direction Sideswipe	1.469	3.920	1.545	1.473
Non-motorized	2.080	4.964	2.290	2.094

As a preliminary analysis, CMFs by different influence area of intersections were estimated using the cross-sectional method. The simple SPFs only with daily vehicle-miles-traveled



(DVMT) and MUT dummy variables were developed for estimating the CMFs. Table 6-9 summarizes the estimated CMFs. It would be problematic if we do not consider crashes at U-turn lanes as they have several conflict points which have been moved downstream from the main intersection. Also, the buffers covering both U-turn lanes cover too wide area. The team has decided to use (4) Main 250 ft + U-Turn 50 ft because the U-turn lane have only two conflict points and their influence area is quite limited. Considering 150 feet for U-turn lanes might consider crashes that are not relevant to MUT intersections. Based on the influence area of intersections, (4) Main 250 ft + U-turn 50 ft, the crash (i.e., response) and explanatory variables are prepared (Table 6-10).

**Table 6-9: Estimated CMFs by different influence area of intersections**

*MUT: Type A*

Crash type	CMF			
	(1) Main 250 ft	(2) Covering both U-turn lanes	(3) Main 250 ft + U-turn 150 ft	(4) Main 250 ft + U-turn 50 ft
Total	0.5973***	0.9830	0.6086***	0.6087***
Injury	0.7037***	1.1279	0.7854**	0.7233***
Single-vehicle	1.5073***	3.8954***	2.0303***	1.5206***
Head-on	0.2472***	1.1200	0.2611***	0.2440**
Head-on Left-turn	0.0623***	0.2497***	0.0552***	0.0604***
Angle	0.5988***	0.9778	0.6401***	0.7064***
Rear-end	0.5823***	0.7471**	0.5587***	0.5019***
Rear-end Left-turn	0.3582***	0.9501	0.3452***	0.3933***
Rear-end Right-turn	0.9638	1.5203*	0.9665	0.8903***
Same-direction Sideswipe	0.7189***	1.2533	0.7238***	0.7956*
Opposite-direction Sideswipe	0.2220***	1.2285	0.2583***	0.2287***
Non-motorized	2.1968***	5.4162***	2.7632***	2.2425***

*MUT: Type B*

Crash type	CMF			
	(1) Main 250 ft	(2) Covering both U-turn lanes	(3) Main 250 ft + U-turn 150 ft	(4) Main 250 ft + U-turn 50 ft
Total	0.6694 <sup>***</sup>	1.5785 <sup>***</sup>	0.6497 <sup>***</sup>	0.6322 <sup>***</sup>
Injury	0.7126 <sup>***</sup>	1.7169 <sup>***</sup>	0.7411 <sup>**</sup>	0.6896 <sup>***</sup>
Single-vehicle	1.5544 <sup>***</sup>	5.9501 <sup>***</sup>	1.9152 <sup>***</sup>	1.5885 <sup>***</sup>
Head-on	0.4675 <sup>**</sup>	1.6871	0.3969 <sup>***</sup>	0.4410 <sup>**</sup>
Head-on Left-turn	0.0681 <sup>***</sup>	0.3272 <sup>***</sup>	0.0566 <sup>***</sup>	0.0623 <sup>***</sup>
Angle	0.6276 <sup>***</sup>	1.5842 <sup>***</sup>	0.6354 <sup>***</sup>	0.6648 <sup>***</sup>
Rear-end	0.5840 <sup>***</sup>	1.0685	0.5303 <sup>***</sup>	0.4898 <sup>***</sup>
Rear-end Left-turn	0.4655 <sup>***</sup>	1.1807	0.3635 <sup>***</sup>	0.4177 <sup>***</sup>
Rear-end Right-turn	1.1185	2.2513 <sup>***</sup>	1.0650	1.0436
Same-direction Sideswipe	0.9992	2.1310 <sup>***</sup>	0.9382	0.9865
Opposite-direction Sideswipe	0.1273 <sup>***</sup>	2.0063 <sup>***</sup>	0.2573 <sup>***</sup>	0.1414 <sup>***</sup>
Non-motorized	1.8718 <sup>***</sup>	8.6798 <sup>***</sup>	2.4527 <sup>***</sup>	1.9203 <sup>***</sup>

<sup>\*\*\*</sup> significant at 99%, <sup>\*\*</sup> significant at 95%, and <sup>\*</sup> significant at 90%.

Several exposure variables were attempted, including major and minor AADTs, total entering vehicles, major and minor DVMT, and total DVMT. The total entering vehicle is defined as the number of total vehicles entering the intersection, which is calculated by adding major and minor AADT (for four-legged intersections). The DVMT (daily vehicle-miles-traveled) is calculated by multiplying AADT by travel distance. The skew angle of each intersection was measured using Google Map. The skew angle is defined as the degree of deviation from 90°. The “skewed” is a dummy variable indicating whether an intersection’s skew angle is greater than 5° or not. The pedestrian crossing is a variable indicating whether the intersection has a pedestrian crosswalk or not. The international roughness index (IRI) is a measure of roughness of a pavement, expressed as the ratio of the accumulated suspension motion to the distance traveled obtained from a mathematical model of a standard quarter car traversing a measured profile at a

speed of 50 mph (unit: inch per mile). In addition, no meaningful difference was found in major/minor speed limits between conventional, MUT Type A, and MUT Type B. The average speed limits of the major leg of those three types are 40.8, 43.3, and 42.0 mph, and those of the minor leg are 35.5, 35.4, and 38.2 mph, respectively. Other than the abovementioned variables, the numbers of lanes by type were tried in the SPFs. Similar candidate explanatory variables were attempted in other alternative intersections (i.e., continuous flow intersections and Jughandle intersections). Signal timing has not been considered in previous studies evaluating safety treatments because such assessments are conducted at the aggregated level (with several crash-years). The signal timing (e.g., cycle length, yellow interval durations) might have safety effects; however, it is difficult to reflect them in the aggregate level analysis. Thus, the team did not consider gathering information on signal timing. The team confirmed there is no automated red-light enforcement devices at the study intersections.

**Table 6-10: Descriptive statistics of the prepared data for MUTs**

(A) Crash variables

Variable	Conventional (N=151)				MUT A (N=53)				MUT B (N=20)			
	Mean	Stdev	Min	Max	Mean	Stdev	Min	Max	Mean	Stdev	Min	Max
Total	128.437	66.236	9	341	127.302	70.973	40	436	137.200	86.626	16	320
PDO	101.987	55.331	8	288	98.981	58.980	28	367	110.150	72.557	10	250
Injury	26.377	13.692	1	75	27.887	13.413	10	69	26.700	15.944	6	70
Severe	1.053	1.259	0	7	1.566	1.294	0	6	1.700	1.559	0	6
Fatal	0.073	0.285	0	2	0.434	0.665	0	3	0.350	0.745	0	3
Fatal-and-injury	26.450	13.759	1	75	28.321	13.520	10	69	27.05	16.21719	6	70
Single-vehicle	4.238	2.306	0	11	7.302	3.959	1	17	7.500	6.778	1	27
Multi-vehicle	119.722	63.030	8	320	117.434	69.130	35	420	124.35	79.62959	16	288
Same-direction Sideswipe	16.967	11.234	0	71	22.245	18.152	3	109	30.250	26.614	3	110
Opposite-direction Sideswipe	1.914	1.566	0	8	0.623	0.925	0	3	0.400	0.821	0	3
Head-on	1.060	1.190	0	6	0.377	0.657	0	2	0.650	0.988	0	3
Head-on Left-turn	9.060	9.000	0	59	0.906	2.204	0	11	0.900	0.852	0	3
Angle	27.391	17.442	2	86	24.245	15.031	2	78	23.400	11.887	6	54
Rear-end	58.762	34.172	5	147	62.264	37.236	15	207	61.950	44.753	5	181
Rear-end Left-turn	1.464	1.648	0	11	1.132	1.861	0	8	1.300	1.780	0	6
Rear-end Right-turn	1.570	1.707	0	8	2.264	2.355	0	10	2.600	2.303	0	10
Non-motorized	1.536	1.522	0	6	3.377	2.950	0	14	2.900	3.669	0	16

## (B) Explanatory variables

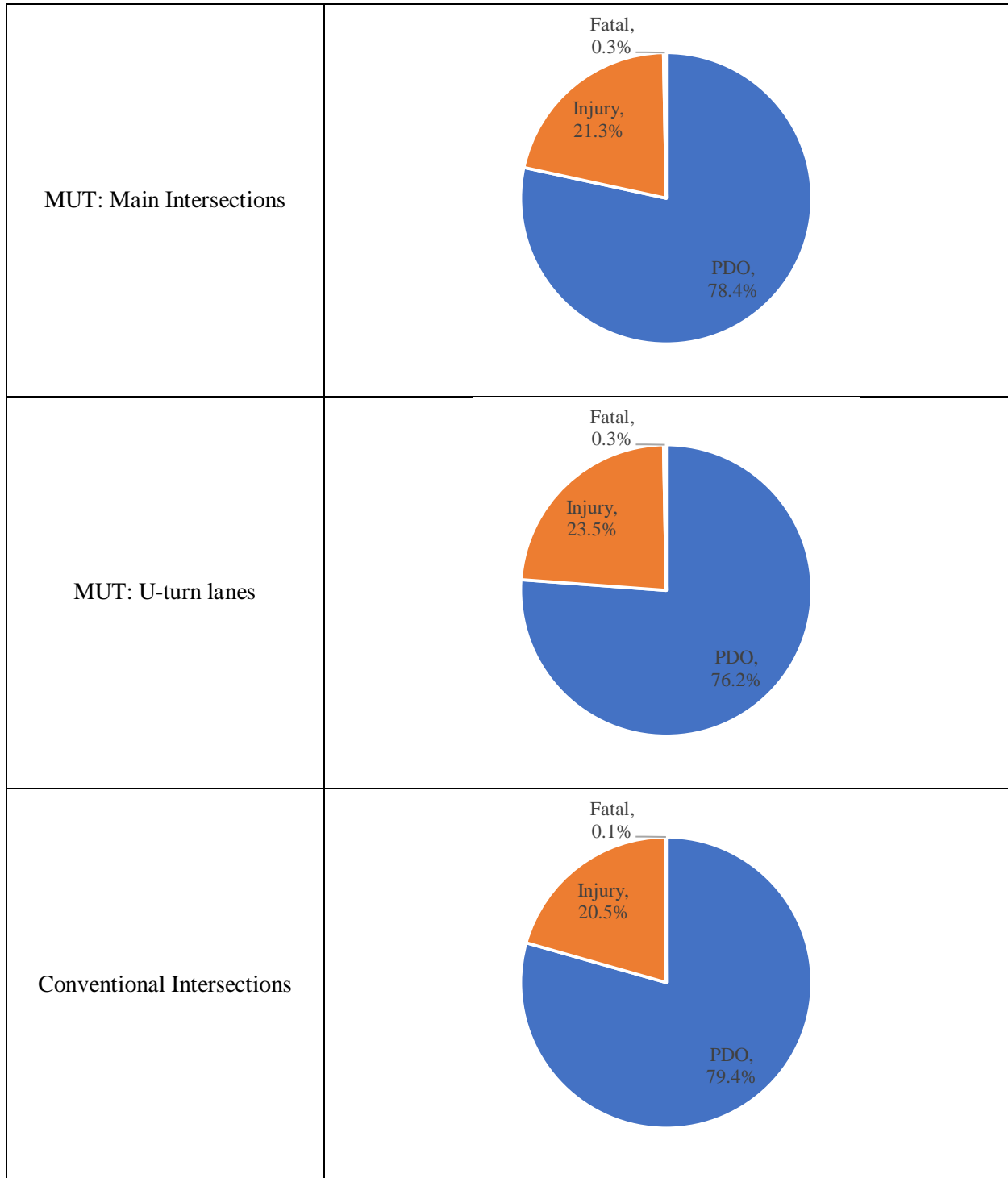
Variable	Conventional (N=151)			MUT A (N=53)				MUT B (N=20)				
	Min	Max	Mean	Min	Max	Mean	Min	Max	Mean	Min	Max	Mean
Major AADT	32855.1	7973.5	12827.0	52477.0	55615.7	13150.7	25512.0	85076.0	49310.7	16144.5	19267.0	72074.0
Minor AADT	15438.6	8006.1	933.0	35508.0	13337.9	7889.0	246.0	37958.0	18625.2	14827.5	1204.0	58591.0
Total Entering Vehicles	48293.7	11890.4	17681.0	79749.0	68953.6	15385.9	29522.0	99249.0	67935.9	25203.5	22210.0	130665.0
Major DVMT	1555.6	377.5	607.3	2484.7	3160.0	747.2	1449.6	4833.9	2801.7	917.3	1094.7	4095.1
Minor DVMT	731.0	379.1	44.2	1681.2	757.8	448.2	14.0	2156.7	1058.2	842.5	68.4	3329.0
Total DVMT	4573.3	1126.0	1674.3	7552.0	7056.4	1565.2	3066.8	10167.6	6900.3	2515.1	2299.8	13056.1
Skew Angle(°)	4.967	11.268	0	43	15.887	17.142	0	43	21.700	16.547	0	44
Skewed (yes=1, no=0)	0.232	0.423	0	1	0.509	0.505	0	1	0.700	0.470	0	1
Major Speed Limit (mph)	41.954	5.887	25	55	43.302	4.154	35	55	40.750	5.200	30	50
Minor Speed Limit (mph)	38.212	7.008	25	50	35.377	6.567	25	50	35.500	7.237	20	45
Lighting	0.987	0.115	0	1	0.887	0.320	0	1	0.950	0.224	0	1
International Roughness Index (inch/mile)	221.5	139.6	0.0	943.0	222.0	149.1	75.0	705.0	232.1	117.4	93.0	514.0
Pedestrian Crossing	1.000	0.000	1	1	0.981	0.137	0	1	0.950	0.224	0	1
Major Left-Turn Lanes	2.060	0.465	0	4	0.075	0.385	0	2	0.100	0.308	0	1
Minor Left-Turn Lanes	1.887	0.649	0	4	0.019	0.137	0	1	0.150	0.489	0	2
Major Right-Turn Lanes	1.033	0.989	0	4	1.208	0.906	0	2	0.850	0.933	0	2
Minor Right-Turn Lanes	1.000	0.902	0	4	1.283	0.928	0	3	1.150	0.875	0	2
Major Through Lanes	4.179	1.007	1	8	8.000	1.373	4	10	7.000	1.376	4	8
Minor Through Lanes	3.139	1.211	0	6	3.396	1.276	1	7	4.450	1.538	2	9
Major Left+Through Lanes	0.013	0.115	0	1	0.000	0.000	0	0	0.000	0.000	0	0
Minor Left+Through Lanes	0.132	0.442	0	2	0.000	0.000	0	0	0.000	0.000	0	0
Total Through Lanes	7.351	1.480	3	12	11.434	2.033	8	17	11.500	2.259	8	17
Total Left-Turn Lanes	3.887	0.884	1	8	0.075	0.385	0	2	0.200	0.523	0	2
Total Right-Turn Lanes	1.940	1.511	0	4	2.509	1.436	0	5	2.100	1.294	0	4
Total Left+Through Lanes	0.146	0.468	0	2	0.000	0.000	0	0	0.000	0.000	0	0

The percentages of crashes by injury severity at MUT's main intersections and U-turn lanes, and conventional intersections are exhibited in Figure 9. It was shown that the percentage of fatal crashes at MUTs: 0.3% (both at main intersections and U-turn lanes), are three times higher than that at conventional intersections (0.1%). In addition, the percentages of injury crashes at MUTs' main intersections and U-turn lanes are slightly higher (21.3% and 23.5%, respectively) than that at conventional intersections (20.5%). On the other hand, the percentages of PDO crashes at MUTs (78.4% and 76.2%) are lower than that at conventional intersections (79.4%). The differences in the percentages were statistically significant ( $\chi^2=36.284$ , d.f.=4,  $p<0.001$ ).

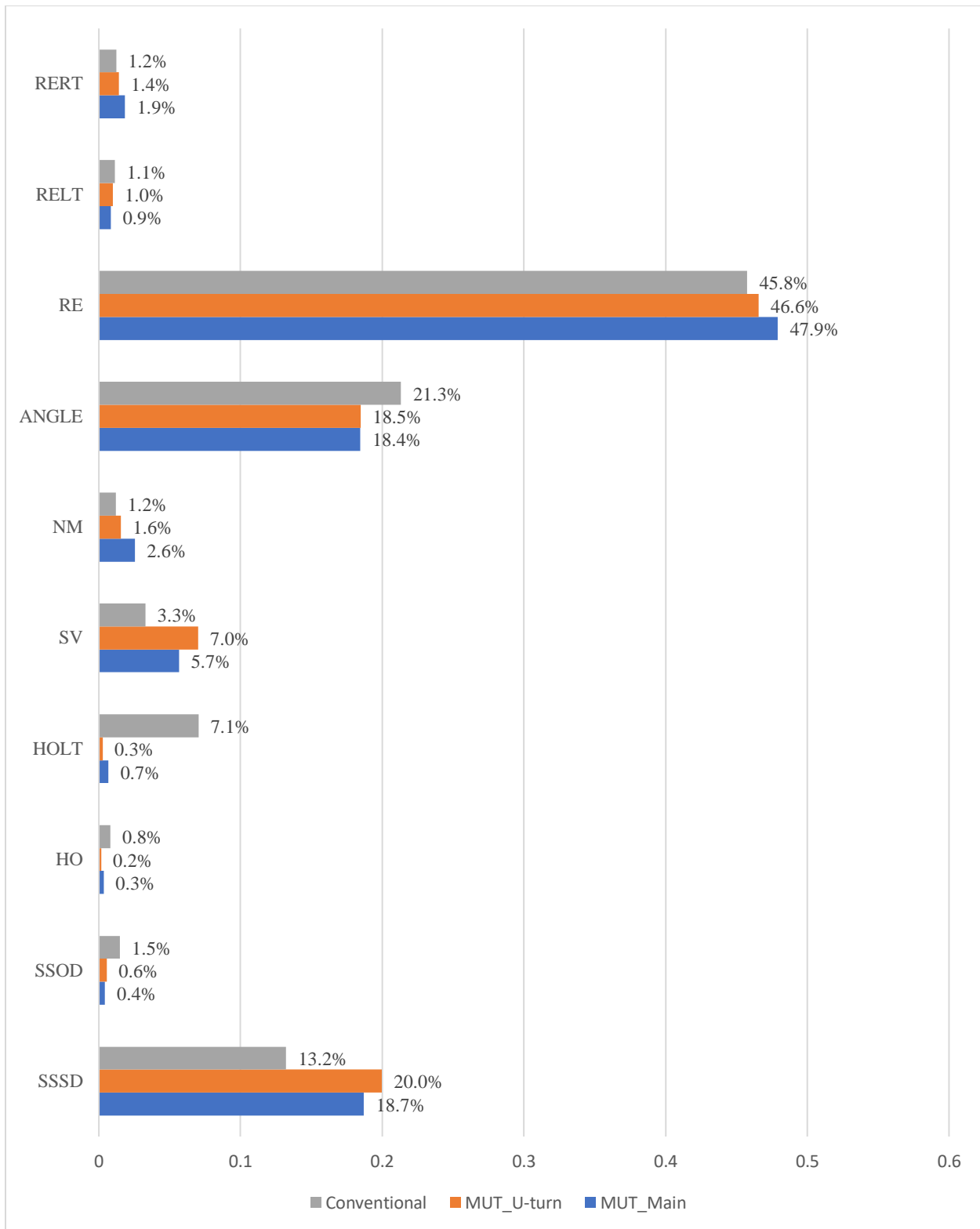
Figure 10 depicts the percentages of crashes by type at MUT and conventional intersections. For rear-end right-turn, rear-end, and non-motorized crashes, the percentages is always the highest at MUT main intersections, and it is followed by MUT U-turn lanes, and conventional intersections has the lowest percentage. For angle crashes, the percentage is the highest at conventional intersections and those at MUT main intersections and U-turn lanes are lower. On the other hand, the percentage of single-vehicle and same-direction sideswipe crashes at MUT U-turn lanes is the highest and those at MUT main intersections and conventional intersections are relatively lower. Regarding head-on left-turn, left-turn, and opposite direction sideswipe crashes, the percentages at conventional intersections are considerably higher than those at MUT main intersections and U-turn lanes. The difference in the percentages of crash types between MUT main intersections, MUT U-turn lanes, and conventional intersections are statistically significantly different ( $\chi^2=953.536$ , d.f.=18,  $p<0.001$ ).

Figures 6-9 and 6-10 simply compare the percentages of crash types and injury severity levels between MUT's main intersections, MUT's U-turn lanes, and conventional intersections. Still,

they do not indicate which ones are safer or more dangerous, which are shown in the following SPFs and CMFs sections.



**Figure 6-9: Percentage of crashes by injury severity at MUT and conventional intersections**



\* RERT: Rear-End Right Turn, RELT: Rear-End Right Turn, RE: Rear-End, NM: Non-Motorized, SV: Single-Vehicle, HOLT: Head-On Left-Turn, HO: Head-On, SSOD: Sideswipe (Opposite Direction), SSSD: Sideswipe (Same Direction)

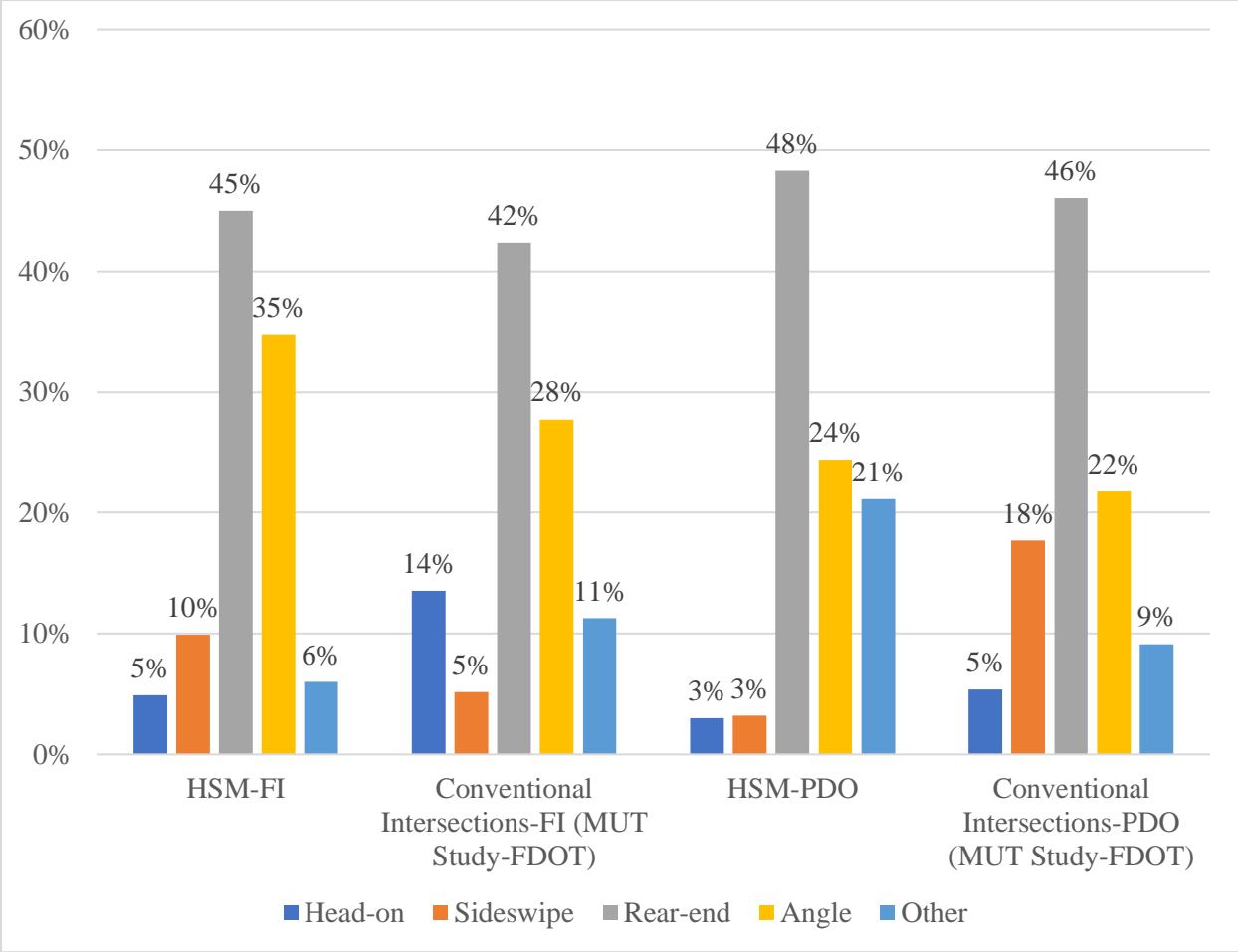
**Figure 6-10: Percentages of crashes by types at MUT and conventional intersections**



In order to ensure that the crash data have reasonable distributions of crash severity and types, they were compared with those of previous studies including the Highway Safety Manual and NCHRP 17-62: “Improved Prediction Models for Crash Types and Crash Severities”.

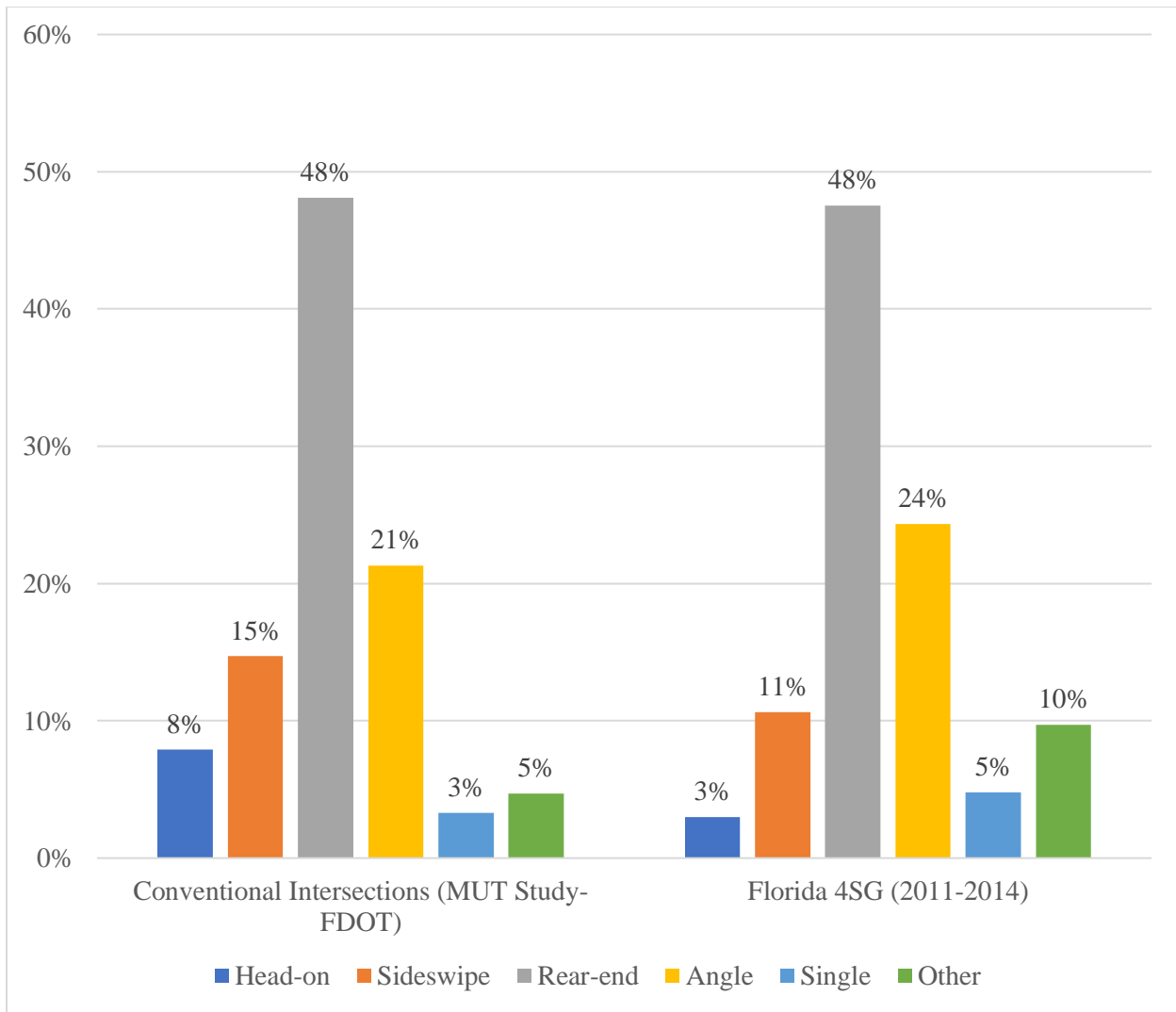
The crash distributions in the HSM Part C urban/suburban intersections rely on data from one state, California (2002-2006). It is rather old data; in addition based on NCHRP 17-62 we believe CA has different characteristics. The research team compared the distributions in the HSM and in the study area. There are several differences from the two sources. The HSM provides four different distributions/SPFs for fatal-and-injury (FI) crashes and PDO crashes by single/multi-vehicle crashes. Thus, the research team matched the crash types and compared their distributions.

The following Figure 6-11 shows the distributions of (1) HSM-FI; (2) HSM-PDO; and (3) total crashes at conventional intersections in the MUT study area. Although there are some differences in head-on and sideswipe crashes between HSM and conventional intersections, the general trend in proportions in rear-end and angle crashes are similar. For fatal-and-injury crashes, the percentages of rear-end crashes in the HSM and in the MUT study in this project are 45% and 42%, respectively, and those of angle crashes are 35% and 28%, respectively. For PDO crashes, those of rear-end crashes are 48% and 46%, respectively, and those of angle crashes are 24% and 22%, respectively.



**Figure 6-11: Distribution of crash types in HSM and this study**

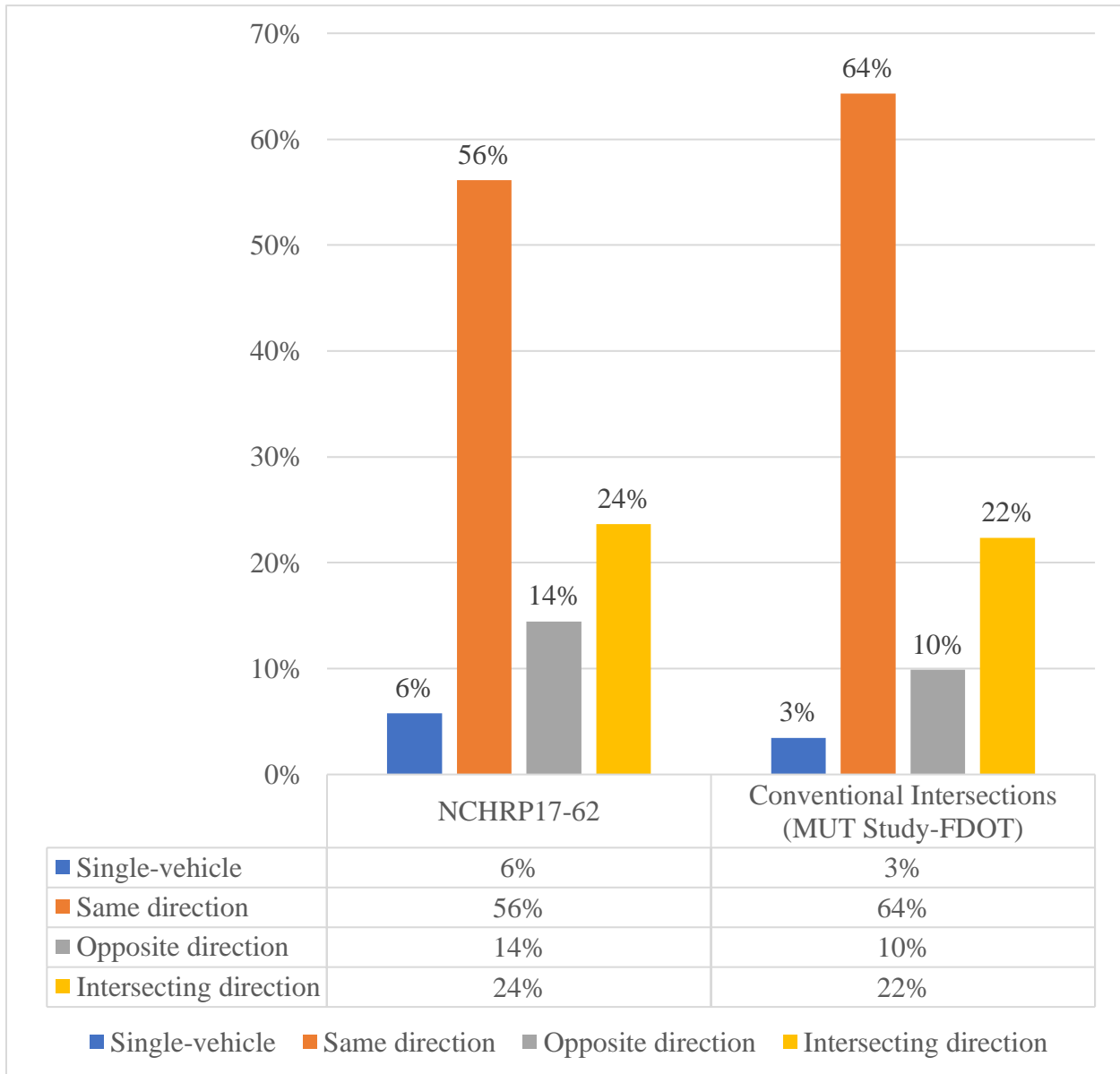
In addition, the team collected data from Florida’s four-legged intersections (2011-2014), and compared the distributions with the crash data used in the analysis (Figure 12). It was found that the distributions are consistent in all collision types, especially for major crash types (e.g., rear-end, angle, and sideswipe crashes). The percentages of rear-end crashes at the conventional intersections in our MUT study (Michigan) are similar at 48%, and those of angle crashes are 21% and 24%, respectively.



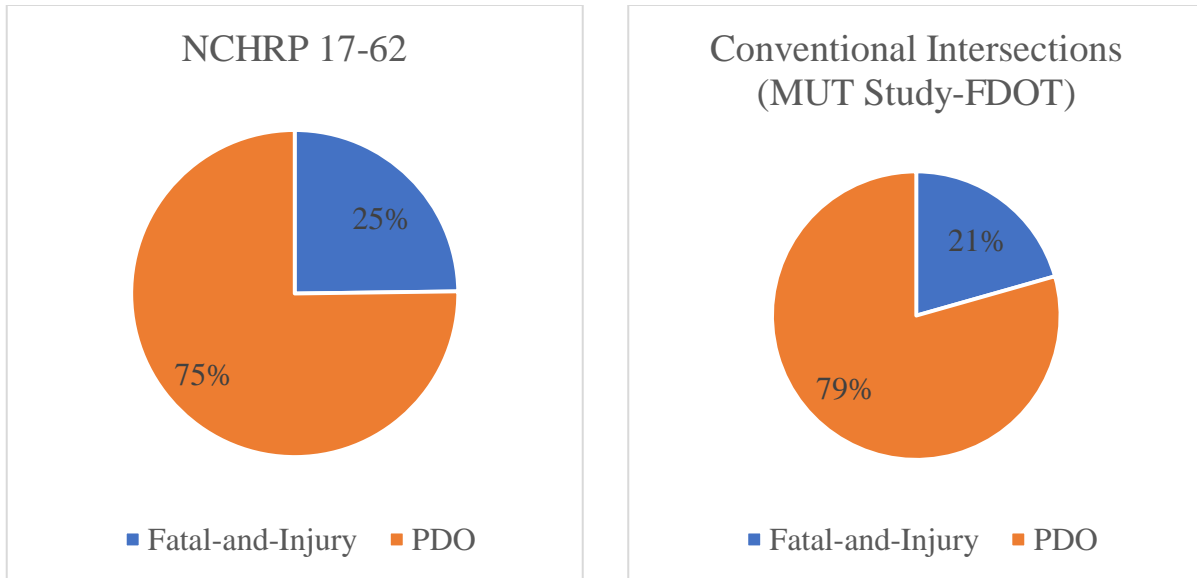
**Figure 6-12: Distribution of crash types in this study and Florida 4SG crash data**

The team compared the proportions from NCHRP 17-62 (589 four-legged signalized intersections in urban/suburban in Ohio, 2007-2011) and the current project. NCHRP 17-62 used new crash types, which are single-vehicle, same direction (e.g., rear-end and same direction sideswipe), opposite direction (e.g., head-on and opposite direction sideswipe), intersecting direction (e.g., angle) crashes.

The following charts (Figures 6-13 to 6-14) show that there is no considerable difference in the distributions. Thus, the research team concluded that the crash distributions are not very different from another reliable study (both collision types and severity levels).



**Figure 6-13: Distribution of crash types in NCHRP 17-62 and this study (MUT Study-FDOT)**



**Figure 6-14: Distribution of severity levels in NCHRP 17-62 and this study (MUT Study-FDOT)**

### 6.3.2. Developing SPFs for Median U-Turn Intersections

Using the prepared data, two types of SPFs were developed: (1) fully-specified SPFs and (2) simple SPFs. The fully-specified SPFs include all significant explanatory variables along with DVMT and MUT dummy variable whereas the simple SPFs contain only DVMT and MUT dummy variable. For MUTs, the numbers of crashes from both main intersections and U-turn lanes were combined. Because the team aims at comparing MUTs and conventional intersections, the influence areas of intersections are different (MUTs: 250 feet from the main intersection and 50 feet from each U-turn lane vs. conventional intersections: 250 feet from the main intersection) and using AADT (or total entering vehicles, or TEV) would result in biased results. Thus, to more accurately control traffic volume, DVMT was chosen as the exposure variable in this analysis.

Table 6-11 summarizes the developed fully-specified SPFs. For total, PDO, and injury crashes, the following variables have positive effects: Log (Major DVMT), Log (Minor DVMT), Major Speed Limit and Minor Speed Limit, and Minor Through Lanes. Only the injury SPF has an additional significant variable: international roughness index (IRI) and it also has a positive coefficient, which implies that rough pavement could increase injury crashes. For those crash types, the coefficients for MUT: Types A and B were found significant and they are negative.

For single-vehicle crashes, either Log (Major DVMT) or Log (Total DVMT) was not significant; but only Log (Minor DVMT) was significant. Beside the exposure variable, Minor Speed Limit and Minor Through Lanes have significant and positive coefficients. The coefficients for MUT: Types A and B were found significant and they are positive. Regarding head-on crashes, Log (Total DVMT) and Minor Through Lanes are significant and have positive coefficients, and the MUT coefficients are significant and negative. Concerning head-on left-turn crashes, Log (Total DVMT), Major Left-Turn Lanes, and Minor Left-Turn Lanes were found significant and their coefficients are significant. The MUT coefficients are significant and negative.

About angle crashes, Log (Major DVMT), Log (Minor DVMT), and Minor Through Lanes were found significant and the coefficients are positive. The MUT coefficient are significant and negative. For rear-end crashes, both exposure variables: Log (Major DVMT) and Log (Minor DVMT) were significant. In addition, Major Speed Limit, Minor Speed Limit, and Minor Through lanes are significant and they have positive coefficients. The MUT coefficients were significant and negative. For rear-end left-turn crashes, both exposure variables: Log (Major DVMT) and Log (Minor DVMT) were significant. Minor speed limit and minor through lanes were found significant and have positive coefficients. The MUT coefficients were significant and negative.

Both rear-end right-turn and same-direction sideswipe crashes have insignificant MUT dummy variable, which implies that there is no significant difference in safety between MUT and conventional intersections.

For opposite-direction sideswipe crashes, Log (Total DVMT) and minor through lanes were found significant and have a positive coefficient. The MUT coefficients were significant and negative. Lastly, non-motorized users related crashes have positive coefficients for Log (Total DVMT) and Pedestrian Crossing. The MUT coefficients were found significant and positive.

Table 6-12 summarizes the simple SPFs. For total, PDO, injury, fatal, angle, rear-end, rear-end left-turn, same-direction sideswipe, and opposite-direction sideswipe crashes have significant and positive Log (Major DVMT) and Log (Minor DVMT). As regards single-vehicle, head-on, head-on left-turn, and rear-end right-turn, and non-motorized crashes, only Log (Total DVMT) was significant. Most of the coefficients were positive except for non-motorized crashes.

The coefficients of MUT dummy variables are negative (and significant) for total, PDO, injury, fatal-and-injury, rear-end, opposite-direction sideswipe crashes. For same-direction sideswipe crashes, only MUT: Type A was significant at 90% confidence level and it has a negative coefficient; but MUT: Type B was not significant. There are some crash types that have positive MUT coefficients including fatal, single-vehicle, and non-motorized crashes.

**Table 6-11: Fully-specified SPFs for MUTs**

*N=224, (Type A: 53, Type B: 20, and Conventional: 151)*

Variables	Total		PDO		Injury		Fatal		Fatal-and-injury	
	Coef.	S.E.	Coef.	S.E.	Coef.	S.E.	Coef.	S.E.	Coef.	S.E.
Intercept	-3.3366***	0.6387	-4.1196***	0.6761	-2.9741***	0.7326	1.4014	3.7227	-2.8855***	0.7338
Log (Major DVMT)	0.6733***	0.0943	0.7221***	0.0998	0.4890***	0.1057	-1.0979**	0.5022	0.4755***	0.1059
Log (Minor DVMT)	0.3069***	0.0362	0.3343***	0.0388	0.2014***	0.0422	0.6098**	0.2448	0.2036***	0.0423
Major Speed Limit	0.0102*	0.0058	0.0106**	0.0062	0.0113*	0.0065			0.0113*	0.0065
Minor Speed Limit	0.0157***	0.0048	0.0156***	0.0051	0.0147***	0.0051			0.0148***	0.0051
Minor Through Lanes	0.0588***	0.0218	0.0593**	0.0233	0.0614***	0.0237			0.0603**	0.0238
International Roughness Index					0.0004**	0.0002			0.0004**	0.0002
MUT: Type A	-0.4573***	0.0845	-0.5135***	0.0897	-0.2813***	0.0939	2.5424***	0.5047	-0.2572***	0.0939
MUT: Type B	-0.4296***	0.1027	-0.4627***	0.1092	-0.3525***	0.1134	2.0354***	0.5625	-0.3320***	0.1134
Overdispersion	0.1178	0.0119	0.1305	0.0133	0.1082	0.0138	0.0002	0.3201	0.1093	0.0138

\*\*\* significant at 99%, \*\* significant at 95%, and \* significant at 90%.



**Table 6-11: Fully-specified SPFs for MUTs (continued)**

*N=224, (Type A: 53, Type B: 20, and Conventional: 151)*

Variables	Single-vehicle		Head-on		Head-on Left-turn		Angle		Rear-end	
	Coef.	S.E.	Coef.	S.E.	Coef.	S.E.	Coef.	S.E.	Coef.	S.E.
Intercept	-0.2145	0.3828	-5.8488**	2.5874	-9.6125***	2.2068	-2.1805**	0.9398	-6.8347***	0.7824
Log (Major DVMT)							0.3682***	0.1298	1.0542***	0.1131
Log (Minor DVMT)	0.1361**	0.0607					0.3920***	0.0539	0.2577***	0.0427
Log (Total DVMT)			0.5990*	0.3105	1.2654***	0.2589				
Major Speed Limit									0.0124*	0.0069
Minor Speed Limit	0.0133**	0.0066							0.0200***	0.0058
Major Left-Turn Lanes					0.3164**	0.1559				
Minor Left-Turn Lanes					0.2485*	0.1376				
Minor Through Lanes	0.0650*	0.0354	0.2571***	0.0669			0.0686**	0.0320	0.0488*	0.0263
International Roughness Index										
MUT: Type A	0.3221**	0.1601	-1.3631***	0.2809	-1.7609***	0.4360	-0.3805***	0.1235	-0.6428***	0.1006
MUT: Type B	0.3679**	0.1634	-1.0960***	0.3422	-1.7214***	0.5045	-0.4930***	0.1492	-0.6620***	0.1240
Overdispersion	0.1331	0.0311	0.1647	0.1302	0.6341	0.0847	0.2281	0.0255	0.1599	0.0169

\*\*\* significant at 99%, \*\* significant at 95%, and \* significant at 90%.

**Table 6-11: Fully-specified SPFs for MUTs (continued)**

*N=224, (Type A: 53, Type B: 20, and Conventional: 151)*

Variables	Rear-end Left-turn		Rear-end Right-turn		Same-direction Sideswipe		Opposite-direction Sideswipe		Non-motorized	
	Coef.	S.E.	Coef.	S.E.	Coef.	S.E.	Coef.	S.E.	Coef.	S.E.
Intercept	-11.1325***	2.3732	-7.7568***	2.1296	-5.1708***	0.9134	-6.9211***	2.0805	-1.4222	2.3965
Log (Major DVMT)	0.7249**	0.3166			0.5264***	0.1280				
Log (Minor DVMT)	0.5547***	0.1386			0.4441***	0.0545				
Log (Total DVMT)			0.7733***	0.2609			0.8525***	0.2503	-0.0028	0.2438
Major Speed Limit	0.0466***	0.0158	0.0332**	0.0134						
Minor Left-Turn Lanes					0.2485***	0.0639				
Minor Right-Turn Lanes			0.2306***	0.0738	0.1314***	0.0387				
Major Through Lanes					0.0966***	0.0315				
Minor Through Lanes	0.1652***	0.0638			0.0611**	0.0295	0.1182**	0.0523		
Pedestrian Crossing									1.8748*	1.1205
MUT: Type A	-0.9310***	0.2892	-0.0660	0.1760	-0.0883	0.1888	-1.5291***	0.2183	0.8079***	0.1865
MUT: Type B	-0.9315***	0.3480	0.2100	0.2357	0.1236	0.1877	-2.0641***	0.3848	0.6717***	0.2414
Overdispersion	0.3391	0.1053	0.2984	0.0844	0.1746	0.0228	0.0925	0.0786	0.4746	0.1020

\*\*\* significant at 99%, \*\* significant at 95%, and \* significant at 90%.

**Table 6-12: Simple SPFs for MUTs**

*N=224, (Type A: 53, Type B: 20, and Conventional: 151)*

Variables	Total		PDO		Injury		Fatal		Fatal-and-injury	
	Coef.	S.E.	Coef.	S.E.	Coef.	S.E.	Coef.	S.E.	Coef.	S.E.
Intercept	-3.0611***	0.6747	-3.8457***	0.7080	-2.7777***	0.7653	1.4014	3.7227	-2.6938***	0.7665
Log (Major DVMT)	0.7154***	0.0936	0.7651***	0.0983	0.5353***	0.1037	-1.0979**	0.5022	0.5227***	0.1039
Log (Minor DVMT)	0.4071***	0.0333	0.4353***	0.0354	0.3266***	0.0376	0.6098**	0.2448	0.3283***	0.0377
Log (Total DVMT)										
MUT: Type A	-0.4964***	0.0889	-0.5515***	0.0936	-0.3239***	0.0976	2.5424***	0.5047	-0.3015***	0.0976
MUT: Type B	-0.4586***	0.1041	-0.4930***	0.1096	-0.3716***	0.1136	2.0354***	0.5625	-0.3532***	0.1137
Overdispersion	0.1389***	0.0139	0.1514	0.0153	0.1293	0.0158	0.0002	0.3201	0.1304	0.0159

Variables	Single-vehicle		Head-on		Head-on Left-turn		Angle		Rear-end	
	Coef.	S.E.	Coef.	S.E.	Coef.	S.E.	Coef.	S.E.	Coef.	S.E.
Intercept	-0.9254	1.2371	-7.2767***	2.6916	-8.7742***	2.1972	-2.1492**	0.9484	-6.3671***	0.8215
Log (Major DVMT)							0.3517***	0.1308	1.0932***	0.1128
Log (Minor DVMT)							0.4399***	0.0493	0.3669***	0.0392
Log (Total DVMT)	0.2820*	0.1471	0.8705***	0.3186	1.2985***	0.2604				
MUT: Type A	0.4191***	0.1115	-1.4106***	0.2883	-2.8073***	0.2268	-0.3476***	0.1239	-0.6893***	0.1055
MUT: Type B	0.4628***	0.1430	-0.8188**	0.3426	-2.7754***	0.3304	-0.4082***	0.1449	-0.7137***	0.1252
Overdispersion	0.1600	0.0336	0.2832	0.1500	0.6271	0.0857	0.2333	0.0260	0.1880	0.0196

\*\*\* significant at 99%, \*\* significant at 95%, and \* significant at 90%.

**Table 6 12: Simple SPFs for MUTs (continued)**

*N=224, (Type A: 53, Type B: 20, and Conventional: 151)*

Variables	Rear-end Left-turn		Rear-end Right-turn		Same-direction Sideswipe		Opposite-direction Sideswipe		Non-motorized	
	Coef.	S.E.	Coef.	S.E.	Coef.	S.E.	Coef.	S.E.	Coef.	S.E.
Intercept	-11.0683***	2.3690	-9.2891***	2.1341	-5.7272***	0.9579	-5.3631***	1.8784	0.7903	2.0552
Log (Major DVMT)	0.8814***	0.3082			0.6679***	0.1305	0.4883**	0.2490		
Log (Minor DVMT)	0.7576***	0.1302			0.5588***	0.0517	0.3741***	0.0980		
Log (Total DVMT)			1.1541***	0.2523					-0.0430	0.2450
MUT: Type A	-0.9331***	0.2872	-0.1162	0.1832	-0.2286*	0.1266	-1.4754***	0.2611	0.8076***	0.1882
MUT: Type B	-0.8729***	0.3363	0.0427	0.2393	-0.0136	0.1431	-1.9559***	0.3995	0.6525***	0.2433
Overdispersion	0.3983	0.1146	0.3823	0.0943	0.2154	0.0266	0.1035	0.0799	0.4932	0.1041

\*\*\* significant at 99%, \*\* significant at 95%, and \* significant at 90%.

### **6.3.3. Estimating CMFs for Median U-Turn Intersections**

Using the developed fully-specified and simple SPFs, various CMFs for MUT: Types A and B were estimated (Tables 6-13 and 6-14, respectively). Although the fully-specified SPFs have more explanatory variables that controls external factors, there was no significant difference in the CMF values from fully-specified and simple SPFs. Although the CMFs estimated from the fully-specified SPFs (Table 6-13) could be more reliable because the fully-specified SPFs controlled for many other factors. Nevertheless, there was no significant differences in CMF values between the fully-specified and the simple SPFs. Also, it is necessary to be consistent with other alternative intersections, the research team recommend using the CMFs from the simple SPFs (Table 6-14).

**Table 6-13: CMFs from fully-specified SPFs***MUT: Type A*

<b>Crash type</b>	<b>CMF</b>	<b>99% Lower</b>	<b>95% Lower</b>	<b>90% Lower</b>	<b>90% Upper</b>	<b>95% Upper</b>	<b>99% Upper</b>
Total	0.6330***	0.5092	0.5364	0.5508	0.7274	0.7470	0.7869
PDO	0.5984***	0.4750	0.5019	0.5163	0.6935	0.7134	0.7539
Injury	0.7548***	0.5927	0.6279	0.6468	0.8809	0.9073	0.9613
Fatal-and-injury	0.7732***	0.6069	0.6432	0.6625	0.9024	0.9295	0.9852
Single-vehicle	1.3800**	0.9138	1.0083	1.0605	1.7958	1.8887	2.0841
Head-on	0.2559***	0.1241	0.1475	0.1612	0.4062	0.4437	0.5274
Head-on Left-turn	0.1719***	0.0559	0.0731	0.0839	0.3522	0.4040	0.5282
Angle	0.6835***	0.4973	0.5366	0.5579	0.8375	0.8707	0.9394
Rear-end	0.5258***	0.4058	0.4317	0.4456	0.6204	0.6404	0.6813
Rear-end Left-turn	0.3942***	0.1872	0.2236	0.2449	0.6343	0.6948	0.8300
Rear-end Right-turn	0.9361	0.5950	0.6630	0.7008	1.2505	1.3218	1.4729
Same-direction Sideswipe	0.9155	0.5630	0.6323	0.6711	1.2489	1.3254	1.4886
Opposite-direction Sideswipe	0.2167***	0.1235	0.1413	0.1513	0.3104	0.3325	0.3802
Non-motorized	2.2432***	1.3877	1.5564	1.6505	3.0486	3.2331	3.6260

MUT: Type B

<b>Crash type</b>	<b>CMF</b>	<b>99% Lower</b>	<b>95% Lower</b>	<b>90% Lower</b>	<b>90% Upper</b>	<b>95% Upper</b>	<b>99% Upper</b>
Total	0.6508***	0.4995	0.5321	0.5496	0.7705	0.7959	0.8478
PDO	0.6296***	0.4753	0.5083	0.5261	0.7535	0.7798	0.8340
Injury	0.7029***	0.5249	0.5628	0.5833	0.8471	0.8779	0.9413
Fatal-and-injury	0.7175***	0.5355	0.5745	0.5954	0.8646	0.8961	0.9613
Single-vehicle	1.4447**	0.9485	1.0488	1.1042	1.8902	1.9901	2.2004
Head-on	0.3342***	0.1385	0.1709	0.1903	0.5868	0.6536	0.8067
Head-on Left-turn	0.1788***	0.0488	0.0665	0.0780	0.4100	0.4807	0.6555
Angle	0.6108***	0.4160	0.4559	0.4779	0.7807	0.8183	0.8969
Rear-end	0.5158***	0.3748	0.4045	0.4206	0.6325	0.6577	0.7099
Rear-end Left-turn	0.3940***	0.1608	0.1992	0.2222	0.6983	0.7793	0.9652
Rear-end Right-turn	1.2337	0.6724	0.7773	0.8372	1.8180	1.9581	2.2635
Same-direction Sideswipe	1.1316	0.6979	0.7833	0.8310	1.5409	1.6348	1.8348
Opposite-direction Sideswipe	0.1269***	0.0471	0.0597	0.0674	0.2390	0.2698	0.3419
Non-motorized	1.9576***	1.0514	1.2196	1.3160	2.9119	3.1420	3.6448

\*\*\* significant at 99%, \*\* significant at 95%, and \* significant at 90%.

**Table 6-14: CMFs from simple SPFs***MUT: Type A*

<b>Crash type</b>	<b>CMF</b>	<b>99% Lower</b>	<b>95% Lower</b>	<b>90% Lower</b>	<b>90% Upper</b>	<b>95% Upper</b>	<b>99% Upper</b>
Total	0.6087***	0.4842	0.5114	0.5259	0.7046	0.7246	0.7653
PDO	0.5761***	0.4527	0.4795	0.4939	0.6720	0.6921	0.7331
Injury	0.7233***	0.5626	0.5974	0.6160	0.8493	0.8758	0.9300
Fatal-and-injury	0.7397***	0.5750	0.6109	0.6300	0.8685	0.8957	0.9515
Single-vehicle	1.5206***	1.1411	1.2221	1.2658	1.8267	1.8920	2.0263
Head-on	0.2440***	0.1161	0.1387	0.1519	0.3921	0.4293	0.5126
Head-on Left-turn	0.0604***	0.0337	0.0387	0.0416	0.0877	0.0942	0.1083
Angle	0.7064***	0.5134	0.5541	0.5761	0.8661	0.9005	0.9718
Rear-end	0.5019***	0.3825	0.4082	0.4220	0.5971	0.6172	0.6586
Rear-end Left-turn	0.3933***	0.1878	0.2240	0.2452	0.6309	0.6906	0.8240
Rear-end Right-turn	0.8903***	0.5555	0.6217	0.6586	1.2034	1.2749	1.4270
Same-direction Sideswipe	0.7956*	0.5743	0.6208	0.6461	0.9799	1.0197	1.1023
Opposite-direction Sideswipe	0.2287***	0.1167	0.1371	0.1488	0.3514	0.3815	0.4480
Non-motorized	2.2425***	1.3812	1.5507	1.6454	3.0563	3.2429	3.6408



MUT: Type B

Crash type	CMF	99% Lower	95% Lower	90% Lower	90% Upper	95% Upper	99% Upper
Total	0.6322***	0.4835	0.5155	0.5327	0.7502	0.7753	0.8265
PDO	0.6108***	0.4606	0.4927	0.5100	0.7315	0.7572	0.8100
Injury	0.6896***	0.5147	0.5520	0.5721	0.8313	0.8616	0.9240
Fatal-and-injury	0.7024***	0.5239	0.5621	0.5826	0.8469	0.8778	0.9419
Single-vehicle	1.5885***	1.0992	1.2002	1.2555	2.0098	2.1024	2.2957
Head-on	0.4410**	0.1825	0.2253	0.2510	0.7747	0.8630	1.0654
Head-on Left-turn	0.0623***	0.0266	0.0326	0.0362	0.1073	0.1191	0.1459
Angle	0.6648***	0.4578	0.5005	0.5238	0.8438	0.8832	0.9655
Rear-end	0.4898***	0.3548	0.3832	0.3987	0.6019	0.6261	0.6762
Rear-end Left-turn	0.4177***	0.1757	0.2161	0.2402	0.7264	0.8075	0.9931
Rear-end Right-turn	1.0436	0.5636	0.6529	0.7040	1.5470	1.6682	1.9327
Same-direction Sideswipe	0.9865	0.6824	0.7452	0.7796	1.2483	1.3059	1.4260
Opposite-direction Sideswipe	0.1414***	0.0506	0.0646	0.0733	0.2729	0.3095	0.3957
Non-motorized	1.9203***	1.0263	1.1920	1.2869	2.8655	3.0937	3.5930

\*\*\* significant at 99%, \*\* significant at 95%, and \* significant at 90%.

### 6.3.4. Before-and-After Analysis for Partial MUTs

After 2007, several states implemented MUTs with only one U-turn lane, which is referred to as “partial MUTs”. The research team found ten partial MUTs in Utah (2), Ohio (1), Arizona (2), and Texas (5). Ten comparison sites were selected, which are conventional, close to the partial MUTs, four-legged, and signalized (consistent with the partial MUTs). In addition, the comparison sites have comparable AADT with their treated sites (i.e., partial MUTs).

The research team compares AADT of the partial MUTs and the comparison sites in Table 6-15.

The t-test showed that there is no evidence that the AADT values in partial MUTs and the comparison sites are different.

**Table 6-15: Comparison of AADT of partial MUTs and comparison sites**

Site	Mean	Stdev	Min	Max
Partial MUTs	46792.3	21260.8	24190	83300
Comparison sites	37660.0	22979.1	19260	97000
t-statistic (p)	0.9225 (p=0.3685)			

The research team estimated CMFs using a before-and-after method with the comparison group, and the results are summarized in Table 16. The results showed that total, PDO, and multi-vehicle crashes were reduced after the implementation of the partial MUTs by 16%, 28%, and 20%, respectively. On the other hand, non-motorized crashes increased by about 2.5 times. No significant changes were found for injury, fatal-and-injury, and single-vehicle crashes.

**Table 6-16: CMFs for partial MUTs (before-and-after study with the comparison group)**

Crash type	CMF	S.E.	p
Total	0.8398 <sup>***</sup>	0.0517	0.0019
PDO	0.7170 <sup>***</sup>	0.0602	0.0000
Injury	1.0910	0.1000	0.3625
Fatal-and-injury	1.1265	0.1003	0.2072
Single-vehicle	1.3529	0.2833	0.2130
Multi-vehicle	0.7951 <sup>***</sup>	0.0534	0.0001
Non-motorized	3.5691 <sup>***</sup>	0.9756	0.0085

<sup>\*\*\*</sup> significant at 99%, <sup>\*\*</sup> significant at 95%, and <sup>\*</sup> significant at 90%.

### 6.3.5. Summary

The safety effects of MUTs were explored in the analysis. Overall, data from 73 MUT intersections were acquired. Among them, 53 were MUT: Type A and 20 were MUT: Type B. Furthermore, data from 151 conventional intersections were collected for comparison.

The CMFs estimated from the simple SPFs identified the safety effects of MUT: Type A and Type B. It was found that MUT: Type A has reduced crashes for total (-39%), PDO (-42%), injury (-28%), fatal-and-injury (-26%), head-on (-76%), head-on left-turn (-94%), angle (-29%), rear-end (-50%), rear-end left-turn (-61%), rear-end right turn (-11%), same-direction sideswipe (-20%), and opposite-direction sideswipe (-77%) types. On the other hand, MUT: Type A have the increased number of crashes for single-vehicle (+52%) and non-motorized (+124%) types.

MUT: Type B have similar safety effects with MUT: Type A although specific percentage changes are slightly different. MUT Type B has decreased crashes for total (-37%), PDO (-39%), injury (-31%), fatal-and-injury (-30%), head-on (-56%), head-on left-turn (-94%), angle (-34%),

rear-end (-51%), rear-end left-turn (-58%), and opposite-direction sideswipe (-86%) types. On the other hand, MUT: Type B increased crashes for single-vehicle (+59%) and non-motorized (+92%) types. No significant differences in safety were found for rear-end right-turn and same-direction sideswipe types.

A before-and-after study with the comparison group was conducted for partial MUTs. The following crashes decreased for three crash types: total (-16%), PDO (-28%), and multi-vehicle crashes (-20%) while non-motorized crashes increased (+250%).

Azizi and Sheikholeslami (2012) analyzed the safety effects of MUTs, and they concluded that there was an increase of about 13% in total crashes. They did not estimate CMFs for other severity or crash types (e.g., fatal, single-vehicle, non-motorized users). The estimated CMF for total crashes are quite different from the findings from our analysis. In the research team's opinion, there are two possible reasons why the results from two studies are inconsistent. First, the study of Azizi and Sheikholeslami (2012) explored only six MUTs while the team analyzed 72 MUTs (cross-sectional) and 10 partial MUTs (before-and-after). Second, driver's behavior, traffic characteristics, design standards in two countries (i.e., US and Iran) are totally different. Generally, MUT intersections (both full and partial MUTs) are safer than conventional ones for total and PDO crashes. In contrast, MUT intersections are significantly more dangerous for crashes involving non-motorized users.

## **6.4. CONTINUOUS FLOW INTERSECTIONS**

### **6.4.1. Data Processing for Continuous Flow Intersections**

Since CFIs consist of both main intersection and crossover left-turn locations, different effectiveness regions of intersections should be studied. In the analysis, the following effectiveness areas of intersections were studied:

(1) 250 feet buffer from the center of the main intersection (same as the traditional approach) using TEV

(2) A large buffer that covers all left-turn crossover points and the main intersection using DVMT

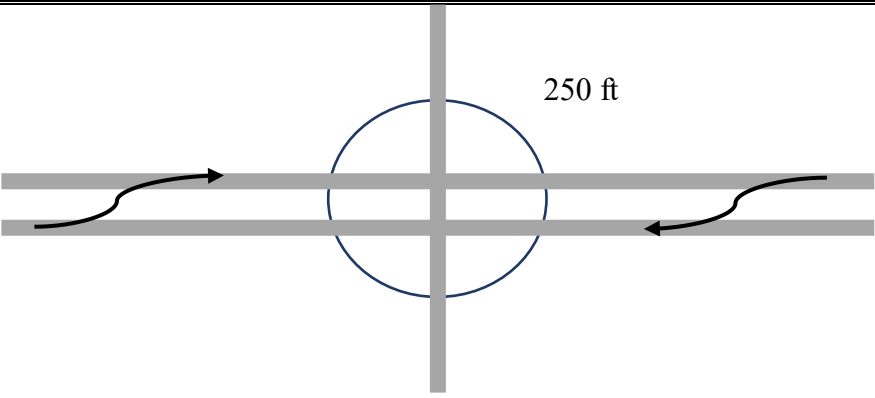
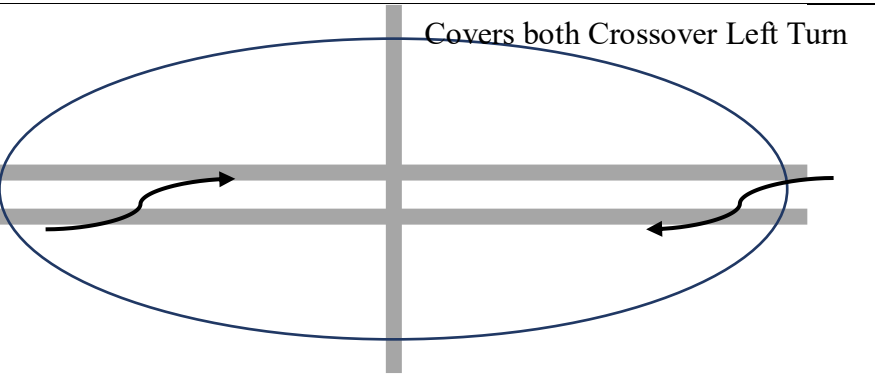
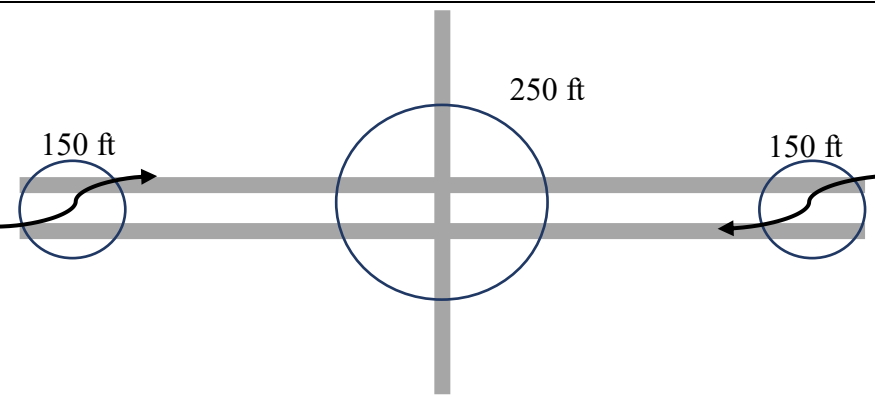
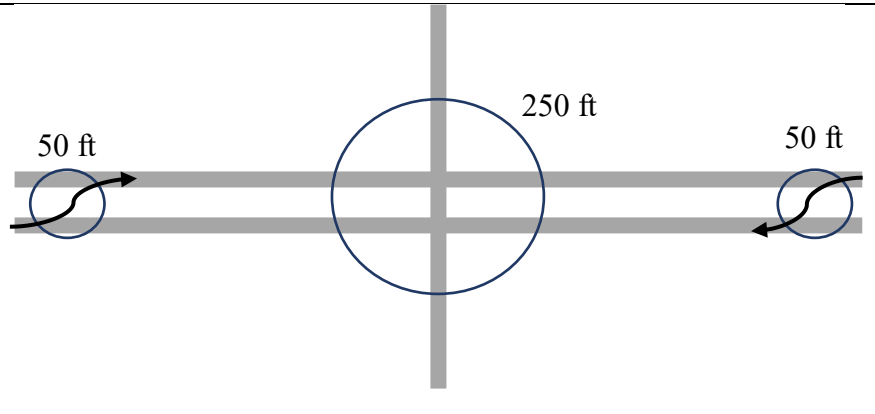
(3) 250 feet buffer from the center of the main intersection and 150 feet buffer from the center of each left-turn crossover point using DVMT

(4) 250 feet buffer from the center of the main intersection and 50 feet buffer from the center of each left-turn crossover point using DVMT

These influence areas of intersections are displayed in Figure 6-15.

The data used in this analysis is from 17 CFIs and 34 conventional intersections as comparison sites for the CFI. These CFIs are located in five states: Utah (10), Texas (3), Louisiana (2), Colorado (1), and Ohio (1). The conventional intersections were chosen considering 1) close distance to the CFIs; 2) same number of legs; 3) same control (i.e., all signalized); and 4) comparable traffic volume.

About the sample size, the team used 17 CFIs and 34 conventional intersections, and the total number of crashes is about 8,000. Therefore, the team determined that the sample size could be used for the analysis.

Influence areas of intersections	Schematic Diagrams
(1)	 <p>A schematic diagram of a crossover intersection. A vertical road crosses a horizontal road. A blue circle with a diameter of 250 ft is centered at the intersection. Arrows on the horizontal road indicate traffic flow from both directions. The circle covers the intersection area.</p>
(2)	 <p>A schematic diagram of a crossover intersection. A vertical road crosses a horizontal road. A large blue oval is drawn around the intersection, extending further along the horizontal road than the 250 ft circle in diagram (1). The text "Covers both Crossover Left Turn" is written above the oval. Arrows on the horizontal road indicate traffic flow from both directions.</p>
(3)	 <p>A schematic diagram of a crossover intersection. A vertical road crosses a horizontal road. A central blue circle with a diameter of 250 ft is centered at the intersection. Two smaller blue circles, each with a diameter of 150 ft, are positioned on the horizontal road, one on each side of the intersection. Arrows on the horizontal road indicate traffic flow from both directions.</p>
(4)	 <p>A schematic diagram of a crossover intersection. A vertical road crosses a horizontal road. A central blue circle with a diameter of 250 ft is centered at the intersection. Two very small blue circles, each with a diameter of 50 ft, are positioned on the horizontal road, one on each side of the intersection. Arrows on the horizontal road indicate traffic flow from both directions.</p>

**Figure 6-15: Influence areas of intersections for the safety analysis for CFIs**

For each influence area, traffic volumes and crash data were prepared. The average crash frequency values by different influence area of intersections for all crash types are presented in Table 6-17. As seen in the table, the average crash frequency values in (1) Main 250 ft, (3) Main 250 feet + crossover 150 feet, and (4) Main 250 feet + crossover 50 feet are not significantly different from each other. Nevertheless, the average crash frequency values in (2) Covering both U-turn lanes are much larger than those in other influence areas of intersections, as it covers much wider areas, and confirms our approach.

**Table 6-17: Annual average crash frequency by different influence area of intersections**

<b>Variables</b>	<b>(1) Main 250 ft</b>	<b>(2) Covering both crossovers</b>	<b>(3) Main 250 ft + crossover 150 ft</b>	<b>(4) Main 250 ft + crossover 50 ft</b>
Total	34.903	51.921	38.818	35.468
Injury	10.609	15.838	11.762	10.774
Fatal-and-injury	10.691	15.932	11.844	10.856
Fatal	0.082	0.094	0.082	0.082
Property Damage Only	24.212	35.918	26.974	24.612
Single-vehicle	1.974	2.688	3.956	2.091
Multi-vehicle	29.215	39.403	31.085	29.768

As a preliminary analysis, CMFs for different influence area of intersections were estimated using the cross-sectional method. The simple SPFs only with daily vehicle-miles-traveled (DVMT) and CFI dummy variables were developed for estimating the CMFs. Table 6-18 summarizes the estimated CMFs. It would be problematic if we do not consider crashes at the crossover left-turn points because they have several conflict points, while the crashes have been moved from the main intersection. Also, the buffers covering both crossover left-turn points cover too wide areas. The team has decided to use (4) Main 250 ft + U-Turn 50 ft because the crossover left turn has only two conflict points, and their influence area is quite limited.

Considering 150 feet for crossover left-turn points might incorporate crashes that are not relevant to CFIs.

**Table 6-18: Estimated CMFs by different influence area of intersections**

Crash type	CMF			
	(1) Main 250 ft (using TEV)	(2) Covering both crossovers (using DVMT)	(3) Main 250 ft + crossover 150 ft (using DVMT)	(4) Main 250 ft + crossover 50 ft (using DVMT)
Total	1.354***	1.501**	1.332**	1.312**
Property Damage Only	1.400***	1.465**	1.346**	1.341**
Injury	1.255*	1.541**	1.288*	1.240*
Fatal-and-injury	1.260*	1.553**	1.297*	1.248*
Fatal	2.101	7.392**	5.393**	4.378**
Single-vehicle	1.462**	1.331	1.120	1.484**
Multi-vehicle	1.337***	1.552**	1.126	1.295**

\*\*\* significant at 99%, \*\* significant at 95%, and \* significant at 90%.

Based on the influence area of intersections, (4) Main 250 ft + left-turn crossover 50 ft, the response variables (i.e., crashes) and explanatory variables were prepared (Table 6-19).

**Table 6-19: Descriptive statistics of the conventional intersections and CFIs**

(1) Conventional intersections

Variables	Mean	Stdev	Min	Max
<i>Crash Variables</i>				
Total	141.265	69.241	34	313
PDO	92.853	46.566	23	220
Injury	48.324	24.271	11	118
Fatal-and-injury	48.471	24.498	11	120
Fatal	0.147	0.436	0	2
Single-vehicle	7.588	5.028	2	22
Multi-vehicle	119.059	57.968	29	260
Non-motorized	3.441	3.007	0	15
<i>Explanatory Variables</i>				
Major AADT	40985.38	8278.54	17652	54000
Minor AADT	16923.00	9968.77	2116	38000
Total Entering Vehicles	57908.38	14214.71	21467	92000
Major DVMT	3881.19	783.95	1671.59	5113.64
Minor DVMT	1602.56	944.01	200.38	3598.48
Total DVMT	5483.75	1346.09	2032.86	8712.12
Skew Angle(°)	3.353	7.746	0	25



Skewed (yes=1, no=0)	0.147	0.359	0	1
Major Speed Limit (mph)	41.912	6.744	35	60
Minor Speed Limit (mph)	36.029	6.717	20	50
Lighting	0.824	0.387	0	1
Pedestrian Crossing	0.941	0.239	0	1

(2) Continuous Flow Intersections (CFIs) (main 250 ft + crossover 50 ft)

Variables	Mean	Stdev	Min	Max
<i>Crash Variables</i>				
Total	168.176	77.106	53	365
PDO	115.294	49.775	38	220
Injury	52.529	31.293	15	144
Fatal-and-injury	52.882	31.470	15	145
Fatal	0.353	0.493	0	1
Single-vehicle	9.941	5.154	3	20
Multi-vehicle	141.294	65.886	44	304
Non-motorized	1.647	2.344	0	8
<i>Explanatory Variables</i>				
Major AADT	49827.24	14220.42	20288	70000
Minor AADT	23883.06	13094.50	6075	43000
Total Entering Vehicles	73710.29	23433.65	28223	104000
Major DVMT	6707.51	1914.29	2731.08	9423.08
Minor DVMT	2296.45	1259.09	584.13	4134.62
Total DVMT	7835.74	2406.89	3056.88	11041.67
Skew Angle(°)	6.235	10.317	0	32
Skewed (yes=1, no=0)	0.294	0.470	0	1
Major Speed Limit (mph)	48.235	6.359	40	60
Minor Speed Limit (mph)	39.706	4.832	30	45
Lighting	0.941	0.243	0	1
Pedestrian Crossing	0.882	0.332	0	1

Also based on the influence area of intersections, (4) Main 250 ft + left-turn crossover 50 ft, the average crash frequency for CFI intersections is 168.176 crashes per intersection. On the other hand, the average crash frequency for conventional intersections is 141.265 crashes per intersection. This indicates CFIs is possibly more dangerous than conventional intersections.

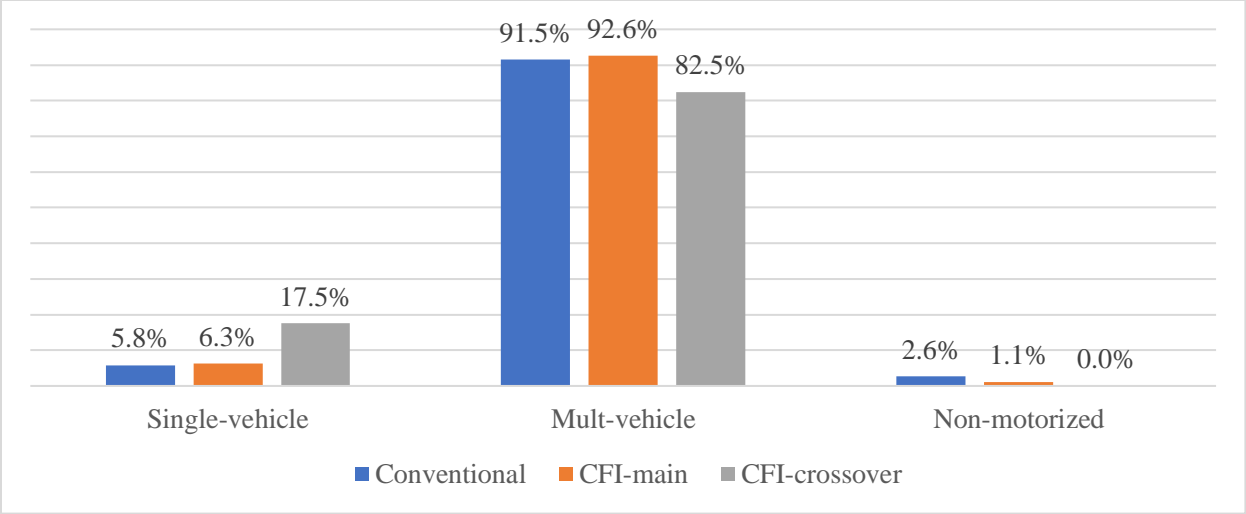
Nevertheless, this simple comparison did not take traffic volume and other factors into account.

Figure 6-16 shows the percentages of crashes by type at CFI and conventional intersections. The figure indicates that, for all intersection types, the percentages of multi-vehicle crashes are much higher than single vehicle crash. In CFI-crossover points, the percentage of single-vehicle

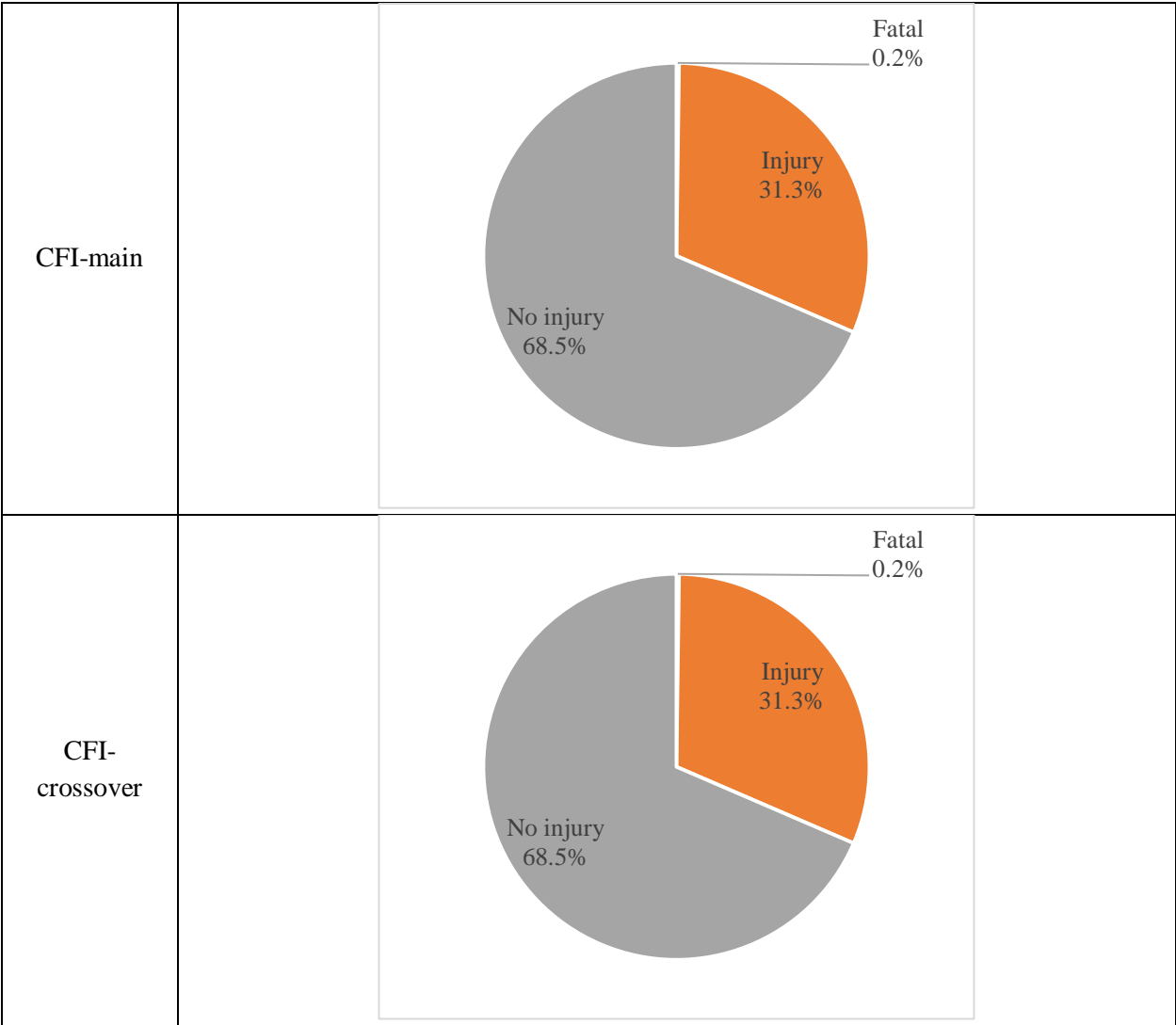
crashes are much higher than others. The differences in the percentages were statistically significant at 99% confidence interval ( $\chi^2=33.481$ , d.f.=4,  $p<0.0001$ ).

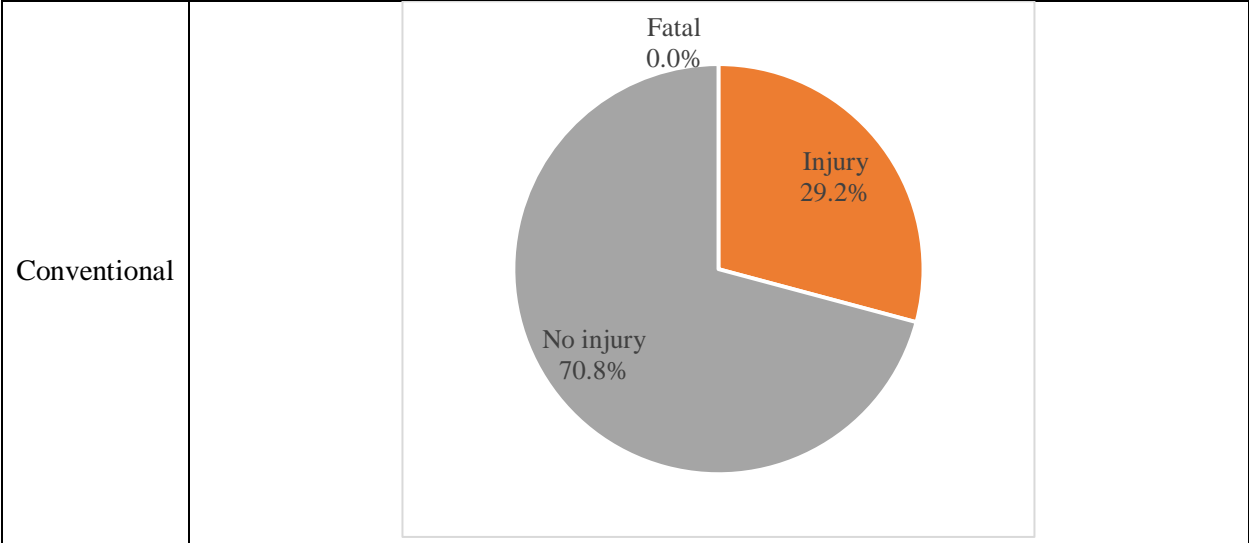
The percentages of crashes by injury severity at CFI's main intersections, CFI's crossover left-turn points, and conventional intersections are exhibited in Figure 6-17. It is shown that the percentages of fatal crashes at CFI main intersections, crossover left-turn points, and conventional intersections are 0.2%, 0% and 0.1% respectively. In addition, the percentage of injury crashes at CFIs main intersections is 31.3%, which is slightly lower than that in the conventional intersections (34.2%); however, higher than that in the CFI-crossover points (29.2%). On the other hand, the percentage of injury crashes at CFIs' main intersections is 68.5%, which is higher than that in conventional intersections (65.7%); but lower than that in CFIs' crossover points (70.8%). The differences are statistically significant at 95% confidence interval ( $\chi^2=8.577$ , d.f.=4,  $p=0.0726$ ).

Nevertheless, both Figures 6-16 and 6-17 simply compare the percentages of crash types and injury severity levels between CFI's main intersections, CFI's crossover left-turn points, and conventional intersections. They showed that they have different crash patterns but it is not possible to directly determine which ones are safer. The comparison of traffic safety between CFIs and conventional intersections is made in the following SPFs and CMFs sections.



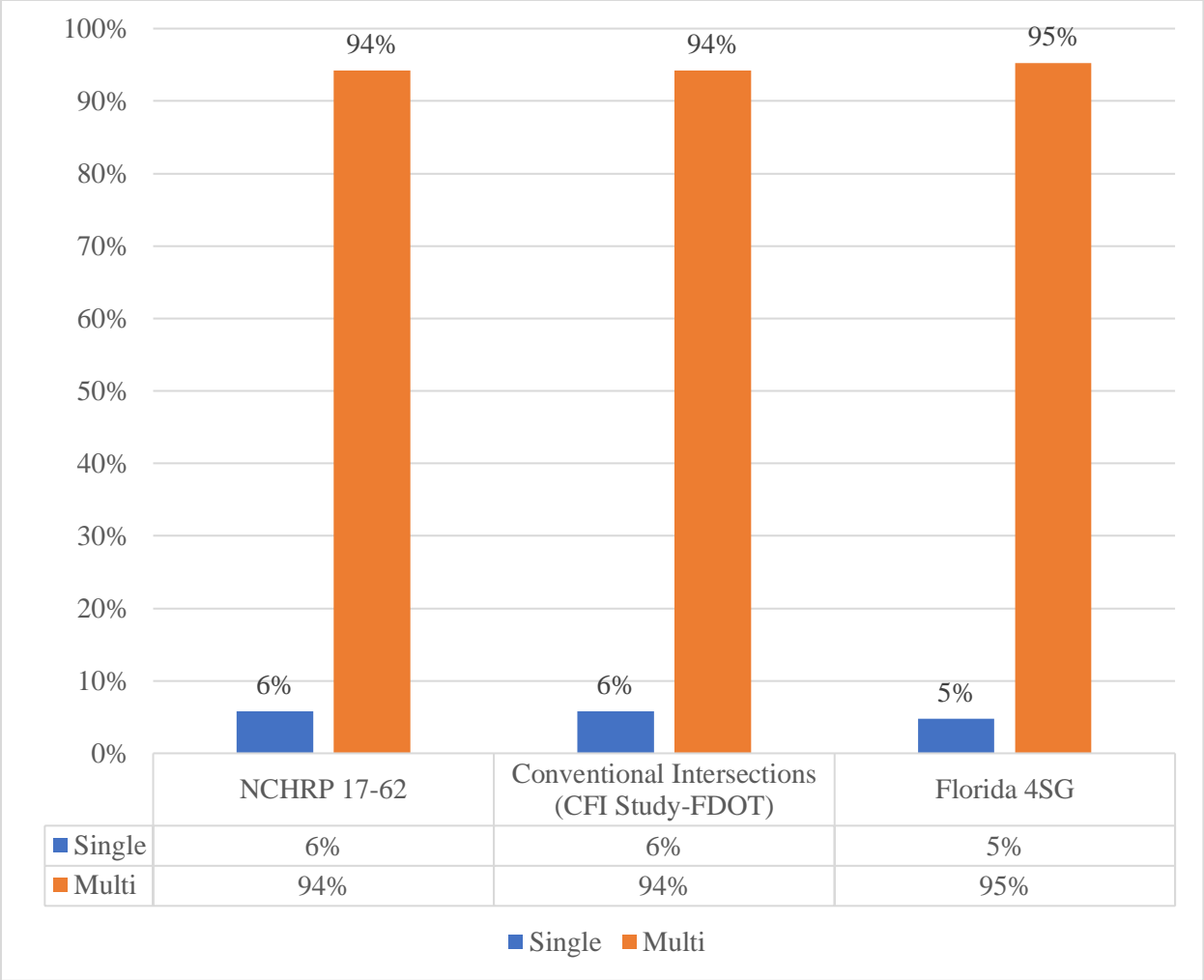
**Figure 6-16: Percentages of crashes by types at CFI and conventional intersections**





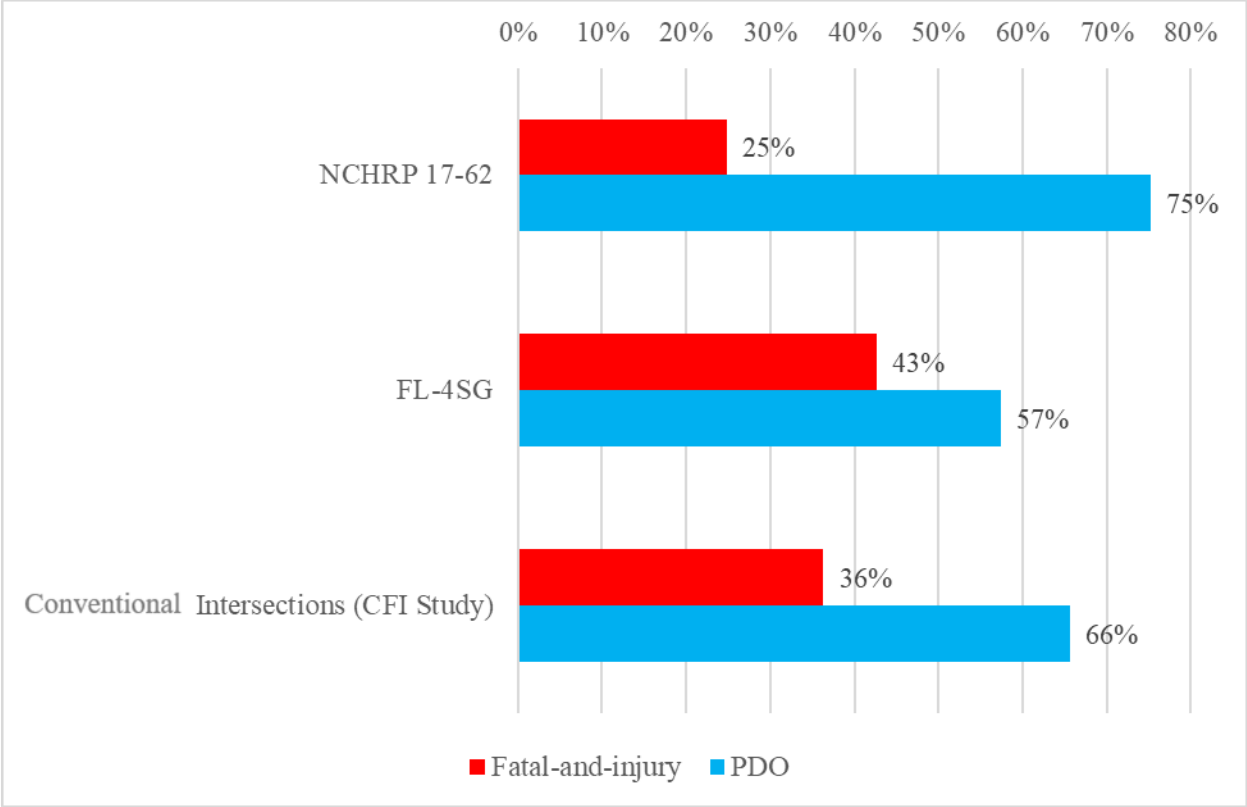
**Figure 6-17: Percentage of crashes by injury severity at CFI and conventional intersections**

Nevertheless, the Highway Safety Manual does not provide the percentages of single and multi-vehicle crashes in urban/suburban areas (most CFIs and their comparison sites in the study are located in urban areas) and crashes by severity. Thus, the team compared the distributions of conventional intersections in the current study with NCHRP 17-62 (589 four-legged signalized intersections in urban/suburban Ohio, 2007-2011) and Florida’s four-legged signalized intersections (2011-2014). Figures 6-18 and 19 show the proportions of single/multi-vehicle crashes in the three sources, and it was revealed that the crash distributions of this study and those from others are almost same.



**Figure 6-18: Distribution of crash types in NCHRP 17-62, this study (CFI-FDOT), and Florida 4SG data**

Figure 6-19 compares the crash distributions by injury severity from the three sources. The severity distribution of conventional intersections in our CFI study is slightly different from two others. The percentage of the fatal-and-injury crashes at conventional intersections in our CFI study is 36% (almost average) while those of NCHRP 17-62 and Florida 4SG (2011-2014) are 25% and 43%, respectively. It shows that the severity distribution of the conventional intersections in our CFI study is similar to those of other data. In conclusion, the team determined that the crash data our study can be used for estimating SPFs and CMFs for CFIs.



**Figure 6-19: Distribution of severity level in NCHRP 17-62, this study (CFI-FDOT), and Florida 4SG data**

#### 6.4.2. Developing SPFs for Continuous Flow Intersections

Using the prepared data, two types of SPFs were developed: (1) fully-specified SPFs and (2) simple SPFs. The fully-specified SPFs include all significant explanatory variables along with the interaction term of DVMT and CFI dummy variables; whereas the simple SPFs only contain DVMT and CFI dummy variables.

Table 6-20 summarizes the developed fully specified SPFs. It shows that the combined effect variable, 'Log (DVMT)\*CFI' has positive effects on total, fatal, injury, PDO, single-vehicle, multi-vehicle crashes. It implies that CFIs are more dangerous at intersections with higher traffic volume. On the other hand, the interaction term, 'Log (DVMT)\*CFI' is negatively associated with non-motorized crashes, which shows that the CFIs are relatively safer for non-motorized users with higher traffic volume.

Table 6-21 summarizes the simple SPFs. It shows that the dummy variable, 'CFI' has positive effects on all crash types except the non-motorized crashes. It is possible that drivers will be confused for the new operation rules of CFIs and resulted in more crashes. In contrast, CFIs tend to have a smaller number of crashes involving pedestrians and bicyclists. This may be due to prohibiting left-turn vehicle movements at the main intersection.

**Table 6-20: Fully-specified SPFs for CFIs**

Variables	Total		PDO		Injury		Fatal-and-injury	
	Coef.	S.E.	Coef.	S.E.	Coef.	S.E.	Coef.	S.E.
Intercept	-0.4637	1.2420	-1.9661	1.3578	-0.2713	1.3410	-0.2120	1.3397
Log (DVMT)	0.3099**	0.1433	0.4660***	0.1531	0.2493*	0.1509	0.2432	0.1507
Log (DVMT)*CFI	0.0206*	0.0121	0.0241*	0.0133	0.0234*	0.0141	0.0243*	0.0141
Major Speed Limit					0.0081**	-0.0339	-0.0184**	0.0081
Minor Speed Limit	0.0201***	0.0073	0.0199**	0.0081	0.0271***	0.0085	0.0274***	0.0085
Lighting	0.2934**	0.1359						
Overdispersion	0.0913	0.0196	0.1085	0.0238	0.0938	0.0233	0.0938	0.0232

Variables	Single-vehicle		Multi-vehicle		Non-motorized	
	Coef.	S.E.	Coef.	S.E.	Coef.	S.E.
Intercept	-2.0273	1.9310	-1.2167	1.2959	-12.1733***	4.2532
Log (DVMT)	0.2654	0.2252	0.4066***	0.1464	1.4311***	0.4828
Log (DVMT)*CFI	0.0443**	0.0189	0.0195	0.0128	-0.1155***	0.0430
Major Speed Limit					-0.0637***	0.0240
Minor Speed Limit			0.0201***	0.0077	0.0559**	0.0228
Overdispersion	0.1155	0.0487	0.1011	0.0218	0.3448	0.1285

\*\*\* significant at 99%, \*\* significant at 95%, and \* significant at 90%.



**Table 6-21: Simple SPFs for CFIs**

Variables	Total		PDO		Injury		Fatal-and-injury	
	Coef.	S.E.	Coef.	S.E.	Coef.	S.E.	Coef.	S.E.
Intercept	-0.0632	1.2646	-1.1558	1.3290	0.1907	1.3771	0.2458	1.3790
Log (DVMT)	0.3770**	0.1471	0.4557***	0.1546	0.2220	0.1602	0.2159	0.1605
CFI	0.2712**	0.1124	0.2933**	0.1183	0.2149*	0.1224	0.2217*	0.1226
Overdispersion	0.1131	0.0237	0.1218	0.0263	0.1187	0.0280	0.1193	0.0281

Variables	Single-vehicle		Multi-vehicle		Non-Motorized	
	Coef.	S.E.	Coef.	S.E.	Coef.	S.E.
Intercept	-2.1656	1.8937	-0.4030	1.2791	-13.0720***	4.3198
Log ( DVMT)	0.2813	0.2207	0.3969***	0.1488	1.4655***	0.5018
CFI	0.3945**	0.1656	0.2583**	0.1140	-1.2155***	0.3783
Overdispersion	0.1149	0.0485	0.1149	0.0244	0.4359***	0.1507

\*\*\* significant at 99%, \*\* significant at 95%, and \* significant at 90%.

### 6.4.3. Estimating CMFs for Continuous Flow Intersections

Using the developed fully-specified and simple SPFs, various CMFs for CFI were estimated. In case of fully specified SPF, the CMF is a function of the total DVMT variable (Table 6-22) which implies that the CFI is more dangerous in case of high traffic volumes. In addition, the CMF values for the simple SPFs are shown in Table 6-23. The values show that CFIs are more dangerous than conventional intersections for all crash types except non-motorized crashes as discussed in the previous section. Figure 6-20 shows the relationship between CMF values and DVMT from the CMFunctions estimated from the fully-specified SPFs. It is noted that the CMFunctions from the fully-specified SPFs are more reliable; however, it is difficult to make a conclusion with a specific percentage. Therefore, in this case, CMFs from the simple SPFs are recommended (particularly for use in SPICE tools); however, it is still important to understand that the CMF values are a function of DVMT.

**Table 6-22: CMFunctions from the fully-specified SPFs**

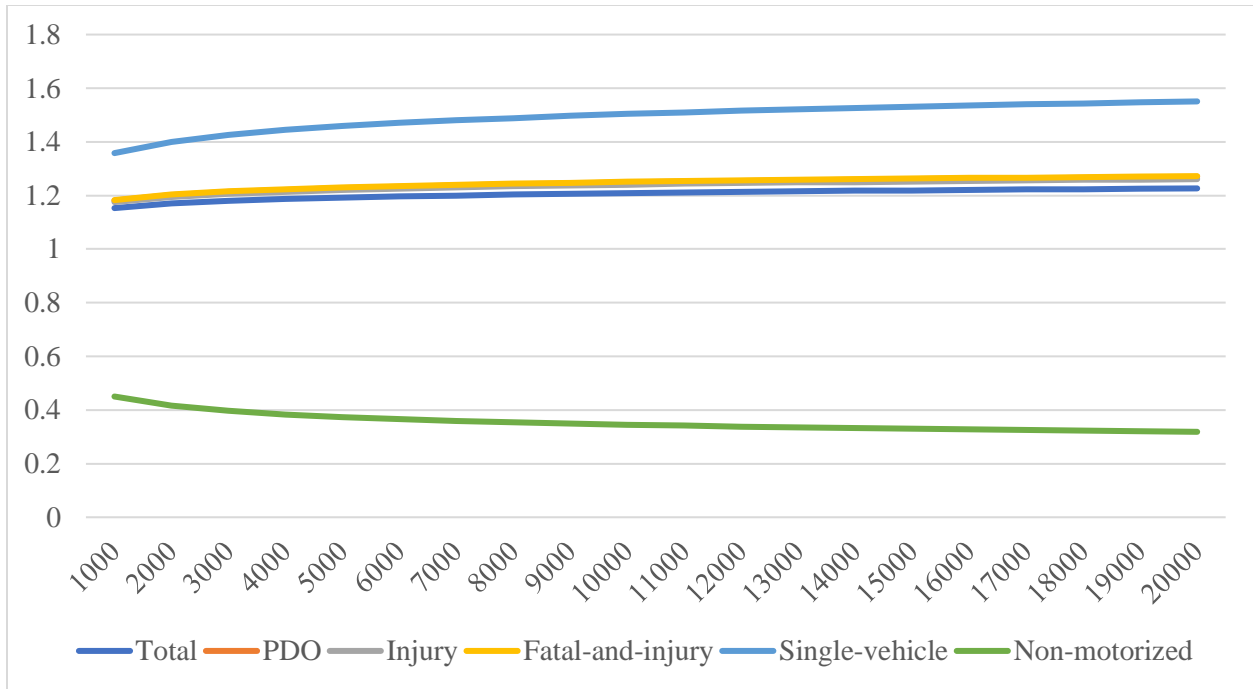
Total	PDO	Injury	Fatal-and-injury	Single-vehicle	Multi-vehicle	Non-motorized
DVMT <sup>0.0206*</sup>	DVMT <sup>0.0241*</sup>	DVMT <sup>0.0234***</sup>	DVMT <sup>0.0243*</sup>	DVMT <sup>0.0443**</sup>	DVMT <sup>0.0195</sup>	DVMT <sup>-0.1155**</sup>

\*\*\* Significant at 99%, \*\* significant at 95%, and \* significant at 90%.

**Table 6-23: CMFs from the simple SPFs**

Total	PDO	Injury	Fatal-and-injury	Single-vehicle	Multi-vehicle	Non-motorized
1.312**	1.341**	1.240*	1.248*	1.484**	1.295**	0.297***

\*\*\* significant at 99%, \*\* significant at 95%, and \* significant at 90%.



**Figure 6-20: Crash modification functions for fully-specified SPFs by crash type (significant CMFunctions only)**

#### 6.4.4. Before-and-After Analysis for Continuous Flow Intersections

In the cross-sectional analysis, to evaluate the safety effects of CFIs, 17 CFIs and 34 conventional intersections were used. For a before-and-after analysis with the comparison group, four CFIs in Utah could not be used as treated sites because they were implemented recently and less than two-years of the crash data were available. Thus, 13 CFIs: 10 from Utah, 1 from Colorado, 1 from Louisiana, and one from Ohio were used as treated sites in the analysis. Twenty-six were chosen, which are conventional, close to the CFIs, have same number of legs, and signalized (consistent with the CFIs).

The research team estimated CMFs using a before-and-after method with the comparison group, and the results are summarized in Table 6-24. The results showed that total, PDO, injury, fatal-and-injury, and single-vehicle crashes increased after the implementation of the CFIs. Total crashes have increased by 22.4% whereas PDO, injury, fatal-and-injury, and single-vehicle crashes have increased approximately by 68.2%, 60.5%, 76.3%, and 57.0%, respectively. No significant change was found for multi-vehicle crashes. The results show a consistent trend with those from the cross-sectional analysis (Table 23). The team also attempted to estimate CMFs using the empirical Bayes (EB) method; however, the CMFs estimated from the reference sites had insignificant exposure (AADT). It is probably due to the small sample size (N=26) and data from multiple states were used simultaneously.

**Table 6-24: CMFs for CFIs (before-and-after study with the comparison group)**

Crash type	CMF	S.E.	p
Total	1.224***	0.068	<0.001
PDO	1.682***	0.115	<0.001
Injury	1.605***	0.162	<0.001
Fatal-and-injury	1.763***	0.174	<0.001
Single-vehicle	1.570***	0.140	<0.001
Multi-vehicle	1.036	0.074	0.631

\*\*\* significant at 99%, \*\* significant at 95%, and \* significant at 90%.

#### 6.4.5. Summary

There are 17 CFIs in five states (Utah, Texas, Louisiana, Ohio, and Colorado). The team used a before-and-after method with the comparison group and a cross-sectional methods in developing CMFs. For the cross-sectional analysis, data from 17 CFIs and 34 conventional intersections were collected for the comparison group. The CMFs were estimated by simple SPFs and fully-specified SPFs. In terms of simple SPFs, it was found that CFI has increased crashes for total (+31%), injury (+24%), fatal-and-injury (+25%), single-vehicle (+48%), and multi-vehicle crashes (+30%). However, it decreased the non-motorized crashes by 70%.

For the before-and-after study, the team used 13 CFIs and 26 conventional intersections. Four CFIs could not be used due to the data limitation in the before-and-after analysis. The before-and-after analysis showed that CFI has increased the number of crashes for total (+22%), PDO (+68%), injury (+61%), fatal-and-injury (+76%), and single-vehicle crashes (+57%).

Generally, CFIs have higher crash frequencies than conventional intersections for most crash types. This may be due to the confusion from prohibiting vehicle left-turn movements at the main intersection. On the other hand, non-motorized crash frequency is smaller at CFIs according to the cross-sectional analysis. It is probably because non-motorized users are safer due to eliminating the conflicts with left-turning vehicles.

According to the Louisiana DOT case (Hughes and Jagannathan, 2009), there was 24% and 19% reduction in total and fatal-and-injury crashes, respectively, after the implementation of the CFI at Airline Highway and Seigen Lane in Baton Rouge. Considering the traffic volume on the major road, the reduction rates are 24% and 22%, respectively. In contrast, we found 25-30% increase in total crashes. The result from the LDOT study is very different from ours. They relied on only one intersection, and it is impossible to determine its statistical significance. Using a

simple B/A study would not be reliable and suffer from many threats to the validity of the study.

Thus, the team believes that our result are accurate and reliable.

## **6.5. JUGHANDLE INTERSECTIONS**

The Jughandle intersection is defined by the New Jersey Road Design Manual (NJDOT, 2015) as an at-grade ramp provided at or between intersections to permit drivers to make indirect left-turns and U-turns. There are three types of the Jughandle intersections.

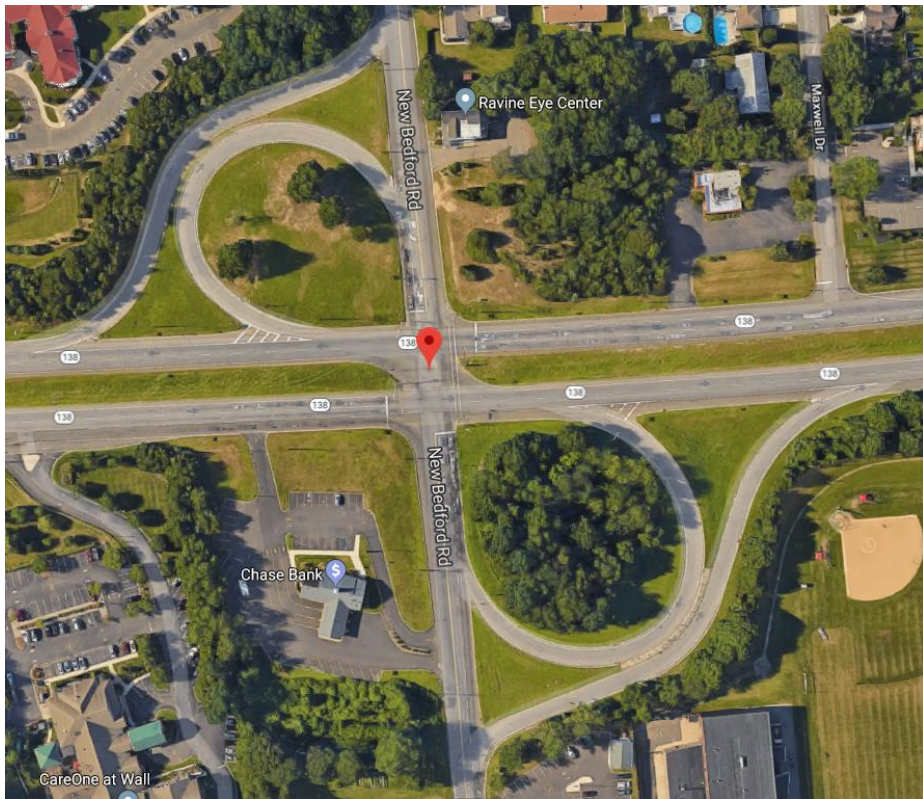
Type 1 (Forward/Forward Jughandle Intersection) contains two forward ramps which allow the drivers to go right before they reach the main intersection if they want to go right, left, or make a U-turn. When the drivers exit the ramp they can go right by merging with the through traffic on the minor road. While if they want to go left or make a U-turn they must cross the minor road first and drive until they reach the main intersection, and then go through (to go left) or go left (if they want to make a U-turn).

Type 2 (Reverse/Reverse Jughandle Intersection) contains two reverse ramps which allow the drivers to go left or make a U-Turn after they cross the main intersection. When the drivers exit the ramp, they must go right by merging with the through traffic on the minor road and drive until reaching the main intersection again then go through (to going left) or go left (if they want to make a U-turn), as displayed in Figure 6-22.

Type 3 (Forward/Reverse Jughandle Intersection) is a combination of the previous two types. It contains forward ramp and reverse ramp, which allows the drivers to go left or make a U-turn as we explained in the previous two types (Figure 6-23).



**Figure 6-21: Forward/forward jughandle intersection, New Jersey**



**Figure 6-22: Reverse/reverse jughandle intersection, New Jersey**





**Figure 6-23: Forward/reverse jughandle intersection, New Jersey**

### 6.5.1. Data Processing for Jughandle Intersections

Since Jughandle intersections have different configurations compared to conventional intersections, four new influence areas of intersections were considered in the data collection and analyses for this alternative intersection type. These areas include the entrance and the exits of the ramps. The entrance area was considered as an intersection-related area because a diverging movement occurs at it when the driver leaves the main road and heads to the ramp. While at the exit area, a crossing (at forward ramp) and merging (at reverse ramp) movements occur when the driver exits the ramp and crosses or merges with the main traffic. Thus, four scenarios for intersection related areas to be used in the analysis are described as follows:

1. 250 ft buffer size from the center of the main intersection (similar to conventional intersections).
2. A large buffer that must covers all the intersection-related areas which were described above.
3. 250 ft buffer size from the center of the main intersection and 150 ft buffer size at the entrance and exit of each ramp.
4. 250 ft buffer size from the center of the main intersection and 50 ft buffer size at the entrance and exit of each ramp.

These four scenarios are based on the different influence areas of intersections are also explained in Figure 6-24 with illustrations.

Twenty-seven Type 1 Jughandle intersections, twenty-six Type 2 Jughandle intersections, and fifteen Type 3 Jughandle intersections were identified, in New Jersey, and used in our study. For the cross-sectional analysis, sixty-two conventional intersections were selected considering: (1) spatially closeness to the Jughandle; (2) same number of legs; (3) same control type (signalized); and (4) similar traffic volume levels.



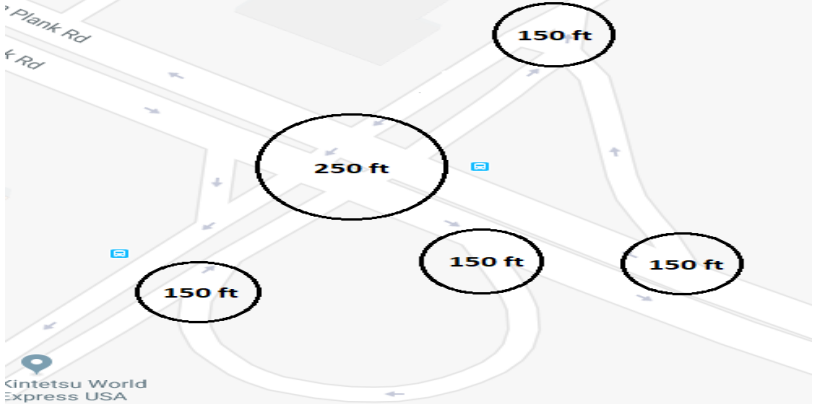

Influence areas of intersections	Schematic Diagrams
(1)	 <p>A schematic diagram of a road intersection with a single large circle centered on the intersection, labeled "250 ft". The background shows a map with road names and a building labeled "Kintetsu World Express USA".</p>
(2)	 <p>A schematic diagram of a road intersection with a large circle that encompasses the entire intersection and surrounding road segments. The text "Cover all the influenced areas" is written inside the circle. The background shows a map with road names and a building labeled "Kintetsu World Express USA".</p>
(3)	 <p>A schematic diagram of a road intersection with a central circle labeled "250 ft" and three smaller circles labeled "150 ft" positioned at the side intersections. The background shows a map with road names and a building labeled "Kintetsu World Express USA".</p>
(4)	 <p>A schematic diagram of a road intersection with a central circle labeled "250 ft" and three smaller circles labeled "50 ft" positioned at the side intersections. The background shows a map with road names and a building labeled "Kintetsu World Express USA".</p>

Figure 6-24: Influence areas of jughandle intersections for the safety analysis

Crash frequency, traffic, and geometric data were collected for Jughandle intersections with their influence areas, and for conventional intersections. Table 6-25 summarizes the average crash frequency by crash severity and by crash type for each scenario by influence area.

**Table 6-25: Average crash frequency by different influence area of intersections**

Variables	(1) Main 250 ft	(2) Big Buffer	(3) Main 250 ft + others 150 ft	(4) Main 250 ft + others 50 ft
Total	88.882	107.500	165.721	98.294
Injury	22.868	28.353	43.309	25.059
PDO	65.809	78.912	122.059	73.015
Single-Vehicle	0.294	0.397	0.529	0.353
Rear-End	50.294	59.191	94.353	55.485
Same-Direction Sideswipe	13.162	15.985	25.691	14.574
Angle	12.191	15.265	21.897	13.515
Head-On	0.956	1.103	1.588	1.015
Opposite-Direction Sideswipe	0.265	0.324	0.456	0.279
Left/U-Turn	2.176	2.706	4.132	2.397
Non-Motorized	0.471	0.632	0.779	0.544

First, simple SPFs with the variable of only daily vehicle-miles-traveled (DVMT) and the variable of Jughandle type were developed by using the cross-sectional method to estimate the CMFs (Table 6-26). We used this method because the majority of Jughandle intersections were implemented more than 23 years ago, making it irrelevant and difficult to obtain before data for B/A study. The first and the second scenarios are less persuasive. The first option considers only the main intersection into consideration while ignoring the other influenced areas. In addition, the second scenario takes into account too wide areas and some crashes that are not directly related to the intersection. The team found that the fourth scenario is the most reasonable to use than the third scenario because in the third some crashes would not be related to diverging, merging, and crossing maneuvers. The data were processed for the fourth scenario and the descriptive statistics of the prepared data are presented separately for conventional intersections and Jughandle types in Table 6-27.

**Table 6-26: Estimated CMFs by different influence area of intersections**

Type 1 (N=27)	CMF			
	(1) Main 250 ft using TEV	(2) Covering all the influenced areas using DVMT	(3) Main 250 ft + others 150 ft using DVMT	(4) Main 250 ft + others 50 ft using DVMT
Total	1.0499	1.0293	0.7190	0.8552
Injury	1.0272	0.9670	0.7289	0.8340
PDO	1.0625	1.0635	0.7204	0.8704
Single-Vehicle	2.3620	2.4422	1.3250	1.6476
Rear-End	1.3468*	1.2866	0.7956	1.0247
Same-Direction Sideswipe	0.8822	0.9206	0.6364**	0.6909*
Angle	1.0852	1.0911	0.9711	1.0182
Head-On	0.8668	0.8320	0.6666	0.7971
Opposite-Direction Sideswipe	0.9054	1.0170	0.6074	0.9565
Left/U-Turn	0.2106***	0.2247***	0.1301***	0.1860***
Non-Motorized	0.9464	1.1889	1.3581	1.0863

Type 2 (N=26)	CMF			
	(1) Main 250 ft using TEV	(2) Covering all the influenced areas using DVMT	(3) Main 250 ft + others 150 ft using DVMT	(4) Main 250 ft + others 50 ft using DVMT
Total	1.6494***	1.4422**	1.3196	1.3984**
Injury	1.4920***	1.3192*	1.2257	1.2746
PDO	1.7049***	1.4921**	1.3592	1.4479**
Single-Vehicle	3.3582**	3.4223**	2.5805	3.1906*
Rear-End	2.2642***	1.8636***	1.5642**	1.8098***
Same-Direction Sideswipe	1.5765***	1.4285**	1.3051	1.2719
Angle	1.4645*	1.3800	1.4718	1.4292
Head-On	1.1346	0.9935	1.0434	1.1030
Opposite-Direction Sideswipe	0.5690	0.6716	0.7927	0.5892
Left/U-Turn	0.4392**	0.3933***	0.3140***	0.3648***
Non-Motorized	1.7179	2.0651	3.2521**	2.1972*

Type 3 (N=15)	CMF			
	(1) Main 250 ft using TEV	(2) Covering all the influenced areas using DVMT	(3) Main 250 ft + others 150 ft using DVMT	(4) Main 250 ft + others 50 ft using DVMT
Total	1.0900	0.9322	0.8846	0.9454
Injury	1.1013	0.9187	0.8889	0.9632
PDO	1.0909	0.9491	0.8940	0.9487
Single-Vehicle	2.6570	2.9215*	2.1202	2.2952
Rear-End	1.5561**	1.1277	0.9786	1.2149
Same-Direction Sideswipe	0.9641	0.8389	0.8096	0.8211
Angle	0.7667	0.9363	1.0223	0.7901
Head-On	0.7422	0.6060	0.7753	0.7811
Opposite-Direction Sideswipe	0.3298	0.6655	0.9368	0.5104
Left/U-Turn	0.3154***	0.2407***	0.2514***	0.2717***
Non-Motorized	0.2892	0.7497	2.1374	0.8603

\*\*\* significant at 99%, \*\* significant at 95%, and \* significant at 90%.

**Table 6-27: Descriptive statistics of conventional and jughandle Intersections**

(1) Conventional intersections (N=62)

<b>Variables</b>	<b>Mean</b>	<b>Stdev</b>	<b>Min</b>	<b>Max</b>
<i>Crash Variables</i>				
Total	58.00	45.35	2.00	279.00
Fatal	0.10	0.35	0.00	2.00
Injury	16.23	15.95	0.00	116.00
Fatal-and-injury	16.32	15.94	0.00	116.00
PDO	41.68	31.51	1.00	163.00
Single-Vehicle	0.10	0.30	0.00	1.00
Rear-End	23.06	15.90	1.00	72.00
Same-Direction Sideswipe	9.24	7.62	0.00	34.00
Angle	9.79	10.32	0.00	48.00
Head-On	0.95	1.40	0.00	6.00
Opposite-Direction Sideswipe	0.40	0.73	0.00	3.00
Left/U-Turn	6.26	17.22	0.00	135.00
Non-Motorized	0.48	1.07	0.00	7.00
<i>Explanatory Variables</i>				
Major AADT	29889.47	11225.70	13763.00	63505.00
Minor AADT	10577.27	5880.91	278.00	27822.00
Total DVMT	3768.70	1285.54	1487.83	6787.12
Skewed	0.16	0.37	0.00	1.00
Skew Angle (°)	3.11	8.19	0.00	37.00
Number of Legs	3.84	0.37	3.00	4.00
Number of Ramps	0	0	0	0
Major Speed Limit (mph)	35.81	6.66	25.00	50.00
Minor Speed Limit (mph)	26.69	9.36	0.00	50.00
Pedestrian Crossing	0.95	0.22	0.00	1.00
Lighting	0.97	0.18	0.00	1.00
International Roughness Index	279.42	187.50	0.00	900.00

## (2) Jughandle Type 1 (N=27)

<b>Variables</b>	<b>Mean</b>	<b>Stdev</b>	<b>Min</b>	<b>Max</b>
<i><b>Crash Variables</b></i>				
Total	85.67	50.28	1.00	189.00
Fatal	0.15	0.36	0.00	1.00
Injury	22.00	13.13	1.00	47.00
Fatal-and-injury	22.15	13.10	1.00	47.00
PDO	63.52	37.94	0.00	142.00
Single-Vehicle	0.26	0.45	0.00	1.00
Rear-End	46.63	28.21	1.00	92.00
Same-Direction Sideswipe	12.00	8.38	0.00	28.00
Angle	13.11	11.57	0.00	43.00
Head-On	0.93	1.17	0.00	4.00
Opposite-Direction Sideswipe	0.37	0.63	0.00	2.00
Left/U-Turn	1.89	2.64	0.00	12.00
Non-Motorized	0.37	0.63	0.00	2.00
<i><b>Explanatory Variables</b></i>				
Major AADT	49304.15	18486.40	15404.00	95408.00
Minor AADT	6920.85	3413.69	1566.00	13592.00
Total DVMT	6973.32	2569.13	2160.23	13166.37
Skewed	0.26	0.45	0.00	1.00
Skew Angle (°)	7.04	15.03	0.00	56.00
Number of Legs	3.74	0.45	3.00	4.00
Number of Ramps	1.59	0.50	1.00	2.00
Major Speed Limit (mph)	50.74	4.54	40.00	55.00
Minor Speed Limit (mph)	33.70	9.47	0.00	50.00
Pedestrian Crossing	0.59	0.50	0.00	1.00
Lighting	0.85	0.36	0.00	1.00
International Roughness Index	159.93	109.50	0.00	528.00

## (3) Jughandle Type 2 (N=26)

<b>Variables</b>	<b>Mean</b>	<b>Stdev</b>	<b>Min</b>	<b>Max</b>
<i><b>Crash Variables</b></i>				
Total	119.23	83.26	39.00	446.00
Fatal	0.42	0.70	0.00	3.00
Injury	29.46	19.02	7.00	99.00
Fatal-and-injury	29.88	19.38	7.00	102.00
PDO	89.35	64.88	31.00	344.00
Single-Vehicle	0.46	0.99	0.00	4.00
Rear-End	68.58	52.90	14.00	265.00
Same-Direction Sideswipe	18.54	13.77	3.00	74.00
Angle	16.31	15.33	2.00	62.00
Head-On	1.19	1.27	0.00	4.00
Opposite-Direction Sideswipe	0.23	0.51	0.00	2.00
Left/U-Turn	3.04	3.48	0.00	14.00
Non-Motorized	0.85	1.16	0.00	4.00
<i><b>Explanatory Variables</b></i>				
Major AADT	36992.54	15070.99	18513.00	84932.00
Minor AADT	9727.77	5851.32	1546.00	23839.00
Total DVMT	5910.69	2052.13	2745.51	10850.06
Skewed	0.77	0.43	0.00	1.00
Skew Angle (°)	16.65	16.16	0.00	48.00
Number of Legs	3.96	0.20	3.00	4.00
Number of Ramps	1.69	0.47	1.00	2.00
Major Speed Limit (mph)	48.46	5.96	35.00	55.00
Minor Speed Limit (mph)	36.54	5.62	25.00	50.00
Pedestrian Crossing	0.81	0.40	0.00	1.00
Lighting	0.96	0.20	0.00	1.00
International Roughness Index	220.65	189.78	53.00	900.00



## (4) Jughandle Type 3 (N=15)

<b>Variables</b>	<b>Mean</b>	<b>Stdev</b>	<b>Min</b>	<b>Max</b>
<b><i>Crash Variables</i></b>				
Total	84.73	51.59	16.00	176.00
Fatal	0	0	0	0
Injury	22.93	14.22	4.00	47.00
Fatal-and-injury	22.93	14.22	4.00	47.00
PDO	61.80	39.99	11.00	129.00
Single-Vehicle	0.33	0.72	0.00	2.00
Rear-End	48.73	37.93	4.00	117.00
Same-Direction Sideswipe	12.33	8.50	2.00	37.00
Angle	9.40	5.46	2.00	20.00
Head-On	0.87	1.06	0.00	3.00
Opposite-Direction Sideswipe	0.20	0.41	0.00	1.00
Left/U-Turn	2.20	4.00	0.00	15.00
Non-Motorized	0.33	0.72	0.00	2.00
<b><i>Explanatory Variables</i></b>				
Major AADT	38783.33	17458.66	17039.00	84932.00
Minor AADT	5836.80	3921.92	717.00	13742.00
Total DVMT	5988.60	2551.50	2354.02	12658.40
Skewed	0.53	0.52	0.00	1.00
Skew Angle (°)	12.47	16.45	0.00	47.00
Number of Legs	3.80	0.41	3.00	4.00
Number of Ramps	2.13	0.35	2.00	3.00
Major Speed Limit (mph)	48.00	5.28	35.00	55.00
Minor Speed Limit (mph)	36.33	7.67	25.00	50.00
Pedestrian Crossing	0.60	0.51	0.00	1.00
Lighting	0.80	0.41	0.00	1.00
International Roughness Index	162.40	94.44	65.00	421.00

Figure 6-26 shows that for the first type of Jughandle intersections the percentage of fatal crashes at Jughandle main intersection (0.182%) is higher than that at the entrance and exit of ramps (0%) and conventional intersections (0.167%). While the percentages of the injury crash at Jughandle main intersection (26%) and at entrance and exit of ramps (20.7%) are lower than that at conventional intersections (28%). On the other hand, Percentage of PDO crashes at Jughandle main intersection (73.9%) and at entrance and exit of ramps (79.3%) are higher than that at conventional intersections (71.9%). CMH (Mantel-Haenszel  $\chi^2$ ) test was used instead of regular  $\chi^2$  test since two of the cells in the contingency table (i.e., Jughandle main intersection-fatal and entrance and exit of Jughandle ramps-fatal) have expected counts less than five. The CMH value was 2.8488 and  $p = 0.0914$ . Thus, we can conclude that the percentages of injury severity levels between Jughandle main intersection, entrance and exit of Jughandle ramps, and conventional intersections are not statistically significantly different.

Figure 6-27 presents the crash severity distributions of the second type of Jughandle intersections. The percentage of fatal crashes at Jughandle main intersection (0.359%) is higher than that at the entrance and exit of ramps (0.319%) and conventional intersections (0.167%). While the percentages of the injury crash at Jughandle main intersection (24.9%) and at entrance and exit of ramps (23%) are lower than that at conventional intersections (28%). On the other hand, Percentage of PDO crashes at Jughandle main intersection (74.7%) and at entrance and exit of ramps (76.7%) are higher than at conventional intersections (71.9%). The differences in the percentages are statistically significant ( $\chi^2 = 11.7236$ , d.f.=4,  $p = 0.0195$ ).

Figure 6-28 displays the crash severity distribution of the third type of Jughandle intersections. The percentage of fatal crashes at Jughandle main intersection (less than 0.001%) and at the entrance and exit of ramps (less than 0.001%) are considerably lower than at conventional

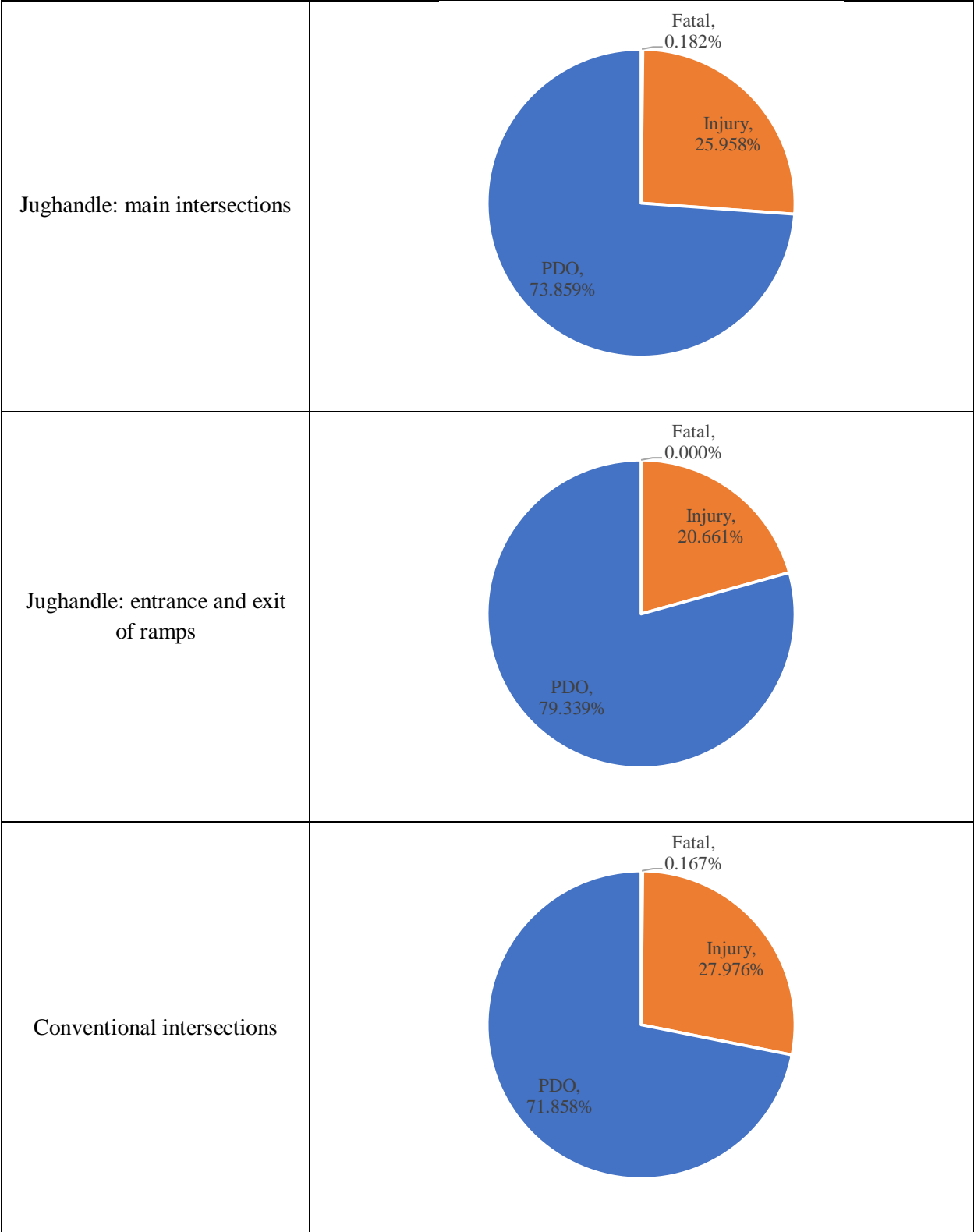
intersections (0.167%). While the percentages of the injury crash at Jughandle main intersection (27.4%) and at entrance and exit of ramps (25.2%) are lower than at conventional intersections (28%). On the other hand, Percentage of PDO crashes at Jughandle main intersection (72.6%) and at entrance and exit of ramps (74.8%) are higher than at conventional intersections (71.9%). The CMH value is 0.4598 ( $p = 0.4977$ ). Thus, we can conclude that the percentages of injury severity levels between Jughandle main intersection, entrance and exit of Jughandle ramps, and conventional intersections are not statistically significantly different.

Figure 6-29 compares between the percentages of each crash type at Type 1 Jughandle and conventional intersections and shows that the percentages of same-direction sideswipe, head-on, opposite-direction sideswipe, and non-motorized crashes at conventional intersections are higher than at Jughandle main intersections then at entrance and exit of Jughandle ramps. For single-vehicle crashes, the highest percentage is at Jughandle main intersections then at conventional intersections then at entrance and exit of Jughandle ramps. For rear-end crashes, the highest percentage is at Jughandle main intersections then at entrance and exit of Jughandle ramps then at conventional intersections, exactly the opposite for left/U-turn crashes. For angle crashes, the highest percentage is at entrances and exits of Jughandle ramps, then at conventional intersections then at Jughandle main intersections. The CMH value was 48.5312 ( $p < 0.0001$ ). Thus, we can conclude that the percentages of crash types between Jughandle main intersection, entrance and exit of Jughandle ramps, and conventional intersections are statistically significantly different.

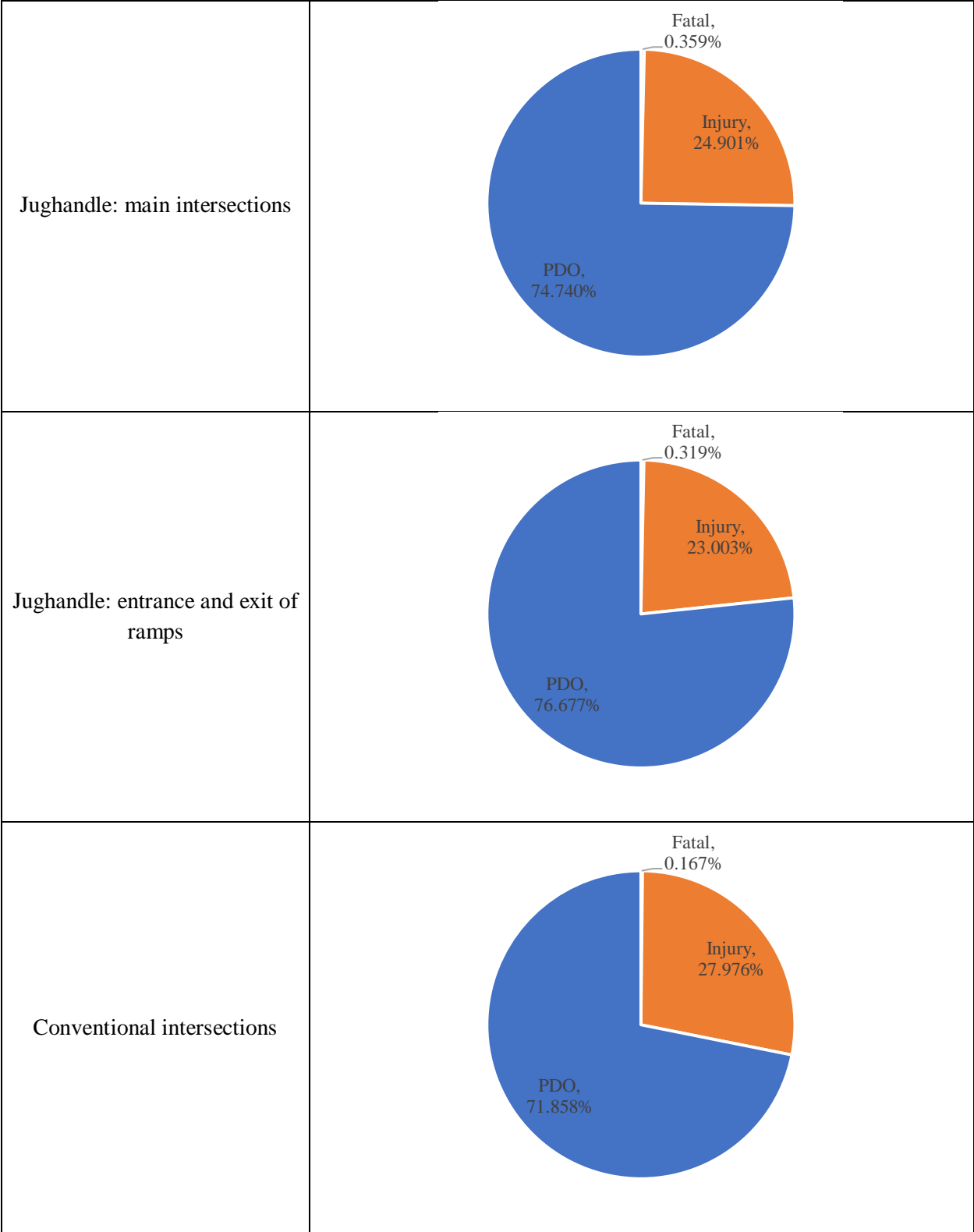
Figure 6-30 compares the percentages of each crash type at Type 2 Jughandle with conventional intersections. It could be noticed that the percentages of same-direction sideswipe, head-on, angle, opposite-direction sideswipe, left/U-turn, and non-motorized crashes at conventional

intersections are higher than at Jughandle main intersections then at entrance and exit of Jughandle ramps. For single-vehicle and rear-end crashes, the highest percentage is at entrance and exit of Jughandle ramps then at Jughandle main intersections then at conventional intersections. The differences in the percentages are statistically significant ( $\chi^2= 300.3318$ , d.f.=14,  $p <0.0001$ ).

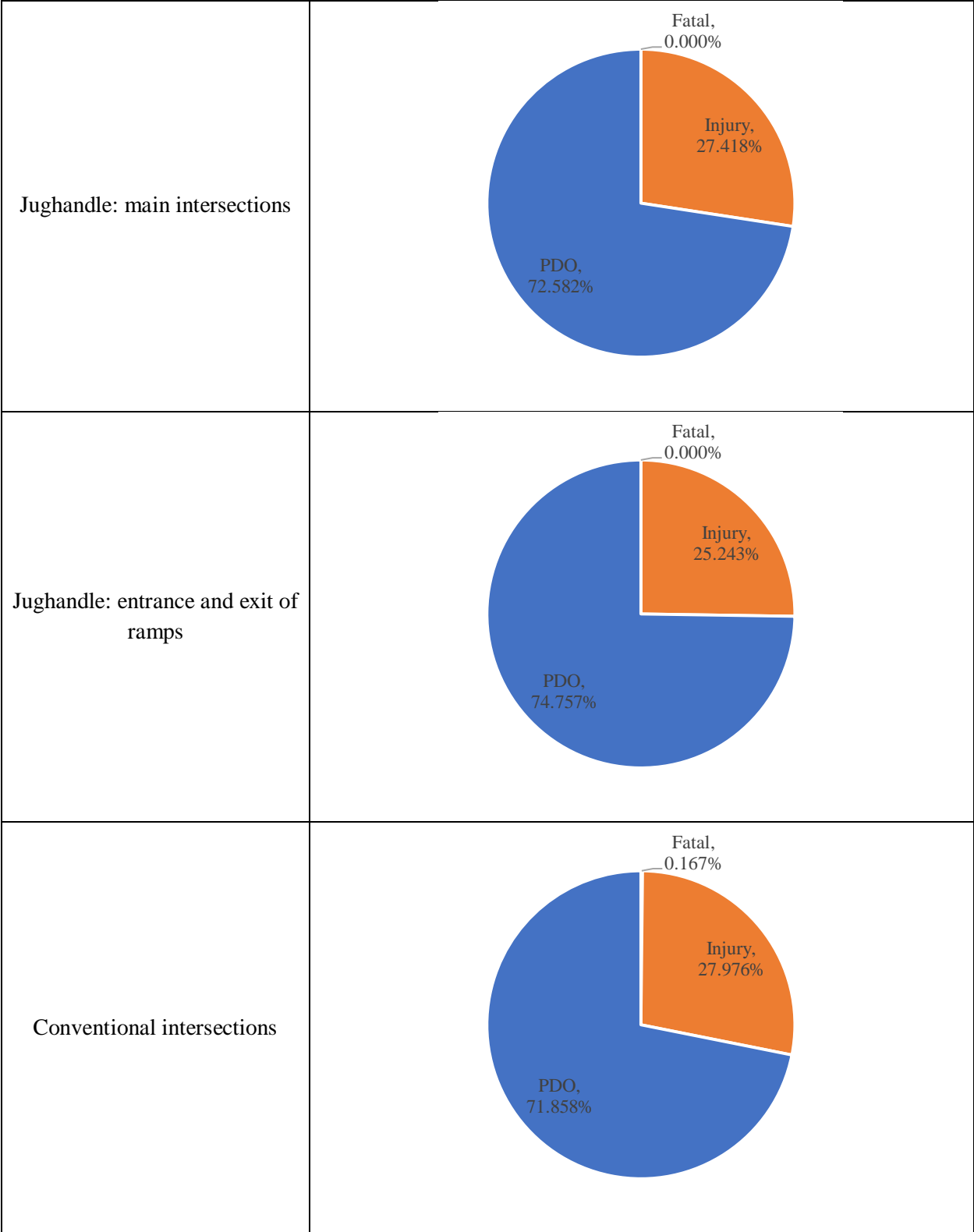
From Figure 6-31, which compares between the percentages of each crash type at Type 3 Jughandle and conventional intersections, it can be noticed that the percentages of head-on and left/U-Turn crashes at conventional intersections are the highest followed by Jughandle main intersections then at entrance and exit of Jughandle ramps. For same-direction sideswipe and non-motorized crashes, the highest percentage is observed at the entrance and exit of Jughandle ramps then at conventional intersections then at Jughandle main intersections. For rear-end crashes, the highest percentage is at Jughandle main intersections then at entrance and exit of Jughandle ramps then at conventional intersections, exactly the opposite for opposite-direction sideswipe crashes. For single-vehicle crashes, the highest percentage is at the entrance and exit of Jughandle ramps then at Jughandle main intersections then at conventional intersections. For angle crashes, the highest percentage is at conventional intersections then at entrance and exit of Jughandle ramps then at Jughandle main intersections. The CMH value was 74.3267 ( $p <0.0001$ ). Thus, we can conclude that the percentages of crash types between Jughandle main intersection, entrance and exit of Jughandle ramps, and conventional intersections are statistically significantly different.



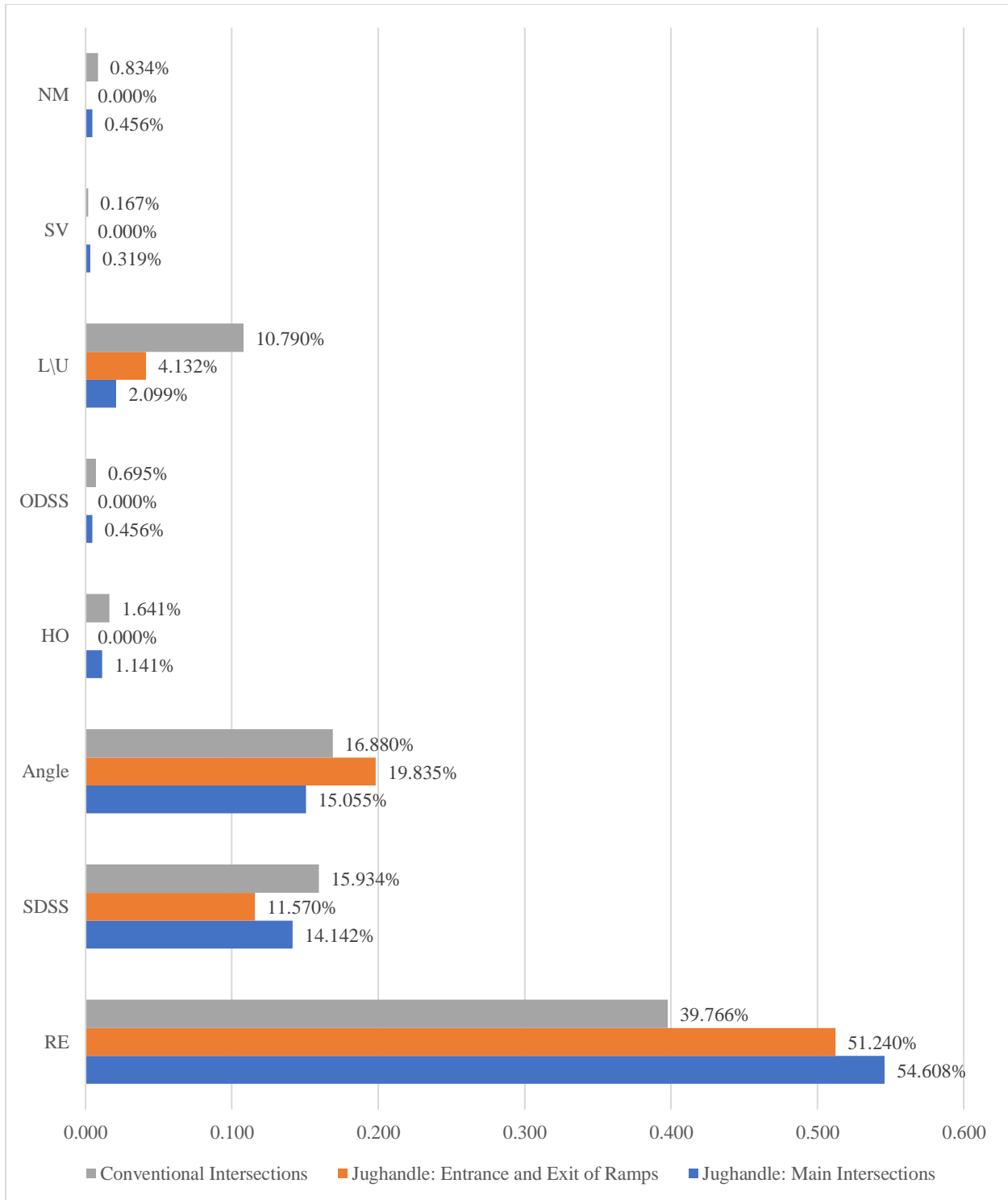
**Figure 6-25: Percentage of crashes by severity at Type 1 jughandle and conventional intersections**



**Figure 6-26: Percentage of crashes by severity at Type 2 jughandle and conventional intersections**



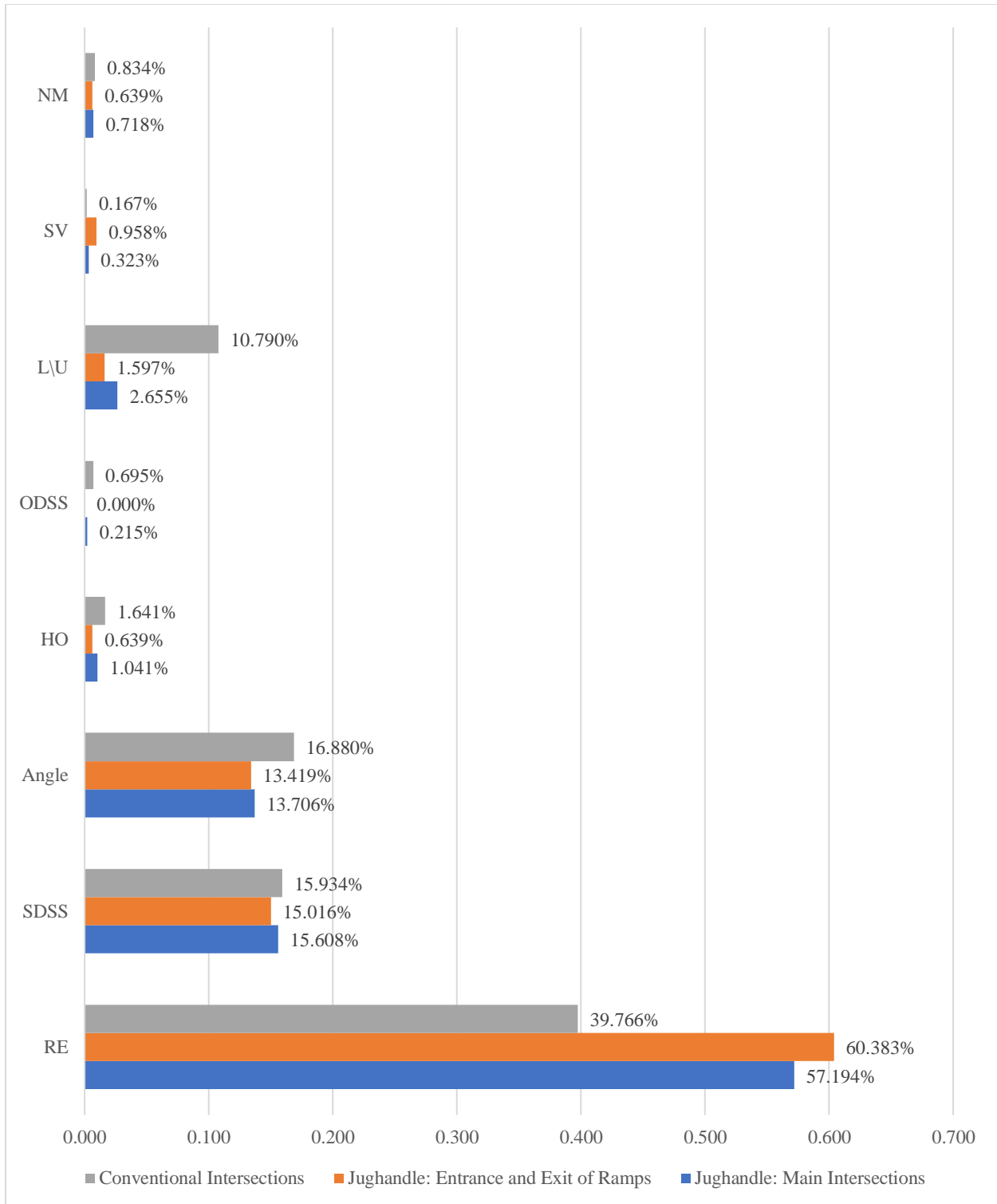
**Figure 6-27: Percentage of crashes by severity at Type 3 jughandle and conventional intersections**



\* SV: Single-Vehicle, RE: Rear-End, SDSS: Same-Direction Sideswipe, HO: Head-On, ODSS: Opposite-Direction Sideswipe, L/U: Left/U-Turn, NM: Non-Motorized

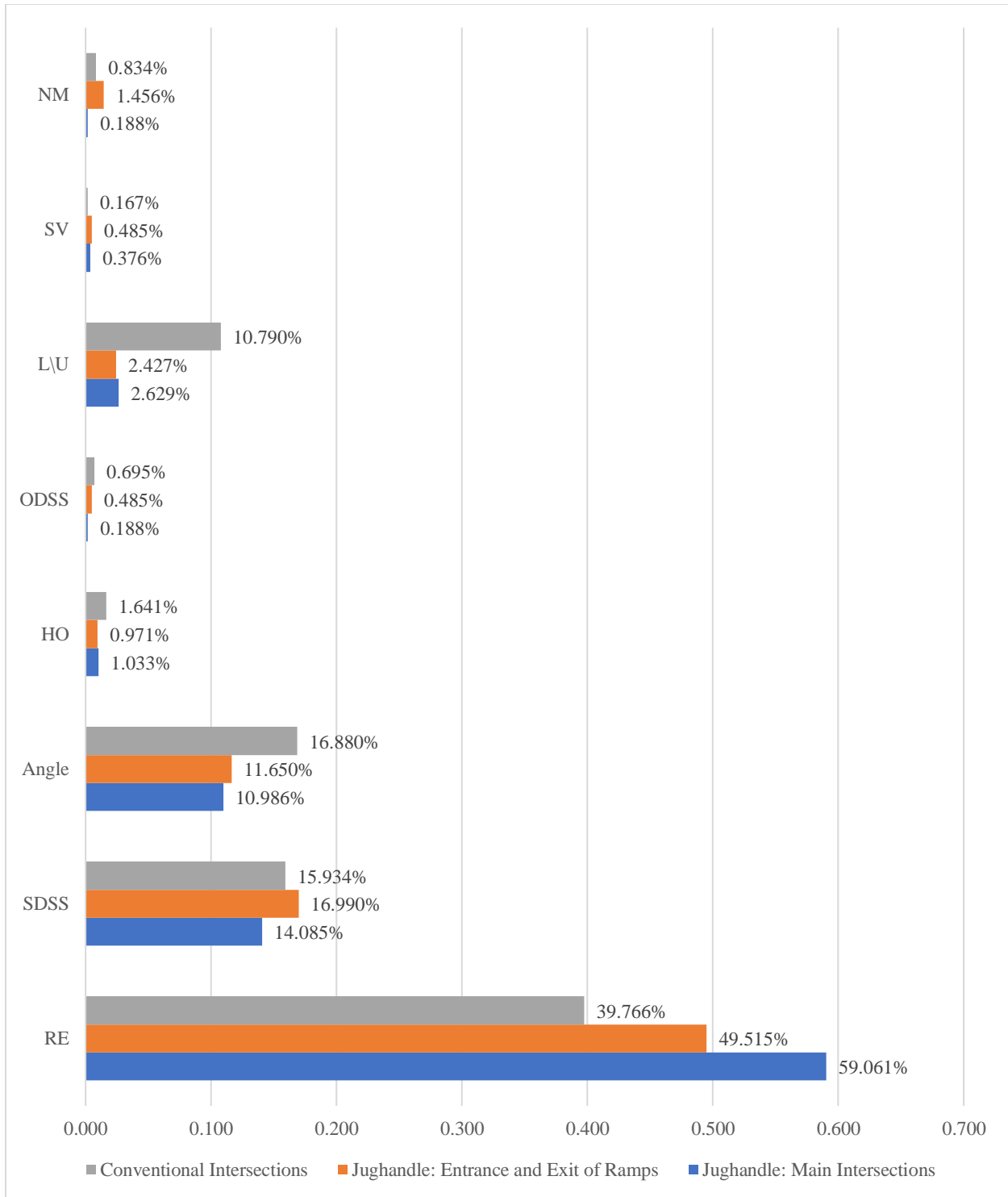
**Figure 6-28: Percentages of crashes by types at Type 1 jughandle and conventional intersections**





\* SV: Single-Vehicle, RE: Rear-End, SDSS: Same-Direction Sideswipe, HO: Head-On, ODSS: Opposite-Direction Sideswipe, L/U: Left/U-Turn, NM: Non-Motorized

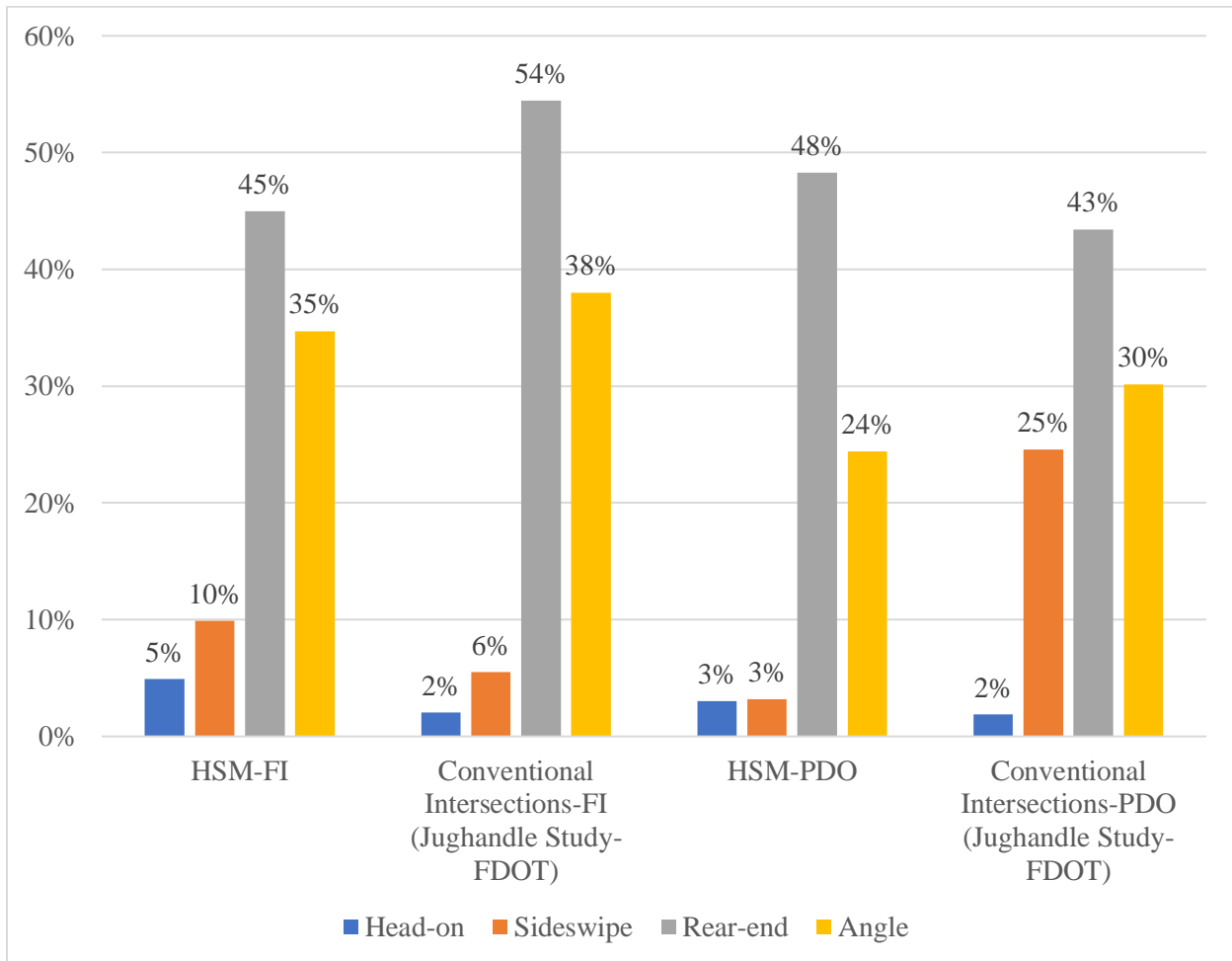
**Figure 6-29: Percentages of crashes by types at Type 2 jughandle and conventional intersections**



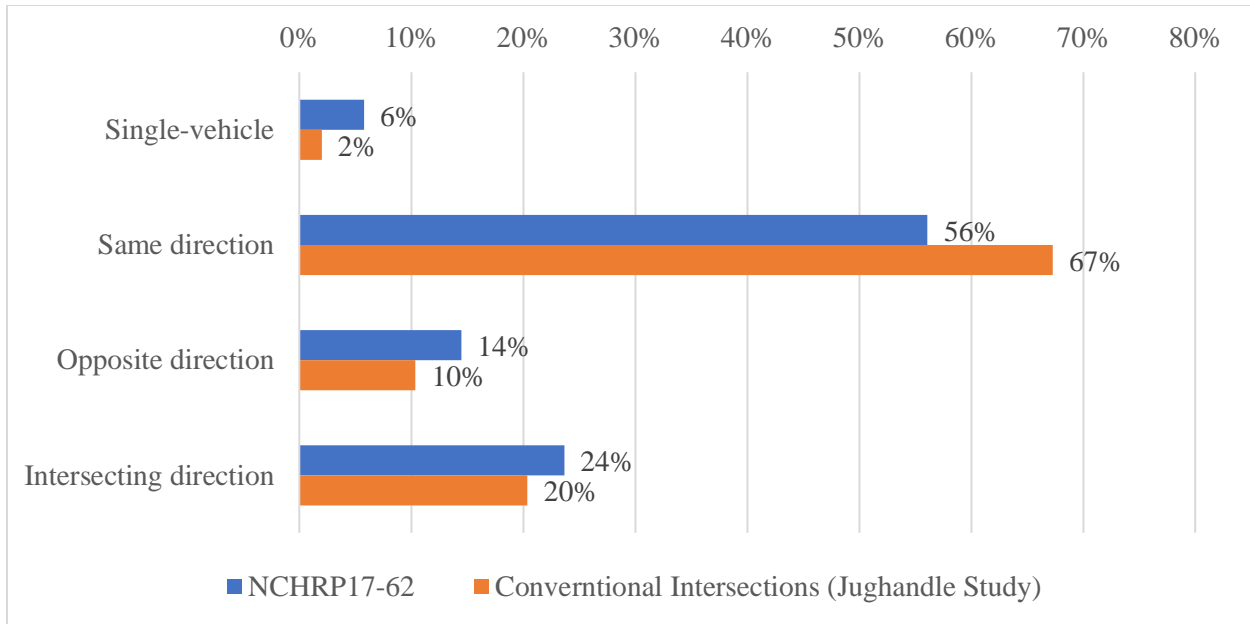
\* SV: Single-Vehicle, RE: Rear-End, SDSS: Same-Direction Sideswipe, HO: Head-On, ODSS: Opposite-Direction Sideswipe, L/U: Left/U-Turn, NM: Non-Motorized

**Figure 6-30: Percentages of crashes by types at Type 3 jughandle and conventional intersections**

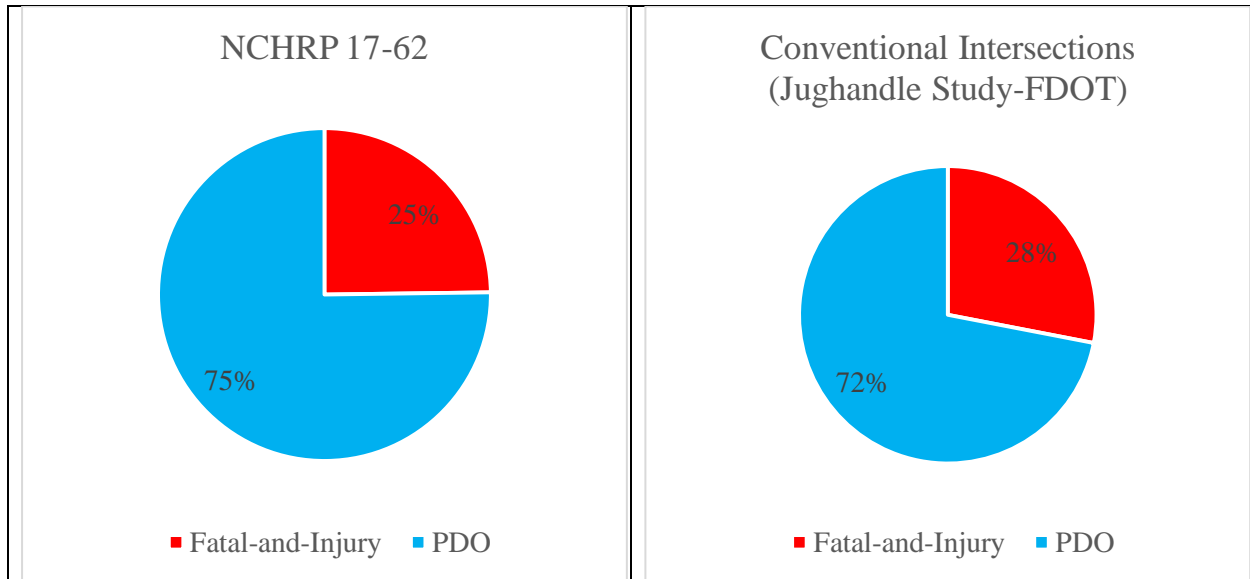
Prior to proceeding to the next step, the distributions of crash severities and types were compared with the Highway Safety Manual and NCHRP 17-92. Only sub-classification of multi-vehicle crashes were compared since the HSM only provides the distribution of multi-vehicle crashes. As shown in Figures 6-31 to 6-33, no considerable difference in the distributions was observed.



**Figure 6-31: Distribution of crash types in HSM and this study (Jughandle-FDOT)**



**Figure 6-32: Distribution of crash types in NCHRP 17-62 and this study (Jughandle-FDOT)**



**Figure 6-33: Distribution of severity levels in NCHRP 17-62 and this study (Jughandle-FDOT)**

### 6.5.2. Developing SPFs for Jughandle Intersections

Two types of SPFs were developed: (1) fully-specified SPFs (Table 6-28) and (2) simple SPFs (Table 6-29). The fully-specified SPFs includes all significant explanatory variables along with the interaction variable of log (DVMT) and Jughandle type, while the simple SPFs includes only the log (DVMT) and Jughandle type variables.

From the fully-specified SPFs we can notice that for total and PDO crashes, only the second type of Jughandle intersections has the significant positive effect, while for fatal-and-injury crashes all the three types of Jughandle intersections' effects are not significant.

For single-vehicle, rear-end, and angle crashes, only the second type of Jughandle intersections has significant positive effects. Skew angle and the number of legs variables also have a significant effect on angle crashes, and they have negative and positive effects, respectively.

For same-direction sideswipe crashes, only the first type of Jughandle intersections has a significant negative effect. For opposite-direction sideswipe, all the three types of Jughandle intersections have no significant effect while the number of ramps has a significant negative effect on opposite-direction sideswipe crashes.

All types of Jughandle intersections has a significant negative effect on left/U-Turn crashes. For non-motorized crashes the second type of Jughandle intersections have a significant positive effect. Major road speed limit also has a significant negative effect on non-motorized crashes.

For head-on crashes, the first type of Jughandle intersections has a negative effect. The second type has negative effects when the total entering vehicle (TEV) is greater than 50,000, while the third type has a negative effect on this type of crashes when TEV is below 63,000. Skew angle variable has significant negative effects on head-on crashes.

From the simple SPFs we found that for total, PDO, single-vehicle, rear-end, and non-motorized crashes, only the second type of Jughandle intersections has significant effect and it is positive effect, while for same-direction sideswipe crashes only the first type of Jughandle intersections has significant effect and it is a negative effect.

For fatal, injury, angle, head-on and opposite-direction sideswipe crashes, all the three types of Jughandle intersections are not have significant effect. All types of Jughandle intersections has a significant negative effect on left/U-Turn crashes.

**Table 6-28: Fully-specified SPFs for jughandle intersections**

Variables	Total		Injury		Fatal-and-injury		PDO	
	Coef.	S.E.	Coef.	S.E.	Coef.	S.E.	Coef.	S.E.
Intercept	-4.5928***	1.3961	-5.4972***	1.4248	-5.5289***	1.4144	-4.925***	1.4365
Log (DVMT)	0.858***	0.1708	0.8123***	0.174	0.8169***	0.1727	0.8586***	0.1759
Log (DVMT) × Type 1	-0.017	0.0209	-0.021	0.0209	-0.0212	0.0208	-0.0145	0.0217
Log (DVMT) × Type 2	0.039**	0.0194	0.0278	0.0195	0.0285	0.0194	0.0432**	0.02
Log (DVMT) × Type 3	-0.0054	0.0235	-0.0041	0.0235	-0.0050	0.0234	-0.0047	0.0243
Over- dispersion	0.39	0.0487	0.3626	0.0509	0.3572	0.0502	0.4111	0.0525

Variables	Single-Vehicle		Rear-End		Same-Direction Sideswipe		Angle	
	Coef.	S.E.	Coef.	S.E.	Coef.	S.E.	Coef.	S.E.
Intercept	-10.0879**	4.9122	-6.938***	1.4139	-7.7352***	1.4796	-1.2217	2.1526
Log (DVMT)	0.7473	0.5963	1.031***	0.173	1.0153***	0.1806	0.1718	0.2689
Skew Angle							-0.0121*	0.0064
Number of Legs							0.5793**	0.2338
Log (DVMT) × Type 1	0.0596	0.0822	0.0052	0.0212	-0.0421*	0.0224	0.0338	0.0317
Log (DVMT) × Type 2	0.1384*	0.0735	0.0701***	0.0197	0.0276	0.0205	0.0617**	0.0286
Log (DVMT) × Type 3	0.1003	0.0866	0.0249	0.0237	-0.0226	0.025	0.0041	0.0347
Overdispersion	1.0693	0.8822	0.3815	0.0506	0.3728	0.0601	0.6917	0.0979

Variables	Head-On		Opposite-Direction Sideswipe		Left/U-Turn		Non-Motorized	
	Coef.	S.E.	Coef.	S.E.	Coef.	S.E.	Coef.	S.E.
Intercept	-5.5228	4.1397	-3.0362	3.5658	-7.7329**	3.3134	1.4436	3.5816
Log (DVMT)	0.476	0.5038	0.0642	0.4354	0.964**	0.4026	-0.1693	0.4666
Skew Angle	-0.0181*	0.0105						
Number of Ramps			-1.0769*	0.5642				
Major Speed Limit							-0.0696**	0.0271
Type 1	-1.9909	7.94						
Type 2	9.6203	7.1148						
Type 3	-3.8976	9.7709						
Log (DVMT) × Type 1	0.1981	0.918	0.164	0.1014	-0.198***	0.0473	0.1117	0.0711
Log (DVMT) × Type 2	-1.0902	0.8401	0.1285	0.1136	-0.1238***	0.042	0.1693***	0.0582
Log (DVMT) × Type 3	0.4308	1.1349	0.1729	0.1533	-0.1587***	0.0515	0.0606	0.0763
Overdispersion	0.7143	0.2685	0.4135	0.4835	1.7052	0.2655	0.9048	0.4467

\*\*\* significant at 99%, \*\* significant at 95%, and \* significant at 90%.

**Table 6-29: Simple SPFs for Jughandle intersections**

Variables	Total		Injury		Fatal-and-injury		PDO	
	Coef.	S.E.	Coef.	S.E.	Coef.	S.E.	Coef.	S.E.
Intercept	-4.6521***	1.344	-5.4908***	1.3754	-5.5223***	1.3654	-5.0148***	1.3822
Log (DVMT)	0.8653***	0.1641	0.8114***	0.1676	0.8159***	0.1664	0.8697***	0.1689
Type 1	-0.1568	0.1783	-0.1823	0.1785	-0.1839	0.1772	-0.1391	0.1852
Type 2	0.336*	0.1633	0.244	0.1647	0.2507	0.1635	0.3706*	0.1686
Type 3	-0.0566	0.1995	-0.0382	0.2005	-0.0456	0.1991	-0.053	0.2064
Over-dispersion	0.3893	0.0487	0.3623	0.0508	0.3569	0.0502	0.4103	0.0524

Variables	Single-Vehicle		Rear-End		Same-Direction Sideswipe		Angle	
	Coef.	S.E.	Coef.	S.E.	Coef.	S.E.	Coef.	S.E.
Intercept	-10.7265**	4.7068	-7.1539***	1.3623	-7.6997***	1.4285	-2.7926	2.088
Log (DVMT)	0.8247	0.5672	1.0576***	0.1664	1.011***	0.1739	0.4226*	0.2546
Type 1	0.4993	0.6978	0.0241	0.1816	-0.3711*	0.1917	0.018	0.267
Type 2	1.1602*	0.618	0.5938***	0.1662	0.2427	0.1734	0.3571	0.2296
Type 3	0.8308	0.736	0.1944	0.2022	-0.1981	0.2131	-0.2356	0.2906
Overdispersion	1.087	0.8886	0.3813	0.0506	0.3721	0.06	0.749	0.1037

Variables	Head-On		Opposite-Direction Sideswipe		Left/U-Turn		Non-Motorized	
	Coef.	S.E.	Coef.	S.E.	Coef.	S.E.	Coef.	S.E.
Intercept	-4.3519	2.8001	-1.9452	3.5411	-6.9053**	3.24	1.9082	3.5528
Log (DVMT)	0.3283	0.3407	-0.07	0.432	0.8626**	0.3927	-0.522	0.4365
Type 1	-0.2268	0.3792	-0.0445	0.4831	-1.6818***	0.4063	0.0828	0.5313
Type 2	0.098	0.3339	-0.529	0.5204	-1.0084***	0.3549	0.7872*	0.4265
Type 3	-0.2471	0.4333	-0.6725	0.6728	-1.3031***	0.4372	-0.1505	0.6052
Overdispersion	0.8182	0.286	0.5843	0.5385	1.7148	0.2666	1.1728	0.5073

\*\*\* significant at 99%, \*\* significant at 95%, and \* significant at 90%.



### 6.5.3. Estimating CMFs for Jughandle Intersections

A cross-sectional method was applied to estimate the CMFs for implementing Jughandle intersections. Both before-and-after methods with the comparison group and with empirical Bayes could not be adopted in the analysis because the Jughandle intersections in New Jersey were implemented more than twenty years ago. Thus, it was not possible to obtain the crash data before the construction.

Two types of CMFs were estimated for Jughandle intersections. The first ones are CMFs, which are functions of DVMT, which were estimated from the fully-specified SPF model (referred to as CMFunction) and the second ones are CMFs estimated from the simple SPF model. The results of the two types of CMFs are summarized in Tables 6-30 and 6-31, respectively. In addition, the relationship between CMF values and DVMT are displayed in Figures 6-34 to 6-36. We can notice from Figure 6-34 that CMFs of same-direction sideswipe and left/U-Turn crashes at the first type of Jughandle intersections decrease (i.e., safer) when DVMT increases. At the second type of Jughandle intersections, the CMFs of most of crash types increase (i.e., more dangerous) when DVMT increases except for left/U-Turn crashes which slightly decrease when DVMT increases (Figure 6-35). For the third type of Jughandle intersections only the CMFs of Left/U-Turn crashes decrease when DVMT increases (Figure 6-36). Lastly, CMF values estimated from the simple SPFs are summarized in Table 6-31, we can notice that the first type of Jughandle intersections significantly reduced same-direction sideswipe and left/U-turn crashes. The second type of Jughandle intersections significantly reduced left/U-turn crashes, while it significantly increased total, PDO, single-vehicle, rear-end, and non-motorized crashes. For the third type of Jughandle intersections, it was found that it significantly reduced left/U-turn crashes. Therefore,

the team recommend to implement the first type of Jughandle intersections and recommend CMF values in Table 6-31 to be use by practitioners (SPICE tools).

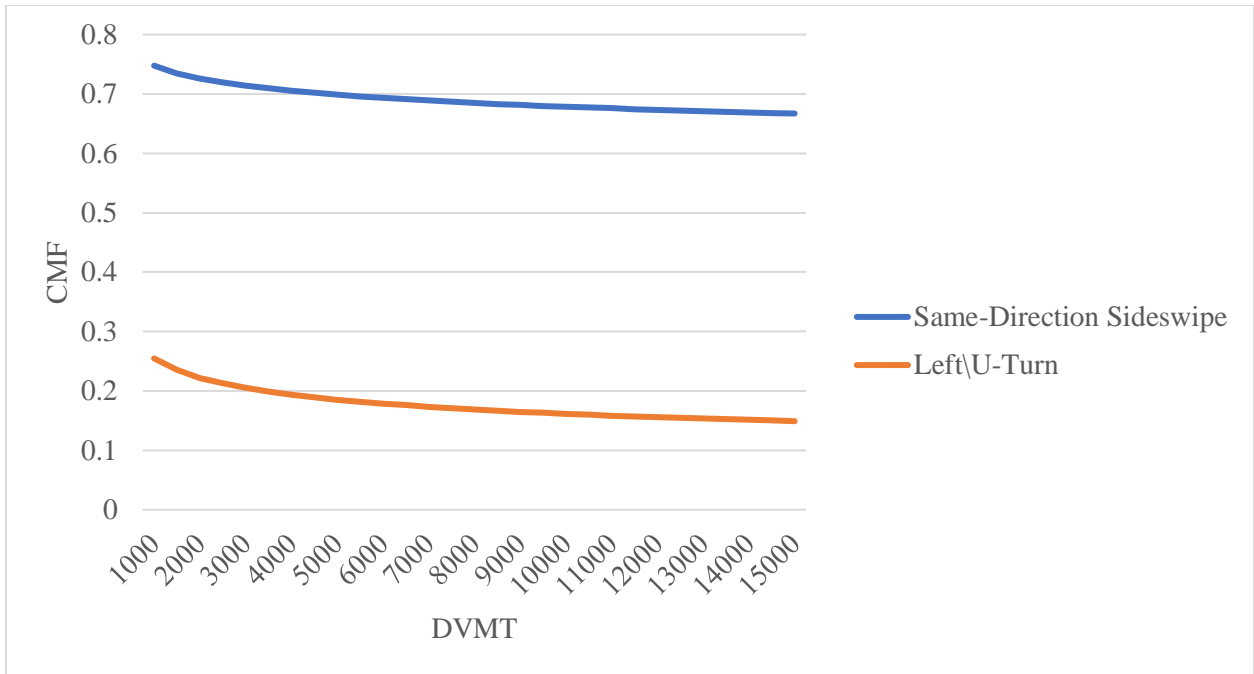
**Table 6-30: CMFunctions from the fully-specified SPFs**

<b>Type 1</b>			
<b>Crash type</b>	<b>CMF</b>	<b>95% Lower</b>	<b>95% Upper</b>
Total	DVMT <sup>-0.017</sup>	DVMT <sup>-0.058</sup>	DVMT <sup>0.024</sup>
Injury	DVMT <sup>-0.021</sup>	DVMT <sup>-0.062</sup>	DVMT <sup>0.02</sup>
Fatal-and-injury	DVMT <sup>-0.0212</sup>	DVMT <sup>-0.0619</sup>	DVMT <sup>0.0195</sup>
PDO	DVMT <sup>-0.0145</sup>	DVMT <sup>-0.057</sup>	DVMT <sup>0.0281</sup>
Single-Vehicle	DVMT <sup>0.0596</sup>	DVMT <sup>-0.1015</sup>	DVMT <sup>0.2206</sup>
Rear-End	DVMT <sup>0.0052</sup>	DVMT <sup>-0.0365</sup>	DVMT <sup>0.0468</sup>
Same-Direction Sideswipe	DVMT <sup>-0.0421*</sup>	DVMT <sup>-0.0859</sup>	DVMT <sup>0.0018</sup>
Angle	DVMT <sup>0.0338</sup>	DVMT <sup>-0.0283</sup>	DVMT <sup>0.096</sup>
Head-On	-1.9909 * DVMT <sup>0.1981</sup>	-17.5533 * DVMT <sup>-1.6012</sup>	13.5715 * DVMT <sup>1.9973</sup>
Opposite-Direction Sideswipe	DVMT <sup>0.164</sup>	DVMT <sup>-0.0347</sup>	DVMT <sup>0.3627</sup>
Left/U-Turn	DVMT <sup>-0.198***</sup>	DVMT <sup>-0.2906</sup>	DVMT <sup>-0.1054</sup>
Non-Motorized	DVMT <sup>0.1117</sup>	DVMT <sup>-0.0276</sup>	DVMT <sup>0.2511</sup>

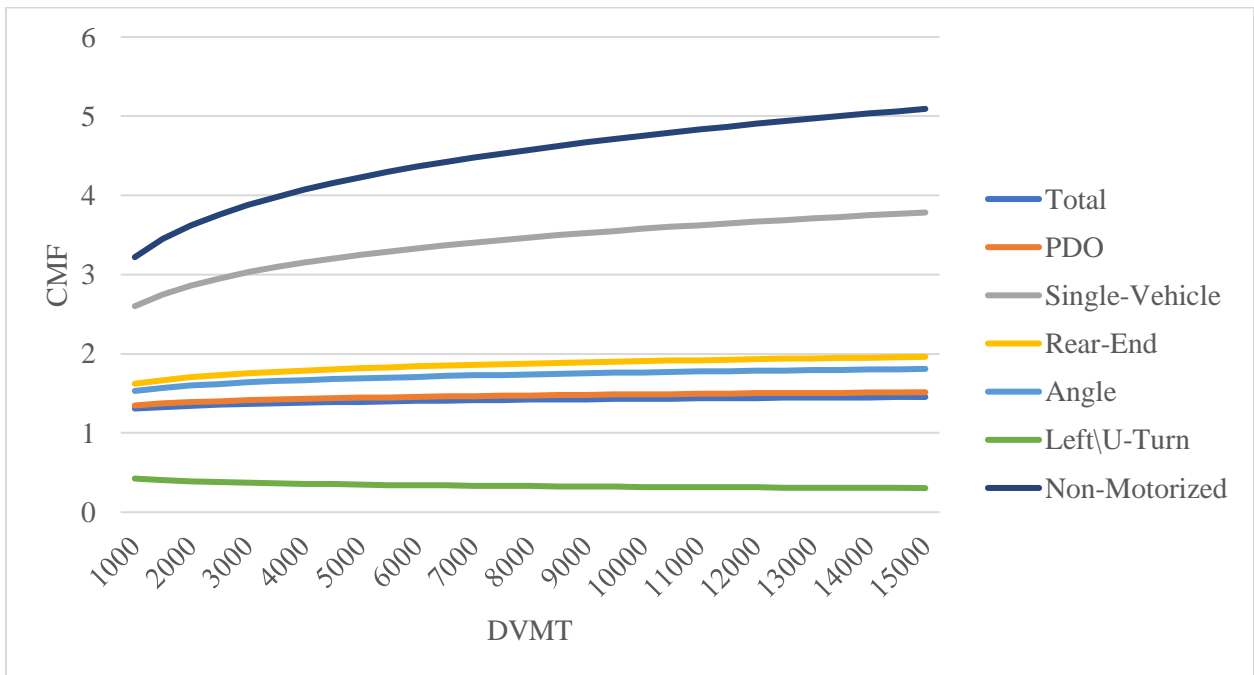
<b>Type 2</b>			
<b>Crash type</b>	<b>CMF</b>	<b>95% Lower</b>	<b>95% Upper</b>
Total	DVMT <sup>0.039**</sup>	DVMT <sup>0.001</sup>	DVMT <sup>0.0769</sup>
Injury	DVMT <sup>0.0278</sup>	DVMT <sup>-0.0104</sup>	DVMT <sup>0.066</sup>
Fatal-and-injury	DVMT <sup>0.0285</sup>	DVMT <sup>-0.0094</sup>	DVMT <sup>0.0665</sup>
PDO	DVMT <sup>0.0432**</sup>	DVMT <sup>0.004</sup>	DVMT <sup>0.0824</sup>
Single-Vehicle	DVMT <sup>0.1384*</sup>	DVMT <sup>-0.0057</sup>	DVMT <sup>0.2825</sup>
Rear-End	DVMT <sup>0.0701***</sup>	DVMT <sup>0.0316</sup>	DVMT <sup>0.1087</sup>
Same-Direction Sideswipe	DVMT <sup>0.0276</sup>	DVMT <sup>-0.0126</sup>	DVMT <sup>0.0678</sup>
Angle	DVMT <sup>0.0617**</sup>	DVMT <sup>0.0055</sup>	DVMT <sup>0.1178</sup>
Head-On	9.6203 * DVMT <sup>-1.0902</sup>	-4.3247 * DVMT <sup>-2.7369</sup>	23.5653 * DVMT <sup>0.5564</sup>
Opposite-Direction Sideswipe	DVMT <sup>0.1285</sup>	DVMT <sup>-0.0942</sup>	DVMT <sup>0.3512</sup>
Left/U-Turn	DVMT <sup>-0.1238***</sup>	DVMT <sup>-0.2063</sup>	DVMT <sup>-0.0414</sup>
Non-Motorized	DVMT <sup>0.1693***</sup>	DVMT <sup>0.0553</sup>	DVMT <sup>0.2833</sup>

<b>Type 3</b>			
<b>Crash type</b>	<b>CMF</b>	<b>95% Lower</b>	<b>95% Upper</b>
Total	DVMT <sup>-0.0054</sup>	DVMT <sup>-0.0515</sup>	DVMT <sup>0.0406</sup>
Injury	DVMT <sup>-0.0041</sup>	DVMT <sup>-0.0503</sup>	DVMT <sup>0.042</sup>
Fatal-and-injury	DVMT <sup>-0.0050</sup>	DVMT <sup>-0.0508</sup>	DVMT <sup>0.0409</sup>
PDO	DVMT <sup>-0.0047</sup>	DVMT <sup>-0.0523</sup>	DVMT <sup>0.0429</sup>
Single-Vehicle	DVMT <sup>0.1003</sup>	DVMT <sup>-0.0694</sup>	DVMT <sup>0.27</sup>
Rear-End	DVMT <sup>0.0249</sup>	DVMT <sup>-0.0217</sup>	DVMT <sup>0.0714</sup>
Same-Direction Sideswipe	DVMT <sup>-0.0226</sup>	DVMT <sup>-0.0716</sup>	DVMT <sup>0.0264</sup>
Angle	DVMT <sup>0.0041</sup>	DVMT <sup>-0.064</sup>	DVMT <sup>0.0721</sup>
Head-On	-3.8976 * DVMT <sup>0.4308</sup>	-23.0486 * DVMT <sup>-1.7936</sup>	15.2534* DVMT <sup>2.6552</sup>
Opposite-Direction Sideswipe	DVMT <sup>0.1729</sup>	DVMT <sup>-0.1276</sup>	DVMT <sup>0.4734</sup>
Left/U-Turn	DVMT <sup>-0.1587***</sup>	DVMT <sup>-0.2595</sup>	DVMT <sup>-0.0578</sup>
Non-Motorized	DVMT <sup>0.0606</sup>	DVMT <sup>-0.0889</sup>	DVMT <sup>0.2102</sup>

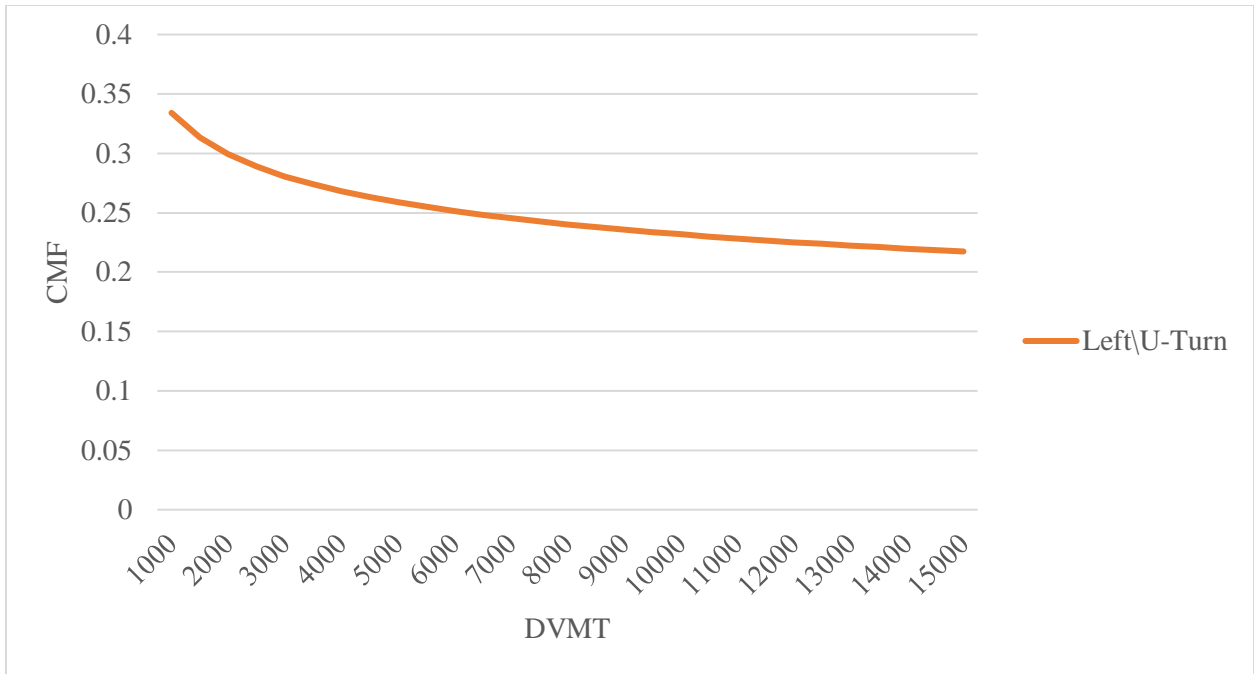
\*\*\* significant at 99%, \*\* significant at 95%, and \* significant at 90%.



**Figure 6-34: CMF values by DVMT for jughandle: Type 1 (significant types only)**



**Figure 6-35: CMF values by DVMT for jughandle: Type 2 (significant types only)**



**Figure 6-36: CMF values by DVMT for jughandle: Type 3 (significant type only)**

**Table 6-31: CMFs for Jughandle intersections from simple SPFs**

<b>Type 1</b>					
<b>Crash type</b>	<b>CMF</b>	<b>95% Lower</b>	<b>90% Lower</b>	<b>90% Upper</b>	<b>95% Upper</b>
Total	0.8552	0.6027	0.6376	1.1463	1.2125
Injury	0.8340	0.5874	0.6213	1.1177	1.1823
Fatal-and-injury	0.8320	0.5879	0.6216	1.1136	1.1775
PDO	0.8704	0.6053	0.6416	1.1801	1.2511
Single-Vehicle	1.6476	0.4196	0.5228	5.1924	6.4695
Rear-End	1.0247	0.7176	0.7599	1.3810	1.4623
Same-Direction Sideswipe	0.6909*	0.4738	0.5033	0.9457	1.0047
Angle	1.0182	0.6033	0.6563	1.5796	1.7182
Head-On	0.7971	0.3790	0.4272	1.4874	1.6760
Opposite-Direction Sideswipe	0.9565	0.3711	0.4321	2.1174	2.4655
Left/U-Turn	0.1860***	0.0839	0.0954	0.3630	0.4125
Non-Motorized	1.0863	0.3834	0.4533	2.6033	3.0776

<b>Type 2</b>					
<b>Crash type</b>	<b>CMF</b>	<b>95% Lower</b>	<b>90% Lower</b>	<b>90% Upper</b>	<b>95% Upper</b>
Total	1.3984**	1.0161	1.0697	1.8305	1.9271
Injury	1.2746	0.9241	0.9735	1.6735	1.7628
Fatal-and-injury	1.2849	0.9326	0.9819	1.6815	1.7703
PDO	1.4479**	1.0409	1.0978	1.9115	2.0158
Single-Vehicle	3.1906*	0.9502	1.1544	8.8180	10.7135
Rear-End	1.8098***	1.3075	1.3777	2.3802	2.5080
Same-Direction Sideswipe	1.2719	0.9074	0.9584	1.6954	1.7905
Angle	1.4292	0.9112	0.9796	2.0851	2.2416
Head-On	1.1030	0.5733	0.6368	1.9104	2.1221
Opposite-Direction Sideswipe	0.5892	0.2125	0.2503	1.3869	1.6338
Left/U-Turn	0.3648***	0.1820	0.2035	0.6540	0.7315
Non-Motorized	2.1972*	0.9524	1.0894	4.4318	5.0693

<b>Type 3</b>					
<b>Crash type</b>	<b>CMF</b>	<b>95% Lower</b>	<b>90% Lower</b>	<b>90% Upper</b>	<b>95% Upper</b>
Total	0.9454	0.6392	0.6806	1.3121	1.3971
Injury	0.9632	0.6499	0.6921	1.3386	1.4258
Fatal-and-injury	0.9554	0.6467	0.6886	1.3257	1.4115
PDO	0.9487	0.6329	0.6754	1.3318	1.4212
Single-Vehicle	2.2952	0.5424	0.6839	7.7022	9.7114
Rear-End	1.2149	0.8172	0.8709	1.6938	1.8053
Same-Direction Sideswipe	0.8211	0.5403	0.5777	1.1647	1.2455
Angle	0.7901	0.4470	0.4899	1.2743	1.3965
Head-On	0.7811	0.3341	0.3829	1.5931	1.8259
Opposite-Direction Sideswipe	0.5104	0.1365	0.1688	1.5439	1.9083
Left/U-Turn	0.2717***	0.1153	0.1324	0.5577	0.6401
Non-Motorized	0.8603	0.2627	0.3179	2.3282	2.8168

\*\*\* significant at 99%, \*\* significant at 95%, and \* significant at 90%.

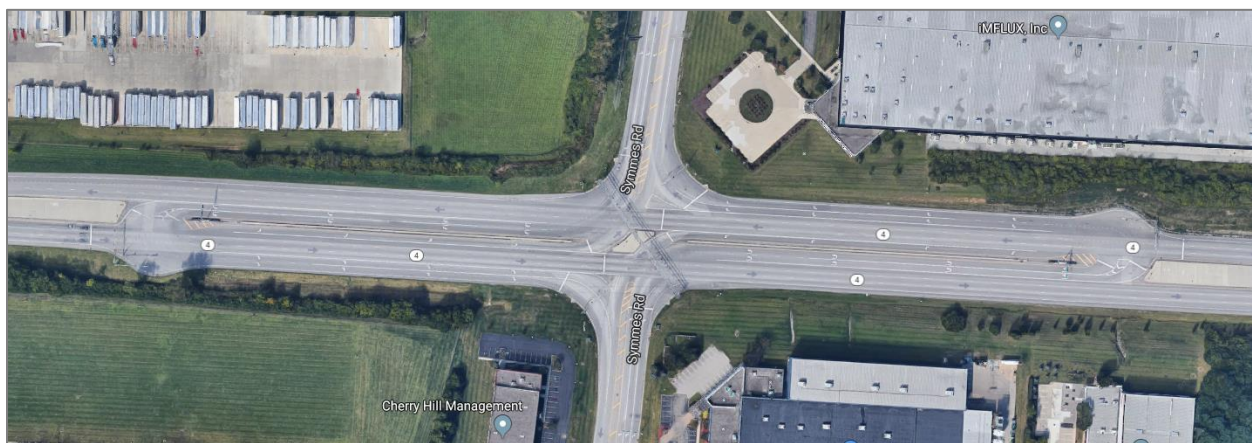
#### 6.5.4. Summary

Sixty-eight Jughandle intersections were compared with sixty-two conventional intersections in this study. Jughandle intersections were classified into three types (Type 1: Forward/Forward Jughandle Intersection, Type 2: Reverse/Reverse Jughandle Intersection, and Type 3: Forward/Reverse Jughandle Intersection).

It was found that type 1 Jughandle intersections have less same-direction sideswipe and left/U-turn crashes (by 31% and 81%, respectively). Type 2 Jughandle intersections have the reduced number of left/U-turn crashes (by 64%), while they have significantly more total (+40%), PDO (+45%), single-vehicle (+219%), rear-end (+81%), and non-motorized crashes (+120%). For type 3 Jughandle intersections, it was found that they have the significantly less left/U-turn crashes (-73%). In conclusion, all Jughandle intersections, regardless of types, have smaller number of left/U-turn crashes. Type 1 is also effective in reducing the same-direction sideswipe crashes whereas Type 2 is dangerous for multiple crash types including total, PDO, single-vehicle, rear-end, and non-motorized crashes.

## 6.6. RESTRICTED CROSSING U-TURN INTERSECTION

Restricted Crossing U-Turn (RCUT) signalized intersections are among the alternative intersection designs that is used to improve both operation and safety of conventional signalized intersections. It permits the major movements (right-turn, through, and left-turn) for the major road traffic, while it prohibits all these movement for the minor road traffic as well as U-Turns (for major and minor traffic) at the main intersection. U-Turn movement for major traffic is done downstream of the intersection by using U-Turn lanes. All vehicles on the minor road must make a right turn first and then use the U-Turn lanes if the driver wants to go through, left, or make a U-Turn. Figure 6-37 shows an example of a signalized RCUT intersection.



**Figure 6-37: RCUT intersection in Hamilton, Ohio**

### 6.6.1. Data Processing for RCUT Intersections





Since RCUT intersections have a different configuration compared to conventional intersections, U-Turn areas were considered as new influence areas of the intersection in the data collection and analyses for this alternative intersection type. Thus, four scenarios for intersection-related areas that could be used in the analysis are described as follows:

1. 250 feet buffer size from the center of the main intersection (like conventional intersections).
2. A larger buffer that covers all the intersection-related areas which were described above.
3. 250 feet buffer size from the center of the main intersection and 150 feet buffer size from the center of both U-Turn areas.
4. 250 feet buffer size from the center of the main intersection and 50 feet buffer size from the center of both U-Turn areas.

These four scenarios are based on the different influence areas of intersections are also explained in Figure 6-38 with illustrations.

Thirteen RCUT intersections, three in Ohio and ten in North Carolina, were identified and used in our study. Twenty-six conventional intersections were selected considering: (1) spatially closeness to the RCUT intersections; (2) same number of legs (4); (3) same control type (signalized); and (4) similar traffic volume levels. Only twenty conventional intersection were used because it was found that there was no crashes at six conventional intersections during the selected years in this study.



Influence areas of intersections	Schematic Diagrams
Scenario 1	
Scenario 2	
Scenario 3	
Scenario 4	

**Figure 6-38: Influence areas of intersections for the safety analysis for RCUT intersections**

Crash frequency, traffic, and geometric data were collected for RCUT intersections with their influence areas, and for conventional intersections. Table 6-32 summarizes the average crash frequency by crash severity and by crash type for each scenario of influence areas.

**Table 6-32: Average crash frequency by different influence areas of intersection**

<b>Variables</b>	<b>Scenario 1</b>	<b>Scenario 2</b>	<b>Scenario 3</b>	<b>Scenario 4</b>
Total	47.231	101.000	55.769	48.000
Fatal	0.077	0.077	0.077	0.077
Injury	12.538	26.615	15.077	12.692
Fatal and Injury	12.615	26.692	15.154	12.769
PDO	34.385	73.308	40.308	35.000
Single-Vehicle	4.846	12.385	6.077	4.846
Rear-End	21.154	43.692	24.692	21.615
Head-On	0.308	0.923	0.308	0.308
Angle	7.308	14.077	8.308	7.385
Same-Direction Sideswipe	5.769	10.462	6.846	5.846
Opposite-Direction Sideswipe	0.462	1.000	0.538	0.462
Non-Motorized	0.231	0.846	0.385	0.231

First, simple SPFs with the variables of only daily vehicle-miles-traveled (DVMT) on major road and RCUT were developed by using the cross-sectional method to estimate the CMFs (Table 6-33). Major DVMT variable was used instead of total DVMT due to absence of minor road AADT at some locations. The first and the second scenarios are less persuasive. The first option considers only the main intersection while ignoring the other influence areas. In addition, the second scenario covers too wide area; therefore, some crashes that are not directly related to the intersection could be taken into account. As a result, scenario 2 generated unrealistic CMF values. The third scenario also covers some crashes not directly related to intersections. The team found that the fourth scenario is the most reasonable one to use. The data were processed for the fourth scenario, and the descriptive statistics of the prepared data are presented in Table 6-34.

**Table 6-33: Estimated CMFs by different influence area of intersections**

Crash Type	CMF			
	Scenario 1	Scenario 2	Scenario 3	Scenario 4
Total	0.628	3.611	0.870	0.708
Fatal	1.325	0.000	0.701	1.009
Injury	0.646	-	1.068	0.787
Fatal and Injury	0.652	-	1.066	0.790
PDO	0.621	3.159	0.796	0.678
Single-Vehicle	1.462	-	-	-
Rear-End	0.538	1.515	0.703	0.578
Head-On	0.542	-	1.528	1.042
Angle	0.728	-	1.030	0.867
Same-Direction Sideswipe	0.606	3.869	0.825	0.752
Opposite-Direction Sideswipe	0.522	-	0.261	0.322
Non-Motorized	0.390	-	1.597	0.725

\*\*\* significant at 99%, \*\* significant at 95%, and \* significant at 90%.

**Table 6-34: Descriptive statistics of conventional and RCUT intersections**

(1) Conventional intersections (N=20)

Variables	Mean	Stdev	Min	Max
<i>Crash Variables</i>				
Total	78.700	71.371	1.000	226.000
Fatal	0.050	0.224	0.000	1.000
Injury	19.750	18.055	0.000	63.000
Fatal and Injury	19.800	18.182	0.000	64.000
PDO	58.300	53.914	1.000	165.000
Single-Vehicle	3.750	4.153	0.000	16.000
Rear-End	40.350	37.934	0.000	114.000
Head-On	0.650	0.875	0.000	3.000
Angle	9.400	8.846	0.000	33.000
Same-Direction Sideswipe	10.500	9.865	0.000	34.000
Opposite-Direction Sideswipe	0.750	1.251	0.000	5.000
Non-Motorized	0.650	0.875	0.000	2.000
<i>Explanatory Variables</i>				
Major AADT	35739.650	5279.269	28319.000	45800.000
Major DVMT	3384.450	499.900	2682.000	4337.000
Skewed	0.200	0.410	0.000	1.000
Skew Angle (°)	4.050	8.432	0.000	25.000
Major Speed Limit (mph)	40.500	6.048	25.000	45.000
Minor Speed Limit (mph)	37.500	6.387	25.000	45.000
Pedestrian Crossing	0.900	0.308	0.000	1.000
Lighting	0.850	0.366	0.000	1.000
IRI*	156.300	140.728	0.000	400.000

(2) RCUT intersections (N=13)

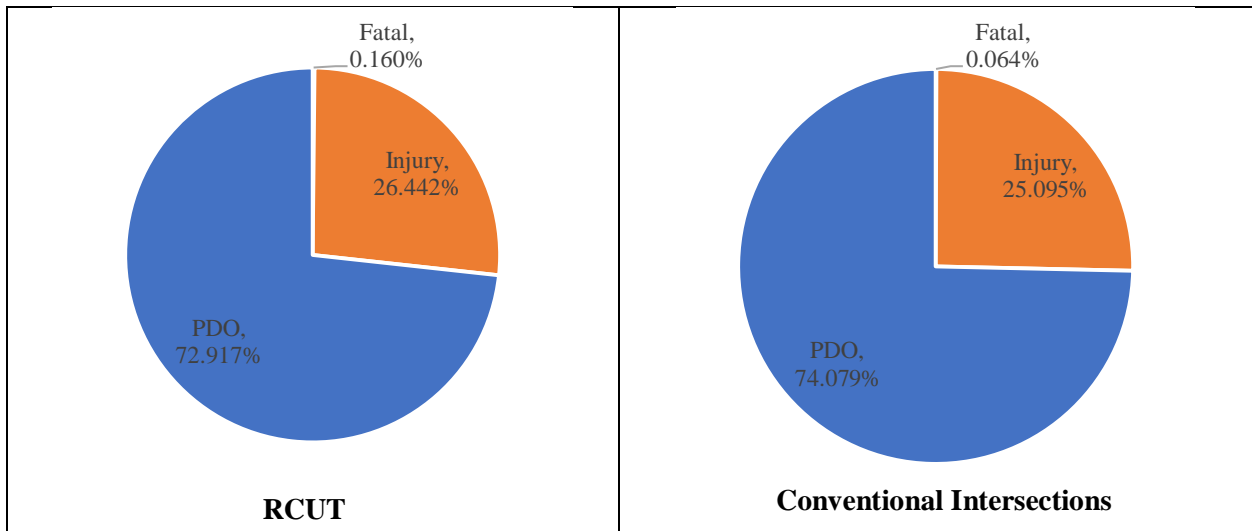
Variables	Mean	Stdev	Min	Max
<i>Crash Variables</i>				
Total	48.000	27.172	10.000	92.000
Fatal	0.077	0.277	0.000	1.000
Injury	12.692	7.216	3.000	25.000
Fatal and Injury	12.769	7.167	3.000	25.000
PDO	35.000	21.048	7.000	67.000
Single-Vehicle	4.846	4.469	0.000	15.000
Rear-End	21.615	12.620	5.000	39.000
Head-On	0.308	0.630	0.000	2.000
Angle	7.385	7.411	1.000	23.000
Same-Direction Sideswipe	5.846	4.828	1.000	18.000
Opposite-Direction Sideswipe	0.462	0.660	0.000	2.000
Non-Motorized	0.231	0.439	0.000	1.000
<i>Explanatory Variables</i>				
Major AADT	38813.000	6910.175	31745.000	50000.000
Major DVMT	4999.077	1076.624	3314.000	6629.000
Skewed	0.154	0.376	0.000	1.000
Skew Angle (°)	3.923	9.596	0.000	27.000
Major Speed Limit (mph)	54.615	3.798	45.000	60.000
Minor Speed Limit (mph)	33.077	10.712	15.000	55.000
Pedestrian Crossing	0.231	0.439	0.000	1.000
Lighting	0.846	0.376	0.000	1.000
IRI*	164.769	42.488	101.000	239.000

\* International Roughness Index

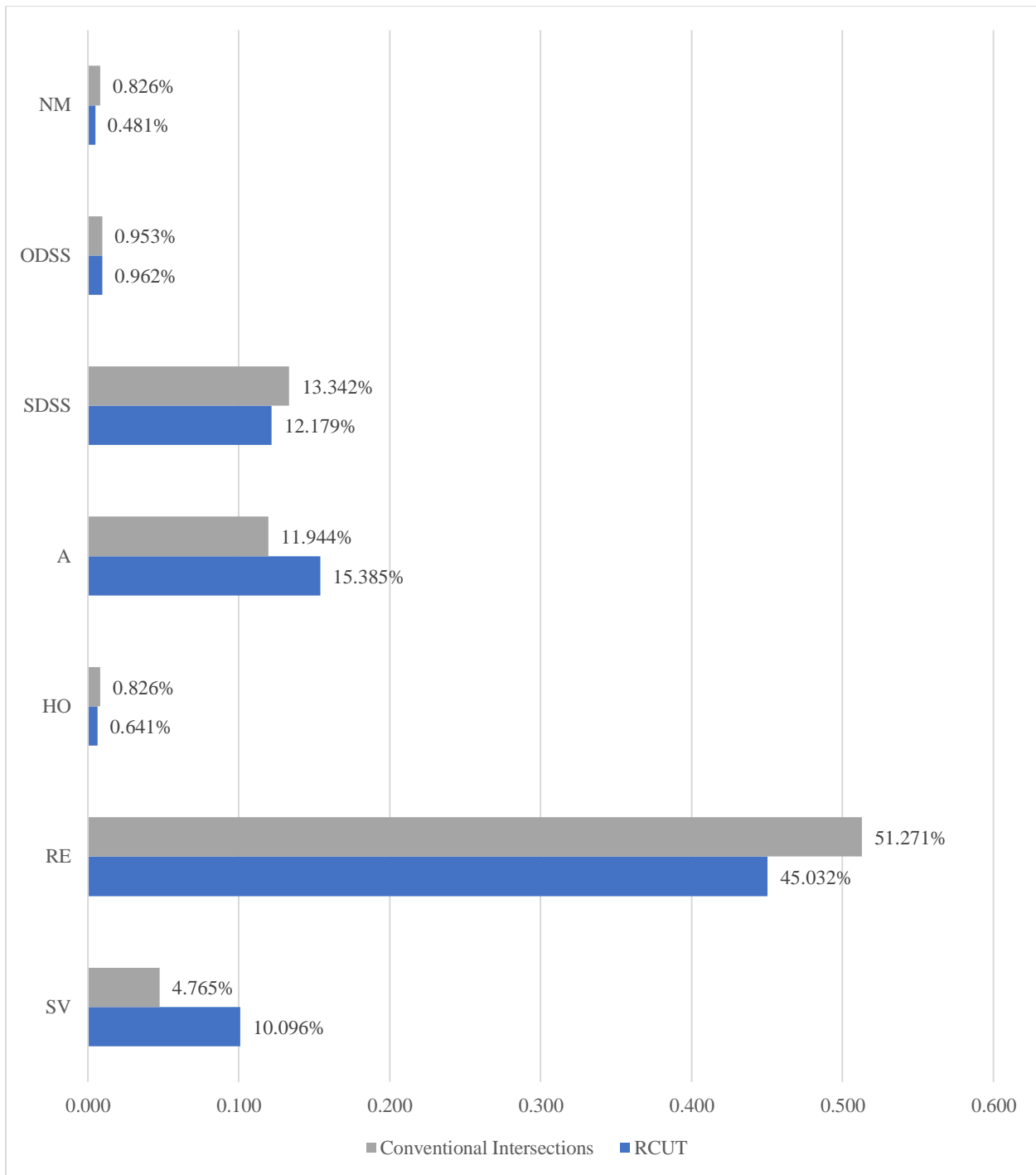
Figure 6-39 shows that the percentages of fatal (0.16%) and injury (26.442%) crashes at RCUT intersections are higher than these at conventional intersections (0.064%) and (25.095%) respectively. On the other hand, Percentage of PDO crashes at conventional intersections (74.079%) is higher than that at RCUT intersections (72.917%). CMH (Mantel-Haenszel  $\chi^2$ ) test was used instead of regular  $\chi^2$  test since 33% of the cells have expected counts less than 5. The CMH value was 0.5002 ( $p = 0.4794$ ). Thus, we can conclude that the percentages of injury severity levels between RCUT intersections and conventional intersections are not statistically significantly different.

Figure 6-40 compares between the percentages of each crash type at RCUT and conventional intersections, it shows that the percentages of single-vehicle crashes, angle, and opposite-

direction sideswipe crashes at RCUT intersections are higher than those at conventional intersections. On the other hand, the percentages of rear-end, head-on, same-direction sideswipe, and non-motorized crashes at conventional intersections are higher than those at RCUT intersections. The differences in the percentages are statistically significant ( $\chi^2 = 29.0643$ , d.f. = 6,  $p < 0.0001$ ). Thus, we can conclude that the percentages of crash types between RCUT intersections and conventional intersections are statistically significantly different.



**Figure 6-39: Percentage of crashes by severity at RCUT and conventional intersections**



\* SV: Single-Vehicle, RE: Rear-End, HO: Head-On, A: Left-Turn, SDSS: Same-Direction Sideswipe, ODSS: Opposite-Direction Sideswipe, NM: Non-Motorized.

**Figure 6-40: Percentages of crashes by types at RCUT and conventional intersections**

### 6.6.2. Before-and-After Analysis for RCUT Intersections

A before-and-after method was applied to estimate CMFs for implementing RCUT intersections.

The average sample odds ratio was calculated to make sure that the selection of comparison locations is reasonable. It was equal to 1.277 (close to 1), this showed that there is no evidence that the frequency of crashes which occurred in the before period at RCUT locations and comparison sites are different.

The CMFs estimated from the before-and-after method are summarized in Table 4. The results showed that total, injury, fatal and injury, PDO, rear-end, head-on, left-turn, and opposite-direction sideswipe crashes were significantly reduced after the implementation of RCUTs by 24%, 43%, 43%, 16%, 25%, 93%, 41%, and 67%, respectively. No significant changes were found for single-vehicle and same-direction sideswipe crashes.

**Table 6-35: CMFs for RCUTs (before-and-after study with the comparison group)**

Crash Type	CMF	Confidence Interval						P-Value
		99 % LL	95 % LL	90 % LL	90 % UL	95 % UL	99 % UL	
Total	0.763***	0.5791	0.6232	0.6457	0.8808	0.9033	0.9473	0.0009
Fatal	-	-	-	-	-	-	-	-
Injury	0.573***	0.3095	0.3724	0.4045	0.7406	0.7727	0.8356	<0.0001
Fatal and Injury	0.567***	0.3076	0.3696	0.4013	0.7325	0.7642	0.8262	<0.0001
PDO	0.841*	0.6032	0.6602	0.6893	0.9935	1.0226	1.0796	0.0863
Single-Vehicle	1.308	0.3001	0.5411	0.6643	1.9515	2.0748	2.3158	0.4313
Rear-End	0.751**	0.4848	0.5485	0.5810	0.9212	0.9538	1.0175	0.0161
Head-On	0.067***	- 0.0263	- 0.0041	0.0073	0.1261	0.1374	0.1597	<0.0001
Left-turn	0.585***	0.2322	0.3167	0.3599	0.8109	0.8540	0.9385	0.0025
Same-Direction Sideswipe	0.929	0.3028	0.4525	0.5291	1.3290	1.4056	1.5553	0.7704
Opposite-Direction Sideswipe	0.330***	- 0.1595	- 0.0424	0.0174	0.6424	0.7022	0.8193	0.0004
Non-Motorized	-	-	-	-	-	-	-	-

\*\*\* significant at 99%, \*\* significant at 95%, and \* significant at 90%.

### 6.6.3. Summary

Thirteen RCUT intersections were compared with twenty conventional intersections in this study. It was found from the cross-sectional method that RCUT intersections significantly increase single-vehicle crashes. On the other hand from the before and after method, RCUT intersections were found to significantly reduce the other crash types except for same-direction sideswipe crashes which did not change significantly by implementing the RCUT design.

RCUT intersections are a variant of median U-turn (MUT) intersections. These two alternative intersections are sometimes classified as U-turn based intersections. For these reasons, the safety effects of the RCUT implementation are similar to those of the MUT intersections to some extent (Table 6-36). MUTs Types A and B are often more effective to reduce total, PDO, and rear-end crashes; however, RCUTs showed higher effectiveness for decreasing injury, fatal-and-injury, head-on, and angle crashes. Compared with partial MUTs, RCUTs are more effective to reduce total crashes but less effective to reduce PDO crashes.

**Table 6-36: Comparison of CMFs of RCUT and MUT intersections**

Crash Type	RCUT	MUT: Type A	MUT: Type B	Partial MUT
Total	0.763 <sup>***</sup>	0.6087 <sup>***</sup>	0.6322 <sup>***</sup>	0.8398 <sup>***</sup>
Injury	0.573 <sup>***</sup>	0.7233 <sup>***</sup>	0.6896 <sup>***</sup>	1.0910
Fatal and Injury	0.567 <sup>***</sup>	0.7397 <sup>***</sup>	0.7024 <sup>***</sup>	1.1265
PDO	0.841 <sup>*</sup>	0.5761 <sup>***</sup>	0.6108 <sup>***</sup>	0.7170 <sup>***</sup>
Single-Vehicle	1.308	1.5206 <sup>***</sup>	1.5885 <sup>***</sup>	1.3529
Multi-Vehicle	-	-	-	0.7951 <sup>***</sup>
Rear-End	0.751 <sup>**</sup>	0.5019 <sup>***</sup>	0.4898 <sup>***</sup>	-
Head-On	0.067 <sup>***</sup>	0.2440 <sup>***</sup>	0.4410 <sup>**</sup>	-
Angle+left-turn	0.585 <sup>***</sup>	0.7064 <sup>***</sup>	0.6648 <sup>***</sup>	-
Same-Direction Sideswipe	0.929	0.7956 <sup>*</sup>	0.9865	-
Opposite-Direction Sideswipe	0.330 <sup>***</sup>	0.2287 <sup>***</sup>	0.1414 <sup>***</sup>	-
Non-Motorized	-	2.2425 <sup>***</sup>	1.9203 <sup>***</sup>	3.5691 <sup>***</sup>

<sup>\*\*\*</sup> significant at 99%, <sup>\*\*</sup> significant at 95%, and <sup>\*</sup> significant at 90%.



## 6.7. SUMMARY AND CONCLUSIONS

In this chapter, we summarize the tasks of developing safety performance functions (SPFs) and crash modification factors (CMFs). The team estimated all possible SPFs and CMFs using all possible approaches for continuous green T-intersections (CGTs), median U-turn intersections (MUTs), continuous flow intersections (CFIs), Jughandle intersections and restricted crossing U-turn intersections (RCUTs), and their sub types if relevant. If there are CMFs from both before-and-after and cross-sectional analyses, the team recommend using the significant CMFs from the before-and-after study. The findings for each type are as follows (reductions are underlined):

### 1. *CGTs vs. conventional intersections*

#### **Before-and-after study with the comparison group method**

- 46% and 56% increases in total and fatal-and-injury crashes, respectively
- 44% increases in no injury crashes
- 61% and 64% increases in rear-end and CGT-related crashes, respectively

#### **Cross-sectional method**

- 47% and 46% increase in total and fatal-and-injury crashes, respectively
- 44% and 91% increase in no injury and CGT-related crashes, respectively

### 2. *MUTs: Type A vs. conventional intersections (cross-sectional method)*

- 39% and 42% decrease in total and no injury crashes, respectively
- 28% and 26% decrease in injury and fatal-and-injury crashes, respectively
- 76% and 94% decrease in head-on and head-on left-turn crashes, respectively
- 29% decrease in angle crashes

- 50%, 61%, and 11% decrease in rear-end, rear-end left-turn, and rear-end right-turn, respectively
- 20% and 77% decrease in same-direction sideswipe and opposite-direction sideswipe crashes, respectively
- 52% and 124% increase in single-vehicle and non-motorized crashes, respectively

### 3. *MUTs: Type B vs. conventional intersections (cross-sectional method)*

- 37% and 39% reduction of total and no injury crashes, respectively
- 31% and 30% reduction of injury and fatal-and-injury crashes, respectively
- 56% and 94% reduction of head-on and head-on left-turn crashes, respectively
- 34% reduction of angle crashes
- 51% and 58% reduction of rear-end and rear-end left-turn crashes, respectively
- 86% reduction of opposite-direction sideswipe crashes
- 59% and 92% growth of single-vehicle and non-motorized crashes, respectively

### 4. *Implementation of Partial MUTs (before-and-after study with the comparison group method)*

- 16% and 28% decrease in total and no injury crashes, respectively
- 20% decrease in multi-vehicle crashes
- 257% increase in non-motorized crashes

### 5. *CFIs vs. conventional Intersections*

#### **Before-and-after study with the comparison group method**

- 22% increase in total crashes
- 68% and 61% increase in no injury and injury crashes, respectively
- 76% and 57% increase in fatal-and-injury and single-vehicle crashes, respectively

### **Cross-sectional method**

- 70% reduction in non-motorized crashes
- 31% and 34% increase in total and no injury crashes, respectively
- 24% and 25% increase in injury and fatal-and-injury crashes, respectively
- 48% and 30% increase in single-vehicle and multi-vehicle crashes, respectively

#### **6. *Jughandle: Type 1 vs. conventional intersections (cross-sectional method)***

- 31% and 81% reduction in same-direction and left/U-turn crashes, respectively

#### **7. *Jughandle: Type 2 vs. conventional intersections (cross-sectional method)***

- 64% reduction of left/U-turn crashes
- 40% and 45% increase of total and no injury crashes, respectively
- 219% and 81% growth of single-vehicle and rear-end crashes, respectively
- 120% growth of non-motorized crashes

#### **8. *Jughandle: Type 3 vs. conventional intersections (cross-sectional method)***

- 73% reduction in left/U-turn crashes

#### **9. *Implementation of RCUTs (before-and-after study with the comparison group method)***

- 24% reduction in total crashes
- 43% decreases of both injury and fatal-and-injury crashes
- 16% decrease in no injury crashes
- 25% and 93% reductions of rear-end and head-on crashes, respectively
- 42% and 67% decreases of angle+left-turn and opposite-direction sideswipe crashes, respectively

CGTs, CFIs, Jughandle: Type 2 need to be cautiously considered. These types of alternative intersections are effective to increase the operational efficiency by allowing the through traffic without stopping at the intersection (CGT) or separate left-turning movements from the main intersection (CFIs, Jughandle: Type 2).

Nevertheless, CGTs might confuse drivers on the CGT through lane whether they should stop on red. They also confuse left-turning drivers from the minor-leg as some might think they have the right-of-way to use full lanes on the major road because of the green signal. Thus, a physical separation (e.g., barrier) is effective to reduce crashes. Also, maintaining good pavement conditions could effectively reduce crashes.

Theoretically, CFIs and Jughandle: Type 2 are safer because they have less number of conflict points compared to conventional intersections. From the analysis, the opposite was found to be true for CFIs and Jughandle: Type 2 in the real world. The major reason would be drivers' unfamiliarity with the new design and movement at the alternative intersections. The drivers would not expect that a left-turn should be made before the major intersection (CFIs) or after the major intersection through loop on the right (Jughandle: Type 2). However, CFIs have an advantage for non-motorized road users (mostly pedestrians) as they would not be in a conflict with left-turning vehicles while they cross the intersection. Jughandle: Type 2 along with other Jughandle types have significantly fewer left/U-turn related crashes. In addition, Jughandle: Type 1 was effective to reduce same-direction sideswipe crashes.

On the other hand, MUTs are found to be generally safer for most crash types. Different from CFIs and Jughandle intersections, MUTs are easier to follow and intuitive. If a driver found that the left-turn is prohibited at the intersection, the driver would go through and try to make a U-turn at the median opening or at the next intersection, and turn right. Still, MUTs need

improvements in safety, especially for single-vehicle and pedestrian/bicycle-involved crashes. This is possibly due of multiple factors. First, the existence of wide raised median of the MUT design. Many MUTs have wide median because vehicles need a sufficient space to make a U-turn, which could lead to many jaywalking of pedestrians. Also, many MUTs are located in urban areas with residential/commercial land-uses, and high pedestrian/bicycle activities are expected. However, very few mid-block crosswalks are generally. Therefore, the following countermeasure could be effective to prevent non-motorized user crashes:

- Providing mid-block crosswalks
- If mid-block crosswalks are provided, it will be better to install a pedestrian signal or rectangular rapid-flashing beacon (RRFB).
- Installing pedestrian bridges
- Installing guardrails at the roadside and raised median to prevent jaywalking
- Installing street lighting to reduce non-motorized user involved crashes at nighttime

It was found that implementing RCUTs is very effective to reduce various types of crashes. Especially, they are capable of decreasing fatal-and-injury (-43%), head-on (-93%), angle, left-turn (-42%), and opposite-direction sideswipe (-67%) crashes. The only CMF that is greater than one was for single-vehicle crashes (1.308) but it was not statistically significant.

In conclusion, traffic safety at alternative intersections are quite different by type. CGTs have more crashes than conventional intersections but many of them are preventable by physical separation. CFIs have more total and single-vehicle crashes; however, they can be considered if some conventional intersections have an excessive number of pedestrian/bicycle-involved

crashes, and the need to increase throughput justifies them. MUTs could be a good solution to improve safety; but they have problems with some crash types. Jughandle intersections are effective to decrease left/U-turn crashes; but Jughandle Type 2 has serious safety issues for many crash types including total, no injury, rear-end, and non-motorized crashes. On the other hand, Jughandle Type 1 could reduce same-direction sideswipe crashes, in addition to left/U-turn crashes. Lastly, RCUTs are effective to enhance traffic safety for many crash types including total, injury, fatal-and-injury, no injury, rear-end, head-on, angle+left-turn, and opposite-direction sideswipe crashes.

Many alternative intersection types were found to suffer from potential drivers' confusion. Therefore, considerable effort would be needed to minimize traffic safety problems at alternative intersections including engineering adjustments (e.g., appropriate signs, markings, channelization, and physical separation), and education about the design and movements at the alternative intersections.

Compared to the previous studies (including CMF Clearinghouse), the research team used larger sample sizes from multiple states. The team specifically explored sub-types of MUTs (i.e., Type A, Type B, and Partial MUTs) and Jughandle intersections (Types 1-3). Overall, the team investigated the safety effects of nine different alternative intersections.

The following Table 6-37 provides the suggested CMFs for SPICE. In this table, only total, fatal-and-injury, single-vehicle, rear-end, left-turn/U-turn, and non-motorized CMFs are suggested. More crash severities and types could be updated upon request from practitioners. Some CMFs are insignificant at 90% confidence interval, and it is recommended to be careful when applying statistically insignificant CMFs.

**Table 6-37: Suggested CMFs for Safety Performance for Intersection Control Evaluation (SPICE)**

Intersection Type		Crash type					
		Total	Fatal-and-injury	Single-vehicle	Rear-end	Left-turn/U-turn	Non-motorized
CGTs		<b>1.461</b> <sup>***</sup>	<b>1.556</b> <sup>***</sup>	1.307 <sup>#</sup>	<b>0.393</b> <sup>***</sup>	-	0.281 <sup>#</sup>
MUTs	Type A	<b>0.609</b> <sup>***</sup>	<b>0.740</b> <sup>***</sup>	<b>1.521</b> <sup>***</sup>	<b>0.502</b> <sup>***</sup>	-	<b>2.243</b> <sup>***</sup>
	Type B	<b>0.632</b> <sup>***</sup>	<b>0.702</b> <sup>***</sup>	<b>1.589</b> <sup>***</sup>	<b>0.490</b> <sup>***</sup>	-	<b>1.920</b> <sup>***</sup>
	Partial	<b>0.840</b> <sup>***</sup>	1.127 <sup>#</sup>	1.353 <sup>#</sup>	-	-	<b>3.569</b> <sup>***</sup>
CFIs		<b>1.224</b> <sup>***</sup>	<b>1.763</b> <sup>***</sup>	<b>1.570</b> <sup>***</sup>	-	-	<b>0.297</b> <sup>***</sup>
Jughandle	Type 1	0.855 <sup>#</sup>	0.832 <sup>#</sup>	1.648 <sup>#</sup>	1.025 <sup>#</sup>	<b>0.186</b> <sup>***</sup>	1.086 <sup>#</sup>
	Type 2	<b>1.398</b> <sup>**</sup>	1.275 <sup>#</sup>	<b>3.191</b> <sup>*</sup>	<b>1.810</b> <sup>***</sup>	<b>0.365</b> <sup>***</sup>	<b>2.197</b> <sup>*</sup>
	Type 3	0.945 <sup>#</sup>	0.955 <sup>#</sup>	2.295 <sup>#</sup>	1.215 <sup>#</sup>	<b>0.272</b> <sup>***</sup>	0.860 <sup>#</sup>
RCUTs		<b>0.763</b> <sup>***</sup>	<b>0.567</b> <sup>***</sup>	1.308 <sup>#</sup>	<b>0.751</b> <sup>***</sup>	<b>0.585</b> <sup>***</sup>	-

## 7. TRAFFIC SAFETY DIAGNOSIS FOR REAR-END CRASHES

### 7.1. METHODOLOGIES

In order to comprehensively investigate rear-end crashes, different methodologies were employed. Regarding the before-and-after methods and the cross-sectional methods were already discussed in the previous chapter. Thus, they were not explained in this chapter to prevent the redundancy. Newly adopted methods: K-nearest neighbors and K-means clustering and quasi-induced exposure methods are introduced in this section.

#### K-Nearest Neighbors and K-Means Clustering

The K-nearest neighbors (KNN) algorithm is a non-parametric method, which is used to identify K most similar observations to a given observation. The similarity of the two observation is measured according to the distance between them by considering all of their attributes (Zakka, 2016). A commonly used distance is the Euclidean distance given by the following equation:

$$d(x, x') = \sqrt{(x_1 - x'_1)^2 + (x_2 - x'_2)^2 + \dots + (x_n - x'_n)^2} \quad (26)$$

where,  $x_n$  and  $x'_n$ , are the  $n_{th}$  attributes of the two observations.

The K-means clustering algorithm aims at partitioning N observations into K ( $k \leq N$ ) groups such that the summation of the variance in each cluster is minimized (Politecnico, 2018).

Formally, the objective function is the following.

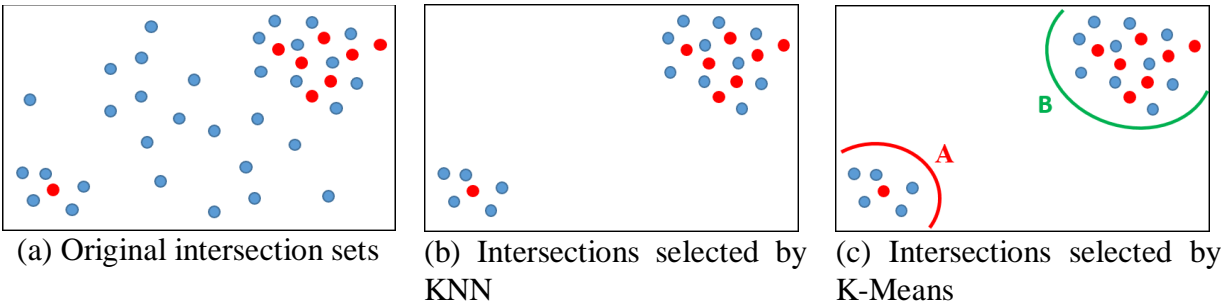
$$\min J = \min \sum_{j=1}^K \sum_{i=1}^n \|x_i^j - c_j\|^2 \quad (27)$$

where,  $x_i^j$  is a data point,  $i$ , in cluster  $j$  and  $\|x_i^j - c_j\|^2$  is the distance (usually the Euclidean distance) between the data point  $x_i^j$  and the cluster center  $c_j$ .



Both the KNN and K-means clustering algorithms require standardizing the predictors. Formulas (Stamatiadis and Deacon, 1997) and (Friedman, 1991) show that if an input feature has a variance that is significantly larger than other features it may have a substantial effect on the objective function and render the algorithm unable to learn from other features correctly as expected (Scikit-Learn Developers, 2018).

The use of the method involving the combination of the KNN and K-means clustering algorithms outputs a selection process depicted in Figure 7-1. In Figure 7-1(a), an assumption was made that we have a set of locations which are stop-controlled intersections and signalized intersections. The intersections' attributes vary significantly as shown (here a two-dimensional space is used for convenience). Figure 7-1(b) shows that by the use of the KNN algorithm, only those stop-controlled intersections and signalized intersections which have similar features are selected. While the KNN algorithm only guarantees that there always exists pairs of similar stop-controlled intersections and signalized intersections, there may still be a significant difference among these selected pairs. As shown in Figure 7-1(b), it may be more reasonable to analyze only the intersections in the upper right corner rather than to analyze all intersections depicted in Figure 7-1(b). Thus, the K-means algorithm is then used to identify possible patterns in the dataset and to select only specific groups. In Figure 7-1(c), the K-means algorithm distinguishes the attribute space into two parts, A and B. This makes it possible to filter out intersections belonging to part B.



**Figure 7-1: Using K-nearest neighbors and K-means to select similar stop-controlled intersections and signalized intersections**

*(Note: The red points stand for the signalized intersections and the blue point stands for the stop-controlled intersections)*

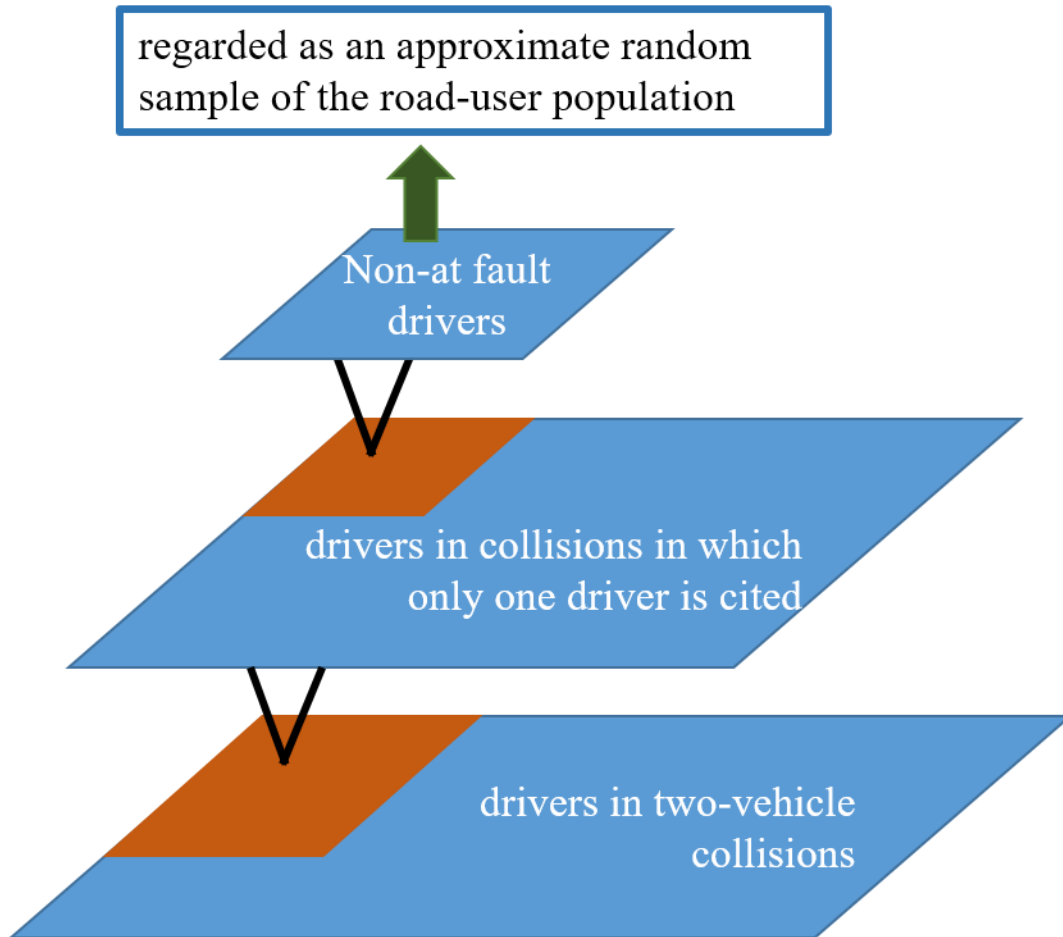
In this study, the major road AADT and the ratio of minor road AADT to major road AADT are used as control variables to identify similar sites, whether treated or untreated locations. The AADT was used as a reasonable exposure variable of an intersection. Intersections with similar AADT are expected to have similar crash frequencies. Theoretically, adding more controlled variables such as geometric designs could enhance the similarity between locations. However, too many controlled variables may lead to an under-dispersion issue of locations when considering their mean and variance of the crash frequency, and the variables of interest may become insignificant in the SPF model due to lack of crash variance. Besides, the geometric designs such as the number of lanes and speed limit are highly correlated with the AADT. Thus, only AADT is selected as the control variable, and it is standardized with zero mean and unit variance before it is inputted into the KNN and K-means algorithm. The variables other than AADT are added when developing SPF models.

## **Quasi-Induced Exposure Method**

The State of Florida has a very high proportion of elderly people. The safety effect of the signalization treatment on rear end crashes may be different when the proportion of the elderly drivers who are using intersection changes. Although there have been many studies that explored the safety effects of signalization, the safety effects for elderly drivers have not been investigated. The quasi-induced exposure method provides a promising approach to identify the proportion of elderly drivers using a specific intersection. The quasi-induced exposure method is used to estimate the increase in the risk of being involved in a crash associated with driver-related or vehicle-related characteristics when there is no direct way to measure the intensity of exposure for these characteristics (Martínez-Ruiz et al., 2013). The basic idea for the quasi-induced exposure method is that the non-at-fault drivers/vehicles involved in two-vehicle collisions (in these crashes only one of the two drivers was considered responsible for the crash) may be considered an approximately random sample of the road-user population (Keall & Newstead, 2009; Martínez-Ruiz et al., 2013; Stamatiadis and Deacon, 1997). The quasi-induced exposure method is applied to the crash data in such a way which is shown in Figure 7-2. In this study, the ratio of the non-at-fault elderly drivers ( $\text{age} \geq 65$ ) to the non-at-fault all drivers are used as the proportion of elderly drivers using an intersection.

In this study, the proportion of elderly drivers was calculated at the county subdivision scale, i.e., the intersections in the same county subdivision have the same elderly driver proportion. The county subdivision scale defines an area which has the size between the county and the census tract. Theoretically, a smaller scale such as census tract or block group may better represent the heterogeneity of elderly drivers between intersections. However, these scales do not have enough

crashes which involve non-at-fault elderly drivers in the analysis period, and this may lead to a bias in the actual proportion of elderly drivers.



**Figure 7-2: Flowchart of quasi-induced exposure method for the crash data**

## **7.2. DATA COLLECTION AND PREPARATION**

Both the before-and-after with EB method and the cross-sectional method require a minimum number of intersections (including treated sites and reference sites) with corresponding crash information, traffic operation information and geometric information. For the before-and-after analysis with EB method, it requires approximately 30-50 locations for calibration purposes. For the cross-sectional method, it requires much more samples than the before-and-after study, say 100-1000 sites (Carter et al., 2012), and it also requires that the crash data be available for both treated and untreated sites for the same period of 3-5 years.

In this study, multiple databases maintained by FDOT are used to identify the intersections which experienced the signalization treatment/upgrade. Then the crash data before and after the treatment are collected using the crash database. The databases include Financial Management (FM) Database, the Roadway Characteristic Inventory (RCI), FDOT GIS (Geographic Information System) layers, and the Crash Analysis Reporting System (CARS). Also, the Google Earth and Google Map are also used to verify and collect the geometric features of the intersections. Each database is described in detail in the following section.

## **7.3. INTRODUCTION OF DATABASES**

### **(1) Financial Management (FM) Database**

Road facility construction projects are recorded in the FM database. The database offers a search system named “Financial Project Search”. Through this system, specific financial project and its relevant information can be identified. Also, the system provides a function to search financial projects by various conditions such as district, status, work types and year. The information

provided in the FM database was too general in which other data sources have to be utilized to collect more information about the treated sites.

#### (2) Roadway Characteristics Inventory (RCI)

The RCI is mainly used to identify the type of road configuration and geometrics of roadway segments and intersections, e.g., overall surface lane width, number of lanes, shoulder type and width, median width, maximum speed limit, and other roadway and traffic characteristics.

#### (3) FDOT GIS (Geographic Information System) layers

The FDOT GIS layers have provided the GIS layers containing enormous information for an intersection such as the AADT, the speed limit, the location, the type of the control device, the number of legs, the truck AADT, etc.

#### (4) Highway Performance Monitoring System (HPMS)

The Highway Performance Monitoring System (HPMS) has provided the AADT and the truck AADT information.

#### (5) Crash Analysis Resource System (CARS)

The CARS is maintained by FDOT. It consists of the traffic crash data from 2003 to date. The data can be retrieved from the server with detailed crash information. This database is generated by collecting data from the Department of Highway Safety and Motor Vehicles (DHSMV).

#### (6) Google Earth and Google Map

The Google Earth provides the historical satellite view of the intersection, and this information is used to check the date of signalization treatment at an intersection. The Google Map provides the latest street view of the intersection, and it is used to collect some supplemental geometric/traffic

operation information such as the speed limit, the pedestrian crosswalk, the number of lanes with a function, etc.

Table 7-1 shows the variables that were collected in this study and their data source.

**Table 7-1: Intersection-related variables collected and corresponding data source**

Variable	Description	Data Source
crash information (2005-2014)		Crash Analysis Resource System (CARS)
intersection location		Financial Management (FM) Database, FDOT GIS layers
geometric design	skew angle, street lighting, pedestrian crosswalk, No. of exclusive right turning lane, number of exclusive left turning lane, number of exclusive through lane, number of through & right turning lane, number of through & left & right turning lane, number of through & left turning lane, number of right & left turning lane, channelized right-turn lane, channelized left-turn lane, speed limit on major road, speed limit on minor road, number of legs	Google Map, Roadway Characteristics Inventory (RCI), FDOT GIS layers
traffic operation	major road AADT, minor road AADT, total entering vehicle (TEV), truck proportion, control type, the truck AADT	FDOT GIS layers, Highway Performance Monitoring System (HPMS)
other	school zone, the ramp approach	Google Map
construction of the signalization treatment (2007-2010)	Construction date and effective date, other information of the construction such as the whether the number of the leg is changed, whether it was originally a ramp, whether there is a big change of the geometric design and etc.	Financial Management (FM) Database, Google Earth



## Data Collection for Urban Intersections

From the Financial Management (FM) Database, 143 intersections in the urban area are found to have been converted from a two-way stop controlled intersection to a signalized intersection from 2007 to 2010. After considering the details of the construction, those intersections which experienced a massive change of the geometric design such as the change of the number of legs are filtered out from our analysis. Finally, 100 treated intersections in the urban area are qualified for the analysis. Table 7-2 shows the proportion of 3-leg and 4-leg urban intersections for the treated intersections.

The reference sites are all urban two-way stop-control intersections. These reference sites are first selected by having similar geometric designs as the treated intersections. Another important consideration for a suitable reference group is that the annual trend in crash frequencies of the reference group is similar to that of the treatment group (Gross et al., 2010).

Hauer (1997) proposed the use of the sample odds ratios to evaluate the suitability of a candidate reference group. Equation (18) shows how to calculate the sample odds ratio. The sample odds ratios are calculated for each before-and-after pair in the time series in the before period.

Subsequently, the sample mean and standard error are determined for these sample odds ratios. If this sample mean is sufficiently close to 1.0 (i.e., subjectively close to 1.0 and the confidence interval includes the value of 1.0), then the candidate reference group is deemed suitable (Gross et al., 2010).

$$\begin{aligned} & \text{sample odds ratio} \\ & = \frac{(Treatment_{before} Comparison_{after}) / (Treatment_{after} Comparison_{before})}{1 + \frac{1}{Treatment_{after}} + \frac{1}{Comparison_{before}}} \end{aligned} \quad (28)$$

where,

$Treatment_{before}$  = total crashes for the treatment group in year i.

$Treatment_{after}$  = total crashes for the treatment group in year j.

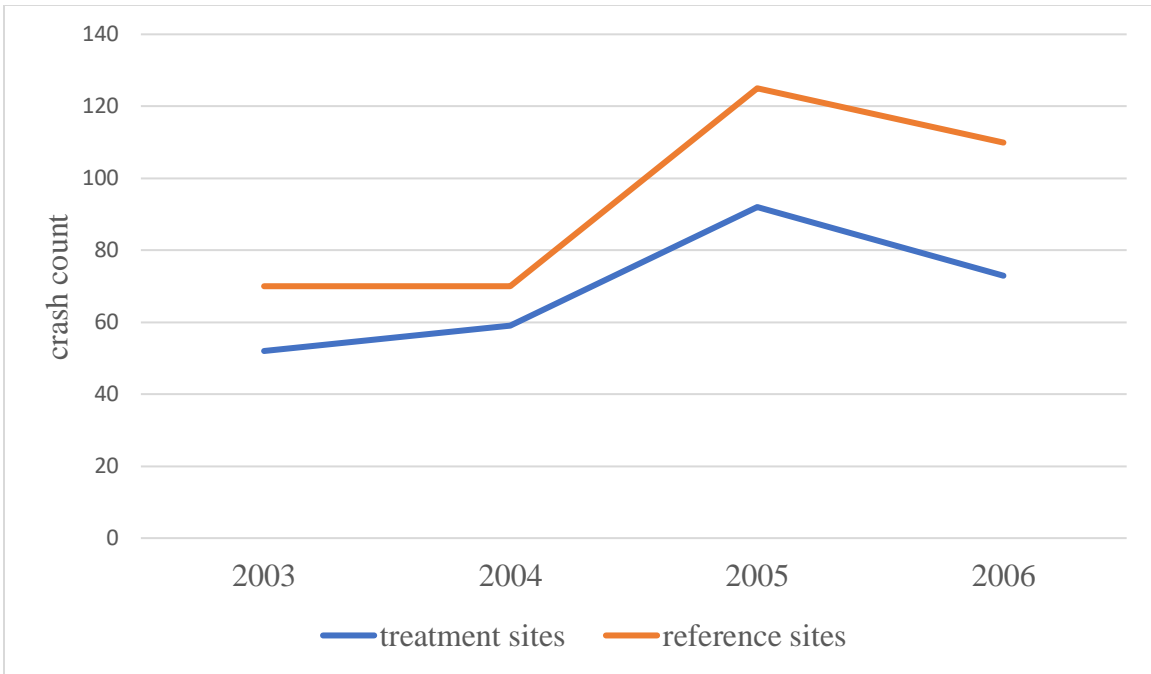
$Comparison_{before}$  = total crashes for the comparison group in year i.

$Comparison_{after}$  = total crashes for the comparison group in year j.

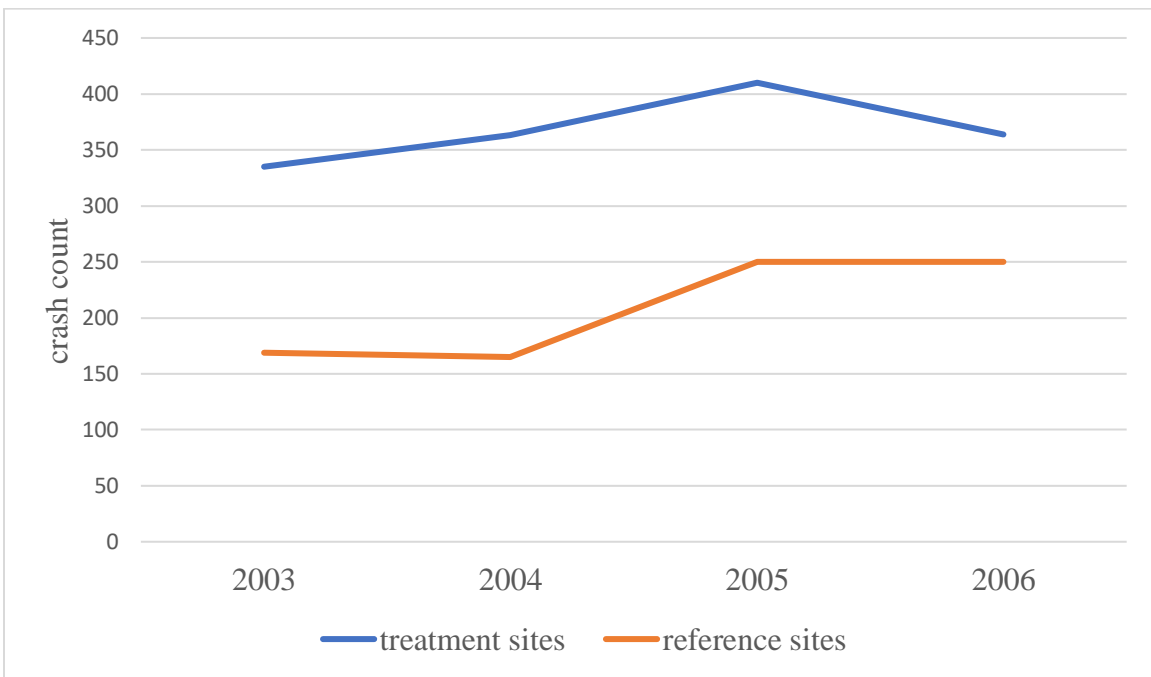
Finally, 195 reference sites were selected. The number of 3-leg and 4-leg intersections for the reference sites are shown in Table 7-2. Figure 7-3 and Figure 7-4 show that the annual trends in crash frequencies in the four-year before period (from 2003 to 2006) for the treatment sites and the reference sites, respectively, and they are similar to each other.

**Table 7-2: Proportion of 3-leg and 4-leg urban intersections**

		3-leg Intersection (Urban)	4-leg Intersection (Urban)
Treated Sites	Number	30	70
	Percentage (%)	30%	70%
Reference Sites	Number	85	110
	Percentage (%)	44%	56%



**Figure 7-3: Annual trends in crash frequencies in the before period for urban 3-leg treatment sites and reference sites**



**Figure 7-4: Annual trends in crash frequencies in the before period for urban 4-leg treatment sites and reference sites**

Table 7-3 shows the mean and the standard error of the sample odds ratios for each before-and-after pair in the time series in the before period from 2003 to 2006. Because the sample mean is sufficiently close to 1.0 and the confidence interval includes the value of 1.0, the candidate reference group of the 195 selected intersections is deemed suitable for the 100 treated intersections.

**Table 7-3: Sample odds ratios for treatment and reference groups**

	Parameters	Urban 3-Leg	Urban 4-Leg
Sample Odds Ratio	03-04	0.855	0.893
	04-05	1.117	1.330
	05-06	1.085	1.119
	Mean	1.019	1.114
	Standard Error	0.143	0.218
	CI-Upper (95%)	1.300	1.542
	CI-Lower (95%)	0.738	0.686

For the reference sites, the rear-end crash data from 2005 to 2010 is collected to develop the SPFs. The rear-end crashes, the rear-end crashes involving the elderly drivers, and the rear-end crash without elderly drivers are mapped to each reference site using an intersection-related range of 250 feet, i.e. if a crash occurs within 250 feet from the center point of an intersection, then this crash is an intersection-related crash and should be mapped to this intersection. Since a good portion of minor road AADT is missing, in this study we use the major road AADT as the independent variable to develop the SPFs. The major road AADT in the year of 2007 is used as a representative AADT from 2005 to 2010. Finally, the proportion of elderly drivers who are using an intersection is estimated by using the quasi-induced exposure method based on the total crash data from 2005 to 2010, and the elderly driver proportion is then applied to the major road AADT to estimate the traffic volumes for the elderly drivers and the non-elderly drivers, respectively. The elderly driver proportion is affected by the proportion of the old population

and is expected to be relatively stable from 2005 to 2010. Table 7-4 and Table 7-5 present the descriptive statistics for the reference sites from 2005 to 2010.

**Table 7-4: Descriptive statistics for reference sites (urban 3-leg)**

Variable	Mean	Standard Deviation	Minimum	Maximum
Rear-End Crashes	2.41	4.23	0	24
Rear-End Crashes Involving Elderly Drivers	0.40	0.91	0	6
Rear-End Crashes without Elderly Drivers	2.01	3.59	0	20
Major Road AADT	12954	10213	700	56000
Elderly Driver Proportion (%)	8.07%	2.71%	4.02%	21.01%

**Table 7-5: Descriptive statistics for reference sites (urban 4-leg)**

Variable	Mean	Standard Deviation	Minimum	Maximum
Rear-End Crashes	2.21	4.11	0	26
Rear-End Crashes Involving Elderly Drivers	0.38	0.99	0	7
Rear-End Crashes without Elderly Drivers	1.83	3.54	0	24
Major Road AADT (%)	10559	9046	850	42500
Elderly Driver Proportion (%)	8.70%	2.94%	3.02%	18.62%

For the treated sites, the rear-end crash data from 2005 to 2006 is considered as the before-period, and the rear-end crash data from 2011 to 2012 is used as the after-period (Tables 7-6 and 7-7). The elderly drivers' proportion is estimated from the total crash data from 2005 to 2010 and assumed to be the same during 2005-2006 and 2011-2012.

**Table 7-6: Descriptive statistics for treated sites (urban 3-leg)**

Variable	Mean	Standard Deviation	Minimum	Maximum
Rear-End Crashes_before	1.40	1.56	0	6
Rear-End Crashes_after	4.27	6.20	0	34
Rear-End Crashes Involving Elderly Drivers_before	0.10	0.30	0	1
Rear-End Crashes Involving Elderly Drivers_after	0.97	1.96	0	10
Rear-End Crashes without Elderly Drivers_before	1.30	1.53	0	6
Rear-End Crashes without Elderly Drivers_after	3.30	4.44	0	24
Major Road AADT_before	28,364	14,025	5,100	59,000
Major Road AADT_after	28,477	11,505	6,500	51,000
Elderly Driver Proportion (%)	8.50%	2.88%	4.83%	17.35%

**Table 7-7: Descriptive statistics for treated sites (urban 4-leg)**

Variable	Mean	Standard Deviation	Minimum	Maximum
Rear-End Crashes_before	2.44	3.13	0	18
Rear-End Crashes_after	4.34	3.37	0	14
Rear-End Crashes Involving Elderly Drivers_before	0.34	0.63	0	3
Rear-End Crashes Involving Elderly Drivers_after	0.73	0.98	0	4
Rear-End Crashes without Elderly Drivers_before	2.10	2.95	0	14
Rear-End Crashes without Elderly Drivers_after	3.61	3.05	0	13
Major Road AADT_before	28,814	15,113	4,300	66,500
Major Road AADT_after	28,638	15,627	6,200	83,000
Elderly Driver Proportion (%)	8.02%	2.74%	4.15%	18.26%

## Data Collection for Rural Intersections

From the Financial Management (FM) Database, only 16 intersections in the rural area are found to have been converted from a 2-way stop controlled intersection to a signalized intersection from 2007 to 2010. After considering the details of the construction, those intersections which experienced a massive change of the geometric design such as the change of the number of legs are filtered out from our analysis. Finally, 13 intersections in the rural area are qualified for the analysis. The number of 3-leg and 4-leg intersections are shown in Table 7-8.

**Table 7-8: Proportions of 3-leg and 4-leg rural intersections**

		3-leg Intersection (Rural)	4-leg Intersection (Rural)
Treated Sites	Number	5	8
	Percentage (%)	38.5%	61.5%

Since the total number of the treated sites at the rural area is limited and is not qualified to conduct the before-and-after with EB method, the cross-sectional method is used for the treated sites at the rural area.

In total, 438 rural four-leg intersections and 520 rural three-leg intersections are collected for the cross-sectional method. That includes 121 signalized intersections and 837 stop-controlled intersections. The crash, geometric design and traffic data of these intersections were identified for four years (2011-2014) from multiple sources. The crash records were collected from the Crash Analysis Reporting System (CARS) database maintained by the Florida Department of Transportation (FDOT). The geometric design data were collected from Google Maps. The traffic data were obtained from the Highway Performance Monitoring System (HPMS) and the FDOT. For the application of the cross-sectional method, typically 3 to 5 years of crash records are recommended. Furthermore, 100 to 1,000 intersection samples are required (Carter et al.,

2012). The KNN and K-means methods were applied to select similar intersections. The selection process selected 140 rural four-leg intersections and 79 rural three-leg intersections for estimating crash prediction models. The distributions of the attributes of the selected rural 3-leg and rural 4-leg intersections are summarized in Tables 7-9 and 7-10, respectively.

**Table 7-9: Descriptive statistics for sampled intersections (rural 3-leg)**

		Rural 3 Leg Intersections			
		Two-Way Stop-Control		Signalization	
Variable		Mean	S.D.	Mean	S.D.
crash (2011-2014)	crash frequency	4.667	4.320	9.368	4.621
geometric design (Constant in 2011-2014)	skew angle	9.417	13.375	5.789	11.336
	street lighting	Yes=7%, No=93%		Yes=64%, No=36%	
	pedestrian crosswalk	Yes=3.3%, No=96.7%		Yes=29%, No=71%	
	No. of exclusive right turning lane	0.567	0.767	1.824	0.636
	No. of exclusive left turning lane	0.717	0.783	2.235	0.562
	No. of exclusive through lane	0.767	0.945	2.529	1.281
	No. of through & right turning lane	0.400	0.494	0.235	0.437
	No. of through & left turning lane	0.717	0.640	0.118	0.332
	No. of right & left turning lane	0.717	0.490	0.059	0.243
	No. of through & left & right turning lane	0.317	0.504	0.059	0.243
	channelized right-turn lane	Yes=10%, No=90%		Yes=42%, No=58%	
	channelized left-turn lane	None		None	
	speed limit on major road	50.875	7.850	48.421	6.021
speed limit on minor road	45.660	7.908	41.667	8.225	
traffic (Averaged from 2011- 2014)	major road AADT	7,721	5,164	12,640	4,593
	minor road AADT	2,673	2,041	6,457	3,237
	total entering vehicle	9,108	5,479	15,748	6,156
	truck proportion	0.084	0.055	0.087	0.050
	elderly driver proportion county subdivision	0.133	0.053	0.129	0.042
other	adjacent to school zone	No		No	
	having approaches serving as ramp	None		None	
total	sample size	60		19	



**Table 7-10: Descriptive statistics for sampled intersections (rural 4-leg)**

		Rural 4 Leg Intersections					
		All-Way Stop-Control		Two-Way Stop-Control		Signalization	
Variable		Mean	S.D.	Mean	S.D.	Mean	S.D.
crash (2011-2014)	crash frequency	2.357	2.959	3.954	4.388	8.000	6.494
geometric design (Constant in 2011-2014)	skew angle	2.500	7.638	7.241	11.148	4.400	11.843
	street lighting	Yes=11%, No=89%		Yes=21%, No=79%		Yes=58%, No=42%	
	pedestrian crosswalk	Yes=14%, No=86%		Yes=10%, No=90%		Yes=72%, No=28%	
	No. of exclusive right turning lane	0.107	0.416	0.241	0.570	0.720	1.173
	No. of exclusive left turning lane	0.500	1.291	0.621	1.026	2.040	1.541
	No. of exclusive through lane	0.321	1.056	0.138	0.462	1.160	2.014
	No. of through & right turning lane	0.464	1.261	0.563	0.872	1.560	1.502
	No. of through & left turning lane	0.071	0.378	0.184	0.518	0.160	0.473
	No. of right & left turning lane	None		None		None	
	No. of through & left & right turning lane	3.429	1.317	3.195	1.150	1.760	1.451
	channelized right-turn lane	None		None		None	
	channelized left-turn lane	None		None		None	
	speed limit on major road	46.058	7.006	48.373	8.699	42.400	8.675
	speed limit on minor road	40.288	9.443	44.103	9.918	37.300	8.658
	traffic (Averaged from 2011-2014)	major road AADT	3,890	3,647	4,216	3,134	6,267
minor road AADT		1,447	1,010	1,622	850	3,192	1,749
total entering vehicle		5,329	4,348	5,925	3,601	9,501	4,609
truck proportion		0.092	0.063	0.085	0.054	0.106	0.037
elderly driver proportion county subdivision		0.143	0.066	0.134	0.046	0.130	0.050
other	adjacent to school zone	No		No		No	
	having approaches serving as ramp	No		No		No	
total	sample size	28		87		25	

#### 7.4. CRASH FEATURES AT INTERSECTIONS IN FLORIDA

In this part, the distribution of the crash types and the distribution of the crash severity are analyzed separately for the stop-controlled and the signalized intersections. The crash data from 2011 to 2014 that were extracted from the CARS database were used for the analysis. The dataset includes crash data for four years from 7,956 intersections by the area type and by the number of legs are shown in Table 7-11.

**Table 7-11: Intersection proportions for analysis**

Area	Number of legs	Control type	Number	Crash count
Rural	3	minor-road stop-controlled	509	1,984
		all-way stop-controlled	N/A	N/A
		signalized	13	241
		total	514	2,225
	4	minor-road stop-controlled	357	1,946
		all-way stop-controlled	37	181
		signalized	54	1,175
		total	448	3,302
Urban	3	minor-road stop-controlled	894	10,956
		all-way stop-controlled	37	226
		signalized	807	41,376
		total	1,738	52,558
	4	minor-road stop-controlled	676	9,725
		all-way stop-controlled	221	2,057
		signalized	4,351	359,538
		total	5,248	371,320

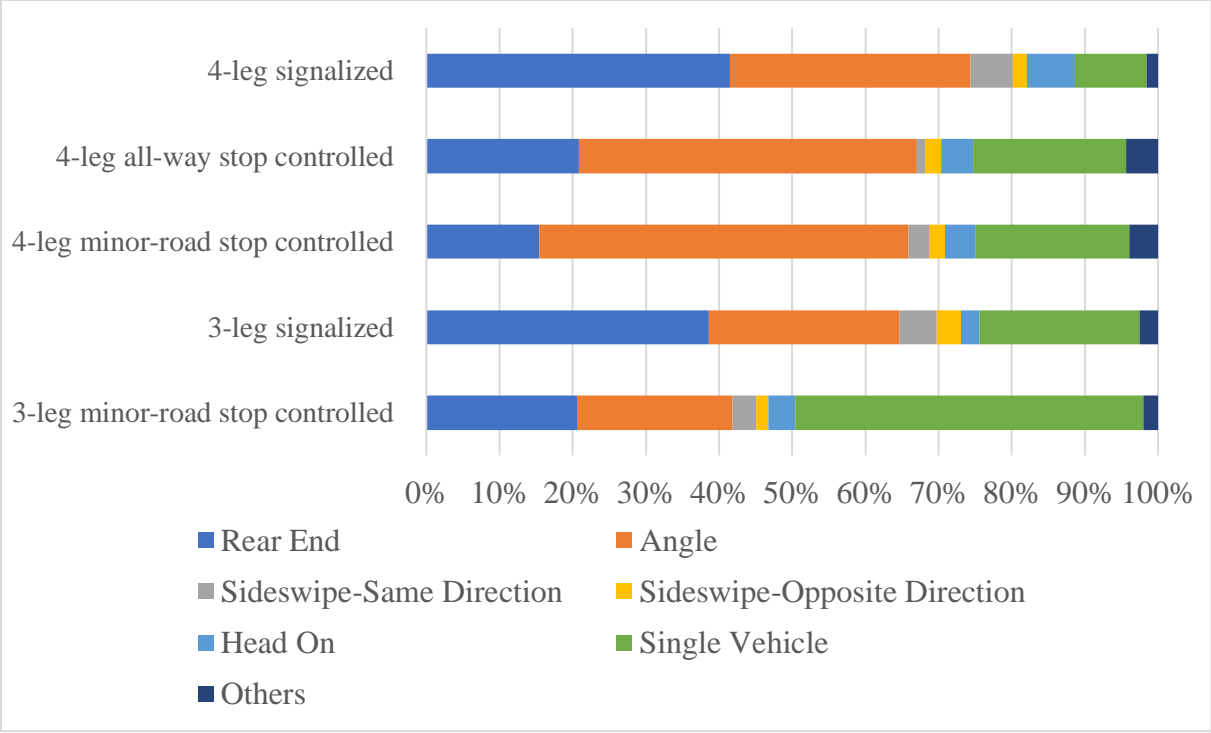
## **Descriptive Statistics of Crash Types**

### **(1) Total crashes**

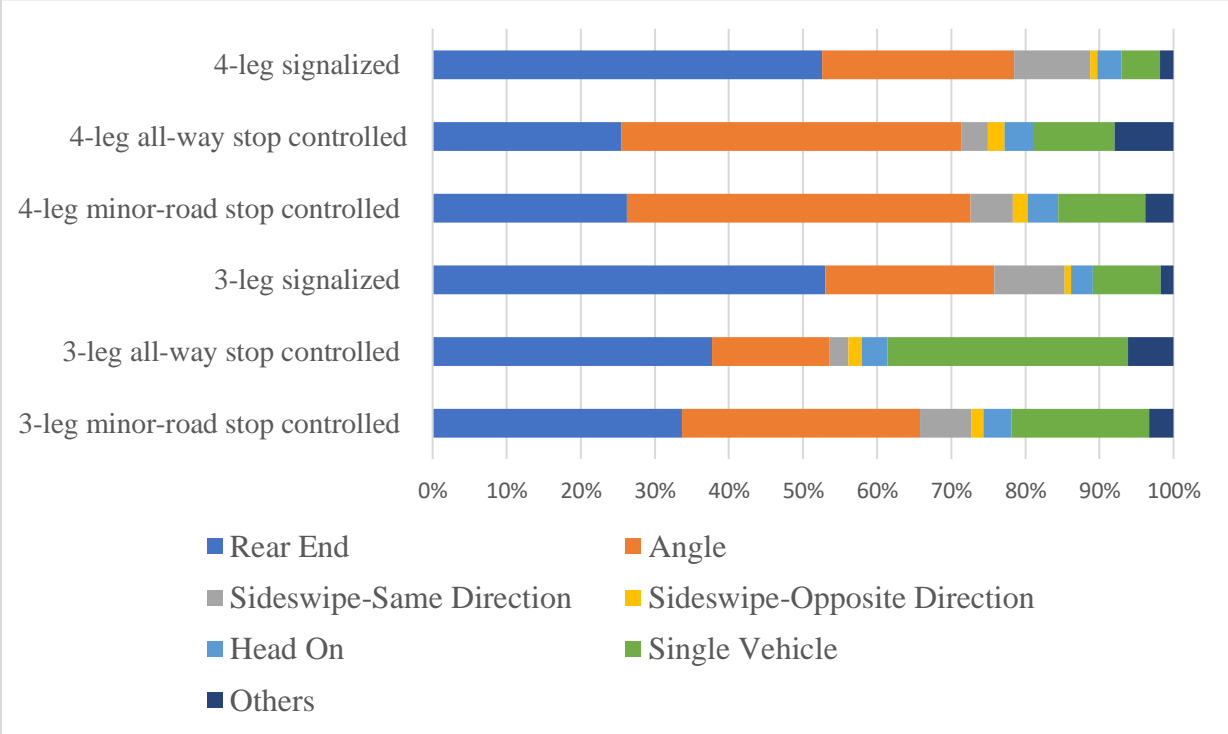
Figures 7-5 and 7-6 show the distribution of different crash types at the rural and urban intersections, respectively. Different types of intersections tend to have different crash type distribution.

The rear-end crash is the most frequent crash type at both of the 3-leg and 4-leg signalized intersections. In addition, the signalized intersections has higher proportion of rear end crashes than the stop-controlled intersections. More specifically, at the rural signalized intersections, the proportion of rear end crashes is around 40%, and at the urban signalized intersections the rear end crashes represent about 50%. However, at the rural stop-controlled intersections, the proportion of rear end crashes is less than 25%; and at the urban stop-controlled intersections, the proportion of rear end crashes is less than 40%.

The angle crash is the most frequent crash type at the 4-leg stop-controlled intersections (over 40%). The single vehicle crashes take up the most proportion of total crashes at the rural 3-leg minor-road stop-controlled intersections (around 50%).



**Figure 7-5: Total crashes: proportions of crash types at different rural intersections**



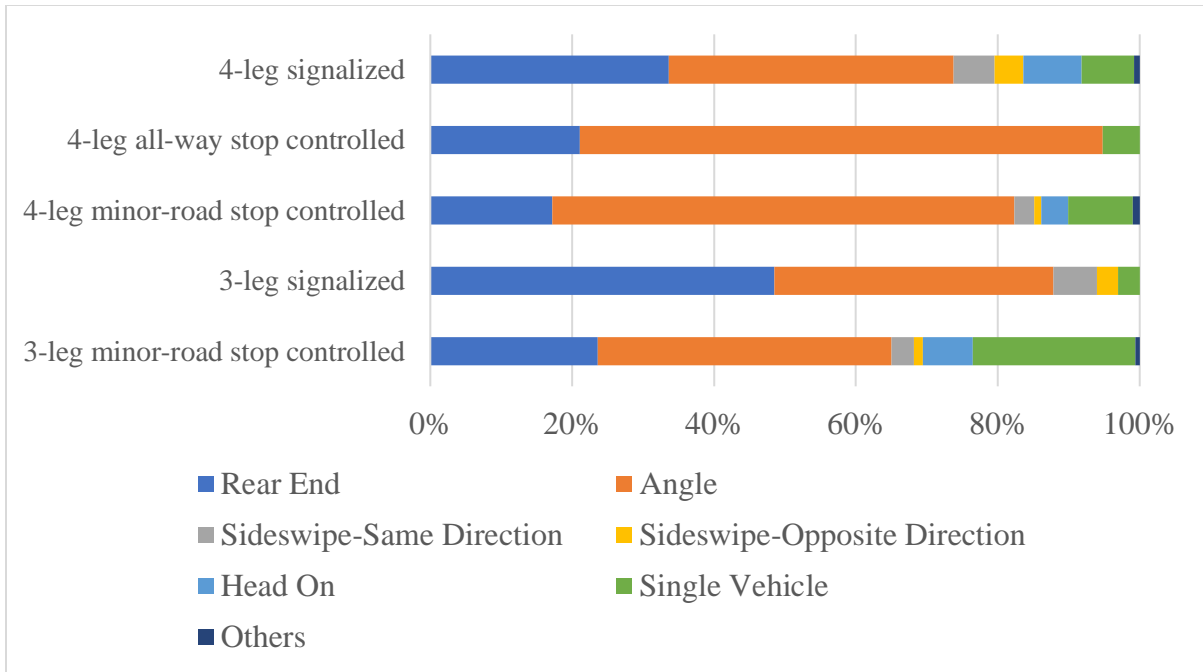
**Figure 7-6: Total crashes: proportions of crash types at different urban intersections**

## (2) Crashes with elderly driver involvement

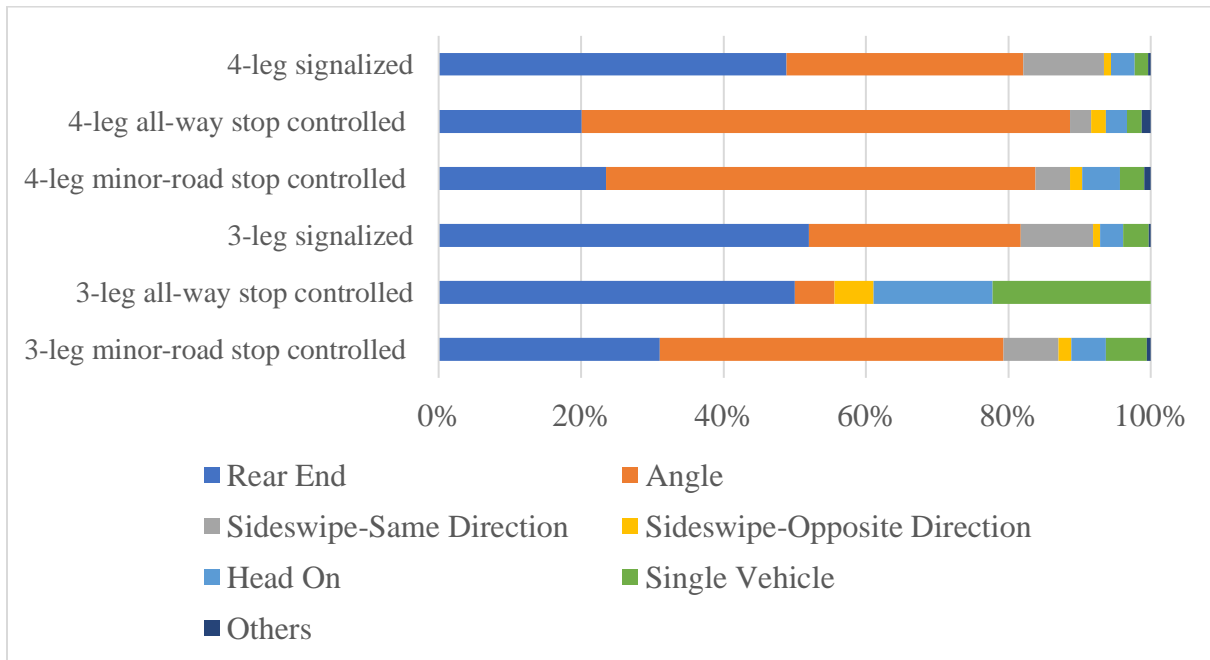
Figures 7-7 and 7-8 show the distribution of different crash types with the elderly driver involvement at rural and urban intersections, respectively.

Among those crashes with the elderly driver involvement, the rear end crashes are the most frequent crash type at the signalized intersections except for the rural 4-leg signalized intersection (around 50%); in addition, there are more rear end crashes with the elderly driver involvement at the signalized intersections than at the stop-controlled intersections. Except for the urban 3-leg all-way stop-controlled intersections, the proportion of the rear end crashes with the elderly driver involvement is approximate 20-30%.

Angle crashes are the most frequent crash type involving elderly drivers at both of the 3-leg and 4-leg stop-controlled intersections except for the urban 3-leg all-way stop-controlled intersections. The proportion of the angle crashes with the elderly driver involvement at those stop-controlled intersections is 40-80%.



**Figure 7-7: Crashes involving elderly drivers: proportions of crash types at different rural intersections**



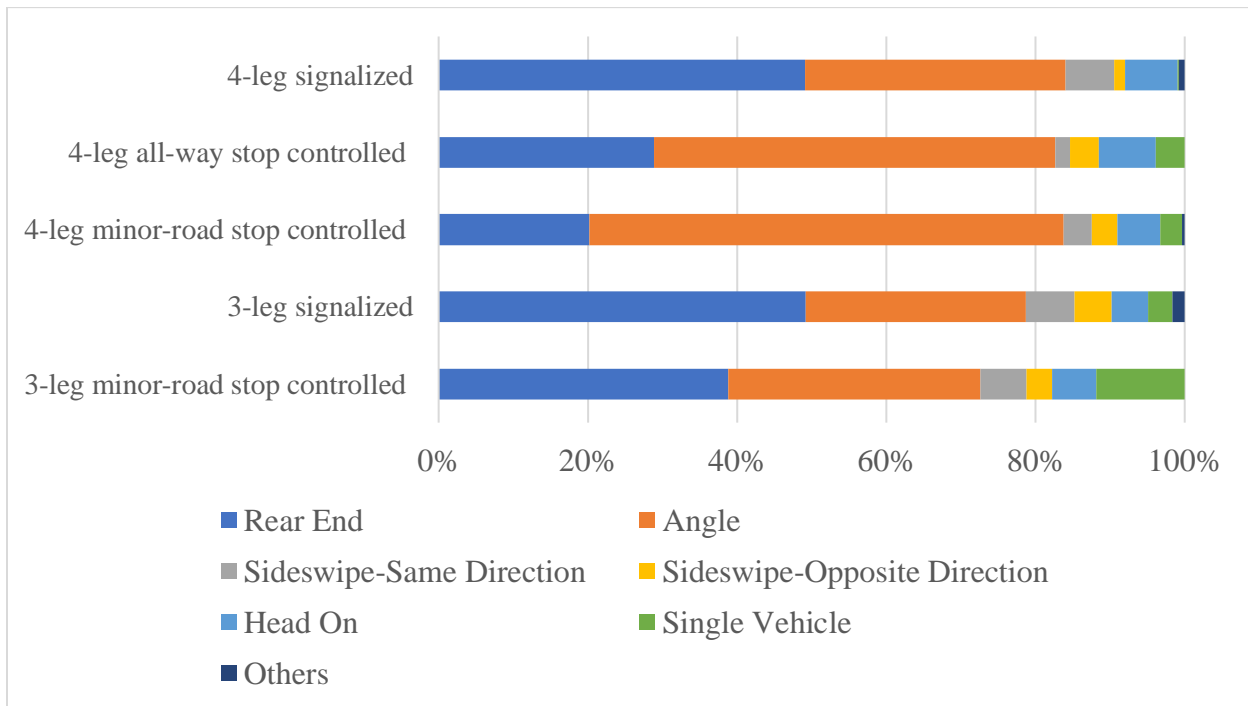
**Figure 7-8: Crashes involving elderly drivers: proportions of crash types at different urban intersections**

### (3) Crashes not involving elderly drivers

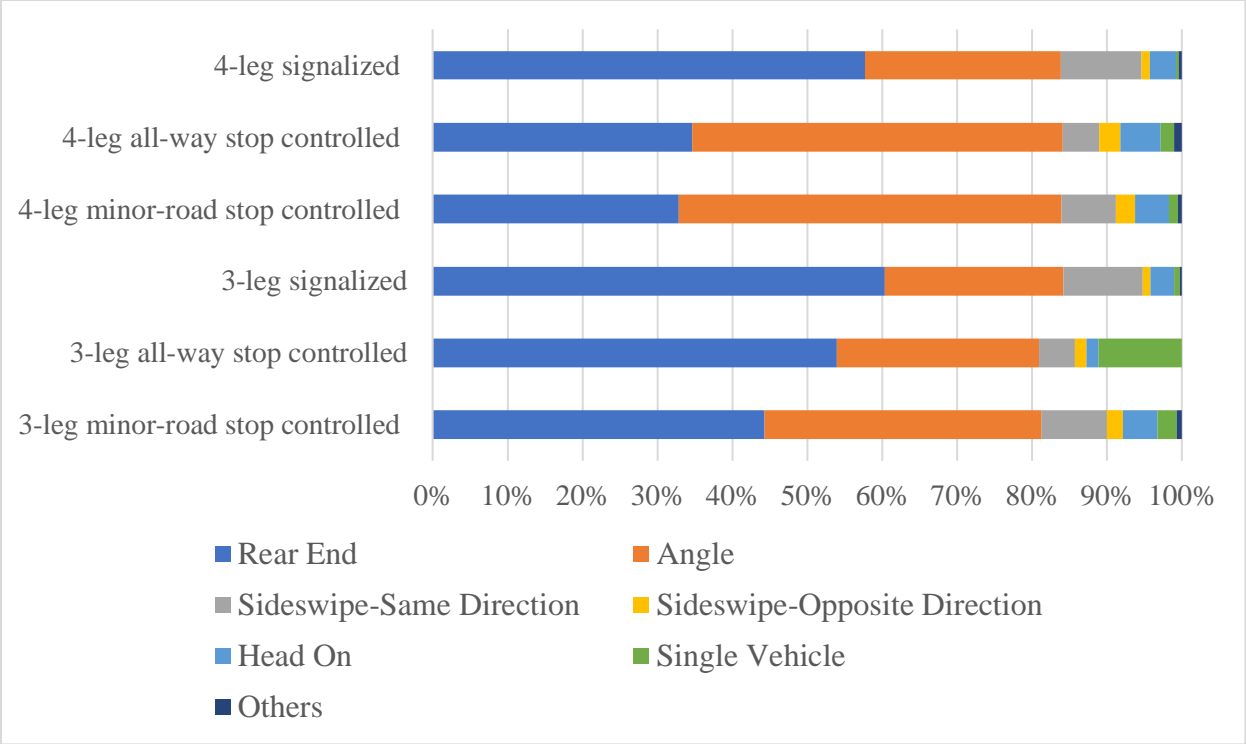
Figures 3-9 and 3-10 show the distribution of different crash types without elderly drivers involved at the rural and urban intersections, respectively.

Among those crashes not involving elderly drivers, the rear end crash is the most frequent crash type at signalized intersection and at the urban 3-leg stop-controlled intersections (40%-60%).

The angle crashes are the most frequent crash type at the 4-leg stop-controlled intersections (40%-60%).



**Figure 7-9: Crashes not involving elderly drivers: proportions of crash types at different rural intersections**



**Figure 7-10: Crash not involving elderly drivers: proportions of crash types at different urban intersections**

**Descriptive Statistics of Crash Severity**

In this part, the fatal and injury crashes are represented by the “KAB” crashes, the possible injury crashes are represented by the “C” crashes and the PDO crashes are presented by the “O” crashes. The later sections mainly concentrate on the analysis of the fatal/injury crashes and the PDO crashes, since these two types of crashes could be clearly reported without uncertainty.

(1) Total crashes

Tables 7-12 and 7-13 show the distribution of different crash severities at rural and urban intersections, respectively.



The PDO crashes account for 40-50% among the total crashes at intersections; the injury crashes account for 35-45%; the possible injury crashes account for 8-20%, and the fatal crashes account for less than 5%.

The ANOVA test shows that the distribution of the crash severities is significantly different between the intersections ( $P\text{-value}<0.0001$ ). Except for the rural 4-leg minor-road stop-controlled intersection, the PDO crash is the most frequent crash type at the intersections.

However, the proportions of the PDO crashes and the fatal and injury crashes could be very close to each other. The paired T-test shows that only at the rural 4-leg minor-road stop-controlled intersections ( $P\text{-value}=0.0534$ ), at the urban signalized intersections ( $P\text{-value}<0.0001$ ), and at the urban 4-leg all-way stop-controlled intersections ( $P\text{-value}=0.001$ ), the proportions of the PDO crashes are significantly larger than those of the fatal and injury crashes.

At the rural 4-leg minor-road stop-controlled intersection, the fatal and injury crashes have a little larger proportion (47.3%) than the PDO crashes (39.41%). The paired t-test shows that the difference is significant ( $P\text{-value}=0.0534$ ) at 90% confidence level.

More fatal crashes are found at the stop-controlled intersections than at the signalized intersections. The mean proportion of the fatal crashes at the stop-controlled intersections is 1.7%, while at the signalized intersection the mean proportion of the fatal crashes is 0.4%. The ANOVA test shows that the difference is significant ( $P\text{-value}<0.0001$ ) at 95% confidence level.

**Table 7-12: Total crashes: proportions of crash severities at different rural intersections**

Control Type	Number of Intersections	Number of Crashes	Crash type	Average Proportion
3-leg minor-road stop controlled intersection	509	1177	fatal	2.50%
			injury	41.40%
			possible injury	11.88%
			PDO	44.22%
3-leg signalized intersection	13	144	fatal	0.00%
			injury	40.37%
			possible injury	13.88%
			PDO	45.74%
4-leg all-way stop controlled intersection	37	107	fatal	1.85%
			injury	37.72%
			possible injury	11.97%
			PDO	48.46%
4-leg minor-road stop controlled intersection	357	1197	fatal	4.24%
			injury	43.11%
			possible injury	13.24%
			PDO	39.41%
4-leg signalized intersection	54	751	fatal	0.56%
			injury	38.39%
			possible injury	20.07%
			PDO	40.97%

**Table 7-13: Total crashes: proportions of crash severities at different urban intersections**

Control Type	Number of Intersections	Number of Crashes	Crash Type	Average Proportion
3-leg all-way stop controlled intersection	37	137	fatal	0.69%
			injury	42.20%
			possible injury	8.64%
			PDO	48.47%
3-leg minor-road stop controlled intersect	894	6951	fatal	1.31%
			injury	38.83%
			possible injury	17.01%
			PDO	42.85%
3-leg signalized intersection	807	26470	fatal	0.57%
			injury	36.54%
			possible injury	19.88%
			PDO	43.01%
4-leg all-way stop controlled intersection	221	1271	fatal	0.38%
			injury	35.08%
			possible injury	14.94%
			PDO	49.61%
4-leg minor-road stop controlled intersection	676	6267	fatal	1.18%
			injury	39.66%
			possible injury	17.61%
			PDO	41.55%
4-leg signalized intersection	4351	230941	fatal	0.39%
			injury	36.35%
			possible injury	20.28%
			PDO	42.98%

## (2) Crashes involving elderly drivers

Tables 7-14 and 7-15 show the distribution of different crash severities involving elderly drivers at rural and urban intersections, respectively.

While at the signalized intersections, the proportions of the PDO crashes involving elderly drivers are between 40-60%, which are larger than the proportion of the fatal/injury crashes involving elderly drivers. However, the paired t-test shows that the differences between the proportions of the two types of crashes are not always significant.

At the rural 3-leg signalized intersections, the PDO crashes involving elderly drivers take up 49.3%, while the fatal/injury crashes involving elderly drivers take up 35.6%. The paired T-test shows that the difference is not significant (P-value=0.448). Similarly, at the rural and urban 4-leg signalized intersections, the difference between the proportions of the two types of crashes is not significant (P-value>0.1).

At the urban 3-leg signalized intersections, the proportion of the PDO crashes involving elderly drivers is 42.9%, while the proportion of the fatal/injury crashes involving elderly drivers is 39.2%. The paired T-test shows that the difference between the two proportions is significant (p-value=0.07) at 90% confidence level.

At the minor-road stop controlled intersections, the proportion of the fatal/injury crashes involving elderly drivers are between 45%-55% which are larger than the proportion of the PDO crashes involving elderly drivers. To be more specific, at the rural 3-leg minor-road stop controlled intersections, the proportion of the fatal/injury crashes is 53.5 while for the PDO crashes is 35.2%. The paired T-test shows that the difference is significant (P-value=0.0186).

Similarly, at the rural 4-leg minor-road stop controlled intersections, the paired T-test shows that

the proportion of the fatal/injury crashes (61.2%) is also significantly larger than that of PDO crashes (27.8%) with the P-value<0.0001.

**Table 7-14: Crashes involving elderly drivers: proportions of crash severities at different rural intersections**

Control Type	Number of Intersections	Number of Crashes	Crash type	Average Proportion
3-leg minor-road stop controlled intersection	509	215	fatal	2.19%
			injury	51.31%
			possible injury	11.28%
			PDO	35.22%
3-leg signalized intersection	13	42	fatal	0.00%
			injury	35.58%
			possible injury	15.08%
			PDO	49.34%
4-leg all-way stop controlled intersection	37	24	fatal	0.00%
			injury	30.24%
			possible injury	9.76%
			PDO	60.00%
4-leg minor-road stop controlled intersection	357	288	fatal	6.96%
			injury	54.28%
			possible injury	10.96%
			PDO	27.80%
4-leg signalized intersection	54	166	fatal	1.06%
			injury	38.17%
			possible injury	16.91%
			PDO	43.86%

**Table 7-15: Crashes involving elderly drivers: proportions of crash severities at different urban intersections**

Control Type	Number of Intersections	Number of Crashes	Crash type	Average Proportion
3-leg all-way stop controlled intersection	37	23	fatal	0.00%
			injury	45.95%
			possible injury	5.36%
			PDO	48.69%
3-leg minor-road stop controlled intersection	894	1328	fatal	1.97%
			injury	41.85%
			possible injury	14.90%
			PDO	41.28%
3-leg signalized intersection	807	5436	fatal	0.65%
			injury	38.55%
			possible injury	17.96%
			PDO	42.85%
4-leg all-way stop controlled intersection	221	319	fatal	1.36%
			injury	37.31%
			possible injury	11.04%
			PDO	50.30%
4-leg minor-road stop controlled intersection	676	1537	fatal	1.76%
			injury	42.05%
			possible injury	14.99%
			PDO	41.20%
4-leg signalized intersection	4351	46115	fatal	0.38%
			injury	39.65%
			possible injury	19.64%
			PDO	40.33%

### (3) Crashes not involving elderly drivers

Tables 7-16 and 7-17 show the distribution of different crash severities without elderly drivers involved at the rural and urban intersections, respectively.

The PDO crashes without elderly drivers involved take up 40% -50% among the total crashes at intersections; the injury crashes without elderly drivers involved take up 35% -45%; the possible injury crashes without elderly drivers involved take up 9% -20%; and the fatal crashes without elderly driver involved take up less than 4%. The PDO crash is the most frequent crash type without elderly drivers involved at the intersections, except for the rural 4-leg minor-road stop controlled intersections. While the proportions of the PDO crashes and the fatal/injury crashes could be very close to each other. The paired T-test shows that at only at the urban signalized intersections, at the urban 4-leg all-way stop controlled intersections, and at the urban 3-leg minor-road stop controlled intersections, the proportion of the PDO crashes is significantly larger than that of the fatal/injury crashes at the 90% confidence level.

At the rural 4-leg minor-road stop controlled intersections, the proportion of the fatal/injury crashes is significantly larger than that of the PDO crashes at the 90% confidence level (P-value=0.0517).

**Table 7-16: Crashes not involving elderly drivers: proportions of crash severities at different rural intersections**

Control Type	Number of Intersections	Number of Crashes	Crash type	Average Proportion
3-leg minor-road stop controlled intersection	509	992	fatal	2.40%
			injury	41.67%
			possible injury	11.20%
			PDO	44.74%
3-leg signalized intersection	13	104	fatal	0.00%
			injury	38.21%
			possible injury	10.93%
			PDO	50.86%
4-leg all-way stop controlled intersection	37	83	fatal	2.67%
			injury	40.07%
			possible injury	14.47%
			PDO	42.80%
4-leg minor-road stop controlled intersection	357	968	fatal	3.21%
			injury	45.12%
			possible injury	11.89%
			PDO	39.78%
4-leg signalized intersection	54	597	fatal	0.27%
			injury	37.03%
			possible injury	18.46%
			PDO	44.24%



**Table 7-17: Crashes not involving elderly drivers: proportions of crash severities at different urban intersections**

Control Type	Number of Intersections	Number of Crashes	Crash type	Average Proportion
3-leg all-way stop controlled intersection	37	114	fatal	0.96%
			injury	42.19%
			possible injury	8.94%
			PDO	47.91%
3-leg minor-road stop controlled intersection	894	5759	fatal	1.04%
			injury	38.80%
			possible injury	16.44%
			PDO	43.72%
3-leg signalized intersection	807	21510	fatal	0.48%
			injury	36.58%
			possible injury	19.12%
			PDO	43.82%
4-leg all-way stop controlled intersection	221	952	fatal	0.23%
			injury	33.02%
			possible injury	14.34%
			PDO	52.41%
4-leg minor-road stop controlled intersection	676	4884	fatal	0.93%
			injury	40.93%
			possible injury	16.98%
			PDO	41.16%
4-leg signalized intersection	4351	188708	fatal	0.40%
			injury	36.51%
			possible injury	19.42%
			PDO	43.66%

## Summary

Rear-end crashes are the most frequent crash type at both of the 3-leg and 4-leg signalized intersections. In addition, the signalized intersections has higher proportion of rear end crashes than the stop-controlled intersections. The angle crash is the most frequent crash type at the 4-leg stop-controlled intersections.

Among those crashes with the elderly driver involvement, the rear end crashes are the most frequent crash type at the signalized intersections except for the rural 4-leg signalized intersection (around 50%); in addition, there are more rear end crashes with the elderly driver involvement at the signalized intersections than at the stop-controlled intersections. Angle crashes are the most frequent crash type involving elderly drivers at both of the 3-leg and 4-leg stop-controlled intersections except for the urban 3-leg all-way stop-controlled intersections.

Among those crashes not involving elderly drivers, the rear end crash is the most frequent crash type at signalized intersection and at the urban 3-leg stop-controlled intersections. The angle crashes are the most frequent crash type at the 4-leg stop-controlled intersections.

As for the total crashes, the proportion of the PDO crashes is significantly larger than other types of crashes at the rural 4-leg minor-road stop controlled intersections, the urban signalized intersections, and the urban 4-leg all-way stop controlled intersections, At the rural 4-leg minor-road stop controlled intersection, the proportion of the fatal/injury crashes is significantly larger than other types of crashes. More fatal crashes are found at the stop-controlled intersections than at the signalized intersections.

Among those crashes with the elderly driver involvement, the PDO crashes usually has a larger proportion than other types of crashes. However, the paired t-test shows that the difference between the proportions of the PDO crashes and other types of crashes is not always significant.

To be more specific, at the rural 3-leg signalized intersections, and the rural and urban 4-leg signalized intersections, the paired T-test shows that the difference is not significant. While at the rural minor-road stop controlled intersections, the proportion of the fatal/injury crashes is significantly larger than that of other crash types.

Among those crashes without the elderly driver involvement, the proportion of the PDO crashes is significantly larger than that of other types of crashes at the urban signalized intersections, at the urban 4-leg all-way stop controlled intersections, and at the urban 3-leg minor-road stop controlled intersections. At the rural 4-leg minor-road stop controlled intersections, the proportion of the fatal/injury crashes is significantly larger than that of other types of crashes.

## **7.5. EFFECTS OF SIGNALIZATION AT URBAN INTERSECTIONS**

### **Introduction**

A before-and-after study with the EB method is used to estimate the CMF for signalization of rear-end crashes at urban intersections since the number of the treated sites, and the number of the reference sites are enough to conduct the before-and-after study.

In total, 100 urban intersections which were signalized in the period between 2007 and 2010 were identified with the crash, geometric design, and traffic information, etc., from multiple data sources that were mentioned in Chapter 2. These 100 urban intersections include 30 urban 3-leg intersections and 70 urban 4-leg intersections. The reference sites are selected to have similar traffic trend, physical characteristics, and land use as the treated sites. Finally, 195 urban 2-way stop-controlled intersections are selected as the reference sites. The reference sites include 85 urban 3-leg intersections and 110 urban 4-leg intersections.

For the reference sites, the rear-end crash data from 2005 to 2010 is collected to develop the SPFs. The rear-end crashes that have occurred within the 250 feet from the center of an intersection is mapped to this intersection. Since most minor roads lack AADT data, the major road AADT was used as the independent variable to develop the SPFs. The major road AADT in the year of 2007 was used as an average AADT from 2005 to 2010. By using the quasi-induced exposure method, the proportion of the elderly drivers who are using an intersection is estimated. The elderly driver proportion was then applied to the major road AADT to estimate the traffic volumes for the elderly and non-elderly drivers.

For the treated sites, the rear-end crash data from 2005 to 2006 is made as the before-period, and the rear-end crash data from 2011 to 2012 is made as the after-period. The elderly drivers'

proportion is estimated from the total crash data from 2005 to 2010 and assumed to be the same during 2005-2006 and during 2011-2012.

## **Crash Modification Factors**

### (1) Rear-end crashes

#### *Total rear-end crashes*

A before-and-after study with the EB method is used to estimate the CMF for signalization of rear-end crashes at urban intersections since the number of the treated sites, and the number of the reference sites are enough to conduct the before-and-after study.

In total, 100 urban intersections which were signalized in the period between 2007 and 2010 were identified with the crash, geometric design, and traffic information, etc., from multiple data sources. These 100 urban intersections include 30 urban 3-leg intersections and 70 urban 4-leg intersections. The reference sites are selected to have similar traffic trend, physical characteristics, and land use as the treated sites. Finally, 195 urban 2-way stop-controlled intersections are selected as the reference sites. The reference sites include 85 urban 3-leg intersections and 110 urban 4-leg intersections.

For the reference sites, the rear-end crash data from 2005 to 2010 is collected to develop the SPFs. The rear-end crashes that have occurred within the 250 feet from the center of an intersection is mapped to this intersection. Since most minor roads lack AADT data, the major road AADT was used as the independent variable to develop the SPFs. The major road AADT in the year of 2007 was used as an average AADT from 2005 to 2010. By using the quasi-induced

exposure method, the proportion of the elderly drivers who are using an intersection is estimated. The elderly driver proportion was then applied to the major road AADT to estimate the traffic volumes for the elderly and non-elderly drivers.

For the treated sites, the rear-end crash data from 2005 to 2006 is made as the before-period, and the rear-end crash data from 2011 to 2012 is made as the after-period. The elderly drivers' proportion is estimated from the total crash data from 2005 to 2010 and assumed to be the same during 2005-2006 and during 2011-2012. The results are summarized in Table 7-18.

**Table 7-18: CMFs for signalization on total rear-end crashes at urban intersections**

Intersection Type	Parameters	Total Crashes	Crashes Involved Elderly Drivers	Crashes Without Elderly Drivers	
Urban 3-Leg Minor-road Stop Controlled Intersections	Sample Size	30	30	30	
	CMF	2.954***	5.590	2.457***	
	CMF variance	0.391	9.803	0.291	
	CMF standard Error	0.626	3.131	0.539	
	CMF upper limit	4.180	11.727	3.513	
	CMF lower limit	1.728	0.000	1.400	
	Alpha	0.050	0.050	0.050	
	Coefficients of SPF				
	Intercept	-10.531	-12.120	-10.039	
	Log_major_AADT	1.015	1.342 <sup>a</sup>	0.9536 <sup>b</sup>	
Urban 4-Leg Minor-road Stop Controlled Intersections	Sample Size	70	70	70	
	CMF	1.779***	2.063***	1.720***	
	CMF variance	0.037	0.323	0.040	
	CMF standard error	0.191	0.568	0.199	
	CMF upper limit	2.155	2.998	2.111	
	CMF lower limit	1.404	1.128	1.330	
	Alpha	0.050	0.100	0.050	
	Coefficients of SPF				
	Intercept	-11.636	-11.525	-11.512	
	Log_major_AADT	1.143	1.268 <sup>a</sup>	1.121 <sup>b</sup>	

Note:

- a. For crashes involved elderly drivers, the AADT is the elderly driver related AADT, which equals the major road AADT multiplied by elderly driver proportion at the county subdivision level.
- b. For crashes not involving elderly drivers, the AADT is the non-elderly drivers related AADT, which equals major road AADT multiplied by (1-elderly driver proportion at county subdivision level).
- c. \*\*\*, \*\* and \* indicate the CMF is significant at 95%, 90% and 85% levels, respectively.

### *Rear-end severity level*

Table 7-19 shows the CMFs of signalization estimated by using Before-and-After with the EB method for different crash severities of the rear end crashes in the urban areas. Three types of crash severity of the rear end crashes are analyzed and they are KAB, KABC and PDO crashes. Here the “KAB” indicates the fatal and injury crashes, the C indicates the possible injury crashes, while the PDO crashes represent the property damaged only crashes. Finally, the rear end-KAB crashes, rear end-KABC crashes and rear end-PDO crashes are analyzed. For example, the rear end-KAB crashes indicate those rear end crashes which are also fatal/injury crashes. All the variables in the SPFs are significant at a 95% confidence level.

For urban 3-leg intersections, after signalization, the rear end-KABC crashes increased by 136%, and the rear end-PDO crashes increased by 502%. However, the CMF for the rear end-KAB crashes is not significant at 95% or 90% confidence levels. This indicates that at the urban 3-leg intersections the signalization would increase the frequency of the rear end crash, while it would not increase the crash severity of the rear end crashes.

For urban 4-leg intersections, after signalization, the rear end-KAB crashes increased by 65% (85% significant level), and the rear end-PDO crashes increased by 89%.

**Table 7-19: CMFs for signalization on rear-end crash severities at urban intersections**

Intersection Type	Parameters	Rear End-KAB	Rear End-KABC	Rear End-PDO	
Urban 3-Leg Minor-road Stop Controlled Intersections	Sample Size	30	30	30	
	CMF	1.990	2.357***	6.016***	
	CMF Variance	0.805	0.481	4.455	
	CMF Standard Error	0.897	0.694	2.111	
	CMF Upper limit	3.749	3.498	10.153	
	CMF Lower limit	0.231	1.216	1.879	
	Alpha	0.05	0.1	0.05	
	Coefficients of SPF				
	Intercept	-18.574	-13.758	-12.141	
	Log_major_AADT	1.513	1.071	0.860	
Urban 4-Leg Minor-road Stop Controlled Intersections	Sample Size	70	70	70	
	CMF	1.645*	N/A	1.893***	
	CMF Variance	0.169		0.089	
	CMF Standard Error	0.411		0.298	
	CMF Upper limit	2.236		2.477	
	CMF Lower limit	1.054		1.309	
	Alpha	0.1		0.05	
	Coefficients of SPF				
	Intercept	-17.208	N/A	-19.700	
	Log_major_AADT	1.377		1.757	

Note:

- a. \*\*\*, \*\* and \* indicate the CMF is significant at 95%, 90% and 85% levels, respectively.
- b. N/A means the SPF doesn't have a converged result.



## (2) Angle crashes

Table 7-20 shows the CMFs of signalization estimated by using Before-and-After with the EB method for angle crashes in the urban areas. The all the variables in the SPFs are significant at a 95% confidence level.

For urban 3-leg intersections, after signalization, the angle crashes decreased by 32%, and the angle crashes without elderly drivers involvement decreased by 29%. The CMF for the angle crashes involving elderly drivers was neither significant at the 95% nor the 90% confidence level. This may be due to the reason that the sample size for the angle crashes involving elderly drivers is limited.

For urban 4-leg intersections, after signalization, the angle crashes decreased by 51%, the angle crashes involving elderly drivers decreased by 56%, and the angle crashes not involving elderly drivers decreased by 48%.

For urban 4-leg intersections, the CMF of the angle crashes involved elderly drivers are the smallest one when compared with the CMFs of the total angle crashes and the angle crashes without elderly drivers. This indicates that the signalization may decrease slightly more of the angle crashes for elderly drivers than for the non-elderly drivers.

**Table 7-20: CMFs for signalization on angle crashes at urban intersections**

Intersection Type	Parameters	Total Crash	Crashes Involved Elderly Drivers	Crashes without Elderly Drivers	
Urban 3-Leg Minor-road Stop Controlled Intersections	Sample Size	30	30	30	
	CMF	0.678***	0.689	0.709***	
	CMF Variance	0.012	0.059	0.017	
	CMF Standard Error	0.110	0.242	0.131	
	CMF Upper limit	0.894	1.164	0.965	
	CMF Lower limit	0.462	0.214	0.453	
	Alpha	0.05	0.05	0.05	
	Coefficients of SPF				
	Intercept	-12.41	-10.956	-11.951	
	Log_major_AADT	1.15	1.103 <sup>a</sup>	1.094 <sup>b</sup>	
Urban 4-Leg Minor-road Stop Controlled Intersections	Sample Size	70	70	70	
	CMF	0.494***	0.438***	0.515***	
	CMF Variance	0.001	0.004	0.002	
	CMF Standard Error	0.037	0.063	0.046	
	CMF Upper limit	0.567	0.562	0.604	
	CMF Lower limit	0.420	0.314	0.425	
	Alpha	0.05	0.05	0.05	
	Intercept	-2.657	-4.110	-3.016	
	Log_major_AADT	0.264	0.359 <sup>a</sup>	0.277 <sup>b</sup>	

Note:

- a. For crashes involved elderly drivers, the AADT is the elderly driver related AADT, which equals the major road AADT multiplied by elderly driver proportion at county subdivision level.
- b. For crashes without elderly drivers, the AADT is the non-elderly driver related AADT, which equals major road AADT multiplied by (1-elderly driver proportion at county subdivision level).
- c. \*\*\*, \*\* and \* indicate the CMF is significant at 95%, 90% and 85% levels, respectively.

### (3) Total crashes

Table 7-21 shows the CMFs of signalization estimated by using Before-and-After with the EB method for total crashes in the urban areas. All the variables in the SPFs are significant at a 95% confidence level.

For urban 3-leg intersections, after signalization, the total crashes increased by 42%, and the total crashes not involving elderly drivers increased by 32%.

For urban 4-leg intersections, after signalization, the total crashes decreased by 15%, the total crashes involving elderly drivers decreased by 20%, and the total crashes not involving elderly drivers decreased by 11%.

The signalization treatment has the contrary effect on the total crashes between the urban 3-leg intersections and the urban 4-leg intersections. The signalization treatment would increase the total crashes, particularly the crashes not involving elderly drivers, at the urban 3-leg intersections, while it would decrease the total crashes, particularly the crashes involving elderly drivers, at the urban 4-leg intersections.

**Table 7-21: CMFs for signalization on total crashes at urban intersections**

Intersection Type	Parameters	Total Crashes	Crashes Involved Elderly Drivers	Crashes without Elderly Drivers	
Urban 3-Leg Minor-road Stop Controlled Intersections	Sample Size	30	30	30	
	CMF	1.416***	1.793	1.317***	
	CMF Variance	0.024	0.238	0.024	
	CMF Standard Error	0.154	0.488	0.154	
	CMF Upper limit	1.718	2.749	1.619	
	CMF Lower limit	1.114	0.837	1.014	
	Alpha	0.05	0.1	0.05	
	Coefficients of SPF				
	Intercept	-8.119	-9.374	-7.739	
	Log_major_AADT	0.899	1.136 <sup>a</sup>	0.849 <sup>b</sup>	
Urban 4-Leg Minor-road Stop Controlled Intersections	Sample Size	70	70	70	
	CMF	0.851***	0.802***	0.886***	
	CMF Variance	0.002	0.008	0.003	
	CMF Standard Error	0.043	0.091	0.050	
	CMF Upper limit	0.936	0.980	0.984	
	CMF Lower limit	0.766	0.625	0.787	
	Alpha	0.05	0.05	0.05	
	Coefficients of SPF				
	Intercept	-4.051	-4.793	-4.217	
	Log_major_AADT	0.520	0.573 <sup>a</sup>	0.521 <sup>b</sup>	

Note:

a. For crashes involved elderly drivers, the AADT is the elderly driver related AADT, which equals the major road AADT multiplied by elderly driver proportion at county subdivision level.

b. For crashes without elderly drivers, the AADT is the non-elderly driver related AADT, which equals major road AADT multiplied by (1-elderly driver proportion at county subdivision level).

c. \*\*\*, \*\* and \* indicate the CMF is significant at 95%, 90% and 85% levels, respectively.

#### (4) KAB crashes

Table 7-22 shows the CMFs of signalization estimated by using Before-and-After with the EB method for KAB crashes (the fatal, incapacitating injury, and the non-incapacitating injury) in the urban areas. All the variables in the SPFs are significant at a 95% confidence level.

For urban 3-leg intersections, the effect of the signalization treatment on the KAB crashes was not significant. This may be due to the reason that the sample size is limited.

For urban 4-leg intersections, after signalization, the total KAB crashes decreased by 31%, the KAB crashes involving elderly drivers decreased by 50%, and the KAB crashes not involving elderly drivers decreased by 23%. This indicates that the signalization treatment would have a benefit in reducing the fatal/injury crashes and would be particularly good for the elderly drivers.

**Table 7-22: CMFs for signalization on KAB crashes at urban intersections**

Intersection Type	Parameters	Total Crash	Crashes Involved Elderly Drivers	Crashes without Elderly Drivers	
Urban 3-Leg Minor-road Stop Controlled Intersections	Sample Size	30	30	30	
	CMF	1.123	0.639	1.279	
	CMF Variance	0.051	0.050	0.091	
	CMF Standard Error	0.227	0.224	0.301	
	CMF Upper limit	1.568	1.078	1.869	
	CMF Lower limit	0.679	0.200	0.688	
	Alpha	0.05	0.05	0.05	
	Coefficients of SPF				
	Intercept	-12.855	-13.993	-12.366	
	Log_major_AADT	1.253	1.600 <sup>a</sup>	1.194 <sup>b</sup>	
Urban 4-Leg Minor-road Stop Controlled Intersections	Sample Size	70	70	70	
	CMF	0.691***	0.496***	0.768***	
	CMF Variance	0.004	0.007	0.007	
	CMF Standard Error	0.063	0.083	0.082	
	CMF Upper limit	0.814	0.660	0.929	
	CMF Lower limit	0.568	0.332	0.607	
	Alpha	0.05	0.05	0.05	
	Intercept	-4.046	-4.104	-4.738	
	Log_major_AADT	0.396	0.289 <sup>a</sup>	0.455 <sup>b</sup>	

Note:

- a. For crashes involved elderly drivers, the AADT is the elderly driver related AADT, which equals the major road AADT multiplied by elderly driver proportion at county subdivision level.
- b. For crashes without elderly drivers, the AADT is the non-elderly driver related AADT, which equals major road AADT multiplied by (1-elderly driver proportion at county subdivision level).
- c. \*\*\*, \*\* and \* indicate the CMF is significant at 95%, 90% and 85% levels, respectively.

#### (5) KABC Crashes

Table 7-23 displays the CMFs of signalization estimated by using Before-and-After with the EB method for KABC crashes in the urban areas. All the variables in the SPFs are significant at a 95% confidence level.

For urban 3-leg intersections, the effect of the signalization treatment on the KABC crashes was not significant. This may be due to the reason that the sample size is limited.

For urban 4-leg intersections, after signalization, the total KABC crashes decreased by 17%, the KABC crashes involving elderly drivers decreased by 25%, and the KABC crashes not involving elderly drivers decreased by 15%. This indicates that the signalization at the urban 4-leg intersections would be more useful for decreasing the crash severity of the crashes involving elderly drivers.

**Table 7-23: CMFs for signalization on KABC crashes at urban intersections**

Intersection Type	Parameters	Total Crash	Crashes Involved Elderly Drivers	Crashes without Elderly Drivers	
Urban 3-Leg Minor-road Stop Controlled Intersections	Sample Size	30	30	30	
	CMF	1.094	1.072	1.075	
	CMF Variance	0.025	0.118	0.029	
	CMF Standard Error	0.158	0.343	0.170	
	CMF Upper limit	1.404	1.744	1.408	
	CMF Lower limit	0.785	0.400	0.741	
	Alpha	0.05	0.05	0.05	
	Coefficients of SPF				
	Intercept	-11.039	-10.580	-10.854	
	Log_major_AADT	1.135	1.230 <sup>a</sup>	1.106 <sup>b</sup>	
Urban 4-Leg Minor-road Stop Controlled Intersections	Sample Size	70	70	70	
	CMF	0.827***	0.746***	0.854***	
	CMF Variance	0.003	0.010	0.004	
	CMF Standard Error	0.056	0.100	0.067	
	CMF Upper limit	0.936	0.943	0.985	
	CMF Lower limit	0.717	0.550	0.723	
	Alpha	0.05	0.05	0.05	
	Intercept	-3.491	-4.364	-3.957	
	Log_major_AADT	0.395	0.433 <sup>a</sup>	0.425 <sup>b</sup>	

Note:

- a. For crashes involved elderly drivers, the AADT is the elderly driver related AADT, which equals the major road AADT multiplied by elderly driver proportion at county subdivision level.
- b. For crashes without elderly drivers, the AADT is the non-elderly driver related AADT, which equals major road AADT multiplied by (1-elderly driver proportion at county subdivision level).
- c. \*\*\*, \*\* and \* indicate the CMF is significant at 95%, 90% and 85% levels, respectively.



(6) PDO crashes

Table 7-24 shows the CMFs of signalization estimated by using Before-and-After with the EB method for PDO crashes in the urban areas. All the variables in the SPFs are significant at a 95% confidence level.

For urban 3-leg intersections, after signalization, the total PDO crashes increased by 79%, and the PDO crashes not involving elderly drivers increased by 59%. For urban 4-leg intersections, the effect of the signalization treatment on the PDO crashes was not significant.

**Table 7-24: CMFs for signalization on PDO crashes at urban intersections**

Intersection Type	Parameters	Total Crash	Crashes Involved Elderly Drivers	Crashes without Elderly Drivers	
Urban 3-Leg Minor-road Stop Controlled Intersections	Sample Size	30	30	30	
	CMF	1.786***	2.919	1.588***	
	CMF Variance	0.085	1.661	0.074	
	CMF Standard Error	0.291	1.289	0.272	
	CMF Upper limit	2.357	5.445	2.122	
	CMF Lower limit	1.215	0.392	1.054	
	Alpha	0.05	0.05	0.05	
	Coefficients of SPF				
	Intercept	-6.421	-9.304	-5.970	
	Log_major_AADT	0.642	1.000 <sup>a</sup>	0.584 <sup>b</sup>	
Urban 4-Leg Minor-road Stop Controlled Intersections	Sample Size	70	70	70	
	CMF	0.923	0.922	0.920	
	CMF Variance	0.005	0.035	0.006	
	CMF Standard Error	0.071	0.188	0.076	
	CMF Upper limit	1.061	1.291	1.068	
	CMF Lower limit	0.784	0.554	0.772	
	Alpha	0.05	0.05	0.05	
	Intercept	-6.394	-7.375	-6.040	
	Log_major_AADT	0.686	0.816 <sup>a</sup>	0.634 <sup>b</sup>	

Note:

a. For crashes involved elderly drivers, the AADT is the elderly driver related AADT, which equals the major road AADT multiplied by elderly driver proportion at county subdivision level.

b. For crashes without elderly drivers, the AADT is the non-elderly driver related AADT, which equals major road AADT multiplied by (1-elderly driver proportion at county subdivision level).

c. \*\*\*, \*\* and \* indicate the CMF is significant at 95%, 90% and 85 level respectively.

## Summary

The effects of signalization on the rear end crashes in the urban areas are summarized as follows:

- (1) The signalization treatment increased total rear-end crashes at the urban intersections. In particular, the signalization increased more rear-end crashes at the urban 3-leg stop-controlled intersections (195%) than at the urban 4-leg stop controlled intersections (78%);
- (2) The signalization treatment increased more rear-end crashes involving elderly drivers (106%) than those not involving elderly drivers (72%) at the urban 4-leg stop-controlled intersections. however, at the urban 3-leg stop controlled intersections, there was no evidence about the effect of the signalization.
- (3) The signalization at the urban 4-leg stop-controlled intersections not only increased the frequency of the rear end crashes but also increased the severity of the rear end crashes. However, at the urban 3-leg stop-controlled intersections, the signalization only increased the frequency of rear end crashes, without increasing the crash severity.

The effects of signalization on other types of crashes in the urban areas are summarized as follows:

- (1) The signalization treatment decreased total angle crashes at the urban intersections. In particular, the signalization decreased more angle crashes at the urban 4-leg stop controlled intersections (51%) than at the urban 3-leg stop-controlled intersections (32%).

- (2) The signalization treatment decreased more angle crashes involving elderly drivers (56%) than those not involving elderly drivers (48%) at the urban 4-leg stop-controlled intersections.
- (3) The signalization treatment increased total crashes (42%), particularly the crashes not involving elderly drivers (32%), at the urban 3-leg stop-controlled intersections, while it decreased total crashes (15%), and crashes involving (20%)/not involving elderly drivers (11%) at the urban 4-leg stop-controlled intersection.
- (4) The signalization treatment decreased KAB crashes (31%), especially the KAB crashes involving elderly drivers (50%), at the urban 4-leg stop-controlled intersections.
- (5) The signalization treatment increased PDO crashes and particularly the PDO crashes not involving elderly drivers at the urban 3-leg stop-controlled intersections (59-79%).

The recommendations of the signalization treatment are concluded as follows:

- (1) The signalization treatment is recommended at the urban 4-leg stop-controlled intersections. It could reduce the total crash frequency as well as reduce the total crash severity. In particular, the signalization treatment is especially recommended for those urban 4-leg stop-controlled intersections which have a large proportion of elderly drivers. The signalization treatment could significantly decrease the crash frequency and the crash severity for elderly drivers. However, since the signalization would increase not only the frequency of the rear end crash but also the crash severity of the rear end crashes, additional countermeasures should be considered and they include but are not limited to lower posted speed limits and redundant signs to reduce the risk of failure to comply.

(2) The signalization treatment should be carefully considered before the implementation at the urban 3-leg stop-controlled intersections, particularly at the urban 3-leg stop-controlled intersections, which have a low proportion of elderly drivers. The signalization treatment increases the crash frequency, particularly for the non-elderly drivers, at the urban 3-leg stop-controlled intersections. However, there is no solid evidence about the effect of the signalization treatment on the total crash severity at the urban 3-leg stop-controlled intersections. Other measures could be considered in addition to signalization including beacons or warning signs.

## **7.6. EFFECTS OF SIGNALIZATION AT RURAL INTERSECTIONS**

### **Introduction**

During 2007 to 2010, there were only 16 rural intersections that had experienced signalization. Only 13 intersections of them are qualified for this study. Since there lack enough samples for the Before-and-After analysis, the cross-sectional method was used for the rural intersections. Specifically, the simple safety performance function as well as complicated safety performance function were developed for the different crash types and crash severities at the rural intersections. The simple safety performance function includes the AADT, control type and other variables as the independent variables. In the simple safety performance function, there is no interaction term between the control type and other variables, and the CMF value of the signalization could be derived directly from the exponential of the coefficient of control type in the simple safety performance function. The complicated safety performance function considers an interaction effect between the control type and other variables. The CMF derived from the complicated safety performance function is a function which depends on the variables which have an interaction effect with the control type.

In this study, 958 rural intersections in total including 121 signalized intersections and 837 stop-controlled intersections are used for the dataset.

The crashes, geometric design and traffic data of these intersections were identified for four years (2011-2014) from multiple sources. The crash records were collected from the Crash Analysis Reporting System (CARS) database maintained by the Florida Department of Transportation (FDOT). The geometric design data were collected from Google Maps. The traffic data were obtained from the Highway Performance Monitoring System (HPMS) and FDOT. The KNN and K-means methods were applied to select similar intersections. In this

study, the major road AADT and the ratio of minor road AADT to major road AADT are used as control variables to identify similar sites, whether treated or untreated locations. The AADT was used as a reasonable exposure variable of an intersection. Intersections with similar AADT are expected to have similar crash frequencies. The selection process identified 140 rural four-leg intersections and 79 rural three-leg intersections for estimating crash prediction models. Tables 7-25 to 7-30 show the simple and complicated SPFs for the rear end, rear end of different crash severities, angle, total, KAB, and PDO crashes, respectively. The variables of the traffic operation and geometric design in Table 7-25 are used for developing the SPFs. All variables are selected at the 95% confidence level. The final models are selected with the minimum mean absolute deviance (MAD) and the minimum root mean square error (RMSE).

**Table 7-25: SPFs of signalization for rear-end crashes at rural intersections**

(a) SPFs without interaction terms

Intersection Type	Parameter	Total Crashes	Crashes without Elderly Drivers	Crashes Involving Elderly Drivers
Rural 4-Leg Minor-Road Stop controlled Intersections	Intercept	-14.8097 (2.3793)	-13.8723 (2.4384)	-9.7986 (2.2151)
	lnTEV	1.4366** (0.2633)	1.3407*** (0.2767)	0.9656*** (0.3154)
	Signalization	1.2775** (0.2562)	1.259** (0.2777)	1.5193** (0.4452)
	Skew Angle	0.0304** (0.0103)	N/A	0.0342** (0.0157)
	Street Lighting	N/A	N/A	-0.8773* (0.4913)
	Dispersion	0.3702 (0.1795)	0.3839 (0.2308)	0.3266 (0.4809)
	MAD	0.9361	0.7330	0.3506
Rural 4-Leg All-way Stop controlled Intersections	Intercept	-11.6222 (2.1363)	-12.529 (2.4019)	N/A
	LnTEV	1.1282** (0.2378)	1.2264*** (0.2693)	
	Signalization	1.0568** (0.3023)	0.9406** (0.3244)	
	Dispersion	0.1297 (0.1254)	0.0989 (0.1376)	
	MAD	1.1123	0.9308	
	RMSE	1.5868	1.3220	
Rural 3-Leg Minor-Road Stop controlled Intersections	Intercept	-11.2777 (1.9118)	-10.8968 (1.8079)	-8.7518 (2.4706)
	LnTEV	1.1294** (0.207)	1.0829 *** (0.1975)	0.8572*** (0.3413)
	Signalization	0.5058 ** (0.2149)	0.3918 * (0.2056)	1.0666** (0.4015)
	Dispersion	0.1845 (0.1047)	0.0649 ( 0.0897)	0.4516 (0.4106)
	MAD	1.3688	1.0500	0.5483
	RMSE	1.9504	1.4398	0.8276



## (b) SPFs with interaction terms

Intersection Type	Parameter	Total Crashes	Crashes without Elderly Drivers	Crashes Involving Elderly Drivers
Rural 4-Leg Minor-Road Stop controlled Intersections	Intercept	-14.3622 (2.4036)	-13.4455 (2.4742)	-9.0153 (2.2352)
	lnTEV	1.3863** (0.2668)	1.2926*** (0.2817)	0.8483*** (0.3225)
	lnTEV*Signalization	0.1402*** (0.0283)	0.1395** (0.0313)	0.2208** (0.0645)
	Skew Angle	0.0304** (0.0102)	N/A	0.0344 ** (0.0155)
	Street Lighting	N/A	N/A	-0.8743* (0.4936)
	Dispersion	0.3749 (0.1802)	0.3976 (0.2332)	0.3019 (0.4760)
	MAD	0.9372	0.7379	0.34613
	RMSE	1.5178	1.1770	0.6000
Rural 4-Leg All-way Stop controlled Intersections	Intercept	-11.0320 (2.1705)	-12.0601 (2.4349)	-7.5016 (2.2175)
	LnTEV	1.0623** (0.2443)	1.1747*** (0.2756)	0.5965** (0.3424)
	lnTEV*Signalization	0.1164** (0.0337)	0.1030** (0.0363)	0.2359* (0.0990)
	Dispersion	0.1356 (0.1272)	0.1060 (0.1396)	<0.0001 (0.0004)
	MAD	1.1212	0.9379	0.4089
	RMSE	1.5984	1.3338	0.6534
Rural 3-Leg Minor-Road Stop controlled Intersections	Intercept	-11.1603 (1.9314)	-10.7979 (1.8282)	-8.4943 (2.5324)
	LnTEV	1.1166** (0.2093)	1.0720*** (0.2000)	0.8230*** (0.3516)
	lnTEV*Signalization	0.0530** (0.0224)	0.0416* (0.0217)	0.1390** (0.0543)
	Dispersion	0.1846	0.0654	0.4804
	MAD	1.3678	1.0485	0.5530
	RMSE	1.9573	1.4423	0.8417

Note:

- a. For crashes without elderly drivers, the TEV is the non-elderly driver related TEV, which equals TEV multiplied by (1-elderly driver proportion at county subdivision level).
- b. For crashes involving elderly drivers, the TEV is the elderly driver related TEV, which equals the TEV multiplied by elderly driver proportion at county subdivision level.
- c. \*\*means the variable is significant at 95% confidence level and \*means 90% significant level.

**Table 7-26: SPFs of signalization for different crash severity levels of rear-end crashes at rural intersections**

Intersection Type	Parameter	Rear End-KAB	Rear End-PDO
Rural 4-Leg Minor-Road Stop controlled Intersections	Intercept	-9.9475 (4.8866)	-15.6996 (3.2163)
	lnTEV	0.7008 (0.5600)	1.4594 (0.3557)
	lnTEV*Signalization	0.1826 (0.0665)	0.1423 (0.0361)
	Skew Angle	N/A	0.0284 (0.0133)
	Dispersion	1.7448 (1.3383)	0.3954 (0.2829)
	MAD	0.2912	0.5876
	RMSE	0.5387	0.9529
Rural 4-Leg All-way Stop controlled Intersections	Intercept	-15.2020 (6.9425)	-11.2098 (2.6010)
	LnTEV	1.2867 (0.7684)	1.0336 (0.2931)
	lnTEV*Signalization	0.1702 (0.0942)	0.0964 (0.0405)
	Dispersion	1.5085 (1.2322)	0.0686 (0.1758)
	MAD	0.4481	0.7668
	RMSE	0.7324	1.0645
Rural 3-Leg Minor-Road Stop controlled Intersections	N/A		

Note:

- a. For crashes without elderly drivers, the TEV is the non-elderly driver related TEV, which equals TEV multiplied by (1-elderly driver proportion at county subdivision level).
- b. For crashes involving elderly drivers, the TEV is the elderly driver related TEV, which equals the TEV multiplied by elderly driver proportion at county subdivision level.
- c. \*\*means the variable is significant at 95% confidence level and \*means 90% significant level.

**Table 7-27: SPF of signalization for angle crashes at rural intersections**

Intersection Type	Parameter	Total Crashes	Crashes Without Elderly Drivers	Crashes Involving Elderly Drivers
Rural 4-Leg Minor-Road Stop controlled Intersections	Intercept	-10.2186 (2.0166)	-10.4109 (1.9388)	N/A
	lnTEV	1.0319** (0.2168)	1.0152*** (0.2103)	
	lnTEV*Signalization	-0.0579* (0.0324)	-0.0589* (0.0315)	
	Ratio	1.6313** (0.5413)	1.7869** (0.5223)	
	Dispersion	0.8586	0.5684	
	MAD	2.0985	1.3715	
	RMSE	3.0775	1.9721	
Rural 4-Leg All-way Stop controlled Intersections	N/A			
Rural 3-Leg Minor-Road Stop controlled Intersections	N/A			

Note:

- a. For crashes without elderly drivers, the TEV is the non-elderly driver related TEV, which equals TEV multiplied by (1-elderly driver proportion at county subdivision level).
- b. For crashes involving elderly drivers, the TEV is the elderly driver related TEV, which equals the TEV multiplied by elderly driver proportion at county subdivision level.
- c. \*\*means the variable is significant at 95% confidence level and \*means 90% significant level.

**Table 7-28: SPF of signalization for total crashes at rural intersections**

Intersection Type	Parameter	Total Crashes	Crashes without Elderly Drivers	Crashes Involving Elderly Drivers
Rural 4-Leg Minor-Road Stop controlled Intersections	Intercept	-7.2291 (1.2671)	N/A	-6.9667 (1.1870)
	lnTEV	0.8147** (0.1466)		0.8262 <sup>b**</sup> (0.1761)
	lnTEV*Signalization	0.0397* (0.0233)		0.0663* (0.0391)
	Skew Angle	0.0214** (0.0075)		0.0348** (0.0095)
	Dispersion	0.5246		0.6433
	MAD	3.1995		1.3000
	RMSE	4.2407		2.1402
Rural 4-Leg All-way Stop controlled Intersections	Intercept	-9.0146 (1.4041)	-9.9003 (1.5379)	-6.1078 (1.4644)
	LnTEV	0.9892** (0.1612)	1.0825 <sup>a**</sup> (0.1780)	0.6481 <sup>b**</sup> (0.2240)
	lnTEV*Signalization	0.0690** (0.0235)	0.0620** (0.0256)	0.1487** (0.0524)
	Dispersion	0.1997	0.2124	0.3516
	MAD	2.4750	1.9770	1.1490
	RMSE	3.4720	2.8380	1.7214
Rural 3-Leg Minor-Road Stop controlled Intersections	N/A			

Note:

- a. For crashes without elderly drivers, the TEV is the non-elderly driver related TEV, which equals TEV multiplied by (1-elderly driver proportion at county subdivision level).
- b. For crashes involving elderly drivers, the TEV is the elderly driver related TEV, which equals the TEV multiplied by elderly driver proportion at county subdivision level.
- c. \*\*means the variable is significant at 95% confidence level and \*means 90% significant level.

**Table 7-29: SPF of signalization for KAB crashes at rural intersections**

Intersection Type	Parameter	Total Crashes	Crashes without Elderly Drivers	Crashes Involving Elderly Drivers
Rural 4-Leg Minor-Road Stop controlled Intersections	Intercept	-12.0654 (2.5620)	-11.3233 (2.3099)	-8.9010 (1.2316)
	Lnmajor_road_AADT	1.1827** (0.2794)	1.0898*** (0.2554)	0.9687*** (0.1828)
	lnmajor_road_AADT* Signalization	-0.0685* (0.0410)	-0.0693* (0.038)	-0.0959* (0.0521)
	Ratio	2.6610** (0.7378)	2.5171** (0.6656)	1.6264** (0.5253)
	Dispersion	1.0847	0.6391	0.9093
	MAD	1.4789	1.1001	0.5307
	RMSE	1.9132	1.4811	0.8356
Rural 4-Leg All-way Stop controlled Intersections	N/A			
Rural 3-Leg Minor-Road Stop controlled Intersections	N/A			

Note:

- a. For crashes without elderly drivers, the TEV is the non-elderly driver related TEV, which equals TEV multiplied by (1-elderly driver proportion at county subdivision level).
- b. For crashes involving elderly drivers, the TEV is the elderly driver related TEV, which equals the TEV multiplied by elderly driver proportion at county subdivision level.
- c. \*\*means the variable is significant at 95% confidence level and \*means 90% significant level.

**Table 7-30: SPF of signalization for PDO crashes at rural intersections**

Intersection Type	Parameter	Total Crashes	Crashes without Elderly Drivers	Crashes Involving Elderly Drivers
Rural 4-Leg Minor-Road Stop controlled Intersections	Intercept	-7.4800 (1.4893)	-6.8536 (1.4859)	-7.2917 (1.7752)
	lnTEV	0.7562** (0.1718)	0.6889 <sup>a**</sup> (0.1746)	0.7635 <sup>b**</sup> (0.2667)
	lnTEV*Signalization	0.0684** (0.0253)	0.0527** (0.0266)	0.1119** (0.0560)
	Dispersion	0.5109	0.5213	1.3600
	MAD	1.5097	1.3622	0.7169
	RMSE	2.2539	1.9889	1.1957
Rural 4-Leg All-way Stop controlled Intersections	N/A			
Rural 3-Leg Minor-Road Stop controlled Intersections	Intercept	-8.1910 (1.8165)	N/A	N/A
	lnTEV	0.8216** (0.1987)		
	lnTEV*Signalization	0.0487** (0.0237)		
	Dispersion	0.3025		
	MAD	1.7150		
	RMSE	2.3091		

Note:

- a. For crashes without elderly drivers, the TEV is the non-elderly driver related TEV, which equals TEV multiplied by (1-elderly driver proportion at county subdivision level).
- b. For crashes involving elderly drivers, the TEV is the elderly driver related TEV, which equals the TEV multiplied by elderly driver proportion at county subdivision level.
- c. \*\*means the variable is significant at 95% confidence level and \*means 90% significant level.

## **Crash Modification Function**

### (1) Rear-end crashes

#### *Total rear-end crashes*

Table 7-31 shows the crash modification function for the rear-end crashes obtained from Table 7-25. The crash modification function of the total rear-end crashes is affected by the total entering vehicles (TEV) at an intersection. The crash modification functions of the rear-end crashes with/without elderly drivers are affected by the total entering vehicles (TEV) and the elderly driver proportion.

Figures 7-11 to 7-13 show that the signalization would increase the rear-end crashes at rural intersections because the CMF is greater than 1.0 (at 95% confidence level). In particular, the signalization would increase rear-end crashes involving elderly drivers than rear-end crashes without elderly drivers, especially at those intersections which have a relatively high elderly driver proportion and total entering vehicles. The larger the elderly driver proportion and the larger the total entering vehicles, the larger the CMF for the rear-end crash. This indicates that the increase of the elderly driver proportion and the total entering vehicle would cause more rear-end crashes.

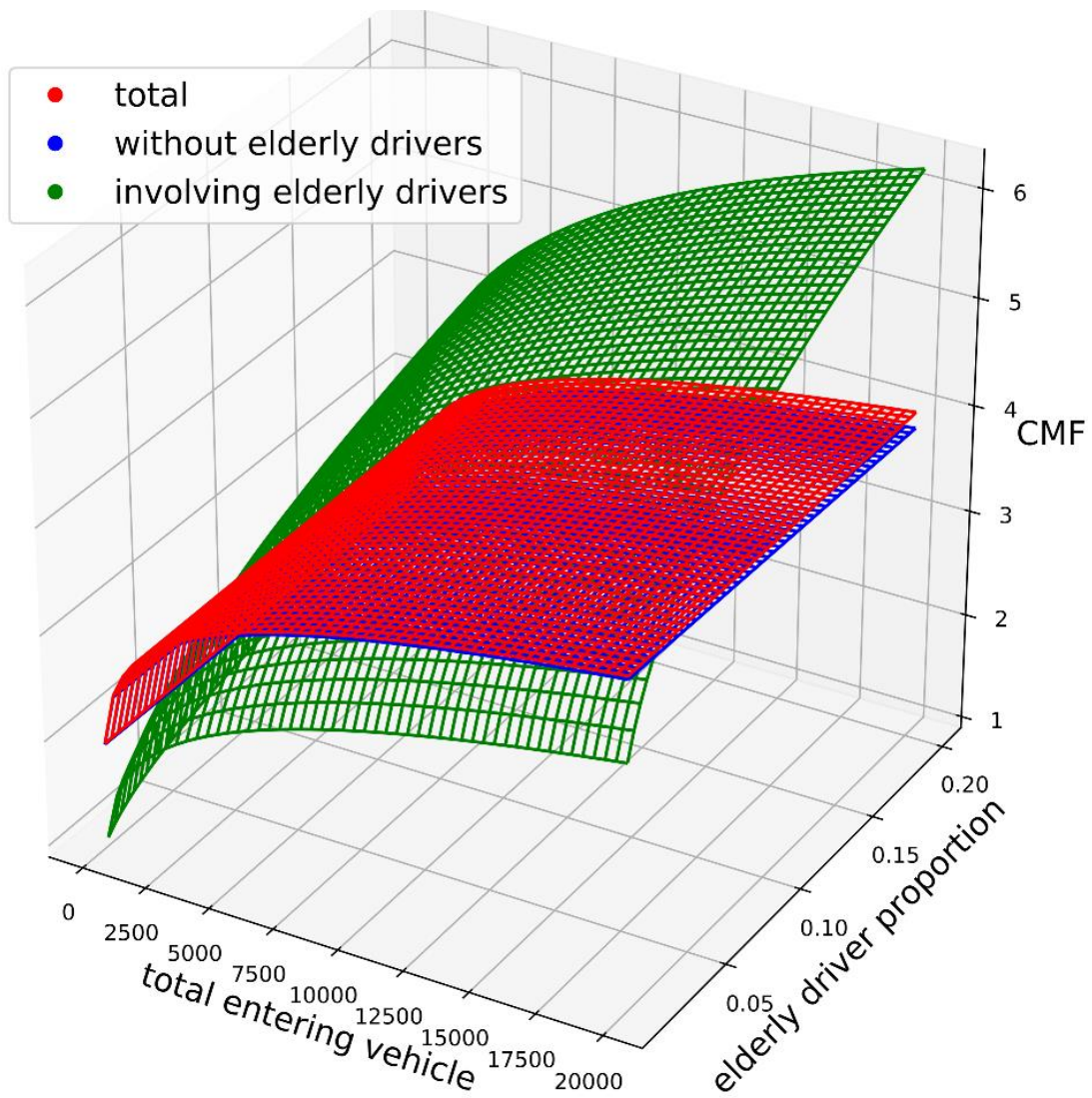
Figures 7-11 to 7-13 also show that the signalization effect on the rear-end crashes varies between locations. In general, the signalization would increase total rear-end crashes at the rural 4-leg minor-road stop-controlled intersections, followed by the rural 4-leg all-way stop-controlled intersections. The least increase of the total rear-end crashes after the signalization treatment is observed at the rural 3-leg minor road stop-controlled intersections. For the elderly-

driver-involved rear-end crashes, the signalization would increase crashes at the rural 4-leg all-way stop-controlled intersections and the rural 3-leg minor-road stop-controlled intersections.

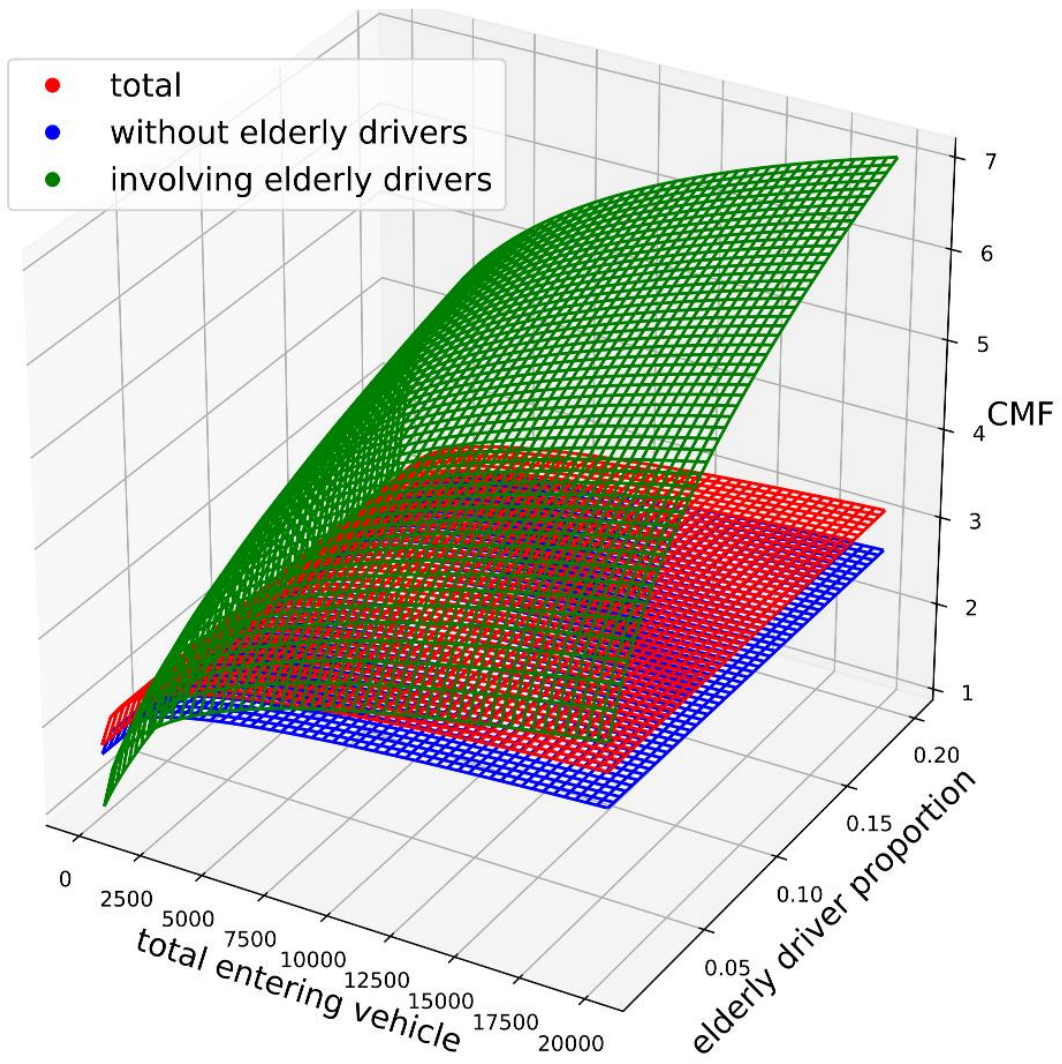
**Table 7-31: Crash modification function of signalization on rear-end crashes at different rural intersections**

Intersection Type	Crash Type	Crash Modification Function
Rural 4-Leg Minor-Road Stop controlled Intersections	Total Crashes	$\exp(0.1402 * \ln TEV)$
	Crashes without Elderly Drivers	$\exp(0.1395 * \ln(TEV * (1 - \text{elderly driver proportion})))$
	Crashes Involving Elderly Drivers	$\exp(0.2208 * \ln(TEV * \text{elderly driver proportion}))$
Rural 4-Leg All-way Stop controlled Intersections	Total Crashes	$\exp(0.1164 * \ln TEV)$
	Crashes without Elderly Drivers	$\exp(0.1030 * \ln(TEV * (1 - \text{elderly driver proportion})))$
	Crashes Involving Elderly Drivers	$\exp(0.2359 * \ln(TEV * \text{elderly driver proportion}))$
Rural 3-Leg Minor-Road Stop controlled Intersections	Total Crashes	$\exp(0.0530 * \ln TEV)$
	Crashes without Elderly Drivers	$\exp(0.0416 * \ln(TEV * (1 - \text{elderly driver proportion})))$
	Crashes Involving Elderly Drivers	$\exp(0.139 * \ln(TEV * \text{elderly driver proportion}))$

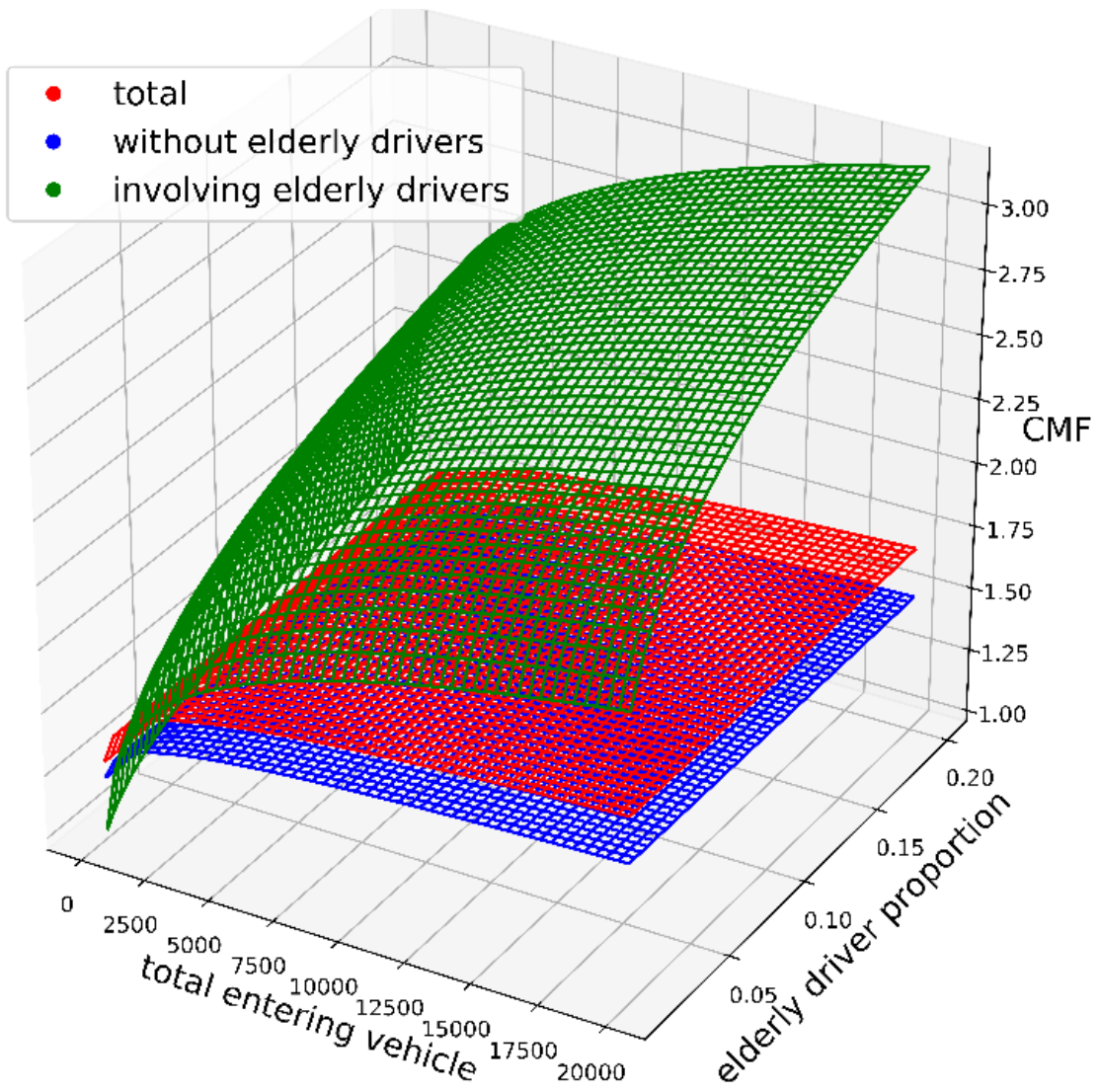




**Figure 7-11: Rural 4-leg intersections: signaled vs. minor-road stop-controlled (rear-end crashes)**



**Figure 7-12: Rural 4-leg intersections: signaled vs. all-way stop-controlled (rear-end crashes)**



**Figure 7-13: Rural 3-leg intersections: signaled vs. minor-road stop-controlled (rear-end crashes)**

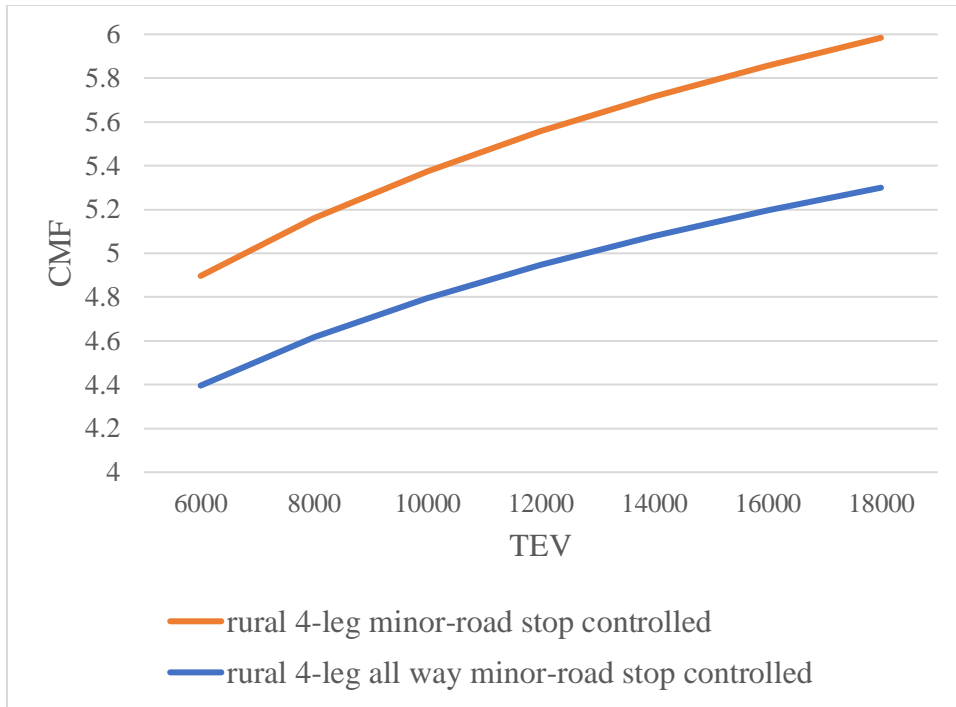
*Rear-end severity level*

Table 7-32 shows the crash modification function for the different crash severities of rear-end crashes obtained from Table 7-26. The crash modification function of the rear end crashes of different crash severities is affected by the total entering vehicle (TEV) at an intersection.

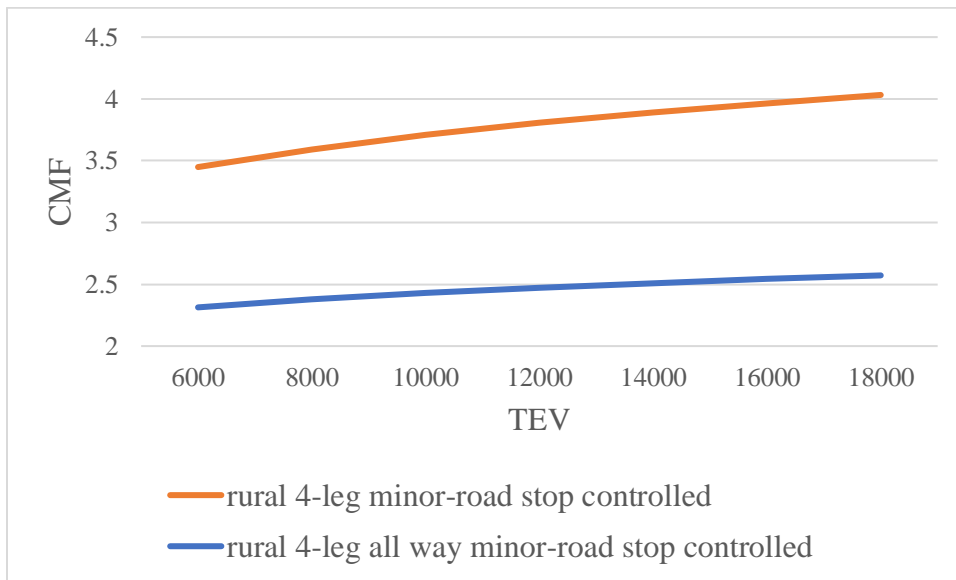
Figures 7-14 and 7-15 show that, the signalization would increase not only more rear end crashes but also more severe rear end crashes (i.e. rear end-KAB crashes) at the rural 4-leg stop controlled intersections, especially at the rural 4-leg minor-road stop controlled intersections.

**Table 7-32: Crash modification function of signalization on different crash severity levels of rear-end crashes at different rural intersections**

Intersection Type	Crash Type	Crash Modification Function
Rural 4-Leg Minor-Road Stop controlled Intersections	Rear End-KAB	$\exp(0.1826 \cdot \ln \text{TEV})$
	Rear End-PDO	$\exp(0.1423 \cdot \ln \text{TEV})$
Rural 4-Leg All-way Stop controlled Intersections	Rear End-KAB	$\exp(0.1702 \cdot \ln \text{TEV})$
	Rear End-PDO	$\exp(0.0964 \cdot \ln \text{TEV})$
Rural 3-Leg Minor-Road Stop controlled Intersections	Rear End-KAB	N/A
	Rear End-PDO	



**Figure 7-14: CMFs for rear-end KAB crashes at the rural 4-leg stop controlled intersections**



**Figure 7-15: CMFs for rear-end PDO crashes at the rural 4-leg stop controlled intersections**

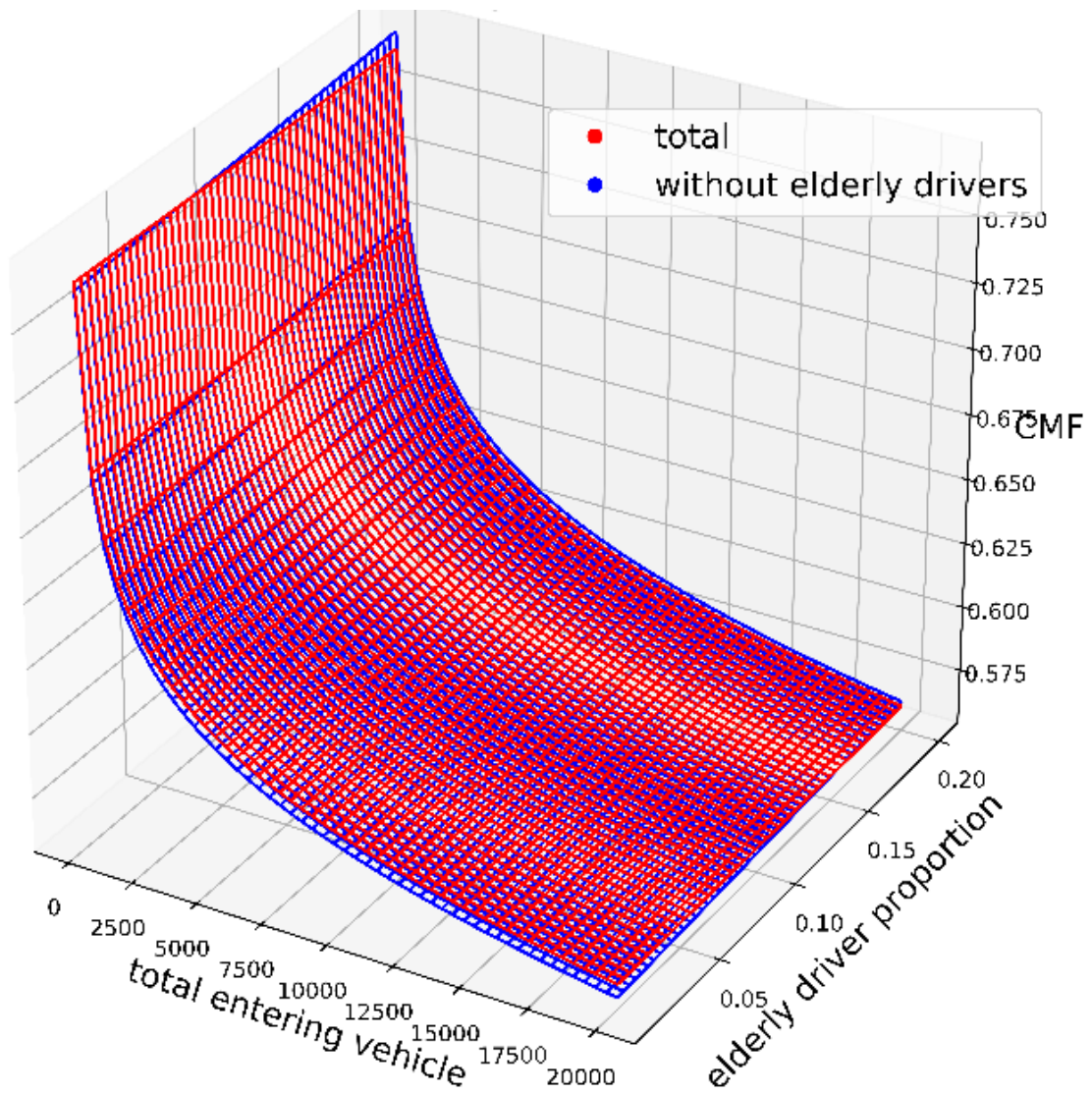
(2) Angle crashes

Table 7-33 shows the crash modification function for the angle crashes obtained from Table 7-27. At the rural 4-leg minor-road stop controlled intersections, the crash modification functions of the total angle crashes and of the angle crashes without elderly drivers are affected by the total entering vehicle (TEV). At the other types of the stop controlled intersections, the crash modification function of the angle crash is not available due to the insignificance of the signalization treatment variable in the SPF.

Figure 7-16 shows that, the signalization would decrease the total angle crashes and the angle crashes without elderly drivers at rural 4-leg minor-road stop controlled intersections. If the intersection has a large total entering vehicle and a small elderly driver proportion, the signalization would decrease more angle crashes.

**Table 7-33: Crash modification function of signalization on angle crashes at different rural intersections**

Intersection Type	Crash Type	Crash Modification Function
Rural 4-Leg Minor-Road Stop controlled Intersections	Total Crashes	$\exp(-0.0579 \cdot \ln TEV)$
	Crashes without Elderly Drivers	$\exp(-0.0589 \cdot \ln(TEV \cdot (1 - \text{elderly driver proportion})))$
	Crashes Involving Elderly Drivers	N/A
Rural 4-Leg All-way Stop controlled Intersections	Total Crashes	N/A
	Crashes Without Elderly Drivers	
	Crashes Involving Elderly Drivers	
Rural 3-Leg Minor-Road Stop controlled Intersections	Total Crashes	N/A
	Crashes Without Elderly Drivers	
	Crashes Involving Elderly Drivers	



**Figure 7-16: Rural 4-leg intersections: signalized vs. minor-road stop-controlled (angle crashes)**

### (3) Total crashes

Table 7-34 shows the crash modification function for the total crash obtained from Table 7-28. At the rural 4-leg stop controlled intersections including the minor-road stop controlled and the all-way stop controlled, the crash modification function of the total crash is affected by the total entering vehicle (TEV) at an intersection, while the crash modification functions of the total crashes with/without elderly drivers are affected by the total entering vehicle (TEV) and the elderly driver proportion. At the rural 3-leg stop controlled intersections, the CMF is not available due to the insignificance of the signalization treatment variable in the SPF.

Figures 7-17 and 7-18 show that, the signalization treatment would increase the total crashes at the rural 4-leg stop controlled intersections since the CMF is greater than 1.0 (at 95% confidence level).

At the rural 4-leg minor-road stop controlled intersections, the signalization treatment would increase more total crashes and total crashes involving elderly drivers at the intersections with high total entering vehicle. The signalization treatment would also increase more total crashes involving elderly drivers at the intersections with high elderly driver proportions.

At the rural 4-leg all-way stop controlled intersections, the signalization treatment would increase total crashes, total crashes involving elderly drivers and the total crashes without the elderly drivers at the intersections. In particular, the signalization treatment would increase more crashes at the intersections with high total entering vehicle. As for the elderly driver proportion, the signalization treatment would cause more crashes involving elderly drivers at the intersections with high elderly driver proportions.

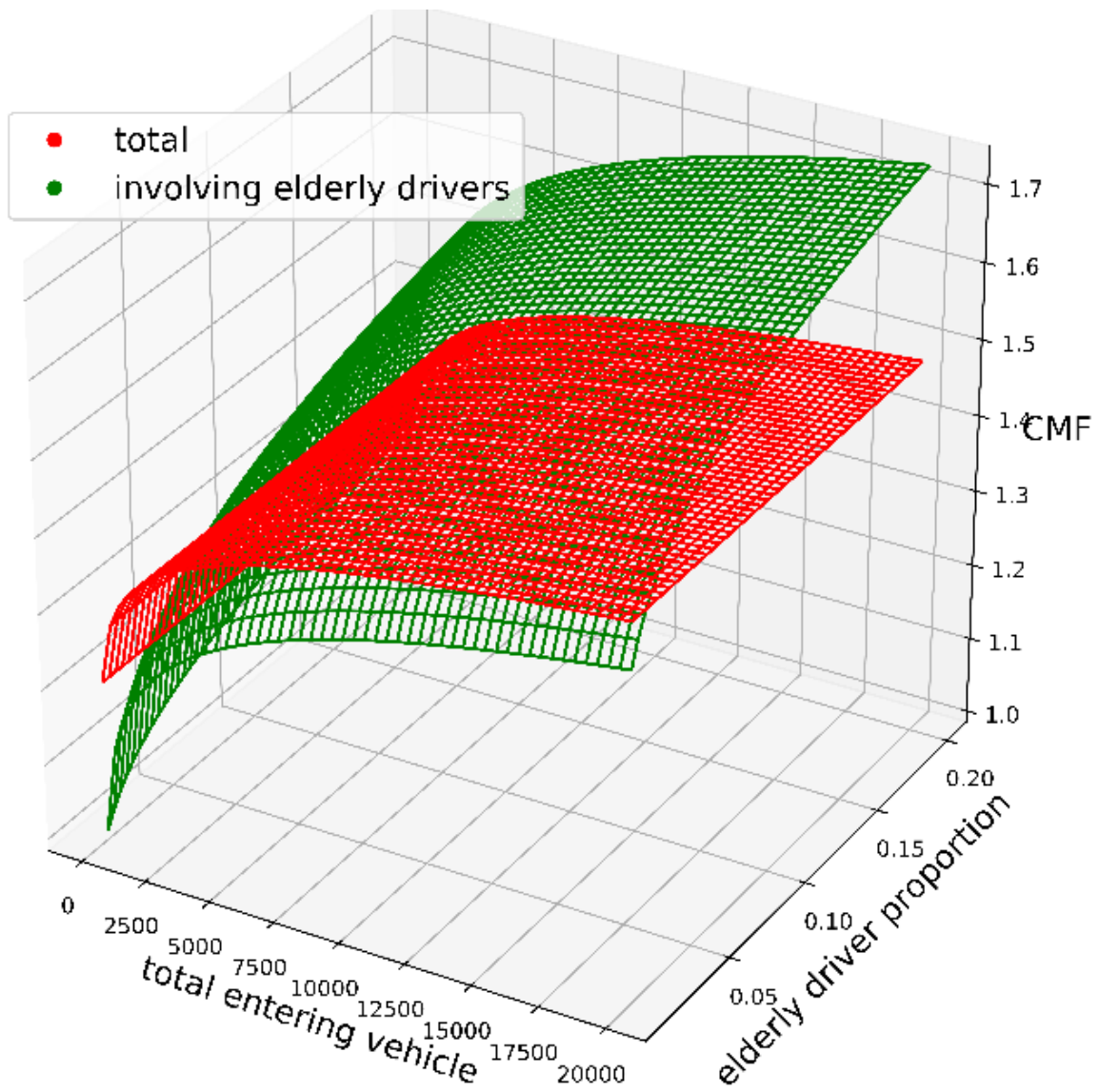


The signalization treatment would increase more crashes involving elderly drivers than crashes without elderly drivers. This indicates that the elderly drivers are more vulnerable than the non-elderly drivers to the signalization treatment.

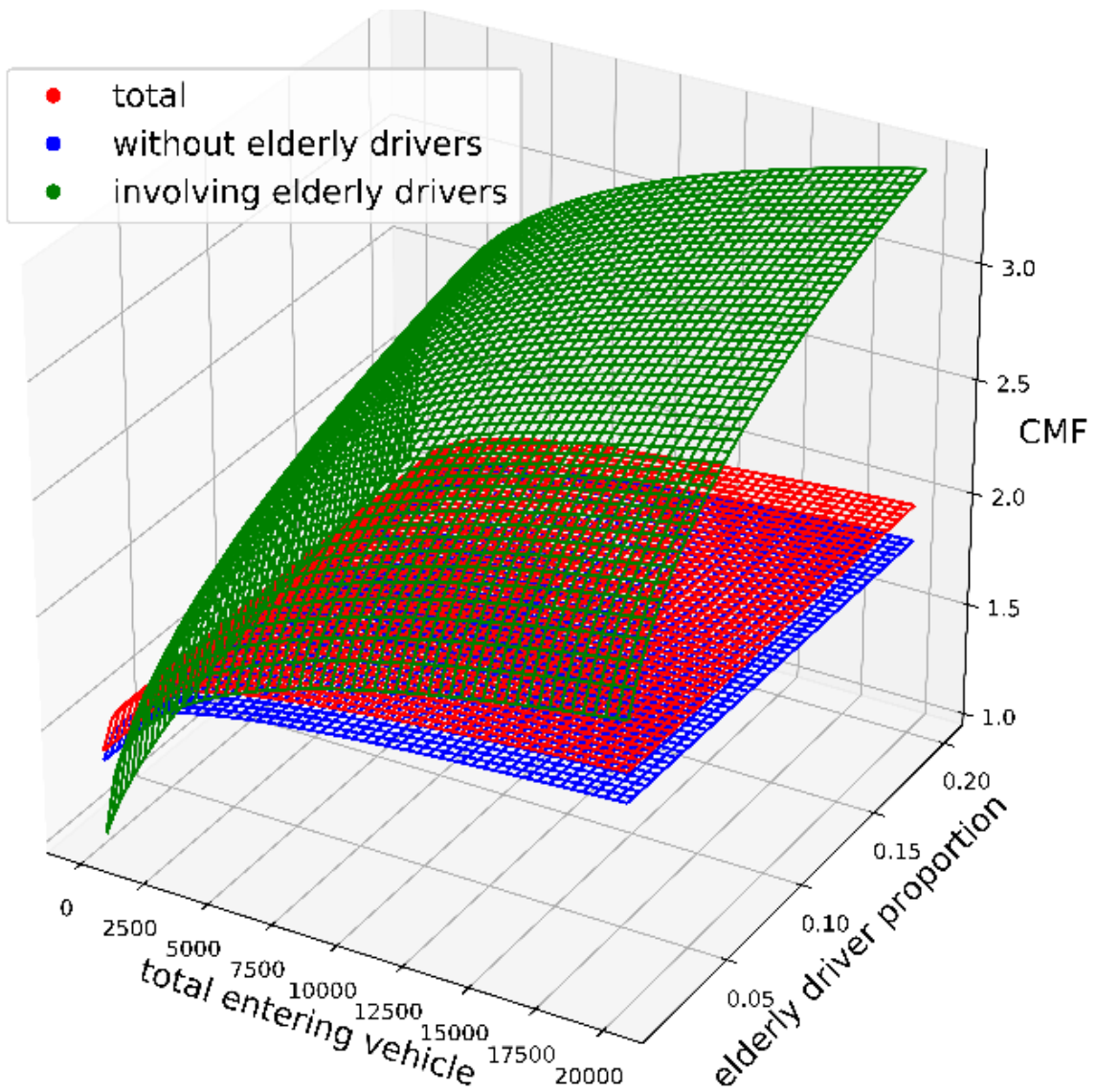
Figures 7-17 and 7-18 also show that the signalization effect on the total crashes varies between locations. In general, the signalization would increase more total crashes and crashes involving elderly drivers at the rural 4-leg all-way stop controlled intersections than at the rural 4-leg minor-road stop controlled intersections.

**Table 7-34: Crash modification function of signalization on total crashes at different rural intersections**

Intersection Type	Crash Type	Crash Modification Function
Rural 4-Leg Minor-Road Stop controlled Intersections	Total Crashes	$\exp(0.0397 \cdot \ln TEV)$
	Crashes without Elderly Drivers	N/A
	Crashes Involving Elderly Drivers	$\exp(0.0663 \cdot \ln(TEV \cdot \text{elderly driver proportion}))$
Rural 4-Leg All-way Stop controlled Intersections	Total Crashes	$\exp(0.0690 \cdot \ln TEV)$
	Crashes without Elderly Drivers	$\exp(0.0620 \cdot \ln(TEV \cdot (1 - \text{elderly driver proportion})))$
	Crashes Involving Elderly Drivers	$\exp(0.1487 \cdot \ln(TEV \cdot \text{elderly driver proportion}))$
Rural 3-Leg Minor-Road Stop controlled Intersections	Total Crashes	N/A
	Crashes without Elderly Drivers	
	Crashes Involving Elderly Drivers	



**Figure 7-17: Rural 4-leg intersections: signaled vs. minor-road stop-controlled (total crashes)**



**Figure 7-18: Rural 4-leg intersections: signaled vs. all-way stop-controlled (total crashes)**

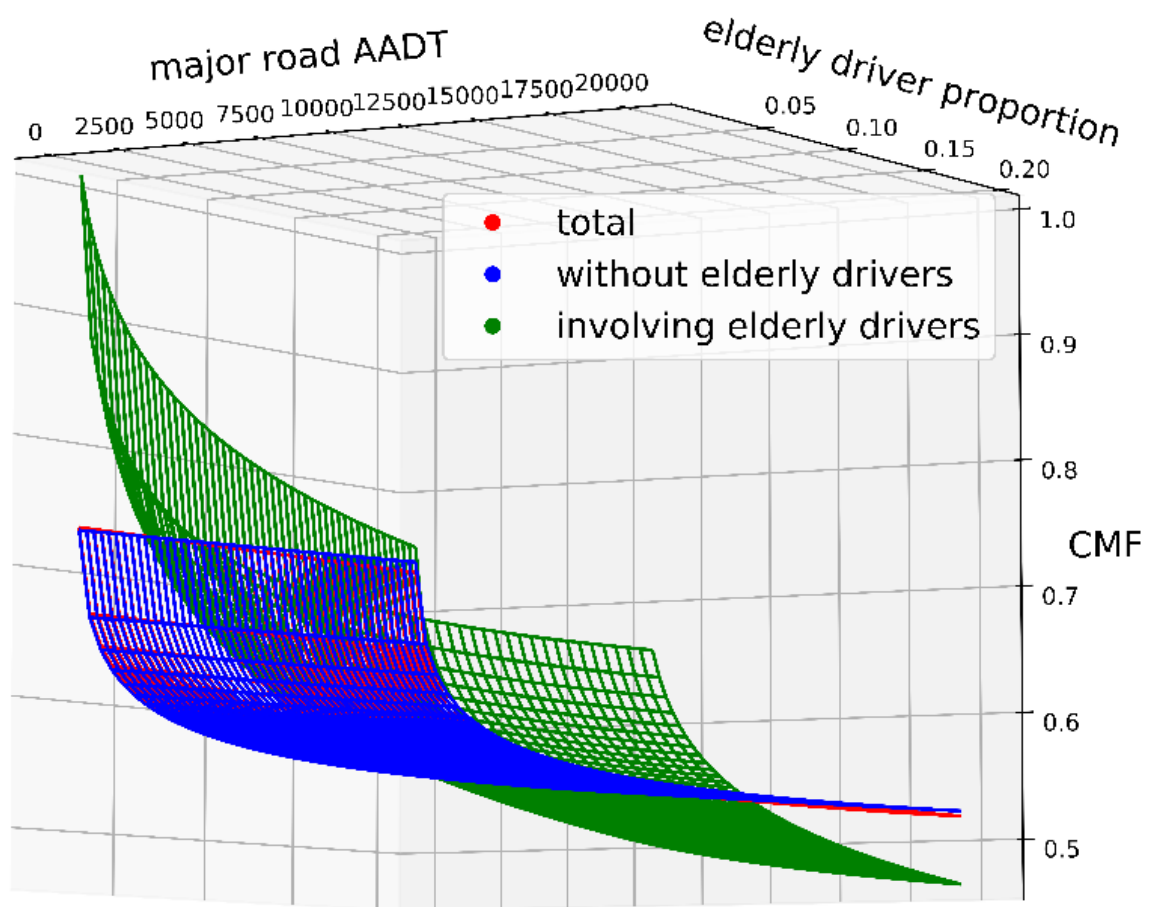
#### (4) KAB crashes

Table 7-35 shows the crash modification function for the KAB crashes obtained from Table 7-29. At the rural 4-leg minor-road stop controlled intersections, the crash modification function of the total KAB crashes is affected by the major road AADT at an intersection. The crash modification functions of the KAB crashes with/without elderly drivers are affected by the major road AADT and the elderly driver proportion. At the other types of the stop controlled intersections, the crash modification function of the angle crashes is not available due to the insignificance of the signalization treatment variable in the SPF.

Figure 7-19 shows that, the signalization would decrease the KAB crashes at the rural 4-leg minor-road stop controlled intersections. In particular, when the major road AADT is low, the signalization treatment would decrease more KAB crashes for the non-elderly drivers than the elderly drivers, while when the major road AADT is high, more crashes involving elderly drivers than the crashes without the elderly drivers would be avoided.

**Table 7-35: Crash modification function of signalization on KAB Crashes at different rural intersections**

Intersection Type	Crash Type	Crash Modification Function
Rural 4-Leg Minor-Road Stop controlled Intersections	Total Crashes	$\exp(-0.0685 \cdot \ln(\text{major\_road\_AADT}))$
	Crashes without Elderly Drivers	$\exp(-0.0693 \cdot \ln(\ln(\text{major\_road\_AADT} \cdot (1 - \text{elderly driver proportion}))))$
	Crashes Involving Elderly Drivers	$\exp(-0.0959 \cdot \ln(\ln(\text{major\_road\_AADT} \cdot \text{elderly driver proportion})))$
Rural 4-Leg All-way Stop controlled Intersections	Total Crashes	N/A
	Crashes without Elderly Drivers	
	Crashes Involving Elderly Drivers	
Rural 3-Leg Minor-Road Stop controlled Intersections	Total Crashes	N/A
	Crashes without Elderly Drivers	
	Crashes Involving Elderly Drivers	



**Figure 7-19: Rural 4-leg intersections: signaled vs. minor-road stop-controlled (KAB crashes)**

#### (5) PDO crashes

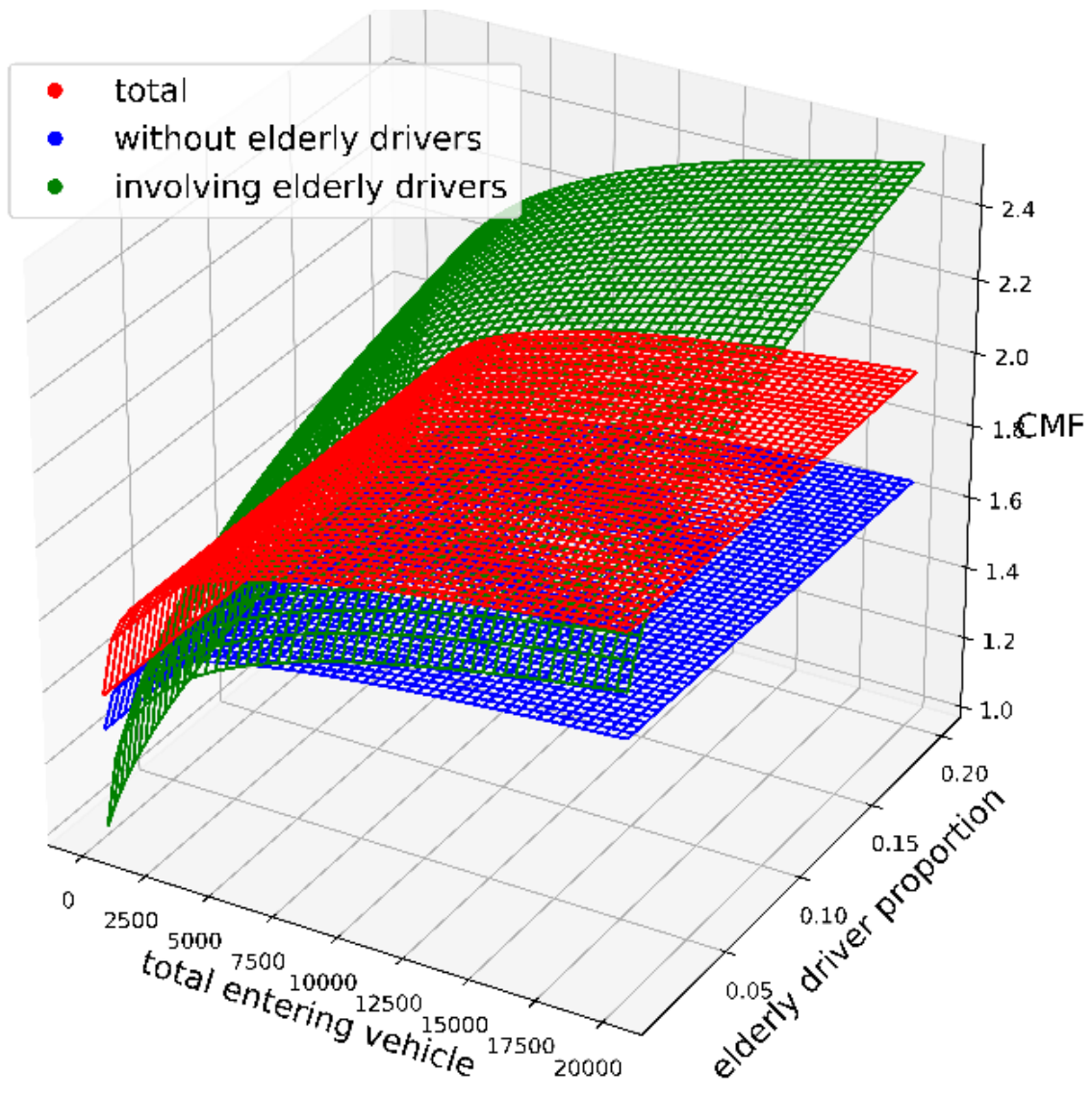
Table 7-36 shows the crash modification function for the PDO crashes obtained from Table 7-30. At the rural 4-leg minor-road stop controlled intersections, the crash modification function of the total PDO crashes is affected by the total entering vehicle (TEV) at an intersection, while the crash modification functions of the PDO crashes with/without elderly drivers are affected by the total entering vehicle (TEV) and the elderly driver proportion. At the rural 3-leg minor-road stop controlled intersections, the crash modification function of the total PDO crashes is affected by the total entering vehicle (TEV) at an intersection. At the other types of the stop controlled intersections, the crash modification function of the angle crashes is not available due to the insignificance of the signalization treatment variable in the SPF.

Figures 7-20 and 7-21 shows that, the signalization treatment would increase the PDO crashes at the rural 4-leg minor-road stop controlled intersections and the rural 3-leg minor-road stop controlled intersections. In particular, at the rural 4-leg minor-road stop controlled intersections, the signalization treatment would increase more PDO crashes involving elderly drivers than PDO crashes without elderly drivers especially at those intersections which have a relatively high elderly driver proportion and the total entering vehicle. The higher the elderly driver proportion and the larger the total entering vehicle, the larger the CMF for the PDO crash. This indicates that the increase of the elderly driver proportion and the total entering vehicle would cause more PDO crashes.

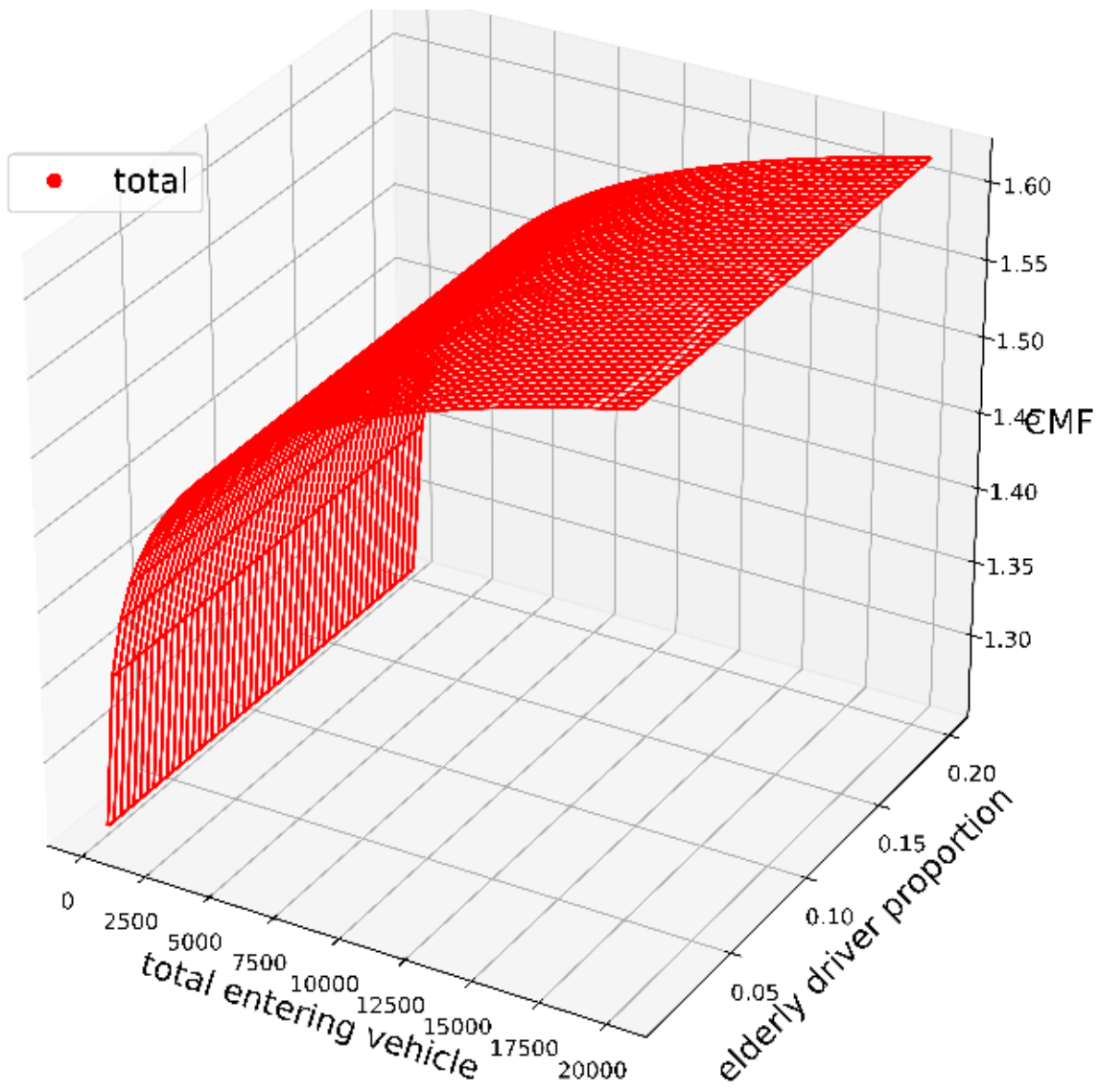
**Table 7-36: Crash modification function of signalization on PDO crashes at different rural intersections**

Intersection Type	Crash Type	Crash Modification Function
Rural 4-Leg Minor-Road Stop controlled Intersections	Total Crashes	$\exp(0.0684 * \ln TEV)$
	Crashes without Elderly Drivers	$\exp(0.0527 * \ln(TEV * (1 - \text{elderly driver proportion})))$
	Crashes Involving Elderly Drivers	$\exp(0.1119 * \ln(TEV * \text{elderly driver proportion}))$
Rural 4-Leg All-way Stop controlled Intersections	Total Crashes	N/A
	Crashes without Elderly Drivers	
	Crashes Involving Elderly Drivers	
Rural 3-Leg Minor-Road Stop controlled Intersections	Total Crashes	$\exp(0.0487 * \ln TEV)$
	Crashes without Elderly Drivers	N/A
	Crashes Involving Elderly Drivers	





**Figure 7-20: Rural 4-leg intersections: signaled vs. minor-road stop-controlled (PDO crashes)**



**Figure 7-21: Rural 3-leg intersections: signaled vs. minor-road stop-controlled (PDO-Total)**

## Summary

The effects of the signalization on the rear-end crashes at the rural areas could be summarized as follows:

- (1) The signalization would increase the rear-end crashes at rural intersections. In particular, the signalization would increase more rear-end crashes involving elderly drivers than rear-end crashes not involving elderly drivers especially at those intersections which have a relatively high elderly driver proportion and total entering vehicles.
- (2) In general, the signalization would increase more total rear end crashes at the rural 4-leg minor-road stop-controlled intersections, then followed by the rural 4-leg all-way stop-controlled intersections, and then followed by rural 3-leg minor road stop-controlled intersections.
- (3) In general, the signalization would increase more elderly-driver-involved rear-end crashes at the rural 4-leg all-way stop-controlled intersections, then followed by the rural 4-leg minor-road stop-controlled intersections, and then followed by rural 3-leg minor road stop-controlled intersections.
- (4) The signalization would increase severe rear end crashes (i.e. rear end-KAB crashes) at rural 4-leg stop controlled intersections.

The effects of the signalization on the angle crashes at the rural areas would be summarized as the following:

- (1) The signalization would decrease the total angle crashes and the angle crashes without elderly drivers at rural 4-leg minor-road stop controlled intersections, in particular, the

signalization would decrease more angle crashes at those intersections which have a large total entering vehicle and a small elderly driver proportion

The effects of the signalization on the total crashes at the rural areas could be summarized as the following:

- (1) The signalization treatment would increase the total crashes at the rural 4-leg stop controlled intersections.
- (2) The signalization treatment would increase more crashes involving elderly drivers than crashes without elderly drivers.
- (3) In general, the signalization would increase more total crashes and crashes involving elderly drivers at the rural 4-leg all-way stop controlled intersections than at the rural 4-leg minor-road stop controlled intersections.

The effects of the signalization on the KAB crashes at the rural areas would be summarized as the following:

- (1) The signalization would decrease the KAB crashes at the rural 4-leg minor-road stop controlled intersections. Particularly when the major road AADT is low, the signalization treatment would decrease more KAB crashes for the non-elderly drivers than the elderly drivers, while when the major road AADT is high or the proportion of the elderly driver is high, more KAB crashes involving elderly drivers than the crashes without the elderly drivers would be avoided.

The effects of the signalization on the PDO crashes at the rural areas would be summarized as the following:

- (1) The signalization treatment would increase the PDO crashes at the rural 4-leg minor-road stop controlled intersections and the rural 3-leg minor-road stop controlled intersections. In particular, at the rural 4-leg minor-road stop controlled intersections, the signalization treatment would increase more PDO crashes involving elderly drivers than PDO crashes without elderly drivers especially at those intersections which have a relatively high elderly driver proportion and the total entering vehicle.

The policy implications for the signalization from the findings are concluded as the following:

- (1) The signalization is recommended for the rural 4-leg minor-road stop-controlled intersections. Although the signalization treatment increases the crash frequency at the rural 4-leg minor-road stop-controlled intersections, the crash severity is reduced. In particular, the signalization treatment is strongly recommended for those rural 4-leg minor-road stop-controlled intersections which have a large major road AADT or a large proportion of elderly drivers. The signalization treatment could significantly decrease the crash severity for elderly drivers at those intersections. However, at the rural 4-leg minor-road stop-controlled intersections, other supplemental countermeasures other than the signalization treatment should also be considered. The signalization increases the PDO crashes and the rear-end crashes (especially the rear end-KAB crashes). In order to reduce these crashes, the countermeasures include but are not limited to lowering posted speed limits and additional signs to reduce the risk of failure to comply.
- (2) The signalization should be carefully implemented for the rural 4-leg all-way stop-controlled intersections. The signalization treatment increases the total crash frequency at the rural 4-leg all-way stop-controlled intersections. It also increases more rear end crashes

especially more rear end-KAB crashes. However, there is no solid evidence about the effect of the signalization treatment on the total crash severity at those intersections.

## **7.7. COMPARISON BETWEEN RURAL AND URBAN AREAS**

### **Rear-end Crashes**

The signalization treatment would increase the rear end crashes. Also, the signalization would increase more rear-end crashes of the elderly drivers than to the non-elderly drivers. This may be due to the reason that the elderly drivers are more vulnerable than the non-elderly drivers because their perception and reaction time is usually longer. This phenomenon is observed at both the rural and urban intersections. In addition, the signalization would increase not only the frequency of the rear end crashes but also the crash severity of the rear end crashes at both the rural and urban 4-leg stop controlled intersections.

However, considering the intersection types in detail, more variation of the signalization effect on the rear-end crashes are observed between the rural and urban intersections.

For the urban intersections, the signalization would increase rear end crashes at the urban 3-leg intersections than at the urban 4-leg intersections. While for the rural intersections, in general, the signalization would increase more rear end crashes at the rural 4-leg minor-road stop controlled intersections, then followed by the rural 4-leg all-way stop-controlled intersections, and then followed by the rural 3-leg minor road stop-controlled intersections. In addition, the signalization treatment would increase more elderly-driver-involved rear-end crashes at the urban 3-leg intersections than at the urban 4-leg intersections. While at the rural areas, in general, the signalization would increase more elderly-driver-involved rear-end crashes at the rural 4-leg all-way stop controlled intersections, followed by the rural 4-leg minor-road stop controlled intersections, and then followed by the rural 3-leg minor road stop controlled intersections.

Besides, at the urban 3-leg stop controlled intersections the signalization would increase the frequency of the rear end crashes, while it would not increase the crash severity of the rear end crashes. For rural stop controlled intersections, no evidence supports such findings.

### **Angle crashes**

The signalization treatment would decrease the angle crashes. This phenomenon is observed both at the rural intersections and at the urban intersections.

However, some variations of the signalization effect on the angle crashes are also observed between the rural intersections and the urban intersections. The signalization treatment would decrease more angle crashes (the total angle crashes & the angle crash without elderly drivers) at the urban 4-leg intersections than at the urban 3-leg intersections. In addition, the signalization would decrease more of the angle crashes for elderly drivers than for the non-elderly drivers at the urban 4-leg intersections. While for rural intersections, the data only shows the evidence that the signalization would decrease the total angle crashes and the angle crashes without elderly drivers at rural 4-leg minor-road stop controlled intersections.

### **Total crashes**

The signalization treatment has various effect on the total crashes between rural intersections and urban intersections.



For urban intersections, the signalization treatment would increase the total crash, particularly the crashes involving elderly drivers, at the urban 3-leg intersections, while it will decrease the total crash, particular the crashes involving elderly drivers, at the urban 4-leg intersection.

For rural intersections, the signalization treatment would increase the total crashes at the rural 4-leg intersections. In addition, the signalization would increase more total crashes and crashes involving elderly drivers at the rural 4-leg all-way stop controlled intersections than at the rural 4-leg minor-road stop controlled intersections. The effect of the signalization treatment at the rural 3-leg intersections are unclear based on the data in this study.

### **KAB crashes**

The signalization treatment would decrease the KAB crashes. This phenomenon is observed both at the rural intersections and at the urban intersections.

The signalization treatment would decrease the KAB crashes at the urban 4-leg intersections, particularly for the elderly drivers.

For rural intersections, the signalization treatment would decrease the KAB crashes at the rural 4-leg minor-road stop controlled intersections. In particular, the signalization treatment would decrease more KAB crashes for the non-elderly drivers than the elderly drivers when the major road's AADT is low, while when the major road AADT is high, more crashes involving elderly drivers than the crashes without the elderly drivers would be reduced.

## **PDO crashes**

The signalization treatment would increase the PDO crashes. This phenomenon is observed both at the rural intersections and at the urban intersections.

For urban 3-leg intersections, the signalization treatment would cause more PDO crashes to the elderly drivers than to the non-elderly drivers.

For rural intersections, at the rural 4-leg minor-road stop controlled intersections, the signalization treatment would increase more PDO crashes involving elderly drivers than PDO crashes without elderly drivers especially at those intersections which have a relatively high elderly driver proportion and the total entering vehicles.

## **7.8. SUMMARY AND CONCLUSIONS**

In urban areas, signalization would increase the rear end crashes, especially more rear-end crashes to the elderly drivers than to the non-elderly drivers. In addition, signalization would increase not only the frequency of the rear end crashes but also the crash severity of the rear end crashes at urban 4-leg stop controlled intersections. The signalization treatment would increase the total crashes, particularly crashes involving elderly drivers, at urban 3-leg intersections. After signalization, the PDO crashes would also increase at the urban 3-leg intersections, especially for the elderly drivers. Although the crash frequency for the rear end crashes, the total crashes and the PDO crashes would increase after the signalization treatment, the crash severity would decrease due to the decrease of the angle and the KAB crashes. Signalization would decrease the angle crashes at the urban intersections. Moreover, the signalization treatment would decrease more angle crashes of the elderly drivers than to the non-elderly drivers at the urban 4-leg intersections. Signalization would decrease the total KAB crashes at the urban 4-leg intersections, particularly for elderly drivers.

At the rural areas, similar results are found. The signalization would increase the rear end crashes, particularly for the elderly drivers at those intersections, which have a relatively high elderly driver proportion and total entering vehicles. Signalization would increase not only the frequency of the rear end crashes but also the crash severity of the rear end crashes at rural 4-leg stop controlled intersections. After signalization, the total crashes would increase at the rural 4-leg stop-controlled intersections, especially for the elderly drivers. The PDO crashes would also increase at the rural 4-leg minor-road stop-controlled intersections and the rural 3-leg minor-road stop-controlled intersections. Although the crash frequency for the rear end, total and the PDO crashes would increase after signalization, the crash severity levels would decrease. The signalization would

decrease the total angle crashes and the angle crashes without elderly drivers at rural 4-leg minor-road stop controlled intersections. The signalization would also decrease the KAB crashes at the rural 4-leg minor-road stop controlled intersections. In particular, when the major road's AADT is high, the signalization would be useful for elderly drivers since it could reduce more crashes involving elderly drivers than the crashes not involving elderly drivers.

In summary, the signalization treatment is recommended at the urban 4-leg intersections. It could reduce the total crash frequency as well as reduce the crash severity. In particular, the signalization treatment is especially recommended for those urban 4-leg intersections which have a large proportion of elderly drivers. The signalization treatment could significantly decrease the crash frequency and the crash severity for elderly drivers. Signalization should carefully be implemented at urban 3-leg intersections and at the urban 3-leg intersections which have a large proportion of elderly drivers. The signalization treatment increases the crash frequency at the urban 3-leg intersections, however, there is no solid evidence about the effect of the signalization treatment on the crash severity at those intersections.

Furthermore, signalization is recommended at rural 4-leg minor-road stop-controlled intersections. The signalization treatment decreases the crash severity at those intersections. In particular, the signalization treatment is very useful for those rural 4-leg minor-road stop-controlled intersections which have a large major road AADT or a large proportion of elderly drivers. The signalization treatment could significantly decrease the crash severity for elderly drivers at those intersections. However, at the rural 4-leg minor-road stop-controlled intersections, other supplemental countermeasures other than the signalization should also be considered. In order to reduce PDO and rear-end crashes, the countermeasures include but are not limited to lower posted speed limits, beacons and redundant signs to reduce the risk of failure to react or comply. Signalization should

be carefully adopted at rural 4-leg all-way stop-controlled intersections. The signalization treatment increases the crash frequency at the rural 4-leg all-way stop-controlled intersections, however, there is no solid evidence about the effect of the signalization treatment on the crash severity at those intersections.

## **8. HOTSPOT INTERSECTION IDENTIFICATION AND RECOMMENDATIONS**

### **8.1. METHODOLOGIES**

To achieve the objective of this task, hot intersections which have higher crash risk than expected were first identified by using “Excess Expected Average Crash Frequency with EB Adjustments” method which is stated in Highway Safety Manual (AASHTO, 2010). This method was selected because it accounts for the regression to mean bias and provides a performance threshold to detect the intersections that have crash frequencies higher than predicted. Steps of this method are summarized in the following nine steps.

- 1) Calculating the predicted average crash frequency from a safety performance function (SPF).
- 2) Calculating annual correction factor
- 3) Calculating weighted adjustments
- 4) Calculating first year EB-adjusted expected average crash frequency
- 5) Calculating final year EB-adjusted expected average crash frequency
- 6) Calculating the excess expected average crash frequency
- 7) Calculating the average excess expected average crash frequency
- 8) Calculating Severity Weighted Excess
- 9) Ranking the intersections based on the excess expected average crash frequency

These steps are explained in detail in the following:

**1) Calculating the predicted average crash frequency from a safety performance function (SPF):**

Safety performance functions were developed by using crash data of Florida 4-leg signalized intersections for the recent five years (2014-2018). Different SPFs were developed for each crash severity by using the negative binomial model. The developed SPF has the following form:

$$N_{\text{predicted}} = \exp (a + b * \ln (\text{AADT}_{\text{major}}) + c * \ln (\text{AADT}_{\text{minor}})) \quad (29)$$

where:

$N_{\text{predicted}}$ : predicted average crash frequency

$\text{AADT}_{\text{major}}$ : major annual average daily traffic

$\text{AADT}_{\text{minor}}$ : minor annual average daily traffic

Table 8-1 shows the parameters (a, b, and c) for each developed SPF. After developing the SPFs, the predicted average crash frequency for each intersection at year n was calculated using the major and minor AADT for the same year. The predicted average crash frequencies were only calculated for each year in the interval (2014-2017) since the AADT of year 2018 is not available.

**Table 8-1: SPFs for crash severity**

Variables	Fatal		Injury		PDO	
	Coef.	S.E.	Coef.	S.E.	Coef.	S.E.
Intercept	-11.742	0.598	-8.676	0.142	-9.276	0.141
Log (Minor AADT)	0.142	0.041	0.270	0.011	0.334	0.011
Log (Major AADT)	0.726	0.060	0.775	0.015	0.878	0.015
Dispersion	0.561	0.114	0.318	0.008	0.378	0.008

All coefficients are significant at 99% confidence level.

## 2) Calculating annual correction factor:

The annual correction factor ( $C_n$ ) is calculated by crash severity at each intersection for each year by dividing the predicted average crash frequency for year  $n$  by the predicted average crash frequency for year 1. This factor is proposed to consider the effect of traffic, weather and vehicle composition annual variations on crash occurrence. This factor is calculated for each crash severity by using the following equation:

$$C_n = \frac{N_{predicted,n}}{N_{predicted,1}} \quad (30)$$

Where:

$C_n$ : annual correction factor of specific crash severity.

$N_{predicted,n}$ : predicted number of crashes for year  $n$ .

## 3) Calculating weighted adjustments:

The weighted adjusted factor ( $w$ ) was calculated at each intersection for each crash severity. The weighted adjustment is considered as a measure for the reliability of the safety performance function. Safety performance function with low overdispersion parameter has higher reliability. It was calculated by using the following equation:

$$w = \frac{1}{1+k*\sum_{n=1}^N N_{predicted,n}} \quad (31)$$

Where:

$w$ : empirical bayes weight.



k: overdispersion parameter of the SPF.

$N_{predicted, n}$ : predicted average crash frequency from an SPF in year n.

#### 4) Calculating first year EB-adjusted expected average crash frequency:

This step combines the observed and predicted crash frequency. SPF with high reliability is more able to estimate the long-term predicted average crash frequency at the intersection. The EB-adjusted expected number of crashes by severity for the first year was calculated using the following equation:

$$N_{expected,1} = w * N_{predicted,1} + (1 - w) * \left( \frac{\sum_{n=1}^N N_{observed,n}}{\sum_{n=1}^N C_n} \right) \quad (32)$$

Where:

$N_{expected,1}$ : EB-adjusted estimated average crash frequency for year 1.

W: empirical Bayes weight.

$N_{predicted,1}$ : estimated average crash frequency for year 1 for the intersection.

$N_{observed,n}$ : observed crash frequency at the intersection at year n.

$C_n$ : annual correction factor for the intersection at year n.

#### 5) Calculating final year EB-adjusted expected average crash frequency:

The EB-adjusted expected number of crashes by severity for the final year was calculated using the following equation:

$$N_{\text{expected},n} = N_{\text{expected},1} \times C_n \quad (33)$$

Where:

$N_{\text{expected},n}$ : EB-adjusted expected average crash frequency for final year

$N_{\text{expected},1}$ : EB-adjusted expected average crash frequency for year 1

$C_n$ : Annual correction factor for year n

### **6) Calculating the excess expected average crash frequency:**

The excess expected average crash frequency, or potential for safety improvement (PSI), is the difference between the predicted estimates and EB-adjusted estimates at each intersection for each year. It was calculated for each crash severity by using the following equation:

$$\text{Excess}_n = N_{\text{expected},n} - N_{\text{predicted},n} \quad (34)$$

Where:

$\text{Excess}_n$ : excess expected crashes for year n

$N_{\text{expected},n}$ : EB-adjusted expected average crash frequency for year n

$N_{\text{predicted},n}$ : SPF predicted average crash frequency for year n

### **7) Calculating the average excess expected crash frequency:**

The average excess expected crash frequency ( $\text{Excess}_{\text{avg}}$ ) is the average of excesses for all years (4 years). It was calculated for each crash severity at each intersection.

## 8) Calculating Severity Weighted Excess:

Severity weighted excess was calculated at each intersection by the following equation:

$$\text{Excess}_{\text{sw}} = 542 * \text{Excess}_{\text{avg,F}} + 11 * \text{Excess}_{\text{avg,I}} + \text{Excess}_{\text{avg,PDO}} \quad (35)$$

Where:

$\text{Excess}_{\text{sw}}$ : severity weighted excess expected crashes.

$\text{Excess}_{\text{avg,F}}$ : average excess expected fatal crashes.

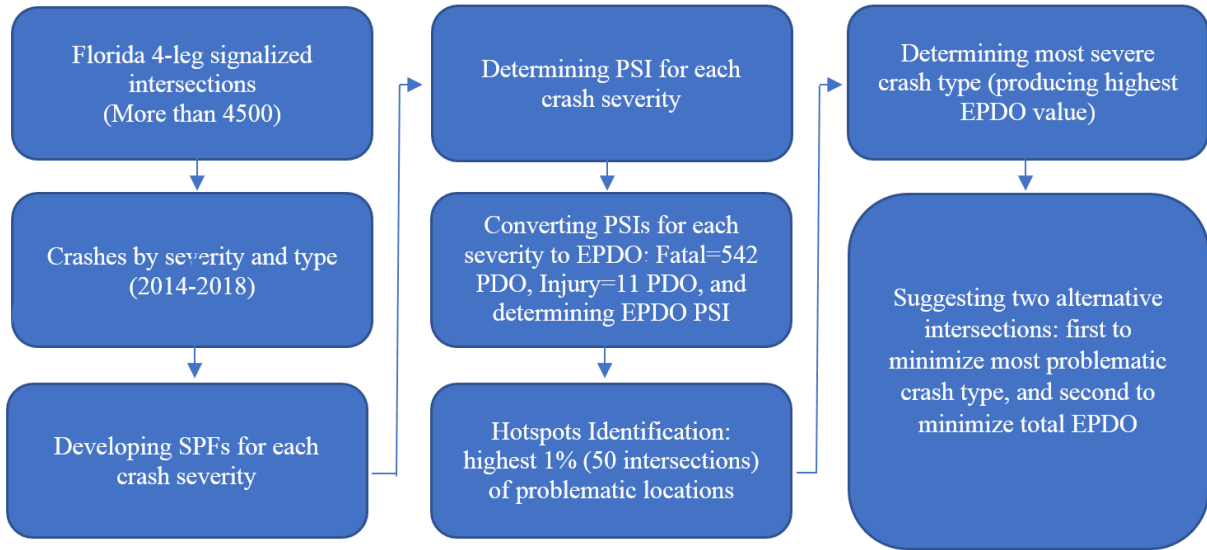
$\text{Excess}_{\text{avg,I}}$ : average excess expected injury crashes.

$\text{Excess}_{\text{avg,PDO}}$ : average excess expected PDO crashes.

## 9) Ranking the intersections based on the excess expected average crash frequency:

The last step is ranking the intersections based on the severity weighted excess expected average crash frequency. Intersections with higher 1% severity weighted excess (50 intersections) were selected to shed light on them in details.

Then, most problematic crash type was determined at each hot intersection. Crash type which caused higher equivalent property damage only (EPDO) value was considered as the most problematic type. Finally, two alternative intersections were suggested. The first one is the most effective intersection in reducing the problematic crash type, while the second one is the most effective in reducing EPDO value (to account for severity). Figure 8-1 shows a flowchart summarizing the utilized procedure.



**Figure 8-1: Procedure of suggesting alternative intersections**

## 8.2. RESULTS

Fifty intersections were identified as hotspots and further analyzed in this task. Most of the intersections are in the metropolitan areas. Figure 8-2 shows the locations of these fifty intersections.



**Figure 8-2: Locations of the fifty most dangerous intersections in Florida**

Table 8-2 summarizes the counties with top 1% hot intersections in Florida. Broward County has the largest number of hot intersections and Miami-Dade County follows. Both of the counties are located in the southeastern region of Florida. Orange County of Central Florida was ranked number 3 in terms of the number of hot intersections, Pasco and Pinellas Counties, which are located in West Florida, follows. Table 8-3 presents more details about the identified fifty hot intersections.

After Table 8-3, specific information for each hot intersection is provided. In the crash type distribution table, the following abbreviations were used: SV: single-vehicle, RE: rear-end HO: head-on, A: angle, SDSS: same direction sideswipe, ODSS: opposite direction sideswipe, RT: right-turn, LT: left-turn, NM: non-motorized.

**Table 8-2: List of counties by the number of identified top 1% hot intersections**

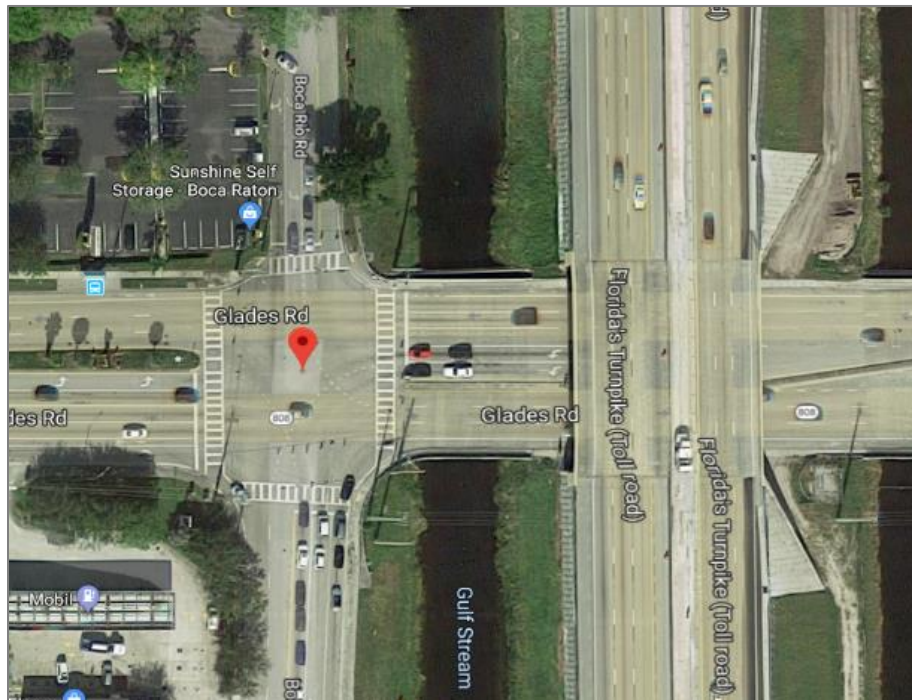
<b>County</b>	<b>Top 1% Hot Intersections</b>
Broward	11
Miami-Dade	9
Orange	7
Pasco	5
Pinellas	4
Duval	3
Escambia	3
Palm Beach	3
Hillsborough	2
Manatee	1
Santa Rosa	1
St Lucie	1

**Table 8-3: Characteristics of the most problematic intersections**

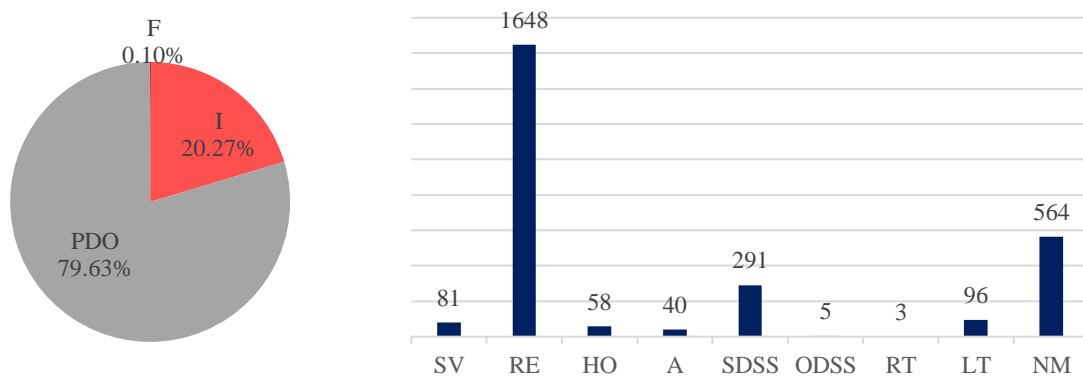
Rank	ID	Name	County	EPDO PSI	Most Severe Crash Type
1	2415	Glades Rd & Boca Rio Rd	Palm Beach	408.4	Rear-End
2	3334	NE 167th St & NE 6th Ave	Miami-Dade	361.7	Rear-End
3	569	14th St W & 53rd Ave W	Manatee	309.8	Left-Turn
4	947	Ridge Rd & Little Rd	Pasco	303.1	Rear-End
5	3426	W Oakland Park Blvd & N State Rd 7	Broward	263.6	Rear-End
6	914	Tampa Rd & Palm Harbor Blvd	Pinellas	254.0	Rear-End
7	3405	W Broward Blvd & N/S University Dr	Broward	250.0	Rear-End
8	4639	Mobile Hwy & Saufley Field Rd	Escambia	230.5	Rear-End
9	191	NW 31st Ave & NW 19th St	Broward	227.1	Rear-End
10	2286	S Dixie Hwy & SW 152nd St	Miami-Dade	219.5	Rear-End
11	3363	Pines Blvd & N/S University Dr	Broward	217.3	Rear-End
12	4626	Mobile Hwy & W Fairfield Dr	Escambia	215.8	Rear-End
13	4160	Silver Star Rd & N Powers Dr	Orange	213.9	Left-Turn
14	3364	Pines Blvd & N/SW 72nd Ave	Broward	212.1	Angle
15	4020	FL-54 & Land O' Lakes Blvd	Pasco	207.3	Rear-End
16	2762	US-19 & County Rd 52	Pasco	207.0	Rear-End
17	3312	NW 79th St & NW 27th Ave	Miami-Dade	206.2	Rear-End
18	3414	W Sunrise Blvd & NW 31st Ave	Broward	204.7	Rear-End
19	3360	Pines Blvd & N/S Flamingo Rd	Broward	199.4	Rear-End
20	3887	N Myrtle Ave & Drew St	Pinellas	199.2	Rear-End
21	454	Okeechobee Blvd & N Military Trl	Palm Beach	197.2	Rear-End
22	3869	Gulf to Bay Blvd & S Belcher Rd	Pinellas	196.1	Left-Turn
23	4398	FL-134 & Firestone Rd	Duval	195.9	Rear-End
24	2296	US-41 & SW 122nd Ave	Miami-Dade	187.9	Rear-End
25	1037	Lake Underhill Rd & Dean Road	Orange	187.1	Left-Turn
26	4078	Conroy Rd & S Kirkman Rd	Orange	184.9	Rear-End
27	219	Commercial Blvd & N University Dr	Broward	184.7	Rear-End
28	3337	NW 186th St & NW 67th Ave	Broward	183.4	Rear-End
29	4024	US-19 & Moog Rd	Pasco	180.8	Rear-End
30	2371	W Oakland Park Blvd & NW 56th Ave	Broward	180.7	Rear-End
31	3947	W Waters Ave & Hanley Rd	Hillsborough	180.0	Rear-End
32	13	NW 7th Ave & NW 103rd St	Miami-Dade	179.9	Non-Motorized
33	4023	SR 54 & Little Rd	Pasco	173.1	Rear-End
34	3336	NW 27 <sup>th</sup> Ave & Miami Gardens Dr	Miami-Dade	172.1	Rear-End
35	3794	Seminole Blvd & Ulmerton Rd	Pinellas	170.8	Rear-End
36	4676	US-90 & Chumuckla Hwy	Santa Rosa	169.0	Left-Turn
37	2523	SR 716 & S Bayshore Blvd	St Lucie	164.9	Rear-End
38	3280	SW 107 <sup>th</sup> Ave & SW 8 <sup>th</sup> St	Miami-Dade	163.2	Rear-End
39	4149	E Colonial Dr & N Goldenrod Rd	Orange	163.1	Rear-End
40	2285	S Dixie Hwy & SW 184 <sup>th</sup> St	Miami-Dade	162.6	Single-Vehicle
41	4158	Silver Star Rd & N Hiawassee Rd	Orange	162.1	Non-Motorized
42	3534	Lake Worth Rd & Jog Rd	Palm Beach	160.9	Rear-End
43	87	Biscayne Blvd & NE 163 <sup>rd</sup> St	Miami-Dade	159.7	Rear-End
44	4397	SR 134 & Ricker Rd	Duval	158.7	Rear-End
45	4449	Beach Blvd & University Blvd S	Duval	157.2	Rear-End
46	3817	SR 60 & N Parsons Ave	Hillsborough	157.0	Rear-End
47	4672	W 9 Mile Rd & Pine Forest Rd	Escambia	156.6	Rear-End
48	987	Turkey Lake Rd & W Sand Lake Rd	Orange	155.9	Rear-End
49	2799	US-441 & W Oak Ridge Rd	Orange	155.0	Rear-End
50	1434	Pines Blvd & SW 145th Ave	Broward	153.0	Rear-End

**Intersection 1: Glades Rd & Boca Rio Rd**

- County: Palm Beach
- Major AADT: 52,125 / Minor AADT: 16,150
- EPDO PSI: 408.4
- Most Severe Crash Type: Rear-End
- Suggestions:
  - 1) MUT Type B to minimize rear-end crashes (CMF for rear-end is 0.49): rear-end crashes would be expected to be reduced by 51% and total EPDO reduced by 45%.
  - 2) RCUT to minimize total EPDO (CMF for FI is 0.57 and CMF for PDO is 0.84): total EPDO would be reduced by 56% and rear-end crashes reduced by 25%.



**Figure 8-3: Satellite image of intersection 1**

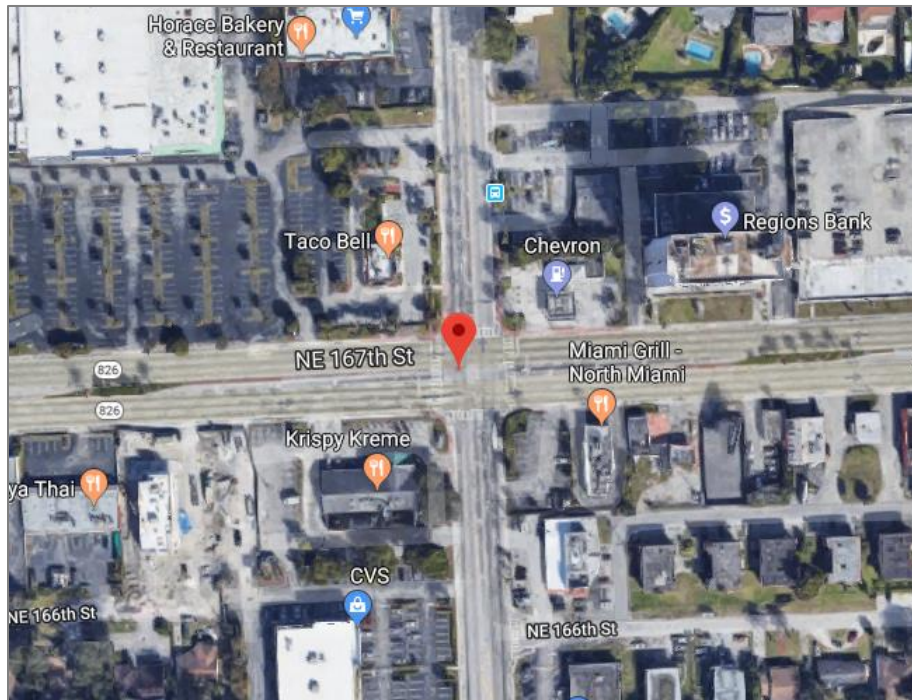


**Figure 8-4: Crash distribution by severity and EPDO distribution by crash type for intersection 1**

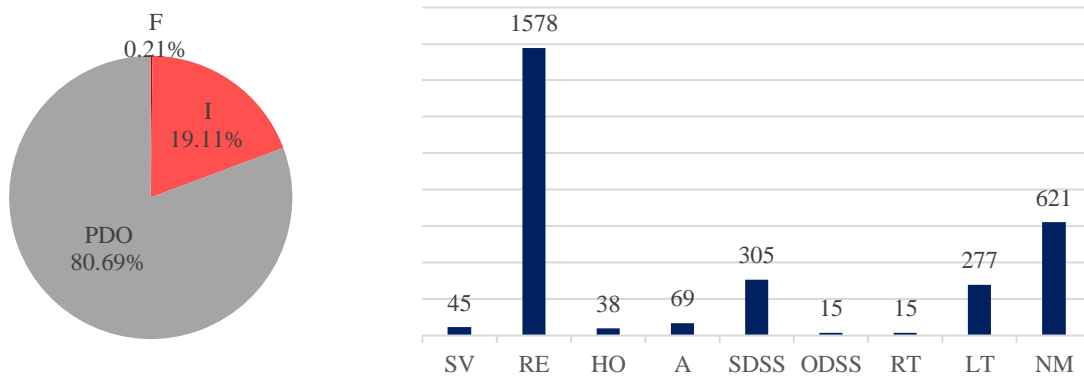


**Intersection 2: NE 167th St & NE 6th Ave**

- County: Miami-Dade
- Major AADT: 64,875 / Minor AADT: 26,375
- EPDO PSI: 361.7
- Most Severe Crash Type: Rear-End
- Suggestions:
  - 1) MUT Type B to minimize rear-end crashes (CMF for rear-end is 0.49): rear-end crashes reduced by 51% and total EPDO reduced by 38%.
  - 2) RCUT to minimize total EPDO (CMF for FI is 0.57 and CMF for PDO is 0.84): total EPDO reduced by 48% and rear-end crashes reduced by 25%.



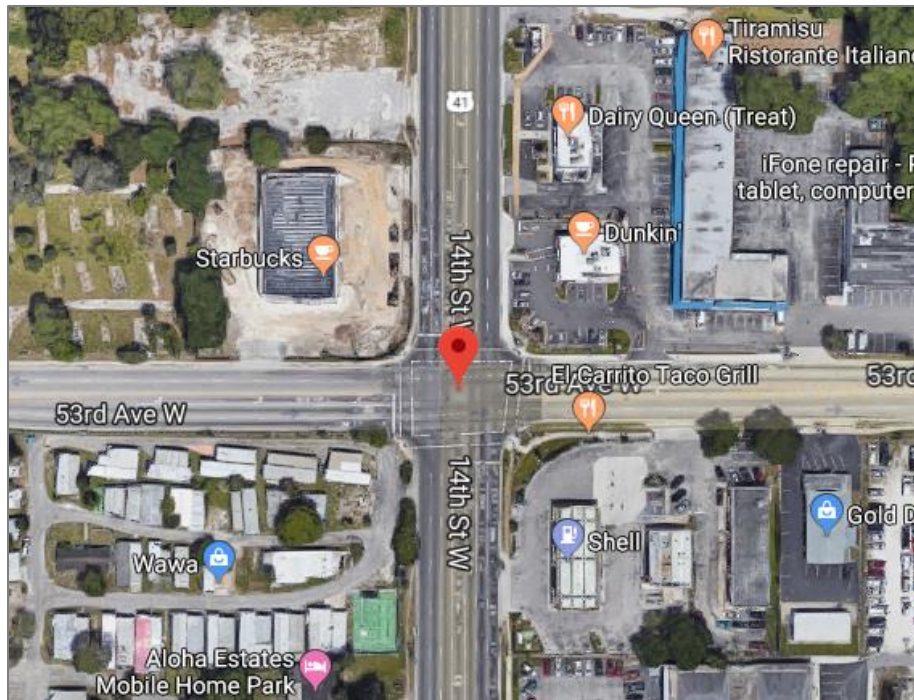
**Figure 8-5: Satellite image of intersection 2**



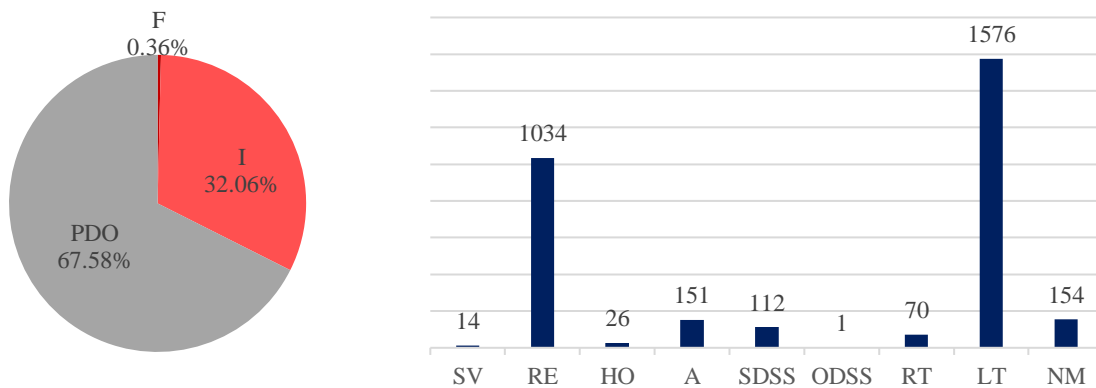
**Figure 8-6: Crash distribution by severity and EPDO distribution by crash type for intersection 2**

**Intersection 3: 14th St W & 53rd Ave W**

- County: Manatee
- Major AADT: 17,575 / Minor AADT: 16,050
- EPDO PSI: 309.8
- Most Severe Crash Type: Left-Turn
- Suggestions:
  - 1) Jughandle Type 1 to minimize rear-end crashes (CMF for left-turn is 0.19): left-turn crashes reduced by 81% and total EPDO reduced by 20%.
  - 2) RCUT to minimize total EPDO (CMF for FI is 0.57 and CMF for PDO is 0.84): total EPDO reduced by 50% and left-turn crashes reduced by 41%.



**Figure 8-7: Satellite image of intersection 3**



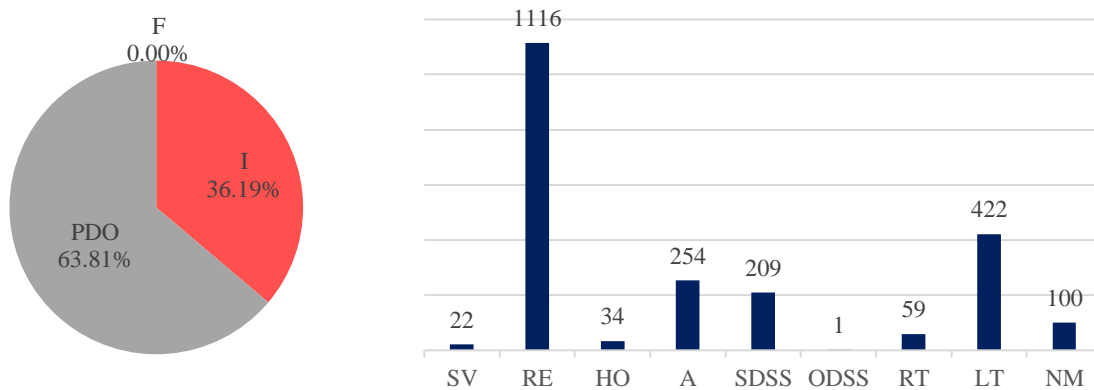
**Figure 8-8: Crash distribution by severity and EPDO distribution by crash type for intersection 3**

**Intersection 4: Ridge Rd & Little Rd**

- County: Pasco
- Major AADT: 50,250 / Minor AADT: 13,675
- EPDO PSI: 303.1
- Most Severe Crash Type: Rear-End
- Suggestions:
  - 1) MUT Type B to minimize rear-end crashes (CMF for rear-end is 0.49): rear-end crashes reduced by 51% and total EPDO reduced by 55%.
  - 2) RCUT to minimize total EPDO (CMF for FI is 0.57 and CMF for PDO is 0.84): total EPDO reduced by 75% and rear-end crashes reduced by 25%.



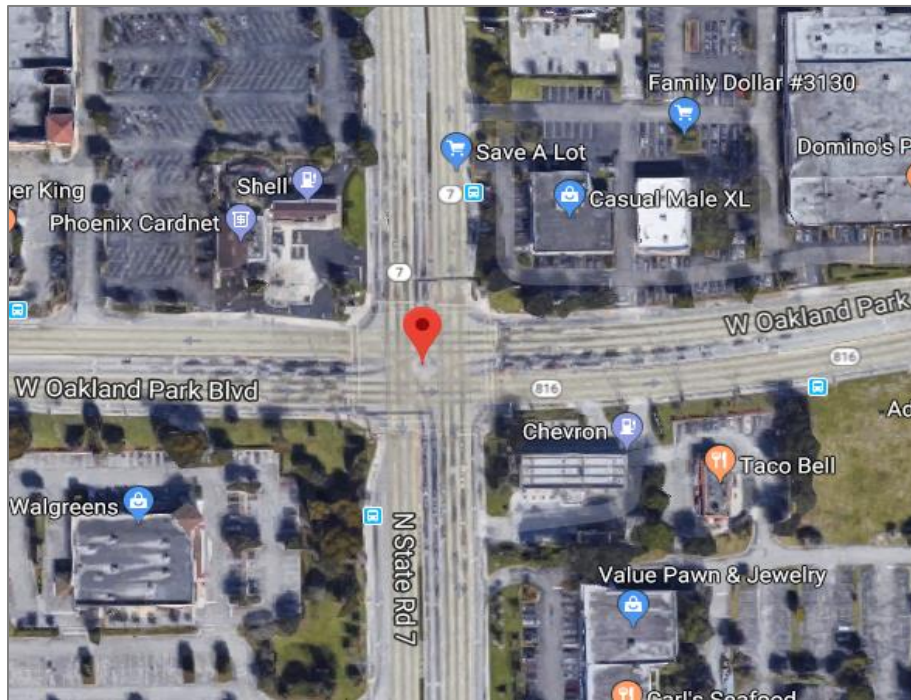
**Figure 8-9: Satellite image of intersection 4**



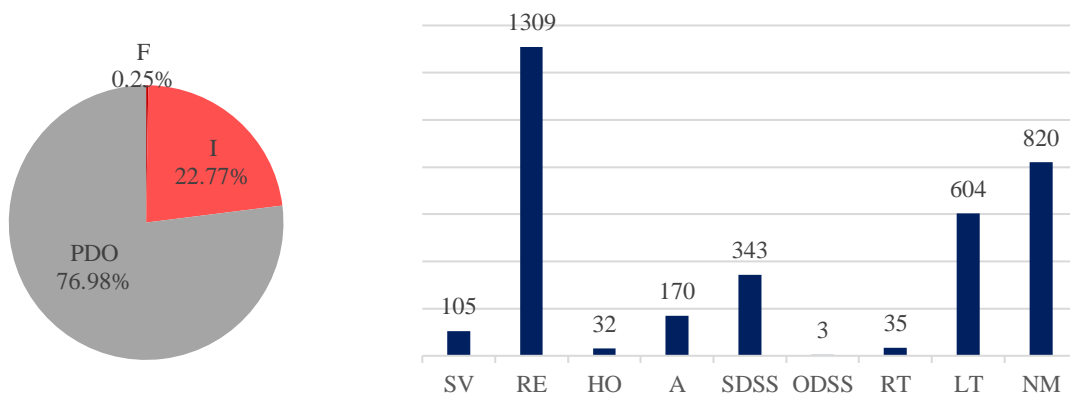
**Figure 8-10: Crash distribution by severity and EPDO distribution by crash type for intersection 4**

**Intersection 5: W Oakland Park Blvd & N State Rd 7**

- County: Broward
- Major AADT: 60,000 / Minor AADT: 49,875
- EPDO PSI: 263.6
- Most Severe Crash Type: Rear-End
- Suggestions:
  - 1) MUT Type B to minimize rear-end crashes (CMF for rear-end is 0.49): rear-end crashes reduced by 51% and total EPDO reduced by 38%.
  - 2) RCUT to minimize total EPDO (CMF for FI is 0.57 and CMF for PDO is 0.84): total EPDO reduced by 49% and rear-end crashes reduced by 25%.



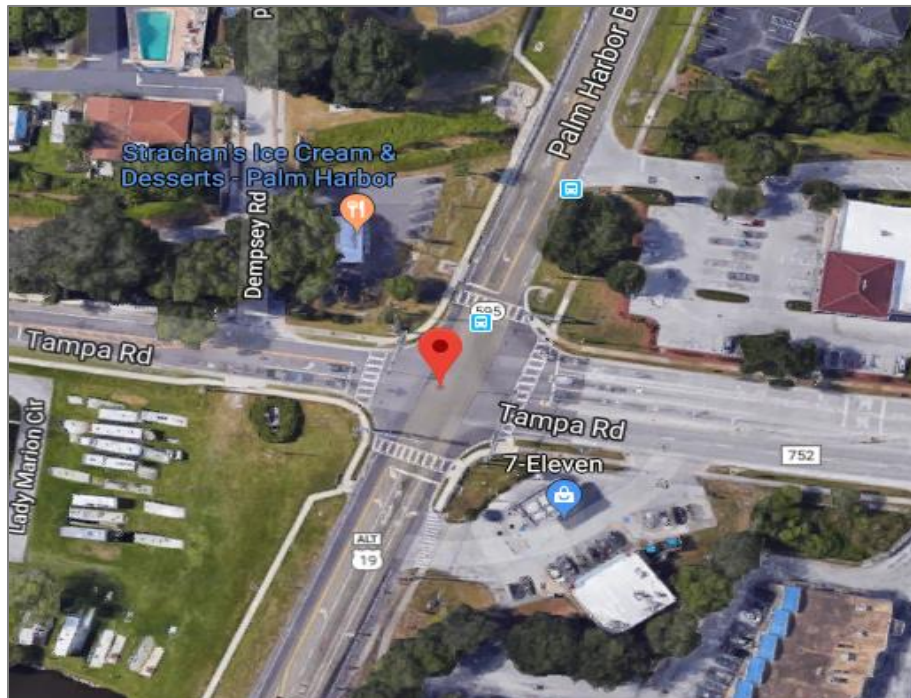
**Figure 8-11: Satellite image of intersection 5**



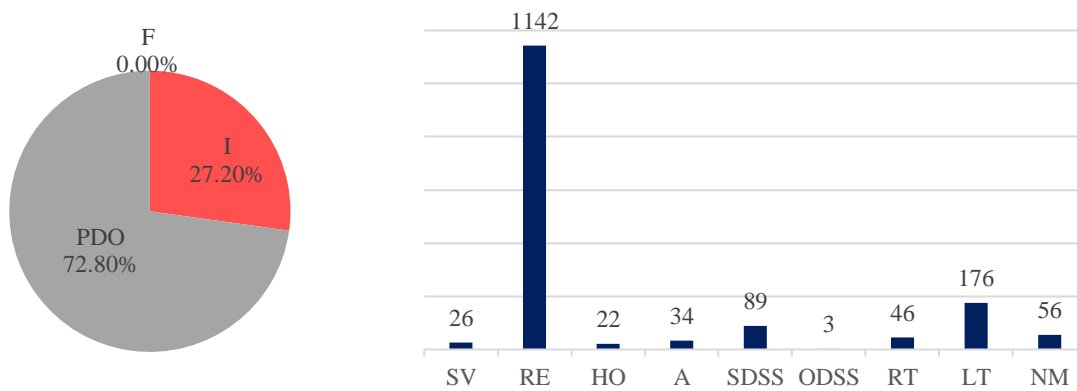
**Figure 8-12: Crash distribution by severity and EPDO distribution by crash type for intersection 5**

**Intersection 6:** Tampa Rd & Palm Harbor Blvd

- County: Pinellas
- Major AADT: 21,500 / Minor AADT: 3,600
- EPDO PSI: 254
- Most Severe Crash Type: Rear-End
- Suggestions:
  - 1) MUT Type B to minimize rear-end crashes (CMF for rear-end is 0.49): rear-end crashes reduced by 51% and total EPDO reduced by 54%.
  - 2) RCUT to minimize total EPDO (CMF for FI is 0.57 and CMF for PDO is 0.84): total EPDO reduced by 71% and rear-end crashes reduced by 25%.



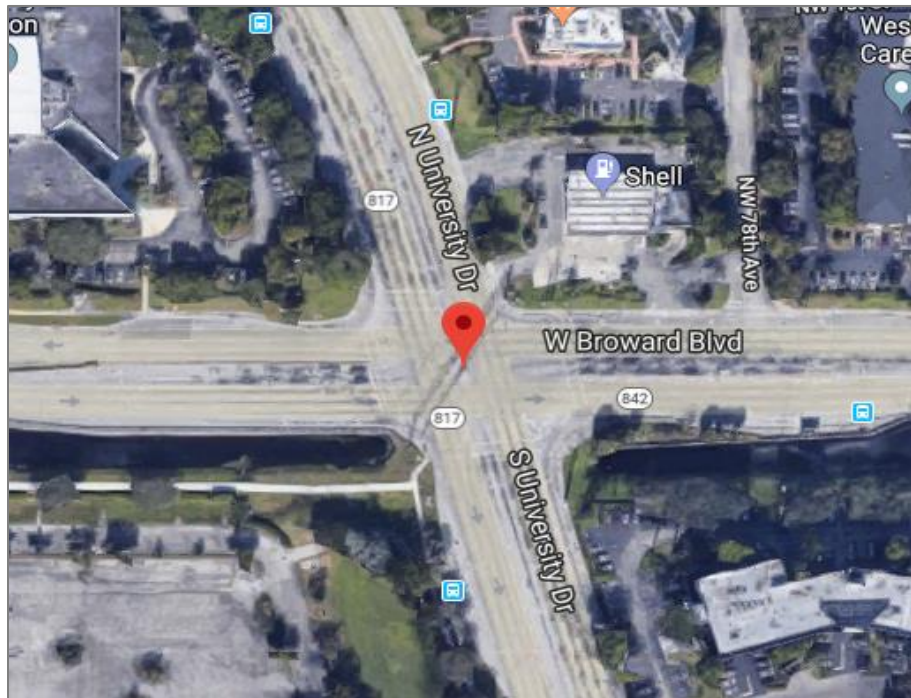
**Figure 8-13:** Satellite image of intersection 6



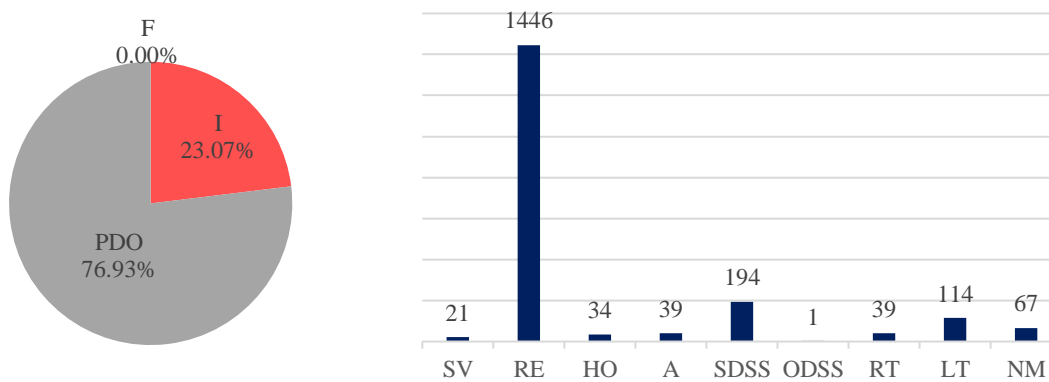
**Figure 8-14:** Crash distribution by severity and EPDO distribution by crash type for intersection 6

**Intersection 7: W Broward Blvd & N/S University Dr**

- County: Broward
- Major AADT: 55,651 / Minor AADT: 40,500
- EPDO PSI: 250
- Most Severe Crash Type: Rear-End
- Suggestions:
  - 1) MUT Type B to minimize rear-end crashes (CMF for rear-end is 0.49): rear-end crashes reduced by 51% and total EPDO reduced by 53%.
  - 2) RCUT to minimize total EPDO (CMF for FI is 0.57 and CMF for PDO is 0.84): total EPDO reduced by 68% and rear-end crashes reduced by 25%.



**Figure 8-15: Satellite image of intersection 7**



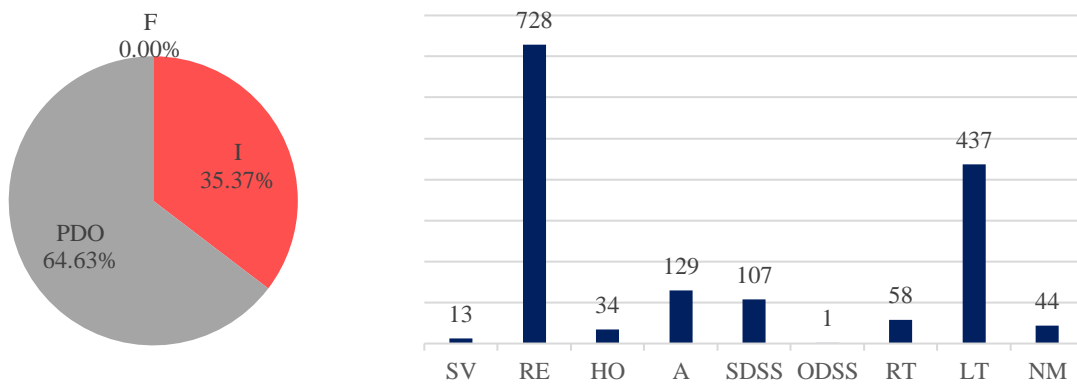
**Figure 8-16: Crash distribution by severity and EPDO distribution by crash type for intersection 7**

**Intersection 8:** Mobile Hwy & Saufley Field Rd

- County: Escambia
- Major AADT: 31,500 / Minor AADT: 18,750
- EPDO PSI: 230.5
- Most Severe Crash Type: Rear-End
- Suggestions:
  - 1) MUT Type B to minimize rear-end crashes (CMF for rear-end is 0.49): rear-end crashes reduced by 51% and total EPDO reduced by 55%.
  - 2) RCUT to minimize total EPDO (CMF for FI is 0.57 and CMF for PDO is 0.84): total EPDO reduced by 74% and rear-end crashes reduced by 25%.



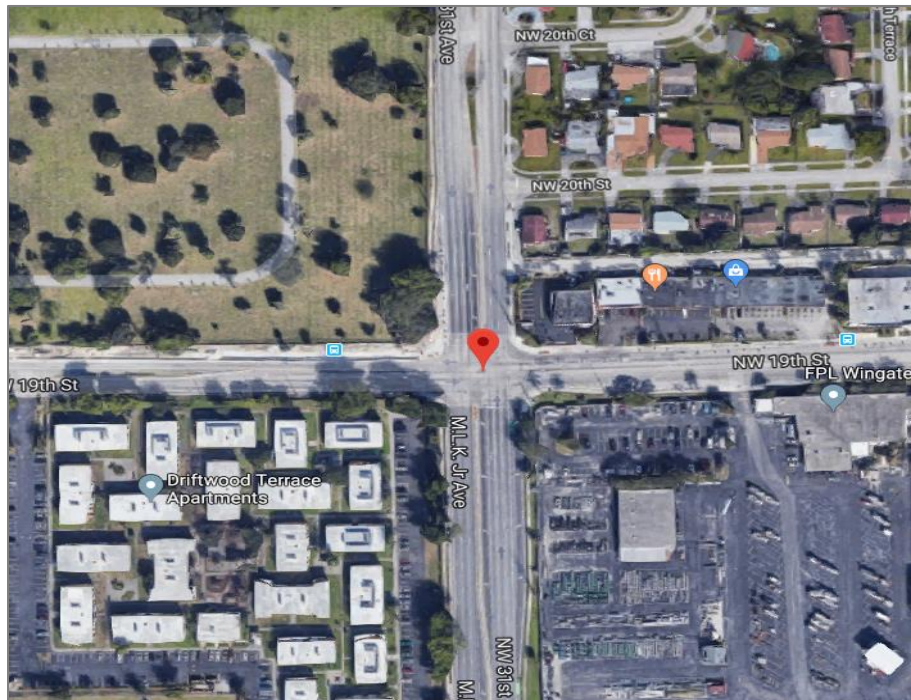
**Figure 8-17:** Satellite image of intersection 8



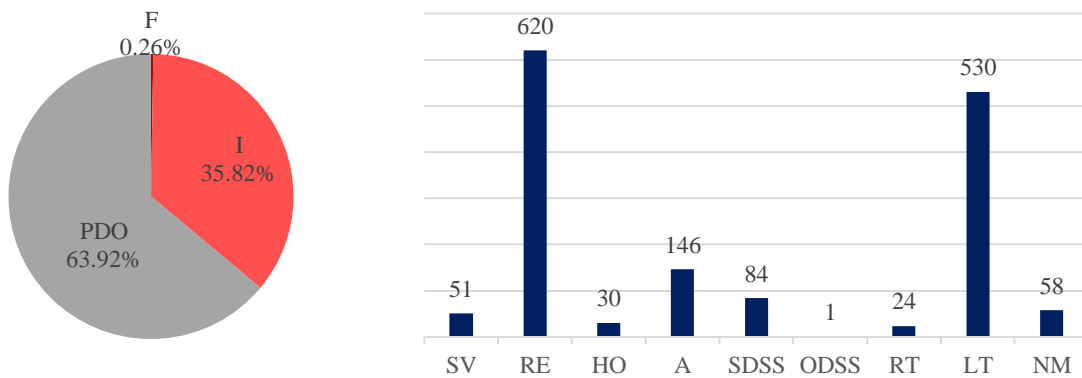
**Figure 8-18:** Crash distribution by severity and EPDO distribution by crash type for intersection 8

**Intersection 9: NW 31st Ave & NW 19th St**

- County: Broward
- Major AADT: 41,875 / Minor AADT: 24,125
- EPDO PSI: 227.1
- Most Severe Crash Type: Rear-End
- Suggestions:
  - 1) MUT Type B to minimize rear-end crashes (CMF for rear-end is 0.49): rear-end crashes reduced by 51% and total EPDO reduced by 43%.
  - 2) RCUT to minimize total EPDO (CMF for FI is 0.57 and CMF for PDO is 0.84): total EPDO reduced by 58% and rear-end crashes reduced by 25%.



**Figure 8-19: Satellite image of intersection 9**

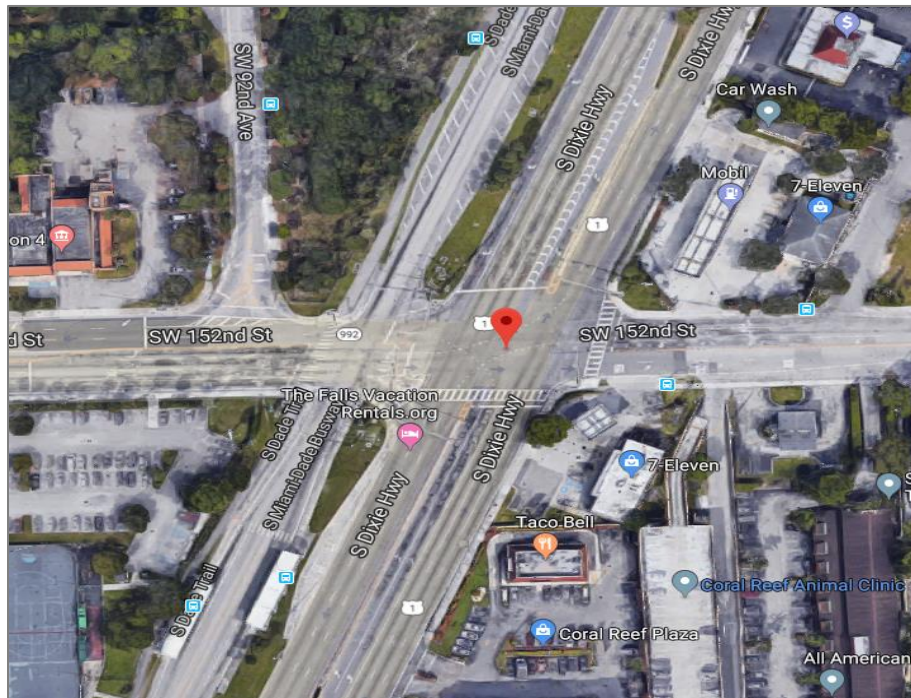


**Figure 8-20: Crash distribution by severity and EPDO distribution by crash type for intersection 9**

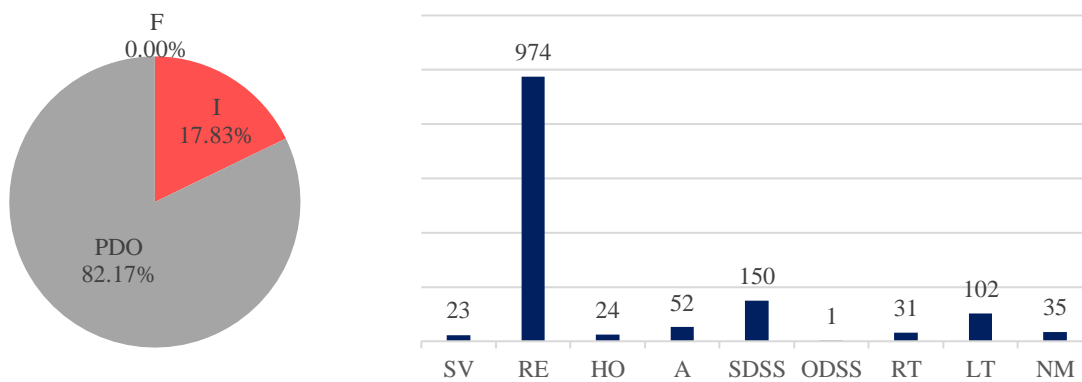


**Intersection 10: S Dixie Hwy & SW 152nd St**

- County: Miami-Dade
- Major AADT: 69,625 / Minor AADT: 500
- EPDO PSI: 219.5
- Most Severe Crash Type: Rear-End
- Suggestions:
  - 1) MUT Type B to minimize rear-end crashes (CMF for rear-end is 0.49): rear-end crashes reduced by 51% and total EPDO reduced by 52%.
  - 2) RCUT to minimize total EPDO (CMF for FI is 0.57 and CMF for PDO is 0.84): total EPDO reduced by 64% and rear-end crashes reduced by 25%.



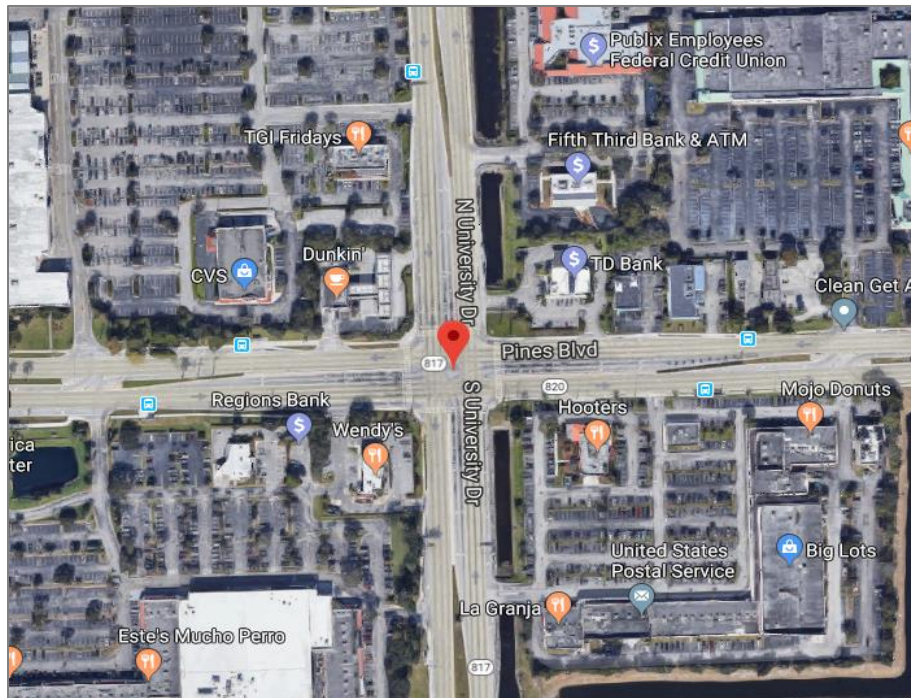
**Figure 8-21: Satellite image of intersection 10**



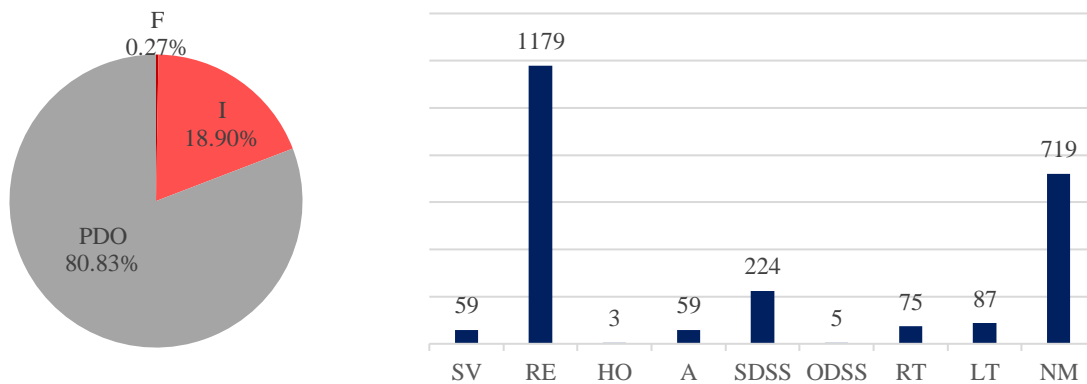
**Figure 8-22: Crash distribution by severity and EPDO distribution by crash type for intersection 10**

**Intersection 11:** Pines Blvd & N/S University Dr

- County: Broward
- Major AADT: 59,000 / Minor AADT: 51,750
- EPDO PSI: 217.3
- Most Severe Crash Type: Rear-End
- Suggestions:
  - 1) MUT Type B to minimize rear-end crashes (CMF for rear-end is 0.49): rear-end crashes reduced by 51% and total EPDO reduced by 35%.
  - 2) RCUT to minimize total EPDO (CMF for FI is 0.57 and CMF for PDO is 0.84): total EPDO reduced by 44% and rear-end crashes reduced by 25%.



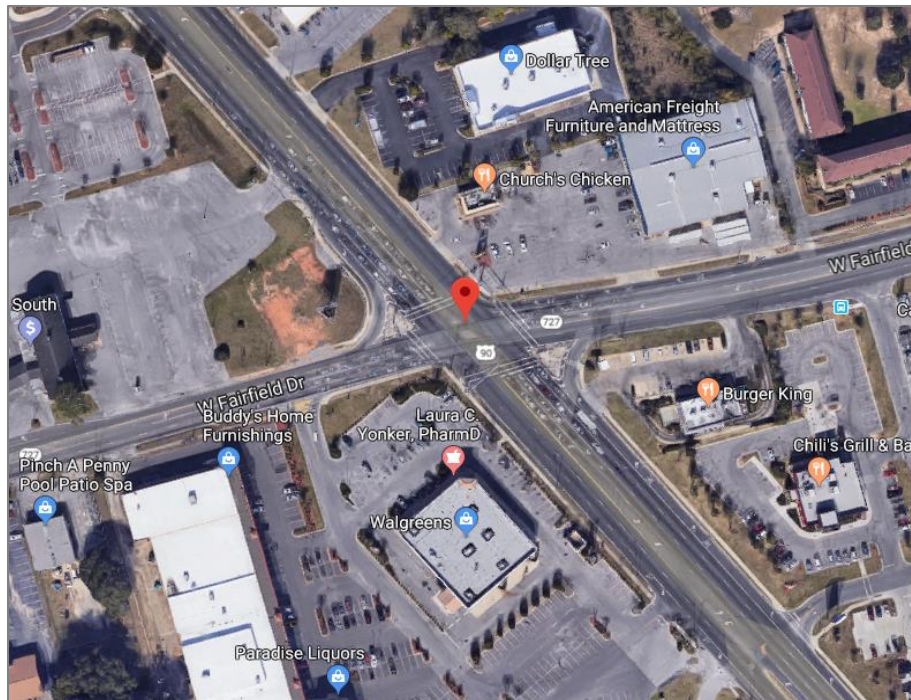
**Figure 8-23:** Satellite image of intersection 11



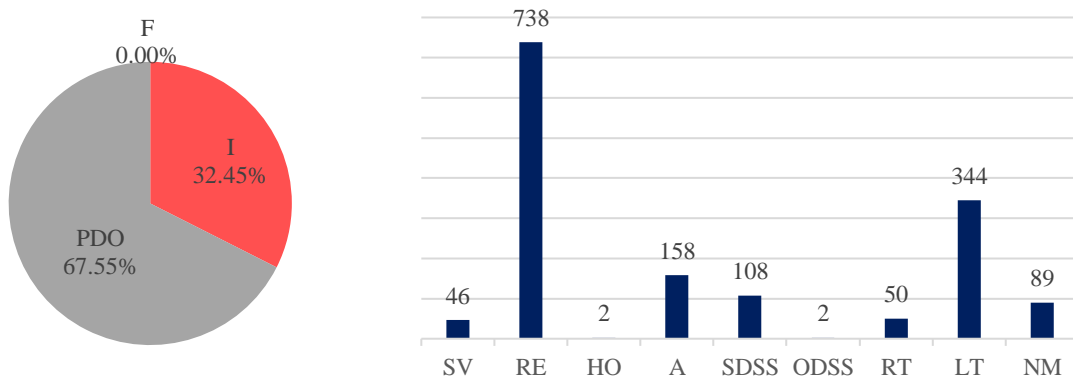
**Figure 8-24:** Crash distribution by severity and EPDO distribution by crash type for intersection 11

**Intersection 12: Mobile Hwy & W Fairfield Dr**

- County: Escambia
- Major AADT: 36,375 / Minor AADT: 21,625
- EPDO PSI: 215.8
- Most Severe Crash Type: Rear-End
- Suggestions:
  - 1) MUT Type B to minimize rear-end crashes (CMF for rear-end is 0.49): rear-end crashes reduced by 51% and total EPDO reduced by 55%.
  - 2) RCUT to minimize total EPDO (CMF for FI is 0.57 and CMF for PDO is 0.84): total EPDO reduced by 73% and rear-end crashes reduced by 25%.



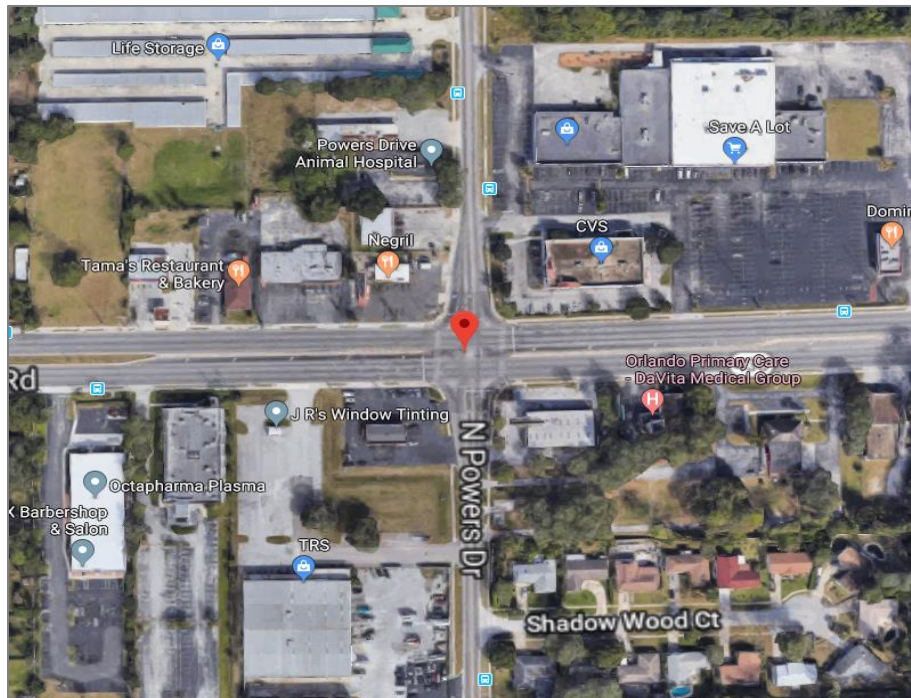
**Figure 8-25: Satellite image of intersection 12**



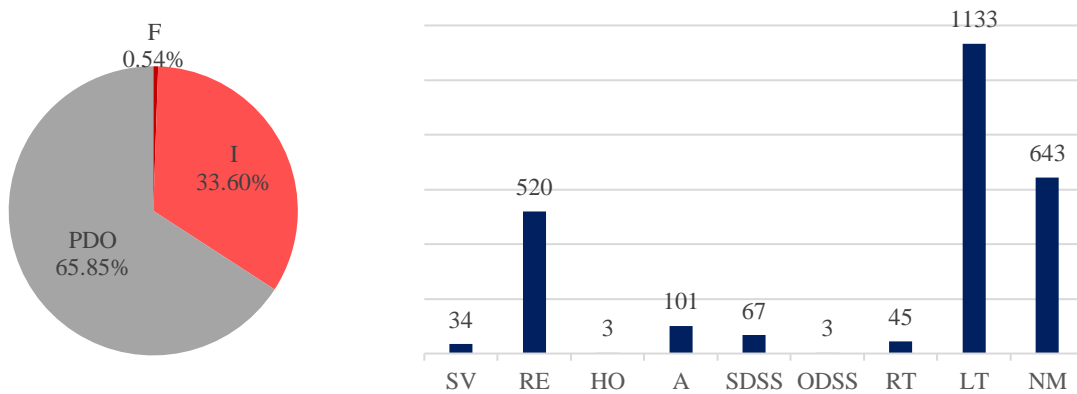
**Figure 8-26: Crash distribution by severity and EPDO distribution by crash type for intersection 12**

**Intersection 13:** Silver Star Rd & N Powers Dr

- County: Orange
- Major AADT: 38,500 / Minor AADT: 7,575
- EPDO PSI: 213.9
- Most Severe Crash Type: Left-Turn
- Suggestions:
  - 1) Jughandle Type 1 to minimize left-turn crashes (CMF for left-turn is 0.19): left-turn crashes reduced by 81% and total EPDO reduced by 18%.
  - 2) RCUT to minimize total EPDO (CMF for FI is 0.57 and CMF for PDO is 0.84): total EPDO reduced by 45% and left-turn crashes reduced by 41%.



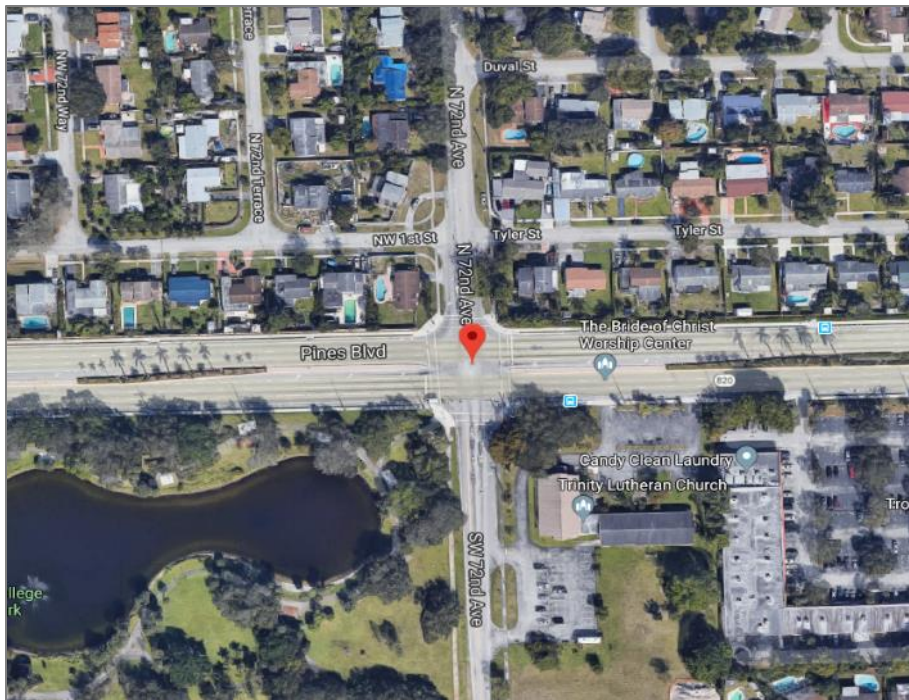
**Figure 8-27:** Satellite image of intersection 13



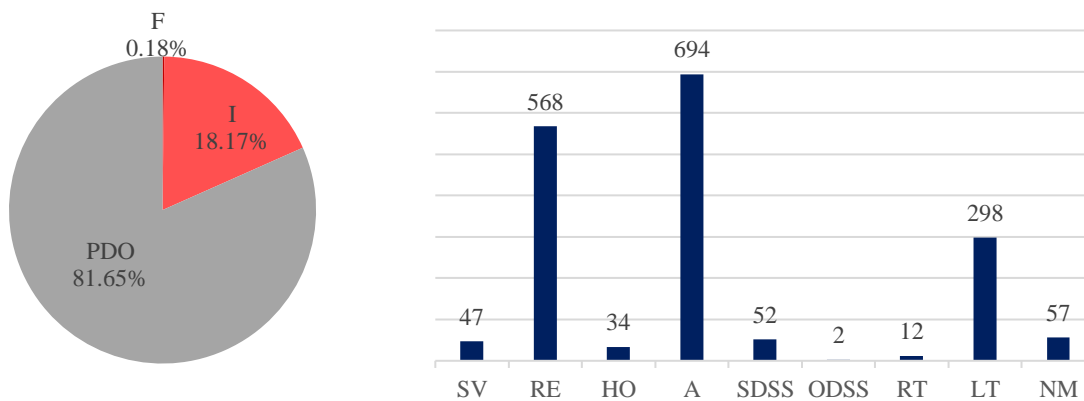
**Figure 8-28:** Crash distribution by severity and EPDO distribution by crash type for intersection 13

**Intersection 14:** Pines Blvd & N/SW 72nd Ave

- County: Broward
- Major AADT: 51,750 / Minor AADT: 10,400
- EPDO PSI: 212.1
- Most Severe Crash Type: Angle
- Suggestions:
  - 1) RCUT to minimize Angle crashes (CMF for Angle is 0.59): Angle crashes reduced by 41% and total EPDO reduced by 48%.
  - 2) RCUT to minimize total EPDO (CMF for FI is 0.57 and CMF for PDO is 0.84): total EPDO reduced by 48% and Angle crashes reduced by 41%.



**Figure 8-29:** Satellite image of intersection 14



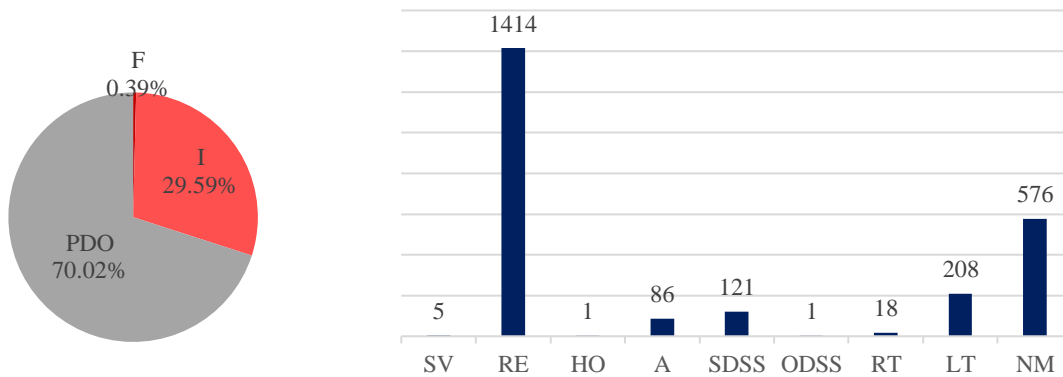
**Figure 8-30:** Crash distribution by severity and EPDO distribution by crash type for intersection 14

**Intersection 15:** FL-54 & Land O' Lakes Blvd

- County: Pasco
- Major AADT: 60,000 / Minor AADT: 50,750
- EPDO PSI: 207.3
- Most Severe Crash Type: Rear-End
- Suggestions:
  - 1) MUT Type B to minimize rear-end crashes (CMF for rear-end is 0.49): rear-end crashes reduced by 51% and total EPDO reduced by 36%.
  - 2) RCUT to minimize total EPDO (CMF for FI is 0.57 and CMF for PDO is 0.84): total EPDO reduced by 48% and rear-end crashes reduced by 25%.



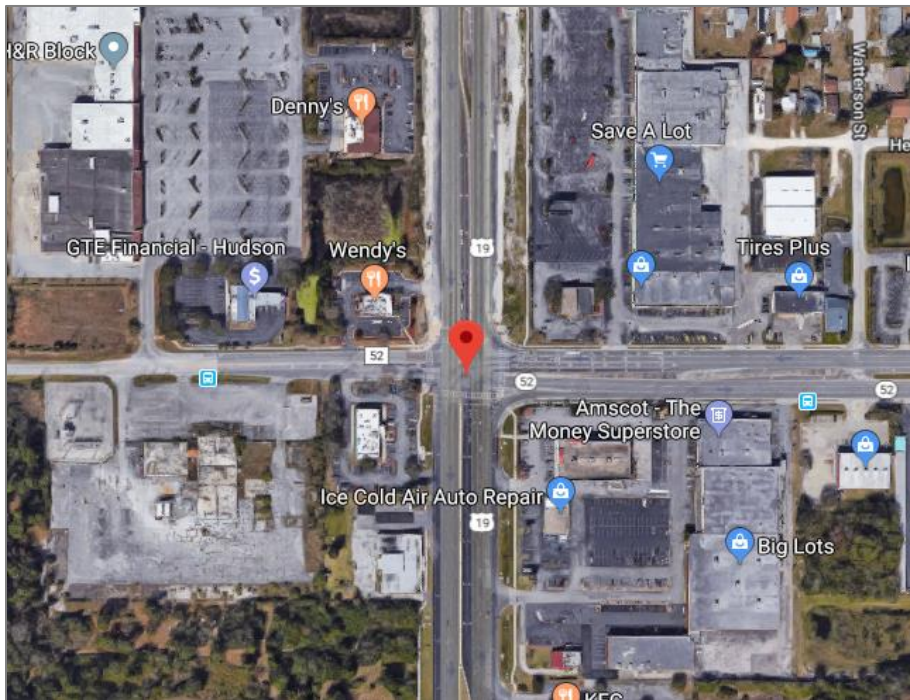
**Figure 8-31:** Satellite image of intersection 15



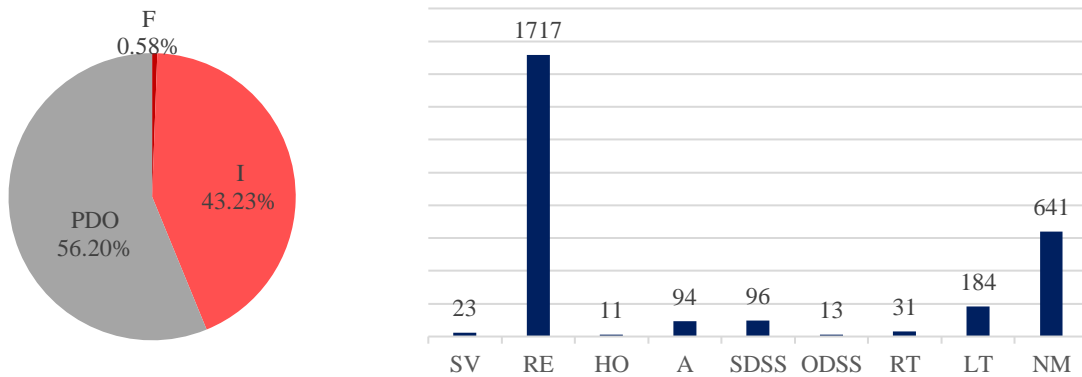
**Figure 8-32:** Crash distribution by severity and EPDO distribution by crash type for intersection 15

**Intersection 16:** US-19 & County Rd 52

- County: Pasco
- Major AADT: 54,125 / Minor AADT: 30,750
- EPDO PSI: 207
- Most Severe Crash Type: Rear-End
- Suggestions:
  - 1) MUT Type B to minimize rear-end crashes (CMF for rear-end is 0.49): rear-end crashes reduced by 51% and total EPDO reduced by 36%.
  - 2) RCUT to minimize total EPDO (CMF for FI is 0.57 and CMF for PDO is 0.84): total EPDO reduced by 49% and rear-end crashes reduced by 25%.



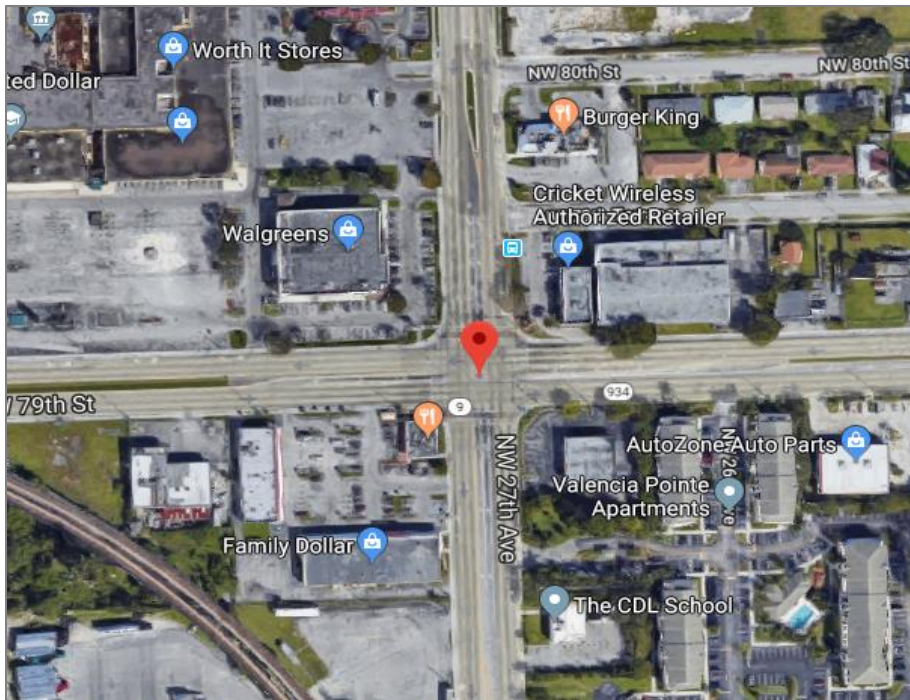
**Figure 8-33:** Satellite image of intersection 16



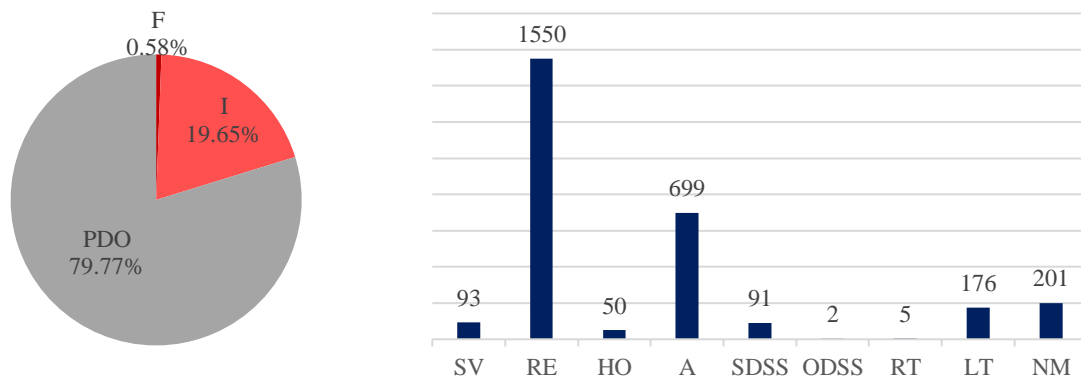
**Figure 8-34:** Crash distribution by severity and EPDO distribution by crash type for intersection 16

**Intersection 17:** NW 79th St & NW 27th Ave

- County: Miami-Dade
- Major AADT: 38,125 / Minor AADT: 26,875
- EPDO PSI: 206.2
- Most Severe Crash Type: Rear-End
- Suggestions:
  - 1) MUT Type B to minimize rear-end crashes (CMF for rear-end is 0.49): rear-end crashes reduced by 51% and total EPDO reduced by 26%.
  - 2) RCUT to minimize total EPDO (CMF for FI is 0.57 and CMF for PDO is 0.84): total EPDO reduced by 33% and rear-end crashes reduced by 25%.



**Figure 8-35:** Satellite image of intersection 17

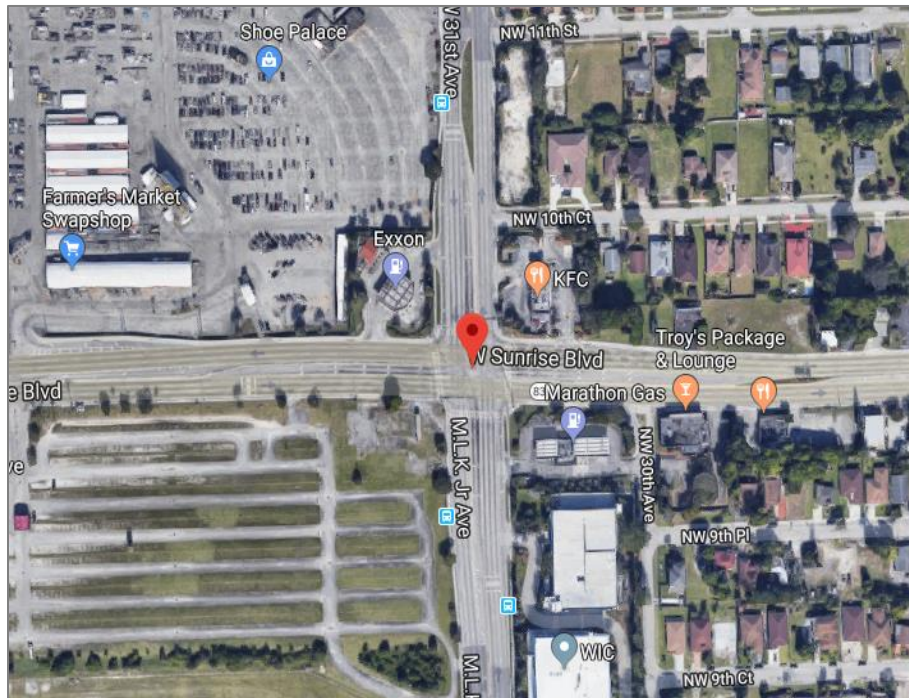


**Figure 8-36:** Crash distribution by severity and EPDO distribution by crash type for intersection 17

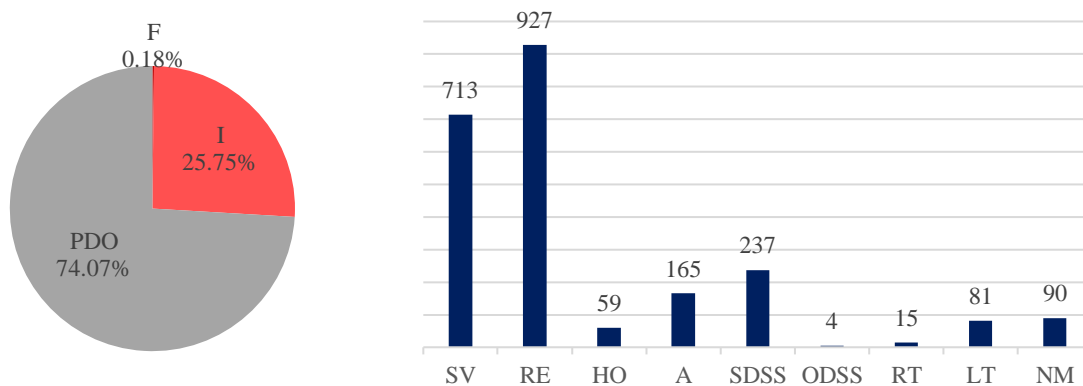


**Intersection 18:** W Sunrise Blvd & NW 31st Ave

- County: Broward
- Major AADT: 57,875 / Minor AADT: 26,125
- EPDO PSI: 204.7
- Most Severe Crash Type: Rear-End
- Suggestions:
  - 1) MUT Type B to minimize rear-end crashes (CMF for rear-end is 0.49): rear-end crashes reduced by 51% and total EPDO reduced by 43%.
  - 2) RCUT to minimize total EPDO (CMF for FI is 0.57 and CMF for PDO is 0.84): total EPDO reduced by 56% and rear-end crashes reduced by 25%.



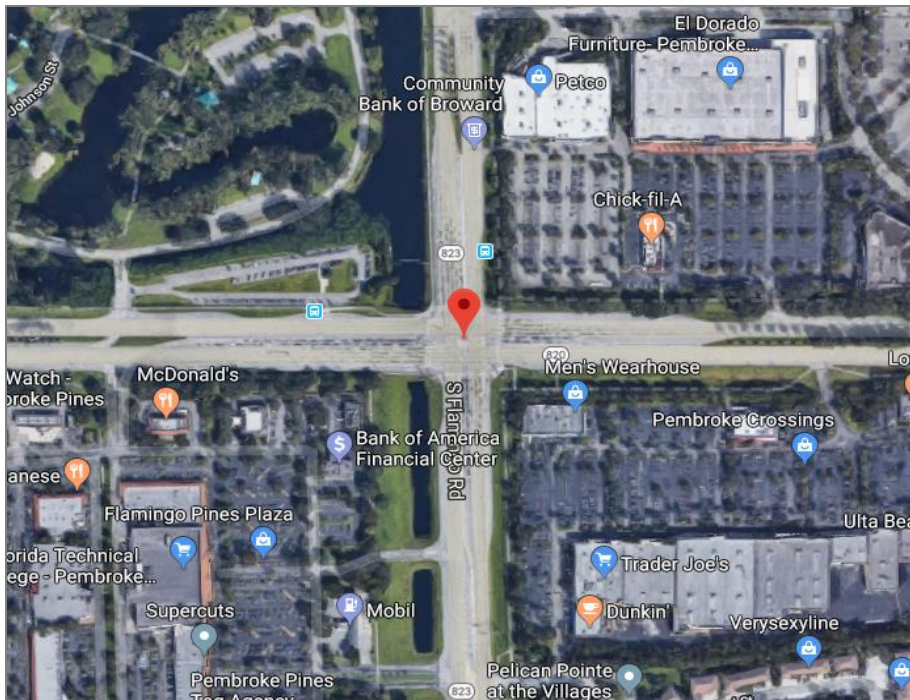
**Figure 8-37:** Satellite image of intersection 18



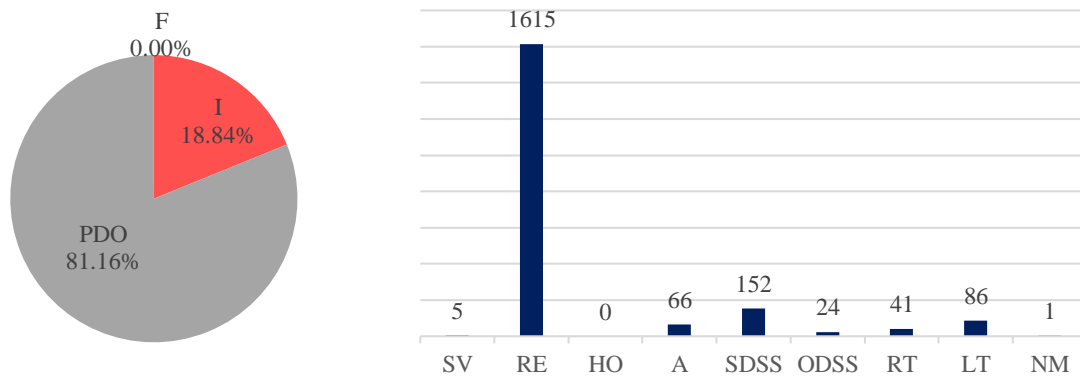
**Figure 8-38:** Crash distribution by severity and EPDO distribution by crash type for intersection 18

**Intersection 19:** Pines Blvd & N/S Flamingo Rd

- County: Broward
- Major AADT: 61,000 / Minor AADT: 43,500
- EPDO PSI: 199.4
- Most Severe Crash Type: Rear-End
- Suggestions:
  - 1) MUT Type B to minimize rear-end crashes (CMF for rear-end is 0.49): rear-end crashes reduced by 51% and total EPDO reduced by 53%.
  - 2) RCUT to minimize total EPDO (CMF for FI is 0.57 and CMF for PDO is 0.84): total EPDO reduced by 65% and rear-end crashes reduced by 25%.



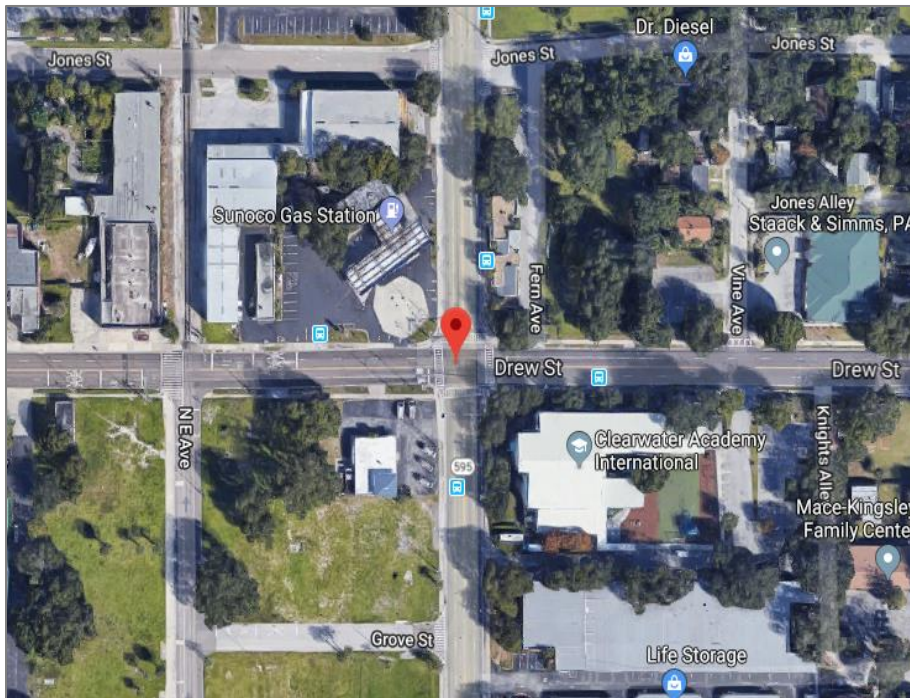
**Figure 8-39:** Satellite image of intersection 19



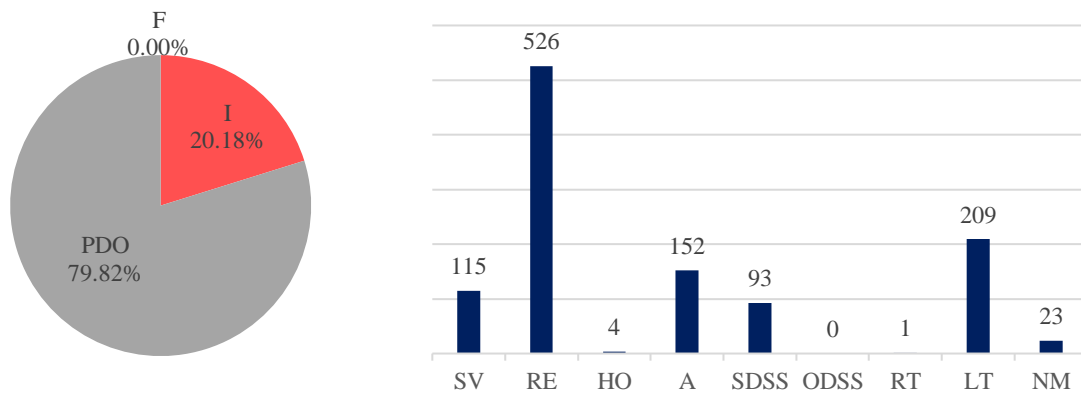
**Figure 8-40:** Crash distribution by severity and EPDO distribution by crash type for intersection 19

**Intersection 20: N Myrtle Ave & Drew St**

- County: Pinellas
- Major AADT: 12,950 / Minor AADT: 12,675
- EPDO PSI: 199.2
- Most Severe Crash Type: Rear-End
- Suggestions:
  - 1) MUT Type B to minimize rear-end crashes (CMF for rear-end is 0.49): rear-end crashes reduced by 51% and total EPDO reduced by 53%.
  - 2) RCUT to minimize total EPDO (CMF for FI is 0.57 and CMF for PDO is 0.84): total EPDO reduced by 66% and rear-end crashes reduced by 25%.



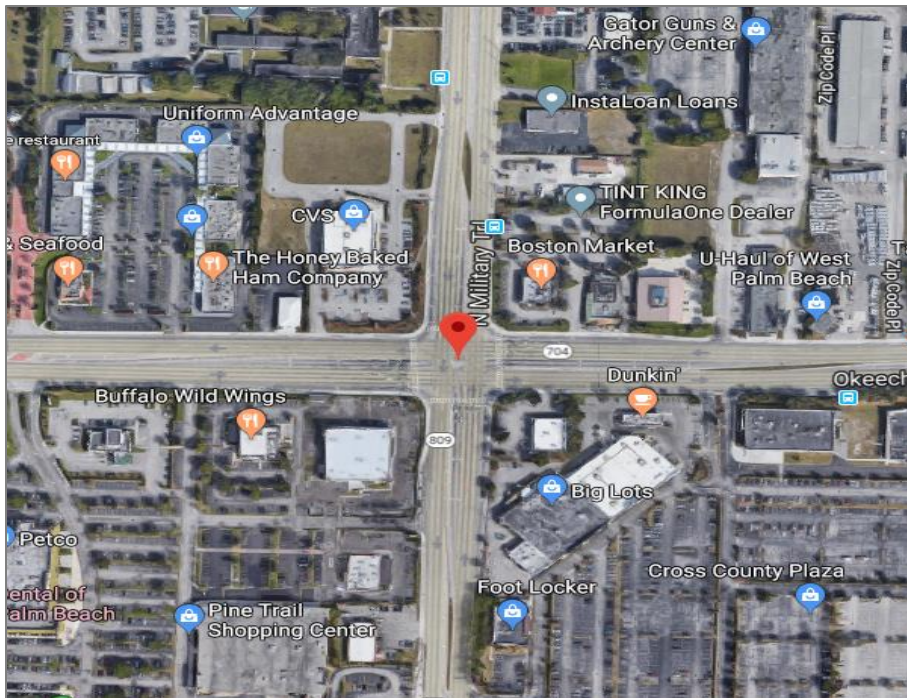
**Figure 8-41: Satellite image of intersection 20**



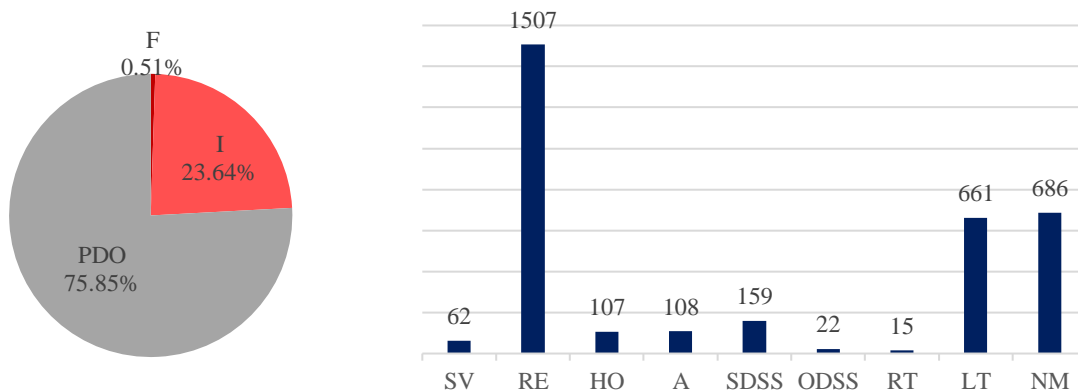
**Figure 8-42: Crash distribution by severity and EPDO distribution by crash type for intersection 20**

**Intersection 21:** Okeechobee Blvd & N Military Trl

- County: Palm Beach
- Major AADT: 19,575 / Minor AADT: 9,300
- EPDO PSI: 197.2
- Most Severe Crash Type: Rear-End
- Suggestions:
  - 1) MUT Type B to minimize rear-end crashes (CMF for rear-end is 0.49): rear-end crashes reduced by 51% and total EPDO reduced by 30%.
  - 2) RCUT to minimize total EPDO (CMF for FI is 0.57 and CMF for PDO is 0.84): total EPDO reduced by 38% and rear-end crashes reduced by 25%.



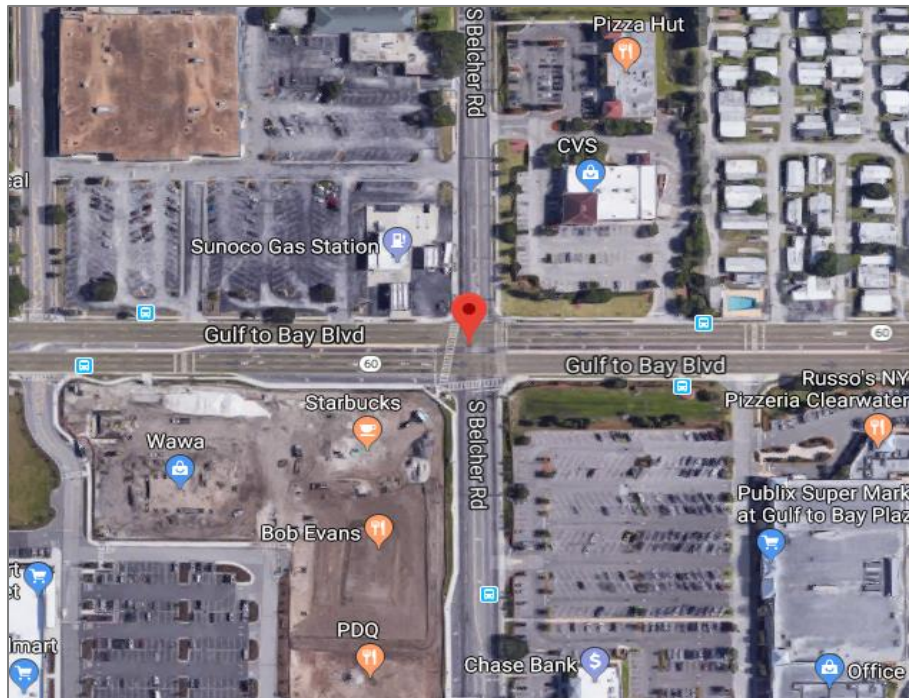
**Figure 8-43:** Satellite image of intersection 21



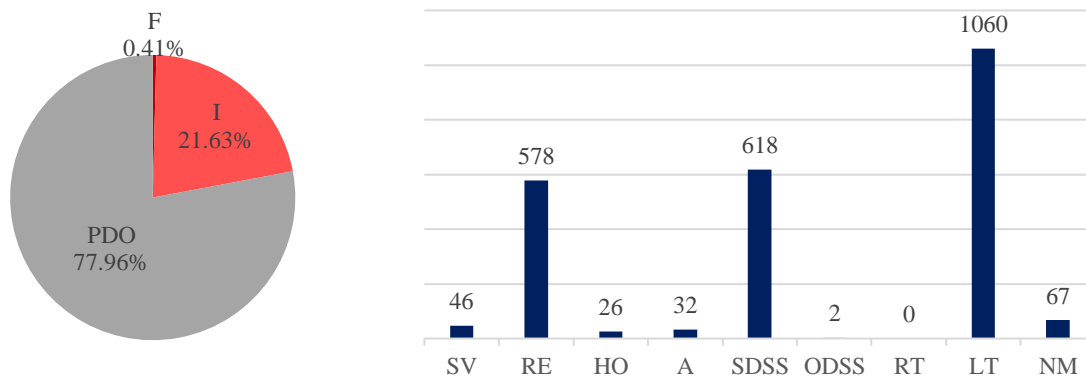
**Figure 8-44:** Crash distribution by severity and EPDO distribution by crash type for intersection 21

**Intersection 22:** Gulf to Bay Blvd & S Belcher Rd

- County: Pinellas
- Major AADT: 52,000 / Minor AADT: 20,000
- EPDO PSI: 196.1
- Most Severe Crash Type: Left-Turn
- Suggestions:
  - 1) Jughandle Type 1 to minimize left-turn crashes (CMF for left-turn is 0.19): left-turn crashes reduced by 81% and total EPDO reduced by 17%.
  - 2) RCUT to minimize total EPDO (CMF for FI is 0.57 and CMF for PDO is 0.84): total EPDO reduced by 40% and left-turn crashes reduced by 41%.



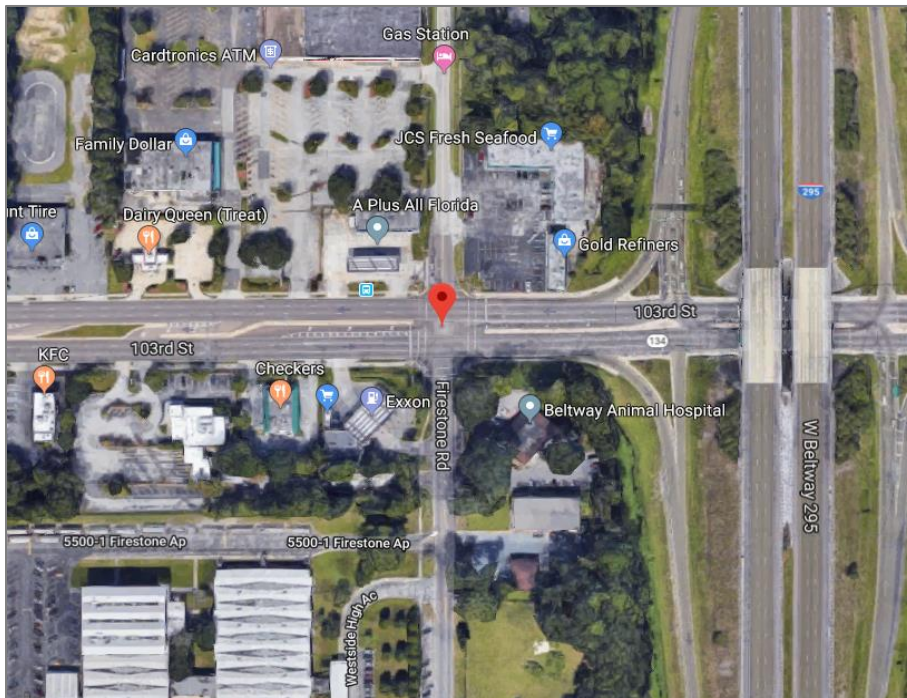
**Figure 8-45:** Satellite image of intersection 22



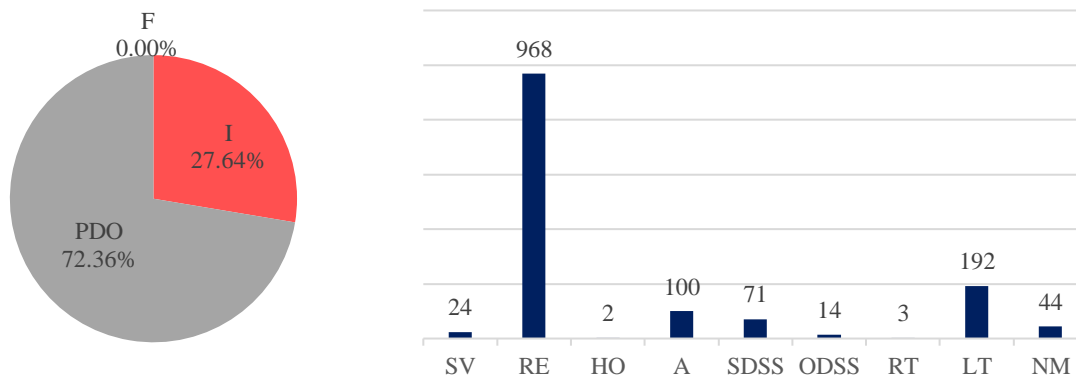
**Figure 8-46:** Crash distribution by severity and EPDO distribution by crash type for intersection 22

**Intersection 23: FL-134 & Firestone Rd**

- County: Duval
- Major AADT: 46,750 / Minor AADT: 5,275
- EPDO PSI: 195.9
- Most Severe Crash Type: Rear-End
- Suggestions:
  - 1) MUT Type B to minimize rear-end crashes (CMF for rear-end is 0.49): rear-end crashes reduced by 51% and total EPDO reduced by 54%.
  - 2) RCUT to minimize total EPDO (CMF for FI is 0.57 and CMF for PDO is 0.84): total EPDO reduced by 71% and rear-end crashes reduced by 25%.



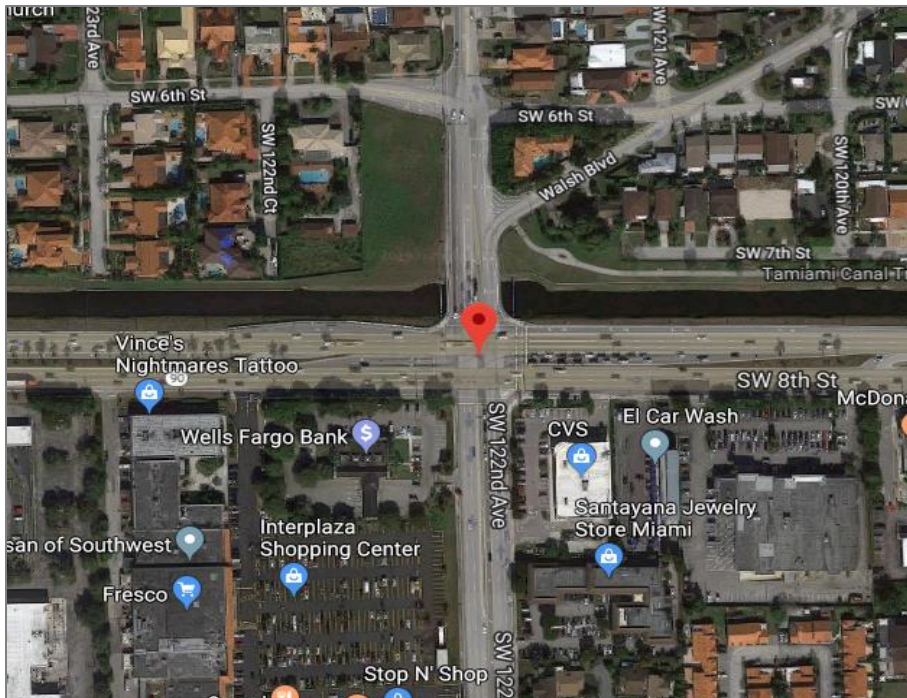
**Figure 8-47: Satellite image of intersection 23**



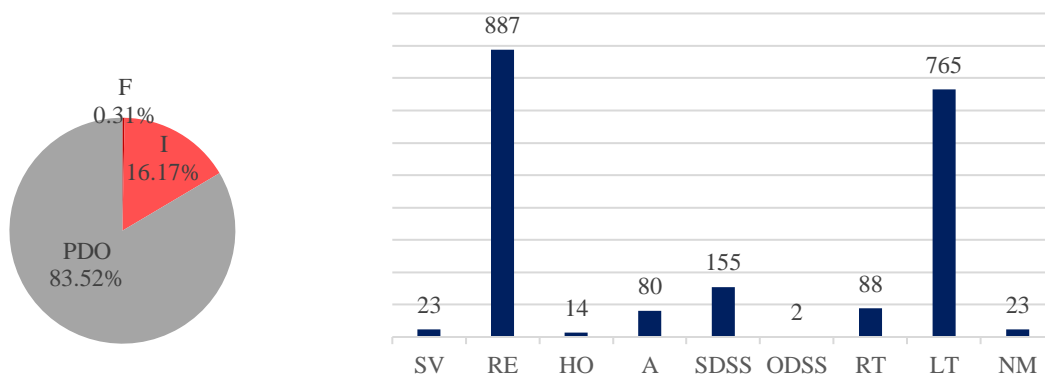
**Figure 8-48: Crash distribution by severity and EPDO distribution by crash type for intersection 23**

**Intersection 24:** US-41 & SW 122nd Ave

- County: Miami-Dade
- Major AADT: 53,375 / Minor AADT: 12,713
- EPDO PSI: 187.9
- Most Severe Crash Type: Rear-End
- Suggestions:
  - 1) MUT Type B to minimize rear-end crashes (CMF for rear-end is 0.49): rear-end crashes reduced by 51% and total EPDO reduced by 32%.
  - 2) RCUT to minimize total EPDO (CMF for FI is 0.57 and CMF for PDO is 0.84): total EPDO reduced by 38% and rear-end crashes reduced by 25%.



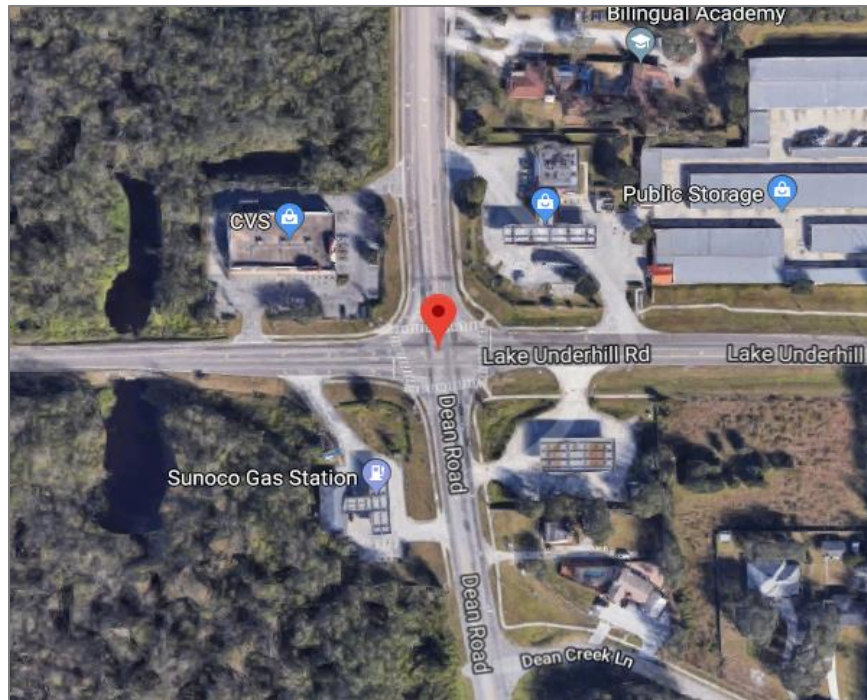
**Figure 8-49:** Satellite image of intersection 24



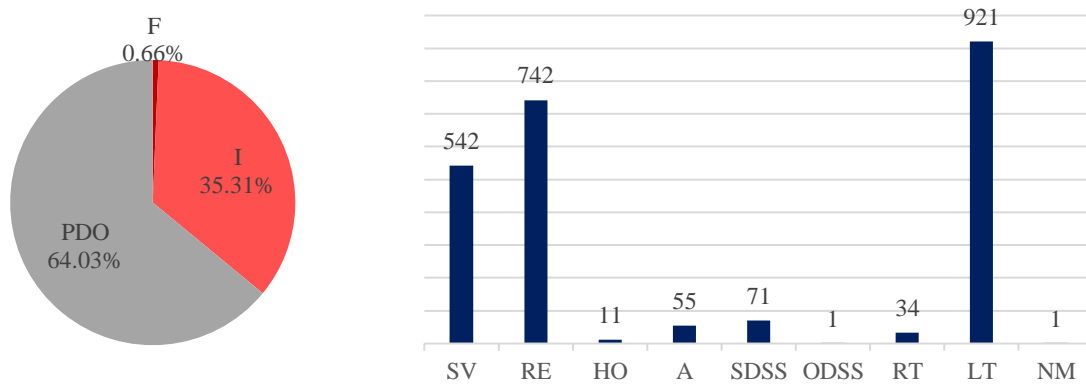
**Figure 8-50:** Crash distribution by severity and EPDO distribution by crash type for intersection 24

**Intersection 25:** Lake Underhill Rd & Dean Road

- County: Orange
- Major AADT: 28,500 / Minor AADT: 16,150
- EPDO PSI: 187.1
- Most Severe Crash Type: Left-Turn
- Suggestions:
  - 1) Jughandle Type 1 to minimize left-turn crashes (CMF for left-turn is 0.19): left-turn crashes reduced by 81% and total EPDO reduced by 17%.
  - 2) RCUT to minimize total EPDO (CMF for FI is 0.57 and CMF for PDO is 0.84): total EPDO reduced by 42% and left-turn crashes reduced by 41%.



**Figure 8-51:** Satellite image of intersection 25

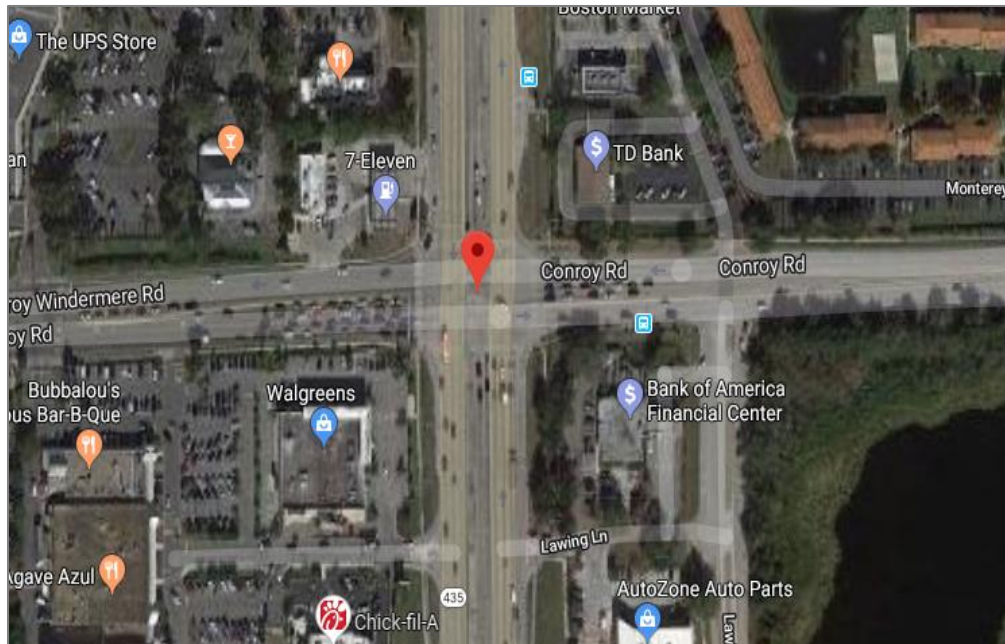


**Figure 8-52:** Crash distribution by severity and EPDO distribution by crash type for intersection 25

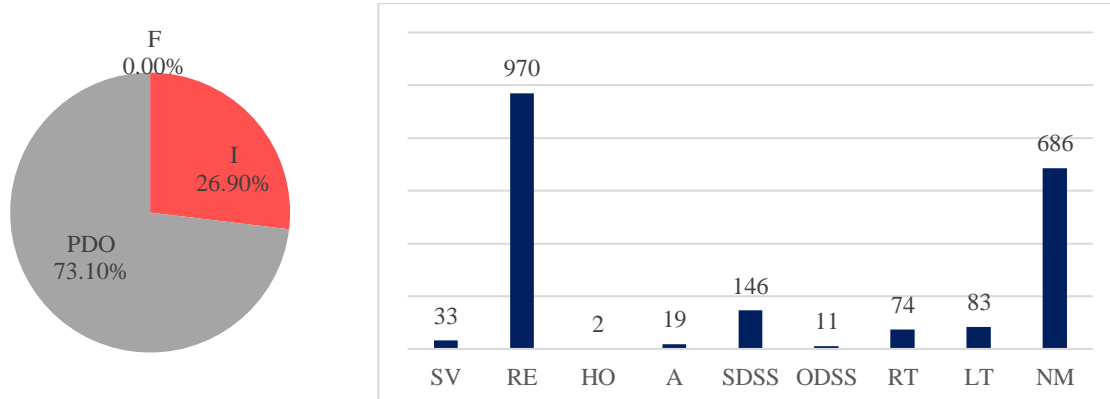


**Intersection 26:** Conroy Rd & S Kirkman Rd

- County: Orange
- Major AADT: 56,625 / Minor AADT: 37,375
- EPDO PSI: 184.9
- Most Severe Crash Type: Rear-End
- Suggestions:
  - 1) MUT Type B to minimize rear-end (CMF for rear-end is 0.49): rear-end crashes reduced by 51% and total EPDO reduced by 54%.
  - 2) RCUT to minimize total EPDO (CMF for FI is 0.57 and CMF for PDO is 0.84): total EPDO reduced by 71% and rear-end crashes reduced by 25%.



**Figure 8-53:** Satellite image of intersection 26



**Figure 8-54:** Crash distribution by severity and EPDO distribution by crash type for intersection 26

**Intersection 27:** Commercial Blvd & N University Dr

- County: Broward
- Major AADT: 56,125 / Minor AADT: 43,500
- EPDO PSI: 184.7
- Most Severe Crash Type: Rear-End
- Suggestions:
  - 1) MUT Type B to minimize rear-end crashes (CMF for rear-end is 0.49): rear-end crashes reduced by 51% and total EPDO reduced by 42%.
  - 2) RCUT to minimize total EPDO (CMF for FI is 0.57 and CMF for PDO is 0.84): total EPDO reduced by 52% and rear-end crashes reduced by 25%.

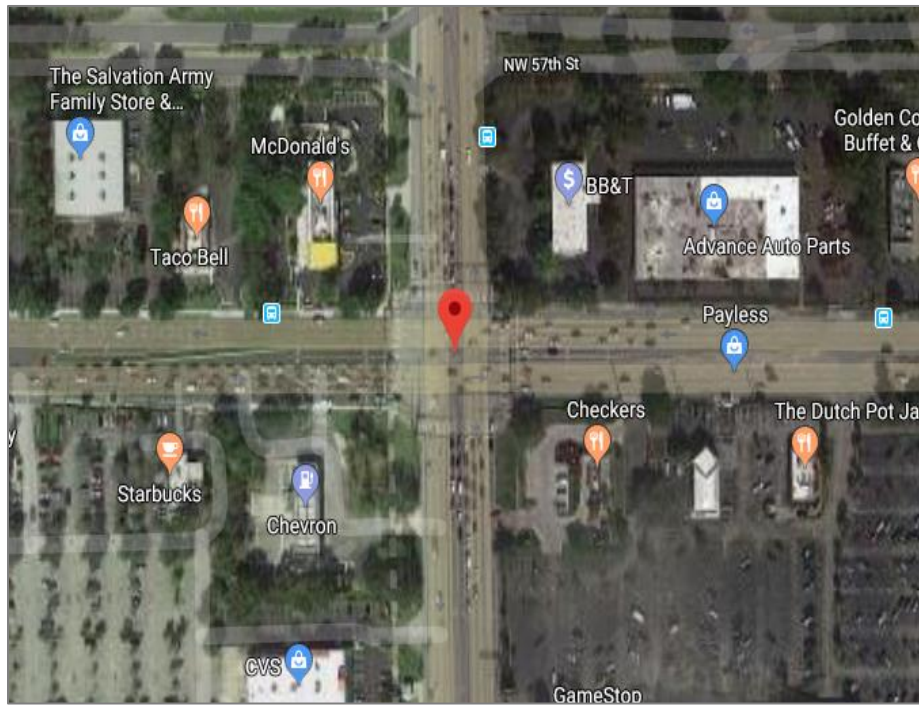


Figure 8-55: Satellite image of intersection 27

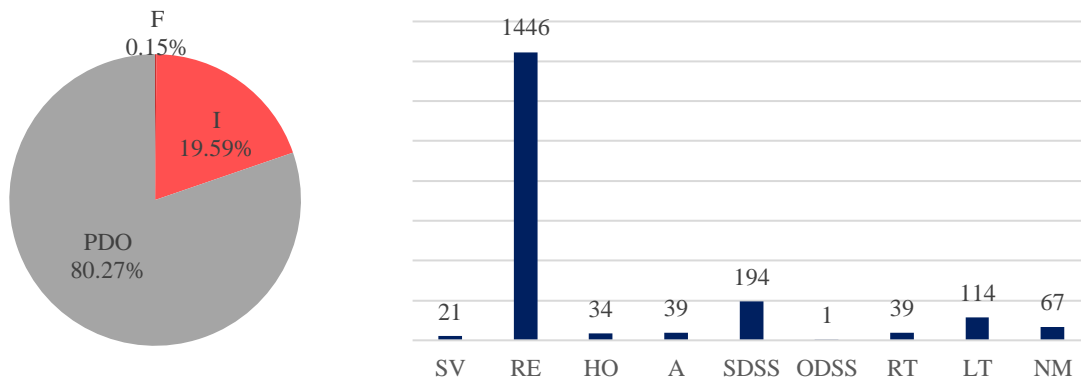
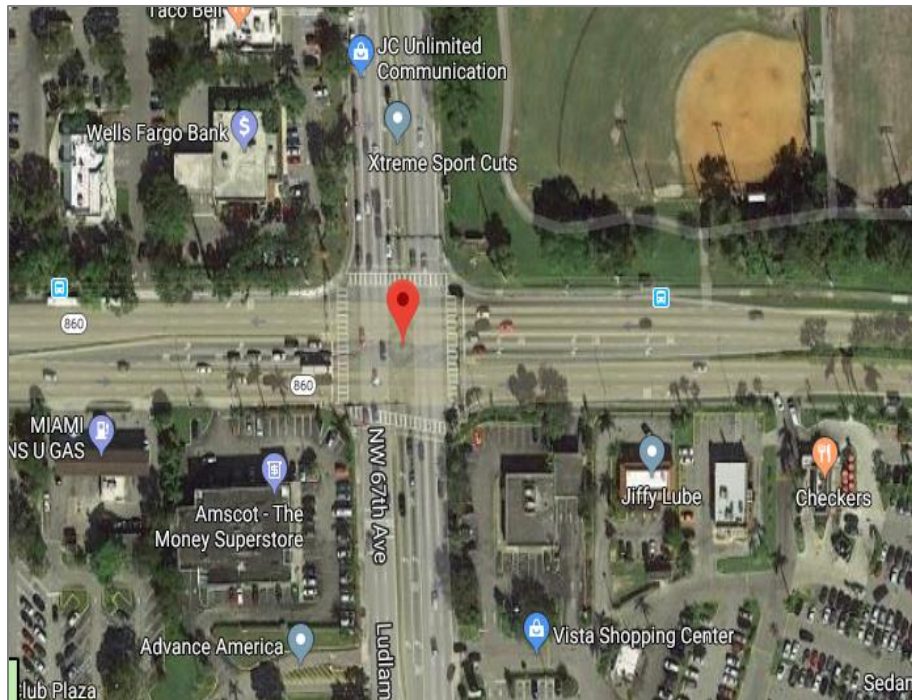


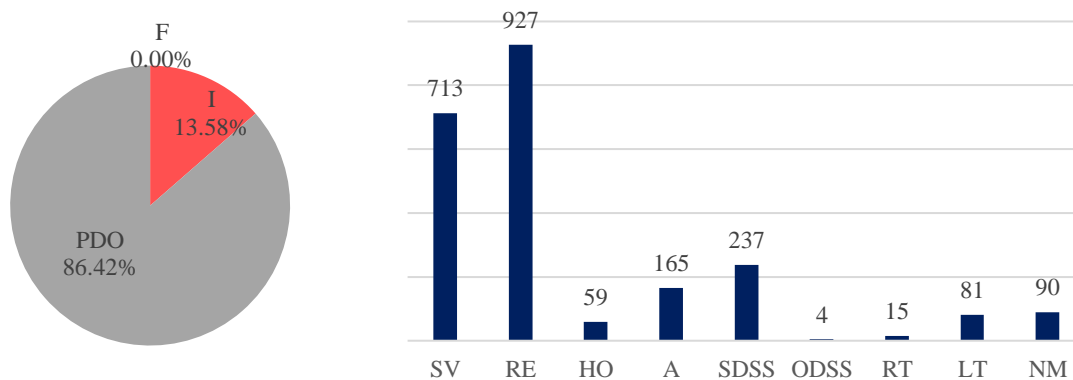
Figure 8-56: Crash distribution by severity and EPDO distribution by crash type for intersection 27

**Intersection 28:** NW 186th St & NW 67th Ave

- County: Broward
- Major AADT: 40,375 / Minor AADT: 35,875
- EPDO PSI: 183.4
- Most Severe Crash Type: Rear-End
- Suggestions:
  - 1) MUT Type B to minimize rear-end crashes (CMF for rear-end is 0.49): rear-end crashes reduced by 51% and total EPDO reduced by 51%.
  - 2) RCUT to minimize total EPDO (CMF for FI is 0.57 and CMF for PDO is 0.84): total EPDO reduced by 59% and rear-end crashes reduced by 25%.



**Figure 8-57:** Satellite image of intersection 28



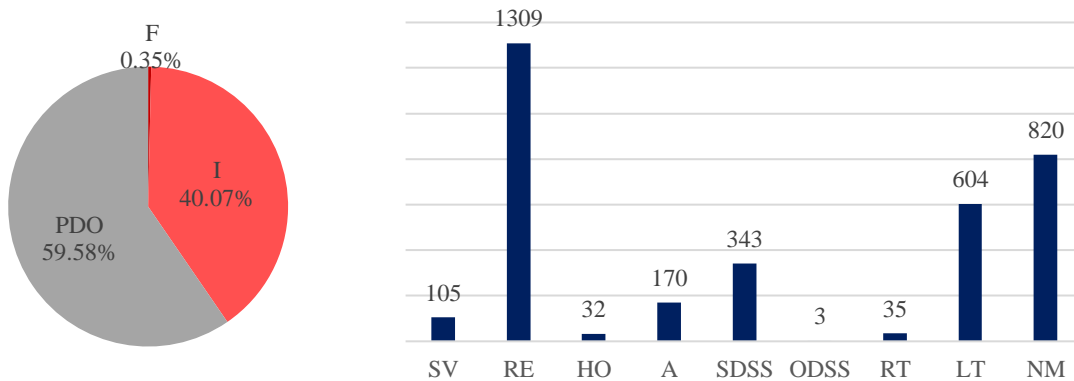
**Figure 8-58:** Crash distribution by severity and EPDO distribution by crash type for intersection 28

**Intersection 29:** US-19 & Moog Rd

- County: Pasco
- Major AADT: 68,500 / Minor AADT: 2,450
- EPDO PSI: 180.8
- Most Severe Crash Type: Rear-End
- Suggestions:
  - 1) MUT Type B to minimize rear-end crashes (CMF for rear-end is 0.49): rear-end crashes reduced by 51% and total EPDO reduced by 41%.
  - 2) RCUT to minimize total EPDO (CMF for FI is 0.57 and CMF for PDO is 0.84): total EPDO reduced by 56% and rear-end crashes reduced by 25%.



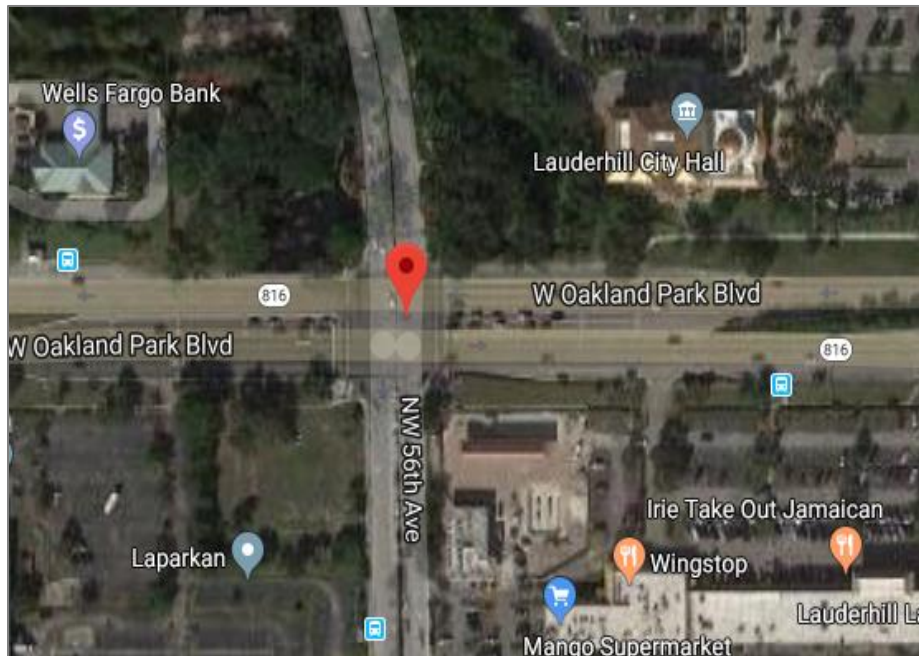
**Figure 8-59:** Satellite image of intersection 29



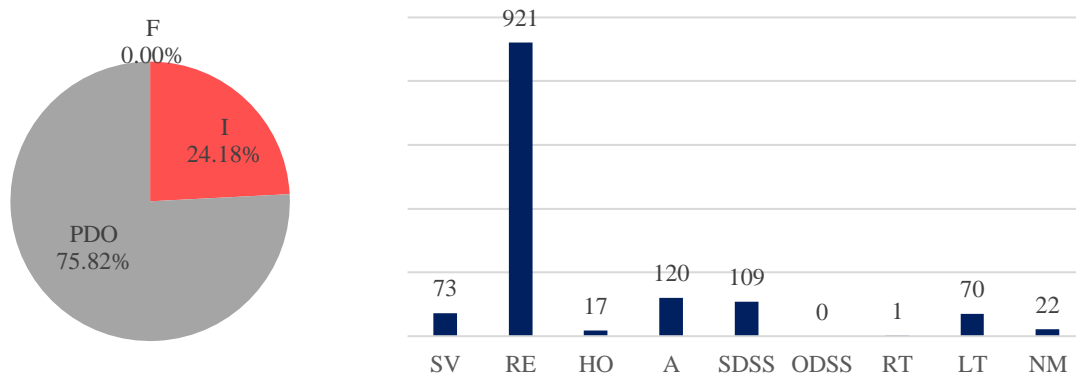
**Figure 8-60:** Crash distribution by severity and EPDO distribution by crash type for intersection 29

**Intersection 30:** W Oakland Park Blvd & NW 56th Ave

- County: Broward
- Major AADT: 69,000 / Minor AADT: 20,225
- EPDO PSI: 180.7
- Most Severe Crash Type: Rear-End
- Suggestions:
  - 1) MUT Type B to minimize rear-end crashes (CMF for rear-end is 0.49): rear-end crashes reduced by 51% and total EPDO reduced by 54%.
  - 2) RCUT to minimize total EPDO (CMF for FI is 0.57 and CMF for PDO is 0.84): total EPDO reduced by 69% and rear-end crashes reduced by 25%.



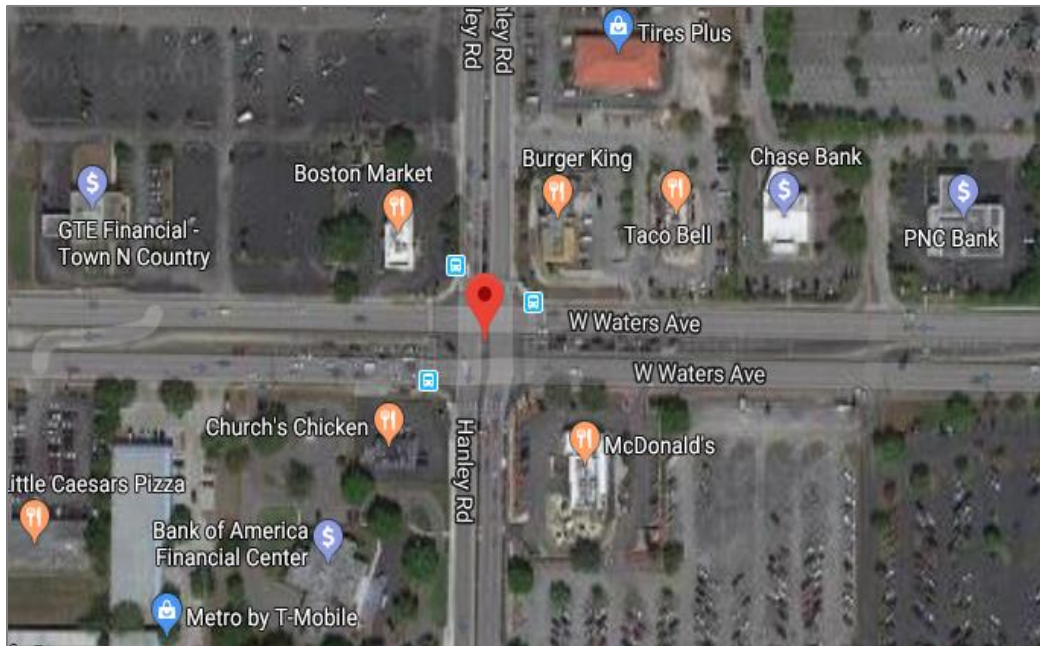
**Figure 8-61: Satellite image of intersection 30**



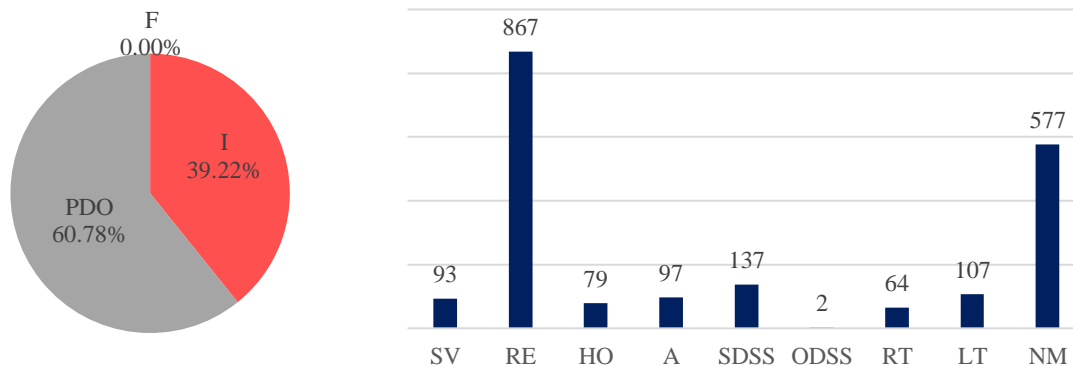
**Figure 8-62: Crash distribution by severity and EPDO distribution by crash type for intersection 30**

**Intersection 31: W Waters Ave & Hanley Rd**

- County: Hillsborough
- Major AADT: 50,250 / Minor AADT: 13,675
- EPDO PSI: 180
- Most Severe Crash Type: Rear-End
- Suggestions:
  - 1) MUT Type B to minimize rear-end crashes (CMF for rear-end is 0.49): rear-end crashes reduced by 51% and total EPDO reduced by 56%.
  - 2) RCUT to minimize total EPDO (CMF for FI is 0.57 and CMF for PDO is 0.84): total EPDO reduced by 76% and rear-end crashes reduced by 25%.



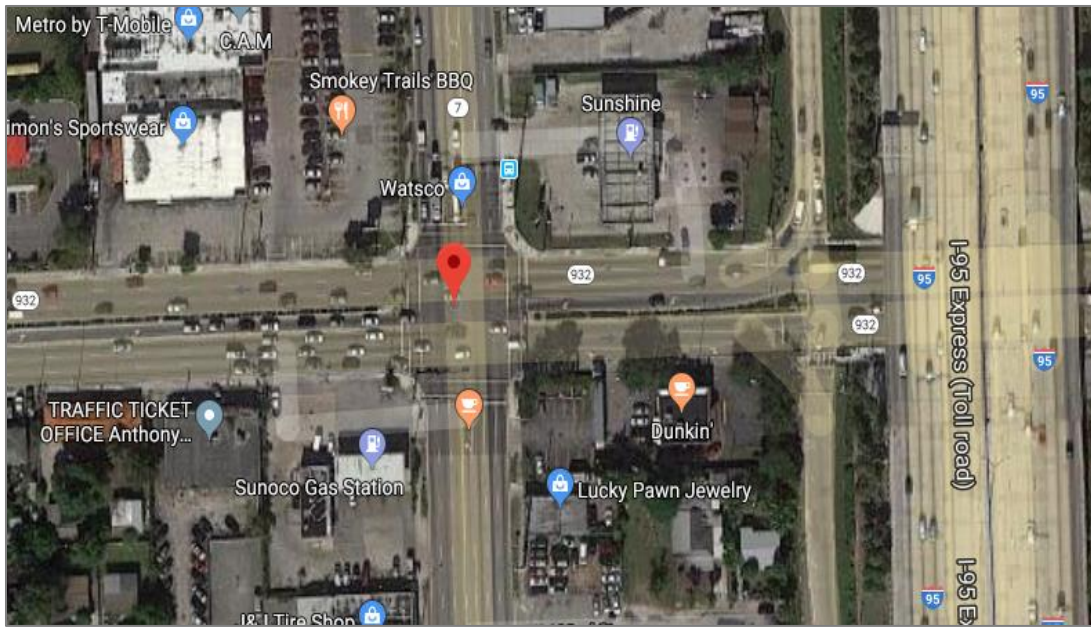
**Figure 8-63: Satellite image of intersection 31**



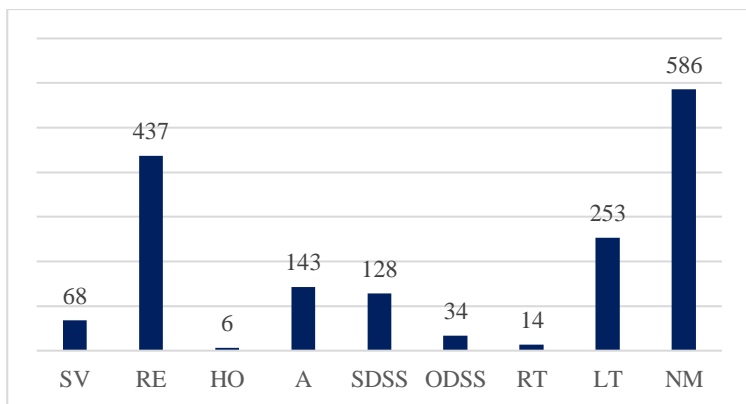
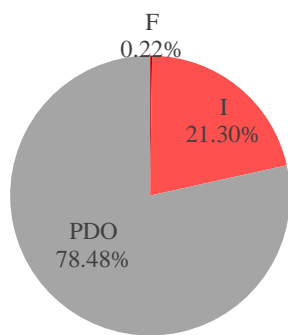
**Figure 8-64: Crash distribution by severity and EPDO distribution by crash type for intersection 31**

**Intersection 32:** NW 7th Ave & NW 103rd St

- County: Miami-Dade
- Major AADT: 32,000 / Minor AADT: 7,925
- EPDO PSI: 179.9
- Most Severe Crash Type: Non-Motorized
- Suggestions:
  - 1) CFI to minimize Non-Motorized crashes (CMF for Non-Motorized is 0.30): Non-Motorized crashes reduced by 70% and total EPDO increased by 32%.
  - 2) RCUT to minimize total EPDO (CMF for FI is 0.57 and CMF for PDO is 0.84): total EPDO reduced by 49%.



**Figure 8-65:** Satellite image of intersection 32



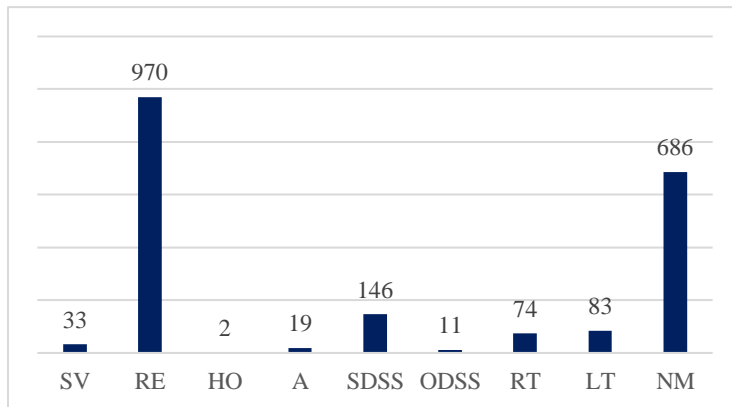
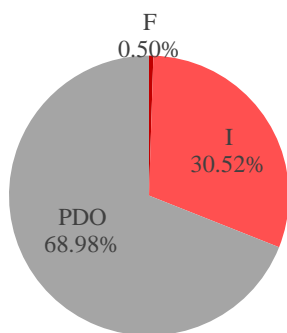
**Figure 8-66:** Crash distribution by severity and EPDO distribution by crash type for intersection 32

**Intersection 33: SR 54 & Little Rd**

- County: Pasco
- Major AADT: 52,375 / Minor AADT: 32,800
- EPDO PSI: 173.1
- Most Severe Crash Type: Rear-End
- Suggestions:
  - 1) MUT Type B to minimize rear-end crashes (CMF for rear-end is 0.49): rear-end crashes reduced by 51% and total EPDO reduced by 33%.
  - 2) RCUT to minimize total EPDO (CMF for FI is 0.57 and CMF for PDO is 0.84): total EPDO reduced by 44% and rear-end crashes reduced by 25%.



**Figure 8-67: Satellite image of intersection 33**

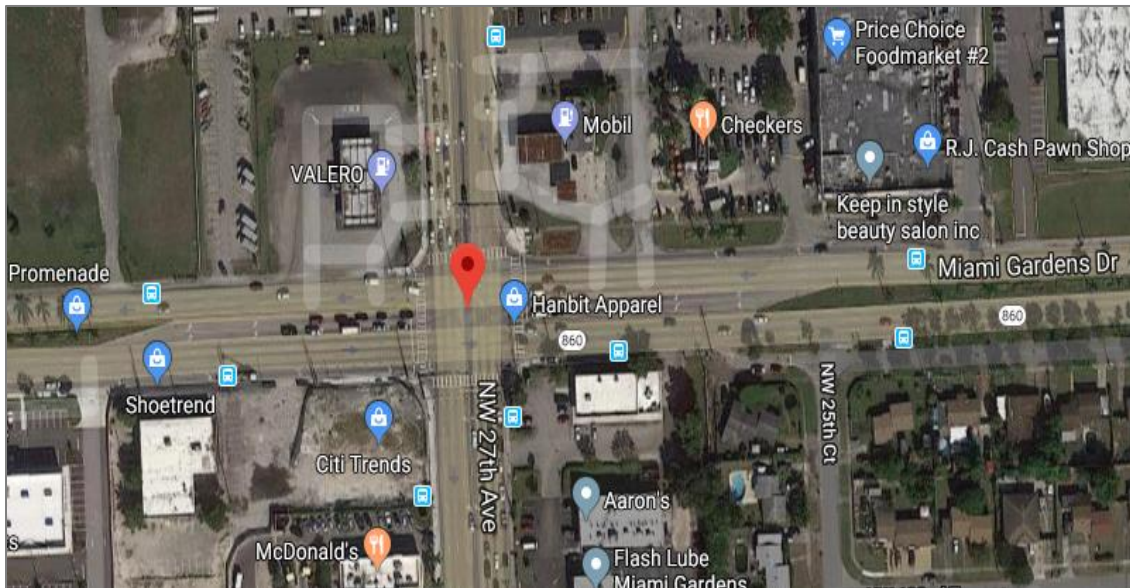


**Figure 8-68: Crash distribution by severity and EPDO distribution by crash type for intersection 33**

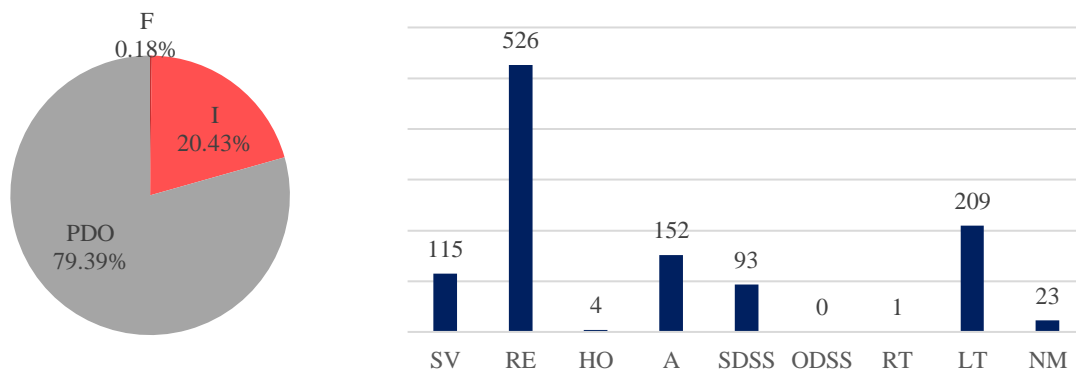


**Intersection 34:** NW 27th Ave & Miami Gardens Dr

- County: Miami-Dade
- Major AADT: 52,250 / Minor AADT: 29,500
- EPDO PSI: 172.1
- Most Severe Crash Type: Rear-End
- Suggestions:
  - 1) MUT Type B to minimize rear-end crashes (CMF for rear-end is 0.49): rear-end crashes reduced by 51% and total EPDO reduced by 40%.
  - 2) RCUT to minimize total EPDO (CMF for FI is 0.57 and CMF for PDO is 0.84): total EPDO reduced by 51% and rear-end crashes reduced by 25%.



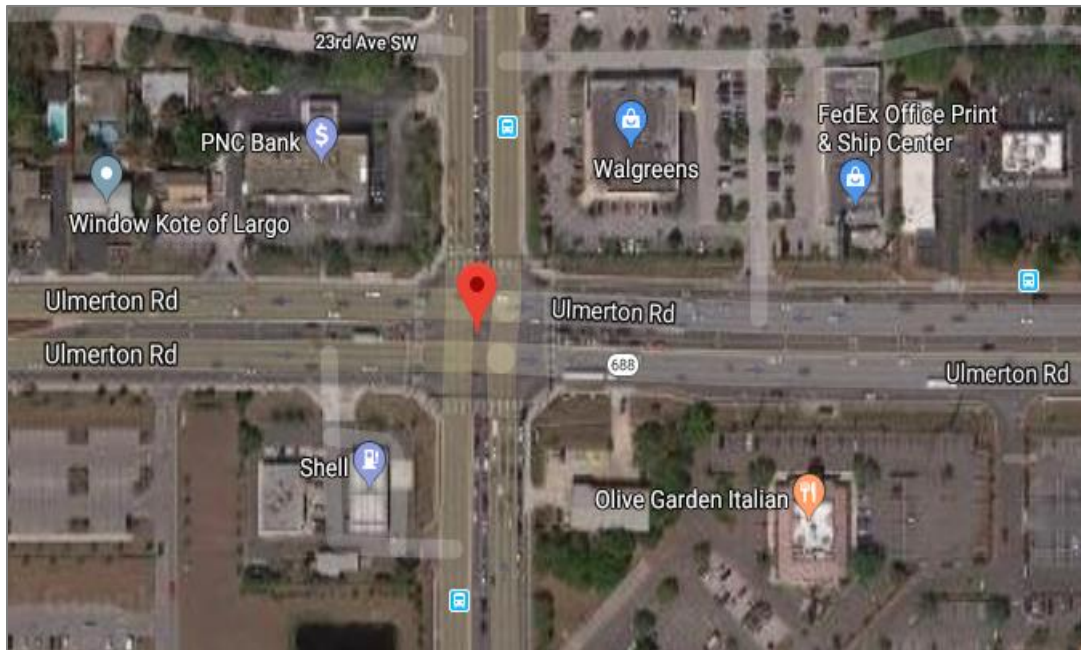
**Figure 8-69:** Satellite image of intersection 34



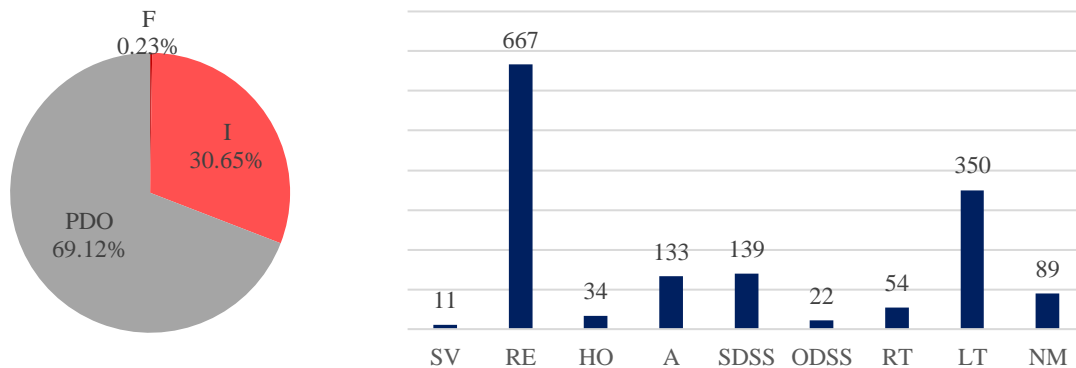
**Figure 8-70:** Crash distribution by severity and EPDO distribution by crash type for intersection 34

**Intersection 35:** Seminole Blvd & Ulmerton Rd

- County: Pinellas
- Major AADT: 50,625 / Minor AADT: 33,750
- EPDO PSI: 170.8
- Most Severe Crash Type: Rear-End
- Suggestions:
  - 1) MUT Type B to minimize rear-end crashes (CMF for rear-end is 0.49): rear-end crashes reduced by 51% and total EPDO reduced by 42%.
  - 2) RCUT to minimize total EPDO (CMF for FI is 0.57 and CMF for PDO is 0.84): total EPDO reduced by 56% and rear-end crashes reduced by 25%.



**Figure 8-71: Satellite image of intersection 35**



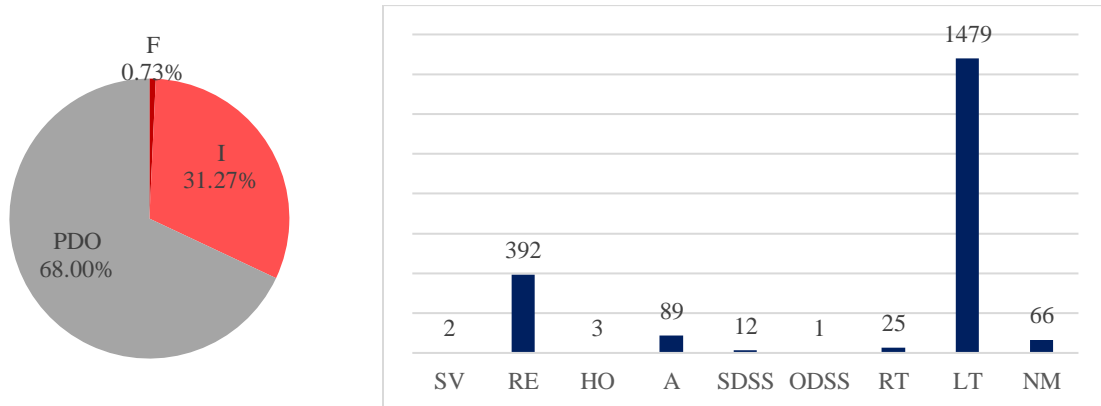
**Figure 8-72: Crash distribution by severity and EPDO distribution by crash type for intersection 35**

**Intersection 36:** US-90 & Chumuckla Hwy

- County: Santa Rosa
- Major AADT: 32,875 / Minor AADT: 2,725
- EPDO PSI: 169
- Most Severe Crash Type: Left-Turn
- Suggestions:
  - 1) Jughandle Type 1 to minimize left-turn crashes (CMF for left-turn is 0.19): left-turn crashes reduced by 81% and total EPDO reduced by 15%.
  - 2) RCUT to minimize total EPDO (CMF for FI is 0.57 and CMF for PDO is 0.84): total EPDO reduced by 38% and left-turn crashes reduced by 41%.



**Figure 8-73:** Satellite image of intersection 36



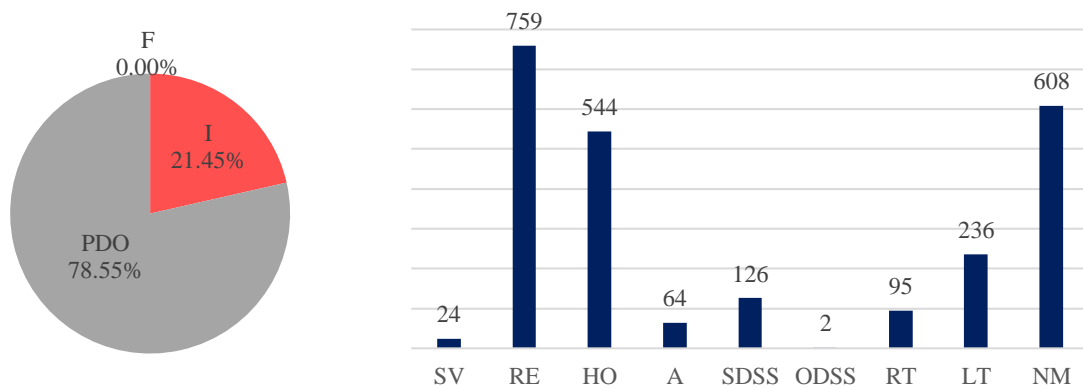
**Figure 8-74:** Crash distribution by severity and EPDO distribution by crash type for intersection 36

**Intersection 37: SR 716 & S Bayshore Blvd**

- County: St. Lucie
- Major AADT: 46,625 / Minor AADT: 1,663
- EPDO PSI: 164.9
- Most Severe Crash Type: Rear-End
- Suggestions:
  - 1) MUT Type B to minimize rear-end crashes (CMF for rear-end is 0.49): rear-end crashes reduced by 51% and total EPDO reduced by 53%.
  - 2) RCUT to minimize total EPDO (CMF for FI is 0.57 and CMF for PDO is 0.84): total EPDO reduced by 67% and rear-end crashes reduced by 25%.



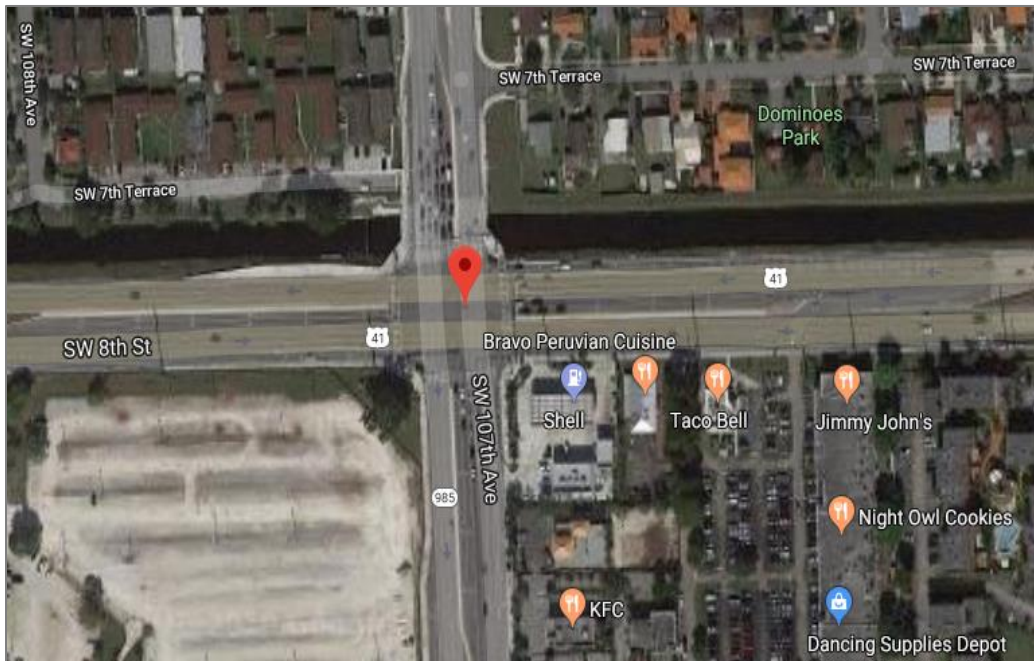
**Figure 8-75: Satellite image of intersection 37**



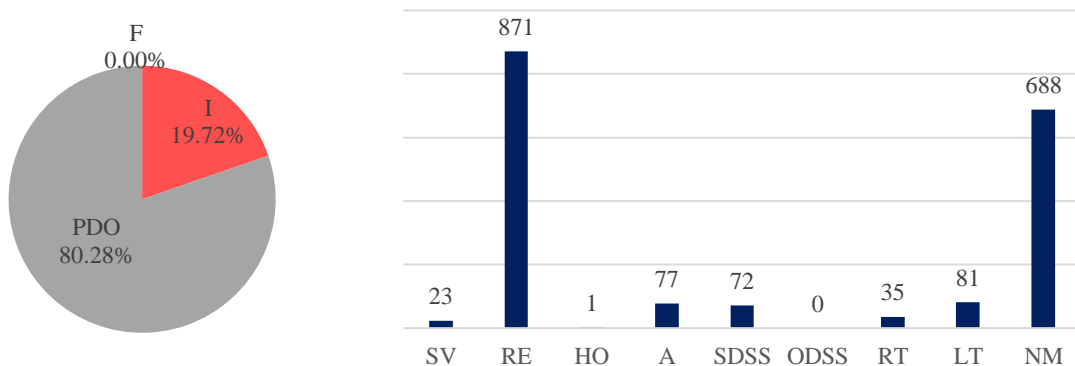
**Figure 8-76: Crash distribution by severity and EPDO distribution by crash type for intersection 37**

**Intersection 38:** SW 107th Ave & SW 8th St

- County: Miami-Dade
- Major AADT: 63,500 / Minor AADT: 36,625
- EPDO PSI: 163.2
- Most Severe Crash Type: Rear-End
- Suggestions:
  - 1) MUT Type B to minimize rear-end crashes (CMF for rear-end is 0.49): rear-end crashes reduced by 51% and total EPDO reduced by 53%.
  - 2) RCUT to minimize total EPDO (CMF for FI is 0.57 and CMF for PDO is 0.84): total EPDO reduced by 42% and rear-end crashes reduced by 25%.



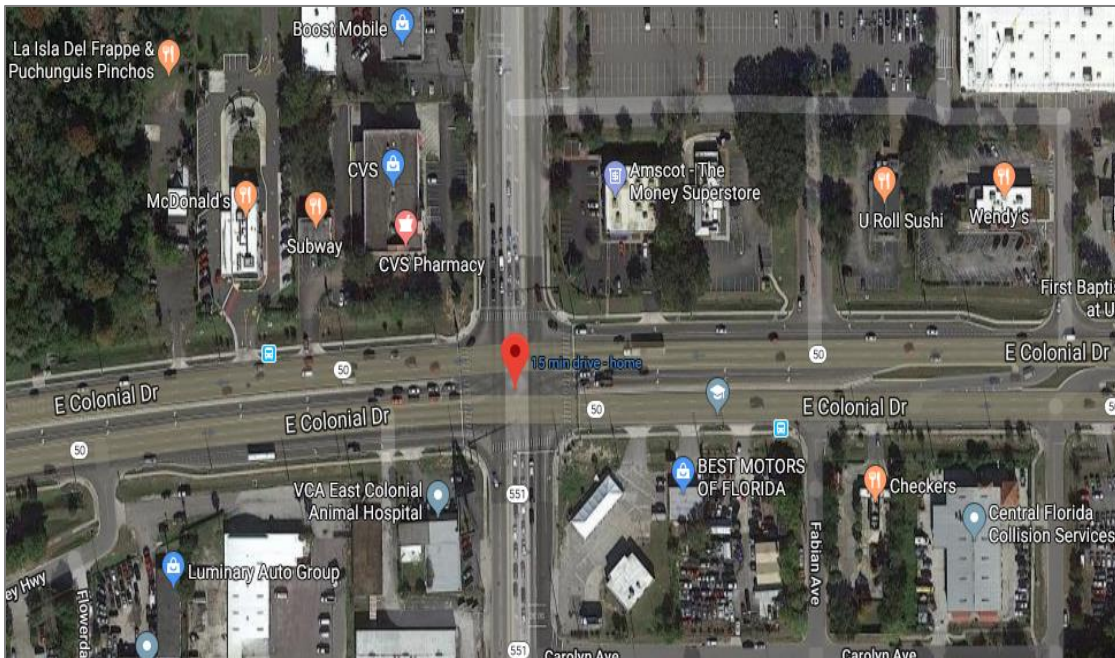
**Figure 8-77:** Satellite image of intersection 38



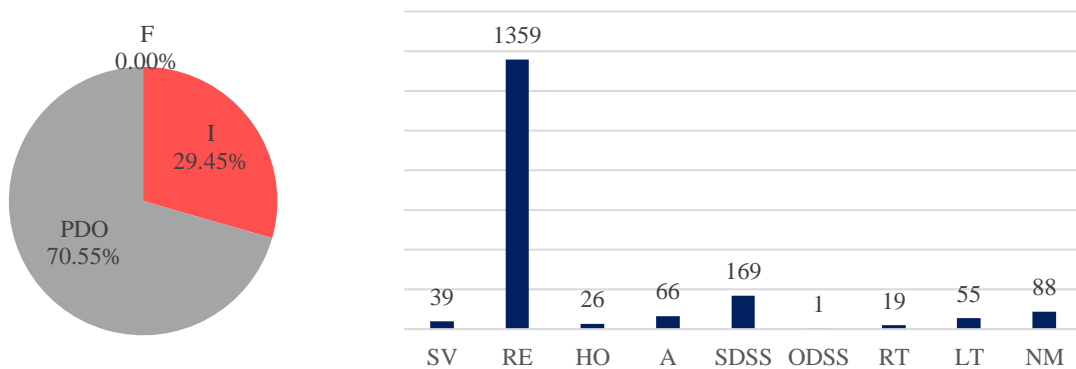
**Figure 8-78:** Crash distribution by severity and EPDO distribution by crash type for intersection 38

**Intersection 39: E Colonial Dr & N Goldenrod Rd**

- County: Orange
- Major AADT: 52,375 / Minor AADT: 30,875
- EPDO PSI: 163.1
- Most Severe Crash Type: Rear-End
- Suggestions:
  - 1) MUT Type B to minimize rear-end crashes (CMF for rear-end is 0.49): rear-end crashes reduced by 51% and total EPDO reduced by 54%.
  - 2) RCUT to minimize total EPDO (CMF for FI is 0.57 and CMF for PDO is 0.84): total EPDO reduced by 72% and rear-end crashes reduced by 25%.



**Figure 8-79: Satellite image of intersection 39**



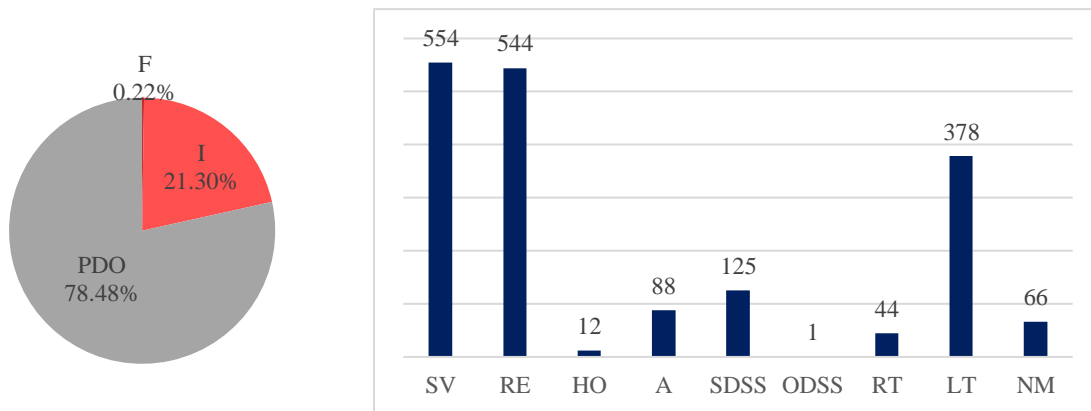
**Figure 8-80: Crash distribution by severity and EPDO distribution by crash type for intersection 39**

**Intersection 40: S Dixie Hwy & SW 184th St**

- County: Miami-Dade
- Major AADT: 51,125 / Minor AADT: 5,700
- EPDO PSI: 162.6
- Most Severe Crash Type: Single-Vehicle
- Suggestions:
  - 1) No alternative intersection type could be suggested because all the alternatives increase the single-vehicle crashes. Other countermeasures should be considered.
  - 2) RCUT to minimize total EPDO (CMF for FI is 0.57 and CMF for PDO is 0.84): total EPDO reduced by 49% and single-vehicle crashes increased by 31%.



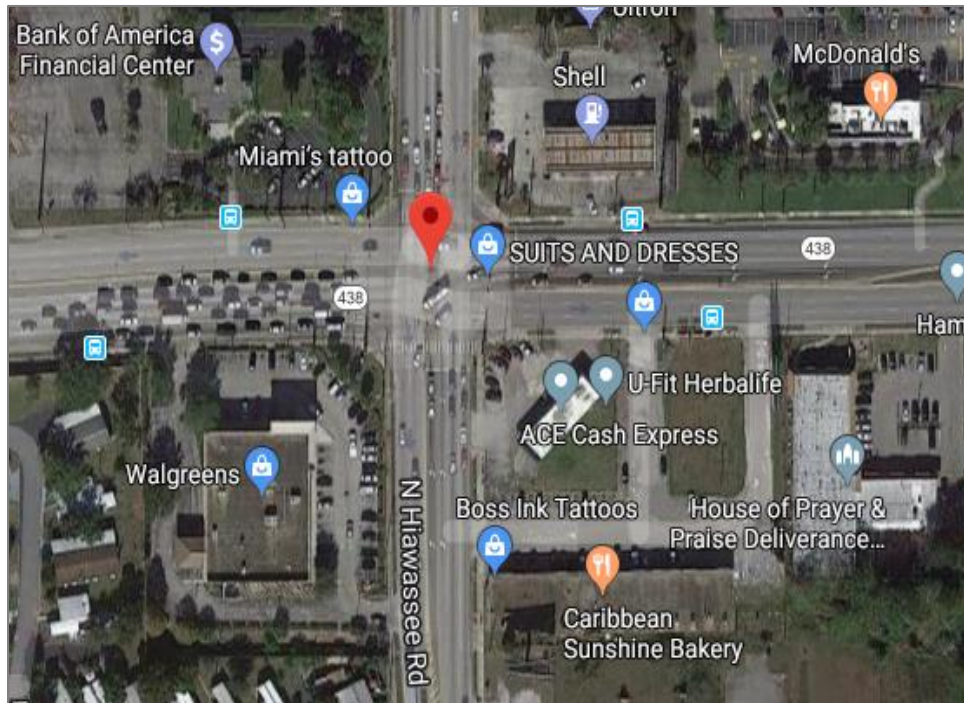
**Figure 8-81: Satellite image of intersection 40**



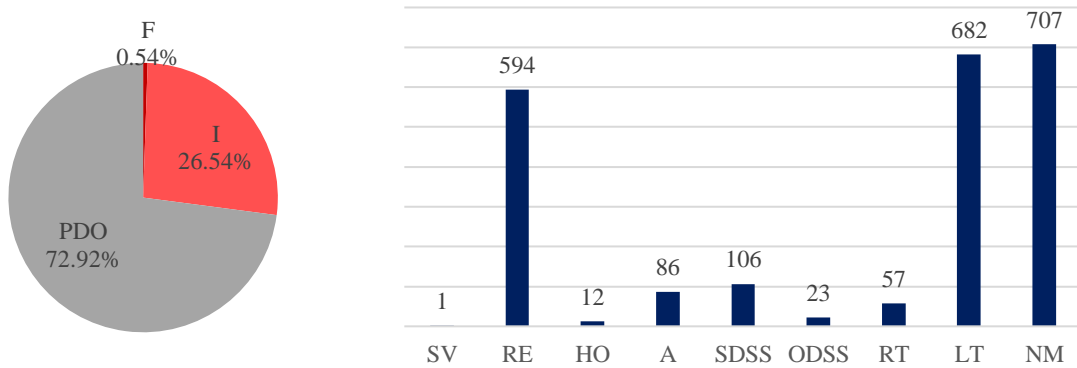
**Figure 8-82: Crash distribution by severity and EPDO distribution by crash type for intersection 40**

**Intersection 41:** Silver Star Rd & N Hiawasse Rd

- County: Orange
- Major AADT: 38,500 / Minor AADT: 19,325
- EPDO PSI: 162.2
- Most Severe Crash Type: Non-Motorized
- Suggestions:
  - 1) CFI to minimize Non-Motorized crashes (CMF for Non-Motorized is 0.30): Non-Motorized crashes reduced by 70% and total EPDO increased by 26%.
  - 2) RCUT to minimize total EPDO (CMF for FI is 0.57 and CMF for PDO is 0.84): total EPDO reduced by 40%.



**Figure 8-83:** Satellite image of intersection 41



**Figure 8-84:** Crash distribution by severity and EPDO distribution by crash type for intersection 41

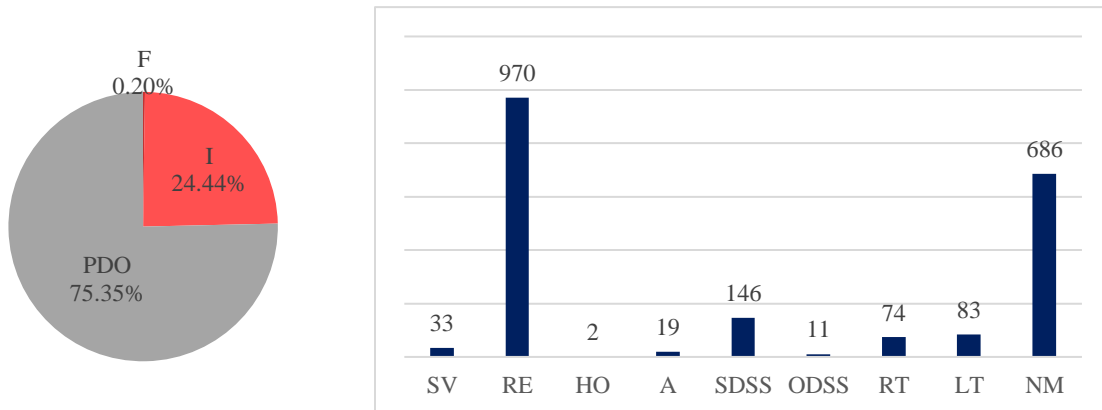


**Intersection 42:** Lake Worth Rd & Jog Rd

- County: Palm Beach
- Major AADT: 45,500 / Minor AADT: 37,750
- EPDO PSI: 160.9
- Most Severe Crash Type: Rear-End
- Suggestions:
  - 1) MUT Type B to minimize rear-end crashes (CMF for rear-end is 0.49): rear-end crashes reduced by 51% and total EPDO reduced by 41%.
  - 2) RCUT to minimize total EPDO (CMF for FI is 0.57 and CMF for PDO is 0.84): total EPDO reduced by 53% and rear-end crashes reduced by 25%.



**Figure 8-85:** Satellite image of intersection 42



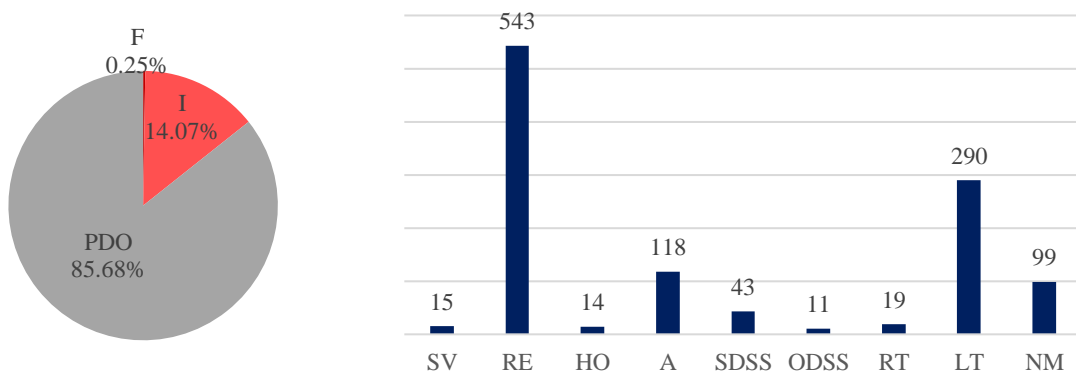
**Figure 8-86:** Crash distribution by severity and EPDO distribution by crash type for intersection 42

**Intersection 43:** Biscayne Blvd & NE 163rd St

- County: Miami-Dade
- Major AADT: 63,500 / Minor AADT: 52,125
- EPDO PSI: 159.7
- Most Severe Crash Type: Rear-End
- Suggestions:
  - 1) MUT Type B to minimize rear-end crashes (CMF for rear-end is 0.49): rear-end crashes reduced by 51% and total EPDO reduced by 33%.
  - 2) RCUT to minimize total EPDO (CMF for FI is 0.57 and CMF for PDO is 0.84): total EPDO reduced by 39% and rear-end crashes reduced by 25%.



**Figure 8-87:** Satellite image of intersection 43



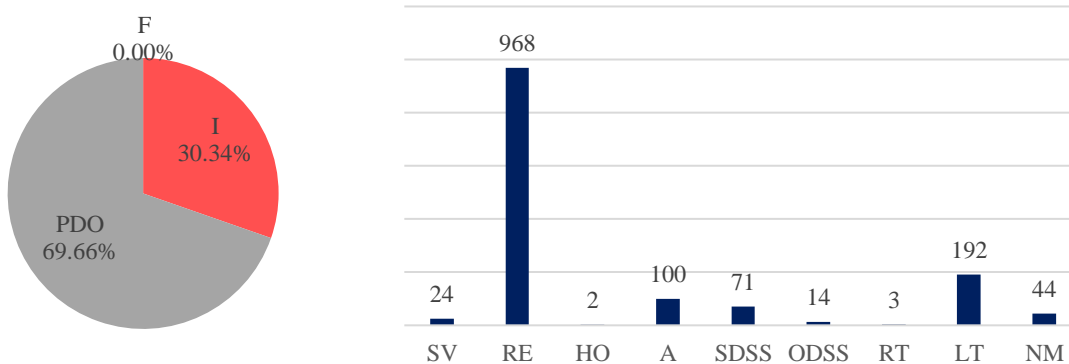
**Figure 8-88:** Crash distribution by severity and EPDO distribution by crash type for intersection 43

**Intersection 44: SR 134 & Ricker Rd**

- County: Duval
- Major AADT: 46,750 / Minor AADT: 9,050
- EPDO PSI: 158.7
- Most Severe Crash Type: Rear-End
- Suggestions:
  - 1) MUT Type B to minimize rear-end crashes (CMF for rear-end is 0.49): rear-end crashes reduced by 51% and total EPDO reduced by 55%.
  - 2) RCUT to minimize total EPDO (CMF for FI is 0.57 and CMF for PDO is 0.84): total EPDO reduced by 72% and rear-end crashes reduced by 25%.



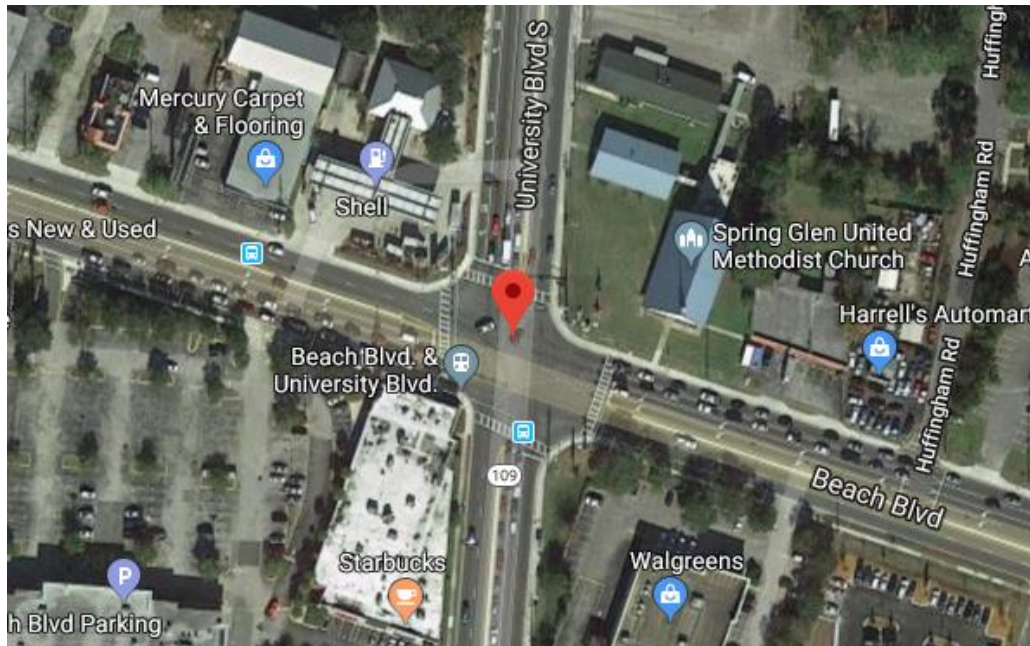
**Figure 8-89: Satellite image of intersection 44**



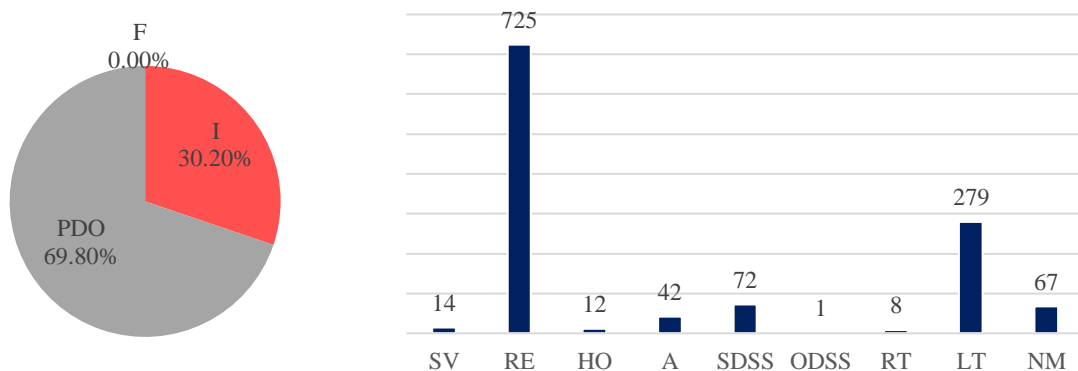
**Figure 8-90: Crash distribution by severity and EPDO distribution by crash type for intersection 44**

**Intersection 45:** Beach Blvd & University Blvd S

- County: Duval
- Major AADT: 32,500 / Minor AADT: 27,750
- EPDO PSI: 157.2
- Most Severe Crash Type: Rear-End
- Suggestions:
  - 1) MUT Type B to minimize rear-end crashes (CMF for rear-end is 0.49): rear-end crashes reduced by 51% and total EPDO reduced by 55%.
  - 2) RCUT to minimize total EPDO (CMF for FI is 0.57 and CMF for PDO is 0.84): total EPDO reduced by 72% and rear-end crashes reduced by 25%.



**Figure 8-91:** Satellite image of intersection 45



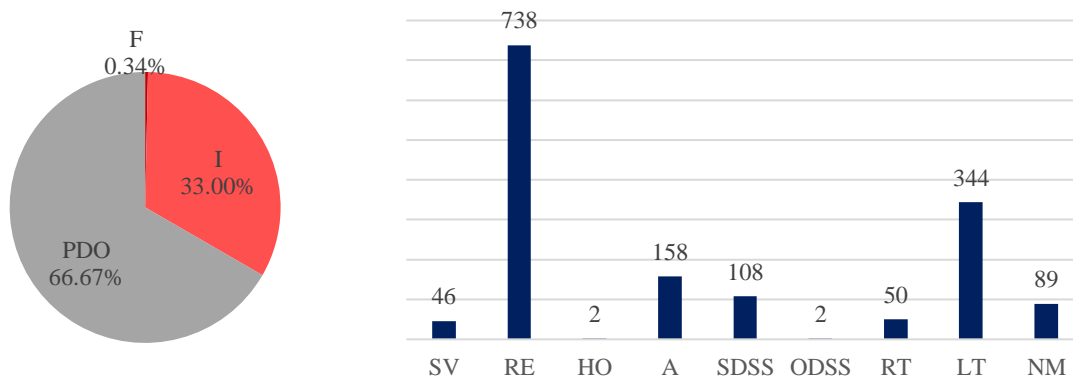
**Figure 8-92:** Crash distribution by severity and EPDO distribution by crash type for intersection 45

**Intersection 46: SR 60 & N Parsons Ave**

- County: Hillsborough
- Major AADT: 66,875 / Minor AADT: 1,000
- EPDO PSI: 157
- Most Severe Crash Type: Rear-End
- Suggestions:
  - 1) MUT Type B to minimize rear-end crashes (CMF for rear-end is 0.49): rear-end crashes reduced by 51% and total EPDO reduced by 39%.
  - 2) RCUT to minimize total EPDO (CMF for FI is 0.57 and CMF for PDO is 0.84): total EPDO reduced by 52% and rear-end crashes reduced by 25%.



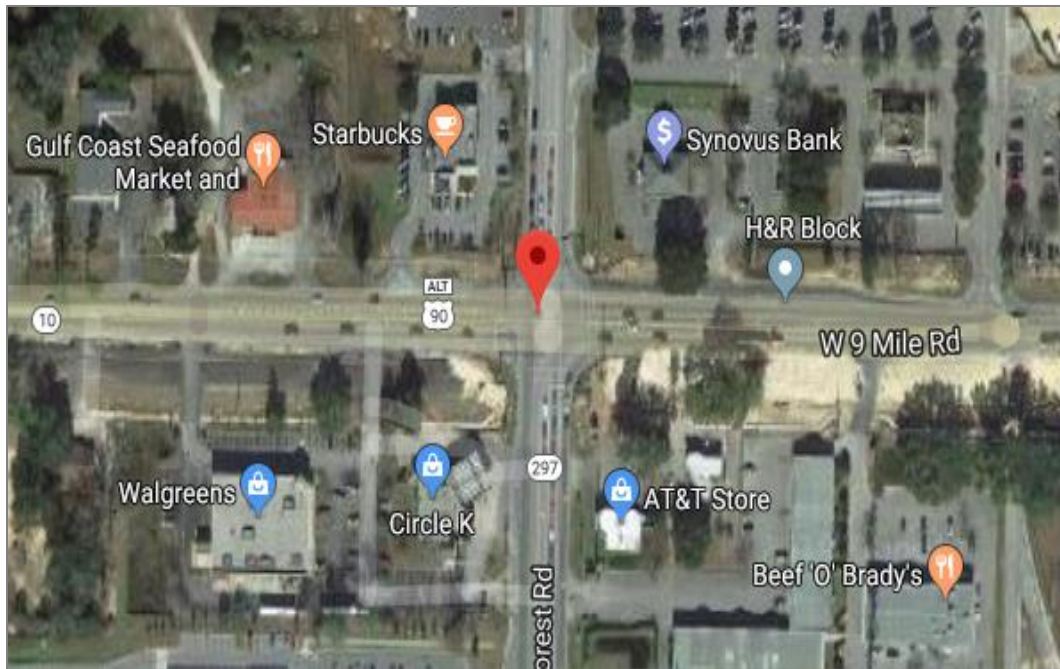
**Figure 8-93: Satellite image of intersection 46**



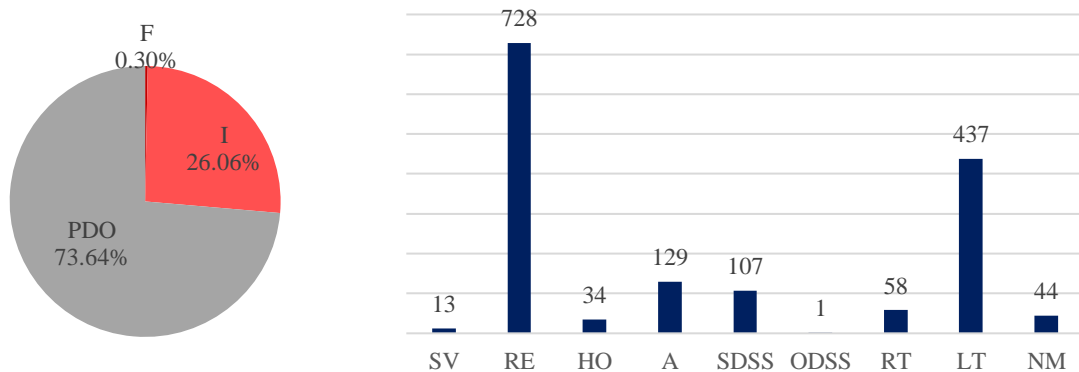
**Figure 8-94: Crash distribution by severity and EPDO distribution by crash type for intersection 46**

**Intersection 47:** W 9 Mile Rd & Pine Forest Rd

- County: Escambia
- Major AADT: 25,875 / Minor AADT: 13,125
- EPDO PSI: 156.6
- Most Severe Crash Type: Rear-End
- Suggestions:
  - 1) MUT Type B to minimize rear-end crashes (CMF for rear-end is 0.49): rear-end crashes reduced by 51% and total EPDO reduced by 37%.
  - 2) RCUT to minimize total EPDO (CMF for FI is 0.57 and CMF for PDO is 0.84): total EPDO reduced by 49% and rear-end crashes reduced by 25%.



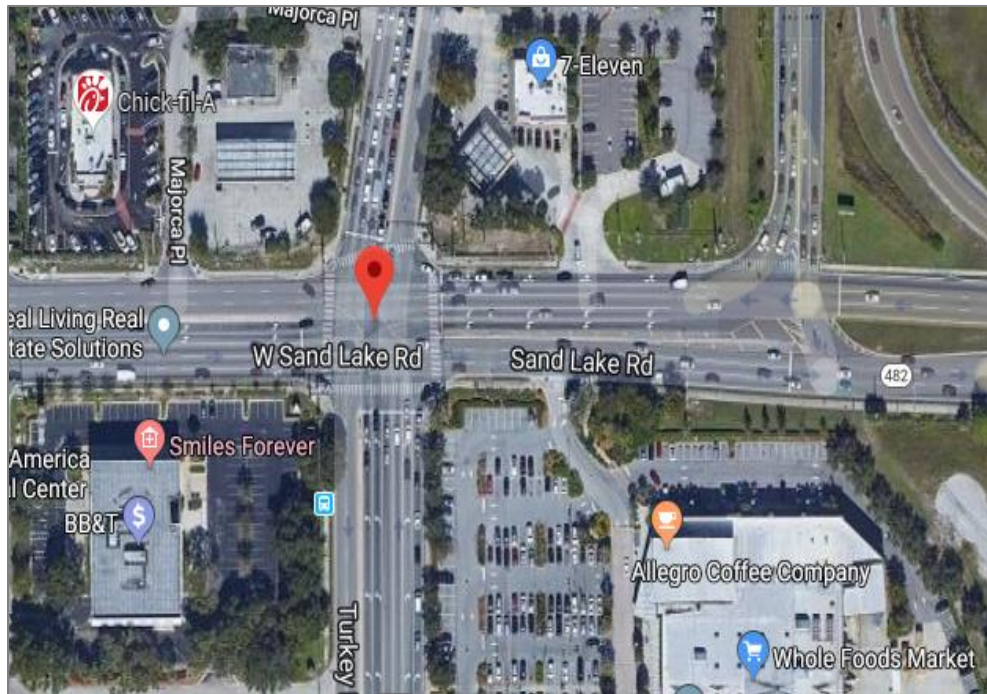
**Figure 8-95:** Satellite image of intersection 47



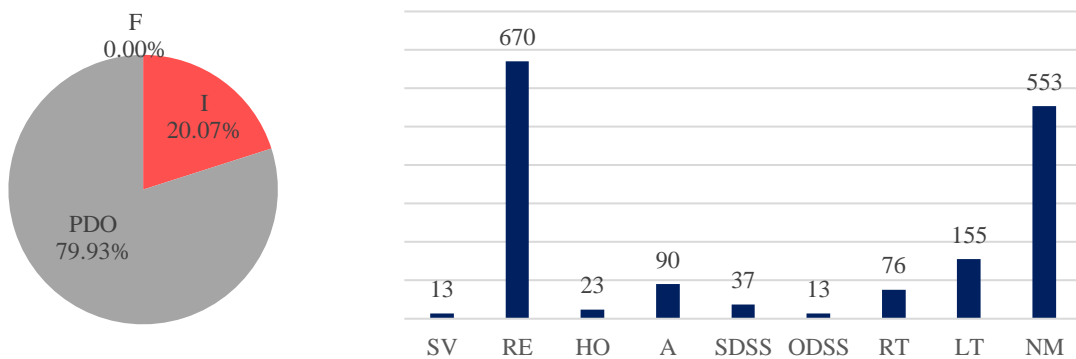
**Figure 8-96:** Crash distribution by severity and EPDO distribution by crash type for intersection 47

**Intersection 48:** Turkey Lake Rd & W Sand Lake Rd

- County: Orange
- Major AADT: 46,750 / Minor AADT: 24,625
- EPDO PSI: 156
- Most Severe Crash Type: Rear-End
- Suggestions:
  - 1) MUT Type B to minimize rear-end crashes (CMF for rear-end is 0.49): rear-end crashes reduced by 51% and total EPDO reduced by 53%.
  - 2) RCUT to minimize total EPDO (CMF for FI is 0.57 and CMF for PDO is 0.84): total EPDO reduced by 66% and rear-end crashes reduced by 25%.



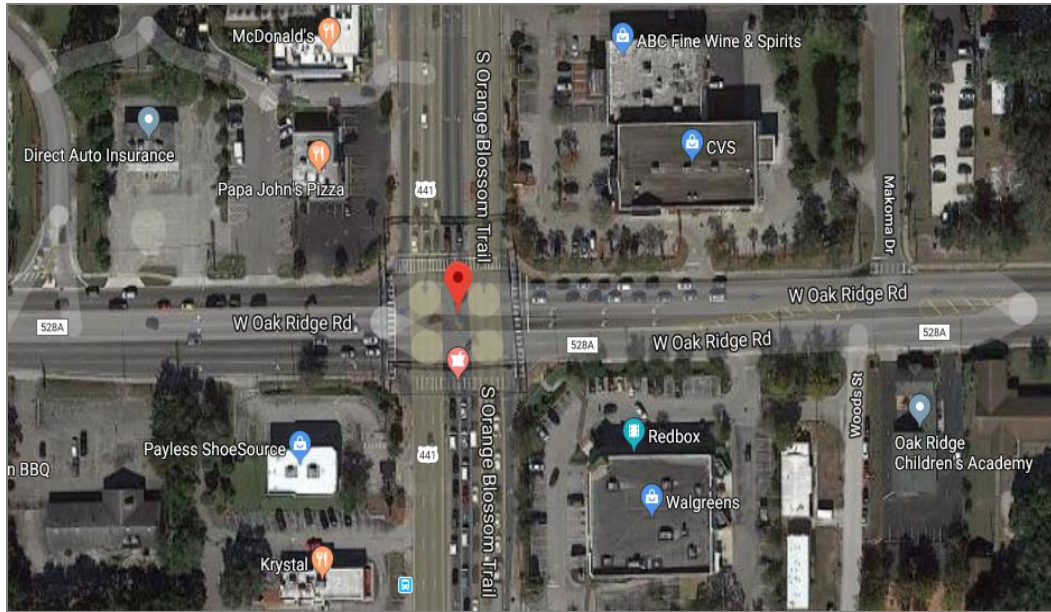
**Figure 8-97:** Satellite image of intersection 48



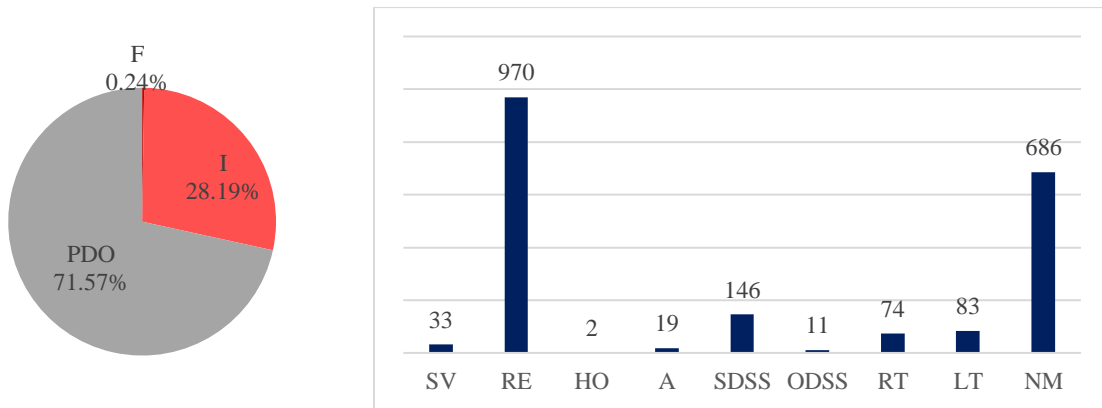
**Figure 8-98:** Crash distribution by severity and EPDO distribution by crash type for intersection 48

**Intersection 49: US-441 & W Oak Ridge Rd**

- County: Orange
- Major AADT: 59,500 / Minor AADT: 18,875
- EPDO PSI: 155
- Most Severe Crash Type: Rear-End
- Suggestions:
  - 1) MUT Type B to minimize rear-end crashes (CMF for rear-end is 0.49): rear-end crashes reduced by 51% and total EPDO reduced by 41%.
  - 2) RCUT to minimize total EPDO (CMF for FI is 0.57 and CMF for PDO is 0.84): total EPDO reduced by 54% and rear-end crashes reduced by 25%.



**Figure 8-99: Satellite image of intersection 49**

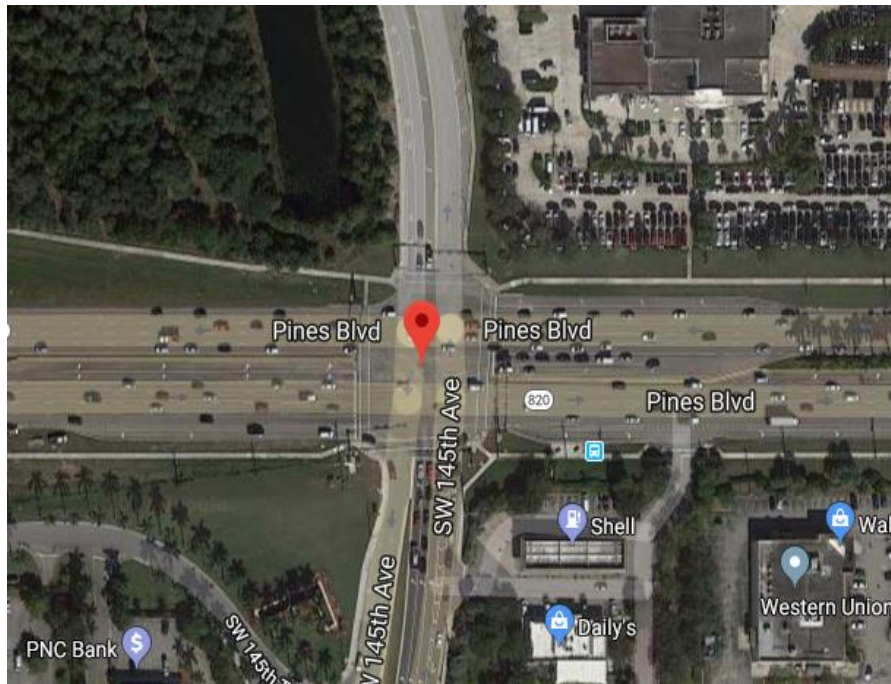


**Figure 8-100: Crash distribution by severity and EPDO distribution by crash type for intersection 49**

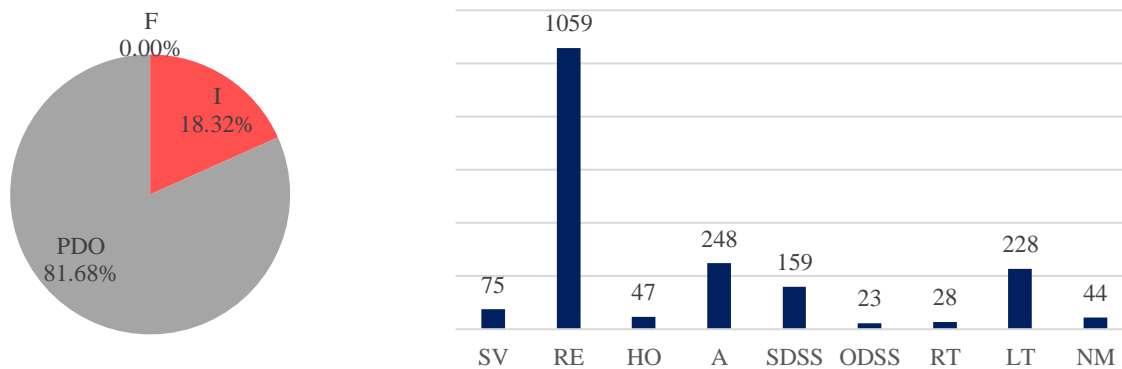


**Intersection 50:** Pines Blvd & SW 145th Ave

- County: Broward
- Major AADT: 81,500 / Minor AADT: 6,650
- EPDO PSI: 153.0
- Most Severe Crash Type: Rear-End
- Suggestions:
  - 3) MUT Type B to minimize rear-end crashes (CMF for rear-end is 0.49): rear-end crashes reduced by 51% and total EPDO reduced by 27%.
  - 4) RCUT to minimize total EPDO (CMF for FI is 0.57 and CMF for PDO is 0.84): total EPDO reduced by 64% and rear-end crashes reduced by 25%.



**Figure 8-101:** Satellite image of intersection 50



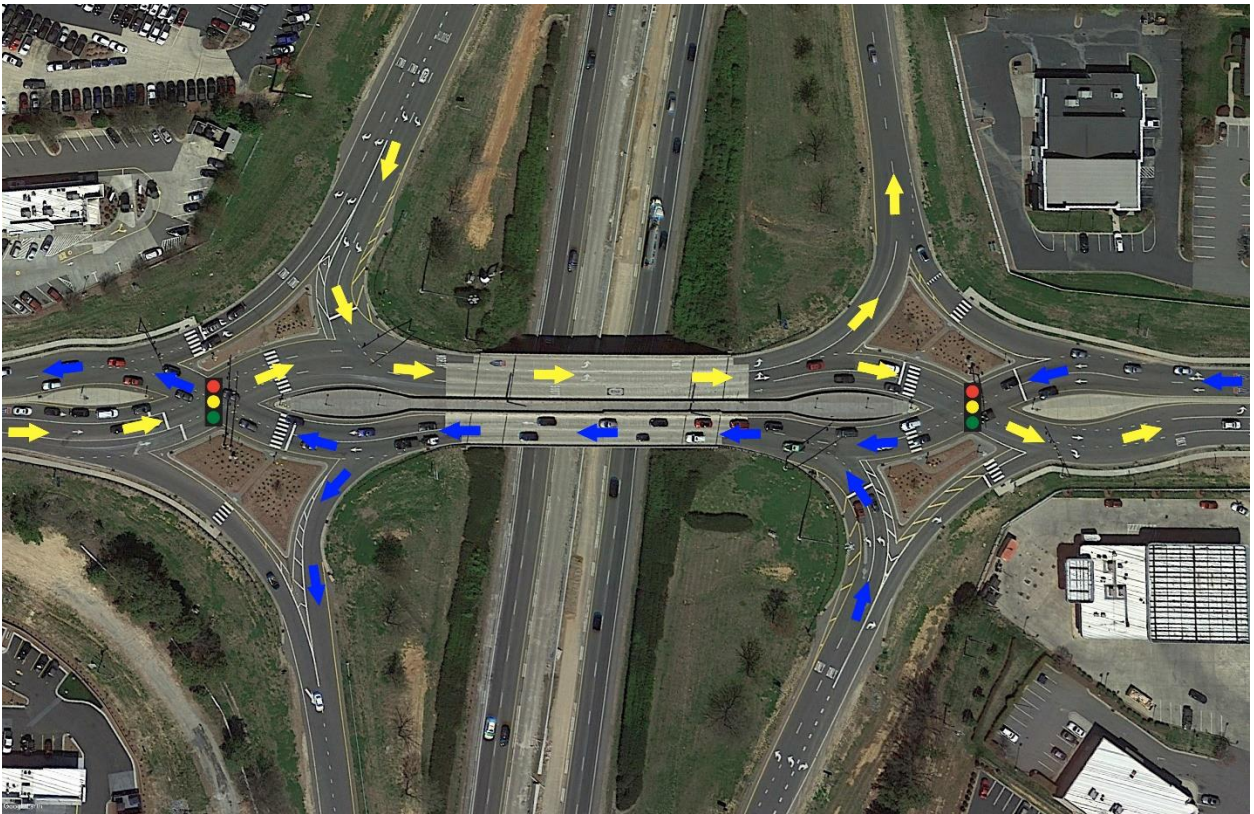
**Figure 8-102:** Crash distribution by severity and EPDO distribution by crash type for intersection 50

### **8.3. SUMMARY AND CONCLUSIONS**

In this chapter, traffic and crash data for more than 4,500 4-leg signalized intersections in Florida were processed to identify hotspots, which are the most dangerous fifty intersections, in terms of EPDO (equivalent property damage only). This was achieved by adopting the Excess Expected Average Crash Frequency with EB Adjustments method, which is suggested by the Highway Safety Manual (AASHTO, 2010). Subsequently, each selected hot intersection was analyzed in detail for its most problematic crash types and suggested alternative intersections to alleviate the specific problem(s). It was found that rear-end crashes are the most frequent problematic crash type at hot intersections. Two alternative intersections were suggested to reduce the problematic crash type and the overall EPDO value. MUT Type B, Jughandle Type 1, CFI, and RCUT intersections were recommended for implementation to effectively reduce rear-end, left-turn, non-motorized, and angle crashes, respectively. Furthermore, RCUT intersections are recommended for reducing overall EPDO value, which could reduce the overall EPDO value by ~76%.

## 9. SAFETY EVALUATION OF DIVERGING DIAMOND INTERCHANGES

The diverging diamond interchange (DDI) is a popular alternative interchange design for improving traffic flow and reducing congestion. It is similar to the conventional diamond interchange except for how the left and through movements navigate between the ramp terminals. The purpose of this interchange design is to accommodate left-turning movements onto arterials and limited-access freeways while eliminating the need for a left-turn bay and a signal phase at the signalized ramp terminals. Figure 9-1 shows the typical movements that are accommodated in a DDI. The freeway is connected to the arterial by two on-ramps and two off-ramps in a manner similar to that of a conventional diamond interchange.



**Figure 9-1: Different traffic movements at a typical DDI design (I-77 & Catawba Ave, Cornelius, North Carolina)**

However, the main difference between a DDI and a conventional diamond interchange is the existence of crossovers on both sides of the interchange, which excludes the need for left-turning vehicles to cross the approaching through vehicles. This is achieved by shifting cross street traffic to the left side of the street between the signalized crossover intersections.

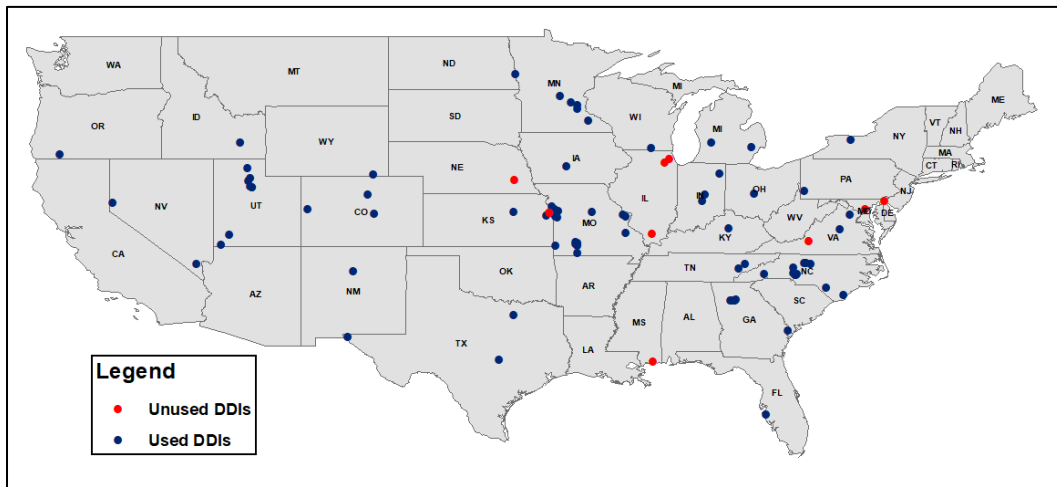
### **9.1. DATA PROCESSING FOR DIVERGING DIAMOND INTERCHANGES**

As of August 2019, there are 99 DDIs across the country with different years of implementation; consequently, intensive efforts were conducted to collect data regarding such a big sample size. However, not all of these DDIs are valid for the analysis because 10 DDIs were recently implemented in 2019 or 2018 with no enough crash data after their implementation. Moreover, 4 DDIs were designed to be different from the regular DDI. For example, partial or 3-leg DDIs, as shown in Figure 9-2. As a result, the remaining number of DDIs is 85, which are located in 27 states.



**Figure 9-2: Example of irregular DDI (Baltimore-Washington Pkwy & Arundel Mills Blvd, Maryland)**

The research team contacted the DOTs of the 27 states asking for multi-year crash and traffic data. Most of them responded and provided the requested data. However, few states were not able to grant the team access to the required data, which are Delaware, Nebraska, and Illinois. It should be noted that Illinois DOT provided the crash data before the DDIs' implementation, which is not sufficient for the proposed analysis. To the end, a total of 80 DDIs in 24 states were considered in this study, as shown in Figure 9-3.



**Figure 9-3: The distribution of used and unused DDIs over the states**

Table 9-1 shows the number of DDIs in each state, as well as the first year of implementation and the available years of crash data. It shows that most of the DDIs (52 out of 80) are located in 6 states, i.e., Missouri, North Carolina, Utah, Minnesota, Georgia, and Kansas. It also shows that some DDIs were implemented as early as 2009. However, in any case, the research team ensured that there is at least one year of crash data available before or after the DDI's implementation.

**Table 9-1: DDI frequency and available crash data by state**

<b>State</b>	<b>Number of Considered DDIs</b>	<b>The Year of Implementation (number of DDIs)</b>	<b>Years of Crash Data</b>
<b>Missouri</b>	18	2009(1), 2010(2), 2011(1), 2012(4), 2013(5), 2014(1), 2015(1), 2016(3)	2002-2018
<b>North Carolina</b>	11	2014(3), 2015(4), 2016(3), 2017(1)	2003-2019
<b>Utah</b>	8	2010(1), 2011(3), 2013(1), 2014(2), 2015(1)	2010-2019
<b>Minnesota</b>	6	2013(3), 2014(1), 2015(1), 2016(1)	2010-2018
<b>Georgia</b>	5	2012(1), 2013(1), 2015(1), 2017(2)	2009-2018
<b>Kansas</b>	4	2013(1), 2014(1), 2015(1), 2016(1)	2010-2018
<b>Colorado</b>	3	2014(1), 2015(1), 2016(1)	2005-2018
<b>Indiana</b>	3	2014(1), 2015(1), 2017(1)	2007-2018
<b>Texas</b>	3	2014(1), 2015(1), 2016(1)	2010-2019
<b>Virginia</b>	2	2014(1), 2016(1)	2011-2018
<b>Michigan</b>	2	2015(1), 2016(1)	2008-2018
<b>Nevada</b>	2	2012(1), 2015(1)	2009-2017
<b>Tennessee</b>	2	2010(1), 2015(1)	2007-2018
<b>Florida</b>	1	2017(1)	2010-2018
<b>Iowa</b>	1	2015(1)	2009-2019
<b>Idaho</b>	1	2013(1)	2010-2018
<b>Kentucky</b>	1	2011(1)	2009-2019
<b>New Mexico</b>	1	2016(1)	2010-2018
<b>New York</b>	1	2012(1)	2009-2018
<b>Ohio</b>	1	2013(1)	2007-2015
<b>Oregon</b>	1	2016(1)	2007-2017
<b>Pennsylvania</b>	1	2016(1)	1998-2018
<b>Wisconsin</b>	1	2016(1)	2011-2019
<b>Wyoming</b>	1	2013(1)	2007-2017

For every treatment site, several comparison or reference sites were selected. Since most of the DDIs were conventional diamond interchange before being converted, the comparison sites were also selected from the conventional diamond interchanges. For each DDI, three comparison sites that have similar AADT values were selected. In total, 240 comparison diamond interchanges were selected for the 80 DDIs.

It should be noted that this sample is not valid for all types of analysis methods that are proposed in this study. The full sample is valid only for the cross-sectional analysis, which only focuses on

the treatment sites after their implementation, regardless of what they were before that. On the other hand, the before-and-after approaches look at the crash frequencies before and after the treatment implementation. In our case, not all the DDIs were diamond Interchanges before converting them to DDIs. The majority were diamond interchanges, while some of them were other types (i.e., cloverleaf interchange, intersection) or not even a junction.

Table 9-2 shows the number of DDIs by the type before implementation. It shows that most of the DDIs (65 out of 80) were conventional diamond interchanges, and 7 DDIs were not even junctions at all, as shown in Figure 9-4. To sum up, different numbers of DDIs were utilized for different analyses. Specifically, 80 DDIs were used for the cross-sectional analysis, while 65 DDIs were used for the before-and-after analysis.

**Table 9-2: Configuration type of the treated sites before being converted to DDI**

<b>DDIs number</b>	<b>Type before implementation</b>
65	diamond interchange
7	Not junction
3	At-grade intersection
2	Full Cloverleaf interchange
2	Partial Cloverleaf interchange
1	Irregular diamond interchange

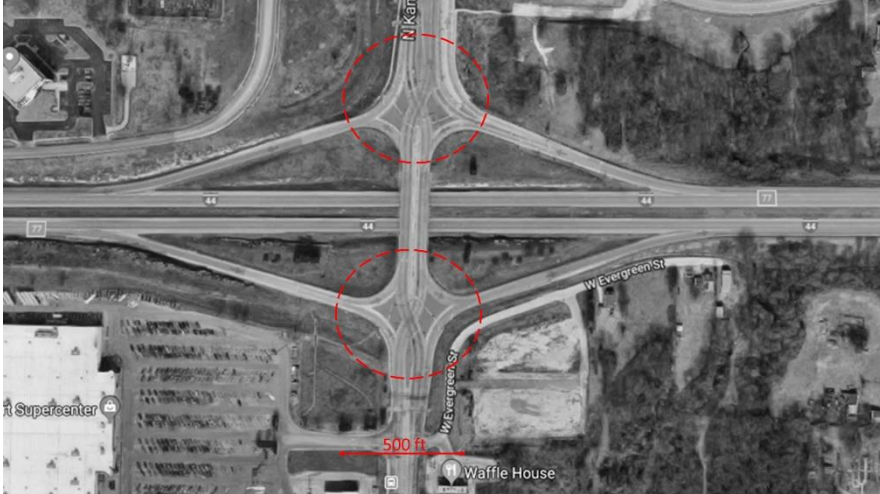
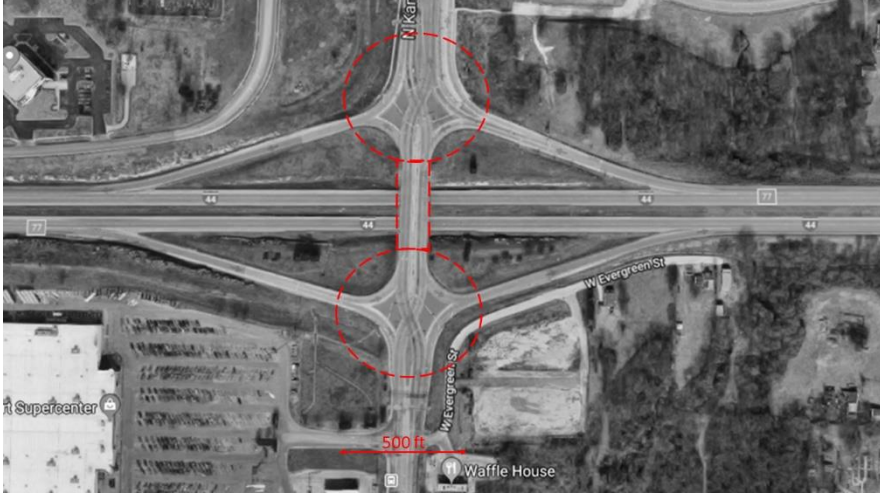
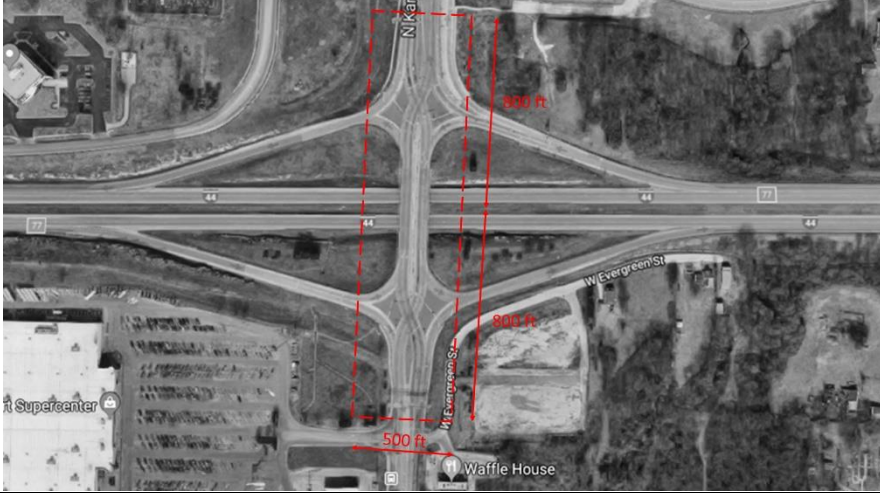


**Figure 9-4: Example of not-junction facility before a DDI implementation (I-65 & Worthsville Road, Greenwood, Indiana)**

In order to calculate the crash frequency at the designated interchanges, a crash influence area should be determined. Since the purpose of this study is to address the safety effects of converting the diamond interchange to DDI, the research team only focused on the crash frequencies at the crossovers/ramp terminals, which are the main differences between DI and DDI. Three different scenarios were proposed for the crash influence area based on the literature review, as shown in Figure 9-5:

- 1) 250 feet buffer from the center of each crossover/ramp terminal (Bonneson et al., 2012)
- 2) 250 feet buffer from the center of each crossover/ramp terminal in addition to the segment between the crossovers
- 3) A large buffer covering 800 feet along the arterial from the freeway centerline in both directions (Nye et al., 2019)



Scenario Number	Crash Influence Area
1	 <p>An aerial photograph of a road intersection. A red circle is drawn around the intersection, with a red line and the text "500 ft" indicating its radius. The intersection is labeled "N Kat" and "W Evergreen St". Other labels include "Supercenter" and "Waffle House".</p>
2	 <p>An aerial photograph of a road intersection, identical to the one in Scenario 1. A red circle is drawn around the intersection, with a red line and the text "500 ft" indicating its radius. The intersection is labeled "N Kat" and "W Evergreen St". Other labels include "Supercenter" and "Waffle House".</p>
3	 <p>An aerial photograph of a road intersection, identical to the ones in Scenarios 1 and 2. A red circle is drawn around the intersection, with a red line and the text "500 ft" indicating its radius. Additionally, a red rectangle is drawn around the intersection, with a red line and the text "300 ft" indicating its width. The intersection is labeled "N Kat" and "W Evergreen St". Other labels include "Supercenter" and "Waffle House".</p>

**Figure 9-5: Different proposed crash influence areas**

The first scenario is based on the NCHRP project No. 17-45 (Bonneson et al., 2012), while the third scenario is based on Nye et al. (2019). It should be noted that the second scenario is the same as the first one but include the roadway between the crossovers/ramp terminals, which may have a significant effect on crash frequency. To select the most appropriate scenario, statistical significance tests were conducted to compare the average crash frequencies of each scenario by crash type, as shown in Table 9-3. The null hypothesis of the t-test assumes there is no difference between the two scenarios. The table shows that there is no strong evidence to reject the null hypothesis when comparing the 1<sup>st</sup> and 2<sup>nd</sup> scenarios. On the other hand, there is a significant difference between the crash frequencies of the 1<sup>st</sup> and the 3<sup>rd</sup> scenarios for most crash types and severities.

**Table 9-3: Comparison between the different scenarios of crash influence area**

<b>Crash Type</b>	<b>Scenario 1 Avg. Crash Frequency</b>	<b>Scenario 2 Avg. Crash Frequency</b>	<b>Scenario 3 Avg. Crash Frequency</b>	<b>P-value of t- test (1) vs. (2)</b>	<b>P-value of t- test (1) vs. (3)</b>
<b>Total</b>	19.855	20.396	25.361	0.642	0.021**
<b>Fatal</b>	0.035	0.042	0.049	0.315	0.963
<b>Injury</b>	4.435	4.489	6.632	0.723	0.047**
<b>PDO</b>	15.404	17.523	19.102	0.932	0.038**
<b>Rear-end</b>	9.991	10.214	13.521	0.423	0.087*
<b>Angle/Left-turn</b>	4.551	5.634	7.301	0.842	0.067*
<b>Sideswipe</b>	2.121	2.642	2.932	0.963	0.253
<b>Head-on</b>	0.363	0.389	0.399	0.421	0.975
<b>Non-motorized</b>	0.051	0.069	0.091	0.652	0.042**
<b>Single-vehicle</b>	2.188	3.301	3.964	0.512	0.083*

\*\*\* significant at 99%, \*\* significant at 95%, and \* significant at 90%.

Based on the statistical significance tests, the team decided to select the 1st scenario for calculating the crash frequencies. Although the 3rd scenario has a significant difference from the 1st scenario, the team believes that it may be not appropriate in this study because the distance 1600 feet could cover the adjacent intersections in case of the crossovers' distance is relatively

short. Figure 9-6 shows an example of a DDI where the crossovers' distance is around 300 feet, and the distance between the two adjacent intersections is less than 1600 feet.



**Figure 9-6: Example of a DDI with a relatively short crossovers' distance (I-29 & Tiffany Springs Pkwy, Kansas City, Missouri)**

Based on the selected crash influence area, the yearly number of crashes was calculated at the DDIs and the comparison diamond interchanges by crash type. The descriptive statistics of the crash data are shown in Table 9-4. It should be noted that the average crash frequency was calculated by averaging over the years and the locations. As shown in Table 9-4, the average crash frequencies of the DDIs are lower than that of the comparison diamond interchanges for most crash types, which may imply that the DDIs are safer than the conventional diamond interchanges. However, this is not strong evidence, and more reliable statistical analyses should be conducted.

**Table 9-4: Crash data descriptive statistics**

Variable	diamond interchange (N=240)				DDI (N=80)			
	Mean	Stdev	Min	Max	Mean	Stdev	Min	Max
<b>Total</b>	21.744	24.450	0.154	107.307	19.855	22.459	0.231	82
<b>Fatal</b>	0.026	0.047	0	0.154	0.035	0.051	0	0.151
<b>Injury</b>	5.093	5.405	0.077	18.923	4.435	4.612	0.013	15.54
<b>PDO</b>	16.625	19.421	0.077	90.154	15.404	18.072	0.154	66.464
<b>Rear-end</b>	10.332	13.042	0.145	53.462	9.991	12.442	0.211	51
<b>Angle/Left-turn</b>	5.378	6.323	0.154	27.615	4.551	4.902	0.114	13.701
<b>Sideswipe</b>	1.923	2.775	0.113	14.231	2.121	3.012	0.012	10.85
<b>Head-on</b>	0.509	0.715	0	3.769	0.363	0.391	0	1.231
<b>Non-motorized</b>	0.043	0.070	0	0.231	0.051	0.074	0	0.232
<b>Single-vehicle</b>	2.764	3.314	0	14.769	2.188	2.252	0.077	7.462

Moreover, many explanatory variables were identified and collected, including the AADTs of the freeway and the arterial, speed limits, the number of lanes for each traffic movement, skew angle, and lighting. It should be noted that arterial AADTs were available for all the 80 DDIs and their comparison sites, while only 47 DDIs and their comparison sites were provided with freeway ramp AADTs. To balance the effects of sample size and the completeness of AADT, two modeling strategies were considered in developing SPFs. The first strategy includes all the 80 DDIs and their comparison sites with only arterial AADTs. The second strategy includes 47 DDIs and their comparison sites with the consideration of total vehicles entering the DDI (TEV), which is the summation of the AADTs of the freeway exit ramps and the arterial. Other important factors that are related to the geometric configuration of DDIs were also considered, such as crossovers' distance and configuration type. The crossovers' distance indicates the distance between

crossovers in the case of DDI and the distance between ramp terminals in the case of the conventional diamond interchange. The configuration type indicates whether the interchange is overpass or underpass, which means the arterial passes over or under the freeway.

To address the effect of the adjacent intersections on the safety performance of DDIs, the distance to the adjacent intersection was considered as an explanatory variable to be included in the developed safety performance functions. It should be noted that every DDI/diamond has two adjacent intersections that are located on both sides. The distance to the adjacent intersection was considered as the average of these two distances. Table 9-5 shows the descriptive statistics of all the collected explanatory variables.

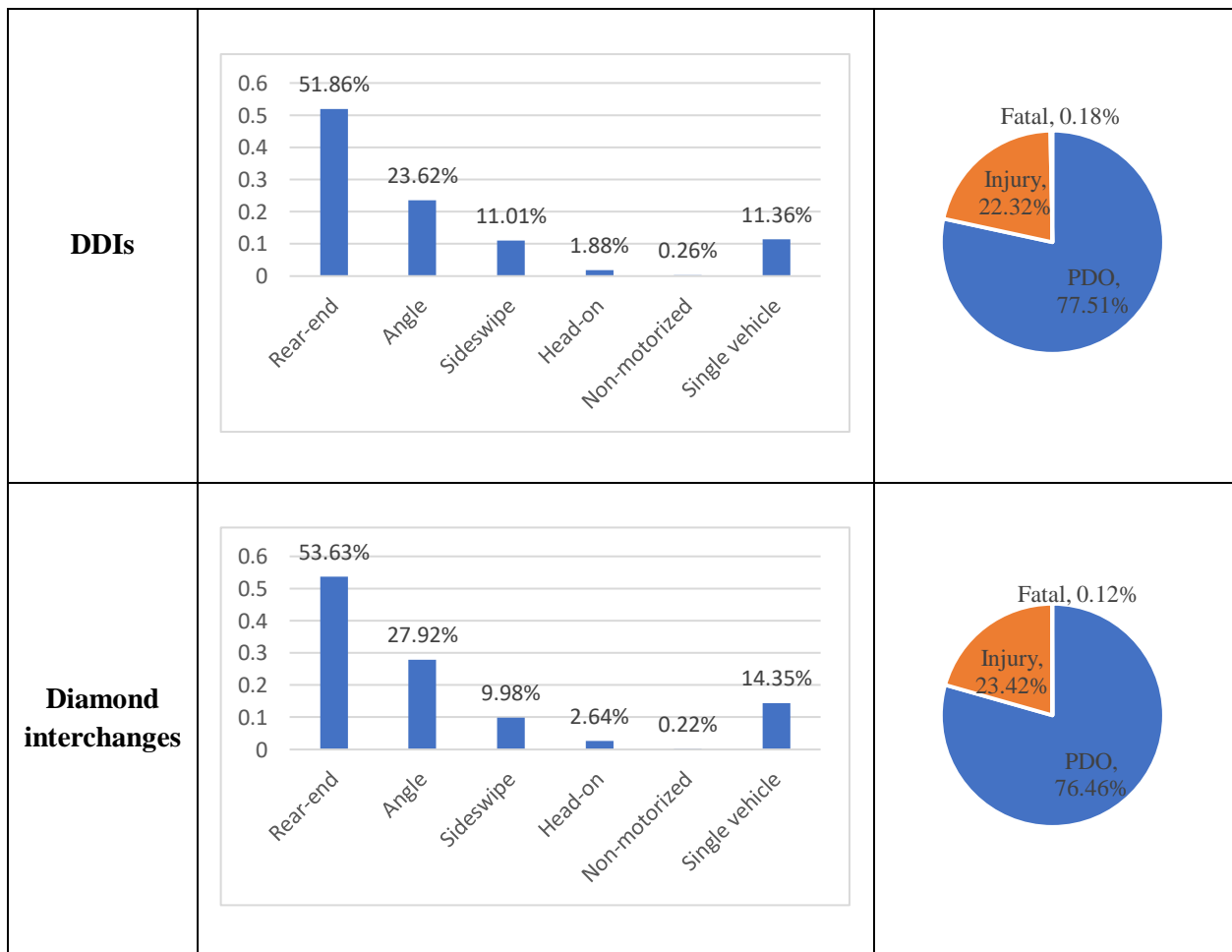
**Table 9-5: Explanatory variables descriptive statistics**

Variable	Diamond interchange (N=240)				DDI (N=80)			
	Mean	Stdev	Min	Max	Mean	Stdev	Min	Max
<b>Freeway Exit Ramp AADT*</b>	6086.8	4097.12	488	21060	6049.19	3870.80	503	18000
<b>Arterial AADT</b>	18934.93	10088.23	1489	46783	21224.08	13287.98	1295	76100
<b>Distance between crossovers/ramp terminals (ft)</b>	667.96	251.65	228.60	1656.07	731.92	244.38	364.23	1651.51
<b>Freeway Exit Speed Limit</b>	36.22	8.2	25	40	39.71	4.13	25	45
<b>Arterial Speed Limit</b>	43.25	3.22	40	55	48.89	4.16	35	55
<b>Distance to the nearest intersection (ft)</b>	954.68	712.33	291	1863	845.32	413.52	176	1147
<b>Configuration Type(overpass=1, underpass=0)</b>	0.63	0.49	0	1	0.70	0.46	0	1
<b>Skew Angle (°)</b>	12.65	9.63	0	38	15.52	13.52	0	45
<b>Lighting</b>	0.71	0.13	0	1	0.85	0.15	0	1
<b>Pedestrian Facility type (median=1, sidewalk=0)</b>	0.23	0.15	0	1	0.62	0.32	0	1
<b>Freeway Exit Right Turn Control Type(signalized=1, unsignalized=0)</b>	0.34	0.05	0	1	0.74	0.38	0	1
<b>Freeway Exit Left Turn Lanes</b>	1.13	0.14	1	2	1.22	0.05	1	2
<b>Arterial Left Turn Lanes</b>	0.89	0.09	0	1	0	0	0	0
<b>Freeway Exit Right Turn Lanes</b>	1.05	0.08	0	2	1.12	0.32	1	2
<b>Arterial Right Turn Lanes</b>	0.78	0.12	0	1	0.65	0.08	0	1
<b>Arterial Through Lanes</b>	2.17	0.28	1	3	2.45	0.11	1	3

\* The descriptive statistics of freeway exit ramp AADT were calculated based on 47 DDIs and 141 diamond interchanges only not the full sample size

Figure 9-7 shows the crash distributions by crash severity and type. The crash severity distributions are quite similar for both DDIs and diamond interchanges, where the PDO crashes

account for around 77% and the injury crashes take up around 23% and fatal crashes are less than 0.2%. On the other hand, rear-end and angle/left-turn crashes account for more than 75% of the total crashes for both DDIs and the diamond interchanges. However, the percentages of rear-end and angle/left-turn crash at diamond interchanges (53.6%, 27.9%) are higher than those at DDIs (51.8%, 23.6%). These differences are statistically significant with chi-squared values of 96.32, 76.23 and P-values less than 0.01. A possible reason might be that DDIs have a lower number of crossing conflict points and they also do not force the freeway left-turn movement to stop at the end of the exit ramp.



**Figure 9-7: Percentage of crashes by injury severity at MUT and conventional intersections**

## **9.2. BEFORE-AND-AFTER ANALYSIS FOR DDIS**

Two before-and-after approaches, before-and-after with comparison group and Empirical Bayes before-after, were conducted in this study. The research team was unable to obtain the Ramps' AADT for most DDIs. Thus, for the EB method, two SPF modeling strategies were considered for the analysis. The first strategy includes 65 DDIs and their reference sites with only the arterials' AADTs. The other strategy included 37 DDIs with their reference sites considering all vehicles entering the DDI (TEV), since ramps' AADT was available for only those 37 interchanges. Table 9-6, Table 9-7, and Table 9-8 show the estimated crash frequencies based on the equations presented in the methodology section. The key difference between the two methods is how to calculate the expected number of crashes after the DDI implementation. In the before-and-after with CG method (Table 9-6), this expected number is calculated based on the observed crash frequencies at the comparison sites before and after the treatment in addition to the observed crash frequency at the treated sites before the implementation. On the other hand, the Empirical Bayes method calculates this expected number based on the predicted crash frequency at the treated sites before and after the implementation. These predictions were conducted based on specific safety performance functions, which were developed using a reference group. Table 9-7 presents the EB results based on arterials AADTs, while Table 9-8 presents the EB results based on the total entering volumes (i.e., arterial + ramps AADTs).



**Table 9-6: Before-after with CG calculations (full sample size)**

<b>Crash Type</b>	<b>DDIs observed crash before</b>	<b>DDIs observed crash after</b>	<b>Comparisons observed crash before</b>	<b>Comparisons observed crash after</b>	<b>DDIs expected crash after</b>
<b>Total</b>	1466.2	886.8	3800.6	3642.7	1405.2
<b>Fatal&amp;Injury</b>	335.7	167.2	884.5	926.4	351.6
<b>PDO</b>	1123.3	690.4	2926.1	2677.4	1027.8
<b>Rear-end</b>	715.6	392.6	1761.2	1568.9	637.5
<b>Angle/Left-turn</b>	377.9	134.8	923.8	996.3	407.5
<b>Sideswipe</b>	121.2	117.8	354.3	342.6	117.2
<b>Head-on</b>	29.65	22.5	56.2	98.3	51.8
<b>Non-motorized</b>	0.7	4.5	5.6	11.25	1.48
<b>Single-vehicle</b>	186.6	148.0	521.6	445.4	159.3

**Table 9-7: Empirical Bayes before-after calculations (full sample size: arterial AADT only)**

<b>Crash Type</b>	<b>DDI observed crash before</b>	<b>DDI observed crash after</b>	<b>DDI predicted crash before</b>	<b>DDI predicted crash after</b>	<b>DDI expected crash before</b>	<b>DDI expected crash after</b>
<b>Total</b>	1466.2	886.8	1205.0	1200.7	1038.0	1033.8
<b>Fatal&amp;Injury</b>	353.7	167.2	320.6	315.5	297.9	300.1
<b>PDO</b>	1123.3	690.4	889.8	886.5	754.9	749.3
<b>Rear-end</b>	715.6	392.6	515.6	510.3	448.6	442.1
<b>Angle/Left-turn</b>	377.9	134.8	336.6	331.1	306.3	302.1
<b>Sideswipe</b>	121.2	117.8	347.3	353.1	384.1	390.3
<b>Head-on</b>	29.65	22.5	36.4	34.1	36.1	34.5
<b>Non-motorized</b>	0.7	4.5	4.1	3.1	3.2	2.4
<b>Single-vehicle</b>	186.6	148.0	149.6	153.7	124.6	127.1

**Table 9-8: Empirical Bayes before-after calculations (partial sample size: TEV)**

<b>Crash Type</b>	<b>DDI observed crash before</b>	<b>DDI observed crash after</b>	<b>DDI predicted crash before</b>	<b>DDI predicted crash after</b>	<b>DDI expected crash before</b>	<b>DDI expected crash after</b>
<b>Total</b>	785.1	558.2	689.1	690.2	659.4	660.8
<b>Fatal&amp;Injury</b>	182.7	101.5	179.4	180.0	178.1	178.6
<b>PDO</b>	599.3	426.0	510.2	510.8	487.6	488.2
<b>Rear-end</b>	405.4	261.8	306.8	307.3	301.3	302.8
<b>Angle/Left-turn</b>	200.1	72.1	190.8	192.4	187.2	188.3
<b>Sideswipe</b>	65.5	73.2	66.5	67.2	64.5	66.7
<b>Head-on</b>	15.6	12.6	42.4	19.5	36.1	16.6
<b>Non-motorized</b>	0.7	2.6	2.1	1.9	1.5	1.1
<b>Single-vehicle</b>	79.4	99.0	85.5	86.1	89.9	91.1

Table 9-9 and Table 9-10 show the developed SPFs that were used to calculate the predicted and then the expected crash frequencies in case of full sample size (65 DDIs) and partial sample size (37 DDIs). These SPFs were developed in terms of the arterial volume in case of the full sample size. On the other hand, in the case of the partial sample size, they were developed using the total entering vehicle volume, which is the summation of the AADTs of the freeway exit ramps and the arterial. The tables show significant positive effects of either the arterial AADT or the TEV on the crash frequencies for most crash types.

**Table 9-9: SPFs for Empirical Bayes' expected crash frequency calculation (full sample size: arterial AADT only)**

Crash Type		Intercept	LnAADT_Arterial	Dispersion
Total	Coef	3.0458	0.0132*	0.6137
	P-value	<.0001	0.0862	
Fatal&Injury	Coef	1.118	0.047*	0.5701
	P-value	0.1392	0.0540	
PDO	Coef	2.919	0.0312*	0.6346
	P-value	0.0001	0.0689	
Rear-end	Coef	2.6995	0.0631**	0.7424
	P-value	0.0012	0.0457	
Angle/Left-turn	Coef	1.8336	0.0193*	0.5447
	P-value	0.0143	0.0800	
Sideswipe	Coef	0.3125	0.0249*	0.8625
	P-value	0.7445	0.0798	
Head-on	Coef	0.2512	0.0875	0.9813
	P-value	0.8323	0.4684	
Non-motorized	Coef	-9.1573	0.6431**	1.3365
	P-value	0.0037	0.0406	
Single-vehicle	Coef	-0.9155	0.1801**	0.5662
	P-value	0.2653	0.0307	

\*\* significant at 95%, and \* significant at 90%.

**Table 9-10: SPFs for Empirical Bayes' expected crash frequency calculation (partial sample size: TEV= arterial+ramps)**

Crash Type		Intercept	LnTEV	Dispersion
Total	Coef	1.9513	0.0971**	0.7637
	P-value	0.1119	0.0429	
Fatal&Injury	Coef	-0.4067	0.1978**	0.7081
	P-value	0.7387	0.0104	
PDO	Coef	1.9568	0.0666*	0.7975
	P-value	0.1219	0.0598	
Rear-end	Coef	1.0678	0.1338**	0.9473
	P-value	0.4245	0.0434	
Angle/Left-turn	Coef	1.4942	0.0146*	0.7395
	P-value	0.2536	0.0911	
Sideswipe	Coef	-1.3101	0.189**	1.0234
	P-value	0.3848	0.0209	
Head-on	Coef	-0.3864	0.0249	1.3121
	P-value	0.8482	0.9014	
Non-motorized	Coef	-8.6964	0.579**	3.2517
	P-value	0.0507	0.0187	
Single-vehicle	Coef	-1.5528	0.238*	0.5827
	P-value	0.2041	0.0512	

\*\* significant at 95%, and \* significant at 90%.

Table 9-11 shows the crash modification factors (CMFs) associated with converting the conventional diamond interchanges to DDIs. The before-and-after with CG method shows that the DDI can decrease the crash frequency of the total, fatal-and-injury, PDO, rear-end, and angle/left-turn crashes by 26%, 49%, 19%, 18%, and 68%, respectively. On the other hand, the Empirical Bayes method shows that it can decrease them by 14%, 44%, 8%, 11%, and 55%, respectively. It should be noted that there is no much difference between considering the arterial AADT and the TEV. However, the research team recommends the CMFs resulting from the larger sample size (arterial AADT). It is clearly shown that the two methods concluded similar trends, while the CMF values of the Empirical Bayes method are slightly higher than those of the before-and-after with CG method. This may be due to the regression to the mean effect. In other words, the before-and-after with CG method showed a higher crash reduction. However, a proportion of this reduction may be due to the regression to the mean effect that the Empirical Bayes approach can successfully account for.

**Table 9-11: CMFs for DDIs resulting from the before-and-after methods**

Crash Type	B-A with CG		EB B-A (full sample size: arterial AADT only)		EB B-A (partial sample size: TEV)	
	CMF	P-value	CMF	P-value	CMF	P-value
<b>Total</b>	0.736***	<0.001	0.858***	<0.001	0.846***	<0.001
<b>Fatal&amp;Injury</b>	0.515***	<0.001	0.558***	<0.001	0.570***	<0.001
<b>PDO</b>	0.812***	0.006	0.920***	<0.001	0.873***	<0.001
<b>Rear-end</b>	0.824**	0.039	0.887***	0.002	0.868**	0.011
<b>Angle/Left-turn</b>	0.319***	<0.001	0.448***	<0.001	0.385***	<0.001
<b>Sideswipe</b>	1.156	0.538	1.241	0.475	1.095	0.464
<b>Head-on</b>	0.378	0.478	0.643	0.412	0.752	0.257
<b>Non-motorized</b>	1.232	0.726	1.762	0.394	1.405	0.642
<b>Single-vehicle</b>	1.166	0.488	0.845	0.213	0.912	0.981

\*\*\* significant at 99%, \*\* significant at 95%.

To sum up, the research team recommends using CMF values that are resulting from the EB method (full sample size) since this method accounts for the regression to the mean issue, and it also provides CMFs with lower p-values for PDO and rear-end crashes. The recommended CMFs are 0.858, 0.558, 0.920, 0.887, and 0.448 for the total, fatal-and-injury, PDO, rear-end, and angle/left-turn crashes, respectively. It should be noted that the reduction in rear-end crashes makes sense because left-turn freeway traffic volumes do not have to stop immediately at the end of the exit ramp as in the conventional diamond interchange. Regarding the huge reduction in angle/left-turn crashes, it can be explained as that the number of crossing conflict points at the DDI is lower than that at the conventional diamond interchange.

### **9.3. CROSS-SECTIONAL METHOD**

Using the Cross-Sectional analysis, safety performance functions were developed for each crash type based on the collected crash data and explanatory variables for two modeling strategies. The first strategy includes 80 DDIs and their comparison sites, while the second one includes 47 DDIs and their comparison sites. These SPFs included all the significant explanatory variables along with the natural logarithm of the traffic volume variable (arterial AADT for the full sample case and TEV (arterial + ramps) for the partial one) and the dummy variable DDI (1 if the interchange is DDI and 0 if it is a diamond interchange). It should be noted that the variable of AADT was used in this study instead of the DVMT that was adopted in previous safety analyses of alternative intersections. This could be explained in that both the treatment and the comparison sites in this study have the same influence area, which is 250 feet from each crossover/ramp terminal. However, in the Median U-Turn intersection or Continuous Flow Intersection case, the treatment sites have a larger influence area to account for the crashes related to the crossovers which are not existing in the comparison sites (conventional signalized intersection).

Table 9-12 and Table 9-13 show the developed SPFs for the total crashes and each crash type considering the arterial AADT and the TEV. Although the two tables show similar estimations, the research team recommends the SPFs resulting from the full sample size (Table 9-12) since they have more significant parameters. Table 9-12 shows that the variable “LnAADT<sub>arterial</sub>” has positive effect on crash frequency for the total number of crashes, as well as other crash types (i.e., fatal-and-injury, PDO, angle/LT, non-motorized and single-vehicle). Moreover, the attribute “DDI=1” has a negative effect on the crash frequencies of the total, fatal-and-injury, PDO, rear-end, and angle/LT crashes, which means that DDIs have lower crash numbers than the conventional diamond interchanges. This finding is consistent with the results of before-and-after methods.

The SPFs also show that the speed limit variables, which are “Arterial Speed Limit” and “Freeway Exit Speed Limit”, have positive effects on the crash frequency. The increase of the arterial’s speed limit can significantly increase the total crashes, while the increase of the freeway exit’s speed limit can significantly increase the total crashes as well as the angle/LT crashes. The developed SPF for PDO crashes shows that signaling the freeway right-turn exit has a negative effect on the PDO crashes. The variables of “Distance to Adjacent intersection” and “Adjacent Intersection Control Type” did not show any significant effects on safety performance.

Furthermore, the variable of “Distance between Crossovers/Ramp Terminals” has a negative effect on the crash frequency of the total crashes as well as the fatal-and-injury, PDO, rear-end, angle, side swipe and single-vehicle crashes, which means that the longer distance between crossovers/ramp terminals is associated with lower crash frequencies.

**Table 9-12: Safety performance functions from the cross-sectional analysis (full sample size: arterial AADT only)**

Crash Type		Intercept	LnAADT <sub>arterial</sub>	DDI	Distance Between Crossovers	Config. Type	Distance To adjacent	Adjacent Intersect. Cont.Type	Freeway Exit Sp. Limit	Arterial Speed Limit	Fr Ex Rt Ct Type
Total	Coef	3.6846	0.0530**	-0.2722***	-0.0005***	0.1343	-0.0001	0.0154	0.0063**	0.0214*	
	P-value	<.0001	0.0312	0.0037	0.0029	0.1086	0.1333	0.8465	0.0305	0.0721	
Fatal&Injury	Coef	0.8986	0.0970*	-0.4816***	-0.0004**	0.1462	-0.0001	0.0320		0.0543	
	P-value	0.0921	0.0614	<.0001	0.0196	0.8484	0.3372	0.6897		0.2415	
PDO	Coef	2.7615	0.0256*	-0.2008***	-0.0006***						-0.8912*
	P-value	<.0001	0.0625	0.0317	<.0001						0.0817
Rear-end	Coef	2.4541	0.0741	-0.0220**	-0.0006***						
	P-value	<.0001	0.2143	0.0416	0.0012						
Angle/Left-turn	Coef	1.8766	0.0208*	-0.8098***	-0.0004**	0.0180	-0.0002	-0.0304	0.2144*	0.7316	
	P-value	0.0007	0.0697	<.0001	0.0297	0.8336	0.5321	0.7077	0.0632	0.2422	
Sideswipe	Coef	0.9158	0.0517	-0.1156	-0.0006***						
	P-value	0.4266	0.4560	0.3625	0.0097						
Head-on	Coef	1.2411	-0.0348	-0.3293							
	P-value	0.3739	0.6891	0.7481							
Non-motorized	Coef	-7.3772	0.7416***	0.5558		0.6417***					
	P-value	0.0121	0.0008	0.4174		0.0088					
Single-vehicle	Coef	0.1970	0.1366***	0.1812	-0.0008***	0.2098**					
	P-value	0.8092	0.0096	0.5274	<.0001	0.0104					

\*\*\* significant at 99%, \*\* significant at 95%, and \* significant at 90%.

DDI (DDI=1, conventional diamond interchange=0)

Configuration Type (underpass=1, overpass=0)

Adjacent Intersection Control Type (signalized=1, unsignalized=0)

Freeway Exit Right-turn Control Type (signalized=1, unsignalized=0)

**Table 9-13: Safety performance functions from the cross-sectional analysis (partial sample size: TEV)**

Crash Type		Intercept	LnTEV	DDI	Distance Between Crossovers	Config. Type	Distance To adjacent	Adjacent Intersect. Cont.Type	Freeway Exit Sp. Limit	Arterial Speed Limit	Fr Ex Rt Ct Type
Total	Coef	4.3085	0.1882**	-0.1110**	-0.0009***		-0.0002	0.1388	0.0062	0.0524***	
	P-value	0.0014	0.0626	0.0456	0.0003		0.1246	0.2596	0.5110	0.0075	
Fatal&Injury	Coef	-0.4672	0.2447**	-0.3627**	-0.0006**	0.0745	-0.0001	0.1469		0.4123	
	P-value	0.6502	0.0145	0.0135	0.0132	0.5722	0.3786	0.2344		0.4712	
PDO	Coef	1.9662	0.1236	-0.0840*	-0.0009						-0.4512
	P-value	0.0575	0.2235	0.0561	<.0001						0.8177
Rear-end	Coef	2.6987	0.2241	-0.0043	-0.0009***						
	P-value	<.0001	0.2544	0.7894	0.0003						
Angle/Left-turn	Coef	1.9283	0.0320	-0.7511***	-0.0005**	-0.0487	-0.0003	0.0702	0.2144	0.3145	
	P-value	0.0905	0.7723	<.0001	0.0515	0.7254	0.6524	0.5922	0.6321	0.7413	
Sideswipe	Coef	1.0565	0.2267*	0.2379	-0.0011***						
	P-value	0.5469	0.0819	0.2147	0.0007						
Head-on	Coef	2.7883	0.0934	-0.2346							
	P-value	0.2156	0.5914	0.3494							
Non-motorized	Coef	-8.5799	1.0572	0.7756		0.5792					
	P-value	0.0379	0.3855	0.5804		0.1173					
Single-vehicle	Coef	0.9153	0.1956	0.3372	-0.0010***	0.2334					
	P-value	0.4303	0.3354	0.7109	<.0001	0.7408					

\*\*\* significant at 99%, \*\* significant at 95%, and \* significant at 90%.

DDI (DDI=1, conventional diamond interchange=0)

Configuration Type (underpass=1, overpass=0)

Adjacent Intersection Control Type (signalized=1, unsignalized=0)

Freeway Exit Right-turn Control Type (signalized=1, unsignalized=0)



In addition, the attribute of “configuration type=underpass” has a positive effect on the non-motorized and single-vehicle crashes, which means that the interchanges with the underpass configuration have more crashes than those of the interchanges with the overpass configuration. Figure 9-8 shows the street view of both types. It is clearly shown that the overpass configuration can provide more space and so better accommodate the non-motorized users, which may be the reason why the underpass type has more non-motorized crashes than the overpass configuration.



**Figure 9-8: Example of overpass and underpass interchanges (Google Earth)**

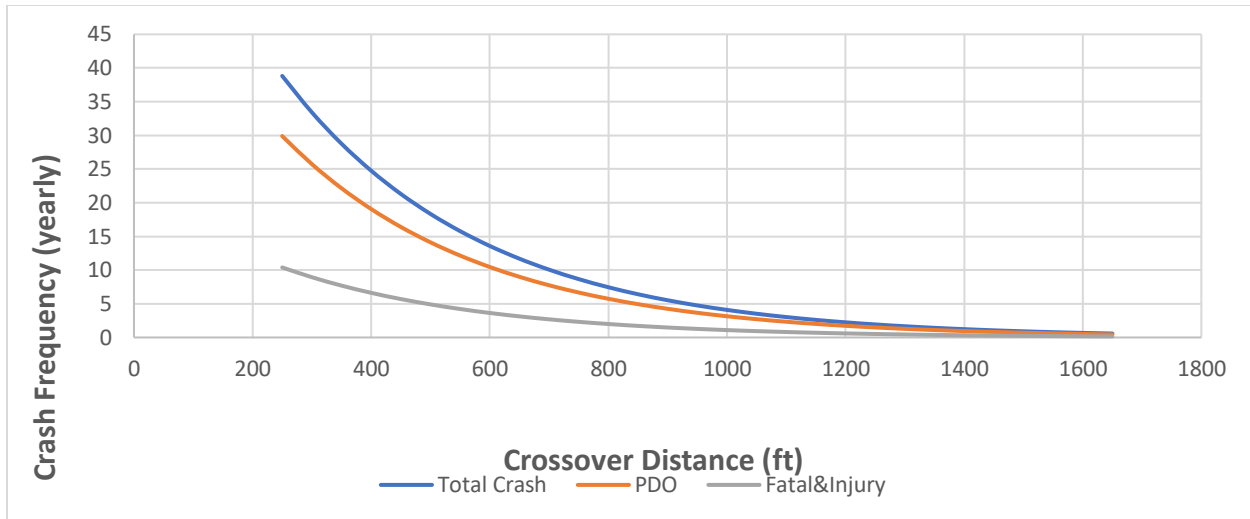
The cross-sectional analysis can also provide CMFs by exponentiating the parameter of the dummy variable “DDI”. As shown in Table 9-14, the CMF values are pretty similar to those developed by the before-and-after methods. However, the latter provides more reliable CMFs because they consider the actual crash observations before and after the treatment’s effect.

**Table 9-14: CMFs resulting from the cross-sectional analysis (full sample size: arterial AADT only)**

<b>Crash Variable</b>	<b>CMF</b>	<b>P-value</b>
<b>Total</b>	0.762***	0.004
<b>Fatal&amp;Injury</b>	0.618***	<0.001
<b>PDO</b>	0.818**	0.032
<b>Rear-end</b>	0.978**	0.042
<b>Angle/Left-turn</b>	0.445***	<0.001
<b>Sideswipe</b>	0.891	0.363
<b>Head-on</b>	0.719	0.748
<b>Non-motorized</b>	1.743	0.418
<b>Single-vehicle</b>	1.198	0.527

\*\*\* significant at 99%, \*\* significant at 95%.

For more clarification of the safety effect of the distance between crossovers/ramp terminals, Figure 9-9 shows the relation between the average crash frequency and the distance between crossovers/ramp terminals in case of all other variables are constant. For instance, if the crossovers’ distance of an interchange increases from 600 to 800 feet, the average total crash frequency could decrease from 12 to 8 crashes per year, which means around 33% decrease.



**Figure 9-9: Effect of crossovers' distance on average crash frequency**

#### 9.4. SUMMARY

In this chapter, the safety performance of DDIs was evaluated in comparison to the conventional diamond interchanges. Three methods were adopted to estimate the CMFs, which are before-and-after with comparison group, Empirical Bayes before-after, and the cross-sectional analysis. The studied sample included 80 DDIs and 240 conventional diamond interchanges as comparison sites located in 24 states. Different data types were collected to conduct the analysis. First, multi-year crash data were acquired from the various states. Then, traffic and geometric features were collected, including AADT, speed limits, and the distance between crossovers/ramp terminals. Since the AADT of the freeway exit ramp was not available for all interchanges, two modeling strategies were considered for the EB method and the cross-sectional analysis. The first strategy included all DDIs and their comparison sites, while the second one included the DDIs with available ramp traffic volumes only and their comparison sites.

The before-and-after analysis with CG showed that converting the conventional diamond interchange to DDI can decrease the total, fatal-and-injury, PDO, rear-end, and angle crashes by

26%, 49%, 19%, 18%, and 68%, respectively. On the other hand, the Empirical Bayes method showed that it could decrease them by 14%, 44%, 8%, 11%, and 55%, respectively. It is obvious that the two methods provided similar trends; however, the CMFs of the Empirical Bayes method are slightly higher than those of the before-after with CG method. This difference may be due to the regression to the mean effect that was considered in the Empirical Bayes approach.

The cross-sectional method was used to develop safety performance functions that describe the relationship between crash frequency and various explanatory variables. The developed SPFs showed that converting the diamond interchange to DDI can decrease the total, fatal-and-injury, PDO, rear-end, and angle crashes, which is consistent with the before-and-after methods. Moreover, the distance between crossover/ramp terminals was found to have a negative effect on the crash frequency, which means that the longer distance lowers the crash frequency. Furthermore, the interchanges with the underpass configuration were found to have more non-motorized and single-vehicle crashes than those of the interchanges with the overpass configuration. In addition, both variables of “Arterial Speed Limit” and “Freeway Exit Speed Limit” were found to have positive effects on the crash frequency. In other words, increasing the speed limit of the freeway exit ramp can significantly increase the total crashes as well the angle crashes, while the increase of the arterial’s speed limit can significantly increase the total crashes. The SPFs also revealed that the variable of “Freeway Exit Right-turn Control Type” is significantly associated with the safety performance of DDI, where the signalized exit has significantly lower frequency of PDO crashes.

The cross-sectional analysis can also provide CMFs by exponentiating the parameter of the dummy variable “DDI” (1 if DDI, 0 if diamond interchange). It showed that converting the diamond interchange to DDI can reduce the total, fatal-and-injury, PDO, rear-end, and angle

crashes by 24%, 38%, 18%, 2%, and 55%, respectively. The results are quite similar to those of the before-and-after methods. However, the before-and-after methods provide more reliable CMFs because they consider the observed crash frequencies before and after the treatment's effect, while the cross-sectional analysis only considers the crash counts after implementing the treatment.

## 10. CONCLUSIONS

Intersections have been of major interest to traffic engineers because there are many conflicts between road users, and they pose considerable exposure to safety risk and traffic congestion. In order to alleviate the safety and congestion problems, several types of alternative intersection designs have been suggested and implemented in some states. It would be useful and important to evaluate the alternative intersections that have been implemented in other states and predict their effects when they are operated in Florida.

Many alternative intersections aim to reduce conflict points by separating turning vehicles (left-turning vehicles in most of cases) at intersections. The survey was conducted to investigate the implementations and the opinions about the alternative intersections. The survey questionnaire forms were distributed to 49 states, and 30 states responded. In order to investigate the safety effects of alternative intersections, data were collected from 27 states including Arizona, Colorado, Florida, Georgia, Idaho, Indiana, Iowa, Kansas, Kentucky, Louisiana, Michigan, Minnesota, Missouri, North Carolina, New Jersey, New Mexico, New York, Nevada, Ohio, Oregon, Pennsylvania, Tennessee, Texas, Virginia, Utah, Wisconsin, and Wyoming.

The alternative intersections that were investigated in this project include: continuous green T-intersections (CGTs), median U-turn intersections (MUTs), continuous flow intersections (CFIs), Jughandle intersections, restricted crossing U-turn intersections, and diverging diamond interchanges (DDIs). Among them, MUTs and Jughandle intersections have different design types. Overall, the safety effects of the 10 alternative intersection designs were explored.

The most effective alternative intersection types that minimize each crash type are as follows:

- Total crashes: MUT Type A (CMF=0.61)

- Fatal-and-injury crashes: RCUT (CMF=0.57)
- EPDO crashes: RCUT (CMF(FI)=0.57 and CMF(PDO)=0.84)
- Rear-end crashes: MUT Type B (CMF=0.49)
- Left-turn crashes: Jughandle Type 1 (CMF=0.19)
- Angle crashes: RCUT (CMF=0.59)
- Non-motorized crashes: CFI (CMF=0.30).

Fifty hot intersections (top 1%) with the highest crash risks were identified. It was found that rear-end crashes are the most frequent ‘most problematic’ crash type, and left-turn crashes follow. For each hotspot intersection, two different alternative intersections were suggested to minimize: (1) the most problematic crash type; and (2) overall EPDO.

In addition to exploring the safety effects of the alternative intersections, it was shown that the signalization is effective in reducing severe crash types (e.g., angle, left-turn); whereas it significantly increases rear-end crashes by 66% to 195%. Also, it was found that the signalization increased the number of rear-end crashes significantly for elderly drivers.

There are multiple policy implications, as follows:

- When an alternative intersection is considered to be implemented, diverse factors should be considered, including but not limited to operational efficiency and safety.
- Since the safety effect of each alternative intersection type is different by crash type, the most effective type for minimizing the most severe crash types or the overall EPDO should be chosen.
- It is strongly suggested that implementing the recommended alternative intersections in the identified hotspot intersections, which have serious safety problems.

- The signalization significantly increases the number of rear-end crashes, particularly for elderly drivers, while it reduces the number of severe crash types. Appropriate remedies should be proactively provided to minimize the rear-end crash occurrence when the signal is planned to be installed.

This study also evaluated the safety benefits of DDIs in comparison to the conventional diamond interchanges. Three methods were adopted to estimate the CMFs, which are before-and-after with comparison group, Empirical Bayes before-after, and the cross-sectional analysis. The studied sample included 80 DDIs and 240 conventional diamond interchanges as comparison sites located in 24 states. Different data types were collected to conduct the analysis. First, multi-year crash data were acquired from the various states. Then, traffic and geometric features were collected, including AADT, speed limits, and the distance between crossovers/ramp terminals. Since the AADT of the freeway exit ramp was not available for all interchanges, two modeling strategies were considered for the EB method and the cross-sectional analysis. The first strategy included all DDIs and their comparison sites, while the second one only included the DDIs with available ramp traffic volumes and their comparison sites.

- The before-and-after analysis with CG showed that converting the conventional diamond interchange to DDI can decrease the total, fatal-and-injury, PDO, rear-end and angle crashes by 26%, 49%, 19%, 18%, and 68%, respectively. On the other hand, the Empirical Bayes method showed that it could decrease them by 14%, 44%, 8%, 11%, and 55%, respectively. It is obvious that the two methods provided similar trends; however, the CMFs of the Empirical Bayes method are slightly higher than those of the Before-and-



after with CG method. This difference may be due to the regression to the mean effect that was considered in the Empirical Bayes approach.

- The cross-sectional method was used to develop safety performance functions that describe the relationship between crash frequency and various explanatory variables. The developed SPFs showed that converting the diamond interchange to DDI can decrease the total, fatal-and-injury, PDO, rear-end, and angle crashes, which is consistent with the before-and-after methods. Moreover, the distance between crossover/ramp terminals was found to have a negative effect on the crash frequency, which means that the longer distance lowers the crash frequency. Furthermore, the interchanges with the underpass configuration were found to have more non-motorized and single-vehicle crashes than those of the interchanges with the overpass configuration. In addition, both variables of “Arterial Speed Limit” and “Freeway Exit Speed Limit” were found to have positive effects on the crash frequency. In other words, increasing the speed limit of the freeway exit ramp can significantly increase the total crashes as well the angle crashes, while the increase of the arterial’s speed limit can significantly increase the total crashes. The SPFs also revealed that the variable of “Freeway Exit Right-turn Control Type” is significantly associated with the safety performance of DDI, where the signalized exit has significantly lower frequency of PDO crashes.
- The cross-sectional analysis can also provide CMFs by exponentiating the parameter of the dummy variable “DDI” (1 if DDI, 0 if diamond interchange). It showed that converting the diamond interchange to DDI can reduce the total, fatal-and-injury, PDO, rear-end, and angle crashes by 24%, 38%, 18%, 2%, and 55%, respectively. The results are quite similar to those of the before-and-after methods. However, the before-and-after methods provide

more reliable CMFs because they consider the observed crash frequencies before and after the treatment's effect, while the cross-sectional analysis only considers the crash counts after implementing the treatment.

## REFERENCES

AASHTO., 2010. Highway Safety Manual. Washington D.C.: American Association of State Highway and Transportation Officials.

Abdel-Aty, M., Chen C., Schott, J., 1998. An Assessment of the Effect of Driver Age on Traffic Accident Involvement Using Log-Linear Models. *Accident Analysis and Prevention* 30 (6), 851– 861.

Abdel-Aty, M., Chen, C., Radwan, E., 1999. Using Conditional Probability to Find Driver Age Effect in Crashes. *American Society of Civil Engineers: Journal of Transportation Engineering* 125 (6), 502–507.

Abdel-Aty, M., Keller, J., Brady, P., 2005. Analysis of Types of Crashes at Signalized Intersections by Using Complete Crash Data and Tree-Based Regression. *Transportation Research Record: Journal of the Transportation Research Board* 1908, 37-45.

Abdel-Aty, M., Lee, C., Park, J., Wang, J., Abuzwidah, M., Al-Arifi, S., 2014. Validation and Application of Highway Safety Manual (Part D) in Florida. Contract BDK78-977-14. Florida Department of Transportation.

Abou-Senna, H., Radwan, E., Tabares, S., Wu, J., Chalise, S., 2015. Evaluating Transportation Systems Management & Operations (TSM&O) Benefits to Alternative Intersection Treatments. Florida Department of Transportation Research Center. Contract BDV24-977-09.

Abramson, P., Bergren, C., Goldblatt, R., 1995. Human Factors Study of the Continuous Flow Intersection at the Dowling College NAT Center. Presented at 4th Annual Symposium on Intermodal Transportation, Oakdale, NY.

Ahmed, M., Abdel-Aty, M., 2015. Evaluation and Spatial Analysis of Automated Red-Light Running Enforcement Cameras. *Transportation Research Part C: Emerging Technologies* 50, 130-140.

An, J., Choi, B., Kim, B., Kim, E., Hwang, J., 2014. Rear-End Collision Warning System Using Linear Discriminant Analysis. *Institute of Electrical and Electronics Engineers: Joint 7th International Conference on Soft Computing and Intelligent Systems and 15th International Symposium on Advanced Intelligent Systems*, 218-221.

Antonucci, N., Hardy, K., Pfefer, R., Neuman, T., 2014. National Cooperative Highway Research Project Report 500: Guidance for Implementation of the AASHTO Strategic Highway Safety Plan 12, v-16–v-19. Transportation Research Board, Washington, D.C.

Attap, 2020. MUID. Retrieved April 18, 2020, from <https://attap.gitbooks.io/muid/content/>

Azizi, L., Sheikholeslami, A., 2012. Safety Effect of U-Turn Conversions in Tehran: Empirical Bayes Observational Before-and-After Study and Crash Prediction Models. *American Society of Civil Engineers: Journal of Transportation Engineering* 139 (1), 101-108.

- Bared, J., 2009. Quadrant Roadway Intersection. Publication FHWA-HRT-09-058. Federal Highway Administration, U.S. Department of Transportation.
- Bared, J., 2009. Restricted Crossing U-Turn Intersection. Publication FHWA-HRT-09-059. Federal Highway Administration, U.S. Department of Transportation.
- Bared, J., Kaiser, E., 2002. Median U-turn Design as an Alternative Treatment for Left Turns at Signalized Intersections. *Institute of Transportation Engineers Journal* 72 (2), 50.
- Braitman, K., Kirley, B., Ferguson, S., Chaudhary, N., 2007. Factors Leading to Older Drivers' Intersection Crashes. *Traffic Injury Prevention* 8 (3), 267-274.
- Brannstrom, M., Coelingh, E., Sjoberg, J., 2010. Model-Based Threat Assessment for Avoiding Arbitrary Vehicle Collisions. *Institute of Electrical and Electronics Engineers: Transactions on Intelligent Transportation Systems* 11 (3), 658-669.
- Caird, J., Chisholm, S., Lockhart, J., 2008. Do In-Vehicle Advanced Signs Enhance Older and Younger Drivers' Intersection Performance? Driving Simulation and Eye Movement Results. *International Journal of Human-Computer Studies* 66 (3), 132-144.
- Carter, D., Srinivasan, R., Gross, F., Council, F., Recommended Protocols for Developing Crash Modification Factors. NCHRP 20-7(314) Final Report. (2012)
- Chen, C., Xiang, H., Qiu, T., Wang, C., Zhou, Y., Chang, V., 2017. A Rear-End Collision Prediction Scheme Based on Deep Learning in the Internet of Vehicles. *Journal of Parallel and Distributed Computing*, in press.
- Chen, C., Zhang, G., Huang, H., Wang, J., Tarefder, R., 2016. Examining Driver Injury Severity Outcomes in Rural Non-Interstate Roadway Crashes Using a Hierarchical Ordered Logit Model. *Accident Analysis and Prevention* 96, 79-87.
- Chen, L., Peng, Y., Tseng, Y., 2011. An Infrastructure-Less Framework for Preventing Rear-End Collisions by Vehicular Sensor Networks. *Institute of Electrical and Electronics Engineers: Communications Letters* 15 (3), 358-360.
- Chiou, Y., Chang, C., 2010. Driver Responses to Green and Red Vehicular Signal Countdown Displays: Safety and Efficiency Aspects. *Accident Analysis and Prevention* 42 (4), 1057-1065.
- Chlewicki, G., 2003, July. New interchange and intersection designs: The synchronized split-phasing intersection and the diverging diamond interchange. In 2nd Urban Street Symposium, Anaheim, California, 28-30.
- Claros, B., Edara, P., Sun, C., 2016. Site-Specific Safety Analysis of Diverging Diamond Interchange Ramp Terminals. *Transportation Research Record: Journal of the Transportation Research Board* 2556, 20-28.
- Claros, B., Edara, P., Sun, C., 2017a. Safety Effect of Diverging Diamond Interchanges on Adjacent Roadway Facilities. *Transportation Research Record: Journal of the Transportation Research Board* 2618, 78-90.

- Claros, B., Edara, P., Sun, C., 2017b. When Driving on the Left Side is Safe: Safety of the Diverging Diamond Interchange Ramp Terminals. *Accident Analysis and Prevention* 100, 133-142.
- Claros, B., Edara, P., Sun, C., Brown, H., 2015. Safety Evaluation of Diverging Diamond Interchanges in Missouri. *Transportation Research Record: Journal of the Transportation Research Board* 2486, 1-10.
- Classen, S., Shechtman, O., Stephens, B., Davis, E., Justiss, M., Bendixen, R., Belchior, P., Sandhu, M., Posse, C., Mccarthy, D., Mann, W., 2007. The Impact of Roadway Intersection Design on Driving Performance of Young and Senior Adults. *Traffic Injury Prevention* 8 (1), 69-77.
- Cobb, R., Coughlin, J., 1998. Are Elderly Drivers a Road Hazard?: Problem Definition and Political Impact. *Journal of Aging Studies* 12 (4), 411-427.
- Das, A., Abdel-Aty, M., 2010. A Genetic Programming Approach to Explore the Crash Severity on Multi-Lane Roads. *Accident Analysis and Prevention* 42 (2), 548-557.
- Davidse, R., 2006. Older Drivers and ADAS: Which Systems Improve Road Safety? *International Association of Traffic and Safety Studies Research* 30 (1), 6-20.
- Davis, G., Aul, N., 2007. Safety Effects of Left-Turn Phasing Schemes at High-Speed. Publication MN/RC-2007-03. Minnesota Department of Transportation.
- Eberhard, J., 2008. Older Drivers' "High Per-Mile Crash Involvement": The Implications for Licensing Authorities. *Traffic Injury Prevention* 9 (4), 284-290.
- Edara, P., Sun, C. and Breslow, S., 2013. Evaluation of j-turn intersection design performance in Missouri (No. cmr 14-005). Missouri. Dept. of Transportation. Organizational Results.
- Erke, A., 2009. Red Light for Red-Light Cameras?: A Meta-Analysis of the Effects of Red-Light Cameras on Crashes. *Accident Analysis and Prevention* 41 (5), 897-905.
- FHWA. (2011). Techbrief: Traffic Performance of Three Typical Designs of New Jersey Jughandle
- Fildes, B., Keall, M., Bos, N., Lie, A., Page, Y., Pastor, C., Pennisi, L., Rizzi, M., Thomas, P., Tingvall, C., 2015. Effectiveness of Low Speed Autonomous Emergency Braking in Real-World Rear-End Crashes. *Accident Analysis and Prevention* 81, 24-29.
- Friedman, J. H., 1991. Multivariate adaptive regression splines. *The annals of statistics*, pp. 1-67.
- Garber, N., Srinivasan, R., 1991. Risk Assessment of Elderly Drivers at Intersections: Statistical Modeling. *Transportation Research Record: Journal of the Transportation Research Board* 1325, 17-22.
- Gross, F., Persaud, B.N. and Lyon, C., 2010. A guide to developing quality crash modification factors (No. FHWA-SA-10-032). United States. Federal Highway Administration.

- Hallmark, S., Orellana, M., Fitzsimmons, E., McDonald, T., Matulac, D., 2010. Evaluating the Effectiveness of an Automated Red Light Running Enforcement Program in Iowa Using a Bayesian Analysis. Transportation Research Board 89th Annual Meeting Compendium of Papers, Washington, D.C.
- Harb, R., Radwan, E., Yan, X., Abdel-Aty, M., 2007. Light Truck Vehicles (LTVs) Contribution to Rear-End Collisions. *Accident Analysis and Prevention* 39 (5), 1026-1036.
- Harkey, D., Srinivasan, R., Baek, J., Council, F., Eccles, K., Lefler, N., Gross, F., Persaud, B., Lyon, C., Hauer, E., Bonneson, J., 2008. National Cooperative Highway Research Project Report 617: Accident Modification Factors for Traffic Engineering and ITS Improvements. National Cooperative Highway Research Program. Transportation Research Board, Washington, D.C.
- Hauer, E., 1997. *Observational Before-After Studies in Road Safety*. Oxford, United Kingdom: Elsevier Science Ltd.
- Hauer, E., 1988. Special Report 218: The Safety of Older Persons at Intersections. *Transportation in an Aging Society: Improving Mobility and Safety for Older Persons* 2, 194-252. Transportation Research Board, Washington, D.C.
- Hochstein, J., Maze, T., Welch, Preston, H., Storm, R., 2008. The J-Turn Intersection: Design Guidance and Safety Experience. Transportation Research Board 88th Annual Meeting Compendium of Papers, Washington, D.C.
- Horswill, M., Marrington, S., McCullough, C., Wood, J., Pachana, N., McWilliam, J., Raikos, M., 2008. The Hazard Perception Ability of Older Drivers. *The Journals of Gerontology: Series B* 63 (4), 212-218.
- Høyve, A., 2013. Still Red Light for Red Light Cameras? An Update. *Accident Analysis and Prevention* 55, 77-89.
- Hughes, W., & Jagannathan, R., 2009. Alternative intersections/interchanges: Information report (AIIR) (FHWA-HRT-09-060). Federal Highway Administration. Washington, DC, 1, 2009.
- Hughes, W., Jagannathan, R., Sengupta, D. and Hummer, J., 2010. Alternative Intersections/Interchanges: Informational Report (AIIR). Publication FHWA-HRT-09-060. Federal Highway Administration, U.S. Department of Transportation.
- Hummer, J., Cunningham, C., Srinivasan, R., Warchol, S., Claros, B., Edara, P., Sun, C., 2016. Safety Evaluation of Seven of the Earliest Diverging Diamond Interchanges Installed in the United States. *Transportation Research Record: Journal of the Transportation Research Board* 2583, 25-33.
- Hummer, J., Haley, J., Ott, R., Foyle, R., Cunningham, C., 2010. Superstreet Benefits and Capacities. Publication FHWA/NC/2009-06. Federal Highway Administration, U.S. Department of Transportation.

- Hummer, J., Ray, B., Daleiden, A., Jenior, P., Knudsen, J., 2014. Restricted Crossing U-Turn Informational Guide. Publication FHWA-SA-14-070. Federal Highway Administration, U.S. Department of Transportation.
- Hummer, J. E., D.Reid, J., 1998. Unconventional left turn alternative for urban and suburban arterials- part one, ITE Journal, 68 (9), 26-29.
- Inman, V., 2009. Evaluation of Signs and Markings for Partial Continuous Flow Intersection. Transportation Research Record: Journal of the Transportation Research Board 2138, 66-74.
- Inman, V., Haas, R., 2012. Field Evaluation of a Restricted Crossing U-Turn Intersection. Publication FHWA-HRT-11-067. Federal Highway Administration, U.S. Department of Transportation.
- Aarp, 2020. Intersections Designed for Driver Safety. Retrieved April 18, 2020, from <https://www.aarp.org/auto/driver-safety/info-2013/new-types-of-intersections.html>
- Isaksson-Hellman, I., Lindman, M., 2015. Evaluation of Rear-End Collision Avoidance Technologies Based on Real World Crash Data. Proceedings of Future Active Safety Technology Towards Zero Traffic Accidents (FASTzero), 471-476.
- Jagannathan, R., Gimbel, M., Bared, J., Hughes, W., Persaud, B., Lyon, C., 2006. Safety Comparison of New Jersey Jug Handle Intersections and Conventional Intersections. Transportation Research Record: Journal of the Transportation Research Board 1953, 187-200.
- Jagannathan, R., 2007. Synthesis of the median u-turn intersection treatment, safety, and operational benefits (No. FHWA-HRT-07-033). United States. Federal Highway Administration. Office of Research, Development, and Technology.
- Jarem, E., 2004. Safety and Operational Characteristics of Continuous Green Through Lanes at Signalized Intersections in Florida. Paper presented at the ITE 2004 Annual Meeting and Exhibit Institute of Transportation Engineers.
- Jensen, S., 2010. Safety Effects of Intersection Signalization: A Before-After Study. Transportation Research Board 89th Annual Meeting Compendium of Papers, Washington, D.C.
- Keall, M., and S. Newstead., 2009. Induced exposure estimates of rollover risk for different types of passenger vehicles. Traffic injury prevention, Vol. 10, No. 1, pp. 30-36.
- Kim, D., Washington, S., Oh, J., 2006a. Modeling Crash Types: New Insights into the Effects of Covariates on Crashes at Rural Intersections. American Society of Civil Engineers: Journal of Transportation Engineering 132 (4), 282-292.
- Kim, T., Edara, P., Bared, J., 2006b. Traffic Efficiency of Two Non-Traditional Intersections; Super Street and Through-About. Presented at 7th Conference on Access Management, Park City, UT.

- Knoblauch, R., Nitzburg, M., Reinfurt, D., Council, F., Zegeer, C., Popkin, C., 1995. Traffic Operations Control for Older Drivers. Publication FHWA-RD-94-119. Federal Highway Administration, U.S. Department of Transportation.
- Ko, M., Geedipally, S., Walden, T., 2013. Effectiveness and Site Selection Criteria for Red Light Camera Systems. *Transportation Research Record: Journal of the Transportation Research Board* 2327, 53-60.
- Kusano, K., Gabler, H., 2012. Safety Benefits of Forward Collision Warning, Brake Assist, and Autonomous Braking Systems in Rear-End Collisions. *Institute of Electrical and Electronics Engineers: Transactions on Intelligent Transportation Systems* 13 (4), 1546-1555.
- Langford, J., Koppel, S., 2006. Epidemiology of Older Driver Crashes—Identifying Older Driver Risk Factors and Exposure Patterns. *Transportation Research Part F: Traffic Psychology and Behaviour* 9 (5), 309-321.
- Lee, J. Abdel-Aty, M., 2019. Safety effects of pavement roughness for freeways: a comparative analysis of interstate highways in five states. *Transportation Research Board Annual Meeting*.
- Lee, J., Nam, B., & Abdel-Aty, M., 2015. Effects of pavement surface conditions on traffic crash severity. *Journal of Transportation Engineering*, 141(10), 04015020.
- Levinson, H.S., Koepke, F.J., Geiger, D., Allyn, D. and Palumbo, C., 2000. Indirect left turns—the Michigan experience. In *Fourth National Access Management Conference Access Management Committee (TRB Committee AD107) of the Transportation Research Board*.
- Li, N., Sathyanarayana, A., Busso, C., Hansen, J., 2013. Rear-End Collision Prevention Using Mobile Devices. *6th Biennial Workshop on DSP for In-Vehicle Systems and Safety*. Seoul, South Korea.
- Liu, P., Lu, J., Chen, H., 2008. Safety Effects of the Separation Distances between Driveway Exits and Downstream U-Turn Locations. *Accident Analysis and Prevention* 40 (2), 760-767.
- Lord, D., van Schalkwyk, I., Chrysler, S., Staplin, L., 2007. A Strategy to Reduce Older Driver Injuries at Intersections Using More Accommodating Roundabout Design Practices. *Accident Analysis and Prevention* 39 (3), 427-432.
- Ma, L., Yan, X., 2014. Examining the Nonparametric Effect of Drivers' Age in Rear-End Accidents through an Additive Logistic Regression Model. *Accident Analysis and Prevention* 64, 129-136.
- Martínez-Ruiz, V., Lardelli-Claret, P., Jiménez-Mejías, E., Amezcua-Prieto, C., Jimenez-Moleon, J. J., & del Castillo, J. d. D. L. (2013). Risk factors for causing road crashes involving cyclists: An application of a quasi-induced exposure method. *Accident Analysis & Prevention*, 51, 228-237.
- Mayhew, D., Simpson, H., Ferguson, S., 2006. Collisions Involving Senior Drivers: High-Risk Conditions and Locations. *Traffic Injury Prevention* 7 (2), 117-124.



- McGee, H., 2003. National Cooperative Highway Research Project Report 491: Crash Experience Warrant for Traffic Signals. Transportation Research Board, Washington, D.C.
- Milanés, V., Pérez, J., Godoy, J. and Onieva, E., 2012. A Fuzzy Aid Rear-End Collision Warning/Avoidance System. *Expert Systems with Applications*, 39 (10), 9097-9107.
- Montella, A., 2011. Identifying Crash Contributory Factors at Urban Roundabouts and Using Association Rules to Explore their Relationships to Different Crash Types. *Accident Analysis and Prevention*, 43 (4), 1451-1463.
- Ni, Y., Li, K., 2014. Estimating Rear-End Accident Probabilities at Signalized Intersections: A Comparison Study of Intersections with and Without Green Signal Countdown Devices. *Traffic Injury Prevention* 15 (6), 583-590.
- Nishida, Y., 1999. Driving Characteristics of the Elderly: Risk Compensation of the Elderly Driver from the Viewpoint of Reaction Behavior. *Japanese Society of Automotive Engineers Review* 20 (3), 375-380.
- NJDOT. (2015). Roadway Design Manual. New Jersey.
- Noyce, D., Talada, V., Gates, T. Safety and Operational Characteristics of Two-Way Left-Turn Lanes: Final Report. Minnesota Department of Transportation. (2006)
- Ortman, J., Velkoff, V., Hogan, H., 2014. An Aging Nation: The Older Population in the United States, 25-1140. U.S. Census Bureau, U.S. Department of Commerce.
- Ott, S., Haley, R., Hummer, J., Foyle, R., Cunningham, C., 2012. Safety Effects of Unsignalized Superstreets in North Carolina. *Accident Analysis and Prevention* 45, 572-579.
- Ou, Y.-K., Liu, Y.-C., 2017. Effects of Age and Different Road Workload on Driver's Situation Awareness. Proceedings of the 2017 Institute of Electrical and Electronics Engineers International Conference on Applied System Innovation. Sapporo, Japan.
- Oxley, J., Fildes, B., Corben, B., Langford, J., 2006. Intersection Design for Older Drivers. *Transportation Research Part F: Traffic Psychology and Behaviour* 9 (5), 335-346.
- Park, S., Rakha, H., 2010. Continuous Flow Intersections: A Safety and Environmental Perspective. *Intelligent Transportation Systems (ITSC) 2010 13th International Institute of Electrical and Electronics Engineers Conference*, 85-90.
- Parsons, G., 2007. The Parallel Flow Intersection: A New Two-Phase Signal Alternative. *Institute of Transportation Engineers Journal* 77 (10), 28-37.
- Pernia, J., Lu, J., Weng, M., Xie, X., Yu, Z., 2002. Development of Models to Quantify the Impacts of Signalization on Intersection Crashes. Publication FDOT-BC-353-05. Florida Department of Transportation.
- Persaud, B., Retting, R., Lyon, C., 2004. Crash reduction following installation of centerline rumble strips on rural two-lane roads. *Accident Analysis and Prevention* 36, 1073-1079.

- Poch, M., Mannering, F., 1996. Negative Binomial Analysis of Intersection-Accident Frequencies. *American Society of Civil Engineers: Journal of Transportation Engineering* 122 (2), 105-113.
- Politecnico, 2018. A Tutorial on Clustering Algorithms. [https://home.deib.polimi.it/matteucc/Clustering/tutorial\\_html/index.html](https://home.deib.polimi.it/matteucc/Clustering/tutorial_html/index.html). Accessed April 4, 2018.
- Preusser, D., Williams, A., Ferguson, S., Ulmer, R., Weinstein, H., 1998. Fatal Crash Risk for Older Drivers at Intersections. *Accident Analysis and Prevention* 30 (2), 151-159.
- Reid, J., Hummer, J., 2001. Travel Time Comparisons Between Seven Unconventional Arterial Intersection Designs. *Transportation Research Record: Transportation Research Board* 1751, 56-66.
- Reid, J., Sutherland, L., Ray, B., Daleiden, A., Jenior, P., Knudsen, J., 2014. Median U-Turn Informational Guide. Publication FHWA-SA-14-069. Federal Highway Administration, U.S. Department of Transportation.
- Retting, R., Kyrychenko, S., 2002. Reductions in Injury Crashes Associated with Red Light Camera Enforcement in Oxnard, California. *American Journal of Public Health* 92 (11), 1822-1825.
- Retting, R., Weinstein, H., Solomon, M., 2003. Analysis of Motor-Vehicle Crashes at Stop Signs in Four US Cities. *Journal of Safety Research* 34 (5), 485-489.
- Rodegerdts, L., Nevers, B., Robinson, B., Ringert, J., Koonce, P., Bansen, J., Nguyen, T., McGill, J., Stewart, D., Suggett, J., Neuman, T., Antonucci, N., Hardy, K., Courage, K., 2004. Signalized Intersections: Informational Guide. Publication FHWA-HRT-04-091. Federal Highway Administration, U.S. Department of Transportation.
- Ross, J., Sperley, M., 2011. Red Light Running Camera Assessment. Publication FHWA-OR-RD-11-09. Federal Highway Administration, U.S. Department of Transportation.
- Sando, T., Chimba, D., Kwigizile, V., & Walker, H., 2010. Safety Characteristics of Unconventional Continuous Green Through Lane Intersections. Paper presented at the Transportation Research Board 89th Annual Meeting, Location: Washington DC, United States.
- Sando, T., Chimba, D., Kwigizile, V., Walker, H., 2012. Safety Analysis of Continuous Green through Lane Intersections. *Journal of the Transportation Research Forum* 50 (1), 5-17.
- Schroeder, B., Cunningham, C., Ray, B., Daleiden, A., Jenior, P., Knudsen, J., 2014. Diverging Diamond Interchange: Informational Guide. Publication FHWA-SA-14-067. Federal Highway Administration, U.S. Department of Transportation.
- Scikit-Learn Developers, 2018. Retrieved April 15, 2018, from <http://scikit-learn.org/stable/modules/preprocessing.html>.

- Shin, K., Washington, S., 2007. The Impact of Red Light Cameras on Safety in Arizona. *Accident Analysis and Prevention*, 39 (6), 1212-1221.
- Smith, D., 2013. Development of a New Jughandle Design for Facilitating High-Volume Left Turns and U-Turns. Submitted Master's Thesis. University of Pittsburgh. Pittsburgh, PA.
- Srinivasan, R., Lan, B., Carter, D., 2014. Safety Evaluation of Signal Installation with and without Left Turn Lanes on Two Lane Roads in Rural and Suburban Areas. Publication FHWA/NC/2013-11. Federal Highway Administration, U.S. Department of Transportation.
- Stamatiadis, N., & Deacon, J. A. (1997). Quasi-induced exposure: methodology and insight. *Accident Analysis & Prevention*, 29(1), 37-52.
- Stamatiadis, N., Taylor, W., Mckelvey, F., 1990. Accidents of Elderly Drivers and Intersection Traffic Control Devices. *Journal of Advanced Transportation* 24 (2), 99-112.
- Staplin, L., Lococo, K., McKnight, A., McKnight, A., Odenheimer, G., 1998. Intersection Negotiation Problems of Older Drivers, Volume II: Background Synthesis on Age and Intersection Driving Difficulties. Publication HS-808 850. National Highway Traffic Safety Administration, U.S. Department of Transportation.
- Steyn, H., Bugg, Z., Ray, B., Daleiden, A., Jenior, P., Knudsen, J., Kittelson and Associates, 2014. Displaced Left-turn Intersection Informational Guide. Publication FHWA-SA-14-068. U.S. Department of Transportation, Federal Highway Administration.
- Subramanian, R., Lombardo, L., 2007. Analysis of Fatal Motor Vehicle Traffic Crashes and Fatalities at Intersections, 1997 to 2004. Publication HS-810-682. National Highway Traffic Safety Administration, U.S. Department of Transportation.
- Tang, A., Yip, A., 2010. Collision Avoidance Timing Analysis of DSRC-Based Vehicles. *Accident Analysis and Prevention*, 42 (1), 182-195.
- Tang, J., & Levett, S. (2010). Driver behaviour and crash profiles at Seagull T-junctions on high speed rural roads. *Journal of the Australasian College of Road Safety*, 21(2), 27.
- Uc, E., Rizzo, M., Anderson, S., Shi, Q., Dawson, J., 2006. Unsafe Rear-End Collision Avoidance in Alzheimer's Disease. *Journal of the Neurological Sciences*, 251 (1), 35-43.
- Uchida, N., Fujita, K., Katayama, T., 1999. Detection of Vehicles on the Other Crossing Path at an Intersection: Visual Search Performance of Elderly Drivers. *Japanese Society of Automotive Engineers Review* 20 (3), 381-386.
- Vanlaar, W., Robertson, R., Marcoux, K., 2014. An Evaluation of Winnipeg's Photo Enforcement Safety Program: Results of Time Series Analyses and an Intersection Camera Experiment. *Accident Analysis and Prevention* 62, 238-247.
- Vaughan, C., Jagadish, C., Bharadwaj, S., Cunningham, C., Schroeder, B., Hummer, J., Findley, D., Roupail, N., 2015. Long-Term Monitoring of Wrong-Way Maneuvers at Diverging

Diamond Interchanges. *Transportation Research Record: Journal of the Transportation Research Board* 2484, 129-139.

Villalba, J., Kirk, A., Stamatiadis, N., 2001. Effects of Age and Cohort on Older Drivers. *Society of Automotive Engineers. Technical Paper* 2001-01-3349.

Wang, J., Abdel-Aty, M., Park, J., Lee, C., Kuo, P., 2015. Estimating Safety Performance Trends Over Time for Treatments at Intersections in Florida. *Accident Analysis and Prevention* 80, 37-47.

Wang, X., Abdel-Aty, M., 2006. Temporal and Spatial Analyses of Rear-End Crashes at Signalized Intersections. *Accident Analysis and Prevention* 38 (6), 1137-1150.

Wood, J., Donnell, E., 2016. Safety Evaluation of Continuous Green T Intersections: A Propensity Scores-Genetic Matching-Potential Outcomes Approach. *Accident Analysis and Prevention* 93, 1-13.

Yahl, M., 2013. Safety Effects of Continuous Flow Intersections. Submitted Master's Thesis. North Carolina State University. Raleigh, North Carolina.

Yan, X., Radwan, E., 2006. Analyses of Rear-End Crashes Based on Classification Tree Models. *Traffic Injury Prevention* 7 (3), 276-282.

Yan, X., Radwan, E., Abdel-Aty, M., 2005. Characteristics of Rear-End Accidents at Signalized Intersections Using Multiple Logistic Regression Model. *Accident Analysis and Prevention* 37 (6), 983-995.

Yan, X., Radwan, E., Guo, D., 2007. Effects of Major-Road Vehicle Speed and Driver Age and Gender on Left-Turn Gap Acceptance. *Accident Analysis and Prevention* 39 (4), 843-852.

Yonekawa, T., Sasaki, K., Iwazaki, K., 2014. Driving Behavior Analysis of Elderly Drivers Passing Through Stop Sign Intersection Using Driving Simulator. *International Journal of Automotive Engineering* 5 (4), 137-144.

Zakka, K., 2016. A Complete Guide to K-Nearest-Neighbors with Applications in Python and R. Retrieved from <https://kevinzakka.github.io/2016/07/13/k-nearest-neighbor/>

Zlatkovic, M., 2015. Development of Performance Matrices for Evaluating Innovative Intersections and Interchanges. Report UT-15.13. Utah Department of Transportation.

## APPENDIX A-QUESTIONNAIRE SURVEY



Dear traffic engineer,

This survey is prepared by the University of Central Florida (UCF) as part of a Florida Department of Transportation (FDOT) project to assess the implementation of alternative intersections in terms of both operating characteristics and safety features. If you face any problems filling out this form electronically, you may print it and fill it out manually. Also, the first question of this survey refers to information to be input in a spreadsheet accompanying the survey. Kindly fill in the required inputs in the spreadsheet as well.

State Name:

Organization Type (DOT, County, City, Private Consulting Firm etc.):

Organization Name (if Applicable):

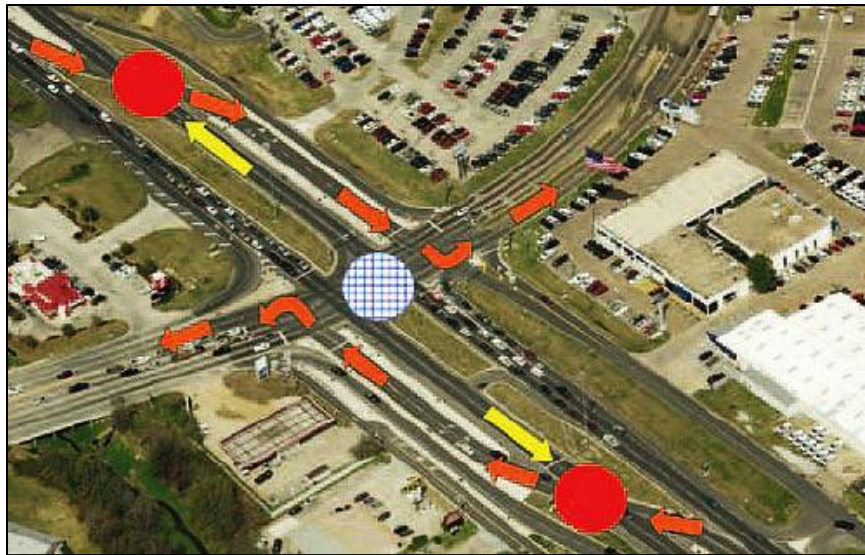
Respondent's Name:

Respondent's Email:

Respondent's Phone:

1. Has your jurisdiction implemented any alternative intersection design? If yes, please enter "yes" after the statements that follow the boxes that apply. If not, you may leave them blank. Figures of the intersections with brief descriptions are provided for clarification. Also, for any intersection, of which type you've entered "yes", kindly provide the intersection's type, date of start of construction, date of construction completion, construction cost, annual maintenance cost, address and GIS coordinates in the accompanying spreadsheet provided.

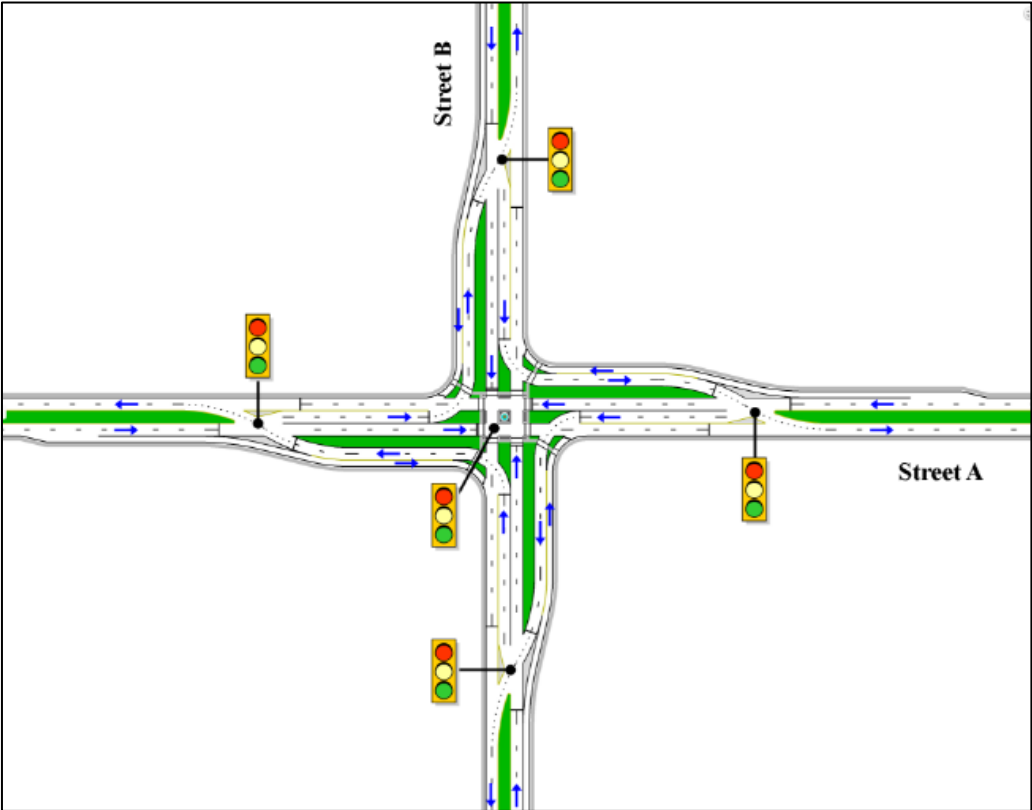
□ Continuous flow (a.k.a. displaced left-turn or cross-over displaced left-turn) intersection:



Source: Hughes et al., 2010

Description: At either intersecting road, upstream of the intersection, left turners will travel across the receiving lanes to reach a road adjacent to the receiving lanes to turn left. Note that roundabouts are not continuous flow intersections.

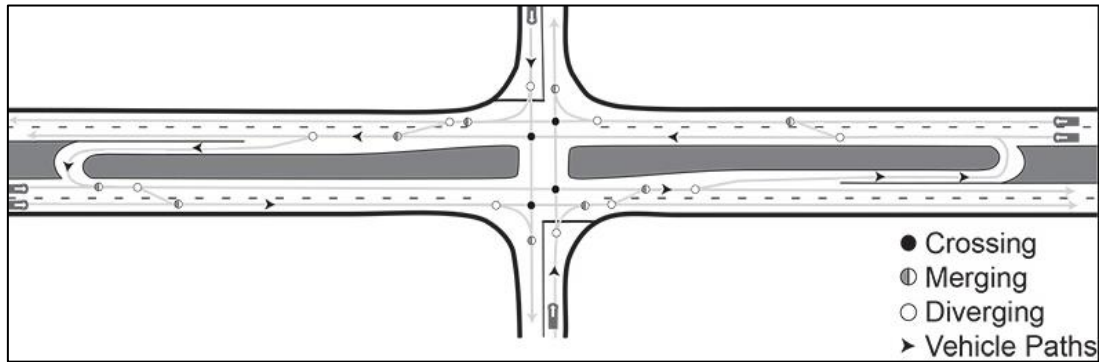
□ Parallel flow (a variant of continuous flow) intersection:



Source: Parsons, 2007

Description: The operation is the same as in the continuous flow intersection (displaced left-turn, cross-over or displaced left-turn intersection) except that after crossing the opposing lanes, left turners travel on a bypass lane parallel to the intersecting road, cross the opposing lanes on the intersecting road and merge with the traffic in the receiving lanes.

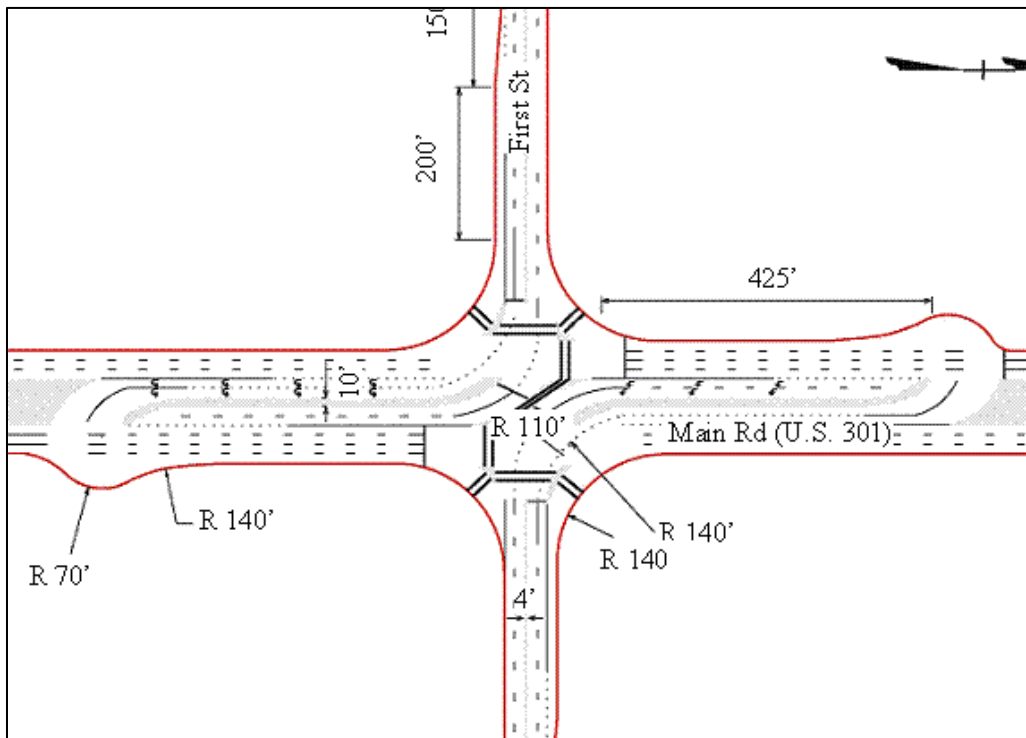
□ Median U-turn (a.k.a. median U-turn cross-over, Michigan left, Michigan loon, boulevard left, turn-around or through U-turn) intersection:



Source: Hummer et al., 2014

Description: Left turns are prohibited from the intersection. Instead, left turners on the major road will navigate through the intersection, make a U-turn downstream of the intersection to return to the intersection and then turn right.

□ Restricted crossing U-turn (a.k.a. super-street J-turn) intersection:

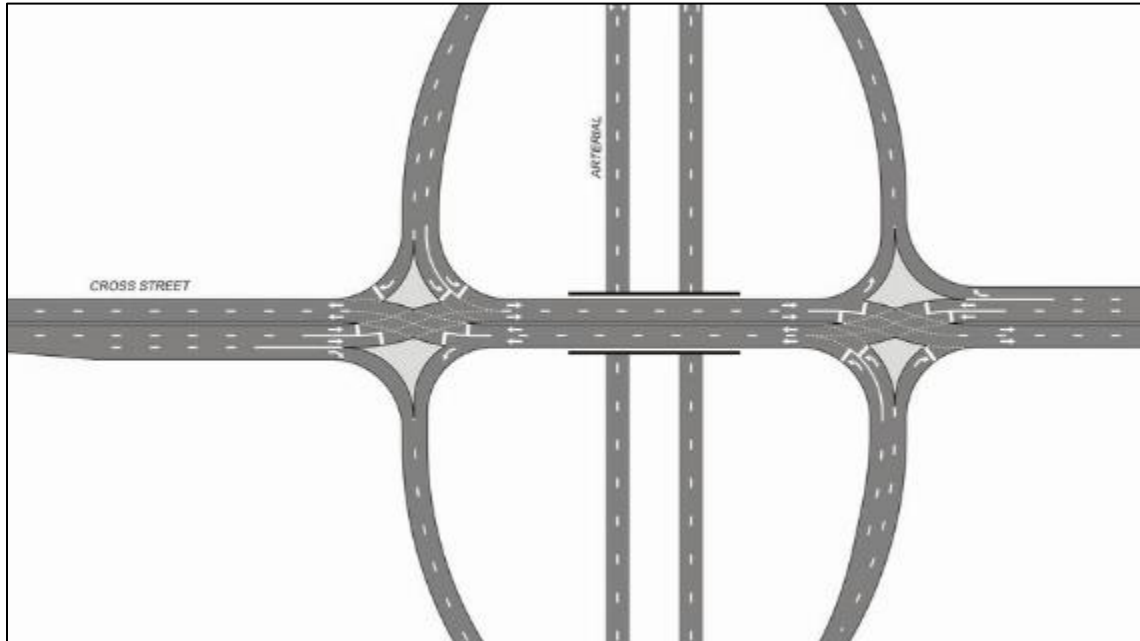


Source: Hughes et al., 2010

Description: Through and left turn movements are prohibited from the minor roads. Instead, the minor road traffic is permitted to turn right and navigate through a U-turn at a median opening downstream to be able to return to the intersection and make their desired movements.



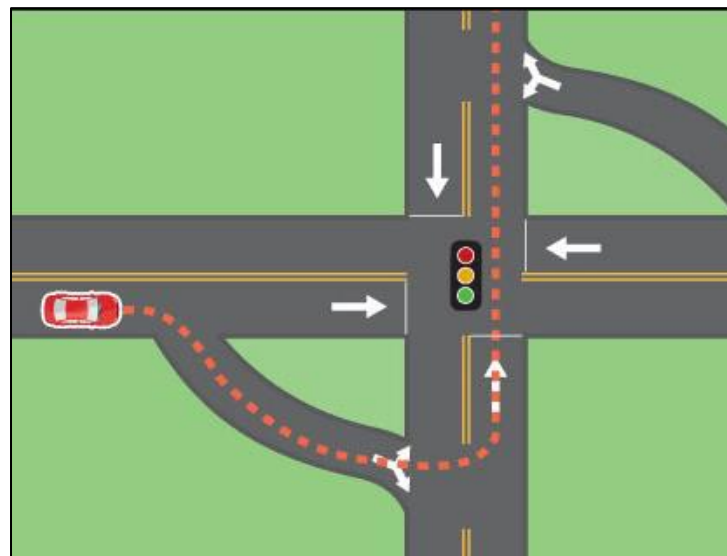
□ Diverging diamond (a.k.a. double cross-over diamond) interchange:



Source: Attap, 2020

Description: On the non-arterial (or non-freeway) section (Eastbound and Westbound route shown in the figure), traffic, traveling either direction, crosses to the opposite side of the roadway and makes through or left-turn movements.

□ Jughandle (a.k.a. Jersey left) intersection:



Source: Aarp, 2020

Description: Upstream of the main intersection, left turners navigate through an at-grade ramp that leads them to another junction adjacent to the intersection to turn left.

Paired intersection:



Source: Attap, 2020

Description: Left turns are prohibited from the main road (the one running East/West shown in the figure) and are permitted turn left or make U-turns at an un-signalized intersection downstream.

Hamburger roundabout (a.k.a. through-about or cut-through) intersection:



Source: Hummer et al., 2014

Description: Through movements from the major road are permitted to navigate through an opening in the roundabout while traffic from the minor road are permitted to circulate around the roundabout in order to make their turns.

□ Continuous green-T (a.k.a. seagull) intersection:



Source: Hughes et al., 2010

Description: The through movement from the major road (the one running Northeast and Southwest shown in the figure) and the left turn movement from the minor road (latter one shown in the figure) are permitted simultaneously.

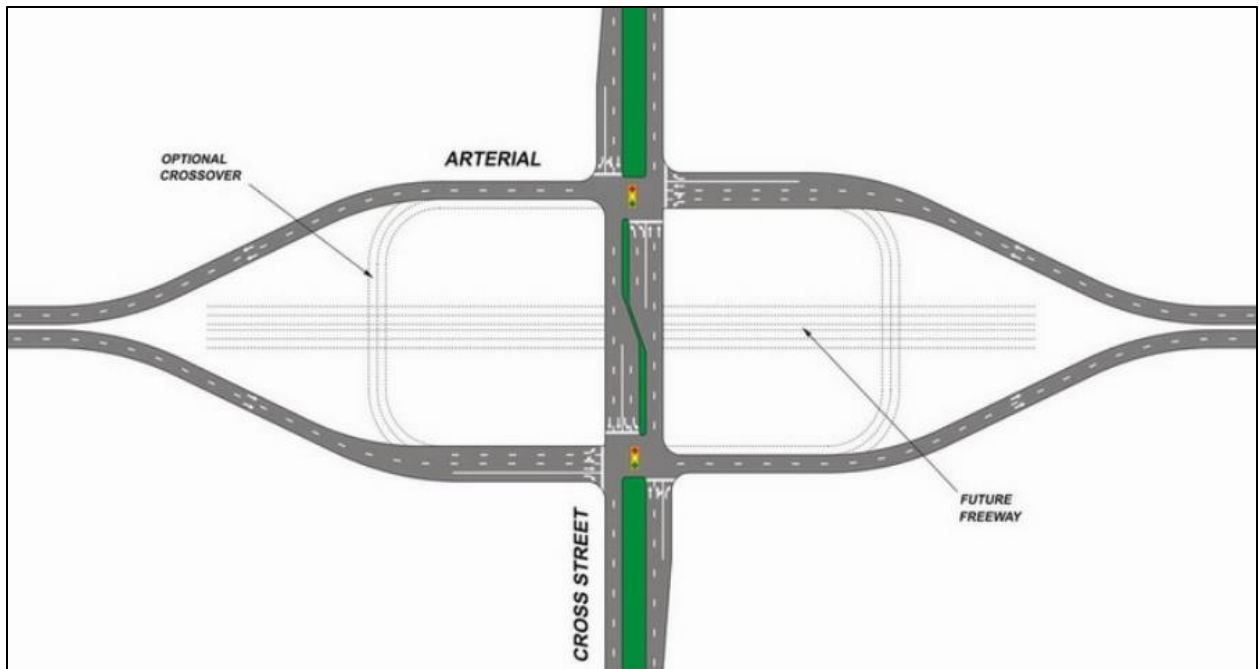
□ Quadrant roadway intersection:



Source: Attap, 2020

Description: Left-turners at the main intersection (where the arterial and the cross street intersect as shown in the figure) may proceed through the intersection, turn left to the quadrant roadway and then turn right at the intersection with the cross street.

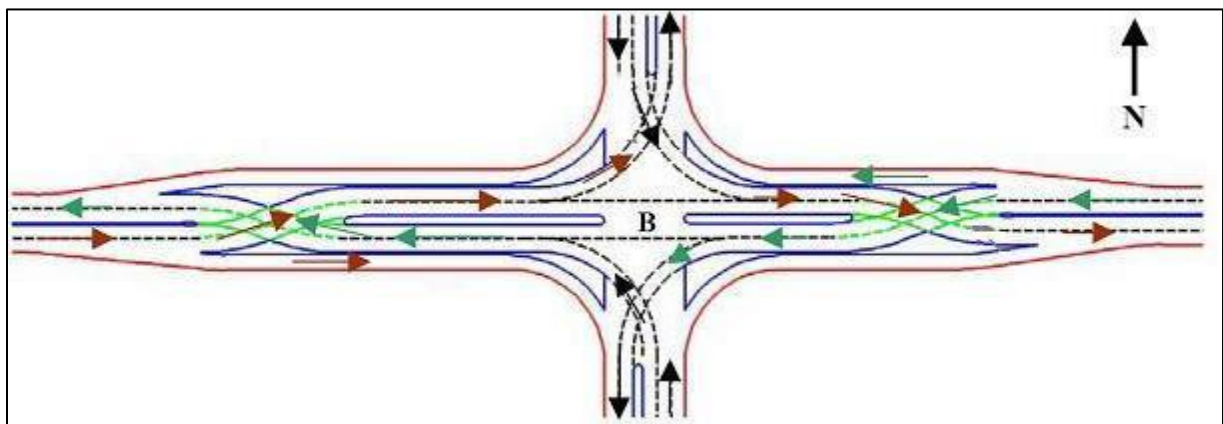
□ Split intersection:



Source: Attap, 2020

Description: Both directions of traffic on the main road (arterial shown in the figure) are split into two one-way roadways, creating two intersections set apart by a couple of hundreds of feet and the need for a separate left turn signal phase for left turners on the main road is eliminated.

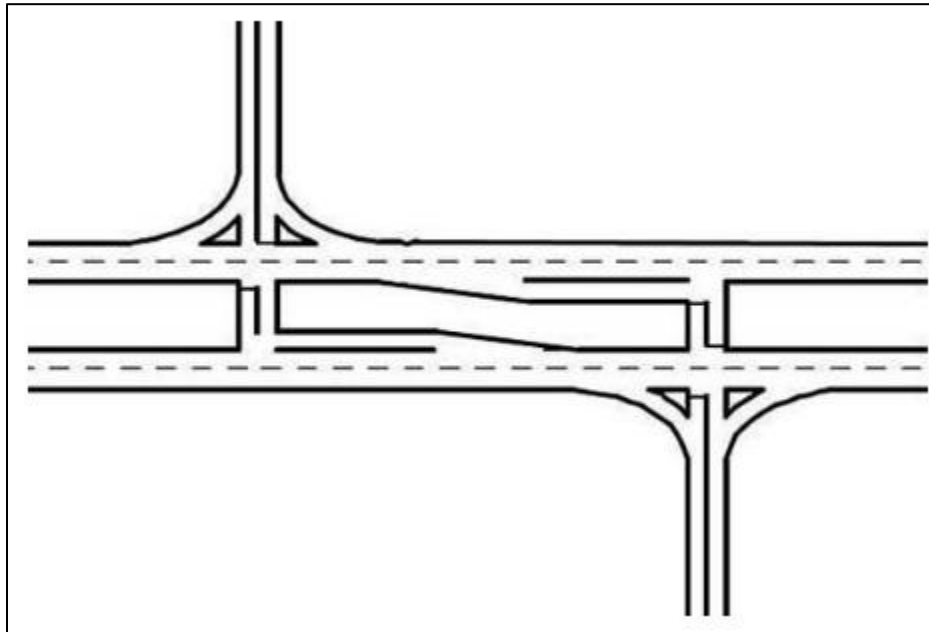
□ Synchronized split-phasing (a.k.a. double cross-over) intersection:



Source: Hughes et al., 2010

Description: Through and left turn movements on the major road (Eastbound and Westbound shown in the figure) cross over to the receiving lanes, upstream of the intersection, before executing the desired movement. This eliminates the conflict between the through traffic and the opposing left turn traffic.

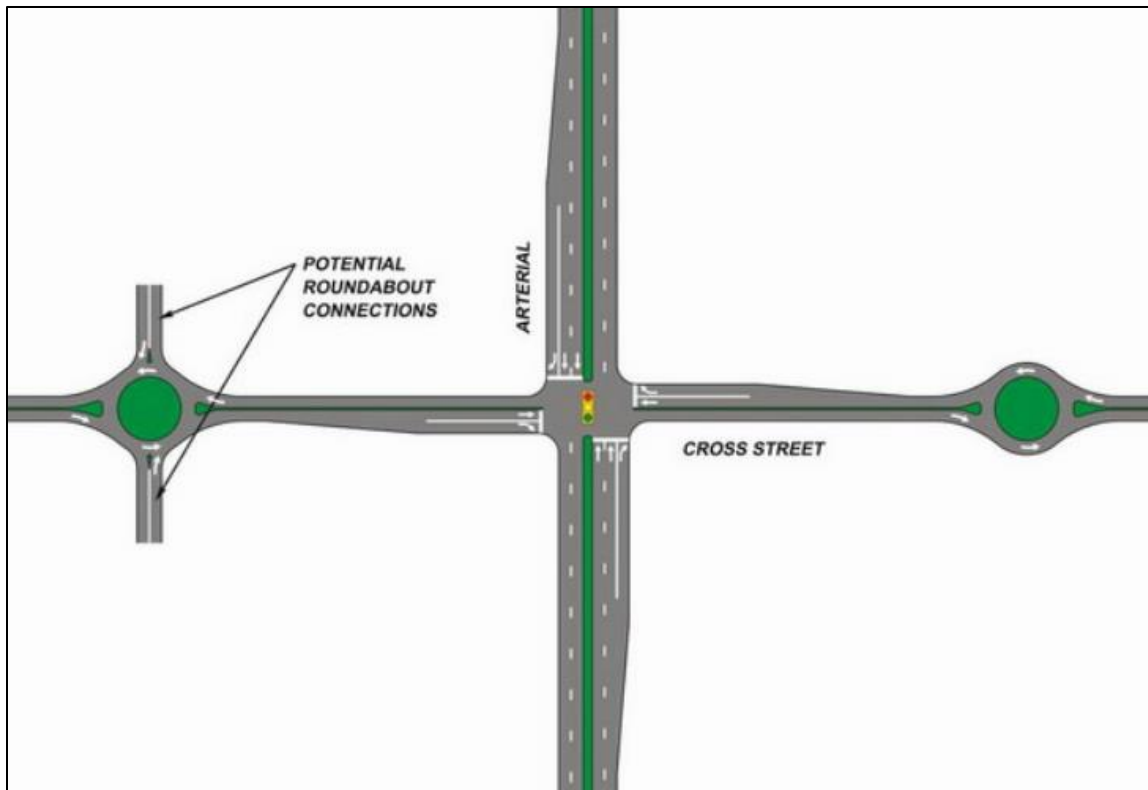
□ Offset T-intersection:



Source: Hughes et al., 2010

Description: The minor road approaches, intersecting with the major road, are offset by a distance forming two T-intersections. Through movements from minor road may proceed through the T-intersection, make a left turn and then turn right at the next T-intersection.

□ Bowtie intersection:



Source: Attap, 2020

Description: Instead of permitting left turns at the main intersection, left turners from the major road (arterial shown in the figure) may turn right and make a U-turn via the roundabout, return to the intersection and then proceed through it. Left turners from the minor road (cross street shown in the figure) may travel through the intersection, make the U-turn using the roundabout, return to the intersection and turn right.

Double wide intersection:



Source: Attap, 2020

Description: Each directional movement (Eastbound and Westbound shown in the figure) of the major road (arterial shown in the figure) are separated into two streams widening traveled way upstream of the main intersection. Downstream of the intersection, a metering signal is provided to merge the two streams back to the original un-widened traveled way.

Other(s); specify:



2. If your jurisdiction has implemented alternative intersection design(s) briefly explain your drivers' education and/or awareness campaign so as not to confuse the drivers about the operating characteristics of the alternative intersection(s) in the space provided.

3. Is your jurisdiction planning to implement alternative intersection design(s) in the future? If yes, which intersection design type(s) is (are) considered for implementation and why?

Intersection type:

Reason; enter "yes" after the statement(s) following the box(es) that applies(y)

- To enhance mobility
- To improve vehicle traffic safety
- To improve pedestrian/bicyclist safety
- Other(s) specify:

Intersection type:

Reason; enter "yes" after the statement(s) following the box(es) that applies(y)

- To enhance mobility
- To improve vehicle traffic safety
- To improve pedestrian/bicyclist safety
- Other(s) specify:

Intersection type:

Reason; enter "yes" after the statement(s) following the box(es) that applies(y)

- To enhance mobility
- To improve vehicle traffic safety
- To improve pedestrian/bicyclist safety
- Other(s) specify:

Intersection type:

Reason; enter "yes" after the statement(s) following the box(es) that applies(y)

- To enhance mobility
- To improve vehicle traffic safety
- To improve pedestrian/bicyclist safety
- Other(s) specify:

Thank you for filling out the survey and accompanying spreadsheet. Your help will provide valuable information to enhance traffic mobility and improve safety at Florida's roads. Kindly email this survey and spreadsheet, filled, to [ahmedtf91@knights.ucf.edu](mailto:ahmedtf91@knights.ucf.edu). Your assistance is highly appreciated.

**APPENDIX B-ALTERED FORM OF THE SURVEY'S ACCOMPANYING SPREADSHEET**

<b>Respondent's Name (1 Input per Respondent)</b>	<b>Respondent's Organization (1 Input per Respondent)</b>	<b>Respondent's Email (1 Input per Respondent)</b>	<b>Intersection Type</b>	<b>Date of Start of Construction (MM-DD- YYYY)</b>	<b>Date of Construction Completion (MM-DD- YYYY)</b>	<b>Construction Cost (\$)</b>	<b>Annual Maintenance Cost (\$)</b>	<b>Address (Major Road- Minor Road)</b>	<b>Latitudinal Coordinate</b>	<b>Longitudinal Coordinate</b>

## APPENDIX C-LOCATIONS OF ALTERNATIVE INTERSECTIONS

State	Junction Type	Latitudinal Coordinate	Longitudinal Coordinate
<b>Florida</b>	CGT Intersection	28.581013	-80.655758
	CGT Intersection	28.526225	-80.679097
	CGT Intersection	28.526234	-80.692990
	DDI	27.388649	-82.448782
<b>Michigan</b>	PFI	42.326842	-83.272466
	DDI	42.946564	-85.566379
	MUT Intersection	42.882017	-85.565532
	Jughandle Intersection (Reverse)	43.065203	-85.579020
	Jughandle Intersection (with Reverse Handle)	42.640351	-83.325620
	MUT Intersection	42.602942	-83.290098
	QR Intersection	42.545177	-83.284096
	Split Intersection	42.385407	-83.276050
	Parallel Flow with MUT Intersection	42.371227	-83.275496
<b>Idaho</b>	DDI	42.912817	-112.466292
<b>Mississippi</b>	CFI	34.360847	-89.571882
	DDI	30.451213	-88.902892
	Roundabout Interchange	34.355569	-89.532808
<b>Kentucky</b>	DDI	38.015740	-84.551265
<b>Oregon</b>	DDI	42.281058	-122.814934
	Jughandle Intersection (Reverse)	44.028796	-121.315865
<b>Washington</b>	DDI (Under Construction)	47.063409	-122.765314
	CGT Intersection	48.463707	-122.581542
<b>Nevada</b>	DDI	39.492954	-119.784624
	CGT Intersection	39.041264	-119.779909
<b>Ohio</b>	CFI	39.596650	-84.229100
	RCUT Intersection	39.343901	-84.502000

<b>State</b>	<b>Junction Type</b>	<b>Latitudinal Coordinate</b>	<b>Longitudinal Coordinate</b>
	RCUT Intersection	39.362818	-84.504200
	RCUT Intersection	39.378717	-84.506800
	DDI	40.002545	-83.118200
	DDI	41.532595	-83.636000
<b>Arizona</b>	MUT Intersection	32.337186	-110.977453
<b>Iowa</b>	DDI	41.569211	-93.853635
<b>Texas</b>	DDI	30.558235	-97.692533
	CFI	30.534683	-97.782651
<b>North Carolina</b>	RCUT Intersection (U-Turn Prohibited at One of Major Approach Legs)	34.031585	-78.257247
	RCUT Intersection (U-Turn Prohibited at One of Major Approach Legs)	34.038385	-78.248985
	RCUT Intersection	34.201160	-78.051735
	RCUT Intersection	34.210680	-78.028340
	RCUT Intersection	34.213862	-78.022814
	RCUT Intersection	34.216052	-78.018955
	RCUT Intersection	34.134761	-77.894853
	RCUT Intersection	34.156867	-77.891945
<b>North Carolina</b>	CGT Intersection (Left-Turn Prohibited at one Major Approach Leg and U-Turn Prohibited at Other Major Approach Leg)	34.692151	-77.478491
	MUT (Major Approaches) with RCUT (Only Through Movements Prohibited on Minor Approaches) Intersection	35.642698	-78.838947
	RCUT Intersection	35.651489	-78.847420
	RCUT Intersection	35.657624	-78.848567
	RCUT Intersection (U-Turn Prohibited at One of Major Approach Legs)	35.662867	-78.846062
	MUT (Major Approaches) with RCUT Intersection (Minor Approaches)	35.941997	-79.018428
	RCUT Intersection (Left-Turn Prohibited at One of Major Approach Legs)	35.885036	-78.568160

<b>State</b>	<b>Junction Type</b>	<b>Latitudinal Coordinate</b>	<b>Longitudinal Coordinate</b>
	RCUT Intersection (U-Turn Prohibited at One of Major Approach Legs)	35.902209	-78.487492
	RCUT Intersection	35.913475	-78.450046
	RCUT Intersection (U-Turn Prohibited at One of Major Approach Legs)	35.937602	-78.428280
	RCUT Intersection	35.021758	-79.151382
	RCUT Intersection	35.254503	-79.032884
	RCUT Intersection	35.261006	-79.046226
	RCUT Intersection (U-Turn Prohibited at One of Major Approach Legs)	35.254026	-80.459737
	MUT Intersection	35.407424	-80.713356
	MUT Intersection	35.404829	-80.706795
	RCUT Intersection (U-Turn Prohibited at One of Major Approach Legs)	35.402088	-80.693932
	RCUT Intersection (U-Turn Prohibited at One of Major Approach Legs)	35.435831	-80.660621
	DDI	34.232279	-77.994199
	DDI	34.670069	-79.005993
	DDI (Planned)	35.607034	-78.564177
	DDI (Planned)	35.825434	-78.621479
	DDI (Planned)	35.783946	-78.700182
	DDI (Planned)	35.861370	-78.814763
	DDI (Under Construction)	36.068701	-79.298501
	DDI	36.026889	-79.883437
	DDI (Planned)	35.903825	-79.953947
	DDI	36.075118	-80.109537
	DDI	36.084019	-80.229289
	DDI	35.807490	-80.876042
	DDI (Under Construction)	35.446022	-80.609195
	DDI	35.435352	-80.657354

<b>State</b>	<b>Junction Type</b>	<b>Latitudinal Coordinate</b>	<b>Longitudinal Coordinate</b>
	DDI	35.401992	-80.698386
	DDI	35.361970	-80.749378
	DDI (Planned)	35.409046	-80.857728
<b>North Carolina</b>	DDI	35.483527	-80.874884
<b>Connecticut</b>	Jughandle Intersection	41.729215	-72.753701
	Jughandle Intersection	41.723732	-72.808675
	Jughandle Intersection (with Reverse Handle)	41.925751	-72.681481
	Jughandle Intersection	41.112603	-73.546336
	Jughandle Intersection	41.622447	-72.741645
<b>Pennsylvania</b>	Jughandle Intersection (Unsignalized)	40.798000	-76.392194
	Jughandle Intersection	41.254111	-77.043139
	Jughandle Intersection (Unsignalized)	41.228528	-76.960222
	Jughandle Intersection (Unsignalized)	41.211611	-76.923528
	Jughandle Intersection (Unsignalized)	41.191778	-76.915806
	Jughandle Intersection (Unsignalized)	40.999472	-76.652972
	Jughandle Intersection (Unsignalized)	41.003222	-76.655222
	Jughandle Intersection	40.790250	-76.526194
	Jughandle Intersection (Unsignalized)	40.797028	-76.392694
	Jughandle Intersection	40.791556	-76.532500
	Jughandle Intersection	40.790667	-76.539056
	Jughandle Intersection (Unsignalized)	40.663056	-76.917361
	Jughandle Intersection (Unsignalized)	40.714528	-76.860611
	Jughandle Intersection (Unsignalized)	40.754778	-76.861944
	Jughandle Intersection (Unsignalized)	40.651806	-76.926972
	Jughandle Intersection (Unsignalized)	41.091639	-76.883889
	Split Intersection	41.266391	-75.864390
	CGT Intersection	40.285731	-76.649904

<b>State</b>	<b>Junction Type</b>	<b>Latitudinal Coordinate</b>	<b>Longitudinal Coordinate</b>
	Jughandle Intersection (Unsignalized)	40.494568	-76.964630
	Jughandle Intersection (Unsignalized)	40.504392	-76.978002
	Jughandle Intersection (Unsignalized)	40.526926	-76.986116
	Jughandle Intersection (Unsignalized)	40.544660	-76.988142
	Jughandle Intersection (Unsignalized)	40.586142	-76.970905
	Jughandle Intersection (Unsignalized)	40.620293	-76.953898
	Jughandle Intersection (Unsignalized)	40.466000	-76.951682
	DDI	40.184061	-80.227345
<b>Missouri</b>	Roundabout Interchange (Single Roundabout)	37.956248	-91.782135
	Roundabout Interchange	38.635664	-90.418193
	Roundabout Interchange	38.967394	-94.519770
	Roundabout Interchange	39.165389	-94.598860
	Roundabout Interchange	37.943958	-91.792392
	Roundabout Interchange	38.774467	-92.252254
	Roundabout Interchange (Single Roundabout)	38.584153	-90.642689
	Roundabout Interchange (Single Roundabout)	38.805622	-90.854694