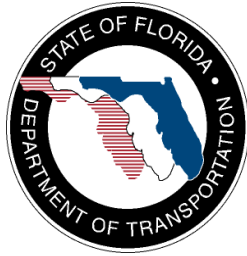


## Final Report

# **Pervious Pavements - Installation, Operations and Strength Part 4: Flexipave® (Recycled Rubber Tires) Systems**

Work Performed for the Florida Department of Transportation



Submitted by

Manoj Chopra, Ph.D., P.E.  
Erik Stuart, E.I.  
Mike Hardin, MSEnv.E., E.I.  
Ikenna Uju, E.I.  
Marty Wanielista, Ph.D., P.E.

**Stormwater Management Academy  
University of Central Florida  
Orlando, FL 32816**



FDOT Project Number: **BDK78**; Work Order **#977-01**  
UCF Office of Research Account Number: **16-60-7024**

**August 2011**

## **Disclaimer**

This report presents the findings of the Stormwater Management Academy and does not necessarily reflect the views or policies of any state agency or water management district, nor does mention of trade names or commercial products constitute endorsement or recommendation for use.

## Technical Report Documentation Page

1. Report No.	2. Government Accession No.	3. Recipient's Catalog No.	
4. Title and Subtitle Pervious Pavements – Installation, Operations and Strength Part 4: FlexiPave (Recycled Rubber Tires) System		5. Report Date August 2011	
		6. Performing Organization Code Stormwater Management Academy	
7. Author(s) Manoj Chopra, Marty Wanielista, Erik Stuart, Mike Hardin, and Ikenna Uju		8. Performing Organization Report No.	
9. Performing Organization Name and Address Stormwater Management Academy University of Central Florida Orlando, FL 32816		10. Work Unit No. (TRAIS)	
		11. Contract or Grant No. <b>BDK78 #977-01</b>	
12. Sponsoring Agency Name and Address Florida Department of Transportation 605 Suwannee Street, MS 30 Tallahassee, FL 32399		13. Type of Report and Period Covered Final Report; May 2008 – Aug 2011	
		14. Sponsoring Agency Code	
15. Supplementary Notes			
16. Abstract Pervious pavement systems are now being recognized as a best management practice by the Environmental Protection Agency and the state of Florida. The pervious concrete system is designed to have enhanced pore sizes in the surface layer compared to conventional pavement types, encouraging flow of water through the material. This research project investigated the infiltration rates, rejuvenation techniques, sustainable storage of the components and complete systems, water quality, and the strength properties of pervious concrete pavements. The work was conducted at the field labs of the Stormwater Management Academy at UCF.  The Flexipave systems indicate that they perform as intended unless subjected to excessive sediment loads or high ground water table. Maintenance by the use of a vacuum sweeper truck was successful in removing surface sediments but is ineffective at removal of deep penetrating sediments. However, it is much harder to clog these in the first place due to a more open surface nature. The reduction in rates is only observed when significant amounts of sediments enter the system and migrate into deeper locations. The sustainable storage of the entire system was found to be about 10%. This pervious pavement system is recommended as an effective infiltration BMP that will perform well throughout its service life. The average compressive strength is about 115 psi and the average modulus of rupture is around 170 psi.			
17. Key Word Stormwater, Recycled rubber, FlexiPave, Strength, water quality, nutrients, Best Management Practices (BMPs), vacuuming sweeping		18. Distribution Statement No Restrictions	
19. Security Classification (of this report) Unclassified	20. Security Classification (of this page) Unclassified	21. No. of Pages 200	22. Price

# Table of Contents

Disclaimer.....	ii
Technical Report Documentation Page .....	iii
LIST OF FIGURES.....	vi
LIST OF TABLES.....	viii
INTRODUCTION.....	1
Background .....	5
Literature Review.....	9
Infiltration Rate.....	11
Laboratory Infiltration Methods .....	12
Field Infiltration Methods.....	13
Double-Ring Infiltrometer.....	14
Single Ring Infiltration Test.....	15
Destructive Test Methods.....	16
Laboratory Permeability Methods.....	16
Field Permeability Methods.....	17
Embedded Ring Infiltrometer Kit.....	18
PAVEMENT INSTALLATION AND SETUP .....	23
Setup for Infiltration and Rejuvenation .....	27
Sustainable Storage Evaluation Setup .....	32
Sustainable Void Space .....	32
Component (Lab) Porosity .....	35
System (Barrel) Porosity.....	39
Strength Testing Setup.....	44
RESULTS AND DISCUSSION.....	49

Infiltration and Rejuvenation Results .....	49
Sustainable Storage Evaluation Results .....	64
Sustainable Storage Strength Evaluation.....	64
Strength Results .....	69
Laboratory Test Results for Flexi-pave.....	69
CONCLUSIONS AND OBSERVATIONS .....	73
General Observations .....	73
Infiltration Rates .....	73
Sustainable Storage .....	75
Water Quality.....	75
Sample Calculations for Quantifying Water Quality Improvement .....	76
Strength Evaluation.....	77
REFERENCES.....	79

## LIST OF FIGURES

Figure 1: FlexiPave surface layer with quarter as scale reference.....	4
Figure 2: Double Ring Infiltrometer used for measuring infiltration into soils.....	14
Figure 3: ERIK monitoring tube .....	19
Figure 4: ERIK embedded ring installed with test collar .....	21
Figure 5: ERIK monitoring cylinder reservoir .....	22
Figure 6: Site and Formwork layout.....	24
Figure 7: Filter fabric installed .....	25
Figure 8: Surface layer installation.....	26
Figure 9: Final layout of FlexiPave sections .....	26
Figure 10: Overcoat application.....	27
Figure 11: Spreading of A-3 sediments over the entire Rejuvenation section .....	28
Figure 12: Washing sediments in with garden hose .....	28
Figure 13: Sediments on surface after being washed in.....	29
Figure 14: Post sediment loading ERIK testing.....	29
Figure 15: Post vacuumed ERIK testing.....	30
Figure 16: ERIK test after sediment loading.....	30
Figure 17: Standard vacuum truck performing maintenance.....	31
Figure 18: Successful vacuuming of Sediments .....	32
Figure 19: FlexiPave material in half gallon containers .....	33
Figure 20: Number 57 stone aggregates in half gallon containers .....	34
Figure 21: Bold&Gold™ materials in half gallon containers.....	34
Figure 22: Surface materials in ½ gallon containers being loaded and draining in sink .....	35
Figure 23: Half gallon container cross sectional drawing .....	36
Figure 24: Half gallon containers draining by gravity .....	38
Figure 25: System 55 gallon barrel cross sectional drawing .....	40
Figure 26: Sediments being washed in .....	43
Figure 27: System barrel being loaded with sediments.....	43
Figure 28: FWD test equipment on FlexiPave section .....	45
Figure 29: FWD conducting test on FlexiPave section .....	46
Figure 30: FlexiPave Rejuvenation cross section (north and south infiltrometers).....	49
Figure 31: Infiltration Rate results (ERIK) Rejuvenation section's North infiltrometer .....	50
Figure 32: Infiltration Rate results (ERIK) Rejuvenation section's South infiltrometer .....	51
Figure 33: FlexiPave Rejuvenation cross section (East and West infiltrometers).....	53
Figure 34: Infiltration Rate results (ERIK) Rejuvenation section's East infiltrometer .....	53
Figure 35: Infiltration Rate results (ERIK) Rejuvenation section's West infiltrometer .....	54
Figure 36: FlexiPave Rejuvenation cross section (New East infiltrometer) .....	55
Figure 37: Infiltration Rate results (ERIK) Rejuvenation section's New East infiltrometer .....	55
Figure 38: FlexiPave Rejuvenation cross section (New West infiltrometer).....	56
Figure 39: Infiltration Rate results (ERIK) Rejuvenation section's New West infiltrometer .....	57

Figure 40: FlexiPave Bold&Gold™ cross section (East and West infiltrometers) ..... 58

Figure 41: Infiltration rate results (ERIK) Bold&Gold™ section's East infiltrometer ..... 59

Figure 42: Infiltration rate results (ERIK) Bold&Gold™ section's West infiltrometer..... 60

Figure 43: FlexiPave Fill cross section (East infiltrometer) ..... 61

Figure 44: Infiltration Rate results (ERIK) Fill section's East infiltrometer ..... 62

Figure 45: Infiltration Rate results (ERIK) Fill section's West infiltrometer ..... 63

Figure 46: System porosity results using 55 gallon barrels..... 66

Figure 47: Washing loaded sediments into pores while pumping infiltrated water out through well pipe  
..... 67

## LIST OF TABLES

Table 1: Individual component Porosity Results measured in ½ gallon containers .....	65
Table 2: Porosity and void ratio data of recycled rubber tire pavement (Flexi-pave®).....	69
Table 3: Statistical Data for Porosity.....	70
Table 4: Statistical Data for Compressive strength.....	70
Table 5: Flexural strength of new recycled rubber tire pavement .....	71
Table 6: Statistical Data for Modulus of Rupture.....	71



## **INTRODUCTION**

Pervious pavement systems are now being recognized as a best management practice by the Environmental Protection Agency (USEPA, 1999) and the new Draft Statewide Stormwater Rule for the state of Florida. This type of pavement system allows rapid passage of water through its joints and infiltration of the underlying soils. A number of these systems are being evaluated at the Stormwater Management Academy field laboratory on the campus of the University of Central Florida.

The natural processes of the water cycle have been fundamentally altered by human development and construction practices. In the natural state, stormwater falls to the earth and gets absorbed into the soil and vegetation where it is filtered, stored, evaporated, and re-dispersed into the ever flowing cycle. The current state of this cycle has reduced this process due to the vast impervious pavements which have sealed the earth's natural filter (Cahill, et al., 2003). In 2005, it was recorded that 43,000 square miles of land in the United States have been paved (Frazer, 2005). Impervious pavements related to automobiles account for two thirds of these surfaces (Lake Superior, 2010).

Permeable pavements provide an alternative to the traditional impervious pavements and due to their porous nature; these ecological consequences can be minimized or even prevented. The advantages include reducing the volume of surface runoff, reduced need for stormwater infrastructure, less land acquisition for stormwater ponds, improved road safety by reduced surface ponding and glare, and a reduced urban heat island effect. Additionally pervious pavements, by using regional or recycled materials such as local recycled automobile tire chips (used in construction of the surface layer), tire crumbs (used in blending of the pollution control

media), and crushed concrete aggregates, can contribute to earning LEED™ points. Pervious pavements allow stormwater to flow into the soil as opposed to flowing over impervious surfaces picking up accumulated contaminants and carrying them offsite. Once an impervious pavement is replaced with a pervious pavement, stormwater is allowed to reach the soil surface where natural processes are able to break down the pollutants (Cahill et al., 2003). According to Brattebo and Booth (2003), infiltrated water from pervious pavement had significantly lower levels of zinc, copper, motor oil, lead, and diesel fuel when compared to runoff from an impervious asphalt pavement.

Notwithstanding the past developments and experiences, there still exists some uncertainty with regard to the infiltration rates with time, the quality of the water that infiltrates, and its strength that has raised some questions about their use as a stormwater management alternative for conventional pavements. An essential aspect of this research involved investigating the infiltration rates, rejuvenation techniques, sustainable storage of the components and complete systems, water quality, and the strength properties of these pavements. Infiltration rate measurements are conducted using an Embedded Ring Infiltrometer Kit (ERIK) device developed at the Academy (Chopra et al, 2010). Storage of water in each material as well as the entire systems is measured in the laboratory and is based on Archimedes's principles of water displacement. Water quality of samples collected through an under drain were analyzed for nutrients using the onsite water quality lab. It should be noted that due to complications in the field water quality analysis was unable to be performed. Strength analysis includes field investigations which include pavement evaluation by means of the FDOT Falling Weight Deflectometer (FWD) equipment.

The Stormwater Management Academy at the University of Central Florida was contracted to conduct water quantity, water quality, and strength analysis of FlexiPave™ (referred to as FlexiPave henceforth in this report) pervious pavement systems. The primary goals for this research are:

1. Evaluate long term infiltration rates and the reduction in these rates due to sediment clogging and effectiveness of rejuvenation using vacuum sweeping.
2. Determine sustainable storage values of the aggregates and surface layer components of the system as well as the entire system storage values.
3. Evaluate the quality of water infiltrating through the system, specifically nutrients.  
(Due to complications in the field water quality analysis was not possible)
4. Determine parameters that represent strength performance of the flexible pavement systems.

The following sections describe the installation of the three full scale pavement sections, laboratory experiments, and a discussion of the results obtained from the study. Pervious pavement systems offer designers and planners an effective tool for managing stormwater. These systems manage stormwater by increasing the rate and volume of infiltration and the reduction of the volume of runoff. By reducing runoff from pavement surfaces, a reduction in the amount of pollutants carried downstream by runoff water can be achieved to minimize non-point source pollution.

The FlexiPave system is designed to have very large pore sizes in the surface layer compared to other existing pervious/permeable pavement types, which are intended to encourage maximum flow of water through the material, see Figure 1 below.



**Figure 1: FlexiPave surface layer with quarter as scale reference**

With such large pore sizes there exists the potential for some of the sediments to also flow freely through the material possibly reducing the storage volume in the rock reservoir layer below. The performance of pervious pavement systems is dependent on the degree of clogging of the opening and pore spaces by fugitive sediments and debris that get deposited onto the surface by both natural and human erosion. How fast a permeable pavement system will infiltrate stormwater throughout its service life will change through periodic sediment accumulation on the surface and maintenance performed.

This report investigates the change in infiltration rates due to high levels of sediment accumulation throughout the entire cross section and the rejuvenation of the pavement system using a standard vacuum sweeper truck. The infiltration testing in this study is conducted by the use of an Embedded Ring Infiltrometer Kit (ERIK) to measure the vertical in-situ infiltration rates of different cross sections of FlexiPave pervious pavement systems. The new draft statewide stormwater rule in Florida suggests that the minimum vertical hydraulic conductivity

of the pervious pavement system (pavement and sub-base layers) shall not be less than 2.0 inches per hour indicated by an ERIK test, based on the pervious pavement design criteria of 85% removal.

The ERIK infiltrometer is embedded into the entire pavement system section that is the pavement layer, stone support/reservoir layer, pollution control layer, and finally the parent earth below the system to measure the vertical infiltration rate. For the purpose of the study, the pavement surfaces are intentionally loaded with large amounts of AASHTO types A-3 soil, A-2-4 soil, and limerock fines to simulate long term worst case scenario clogging. This is done to test the effectiveness of vacuum cleaning as a rejuvenation method for FlexiPave pervious pavement systems to restore its original state of permeability or an improvement from its clogged condition. The results of this study will provide designers, regulators, and contractors with an understanding of how well these pervious pavement systems perform, as per infiltration of water, and the effectiveness of the proposed maintenance method of vacuum truck sweeping for the restoration of the clogged pavement system in a fully operational system.

## ***Background***

Impervious surfaces are responsible for a significant portion of the nation's leading threat to surface water quality, nonpoint source pollution (US EPA, 1994), by producing and transporting un-natural quantities, dynamics, and quality of stormwater runoff into receiving waters. Unlike pollution generated from a single, identifiable source like a factory, the pollutants in stormwater runoff may discharge from many points with uncontrolled amounts of pollutants. Since the exact quantities of stormwater and pollutants in the stormwater cannot be predicted for

all discharge points from every impervious surface, it becomes difficult to treat the runoff effectively and economically.

In the past, the principal concern about runoff from pavements has been drainage and safety, focusing primarily on draining the water off the pavement surface as quickly and efficiently as possible (Chester and James, 1996). Historically, the practice of “out of sight, out of mind” is adhered to once the stormwater was off the pavement surface and into the drainage structure. Unfortunately, this water, once drained from the pavements surface, has to end up somewhere downstream and typically causes negative impacts to ecosystems resulting in habitat loss. The pavement is designed with sufficient cross slope and longitudinal slopes to increase the velocity of the runoff water conveying it away from the pavement before ponding can occur. The result of this increased velocity is the increase in stormwater’s capability of erosion, channel widening, sedimentation, flooding, and spreading of pollutants downstream. Furthermore, impervious pavements are designed with costly measures taken to prevent water from accumulating directly under the pavements and subsequently damaging the structure. Although many pavement designers hope that wearing courses can be kept virtually watertight with good surface seals and high-tech joint fillers, the inevitable stresses and pressures of traffic, temperature fluctuations, oxidation, weathering, and freeze thaw cycles are constantly working to open cracks that allow water to enter. Once the water is in the pavement system it becomes trapped and unable to be expelled quickly. This develops pore water pressures that result in piping and pumping effects that erode away sub soils and cause serious problems to the structure. The only sure way to keep water from accumulating in the structural section is to drain it using a key feature of including a layer of very high permeability (33 in/hr to 333 in/hr or even greater) material under the full width of traffic lanes. This is suitable for good internal drainage of the

systems to prevent deterioration (Cedergren, 1994). The U.S. pavements or “the world’s largest bath tubs” according to Henry Cedergren incurred economic losses of an estimated \$15 billion/yr due to poor drainage practices, which can reduce the service life down to 1/3 of a typical well drained pavement (Cedergren, 1994).

The larger volumes of runoff produced by impervious surfaces and the increased efficiency of water conveyance through pipes, gutters, and other artificially straightened channels, results in increased severity of flooding in areas adjacent and downstream of pavements. It was reported by Chester (1996) this shift away from infiltration reduces groundwater recharge, fluctuates the natural GWT level that could threaten water supplies and reduces the groundwater contribution to stream flow which can result in intermittent or dry stream beds during low flow periods. When runoff bypasses the natural filtering process provided by soils, access to critical ecosystem service is lost and additionally valuable land is not sacrificed to a single-use.

The pervious pavement systems can function as parking areas as well as on-site stormwater control (Dreelin, et. al., 2003). Smith (2005) compares permeable interlocking concrete pavements to infiltration trenches, which have been in use for decades as a means to reduce stormwater runoff volume and pollution, recharge groundwater, and at the same time be used to support pedestrian and vehicular traffic. Research conducted on permeable pavement systems by Scholz (2006) shows that the structure itself can be used as an “effective in-situ aerobic bioreactor,” and function as “pollution sinks” because of their inherent particle retention capacity during filtration due to its high porosity. Most all of the pervious pavement systems share similar applications and all have several advantages over traditional impervious pavement systems. To mention a few, pervious/permeable pavement systems reduce overall runoff, level

of pollution contained in runoff, ponding/hydroplaning, tire spray, glare at night, tire noise, skidding from loss of traction, velocity and temperature of runoff, erosion, and sedimentation (Tennis, et. al., 2004). The enhanced porosity allows for good infiltration and geothermal properties that help in attenuation of pollutants. Additionally, due to the porous nature of the pervious pavement systems, trees have the necessary air and water exchange allowing roots to grow naturally instead of uprooting in search of air and water and causing damage to nearby pavements. More trees in parking lots can benefit owners by providing aesthetics to their property while effectively reducing the heat island effect associated with impervious pavements. Trees and plants serve as natural solar pumps and cooling systems by using the sun's energy to pump water back to the atmosphere resulting in evaporative cooling. The pervious pavement systems allow water to evaporate naturally from the systems similar to natural soils also providing a cooling effect which can even prevent tire blowouts caused by high temperatures.

The stone reservoir/sub-base of the pervious pavement system is designed to store rainwater and allow it to percolate into sub-soils helping to restore the natural groundwater table levels. This ensures that sufficient groundwater exists to supply water wells for irrigation and drinking. It is important to allow the natural hydrologic cycle to remain in balance to efficiently move water from surface water, groundwater, and vegetation to the atmosphere and back to the earth in the form of precipitation. Alterations in this cycle, such as a decrease in infiltration, can cause unwanted impacts resulting in quantity and quality of water that may not be sufficient to provide for all intended economical uses. Structures should be built to control water related events at a risk that is acceptable to the people of an area and within budget expenditures (Wanielista et al., 1997).



Even though pervious pavement systems have been around for many years there is still a lack of needed experimental data associated with the in-situ performance over time. Barriers to the uptake of pervious pavement systems include technical uncertainty in the long term performance, lack of sufficient data, social perception, adoption, and maintenance (Abbot and Comino-Mateos, 2003).

### ***Literature Review***

This research is intended to meet the need by practitioners and researchers to quantify the performance of pervious/permeable pavement systems under field conditions. That is the ability of the complete system (surface and sub-base layers) to store and infiltrate stormwater before it becomes available for runoff. The lack of field data has been an impediment to the use of pervious pavements as a stormwater control tool to help prevent the amount of runoff generated from pavement surfaces. Most of what has been researched before on pervious/permeable pavement systems has been surface infiltration monitoring, which does not give information on clogging effects that may happen below the surface layer of the pavement. Field and laboratory studies have already been conducted on surface infiltration rates of permeable pavements including 14 PICP (permeable interlocking concrete pavement) sites where Bean in 2004 reported median infiltration rates of 31.5 in/hr and 787.4 in/hr when the sites were in close proximity to disturbed soil areas and sites free from loose fines respectively (Bean et. al. 2007). Another study by Illgen et al., (2007) reported infiltration rates of a PICP car park site in Lingen, Germany having initial rates of 8.0, 11.0, and 18.3 in/hr initially and final rates ranging between 5.4 and 11.2 in/hr. It was noted by Illgen et al., (2007) that clogging effects due to fine material accumulating into the slots or voids greatly influence the infiltration capacity and can cause a point-wise decrease of the infiltration rate by a factor of 10 or even 100 compared to newly

constructed pavements. An embedded ring device developed to monitor influences of sub-layer clogging reveals any sub-layer clogging. A pavement systems clogging potential can be tested before and after multiple vacuum sweep attempts. This provides insight into the restoration of these systems over time and at a particular site, given its parent soil conditions.

The infiltration rates are measured using the constant head permeability methodology by adding water to the surface of the pavement inside the extended embedded ring and keeping track of how much water is added over a period of time while maintaining a constant head level. This method is similar to a laboratory constant head permeability test except that the volume of water is measured upstream of the sample instead of downstream due to the nature of the field test which allows water to percolate into the ground where it cannot be collected for measurement. By embedding the ring into the pavement system at a certain depth, the ring prevents water from flowing laterally in a highly permeable layer and instead directs the water vertically downward through any layer of interest. This vertical flow path is more similar to how water will behave in a real rain event in which water is prevented from flowing laterally by other rainwater flowing adjacent to any one spot in the pavement system.

Recycled or shredded tire chips are used in civil engineering applications as replacements for some construction materials such as crushed rock or gravel (RubberPavementAssociation, 2005). Currently, the largest market for recycled rubber tires is the molded products sector, where it is combined with urethane binders. Recycled rubber tire pavements are used for low load applications. This advancement in pavement technology is ideal for driveways, parking lots, walkways, sidewalks, golf cart paths, courtyards, nature trails etc.

Due to the porous nature, recycled rubber tire pavement is being used to decrease the amount of runoff water and also to improve and control stormwater quality and quantity. This

pavement is made from recycled, ground up automobile tires, coarse aggregates and some additives. These materials are bound together by means of a binding agent known as XFP75 (urethane). Recently the manufacturers introduced a new improved product. The binding agent urethane was improved so as to hold recycled passenger tires and aggregates more effectively. The new binder is called XFP95 (polyurethane). According to the manufacturers, it is easily installed over a minimum of 4 inches (100 mm) of well compacted single-sized aggregates or crushed concrete. In addition, it could be installed over concrete or asphalt pavements. It could be installed in temperatures ranges of 45°F – 95°F. But it is clearly advised that when curing this pavement the temperature should not fall below 35°F. After installation, it is ready for use after 24 hours. It comes in various colors as requested by the customer. Porosity ranges from 50% - 60% (Flexi-Pave, 2005).

### ***Infiltration Rate***

The infiltration rate is the velocity of water entering a soil column, usually measured by the depth of water layer that enters the soil over a time period. Infiltration is a function of the soil texture (particle size distribution) and structure (particle arrangement). The infiltration rate is not directly related to the hydraulic conductivity of a media unless the hydraulic boundary conditions are known, such as hydraulic gradient and the extent of lateral flow (Brouwer, et al., 1988). The infiltration rate is influenced by the soil layers, surface conditions, degree of saturation, chemical and physical nature of the soil and liquid, pressure head and temperature of the liquid (ASTM D3385, 2009). It should be noted that filters or porous materials through which a liquid or gas is passed to separate fluid from particulates have both a particle retention and a permeability function (Reddi, 2003). Infiltration rate is relevant to applications on

leaching and drainage efficiencies, irrigation requirements, water seepage and recharge, and several other applications.

### ***Laboratory Infiltration Methods***

Laboratory infiltration testing has been done using rainfall simulators for water supply, computerized falling/constant head permeameters (some with high precision pressure transducers and data acquisition systems), and flume or hopper systems with sprinkling units and tipping gauges for measurement of infiltration of pervious/permeable pavements (Anderson, 1999; Illgen, et. al., 2007; Montes, 2006; Valavala, et. al., 2006). Many of the laboratory tests are classified as destructive tests since either slabs or cores were cut and extracted from existing field pavement sites. The process of cutting pavements may introduce fines into the samples and washing samples may do the opposite and remove some of the existing clogging sediments found on the pavements in an in-situ condition. It was reported that, even though all the samples coming from a particular placement were taken from the same slab, different porosities and hydraulic conductivities within a slab were important and suggested that one sample will not suffice to identify parameters (Montes, 2006). Two core samples taken from another site apparently had no connecting pore channels through the 4 inch diameter core sample which resulted in no flow through. Other samples taken from the same slab had measured values of 19.8 – 35.4 in/hr. The highest hydraulic conductivity values obtained from the tests were reported outside the range of common expected values for pervious concrete, but were in the vicinity of the highest laboratory measurements reported by Tennis et al., (2004). The higher values reported for the pervious concrete samples were around 1,866 in/hr (Montes, 2006).

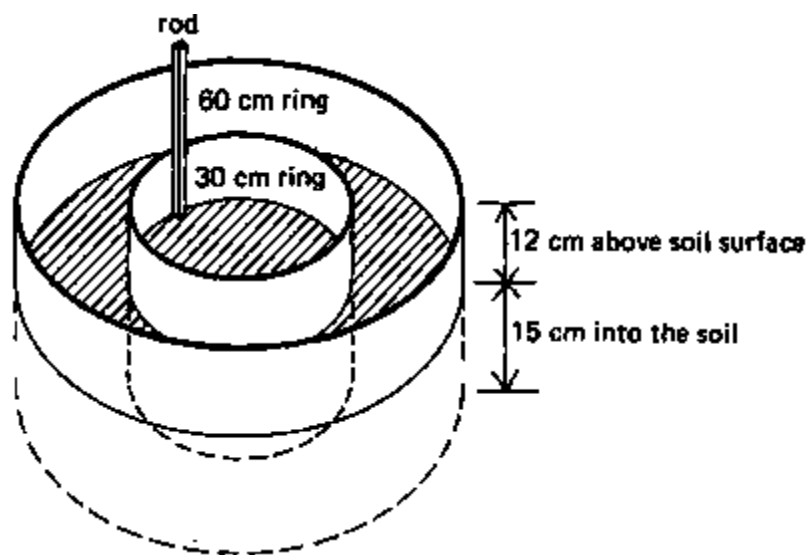
## ***Field Infiltration Methods***

Exfiltration field studies have been completed on pervious/permeable pavement systems by measuring the exfiltration from the systems. Previous studies investigated pervious/permeable pavements under natural rainfall conditions and measured exfiltration, runoff, water depths in pavements systems, and/or precipitation in order to determine infiltration rates through the systems (Abbot and Comino-Mateos, 2003; Brattebo, 2003; Dreelin, et. al., 2003; Schlüter, 2002; Tyner, et. al., 2009). Methods used to measure these parameters consisted of using perforated pipes located in the sub-base which drained the water into tipping bucket gauges for monitoring of ex-filtrated water. In one of the studies, infiltration tests were carried out using a falling head method from an initial head of about 33 inches to a final height of about 8 inches above the pavements surface (Abbot and Comino-Mateos, 2003). It was noted in the report that the measured rates (some as high as 15,287 in/hr) do not represent actual rates which were achieved during actual rainfall events with a column of water applied at such a significant head.

Other researchers used several methods for determining infiltration such as the bore-hole percolation test method, a strategy of completely filling plots with water from an irrigation hose and measuring the water depths in monitor wells, and finally the use of a double ring infiltration test mentioned below (Tyner, et. al., 2009). In this study, different exfiltration methods underneath the pavement systems were investigated to encourage higher exfiltration rates on a compacted clayey soil in eastern Tennessee. They found the performance of trenches filled with stone exfiltrating at 0.43 in/hr to be the highest, followed by ripping with a subsoil exfiltrating at about 0.14 in/hr, then boreholes filled with sand at about 0.075 in/hr.

## ***Double-Ring Infiltrometer***

The double-ring infiltrometer test (DRIT) measures the infiltration rate of soils, in which the outer ring promotes one-dimensional, vertical flow beneath the inner ring. Results from the DRIT are influenced by the diameter and depth of the ring embedment as tests at the same site are not likely to give identical results. The results are recommended primarily for comparative use (ASTM D3385 2009). The testing procedure is as described by the ASTM standard test method for infiltration rate of soils in field using a double-ring infiltrometer ASTM D3385. A typical double-ring infiltrometer set-up for field testing is presented in Figure 2 (Brouwer, et al. 1988).



(Courtesy: Brouwer, et al. 1988)

Figure 2: Double Ring Infiltrometer used for measuring infiltration into soils

The limitation of using the DRIT on pervious systems is that the rings cannot be driven into the pavement surface. In addition, typically soils or vegetative surfaces that would be tested using the DRIT would exhibit a more homogeneous and isotropic strata than a pervious pavement system with layers of significantly different sized aggregates. Therefore, due to lateral

migration of water in the more permeable layers, the test cannot measure the true vertical (one dimensional) infiltration rate of the entire pervious system that is made up of several sub-base layers with varying permeability. This is why the second outer ring is needed when conducting a DRIT, to provide an outer ring of water that creates a curtain of water around the inner “measured” ring and preventing the inner ring water from migrating laterally during the test. It is incorporated to mimic an actual rain event in which there would be the same curtain of water surrounding any one spot on the pavement. In some of the past experiments using the DRIT, Bean et. al., (2007) reported instances of water back up and upward flows out of the surface near the outside of the outer ring. It was determined that this upward flow was due to lower permeability of the underlying layer (Bean et. al., 2007).

More limitations encountered when using the surface infiltration rate tests on highly permeable surfaces are the difficulty in maintaining a constant head or steady state flow through the system during the test, the large amount of water required to run a test, and the need to transport this water to remote locations. According to Bean et. al. (2007) many of the permeable pavement sites had surface infiltration rates that were greater than the filling rate for the DRIT.

### ***Single Ring Infiltration Test***

A modified version of the double-ring infiltrometer is the Single Ring Infiltration Test (SRIT) which uses only a single ring to perform a surface inundation test. It was mentioned that there was difficulty in not only transporting the required amount of water to remote sites to run the DRIT or SRIT, but difficulty was also encountered when filling the inner ring with water at a fast enough rate to maintain a constant head above the surface (Bean et. al., 2007).

The Surface Inundation Test procedure involved recording the time that water started pouring into the single ring from a five gallon bucket until the water in the ring was emptied.

The force of five gallons of water immediately poured on the surface of a clogged pavement may also cause some un-natural dislodging or unclogging of the sediments that are trapped in the surface pores. Plumbers putty was applied to the bottom of the ring and in any joints between pavers to prevent leakage. It was noticed during tests on Permeable Interlocking Concrete Pavers (PICP) and pervious concrete (PC) that the water actually flowed horizontally under the ring bottom and then percolated vertically upward through the pavement surface outside of the single ring, which resulted in over predicted the actual surface rates. However, the DRIT or SRIT provides a method for quantifying the surface infiltration rates of pervious pavements and may serve as a surrogate for the pavement's surface hydraulic conductivity (Bean et. al., 2007).

### ***Destructive Test Methods***

Other test methods include extracting cores of the pavement layers and analyzing the samples in a laboratory. This is a destructive method that may change the pore structures of the flexible pavements and clog pores generated during the coring process. This test method is limited by the inability to repeat tests at the exact same location on the pavement and compare to tests conducted at different times of sediment clogging that is encountered in the field.

### ***Laboratory Permeability Methods***

Most laboratory methods use constant or falling head permeameters that may be equipped with rigid walls (metal, glass, acrylic, PVC, etc.) for coarse grained soils/aggregates and flexible walls (rubber) to prevent sidewall leakage for fine grained samples. Associated sidewall leakage from rigid walled permeameters is usually negligible for sandy and silty soils with permeability rates above  $5 \times 10^{-2}$  cm/s or 70.9 in/hr (Reddi, 2003). These existing permeameters can be computerized and equipped with high precision pressure transducers and data acquisition



systems. Three types of permeability tests include: constant (gradient controlled), variable (gradient controlled), and constant flow rate (flow controlled, pumped at a constant rate) which uses a programmable pump with differential pressure transducers.

### ***Field Permeability Methods***

Investigations on field measurement of infiltration rates of pervious/permeable systems include test methods requiring sealing of the sub-base and installing perforated pipes that drain infiltrate to a collection point or other ex-filtration collection methods. Research has been conducted by a setup containing a sealed sub-base with eight 6-inch perforated pipes used to drain the area from 16 flow events recorded with a v-notch weir and Montec flow logger (Schlüter, 2002). Others have monitored field scale infiltration rates by measuring runoff, precipitation, and infiltration using a tipping bucket gauge. Similar methods for determining field permeability rates of in-situ soils include:

1. Pump test (by pumping water out of a well and measuring GWT drawdown after pumping),
2. Borehole test (using GWT measurements and variable head tests using piezometers or observation wells).

For cases where soil types vary in the domain, the permeability value obtained using the Pump test equations only reflect an effective and averaged value. Both natural and engineered soils are known to exhibit spatial variability in permeability. In natural soils, variability comes from the fact that soil strata/layers were subjected to the different compression forces during formation. In engineered soils and pervious/permeable systems, layered placement and compaction subject these compression forces resulting in generally horizontal permeability being greater because of larger vertical compression forces (Reddi, 2003).

### ***Embedded Ring Infiltrometer Kit***

In order to effectively measure the in-situ performance of the pervious system infiltration capacity over time, an in-place monitoring device named Embedded Ring Infiltrometer Kit (ERIK) was developed at University of Central Florida (UCF), Orlando. It is similar to the existing test for infiltration measurement of soil/vegetated surfaces using a Double Ring Infiltrometer Test (DRIT) (ASTM D3385, 2009). The ERIK device was designed to overcome any difficulties in obtaining infiltration measurements of pervious pavement systems using an efficient, accurate, repeatable, and economical approach. The relatively cheap, simple to install and easy to use device, has no computer, electrical, or moving parts that may malfunction during a test. The kit includes two essential components: one “embedded ring” that is installed into the pavement system at the time of construction and the other a monitoring cylinder reservoir for flow rate measurement purposes used during testing.

The embedded ring is entrenched at predetermined depths into the pavement system to enable measurement of infiltration rates of different layers of the system. There are two types of the ERIK device embedded ring, namely the short-ring and the long-ring ERIK. The short-ring ERIK is extended to the bottom of the pavement layer to measure the infiltration rate of the pavement only. The long-ring ERIK extends down to the bottom of the sub-base layer or even deeper into the parent earth underneath the system to monitor the entire pervious system, giving the parent earth soil conditions. The embedded ring is a pipe made of a hard-wearing synthetic resin made by polymerizing vinyl chloride (PVC) which extends through the pavement layer under consideration. This prevents the lateral migration of water which causes false measurements. The true vertical (one dimensional) steady state infiltration rate can be measured

using the ERIK. Figure 33 below, presents the plan and section views of the ERIK embedded ring as installed in a permeable pavement system while not conducting a test.

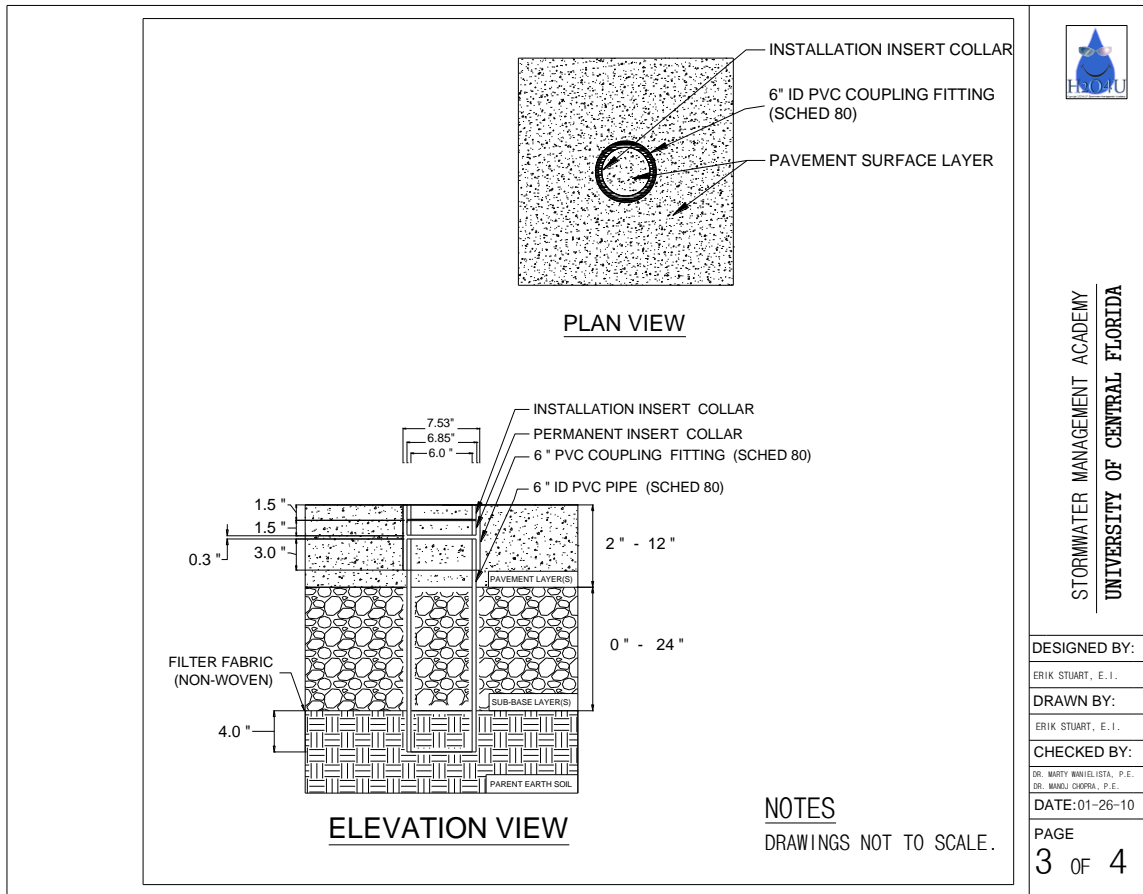


Figure 3: ERIK monitoring tube

The top of the embedded ring is installed flush with the pavement’s surface for ease of pavement construction and to prevent any tripping hazard. In large surface areas of pavement, the embedded ring may function as a grade stake set at an elevation consistent with the final elevation of the pavement surface. The embedded ring allows for screeds, floats, trowels, or any other placing and finishing tools to perform normally and again may even improve their workability. In addition, the ring does not extend beyond the pavement surface; neither does it

interfere with the natural conditions that impact pavement surfaces such as: sediments from wind and water erosions that may accumulate on or penetrate into the system, and sediments from automobile tracks driven into the surface pores of the pavement.

However, when conducting an infiltration test with the ERIK, a temporary “constant head test collar” is inserted into the top of the embedded ring extending above the surface to a desired constant head height and is removed whenever a test is completed. This is illustrated in Figure 4 below. This height is determined based on the height of curbing around the pavement that is capable to provide a certain head of water above the pavement surface during a flood event or a minimum head of one or two inches, for a worst case scenario. This study tested with one or two inches of head to be conservative and since the curbing used was flush with the pavement surface.

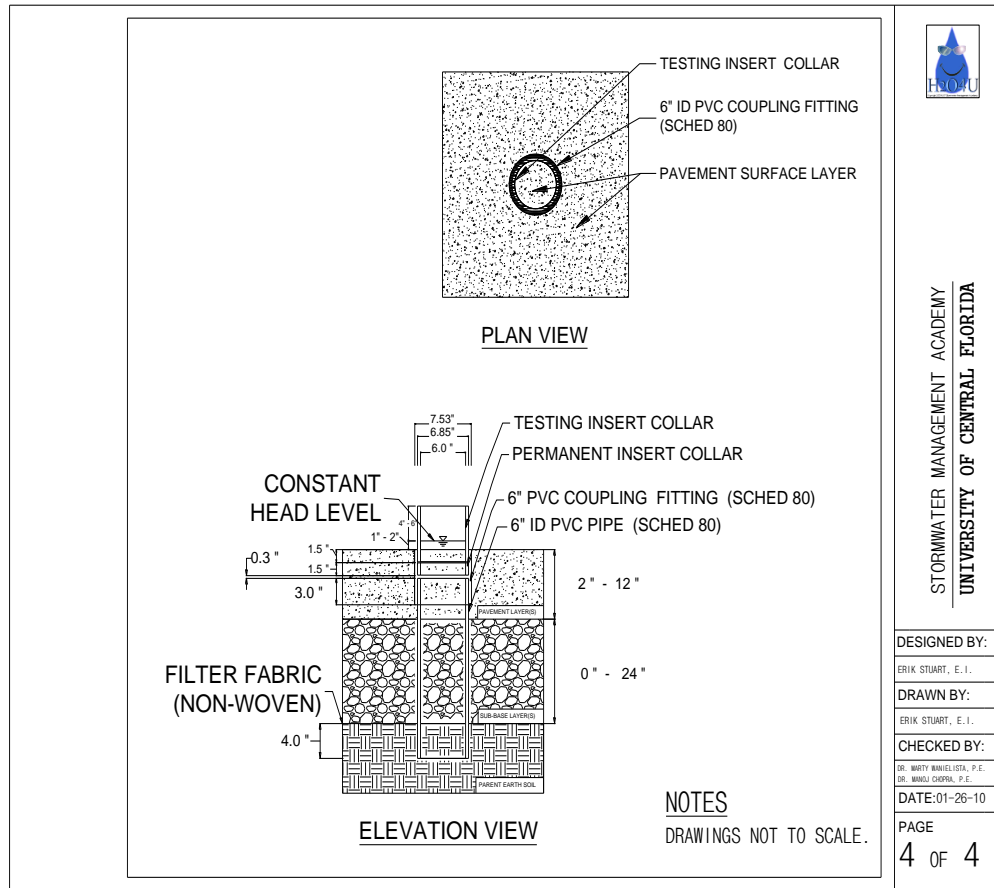


Figure 4: ERIK embedded ring installed with test collar

The second component of the ERIK device, that is the monitoring reservoir, is composed of Schedule 40 PVC piping material. The monitoring component of the kit for measuring flow during testing is essentially a graduated cylinder made of clear Schedule 40 PVC with an adjustable valve near the bottom of the cylinder. The cylinder is graduated with marks at predetermined intervals that make it easy to record and then convert measured flow rates to inches per hour (in/hr), which is typically how rainfall rates are measured. The plan and elevation views of the monitoring device are presented in Figure 5 5 below.

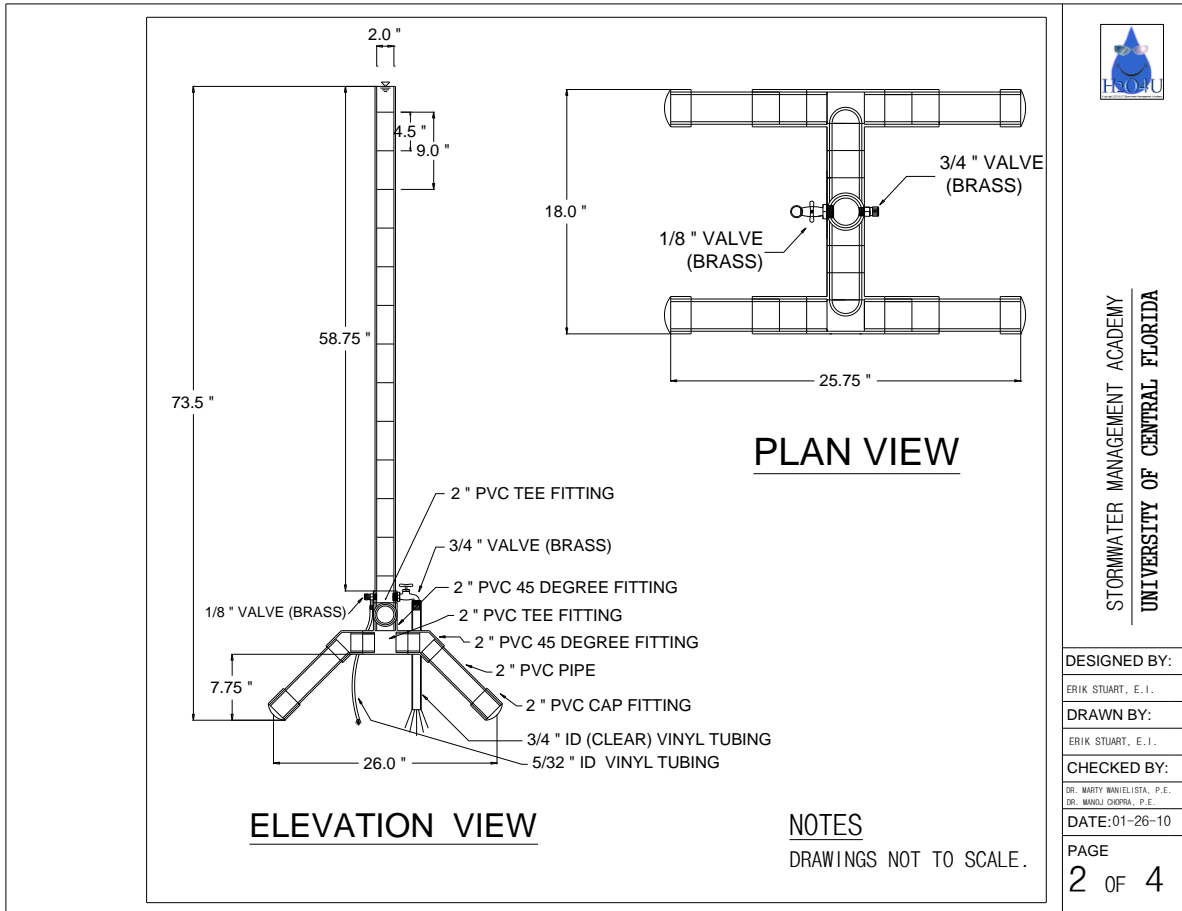


Figure 5: ERIK monitoring cylinder reservoir

## PAVEMENT INSTALLATION AND SETUP

FlexiPave pavement systems were constructed at the University of Central Florida's Stormwater Management Academy laboratory over an area totaling 1500 sq ft. This system was divided into 3 different sections, one designated as the intentional sediment loading and rejuvenation pad, and the other two intended for sub-base comparison while maintaining a more natural sediment accumulation from natural wind erosion and tire tracking of sediments onto the pavements surface. The FP rejuvenation section has dimensions of 20' x 35' or 700 ft<sup>2</sup> with a cross section consisting of 2 inches of Flexipave pavement layer with 4 inches of #57 recycled crushed concrete as a support base/stone reservoir layer which lies on 10 more inches of sandy A-3 fill soil (parent earth). The other two sections 20' x 20' or 400 ft<sup>2</sup> (not portioning between the two sections) are installed with the 2 inches of Flexipave pavement layer on 4 inches of recycled crushed concrete. Impervious concrete flush perimeter curbing is recommended and used for edge restraint extending the total 16 inches of the system to prevent washout of the sub-layers. The section designated as fill consists of 10 inches of sandy A-3 soil for the sub-base and the Bold&Gold<sup>TM</sup> section uses the pollution control media, Bold&Gold<sup>TM</sup> which is made with the same sandy A-3 (parent earth) soil as the sand mixed with crumb rubber from recycled automobile tires. The pavement and sub-base layers are placed on top of the parent earth A-3 soils compacted by vibratory plate compactor prior to subsequent layer construction and separated by a non-woven filter fabric.

Due to the size of the project the parent soils are prepared by excavating the total depth of the system using skid steer loader, grading by back-blade of the loader, then compaction using a "walk behind" vibratory plate compactor. Once soils are prepared the curbing is cured a

separation filter fabric is placed on top of the parent earth soil and extends up the curbing shown below in Figures 6 and 7. Aggregates are brought in by trucks and dumped into piles where the loaders could then place them in their final positions before leveling and compacting.

Embedded ring infiltrometers are placed flush with the final surface elevation and extends down 4 inches for the “shallow”, and 14 inches for the “deep” infiltrometers. The inside of the embedded rings are constructed with the same layers and thicknesses as the rest of the section.



**Figure 6: Site and Formwork layout**





**Figure 7: Filter fabric installed**

Once preparations are complete the final step is to install the FlexiPave surface material. The tire chips, granite aggregates, and flexible binder are combined and mixed in a typical concrete mixer. Once the materials are thoroughly mixed wheel barrels are used to transport the material to its final destination. The mix is dumped into position and flattened using typical concrete bull floats and hand floats shown below in Figure 8. These steps were all done according to the manufacturer's recommended specifications. Figure 9 depicts the final pavement system with the sections delineated by the curbing.



**Figure 8: Surface layer installation**



**Figure 9: Final layout of FlexiPave sections**

The surface layer can be maintained by periodic application of an over coat in which the same binder used to construct the pavement layer can be re-applied by spraying a thin layer over the entire surface (Figure 10). Care should be taken to not over apply the binder in a way that

may cause the binder to fill surface voids and reduce infiltration as well as the binder should be applied after vacuum sweeping when the surface is relatively free of sediments.



**Figure 10: Overcoat application**

### **Setup for Infiltration and Rejuvenation**

Infiltration and rejuvenation studies began by measuring initial infiltration rates soon after installation and curing was completed. After about a month and a half of measurements, the sections were then intentionally loaded with a layer of A-3 soils, approximately 2 inches thick, spread evenly across the surface with the skid steer loader to simulate long term sediment accumulation conditions (see Figure 11 below). The sediments were then washed into the pores using a garden hose (Figures 12 and 13) to simulate accelerated rain events that would eventually wash this sediment into the surface pores by transport processes. While washing the sediments into the pores it was noted that due the large sized pores, the FlexiPave surface allowed much of the sediments to easily pass through the surface layer when compared to some of the smaller

pore sized pervious pavements tested. The skid steer loader then was driven over the sediments back and forth until the sediments were sufficiently compacted into the pores, simulating traffic loading.



**Figure 11: Spreading of A-3 sediments over the entire Rejuvenation section**



**Figure 12: Washing sediments in with garden hose**



**Figure 13: Sediments on surface after being washed in**

The embedded infiltrometers were then used to determine the post loaded infiltration rates to evaluate the loss of the system's infiltration capacity due to the clogging by the sediments, see Figures 14 and 15 below.



**Figure 14: Post sediment loading ERIK testing**



**Figure 15: Post vacuumed ERIK testing**

Finally, a standard street sweeping vacuum truck cleaned the pavement surfaces to simulate typical, real life maintenance, and then the infiltrometers were retested (Figures 16 and 17 below).



**Figure 16: ERIK test after sediment loading**



**Figure 17: Standard vacuum truck performing maintenance**

It was noticed that the vacuum force was unsatisfactory at detaching and removing the fine grained soils in a dry and hardened state. At this time, water was added to saturate the pavements surface. This was done by spraying a garden hose onto the pavement surface until water ponded on the pavement surface and the sediment was sufficiently soft. Once water was introduced, the fine grained sediments reached their liquid limit, became plastic and mobile, and the vacuum force was able to remove the sediment from the surface. Once the surfaces were vacuumed, post-rejuvenation ERIK measurements were continued on the FlexiPave systems, see Figure 18 below.



**Figure 18: Successful vacuuming of Sediments**

These observations lead to the recommendation of coordinating the vacuum truck maintenance either during or immediately after large rain events or if ponding is noticed on the pavement surfaces. The draft statewide stormwater rule recommends nuisance flooding as an additional indicator of a clogged pavement from the ERIK device and this study verifies that vacuuming during the occurrence of water ponding on the surface will result in optimum rejuvenation using a vacuum truck.

## **Sustainable Storage Evaluation Setup**

### ***Sustainable Void Space***

The sustainable void spaces or pore volume that water could occupy during testing were tested for the surface layer materials and sub base layers separately in small containers and then the entire cross sections were built in larger barrels and tested to see what effect, if any, was



caused by mixing near the interfaces of the layers. The individual surface materials and the barrels were loaded with sediments and then vacuumed while conducting tests to see how sediments would reduce the amount of storage due to occupying the empty pore spaces and if these voids could be rejuvenated with a vacuum force.

Due to the nature of the testing, a setup that allowed for repeatability of tests was required to measure the reduction of sustainable storage after clogging, and the rejuvenation of that storage after performing vacuuming on the sample surfaces. To achieve this, small half-gallon plastic containers with screw on lids were chosen for the bench scale testing shown in Figures 19 - 21.



**Figure 19: FlexiPave material in half gallon containers**



Figure 20: Number 57 stone aggregates in half gallon containers



Figure 21: Bold&Gold™ materials in half gallon containers

The bench scale testing was performed to examine the storage values of the individual aggregate components that make up the system layers. The containers were modified by turning them upside down, cutting the bottom out, and then assembling non-woven filter fabric around the threaded opening using a rubber band to keep the fabric in place. This allowed for the lid to be screwed on to seal the bottom in order to measure storage of water, then the lid could be removed after testing to drain (by gravity) the pore water. Subsequent tests could be conducted on the samples without disturbing or changing the structure of the materials. Also, washing and compacting of sediments into the materials and later vacuuming was done while testing the storage values at the different levels of clogging and rejuvenation as shown in Figure 22 below.



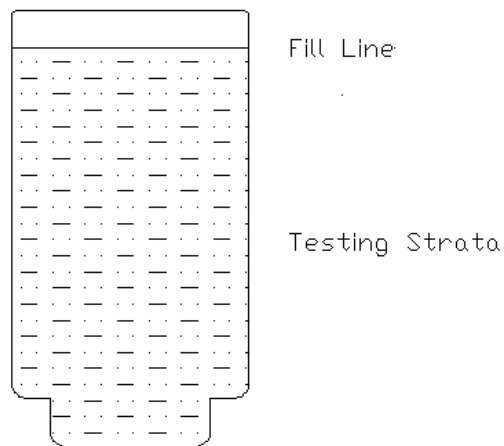
**Figure 22: Surface materials in ½ gallon containers being loaded and draining in sink**

### ***Component (Lab) Porosity***

In accordance with this understanding, a variety of substrates were tested including: the FlexiPave surface layer material, crushed concrete (#57 stone), and Bold&Gold™ pollution

control layer media. Again, in order to properly attain replicable results from the testing method, the proper inventory of materials is required. This inventory includes: the aforementioned specified testing media, a 1.89 liter (½ gallon (US)) plastic jar (including the cap), a 18.92 liters (5 gallon (US)) bucket, nonwoven geotextile (Marifi 160N), rubber bands, a scale capable of reading to 0.01g (SWL testing utilized the OHAUS Explorer Pro), an evaporation pan, 1 cubic foot (Ft<sup>3</sup>) of sand, a paint brush, box cutters, 12.7mm (½ inch) polyurethane tubing, plastic Tupperware, a proctor hammer, an oven, a digital camera, and a data sheet for the purpose of documentation.

The set up procedure included wrapping the threaded end with the non-woven geotextile. Next, rubber bands were used to fasten the geotextile in place. The cap was then fitted over the newly installed geotextile and the specified testing media was placed in the modified half gallon jar to the specified “Fill Line”, as illustrated in Figure 23.



**Figure 23: Half gallon container cross sectional drawing**

Upon the completion of the set up procedure, the experimental process is as follows:

- Place one Tupperware unit (739 mL/25 fl. Oz. unit) on the scale; this unit is utilized to prevent direct spillage onto the scale.
- Tare the scale to zero.
- Place the sample on the Tupperware.
- Take and record the dry weight of the sample.
- Place the sample into a 5 gallon (US) bucket.
- Fill the bucket with water allowing water to seep up through the bottom of the filter fabric wrapped container until it reaches the fill line on the exterior of the modified plastic jar.
- Utilizing a sink/polyurethane tubing setup continue to slowly saturate the sample.
- Allow the sample to rest in the water for approximately 30 (thirty) minutes; during this time, occasionally tap the exterior of the jar to eliminate air voids (Haselbach, et. al., 2005).
- Quickly remove the sample from the 5 gallon (US) bucket and place it on the Tupperware (note the Tupperware should still be tared on the scale).
- Record the saturated weight of the sample.
- Remove the bottom cap from the sample and allow gravity to drain samples (see Figure 24).
- Allow the sample to dry for 24 (twenty-four) hours.
- Replace the cap over the non-woven geotextile.
- Weigh the sample recording the weight of the semi-dry sample.



**Figure 24: Half gallon containers draining by gravity**

Component porosity utilizes weight based calculations to attain total, effective and sustained porosity measurements. The following equations were used:

The porosity of a material is given by:

$$n(\%) = \frac{V_{\text{voids}}}{V} \quad \text{Equation 1}$$

The total volume (V) can be determined by filling the testing apparatus with water to the designated fill line:

$$V = \frac{W_{\text{water to Fill Line}}}{\gamma_{\text{water}}} \quad \text{Equation 2}$$

After adding the desired media into the testing apparatus, the volume of voids ( $V_{\text{voids}}$ ) can be determined via the following equation:

$$V_{\text{voids}} = W_{\text{Water Added}} / \gamma_{\text{Water}} \quad \text{Equation 1}$$

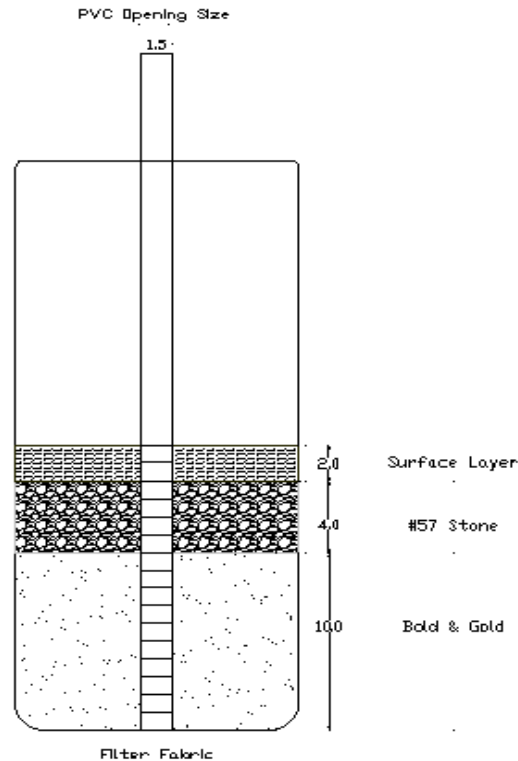
After a 24-hour draining period, the sample is reweighted to determine the amount of residual water remaining. Hence, a new volume of voids ( $V_{\text{voids}}$ ) value is determined yielding a sustained porosity measurement:

$$V_{\text{voids}}' = W_{\text{Water Added (Drained)}} / \gamma_{\text{Water}} \quad \text{Equation 2}$$

Both the system and component porosity methods focus on a simple method to adequately measure the total and effective porosity based volumetric and weight centric calculations.

### ***System (Barrel) Porosity***

System (Barrel) porosity testing methodology was explored as a possible means of achieving reproducible results for a porous paving system. The hypothesis was that replicating field conditions exactly on a smaller scale will yield porosity results comparable to a full scale installation. Figure 25 below shows a cross sectional view drawing of the barrel porosity testing setup.



**Figure 25: System 55 gallon barrel cross sectional drawing**

A specific inventory of materials is required to properly perform the testing procedure discussed above. These materials include: the specified testing media, tap water, a 208.2 liter (55 gallon (US)) plastic barrel, a 2000 milliliter (0.53 gallon (US)) graduated cylinder, a 18.9 liter (5 gallon (US)) bucket, a 1-½ inch PVC pipe, nonwoven geotextile (Marifi 160N), rubber bands, epoxy glue, a funnel, measuring tape, a level, a digital camera and finally, a data sheet with a clip board.

The set up procedure for the barrel construction is as follows: prepare a well pipe by cutting a 1-½ inch PVC Pipe to approximately 40 inches in length. Cut slits in the 1-½ inch PVC pipe, these slits should be lined up in 2 (two) rows, which should be on opposite sides of the cylinder (slits should be evenly spaced at ¼ inch intervals up to 16 inches). Subsequently, the bottom 16 inches of the 1-½ inch PVC pipe are to be wrapped in a nonwoven geotextile, utilizing



rubber bands to fasten the geotextile in place. At this point, the wrapped 1-½ inch PVC well pipe is approximately centered in the plastic drum, where epoxy glue is applied to the bottom surface of the geotextile wrapping and is utilized to hold the material upright and in place. A measuring tape (1.09 meters (1 yard)) or longer is fastened upright against the drum using epoxy glue. It is at this point that each of the specified testing media components are oven dried and then installed. The use of a straight edge is employed to ensure that the uppermost surface of the test surface is completely flat.

Upon the completion of the set up procedure, the experimental process is as follows: portion 2000 milliliter (0.53 gallon (US)) of water using the aforementioned graduated cylinder. Pour the measured volume of water into the top of the previously installed 1-½ inch PVC pipe; to minimize water loss due to transfer spillage the funnel was placed in the top opening of the 1-½ inch PVC pipe. The amount of water added is recorded and the former steps are repeated until water has saturated the system entirely. Saturation visibly occurs when the top layer of testing material has been entirely submerged. The cumulative water added in addition to the final water level is recorded.

The porosity of the complete system was determined by extrapolating the total volume of the specimen based on its height within the 55 gallon barrel, which was previously calibrated by adding known volumes of water and recording the height, and recording the amount of water added to effectively saturate the sample. The porosity was calculated utilizing the aforementioned method.

While similar, the primary difference between the component (laboratory) porosity testing method and system (barrel) porosity testing method, is, as the name would suggest, the measurement of porosity values of components of a system versus the system as a whole. The

method of calculation also differs between the two processes. System porosity is determined via volumetric calculations as opposed to weight measurements used in component porosity.

The porosity equation is:

$$n(\%) = \frac{V_{Voids}}{V} \quad \text{Equation 5}$$

The volume of voids ( $V_{Voids}$ ) is determined by the following equation:

$$V_{Voids} = V_{Water\ Added} - V_{Pipe\ I.Diameter} \quad \text{Equation 6}$$

This, subsequently, can be calculated as:

$$V_{Voids} = V_{Added} - (H_{Water\ Added} * \frac{\pi d_{inner}^2}{4}) \quad \text{Equation 7}$$

The total volume (V) can be determined via the following equations:

$$V = V_{Barrel} - V_{Pipe\ O.Diameter} \quad \text{Equation 8}$$

Based on a prior analysis correlating barrel height to volume of fluid present, the following equation has been prepared:

$$y = 1.745x$$

Where  $x$  represents the height of the fluid specimen in feet, and  $y$  represents the subsequent volume in cubic feet. This can then be used to calculate  $V_{Barrel}$ :

$$V_{Barrel} = H_{Water\ Added} * 1.745 \quad \text{Equation 9}$$

Therefore:

$$V = (H_{Water\ Added} * 1.745) - (H_{Water\ Added} * \frac{\pi d_{outer}^2}{4}) \quad \text{Equation 10}$$

This procedure was replicated after sediments were loaded and washed into the pores (see Figures 26 and 27 below), and then re-tested after the sediments were vacuumed from the surface.



**Figure 26: Sediments being washed in**



**Figure 27: System barrel being loaded with sediments**

## **Strength Testing Setup**

### ***Laboratory Testing***

Compressive strength and modulus of rupture can easily be evaluated by subjecting test samples to loadings until failure occurs. A comparison between cast in place pervious concrete and cored samples from existing parking lots is shown. Cylinders and beams used for compressive and flexural strength testing are made for one time use only. FlexiPave samples with the old proprietary mix design were prepared and tested. Four (4) cylinders with two different aggregate gradations were tested. Two (2) samples were made of the mix HD 2000 with #89 granite and XFP75 urethane and two (2) samples of the mix HD 2000 with #7 granite and XFP75 urethane. The dimension of the cylinders is 2” depth and 6” diameter. The 2 inch thickness is not a standard size for cylinders used in compressive strength test but it was used to replicate the actual thickness of the pavement on site.

Six (6) beams, with three each for the different aggregate size, were tested but the results of the test carried out on these samples were not reported in this research. Subsequent to the initial field installation, a new FlexiPave mix was provided by the manufacturer of FlexiPave and was also tested. The difference between the old and new mix design lies in the binding agent used. For the new FlexiPave samples, the binder HDX 6000 Urethane was used. With this new mix, six (6) cylinders of eight inches depth and 4 inches diameter were tested and flexural test on six (6) beam specimens was also carried out. The results of these testing procedures for the new samples are reported later in this document.

### ***Field Testing using the Falling Weight Deflectometer***

The Falling weight deflectometer (FWD) is a non-destructive field testing apparatus used for the evaluation of the structural condition and modulus of pavements. It is made up of a trailer mounted falling weight system, which is capable of loading a pavement in such a way that wheel/traffic loads are simulated, in both magnitude and duration.



**Figure 28: FWD test equipment on FlexiPave section**



**Figure 29: FWD conducting test on FlexiPave section**

An impulse load is generated by dropping a mass (ranging from 6.7 – 156 KN or 1506.2 – 35,068.8 lbs) from three different heights. The mass is raised hydraulically and is then released by an electrical signal and dropped with a buffer system on a 12-inch (300-mm) diameter rigid steel plate. When this load is dropped a series of sensors resting on the pavements surface at different distances from the point of impact picks up the vertical deflections caused by dropping the mass. The deflection responses are recorded by the data acquisition system located in the tow vehicle. Deflection is measured in “mils”, which are thousandths of an inch. FWD deflection basins are then used to determine rehabilitation strategies for pavements and pavement system capability under estimated traffic loads. Figure 29 shows a FWD test underway on the FlexiPave section.

### **Back-Calculation Program**

The traditional method for interpreting the FWD data is to back-calculate structural pavement properties (Turkiyyah, 2004) which entails extracting the peak deflection from each displacement trace of the sensors (deflection basin) and matching it, through an iterative optimization method, to the calculated deflections of an equivalent pavement response model with synthetic moduli (Goktepe, et al., 2006). Iterations are continually performed until a close match between the measured and calculated/predicted deflection values are attained.

Back-calculation of layer moduli of pavement layers is an application of Non-destructive testing (NDT). It involves measuring the deflection basin and varying moduli values until the best fit between the calculated and measured deflection is reached. This is a standard method presently used for pavement evaluation. According to Huang (2004), there is presently no backcalcualtion method that will give reasonable moduli values for every measured deflection basin.

The Modulus 6.0 microcomputer program (Liu, et al., 2001) is one of the available programs that back-calculates layer moduli. This software is used by most DOTs here in the U.S. The Texas Transportation Institute (TTI) developed this computer program and it can be used to analyze 2, 3 or 4 layered structures. A linear-elastic program called WESLEA can then be utilized to produce a deflection basin database by assuming various modulus ratios. Huang (2004) describes a search routine that fits calculated deflection basins and measured deflection basins. Finally, after mathematical manipulations, the modulus can be expressed as:

$$E_n = \frac{q_a f_i \sum_{i=1}^s \left( \frac{f_i}{f_i \omega_i m} \right)^2}{\sum_{i=1}^s \left( \frac{f_i}{f_i \omega_i m} \right)} \quad \text{Equation 11}$$

Where:

$f_i$  are functions generated from the database

$q$  is contact pressure

$\omega_i^m$  is measured deflection at sensor  $i$

$a$  is the contact radius

### *Determination of Layer Coefficients and Structural Number*

The layer coefficient ( $a_i$ ) and structural number (SN) can be estimated from the deflection data obtained from FWD testing. According to (AASHTO, 1993), the effective structural number  $SN_{eff}$  is evaluated by using a linear elastic model which depends on a two layer structure.  $SN_{eff}$  is determined first before the layer coefficients of the different pavement layers. The effective total structural number can be expressed as:

$$SN_{eff} = 0.0045h_p \sqrt[3]{E_p} \quad \text{Equation 12}$$

Where:

$h_p$  = total thickness of all pavement layers above the subgrade, inches

$E_p$  = effective modulus of pavement layers above the subgrade, psi

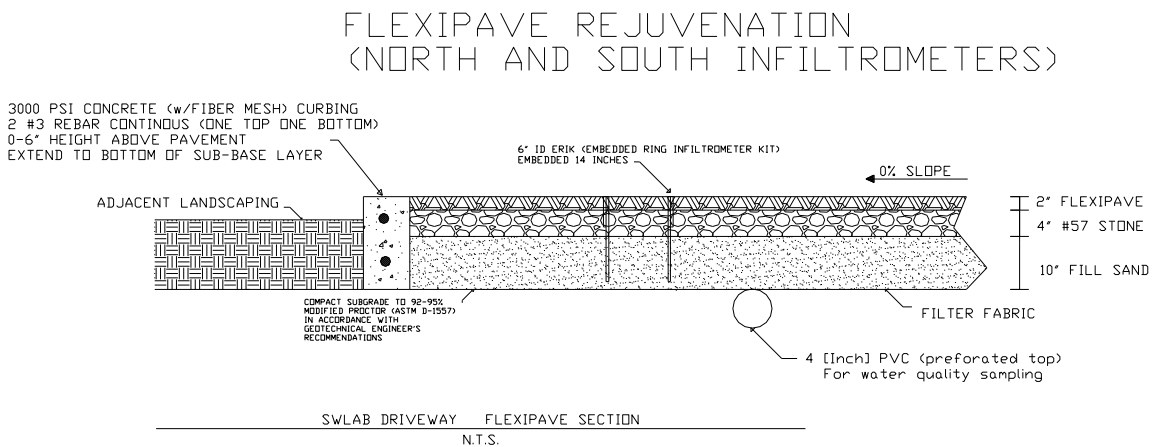
It must be noted that  $E_p$  is the average elastic modulus for all the material above the subgrade.  $SN_{eff}$  is calculated at each layer interface. The difference in the value of the  $SN_{eff}$  of adjacent layers gives the SN. Therefore the layer coefficient can be determined by dividing the SN of the material layer by the thickness of the layer instead of assuming values.



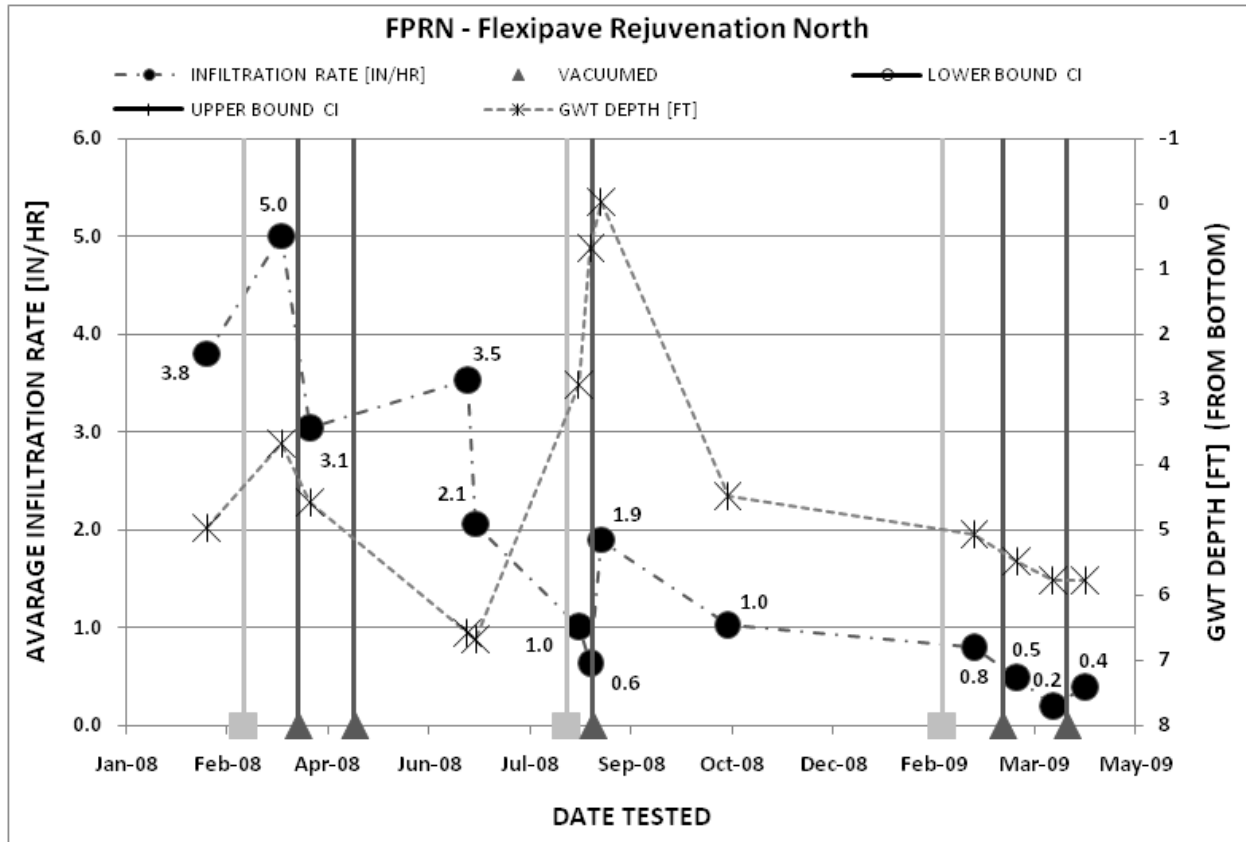
# RESULTS AND DISCUSSION

## Infiltration and Rejuvenation Results

A total of 79 ERIK measurements were taken for the FlexiPave systems. Three rounds of sediment loading and vacuum sweeping runs have also been completed. This section describes the results of the ERIK measurements on the three pavement types. Figure 31 below shows the cross sectional view of the embedded ring infiltrometers (north and south) and the resulting measured infiltration rates are displayed graphically in Figures 32 and 33 below. The results shown below are for the Rejuvenation section.



**Figure 30: FlexiPave Rejuvenation cross section (north and south infiltrmeters)**



**Figure 31: Infiltration Rate results (ERIK) Rejuvenation section's North infiltrmeter**

The initial infiltration rate measured by the north infiltrmeter located in the rejuvenation pad of the flexipave systems was 3.8 in/hr. After the first sand loading event the measured rate showed no decrease and in fact increased to 5.0 in/hr. Then the pad was vacuumed and the measured rate dropped back down close to the initial rate of 3.1 in/hr. It was concluded that due to the variable nature of infiltration rates through these systems that these small differences can be expected and conclude that the first loading and vacuuming attempt did not significantly affect the infiltration rate. Similarly after a second vacuum attempt the next two tests confirmed that the rates remained close to the initial values and were 3.5, and 2.1 in/hr. The powdered limestone loading did appear to effect the pavements ability to infiltrate, causing the rate to decrease to 1.0 and 0.6 in/hr. It is noted that during the limestone loading tests, the GWT was

only at a depth of less than three feet from the bottom of the system. Once vacuuming occurred on the limestone clogged pavement the subsequent test resulted in an increase back to 1.9 in/hr. A month later, the infiltrometer was retested and showed a decrease in the rate to 1.0 in/hr. Four months of natural sediment loading caused by erosion was allowed before the pavement was intentionally reloaded with sandy soils to ensure clogging of the system. The post-loaded result from the test showed that the rate of infiltration was 0.8 in/hr. The next two vacuuming attempts showed minimal success. The first two tests measured after vacuuming the sand showed infiltration rates of 0.5 and 0.2 in/hr. The surface was vacuumed again and the rate increased to 0.4 in/hr. This variation in infiltration rates is not viewed as significant and likely due to variable environmental conditions.

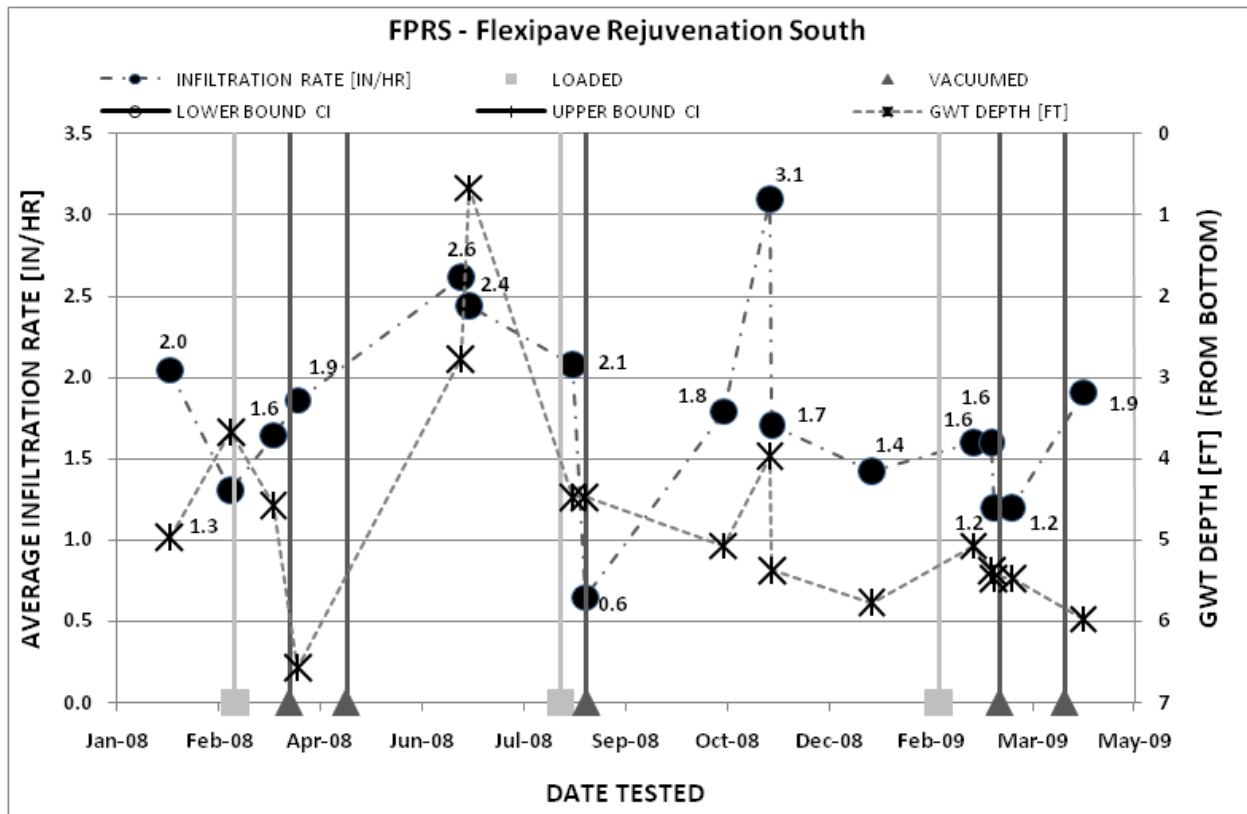
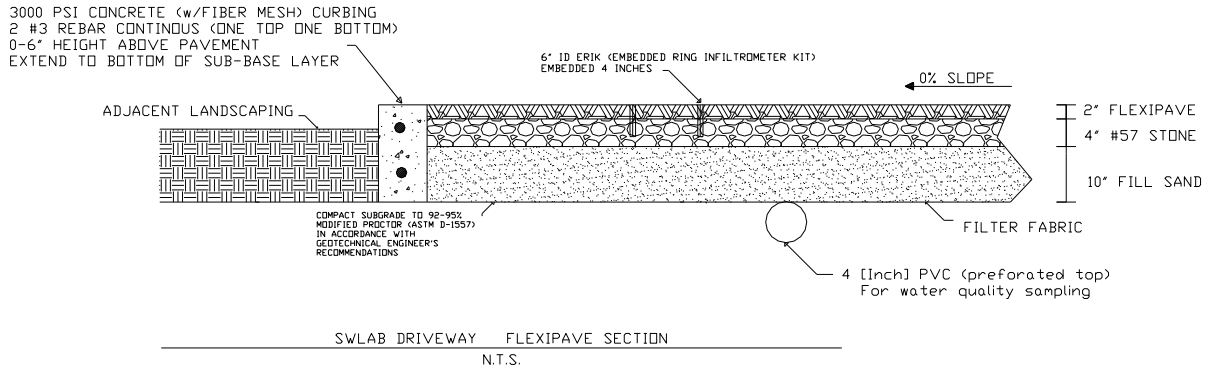


Figure 32: Infiltration Rate results (ERIK) Rejuvenation section's South infiltrometer

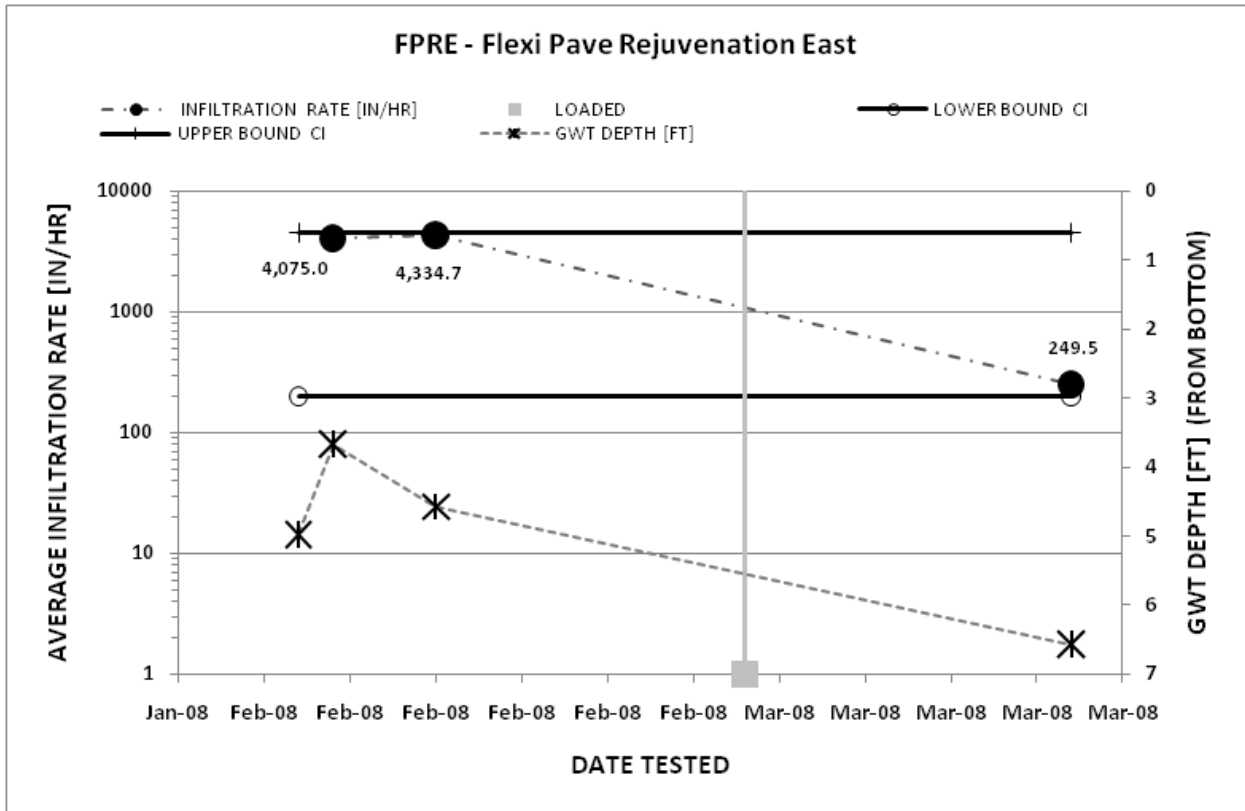
The southern infiltrometer on the same pad gave slightly lower initial results of 2.0 and 1.3 in/hr. Once the surface was clogged with sediments the rate measured at 1.6 in/hr, and post vacuuming rate measured 1.9 in/hr. Again the first loading and vacuuming showed little effect on the performance of the pavement and the variability shown is likely due to natural fluctuations in the soil. The surface was vacuumed again and did result in an increase of the infiltration rate up to 2.6 and 2.4 in/hr during the next two tests, which were conducted during a time of high GWT. This difference is not significant and, again, likely due to environmental conditions. The surface was then clogged with the limestone powder which also had little impact on the performance of the system. The infiltrometer was tested twice during the clogged condition and resulted in a decrease in the infiltration rate to 2.1 and 0.6 in/hr. The post vacuuming tests showed little improvement but did rejuvenate the limestone clogged system back to initial conditions. The post vacuumed rates measured were 1.8, 3.1, 1.7, and 1.4 in/hr during the next four tests respectively. Finally, the last clogging and rejuvenation attempt with A-3 fine sand had little to no effect on the systems performance, similar to the other loading events. The rate stayed at 1.6 and 1.2 in/hr after being clogged and after rejuvenation of the system the rate measured at 1.2 in/hr and the last vacuuming increased the rate up to 1.9 in/hr. Again, these differences are so small that they are not likely a result of the sediment loading and rejuvenation events but rather changes in soil moisture, GWT depth, and other environmental conditions.

Shallow (4 inches deep) infiltrometers were installed in the FlexiPave Rejuvenation sections east and west location (see Figure 34 below), and the resulting measured infiltration graphs are displayed in Figures 35 and 36.

## FLEXIPAVE REJUVENATION (EAST AND WEST INFILTROMETERS)

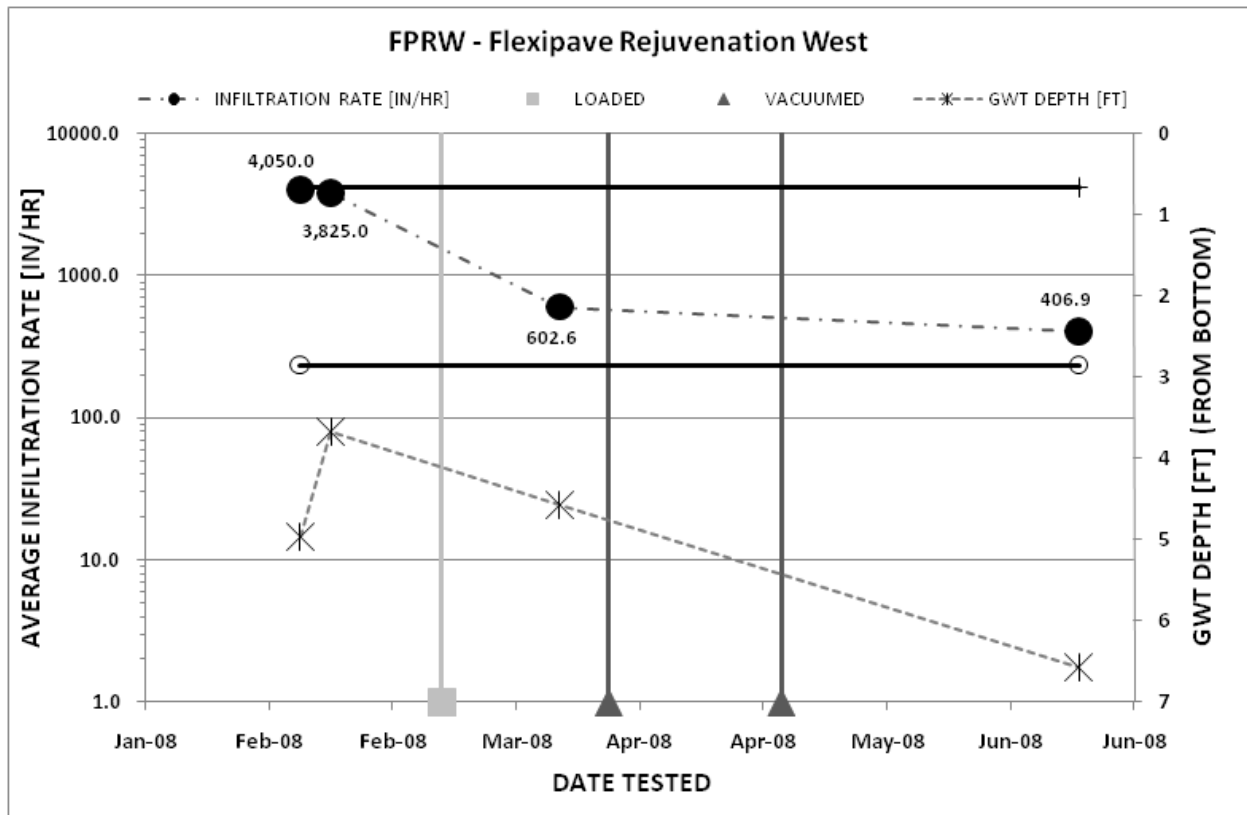


**Figure 33: FlexiPave Rejuvenation cross section (East and West infiltrmeters)**



**Figure 34: Infiltration Rate results (ERIK) Rejuvenation section's East infiltrmometer**

The first infiltrometer in the east location of the Flexipave rejuvenation pad was damaged by the skid steer's bucket while spreading the sediments over the surface, so only initial results were obtained. The initial results of the surface layer of Flexipave measured over 4000 in/hr for the first two tests. Once the sandy soils were applied, washed in, and compacted the resulting infiltration test measured 249.5 in/hr. This shows that the A-3 fine sandy soil did result in a decrease in the infiltration rates but not enough to be detected by the long ring ERIKs.

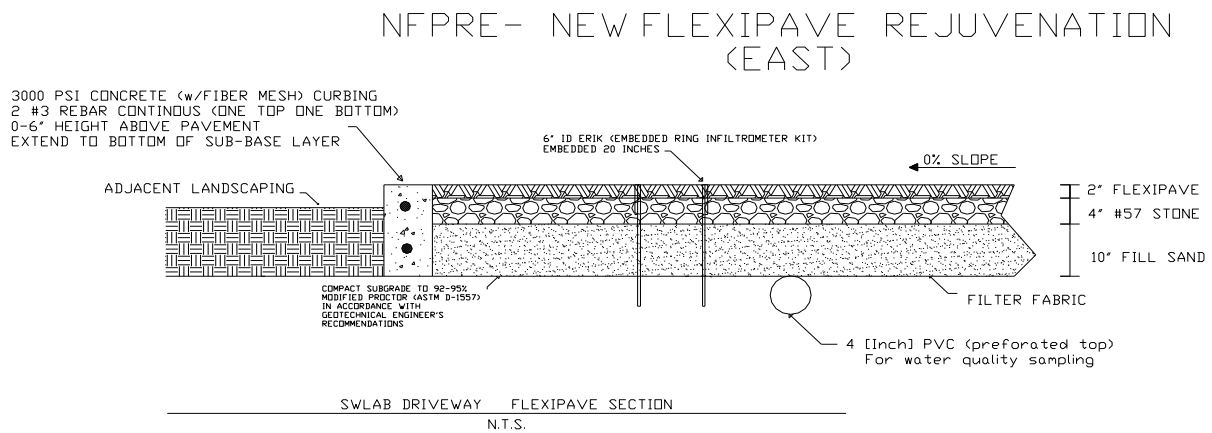


**Figure 35: Infiltration Rate results (ERIK) Rejuvenation section's West infiltrometer**

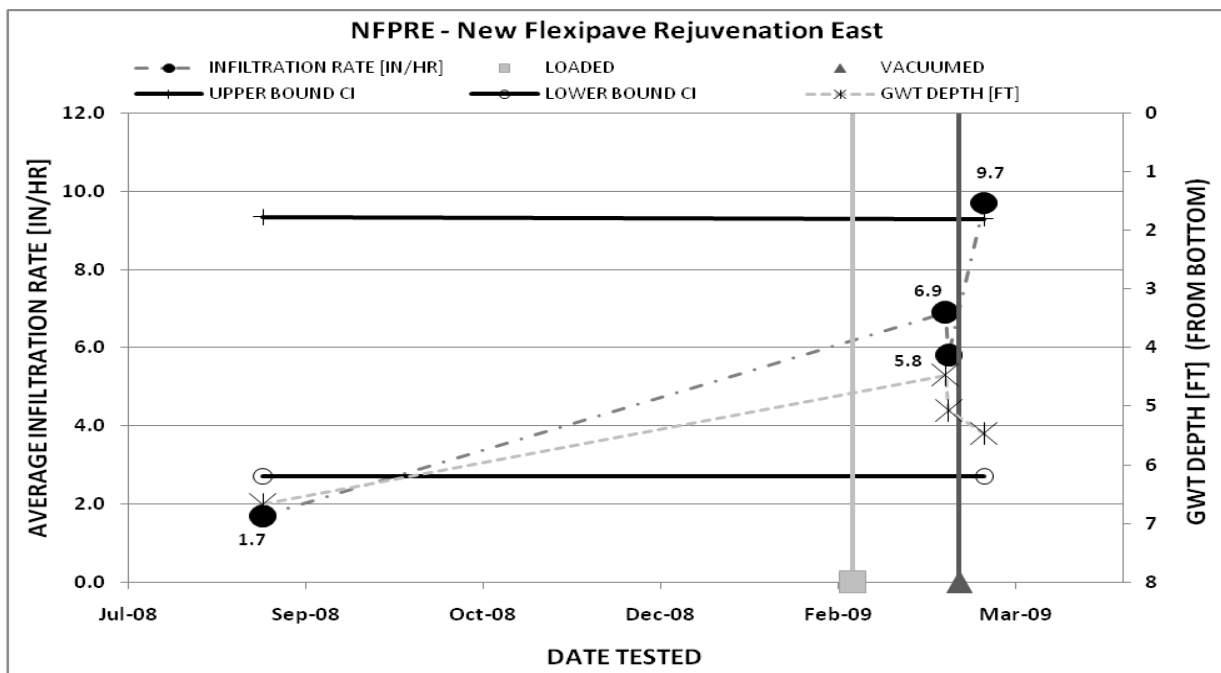
The west infiltrometer had similar initial results as the east with values of 4050 and 3825 in/hr. The first sand loading reduced the rate to 602.6 in/hr, and after two successive vacuums the rate measured was 406.9 in/hr. All short infiltrometers installed in the FlexiPave systems had measured rates above 100 in/hr even after intense sediment loading and high GWT. The vacuum

sweeping showed no improvement in infiltration rate suggesting that sediments were allowed to penetrate to deeper layers than the effective range of the vacuum force.

The east infiltrometer was replaced with a system infiltrometer (20" in length) that extended down 4 inches into the parent earth soils is illustrated in Figure 37 below. The results for infiltration testing are displayed graphically in Figure 38 below.



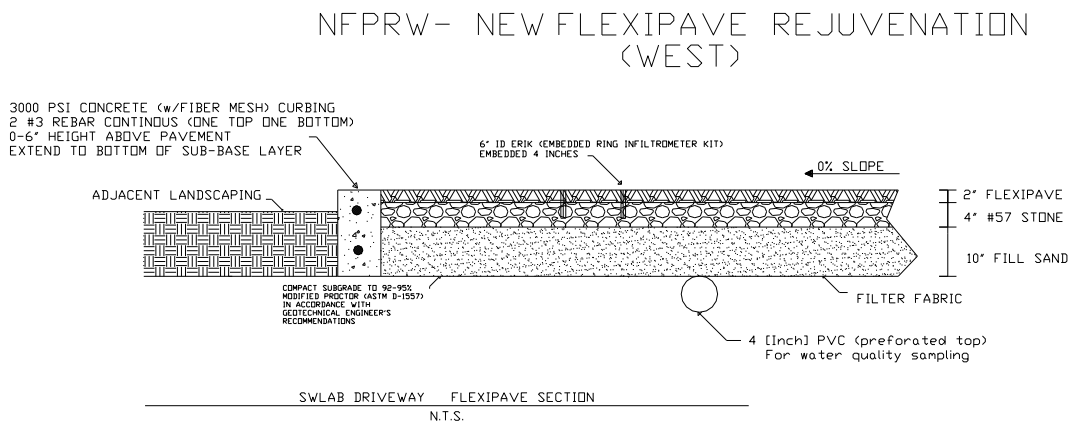
**Figure 36: FlexiPave Rejuvenation cross section (New East infiltrometer)**



**Figure 37: Infiltration Rate results (ERIK) Rejuvenation section's New East infiltrometer**

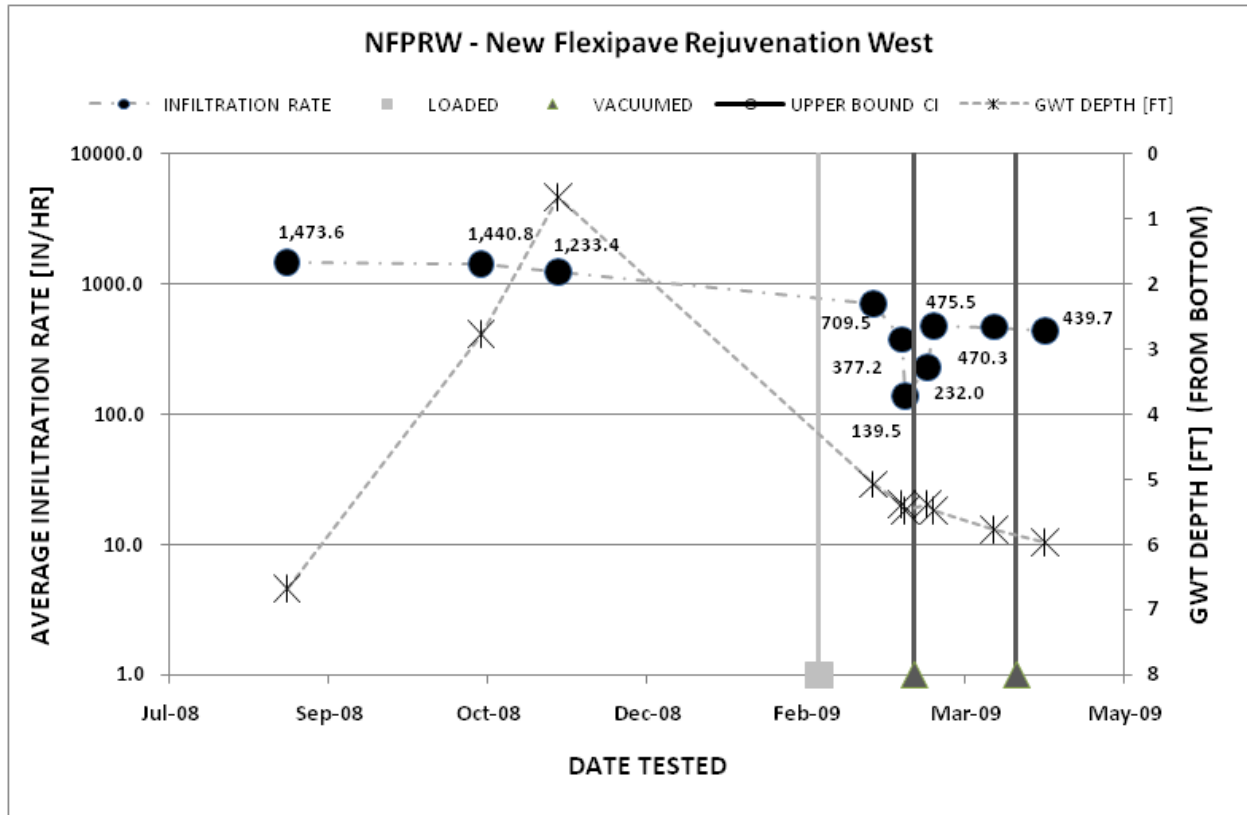
An initial reading of 1.7 in/hr was measured for the deep infiltrometer. After about six months the rates measured at 6.9 and 5.8 in/hr after sediment loading. Then, after the rejuvenation attempt the measured rate increased to 9.7 in/hr. While the infiltration rate did increase after the rejuvenation event this does not indicate that the surface layer was able to be improved by the performed maintenance. This is likely due to the open structure of the pavement surface which allowed for the migration of the soil particles deeper than the vacuum force could effectively reach.

The west infiltrometer in the Rejuvenation section was replaced by a shallow (4 inch deep) infiltrometer with the cross section illustrated in Figure 39 below. The measured infiltration rate results are presented graphically in Figure 40 below.



**Figure 38: FlexiPave Rejuvenation cross section (New West infiltrometer)**

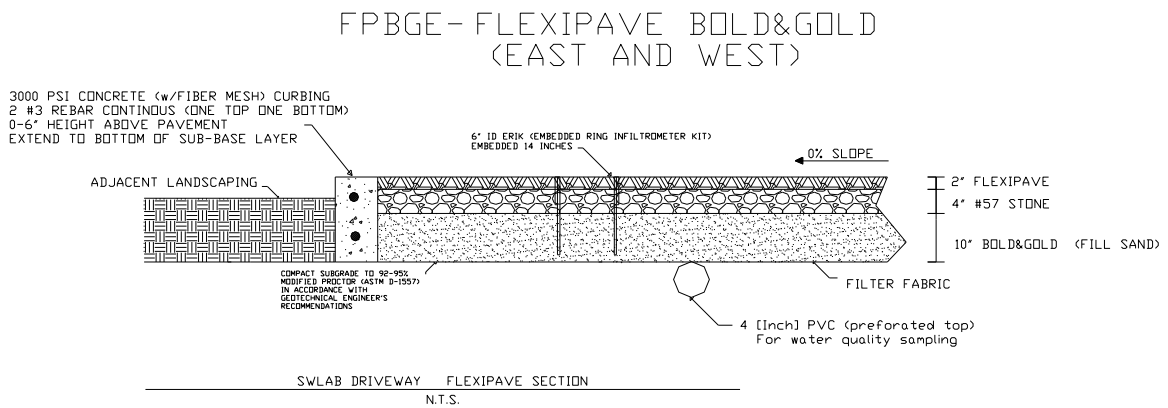




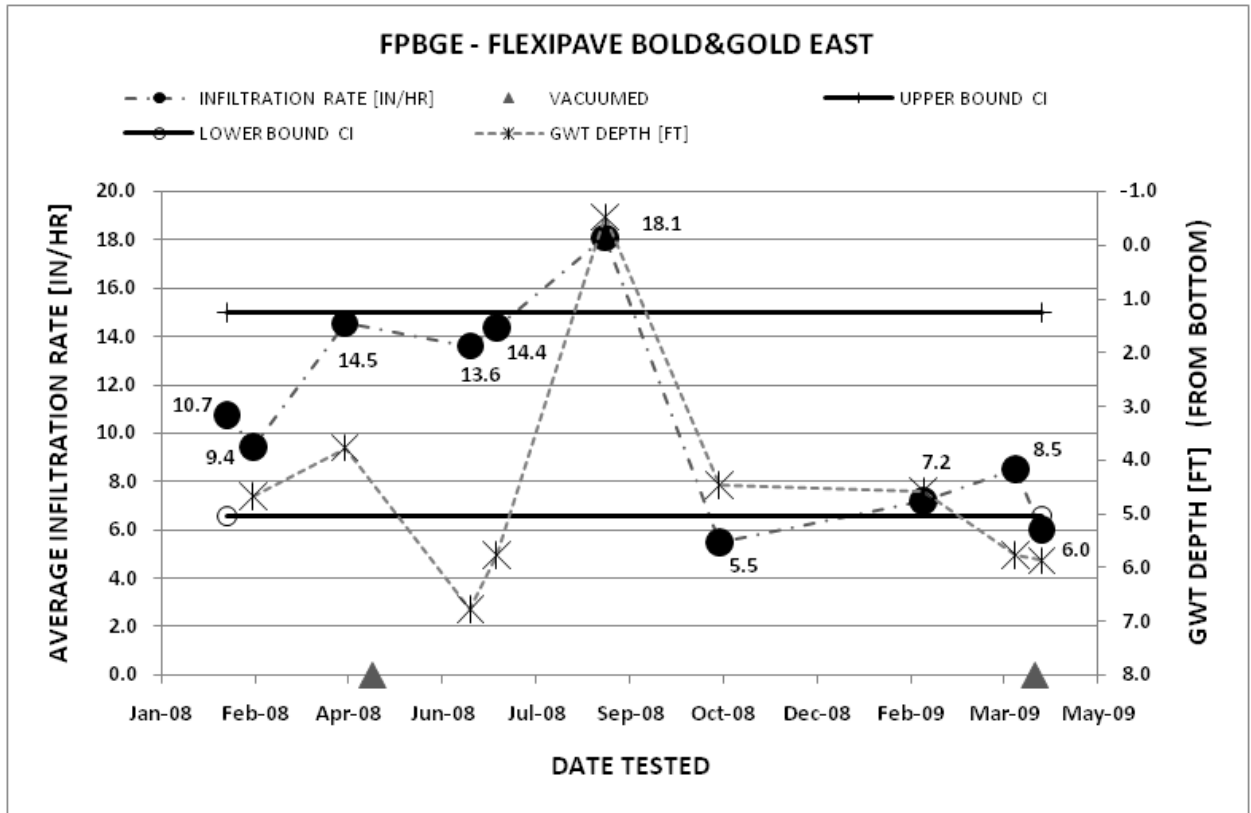
**Figure 39: Infiltration Rate results (ERIK) Rejuvenation section's New West infiltrometer**

The initial rate of the new FlexiPave installed in the west infiltrometer was slightly less than the previously placed FlexiPave, but the rates remained well above 2 in/hr standard throughout testing. The initial results measured remained above 1,000 in/hr even while the GWT depth was less than one foot from the bottom of the system. Once loaded with sandy soils the rates measured were reduced to 709.5, 377.2, and 139.5 in/hr. After performing maintenance with the vacuum sweeping truck the post vacuumed rates measured were 232.0, 475.5, and 470.3 in/hr. Another vacuuming took place and the resulting measured infiltration rate measured 439.7 in/hr. This indicates that vacuuming the surface will not restore the rates back to the initial values but the rate remains well above 2 in/hr on the surface of the system, even under intense sediment loading conditions.

The next system analyzed is the Bold&Gold™ pollution control system with its identical East and West infiltrometers shown in the cross section illustrated in Figure 41. The resulting infiltration rates measured are presented in Figure 42 below.



**Figure 40: FlexiPave Bold&Gold™ cross section (East and West infiltrometers)**



**Figure 41: Infiltration rate results (ERIK) Bold&Gold™ section's East infiltrrometer**

The Flexipave Bold&Gold™ pad was designated as a pollution control system in which the sub-base layer was a Bold&Gold™ pollution control media mix that used local A-3 site soils as the sand component instead of the typically used washed mason sand. This system is equipped with two system infiltrmeters 14 inches in length that extend down close to the bottom of the pollution control media.

The east infiltrrometer measured rates of 10.7, 9.4, and 14.5 in/hr initially when the GW T was at about 4 feet below the bottom of the system. After maintenance had taken place the next three tests indicated rates of 13.6, 14.4, and 18.1 in/hr, the first two had GWT depths of greater than 5 feet, while the 18.1 in/hr took place when the GWT was actually above the bottom of the

system. Over time the system naturally clogged and a system experienced a decrease in performance down to 5.5 in/hr followed by two more tests indicating rates of 7.2, and 8.5 in/hr. The pavement was vacuumed once more and the follow up test measured a rate of 6.0 in/hr for the system. It should be noted that the rate never fell below 5.5 in/hr during the study period and under natural sediment clogging conditions.

The west infiltrometer although identical to the east, resulted in slightly lower measured infiltration rates. The graphical results are presented below in Figure 43.

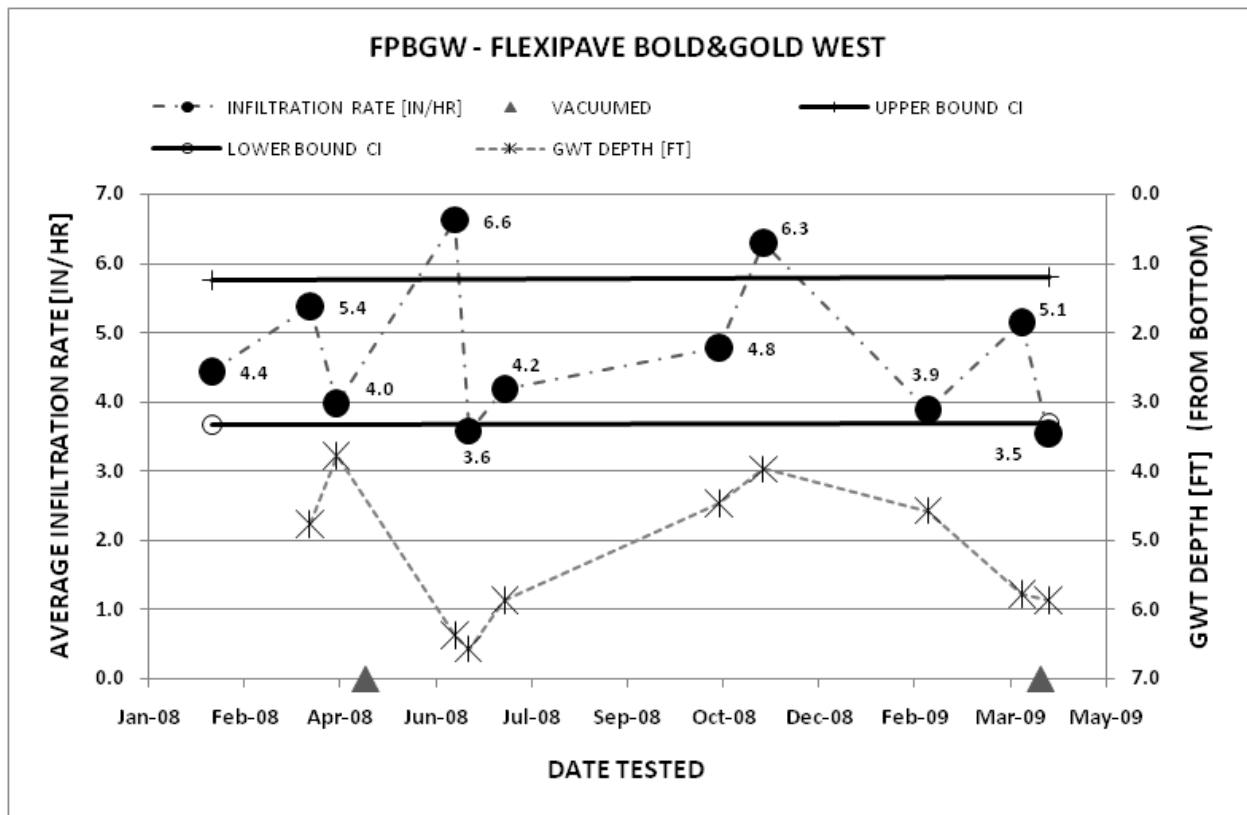
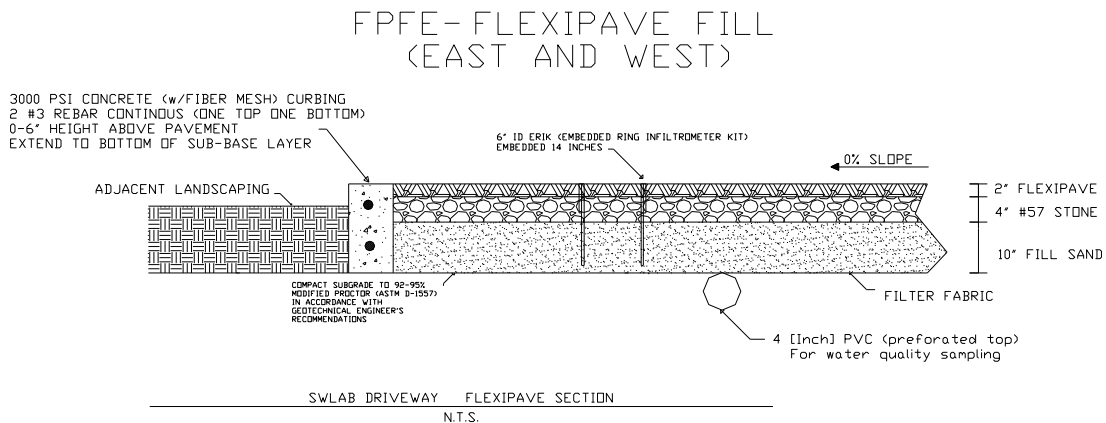


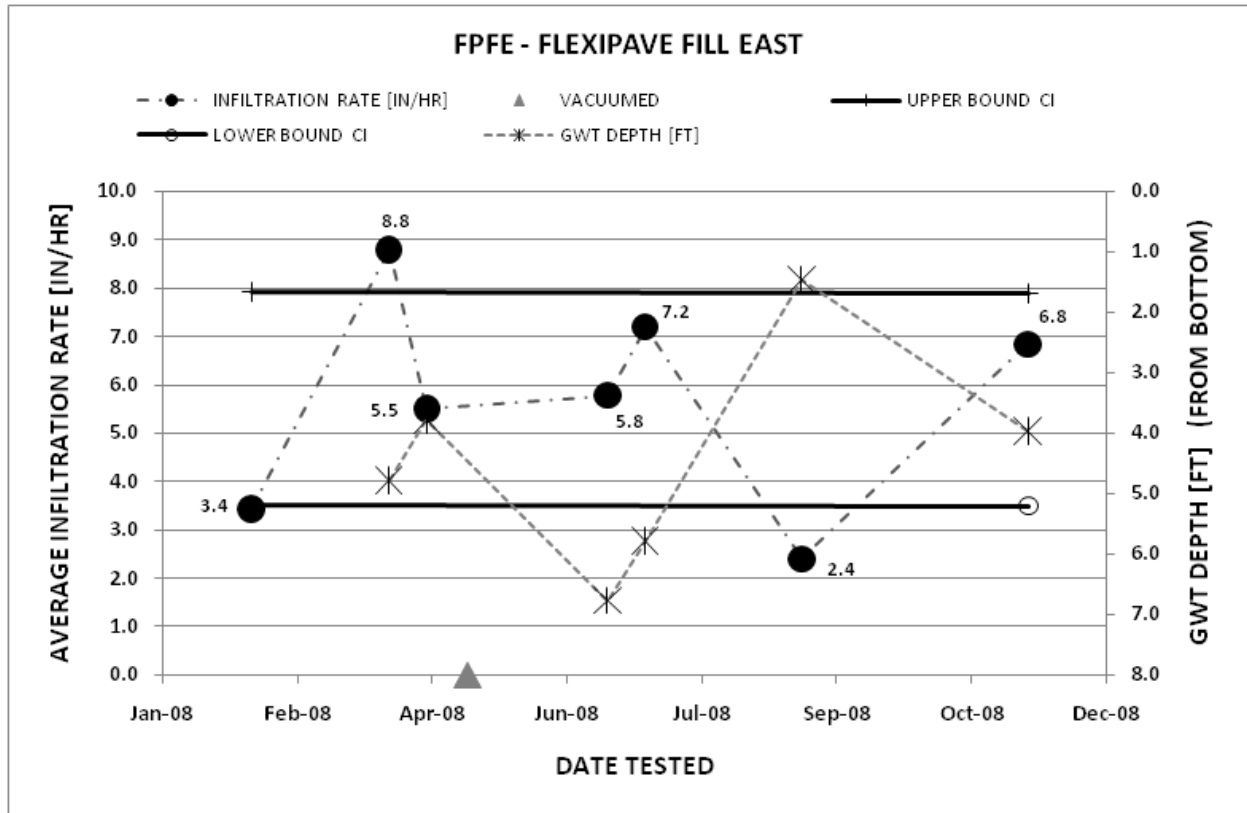
Figure 42: Infiltration rate results (ERIK) Bold&Gold™ section's West infiltrometer

The west infiltrometer had very consistent measured rates throughout the study period. The initial rates measured were 4.4, 5.4, and 4.0 in/hr while the GWT was below 3 ft from the bottom of the system during this time. A vacuuming event took place on the naturally loaded pavement and the post vacuum tests resulted in rates ranging from 6.6 to 3.5 in/hr depending on the depth of the GWT. According to the results, maintenance did not need to occur on this pervious system since the rate never fell below 2.0 in/hr.

The Fill section represents the pavement layer and #57 stone reservoir layer being placed directly on parent earth soils. This could potentially save costs since excavation depth is minimal (only six inches) and additional materials would not need to be brought to the site. Figure 44 below shows the cross sectional view of the east and west infiltrometers which are identical in embedment depth. The resulting measured infiltration rates are displayed graphically in Figures 45 and 46 below.

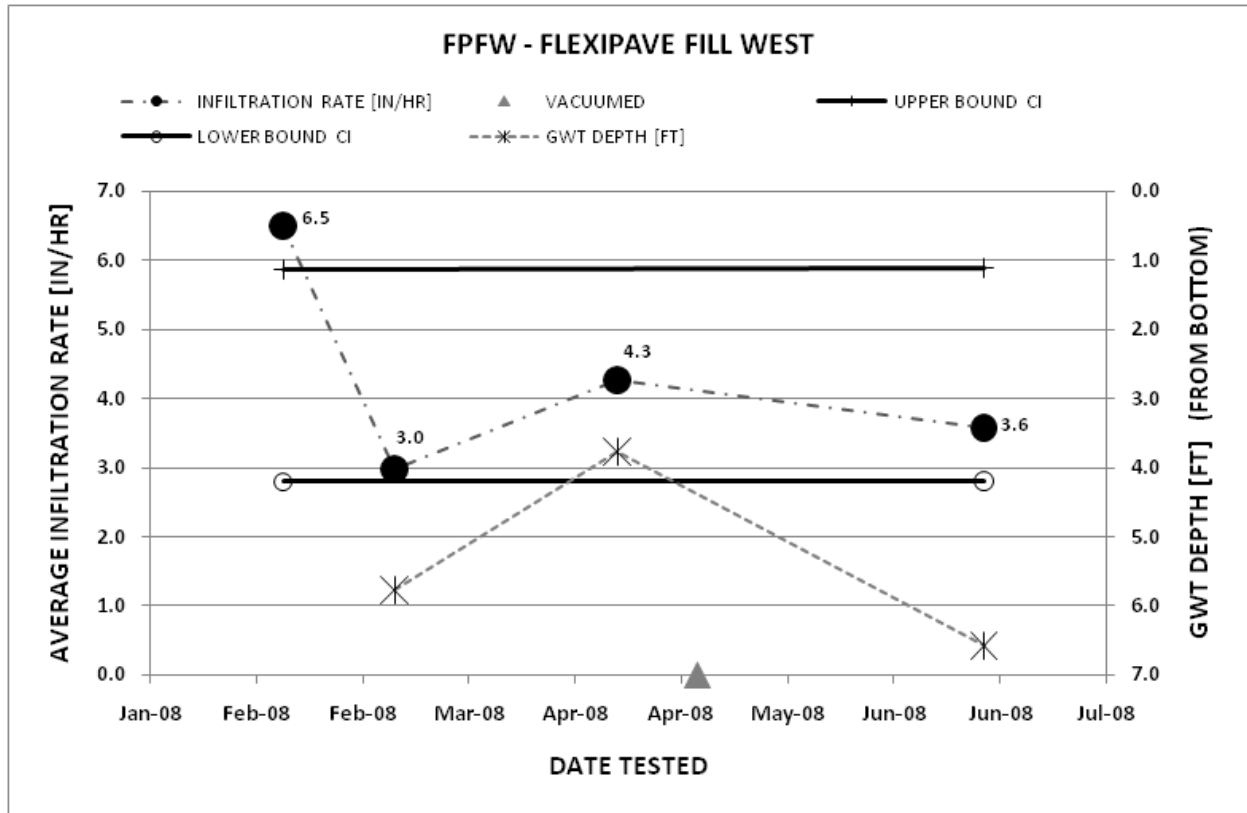


**Figure 43: FlexiPave Fill cross section (East infiltrometer)**



**Figure 44: Infiltration Rate results (ERIK) Fill section's East infiltrometer**

The east infiltrometer located in the FlexiPave section with local fill dirt as the sub-base shared similar results to that of the Bold&Gold™ sub-base which consisted of local fill dirt as the soil component of the mix. The initial measured rates were 3.4, 8.8, and 5.5 in/hr before the maintenance event took place. Once vacuumed, the measured rates were 5.8, 7.2, 2.4, and 6.8 in/hr during the period of study. The GWT depth appeared to affect the rate of infiltration reducing the rate to 2.4 in/hr while it was at a depth of about 1.5 ft beneath the bottom of the system.



**Figure 45: Infiltration Rate results (ERIK) Fill section's West infiltrator**

The west infiltrator was damaged after four months of testing, so only results from four ERIK tests are presented. The initial rates are consistent with the east infiltrator, and similarly, the rate never dropped much below 3.0 in/hr. The first test resulted in a rate of 6.5 in/hr, followed by rates of 3.0, and 4.3 in/hr. After vacuuming of the naturally clogged FlexiPave, the rate was measured at 3.6 in/hr, showing no significant benefit.

## **Sustainable Storage Evaluation Results**

### ***Sustainable Storage Strength Evaluation***

The porosity testing results of the individual component materials are tabulated in Table 1 below. The total porosity of the FlexiPave surface layer measured in the ½ gallon containers is 37.3%. This number represents the porosity of the surface layer after the materials were oven dried, while the rest of the tests were conducted without oven drying the materials and thus can be considered the effective porosity. As seen in Table 1, the effective porosity is 31.1% showing a slight decrease in comparison to the total porosity (almost a 17% reduction). This indicates that the FlexiPave material, with its large pore sizes, is able to dry relatively quickly and recover its storage volume. Next, the FlexiPave material is loaded with sandy sediments to induce clogging of the surface pores. This resulted in an average effective loaded porosity of 10.4% (Table 1). It should be noted that the depth of the material samples in the ½ gallon containers is much more (about 8 inches) than in the field (about 2 inch thickness), so vacuuming may not remove the amount of sediment in the deeper test containers compared to in the field. This reduction in storage is due partially to the fact that some of the volume of sediment particles is now occupying the once empty pore spaces. This is also due to a larger number of smaller pore sizes that retain a larger volume of moisture in the once air filled pores. When the pores are large enough so gravity alone can more easily drain the water from the pore storage is recovered more quickly. It was observed during the testing that much of the sediments were able to easily pass through the surface pores of the FlexiPave material and reach the bottom of the transparent containers without much filtering. This observation agrees with the data, which shows that much of the empty pore spaces were filled with sediments. Little of the sediment was extracted from



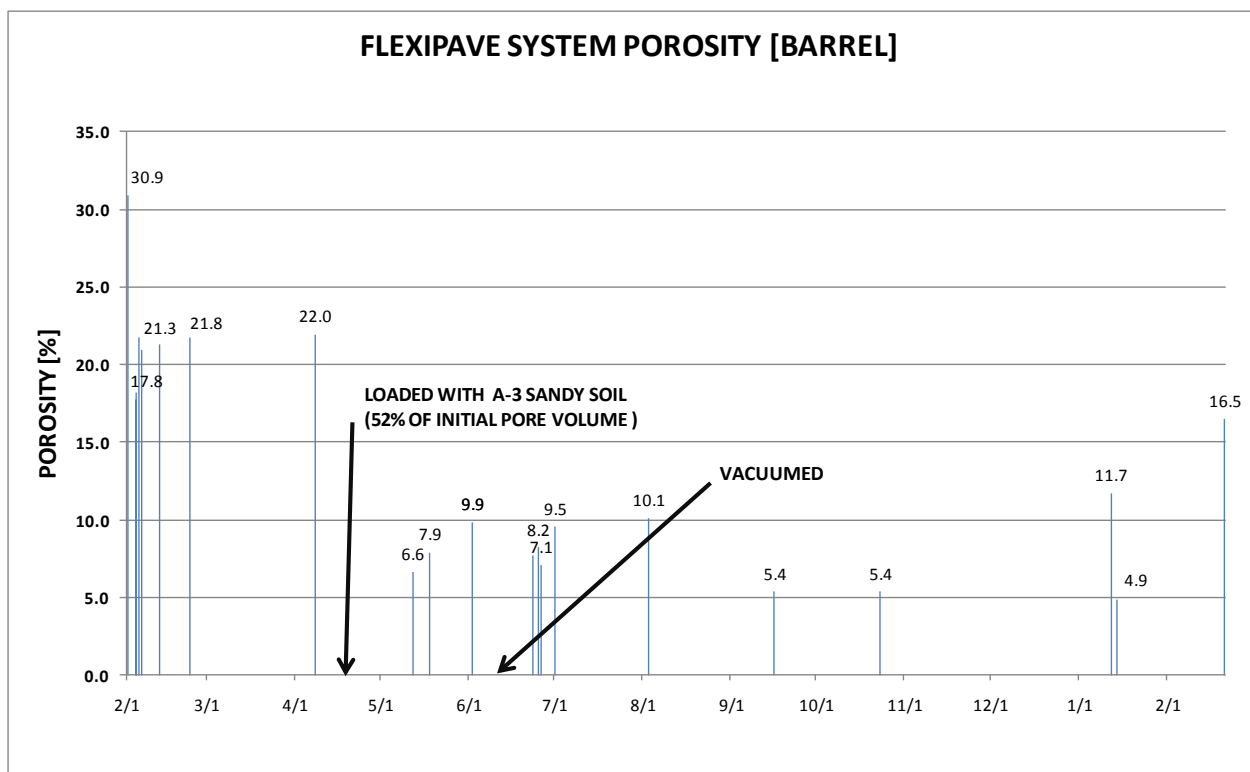
the deeper parts of the cross-section by the vacuum due to the suction force not being sufficient at those depths. However the sediments near the surface were easily removed by the vacuums' suction force, up to about 1-2 inches down from the surface. Porosity measurements were taken after vacuuming the surfaces and an average effective porosity of 13.6% was been measured. This result confirms that the clogging sediments did in fact travel to the bottom of the containers and only the top portion was effectively rejuvenated by vacuuming. This proves the surface layer is not effective at filtering sandy sediments and preventing them from entering the sub-layers, which may cause an eventual reduction in storage capacity of the deeper storage layers. The advantage is the ability of the surface layer to remain unclogged and allow the passage of sediments and water. This helps prevent water from having a chance to runoff before infiltrating into the pervious pavement system.

The sub-base layer materials were tested using the small scale ½ gallon containers and were tested for both total (over dried) and effective (gravitational drainage) porosities. The #57 crushed concrete aggregates provided average values of 47.1% total porosity and 41.4% effective porosity. The Bold&Gold™ pollution control media porosity measured 38.9% for total porosity and 15.2% for effective porosity.

**Table 1: Individual component Porosity Results measured in ½ gallon containers**

Flexi-pave FP	AVERAGE MEASURED POROSITY [%]			
MATERIAL TYPE	Total	Effective	LOADED	VACUMED
Flexi-pave FP	37.3	31.1	10.4	13.6
(#57) Crushed concrete	47.1	41.4		
Bold&Gold	38.9	15.2		

Presented below in Figure 47 are the results from the FlexiPave system porosity testing using the complete cross section in the 55 gallon barrels. The barrel systems consist of all the materials used in the construction of the field scale test pads including the surface layer, stone support/reservoir layer, and pollution control sub-base layer. The initial tests were conducted prior to introducing any sediment to the systems to investigate the total or maximum storage available.



**Figure 46: System porosity results using 55 gallon barrels**

The first value, 30.9% storage, represents the total porosity of the system since the materials were oven dried before placement into the barrels. Due to the large pore sizes of the aggregates, the next four values representing the storage within the system after only a few days

of drainage did not decrease much as the storage volume was able to be recovered. Only the micro pores in the aggregates and near the contact points and dead-end pores small enough to prevent gravity from transmitting this water downward due to capillary pressure exceeding the force of gravity in such a small pore size are able to retain some of the water. These next four tests represent the effective porosity (17.5% - 22.0%) of the system. This is the porosity which can be expected for the in-situ pavement that is not oven dried or has residual water in the micro pores. The sixth test is conducted after loading with a volume of type A-3 soil equal to 52% of the total measured pore volume. The A-3 soil loaded on the surface of the FlexiPave material was washed into the pores while simultaneously pumping the infiltrated water out of the well pipe (see Figure 48 below).



**Figure 47: Washing loaded sediments into pores while pumping infiltrated water out through well pipe**

After the loading takes place the effective porosity was reduced to 6.6% after only one day of drainage, while the next two tests measured rates of 7.9% and 9.9%. After the sediments

were vacuumed from the surface the remainder of the tests measured values slightly greater than the loaded condition but remained almost 50% less than the total porosity measured. The range of measured porosity for the vacuumed system was from 4.9 to 16.5% depending on the number of days allowed for gravity induced drainage of the barrel system. This result indicates that the storage within the system will reduce to less than half of its original condition since the sediments are not filtered but allowed to flow freely into the deeper layers where the vacuum force cannot reach.

The theoretical porosity of the entire system was calculated given the total and effective porosity values of the individual components and then compared to the actual systems constructed in the 55 gallon barrels. The theoretical storage using a weighted porosity of the entire system was calculated by adding the pore volumes for each layer and then totaled to represent storage within the entire system. The theoretical calculation of the system's (total) storage was calculated at 6.6 inches of the entire 16 inch cross section using the total porosity values. When comparing to the actual barrel storage using measured total porosity values the entire 16 inch deep cross section's storage is only 4.9 inches. The same calculation using effective porosity values, the theoretical storage of 3.8 inches within the 16 inch cross section, whereas the actual barrel tests measured storage of 2.8 inches. This shows that there is some mixing of the layers which causes a slight decrease in the pore volume of the complete system.

In conducting the same analysis of the FlexiPave system after intentional sediment loading, the theoretical effective storage in the system is calculated to be 3.4 inches using the individual components with the actual barrel measurement of 1.1 inches. After vacuuming the surfaces the effective theoretical storage in this system is calculated at 3.5 inches while the actual barrel storage is measured at 1.6 inches. It can be concluded that the actual total porosity of a

complete system is about, on the average 26% less than if calculated theoretically using the individual components. The actual effective porosity is, on the average, 49% less than calculated theoretically using the individual components.

## **Strength Results**

### ***Laboratory Test Results for Flexi-pave***

As result of its flexibility and its ability to return to its previous shape after the application of load or deformation, the compressive strength may not be the most desired test on this type of pavement but was studied for comparison. The sample sizes were 8 in. x 4 in. The average porosity of the sample was found to be 0.53, while its average compressive strength was found to be 115.4 psi.

Table 2 presents the results of the laboratory test conducted on the 8 x 4 cylinders. These representative samples were prepared by the manufacturer. The compressive strength ranges from 108 – 129 psi. The porosity is 0.53 while the unit weight ranges from 57 – 59 psi.

**Table 2: Porosity and void ratio data of recycled rubber tire pavement (Flexi-pave®)**

Sample	Maximum Load (lbf)	Compressive strength (psi)	Unit weight (lb/ft <sup>3</sup> )	Porosity, n	Void ratio, e
A2	1449	119.0	56.76	0.53	1.14
B2	1312	107.75	56.33	0.53	1.12
C2	1373	112.76	55.88	0.53	1.14
D2	1568	128.77	58.08	0.53	1.12
E2	1379	113.29	55.88	0.53	1.14
F2	1351	110.95	56.76	0.52	1.10

The average void ratio and porosity for these samples are 1.12 and 0.53 respectively and are shown in Table 3. The  $2\sigma$  test shows that all the void ratio values fall within the specified range.

**Table 3: Statistical Data for Porosity**

Sample	Average Void ratio, e	Average Porosity, n	Standard deviation, $\sigma$	Range ( $n - 2\sigma, n + 2\sigma$ )	Proportion within $2\sigma$	Coefficient of variation, CV
A2 – F2	1.12	0.53	0.0033	(0.52, 0.54)	1	0.006

Table 4 shows that the average compressive strength of these 8 x 4 cylinders is 115.41 psi. All the compressive strength values are within the range in the  $2\sigma$  test. The compressive strength is low but unlike other pervious pavements it can still withstand more applied load even after failure because of its high flexibility. It is important to note that the number of samples tested was low. A sample size of six is limiting the drawing a very accurate conclusion based on this test.

**Table 4: Statistical Data for Compressive strength**

Sample	Average Compressive strength (psi)	Standard deviation, $\sigma$	Range	Proportion within $2\sigma$	Coefficient of variation, CV
A2 – F2	115.41	7.506	(100.40, 130.42)	1	0.065

Also at the instance of failure, from visual observations, it is seen that the crack is not very visible. The elasticity of the sample allows it to return to its initial position upon application of the load. It can however be said that the sample can still accommodate more load even after failure.

The flexural strength is the preferred strength test on this type of pavement because in compression it has the ability to return to its original position after deformation. Visible diagonal cracks were observed at the middle third of the beam under flexural behavior. For this pavement type, it appears that this test actually measures the strength of the polyurethane binder in bending. Table 5 presents the modulus of rupture for each corresponding sample. The range of Modulus of Rupture (MR) is between 164 – 186 psi.

**Table 5: Flexural strength of new recycled rubber tire pavement**

Sample	Maximum load at failure, P (lbf)	Modulus of Rupture, MR (psi)
G2	2153	178.94
H2	2011	184.99
I2	2074	178.26
J2	1751	163.46
K2	2026	180.14
L2	2037	178.53

The statistical analysis of the flexural strength is shown in Table 6. All the results obtained fall within acceptable range. The average modulus of rupture of these samples is 177.39 psi.

**Table 6: Statistical Data for Modulus of Rupture**

Sample	Average Modulus of Rupture (psi)	Standard Deviation, $\sigma$	Range	Proportion within $2\sigma$	Coefficient of variation, CV
G2 – L2	177.39	7.26	(12.86, 191.91)	1	0.041

### ***FWD Testing Results***

Flexipave elastic modulus was between 20 – 230 ksi because of the flexibility of this pavement, the FWD deflection reading was erroneous. The deflections especially at the point of load application surpassed the maximum allowable deflection value by the FWD equipment used (129 mils). It is concluded that FWD should NOT be used for determining the modulus of Flexipave pervious pavements.



## **CONCLUSIONS AND OBSERVATIONS**

### **General Observations**

Observations made during the installation of the pavement sections are included below. By using recycled #57 stone crushed concrete, the materials were readily available and were regional materials providing ease of acquiring the material to the site. This material was noticed to have a small amount of metals and other debris mixed in with the aggregates. The surface layer materials, including the tire chips, granite aggregates, and binder were trucked in by bags and 5 gallon buckets and stored near the site.

Shortly after installation and throughout the study period it was notice that there was a moderate amount of minor surface raveling throughout the sections that was caused by turning movements of the heavy vehicles (semi-trucks, dump trucks, heavy construction equipment, etc.) that drove on the sections. New developments in the strength of the binder were made by the manufacturer since the installation of the pavement, so application of an overcoat was applied to the surface which re-bonded the aggregates to the pavement slab. After application of the overcoat spray, the degree of raveling was greatly reduced.

### **Infiltration Rates**

The determination of the FlexiPave system infiltration rate was conducted for normal operations, intentional sediment loading, and rejuvenation of the system. During the study period, the ERIK device was used 83 times and 74.7% of the runs provided values above the minimum of 2.0 in/hr for all three sections measured by the infiltrometers. For the Rejuvenation section, 58.8% of the results, for Bold&Gold™ section 100% of the results, and for the Fill

section 100% of results showed values greater than or equal to 2.0 in/hr for the north and south infiltrometers. In conclusion, infiltration rates did not drop below 2 inches per hour unless excessive amounts of sediments were spread over, washed in, and compacted into the surface pores. These values can be expected to be representative of a field application that has undergone excessive sediment buildup on the surface of these pervious pavements either from an accidental spill or erosion and sediment deposition onto the surfaces over a long period of time.

The results from this study indicate that FlexiPave pervious pavement systems will perform as intended, unless a worst case scenario excessive sediment loading condition and high ground water table levels exist. Maintenance by the use of a vacuum sweeper truck will remove surface sediments but is ineffective at removal of deep penetrating sediments. However, throughout the study period, there was never ponding observed on the surface during rainfall events in which ponding was observed on many of the other smaller pore sized pervious/permeable pavement types.

Under normal sediment loading conditions it is expected that the FlexiPave systems will perform well above 2 in/hr. The amount of sediment loading depends on the site location and its exposure to sediments being brought onto the pavement's surface by natural (wind and water laid sediments) or un-natural sources (ie. Tire tracking of sediments, spills, etc.).

This pervious pavement system is recommended as an effective infiltration BMP that will perform well throughout its service life. If the infiltration performance is degraded due to sediment accumulation mainly in the lower layer pores, a standard vacuum truck may be unsuccessful at improving its capability to infiltrate, but the surface layer remains unclogged to allow the initial precipitation that falls on its surface to be infiltrated. The ability to readily infiltrate water was noticed as an important factor in preventing runoff despite allowing

sediments to pass through the surface layer so the rainfall has a change to enter the system through the surface before it forced to become runoff due to surface clogging.

### **Sustainable Storage**

After multiple porosity tests were conducted on all the individual components that make up the entire pavement cross section and the actual constructed system that mimicked ideal conditions as well as those in the field such as oven dried samples, gravity drained samples, samples loaded with sediments, and samples after the sediments have been vacuumed from the top surfaces, conclusions can be made on the sustainable storage within each system. It was found that the actual storage within a constructed system is less than the calculated theoretical storage of each individual component. To be conservative, the actual measured values of the complete systems should be used to identify what the storage is in a desired section, as the amount of mixing at the interfaces of each layer will depend on what materials are used. With this, the amount of storage in the entire cross section of the FlexiPave pervious pavement system is about 10%.

### **Water Quality**

One of the objectives of this study was to examine the quality of water that infiltrates through two FlexiPave pervious pavement systems but due to unforeseen circumstances this analysis was unable to be performed. The ongoing testing of fertilizer runoff from fertilized slopes using the test beds and rainfall simulator next to the Flexipave sections caused very high levels of nutrients to be detected in the water samples collected from the below the pavements. Testing of the quality of water through these sections was shifted to the laboratory using barrels.

However, examination of other pervious pavements showed that the quality of water that infiltrates through these systems is typical of concentrations measured in stormwater in the Orlando Florida area. While stormwater is typically treated prior to discharge to a surface water body these systems allow the stormwater to infiltrate onsite and therefore do not discharge to a surface water body. This implies that when assessing the water quality benefit of these systems, reduction in water volume needs to be taken into account.

Based on the results of this study the nutrient mass reduction could be determined by calculating the volume retained by these systems and event mean concentrations. This would give the pollutant mass retained within the pervious system and not discharged into a receiving water body or stormwater pond. An example problem is presented below to show this calculation.

### ***Sample Calculations for Quantifying Water Quality Improvement***

For this example, consider a 1-acre pervious parking lot using FlexiPave as the specified product. The cross section for this system consists of a 4 inch deep layer of # 57 recycled concrete with 2 inches of FlexiPave on top. There is a non-woven filter fabric separating the parent earth soil from the limerock layer. The parking lot is located in Orlando Florida and a 25 year design storm is to be used. The TN and TP mass reduction expected from this site for a 25 year storm event will be determined. The TN and TP concentrations used are 0.79 mg/L as N and 0.68 mg/L as  $\text{PO}_4^{3-}$ , respectively.

Using the pervious pavement water management analysis model located on the Stormwater Management Academy website ([www.stormwater.ucf.edu](http://www.stormwater.ucf.edu)), a runoff coefficient for this system is determined as 0.88. Using the rational method which states that  $Q = CiA$ , a

rainfall excess value can be determined. First the rainfall intensity and duration that has a 25 year return period needs to be determined from the Orlando Florida intensity, duration, and frequency (IDF) curve. Based on this IDF curve the design intensity is 8.4 in/hr for a duration of 10 minutes. Using the rational method, it is determined that the rainfall excess flow rate is 7.39 cfs and multiplying that by the 10 minute duration gives a runoff volume of 4,435 cubic feet, or 125,585 liters. Therefore, the TN mass leaving the system is 99.2 grams and the TP mass leaving the system is 85.4 grams.

Now the mass leaving a typical impervious parking lot needs to be determined for comparison. Assuming a runoff coefficient of 0.95 for regular impervious asphalt the rainfall excess flow rate is 8.04 cfs and multiplying that by the 10 minute duration gives a runoff volume of 4,826 cubic feet, or 136,673 liters. Therefore, the TN mass leaving a typical impervious asphalt parking lot is 108 grams and the TP mass leaving the system is 92.9 grams. This shows that the FlexiPave system would have a TN mass reduction of 8.8 grams (8%) and a TP mass reduction of 7.5 grams (8%) for a one acre parking lot.

The above analysis and example problem shows that there is a water quality benefit to using a FlexiPave system. This benefit is only realized, however, through taking into account the volume reduction. The yearly TP and TN mass reduction has the potential to be much higher considering that more than 90% of the rainfall events in Orlando Florida are less than one inch, which would not generate any runoff.

### **Strength Evaluation**

The average porosity of the sample was found to be 0.53, while its average compressive strength was found to be 115.4 psi. The compressive strength ranges from 108 – 129 psi while

the unit weight ranges from 57 – 59 psi. The average void ratio and porosity for these samples are 1.12 and 0.53 respectively.

The compressive strength is low but unlike other pervious pavements it can still withstand additional applied load even after failure because of its high flexibility. The elasticity of the sample allows it to return to its initial position upon application of the load. The flexural test is more suited but primarily measures the strength of the polyurethane binder in bending. The range of Modulus of Rupture (MR) is between 164 – 186 psi.

Flexipave elastic modulus was between 20 – 230 ksi because of the flexibility of this pavement, the FWD deflection reading was erroneous. It is concluded that FWD should NOT be used for Flexipave pavements.

## REFERENCES

- AASHTO**, Guide for Design of Pavement Structures [Report]. - [s.l.] : American Association of State Highway and Transportation Officials, 1993.
- ASTM D3385.**, Standard test method for infiltration rate of soils in field using double-ring infiltrometer. Vol. 04.08, in *Geotechnical Engineering Standards*, by D18.04 Subcommittee. West Conshohocken, PA: ASTM International, 2009.
- ASTM**, Standard Test Method for Flexural Strength of Concrete (Using Simple Beam with Third-Point Loading) [Book Section] // Annual Book of ASTM Standards. - West Conshohocken : ASTM International, 2004b. - Vol. 04.02.
- Abbot, C. and Comino-Mateos, L.** (2003). In-situ hydraulic performance of a permeable pavement sustainable urban drainage system. *The Journal (volume 17)* , 187-190.
- Anderson.** (1999). "The role of urban surfaces (permeable pavements) in regulating drainage and evaporation: development of a laboratory simulation experiment". *Hydrological Processes volume 13*, 357-609.
- Ballock, C.**, "Construction specifications and analysis of rehabilitation techniques of pervious concrete pavement", 2007 Masters Thesis, University of Central Florida.
- Bean Z. E.**, "Study on the surface infiltration rate of permeable pavements," North Carolina State University, Raleigh, NC, 2004
- Bean, E. Z., Hunt, W. and Bidelspach, D.** (2007, May/June). Field survey of permeable pavement surface infiltration rates. *Journal of Irrigation and Drainage Engineering*.
- Bloomquist, D., Viala, A., and Gartner, M.**, "Development of a Field Permeability Apparatus the Vertical and Horizontal In-situ Permeameter (VAHIP)", 2007 UF.  
[http://www.dot.state.fl.us/researchcenter/Completed\\_Proj/Summary GT/FDOT BD545\\_15\\_rpt.pdf](http://www.dot.state.fl.us/researchcenter/Completed_Proj/Summary_GT/FDOT_BD545_15_rpt.pdf)
- Booth B. D. and Jackson C. R.**, "Urbanization of Aquatic Systems: Degredation Thresholds, Stormwater Detection, and the Limits of Mitigation," Journal of the American Water Resources Association (American Water Resources Association) October 1997
- Brattebo, B. and Booth, D.** "Long-term Stormwater Quantity and Quality Performance of Permeable Pavement Systems." Water Research Volume 37, Issue 18 (2003): 4369-4376.
- Brouwer, C., Prins, K., Kay, M., and Heibloem, M. (1988).** *Irrigation water management: Irrigation methods*. Food and Agricultural Organization. Rome, Italy: FAO.
- Cahill, T. H.** "Porous Asphalt: The Right Choice of Porous Pavements." Hot Mix Asphalt Technology, National Asphalt Pavement Association (2003).
- Casenave A. and Valentin C.**, "A runoff capability classification system based on surface features criteria in semi-arid areas of West Africa," Niamey, Niger, 1991
- Cedergren, H.**, (1994), America's Pavements: World's Longest Bathtubs, Civil Engineering, ASCE, vol. 64, No. 9, pp. 56-58.
- Chester, A. L. and James, G. C.** (1996). Impervious surface coverage; The emergence of a key Environmental Indicator. *Journal of American Planning Association* , 62 (2).

- Chopra, M., Wanielista, M. and Stuart, E.**, Chapter 12 in Statewide Stormwater Rule, Revised Draft Applicant's Handbook., Florida Department of Environmental Protection, 2010  
[http://www.dep.state.fl.us/water/wetlands/erp/rules/stormwater/rule\\_docs.htm](http://www.dep.state.fl.us/water/wetlands/erp/rules/stormwater/rule_docs.htm)
- Chopra M. and Wanielista M.**, Construction and Maintenance Assessment of Pervious Concrete Pavements [Report] : Final Report . - Orlando, Florida : A Joint Research Program of NRMCA, FDOT and Rinker Materials, 2007a.
- Chopra M. and Wanielista M.**, Performance Assessment of a Pervious Concrete Pavement Used as a Shoulder for a Interstate Rest Area parking Lot [Report] : Final Report. - Orlando, Florida : A Joint Research Program of FDOT, Rinker Materials and FDEP, 2007b.
- Chopra M. and Wanielista M.**, Performance Assessment of a Pervious Concrete Pavement Used as a Shoulder for a Interstate Rest Area Parking Lot [Report] : Final Report. - Orlando, Florida : A Joint Research Program of FDOT, Rinker Materials and FDEP, 2007c.
- Chopra M., Wanielista M. and Mulligan A. M.**, Compressive Strength of Pervious Concrete Pavements [Report] : Final Report. - Orlando, Florida : A Joint Research Program of FDOT, Rinker Materials and FDEP, 2007b.
- Crouch, L.K.**, "Pervious PCC Compressive Strength in the Laboratory and the Field: The Effects of Aggregate Properties and Compactive Effort, Report, Tennessee Concrete Association, 2006.
- Das, B. M.** (2006). *Principles of geotechnical engineering* (6th Edition ed.). Pacific Groove, CA: Brooks/Cole.
- Dietz E. M.**, "Low Impact Development Practices: A Review of Current Research Recommendations for Future Directions," Department of Environment and Society, Utah State University, 2007
- Dreelin, E. A., Fowler, L., and Roland, C. C.** (2003). *A test of porous pavement effectiveness on clay soils during natural storm events*. Center for Water Sciences and Department of Fisheries and Wildlife. East Lansing, MI: Michigan State University.
- Flexi-Pave™**. <http://www.kbius.com/productinfo.htm>
- Ferguson, B.**, "Porous Pavements", An integrative studies in water management and land development, 2005.
- Fortez R., Merighi J., and Bandeira A.**, "Laboratory Studies on Performance of Porous Concrete," Department of Civil Engineering, Mackenzie Presbyterian University, Brazil
- Frazer, L.** "Paving Paradise The Peril of Impervious Surfaces." Environmental Health Perspectives Volume 113, NO. 7 (2005): A456-A462.



- Fwa T.W., Tan S.A., and Guwe Y.K.**, “Laboratory Evaluation of Clogging Potential of Porous Asphalt Mixtures,” Center for Transportation Research, National University of Singapore.
- Ghafoori N. and Dutta S.** Development of No-Fines Concrete Pavement Applications [Journal] // Journal of Transportation Engineering. - May/June 1995. - 3 : Vol. 126. - pp. 283-288.
- Ghafoori N. and Dutta S.** Laboratory Investigation of Compacted No-fines concrete for paving materials [Journal] // Journal of Materials in Civil Engineering. - August 1995. - 3 : Vol. 7. - pp. 183 - 191.
- Goktepe A., Burak, A.E. and Hilmi L.A.**, “Advances in backcalculating the mechanical properties of flexible pavements”, Advances in Engineering Software, Vol. 37. - pp. 421-431, 2006.
- Grote K., Hubbard S., and Harvey J., Rubin Y.**, “Evaluation of Infiltration in Layered Pavements using Surface GPR Reflection Techniques,” Department of Geology, University of Wisconsin-Eau Claire 2004
- Haselbach M. L. and Freeman M. R.**, “Vertical Porosity Distributions in Pervious Concrete Pavement,” ACI Materials Journal, Vol. 103, No. 6, 2006
- Haselbach L., Valavala S., and Montes F.**, “Permeability predictions for sand-clogged Portland Cement Pervious Concrete Pavement Systems,” University of South Carolina, Sept 2005
- Haselbach, V. M.** (2005). A new test method for porosity measurements of Portland Cement pervious concrete. *Journal of ASTM International* .
- Huang, Y.**, Pavement Analysis and design, Pearson, Prentice Hall, 2004.
- Huang B.**, Laboratory and analytical study of permeability and strength properties of Pervious concrete [Report]. - Knoxville : Dept of Civil and Environmental Engineering, The University of Tennessee, 2006.
- Lake Superior Duluth Streams. 3 September 2010  
<<http://www.lakesuperiorstreams.org/stormwater/toolkit/paving.html> >.
- Illgen, M., Schmitt, T., and Welker, A.** (2007). Runoff and infiltration characteristics of permeable pavements - Review of an intensive monitoring program. *Water Science Technology* , 1023-1030.
- Kevern, J. T.** (2008). *Advancements in pervious concrete technology*. Iowa State University, Department of Civil Engineering. Ames: John Tristan Kevern.
- Kunzen, T.**, “Hydrologic mass balance of pervious concrete pavement with sandy soils”, 2006 UCF.
- Legret M., Colandini V., and Marc Le C.**, “Effects of a Porous Pavement with Reservoir Structure on the Quality of Runoff Water and Soil,” Laboratory of Central Ponts et Chaussees, B.P.19, 44340 Bouguenais, France 1996
- Liantong M., Huurman M, Shaopeng W., and Molenaar A.**, “Ravelling investigation of porous asphalt concrete based on fatigue characteristics of bitumen-stone adhesion and mortar,” 2009

- Liu, W. and Scullion, T.**, “Modulus 6.0 for Windows: User’s Manual,, Texas Transportation Institute, Texas A&M University, College Station, FHWA/TX-05/0-1869-2, 2001.
- Montes F., Valavala S. and Haselbach L.**, “A new test method for porosity measurements of portland cement pervious concrete,” *Journal of ASTM International*, January 2005, Vol. 2, No.1
- Montes, H.** (2006). Measuring hydraulic conductivity in pervious concrete. *Environmental Engineering Sciences* , 960-969.
- Mulligan, A.M.**, “Attainable compressive strength of pervious concrete paving systems”, 2005 UCF
- Pitt R.E., Maestre, A, Morquecho, R. and Williamson, D.**, “Collection and examination of a municipal separate storm sewer system database” , pp 257-294, In: *Models and Applications to Urban Water Systems*, Vol. 12., W. James (eds.), Guelph, Ontario.
- Pitt R., Clark S. and Field R.**, “Groundwater Contamination Potential from Stormwater Infiltration Practices,” Department of Civil Engineering, The University of Alabama at Birmingham, September 1999
- Ranieri V.**, “Runoff Control in Porous Pavements,” Department of Highways and Transportation, Polytechnic University of Bari, Italy
- Reddi, L. N.** (2003). *Seepage in soils, Principles and Applications*.
- Rohne R. J. and Izevbekhai B. I.**, Early Performance of Pervious Concrete Pavement [Conference] // TRB Conference. - Maplewood : [s.n.], 2009.
- Rubber Pavement Association**, 2005, The development of innovative uses for recycled rubber provides solutions for the disposal of scrap tires, [www.rubberpavements.org](http://www.rubberpavements.org).
- Schlüter, W. A.** (2002). Monitoring the Outflow from a Porous Car Park. *Urban Water Journal*, 4. , 245-253.
- Scholz, M., & Grabowiecki, P.** (2006). *Review of permeable pavement systems*. School of Engineering and Electronics, Institute for Infrastructure and Environment. Scotland, UK: University of Edinburgh.
- Smith, R., D.**, “Permeable Interlocking Concrete Pavements, Selection, Design, Construction, and Maintenance., Third Edition., Interlocking Concrete Pavement Institute., 2006
- Spence, J.**, “Pervious concrete: a hydrologic analysis for stormwater management credit”, UCF., 2006
- Tennis, P., Lenning, M., and Akers, D.** (2004). *Perviuos concrete pavements*. Retrieved from Portland Cement Association:  
[http://www.northinlet.sc.edu/training/training\\_pages/Pervious%20Concrete/CRMCA\\_CD\\_v2005JUN01/content/web\\_pages/Pervious\\_Concrete\\_Pavements.pdf](http://www.northinlet.sc.edu/training/training_pages/Pervious%20Concrete/CRMCA_CD_v2005JUN01/content/web_pages/Pervious_Concrete_Pavements.pdf)
- Tyner, J., Wright, W., and Dobbs, P.** (2009). Increasing exfiltration from pervious concrete and temperature monitoring. *Journal of Environmental Management* , 1-6.

- Turkiyyah, G.** Feasibility of Backcalculation Procedures Based on Dynamic FWD response data [Report]. - [s.l.] : University of Washington, 2004.
- US Environmental Protection Agency,** 1994. The Quality of our Nation's Water: 1992. United States Environmental Protection Agency #EPA-841-5-94-002. Washington, D.C.: USEPA Office of Water.
- US Environmental Protection Agency,** 1999. Porous Pavement, Stormwater Technology Fact Sheet. United States Environmental Protection Agency #EPA-832-F-99-023. Washington, D.C.: USEPA Office of Water.
- Valavala, S., Montes, F., and Haselbach, L.** (2006). Area-Rated rational coefficients for portland cement pervious concrete pavement. *Journal of hydrologic engineering ASCE* , 257-260.
- Wanielista, M., Kersten, R., and Eaglin, R.** (1997). *Hydrology: Water quantity and Quality control* (2nd Edition ed.). Hoboken, NJ: John Wiley & Sons, Inc.
- Wanielista, M. and Yousef, Y.** (1993). *Stormwater Management* , John Wiley & Sons, Inc.
- Yang, J., and Jiang, G.** (2002). *Experimental study on properties of pervious concrete pavement materials*. Department of Civil Engineering. Beijing, China: Tsinghua University.
- Yang J. and Jiang G.,** Experimental study on properties of pervious concrete pavement materials [Journal] // *Cement and Concrete Research*. - 2003. - 33. - pp. 381 - 386.