

Simulation of Prepackaged Grout Bleed under Field Conditions

Revised Draft Final Report

April 2014

Principal investigator:

H. R. Hamilton

Research assistants:

Alexander Piper

Alexander Randell

Brett Brunner

Department of Civil and Coastal Engineering
University of Florida
P.O. Box 116580
Gainesville, Florida 32611

Sponsor:

Florida Department of Transportation (FDOT)
Michael Bergin, P.E. – Project Manager

Contract:

UF Project No. 00097964 and 00097965
FDOT Contract No. BDK75 977-59

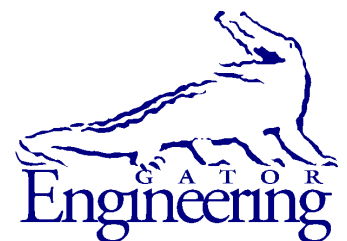

University of Florida
Engineering School of Sustainable Infrastructure and Environment
Department of Civil and Coastal Engineering

Disclaimer

The opinions, findings, and conclusions expressed in this publication are those of the authors and not necessarily those of the State of Florida Department of Transportation. Certain commercial products are identified in this report to specify the materials used and procedures employed. In no case does such identification imply endorsement or recommendation by the Florida Department of Transportation or National Institute of Standards and Technology, nor does it indicate that the products are necessarily the best available for the purpose.

SI* (Modern Metric) Conversion Factors-Approximate Conversions to SI Units

SYMBOL	WHEN YOU KNOW	MULTIPLY BY	TO FIND	SYMBOL
LENGTH				
in	inches	25.4	millimeters	mm
ft	feet	0.305	meters	m
yd	yards	0.914	meters	m
mi	miles	1.61	kilometers	km
AREA				
in²	square inches	645.2	square millimeters	mm ²
ft²	square feet	0.093	square meters	m ²
yd²	square yard	0.836	square meters	m ²
ac	acres	0.405	hectares	ha
mi²	square miles	2.59	square kilometers	km ²
VOLUME				
fl oz	fluid ounces	29.57	milliliters	mL
gal	gallons	3.785	liters	L
ft³	cubic feet	0.028	cubic meters	m ³
yd³	cubic yards	0.765	cubic meters	m ³
NOTE: volumes greater than 1000 L shall be shown in m ³				
MASS				
oz	ounces	28.35	grams	g
lb	pounds	0.454	kilograms	kg
T	short tons (2000 lb)	0.907	Megagrams	Mg (or "t")
TEMPERATURE (exact degrees)				
°F	Fahrenheit	5(F-32)/9 or (F-32)/1.8	Celsius	°C
ILLUMINATION				
fc	foot-candles	10.76	lux	lx
fl	foot-Lamberts	3.426	candela/m ²	cd/m ²
FORCE and PRESSURE or STRESS				
kip	1000 pound force	4.45	kilonewtons	kN
lbf	pound force	4.45	newtons	N
lbf/in²	pound force per square inch	6.89	kilopascals	kPa

*SI is the symbol for the International System of Units. Appropriate rounding should be made to comply with Section 4 of ASTM E380.

SI* (Modern Metric) Conversion Factors-Approximate Conversions from SI Units

SYMBOL	WHEN YOU KNOW	MULTIPLY BY	TO FIND	SYMBOL
LENGTH				
mm	millimeters	0.039	inches	in
m	meters	3.28	feet	ft
m	meters	1.09	yards	yd
km	kilometers	0.621	miles	mi
AREA				
mm²	square millimeters	0.0016	square inches	in ²
m²	square meters	10.764	square feet	ft ²
m²	square meters	1.195	square yards	yd ²
ha	hectares	2.47	acres	ac
km²	square kilometers	0.386	square miles	mi ²
VOLUME				
mL	milliliters	0.034	fluid ounces	fl oz
L	liters	0.264	gallons	gal
m³	cubic meters	35.314	cubic feet	ft ³
m³	cubic meters	1.307	cubic yards	yd ³
MASS				
g	grams	0.035	ounces	oz
kg	kilograms	2.202	pounds	lb
Mg (or "t")	megagrams (or "metric ton")	1.103	short tons (2000 lb)	T
TEMPERATURE (exact degrees)				
°C	Celsius	1.8C+32	Fahrenheit	°F
ILLUMINATION				
lx	lux	0.0929	foot-candles	fc
cd/m²	candela/m ²	0.2919	foot-Lamberts	fl
FORCE and PRESSURE or STRESS				
kN	kilonewtons	0.225	1000 pound force	kip
N	newtons	0.225	pound force	lbf
kPa	kilopascals	0.145	pound force per square inch	lbf/in ²

*SI is the symbol for the International System of Units. Appropriate rounding should be made to comply with Section 4 of ASTM E380.

1. Report No.		2. Government Accession No.		3. Recipient's Catalog No.	
4. Title and Subtitle Simulation of Prepackaged Grout Bleed under Field Conditions				5. Report Date April 2014	
				6. Performing Organization Code	
7. Author(s) A. Piper, A. Randell, B. Brunner and H. R. Hamilton				8. Performing Organization Report No.	
9. Performing Organization Name and Address University of Florida Department of Civil & Coastal Engineering P.O. Box 116580 Gainesville, FL 32611-6580				10. Work Unit No. (TRAIS)	
				11. Contract or Grant No. BDK75 977-59	
12. Sponsoring Agency Name and Address Florida Department of Transportation Research Management Center 605 Suwannee Street, MS 30 Tallahassee, FL 32399-0450				13. Type of Report and Period Covered Final Report Nov 2011-Feb 2014	
				14. Sponsoring Agency Code	
15. Supplementary Notes					
16. Abstract <p>This report contains a summary of the research performed in the area of reproducing and determining the cause of soft grout, which has been found in several PT (Post-Tensioned) tubes around the state of Florida. A modified version of the Euronorm inclined tube test named modified inclined tube test (MITT) was developed and used to conduct the majority of the testing.</p> <p>This research was divided into three primary phases. The first was to develop the Modified Inclined Tube Test and determine the tendency of prepackaged grout for producing soft grout under laboratory and field test conditions. None of the commercially available prepackaged PT grout tested with MITT produced bleed or soft grout when the grout was mixed and injected in accordance with manufacturer's recommendations and tested well before the expiration date printed on the bag.</p> <p>A number of variations on MITT were introduced that would simulate more closely the variations that occur in field conditions. Additional mix water and residual water in the tube produced soft grout consistently in one of the PT grouts. Supplemental tests of fresh grout properties, such as flow cone, unit weight, wet density, pressure bleed, sedimentation, and bleed readings on inclined tubes, did not provide indications that soft grout would be formed during MITT.</p> <p>The second phase of testing focused on the effect of low-reactivity fillers on the production of soft grout in plain grout formulations of portland cement, ground calcium carbonate, and high-range water-reducing admixture (HRWR). Mixtures with 45% and 35% additional filler material consistently generated more soft grout than mixtures with 0% additional filler for any given water-to-solids ratio (w/s).</p> <p>The third and final phase of testing focused on the shelf life of bagged PT grout. Potential modes of degradation included pre-hydration of the portland cement and deterioration of the admixtures over time. Three exposure conditions were developed that provided a broad spectrum conditioning; these conditions were named <i>Laboratory</i>, <i>Field</i>, and <i>Extreme</i>. PT grouts were exposed to these conditions and then tested with MITT for soft grout. Companion particle size analysis (PSA) tests were conducted to determine correlation between the production of soft grout and changes in particle size due to pre-hydration. Prolonged storage times increased the susceptibility of prepackaged PT grouts to the formation of soft grout, even in favorable environments.</p>					
G17. Key Word post-tensioning, grout, modified inclined bleed test, shelf life, storage conditions, cement filler, grout particle size			18. Distribution Statement No restrictions. This document is available to the public through the National Technical Information Service, Springfield, VA, 22161		
19. Security Classif. (of this report) Unclassified		20. Security Classif. (of this page) Unclassified		21. No. of Pages 149	22. Price

Acknowledgments

The authors would like to thank the Florida Department of Transportation (FDOT) State Materials Office and Structural Lab for their support in materials testing assistance with experimental testing. In particular, the authors would like to thank Mike Bergin and Richard DeLorenzo for their help with technical suggestions, and Patrick Carlton for helping with the experimental process in the laboratory.

Furthermore, the authors would like to thank Insteel wire company for donating post-tensioning strand in the beginning of the experimental research. The authors would also like to thank those grout manufacturers who donated pallets of PT grout for this research project.

The authors would also like to thank John Newton for the advice he gave on operating and maintaining the grout plant. Additionally, the authors would like to thank Max McGahan, Kunal Malpani, Marlo Chumioque, Shelby Brothers, Sai Jiang, Matt Brosman, and Amanda Sanyigo for helping with the experimental testing and report.

Executive Summary

The objective of this research project was to determine and be able to reproduce the cause of soft grout that was discovered in post-tensioning (PT) ducts in several bridges around the state of Florida. A modified version of the Euronorm inclined tube test named Modified Inclined Tube Test (MITT) was developed and used to conduct the majority of the testing. The inclined test tube offered a configuration that could be used in a laboratory setting to simulate grout bleed and segregation during full-scale mixing and injection. The change in elevation between the top and the bottom of the inclined test tube causes bleed at the base of the tube to flow upward along the length of the tube due to the pressure head.

This research was divided into three primary phases. The first was to develop the Modified Inclined Tube Test and determine the tendency of prepackaged grout for producing soft grout under laboratory and field test conditions. None of the commercially available prepackaged PT grout tested with MITT produced bleed or soft grout when the grout was mixed and injected in accordance with manufacturer's recommendations and tested well before the expiration date printed on the bag.

In an effort to induce soft grout production, testing was conducted in which a number of variations on MITT were introduced that would simulate more closely the variations that occur in field conditions. Additional mix water and residual water in the tube produced soft grout consistently in one of the PT grouts labeled PT4. Further tests were conducted on PT4 that involved tubes that were packed full of strands, high temperature injection, pressurized set, strand placed in the top of the tube, among others. None of these conditions produced soft grout consistently. Furthermore, supplemental tests of fresh grout properties, such as flow cone, unit weight, wet density, pressure bleed, sedimentation, and bleed readings on inclined tubes, did not provide indications that soft grout would be formed during MITT.

The second phase of testing focused on the effect of low-reactivity fillers on the production of soft grout in plain grout formulations of portland cement, ground calcium carbonate, and high-range water-reducing admixture (HRWR). Mixtures with 45% and 35% additional filler material consistently generated more soft grout than mixtures with 0% additional filler for any given water-to-solids ratio (w/s).

Finally, the third phase of testing focused on the shelf life of bagged PT grout. Preliminary testing indicated that long storage times appeared to make prepackaged PT grout more susceptible to the formation of soft grout under MITT. PT grout manufacturers place expiration dates on their product, yet there appear to be no standards or rational process for determining this date. Potential modes of degradation include pre-hydration of the portland cement and deterioration of the admixtures over time. Three exposure conditions were developed that provided a broad spectrum conditioning; these conditions were named *Laboratory*, *Field*, and *Extreme*. PT grouts were exposed to these conditions and then tested with MITT for soft grout. Companion particle size analysis (PSA) tests were conducted to determine correlation between the production of soft grout and changes in particle size due to pre-hydration. Prolonged storage times increased the susceptibility of prepackaged PT grouts to the formation of soft grout, even in favorable environments.

Table of Contents

Disclaimer	ii
SI* (Modern Metric) Conversion Factors-Approximate Conversions to SI Units	iii
SI* (Modern Metric) Conversion Factors-Approximate Conversions from SI Units.....	iv
Technical Report Documentation Page.....	v
Acknowledgments.....	vi
Executive Summary	vii
List of Figures	xi
List of Tables	xv
1 Introduction.....	1
2 Background.....	3
3 Objective and Approach	7
4 Materials	8
4.1 Prepackaged PT Grout.....	8
4.2 Plain Grout Formulation.....	8
4.3 PT Grout Bag Weights	9
4.4 Portland Cement	9
4.5 Filler Material	10
4.6 High Range Water Reducing Admixtures	11
5 Mixing Equipment and Procedures.....	12
6 Modified Inclined Tube Test (MITT).....	14
6.1 Inclined Tube Test Modifications.....	15
6.2 MITT Injection	16
6.3 MITT Bleed Measurement	18
6.4 MITT Hardened Grout Sampling	18
6.5 MITT Moisture Content	21
7 Field Conditions.....	23
8 Shelf Life	27
8.1 Exposure Conditions	28
8.2 Test Protocol.....	30
9 Particle Size Analysis	33
10 Typical Grout Test Methods	34
10.1 Flow Cone Test.....	34
10.2 Unit Weight Test	35
10.3 Mud Balance Test.....	35
10.4 Pressure Bleed Test	36
10.5 Sedimentation Test	37
10.6 Nominal Shear Rate (NSR) Viscosity Test	38
11 Field Conditions—Results and Discussion.....	41
11.1 Moisture Content Results	41
11.2 Flow Cone Efflux Time, Wet Density, and Unit Weight Results.....	46
11.3 Sampling Observations.....	56
11.4 Soft Grout Summary.....	65
11.5 Bleed Readings.....	65
11.6 Pressure Bleed Test Results.....	70
11.7 Sedimentation Test Results	70
11.8 Moisture Content and Soft Grout	71
12 Inert Filler—Results and Discussion	74

12.1	NSR Viscosity Control	74
12.2	Soft Grout	75
12.3	Moisture Content	76
12.4	Bleed.....	79
12.5	HRWR and Segregation	80
12.6	Plain Grout and PT Grout Comparison	85
13	Shelf Life—Results and Discussion	91
13.1	Pre-hydration Effect on MITT Results	91
13.2	Laboratory and Field Conditions	92
13.3	PSA Results	93
13.4	Moisture Content	95
14	Summary and Conclusions	98
15	Improved Grout Performance	102
16	References.....	103
Appendix A—Modified Inclined Tube Test Procedures		104
	Scope	104
	Summary of Test Method	104
	Significance and Use	104
	Interferences	104
	Apparatus.....	104
	Reagents and Materials.....	106
	Sampling, Test Specimens, and Test Units	106
	Report	107
Appendix B—Supplemental Test Results.....		108
	NSR Viscosity	108
	Characterization and Measurement of Soft Grout	110
	Moisture Content—Plain Grout.....	118
	Moisture Contents—PT Grout.....	123
	Plain Grout Data	126

List of Figures

Figure 1—Precast concrete bridge segment with PT tubes and strands shown	1
Figure 2—Soft grout sample identified in field by FDOT	2
Figure 3—EN445 test configuration.....	3
Figure 4—Particle size distribution for portland cement.....	10
Figure 5—Particle size distribution for calcium carbonate used in the plain grout formulation	11
Figure 6—Colloidal grout plant with various parts labeled.....	12
Figure 7—Bleed and segregation mechanism	15
Figure 8—Schematic of MITT setup	16
Figure 9—MITT setup.....	17
Figure 10—Discharging grout for testing prior to inclined tube injection	17
Figure 11—Attach grout hose to tube.....	17
Figure 12—Saw-cut tubes for sampling	18
Figure 13—Tube wall removed for sampling.....	19
Figure 14—Grout sample removed with chisel	19
Figure 15—Sample locations for MITT	20
Figure 16—Grout sampling locations (a) at base (b) mid-height and (c) top of inclined tube	21
Figure 17—MITT grout sample locations	21
Figure 18—Grout samples drying in oven for moisture content test.....	22
Figure 19—Inclined tube specimen modified with constrictions (a) schematic (b) compared to typical specimen.....	24
Figure 20— <i>Laboratory</i> storage condition	29
Figure 21— <i>Field</i> storage condition	30
Figure 22— <i>Extreme</i> storage condition	31
Figure 23—Cut bag before placement into incubator.....	31
Figure 24—Laser scattering particle size distribution analyzer.....	33
Figure 25—Measurement principles diagram.....	33
Figure 26—Flow cone used to determine fluidity of grout samples during MITT.....	34
Figure 27—Unit weight used to determine grout density	35
Figure 28—Mud balance used to determine wet density of grout samples during MITT	36
Figure 29—Pressure bleed test setup used during MITT.....	36
Figure 30—Pouring grout into cylinder for sedimentation test	37
Figure 31—Sedimentation cylinders from multiple tests	37
Figure 32—Sedimentation cylinder cut into 4 approximately equal pieces	38
Figure 33—Dynamic shear rheometer.....	39
Figure 34—Helical ribbon and cup.....	39
Figure 35—Helical ribbon and cup schematics	40
Figure 36—Variation of moisture content with respect to position along tube for material PT4-1 mixed at MWD.....	41
Figure 37—Maximum moisture content measured in tube for all grouts at maximum water	42
Figure 38—Maximum moisture content measured for all grouts with constricted tubes	43
Figure 39—Variation of moisture content with respect to position along constricted tube for material PT4-2.....	43
Figure 40—Maximum moisture content measured in tube for all grouts with 2 gallons of water in tube prior to injection.....	44
Figure 41—Maximum moisture content measured in tube for all grouts at 1.15·MWD.....	45
Figure 42—Maximum moisture content measured in tube for additional tests run on PT4-1 and PT4-2.....	46
Figure 43—Plot of flow cone time before and after injection for all grouts at maximum water.....	47
Figure 44—Plot of unit weight value before and after injection for all grouts at maximum water	47

Figure 45—Plot of wet density value before and after injection for all grouts at maximum water.....	47
Figure 46—Change in (a) flow cone efflux time, (b) unit weight, and (c) wet density from mixer to hose discharge and to tube discharge in constricted tube	49
Figure 47—Change in (a) flow cone efflux time, (b) unit weight, and (c) wet density from mixer to hose discharge and to tube discharge with water in tube.....	51
Figure 48—Change in (a) flow cone efflux time, (b) unit weight, and (c) wet density from mixer to hose discharge and to tube discharge with 1.15·WMD	53
Figure 49—Change in (a) flow cone efflux time, (b) unit weight, and (c) wet density from mixer to hose discharge and to tube discharge for additional tests conducted on PT4.....	55
Figure 50—Porous surface observed in top half of tube containing PT1-2 at MWD.....	56
Figure 51—Porous grout observed in PT1-2 at 1.15·MWD	57
Figure 52—Smooth grout surface observed in PT2-2 mixed at MWD	58
Figure 53—Grout at top of tube when PT2-2 at 1.15·MWD	58
Figure 54—Smooth grout surface with air bubble observed in PT3-1 mixed at MWD	59
Figure 55—Surface of PT4-1 at MWD. Top half is lighter than bottom half.....	60
Figure 56—Grout containing air bubbles found at top of tubes containing PT4-1 mixed at MWD.....	61
Figure 57—Black material and soft grout found in tubes injected with PT4-2 mixed at 1.15·MWD	61
Figure 58—Soft grout and black material found in tubes injected with PT4-2 mixed at 1.15·MWD	61
Figure 59—Soft grout found at top of constricted tube containing PT4-2 several months after injection .	62
Figure 60—Soft grout found at top of tube containing PT4-1 in which the grout hose was filled with 2 gallons of water prior to injection	63
Figure 61—Top of tube injected with material C45; grout is white and hard	64
Figure 62—Hard, white material coating strands in tube injected with material C675.....	64
Figure 63—White grout at 12:00 position and darker grout everywhere else in tube injected with material C675	64
Figure 64—Opaque PVC fittings used on end of inclined tubes	67
Figure 65—Grout coating interior wall of clear PVC tube.....	67
Figure 66—Bleed water visible in PT2-2 24 h after injection	69
Figure 67—HRWR dosage	74
Figure 68—Resulting initial viscosities	75
Figure 69—Resulting initial flow cones	76
Figure 70—Variation of soft grout with (a) w/c and (b) w/s	76
Figure 71—Moisture content (0% filler)	77
Figure 72—Moisture content (35% filler)	78
Figure 73—Moisture content (45% filler)	78
Figure 74—Variation in moisture content along length of tube with (a) MWD (b) 1.15·MWD.....	79
Figure 75—Comparison of modified inclined tube and pressure bleed measurements with respect to w/c	80
Figure 76—Comparison of modified inclined tube and pressure bleed measurements with respect to w/s	81
Figure 77—Moisture content for C45-0, C675-35, and C825-45.....	82
Figure 78—Bleed water for mixes with and without HRWR.....	82
Figure 79—Soft grout for mixes with and without HRWR.....	83
Figure 80—Viscosity for mixes with and without HRWR.....	83
Figure 81—Maximum moisture content versus water/HRWR ratio	84
Figure 82—Bleed water versus water/HRWR ratio.....	84
Figure 83—Soft grout versus water/HRWR ratio.....	85
Figure 84—HRWR/flow cone time versus w/s ratio (including PT4-6 tests)	86
Figure 85—Flow cone time versus w/s (including all PT grouts)	86
Figure 86—HRWR/viscosity versus w/s ratio (including PT4-6 tests).....	87
Figure 87—Viscosity versus w/s (including all PT grouts).....	87

Figure 88—Soft grout versus w/s for varying amounts of filler (including PT4-6 tests)	88
Figure 89—Moisture contents for tests with no soft grout (left: PT grout, right: Plain grout)	89
Figure 90—Moisture contents for tests with soft grout (left: PT grout, right: Plain grout)	89
Figure 91—Variation of (a) unit weight and (b) wet density with w/s	90
Figure 92—Variation of unit weight with w/s for all PT grouts	90
Figure 93—Pre-hydrated grout chunks removed before mixing	91
Figure 94—Mass of soft grout collected during MITT for expired and unexpired grout in <i>Laboratory</i> and <i>Field</i> conditions	92
Figure 95—Mean particle size data	93
Figure 96—Standard deviation particle size data	94
Figure 97—Mass of soft grout collected during MITT for those grouts measured in the particle size analyzer	94
Figure 98—Ratios of moisture content at the top of the tube to moisture content at the bottom of the tube using MWD for (a) unexpired grout and (b) expired grout	96
Figure 99—Average ratios of the moisture content at top of the tube to moisture content at the bottom of the tube for all tests using MWD and categorized by lot on (a) unexpired grout and (b) expired grout	97
Figure 100—Inclined stand	105
Figure 101—Inclined tube schematic	106
Figure 102—Sampling locations	107
Figure 103—Plain grout viscosity plot for soft grout and water dosage	108
Figure 104—PT1 viscosity plot for soft grout and water dosage	109
Figure 105—PT2 viscosity plot for soft grout and water dosage	109
Figure 106—PT4 viscosity plot for soft grout and water dosage	110
Figure 107—Moist clay like soft grout with darker coloration	111
Figure 108—PT4-6 Soft Grout	112
Figure 109—PT4-6 soft grout	112
Figure 110—C675-45 soft grout	113
Figure 111—C35-0 soft grout	113
Figure 112—C35-0 soft grout	114
Figure 113—C35-35 hardened grout	114
Figure 114—C675-35 large void due to bleed water	115
Figure 115—Segregation canal at top of cross-section	116
Figure 116—Segregation canal at top of cross section (PT grout)	116
Figure 117—Soft grout located in segregation canal	116
Figure 118—Equator line separating hard cement from soft grout	117
Figure 119—Equator line separating hard cement from soft grout (PT grout)	117
Figure 120—C30-0 (left), C35-0 (right)	118
Figure 121—C45-0 (left), C55-0 (right)	118
Figure 122—C675-0 (left), C825-0 (right)	119
Figure 123—C35-35 (left), C45-35 (right)	119
Figure 124—C55-35 (left), C675-35 (right)	120
Figure 125—C825-35 (left), C45-45 (right)	120
Figure 126—C55-45 (left), C675-45 (right)	121
Figure 127—C825-45	121
Figure 128—C55-45 (100 mL HRWR) (left), C45-0 (0 mL HRWR) (right)	122
Figure 129—C675-35 (0 mL HRWR) (left), C825-45 (0 mL HRWR) (right)	122
Figure 130—PT 1-4 MWD (left), PT 1-4 1.15-MWD (right)	123
Figure 131—PT2-4 MWD (left), PT2-4 1.15-MWD (right)	123
Figure 132—PT3-3 MWD (left), PT3-3 1.15-MWD (right)	124
Figure 133—PT4-6 MWD (left), PT4-6 1.15-MWD (right)	124

Figure 134—PT5-1 MWD (left), PT5-1 1.15-MWD (right).....	125
Figure 135—PT6-1 MWD (left), PT6-1 1.15-MWD (right).....	125
Figure 136—Flow cone efflux time (left), Grout temperature: 0% filler (right)	126
Figure 137—Grout temperature: 35% filler (left), Grout temperature: 35% filler (right).....	126
Figure 138—Grout temperature: 45% filler (left), Grout temperature: 45% filler (right).....	127
Figure 139—Wet density: 0% filler (left), Wet density: 35% filler (right)	127
Figure 140—Wet density: 35% filler (left), Wet density: 45% filler (right)	128
Figure 141—Wet density: 45% filler (left), Unit weight: 0% filler (right).....	128
Figure 142—Unit weight: 35% filler (left), Unit weight: 35% filler (right).....	129
Figure 143—Unit weight: 45% filler (left), Unit weight: 45% filler (right).....	129

List of Tables

Table 1—Summary of PT grout tested	8
Table 2—Summary of weights of bags of PT grouts.....	10
Table 3—Summary of testing conditions for MITT.....	25
Table 4—Summary of additional field conditions tested on PT4.....	26
Table 5—Shelf life of proprietary PT grouts.....	27
Table 6—Storage requirements of proprietary PT grouts as inscribed on bags.....	27
Table 7—Mean temperature and relative humidity values for <i>Field</i> condition.....	30
Table 8— <i>Laboratory</i> exposure durations for MITT.....	32
Table 9— <i>Field</i> exposure timing for MITT.....	32
Table 10— <i>Extreme</i> exposure timing for MITT.....	32
Table 11—PT1-2 MITT.....	56
Table 12—PT2-2 MITT.....	57
Table 13—PT3-1 MITT.....	59
Table 14—PT4-1 and PT4-2 MITT.....	60
Table 15—C45 and C675 MITT.....	63
Table 16—Summary of MITT conditions that produced soft grout.....	66
Table 17—Summary of conditions that resulted in the bleed water within 24 h following injection.....	68
Table 18—Results of pressure bleed test.....	70
Table 19—Results of sedimentation test.....	71
Table 20—Summary of conditions that produced soft grout.....	73
Table 21—Summary of conditions that did not produce soft grout.....	73
Table 22—Soft grout summary.....	111
Table 23—Plain grout summary (0% filler)-Mixing.....	130
Table 24—Plain grout summary (0% filler)-Post-mixing process.....	130
Table 25—Plain grout summary (0% filler)-Post-grouting process.....	130
Table 26—Plain grout summary (0% filler)-Dissection.....	130
Table 27—Plain grout summary (35% filler)-Mixing.....	131
Table 28—Plain grout summary (35% filler)-Post-mixing process.....	131
Table 29—Plain grout summary (35% filler)-Post-grouting process.....	131
Table 30—Plain grout summary (35% filler)-Dissection.....	131
Table 31—Plain grout summary (45% filler)-Mixing.....	132
Table 32—Plain grout summary (45% filler)-Post-mixing process.....	132
Table 33—Plain grout summary (45% filler)-Post-grouting process.....	132
Table 34—Plain grout summary (45% filler)-Dissection.....	132
Table 35—PT results (1)-Mixing.....	133
Table 36—PT results (1)-Post-mixing process.....	133
Table 37—PT results (1)-Post-grouting process.....	133
Table 38—PT results (1)-Dissection.....	133
Table 39—PT results (2)-Mixing.....	134
Table 40—PT results (2)-Post-mixing process.....	134
Table 41—PT results (2)-Post-grouting process.....	134
Table 42—PT results (2)-Dissection.....	134

1 Introduction

Prestressed concrete has proven to be an efficient and long-lasting design choice in post-tensioned bridge construction. In post-tensioned (PT) concrete, high strength steel tendons are installed in ducts and tensioned against anchors that are cast into the concrete with the ducts. A portland cement grout mixture, which provides corrosion protection and structurally bonds the tendon to the surrounding concrete is then injected into the duct. Figure 1 shows the installation of PT tendons into a precast concrete section.

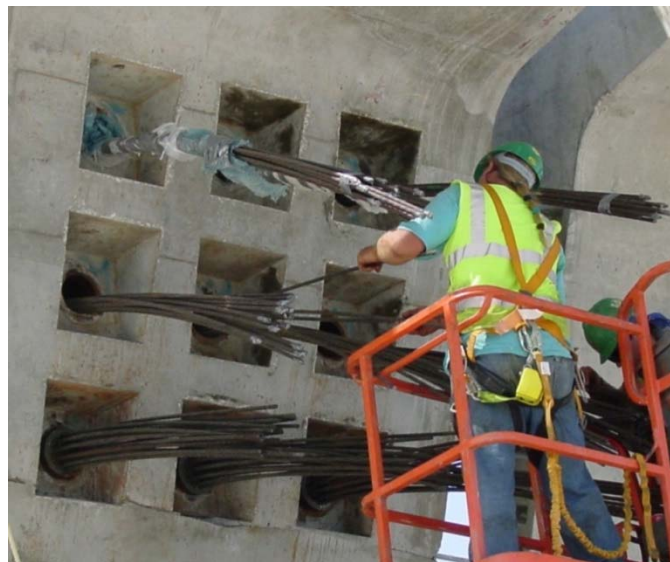

Figure 1—Precast concrete bridge segment with PT tubes and strands shown

Problems have been discovered with the grout in several bridges around the state of Florida. In these bridges, the grout was found to be soft (unhydrated) and contain high levels of moisture and potentially damaging chemicals several years after construction was complete. Figure 2 shows an example of unhydrated material that accumulated under the cap on PT anchor. The texture of the grout is similar to wet clay. Soft grout samples can be collected by gently scraping the material and moisture contents are typically 50-80%.

In some cases, tendons encapsulated by this deficient grout exhibited severe corrosion. Although there have been no catastrophic structural failures related to grout in the United States, expensive repairs must be made to prevent such failures in the future. This report covers experimental work aimed at discovering the cause of soft grout and how to test prepackaged grouts for their susceptibility to such deficiencies.



Figure 2—Soft grout sample identified in field by FDOT

2 Background

Grout bleed occurs when excess water rises to the top of the grout as cement particles settle to the bottom (Schokker et al., 2002). If bleeding occurs in sufficient volume, then structural bond is lost and prestressing steel may be exposed and at risk of corrosion. Excessive bleeding can also lead to segregation of solids, which may result in the formation of soft grout. While bleed water can be reabsorbed by the grout during hydration, soft grout has a lower pH, retains moisture, and can be extremely corrosive to the tendon. Soft grout has been found near corroded tendons and tube sections in both the U.S. and abroad and has been attributed to grout segregation (Bertolini and Carsana, 2011).

Identifying problems with grout bleed and segregation in high performance post-tensioning (PT) grout has customarily been accomplished using the pressure bleed test (ASTM C1741) and the wick induced bleed test, which is a modified version of ASTM C940. In the late 1990's, (Fuzier, 2001) (Chaussin & Chabert, 2001) a method for determining bleed resistance was developed in Europe (Figure 3). The test consists of an inclined tube containing twelve 0.6 in diameter unstressed PT strands and placed at a 30 degree incline from horizontal. PT grout is injected into the low point of the inclined tube and discharged at the top of the incline. The exit valve is then shut off and the grout pressure is then maintained at the value and for the duration specified in the method statement. The tube used for the inclined tube is transparent, which allowed for visual identification of bleed and segregation. Grout segregation is identified by a change in color along the length of the tube.

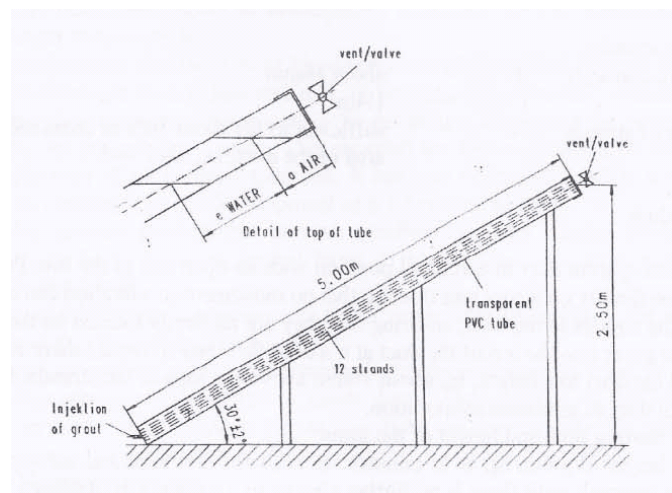

Figure 3—EN445 test configuration

Type I/II portland cement is a hydraulic cement that reacts with water and results in a hardened material that is impervious to water. There are many variations of portland cement that range from Type I to Type V, with additional types that include air entraining agents for example. portland cement undergoes a hydration process where the chemical compound tricalcium aluminate (C_3A) undergoes a rapid initial hydration. The hydration process can continue for an extended period of time after the initial cement hydration. This hydration process can sometimes last for years (Corven & Moreton, May 2004). ASTM C150 specifies that portland cement can be composed of up to 5% limestone filler material, and that certain physical properties must be verified in order to be qualified under ASTM C 150. These physical requirements are: setting time, soundness, fineness, consistency, compressive strength, heat of hydration, loss of ignition and specific gravity.

Mineral additives such as fly ash, slag, and other supplemental cementitious materials are permitted as ingredients of grout per PTI grouting specifications. Fly ash is a by-product of the production of coal through a combustion process and reduces bleed and permeability of the grout. Fly ash also reduces the amount of HRWR needed to achieve desirable rheological properties in grout (Schokker et al., 1999).

Silica fume is an extremely fine material that is the by-product of silicon manufacturing. It can be produced in three forms: slurry, undensified, and densified. Densified silica fume is produced by tumbling undensified silica fume in a silo, which statically charges the particles, causing them to clump together and increase the bulk density in the remaining material which makes for easier transportation methods.

Undensified silica fume is used almost exclusively in PT grout. Silica fume can reduce bleed and permeability, while increasing the strength of the grout. The demand for dosage of HRWR is increased when using silica fume, and they increase the thixotropic nature of the grout (Schokker et al., 1999). Blast furnace slag that is type 120 is used in prepackaged PT grouts. The grades of blast furnace slag are categorized based on their activity index, which gives the mix designer an idea of how the compressive strength of the material will be affected by the use of ground granulated blast furnace slag. The durability of the resulting cement is improved because there is an increased production of calcium silicate hydrate during the pozzolanic reaction between the blast furnace slag and water and cement (Cervantes and Roesler, 2007).

Clean potable water is used when mixing prepackaged PT grouts. The temperature of the water may sometimes need to be adjusted prior to mixing to better suit the ambient conditions present at the construction site. Water can be present in various places along the pathway of the grout such as the grout hoses, inside of the tubes, and inside of the grout pump that is used to place the fluid grout. Excess water can mix with the grout that is being injected, which is why it is recommended by the FHWA Grouting Manual to discharge at least 2 gallons of consistent grout through the exit valves before grouting can be terminated (Corven and Moreton, 2004). Excess mixing water is one way moisture content levels are increased in the tubes, which will result in corrosion of the steel tendons.

Chemical admixtures can serve multiple roles in PT grouts. They can help with pumpability by reducing the viscosity of the grout, while also helping with controlling the time it takes for the grout to set. Reduction in water is another advantage to using chemical admixtures, while corrosion control, volume control, and air-entrainment are also benefits to using chemical admixtures in PT grouts. High range water reducing (HRWR) admixtures are used to achieve low water-to-solids ratios (w/s) in prepackaged grouts. They can be either polycarboxylate, melamine sulfonate or naphthalene sulfano based. Polycarboxylate based HRWR are used in post tensioning applications. Experimental data has shown that the yield stress and plastic viscosity for a cement paste with a polycarboxylate based HRWR decreases as you increase the HRWR dosage up until the saturation dosage. High temperatures can have an interesting effect on cement pastes with polycarboxylate based HRWR. An increase in temperature will amplify the thixotropic nature of the cement paste that has polycarboxylate based HRWR (Martini and Nehdi, 2009). HRWR do have their drawbacks. Bleed has been shown to increase when HRWR are used in PT grouts. Additionally, HRWR have been shown to increase the time in which it takes for the grout to set, which can lead to additional bleeding.

Fine aggregates or fillers have been commonly used in prepackaged PT grouts. Filler material acts as a cost efficient way to minimize the quantity of portland cement used per bag. Furthermore, inert fillers such as calcium carbonate used in portland cement paste will decrease the temperature sensitivity of the cement paste. (Jue, 2012). This could make filler material a desirable component in PT grouts for hot-weather injection. A common misconception about calcium carbonate is that it is completely inert. It has been shown that the calcium carbonate when used as a filler up to 5% does react to some degree with the tri-calcium aluminate that

occurs when portland cement and water react to form monocarboaluminate (Hawkins et al., 2003). The filler material calcium carbonate has been shown to decrease the initial and final set time when substituted into portland cement mixes (El-Didamony et al., 1994).

3 Objective and Approach

The objective of this research was to determine potential causes of soft grout formation in PT duct following injection. To this end, a modified version of the inclined tube test specified in Euronorm standards was developed (CEN/TC 104, 2007). The test consisted of using a full-scale colloidal grout plant to mix and inject grout into a 15-ft long tube containing prestressing strand. The tube was placed at an angle of 30 degrees from horizontal. A range of variables were studied in using both plain grout and proprietary prepackaged post-tensioning grouts. Many of the typical test methods used to evaluate grout were conducted concurrently with the inclined tube test. Testing was conducted in three series, which were intended to represent conditions under which soft grout is formed:

1. **Field conditions:** inclined tube test was altered to introduce variations that might occur in the field with respect to the tube geometry and the introduction of unintended water into the grout. In addition, tube constructions; tube overfilled with strand; placement of strand in the top of the tube; injecting under pressure; injecting and setting under pressure; and high-temperature injection were evaluated.
2. **Inert filler:** a series of modified inclined tube tests were conducted using plain grout to determine the relative effect of ground limestone and high-range water-reducing admixture (HRWR) on the formation of soft grout
3. **Shelf life:** a series of modified inclined tube tests were conducted on PT grout beyond their expiration date to determine the effect of age on the production of soft grout.

4 Materials

Testing was conducted on both plain portland cement grouts and prepackaged PT grouts. Plain grouts containing portland cement, pulverized limestone, high-range water reducer, and water were tested. Prepackaged proprietary PT grouts were also tested. This chapter describes the materials used in both sets of testing.

4.1 Prepackaged PT Grout

Table 1 summarizes the PT grout tested. Testing identification PT_x-y is used to distinguish between specific manufacturers (x) and their respective lot numbers (y).

Table 1—Summary of PT grout tested

Testing ID	Date manufactured	Expiration Date
PT1-2	11/17/11	05/17/12
PT1-3	06/25/12	01/01/13
PT1-4	04/29/13	11/01/13
PT2-2	01/05/12	07/05/12
PT2-3	06/26/12	12/01/12
PT2-4	03/28/13	09/28/13
PT3-1	10/19/11	04/19/12
PT3-2	06/01/12	12/01/12
PT3-3	04/10/13	10/07/13
PT4-1	08/25/11	02/25/12
PT4-2	02/02/12	08/02/12
PT4-3	03/19/12	09/19/12
PT4-4	03/03/12	09/03/12
PT4-5	05/24/12	11/24/12
PT4-6	05/04/13	11/04/13
PT5-1	06/10/13	06/10/14
PT6-1	06/03/13	06/03/14

4.2 Plain Grout Formulation

Plain grout was formulated and tested with portland cement and ground limestone to determine the effect that inert filler had on the development of soft grout. The plain grout mixtures were formulated from water, portland cement, ground limestone, and high-range water-reducing admixture (HRWR). This chapter describes the materials that were used to create these

grout mixtures. Prepackaged grouts were also tested; constituent materials and their proportions, however, were unknown due to the proprietary nature of the products.

Filler was tested at 0%, 35%, and 45% by weight of total solids. The mixtures are identified with the label Cxx-yy, where xx is the ratio of water to total solids (portland cement and ground limestone), and yy is the percentage of filler by weight of solids. For example, C55-45 indicates a water-to-solids (w/s) ratio of 0.55 and 45% filler.

4.3 PT Grout Bag Weights

Each of the commercial PT grouts were prepackaged in a 50-lb or 55-lb bag. Prepackaging allows all constituents not including water to be included in a single package, which avoids the potential errors associated with job-site proportioning. Bags are typically marked with the allowable range of water dosage based on an assumed dry bag weight. This method of water dosage requires that the bag quantities match the weight shown on the bag or that the field personnel weigh the bags and make adjustments for bags containing more or less material than specified.

To determine the variation in delivered bag weight, a number of bags were weighed before testing (Table 2). The weights shown in the table include bag and contents, where the weight of the paper bag was generally found to be approximately 0.30 lb. Materials PT4-3 and PT4-4 arrived on one pallet from the manufacturer. Every bag on this pallet was weighed, and no distinction was made between two lot numbers.

4.4 Portland Cement

ASTM C150 type I/II portland cement was used to produce the plain grout mixtures for testing. The portland cement was obtained from Florida Rock in Gainesville, Florida. Figure 4 shows the particle size distribution for the type I/II portland cement that was used in these experiments.

Three total particle size analyses were conducted on the Type I/II portland cement, with the following mean and standard deviation values: [15.74 (μm), 14.26 (μm)], [16.1 (μm), 17.14 (μm)], [14.83 (μm), 10.59 (μm)].

Table 2—Summary of weights of bags of PT grouts

Material	Expected	Number of bags	Average (lb)	CoV**	Percentage of bags underweight	Min (lb)	Max (lb)
PT1-3	50	40	51.1	1.86%	12.5%	48.3	52.
PT1-4	50	40	48.9	1.04%	100%	46.3	49.
PT2-3	55	58	55.5	0.84%	8.62%	54.1	56.
PT2-4	55	60	55.6	0.97%	15%	54.1	56.
PT3-2	55	60	55.9	0.64%	0%	55.2	56.
PT3-3	55	60	56.1	0.74%	1.67%	54.3	57.
PT4-2	50	3	50.5	3.8%	N/A	48.3	51.8
PT4-3 and PT4-4	50	63	52.1	2.7%	7.94%	49.1	54.6
PT4-5	50	73	50.6	1.84%	24.66%	48.9	53.
PT4-6	50	64	50.1	1.40%	35.94%	48.5	52.
PT5-1*	55	32	57.2	1.94%	3.13%	54.8	60.5
PT6-1*	50	29	50.3	1.60%	34.48%	49.0	52.2

*materials weights excluding the bag weight

**coefficient of variation

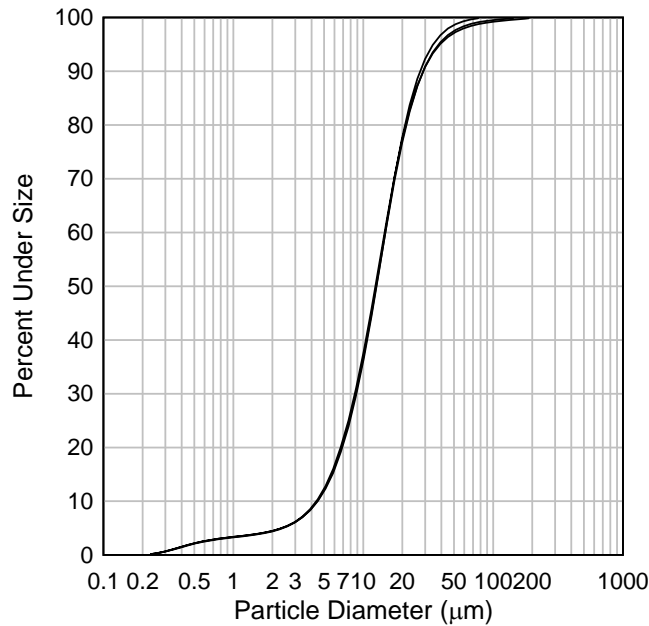

Figure 4—Particle size distribution for portland cement

4.5 Filler Material

Pulverized limestone (calcium carbonate) was obtained at a local farm supply store for use as filler in the plain grout formulations. Laser diffraction particle size analysis results for the material are given in Figure 5. Three total particle size analyses were conducted, with the

following mean and standard deviation values: [30.03 (μm), 39.99 (μm)], [6.70 (μm), 34.19 (μm)], [29.89 (μm), 39.19 (μm)].

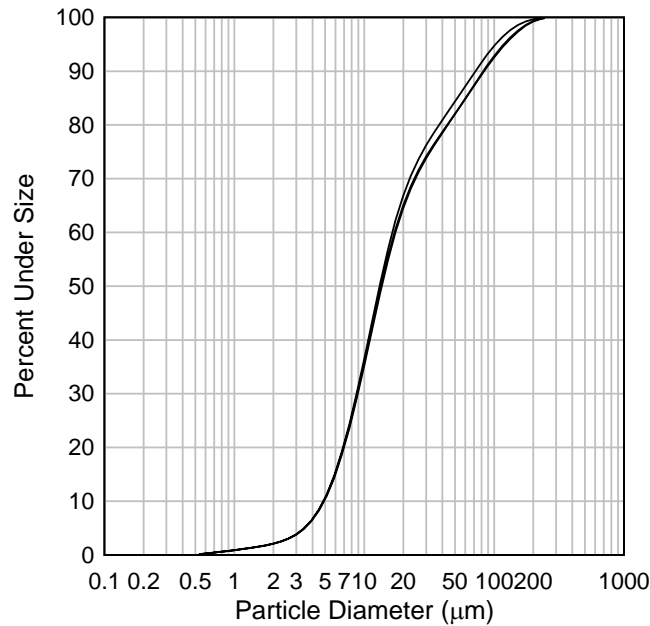

Figure 5—Particle size distribution for calcium carbonate used in the plain grout formulation

4.6 High Range Water Reducing Admixtures

Adva-cast 600, which is a type “F” polycarboxylate based high-range water-reducing admixture (HRWR) was used to control the viscosity of the grout. Dosage of HRWR was adjusted with each mixture to maintain a maximum viscosity of 250 mPa·s when measured using the nominal shear rate (NSR) viscosity test covered in chapter 10. This value corresponds to viscosities measured on prepackaged PT grouts. Specific HRWR dosages are discussed further in section 12.5.

5 Mixing Equipment and Procedures

Figure 6 shows the grout plant used to prepare grout mixtures for testing. The plant was equipped with a centrifugal diffuser-type pump rotating at speeds up to 2,000 RPM (209 rad/s) to encourage dispersal and complete wetting of fine cementitious particles. The agitator tank was equipped with a variable speed paddle mixer that prevents the grout from building structure before it is pumped. The grout pump, connected directly to the agitator tank, was a three stage progressing cavity, positive displacement, rotor-stator pump. Two grout plant models were used in this research. While mixing, agitation and injection components were similar, one plant was powered by compressed air and the other was electric/hydraulic.

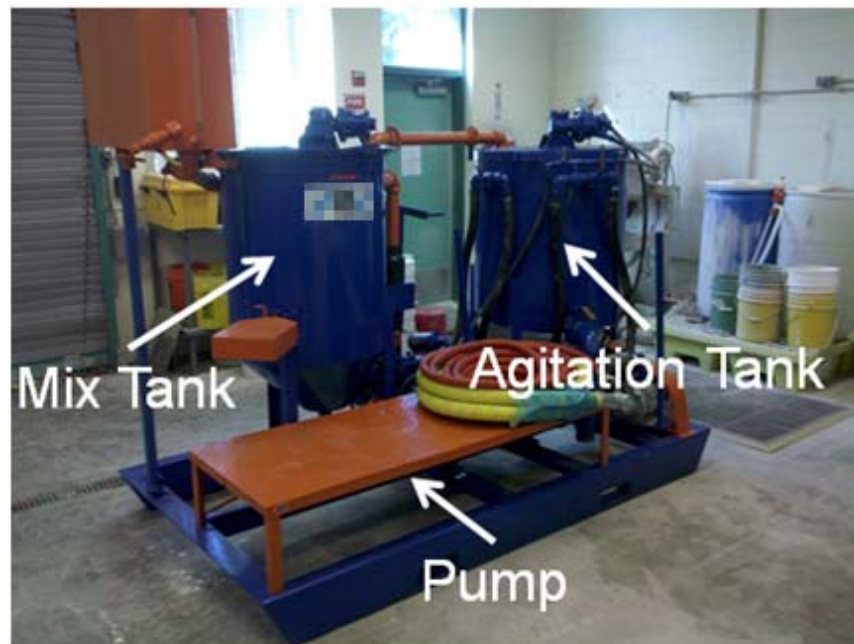

Figure 6—Colloidal grout plant with various parts labeled

The following procedure was used to prepare a mixture of prepackaged PT grout:

1. Add water to mix tank and turn on colloidal mixer and agitator paddle.
2. Add one bag of grout at a time. Add grout over a period of 20-30 s per bag.
3. Continue running colloidal mixer and agitator paddle for 2 minutes after adding last bag of grout.
4. Transfer the grout to the agitation tank and start the paddle in the agitation tank.

The following procedure was used to prepare a mixture of plain PT grout:

1. Add water to mixing basin and turn on colloidal mixer and agitator paddle.
2. Add one bag of portland cement at a time. Add portland cement over a period of 40-60 s per 94 pound bag
3. After adding all of the portland cement, add HRWR then the first 50 pound bag of calcium carbonate over a period of 20-30 s per bag.
4. Repeat step 3 until all bags of calcium carbonate are added. Check the flow cone of the plain grout when it is still in the mixer. If needed, add additional HRWR to attain the desired grout fluidity.
5. Continue with step 3 from Section 6.1.1 PT Grout Mixing Procedure

6 Modified Inclined Tube Test (MITT)

Although not currently used in the U.S., the inclined tube test has been used for several years in Europe to test grout mixture designs to determine the potential for bleed under simulated field conditions. The standard for the inclined tube test is given in Euronorm EN445 2007. The test is conducted by injecting a 15-ft long x 3-in. diameter transparent PVC pipe filled with twelve 0.6-in. diameter post-tensioning strands. The grout is mixed and injected using a colloidal grout plant. In the 24 h following grout injection, visual observations are made of the tube to determine if bleed water has collected at the top of the tube or if overall volume has changed.

Preliminary inclined tube tests were conducted on commercially available prepackaged PT grout. In nearly all cases, if proportioned and mixed in accordance with manufacturer's instructions, the test revealed no bleed, volume change, or soft grout. Under some conditions, however, such as the use of excess water or the use of expired grout, soft grout was discovered at the top of the incline tube upon dissection. This soft grout is thought to be the result of segregation of particles within the suspension based on their density (Figure 7). The change in elevation between top and bottom of the inclined test tube causes bleed water to rise. The rising bleed water carries less dense particles in suspension upward until contact is made with the strand bundle or tube. At this point the particles are carried to the top of the incline, resulting in the formation of unreacted material near the free surface of the grout at the exit of the inclined tube. Hardened grout, though, was still present along the remainder of the length of the tube.

The Euronorm test (EN445-07) is focused on determining "...the bleed properties and volume stability of grout at full-scale..." The test method, as indicated, is designed to measure bleed water and volume change of grout after injection and does not specifically address the issue of soft or segregated grout. Bleed water and air are measured at the top of the inclined tube over a period of 24 h following injection of the grout. These data are then reported as part of the test. No specific measurement or inspection for soft or segregated grout is required in the referenced version of the test. In some cases, identification and distinction between grout and bleed is visually obscure even through the transparent tube. Investigation of soft grout for this research required that the specimen be dissected 24 h after injection to determine if soft grout was present at the top of the incline.

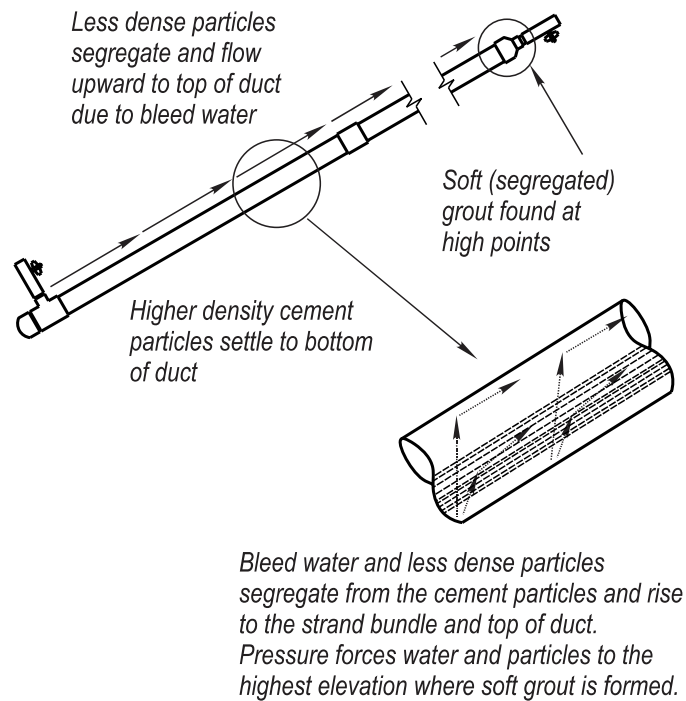

Figure 7—Bleed and segregation mechanism

6.1 Inclined Tube Test Modifications

Because procedures in the Euronorm standard do not directly address soft grout, the following supplemental measurements were taken to identify grout formulations or grouting conditions that would result in the formation of soft grout:

1. Tube was dissected at the top of the inclined tube and visually inspected for segregated or soft grout. Mass of collected sample was measured and moisture content of soft grout was determined using ASTM C566.
2. Grout was sampled at selected locations along the length of the tube and at the top and bottom of the cross-section. The samples were tested for moisture content using ASTM C566.
3. Strand bundle was shortened to a 14-ft length to allow unimpeded sampling of the grout near the top of the inclined tube.

This test is referred to as the modified inclined tube test (MITT) in this report. The ideal benchmark to determine the relative quality of hardened grout samples is unit weight. Relative unit weight would show whether or not the grout is homogenous throughout the tube. A sample

containing voids or excessive water would have a lower unit weight than one that did not. Determining the unit weight of a small, irregular shaped sample is impractical and probably unnecessary. Instead of unit weight, the moisture content of grout samples collected along the length of the tube was measured. If the grout segregated along the length of the inclined column, then it is expected that the moisture content of the grout at the top of the column would be higher than that at the bottom of the column. Ultimately, moisture content provided a quantitative comparison between grout samples collected from the inclined tubes.

6.2 MITT Injection

Although no significant modifications were deemed necessary in the other aspects of the inclined tube test, some additional test methods and slight modifications to the injection process were implemented. In general, the following procedures were followed:

1. Prepare inclined tube specimen and secure into frame (Figure 8 and Figure 9).
2. Prepare grout mixture for injection.
3. Transfer grout to agitation tank, and start agitator paddle.
4. Collect grout samples for conducting flow cone, mud balance, and unit weight tests.
5. Pump grout from agitation tank through 25 ft of 1 in. dia. grout hose and into a bucket. Discharge approximately 2 gallons to collect samples for conducting flow cone, mud balance, unit weight, and pressure bleed tests (Figure 10).
6. Attach grout hose to injection port on inclined tube.
7. Inject grout into tube over a period of approximately 1 min (Figure 11). Collect approximately 2 gallons of grout from discharge point.
8. Conduct flow cone, mud balance, and unit weight tests on discharged grout. In addition, form a cylinder for the sedimentation test, if required.

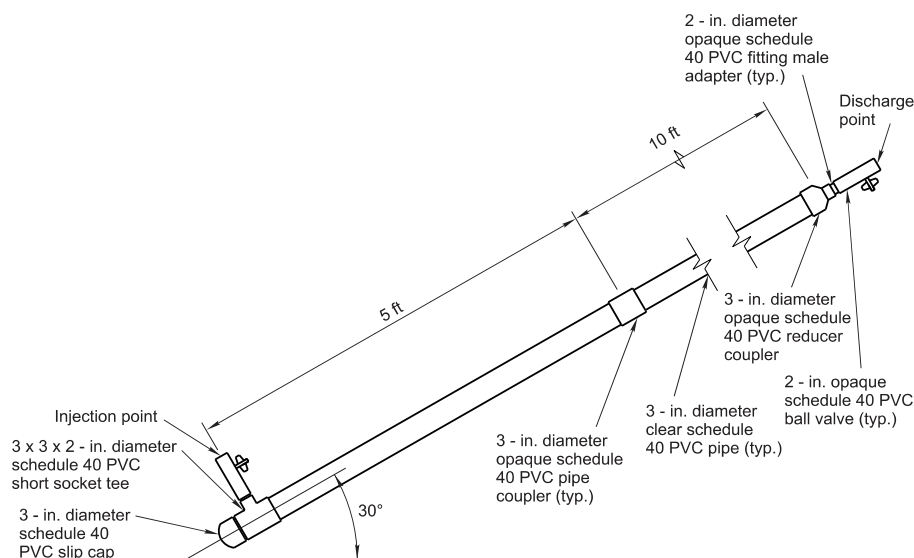

Figure 8—Schematic of MITT setup



Figure 9—MITT setup



Figure 10—Discharging grout for testing prior to inclined tube injection



Figure 11—Attach grout hose to tube

6.3 *MITT Bleed Measurement*

The inclined tube test method indicates bleed measurements should be at 0, 30 min, 1 h, 3 h, and 24 h after injection. At these intervals, bleed water level and any other liquid that is visible through the tube near the top of the incline are recorded. These same observations were used for taking readings during testing of prepackaged PT grout. In nearly all tests, however, bleed water was not detected at the top of the inclined.

Bleed occurred regularly on plain grout tests. For these tests, tubes were removed from the inclined stand and the top exit valve was removed. The tube was then carefully tilted so that bleed water was decanted into a large graduated cylinder for measurement of the volume.

6.4 *MITT Hardened Grout Sampling*

After the grout had been allowed to set for at least 24 h, samples were collected along the length of the tube. Early in the testing program, each tube was generally sampled in 4 to 5 locations along its length. When possible, the grout in the fitting at the very top of the tube was sampled as well. First, the tubes were cut into three 5 ft long sections for handling and storage on a band saw (Figure 12). The cuts passed through the tube, grout and strand and required a special bi-metal blade that required frequent replacement. The cut tube sections were labeled with flow direction, 12 o'clock position, and dimensions.



Figure 12—Saw-cut tubes for sampling

After cutting the tubes into smaller sections, the PVC casing was removed to provide direct access to the grout. The casing was removed using a hand-held rotary tool, which did not

disturb the surface of the grout. Typically, a 6 in. window of PVC casing was removed (Figure 13).



Figure 13—Tube wall removed for sampling

After exposing the surface of the grout, a chisel was used to collect at least 50 grams of grout sample (Figure 14). Samples were stored in sealed plastic bags to prevent loss of moisture. During sampling, observations were made on grout color, hardness, surface condition, and consistency.



Figure 14—Grout sample removed with chisel

As inclined testing progressed, results indicated that the sampling procedure could be simplified to avoid having to cut the strands and to sample in fewer locations without weakening the overall results of the test. Three locations were found to be sufficient to characterize the

moisture content of the grout and to recover soft grout that might be present. Figure 15 shows an example inclined test tube after sampling. Strand surface is corroded due to outdoor exposure that occurred after sampling and was not due to exposure to the PT grout. The base and mid-height of the inclined tube were sampled by cutting and removing the PVC tube over a length of approximately 6-in (Figure 16). Grout samples were then taken from around the strand bundle without the need to cut the strand. At the top of the incline, grout is more easily sampled due to lack of strand near the top. Samples are taken in two locations: one under the end cap and over a 6-in. length near the end of the strand bundle. Because the primary focus of the inclined testing was on measurement of soft grout and moisture content, opaque tubes were used to reduce testing costs. Figure 19 shows the specimen construction along with the sampling locations.



Figure 15—Sample locations for MITT

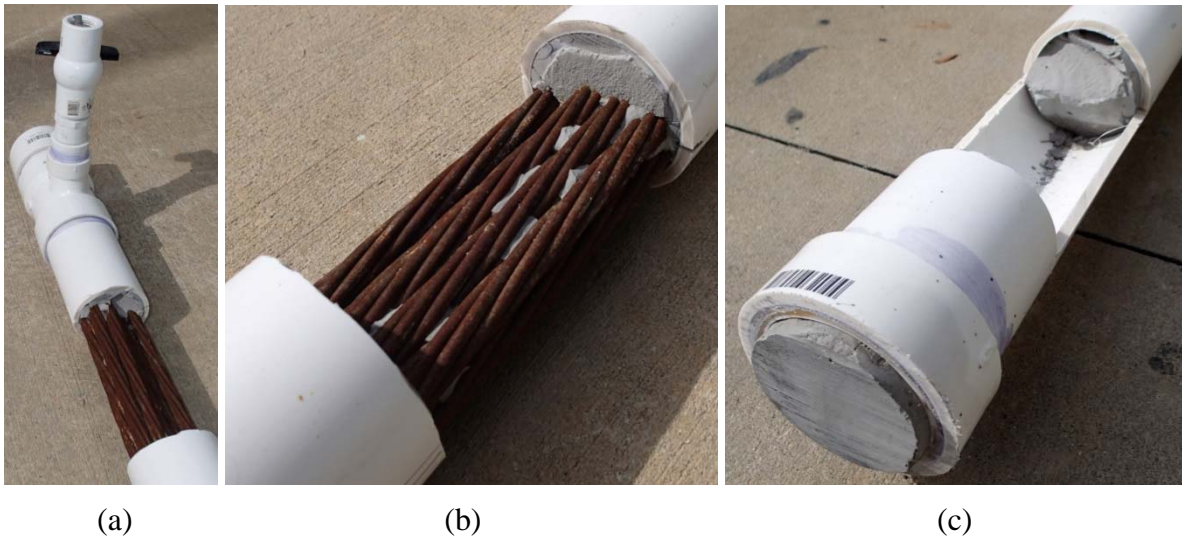

Figure 16—Grout sampling locations (a) at base (b) mid-height and (c) top of inclined tube

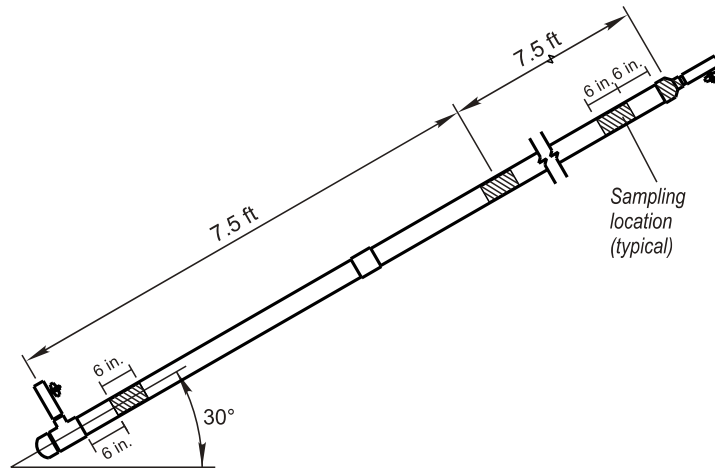

Figure 17—MITT grout sample locations

6.5 MITT Moisture Content

Moisture content of grout samples was determined using ASTM C 566-97 Standard Test Method for Total Evaporable Moisture Content of Aggregate (Figure 18). Moisture content was sampled at the various locations to determine the variation with specimen length to be evaluated.

The following procedures were used to determine moisture content in a sample of grout:

1. Moisture content samples of approximately 25 grams were taken from the top and bottom of the cross section at locations shown in Figure 17 for a total sample size at each location of approximately 50 grams.
2. Measure initial mass of grout sample.
3. Dry sample in oven at 110°C. Sample is dry when 2 consecutive 24 hour mass readings exhibit less than 0.5% difference.

4. Moisture content is defined as the difference between initial weight and dry weight divided by initial weight.



Figure 18—Grout samples drying in oven for moisture content test

7 Field Conditions

None of the commercially available prepackaged PT grout tested using MITT produced bleed or soft grout when the grout was fresh and when it was mixed and injected in accordance with manufacturer's recommendations. For these initial tests, the grouts were mixed at the maximum water dosage (MWD) recommended by the manufacturer. Consequently, in an effort to induce soft grout production, a number of variations on the test method were introduced that would simulate more closely the variations that occur in field conditions. Initially, the following variations were imposed on all of the PT grouts tested:

- 15% above maximum water dosage (1.15·MWD)
- Residual water in the tube
- Duct constriction

It was discovered in initial tests that mixtures prepared with higher water dosage than recommended by the manufacturer, might be prone to produce soft grout. Consequently, two series of tests were developed to simulate conditions in which excess water might be introduced into the grout in the field. The first was the addition of too much mixing water, which might occur due to an error in the measurement of the material quantities or in an effort to temper or increase fluidity of the PT grout before injection. For a typical sized batch of test grout, 2 gallons of water corresponded to approximately 15% of the manufacturer's maximum recommended water dosage (1.15·MWD). The second was to introduce residual water in the inclined tube specimen. This simulated the presence of water in PT duct that might occur in the field in which the ducts are not adequately cleared of water prior to grouting. Each tube was filled with 2 gallons of water, which occupied approximately half of the volume of the tube.

Post-tensioning ducts may have constrictions due to anchorages or couplings, which may force grout through a tortuous path and perhaps result in a mechanical filtering of large particles, causing different behavior in the fluid or hardened grout. To simulate the effect of these constrictions the inclined tube specimen was redesigned with a series of smaller diameter sections (Figure 19). To further enhance the constriction, the reduced-diameter sections were packed full with 7-wire strand. Some of the 7-wire strand was separated into individual wire and packed into the constrictions in order to create the tightest fit possible. No strand was placed in the remainder of the specimen.

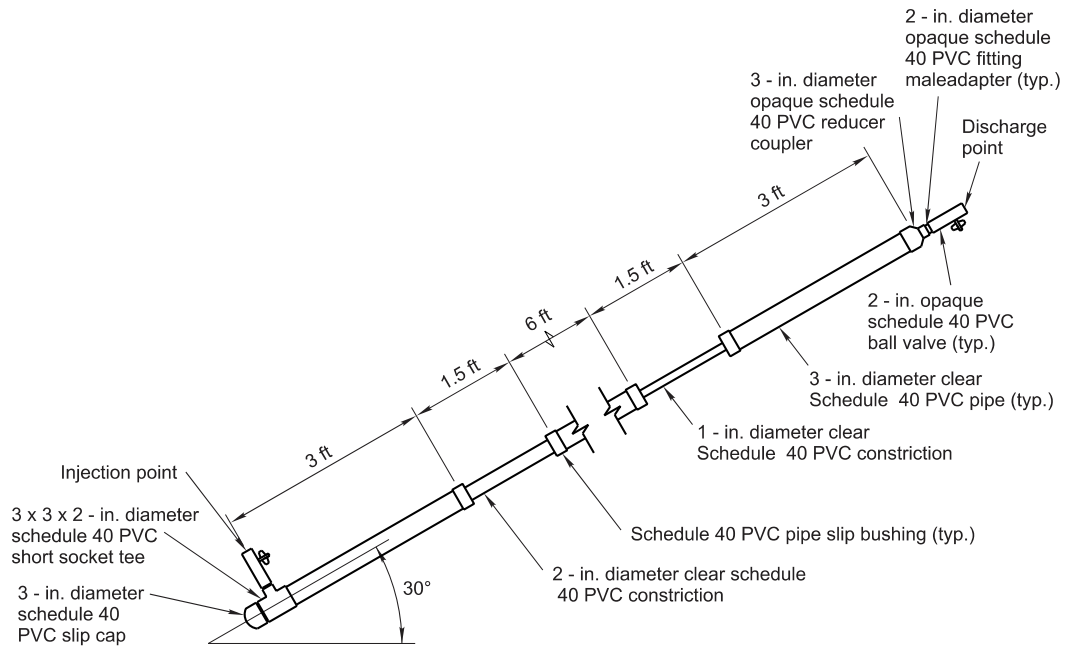

(a)



(b)

Figure 19—Inclined tube specimen modified with constrictions
 (a) schematic (b) compared to typical specimen.

Table 3 provides a summary of MITT that were conducted. These tests were conducted on PT1 through PT4. PT5 and PT6 were not yet available for testing. In an effort to more fully

consider the geometric variations in actual PT ducts, additional variations were imposed on PT4 to find other mechanisms that might produce soft grout; these are summarized in Table 4.

Table 3—Summary of testing conditions for MITT

Material	Condition	Number of Tests
PT1-2	1.15·MWD	3
	Constriction	1
	2 gal water in tube	1
	MWD	1
PT2-2	1.15·MWD	3
	Constriction	1
	2 gal water in tube	1
	MWD	1
PT3-1	1.15·MWD	3
	Constriction	1
	2 gal water in tube	1
	MWD	1
PT4-1	MWD	2
	2 gal water in tube	1
	1.5·MWD	1
	2 gal water in hose	1
	Strand at top of tube	1
	Tube packed full of strand	1
	Pressurized injection (55 psi)	1
PT4-2	1.15·MWD	3
	Constriction	2
	2 gal water in tube	1
	Pressurized set (60 psi)	1
C45	Standard tube	1
C675	Standard tube	1

Table 4—Summary of additional field conditions tested on PT4

Condition	Description
Tube full of strand	The standard 3-in. dia. clear tube was filled to capacity with strands. 18 strands were used instead of the standard 12. Grout was mixed at MWD.
Pressurize injection (55 psi)	The pressure at the injection point was 55 psi. Standard injection pressure was 20-30 psi. Grout was mixed at MWD.
Strand at top of tube	The standard 3 in. clear tube was filled with 12 strands that were elevated to the top of the tube cross-section. The strand in standard tubes laid flat on the bottom of the tube cross-section. Grout was mixed at MWD.
Pressurize set (60 psi)	The tube was sealed at a pressure of 60 psi, and then the grout was allowed to set. Standard tubes were sealed at 0 psi. Grout was mixed at MWD.
High temp injection	The grout material and water were conditioned to 90°F in an oven prior to testing. Standard materials were stored at room temperature. Grout was mixed at MWD.
2 gal water in hose	The grout hose was filled with 2 gallons of water prior to injection. This is similar to the 2 gallons of water in the tube test, except that the water was in the grout hose instead of the tube. Grout was mixed at MWD.
1.5·MWD	The grout was mixed with a water dosage 50% greater than MWD

8 Shelf Life

Preliminary testing indicated long storage times appeared to make prepackaged PT grout more susceptible to the formation of soft grout under MITT. This raised questions regarding the effect of age and exposure condition during storage on the constituents of PT grout. Does elapsed time between manufacturing and mixing affect the constituents such that the rheological performance of the PT grout is impaired? If so, which constituent is affected, and what is the mechanism of deterioration? What environmental conditions might affect the degradation of the PT grout?

Prepackaged PT grout manufacturers place expiration dates or shelf life on their product, yet there appear to be no standards or rational process for determining this date (Table 5). In addition, some include details of the storage conditions under which the PT grout may be held to ensure full shelf life and some do not (Table 6).

Table 5—Shelf life of proprietary PT grouts

PT Grout	Shelf Life (months)
PT1	6
PT2	6
PT3	6
PT4	9
PT5	12
PT6	12

Table 6—Storage requirements of proprietary PT grouts as inscribed on bags

“Keep container dry”
“Normal cement storage and handling practices should be observed. Store material in an interior, cool, dry place.”
“Store dry at 40-95°F”
“Store in unopened bags in clean, dry conditions”
“Store in unopened bags in clean, dry conditions”
“Store materials in a dry place”

Potential modes of degradation include pre-hydration of the portland cement and deterioration of the admixtures over time. These effects may result in sufficient changes to the rheological properties such that soft grout forms when the PT grouts are stored for long periods

or at extreme environments. Prepackaged PT grout is typically proprietary so that the exact constituents and quantities are unknown. One constituent, however, that is common to all prepackaged grouts is portland cement, which is subject to accelerated pre-hydration with exposure to elevated heat and humidity. Consequently, the testing focused on the effect of conditioning on the pre-hydration of the portland cement particles contained in the PT grout.

The authors' are not aware of standard exposure conditions that might be used to evaluate the shelf life of prepackaged PT grout. Indeed, storage requirements for PT grout are vague and vary among manufacturers. Table 5 shows the shelf life and associated storage requirements shown on the bags for several commercially available PT grouts. All manufacturers indicate that the bags should be stored in "dry" conditions, but with no other specific relative humidity requirements. Furthermore, temperature of storage is not mentioned in several of the descriptions. Consequently, an existing test protocol for evaluating shelf life of PT grouts does not appear to be available.

8.1 *Exposure Conditions*

To address the lack of test protocols, a test program was designed using three exposure conditions for the grout constituents. Although not necessarily standard, the exposure conditions were selected to ensure that the boundaries of the problem were explored; the exposure conditions varied from laboratory (cool and dry) to extreme (hot and humid). Because conditions were selected at the extreme ends of storage environments, a third condition was also used that represented an environment that was between the extremes. The three environments were as follows:

- **Laboratory**—65°F, 50-75% RH
- **Field**—under cover at ambient outdoor conditions
- **Extreme**—95°F, 95% RH

Laboratory storage condition was facilitated by either storage in the SMO concrete mixing room or in an air-conditioned storage container that was approximately 8 ft x 8 ft x 80 ft and was insulated (Figure 20). An air-conditioning unit was installed and operated full-time in the storage container, which kept the temperature at a nearly constant 65°F. In addition to the air-conditioning unit, a dehumidifier was used to maintain 50% to 70% RH. SMO laboratory

conditions are typically kept at 75°F with approximately 50% RH. PT grout bags were stacked on pallets and left undisturbed until they were removed from storage for mixing and testing. The bags were left intact and in the same position on the pallets as delivered. This environment was expected to be the most suitable of the three and ultimately produce the most consistent PT grout mixtures under modified inclined tube testing.



Figure 20—*Laboratory storage condition*

A bulk aggregate storage bin on the FDOT State Materials Office Site was used for the *Field* storage condition (Figure 21). The bins are fitted with permanent retractable covers that protected the PT grout from rainfall and direct sun, but leave the grout exposed to ambient temperature and humidity. This form of storage might be considered “dry” and thus in accordance with some manufacturer’s recommendations. These conditions were chosen to reflect uncontrolled field storage conditions on a construction site during summer in Florida. PT grout was stacked on pallets inside the chamber and left undisturbed until they were removed from the chamber for mixing and testing. The bags were left intact and in the same position on the pallets as they arrived when received from shipping. It was noted during testing that the bags closer to the bottom of the pallet had pre-hydrated considerably more than those near the top of the pallet. In a heavy downpour, rainwater collected under the pallets. Although the grout did not have direct contact with the rainwater, high heat and evaporation were likely to increase the humidity in the storage area. During the exposure period from June 2013 to November 2013, the average monthly conditions are shown in Table 7.



Figure 21—*Field* storage condition

Table 7—Mean temperature and relative humidity values for *Field* condition

	Mean Temperature (°F)			Mean RH (%)		
	High	Average	Low	High	Average	Low
June	90	81	72	94	74	53
July	92	84	75	98	78	60
August	91	83	73	95	74	59
September	89	80	70	95	75	53
October	84	72	60	95	72	50
November	76	65	54	88	73	55

* Values taken from Weather Underground for Gainesville Regional Airport

The *Extreme* storage condition was a high heat, high humidity incubator adjusted to maintain 95°F and 95% RH (Figure 22). Before placing the bags into the incubator, three 18-in. long cuts were made through the bag thickness in the top face of every bag as shown below in Figure 23. These incisions exposed the grout constituents directly to the incubator environment. The purpose of utilizing these extreme exposure conditions was to intensify the effect of heat and humidity to such a level that soft grout was formed.

8.2 Test Protocol

Shelf life of the PT grouts ranged from 6 to 12 months. MITT testing indicated that constituents degraded gradually over these periods rather than rapidly near the expiration date. To aid in tracking the shelf life of a particular PT grout, the expiration ratio (R_{exp}) was defined as follows:

$$R_{exp} = \frac{\text{Testing Date} - \text{Expiration Date}}{\text{Shelf Life}} \quad \text{Equation 1}$$

where the *Testing Date* is the date on which the grout was tested, and the *Expiration Date* and *Shelf Life* are those of grout being tested. This ratio gives the percentage of the shelf life that has passed for the date of a particular test.



Figure 22—*Extreme* storage condition



Figure 23—Cut bag before placement into incubator

To determine the effect of age on the tendency to produce soft grout, MITT was conducted when R_{exp} was between 0.5 and 1 and was designated as Midpoint MITT. In addition, Expired MITT was conducted when $R_{exp} > 1$. Table 8 shows the R_{exp} for *Laboratory* exposure for each PT grout.

Table 8—*Laboratory* exposure durations for MITT

Grout	Midpoint MITT	Expired MITT
	R_{exp}	R_{exp}
PT1-4	0.64	1.06
PT2-4	0.84	1.24
PT3-3	0.78	1.21
PT4-6	0.62	1.05
PT5-1	0.21	*
PT6-1	0.26	*

* Testing not completed prior to contract end date

Upon delivery, PT grout was stored in *Laboratory* conditions. Due to delays in initiating this portion of the research, the *Field* exposure was not initiated immediately upon receipt of the material. Instead, the *Field* exposure began at R_{exp} indicated in Table 9. For example, PT1-4 was placed in *Field* conditions for 73 d prior to testing near the mid-length of the shelf life ($R_{exp} = 0.64$) and 151 d prior to testing after the expiration date ($R_{exp} > 1.0$).

Due to the more intense environment of the *Extreme* condition, exposure was limited to 14 d. Table 10 shows the exposure duration and associated expiration ratio.

Table 9—*Field* exposure timing for MITT

Grout	Begin <i>Field</i> Exposure		Midpoint MITT	Expired MITT
	R_{exp}	d	R_{exp}	R_{exp}
PT1-4	0.23	41	0.64	1.06
PT2-4	0.42	76	0.84	1.24
PT3-3	0.36	65	0.78	1.21
PT4-6	0.21	38	0.62	**
PT5-1	0.05	18	0.21	*
PT6-1	0.10	36	0.26	*

* Testing not completed prior to contract end date

** Severe pre-hydration prevented testing

Table 10—*Extreme* exposure timing for MITT

Grout	1 d	3 d	7 d	14 d
PT1-4	0.46	0.43	0.42	N/A
PT2-4	0.64	0.60	0.55	N/A
PT3-3	0.58	0.57	0.63	N/A
PT4-6	0.47	0.47	0.51	N/A
PT5-1	0.16	0.12	0.06	0.10
PT6-1	0.16	0.14	0.16	0.21

9 Particle Size Analysis

To determine the change in particle characteristics caused by pre-hydration of the portland cement and perhaps other pozzolanic components particle size distribution was measured using a Horiba LA-950V2 Laser Scattering Particle Size Distribution Analyzer (Figure 24). Measurements were conducted on dry material.



Figure 24—Laser scattering particle size distribution analyzer

Whenever light collides with a particle, the particle diffracts the light and scatters the light rays. Using light scattering theory, the scattered light strength is determined by the particle's diameter and the particle's refractive index. The HORIBA LA-950V2 first asks the user to input the refractive index of the material being test, then controls the wavelength of the incoming light, and finally, it measures the strength of the scattered light in various directions. With these three pieces of information: 1) refractive index 2) wavelength of incoming light 3) strength of diffracted light in various directions; the computer uses light scattering theory to determine the particle size distribution.

Figure 25 below was taken from the HORIBA LA-950V2 user's manual and illustrates how this process works.

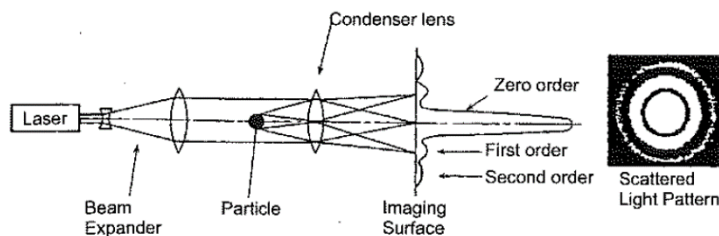

Figure 25—Measurement principles diagram

10 Typical Grout Test Methods

Several tests methods were used to evaluate the fresh and hardened properties of the grout for each MITT. The modified flow cone, unit weight, mud balance, pressure bleed, sedimentation and NSR viscosity tests were conducted on the fluid grout immediately following mixing to assess the rheological properties of the grout. Pressure bleed test was used to determine susceptibility of grout to bleeding under pressure. The sedimentation test was conducted to determine if this might be a more expedient test to determine susceptibility to the formation of soft grout.

10.1 Flow Cone Test

The flow cone is typically used in the field to measure the fluidity of freshly mixed grout. The flow cone test was run at three points during MITT. The first sample was collected in the colloidal grout plant, the second sample was collected from the grout hose just before injecting the grout, and the third sample was collected from the discharge at the top of the tube. Figure 26 shows the flow cone test being run during MITT.



Figure 26—Flow cone used to determine fluidity of grout samples during MITT

The flow cone test procedure is a modified version of ASTM C939. The procedure for running the flow cone test is as follows:

1. Fill flow cone with water.
2. One minute or less before introducing the grout, drain the water out of the flow cone and close the outlet with a rubber stopper.
3. Fill flow cone to top with grout. Place 1000 mL cylinder below flow cone.
4. Remove the rubber stopper from the outlet and start the stopwatch.
5. After 1000 mL has drained from flow cone, stop the stopwatch.
6. Record this time as the flow cone efflux time.

10.2 Unit Weight Test

The unit weight test is used in order to determine the density of a sample of wet grout. The unit weight had a known volume of 0.0141 ft³. A unit weight is shown in Figure 27. The unit weight test was conducted three times during MITT. The first sample was collected in the colloidal grout plant, the second sample was collected from the grout hose just before injecting the grout, and the third sample was collected from the discharge at the top of the tube. The unit weight test was run in addition to the mud balance test in order to determine the unit weight of fluid samples of grout.

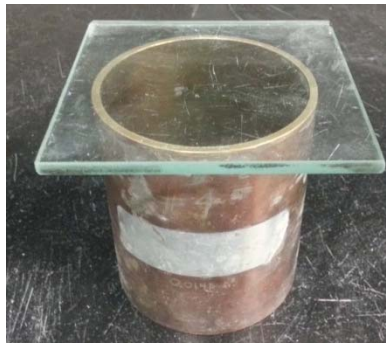

Figure 27—Unit weight used to determine grout density

The procedure for the unit weight test was as follows:

1. Tare the unit weight cup and glass top.
2. Fill the cup with grout. Tap the side of the cup to ensure that air bubbles rise to surface.
3. Use the glass top to screed the surface of the grout in the cup.
4. Weigh the tared cup, which is filled with grout.
5. Calculate the unit weight. Divide the weight of the grout by the volume of the cup.

10.3 Mud Balance Test

The mud balance test is used in the field in order to determine the wet density of a small sample of fluid grout. The mud balance test was conducted at three points during MITT. The first sample was collected in the colloidal grout plant, the second sample was collected from the grout hose just before injecting the grout, and the third sample was collected from the discharge at the top of the tube. A mud balance is shown in Figure 28.



Figure 28—Mud balance used to determine wet density of grout samples during MITT

The procedure for determining wet density is given in ASTM D4380, “Standard Procedures for Field Testing Water-Based Drilling Fluids”. The procedure was as follows:

1. Pour a sample of grout into the cup on the balance.
2. Tap the side of the cup to ensure that air bubbles rise to surface.
3. Place the cap onto the cup. Allow grout to flow out through the hole in the cap, ensuring that the cup is totally filled.
4. Place the mud balance assembly on the fulcrum in the case.
5. Adjust the weight on the balance arm until the mud balance is level.
6. Record the wet density of the grout sample.

10.4 Pressure Bleed Test

Pressure bleed testing was conducted in accordance with ASTM C1741 at a pressure of 100 psi. The equipment used to conduct test is shown in Figure 29.



Figure 29—Pressure bleed test setup used during MITT

10.5 Sedimentation Test

The sedimentation test was conducted in conjunction with MITT. The sedimentation test is used to determine the difference in density of grout at the top and bottom of a small cylinder. Figure 30 contains a photograph of grout being poured into a cylinder for the sedimentation test. Figure 31 shows several hardened cylinders that were cast during multiple MITT. Figure 32 shows a sedimentation cylinder after it was cut into four pieces for density testing.



Figure 30—Pouring grout into cylinder for sedimentation test



Figure 31—Sedimentation cylinders from multiple tests



Figure 32—Sedimentation cylinder cut into 4 approximately equal pieces

The procedure for the sedimentation test, which is given in Concrete Society Technical Report No. 47, is as follows:

1. Use clear cylinder 2 inches in diameter and 7 to 12 inches in height.
2. Fill cylinder with grout and seal.
3. Allow cylinder to set for at least 24 h undisturbed.
4. Cut the grout column into 4 approximately equal segments.
5. Measure the wet density of each segment following ASTM C642.
6. If the variation in density from the top to bottom of the sample is less than 5%, the grout passes the test.

10.6 Nominal Shear Rate (NSR) Viscosity Test

Grout viscosity measured before and after injection using a dynamic shear rheometer (DSR). Figure 33 shows a photo of the DSR with the doors open. A helical ribbon geometry and cup were used to test the grout (Figure 34). The following procedure was used to conduct the test:

- Load a sample of grout into the DSR.
- Subject the grout to a shear rate of 165 s^{-1} for 30 s.
- Subject the grout to a shear rate of 50 s^{-1} for a period of 1 min, sampling every 1 s. The NSR viscosity is the viscosity measured at 1 min.
- Clean the grout out of the cup and ribbon.



Figure 33—Dynamic shear rheometer



Figure 34—Helical ribbon and cup

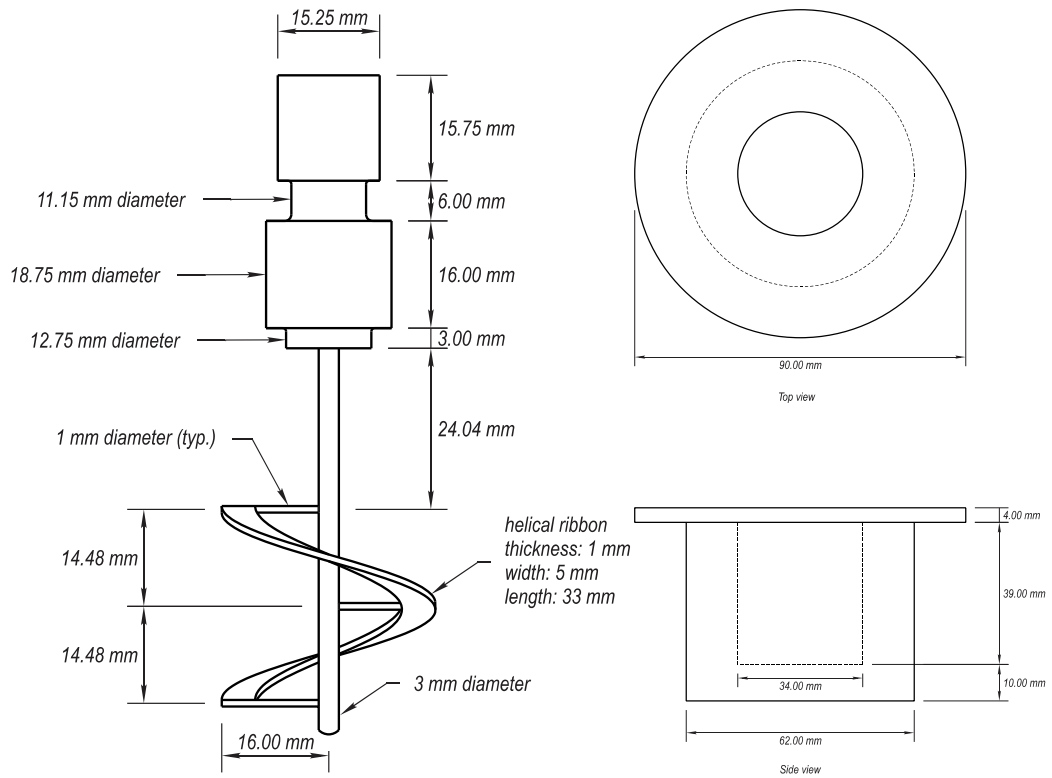

Figure 35—Helical ribbon and cup schematics

11 Field Conditions—Results and Discussion

This chapter presents the results of the modified inclined tube testing (MITT) of grouts PT1 through PT4. Quantitative results as well as visual observations made during dissection are presented. The tests reported in this chapter were conducted using the grout plant powered by compressed air.

11.1 Moisture Content Results

This section presents the moisture content measured in grout samples taken from the inclined tube specimens and evaluates the effect of the variables on this moisture content.

11.1.1 Maximum Water Dosage (MWD)

PT1-2, PT2-2, and PT3-1 were tested once at MWD. PT4-1 was tested twice under this condition. Figure 36 shows the variation in moisture content value with respect to location along the tube for PT4-1 mixed at MWD.

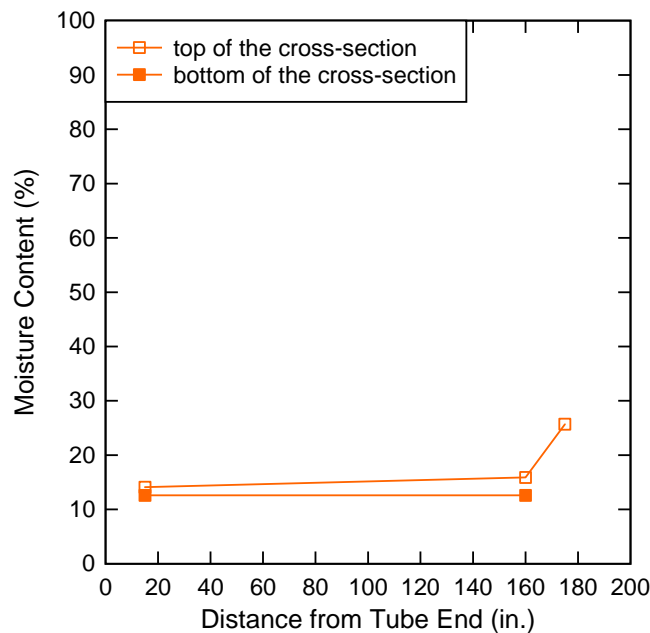

Figure 36—Variation of moisture content with respect to position along tube for material PT4-1 mixed at MWD

It can be seen that the moisture content increases as the position along the tube increases. It can also be seen that the moisture content measured in the top half of the tube cross-section is greater than that measured in the bottom half of the tube cross-section. The highest moisture

content is measured in the grout sampled at the very top of the tube; this was true for all grouts tested.

Figure 37 shows the maximum moisture content measured in each tube for all of the grouts mixed at the manufacturer’s maximum specified water dosage.

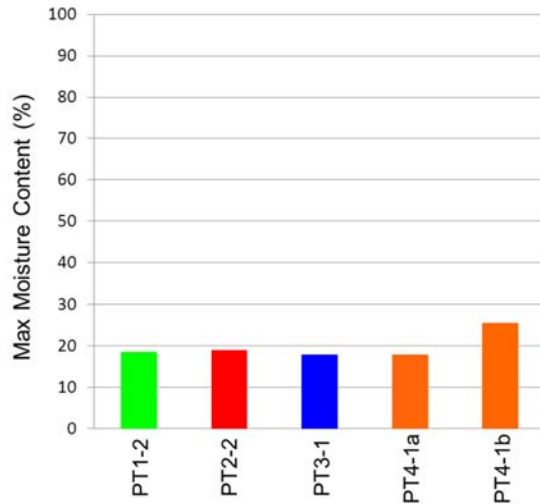

Figure 37—Maximum moisture content measured in tube for all grouts at maximum water

All grouts performed well with respect to moisture content when mixed at MWD. None of the grouts exhibited a moisture content higher than 25%, and soft grout was not found in any of the tubes.

11.1.2 Constricted Tube

PT1-2, PT2-2, and PT3-1 were tested once and PT4-2 was tested twice using a constricted tube. In the first test of PT4-2, the grout was injected in the standard manner. In the second test, the grout was re-circulated through the constricted tube. During recirculation one of the fittings failed, which resulted in the tube being partially filled grout.

Moisture content samples for the constricted tube were collected on both ends of both constrictions and at the top of the incline. Figure 38 shows the maximum moisture content measured at any of these locations for each test. Results indicate that the PT4-2 had high moisture content relative to the other results, indicating soft grout. Figure 39 shows the variation in moisture content with respect to position along the tube for material PT4-2 in the non-recirculation case.

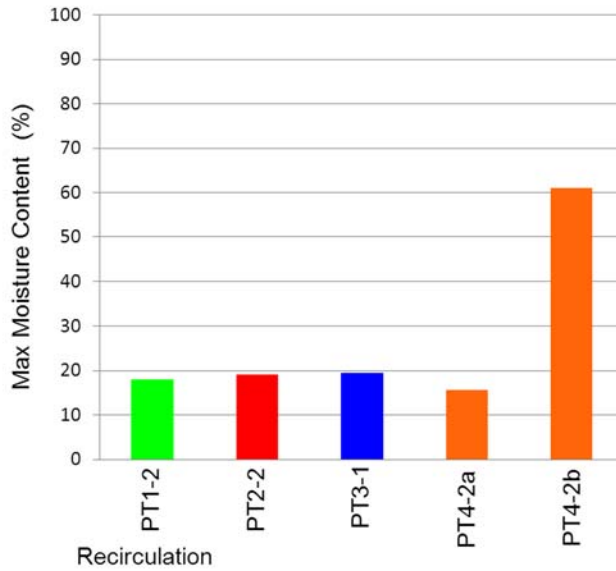

Figure 38—Maximum moisture content measured for all grouts with constricted tubes

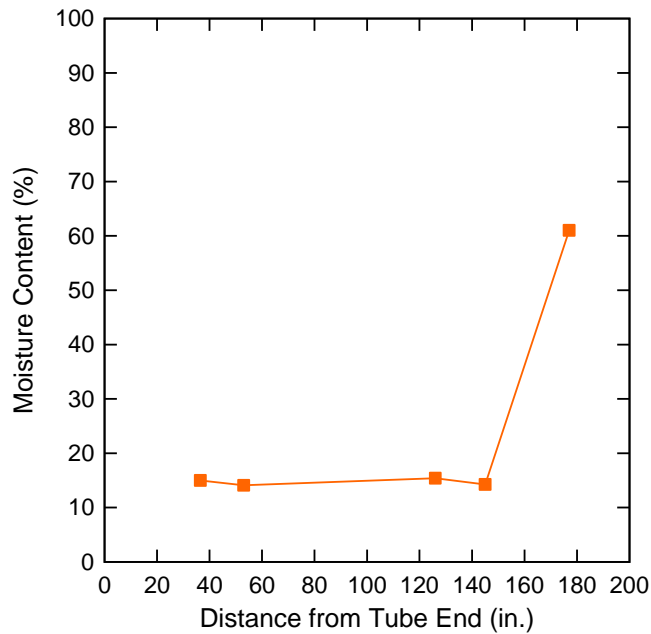

Figure 39—Variation of moisture content with respect to position along constricted tube for material PT4-2

The results shown in Figure 39 indicate that the same moisture content value is measured on either end of the constrictions. The highest moisture content, as with the maximum water MITT samples, was measured at the top of the tube. Figure 38 shows the maximum moisture content measured in the constricted tubes.

The maximum moisture content in the constricted tubes for PT1-2, PT2-2, and PT3-1 was nearly identical to that measured using the standard tubes. PT4-2, however, exhibited a low moisture content at the top of the tube in the case when it was injected through a constriction and recirculated. Furthermore, PT4-2 exhibited a high moisture content at the top of the tube in the other case when it was injected through a constriction in the standard manner.

11.1.3 Water in Tube

Figure 40 shows the maximum moisture content measured in each tube filled with 2 gallons of water prior to injection. Moisture content values varied widely among the various PT grouts. PT2-2 and PT3-1 behaved in a similar manner to a mixture at MWD. PT1-2 exhibited a higher moisture content than it did when mixed at MWD. PT4-1 exhibited a very high moisture when compared to that measured when the grout was mixed at MWD. PT4-2 exhibited an even higher moisture content than PT4-1. This was the only case in which the same testing condition was run on both materials PT4-1 and PT4-2. These results indicate that PT4-2 was more susceptible to high moisture content than PT4-1.

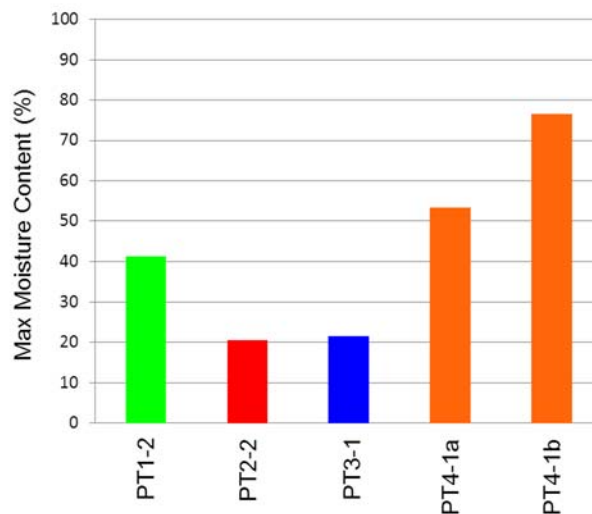

Figure 40—Maximum moisture content measured in tube for all grouts with 2 gallons of water in tube prior to injection

11.1.4 Excess Mixing Water

PT1-2, PT2-2, PT3-1, and PT4-2 were each tested three times at 1.15·MWD. Figure 41 shows the maximum moisture content measured in each tube for all grouts at 1.15·MWD. These results are very similar to those seen when 2 gallons of water was placed in the tube prior to injection (Figure 40). Soft grout was found at the top of all of the tubes injected with PT4-2. It

was not found in any other case, although porous grout was found in the tubes injected with PT1-2.

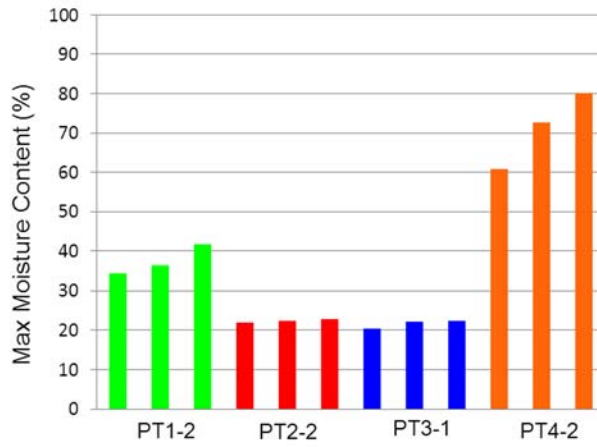

Figure 41—Maximum moisture content measured in tube for all grouts at 1.15-MWD

11.1.5 Other Conditions

Because PT4-1 and PT4-2 were the only materials that produced soft grout, additional tests were conducted to determine if other conditions would produce soft grout. Figure 42 contains a summary of the maximum moisture content measured for the additional tests run on PT4-1 and PT4-2. Of the conditions listed in the figure, two resulted in soft grout. One was 1.5-MWD. The other condition was when 2 gallons of water was placed in the hose. Pressurized injection and strand at top of tube tests resulted in similar moisture content values from MWD mixture.

When grout was mixed for the pressurized set test, it was noted that some solids remained in the mixer. Lower flow cone time and unit weight values in the mixer were measured than typical. No solids were noted in the mixer for the high temperature injection test; however, similar initial unit weight and flow cone values were measured as to the pressurized set tube. It is not clear why this occurred, but notable that both of the mixtures in which solids were noted had higher moisture contents.

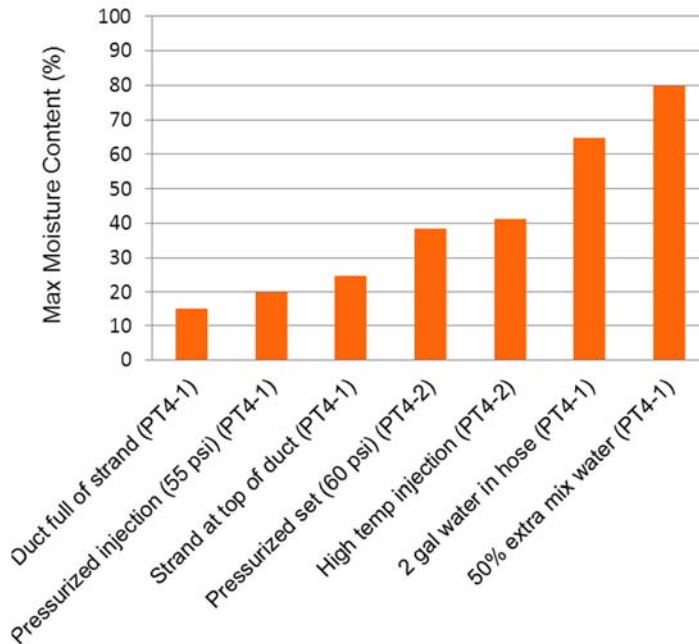

Figure 42—Maximum moisture content measured in tube for additional tests run on PT4-1 and PT4-2

11.2 Flow Cone Efflux Time, Wet Density, and Unit Weight Results

11.2.1 Maximum Water Dosage (MWD) Tests

For the tests described in this section, flow cone and mud balance tests were not conducted on the material in the mixer. Results of flow cone tests before and after injection are shown in Figure 43.

PT3-1 exhibited a large change in flow cone time before and after injection. This material was extremely thixotropic; as such, the time between collecting the sample and running the flow cone test was very critical. It is likely that the flow cone test was run immediately after sampling before injection, and that it was allowed to rest for a few minutes between sampling and testing after injection. PT1-2 also exhibited a large variation in flow cone time before and after injection. This may be because the samples collected before injection contained excessive water. Materials PT2-2 and PT4-1 exhibited relatively constant flow cone times before and after injection.

A plot of the unit weight before and after injection for each test MWD is shown in Figure 44. Figure 45 contains a similar plot for the wet density values. Wet density and unit weight both gave very similar values for the materials before and after injection. This is a good indication that the MITT procedure not causing changes in the grout characteristics.

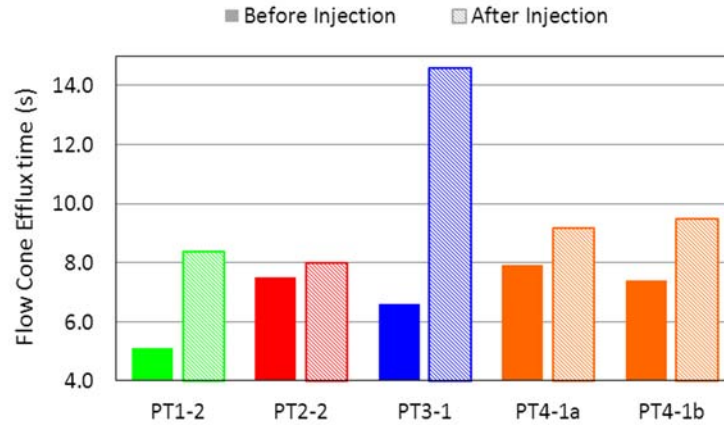

Figure 43—Plot of flow cone time before and after injection for all grouts at maximum water

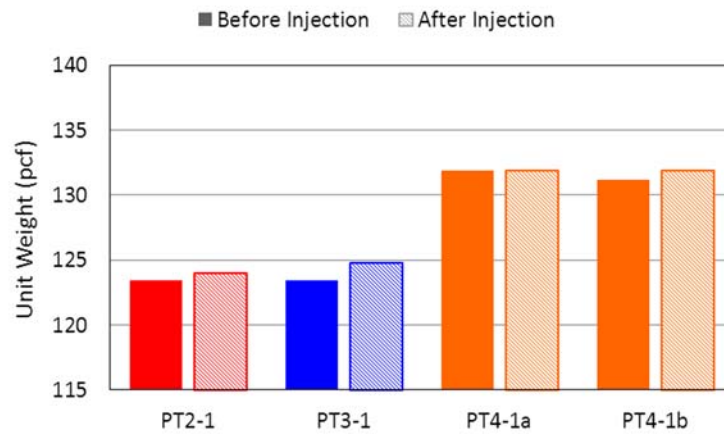

Figure 44—Plot of unit weight value before and after injection for all grouts at maximum water

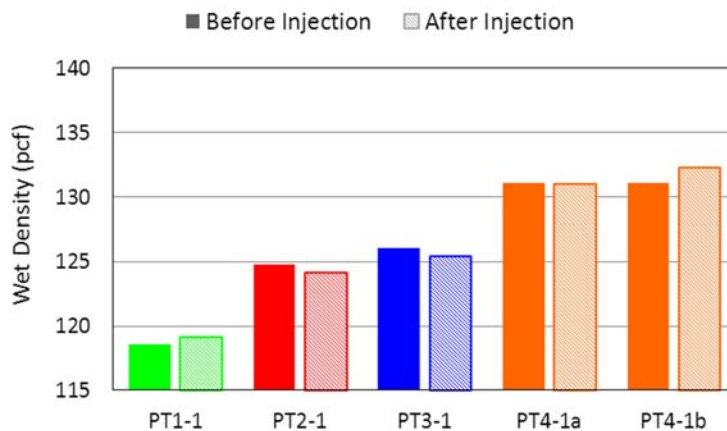
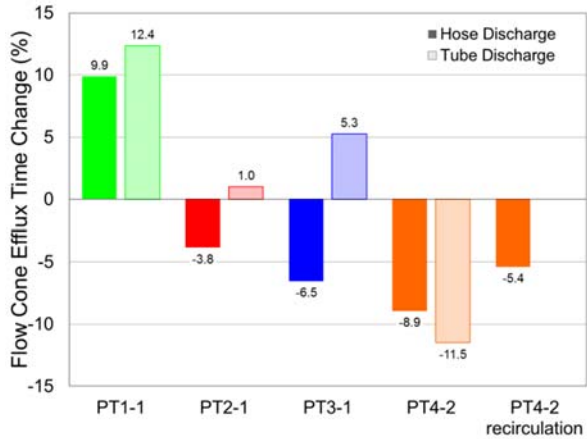

Figure 45—Plot of wet density value before and after injection for all grouts at maximum water

11.2.2 Constricted Tube

Figure 46 shows the relative change of several parameters during injection of the constricted relative to the values measured immediately after mixing. Flow cone efflux times vary moderately with a maximum increase of 12.4% and decrease of 11.5% for PT1-1 and PT4-2, respectively, for the grout discharged from the tube following injection. This is likely due to the natural variability of the test and not an indication of changes in rheology. The figure also indicates very little change (< 3%) in unit weight and wet density during injection. This is a good indication that the constricted tubes were not affecting the rheological properties of the grout in any significant manner. Unit weight and wet density values do not vary significantly with respect to sampling position. It is likely that, if the constricted tubes were filtering out large particles, this would be reflected by a change in unit weight before and after injecting the grout.



(a)

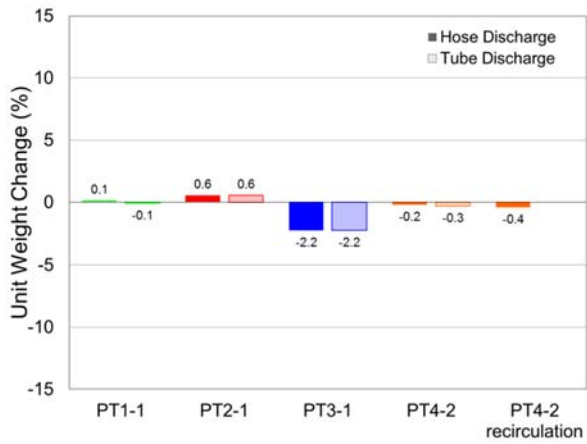

(b)

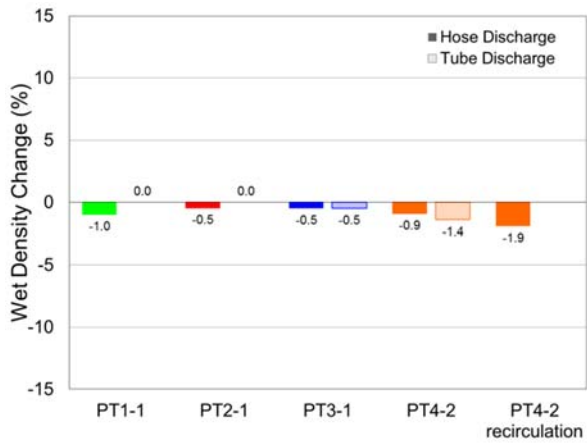

(c)

Figure 46—Change in (a) flow cone efflux time, (b) unit weight, and (c) wet density from mixer to hose discharge and to tube discharge in constricted tube

11.2.3 Water in Tube

Figure 47 contains a plot showing the ratio of flow cone time measured in the mixer to that measured before and after injection when 2 gallons of water were in the tube. The number indicated below the material label on the x-axis is the flow cone time in seconds that was measured when sampled from the mixer. Flow cone tests were not conducted on PT2-2 under this condition. In all cases, approximately 2 gallons of material was discharged from the top of the tube as a part of the injection procedure. The flow cone, mud balance, and unit weight tests were conducted on the discharged material.

Flow cone times decreased substantially after injection. In all cases, the flow cone time measured after injection was about 3 s, which is very close to the flow cone time for water. This indicates that the grout pushed most of the water out of the tube rather than mixing with the water during the injection process.

The plot also shows the change in unit weight and wet density during injection. For each grout, the a constant unit weight and wet density were maintained when grout was pumped through the hose. After injection into the tube, however, the unit weight and wet density for all of the grouts decreased by approximately 50% to a value of about 65 pcf, which is near the unit weight of water, providing further proof that the grout pushed most of the water out of the tube during the injection process.

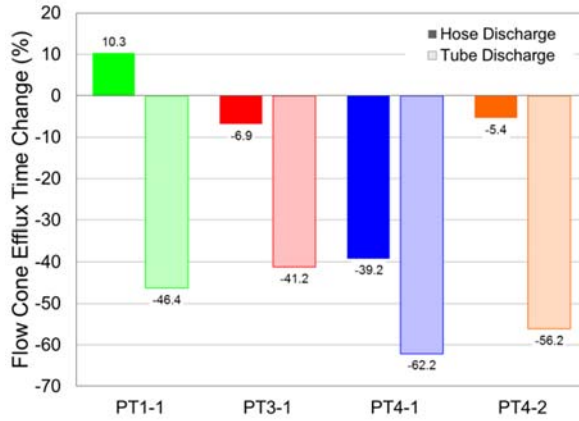

(a)

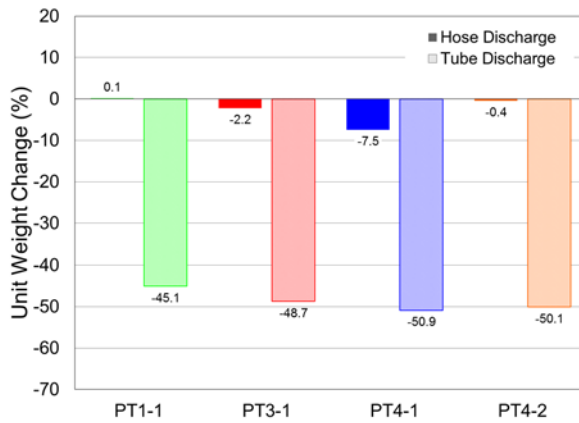

(b)

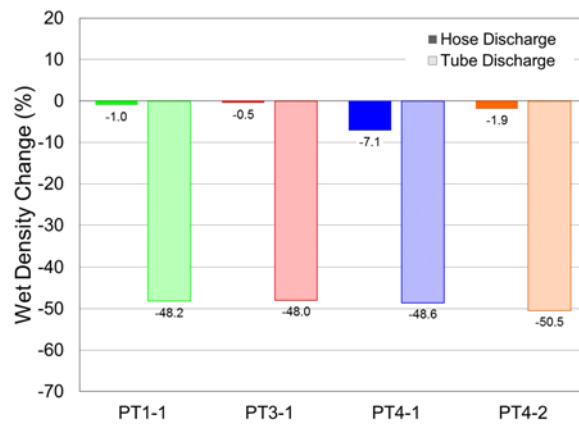

(c)

Figure 47—Change in (a) flow cone efflux time, (b) unit weight, and (c) wet density from mixer to hose discharge and to tube discharge with water in tube

11.2.4 Excess Water Dosage

Figure 48 contains a plot showing the change in flow cone time measured in the mixer to that measured before and after injection for each of the grouts tested at 1.15·MWD. The flow cone time does not vary substantially with respect to sampling location for PT3-1 and PT4-2 when tested at 1.15·MWD. This was a good indication that the MITT procedure was not causing any changes in the grout rheology for PT3-1 and PT4-2. In one out of three cases for PT2-2, the flow cone time measured before and after injection was substantially lower than that measured in the mixer. In this case, the mixer flow cone time of 7.6 s was unusually high for this grout. It is not clear why.

The figure also shows the change in unit weight and wet density. None of the grouts exhibited a difference in unit weight greater than 10% measured at any of the sampling locations during any of the tests. This is also a good indication that the grout remained homogeneous throughout the MITT.

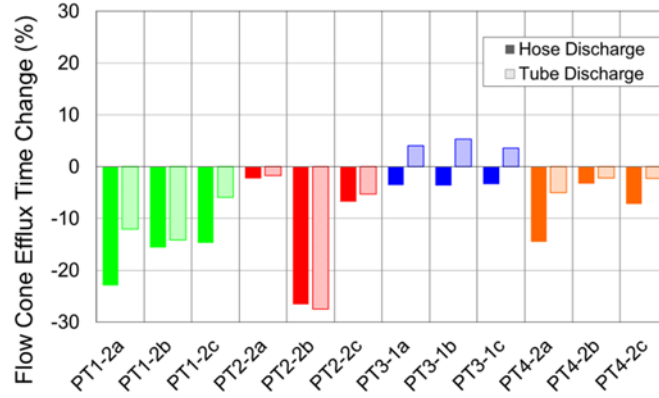

(a)

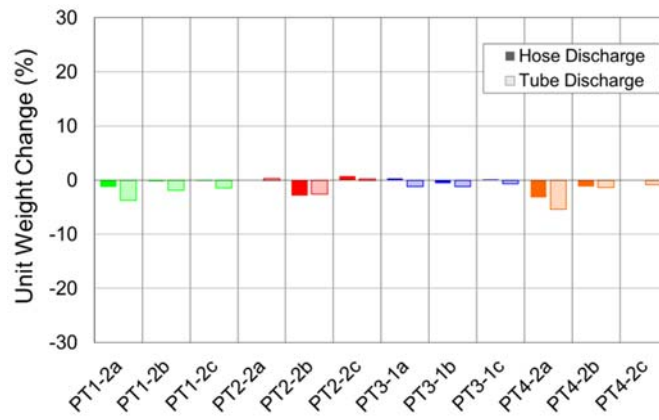

(b)

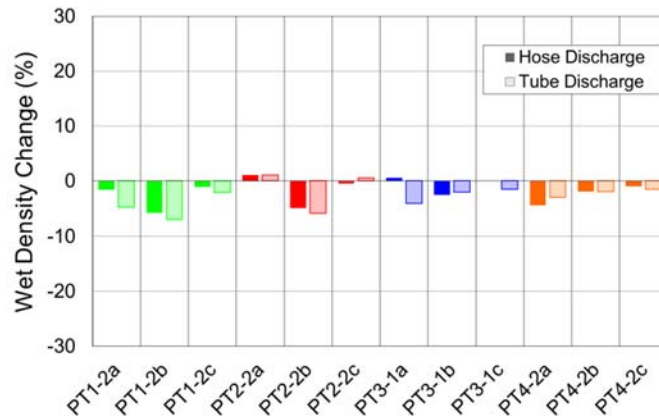

(c)

Figure 48—Change in (a) flow cone efflux time, (b) unit weight, and (c) wet density from mixer to hose discharge and to tube discharge with 1.15·WMD

11.2.5 Other Conditions

Figure 49 shows the change in flow cone time from the mixer to the hose discharge and to the tube discard for each of the additional PT4 test conditions. Grout from 1.5-MWD was significantly more fluid than the others. The high temperature injection and pressurized set mixes have lower mixer flow cone values than the others, which indicated that they may not have been mixed properly. All other batches had similar mixer flow cone times to the other batches of PT4 mixed at MWD. The flow cone time for the 2 gallons of water in the hose test decreased after injection, but not as much as the 2 gallons of water in the tube test shown in Figure 47. When the tube was full of strand, the flow cone time decreased after injection. When the strand was at the top of the tube, the flow cone time increased after injection.

Unit weight and wet density change are also shown. Unit weight of 1.5-MWD is much lower than that from the other mixes. Unit weight of the mix with 2 gallons of water in the grout hose decreased slightly after injection, but not as much as it did with 2 gallons of water in the tube. This indicates that, when water was in the hose instead of the tube, it mixed with the grout much more during the injection process. Otherwise, all of the samples exhibited a relatively constant unit weight throughout the modified inclined tube procedure.

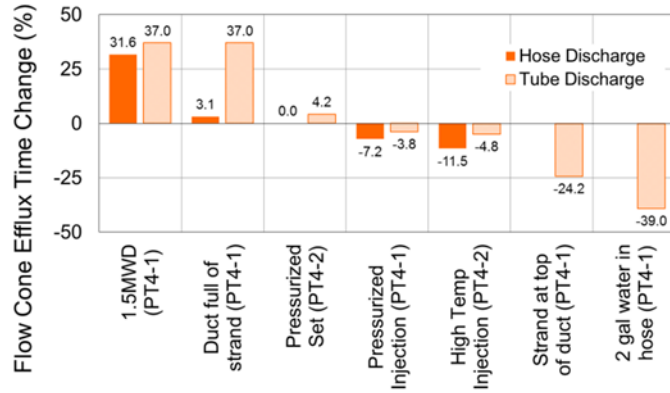

(a)

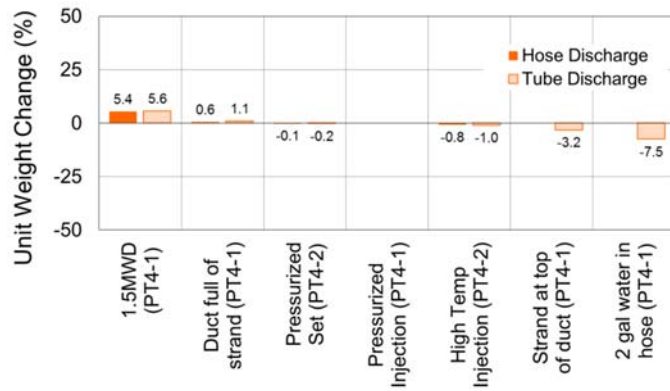

(b)

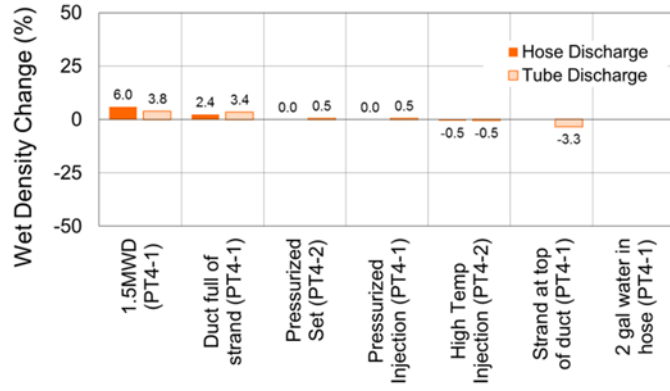

(c)

Figure 49—Change in (a) flow cone efflux time, (b) unit weight, and (c) wet density from mixer to hose discharge and to tube discharge for additional tests conducted on PT4

11.3 Sampling Observations

11.3.1 PT1-2

A summary of the modified inclined tube tests that were run on PT1-2 is given in Table 11.

Table 11—PT1-2 MITT

Material	Condition	Number of Tests
PT1-2	MWD	1
	1.15·MWD	3
	2 gal water in tube	1
	Constriction	1

When mixed at MWD, PT1-2 exhibited a smooth surface in the bottom half of the tube, and a porous surface in the top half of the tube (Figure 50). The bubbles on the top half of the tube did not extend into the grout beyond what was visible on the surface.



Figure 50—Porous surface observed in top half of tube containing PT1-2 at MWD

At 1.15·MWD, PT1-2 exhibited a much more porous surface than it had at MWD. This was specifically noted in the samples collected at the top of the tubes (Figure 51).



Figure 51—Porous grout observed in PT1-2 at 1.15·MWD

The composition of the grout was different than the soft grout collected from PT4-1 and PT4-2 but could still be sampled by scraping gently. The porous grout was found to extend about 3 to 4 in. into the surface of the grout. Below the porous grout, bleed water was found. Below the bleed water was hard, non-porous grout. The porous grout was found for each test with PT1-2 at 1.15·MWD.

One MITT was run on PT1-2 in which 2 gallons of water were placed into the tube prior to injection. The tube was cut open 24 h after injection, and the sample was observed to be porous and somewhat soft and was placed in an air-tight plastic bag. However, 3 d after the sample was collected, the grout was observed to have hardened. It is believed that the cement in the grout had not hydrated to the point that the grout was hard after 24 h. However, several days later, the hydration reaction had continued such that the grout was more hardened.

Finally, PT1-2 was tested once using a constricted tube in the MITT. Nothing unusual was noted in this tube during the sampling procedure.

11.3.2 PT2-2

A summary of MITT conducted on PT2-2 is given in Table 12.

Table 12—PT2-2 MITT

Material	Condition	Number of Tests
PT2-2	MWD	1
	1.15·MWD	3
	2 gal water in tube	1
	Constriction	1

When the MITT was conducted on PT2-2 at MWD, the grout surface was found to be fairly smooth around the circumference. Figure 52 contains a photo showing the surface of the grout under this condition.



Figure 52—Smooth grout surface observed in PT2-2 mixed at MWD

A set of three MITT were conducted on PT2-2 at 1.15-MWD. In each case, during sampling, the surface of the grout everywhere but the top of the tube was smooth as it was under when mixed with MWD. Bleed water was observed in each case when the tube was cut open at the top, but no soft grout was found even though it appears soft in Figure 53.



Figure 53—Grout at top of tube when PT2-2 at 1.15-MWD

One MITT was conducted on PT2-2 in which 2 gallons of water were placed in the tube prior to injection. Similar to the extra mixing water condition, some bleed water was found at the top of the tube. However, the grout in contact with the bleed water had hardened.

Nothing unusual was noted during sampling of the MITT with constriction conducted on PT2-2.

11.3.3 PT3-1

A summary of the modified inclined tube tests that were run on PT3-1 is given in Table 13.

Table 13—PT3-1 MITT

Material	Condition	Number of Tests
PT3-1	MWD	1
	1.15·MWD	3
	2 gal water in tube	1
	Constriction	1

When MITT was conducted on PT3-1 mixed at MWD, the grout surface was found to be smooth around the circumference with some smaller and one larger air bubble (Figure 54).



Figure 54—Smooth grout surface with air bubble observed in PT3-1 mixed at MWD

Three MITT were conducted on PT3-1 at 1.15·MWD. Very similar results were found to PT2-2. There was some bleed water at the tops of the inclined tubes, but grout in contact with the bleed water had hardened. MITT with 2 gallons of water placed in the tube prior to injection had the same results. Some bleed water was found at the top of the tube, but the grout was hard.

Nothing unusual was noted during sampling MITT with constriction conducted on PT3-1.

11.3.4 PT4-1 and PT4-2

A summary of the modified inclined tube tests that were run on PT4-1 and PT4-2 is given in Table 14.

When PT4-1 was mixed with MWD, no soft grout was found. The surface of the grout was observed to have two distinct colors. The bottom half of the surface was darker, while the top half was lighter (Figure 55).

Table 14—PT4-1 and PT4-2 MITT

Material	Condition	Number of Tests
PT4-1	MWD	2
	2 gal water in tube	1
	1.5·MWD	1
	2 gal water in hose	1
	Strand at top of tube	1
	Tube packed full of strand	1
	Pressurized injection (55 psi)	1
PT4-2	1.15·MWD	3
	Constriction	2
	2 gal water in tube	1
	Pressurized set (60 psi)	1
	High temp injection	1



Figure 55—Surface of PT4-1 at MWD. Top half is lighter than bottom half

The material at the top of the tube injected with PT4-1 mixed at MWD was hardened but was also black and contained excessive air bubbles, which varied from grout sampled elsewhere in the tube (Figure 56).

Although the majority of the grout in the tube had hardened, some soft grout (Figure 57) was found at the top of the tube in each instance when PT4-2 was mixed with a water dosage greater than MWD.

The soft grout could be sampled by moderate scraping. In each case, there was layer of black material found on top of the soft grout. Figure 58 contains another photograph of the soft grout with the black material on the surface.



Figure 56—Grout containing air bubbles found at top of tubes containing PT4-1 mixed at MWD



Figure 57—Black material and soft grout found in tubes injected with PT4-2 mixed at 1.15·MWD



Figure 58—Soft grout and black material found in tubes injected with PT4-2 mixed at 1.15·MWD

PT4-2 exhibited different behavior in each of the two constriction tests. In one case, the grout was re-circulated through the constricted tube in order to attempt to filter out large particles. As the grout was re-circulating, enough pressure was built up to cause one of the connections on the tube to rupture. The fitting was re-attached, and the grout was allowed to set. When the tube was sampled, hard grout was found everywhere including the top of the tube.

In the second case, the grout was injected into the constricted tube in the standard manner. Four samples were collected (one on each end of the two constrictions), and nothing unusual was noted. No sample was collected at the top of the tube. The tube was then stored outside, unprotected from the elements, for approximately 3 months. After 3 months, a sample was collected from the top of the tube. The grout at the top of the tube was found to be soft.



Figure 59—Soft grout found at top of constricted tube containing PT4-2 several months after injection

Similar results were found for the tubes injected with PT4-1 and PT4-2 when the tubes were filled with 2 gallons of water prior to injection. In each case, the grout along the length of the tube was hard. The grout at the top of the tube, however, was soft. Very similar results were found in the case when PT4-1 was injected with 2 gallons of water in the grout hose. Figure 60 contains a photograph showing the soft grout discovered at the top of the tube in which the grout hose was filled with 2 gallons of water prior to injection.



Figure 60—Soft grout found at top of tube containing PT4-1 in which the grout hose was filled with 2 gallons of water prior to injection

No soft grout was found, and nothing unusual was noted in the following cases for PT4-1: strand at top of tube, tube full of strand, pressurized injection. In addition, for PT4-2, no soft grout was found in the pressurized set case. When PT4-2 was mixed and injected at high temperature (90°F), the grout along the length of the tube was hard. The sample at the top of the tube was not considered soft, but was noted to be somewhat moist.

11.3.5 Material C45 and C675

A summary of the modified inclined tube tests that were run on materials C45 and C675 is given in Table 15.

Table 15—C45 and C675 MITT

Material	Condition	Number of Tests
C45	Standard tube	1
C675	Standard tube	1

The tube injected with material C45 contained a significant amount of bleed water. Grout in contact with the bleed water was white in color and very hard. A photograph of this grout is shown in Figure 61. No soft grout was found in this tube.



Figure 61—Top of tube injected with material C45; grout is white and hard

Similar to the tube injected with C45, the tube injected with C675 contained an excessive amount of bleed water. The grout in contact with this material was hardened. The strands at the top of the tube were coated with a hard, white material as shown in Figure 62. At approximately 4 ft from the top of the tube, the grout was white in the 12 o'clock position, and dark in other positions (Figure 63). No soft material was found in the tube injected with material C675.



Figure 62—Hard, white material coating strands in tube injected with material C675



Figure 63—White grout at 12:00 position and darker grout everywhere else in tube injected with material C675

11.3.6 Summary of Sampling Observations

PT1-2 exhibited strange behavior when extra mixing water was introduced. The samples collected at the top of the tube were found to be extremely porous. Below the porous material, bleed water was found. The cause of this phenomenon is unknown, but further investigation is warranted.

Nothing particularly unusual was observed during the sampling of the tubes containing PT2-2 and PT3-1. Bleed water was found in tubes for both materials when extra water was introduced, but the grout at the top of the tubes was always hardened. No soft grout was found in the tubes containing PT2-2 or PT3-1.

Soft grout was found in both PT4-1 and PT4-2. Both of these materials became soft in each instance in which extra water was introduced. In addition, soft grout was found one out of two times when PT4-2 was injected into a constricted tube. Finally when PT4-2 was mixed and injected at high temperature, hard, but somewhat moist, grout was found at the top of the tube.

Materials C45 and C675 both produced an excessive amount of bleed water. The grout that was in contact with the bleed water was white and hard. No soft grout was found in the tubes containing material C45 or C675.

11.4 Soft Grout Summary

Table 16 provides a summary of all of the modified inclined tube tests that were conducted as well as the conditions that produced soft grout.

11.5 Bleed Readings

Readings were made on the inclined tubes at the following times after injection: 30 minutes, 1 h, 2 h, and 24 h. Bleed water in the tubes was difficult to visually discern for several reasons. First, although the tubes were constructed of clear PVC, the fittings on either end were opaque (Figure 64) and covered several inches of grout at the end of the tube. When the tubes were fully grouted, they were completely filled and small amounts of bleed water would have been covered by the opaque fittings.

In addition to the opaque fittings, the grout generally coated the interior wall of the clear PVC tubes during the injection process. An example of this is shown in Figure 65. In this case, the grout did not completely fill the tube, but during the injection process it stuck to the wall of the tube, making bleed readings difficult.

Despite these obstacles, bleed water was still observed in some of the inclined tubes. It is important to note, however, that bleed water may have been present in some of the other tubes, but not necessarily observed. Table 17 provides a summary of the samples that were observed to exhibit bleed water at any point during the 24 h following injection. In addition, the table lists

the tests that resulted in the formation of soft grout. In most cases, observed bleed does not correspond to soft grout.

Table 16—Summary of MITT conditions that produced soft grout

Material	Condition	Runs	Soft Grout
PT1-2	1.15-MWD	3	0
	Constriction	1	0
	2 gal water in tube	1	0
	MWD	1	0
PT2-2	1.15-MWD	3	0
	Constriction	1	0
	2 gal water in tube	1	0
	MWD	1	0
PT3-1	1.15-MWD	3	0
	Constriction	1	0
	2 gal water in tube	1	0
	MWD	1	0
PT4-1	MWD	2	0
	2 gal water in tube	1	1
	1.5-MWD	1	1
	2 gal water in hose	1	1
	Strand at top of tube	1	0
	Tube packed full of strand	1	0
	Pressurized injection (55 psi)	1	0
PT4-2	1.15-MWD	3	3
	Constriction	2	1
	2 gal water in tube	1	1
	Pressurized set (60 psi)	1	0
C45	Standard tube	1	0
C675	Standard tube	1	0



Figure 64—Opaque PVC fittings used on end of inclined tubes



Figure 65—Grout coating interior wall of clear PVC tube

PT1-2 exhibited bleed for 1.15·MWD. Bleed water was observed to be yellow in color, and was located below a layer of porous grout at the top of the tube. Bleed water was not observed until 24 h after the tube was injected.

PT2-2 exhibited bleed water when 2 gallons of water were in the tube prior to injection. This was not observed when the tube was in the inclined position, but instead when the tube was cut open 24 h after injection. PT2-2 also exhibited bleed three times for 1.15·MWD. In one case, bleed water was observed 2 h after injection and again 24 h after injection. In the next case, bleed water was only observed 24 h after injection. In the final case, bleed water was not observed when the grout was in the inclined position, but instead when it was cut open 24 h after

injection. In each case, bleed water was yellow in color. Figure 66 shows a photograph of the yellow bleed water visible 24 h after injection.

Table 17—Summary of conditions that resulted in the bleed water within 24 h following injection

Material	Condition	Number of Tests	Bleed Observed	Soft Grout
PT1-2	1.15·MWD	3	1	0
	Constriction	1	0	0
	2 gal water in tube	1	0	0
	MWD	1	0	0
PT2-2	1.15·MWD	3	3	0
	Constriction	1	0	0
	2 gal water in tube	1	1	0
	MWD	1	0	0
PT3-1	1.15·MWD	3	3	0
	Constriction	1	0	0
	2 gal water in tube	1	1	0
	MWD	1	0	0
PT4-1	MWD	2	0	0
	2 gal water in tube	1	0	1
	1.5·MWD	1	0	1
	2 gal water in hose	1	0	1
	Strand at top of tube	1	0	0
	Tube packed full of strand	1	0	0
	Pressurized injection (55 psi)	1	0	0
PT4-2	1.15·MWD	3	0	3
	Constriction	2	0	1
	2 gal water in tube	1	0	1
	Pressurized set (60 psi)	1	0	0
C45	Standard tube	1	1	0
C675	Standard tube	1	1	0



Figure 66—Bleed water visible in PT2-2 24 h after injection

PT3-1 exhibited bleed when mixed at 1.15-MWD. In each case, bleed water was visible between 30 minutes and 2 h after the tube was injected. Twenty-four hours after the tube was injected, however, bleed water was no longer visible. PT3-1 also exhibited bleed water when there was 2 gallons of water in the tube prior to injection. Bleed water, however, was not observed until the tube was cut open 24 h after injection.

PT4-1 and PT4-2 did not exhibit bleed water but rather formed soft when extra mixing water is introduced.

Finally, the two plain cement grouts C45 and C675 both exhibited bleed. Bleed water was visible 30 minutes after injection in each case, and continued to be visible 24 h after injection. Material C675 exhibited bleed water extending approximately 4 ft down from the top of the tube.

Overall, the bleed water observed during MITT does not appear to correlate well to the formation of soft grout. Each of the materials aside from PT4-1 and PT4-2 exhibited bleed water, but not soft grout. PT4-1 and PT4-2, however, exhibited soft grout several times, but did not exhibit bleed water in any case.

11.6 Pressure Bleed Test Results

Pressure bleed testing was conducted on grout samples prepared for MITT listed in Table 18. Samples for the pressure bleed test were collected in the mixer before injection into the tube. The table indicates the number of times the pressure bleed test was conducted as well as the number of failing results. In addition, the table lists MITT tests that resulted in the formation of soft grout.

PT3-1 and C675 failed the pressure bleed test. Yet, none produced soft grout under MITT. This agrees with the findings regarding bleed readings for MITT, which is that the propensity to bleed does not necessarily indicate an affinity to produce soft grout.

Table 18—Results of pressure bleed test

Material	Condition	Tests	Failures	Soft Grout
PT1-2	1.15·MWD	3	0	0
	Constriction	1	0	0
	2 gal water in tube	1	0	0
	MWD	1	0	0
PT2-2	1.15·MWD	3	0	0
	Constriction	1	0	0
	2 gal water in tube	1	0	0
	MWD	1	0	0
PT3-1	1.15·MWD	3	3	0
	MWD	1	1	0
PT4-1	MWD	2	0	0
	2 gal water in tube	1	0	1
	2 gal water in hose	1	0	1
	Strand at top of tube	1	0	0
PT4-2	1.15·MWD	1	0	1
	Constriction	1	0	1
	2 gal water in tube	1	0	1
	High temp injection	1	0	0
C675	Standard tube	1	1	0

11.7 Sedimentation Test Results

Sedimentation testing was conducted on grout samples listed in Table 19. Samples for the sedimentation test were prepared from the material collected from the inclined tube

discharge. The table indicates the number of times the sedimentation test was conducted as well as the number of failing results. In addition, the table lists the number of simultaneous modified inclined tube tests that resulted in the formation of soft grout.

Table 19—Results of sedimentation test

Material	Condition	Tests	Failures	Soft Grout
PT1-2	1.15-MWD	3	3	0
	Constriction	1	0	0
	2 gal water in tube	1	0	0
PT2-2	1.15-MWD	3	0	0
	Constriction	1	0	0
PT3-1	1.15-MWD	3	0	0
	Constriction	1	0	0
	2 gal water in tube	1	0	0
PT4-1	1.5-MWD	1	1	1
	Tube packed full of strand	1	0	0
	Pressurized injection (55 psi)	1	0	0
PT4-2	1.15-MWD	3	1	3
	Constriction	1	0	1
	2 gal water in tube	1	0	1
	High temp injection	1	0	0
C45	Standard tube	1	0	0
C675	Standard tube	1	1	0

None of the sedimentation tests run on PT2-2, PT3-1, or C45 resulted in failure. At 1.15-MWD, PT1-2 failed every test. PT4-2 failed one of three sedimentation tests when 1.15-MWD and PT4-1 failed the 1.5-MWD test. Finally, material C675 failed the sedimentation test. Overall, the sedimentation test does not seem to be an adequate predictor of soft grout. Many of the samples of PT4-1 and PT4-2 that resulted in soft grout in MITT did not fail the sedimentation test. In addition, several tests on PT1-2 and C675 failed the sedimentation test, but the inclined tube samples did not contain any soft grout.

11.8 Moisture Content and Soft Grout

Table 20 provides a summary of the testing conditions that resulted in the formation of soft grout and Table 21 were testing conditions that did not. Both tables also indicate the

maximum moisture content measured in the tube under each condition. The minimum moisture content measured in a soft grout sample was 53%. This sample was observed to be semi-hard, but could be scraped out using the tip of a screwdriver. The maximum moisture content in a hardened sample of PT4 was 41%. This sample could not be collected by scraping with a screwdriver. If the plain grout, C675, is not considered, then the maximum moisture content found in any hardened sample was 42%. Although the definition of soft grout is not based on measureable mechanical properties, the data indicate that if the moisture content approaches 50%, then the sample is likely to fit the description of soft grout.

While the minimum moisture content of a soft grout is likely to be greater than 50%, it was noted that the plain grout sample exhibited higher moisture content but was not necessarily considered soft. This is likely due to the large amount of bleed water present that was not present in PT4 tests.

Table 20—Summary of conditions that produced soft grout

Material	Condition	Max Moisture Content
PT4-1	2 gal water in tube	53%
	2 gal water in hose	65%
	1.5·MWD	80%
PT4-2	Constriction	61%
	1.15·MWD	61%
	1.15·MWD	73%
	2 gal water in tube	77%
	1.15·MWD	80%

Table 21—Summary of conditions that did not produce soft grout

Material	Condition	Max Moisture Content
C45	Standard tube	23%
C675	Standard tube	54%
PT1-2	Constriction	18%
	MWD	19%
	1.15·MWD*	35%
	1.15·MWD*	36%
	2 gal water in tube*	41%
	1.15·MWD*	42%
PT2-2	MWD	19%
	Constriction	19%
	2 gal water in tube	21%
	1.15·MWD	22%
	1.15·MWD	22%
	1.15·MWD	23%
PT3-1	MWD	18%
	Constriction	20%
	1.15·MWD	21%
	2 gal water in tube	22%
	1.15·MWD	22%
	1.15·MWD	23%
PT4-1	Tube full of strand	15%
	MWD	18%
	Pressurized injection (55 psi)	20%
	Strand at top of tube	25%
	MWD	26%
PT4-2	Recirculate through constriction	16%
	Pressurized set (60 psi)	39%
	High temp injection	41%

* porous grout observed

12 Inert Filler—Results and Discussion

This chapter presents the results of modified inclined tube testing (MITT) of plain grout formulated with inert filler and further testing of prepackaged grouts PT1 through PT6.

Quantitative results as well as visual observations made during dissection are presented. The tests reported in this chapter were conducted using the grout plant powered by compressed air.

The objective of these tests was to determine the effect of filler material calcium carbonate on the formation of soft grout at varying water-to-cement ratio (w/c) and percentage of filler additions.

12.1 NSR Viscosity Control

Plain grout mixtures were formulated so that the initial viscosity was at or below 250 mPa·s for all of the plain grout tests. This was accomplished by adjusting the HRWR dosage using the flow cone values and visual observation of the mixture in the mixing tank during mixing. Measurements of viscosity made after mixing were recorded. Figure 67 shows the HRWR quantity used for each mix at different percentages of filler material versus the water-to-cement ratio (w/c).

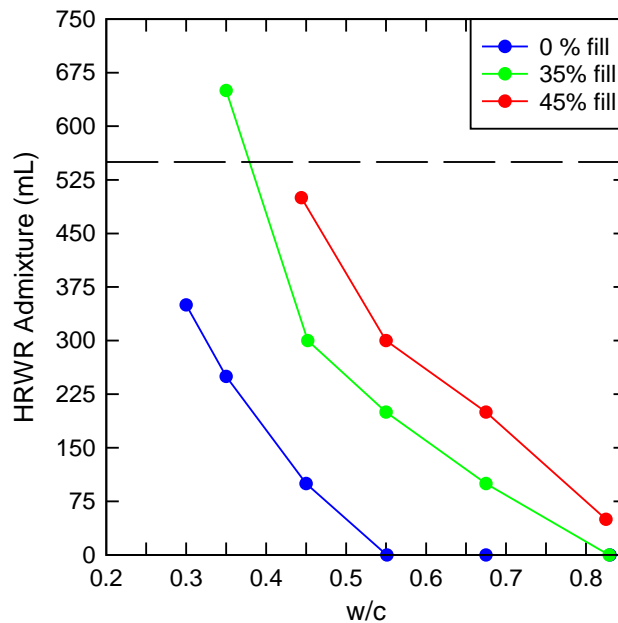

Figure 67—HRWR dosage

Figure 68 shows the resulting viscosity levels for the plain grout tests and demonstrates that the apparent viscosities were all maintained near 250 mPa·sec. The vertical axis limits for Figure 68 were selected based on the results of C55-45. This test required a pumping pressure of over 90 psi to inject the grout into the inclined tube, while all other tests were easily controllable with 40 psi pumping pressures. This is because only 100 mL of HRWR was used, resulting in a viscosity of 1038 mPa·sec.

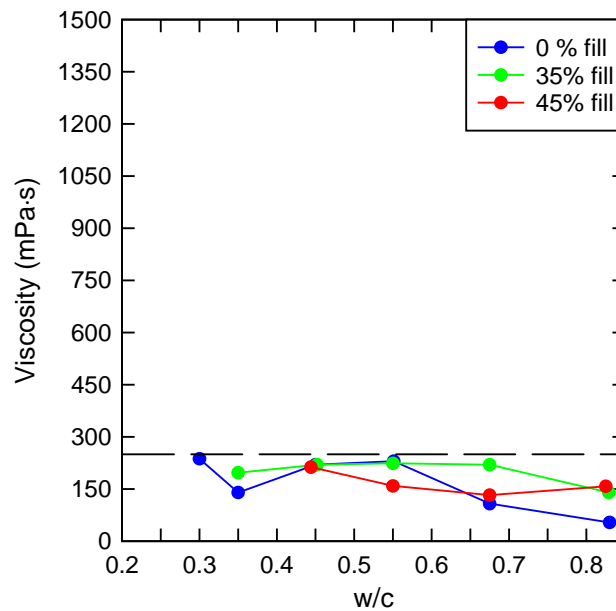

Figure 68—Resulting initial viscosities

Figure 69 shows the resulting initial flow cone efflux times from all and confirms that at a given w/c, increasing the percentage of filler causes a slight increase the modified flow cone efflux time. This is expected because for any given w/c, the same amount of water was used to mix the grout, so increasing the percentage of filler only adds solids to the mixture, which would intuitively yield a larger flow cone value.

12.2 Soft Grout

Figure 70 shows the effect of w/c and w/s on the presence and mass of soft grout produced with MITT. Generally, the quantity of soft grout increased when additional filler material was used. Additionally, lower w/s achieved zero soft grout for mixtures with increasing percentages of filler material.

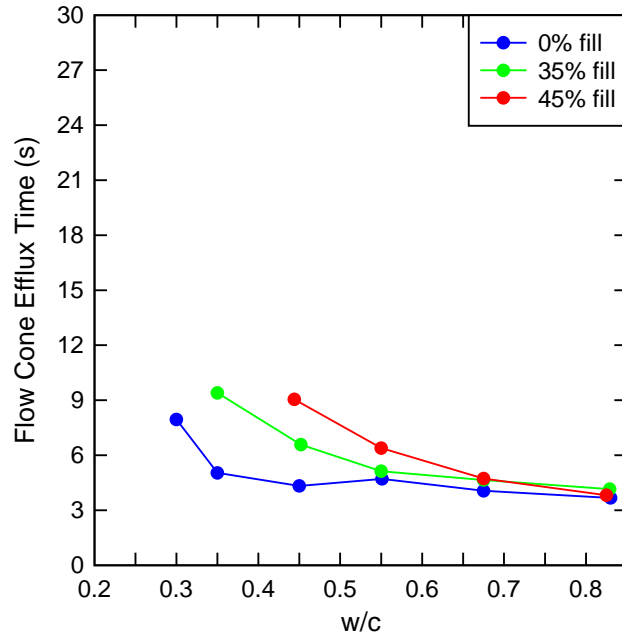

Figure 69—Resulting initial flow cones

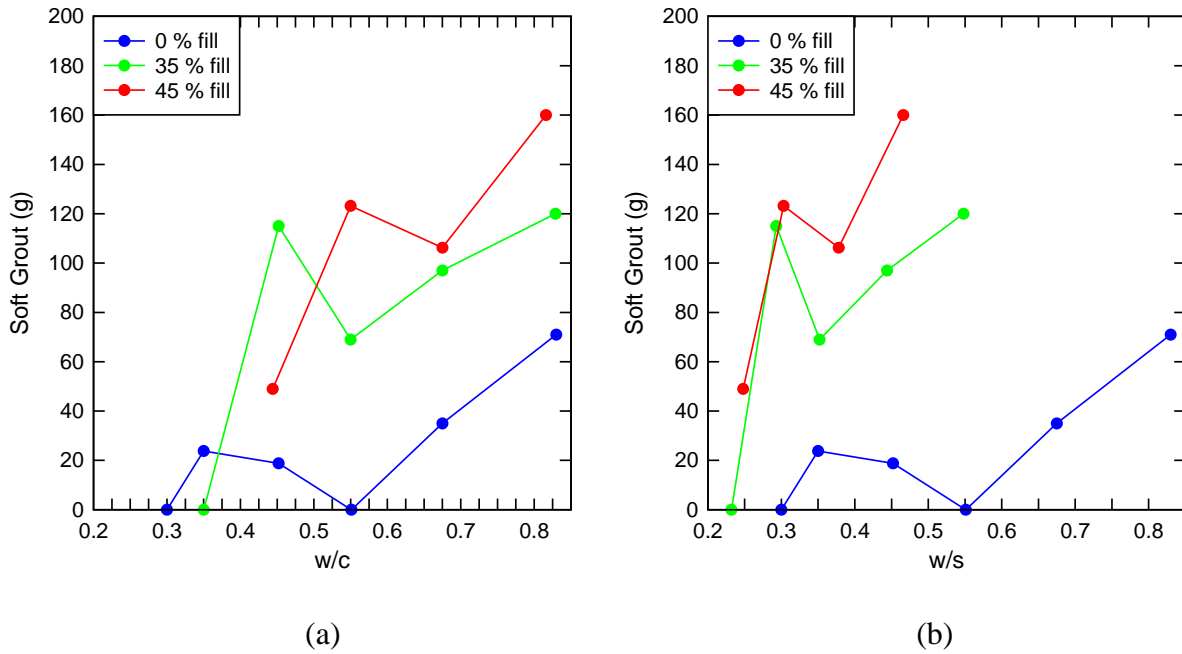

Figure 70—Variation of soft grout with (a) w/c and (b) w/s

12.3 Moisture Content

12.3.1 Plain Grout

Figure 71, Figure 72, and Figure 73 show moisture contents along the length of the tube for varying w/c with 0%, 35%, and 45% filler, respectively. Several trends are noteworthy. First,

moisture content below the discharge generally ranged from a low of 15% to a high of 30%. As would be expected, the increase in moisture content followed the increase in w/c. Also, moisture content increased gradually along the length of the tube up to the discharge point where large increases in moisture content were measured. Since the HRWR was used in conjunction with water to limit the initial viscosity for most of the tests, all but three of the tests resulted in soft grout near the exit region. The relatively high moisture contents near the exit region are a clear indication of this.

C30-0 displayed in Figure 71 has moisture contents that are consistently below 20% and resulted in zero measurable soft grout. This test also required the highest dose of HRWR to limit the initial viscosity. This is clear indication that with low enough w/c, large amounts of HRWR can be used to achieve desirable fluidity characteristics without resulting in segregation of the portland cement and filler material.

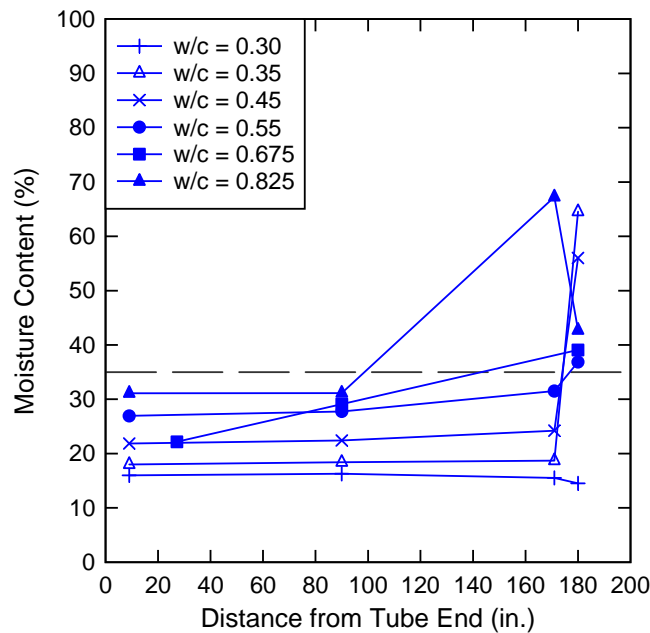

Figure 71—Moisture content (0% filler)

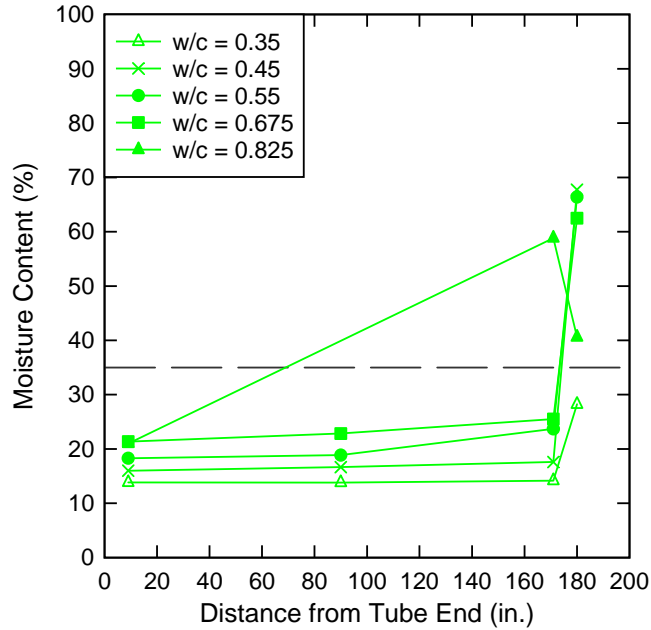

Figure 72—Moisture content (35% filler)

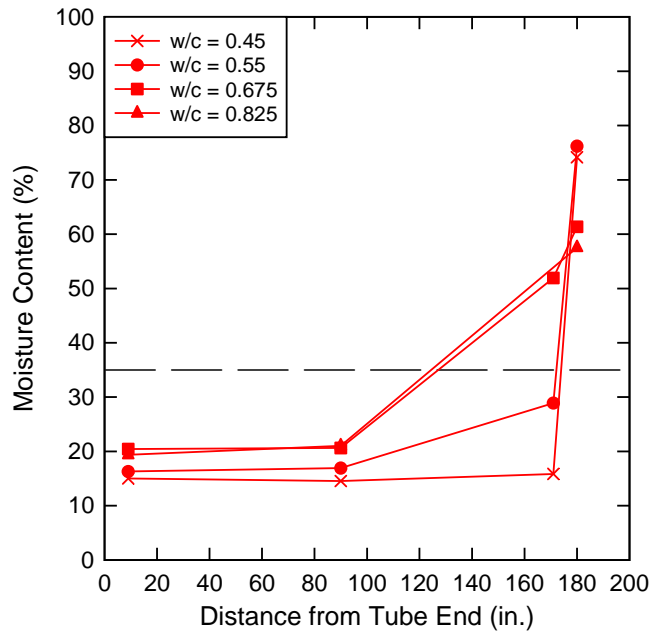

Figure 73—Moisture content (45% filler)

12.3.2 Prepackaged PT grout

Figure 74 shows the moisture content along the length of the tube for prepackaged PT grouts mixed at their maximum specified w/s. Based on Figure 74, all of the PT grouts behaved satisfactorily with no soft grout or bleed water present along the length of the tube. Figure 74

shows the moisture contents along the length of the tube for all high performance prepackaged PT grouts mixed at 15 percent extra mixing water.

Figure 74 also indicates that all of the PT grouts behaved satisfactorily, with the exception of PT 2-4, and PT4-6. The moisture content at the free surface of the grout near the exit valve for PT 2-4 was relatively high, but there was no visible soft grout present. PT 4-6 mixed at 15 percent extra water resulted in soft grout near the exit valve. This compares well with results presented in Figure 41 from tests on previous lots of prepackaged PT grout. PT 4-6 was the only prepackaged grout that had soft grout near the exit for any of these tests on the high performance grouts.

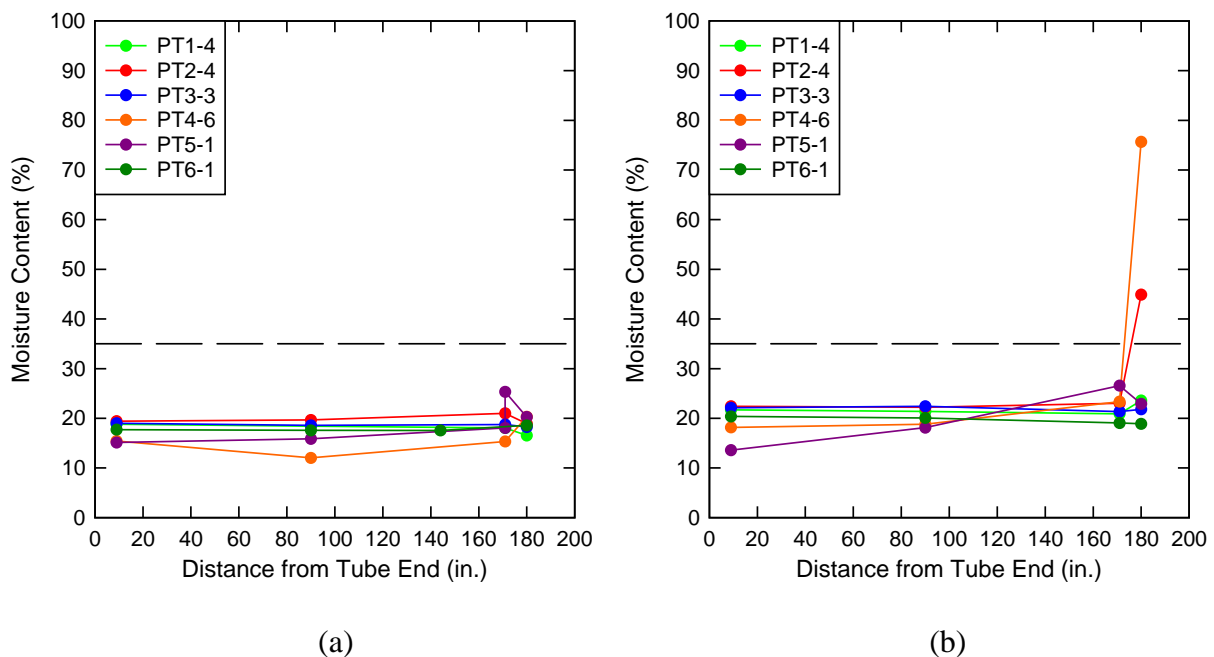

Figure 74—Variation in moisture content along length of tube with (a) MWD (b) 1.15·MWD

12.4 Bleed

MITT presented an effective way to measure bleed water observed in a full-scale grouting operation. These bleed quantities could then be compared with the results from pressure bleed tests. Figure 75 and Figure 76 compare the bleed measured with MITT and pressure bleed test.

According to Figure 75 (left), increasing the percentage of filler decreases the amount of bleed water at higher w/c. However, at lower w/c such as 0.45, there is no bleed water present for any of the percentages of filler including plain cement. PT grouts are typically mixed at w/c

less than 0.45, so the use of filler material for reducing bleed is not justifiable based on these findings.

Figure 75 (right) shows that increasing the percentage of filler at any w/c will decrease bleed. PT grout bleed is typically addressed using small scale laboratory tests like the pressure bleed test. Based on the results from Figure 75, the pressure bleed test detects bleed susceptibility over all ranges of filler content and w/c. Inclined bleed, however, is not detected at lower w/c ratios, which is also the levels at which the PT grouts are mixed.

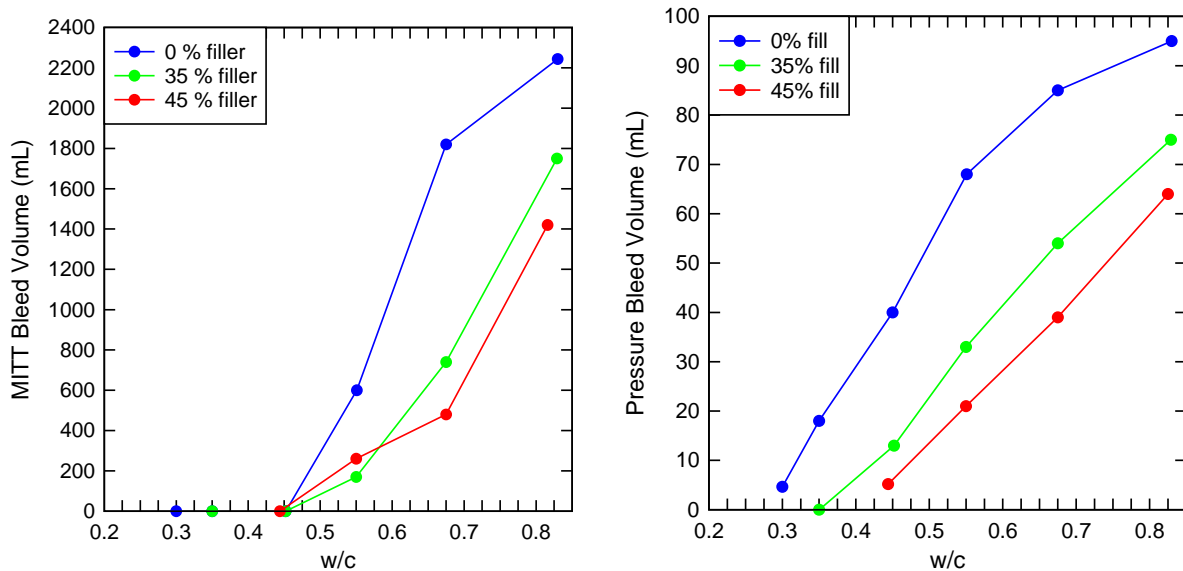

Figure 75—Comparison of modified inclined tube and pressure bleed measurements with respect to w/c

Figure 76 (left) shows that as the percentage of filler material is increased, a lower w/s was necessary to achieve zero bleed in the inclined tube. Figure 76 (right) shows practically no difference between the mixes conducted at 35% and 45% filler. Results from mixtures with and without fillers, however, indicate significant differences in bleed.

12.5 HRWR and Segregation

Figure 77 shows that increased dosage of HRWR admixture increased segregation as measured by moisture content. The plot indicates that the moisture content is relatively consistent with the exception of the top of the inclined where the mixture containing HRWR has nearly twice the moisture content as that of the mixture without HRWR. Given that this mixture contained no added filler, it is possible that the small percentage of the inert filler material that is

present in the portland cement was segregated because of the use of the HRWR. Figure 77—Moisture content for C45-0 also shows the moisture content with and without HRWR for 35% filler tested at $w/c=0.675$, and 45% filler tested at $w/c=0.825$, respectively.

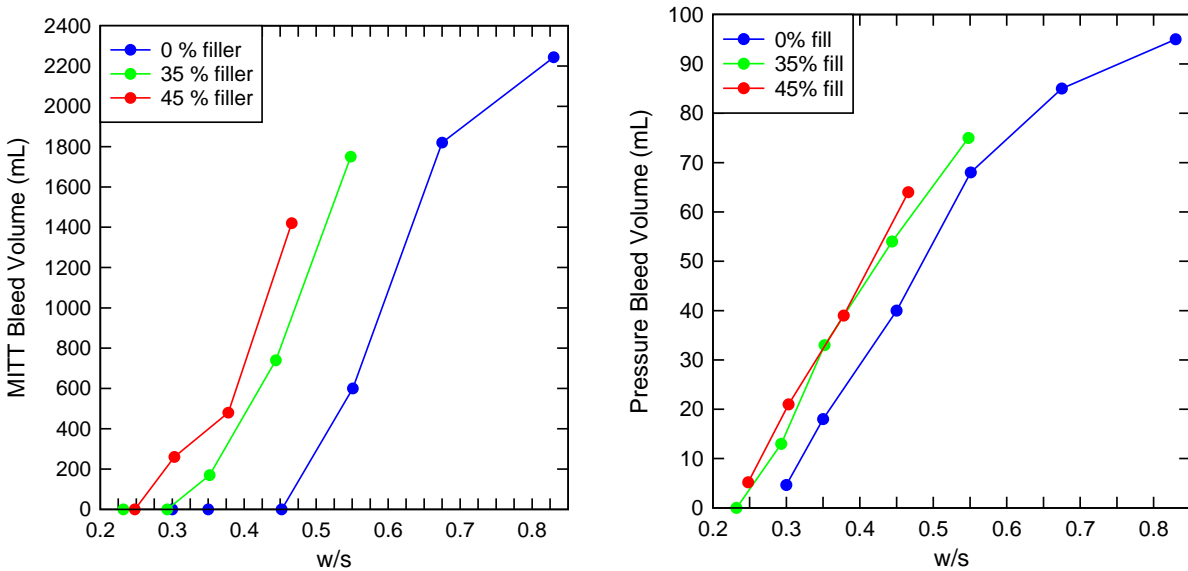

Figure 76—Comparison of modified inclined tube and pressure bleed measurements with respect to w/s

Based on Figure 77, the moisture contents along the length of the tube are consistently higher when no HRWR admixture is used, except at the exit of the inclined tube where they are consistently lower. One explanation for this behavior is that HRWR caused filler material segregation from the cementitious material due to excessive bleeding, which resulted in normal hardened grout along the length of the tube up to the exit.

Figure 78, Figure 79, and Figure 80 show the bleed, soft grout, and viscosity readings from multiple experiments, respectively. Based on the comparison between multiple tests conducted at the same w/c and percentages of filler material, the use of HRWR increased the grout bleed and soft grout quantities observed in the inclined tube. HRWR also decreases the viscosity of the grout in fluid form substantially.

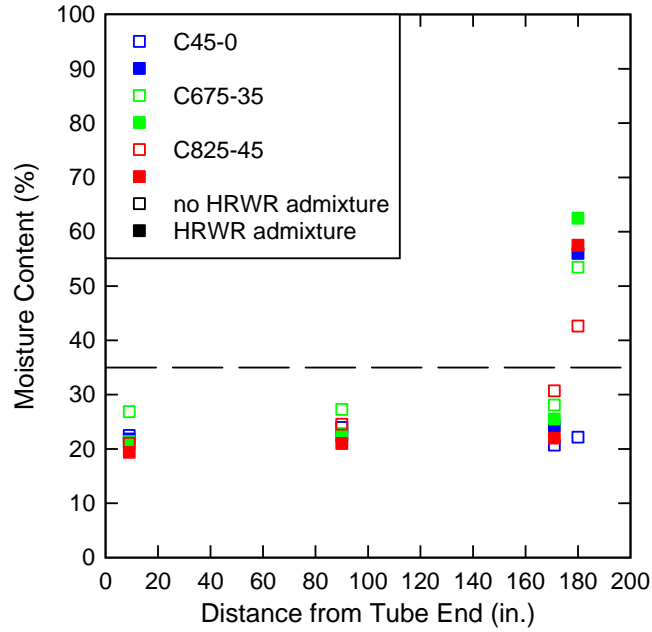

Figure 77—Moisture content for C45-0, C675-35, and C825-45

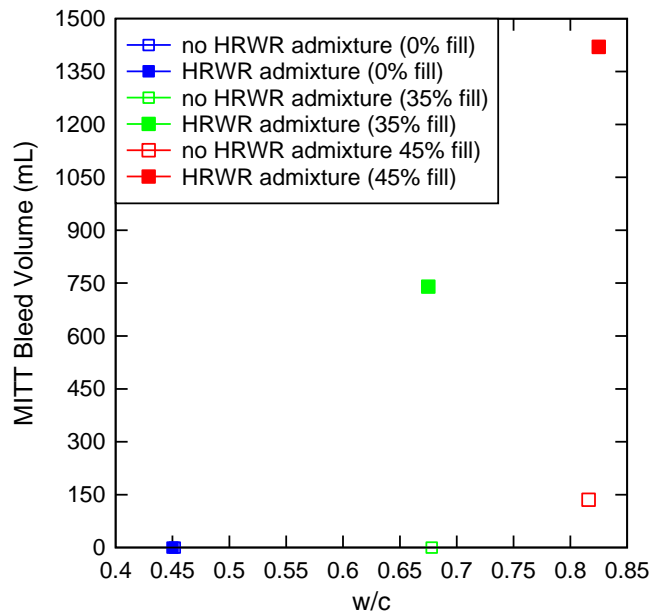

Figure 78—Bleed water for mixes with and without HRWR

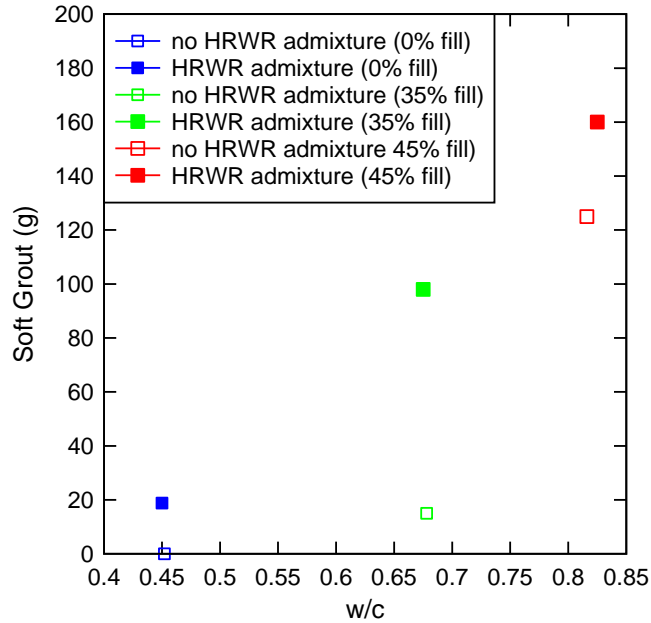

Figure 79—Soft grout for mixes with and without HRWR

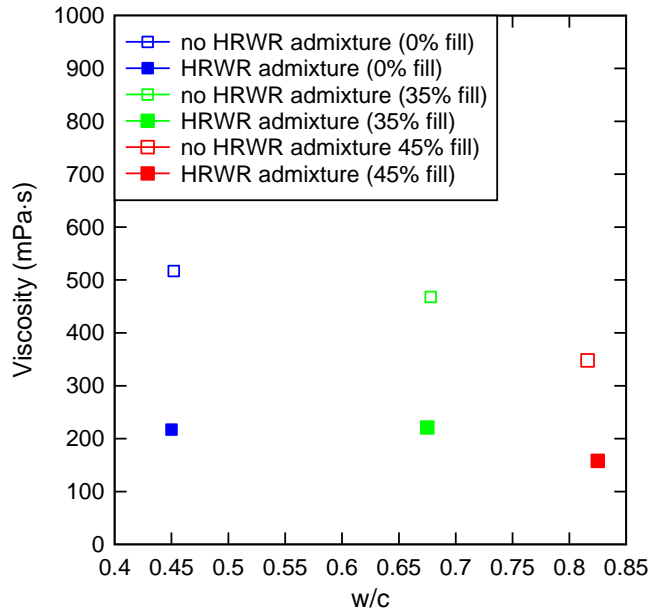

Figure 80—Viscosity for mixes with and without HRWR

Figure 81, Figure 82, and Figure 83 show the ratio of mixing water volume to HRWR volume plotted against the maximum moisture content, bleed water, and soft grout, respectively. Figure 81 reveals an interesting trend in the moisture content results. All three sets of data with different percentages of filler material appear to converge to approximately 60% moisture

content at high water-HRWR ratios. Additionally, at low water-HRWR ratios the maximum moisture content increased as the percentage of filler material was increased.

Figure 82 and Figure 83 also show that for a given water/HRWR ratio, increasing the percentage of filler increased the amount of bleed and soft grout formation.

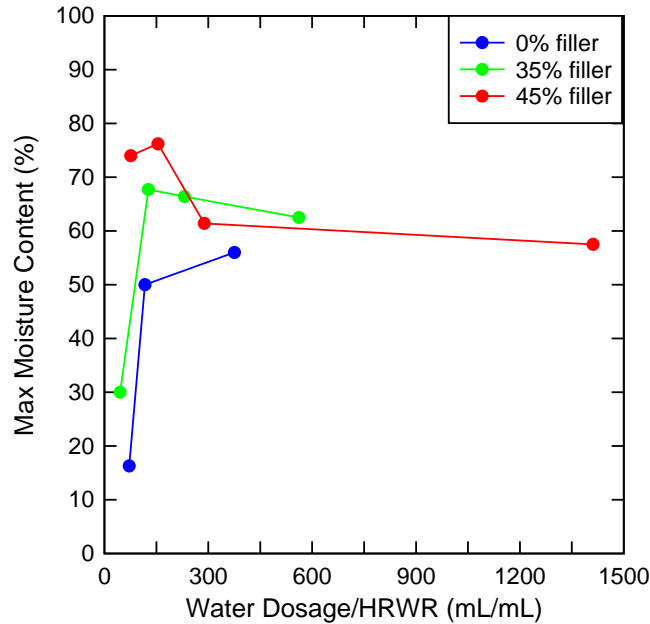

Figure 81—Maximum moisture content versus water/HRWR ratio

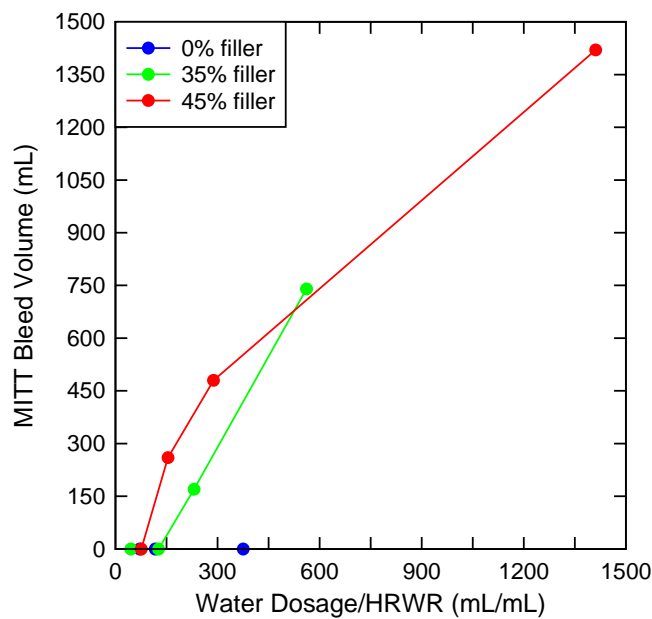

Figure 82—Bleed water versus water/HRWR ratio

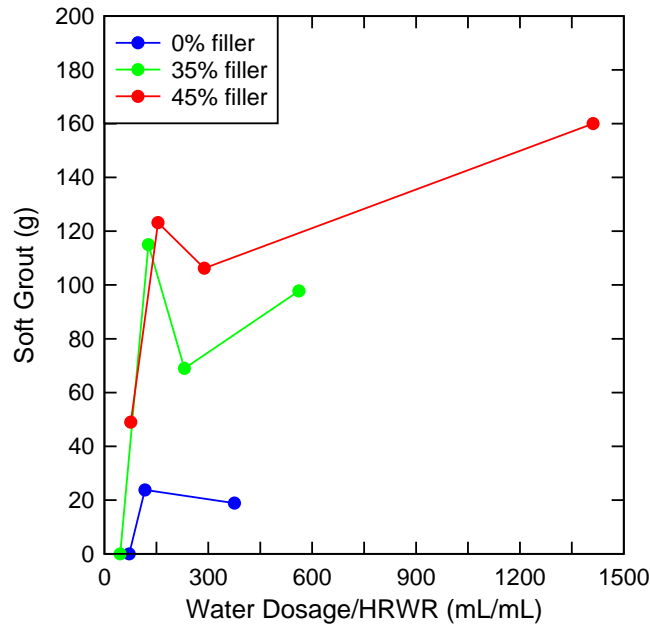

Figure 83—Soft grout versus water/HRWR ratio

12.6 Plain Grout and PT Grout Comparison

PT4-6 was the only grout that produced soft grout when excess water was used to mix the grout. For this reason, four supplemental tests were conducted on PT4-6 to study its sensitivity to w/s. Since the relative constituent volumes are not known, the results from the sensitivity study on PT 4-6 cannot be compared directly to results of testing on plain grout with filler. One indirect method, however, is to compare the results using w/s.

Figure 84 shows the flow cone times from the PT4-6 water sensitivity study plotted with results from plain grout tests. Flow cone times for the PT4-6 test have the same upward concavity and relative magnitude that the plain grout efflux times have at low w/s. One conclusion that can be drawn is that at low w/s, the filler material has a positive effect on the fluidity of the grout. For example, the test conducted near the 0.3 w/s and 0% filler required more HRWR than the tests with filler material, but still had a higher flow cone value.

Figure 85 shows a plot of the flow cone against w/s for all PT grouts, as well as the filler cement combinations. Based on Figure 85, it is difficult to draw conclusions on how a PT grout will behave in the inclined tube based exclusively on the flow cone efflux times. For example, PT 5-1 has similar w/s ranges and magnitudes of flow cone times as PT4-6, but PT4-6 resulted in soft grout and PT 5-1 did not. Additionally, PT 3-3 closely follows the trend of the filler flow cone values, but resulted in no soft grout in the inclined test tube.

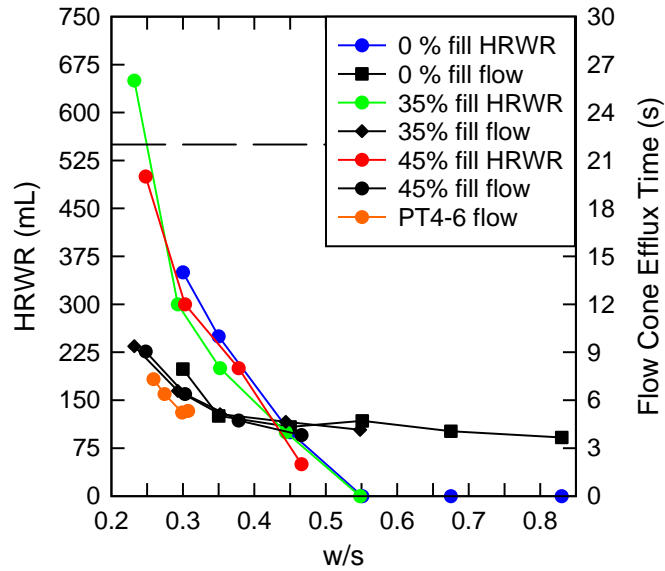

Figure 84—HRWR/flow cone time versus w/s ratio (including PT4-6 tests)

Figure 86 shows viscosity readings from the PT4-6 water sensitivity study plotted with results from the plain grout and filler testing. Figure 86 shows that the viscosity values for the PT4-6 test are more sensitive to variation in w/s than the plain grouts based on the slope of the PT4-6 viscosity line. However, the values are less than or equal to 250 mPa·s.

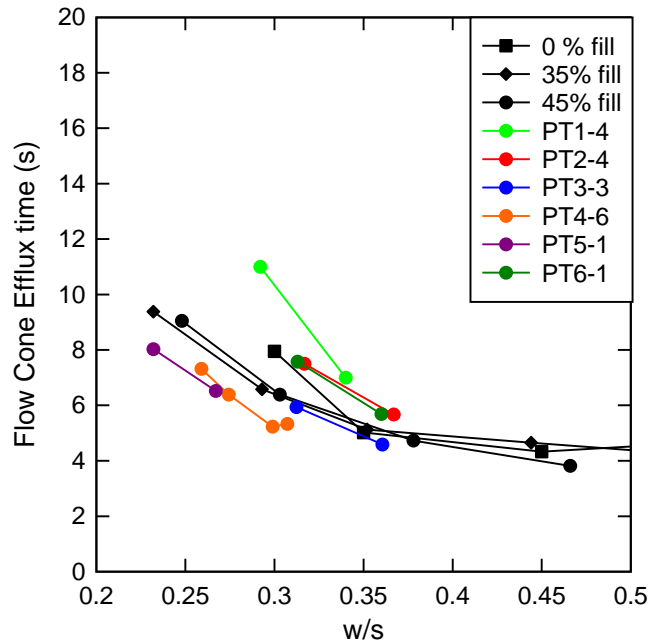

Figure 85—Flow cone time versus w/s (including all PT grouts)

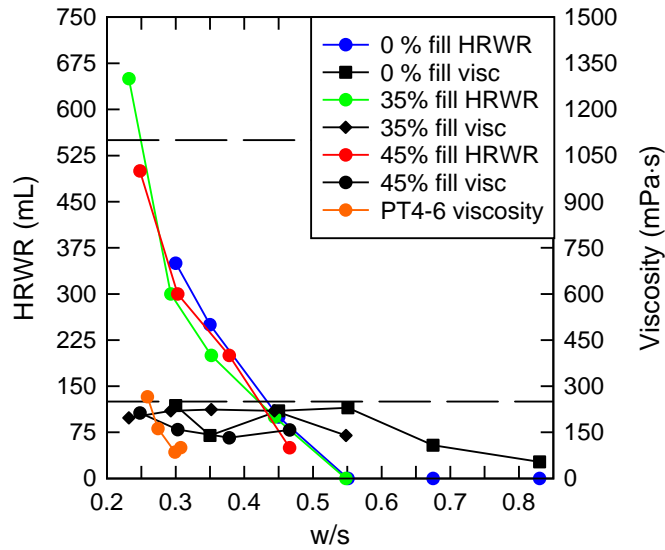

Figure 86—HRWR/viscosity versus w/s ratio (including PT4-6 tests)

Figure 87 shows a plot of the viscosity versus w/s for the plain grouts as well as all PT grouts tested. Based on Figure 87 above, all PT grouts exhibited highly sensitive viscosity behavior for MWD and 1.15·MWD.

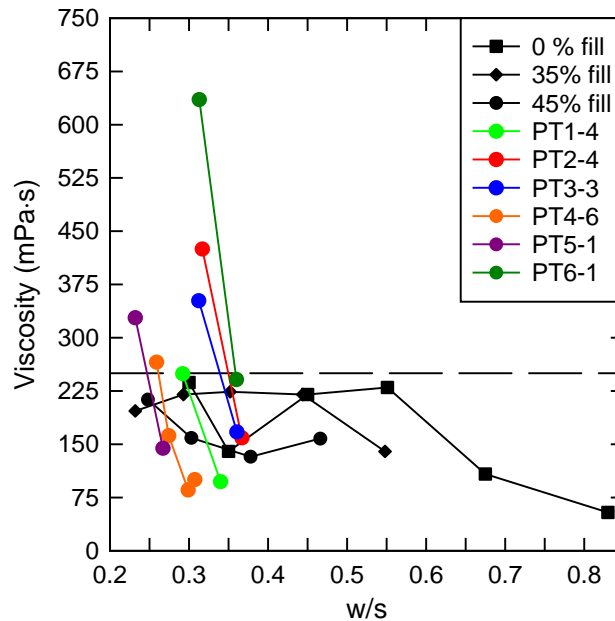

Figure 87—Viscosity versus w/s (including all PT grouts)

Figure 88 is a plot of the amount of soft grout sampled from the plain grout tests, as well as the samples from the PT4-6 sensitivity study. Figure 88 reveals the same trend between the

plain grout tests and the PT4-6 grout tests. The soft grout quantities for PT4-6 seem to fall between the tests conducted with and without additional filler material. This could possibly be an indication that PT4-6 has up to 35% filler by powder weight.

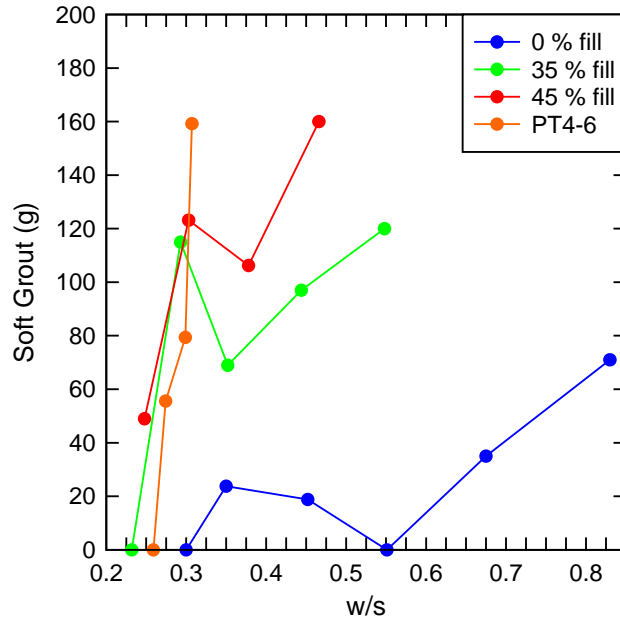

Figure 88—Soft grout versus w/s for varying amounts of filler (including PT4-6 tests)

Figure 89 and Figure 90 show the moisture content values for tests conducted on both prepackaged PT grouts and plain grouts that resulted in no soft grout and soft grout, respectively. Figure 89 shows the constant low moisture content along the length of the tube up until the exit region that is almost exclusively observed for incline tests resulting in soft grout.

As with testing reported earlier in this report, higher moisture contents appear to be an indicator of soft grout. In general, when the moisture content is above the range from 35% to 50%, then that test is likely to have produced soft grout. When compared to the original moisture content of the mixture, prepackaged PT grouts are typically mixed at w/s = 0.25 to 0.35, which would lead to moisture contents in the 25 to 35% range, if bound water is neglected.

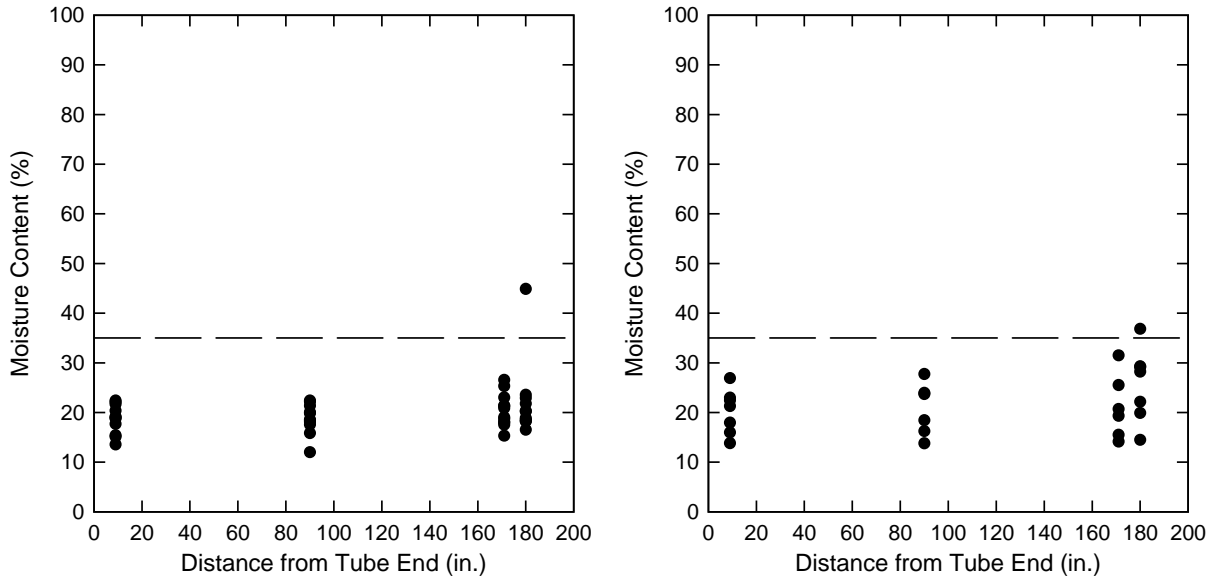

Figure 89—Moisture contents for tests with no soft grout (left: PT grout, right: Plain grout)

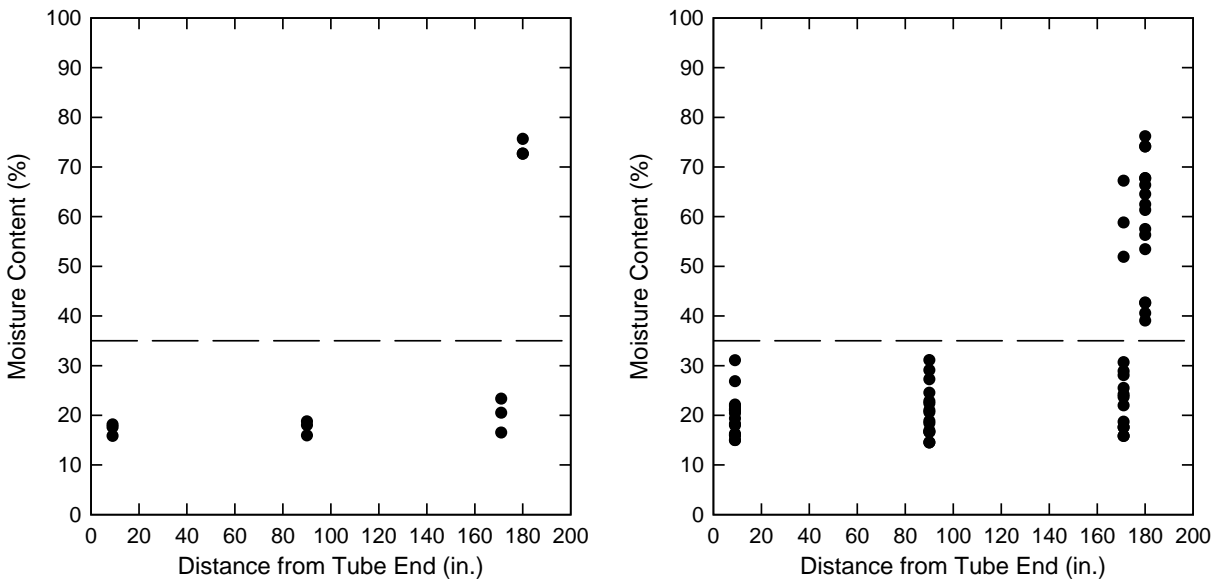

Figure 90—Moisture contents for tests with soft grout (left: PT grout, right: Plain grout)

(a)

(b)

Figure 91 shows unit weight and wet density data from the plain grout tests, as well as the results from the sensitivity study conducted on PT 4-6. The horizontal and vertical limits have been adjusted for these plots to show an enlarged view of the area of interest. The unit weight values follow the trend from all of the other physical data collected from these experiments: that is PT4-6 results match up with the results from the plain grout tests with additional filler material.

Figure 92 shows a plot of the unit weight values versus w/s for all PT grouts. Based on Figure 92, all of the grouts have relatively the same slope, with the unit weight increasing as w/s decreases. One possible explanation as to why the other PT grouts have lower unit weight values than PT 4-6 and did not result in soft grout could be that they have larger proportions of lighter weight supplemental cementitious material such as silica fume or fly ash.

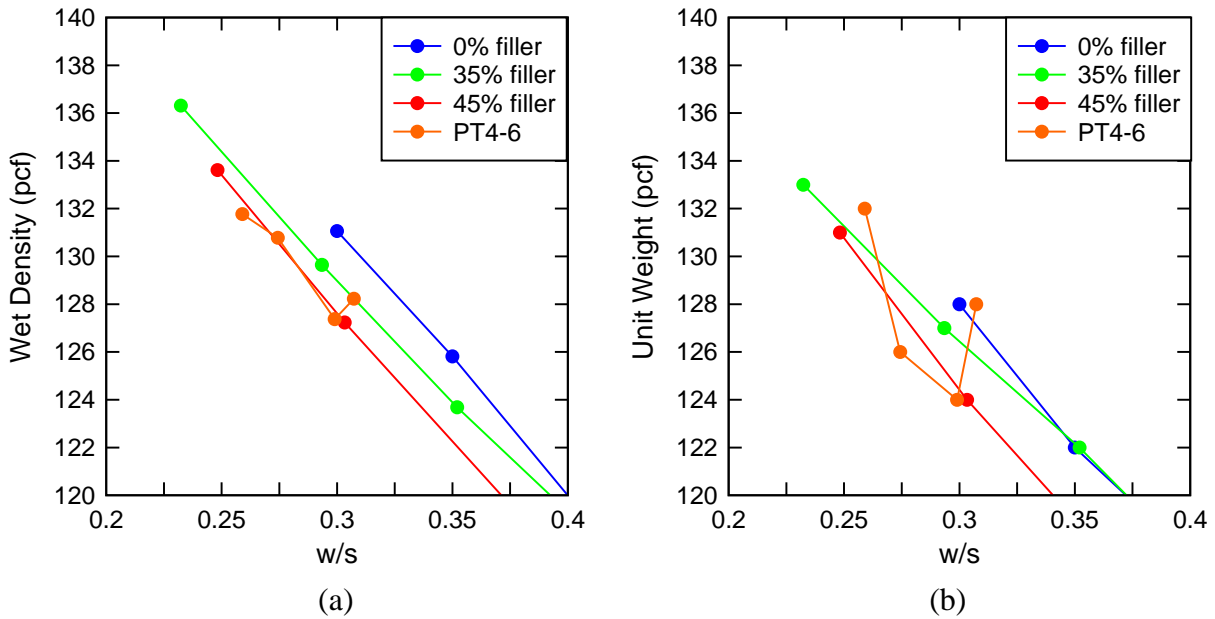

Figure 91—Variation of (a) unit weight and (b) wet density with w/s

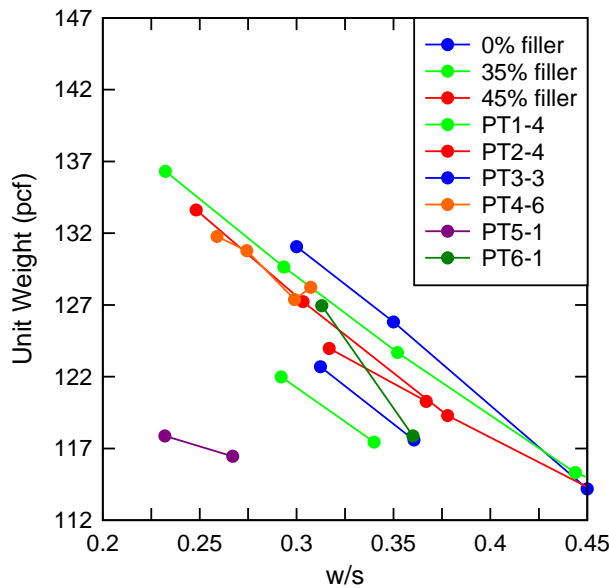

Figure 92—Variation of unit weight with w/s for all PT grouts

13 Shelf Life—Results and Discussion

This chapter presents the results of modified inclined tube testing (MITT) of prepackaged grouts PT1 through PT6 after exposing bagged material to various environments. The objective of these tests was to determine the effect bagged material age on the production of soft grout.

The tests reported in this chapter were conducted using the grout plant powered by compressed air.

13.1 Pre-hydration Effect on MITT Results

MITT conducted on aged grout revealed two instances in which pre-hydration of the grout affected the mixing process. The first incident occurred during the *Field* condition expiration test of PT2-4. During the mixing process for that inclined tube test, 8.46 lb of pre-hydrated grout chunks had to be removed because they were too large to run through the injection pump (Figure 93).



Figure 93—Pre-hydrated grout chunks removed before mixing

It is possible that these pre-hydrated chunks formed as a result of prolonged exposure to the *Field* condition in which relative humidity values fluctuate as high as 77% RH. It is also possible that some rain water leaked into the *Field* condition storage bin and made direct contact with some of the bags stacked on the outer edge of the pallets. The *Field* condition expiration test of PT4-6 had to be abandoned because all four bags contained unusable material.

13.2 Laboratory and Field Conditions

For the shelf life study, all six PT grouts were exposed to both *Laboratory* and *Field* conditions and then MITT tested both before and after their expiration date. The exceptions were PT5-1 and PT6-1, which had specified shelf lives of 365 d, and could not be tested before the end of the research contract.

Figure 94 shows amount of soft grout found in the pre- and post-expiration MITT tests for *Field* and *Laboratory* conditions. PT5-1 and PT6-1 are excluded from this figure because their expiration MITT has not yet been conducted, and the PT4-6 expiration test for the *Field* condition is not shown because the test was unable to be conducted due to pre-hydration of the grout as explained in section 13.1.

Figure 94 shows that for every grout in which all the data regarding the weight of soft grout was able to be obtained, the increase in the amount of soft grout found during the inclined bleed test was greater when the grout was exposed to *Field* conditions as compared to *Laboratory* conditions. This trend is shown in Figure 94 in that the slopes of all the *Field* condition lines are greater than the slopes of the *Laboratory* condition lines for their respective grouts. Such a trend indicates that the factors responsible for the degradation of PT grouts have a stronger, more expedited effect on the grout in *Field* conditions than in *Laboratory* conditions.

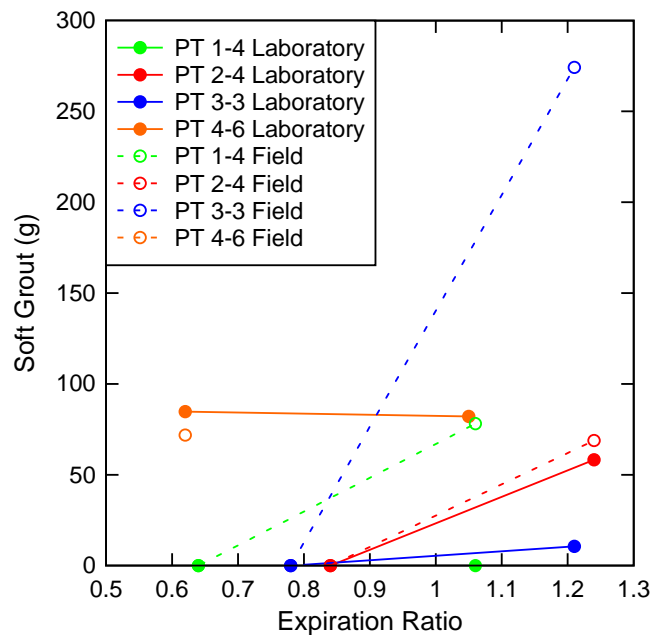

Figure 94—Mass of soft grout collected during MITT for expired and unexpired grout in *Laboratory* and *Field* conditions

13.3 PSA Results

For the particle size analysis study, a particle size analyzer was used to measure the mean and standard deviations of PT grout samples in an attempt to find some correlation between these two measurements and the formation of soft grout during MITT. Figure 95 shows the mean particle size data for all six grout types tested as well as for portland cement. Mean particle sizes were all measured before the samples were placed in the *Extreme* condition incubator and then measured again after the sample had been exposed to the high heat and high humidity environment for the following lengths of time: 1 d, 3 d, 7 d, and 14 d.

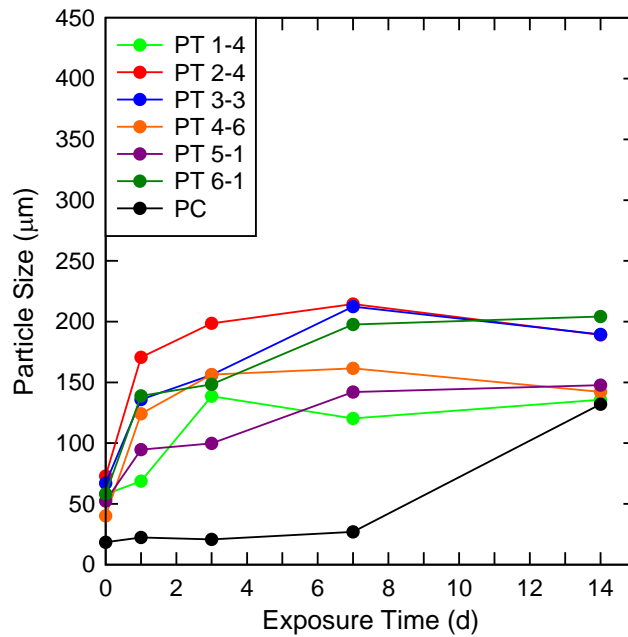

Figure 95—Mean particle size data

Figure 96 displays the standard deviation of the particle sizes for these same grout samples at the same time intervals: 1 d, 3 d, 7 d, and 14 d.

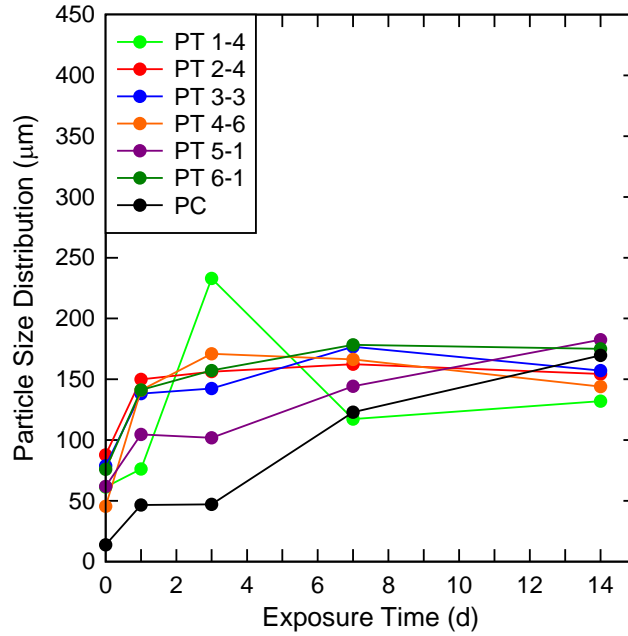

Figure 96—Standard deviation particle size data

Figure 97 shows the weight of the soft grout that was found during MITT for those grouts measured in the particle size analyzer. The numbers in parenthesis in the legend indicate the 7 d expiration ratios for their respective grouts.

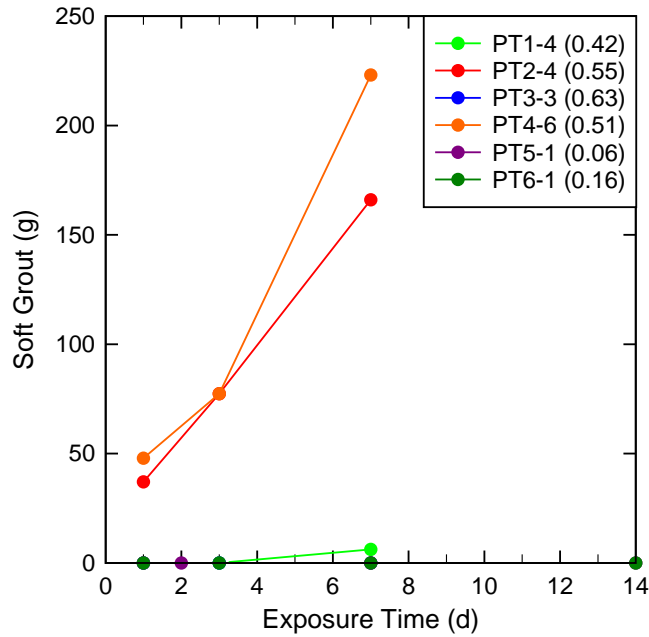

Figure 97—Mass of soft grout collected during MITT for those grouts measured in the particle size analyzer

Figure 95 and Figure 96 indicate that both the mean and the standard deviation of the grout particle sizes consistently increased over time when the samples were exposed to the *Extreme* condition of the incubator. The increase in mean particle size over time when exposed to *Extreme* condition suggests that either the heat of the incubator, the humidity of the incubator, or the combination of the two produces growth in the size of the grout particles. The increase in the particle size distribution when exposed to *Extreme* condition suggests that at least some of the grout particles being exposed to the heat and humidity are changing in size. Although there are several mechanisms that could be responsible for this change in particle size, one hypothesis is that the grout particles experience hydration during their exposure to heat and humidity. Further testing would need to be done in order to more specifically determine the cause of this growth in grout particle size over time when exposed to the *Extreme* conditions of the incubator.

Figure 97 shows that of the PT grouts exposed to the *Extreme* condition for 1, 3, 7 and 14 d, PT1, PT2, and PT4 experienced an increase in the formation of soft grout while PT3, PT5, and PT6 did not form any soft grout after the exposure. Because the trend in Figure 97 indicates that prolonged exposure to the *Extreme* condition increases the formation of soft grout, it may be beneficial to conduct another test under the same conditions, but using longer exposure times to observe if all six grouts eventually start producing soft grout. This trend could be an indication of the hypothesis presented earlier that prolonged exposure to heat and humidity results in the pre-hydration and growth of grout particle, which ultimately produced soft grout. If this hypothesis is true, it may be possible to use the particle size analysis to qualify the quality of a particular grout by predicting whether or not that grout will form soft grout based on its mean particle size and/or particle size distribution. It should be noted, however, that there may be some other flocculation phenomenon that is to some extent responsible for this increase in mean particle size and that pre-hydration may not be the only mechanism resulting in soft grout. But in order to gain a better understanding of this phenomenon, further testing would need to be conducted.

13.4 Moisture Content

Throughout this shelf life study, the performance of PT grouts has been based on the formation of soft grout. Although it is directly related to the formation of soft grout, another way to analyze the performance of a grout with MITT is to compare the moisture content at the

bottom of the tube to the moisture content at the top of the tube. Although the moisture content of the grout is almost always slightly higher at the top of the tube than at the bottom of the tube, in the tubes that did not show the formation of soft grout, the moisture content at the top of the tube was very similar to the moisture content at the bottom of the tube, usually between 15 and 25%. However, in those tubes that experienced the formation of soft grout, the moisture content at the top of the tube was much higher, sometimes reaching over 80%.

Figure 98 shows the average ratios for each grout of the moisture content at the top of the tube to the moisture content at the bottom of the tube for all tests conducted using MWD and within the manufacturer’s specified shelf life (i.e. no excess water with unexpired grout). Those tests with a ratio of approximately 1.0 indicate that the moisture contents are roughly the same at the top and bottom of the tube and that no soft grout was formed.

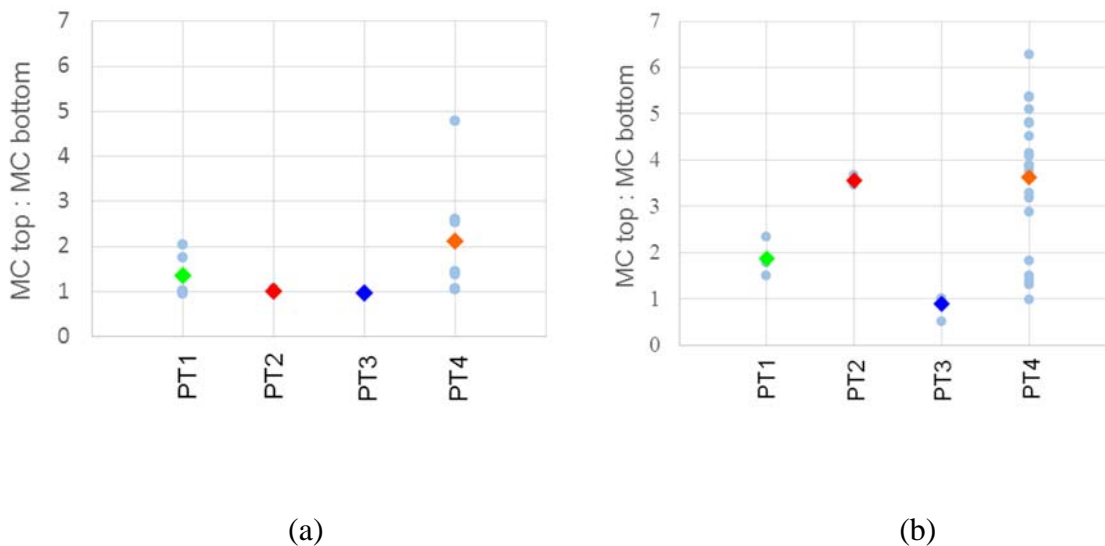

Figure 98—Ratios of moisture content at the top of the tube to moisture content at the bottom of the tube using MWD for (a) unexpired grout and (b) expired grout

Figure 98 shows the ratios of all the individual tests along with the average for each grout with the exception of PT5 and PT6. Test results shown in the figure contain multiple lots from the same manufacturer. Comparing the unexpired grout ratios to the expired grout ratios shows significant increases in all the grouts except PT3. The average ratio of PT1 increases from 1.4 to 1.9, the average ratio of PT 2 increases from 1.0 to 3.6, and the average ratio of PT4 increases from 2.1 to 3.6. This increase indicates that moisture is moving toward the top of the incline and

that solids are settling to the bottom. Disproportionate moisture content between the top and bottom correlated with the soft grout. One conclusion that can be made from these results is that time negatively affects the performance of a grout by increasing its susceptibility to the formation of soft grout.

Figure 99 displays the average ratios of the moisture content at the top of the tube to the moisture content at the bottom of the tube for all the same test displayed in Figure 98, but the ratios are divided into their respective lots. Although direct comparison within lots is not possible, the same general trend can be seen in that the expired grouts, regardless of their lot, are more susceptible to high moisture content ratios and soft grout than unexpired grouts.

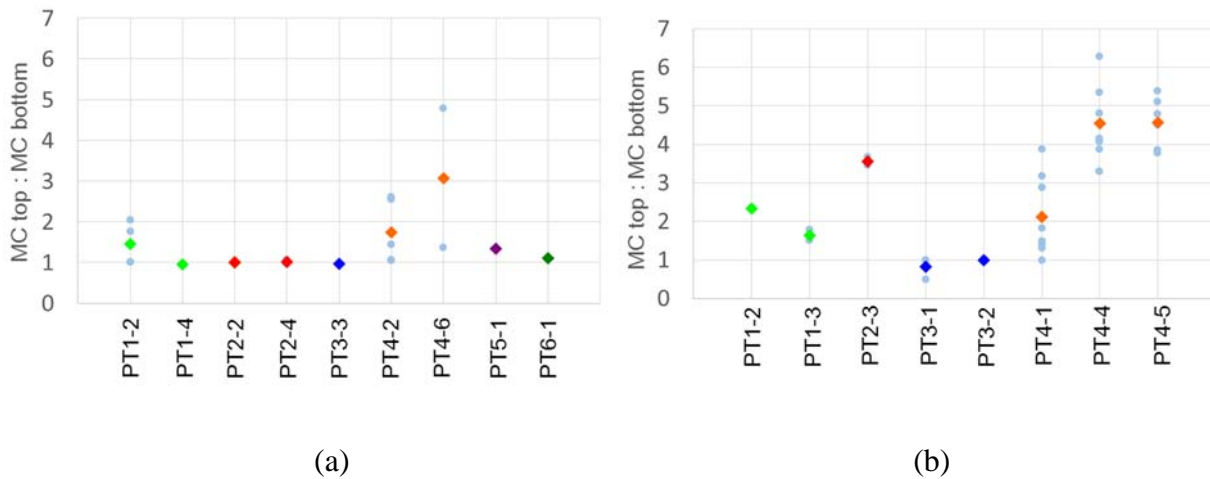

Figure 99—Average ratios of the moisture content at top of the tube to moisture content at the bottom of the tube for all tests using MWD and categorized by lot on (a) unexpired grout and (b) expired grout.

14 Summary and Conclusions

The objective of this research project was to determine and be able to reproduce the cause of soft grout that was discovered in post-tensioning (PT) ducts in several bridges around the state of Florida. A modified version of the Euronorm inclined tube test named Modified Inclined Tube Test (MITT) was developed and used to conduct the majority of the testing. The inclined test tube offered a configuration that could be used in a laboratory setting to simulate grout bleed and segregation during full-scale mixing and injection. The change in elevation between the top and the bottom of the inclined test tube causes bleed at the base of the tube to flow upward along the length of the tube due to the pressure head. This bleed then filters or washes out the less dense particles present in suspension, resulting in an unreacted putty grout near the free surface of the grout at the exit of the inclined test tube, and normal hardened grout along the length of the tube. Modifications to the inclined test method included using a slightly shorter length of bundled strand to facilitate grout sampling at top end of tube; sampling and inspecting for soft grout at top, bottom, and mid-height of the specimen; and measuring moisture content in sampled grout.

Other common grout fresh property tests including flow cone, wet density, unit weight, and pressure bleed were routinely conducted in parallel with the MITT. Apparent viscosity testing was conducted using a dynamic shear rheometer in parallel with MITT to determine if a correlation could be established between the rheology of the grout and its affinity for producing soft grout.

This research was divided into three primary phases. The first was to develop the Modified Inclined Tube Test and determine the affinity of prepackaged grout for producing soft grout under laboratory and field test conditions. None of the commercially available prepackaged PT grout tested with MITT produced bleed or soft grout when the grout was mixed and injected in accordance with manufacturer's recommendations and tested well before the expiration date printed on the bag.

In an effort to induce soft grout production, testing was conducted in which a number of variations on MITT were introduced that would simulate more closely the variations that occur in field conditions. In this series of testing, the following variations were imposed on all of the PT grouts tested:

- 15% additional water beyond maximum recommended water dosage (1.15·MWD)
- Residual water in the tube
- tube constriction

Additional mix water and residual water in the tube produced soft grout consistently in one of the PT grouts, and in one case with the tube constriction (PT4). Further tests were conducted on PT4 that involved tubes that were packed full of strands, high temperature injection, pressurized set, strand placed in the top of the tube, among others. None of these conditions produced soft grout consistently.

The second phase of testing focused on the effect of low-reactivity fillers on the production of soft grout in plain grout formulations. A plain grout formulation consisting of ASTM C150 Type I/II portland cement, varying percentages of ground calcium carbonate, varying levels of HRWR, and varying w/c was tested to determine how the formation of soft grout and bleed was affected by each constituent. The levels of HRWR were varied so that each grout mixture achieved a viscosity that was below 250 mPa·s.

Finally, the third phase of testing focused on the shelf life of bagged PT grout. Preliminary testing indicated that long storage times appeared to make prepackaged PT grout more susceptible to the formation of soft grout under MITT. PT grout manufacturers place expiration dates on their product, yet there appear to be no standards or rational process for determining this date. In addition, some include details of the storage conditions under which the PT grout may be held to ensure full shelf life and some do not. Potential modes of degradation include pre-hydration of the portland cement and deterioration of the admixtures over time. Three exposure conditions were selected *Laboratory*, *Field*, and *Extreme* to which PT grout was exposed and then tested with MITT for soft grout. Companion particle size analysis (PSA) tests were conducted to determine correlation between the production of soft grout and changes in particle size due to pre-hydration.

Conclusions from Field Conditions Testing:

- High performance prepackaged PT grouts tested at the MWD recommended by their manufacturers and tested well before the expiration date resulted in no soft grout.
- Soft grout was produced in PT4-1, PT4-2, and PT4-6 under several conditions. When extra water was introduced into the mixing and injection process, PT4-1,

PT4-2, and PT4-6 were found to produce soft grout. In addition, in one out of two cases in which the grout was injected through a constricted path, PT4-2 was found to produce soft grout.

- When PT1-2 was mixed with a water dosage greater than MWD, porous hardened grout was found at the top of the inclined tube.
- With the exception of PT4-1, PT4-2, and PT4-6, high performance prepackaged PT grouts were robust when subjected to 1.15·MWD, resulting in no soft grout. PT 2-4 did have a larger moisture content of 45% at the exit region of the inclined tube relative to the other four PT grouts, but did not have any visually identifiable soft grout. PT4-6 had a moisture content of 76% at the exit region, with 55.6 grams of soft grout.
- Supplemental tests of fresh grout properties such as flow cone, unit weight, wet density, pressure bleed, sedimentation, and bleed readings on inclined tubes. The results of these tests did not provide indications that soft grout would be formed during MITT.

Conclusions from Inert Filler testing:

- Mixtures with 45% and 35% additional filler material consistently generated more soft grout than mixtures with 0% additional filler for any given w/s.
- All tests conducted at 0%, 35%, and 45% additional filler material exhibited no bleed when the w/c was reduced below 0.45.
- Pressure bleed test detected bleed tendency in plain grouts at a lower w/c than MITT
- For a given w/s, increasing the percentage of filler material will in fact increase the amount of bleed water in the inclined tube.
- In plain grout tests, HRWR decreased the viscosity of the mixture, increased the volume of bleed and segregation, and increased the moisture content near the exit region of the inclined tube.
- Moisture content along the length of the tube for tests conducted on plain grouts and prepackaged PT grouts had very similar distributions for tests resulting in soft grout and no soft grout. Tests resulting in soft grout consistently had an

excessively high moisture content level near the exit region for both prepackaged PT grouts and plain grouts, which ranged from 35% to over 50%.

- Mixtures with low w/c, large HRWR dosage, and 34% or 45% filler material achieved desirable fluidity characteristics without resulting in segregation of the portland cement and filler material.

Conclusions from Shelf Life Study:

- Prolonged storage times increased the susceptibility of prepackaged PT grouts to the formation of soft grout, even in favorable environments.
- High temperature and relative humidity environments during storage of dry grout material led to increased tendency for soft grout to form.
- Mean particle size of dry prepackaged PT grout material increased significantly when exposed to high heat and humidity. In many cases, this was accompanied by an increase in susceptibility to the formation of soft grout.

15 Improved Grout Performance

The following observations that are based on the research reported herein may be useful for improving the performance of PT grouts:

- Modified inclined tube test can be used to test prepackaged or custom formulated grout mixtures for bleed and soft or other irregular grout formation. Testing should include bleed, volume, and hardened grout moisture content.
- To encourage a robust formulation, PT grouts should be tested using more mixing water than the maximum recommended by the manufacturer. Measures should be taken to ensure that the manufacturers do not artificially decrease their MWD.
- Inert filler material increased the tendency to produce soft grout in plain grout formulations that included high-range water reducers. Their use should be carefully considered in PT grout.
- This research showed that several prepackaged PT grouts are susceptible to producing soft grout when the dry bagged material is stored in hot, humid environments.
- Standard methods for determining the shelf life of grout should be developed to ensure that PT grout will perform adequately after storage.
- There needs to be specific requirements for the temperature and relative humidity value limits in storage environments for PT grouts.

16 References

- ASTM C150-12 Standard Specification for Portland Cement*. (2012). West Conshohocken: ASTM International.
- ASTM C940 Standard Test Method for Expansion and Bleeding of Freshly Mixed Grouts for Preplaced-Aggregate Concrete in the Laboratory* (2010).
- ASTM C1741-12 Standard Method for Bleed Stability of Cementitious Post-tensioning Tendon Grout*. (2012). ASTM.
- Bertolini, L. and Carsana, M., (2011), "High pH Corrosion of Prestressing Steel in Segregated Grout," *Modeling of Corroding Concrete Structures*, RILEM Book Series Volume 5, pp 147-158
- CEN/TC 104. (2007). *Grout for prestressing tendons - test methods* (EN 445). Brussels, Belgium: European Committee for Standardization.
- Cervantes, V. and Roesler, J. (July 2007). *Ground Granulated Blast Furnace Slag*. Urbana, Illinois: University of Illinois; Department of Civil and Coastal Engineering.
- Chaussin, R. and Chabert, A. (2001). Strategies for Improvement - Approach in France -. *Durability of Post-Tensioning Tendons* (pp. 235 - 244). Ghent (Belgium): International Federation for Structural Concrete (fib).
- Corven, J. and Moreton, J. (May 2004). *Post-Tensioning Tendon Installation and Grouting Manual*. Federal Highway Administration.
- El-Didamony, H., Salem, T., Gabr, N., & Mohamed, T. (1994). *Limestone as a Retarder and Filler in Limestone Blended Cement*. Ceramics.
- Fuzier, J. P. (2001). Development of Grout and Grouting Techniques. *Durability of Post-Tensioning Tendons* (pp. 173 - 194). Ghent (Belgium): International Federation for Structural Concrete (fib).
- Hawkins, P., Tennis, P., & Detwiler, R. (2003). *The Use of Limestone in Portland Cement: A State of the Art Review*. Portland Cement Association.
- Jue, M. (2012). Effect of Inert Nanoparticles on Cement Hydration. *Nin Reu Research Accomplishments*, pp. 96-97.
- Martini, S. A. and Nehdi, M. (August 2009). *Coupled Effects of Time and High Temperature on Rheological Properties of Cement Pastes Incorporating Various Superplasticizers*. Journal of Material in Civil Engineering ASCE.
- Schokker, A., Koester, B., Breen, J., & Kreger, M. (October 1999). *Development of High Performance Grouts for Bonded Post-Tensioning Structures*. Austin, Texas: Center for Transportation Research.

Appendix A—Modified Inclined Tube Test Procedures

Scope

The purpose of the Modified Inclined Tube Test is to observe how post-tensioning (PT) grouts behave under field conditions. The test is used to see if bleed water and/or soft/segregated grout will be present after full-scale mixing and injection of the grout into PT tubes. The test is both qualitative and quantitative. The test is qualitative in nature because bleed and soft grout are visually identified. The method is quantitative because the amount of soft grout and bleed water are measured, as well as the moisture content of the hardened grout along the length of the tube.

Summary of Test Method

The test is conducted by grouting a 15-ft. long x 3-in. diameter transparent PVC pipe filled with twelve 0.6-in. diameter post-tensioning strands. The grout is mixed and pumped using a colloidal grout plant. In the 24 h following grout injection, visual observations are made of the tube to determine if bleed water has separated from the grout

Significance and Use

Although not currently used in the U.S., the inclined tube test has been used for several years in Europe to test grout mixture designs to determine the potential for bleed under simulated field conditions. The standard for the inclined tube test is given in Euronorm EN445 2007. The modified inclined tube test (MITT) is similar to the EN445, and is meant to identify grouts that will segregate as well as bleed under field conditions.

Interferences

When sampling the quantity of soft grout located inside of the inclined tube, the precision of this step is different between different operators. The amount of force used to gently scrape the soft grout for sampling can be variable, possibly resulting in bias in the test results.

Apparatus

Equipment items needed to perform this test are: colloidal grout mixing plant and hoses, inclined stand, and the tube specimen.

The colloidal grout mixing plant must be a production scale mixer typically seen in full-scale operations. The colloidal mixing tank must be large enough to mix a four bag mixture. Typical mixing tank volumes are between 8 and 13 cubic feet. The pump should be a progressive cavity style, and must be capable of conveying the fluid grout at a constant pressure and flow rate. The pump must be able to maintain an outlet pressure of 145 psi, although injection should be controlled at 40 psi throughout the system. The grout flow rate is controlled at roughly 16 ft of tube per minute. The hose used from the pump outlet to the tube inlet should be 50 ft x 1 in diameter hose.

The inclined stand must be capable of holding as many filled tubes as needed. The angle that the tubes are oriented is 30 degrees from the horizontal. The stand should be similar to the configuration shown in Figure 100 below.



Figure 100—Inclined stand

The tube specimen that is injected with grout is made up of clear schedule 40 PVC pipe and various fittings. The tube should have an overall length of 15 ft from the injection point to the far edge of the top clear PVC section as shown in Figure 101 below. The tube should be

filled with (12) 0.6-in. diameter PT strand cut to 14.5 ft lengths. This will result in a region of tube at the highest elevation that will not have any strand interference for sampling of the soft grout and bleed water. All fittings and pipe must be sanded and primed at the connection points before using PVC cement to ensure an air tight tube.

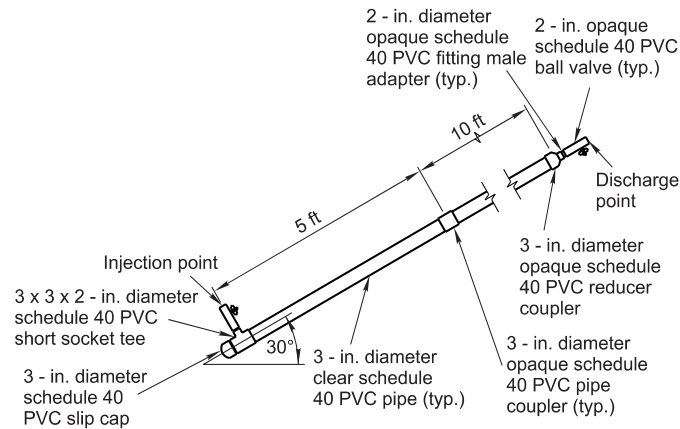

Figure 101—Inclined tube schematic

Reagents and Materials

The materials that are tested for this test method are cement based grouts. The grout that is tested using this standard test method is prepackaged, thixotropic PT grout used to encase the high strength steel tendons used in bridge construction around the world. Furthermore, potable water is used to mix the prepackaged PT grouts for testing.

Sampling, Test Specimens, and Test Units

Testing of the fresh grout

Before and after injection, multiple tests should be conducted on the grout in fluid form. After 2 gallons of fluid grout have been discharged immediately after mixing, the following tests are conducted:

- Flow cone
- Mud balance
- Unit weight
- Pressure Bleed Test
- Apparent Viscosity

After injecting the grout into the inclined tube, 2 gallons of grout should be discharged from the exit valve of the tube. The above tests should then be conducted again.

Testing of the hardened grout

After injection, the inclined tube should be sampled 24 h later. The tube must be lowered from the inclined stand before sampling can begin. The exit region of the tube should be opened using a handheld ban saw, and any bleed water and soft grout should be sampled and stored in an air-tight container. Moisture content samples of approximately 25 grams should be taken from the top and bottom of the cross section at the locations shown in Figure 102. Total sample size at each location should then be approximately 50 grams. Determine moisture content using ASTM D2216-10.

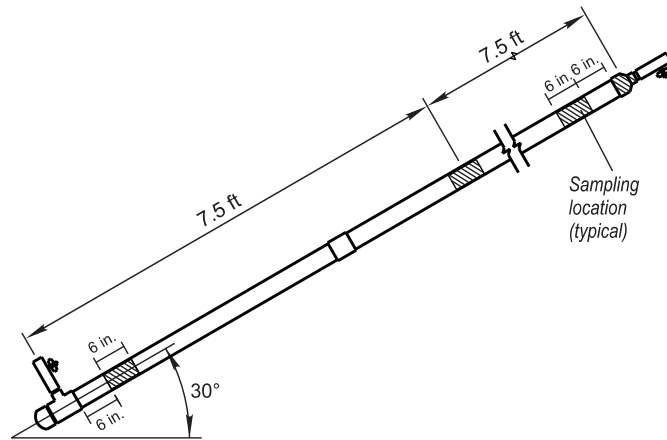

Figure 102—Sampling locations

Report

After testing is complete, and 24 hour samples have been taken and tested, the report can be written. Include the following in the report:

1. Field test data from prior to injection
2. Field test data from after injection
3. Moisture content test results along with location of sample along the length of the tube
4. Volume of bleed water and mass of soft grout obtained
5. Any other pertinent visual observations

Appendix B—Supplemental Test Results

NSR Viscosity

Figure 103 shows the mass of soft grout and the MWD plotted against the viscosity measurements for plain grout. The data for the viscosity of plain grout does not seem to indicate a clear trend. Figure 104 shows the mass of soft grout and the water dosage plotted against the viscosity measurements for PT1.

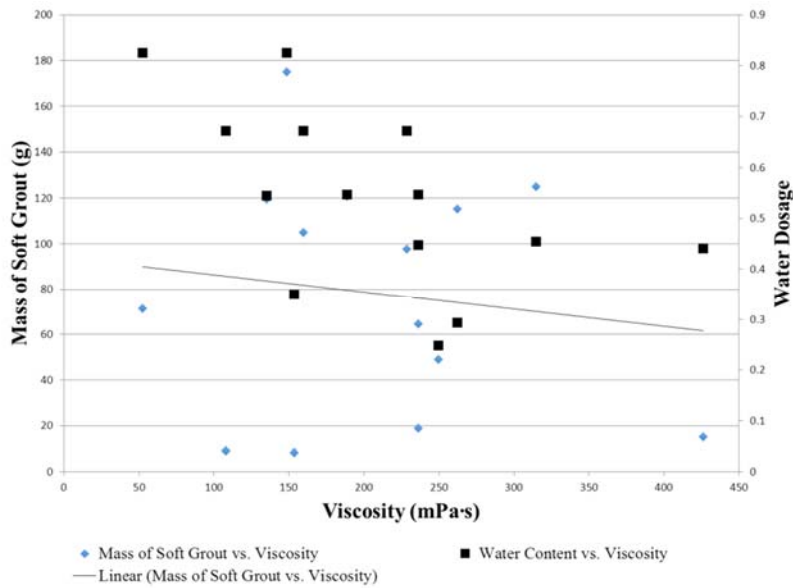

Figure 103—Plain grout viscosity plot for soft grout and water dosage

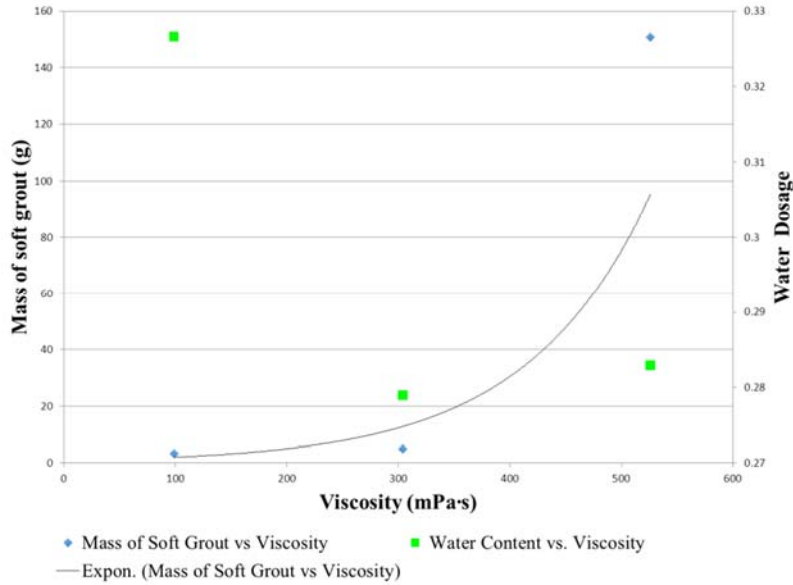

Figure 104—PT1 viscosity plot for soft grout and water dosage

The data for the viscosity of PT1 does not seem to indicate a clear trend.

Figure 105 shows the mass of soft grout and the water content plotted against the viscosity measurements for PT2.

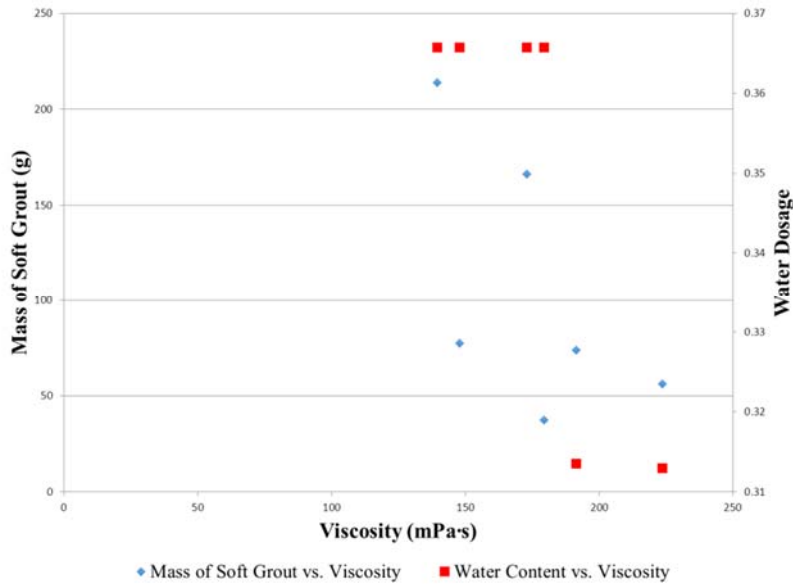

Figure 105—PT2 viscosity plot for soft grout and water dosage

The data for the viscosity of PT2 does not seem to indicate a clear trend.

Figure 106 shows the mass of soft grout and the water dosage plotted against the viscosity measurements for PT4.

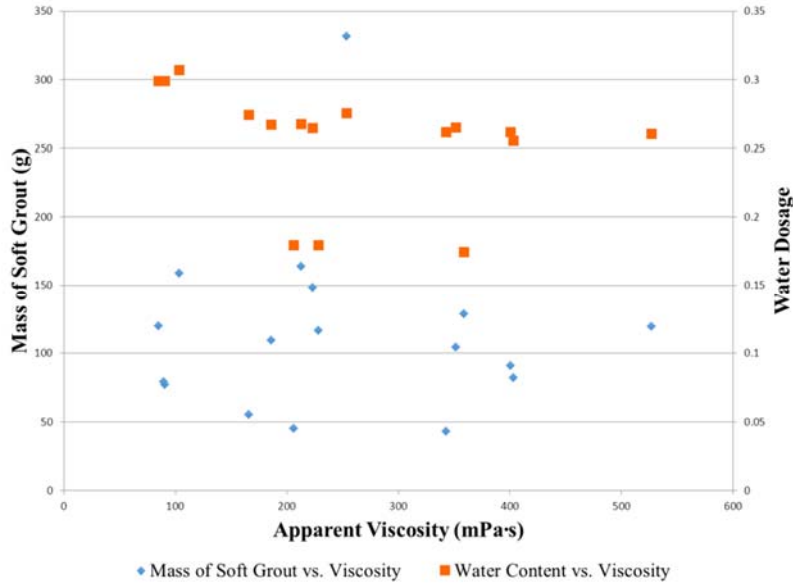

Figure 106—PT4 viscosity plot for soft grout and water dosage

The data for the viscosity of PT2 does not seem to indicate a clear trend.

Characterization and Measurement of Soft Grout

The consistency, moisture content, color, and quantity of soft grout obtained from MITT tests varied depending on the formulation as summarized in Table 22. Soft grout could be placed in three groups based on their characteristics. For PT4-6, there was one type of soft grout which had a dark gray color and a mud-like consistency with moisture content over 72%. Plain grouts exhibited two distinctly different types of soft grout. The first was lighter colored firm clay-like wafer that was observed at low w/c and high HRWR dosage. The second was darker in color and had a similar consistency to the soft grout obtained from the PT4-6 mixtures. Figure 107 below shows this type of soft grout. Figure 108 shows the soft grout being sampled from a test conducted on PT4-6 which has more of a wet consistency relative to all other soft grout samples that were obtained during these tests.

Table 22—Soft grout summary

Test ID	Color	Consistency/ Description	Quantity (g)	Moisture Content
C35-0	Light gray	Firm moist clay wafer	23.8	64.5
C45-0	Light gray	Firm moist clay wafer	18.9	56.3
C675-0	Light gray	Moist/ soft clay	35.1	39.1
C825-0	Light gray	Moist/ soft clay	71	67.3
C35-45	Light gray	Firm moist clay wafer	115	67.7
C35-55	Tan	Moist/ soft clay	69	66.4
C35-675	Light gray	Moist/ soft clay	97.8	62.5
C35-825	Light gray	Moist/ soft clay	120	58.8
C45-4	Light gray	Firm moist clay wafer	49	74.2
C45-5	Light gray	Moist/soft clay	123.2	76.2
C45-67	Tan	Moist/soft clay	106.2	61.4
PT4-6	Light gray	Moist/ soft clay	160	57.5
PT4-6	Dark gray	Moist/soft clay	55.6	72.7
PT4-6	Dark gray	Moist/ wet mud	159.2	72.7
PT4-6	Dark gray	Moist/soft clay	79.4	75.7



Figure 107—Moist clay like soft grout with darker coloration



Figure 108—PT4-6 Soft Grout

Figure 108 shows that the soft grout obtained from PT4-6 had a similar consistency of wet mud.

Figure 109 below shows another PT4-6 inclined test exit region that had soft grout.



Figure 109—PT4-6 soft grout

Figure 109 shows a slightly different consistency of soft grout found when conducting the sensitivity study on PT4-6. This soft grout had a consistency that was similar to wet clay, instead of wet mud.

Figure 110 shows the segregated soft grout material being sampled from the exit region of the tube injected with C675-45.



Figure 110—C675-45 soft grout

Figure 110 above shows that the soft grout obtained from mixing portland cement and calcium carbonate filler has a similar consistency as the soft grout shown in Figure 109. The coloration of the two different soft grout samples was different, with C675-45 soft grout being lighter than PT4-6 soft grout.

Figure 111 below shows the soft grout material that was obtained from mixing C35-0 portland cement and no additional filler material.



Figure 111—C35-0 soft grout

Figure 111 shows a different consistency of soft grout than that found in Figure 110. This soft grout had a consistency similar to a moist cake like material. At first sight, it appeared to be a dry cake, but when squeezed together it deformed and revealed a soft moist material. Figure

112 shows the wet clay like material that is left over after the moist wafer has been squeezed between ones fingers.



Figure 112—C35-0 soft grout

As you can see from Figure 112 above, the soft grout was initially a wafer like material, but after shearing it between two surfaces such as fingers, the wafer compressed into a wet clay like material. The moisture content for this soft grout was typically above 60% moisture.

Figure 113 shows hardened grout for the test C35-35.

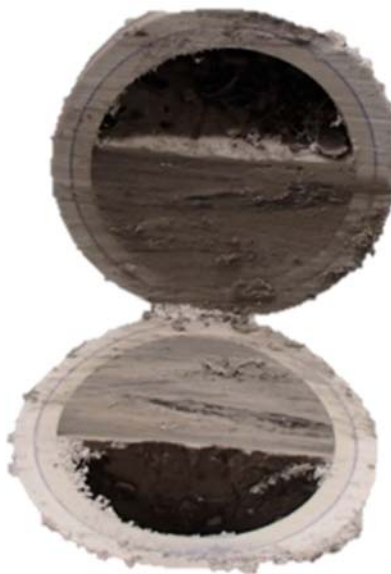

Figure 113—C35-35 hardened grout

Figure 113 above shows hardened grout for the test C35-35, which had a moisture content of approximately 30% with no gelatinous soft grout or equator line separating the soft grout from the hardened grout.

Sampling of soft grout from inclined specimens results in some variability due to the interference of the prestressing strand and the transitional nature of the grout properties. Additionally, at extremely high w/c, the bleed water occupies a large portion of the inclined tube near the exit. Thus, the free surface of the soft grout occupies the same region of tube that the PT strands occupy. Consequently, extracting all soft grout from the sample is not possible in some cases, which may lead to variability in the results. Figure 114 below shows the dissection of the test run at 0.675 w/c and 35 percent filler material.



Figure 114—C675-35 large void due to bleed water

As you can see from Figure 114, there is a thin layer of soft grout that coats the PT strands near the exit of the inclined tube, then extends further down the tube. This makes it extremely difficult to get an accurate reading on the quantity of the soft grout present in the inclined tube.

The filler material segregated from the more dense cementitious material, and was conveyed to the top of the inclined tube through a small canal shown in Figure 115 below. This canal, which was located at the top of the cross-section of the tube, was a clear indication that segregation had occurred. Figure 116 shows an example of the canal that formed from PT4-6 that had soft grout near the exit.



Figure 115—Segregation canal at top of cross-section



Figure 116—Segregation canal at top of cross section (PT grout)

Soft grout was typically found near the exit region, and sometimes occupied the top of the cross-section along the length of the tube where the segregation canal was located.

Figure 117 below shows soft grout for the inclined test on C35-55 which extended roughly one foot down the segregation canal.



Figure 117—Soft grout located in segregation canal

Figure 118 shows the “equator” line that separates the completely hardened cement and the soft grout. Figure 119 shows the equator line for observed when dissecting an inclined test tube injected with PT4-6 at 1.15-MWD.



Figure 118—Equator line separating hard cement from soft grout



Figure 119—Equator line separating hard cement from soft grout (PT grout)

Figure 118 and Figure 119 both show the line between the hardened grout and the soft gelatinous grout. The equator line for the plain grout shown in Figure 118 is closer to the bottom of the cross-section because there is a larger void present. The equator line for PT4-6 in Figure 119 is higher in the cross-section than the equator line shown in Figure 118. Note that the arrow in Figure 119 points slightly below the pronounced line above which is the free surface of the soft grout. This is because the soft clay like grout occupied the region of the tube above where the arrow is pointing, and the hardened cement occupied the rest.

Additional observations can be made on the appearance of the grout in Figure 118 and Figure 119. PT4-6 in Figure 119 has a thin layer of black material which has also segregated and

ended up at the free surface of the grout. This material is most likely silica fume. The soft grout found when PT4-6 was used had a grey coloration. This is different from the soft grout found in the plain grout mixes, which was typically lighter in color.

Moisture Content—Plain Grout

The following appendices contain all of the additional test data that was not presented in the main body of this report for both plain grouts and PT grouts.

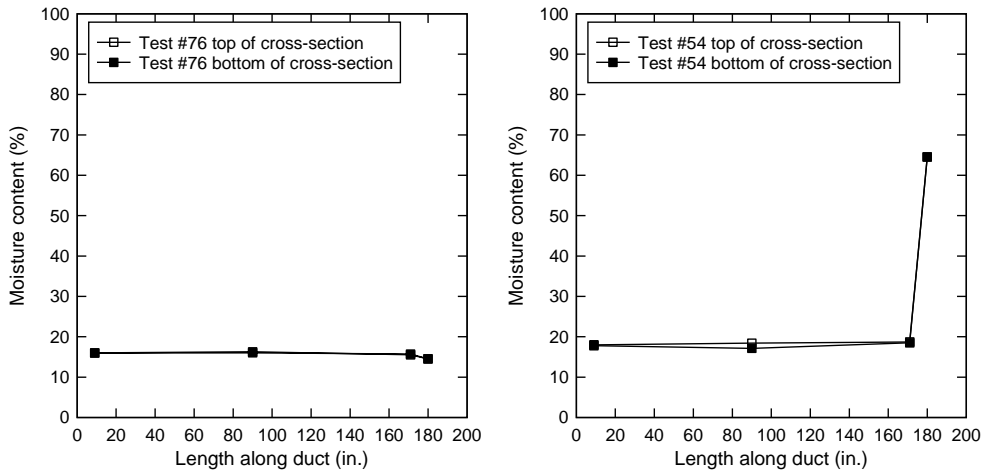

Figure 120—C30-0 (left), C35-0 (right)

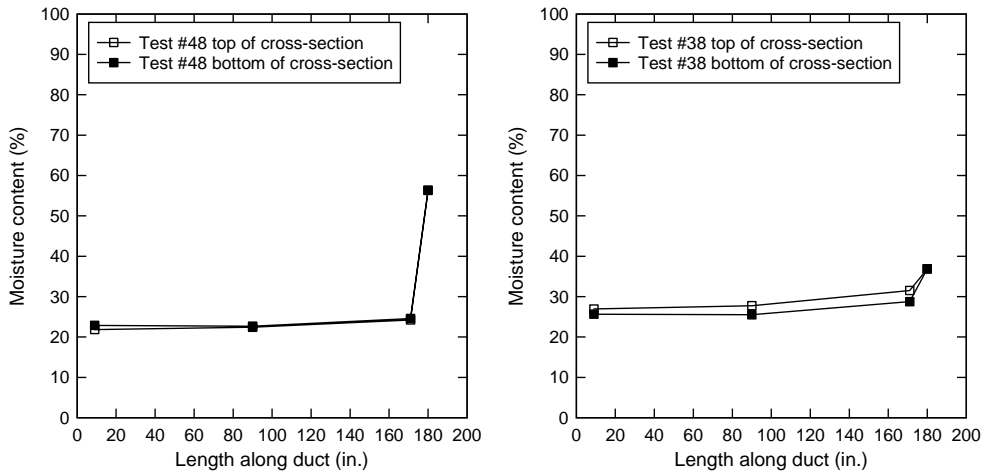

Figure 121—C45-0 (left), C55-0 (right)

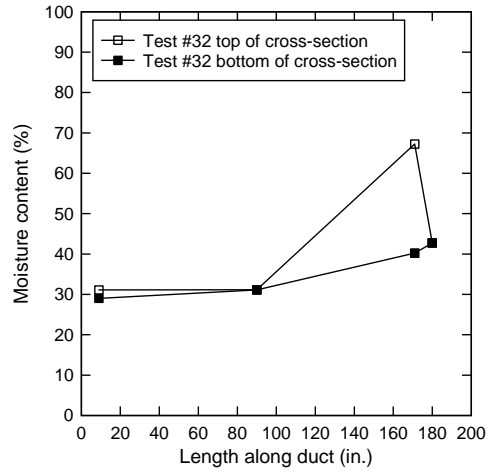
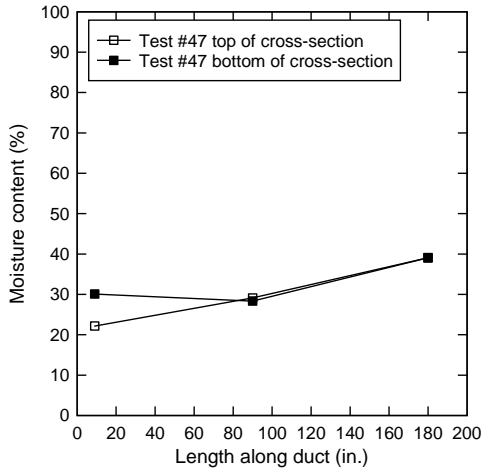

Figure 122—C675-0 (left), C825-0 (right)

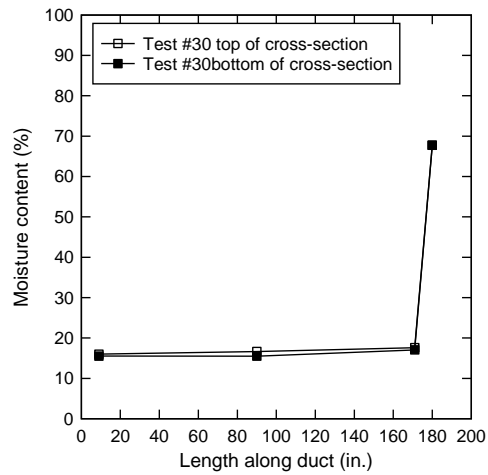
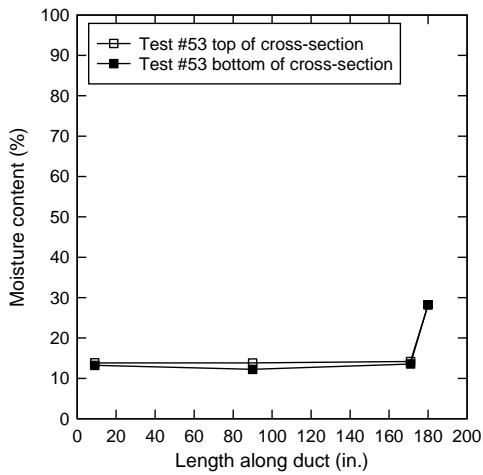

Figure 123—C35-35 (left), C45-35 (right)

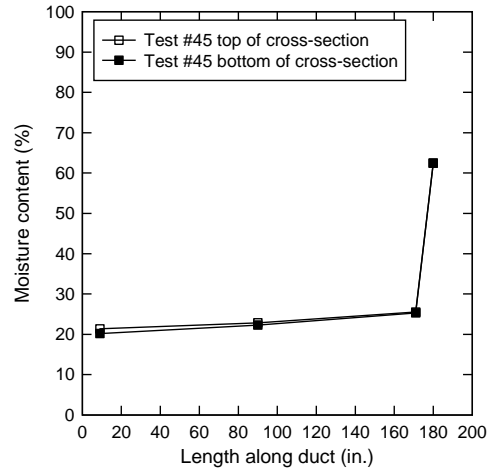
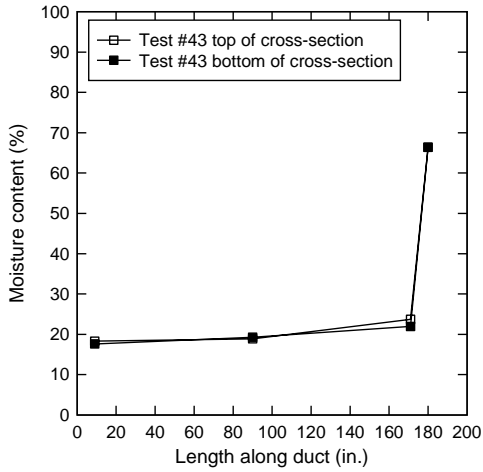

Figure 124—C55-35 (left), C675-35 (right)

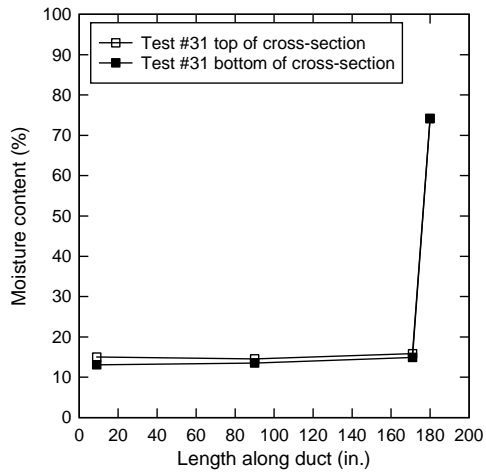
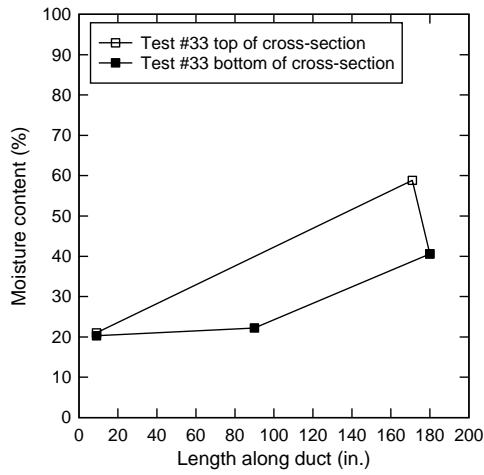

Figure 125—C825-35 (left), C45-45 (right)

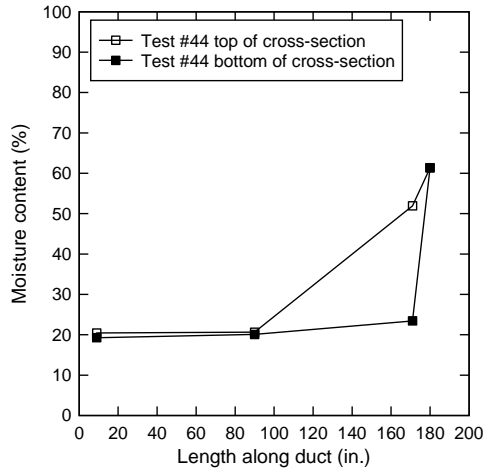
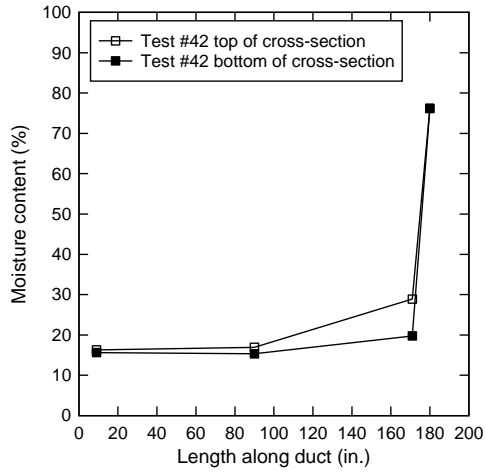

Figure 126—C55-45 (left), C675-45 (right)

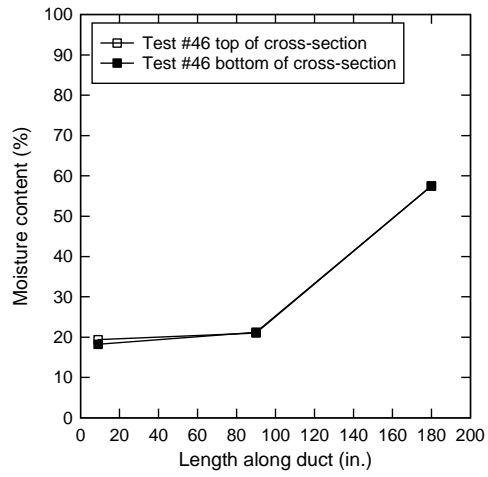

Figure 127—C825-45

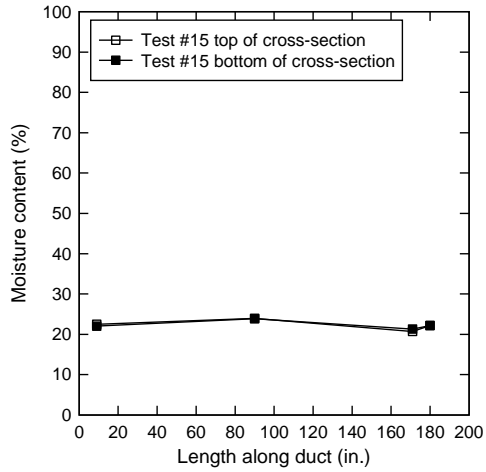
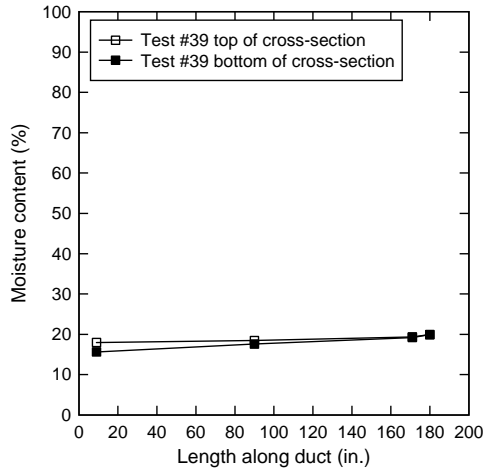

Figure 128—C55-45 (100 mL HRWR) (left), C45-0 (0 mL HRWR) (right)

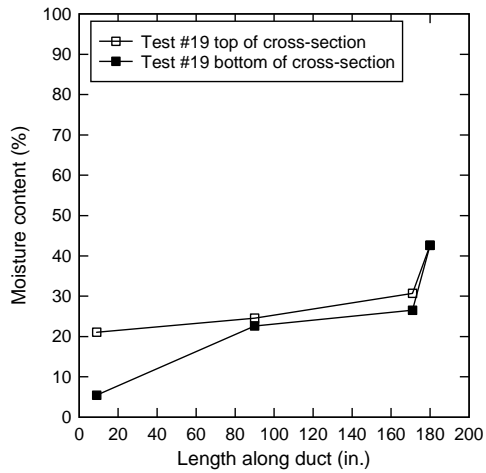
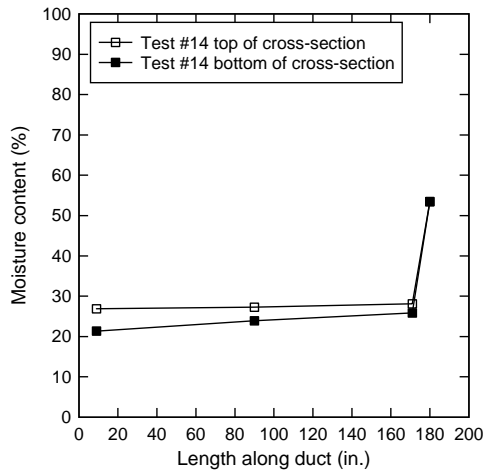

Figure 129—C675-35 (0 mL HRWR) (left), C825-45 (0 mL HRWR) (right)

Moisture Contents—PT Grout

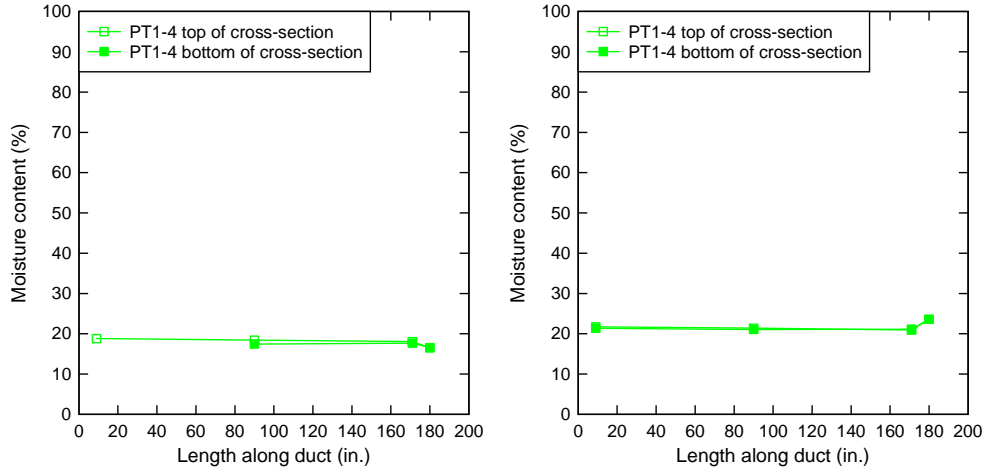

Figure 130—PT 1-4 MWD (left), PT 1-4 1.15·MWD (right)

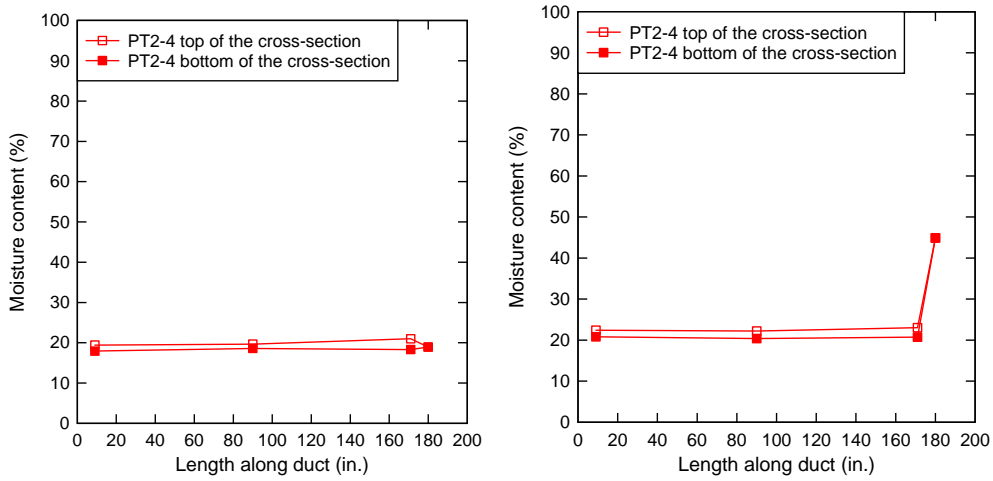

Figure 131—PT2-4 MWD (left), PT2-4 1.15·MWD (right)

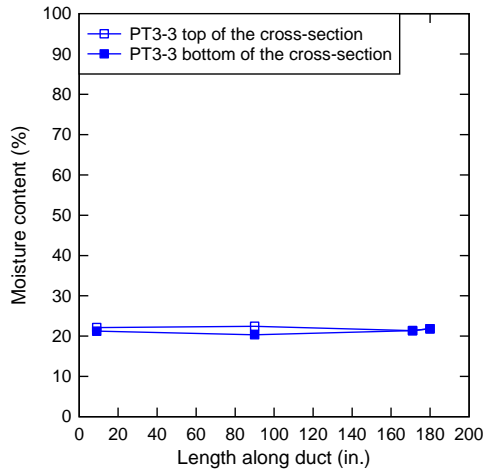
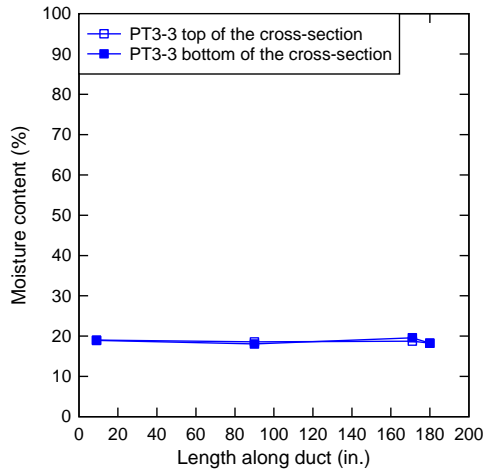

Figure 132—PT3-3 MWD (left), PT3-3 1.15-MWD (right)

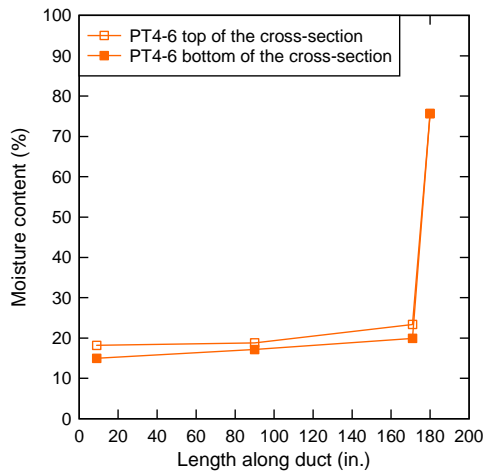
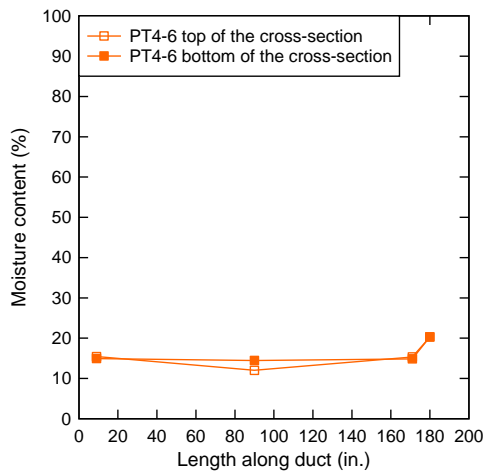

Figure 133—PT4-6 MWD (left), PT4-6 1.15-MWD (right)

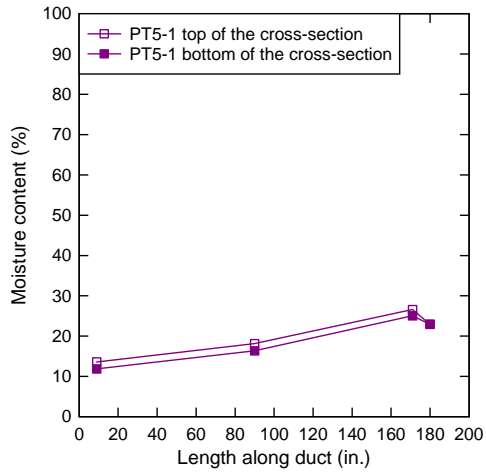
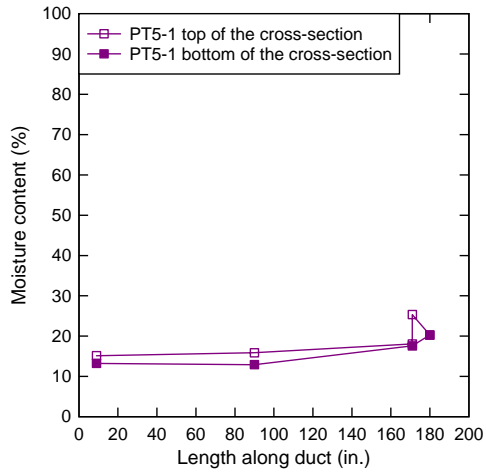

Figure 134—PT5-1 MWD (left), PT5-1 1.15-MWD (right)

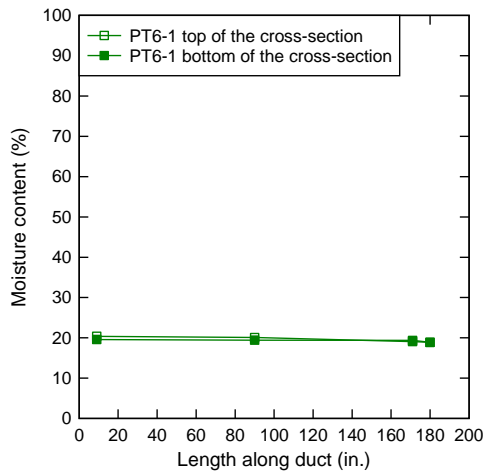
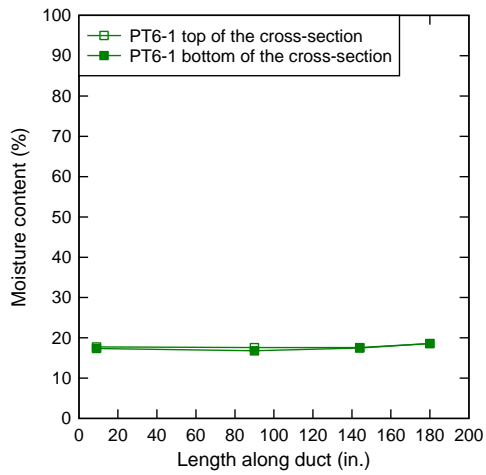

Figure 135—PT6-1 MWD (left), PT6-1 1.15-MWD (right)

Plain Grout Data

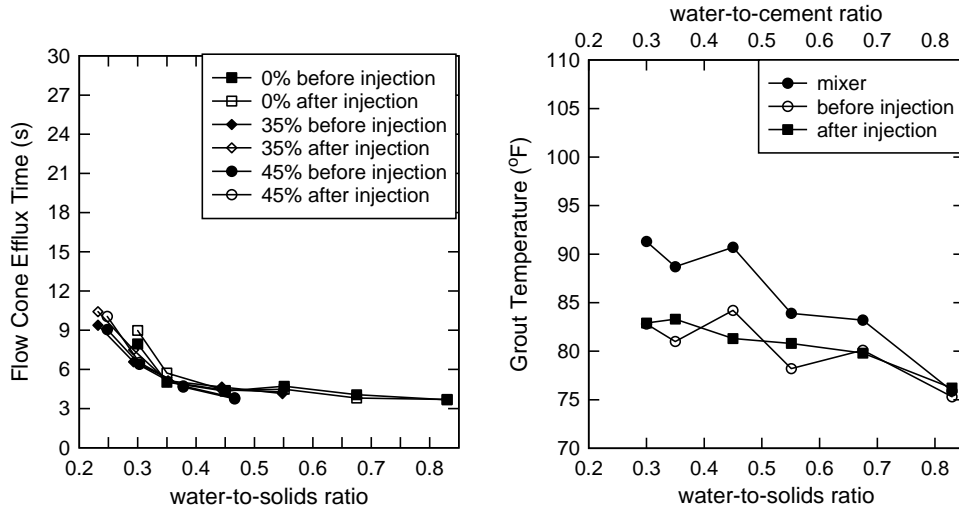

Figure 136—Flow cone efflux time (left), Grout temperature: 0% filler (right)

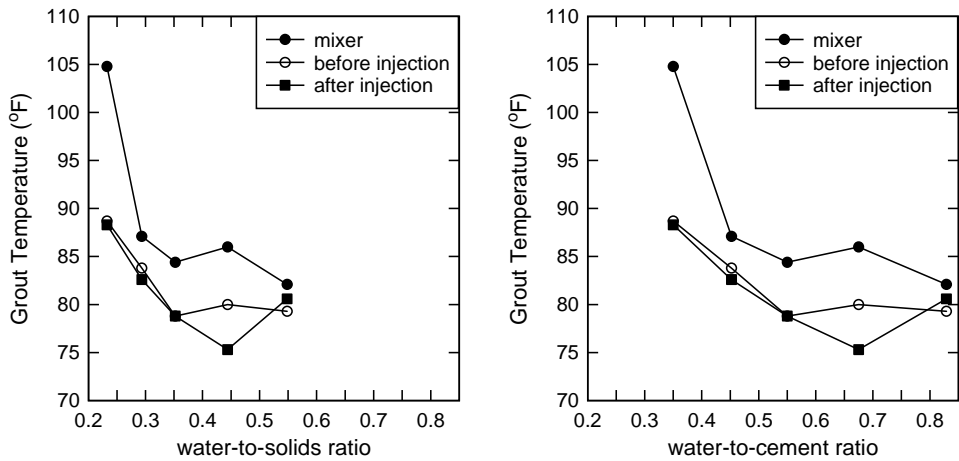

Figure 137—Grout temperature: 35% filler (left), Grout temperature: 35% filler (right)

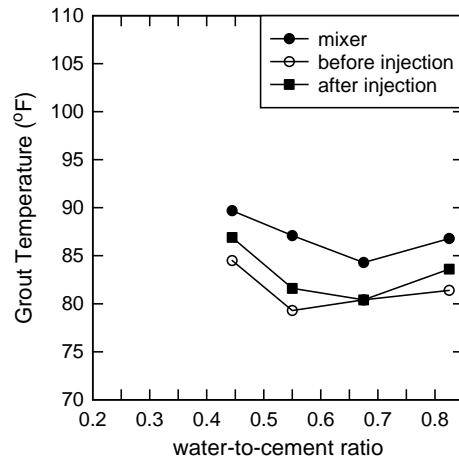
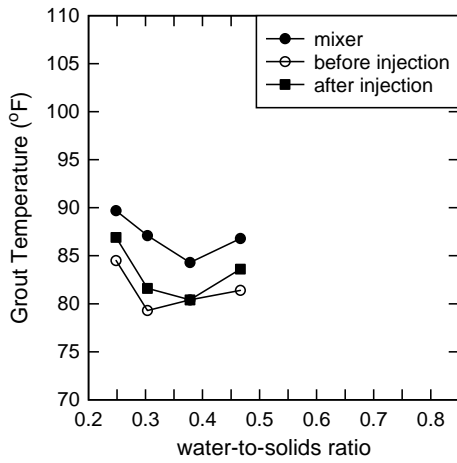

Figure 138—Grout temperature: 45% filler (left), Grout temperature: 45% filler (right)

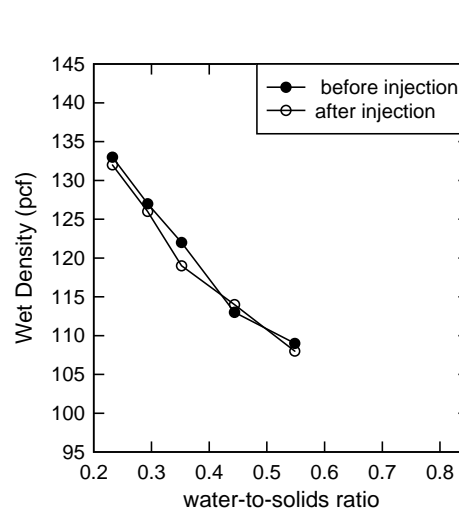
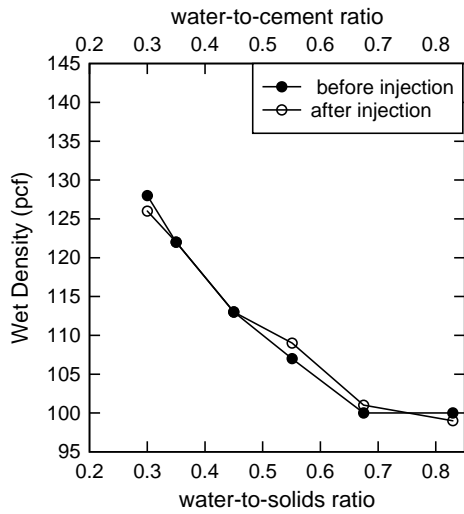

Figure 139—Wet density: 0% filler (left), Wet density: 35% filler (right)

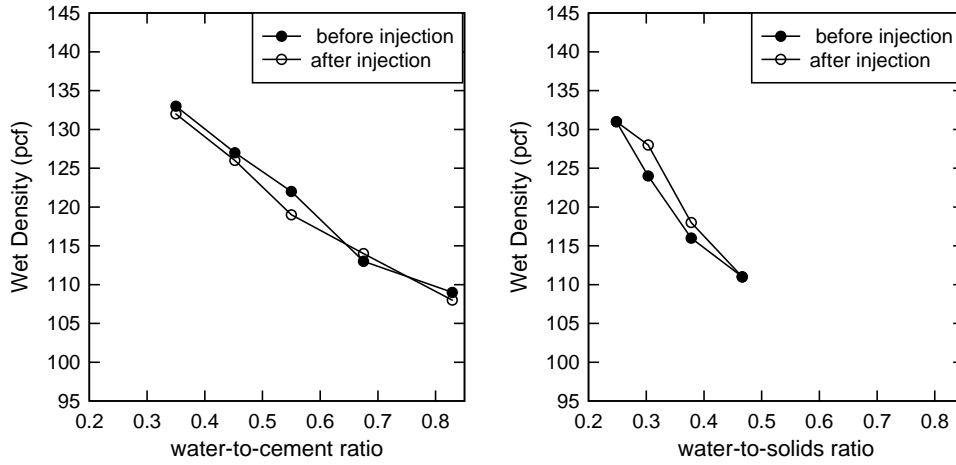

Figure 140—Wet density: 35% filler (left), Wet density: 45% filler (right)

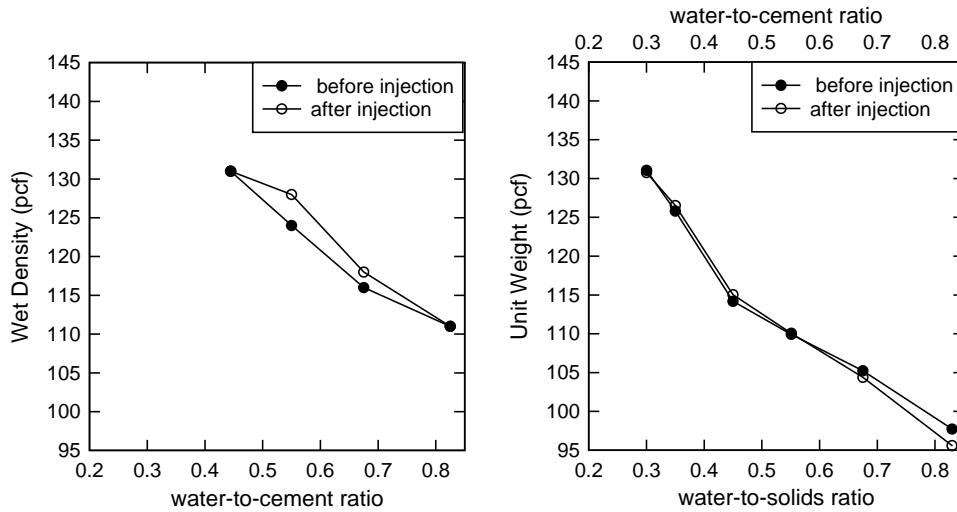

Figure 141—Wet density: 45% filler (left), Unit weight: 0% filler (right)

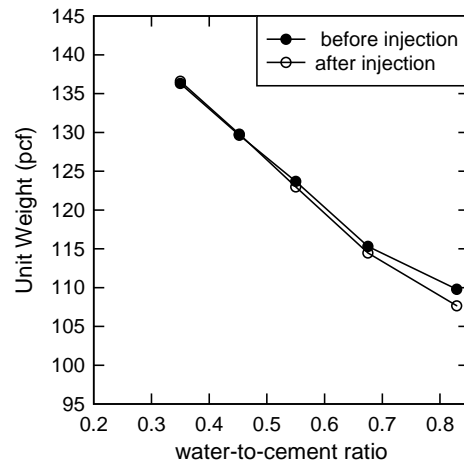
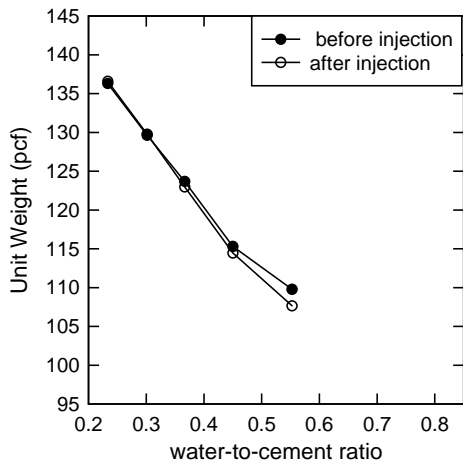

Figure 142—Unit weight: 35% filler (left), Unit weight: 35% filler (right)

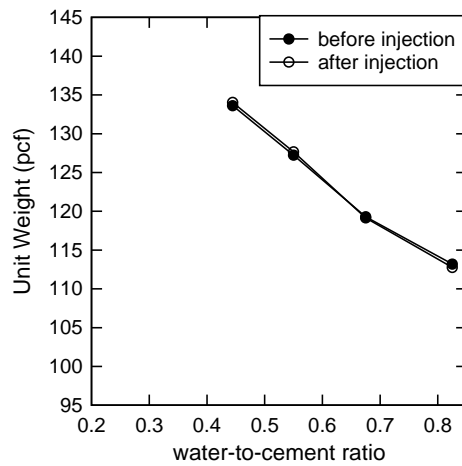
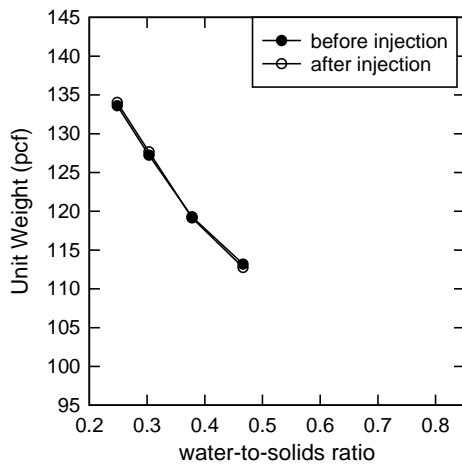

Figure 143—Unit weight: 45% filler (left), Unit weight: 45% filler (right)

Table 23—Plain grout summary (0% filler)-Mixing

Experiment	76	54	48	38	47	32
PT	C30-0	C35-0	C45-0	C55-0	C675-0	C825-0
Manufacturer	PC	PC	PC	PC	PC	PC
Dry powder wt (lb)	183.9	184.3	183.9	187.7	187.1	185.3
Powder temp (F)	70.3	N/A	74.3	71.8	72.8	74.1
Water weight (lb)	55.18	64.5	82.76	103.4	126.3	153
Water temperature (F)	77.6	N/A	79.3	77.3	79	75.3
Target w/c	0.30	0.35	0.45	0.55	0.675	0.825
Theoretical w/s	0.30	0.34997	0.44998	0.551	0.67497	0.82551
Theoretical w/c	0.30	0.35	0.45	0.55	0.67	0.83
Actual % fill	0	0	0	0	0	0
HRWR (mL)	350	250	100	0	0	0
Mix time (min.)	10	7	10	6	5	N/A
Temperature measured from mixer (F)	91.3	88.7	90.7	83.9	83.2	75.9

Table 24—Plain grout summary (0% filler)-Post-mixing process

Temperature at hose exit (F)	82.8	81	84.2	78.2	80.1	75.3
Flow cone (s)	8	5	4.3	4.7	4.1	3.7
Wet density (pcf)	128	122	113	107	100	100
Unit wt (pcf)	131.06	125.81	114.18	109.92	105.24	97.73
Apparent viscosity (mPa-s)	237	134.8	217.1	238.8	100.3	50.61
Temperature for DSR readings (F)	82.8	81	84.2	78.2	80.1	75.3
Pressure bleed (mL)	4.66	18	40	68	85	95

Table 25—Plain grout summary (0% filler)-Post-grouting process

Flow cone (s)	9	5.7	4.4	4.5	3.8	3.7
Wet density (pcf)	126	122	113	109	101	99
Unit wt (pcf)	130.78	126.52	115.03	110.07	104.39	95.60
Apparent viscosity (mPa-s)	224.3	153.5	236.4	265.9	108.1	52.58
Temperature for DSR readings (F)	82.9	83.3	81.3	80.8	79.8	76.2
Pressure bleed (mL)	5.71	15	39	67	85	100
Pump outlet pressure (psi)	40	N/A	40	40	40	40
Duct inlet pressure (psi)	40	N/A	40	40	40	40
Discharge at tube exit valve (gal)	2	2	2	2	2	2
Duct fill time (s)	63	56	75.06	50.29	66.94	92

Table 26—Plain grout summary (0% filler)-Dissection

Mass of soft grout collected (g)	0	23.79	18.88	0	35.09	71
Moisture content at bottom	14.51	17.13	21.86	25.5	22.17	29.02
Moisture content at exit	16.3	64.5	56.3	36.9	39.1	67.3
Bleed water	0	0	0	600	1820	2244

Table 27—Plain grout summary (35% filler)-Mixing

experiment	53	30	43	45	33
PT	C35-35	C45-35	C55-35	C675-35	C825-35
Manufacturer	PC/CaCO3	PC/CaCO3	PC/CaCO3	PC/CaCO3	PC/CaCO3
dry powder wt (lb)	185.2	285.6	289.2	278.9	290.5
powder temp (F)	N/A	77	72	71	73
water weight (lb)	64.84	83.83	101.8	123.8	158.3
water temperature (F)	N/A	74.4	76.6	72.3	75.5
target w/c	0.35	0.45	0.55	0.675	0.825
theoretical w/s	0.35	0.29	0.35	0.44	0.54
theoretical w/c	0.35	0.45	0.55	0.68	0.83
Actual % fill	0.336	0.351	0.360	0.342	0.339
HRWR (mL)	650	300	200	100	0
mix time (min.)	16	11	6	8	8
temperature measured from mixer (F)	104.8	87.1	84.4	86	82.1

Table 28—Plain grout summary (35% filler)-Post-mixing process

temperature at hose exit (F)	88.7	83.8	78.8	80	79.3
flow cone (s)	9.4	6.6	5.1	4.7	4.2
wet density (pcf)	133	127	122	113	109
unit wt (pcf)	136.31	129.65	123.69	115.32	109.79
viscosity (mPa-s)	197.4	219.6	223.8	220.9	133.3
temperature for DSR readings (F)	88.7	83.8	78.8	80	79.3
Pressure bleed (mL)	0	13	33	54	75

Table 29—Plain grout summary (35% filler)-Post-grouting process

flow cone (s)	10.4	7.49	5.06	4.44	4.27
wet density (pcf)	132	126	119	114	108
unit wt (pcf)	136.60	129.79	122.98	114.47	107.66
viscosity (mPa-s)	222.1	262.1	236.2	228.4	135
temperature for DSR readings (F)	88.3	82.6	N/A	75.3	80.6
Pressure bleed (mL)	0	13	36	57	78.5
pump outlet pressure (psi)	N/A	40	40	40	40
duct inlet pressure (psi)	N/A	40	40	40	40
discharge at tube exit valve (gal)	2	2	2	2	2
duct fill time (s)	57.6	67	74	58	62.5

Table 30—Plain grout summary (35% filler)-Dissection

mass of soft grout collected (g)	0	115.37	64.54	97.74	119.51
moisture content at bottom	12.3	15.5	17.6	20.2	20.3
moisture content at exit	28.2	67.7	66.4	62.5	58.8
bleed water	0	0	170	740	1750

Table 31—Plain grout summary (45% filler)-Mixing

experiment	31	42	44	46
PT	C45-45	PC55-45	PC675-45	PC825-45
Manufacturer	PC/CaCO ₃	PC/CaCO ₃	PC/CaCO ₃	PC/CaCO ₃
dry powder wt (lb)	337.6	336.8	337.5	333.5
powder temp (F)	78	73	73	71
water weight (lb)	83.83	102.1	127.1	155.5
water temperature (F)	76.4	76.9	76.8	69.8
target w/c	0.45	0.55	0.675	0.825
theoretical w/s	0.25	0.30	0.38	0.47
theoretical w/c	0.44	0.55	0.68	0.83
Actual % fill	0.442	0.449	0.44	0.435
HRWR (mL)	500	300	200	50
mix time (min.)	9	9	8	11
temperature measured from mixer (F)	89.7	87.1	84.3	86.8

Table 32—Plain grout summary (45% filler)-Post-mixing process

temperature at hose exit (F)	84.5	79.3	80.4	81.4
flow cone (s)	9.1	6.4	4.7	3.8
wet density (pcf)	131	124	116	111
unit wt (pcf)	133.61	127.23	119.29	113.19
viscosity (mPa-s)	213	159	133	158
temperature for DSR readings (F)	84.5	79.3	80.4	81.4
Pressure bleed (mL)	5.2	21	39	64

Table 33—Plain grout summary (45% filler)-Post-grouting process

flow cone (s)	10.1	6.52	4.65	3.74
wet density (pcf)	131	128	118	111
unit wt (pcf)	134.04	127.66	119.14	112.76
viscosity (mPa-s)	250	189	160	149
temperature for DSR readings (F)	86.9	81.6	N/A	83.6
Pressure bleed (mL)	5.2	20	38	68
pump outlet pressure (psi)	40	40	40	40
duct inlet pressure (psi)	40	40	40	40
discharge at tube exit valve (gal)	2	2	2	2
duct fill time (s)	N/A	98.4	42	59.6

Table 34—Plain grout summary (45% filler)-Dissection

mass of soft grout collected (g)	49	123.2	106.2	160
moisture content at bottom	13.1	15.3	19.3	18.2
moisture content at exit	74.2	76.2	61.4	57.5
bleed water	0	260	480	1420

Table 35—PT results (1)-Mixing

experiment	37	40	41	50	51	56	57
PT	PT1-4	PT4-6	PT4-6	PT5-1	PT5-1	PT6-1	PT6-1
dry powder wt (lb)	192	201	200	227	229	203	200
powder temp (F)	76.2	74.2	74.3	70.1	71.30	N/A	N/A
water weight (lb)	65.3	52.1	59.9	52.6	61.04	73.3	62.7
water temperature (F)	N/A	78	77.1	73.3	76.50	N/A	N/A
target w/s	0.327	0.260	0.299	0.232	0.267	0.360	0.360
theoretical w/s	0.340	0.259	0.299	0.232	0.267	0.360	0.313
mix time (min.)	7.00	8.00	6.00	10.00	15.00	10.00	11.00
temperature measured from mixer (F)	97.8	92.8	90.3	95.2	92.80	91.9	89.4

Table 36—PT results (1)-Post-mixing process

temperature at hose exit (F)	85.2	85	81.7	83.2	80.40	78.1	78.2
flow cone (s)	4.9	7.3	5.2	8	6.52	5.7	7.6
wet density (pcf)	117	132	124	116	112.00	116	123
unit wt (pcf)	117.45	131.77	127.38	117.87	116.45	117.87	126.95
viscosity (mPa-s)	97.47	265.8	85.83	328.2	144.50	241.3	635.4
temperature for DSR readings (F)	85.2	85	81.7	83.2	80.40	78.1	78.2
Pressure bleed (mL)	0	N/A	N/A	0	0.00	4	0

Table 37—PT results (1)-Post-grouting process

flow cone (s)	4.96	7.66	5.39	8.12	6.64	7.16	10.4
wet density (pcf)	115	128	126	111	113.00	119	121
unit wt (pcf)	116.31	132.20	125.11	119.01	116.31	119.86	123.83
viscosity (mPa-s)	110.1	250.2	89.06	262	149.10	467.2	912.3
temperature for DSR readings (F)	N/A	86.6	82.8	83.8	81.90	N/A	N/A
Pressure bleed (mL)	0	N/A	N/A	0	0.00	5	0
pump outlet pressure (psi)	40	40	40	35	30.00	N/A	N/A
duct inlet pressure (psi)	40	40	12	40	30.00	N/A	N/A
discharge at tube exit valve (gal)	2	2	2	2	2	2	2
duct fill time (s)	39	90	35.6	65	54.00	64	35.1

Table 38—PT results (1)-Dissection

mass of soft grout collected (g)	0	0	79.384	0	0.00	0	0
moisture content at bottom	21.40	14.90	15.00	15.13	13.58	18.88	16.79
moisture content at exit	23.60	20.30	75.70	20.27	22.92	20.38	18.58

Table 39—PT results (2)-Mixing

experiment	26	27	28	29	34	35	36
PT	PT2-4	PT4-6	PT1-4	PT3-3	PT4-6	PT3-3	PT2-4
dry powder wt (lb)	276	246	243	280	202	223	219
powder temp (F)	77	75	73	75	74	77	77
water weight (lb)	87.5	67.5	71	87.5	62.1	80.5	80.5
water temperature (F)	76.3	74.8	73.9	76.5	76.2	76.3	76.8
target w/s	0.318	0.270	0.284	0.318	0.311	0.366	0.366
theoretical w/s	0.317	0.274	0.292	0.312	0.307	0.361	0.367
mix time (min.)	8.00	9.00	11.00	9.00	8.00	7.00	8.00
temperature measured from mixer (F)	94.1	96.3	98.3	89.6	90.5	91.1	90.1

Table 40—PT results (2)-Post-mixing process

temperature at hose exit (F)	86.8	84.1	85.5	84.1	71.8	82.7	80.4
flow cone (s)	7.5	6.4	6.3	5.9	5.3	4.6	5.7
wet density (pcf)	124	126	120	121	128	119	120
unit wt (pcf)	123.97	130.78	121.99	122.70	128.23	117.59	120.28
viscosity (mPa-s)	425	162.2	249.4	352.2	100.4	167.4	159.1
temperature for DSR readings (F)	86.8	84.1	85.5	84.1	71.8	82.7	80.4
Pressure bleed (mL)	N/A	0	0	1.9	0	2	1.6

Table 41—PT results (2)-Post-grouting process

flow cone (s)	8.1	6.6	6.8	7.4	5.4	5	5.4
wet density (pcf)	123	132	119	124	128	118	120
unit wt (pcf)	124.96	131.06	121.70	123.40	128.51	119.50	119.86
viscosity (mPa-s)	394	165.6	290.9	423.2	103	189.2	142.1
temperature for DSR readings (F)	86.4	82.1	83.8	79.9	84.2	85.1	82.7
Pressure bleed (mL)	N/A	0	0	1.3	0	2	0
pump outlet pressure (psi)	40	40	40	40	40	40	40
duct inlet pressure (psi)	40	40	30	40	40	40	40
discharge at tube exit valve (gal)	2	2	2	2	2	2	2
duct fill time (s)	57.6	69.2	58.9	69.5	58	74	63

Table 42—PT results (2)-Dissection

mass of soft grout collected (g)	0.00	55.57	0.00	0.00	159.22	0.00	0.00
moisture content at bottom	17.90	15.22	17.40	18.90	16.00	21.20	20.80
moisture content at exit	18.90	72.70	16.60	18.30	72.70	21.80	44.90