



Florida Department of Transportation

RON DESANTIS
GOVERNOR

605 Suwannee Street
Tallahassee, FL 32399-0450

JARED W. PERDUE, P.E.
SECRETARY

M E M O R A N D U M NO: DOT-ITB-24-9069-SJ-2

DATE: July 3, 2024
TO: FDOT Offices and Districts
FROM: Procurement Office
SUBJECT: MFMP Contract # CR854
Aluminum Materials – Eastern Metal Supply
DOT-ITB-24-9069-SJ / DOT-ITB-24-9093-SJ

The subject contract is being amended to add Eastern Metal Supply as the awarded vendor for the following items as advertised and subsequently negotiated with the vendor under DOT-ITB-24-9093-SJ (REBID).

TUBES: Not Fabricated

OVIEDO, FL

"DOT" NUMBER	DESCRIPTION	MINIMUM ORDER QUANTITY	LBS LF	UNIT PRICE	VENDOR
702-240	6.5" x .250" x 24' Alloy 6061-T6		5.773	\$450.24	Eastern Metal

TUBES: Not Fabricated**STATEWIDE MAINTENANCE**

"DOT" NUMBER	DESCRIPTION	MINIMUM ORDER QUANTITY	LBS LF	UNIT PRICE	VENDOR
208-012	.1875" x 3.5" x 17' Alloy 6061-T6	650'	2.30	\$117.30	Eastern Metal
208-004	.1875" x 3.5" x 34' Alloy 6061-T6	650'	2.30	\$234.60	Eastern Metal
208-558*	1.75" x .1875" x 20' Alloy 6061-T6	1400'	1.080	\$64.80	Eastern Metal

*Die Charge: \$2,800.00

The contract document has been updated to reflect the necessary revisions. Any questions on delivery or service that may arise regarding this contract may be directed to Renee Matthews at renee.matthews@dot.state.fl.us.



Florida Department of Transportation

RON DESANTIS
GOVERNOR

605 Suwannee Street
Tallahassee, FL 32399-0450

JARED W. PERDUE, P.E.
SECRETARY

M E M O R A N D U M NO: DOT-IITB-24-9069-SJ-1

DATE: February 26, 2024
TO: FDOT Offices and Districts
FROM: Procurement Office
SUBJECT: MFMP Contract # CR854
Aluminum Materials – Eastern Metal Supply
DOT-ITB-24-9069-SJ

The subject contract is being amended to remove Eastern Metal Supply as the awarded vendor for the following items as requested by the vendor:

“DOT” NUMBER	DESCRIPTION	MINIMUM ORDER QUANTITY	LBS LF	UNIT PRICE	VENDOR
208-012	.1875" x 3.5" x 17' Alloy 6061-T6	870 ft.		\$77.10	Eastern Metal
208-004	.1875" x 3.5" x 34' Alloy 6061-T6	870 ft.	1.930	\$154.20	Eastern Metal

The contract document has been updated to reflect the necessary revisions. Any questions on delivery or service that may arise regarding this contract may be directed to Renee Matthews at renee.matthews@dot.state.fl.us.

**State of Florida
Department of Transportation**



INVITATION TO BID
ALUMINUM MATERIALS

DOT-ITB-24-9069-SJ

EFFECTIVE DATES:

February 23, 2024 – February 22, 2026

VENDOR

**Eastern Metal Supply – CR854
Mandel Metals Inc. dba US Standard Sign – CR855**

BID SHEET (Page 1 of 17)

BID #: DOT-ITB-24-9069-SJ

BID TITLE: Aluminum Materials

Bid As Specified

The following aluminum materials shall be of the appropriate alloy for the point of delivery and meet all applicable “DOT” specifications and requirements.

The Offeror shall insert the Unit Price for the item set forth in the table.

Delivery must be made within thirty (30) calendar days or less upon receipt of a purchase order by the contract vendor at their designated ordering location. If more time is needed, the bidder should state the extra time required and the reasons why, in their response. Acceptance will be subject to the Department’s approval – orders (30) calendar days or older maybe subject to the Department’s denial or order.

DMS COMMODITY #30101500 – Used for MyFloridaMarketPlace

DOT NUMBER (COMMODITY NUMBER) – Used by the Department for the inventory system.

Must be included with ALL bids: “In-State Preference Form”.

In-State Preference: Based on the company’s registration with the Department of State and/or MyFloridaMarketPlace (MFMP), if you are considered an out of state vendor you must include a written opinion by an attorney licensed to practice law in the same state as your company’s registration of record.

ANGLES: Not Fabricated

OVIEDO, FL

“DOT” NUMBER	DESCRIPTION	MINIMUM ORDER QUANTITY	LBS LF	UNIT PRICE	VENDOR
705-040	1" x 1" x .1875" x 25' Alloy 6063-T52	6,100 ft.	.401	\$30.10	Eastern Metal
705-060	1.5" x 1.5" x .125" x 24' Alloy 6063-T52	2,300 ft.	.422	\$30.38	Eastern Metal
705-070	2" x 3" x .1875" x 25' Alloy 6061-T6	900 ft.	1.071	\$82.00	Eastern Metal
705-071	2" x 2" x .1875" x 20' Alloy 6063-52	1,160 ft.	0.859	\$51.60	Eastern Metal
705-080	2" x 2" x .250" x 25' Alloy 6063-T52	900 ft.	1.125	\$85.00	Eastern Metal
705-090	1" x 1" x .125" x 25' Alloy 6063-T52	3,600 ft.	.276	\$21.00	Eastern Metal
705-100	1.25" x 1.25" x .1875" x 25' Alloy 6063-T52	2,900 ft.	.511	\$38.33	Eastern Metal

BID SHEET (Page 2 of 17)

BID #: DOT-ITB-24-9069-SJ

BID TITLE: Aluminum Materials

Bid As Specified

CHANNELS: Not Fabricated

OVIEDO, FL

"DOT" NUMBER	DESCRIPTION	MINIMUM ORDER QUANTITY	LBS LF	UNIT PRICE	VENDOR
706-020	1.5" x .5" x .125" x 20', Sharp Corners, Alloy 6063-T52 *		.327	\$19.62	Eastern Metal
706-030	2" x .5" x .125" x 20' Sharp Corners Alloy 6063-T52 *		.551	\$33.00	Eastern Metal
706-040	1.5" x .625" x .125" x 20' Sharp Corners Alloy 6063-T52 *		.375		No Award
706-050	1" x 1" x .125" x 20' Sharp Corners Alloy 6063-T52 *		.431	\$25.80	Eastern Metal
706-060	1.5" x 1.5" x .125" x 20' Sharp Corners Alloy 6063-T52 *		.637	\$38.00	Eastern Metal
706-070	2" x 1" x .125" x 20' Sharp Corners Alloy 6063-T52 *		.564	\$33.85	Eastern Metal
706-071	2" x 1" x .1875" x 25' Sharp Corners Alloy 6061-T6		.551		No Award
706-090	2.5" x .625" x .1875" x 20' Sharp Corners Alloy 6061-T6		.625		No Award
706-105	3" x 1.5" x .250" x 30' Sharp Corners Alloy 6063-T52		1.730		No Award
706-130	4" x 2 x .230"/.150"x 25' Aluminum Association Alloy 6061-T6		1.738	\$130.00	Eastern Metal
706-150	6" x 2.5" x .290"/.170" x 25' Aluminum Association Alloy 6061-T6		2.128	\$160.00	Eastern Metal
706-165	7" x 2.110" x .230" x 25' Alloy 6061-T6	565 ft.	3.541	\$266.10	Eastern Metal

*Substitute alloy (6063-T2, 6063-T52, 6061-T6, 3003, 5052-H32, 6063, 6061-T6SS) as stated in description.

BID SHEET (Page 3 of 17)

BID #: DOT-ITB-24-9069-SJ

BID TITLE: Aluminum Materials

Bid As Specified

CHANNELS: Not Fabricated

OVIEDO, FL

“DOT” NUMBER	DESCRIPTION	MINIMUM ORDER QUANTITY	LBS LF	UNIT PRICE	VENDOR
706-110	3" x 1" x .125" x 20', Sharp Corners, Alloy 6061-T6	2,800 ft.	0.713	\$43.00	Eastern Metal
000-000	3" x 1.5" x .200"/.130" x 20' Aluminum Association Alloy 6061-T6	1,700 ft.	1.135	\$68.10	Eastern Metal

*Substitute alloy (6063-T2, 6063-T52, 6061-T6, 3003, 5052-H32, 6063, 6061-T6SS) as stated in description.

BARS: Not Fabricated

OVIEDO, FL

“DOT” NUMBER	DESCRIPTION	MINIMUM ORDER QUANTITY	LBS LF	UNIT PRICE	VENDOR
000-000	1.25" x .1875" x 12' Flat Bar Alloy 6061-T6		.338		No Award
000-000	1.25" x .250" x 12' Flat Bar Alloy 6061-T6		.338	\$12.24	Eastern Metal
707-020	1.5" x .250" x 12' Flat Bar Alloy 6061-T6		.441	\$15.90	Eastern Metal
707-060	2" x .250" x 12' Flat Bar Alloy 6061-T6		.588	\$21.50	Eastern Metal
000-000	2.5" x .1875" x 12' Flat Bar Alloy 6061-T6		.338		No Award
707-084	4" x .375" x 12' Flat Bar Alloy 6061-T6		1.764	\$63.50	Eastern Metal
000-000	1.5" x .375" x 12' Flat Bar Alloy 6061-T6		.661	\$23.80	Eastern Metal
707-096	.5" x 6" x 12' Flat Bar Alloy 6061-T6		3.528	\$127.00	Eastern Metal
208-139	.250" x 7" x 12' Alloy 6061-T6		2.058	\$74.00	Eastern Metal
707-090	.75" x 8" x 12' Alloy 6061-T6		7.056	\$254.00	Eastern Metal

*Substitute Alloy (6063-T2, 6063-T52, 6061-T6, 3003, 5052-H32, 6063, 6061-T6SS) as stated in description.

BID SHEET (Page 4 of 17)

BID #: DOT-ITB-24-9069-SJ

BID TITLE: Aluminum Materials

Bid As Specified

I-BEAMS: Not Fabricated

OVIEDO, FL

“DOT” NUMBER	DESCRIPTION	MINIMUM ORDER QUANTITY	LBS LF	UNIT PRICE	VENDOR
708-022	6" x 4" x .190" x 30' Alloy 6061-T6	1,000 ft.	4.030	\$363.00	Eastern Metal
708-042	4" x 3" x .29" x .17 x .25 x 25' Alloy 6061-T6		2.793	\$210.00	Eastern Metal

*Substitute Alloy (6063-T2, 6063-T52, 6061-T6, 3003, 5052-H32, 6063, 6061-T6SS) as stated in description.

PLATES: Not Fabricated

OVIEDO, FL

“DOT” NUMBER	DESCRIPTION	MINIMUM ORDER QUANTITY	LBS LF	UNIT PRICE	VENDOR
704-095	.190" x 60" x 144" Alloy 5052-H32		2.740	\$479.00	Eastern Metal
704-120	.375" x 48" x 144" Alloy 6061-T6		5.290	\$840.00	Eastern Metal
704-130	.5" x 48" x 144" Alloy 6061-T6		7.000	\$1,150.00	Eastern Metal
704-150	.75" x 48" x 144" Alloy 6061-T6		11.000		No Award
208-117	.125" x 48" x 144" Brite Tread Plate Alloy 3003 *		1.900	\$299.00	Eastern Metal

*Substitute Alloy (6063-T2, 6063 T52, 6061 T6, 3003, 5052-H32, 6063, 6061-T6SS) as stated in description.

BID SHEET (Page 5 of 17)

BID #: DOT-ITB-24-9069-SJ

BID TITLE: Aluminum Materials

Bid As Specified

RODS: Not Fabricated

OVIEDO, FL

"DOT" NUMBER	DESCRIPTION	MINIMUM ORDER QUANTITY	LBS LF	UNIT PRICE	VENDOR
707-100	.375" x 12' 6061-T6 PER ASTM B221		.130	\$4.90	Eastern Metal
707-110	.75" x 12' 6061-T6 PER ASTM B 221		.520	\$19.00	Eastern Metal
707-120	.625" x 12' 6061-T6 PER ASTM B 221		.361	\$13.00	Eastern Metal
707-130	.875" x 12' 6061-T6 PER ASTM B 221		.707	\$25.50	Eastern Metal
707-135	1" x 12' 6061-T6 PER ASTM B 221		.924	\$34.00	Eastern Metal
707-140	6" x 12' 6061-T6 PER ASTM B 221		33.25	\$1,300.00	Eastern Metal

SHEETS: Not Fabricated

OVIEDO, FL

"DOT" NUMBER	DESCRIPTION	MINIMUM ORDER QUANTITY	LBS LF	UNIT PRICE	VENDOR
704-010	.080" x 48" x 144" Alloy 5052-H32		1.130	\$133.00	Eastern Metal
704-020	.125" x 36" x 144" Alloy 5052-H32*	10	1.764	\$156.38	Mandel Metals
704-040	.125" x 48" x 144" Alloy 5052-H32*	10	1.764	\$208.50	Mandel Metals
752-281	.125" x 54" x 144" Alloy 5052-H32*	20	1.764	\$238.37	Mandel Metals
704-060	.125" x 60" x 144" Alloy 5052-H32*		1.764	\$215.00	Eastern Metal
000-000	.125" x 48" x 192" Floor Plate Alloy 6061-T6		1.905		No Award
704-080	.1875" x 48" x 144" Alloy 5052-H32*	10	2.740	\$313.58	Mandel Metals
704-090	.250" x 48" x 144" Alloy 6061-T6		3.530	\$475.00	Eastern Metal

BID SHEET (Page 6 of 17)

BID #: DOT-ITB-24-9069-SJ

BID TITLE: Aluminum Materials

Bid As Specified

ZEE-BEAMS: Not Fabricated

OVIEDO, FL

“DOT” NUMBER	DESCRIPTION	MINIMUM ORDER QUANTITY	LBS	UNIT PRICE	VENDOR
708-080	3" x .25" x 30' Alloy 6061-T6		2.330	\$250.00	Eastern Metal
708-100	4" x 3.0625" x .25" x 30' Alloy 6061-T6		2.850		No Award

TUBES: Not Fabricated

OVIEDO, FL

“DOT” NUMBER	DESCRIPTION	MINIMUM ORDER QUANTITY	LBS LF	UNIT PRICE	VENDOR
702-005	1" x .125" x 20' Alloy 6061-T6	2,500 ft.	.405	\$25.00	Eastern Metal
702-010	1.5"x .125"x 12' Alloy 6061-T6	24 ft.	.635	\$31.00	Eastern Metal
702-015	1.75" x .125" x 24' Alloy 6061-T6		.750	\$58.50	Eastern Metal
702-025	2.25" x .125" x 30' Alloy 6061-T6	2,600 ft.	.981	\$89.00	Eastern Metal
702-030	2.5" x .25" x 30' Alloy 6061-T6		2.078		No Award
702-055	3.5" x .1875" x 24' Alloy 6061-T6	870 ft.	2.294	\$165.00	Eastern Metal
702-070	4" x .1875" x 24' Alloy 6061-T6	760 ft.	2.641	\$190.00	Eastern Metal
702-125	4.5" x .250" x 24' Alloy 6061-T6	650 ft.	3.695	\$266.40	Eastern Metal
702-131	4.5" x .375" x 24' Alloy 6061-T6		5.715		No Award
702-161	5" x .375" x 30' Alloy 6061-T6	1,200 ft.	6.408	\$700.00	Eastern Metal
000-000	5" x .5" x 24' Alloy 6061-T6		8.310	\$25.00	No Award

BID SHEET (Page 7 of 17)

BID #: DOT-ITB-24-9069-SJ

BID TITLE: Aluminum Materials

Bid As Specified

TUBES: Not Fabricated

OVIEDO, FL

“DOT” NUMBER	DESCRIPTION	MIINIMUM ORDER QUANTITY	LBS LF	UNIT PRICE	VENDOR
702-180	5.5" x .375 x 24' Alloy 6061-T6		7.031		No Award
208-008	5.5" x .250 x 17' Alloy 6061-T6		4.849		No Award
208-017	6" x .250" x 24' Alloy 6061-T6	925 ft.	5.311	\$424.00	Eastern Metal
702-240	6.5" x .250" x 24' Alloy 6061-T6		5.773	\$450.24	Eastern Metal
702-210	6.0" x .375" x 24' Alloy 6061-T6		7.654		No Award
702-245	6.5"x .375" x 24' Alloy 6061-T6		8.416		No Award
702-265	7" x .375" x 24' Alloy 6061-T6		9.179		No Award
702-900	1.25" x .125" x 21' Square Alloy 6063-T52 *	1,500 ft.	.675	\$42.50	Eastern Metal
702-903	1.5" x 1.5" x .125" x 21', Square, Alloy 6063-T52 *	1,200 ft.	.80	\$55.00	Eastern Metal
702-905	2" x 2" x .125" x 21' Square Alloy 6063-T52 *	900 ft.	1.126	\$77.00	Eastern Metal
702-910	2" x 4" x .125" x 21' Rectangle, Alloy 6063-T52 *	580 ft.	1.673	\$115.00	Eastern Metal
702-913	2" x 4" x .250" x 24' Rectangle Alloy 6063-T52*	760 ft.	3.201	\$231.00	Eastern Metal
702-960	4" x 6" x .250" x 28' Rectangle Alloy 6061-T6	440 ft.	5.700	\$479.00	Eastern Metal
702-961	2" x 2" x .250" x 21' Square Alloy 6063-T52	1,200 ft.	2.058	\$130.00	Eastern Metal
702-962	1.5" x 3" x .187" x 21' Rectangle Alloy 6063-T52		1.250		No Award
000-000	2" x 2" x .1875" x 21' Square Alloy 6061-T6	1,530 ft.	1.627	\$102.50	Eastern Metal

*Substitute Alloy (6063-T2, 6063-T52, 6061-T6, 3003, 5052-H32, 6063, 6061-T6SS) as stated in description.

BID SHEET (Page 8 of 17)

BID #: DOT-ITB-24-9069-SJ

BID TITLE: Aluminum Materials

Bid As Specified

OTHER: Not Fabricated

OVIEDO, FL

“DOT” NUMBER	DESCRIPTION	MINIMUM ORDER QUANTITY	LBS	UNIT PRICE	VENDOR
702-003	1" x 20' Schedule 40 Pipe Alloy 6063-T6		.581	\$35.00	Eastern Metal
702-002	2" x 20' Schedule 40 Pipe Alloy 6063-T52		1.264	\$76.00	Eastern Metal
702-001	3/4" x 20' Schedule 40 Pipe Alloy 6063-T52		.391	\$23.50	Eastern Metal

Substitute Alloys – Sheets & Plates (6061-T6 & 5052-H32) except 208-117 which needs to be Alloy 3003.

Substitute Alloys – Tubing, Bars & Structural Shapes (6061-T6) on certain item(6063-T52). ***

SHEETS: Not Fabricated

LAKE CITY, FL

“DOT” NUMBER	DESCRIPTION	MINIMUM ORDER QUANTITY	LBS LF	UNIT PRICE	VENDOR
752-201	.04" x .36" x 144" Alloy 5052-H38	25	.559	\$48.19	Mandel Metals
752-203	.04" x .36" x 168" Alloy 5052-H38	25	.559	\$56.24	Mandel Metals
752-211	.08" x .30" x 144" Alloy 5052-H38	25	1.117	\$80.33	Mandel Metals
752-221	.08" x 36" x 144" Alloy 5052-H38	25	1.117	\$96.41	Mandel Metals
752-231	.08" x 48" x 144" Alloy 5052-H38	25	1.117	\$128.54	Mandel Metals
752-235	.125" x 24" x 144" Alloy 5052-H38	25	1.746	\$100.41	Mandel Metals
752-241	.125" x 30" x 144" Alloy 5052-H38	25	1.746	\$125.52	Mandel Metals
752-251	.125" x 36" x 144" Alloy 5052-H38	25	1.746	\$150.64	Mandel Metals
752-261	.125" x 42" x 144" Alloy 6063-T52	25	1.764	\$175.73	Mandel Metals
752-271	.125" x 48" x 144" Alloy 5052-H38	25	1.764	\$200.84	Mandel Metals

All items on individual pallets for Lake City location

BID SHEET (Page 9 of 17)

BID #: DOT-ITB-24-9069-SJ

BID TITLE: Aluminum Materials

Bid As Specified

OTHER: Fabricated

LAKE CITY, FL

"DOT" NUMBER	DESCRIPTION	MINIMUM ORDER QUANTITY	LBS	UNIT PRICE	VENDOR
752-101	.08" x 36" x 48" x 48" Triangle. See drawing 13 Alloy 5052-H38	50	1.117	\$20.17	Mandel Metals
752-110	.08" x 36" Toll. See drawing 14 Alloy 5052-H38	50	1.117	\$58.27	Mandel Metals
752-142	.08" x 24" Toll. See drawing 15 Alloy 5052-H38	50	1.117	\$39.21	Mandel Metals
752-147	.08" x 48" Toll. See drawing 16 Alloy 5052-H38	10	1.764	\$101.10	Mandel Metals

*** All items on individual pallets for Lake City location***

SIGN BLANKS: Fabricated

LAKE CITY, FL

"DOT" NUMBER	DESCRIPTION	MINIMUM ORDER QUANTITY	LBS	UNIT PRICE	VENDOR
752-001	.08" x 36" Round See drawing 3 Alloy 5052-H38	50	1.117	\$26.57	Mandel Metals
752-002	.08" x 15" Round See drawing 3b Alloy 5052-H38	100	1.117	\$7.44	Mandel Metals
752-011	.08" x 24" Octagon See drawing 4 Alloy 5052-H38	25	1.117	\$12.17	Mandel Metals
752-016	.08" x 30" Octagon See drawing 5 Alloy 5052-H38	50	1.117	\$16.64	Mandel Metals
752-021	.08" x 36" Octagon See drawing 6 Alloy 5052-H38	50	1.117	\$23.76	Mandel Metals
752-031	.125" x 48" Stop See drawing 6a Alloy 5052-H38	25	1.764	\$66.53	Mandel Metals

BID SHEET (Page 10 of 17)BID #: DOT-ITB-24-9069-SJBID TITLE: Aluminum Materials**Bid As Specified****SIGN BLANKS:** Fabricated**LAKE CITY, FL**

"DOT" NUMBER	DESCRIPTION	MINIMUM ORDER QUANTITY	LBS	UNIT PRICE	VENDOR
752-051	.08" x 24" Interstate shield See drawing 7 Alloy 5052-H38	50	1.117	\$13.86	Mandel Metals
752-056	.08" x 36" Interstate shield See drawing 7a Alloy 5052-H38	50	1.117	\$30.37	Mandel Metals
752-061	.08" x 24" x 30" Rectangle See drawing 8 Alloy 5052-H38	100	1.117	\$14.44	Mandel Metals
752-063	.080 24" x 36" Rectangle Drawing 28 Alloy 5032-H38	100	1.117	\$17.31	Mandel Metals
752-071	.08" x 36" Pentagon See drawing 9 Alloy 5052-H38	50	1.117	\$24.29	Mandel Metals

***** All items on individual pallets for Lake City location*******SIGN BLANKS:** Fabricated**LAKE CITY, FL**

"DOT" NUMBER	DESCRIPTION	MINIMUM ORDER QUANTITY	LBS	UNIT PRICE	VENDOR
752-085	.08" x 30" x 30" Square See drawing 11a & 11b Alloy 5052-H38	100	1.117	\$17.84	Mandel Metals
752-091	.08" x 36" Triangle See drawing 12A Alloy 5052-H38	50	1.117	\$14.37	Mandel Metals
752-092	.08" x 48" Triangle See drawing 12B Alloy 5052-H38	50	1.117	\$25.27	Mandel Metals
752-093	.125" x 60" Triangle See drawing 12C Alloy 5052-H38	50	1.117	\$60.74	Mandel Metals
752-301	.08" x 12" x 12" Square See drawing 17 Alloy 5052-H38	50	1.117	\$3.93	Mandel Metals
752-302	.08" x 12" x 18" Rectangle See drawing 18 Alloy 5052-H38	100	1.117	\$4.66	Mandel Metals

***** All items on individual pallets for Lake City location*****

BID SHEET (Page 11 of 17)

BID #: DOT-ITB-24-9069-SJ

BID TITLE: Aluminum Materials

Bid As Specified

SIGN BLANKS: Fabricated

LAKE CITY, FL

"DOT" NUMBER	DESCRIPTION	MINIMUM ORDER QUANTITY	LBS	UNIT PRICE	VENDOR
752-303	.08" x 12" x 24" Rectangle See drawing 19 Alloy 5052-H38	200	1.117	\$5.84	Mandel Metals
000-000	.08" x 12" x 30" Rectangle See drawing 19 Alloy 5052-H38	200	1.117	\$7.22	Mandel Metals
752-304	.08" x 12" x 36" Rectangle See drawing 20 Alloy 5052-H38	200	1.117	\$8.63	Mandel Metals
752-305	.08" x 12" x 48" Rectangle See drawing 21 Alloy 5052-H38	100	1.117	\$11.34	Mandel Metals
752-310	.08" x 16" x 24" Rectangle See drawing 22 Alloy 5052-H38	200	1.117	\$7.84	Mandel Metals
752-320	.08" x 18" Square/Diamond See drawing 23a & 23b Alloy 5052-H38	200	1.117	\$6.52	Mandel Metals
752-321	.08" x 18" x 24" Rectangle See drawing 24 Alloy 5052-H38	200	1.117	\$8.60	Mandel Metals
752-322	.08" x 18" x 30" Rectangle See drawing 25 Alloy 5052-H38	100	1.117	\$10.66	Mandel Metals
000-000	.08" x 18" x 36" Rectangle See drawing 26 Alloy 5052-H38	100	1.117	\$12.72	Mandel Metals
752-323	.08" x 18" x 48" Rectangle See drawing 26 Alloy 5052-H38	100	1.117	\$16.80	Mandel Metals
752-324	.08" x 18" x 54" Rectangle See drawing 40 Alloy 5052-H38	100	1.117	\$19.21	Mandel Metals

*** All items on individual pallets for Lake City location***

BID SHEET (Page 12 of 17)

 BID #: DOT-ITB-24-9069-SJ

 BID TITLE: Aluminum Materials

Bid As Specified

SIGN BLANKS: Fabricated

LAKE CITY, FL

"DOT" NUMBER	DESCRIPTION	MINIMUM ORDER QUANTITY	LBS LF	UNIT PRICE	VENDOR
752-330	.08" x 24" Square See drawing 27 Alloy 5052-H38	200	1.117	\$11.32	Mandel Metals
752-331	.08" x 24" x 48" Rectangle See drawing 29 Alloy 5052-H38	50	1.117	\$22.64	Mandel Metals
752-340	.08" x 36" x 30" Rectangle See drawing 30 Alloy 5052-H38	100	1.117	\$20.92	Mandel Metals
752-341	.08" x 30" x 48" Rectangle See drawing 31 Alloy 5052-H38	100	1.117	\$27.74	Mandel Metals
752-342	.08" x 36" Square/Diamond See drawing 32a & 32b Alloy 5052-H38	200	1.117	\$25.10	Mandel Metals
752-343	.08" x 36" x 48" Rectangle See drawing 33 Alloy 5052-H38	200	1.117	\$33.29	Mandel Metals
752-344	.08" x 30" x 42" Rectangle See drawing 41 Alloy 5052-H38	200	1.117	\$24.41	Mandel Metals
752-350	.125" x 48" Square/Diamond See drawing 34a & 34b Alloy 5052-H38	100	1.764	\$69.08	Mandel Metals
752-351	.125" x 48" x 60" Rectangle See drawing 35 Alloy 5052-H38	100	1.764	\$86.20	Mandel Metals
752-360	.08" x 4" x 48" Rectangle See drawing 36 Alloy 5052-H38	250	1.117	\$4.69	Mandel Metals
752-361	.08" x 6" x 48" Rectangle See drawing 37 Alloy 5052-H38	250	1.117	\$6.27	Mandel Metals

BID SHEET (Page 13 of 17)

BID #: DOT-ITB-24-9069-SJ

BID TITLE: Aluminum Materials

Bid As Specified

ANGLE: Not Fabricated

STATEWIDE MAINTENANCE

"DOT" NUMBER	DESCRIPTION	MINIMUM ORDER QUANTITY	LBS LF	UNIT PRICE	VENDOR
208-087	Extrusion, sign corner angle, See drawing #38 22- A5024 Alloy 6063-T52		1.100		No Award

TUBES: Not Fabricated

STATEWIDE MAINTENANCE

"DOT" NUMBER	DESCRIPTION	MINIMUM ORDER QUANTITY	LBS LF	UNIT PRICE	VENDOR
000-000	.125" x 2.5" x 17' Alloy 6061-T6	1,000 ft.		\$44.00	Eastern Metal
208-001	.125" x 2.5" x 34' Alloy 6061-T6	1,000 ft.	1.100	\$88.00	Eastern Metal
000-000	.125" x 2" x 17' Alloy 6061-T6	1,200 ft.		\$42.35	Eastern Metal
208-002	.125" x 2" x 34' Alloy 6061-T6	1,200 ft.	1.060	\$84.70	Eastern Metal
208-013	.125" x 3" x 17' Alloy 6061-T6	750 ft.		\$53.15	Eastern Metal
208-003	.125" x 3" x 34' Alloy 6061-T6	750 ft.	1.330	\$106.30	Eastern Metal
208-012	.1875" x 3.5" x 17' Alloy 6061-T6	650 ft.	2.30	\$117.30	Eastern Metal
208-004	.1875" x 3.5" x 34' Alloy 6061-T6	650 ft.	2.30	\$234.60	Eastern Metal
208-029	.250" x 4" x 17' Alloy 6061-T6	700 ft.		\$141.20	Eastern Metal
208-014	.250" x 4" x 34' Alloy 6061-T6	700 ft.	3.534	\$282.40	Eastern Metal
208-558*	1.75" x .1875" x 20' Alloy 6061-T6	1,400 ft.	1.080	\$64.80	Eastern Metal
208-517	3" x 2.6875" x .25" X 20' Alloy 6061-T6	630 ft.	2.333	\$140.00	Eastern Metal

*Die Charge: \$2,800.00

BID SHEET (Page 14 of 17)

BID #: DOT-ITB-24-9069-SJ

BID TITLE: Aluminum Materials

Bid As Specified

Z-BARS: Fabricated

STATEWIDE MAINTENANCE

"DOT" NUMBER	DESCRIPTION	MINIMUM ORDER QUANTITY	LBS LF	UNIT PRICE	VENDOR
208-088	Type-1 8-inch Bracket with Oval - rectangular holes, Top .75" x .375" Bottom 2" x .53125" Holes punched on 2" centers, See Table 26 & Drawing 1. Alloy 6061-T6			\$2.65	Eastern Metal
208-560	1.75" x 1.75" x .1875" x 10' With oval-rectangular holes, .375" x .75" punched on 2" Centers See Table 26 & Drawing 2. Alloy 6061-T6			\$44.00	Eastern Metal
208-095	1.75" x 1.75" x .1875" x 11" 11-inch Bracket with Oval- rectangular holes, Top .75" x .375" Bottom 2" x .53125" Holes punched on 2" centers, See Table 26 & Drawing 1 Alloy 6061-T6			\$3.50	Eastern Metal
208-096	1.75" x 1.75" x .1875" x 14" 14-inch Bracket with oval- rectangular holes, Top .75" x .375" Bottom 2" x .53125" Holes punched on 2" centers, See Table 26 & Drawing 1 Alloy 6061-T6			\$4.20	Eastern Metal
208-089	1.75" x 1.75" x .1875" x 20" 20-inch Bracket with oval- rectangular holes, Top .75" x .375" Bottom 2" x .53125" Holes punched on 2" centers, See Table 26 & Drawing 1 Alloy 6061-T6			\$5.75	Eastern Metal

BID SHEET (Page 15 of 17)

BID #: DOT-ITB-24-9069-SJ

BID TITLE: Aluminum Materials

Bid As Specified

Z-BARS: Fabricated

STATEWIDE MAINTENANCE

"DOT" NUMBER	DESCRIPTION	MINIMUM ORDER QUANTITY	LBS LF	UNIT PRICE	VENDOR
208-090	1.75" x 1.75" x .1875" x 26" 26-inch Bracket with oval- rectangular holes, Top .75" x .375" Bottom 2" x .53125" Holes punched on 2" centers, See Table 26 & Drawing 1 Alloy 6061-T6			\$7.85	Eastern Metal
208-092	1.75" x 1.75" x .1875" x 32" 32- inch Bracket with oval- rectangular holes, Top .75" x .375" Bottom 2" x .53125" Holes punched on 2" centers, See Table 26 & Drawing 1 Alloy 6061-T6			\$9.30	Eastern Metal
208-097	1.75" x 1.75" x .1875" x 38" 38- inch Bracket with oval- rectangular holes, Top .75" x .375" Bottom 2" x .53125" Holes punched on 2" centers, See Table 26 & Drawing 1 Alloy 6061-T6			\$10.75	Eastern Metal
208-093	1.75" x 1.75" x .1875" x 42" 42- inch Bracket with oval- rectangular holes, Top .75" x .375" Bottom 2" x .53125" Holes punched on 2" centers, See Table 26 & Drawing 1 Alloy 6061-T6			\$11.95	Eastern Metal

BID SHEET (Page 16 of 17)

BID #: DOT-ITB-24-9069-SJ

BID TITLE: Aluminum Materials

Bid As Specified

Z-BARS: Fabricated

STATEWIDE MAINTENANCE

"DOT" NUMBER	DESCRIPTION	MINIMUM ORDER QUANTITY	LBS LF	UNIT PRICE	VENDOR
208-098	1.75" x 1.75" x .1875" x 52" 52-inch Bracket with oval- rectangular holes, Top .75" x .375" Bottom 2" x .53125" Holes punched on 2" centers, See Table 26 & Drawing 1 Alloy 6061-T6			\$15.00	Eastern Metal
208-094	1.75" x 1.75" x .1875" x 56" 56-inch Bracket with oval- rectangular holes, Top .75" x .375" Bottom 2" x .53125" Holes punched on 2" centers, See Table 26 & Drawing 1 Alloy 6061-T6			\$18.30	Eastern Metal

BID SHEET (Page 17 of 17)

BID #: DOT-ITB-24-9069-SJ

BID TITLE: Aluminum Materials

DELIVERY: Delivery will be made within _____ days after receipt of Purchase Order.

Is this product available with recycled content? __Yes __No

If yes, please send information separate from this Invitation to Bid (See Recycled Material Special Condition for more information).

RENEWAL: see Introduction Section #7.

THE UNIT PRICE(S) WILL APPLY TO THE INITIAL TERM AND ANY RENEWAL PERIODS.

MFMP Transaction Fee:

All payment(s) to the vendor resulting from this competitive solicitation **WILL** be subject to the MFMP Transaction Fee in accordance with the attached Form PUR 1000 General Contract Condition #14. The Transaction Fees imposed shall be based upon the date of issuance of the payment.

NOTE: In submitting a response, the bidder acknowledges they have read and agree to the solicitation terms and conditions and their submission is made in conformance with those terms and conditions.

ACKNOWLEDGEMENT: I certify that I have read and agree to abide by all terms and conditions of this solicitation and that I am authorized to sign for the bidder. I certify that the response submitted is made in conformance with all requirements of the solicitation.

Bidder: _____ FEID# _____

Address: _____ City, State, Zip: _____

Phone: _____ E-mail: _____

Authorized Signature: _____ Date: _____

Printed/Typed: _____ Title: _____

ALUMINUM Z-BAR

FRONT VIEW

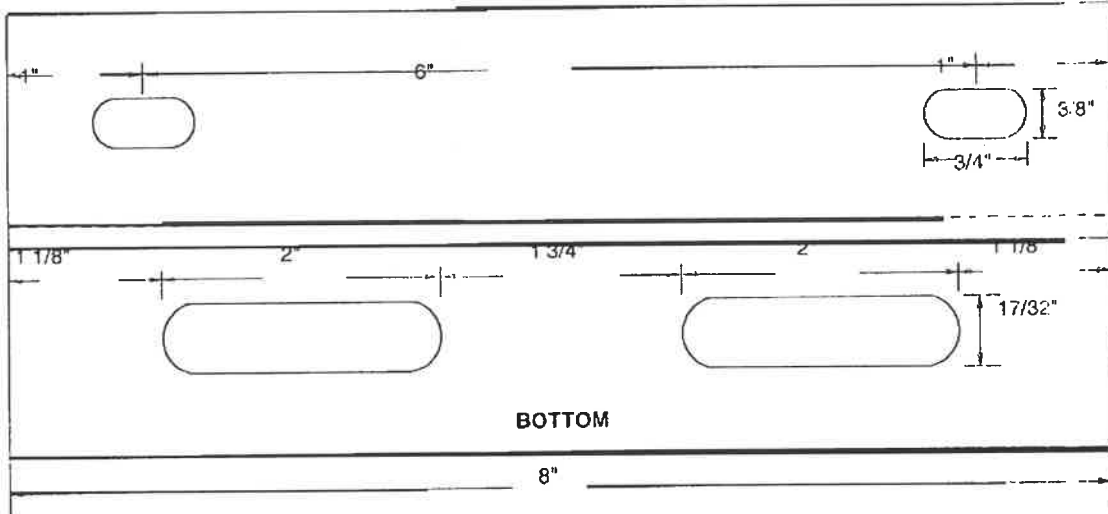

SIDE VIEW

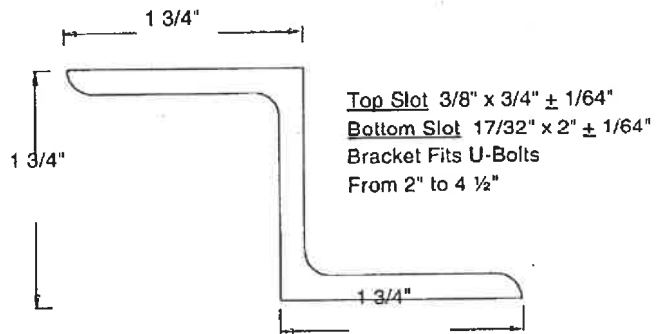

DRAWING #1

26

NO. 1012 DIE SIZE BACKER SIZE FEEDER PLATE SIZE BOLSTER SIZE

DIE NUMBER

APPROVED

My signature on this print indicates my approval of design and dimensions as shown and I authorize the preparation of extrusion dies and acknowledgment that I will pay the cost of making the die which cost shall be NO CHARGE.

Signed: *[Signature]*
 Date: 10-5-79

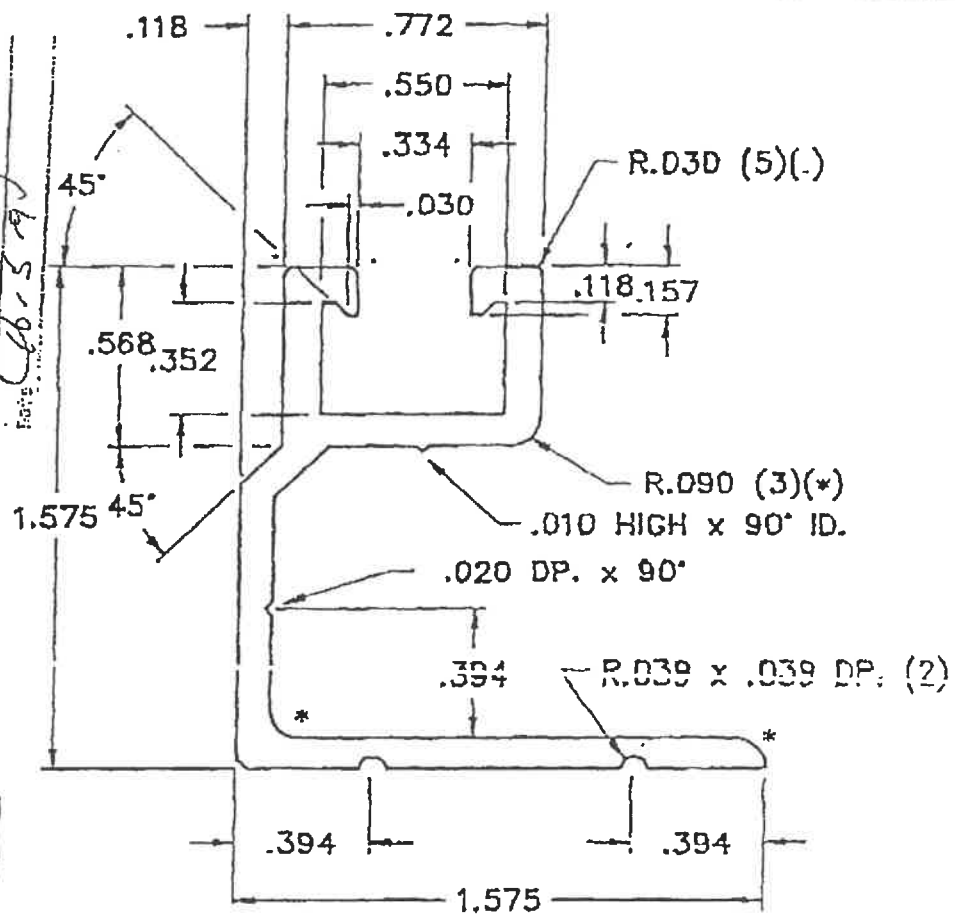

EXPOSED

ACTUAL SIZE

NO.	REVISIONS	DATE
UNSPECIFIED WALL THICKNESS: .098		
EST. AREA	EST. H/F	EST. PARAMETER FACTOR
.451	.541	9.136
Cavity Size	MAX. RATIO	FILE NUMBER
		22-A5024
		CIRCLE SIZE
		2 - 3

STANDARD COMMERCIAL TOLERANCES FOR EXTRUDED PRODUCTS APPLY UNLESS OTHERWISE SPECIFIED DO NOT SCALE DRAWING		
CUSTOMER	FLORIDA D.O.T.	NO. 1
APPLICATION	CORNER ANGLE	MATCH WITH
DRAWN BY	DATE	SCALE
WRG	10/24/78	2:1
ALLOY	6061-T6	
SOLID □	HOLLOW □	SEMI-HOLLOW □
		CUSTOMER # HPN-054

DRAWING #38

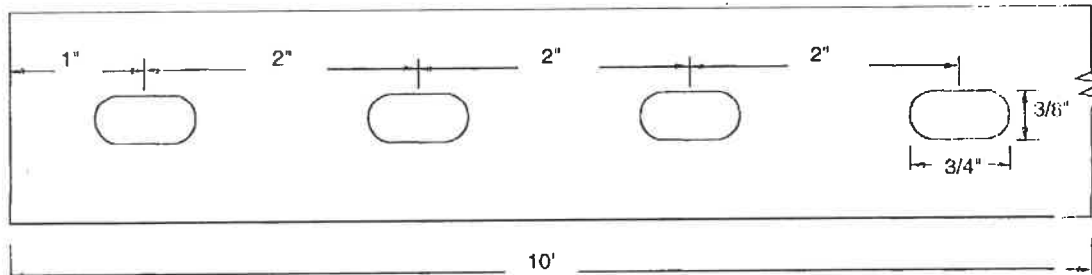

ALUMINUM ZEE BAR (DOT #208-560)
 1 3/4" x 1 3/4" x 3/16" x 10'
 ALLOY 6061-T6
 RECTANGULAR HOLES PUNCHED ON ONE FLANGE
 3/8" x 3/4" ON 2" CENTERS

DRAWING #2

27

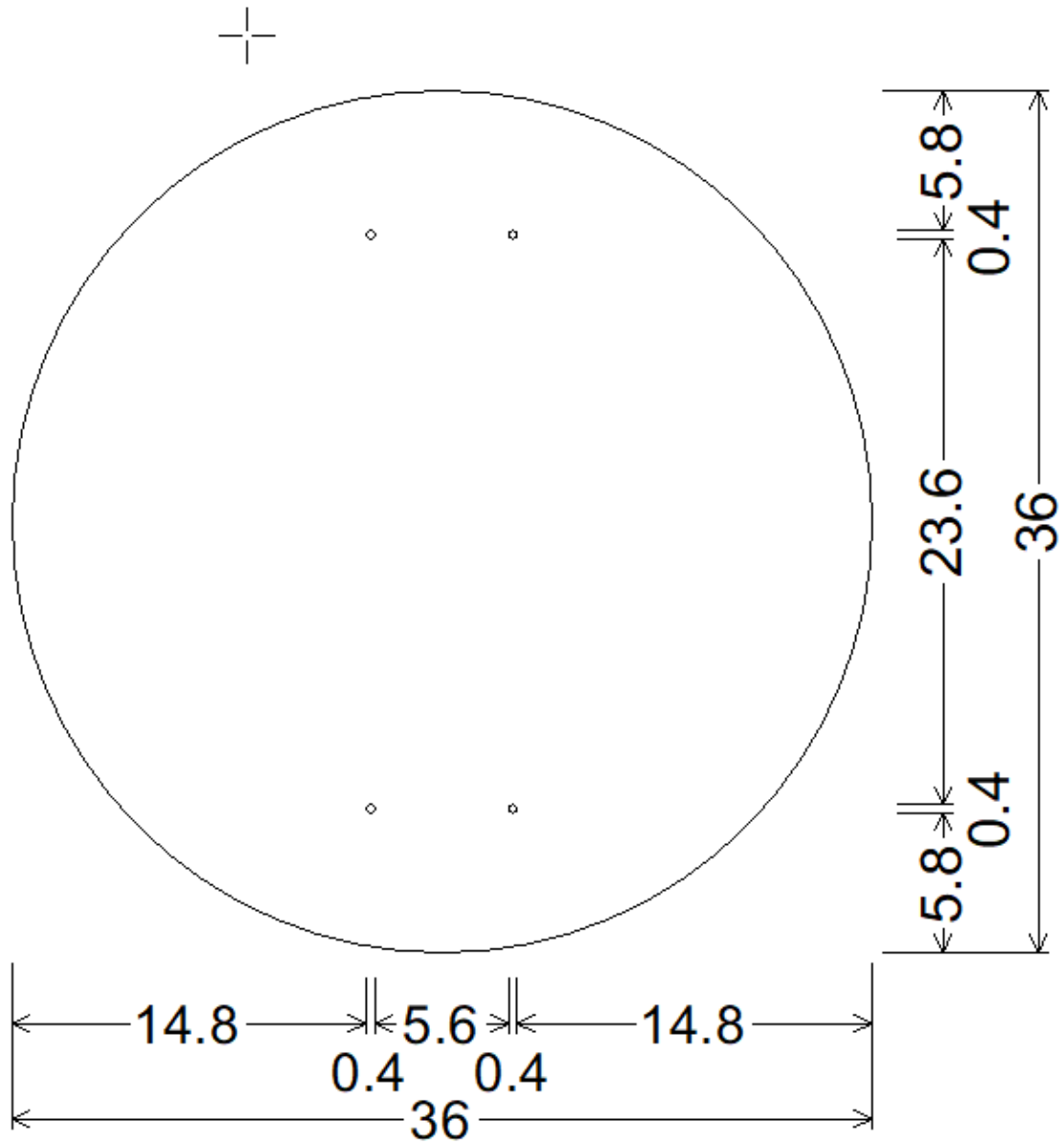

DRAWING 3 36 INCH ROUND;
No border, None;

752-001

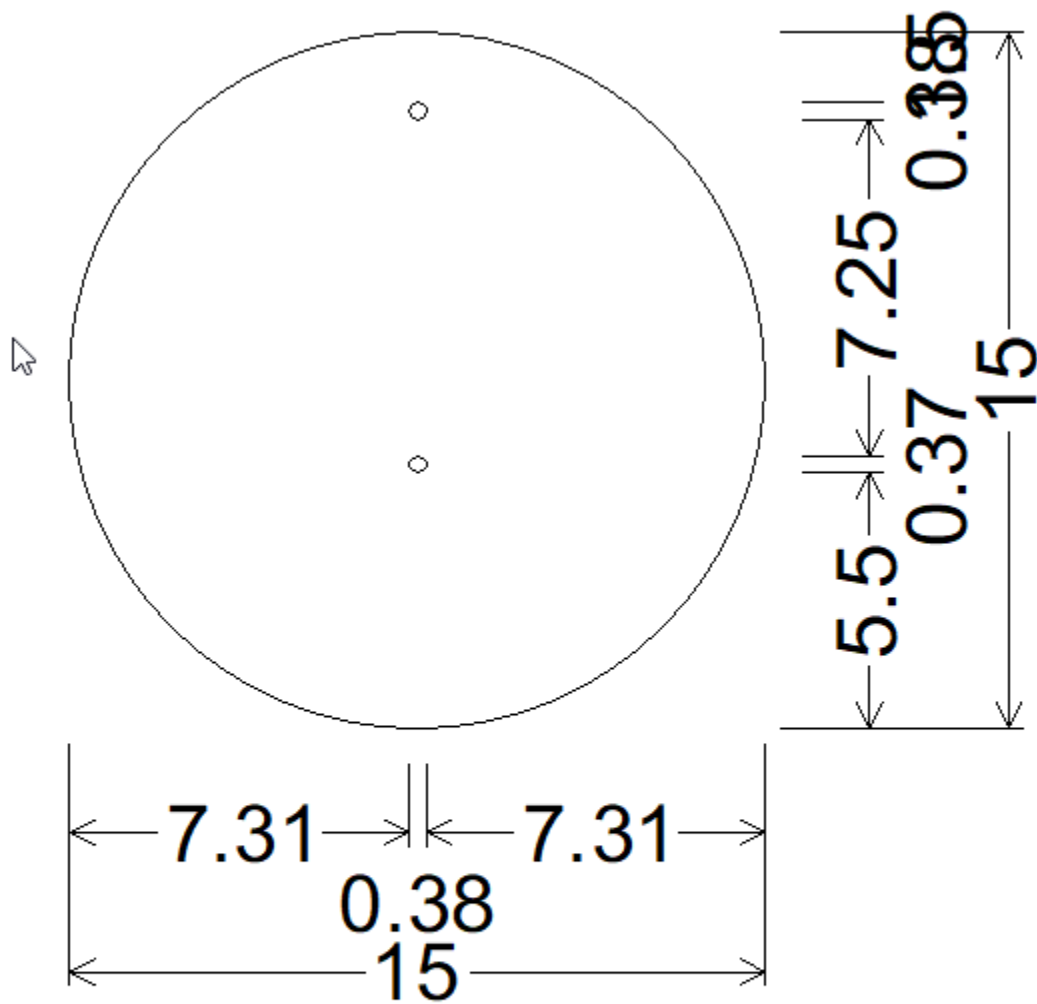

Drawing #3B 15 inch round;
 No border, None;

752-002

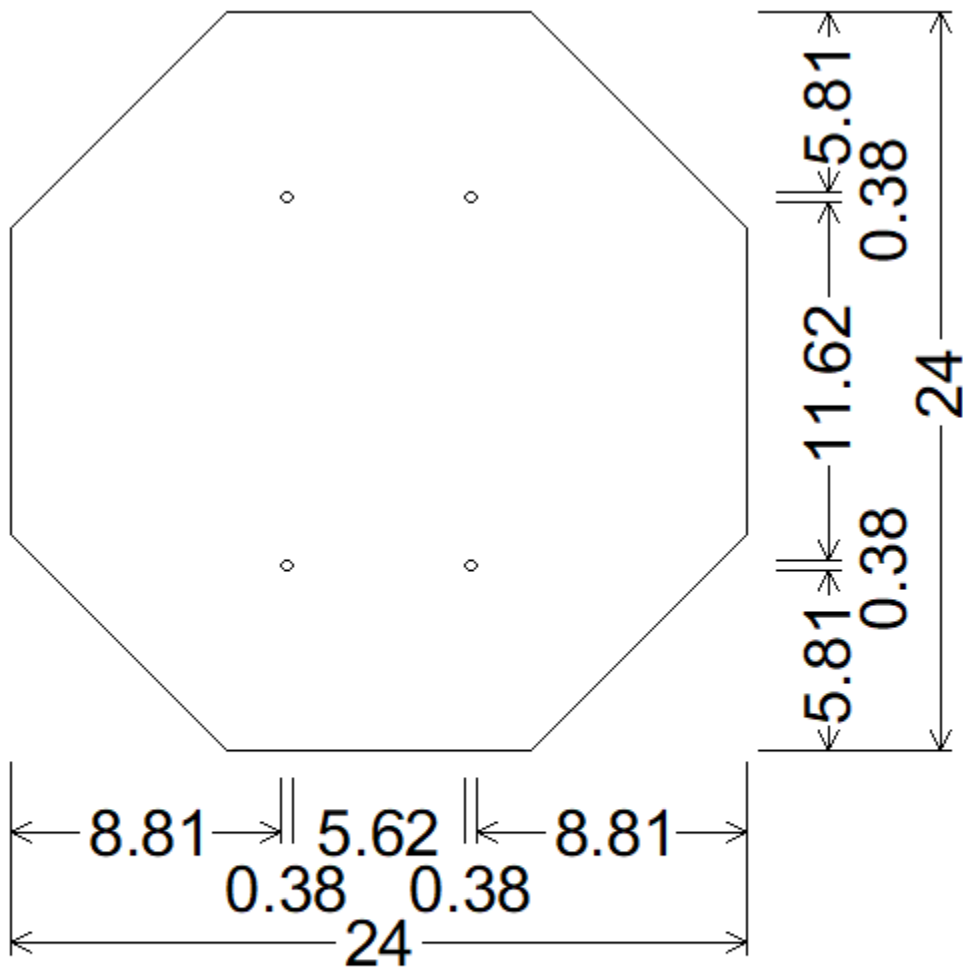

**DRAWING 4 24 INCH OCTAGON;
No border, None;**

752-011

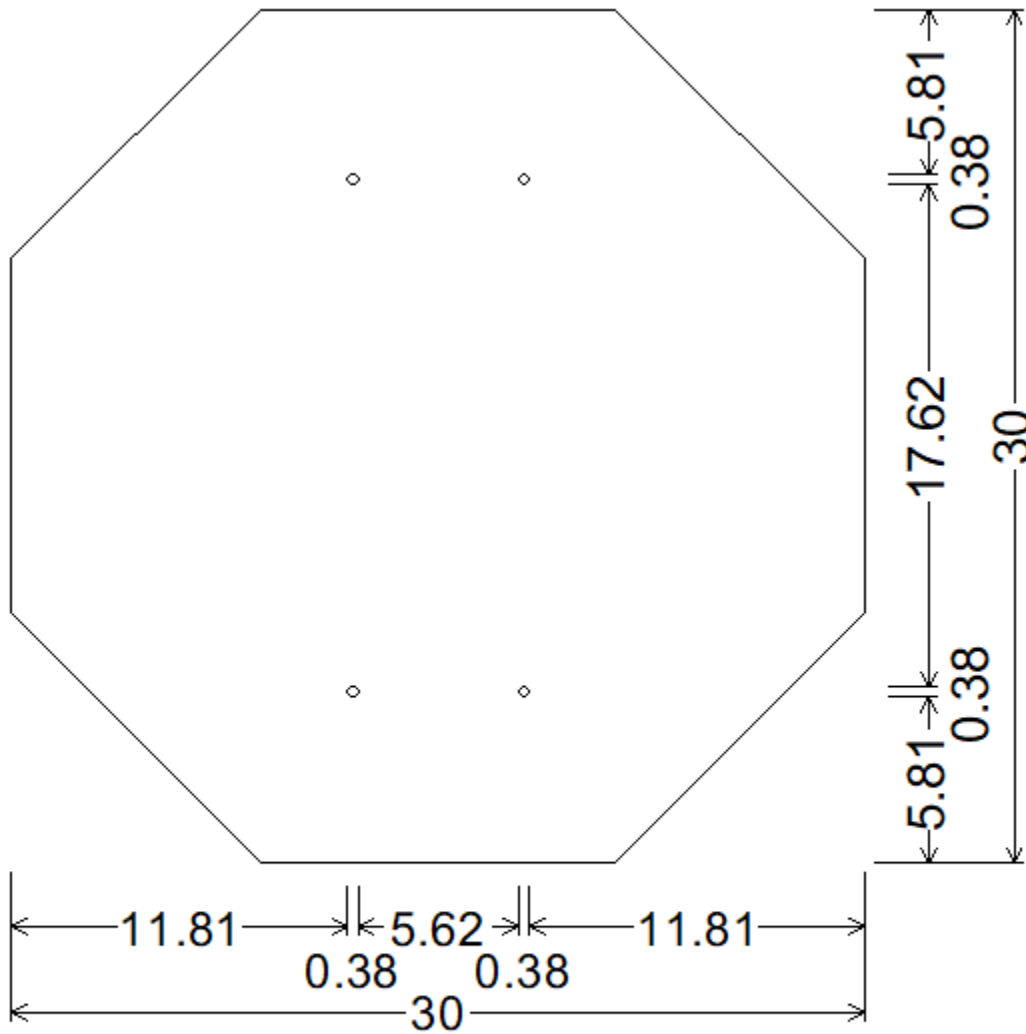

DRAWING 5 30 INCH OCTAGON;
 No border, None;

752-016

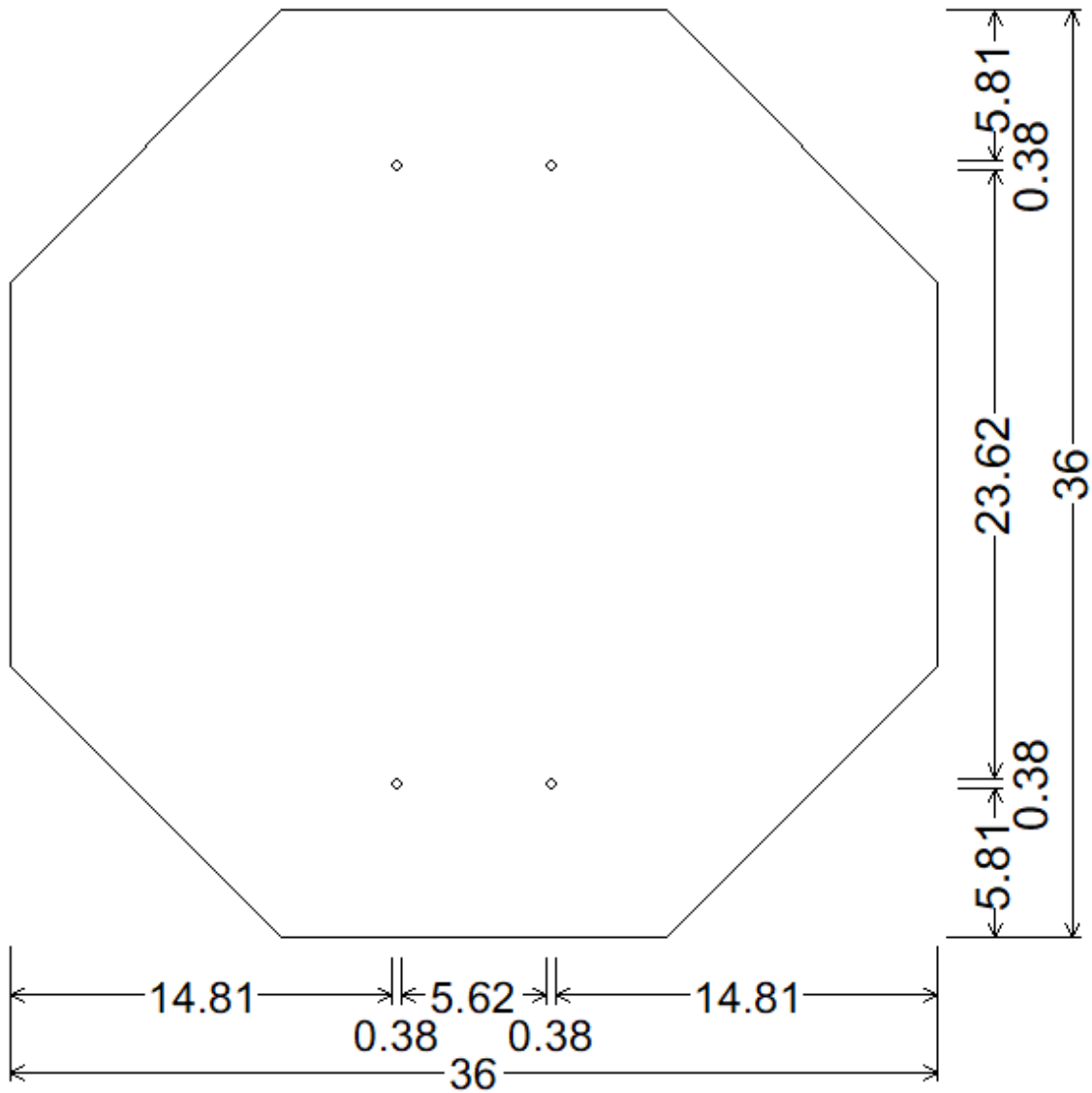

DRAWING 6 36 INCH OCTAGON;
 No border, None;

752-021

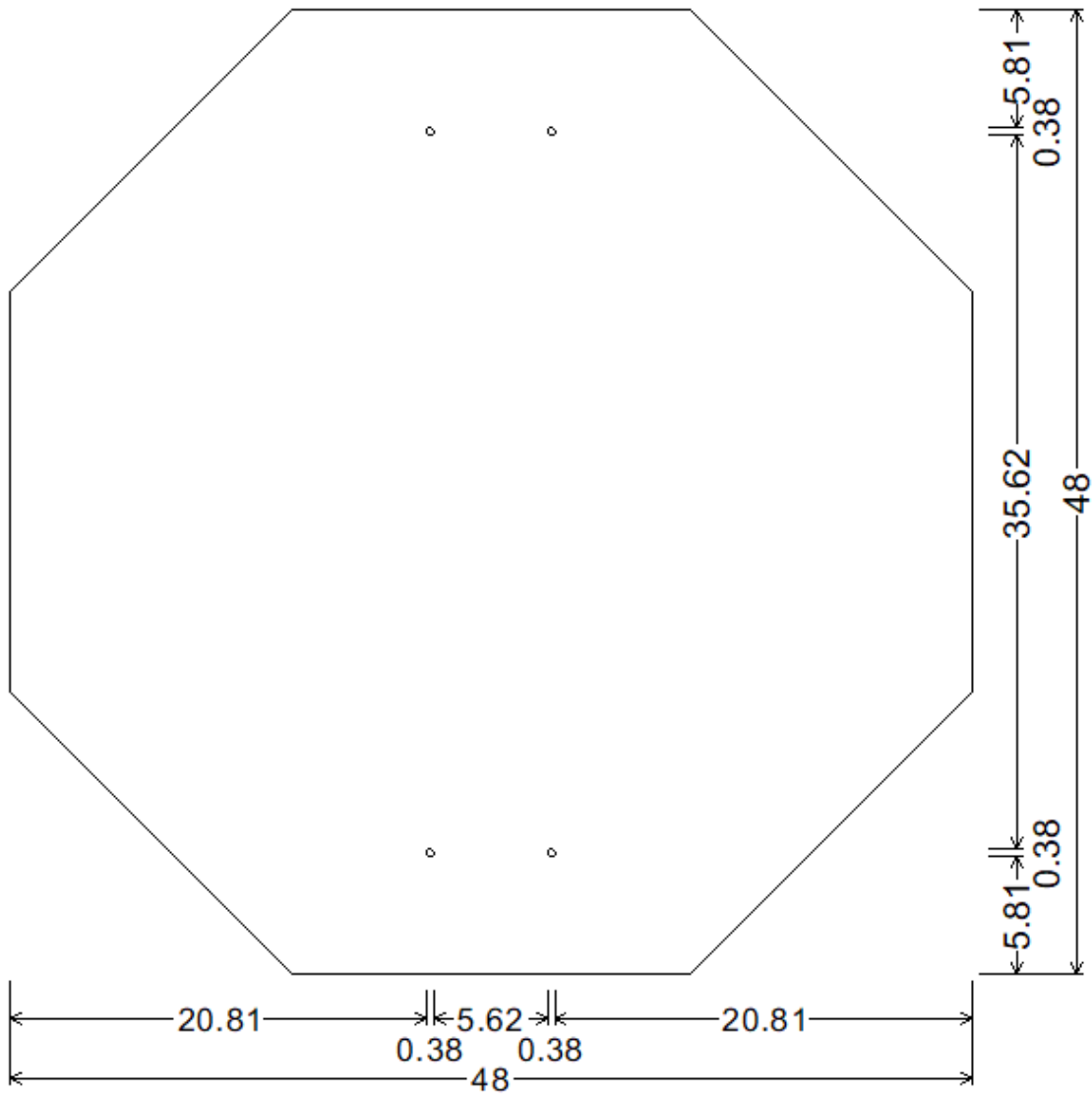

DRAWING 6A 48 INCH OCTAGON;
 No border, None;

752-031

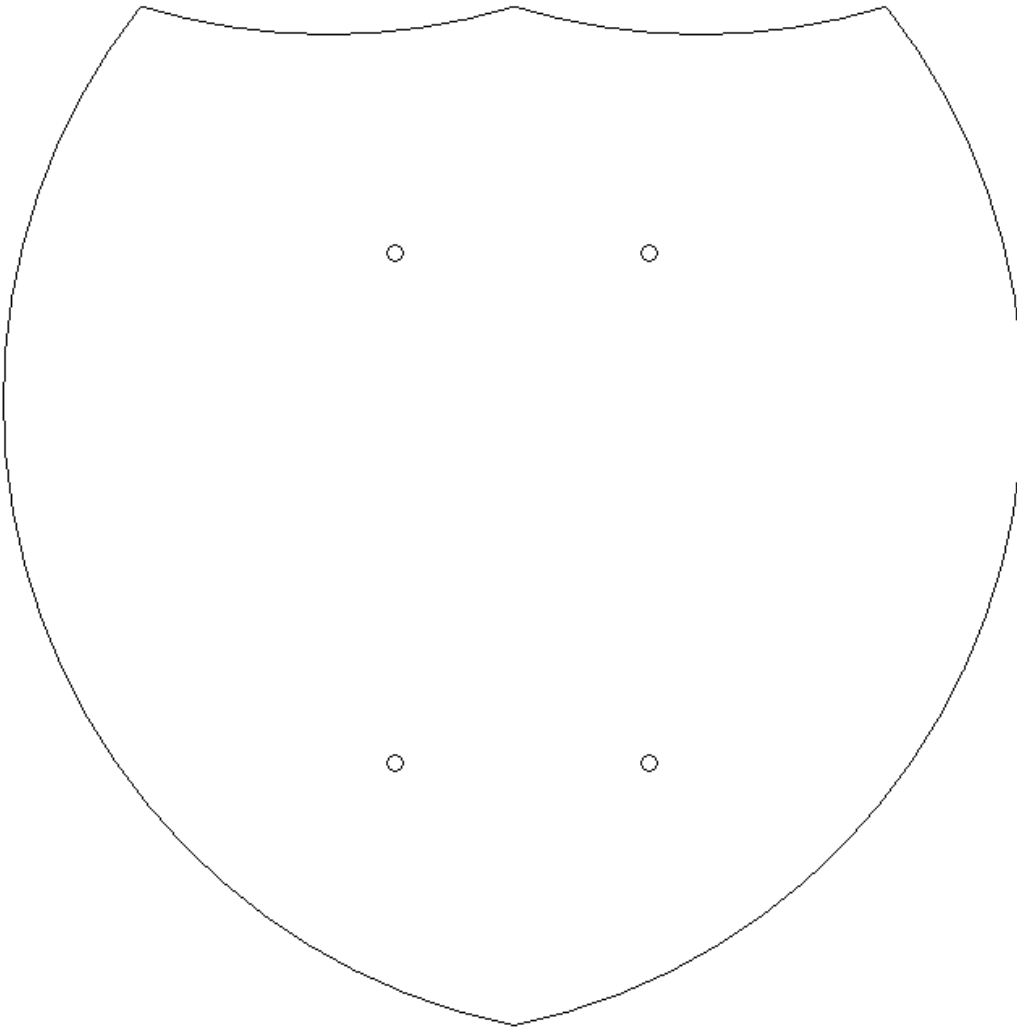

24 INCH INTERSTATE
DRAWING 7

752-051

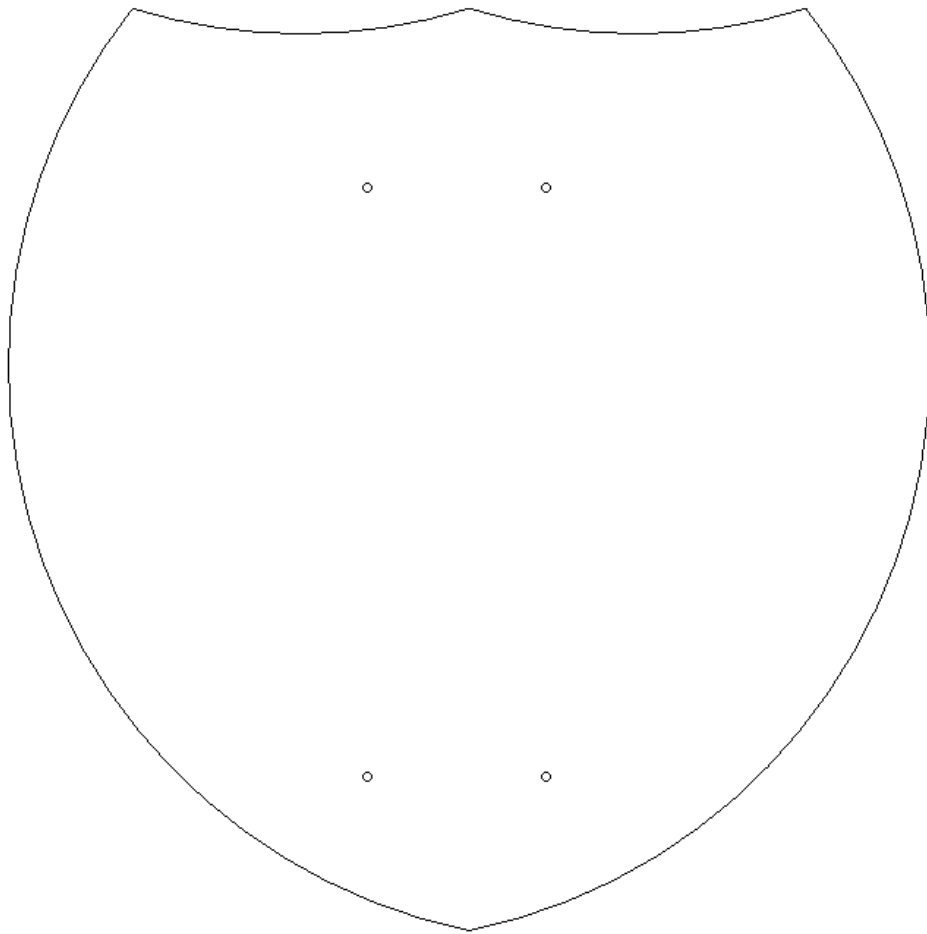

**HOLE 6" CENTERS
36" INTERSTATE
DRAWING 7A**

752-056

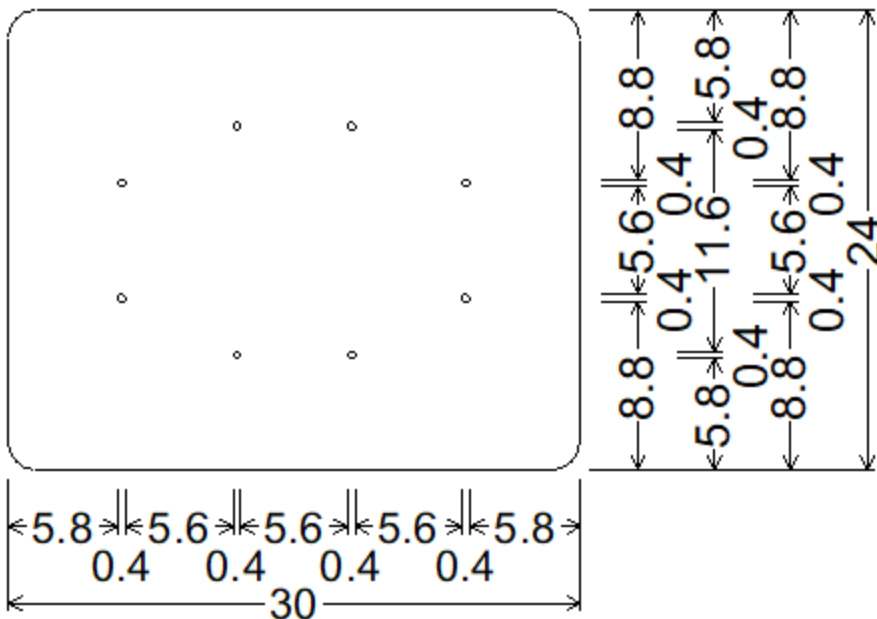

DRAWING 8 24"X30" RECTANGLE;
 1.5" Radius, No border, White on, None;
 Table of widths and spaces

5.8	○	5.6	○	5.6	○
0.4		0.4		0.4	
5.6	○	5.8			
5.8	○	5.6	○	5.6	○
0.4		0.4		0.4	
5.6	○	5.8			

752-061

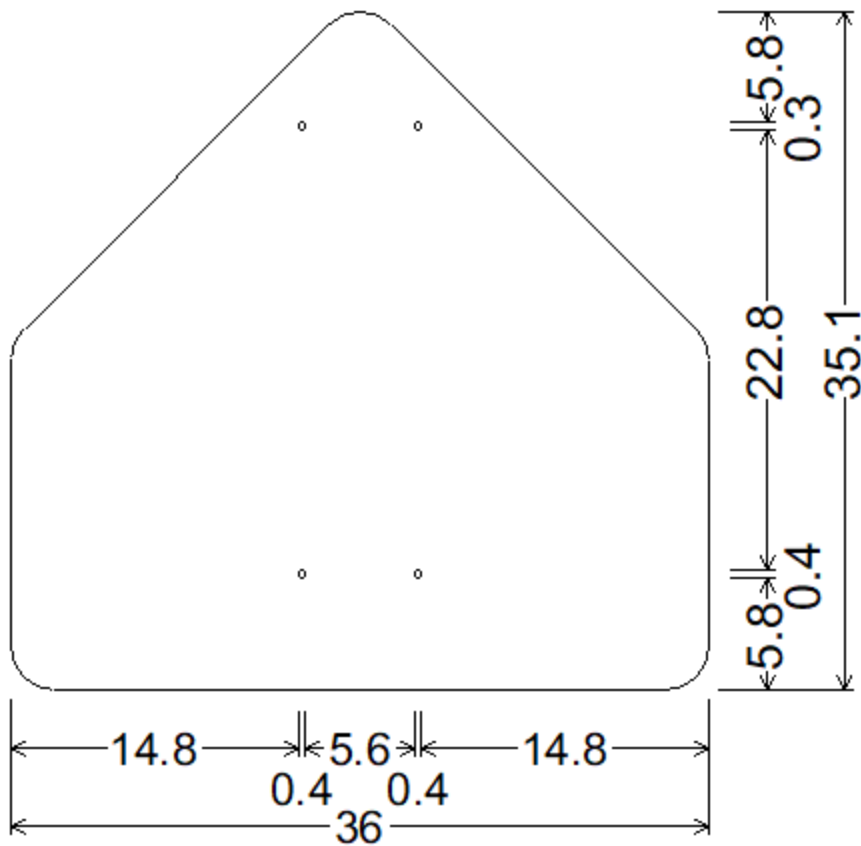

DRAWING 9 36 INCH PENTAGON;
 36.0" base to corner 2.3" Radius, No border, None;
 Table of widths and spaces

14.8	○	0.4	5.6	○	0.4	14.8
14.8	○	0.4	5.6	○	0.4	14.8

752-071

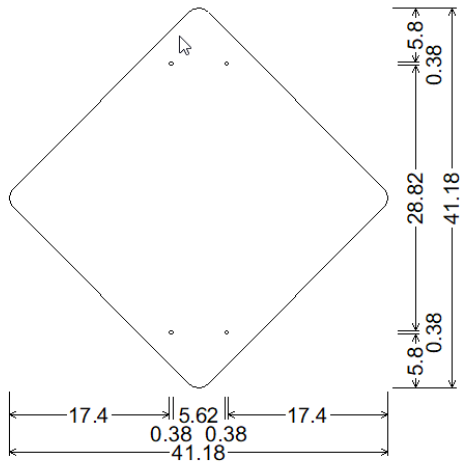

DRAWING 11a 30X30 ON DIAMOND;
 30.00" across sides 1.50" Radius, No border, None;
 Table of widths and spaces

17.40	○	0.38	5.62	○	0.38	17.40
17.40	○	0.38	5.62	○	0.38	17.40

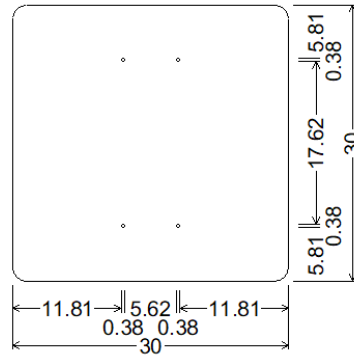

DRAWING 11B GOES WITH DRAWING 11a 30X30 SQUARE;
 1.50" Radius, No border, White on, None;
 Table of widths and spaces

11.81	○	0.38	5.62	○	0.38	11.81
11.81	○	0.38	5.62	○	0.38	11.81

752-085

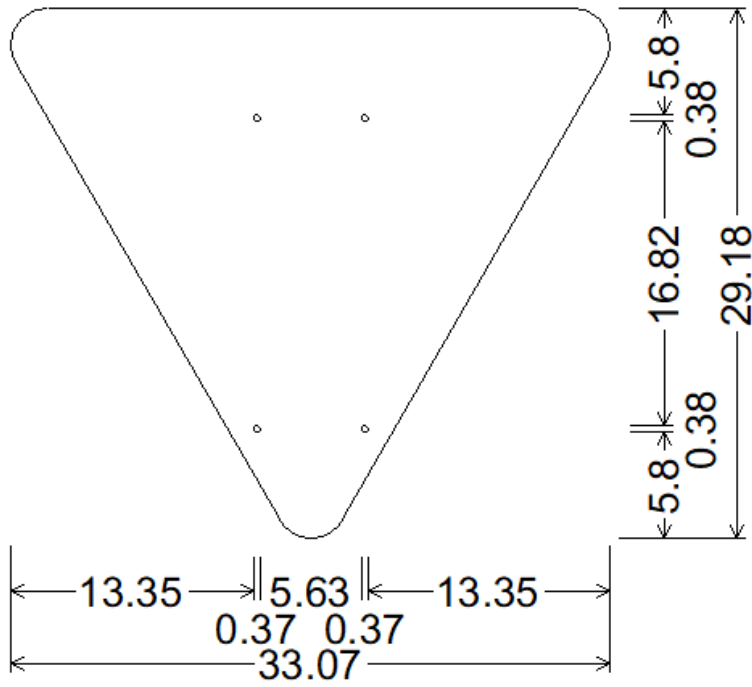

DRAWING 12A 36 INCH TRIANGLE;
 36.00" corner to corner 2.00" Radius, No border, None;
 Table of widths and spaces

13.35	○	0.37	5.63	○	0.37	13.35
13.35	○	0.37	5.63	○	0.37	13.35

752-091

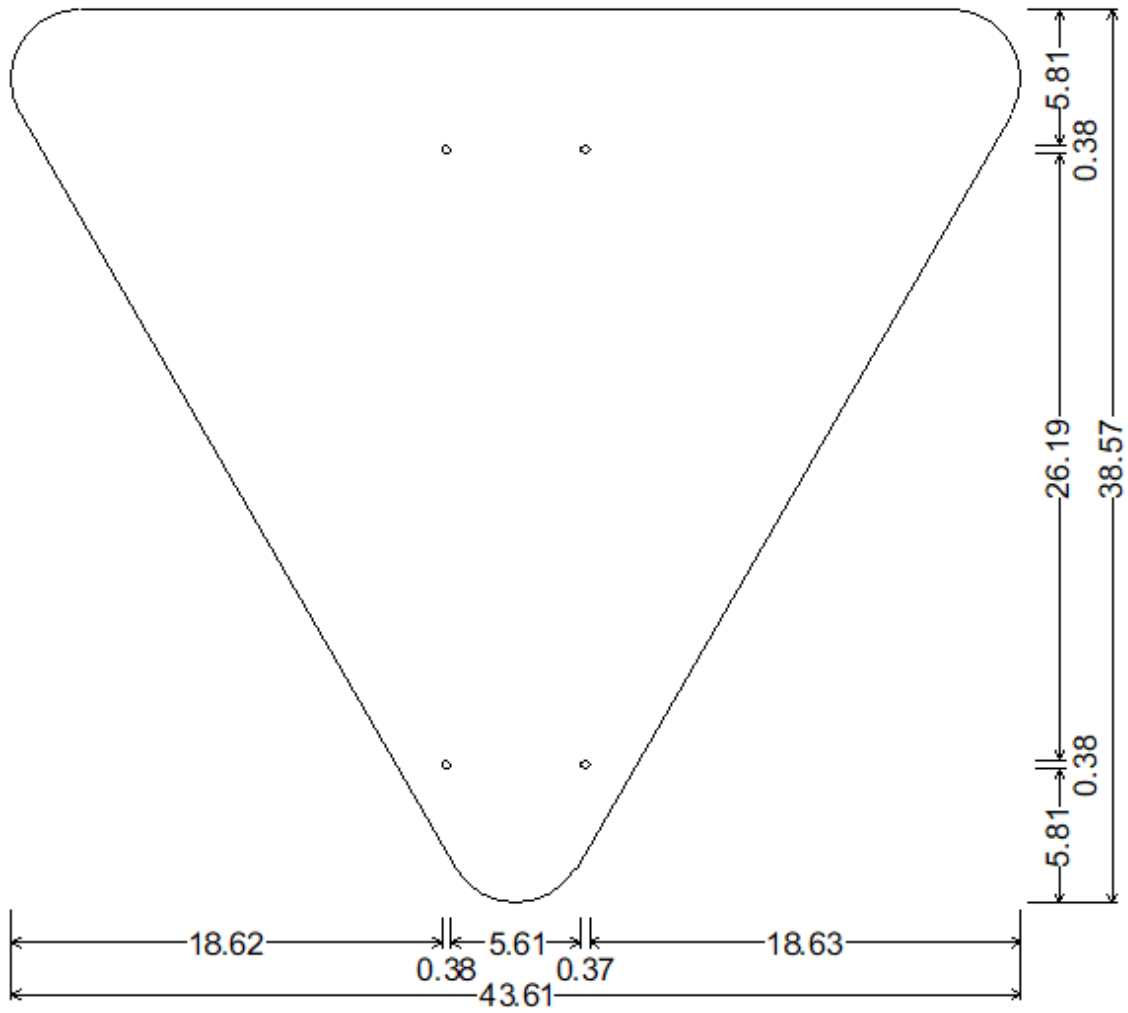

DRAWING 12B 48 INCH;
 48.00" corner to corner 3.00" Radius, No border, None;
 Table of widths and spaces

18.62	○	0.38	5.61	○	0.37	18.63
18.62	○	0.38	5.61	○	0.37	18.63

752-092

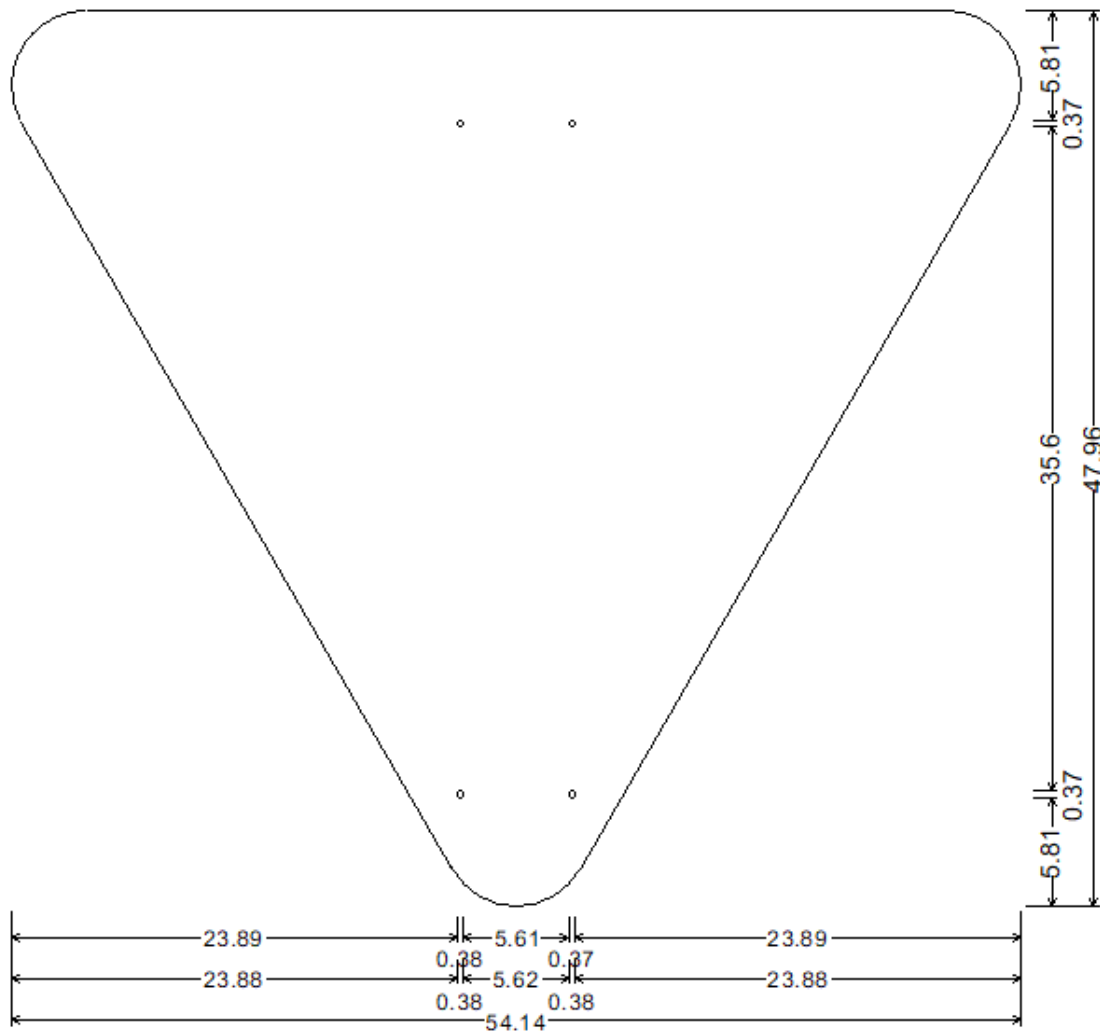

DRAWING 12C 60 INCH YIELD;
 60.00" corner to corner 4.00" Radius, No border, None;

Table of widths and spaces

23.89	○	0.38	5.61	○	0.37	23.89
23.88	○	0.38	5.62	○	0.38	23.88

752-093

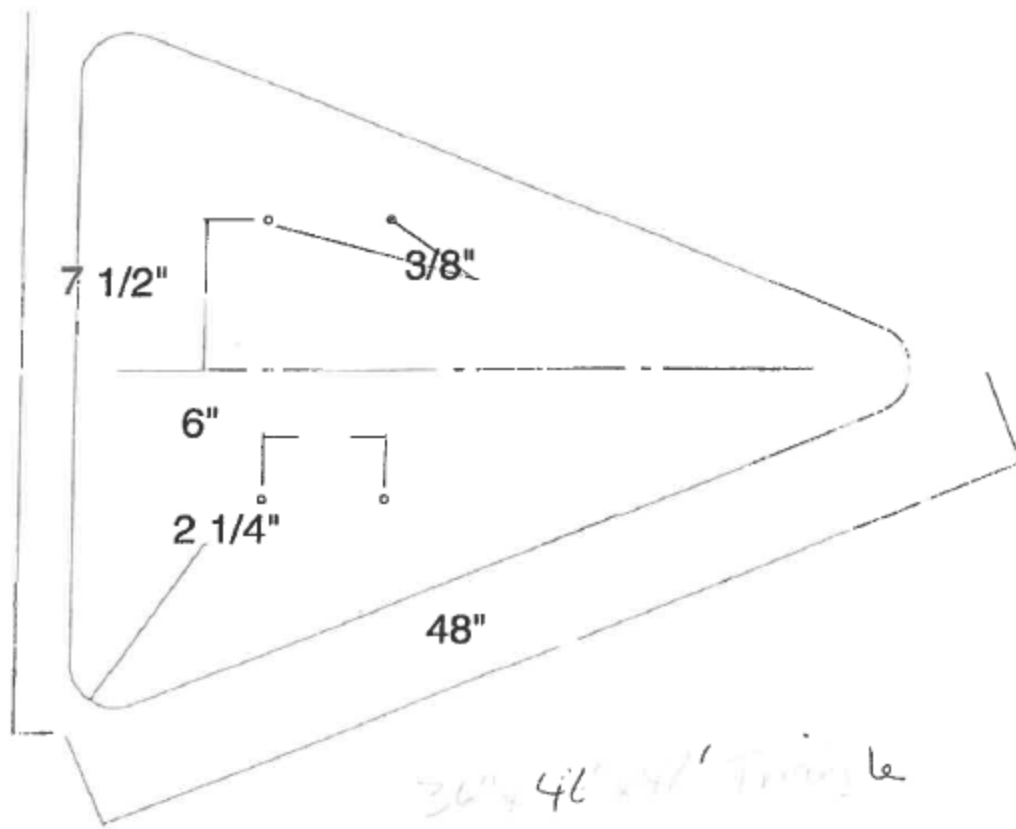

Drawing 13

752-101

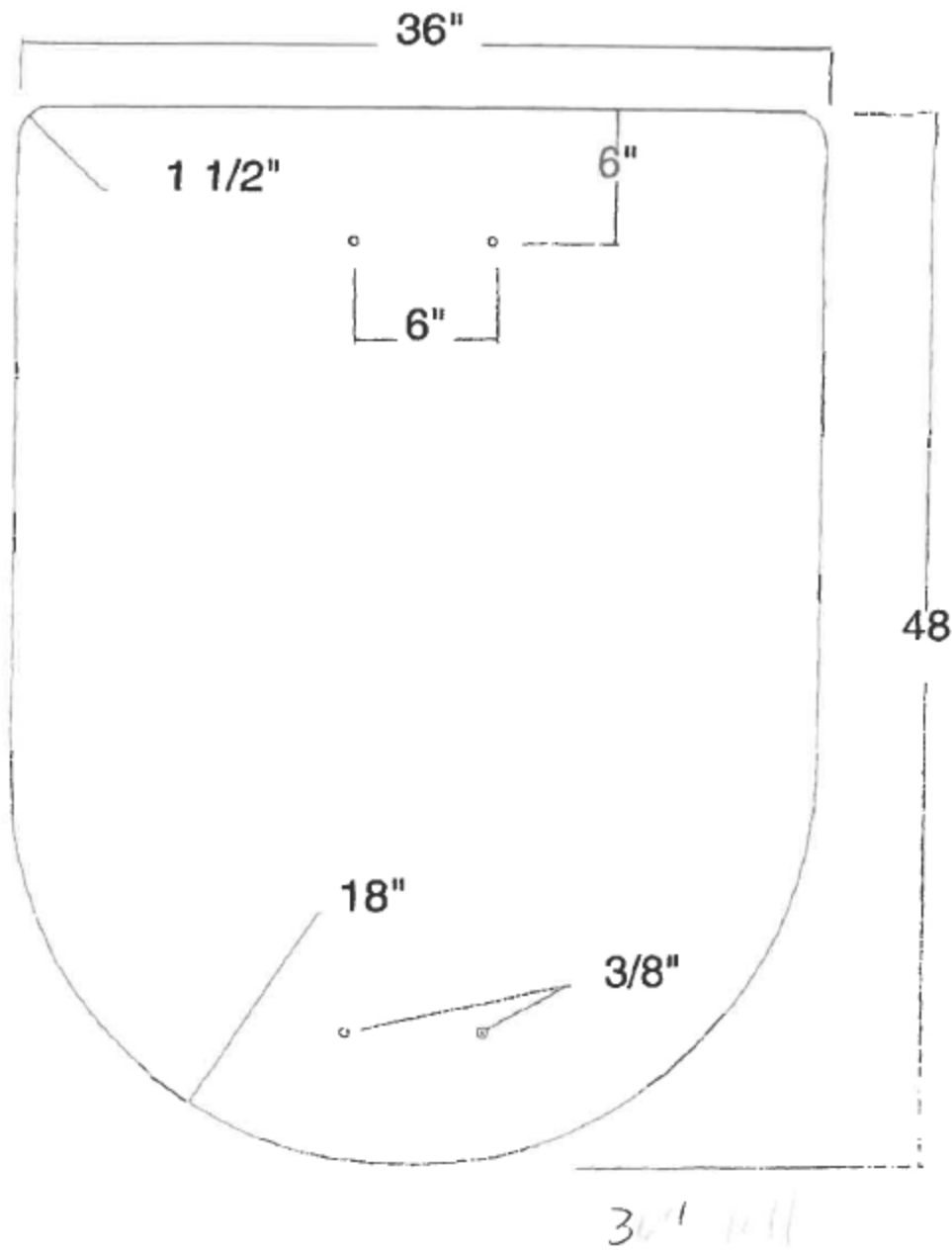

Drawing 14 36"x48"

752-110

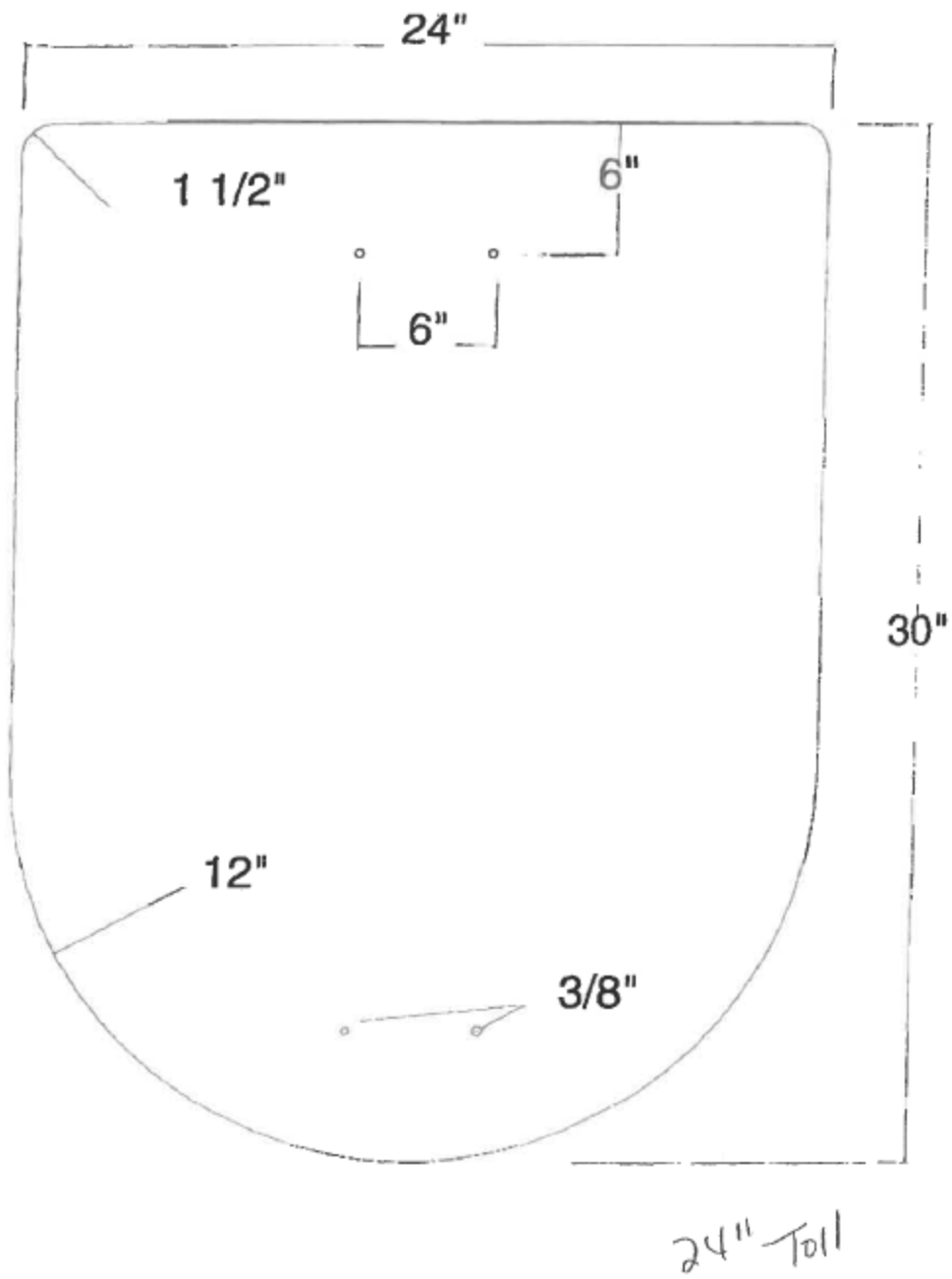

Drawing 15 24"x30"

752-142

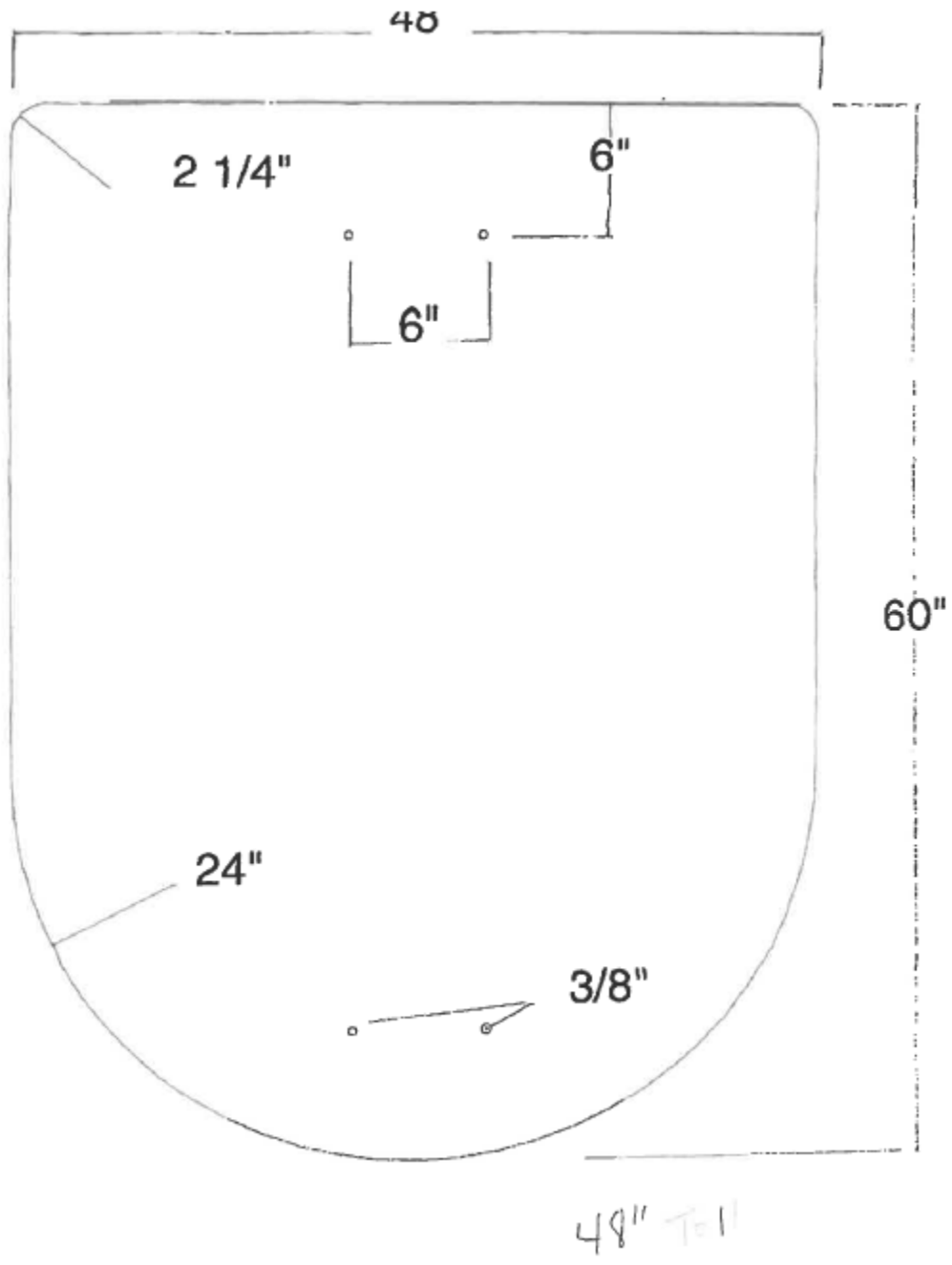

Drawing 16 48"x60"

752-157

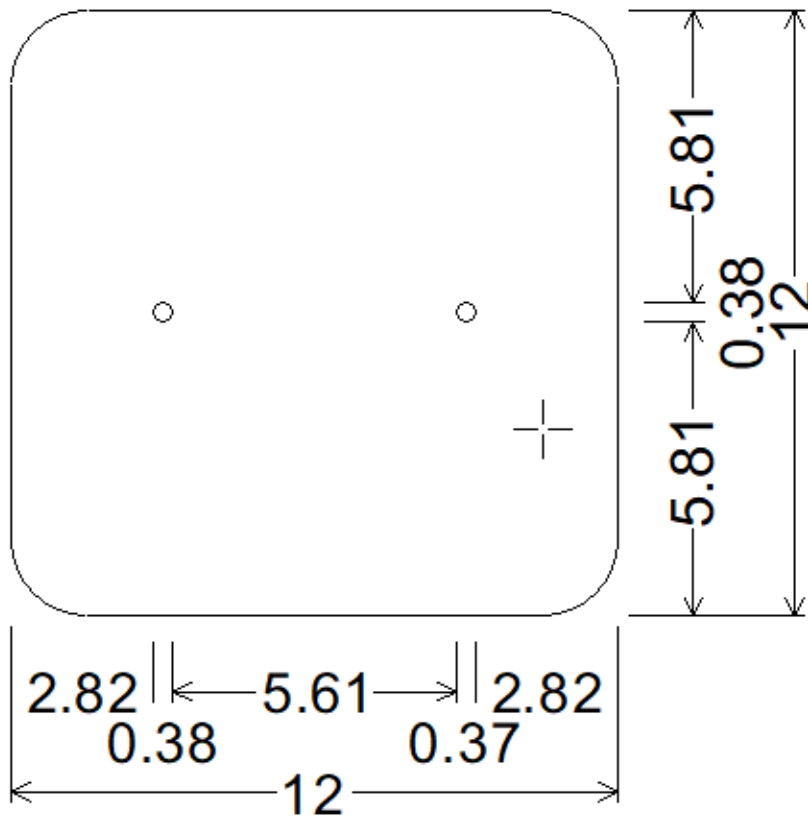

DRAWING 17 12X12;

1.50" Radius, No border, White on, None;

Table of widths and spaces

	○		○	
2.82	0.38	5.61	0.37	2.82

752-301

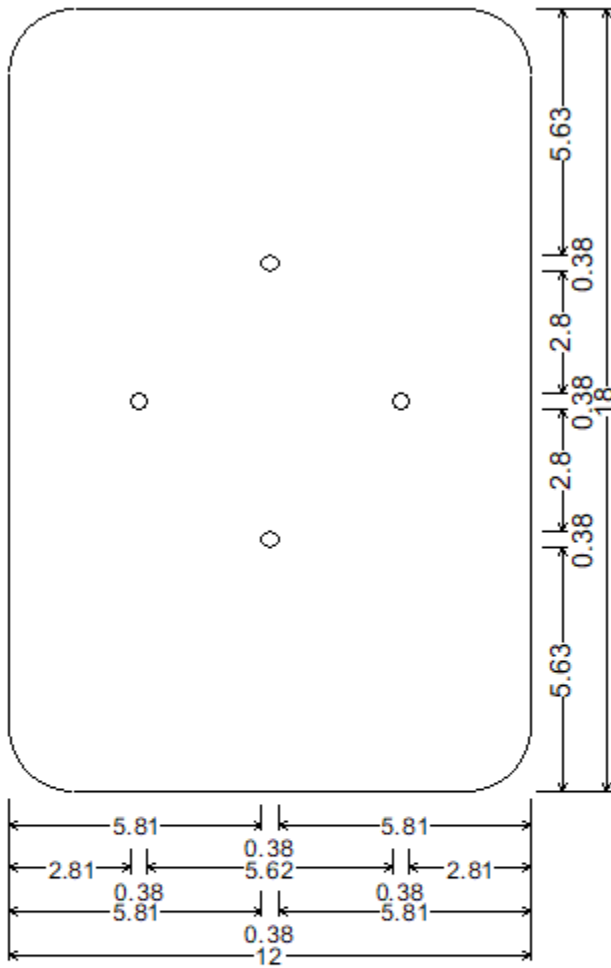

Drawing 18 12x18 Rectangle;
 1.50" Radius, No border, White on, None;
 Table of widths and spaces

5.81	○	0.38	5.81			
2.81	○	0.38	5.62	○	0.38	2.81
5.81	○	0.38	5.81			

752-302

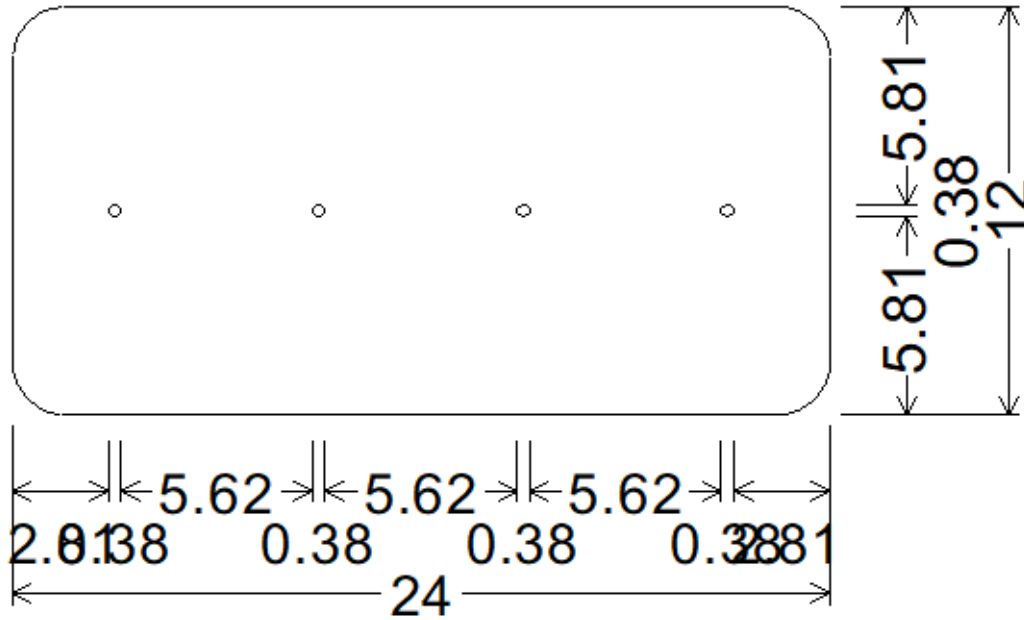

DRAWING 19 12 X24;

1.50" Radius, No border, White on, None;

Table of widths and spaces

	○		○	
2.81	0.38	5.62	0.38	
	○		○	
5.62	0.38	5.62	0.38	2.81

752-303

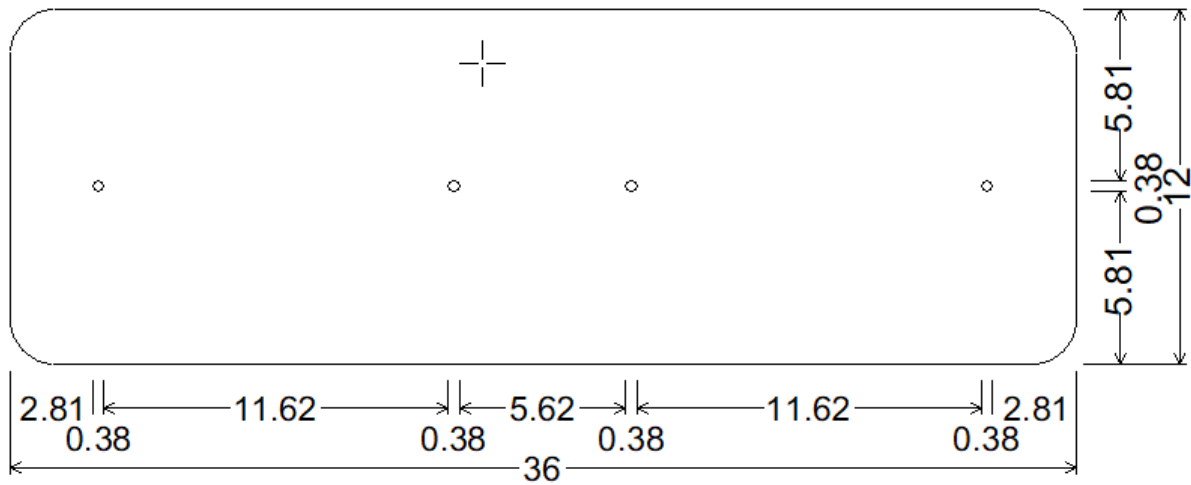

DRAWING 20 12X36;

1.50" Radius, No border, White on, None;

Table of widths and spaces

2.81	○	11.62	○	5.62	○	11.62	○	2.81
	0.38		0.38		0.38		0.38	

752-304

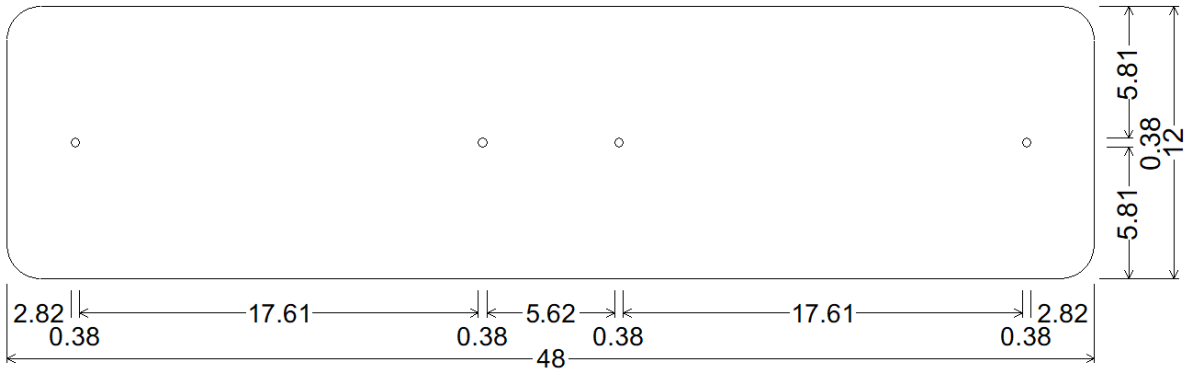

DRAWING 21 12X48;
 1.50" Radius, No border, White on, None;
 Table of widths and spaces

2.82	○	0.38	17.61	○	0.38	5.62	○	0.38	17.61	○	0.38	2.82
------	---	------	-------	---	------	------	---	------	-------	---	------	------

752-305

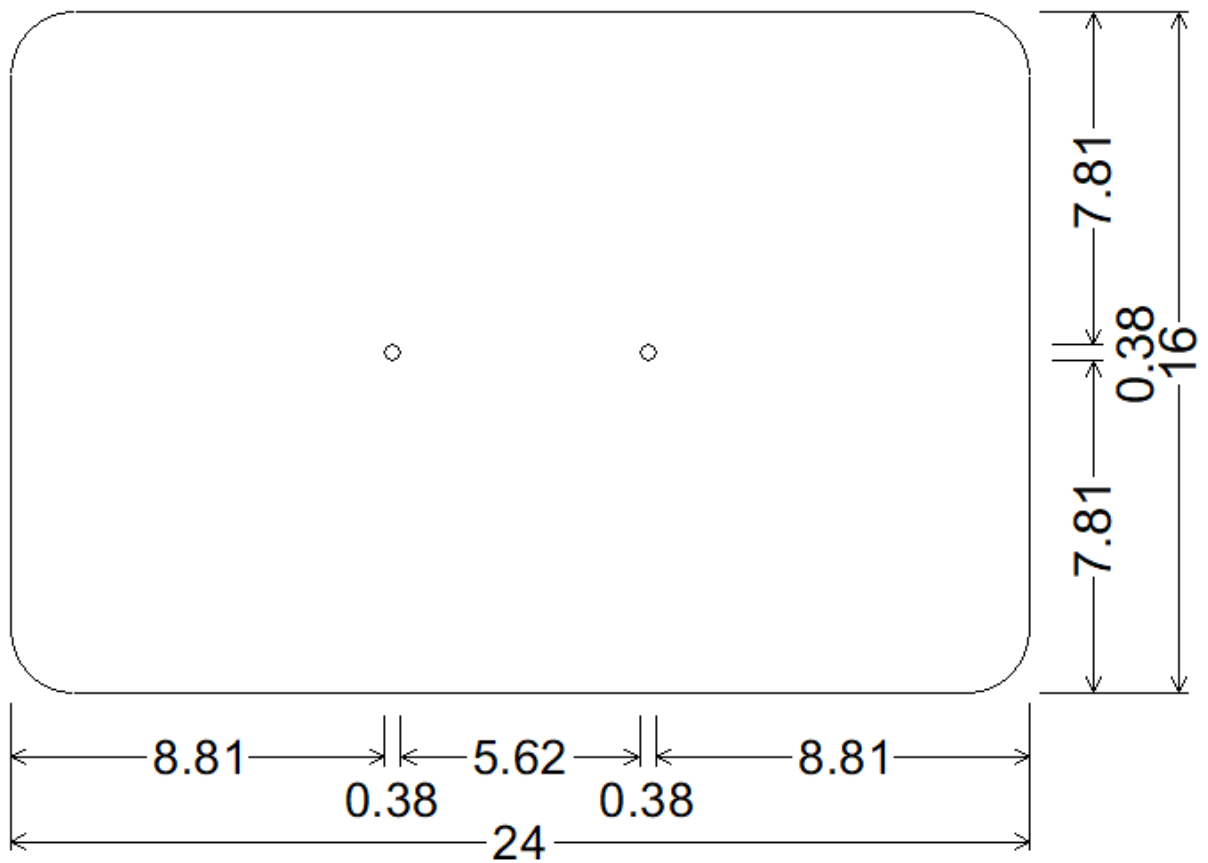

DRAWING 22 16"X24";

1.50" Radius, No border, White on, None;

Table of widths and spaces

	○		○	
8.81	0.38	5.62	0.38	8.81

752-310

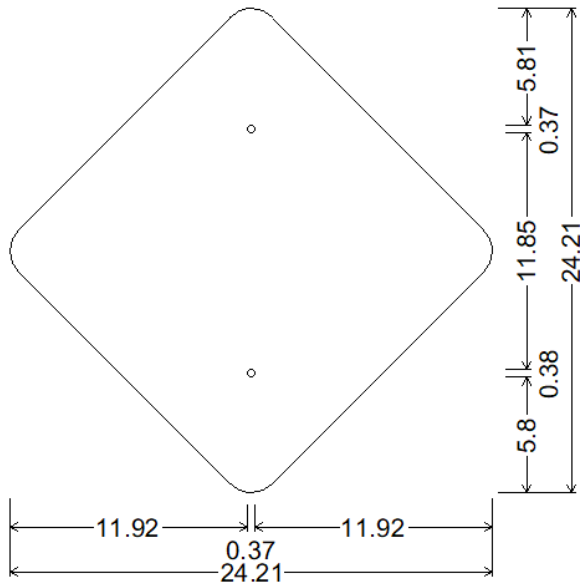

18.00" across sides 1.50" Radius, No border, None;
Table of widths and spaces

11.92	○	0.37	11.92
11.92	○	0.37	11.92

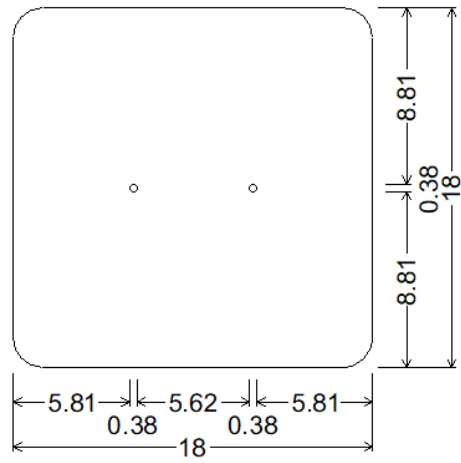

DRAWING 23 18 X 18;
1.50" Radius, No border, White on, None;
Table of widths and spaces

5.81	○	0.38	5.62	○	0.38	5.81
------	---	------	------	---	------	------

752-320 Need holes in both places.

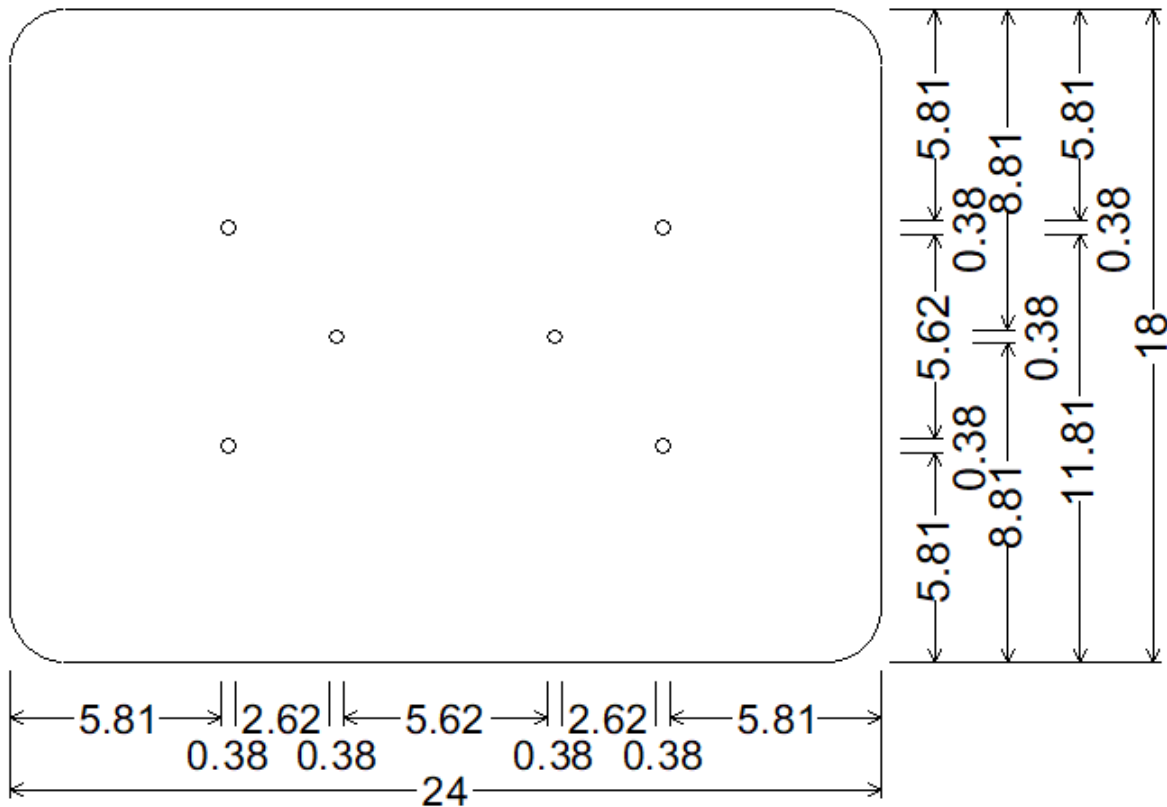

DRAWING 24 18X24;

1.50" Radius, No border, White on, None;

Table of widths and spaces

	○		○		○		○	
5.81	0.38	2.62	0.38	5.62	0.38	2.62	0.38	5.81
	○		○					
5.81	0.38	11.62	0.38	5.81				

752-321

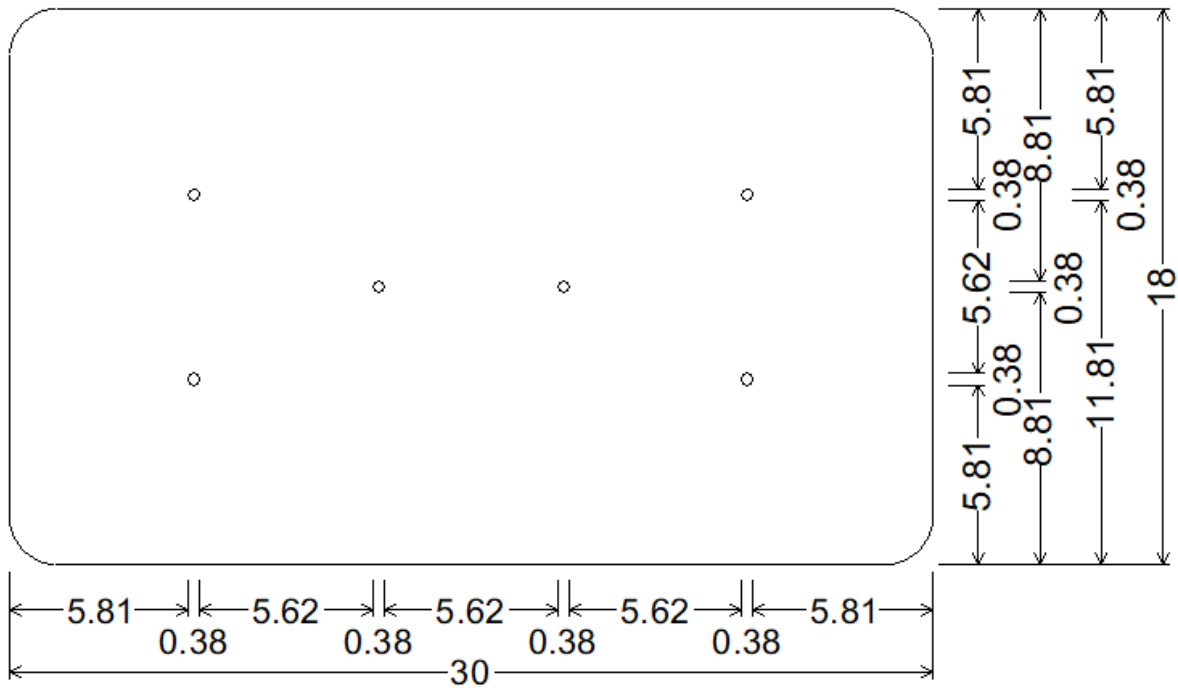

DRAWING 25 18X30;

1.50" Radius, No border, White on, None;

Table of widths and spaces

	○		○		○		○	
5.81	0.38	5.62	0.38	5.62	0.38	5.62	0.38	5.81
5.81	0.38	17.62	0.38	5.81				

752-322

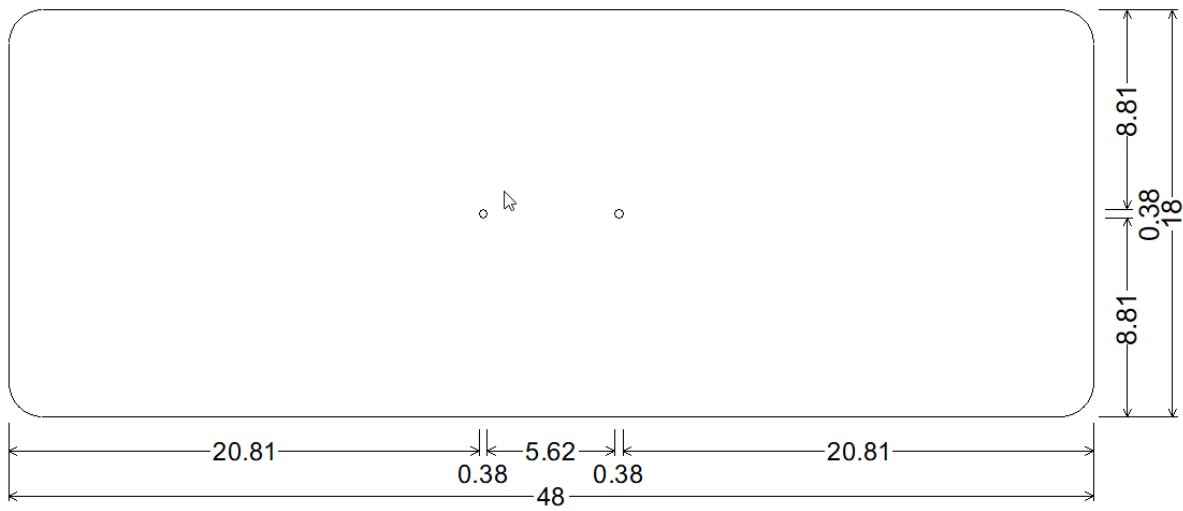

DRAWING 26 18X48;
 1.50" Radius, No border, White on, None;
 Table of widths and spaces

20.81	○	0.38	5.62	○	0.38	20.81
-------	---	------	------	---	------	-------

752-323

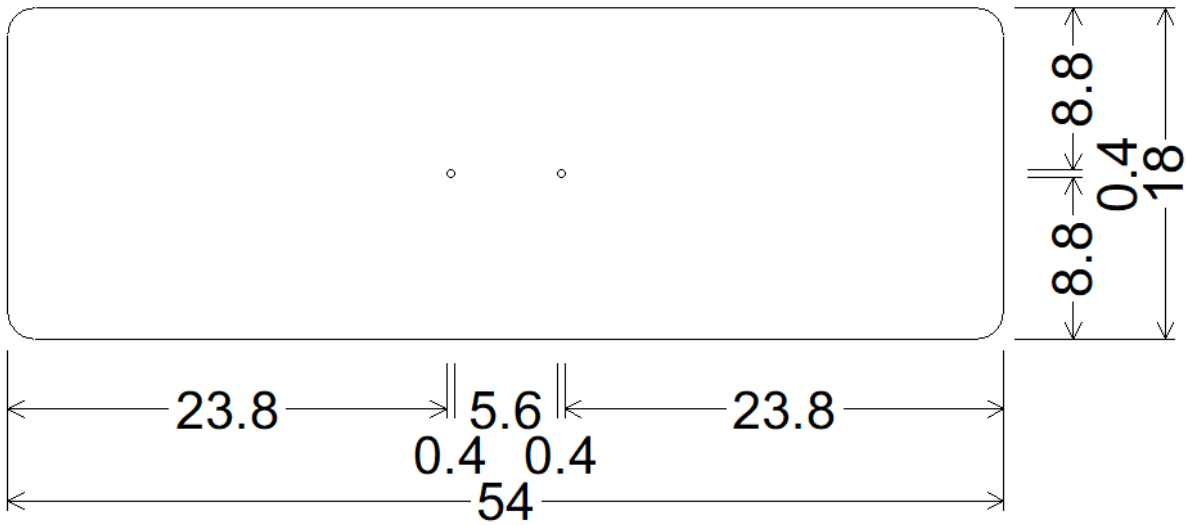

DRAWING 40 18X54;
 1.5" Radius, No border, White on, None;

752-324

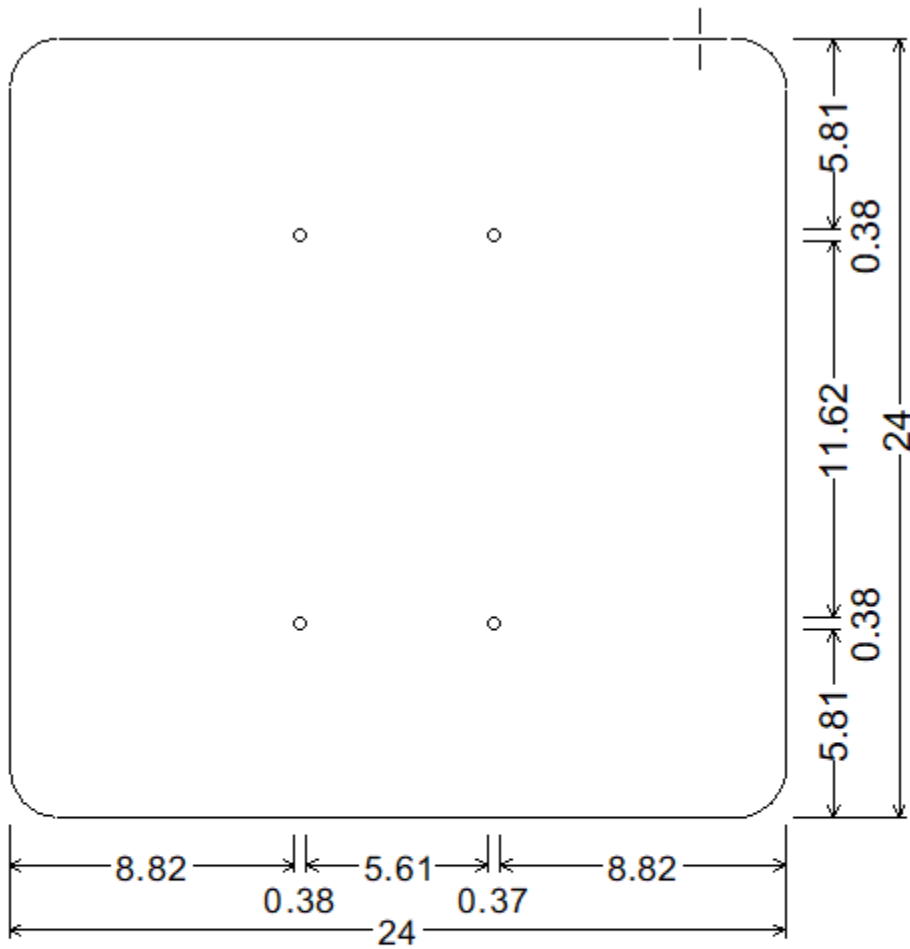

DRAWING 27 24X24;

1.50" Radius, No border, White on, None;

Table of widths and spaces

	○		○	
8.82	0.38	5.61	0.37	8.82
	○		○	
8.82	0.38	5.61	0.37	8.82

752-330

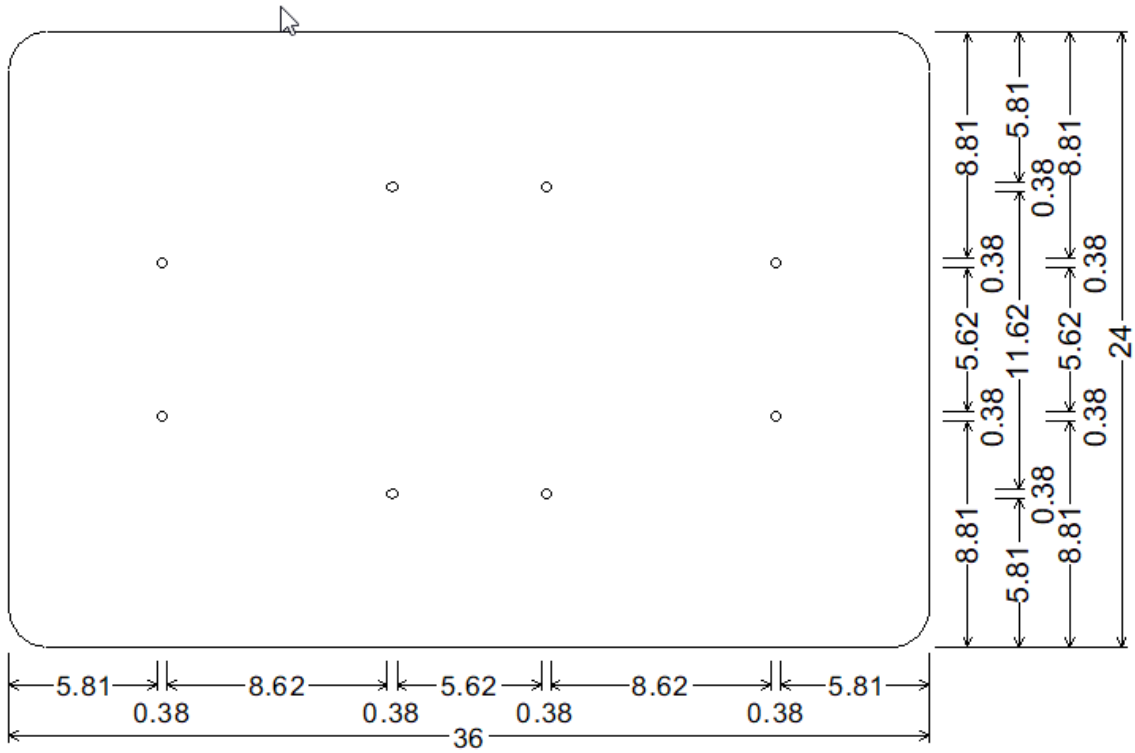

DRAWING 28 24X36;

1.50" Radius, No border, White on, None;

Table of widths and spaces

5.81	○	8.62	○	5.62	○	8.62	○	5.81
5.81	○	8.62	○	5.62	○	8.62	○	5.81

752-063

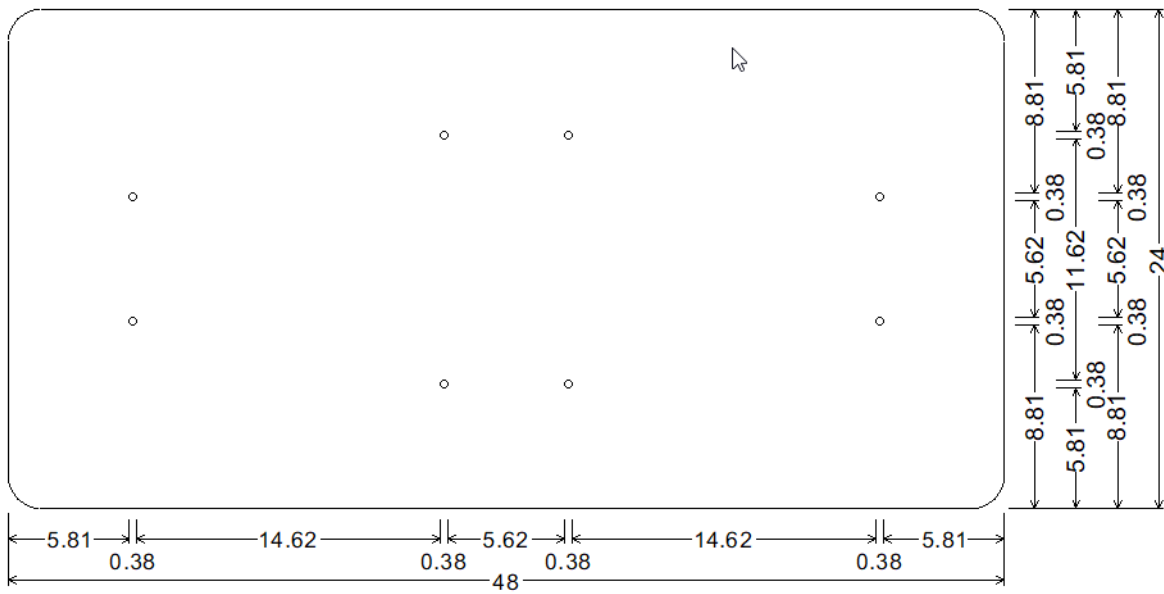

DRAWING 29 24X48;
 1.50" Radius, No border, White on, None;
 Table of widths and spaces

5.81	○	0.38	14.62	○	0.38	5.62	○	0.38	14.62	○	0.38	5.81
5.81	○	0.38	14.62	○	0.38	5.62	○	0.38	14.62	○	0.38	5.81

752-331

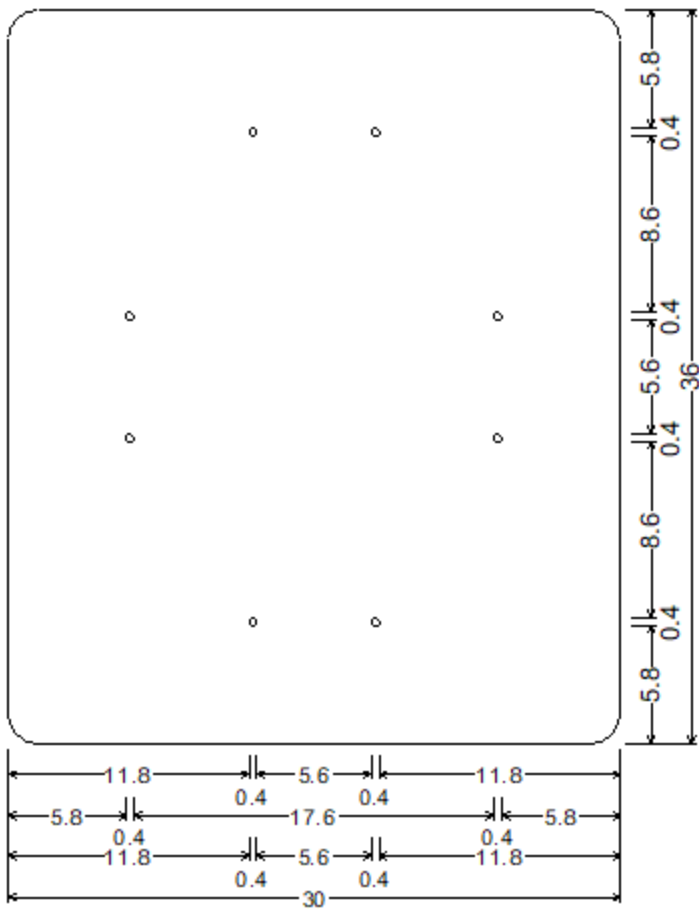

DRAWING 30 36X30;

1.5" Radius, No border, White on, None;

Table of widths and spaces

11.8	○	0.4	5.6	○	0.4	11.8
5.8	○	0.4	17.6	○	0.4	5.8
5.8	○	0.4	17.6	○	0.4	5.8
11.8	○	0.4	5.6	○	0.4	11.8

752-340

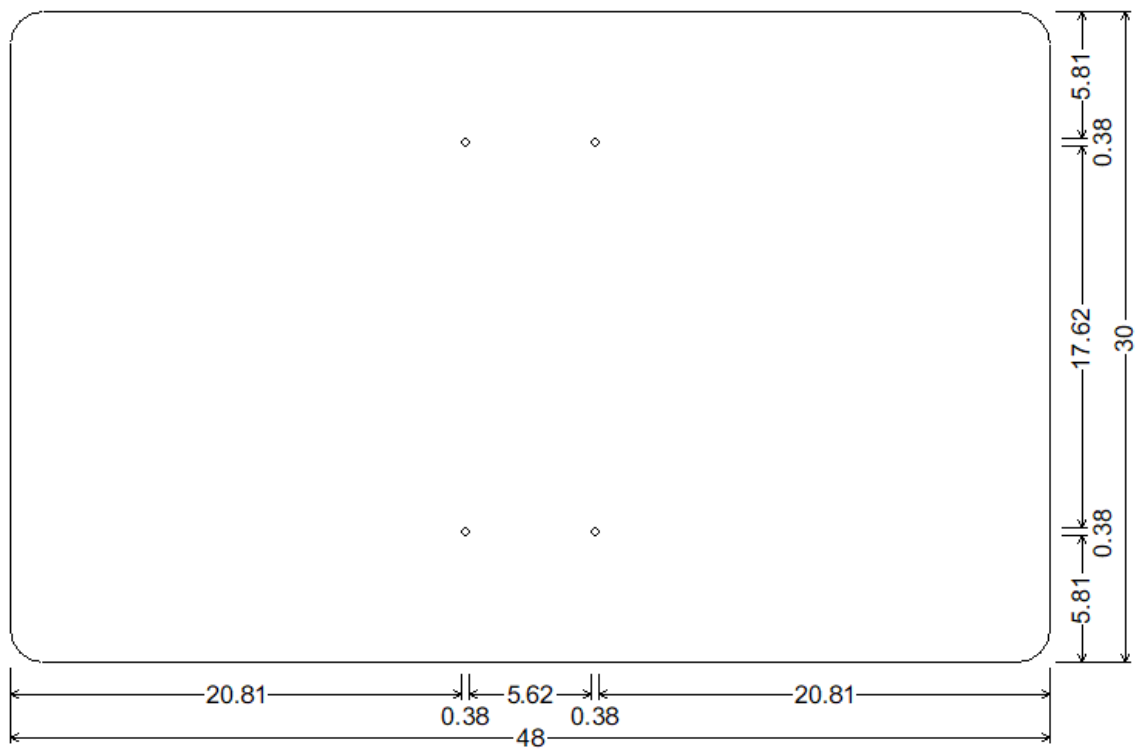

DRAWING 31 30X48;
 1.50" Radius, No border, White on, None;
 Table of widths and spaces

20.81	○	0.38	5.62	○	0.38	20.81
20.81	○	0.38	5.62	○	0.38	20.81

752-341

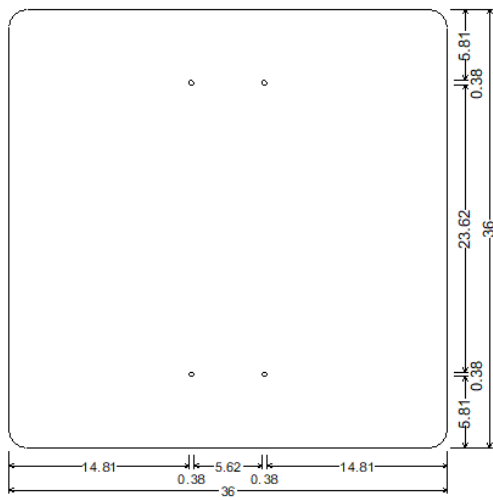

DRAWING 32 36X36;
1.50" Radius, No border, White on, None;
Table of widths and spaces

14.81	0.38	5.62	0.38	14.81
14.81	0.38	5.62	0.38	14.81

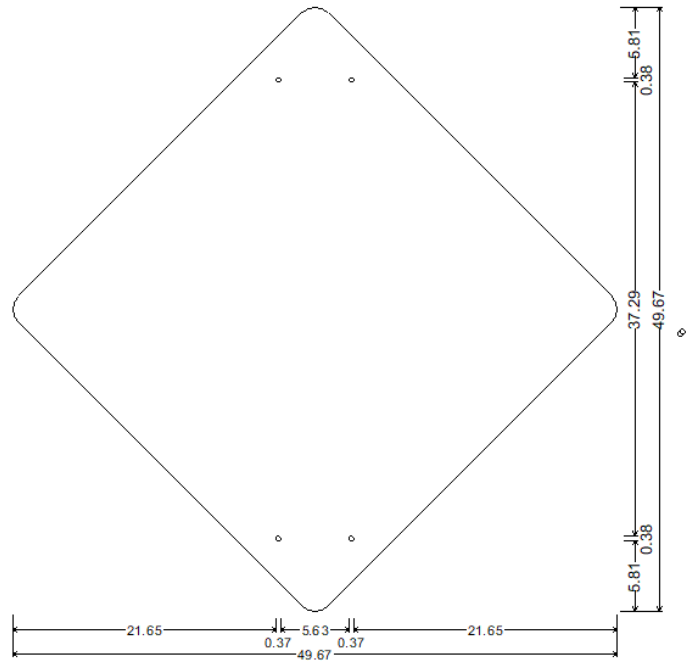

DRAWING 32 36X36 DIA;
36.00" across sides 1.50" Radius, No border, None;
Table of widths and spaces

21.65	0.37	5.63	0.37	21.65
21.65	0.37	5.63	0.37	21.65

752-342 Needs both sets of holes.

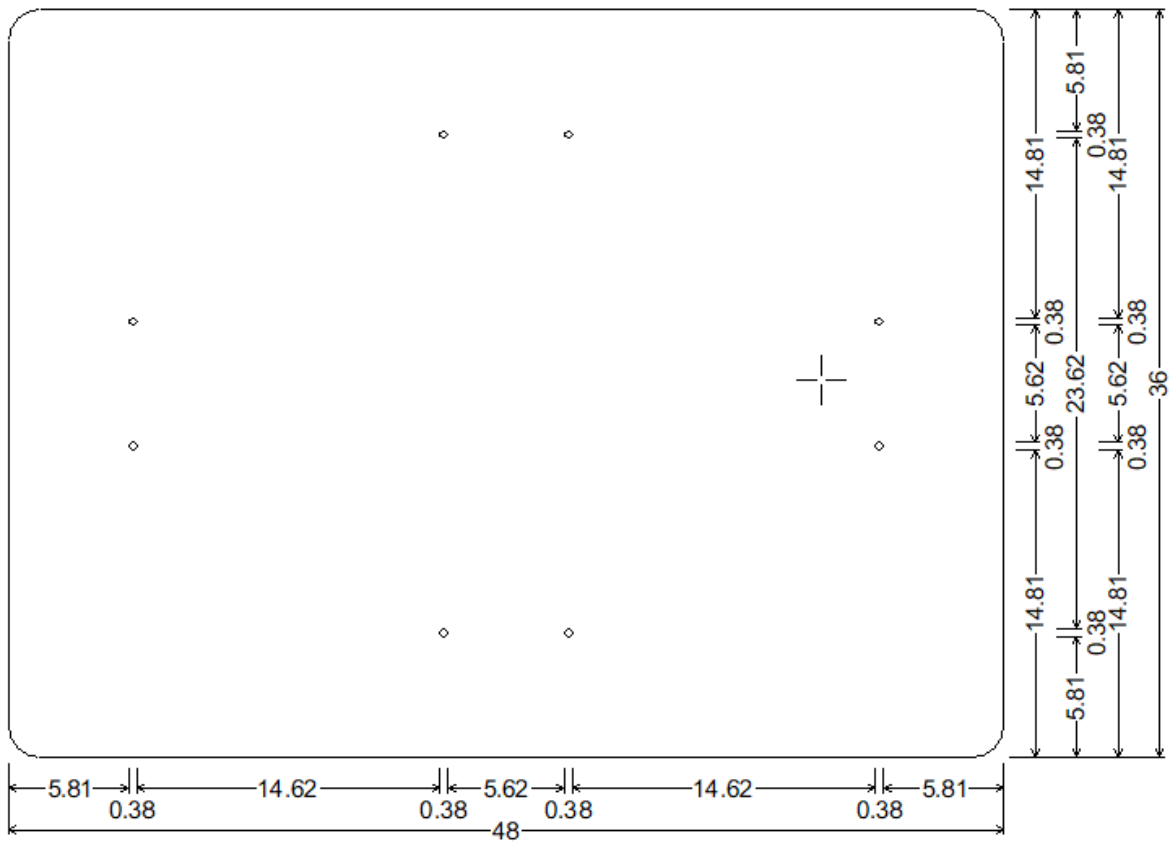

DRAWING 33 36X48;
 1.50" Radius, No border, White on, None;
 Table of widths and spaces

5.81	0.38	14.62	0.38	5.62	0.38	14.62	0.38	5.81
5.81	0.38	14.62	0.38	5.62	0.38	14.62	0.38	5.81

752-343

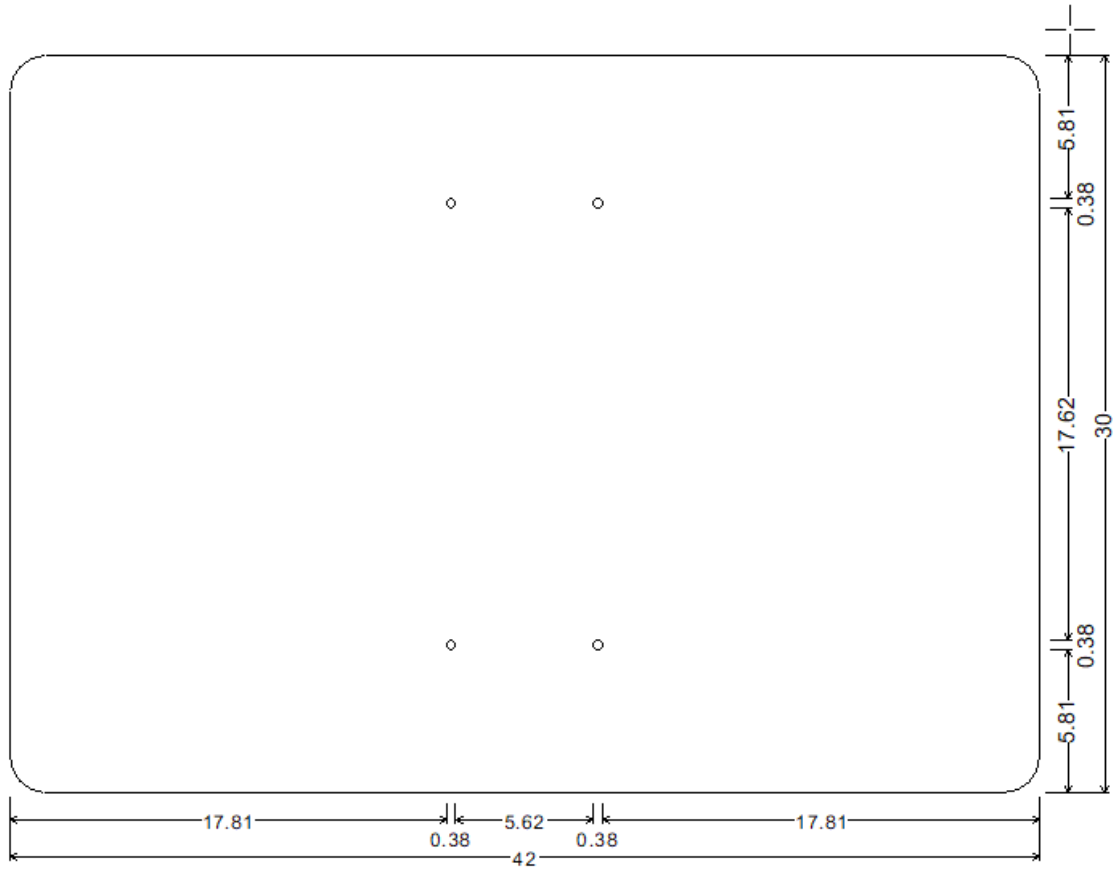

DRAWING 41 30X42;
 1.50" Radius, No border, White on, None;
 Table of widths and spaces

17.81	○	0.38	5.62	○	0.38	17.81
17.81	○	0.38	5.62	○	0.38	17.81

752-344

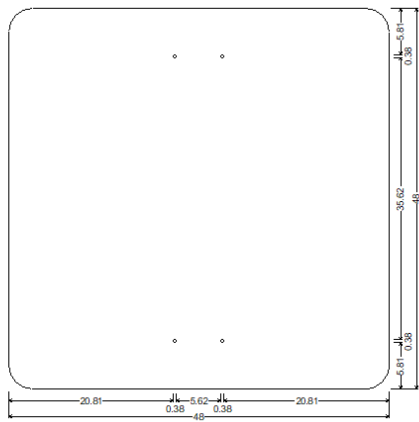

DRAWING 31 48X48;
 3.00" Radius, No border, White on, None;
 Table of widths and spaces

20.81	5.62	5.62	20.81
5.81	5.62	5.62	5.81

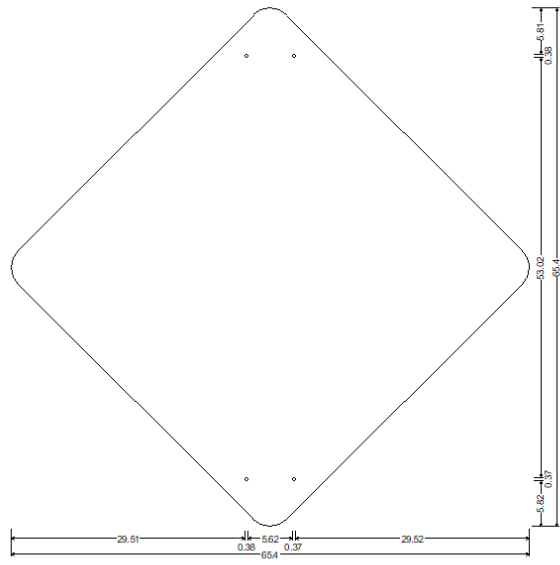

DRAWING 31 48X48 SQUARE;
 48.00" across sides 3.00" Radius, No border, None;
 Table of widths and spaces

29.51	5.62	5.62	29.52
5.82	5.62	5.62	5.81

752-350 Needs both sets of holes.

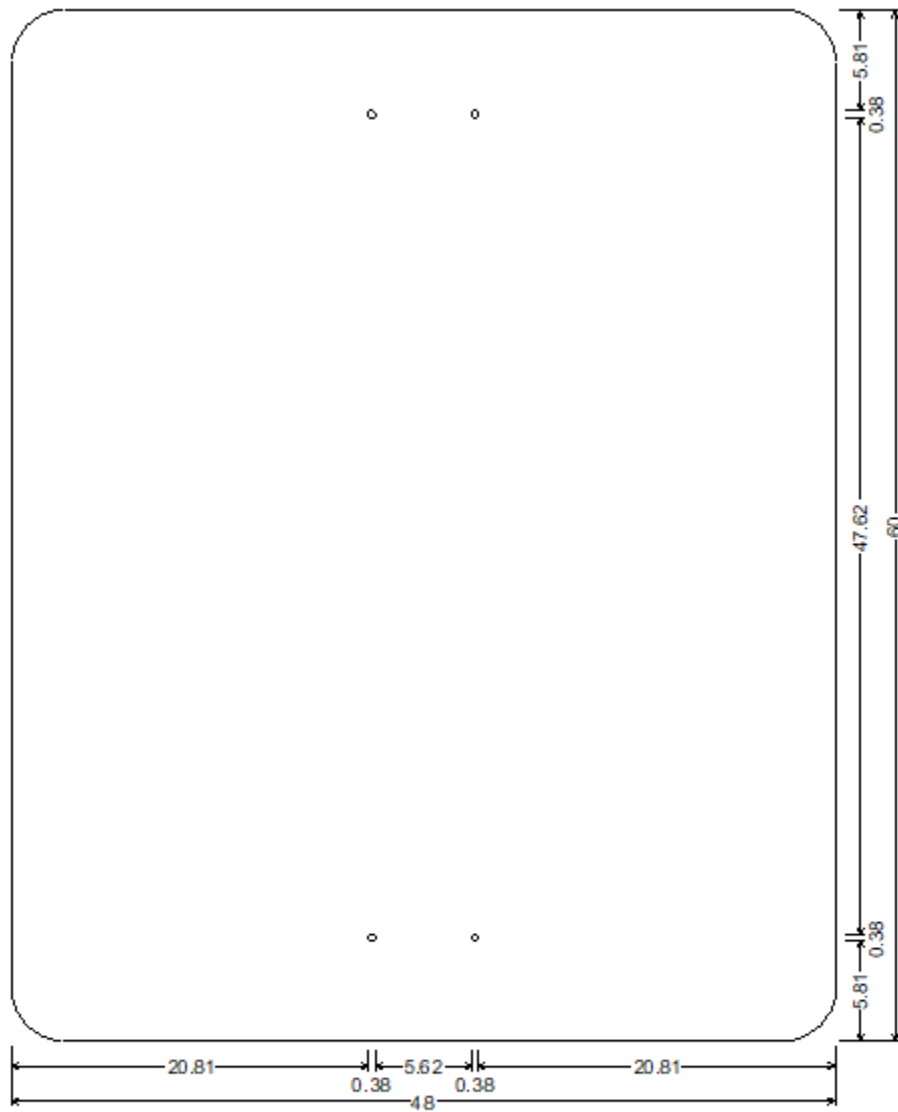

DRAWING 35 48X60;
 3.00" Radius, No border, White on, None;
 Table of widths and spaces

20.81	○	0.38	5.62	○	0.38	20.81
20.81	○	0.38	5.62	○	0.38	20.81

752-351

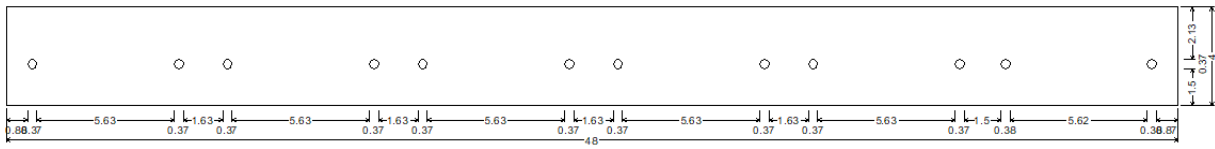

DRAWING 36 4X48:
No border, White on, None;

Table of widths and spaces

0.88	0.37	5.63	1.63	0.37	5.63	1.63	0.37	5.63	1.63	0.37	5.63	1.63	0.37	5.63	1.50	0.38	5.62	0.38	0.87
------	------	------	------	------	------	------	------	------	------	------	------	------	------	------	------	------	------	------	------

752-360

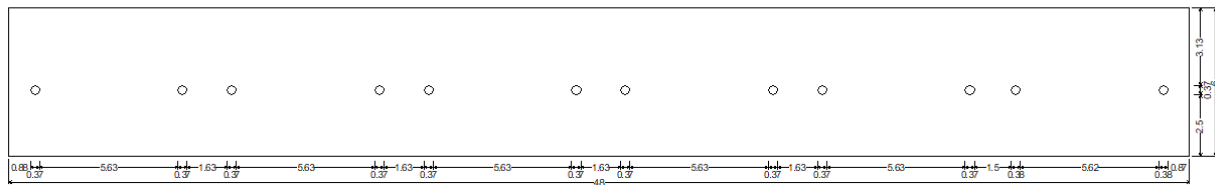

DRAWING 37 6X48:
No border, White on, None;

Table of widths and spaces

0.88	0.37	5.63	1.63	0.37	5.63	1.63	0.37	5.63	1.63	0.37	5.63	1.63	0.37	5.63	1.50	0.38	5.62	0.38	0.87
------	------	------	------	------	------	------	------	------	------	------	------	------	------	------	------	------	------	------	------

752-361

NEW ITEM:

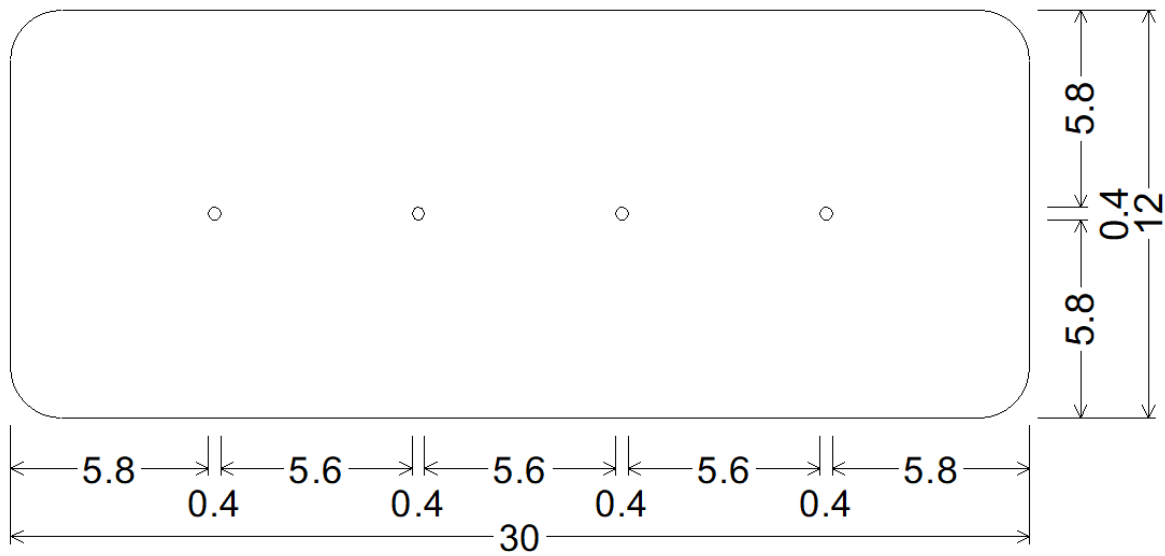

NEW 12X30;

1.5" Radius, No border, White on, None;

FLORIDA DEPARTMENT OF TRANSPORTATION
 MATERIAL SPECIFICATIONS – COMPLIANCE FORM

BID #: DOT-ITB-24-9069-SJ

BID TITLE: Aluminum Materials

A completed copy of this page, filled out in ink, must be returned with the bid. Failure to complete the conformance column may result in a bid being rejected as non-responsive. Unless otherwise stated this data applies to all sites.

REQUIREMENTS	CONFORMANCE
1) The Sheet and Plate materials to be delivered to the Lake City Sign Shop shall meet the requirements of ASTM H-38, or Alloy 5052. The sheets shall be degreased, etched, and alodized using 12 Alodine. The sheets shall be flat (no coil stock). The edges shall be straight and parallel, and free from damage, i.e., nicks, gouges, cracks, etc. (See substitute note on some items).	1) Yes <input checked="" type="checkbox"/> No <input type="checkbox"/> Alloy <u>5052</u>
2) The Sheet and Plate materials to be delivered to the Oviedo Structural Shop shall meet the requirements of ASTM B-209, Alloy 6061-T6 or Alloy 5032-H32. The sheets shall not be etched or alodized. Otherwise, the provisions stated in 1) above apply.	2) Yes <input checked="" type="checkbox"/> No <input type="checkbox"/> Alloy <u>6061</u>
3) The Extruded Tubing shall meet the requirements of ASTM B-221, Alloy 6061-T6. (See substitute note on some items).	3) Yes <input checked="" type="checkbox"/> No <input type="checkbox"/>
4) The Round Bars shall meet the requirements of ASTM B-211, Alloy 6061-T6.	4) Yes <input checked="" type="checkbox"/> No <input type="checkbox"/>
5) The Pipes shall meet the requirements of ASTM B-241, Alloy 6061-T6.	5) Yes <input checked="" type="checkbox"/> No <input type="checkbox"/>
6) The Structural Shapes shall meet the requirements of ASTM B-308, Alloy 6061-T6. (See substitute note on some items).	6) Yes <input checked="" type="checkbox"/> No <input type="checkbox"/>
7) There shall be no paper or other materials used between or on the sheets, tubing, etc.	7) Yes <input checked="" type="checkbox"/> No <input type="checkbox"/>
Tolerances for the above materials shall be within the ASTM specification's limits governing each item.	
The ASTM Standard Specification or Tentative Standard Specification in force on the date of the advertisement of the proposal applies, except where a superseded specification, designation, or method is specifically designated.	
The producer shall furnish, at time of delivery, six (6) certified copies of the mill analysis covering the shipment for each size and type of material.	
Upon delivery, random samples of each item will be tested. Should a sample fail to meet the specifications, the entire lot must be replaced within ten (10) days after notification. Replacement of all materials found defective shall be made without cost to the purchaser, including transportation. At the option of the "DOT", the material may be accepted on the basis of the producer's certified mill analysis.	

Signature: *John Eagleton*
 Name (Print): John Eagleton
 Title: Sales Manager
 Date: 1/26/2024

FLORIDA DEPARTMENT OF TRANSPORTATION
MATERIAL SPECIFICATIONS – COMPLIANCE FORM

BID #: DOT-ITB-24-9069-SJ

BID TITLE: Aluminum Materials

A completed copy of this page, filled out in ink, must be returned with the bid. Failure to complete the conformance column may result in a bid being rejected as non-responsive. Unless otherwise stated this data applies to all sites.

REQUIREMENTS	CONFORMANCE
<p>1) The Sheet and Plate materials to be delivered to the Lake City Sign Shop shall meet the requirements of ASTM H-38, or Alloy 5052. The sheets shall be degreased, etched, and alodized using 12 Alodine. The sheets shall be flat (no coil stock). The edges shall be straight and parallel, and free from damage, i.e., nicks, gouges, cracks, etc. (See substitute note on some items).</p>	<p>1) Yes <input checked="" type="checkbox"/> No <input type="checkbox"/> Alloy <u>5052-H38</u></p>
<p>2) The Sheet and Plate materials to be delivered to the Oviedo Structural Shop shall meet the requirements of ASTM B-209, Alloy 6061-T6 or Alloy 5032-H32. The sheets shall not be etched or alodized. Otherwise, the provisions stated in 1) above apply.</p>	<p>2) Yes <input checked="" type="checkbox"/> No <input type="checkbox"/> Alloy <u>5052-H38</u></p>
<p>3) The Extruded Tubing shall meet the requirements of ASTM B-221, Alloy 6061-T6. (See substitute note on some items).</p>	<p>3) Yes <u>N/A</u> No <input type="checkbox"/></p>
<p>4) The Round Bars shall meet the requirements of ASTM B-211, Alloy 6061-T6.</p>	<p>4) Yes <u>N/A</u> No <input type="checkbox"/></p>
<p>5) The Pipes shall meet the requirements of ASTM B-241, Alloy 6061-T6.</p>	<p>5) Yes <u>N/A</u> No <input type="checkbox"/></p>
<p>6) The Structural Shapes shall meet the requirements of ASTM B-308, Alloy 6061-T6. (See substitute note on some items).</p>	<p>6) Yes <input checked="" type="checkbox"/> No <input type="checkbox"/></p>
<p>7) There shall be no paper or other materials used between or on the sheets, tubing, etc.</p>	<p>7) Yes <input checked="" type="checkbox"/> No <input type="checkbox"/></p>
<p>Tolerances for the above materials shall be within the ASTM specification's limits governing each item.</p> <p>The ASTM Standard Specification or Tentative Standard Specification in force on the date of the advertisement of the proposal applies, except where a superseded specification, designation, or method is specifically designated.</p> <p>The producer shall furnish, at time of delivery, six (6) certified copies of the mill analysis covering the shipment for each size and type of material.</p> <p>Upon delivery, random samples of each item will be tested. Should a sample fail to meet the specifications, the entire lot must be replaced within ten (10) days after notification. Replacement of all materials found defective shall be made without cost to the purchaser, including transportation. At the option of the "DOT", the material may be accepted on the basis of the producer's certified mill analysis.</p>	

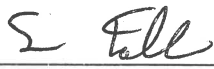
Signature: 

Name (Print): Sean Fallon

Title: Sales

Date: 1/26/24

ORDERING INSTRUCTIONS

Contract Number: CR854

Bid Number: DOT-ITB-24-9069-SJ

Title: Aluminum Materials

NOTE: ALL ORDERS SHOULD BE DIRECTED TO:

FEDERAL EMPLOYER IDENTIFICATION NUMBER (FEID): 59-2249307-002

VENDOR: Eastern Metal Supply

ADDRESS: 3600 23rd Ave. South

CITY, STATE, ZIP: Lake Worth, FL 33461

TELEPHONE: 561-533-6061

TOLL FREE NO.: 800-432-2204

DELIVERY: DELIVERY WILL BE MADE WITHIN 60 DAYS AFTER RECEIPT OF PURCHASE ORDER.

PRODUCT INFORMATION: DIRECT QUESTIONS TO:

NAME & TITLE: John Eagleton

ADDRESS: 3600 23rd Ave. South

CITY, STATE, ZIP: Lake Worth, FL 33461

TELEPHONE: 561-533-6061

TOLL FREE NO.: 800-432-2204

E-MAIL ADDRESS: jeagleton@easternmetal.com

WEB ADDRESS: www.easternmetal.com

ORDERING INSTRUCTIONS

Contract Number: CR855

Bid Number: DOT-ITB-24-9069-SJ

Title: Aluminum Materials

NOTE: ALL ORDERS SHOULD BE DIRECTED TO:

FEDERAL EMPLOYER IDENTIFICATION NUMBER (FEID): F36-2658805-002

VENDOR: Mandel Metals Ind. Dba US Standard Sign

ADDRESS: 11400 Addison Ave.

CITY, STATE, ZIP: Franklin Park, IL 60131

TELEPHONE: 847-447-2234

TOLL FREE NO.: 800-537-4790

DELIVERY: DELIVERY WILL BE MADE WITHIN 30 DAYS AFTER RECEIPT OF PURCHASE ORDER.

PRODUCT INFORMATION: DIRECT QUESTIONS TO:

NAME & TITLE: Sean Fallon, Sales

ADDRESS: 11400 Addison Ave.

CITY, STATE, ZIP: Franklin Park, IL 60131

TELEPHONE: 847-447-2234

TOLL FREE NO.: 800-537-4790

E-MAIL ADDRESS: sean@usstandardsign.com

WEB ADDRESS: www.usstandardsign.com

INTRODUCTION SECTION

1) INVITATION

The purpose of this Invitation to Bid is to obtain competitive bids to establish a two (2) year contract for the purchase of Aluminum Materials by the Department of Transportation, hereafter referred to as the "Department". The contract will become effective on the date the successful bidder(s) receives an acceptance letter from the Department and will expire two years from that date. After the award, said bidder(s) will be referred to as the "Vendor(s)".

All commodities identified in this Invitation to Bid will be subject to the availability of identical commodities as provided by mandatory Department of Management Services' State Contract(s) at such time these commodities become available. In the event of duplication(s) of commodities, the Department of Management Services' mandatory State Contract shall prevail.

2) TIMELINE

Provided below is a list of critical dates and actions. These dates are subject to change. Notices of changes (Addenda) will be posted on the Florida Vendor Information Portal at <https://vendor.myfloridamarketplace.com/> (click on "Search Advertisements") under this bid number. It is the responsibility of all potential bidders to monitor this site for any changing information prior to submitting your bid.

<u>ACTION / LOCATION</u>	<u>DATE</u>	<u>LOCAL TIME</u>
DEADLINE FOR TECHNICAL QUESTIONS - (There is no deadline for administrative questions)	01-19-2024	12:00 PM EST
BIDS DUE (ON OR BEFORE) - Florida Department of Transportation Central Procurement Office Sherill Johnson, Procurement Agent Phone: (850) 414.4381 CO.Purch@dot.state.fl.us	01-30-2024	09:00 AM EST
PUBLIC OPENING - Florida Department of Transportation Central Procurement Office Sherill Johnson, Procurement Agent 605 Suwannee Street Tallahassee, FL 32399-0450	01-30-2024	10:00 AM EST
POSTING OF INTENDED DECISION/AWARD -	02-05-2024	

3) BID OPENING AGENDA

The sealed bids will be opened by the Department's Procurement Office personnel at the date, time and location in the Timeline. All bid openings are open to the public and will be conducted according to the following agenda:

Opening remarks – Approximate time of 2 minutes by Department Procurement Office personnel.
Public input period – To allow a maximum of 15 minutes total for public input related to the bid solicitation.

Bids opened – At conclusion of public input or 15 minutes, whichever occurs first, bids received timely will be opened with bidder's name and prices to be read aloud.

Adjourn - After all bids received timely have been opened, the meeting will be adjourned.

4) **SPECIAL ACCOMMODATIONS**

Any person with a qualified disability requiring special accommodations at a pre-bid conference, public meeting, and/or opening shall contact the contact person at the phone number, e-mail address provided on the title page at least five (5) working days prior to the event. If you are hearing or speech impaired, please contact this office by using the Florida Relay Services which can be reached at 1 (800) 955-8771 (TDD).

5) **CONTRACT USE**

Use of the contract resulting from this bid will be optional for the Department. The Department reserves the right to solicit separate bids for any unusual or abnormal quantity requirements that may arise during the term of the contract.

6) **ESTIMATED PURCHASES**

The Department anticipates purchasing the estimated quantities, shown on the bid sheet(s), for a one (1) year period of any contract resulting from this bid. The estimated quantities are given only as a guideline for preparing your bid and should not be construed as representing the actual quantities to be purchased under this contract. The Vendor(s) shall supply, at bid prices, the actual quantities ordered regardless of whether the total of such quantities is more or less than anticipated. This bid and the resulting contract will be subject to annual appropriated funding.

7) **RENEWAL**

Upon mutual agreement, the Department and the Contract Vendor may renew the contract for a period that may not exceed 3 years or the term of the original contract, whichever is longer. The renewal must be in writing and signed by both parties, and is subject to the same terms and conditions set forth in the initial contract and any written amendments signed by the parties. Any renewal shall specify the renewal price, as set forth in the solicitation response except that an agency may negotiate lower pricing. Renewal is contingent upon satisfactory performance evaluations and subject to the availability of funds.

SPECIAL CONDITIONS

1) **MyFloridaMarketPlace**

BIDDERS MUST BE ACTIVELY REGISTERED IN THE STATE OF FLORIDA'S MYFLORIDAMARKETPLACE SYSTEM BY THE TIME AND DATE OF THE BID OPENING OR THEY MAY BE CONSIDERED NON-RESPONSIVE (see Special Condition 21). All prospective bidders that are not registered should go to <https://vendor.myfloridamarketplace.com/> to complete on-line registration, or call 1-866-352-3776 for assisted registration.

All payment(s) to the vendor resulting from this competitive solicitation **WILL** be subject to the MFMP Transaction Fee in accordance with the referenced Form PUR 1000 General Contract Condition #14. The Transaction Fees imposed shall be based upon the date of issuance of the payment.

2) **FLORIDA DEPARTMENT OF FINANCIAL SERVICES (DFS) W-9 REQUIREMENT**

The Florida Department of Financial Services (DFS) requires all vendors that do business with the state to submit an electronic Substitute Form W-9. Vendors must submit their W-9 forms electronically at <https://flvendor.myfloridacfo.com> to receive payments from the state. Contact the DFS Customer Service Desk at (850) 413-5519 or FLW9@myfloridacfo.com with any questions.

3) **QUESTIONS & ANSWERS**

In accordance with section 287.057(25), Florida Statutes, respondents to this solicitation or persons acting on their behalf may not contact, between the release of the solicitation and the end of the 72-hour period following the agency posting the notice of intended award, excluding Saturdays, Sundays, and state holidays, any employee or officer of the executive or legislative branch concerning any aspect of this solicitation, except in writing to the procurement officer or as provided in the solicitation documents. Violation of this provision may be grounds for rejecting a response.

Any technical questions arising from this Invitation to Bid must be forwarded, in writing, to the procurement agent identified below. Questions must be received no later than the time and date reflected on the Timeline. The Department's written response to written inquiries submitted timely by bidders will be posted on the Florida Vendor Information Portal at <https://vendor.myfloridamarketplace.com/> (click on "Search Advertisements"), under this bid number. It is the responsibility of all potential bidders to monitor this site for any changing information prior to submitting their bid.

WRITTEN TECHNICAL QUESTIONS should be submitted to:

Sherill Johnson at CO.Puch@dot.state.fl.us

Questions regarding administrative aspects of the bid process should be directed to the Procurement Agent in writing at the email address above.

4) **ORAL INSTRUCTIONS / CHANGES TO THE INVITATION TO BID (ADDENDA)**

No negotiations, decisions, or actions will be initiated or executed by a bidder as a result of any oral discussions with a State employee. Only those communications which are in writing from the Department will be considered as a duly authorized expression on behalf of the Department.

Notices of changes (Addenda) will be posted on the Florida Vendor Information Portal at <https://vendor.myfloridamarketplace.com/> (click on "Search Advertisements") under this bid number. It is the responsibility of all potential bidders to monitor this site for any changing information prior to submitting your bid. All Addenda will be acknowledged by signature and subsequent submission of Addenda with bid when so stated in the Addenda.

5) **DIVERSITY ACHIEVEMENT**

The Department, in accordance with ***Title VI of the Civil Rights Act of 1964, 42 USC 2000d-2000d-4, Title 49, Code of Federal Regulations, U.S. Department of Transportation, Subtitle A, Office of the Secretary, Part 21***, Nondiscrimination in federally-assisted programs of the Department of Transportation issued pursuant to such Act, hereby notifies all bidders that the Department will affirmatively ensure that in any contract/agreement entered into pursuant to this advertisement, minority and disadvantaged business enterprises will be afforded the full opportunity to submit bids in response to this invitation and will not be discriminated on the basis of race, color, national origin, or sex in consideration for an award.

The Department encourages the recruitment and utilization of small, minority, women, and service-disabled veteran businesses. The Department, its vendors, suppliers, and consultants should take all necessary and reasonable steps to ensure that small, minority, women, and service-disabled veteran businesses have the opportunity to compete for and perform contract work for the Department in a nondiscriminatory environment.

6) **PRICES/DELIVERY**

Prices shall be firm, net, delivered prices, F.O.B. destination.

Delivery must be made within thirty (30) calendar days or less upon receipt of a purchase order by the contract vendor at their designated ordering location. If more time is needed, the bidder should state the extra time required and the reasons why, in their bid response. Acceptance will be subject to the Department's approval.

7) **IN-STATE PREFERENCE FOR COMMODITY BIDS**

In accordance with Section 287.084, Florida Statutes, when the lowest responsible and responsive bid is submitted by a vendor whose principal place of business is located outside the state of Florida, a 5% price preference shall be awarded to the lowest responsible and responsive vendor whose principal place of business is located in the state of Florida, as determined by the vendor's registration with the Florida Department of State (SunBiz) and/or MyFloridaMarketPlace, unless the state where the out-of-state vendor is located provides a price preference for businesses having a principal place of business in that state. In that case, the same price preference shall be awarded to the lowest responsible and responsive vendor whose principal place of business is located in the state of Florida responding to this Invitation to Bid (ITB).

All bidders MUST complete the attached "In-State Preference Form" and **submit with their bid response**. All vendors whose principal place of business is outside of Florida, as determined by the vendor's registration with the Florida Department of State (SunBiz) and/or MyFloridaMarketPlace, **must accompany any written bid, proposal, or reply documents** with a written opinion of an attorney at law licensed to practice law in that foreign state, as to the preferences, if any or none, granted by the law of that state to its own business entities whose principal places of business are in that foreign state in the letting of any or all public contracts. **Failure to submit the "In-State Preference Form AND written opinion will result in the vendor being found non-responsive.**

For the 5% preference, the Department will apply 5% to the bid price(s) of the lowest out of state vendor whose state does not grant a preference if that vendor has submitted the lowest responsible and responsive bid. The "In-State Preference" does not apply to transportation projects that use federal funds.

8) **INTENDED AWARD**

As the best interest of the State may require, the right is reserved to make award(s) by individual item, group of items, all or none, or a combination thereof: on a geographical district basis and / or on a statewide basis with one or more suppliers to reject any and all bids or waive any minor irregularity or technicality in bids received. When it is determined there is competition to the lowest responsible bidder, evaluation of other bids is not required. Bidders are cautioned to make no assumptions, unless their bid has been evaluated as being responsive. All awards made as a result of this bid shall conform to applicable Florida Statute. If the Department is confronted with identical pricing or scoring from multiple vendors, the Department shall determine the order of award using the following criteria, in the order of preference listed below (from highest priority to lowest priority):

1. Section 295.187(4), Florida Statutes; Veteran Business Enterprise
2. Section 287.087, Florida Statute; Drug Free Work Place
3. Section 287.057(11); Minority Business Enterprise

In the event that the application of the above referenced preferences does not resolve the identical replies, the Department shall determine the award by means of random drawing.

9) **PRE-BID CONFERENCE**

A PRE-BID CONFERENCE WILL NOT BE HELD.

10) **ALTERNATES**

ALTERNATE BRANDS WILL NOT BE CONSIDERED FOR THIS BID. BID AS SPECIFIED.

11) **WARRANTY/SUBSTITUTIONS**

A warranty is required on all items purchased against defective materials, workmanship, and failure to perform in accordance with required industry performance criteria, for a period of not less than ninety (90) days from the date of acceptance by the purchaser. Any deviation from this criteria must be documented in the bid response or the above statement shall prevail. Delivery of substitute commodities requires prior written approval from the ordering location.

12) **REPLACEMENT/RESTOCKING**

Replacement of all materials found defective within the warranty period shall be made without cost to the purchaser, including transportation if applicable. All fees associated with restocking cancelled orders shall be the responsibility of the vendor.

13) **PRODUCT REQUIREMENTS/SPECIFICATIONS**

Items furnished shall be standard products of the manufacturer or their suppliers, shall be new, unused, clean, and free from any defects or features affecting appearance, serviceability, or the safety of the user in normal intended use.

Any deviation from specifications indicated herein must be clearly pointed out; otherwise, it will be considered that items offered are in strict compliance with these specifications, and successful bidder will be held responsible therefore. Deviations must be explained in detail on separate attached sheet(s).

14) **ACCEPTANCE**

All items listed in the specifications, delivered to the Department not meeting specifications or found to be poorly manufactured will not be accepted, but returned to the vendor, at their expense, for replacement. Replacement of all items found defective shall be made without cost to the Department, including transportation, if applicable. As it may be impossible for each facility to inspect all items upon arrival, a reasonable opportunity must be given to these facilities for inspection of the items, and returning those that are defective.

15) **REVIEW OF BIDDER'S FACILITIES & QUALIFICATIONS**

After the bid due date and prior to contract execution, the Department reserves the right to perform or to have performed, an on-site review of the bidder's facilities and qualifications. This review will serve to verify data and representations submitted by the bidder and may be used to determine whether the bidder has adequate facilities, equipment, qualified and experienced staff, and overall management capabilities to provide the required items. The review may also serve to verify whether the bidder has financial capabilities adequate to meet the contract requirements.

Should the Department determine that the bid package has material misrepresentations or that the size or nature of the bidder's facilities, equipment, management capabilities, or the number of experienced personnel (including technical staff) are not adequate to ensure satisfactory contract performance, the Department has the right to reject the bid.

16) PROTEST OF INVITATION TO BID SPECIFICATIONS

Any person who is adversely affected by the contents of this Invitation to Bid must file the following with the Department of Transportation, Clerk of Agency Proceedings, Office of the General Counsel, 605 Suwannee Street, Mail Station 58, Tallahassee, Florida 32399-0450:

1. A written notice of protest within seventy-two (72) hours after the posting of the solicitation, (the notice of protest may be Faxed to 850-414-5264), and
2. A formal written protest in compliance with Section 120.57(3), Florida Statutes, within ten (10) days of the date on which the written notice of protest is filed.

Failure to file a protest within the time prescribed in section 120.57(3), Florida Statutes, or failure to post the bond or other security required by law within the time allowed for filing a bond shall constitute a waiver of proceedings under Chapter 120, Florida Statutes.

17) UNAUTHORIZED ALIENS

The employment of unauthorized aliens by any contractor is considered a violation of Section 274A(e) of the Immigration and Nationality Act. If the contractor knowingly employs unauthorized aliens, such violation shall be cause for unilateral cancellation of the contract.

18) SCRUTINIZED COMPANIES LISTS

ALL Responses, regardless of dollar value, must include a completed [Vendor Certification Regarding Scrutinized Companies Lists](#) to certify the respondent is not on either of those lists. The Form should be submitted with the bid package.

A Vendor is ineligible to enter into a contract with the Department for goods or services of any amount if, at the time of entering into such contract, the Vendor is on the Scrutinized Companies that Boycott Israel List, created pursuant to Section 215.4725, Florida Statutes, or is engaged in a boycott of Israel.

Section 287.135, Florida Statutes, also prohibits companies from entering into a contract for goods or services of \$1 million or more that are on either the Scrutinized Companies with Activities in Sudan List or the Scrutinized Companies with Activities in the Iran Petroleum Energy Sector Lists which were created pursuant to s. 215.473, Florida Statutes.

If the Department determines the Vendor submitted a false certification under Section 287.135 of the Florida Statutes, the Department shall either terminate the Contract after it has given the Vendor notice and an opportunity to demonstrate the Department's determination of false certification was in error pursuant to Section 287.135 of the Florida Statutes, or maintain the Contract if the conditions of Section 287.135 of the Florida Statutes are met.

19) RESERVATIONS

The Department reserves the right to accept or reject any or all bids received and reserves the right to make an award without further discussion of the bids submitted. Therefore, the bidder should make sure that the bid package submitted is complete and accurate and submitted to ensure delivery on or before the bid opening time and date specified in this solicitation. It is understood that the bid will become a part of the Department's official file, without obligation to the Department.

20) ADDITIONAL TERMS & CONDITIONS

No conditions may be applied to any aspect of the ITB by the bidder. Any conditions placed on any

aspect of the bid documents by the bidder may result in the bid being rejected as a conditional bid (see "RESPONSIVENESS OF BIDS"). **DO NOT WRITE IN CHANGES ON ANY ITB SHEET.** The only recognized changes to the ITB prior to bid opening will be a written Addenda issued by the Department.

21) RESPONSIVENESS OF BIDS

Bids will not be considered if not received by the Department **on or before** the date and time specified as the due date for submission. All bids must be typed or printed in ink. A responsive bid is an offer to provide the items specified in this Invitation to Bid in accordance with all requirements of this Invitation to Bid. Bids found to be non-responsive will not be considered. Bids may be rejected if found to be irregular or not in conformance with the specifications and instructions herein contained. A bid may be found to be irregular or non-responsive by reasons that include, but are not limited to, failure to utilize or complete prescribed forms, modifying the bid specifications, submitting conditional bids or incomplete bids, submitting indefinite or ambiguous bids, or executing forms or the bid sheet with improper and/or undated signatures. Other conditions which may cause rejection of bids include, evidence of collusion among bidders, obvious lack of experience or expertise to provide the required items, and failure to perform or meet financial obligations on previous contracts. ALL determinations of responsiveness will be the responsibility of the FDOT Procurement Office.

22) REQUIRED DOCUMENTS

The bidder must use the attached Bid Sheet to submit its bid. The Bid Sheet must be signed and dated by a representative who is authorized to contractually bind the bidder. All bid sheets and other documentation submitted in response to this solicitation must be executed and submitted in accordance with Special Condition 26, Electronic Submission of Bids.

23) "DRUG-FREE WORK PLACE" PREFERENCE

Whenever two or more bids which are equal with respect to price, quality, and service are received, the Department shall determine the order of award first in accordance with section 295.187(4), Florida Statutes, giving preference to "Veteran Business Enterprise" then to bid responses from vendors that certify the business has implemented a drug-free workplace program in accordance with Section 287.087, Florida Statutes. The "Drug-Free Workplace Program Certification" must be completed and submitted with the bid response to be eligible for this preference.

24) COPYRIGHTED MATERIAL

Copyrighted material will be accepted as part of a bid only if accompanied by a waiver that will allow the Department to make paper and electronic copies necessary for the use of Department staff and agents. It is noted that copyrighted material is not exempt from the Public Records Law, Chapter 119, Florida Statutes. Therefore, such material will be subject to viewing by the public, but copies of the material will not be provided to the public.

25) ATTACHMENT TO ITB SUBMITTAL - CONFIDENTIAL MATERIAL

The Bidder must include any materials it asserts to be exempted from public disclosure under Chapter 119, Florida Statutes, in a separate document labeled "Vendor's Name - Confidential Material". The Bidder must identify the specific Statute that authorizes exemption from the Public Records Law. Any claim of confidentiality on materials the Bidder asserts to be exempt from public disclosure and placed elsewhere in the bid will be considered waived by the Bidder upon submission, effective after opening.

26) ELECTRONIC SUBMISSION OF BIDS:

Please follow the below instructions for the submittal of electronic bids, failure to do so, may result in your bid being found non-responsive. Non-responsive replies will not be evaluated.

- a) Subject line must show: DOT-ITB-24-9069-SJ – Vendor's Name
- b) Email shall contain one file attachment marked as the following:

Vendor's Name – Bid Submittal

- c) Documents shall be submitted in portable document format (PDF) and have a size limit of 20MB.
- d) Documents shall not be submitted in a ZIP (.zip) file.
- e) The body of the email shall not contain any information
- f) Bids shall be submitted to: CO.Purch@dot.state.fl.us

It is the bidder's responsibility to assure that the bid is delivered to the proper place **on or before** the Bid Due date and time (See Introduction Section 2 Timeline). Bids which for any reason are not so delivered, will not be considered.

27) MODIFICATIONS, RESUBMITTAL AND WITHDRAWAL

Bidders may modify submitted bids at any time prior to the bid due date. Requests for modification of a submitted bid shall be in writing and must be signed by an authorized signatory of the bidder. Upon receipt and acceptance of such a request, the entire bid will not be considered unless resubmitted by the due date and time. Bidders may also send a change in a separate email to be opened at the same time as the bid.

28) POSTING OF INTENDED DECISION/AWARD

28.1 - General:

The Department's decision will be posted on the Florida Vendor Information Portal at <https://vendor.myfloridamarketplace.com/>, on the date in the Timeline, and will remain posted for a period of seventy-two (72) hours. Any bidder who is adversely affected by the Department's recommended award or intended decision must file the following with the Department of Transportation, Clerk of Agency Proceedings, Office of the General Counsel, 605 Suwannee Street, Mail Station 58, Tallahassee, Florida 32399-0450:

1. A written notice of protest within seventy-two (72) hours after posting of the Intended Award, (the notice of protest may be Faxed to 850-414-5264), and
2. A formal written protest and protest bond in compliance with Section 120.57(3), Florida Statutes, within ten (10) days of the date on which the written notice of protest is filed. At the time of filing the formal written protest, a bond (a cashier's check or money order may be accepted) payable to the Department must also be submitted in an amount equal to one percent (1%) of the estimated contract amount based on the contract price submitted by the protestor.

Failure to file a protest within the time prescribed in Section 120.57(3), Florida Statutes, or failure to post the bond or other security required by law within the time allowed for filing a bond shall constitute a waiver of proceedings under Chapter 120, Florida Statutes.

28.2 - Inability to Post:

If the Department is unable to post as defined above, the Department will notify all bidders by electronic notification on the Florida Vendor Information Portal (see special condition 28.1, above) and/or telephone. The Department will provide notification of any future posting in a timely manner.

28.3 - Request to Withdraw Bid:

Requests for withdrawal will be considered if received by the Department, in writing, within seventy-two (72) hours after the bid opening time and date. Requests received in accordance with this provision will be granted by the Department upon proof of the impossibility to perform based upon obvious error on the part of the bidder. Bidders that do not withdraw as stated above will forfeit their bid bond, if applicable.

29) RECYCLED MATERIAL

The Department encourages the use of products and materials with recycled content and post-consumer recovered materials. If the item(s) specified in the Technical Specification is available with recycled content, we request that you provide product information to help in our search for recycled products. However, this bid request is for the product as specified herein and does not require prices for recycled product. This information should be sent as part of your bid response or may be sent separately.

30) PRICE ADJUSTMENTS

The Department may, in its sole discretion, make an equitable adjustment in the Contract terms and/or pricing if pricing or availability of supply is affected by extreme and unforeseen volatility in the marketplace, that is, by circumstances that satisfy all the following criteria: (1) the volatility is due to causes wholly beyond the Vendor's control, (2) the volatility affects the marketplace or industry, not just the particular Contract source of supply, (3) the effect on pricing or availability of supply is substantial, and (4) the volatility so affects the Vendor that continued performance of the Contract would result in a substantial loss. The Vendor shall provide thirty (30) days written notice to the Department and written approval from the Department is required. Documentation of cost adjustments shall be provided by the Vendor to the Department.

31) DELIVERY LOCATION(S)

Delivery shall be as specified on the purchase orders. Normally, delivery shall be to the following sites:

Ms. Janelle Inman-Albright, Phone: 386/961-7120*
Department of Transportation, Sign Shop
590 NW Lake Jeffery Road, Lake City, FL 32055

Mr. Rishi Moonian, Phone: 407/977-6520 **
Department of Transportation
State Aluminum Structures Shop (SASS)
2590 Camp Road, Oviedo, FL 32765

Deliver on flatbed vehicle with removable sides for forklift operations. The load will be positioned for unloading with moving or off-loading items not for that location.

*Deliveries shall be made between 8:00 A.M. and 4:00 P.M. Monday through Thursday. No Friday or holiday deliveries.

**Deliveries shall be made between 8:00 A.M. and 3:00 P.M. Monday through Thursday. No Friday or holiday deliveries.

32) CANCELLATION

All contract obligations shall prevail for at least one hundred and eighty (180) days after the effective date of the contract. For the protection of both parties, this contract may be cancelled in whole or in part after one hundred and eighty (180) days by either party giving thirty (30) days prior written notice to the other contract party. The contract may, also, be cancelled by the Department for nonperformance (default) in accordance with Rule 60A-1.006(3), F.A.C.

33) ORDERING INSTRUCTIONS

Manufacturers are encouraged to bid direct naming dealers who will accept orders and complete deliveries. Bidders must include complete ordering instructions, including FEDERAL EMPLOYER IDENTIFICATION NUMBER (FEID), for invoicing dealers, with the bid on a separate sheet.

34) ORDER QUANTITIES

No minimum order quantities will be accepted. The Department will order as needed in the quantities needed.

35) OPEN PURCHASE ORDERS

The Department may, at its discretion, establish an open (estimated quantity) purchase order with the contract vendor(s) to facilitate the purchasing of materials. The purchase of materials may be placed by; (1) written purchase order, (2) telephone orders by authorized Department personnel, or (3) an itemized order in writing. The Department will supply the contract vendor(s) with a list of personnel authorized to order. Delivery of items on these open purchase orders shall not exceed the contract effective period.

36) INVOICING

Invoices must match units specified on the Purchase Order.

37) FORMS

The Bidder must complete all required items below and submit them as part of the Bid package. Any Bid in which these forms are not used or in which these forms are improperly executed may be considered non-responsive and the bid may be subject to rejection.

Bid Sheet

Drug-Free Workplace Program Certification (if applicable) (Form 375-040-18)

In-State Preference (Form 375-040-56)

Vendor Certification Regarding Scrutinized Companies Lists (Form 375-030-60)

Ordering Instructions

E-Verify (Form 375-031-06)

Material Specifications – Compliance Form

38) TERMS AND CONDITIONS

38.1 General Contract Conditions (PUR 1000)

The State of Florida's General Contract Conditions are outlined in form PUR 1000, which is a

downloadable document incorporated into this Invitation to Bid (ITB) by reference. Any terms and conditions set forth in this ITB document will take precedence over the PUR 1000 form where applicable.

<http://www.dms.myflorida.com/content/download/2933/11777/1000.pdf>

The following paragraphs do not apply to this Invitation to Bid:

Paragraph 31, Dispute Resolution - PUR 1000

Paragraph 40, PRIDE – PUR 1000, when federal funds are utilized.

38.2 General Instructions to Respondents (PUR 1001)

The State of Florida's General Instructions to Respondents are outlined in form PUR 1001, which is a downloadable document incorporated into this Invitation to Bid (ITB) by reference. Any terms and conditions set forth in this ITB document take precedence over the PUR 1001 form where applicable.

<http://www.dms.myflorida.com/content/download/2934/11780/1001.pdf>

The following paragraphs do not apply to this Invitation to Bid:

Paragraph 3, Electronic Submission – PUR 1001

Paragraph 4, Terms and Conditions – PUR 1001

Paragraph 5, Questions – PUR 1001

38.3 MFMP Purchase Order Terms and Conditions

All MFMP Purchase Order contracts resulting from this solicitation will include the terms and conditions of this solicitation and the State of Florida's standardized Purchase Order Terms and Conditions, which can be found at the Department of Management Services website at the following link:

http://www.dms.myflorida.com/content/download/117735/646919/Purchase_Order_Terms_Sept_1_2015_.pdf

Section 8(B), PRIDE, is not applicable when using federal funds.

39) ORDER OF PRECEDENCE

All responses are subject to the terms and conditions of this solicitation, which, in case of conflict, shall have the following order of precedence listed:

Special Conditions

Technical Specifications

Bid Sheet

MFMP Purchase Order Terms and Conditions – Section 8(B), PRIDE, is not applicable when using federal funds.

General Instructions to Respondents (PUR 1001)

General Contract Conditions (PUR 1000)

Introduction Section

40) PACKAGING

Each Commodity number for the Lake City, Florida location should be palletized separately.

41) MATERIAL SPECIFICATIONS – COMPLIANCE FORM

A completed copy of this page, filled out in ink, must be returned with the bid. Failure to complete the conformance column may result in a bid being rejected as non-responsive. Unless otherwise stated this data applies to all sites.