

DESIGNED BY: RICHARD A. CASTRO, P.E.
 LICENSE NUMBER: 60274
 REGISTERED PROFESSIONAL ENGINEER
 COUNTY: POLK
 STATE: FLORIDA
 PROJECT NUMBER: 4492766-52-01

CROSS SECTIONS

THE OFFICIAL RECORD OF THIS SHEET IS THE ELECTRONIC FILE DYNAMICALLY SHOWN AND SEALED UNDER RULE 61B05-23.004, F.A.C.

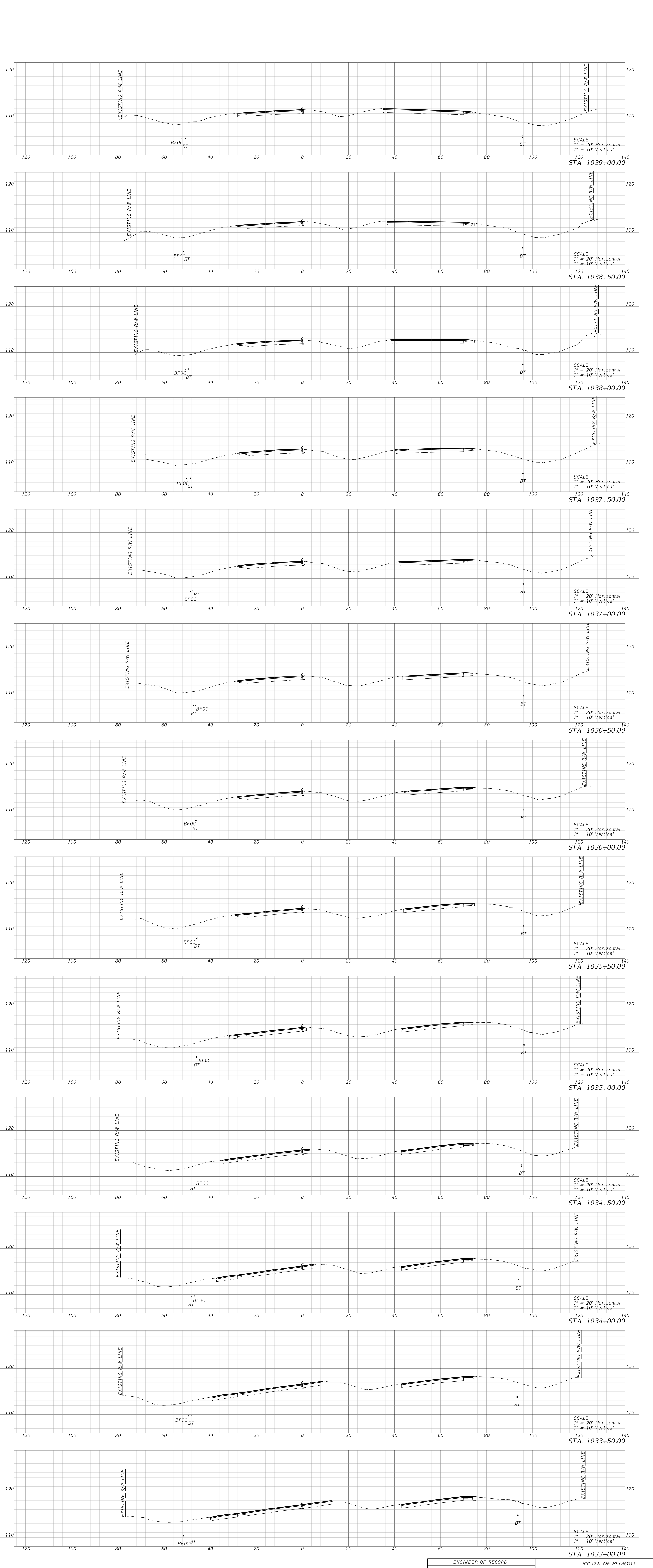
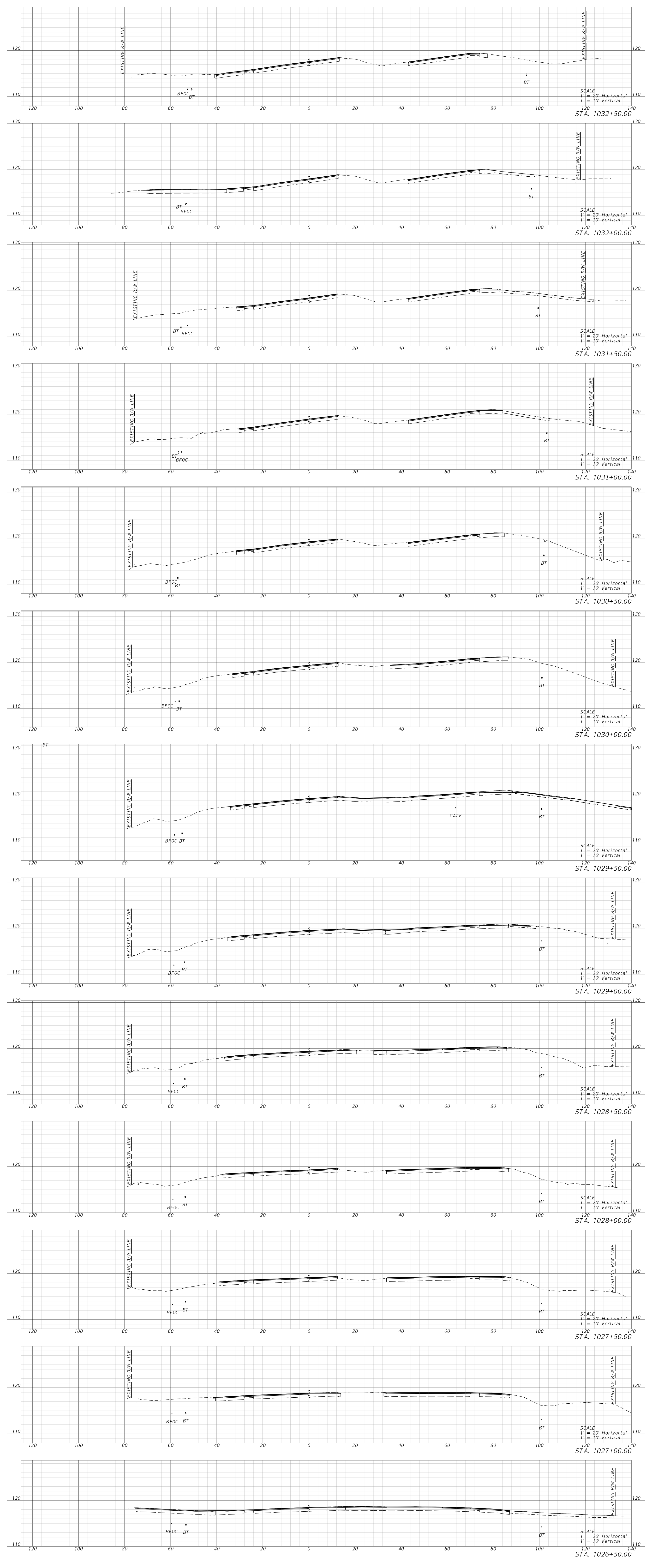
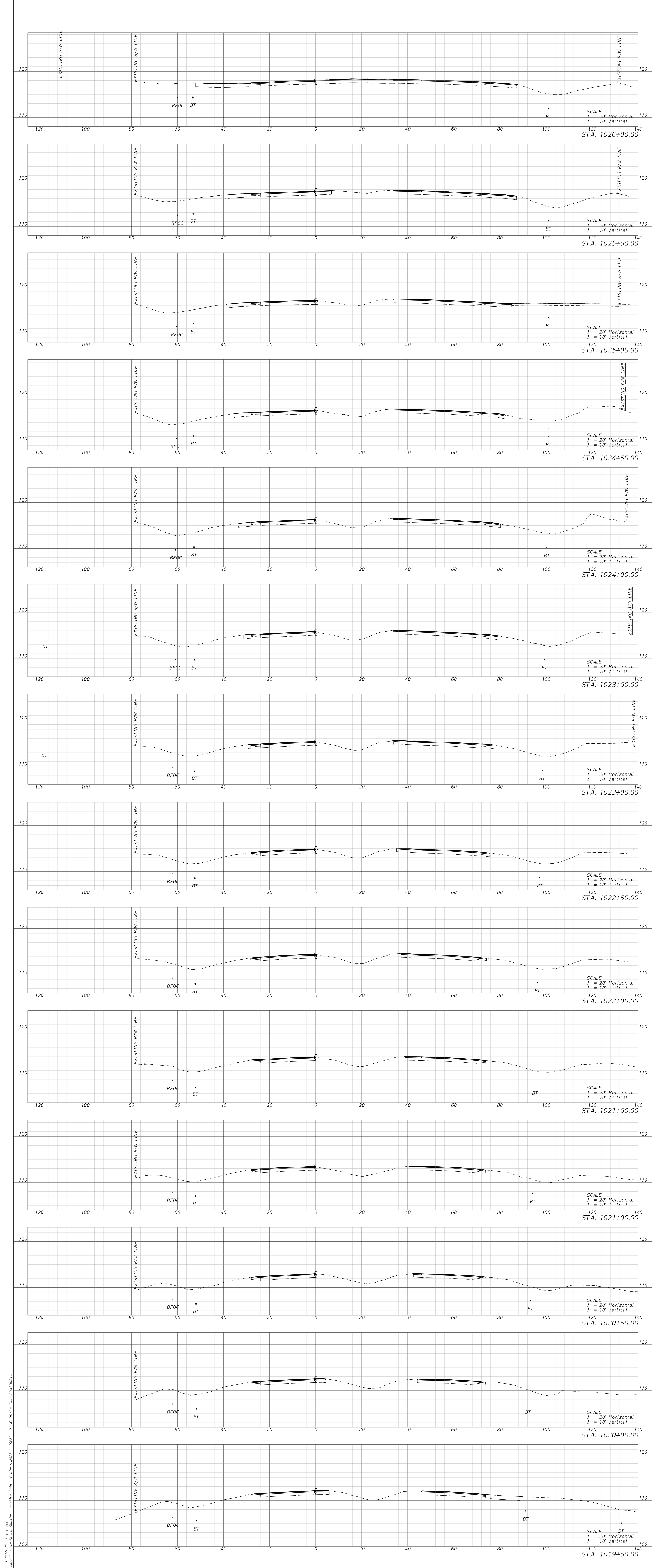

DESIGNER OF RECORD		STATE OF FLORIDA	
RICARDO A. CASTRO, P.E.		DEPARTMENT OF TRANSPORTATION	
ADIAN NO.	LEIFERIS NUMBER #0279	COUNTY	PARANAL PROJECT ID
BOHANNAN CONSULTANTS, INC.	ROADWAY DESIGN DIVISION	POLK	499276-52-01
1000 W. 77th STREET, SUITE 140	DORAL, FL 33126		

CROSS SECTIONS

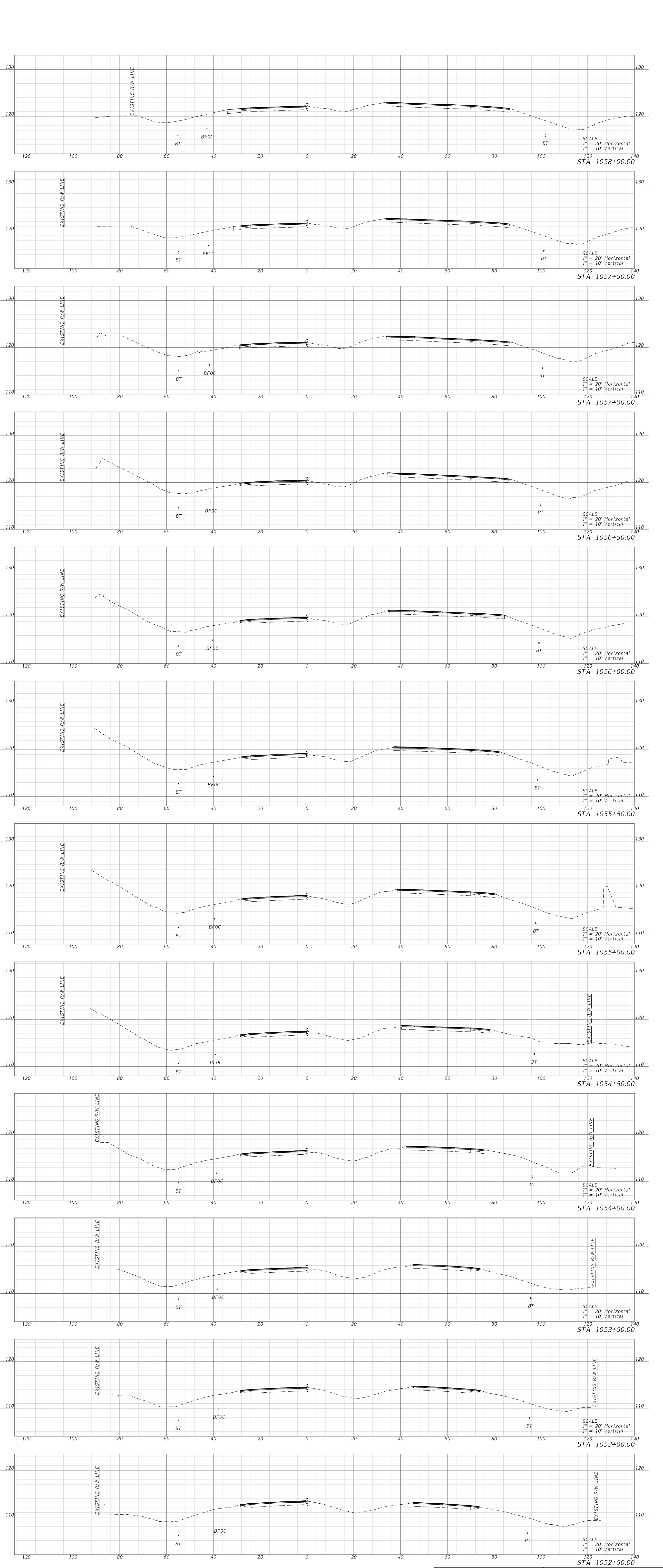
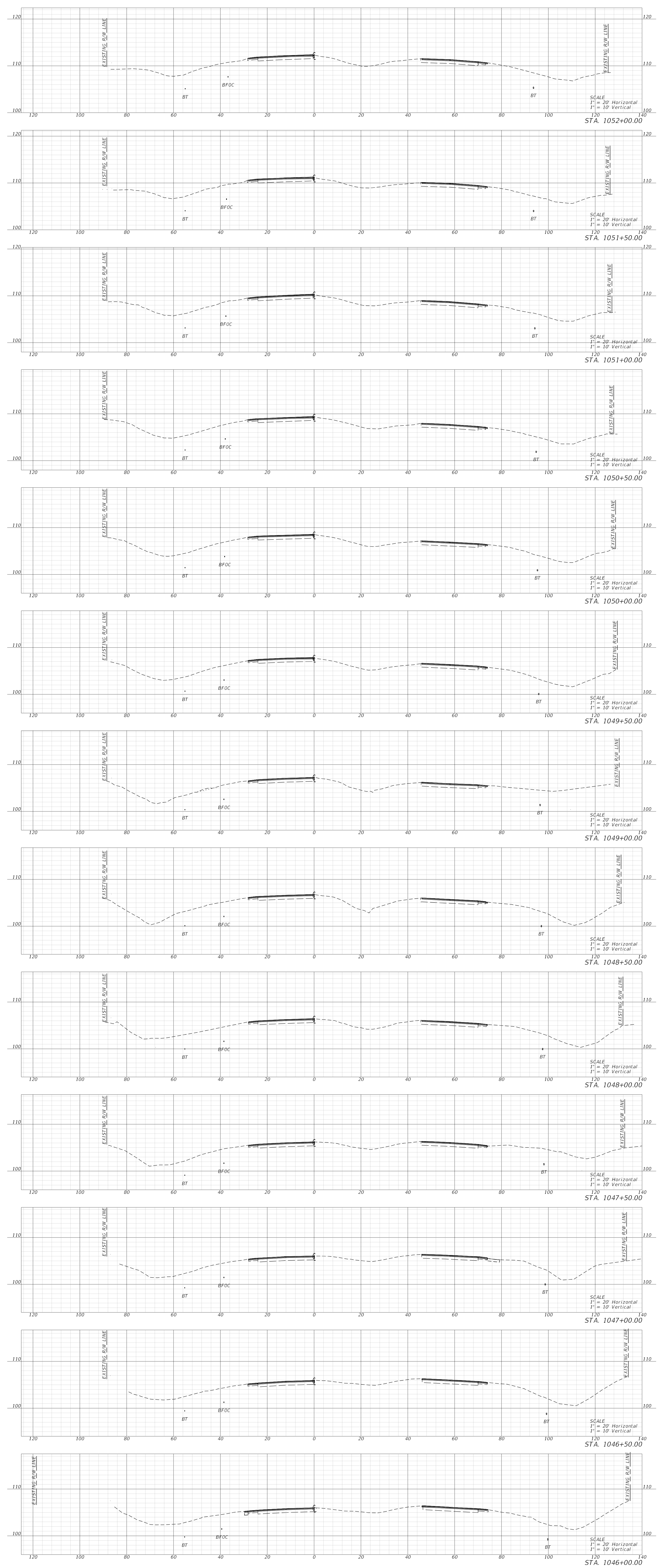
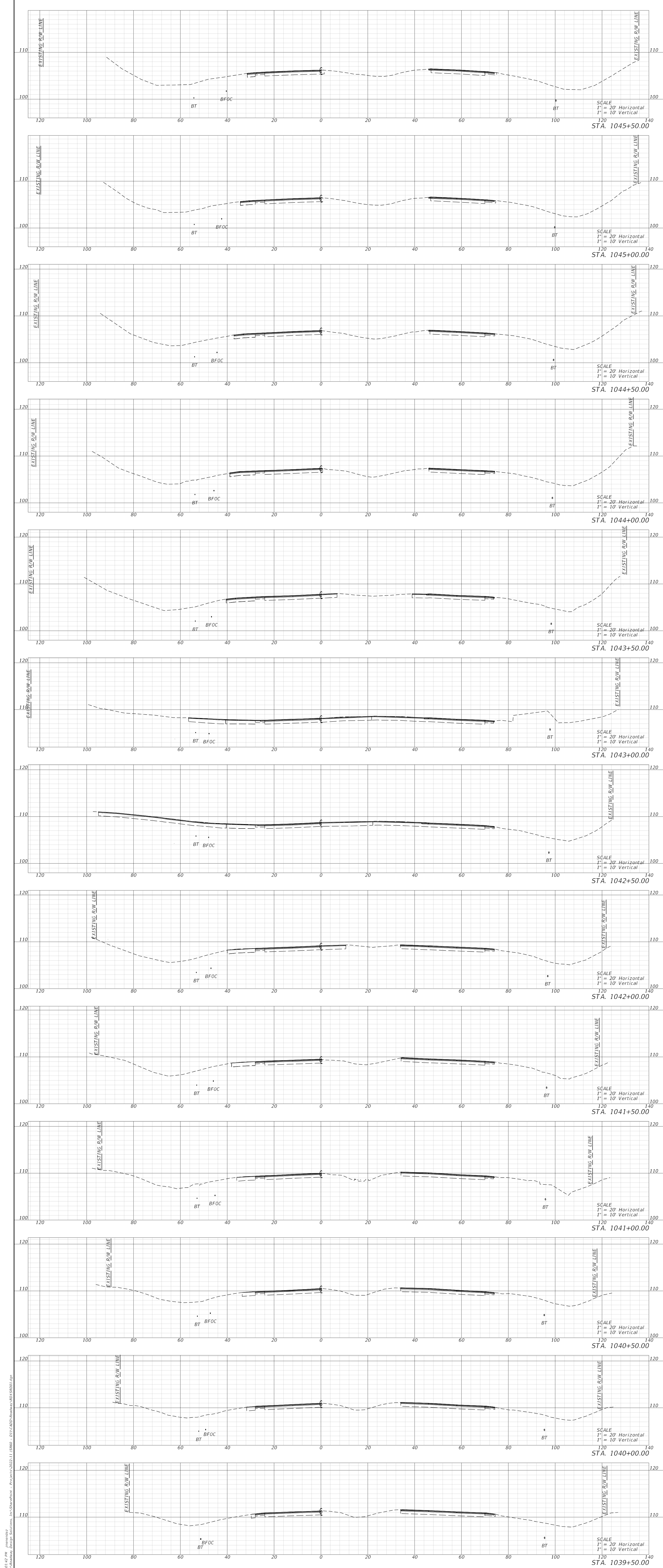

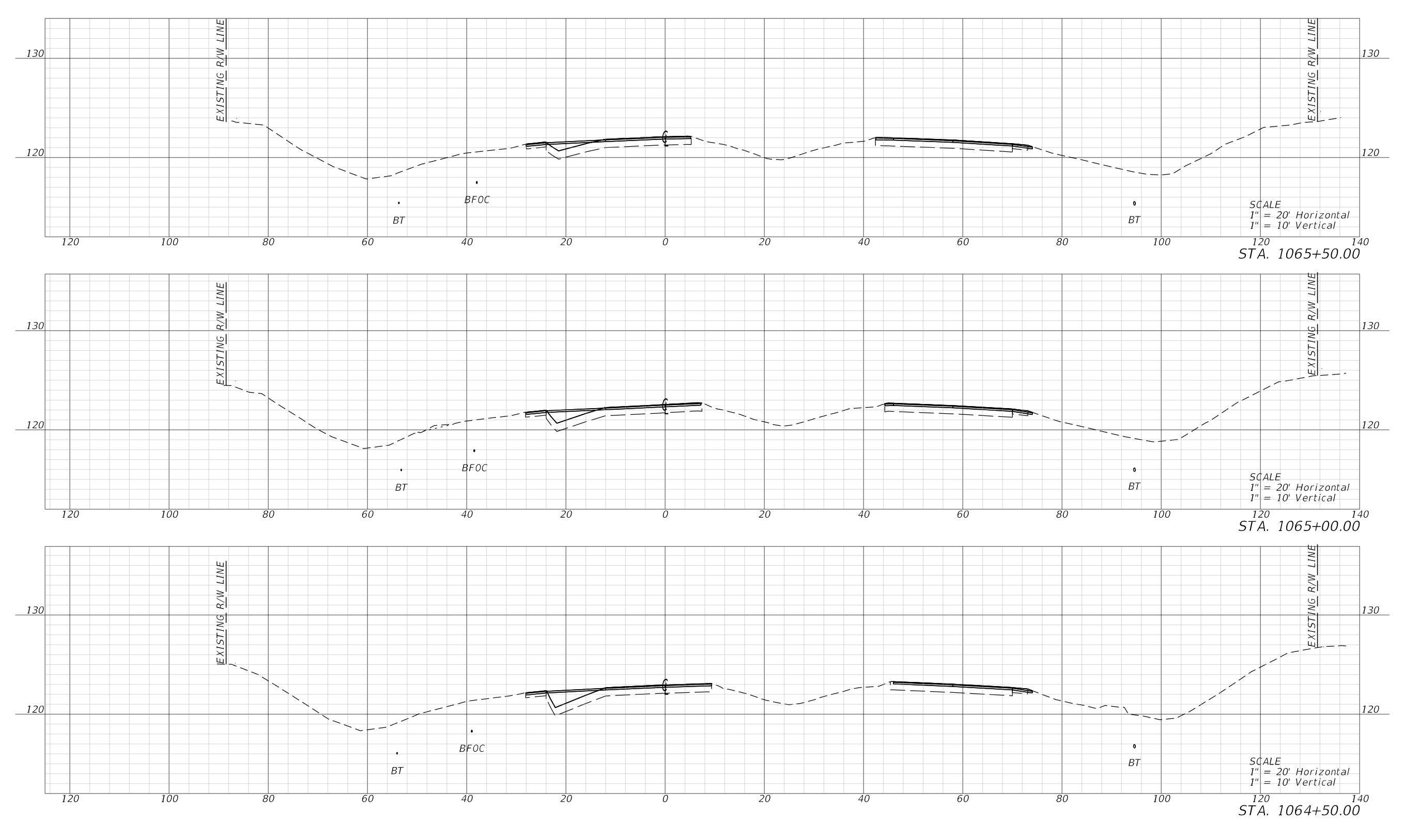
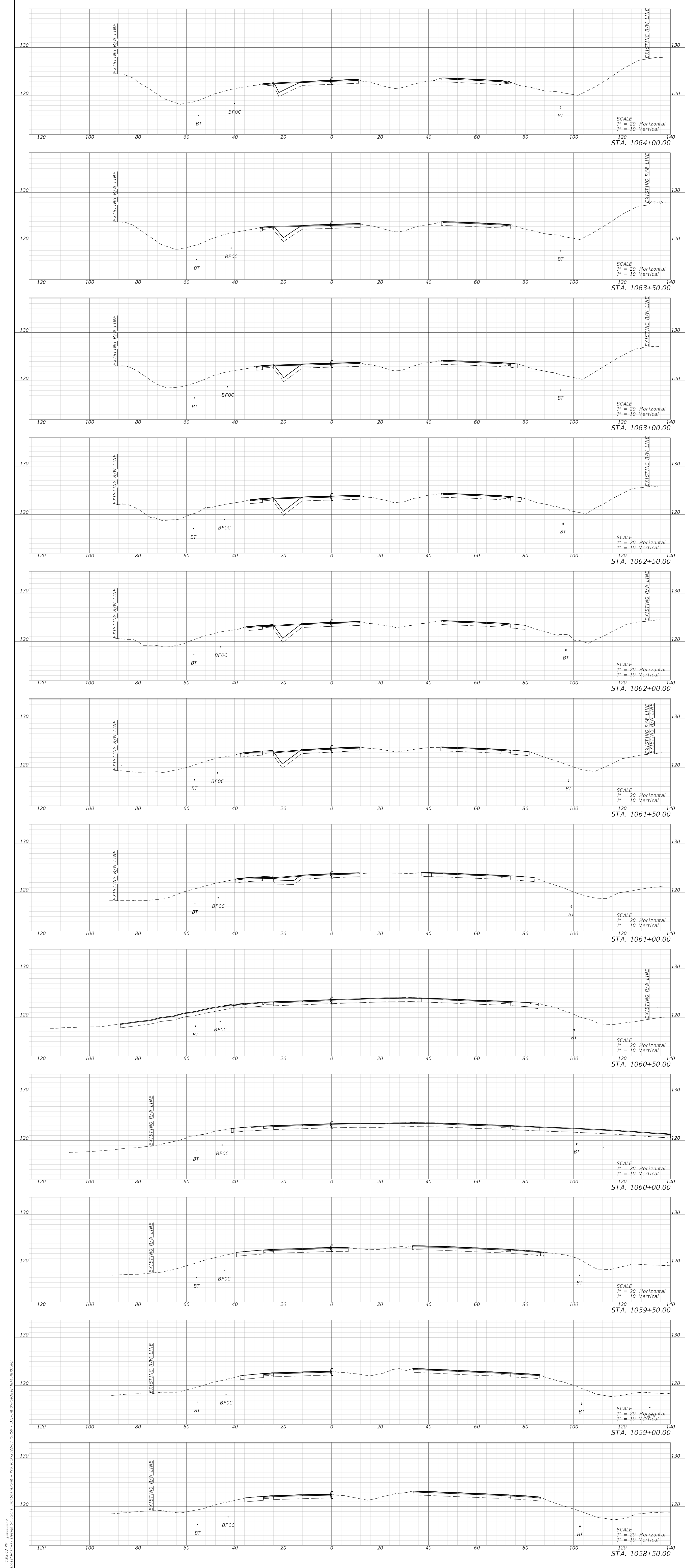

ENGINEER OF RECORD		STATE OF FLORIDA		SHEET NO.
RICARDO A. CASTRO, P.E.		DEPARTMENT OF TRANSPORTATION		
LICENSE NUMBER 68274		ADAM NO.	COUNTY	FINANCIAL PROJECT ID
BOHANNON CONSULTANTS, INC.		SR 60	POLK	
1000 NE 17th STREET, SUITE 140		489276-52-01		CROSS SECTIONS
DORAL, FL 33126				

THE OFFICIAL RECORD OF THIS SHEET IS THE ELECTRONIC FILE DIGITALLY SIGNED AND SEALED UNDER RULE 61E5-23.004, F.A.C.

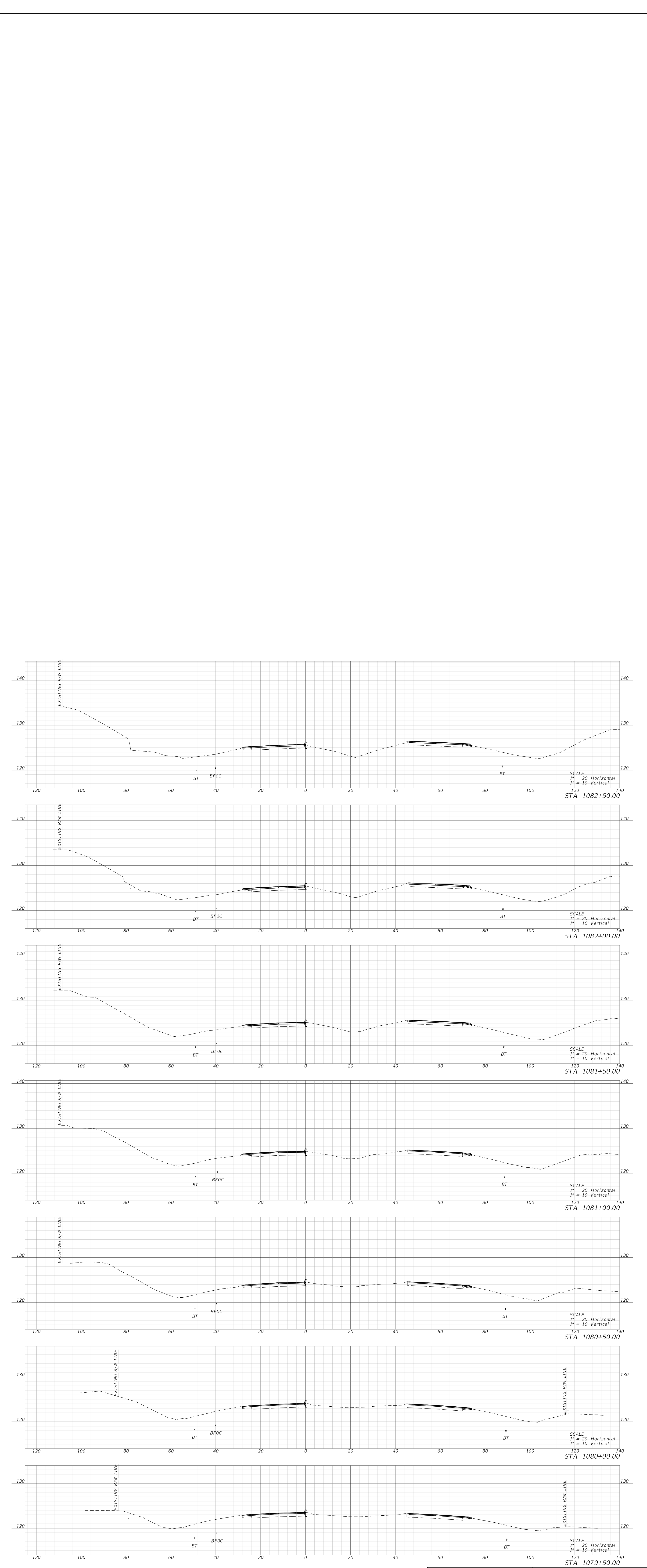
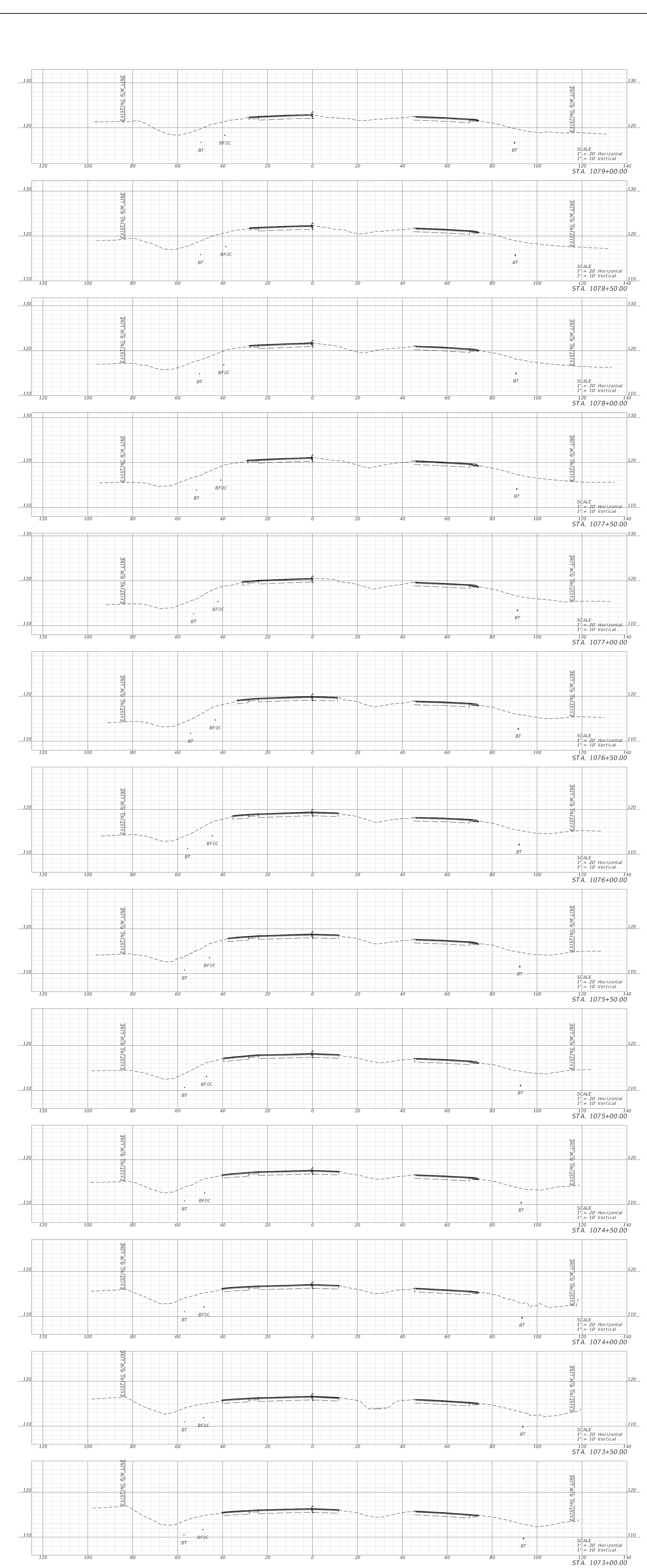
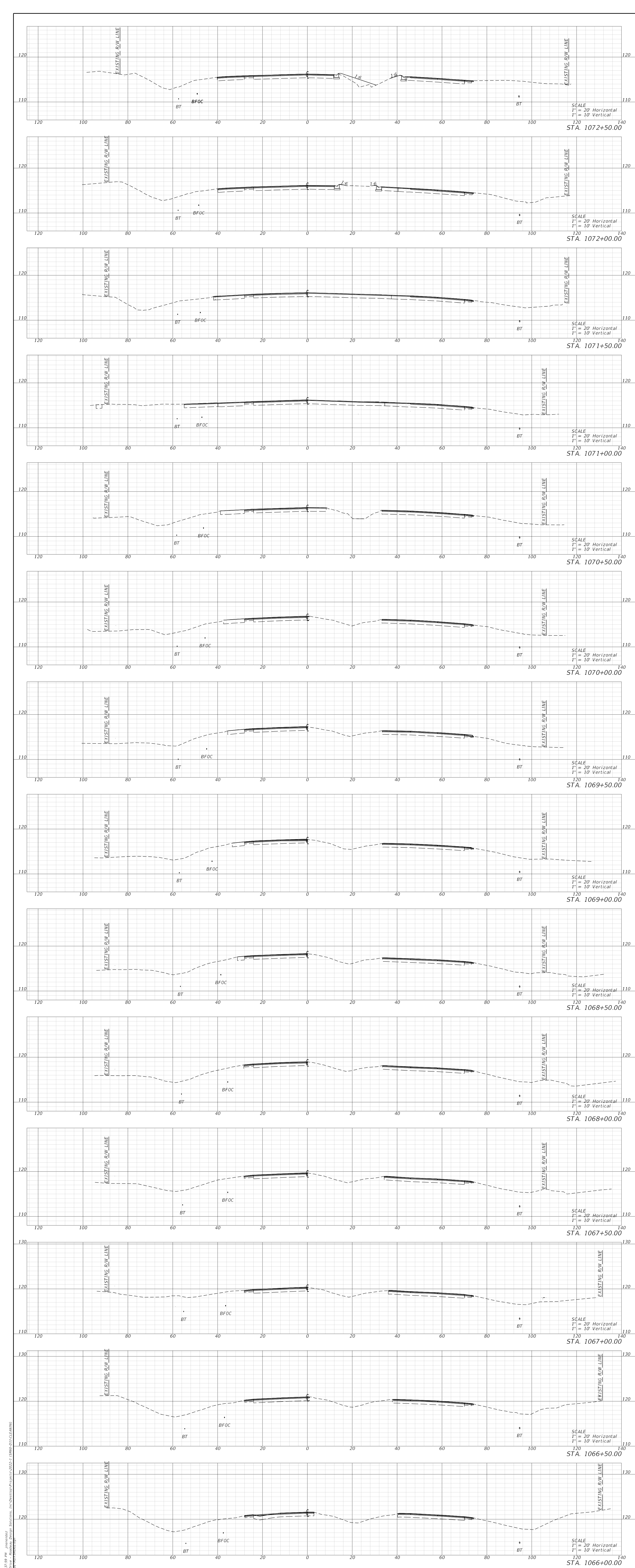

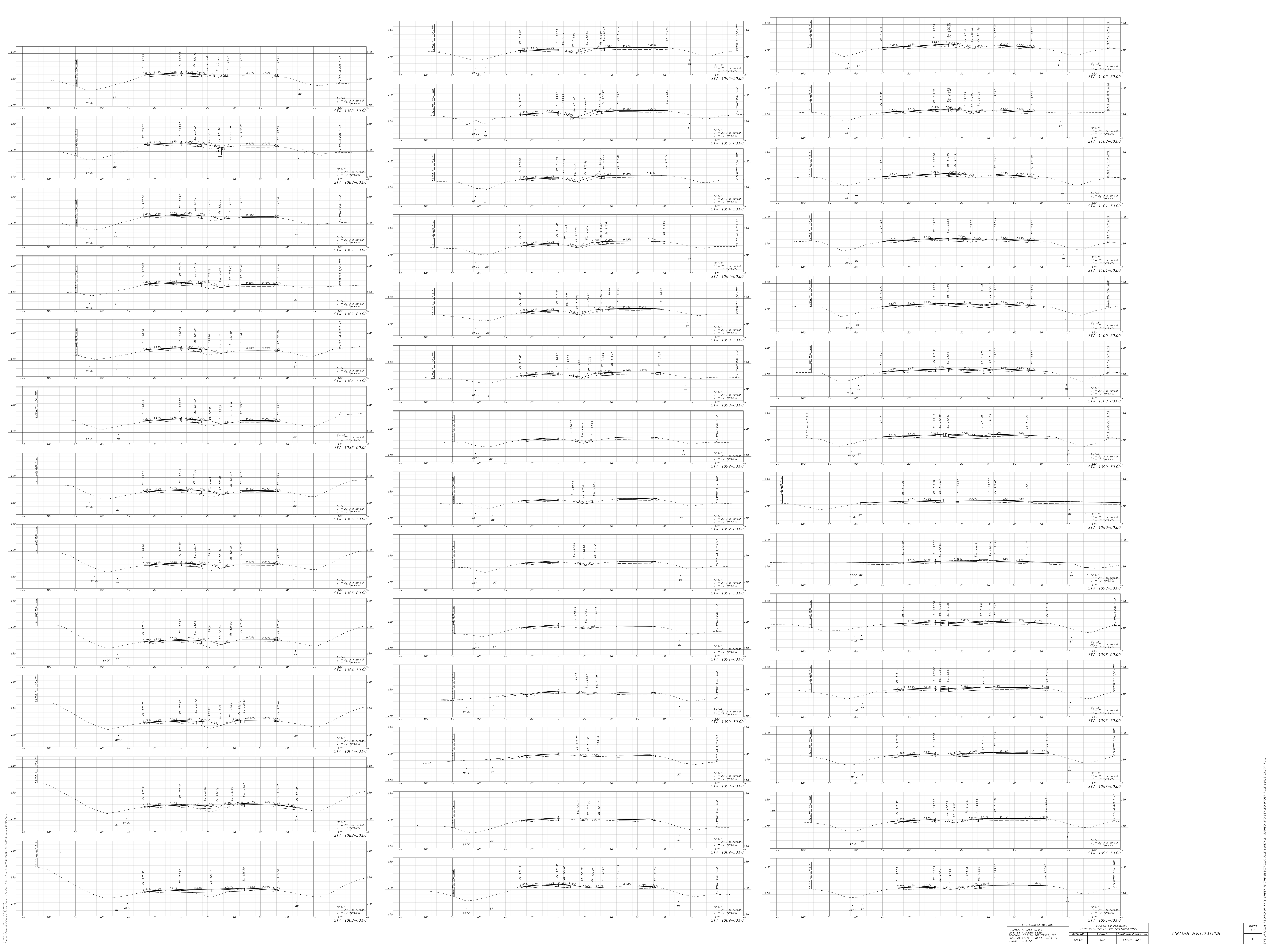

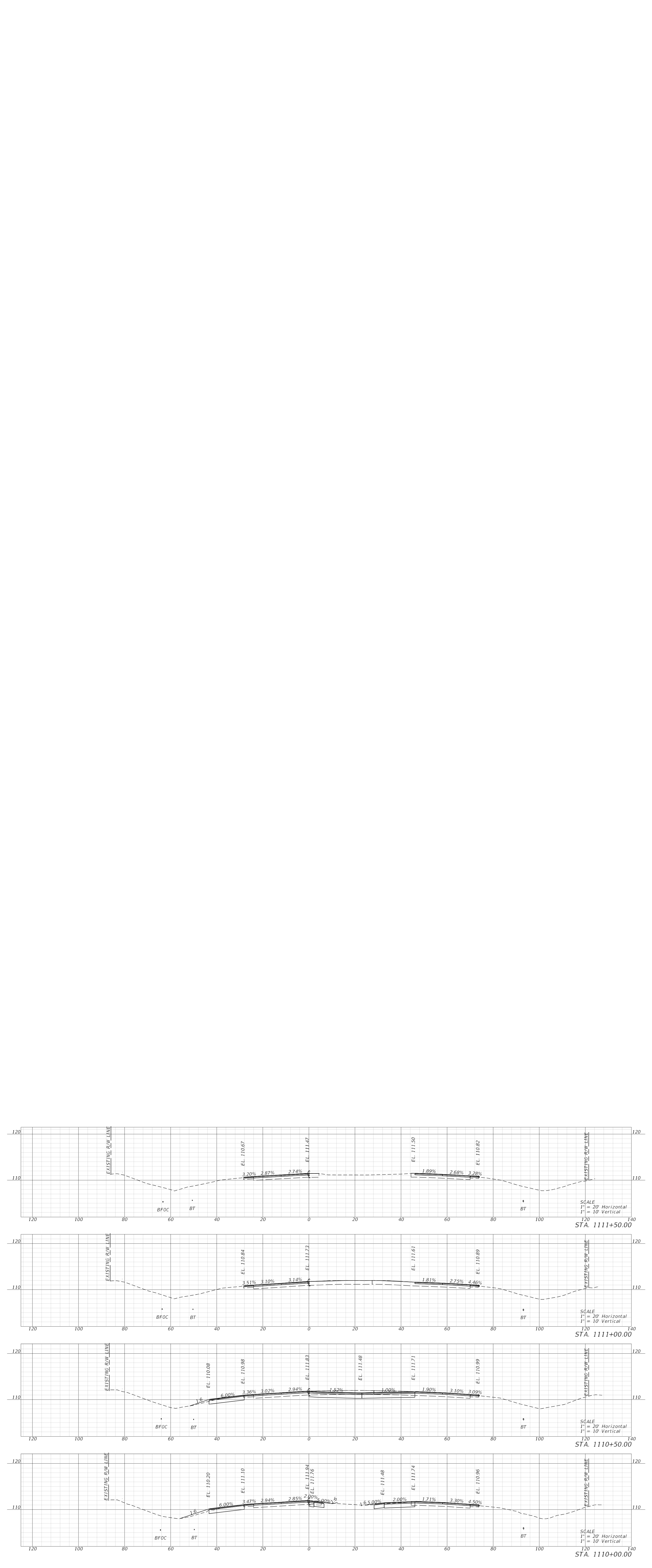
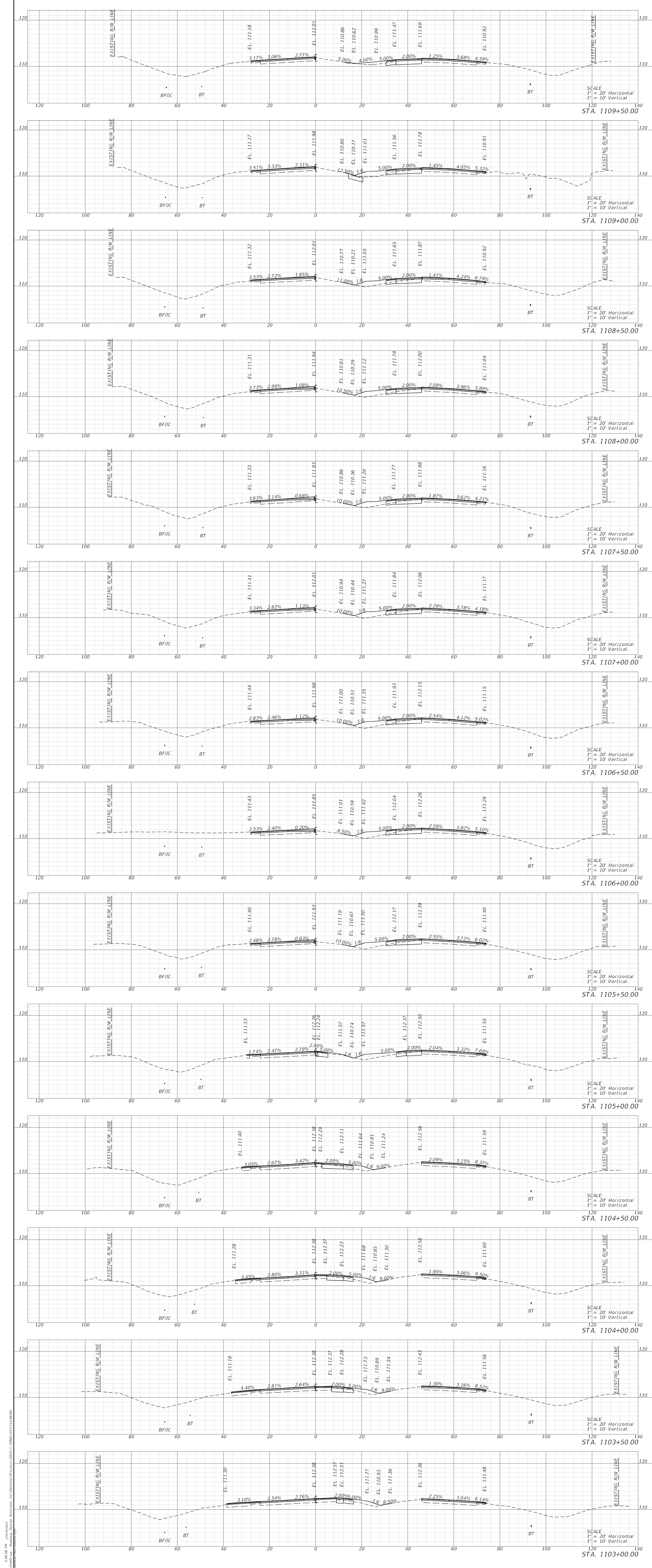

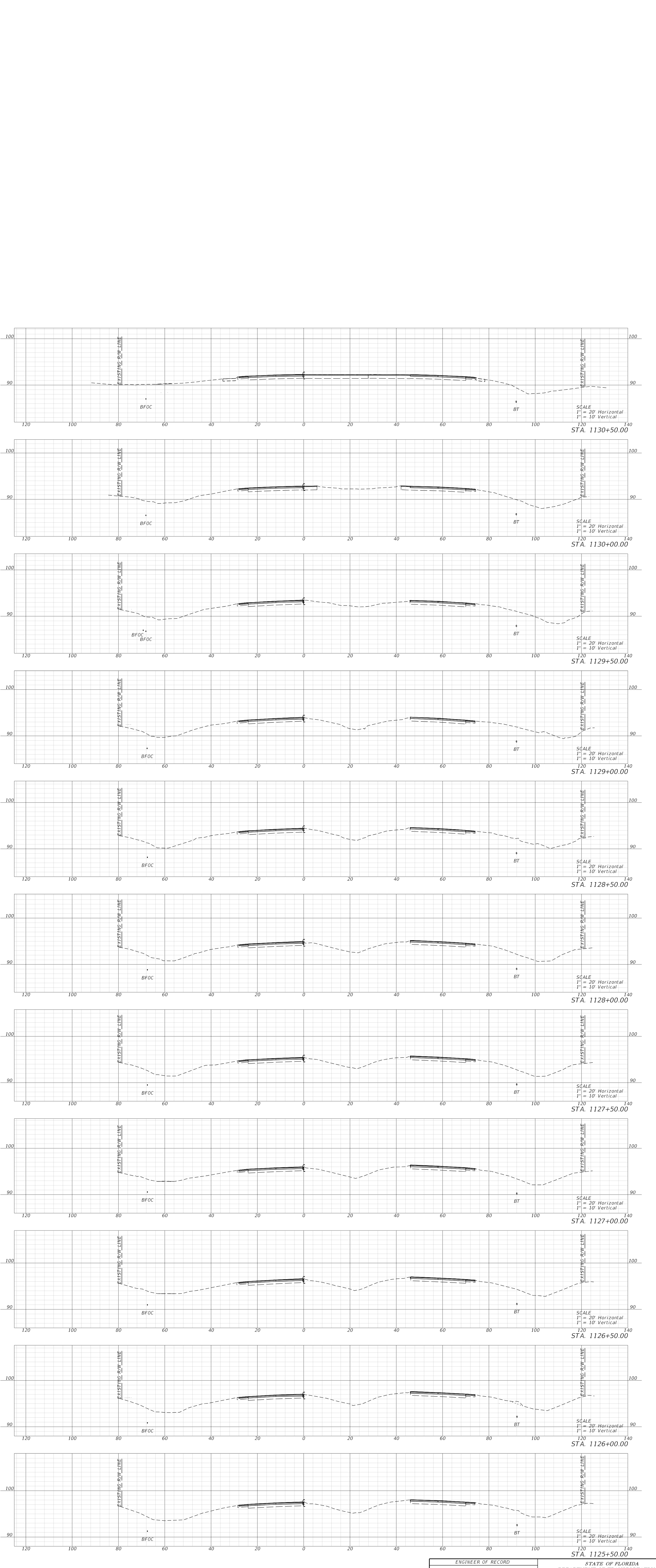
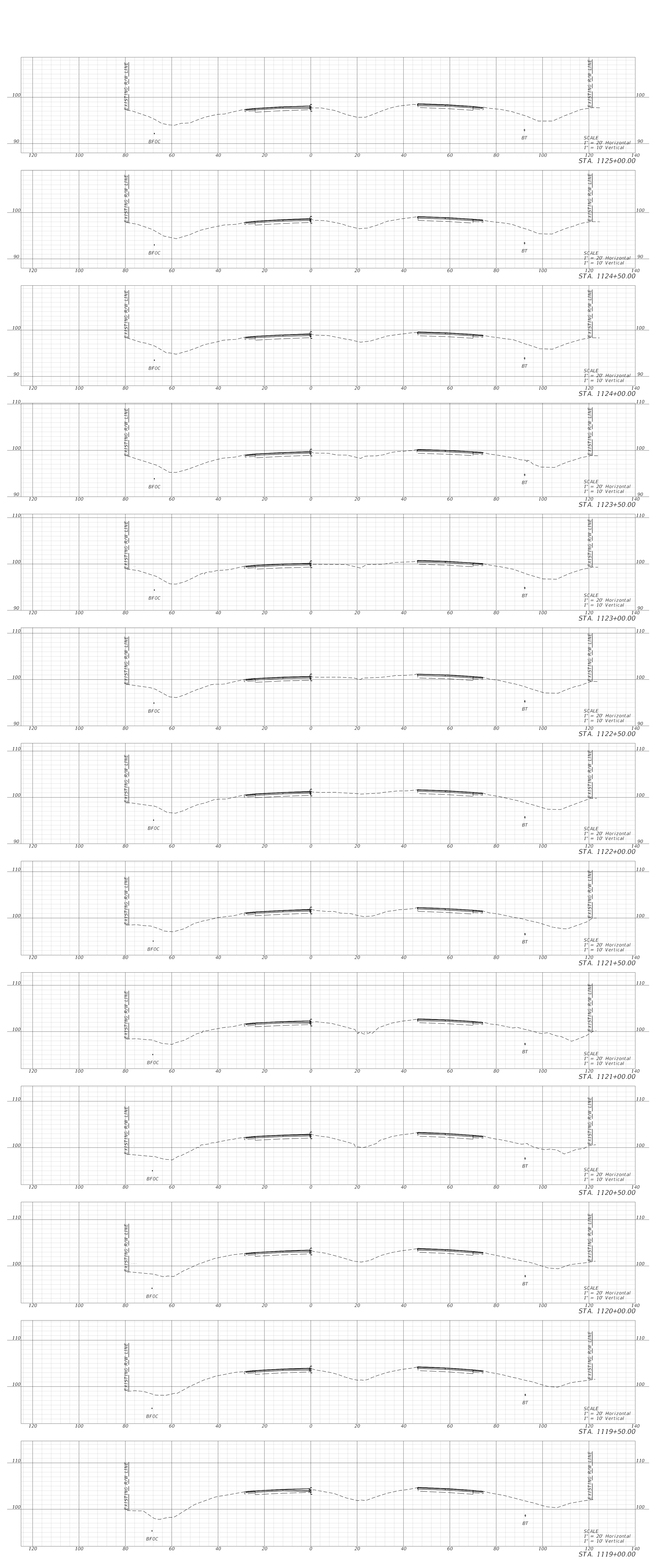
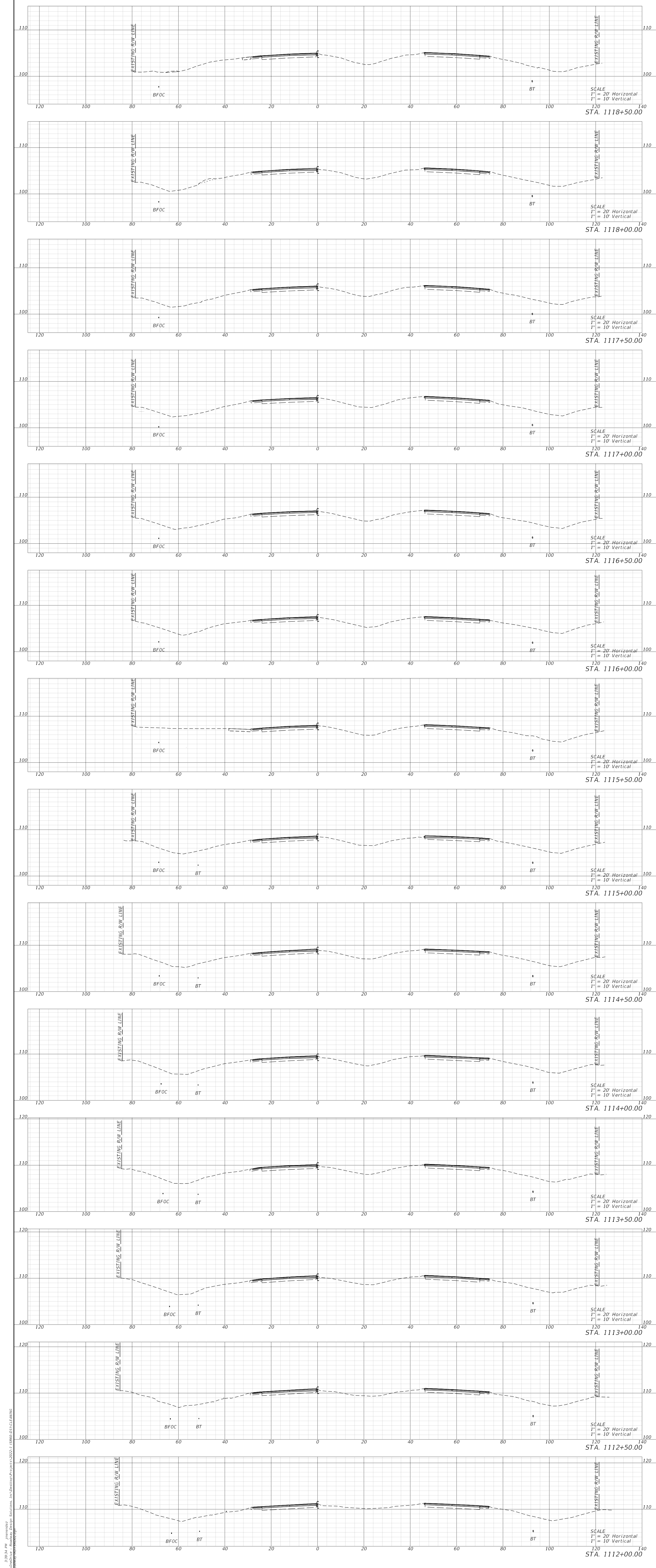

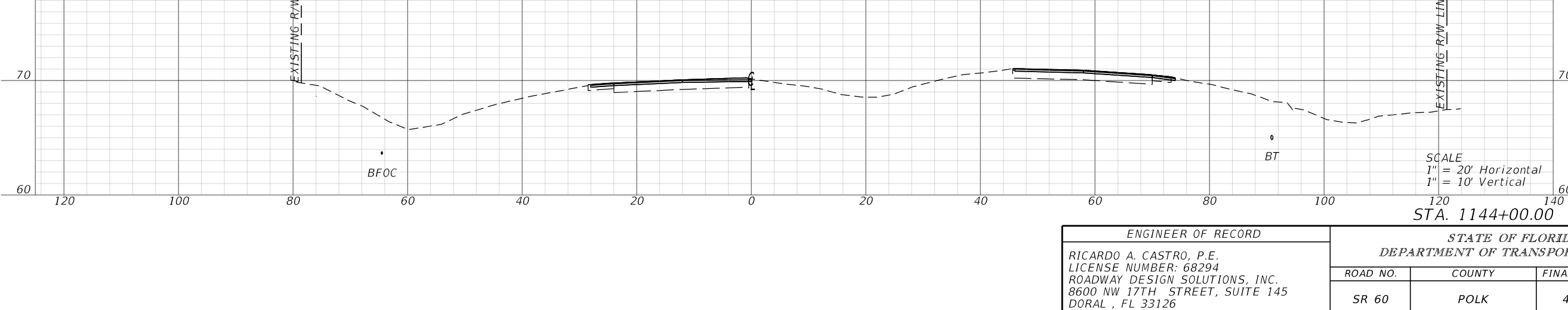
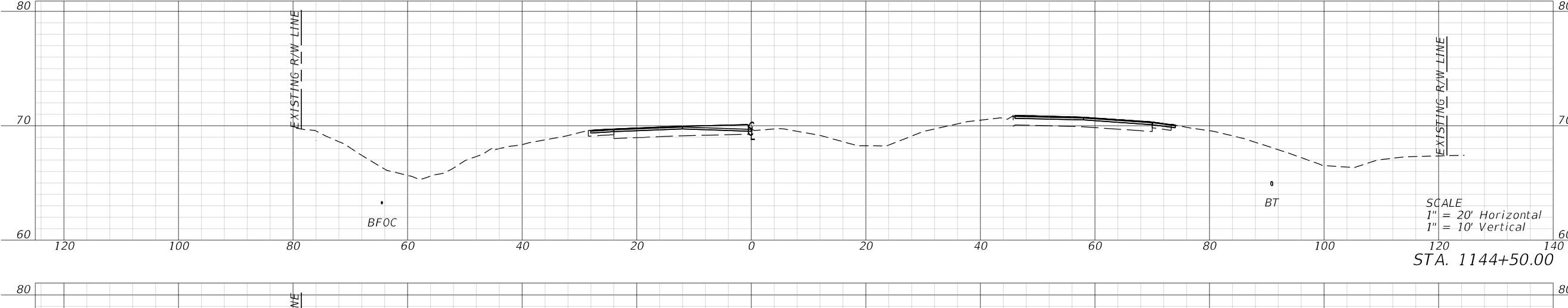
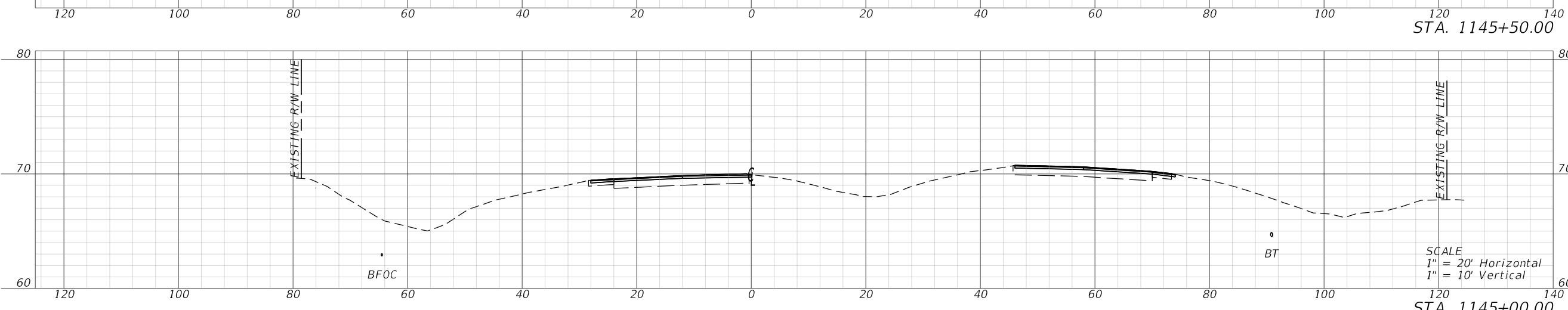
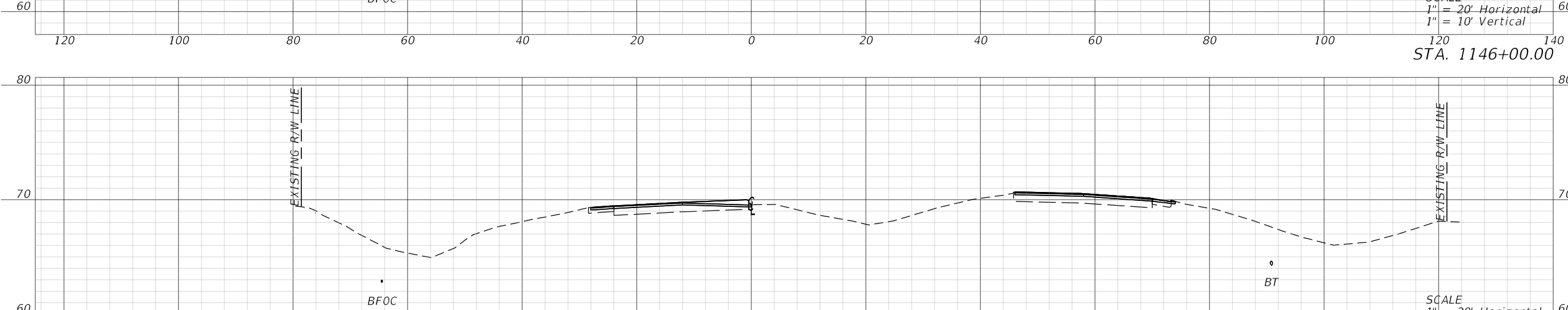
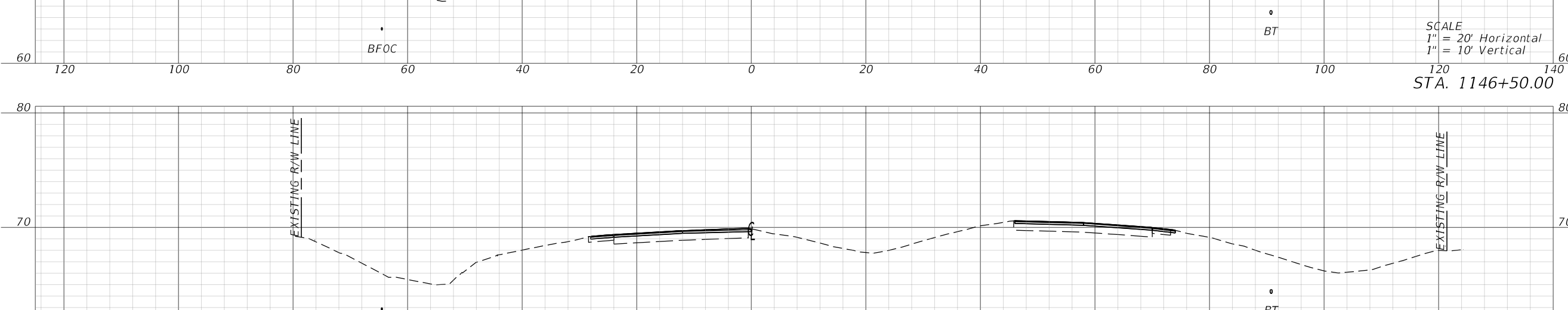
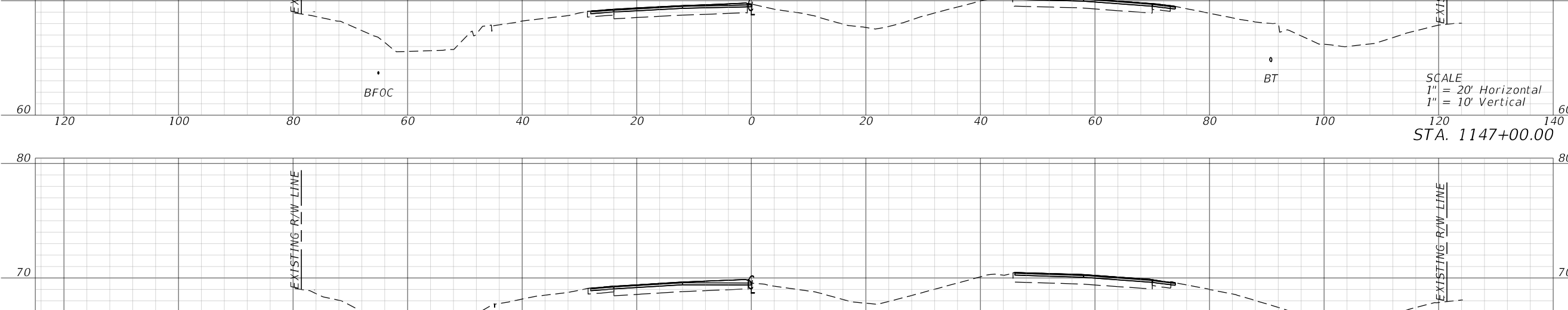
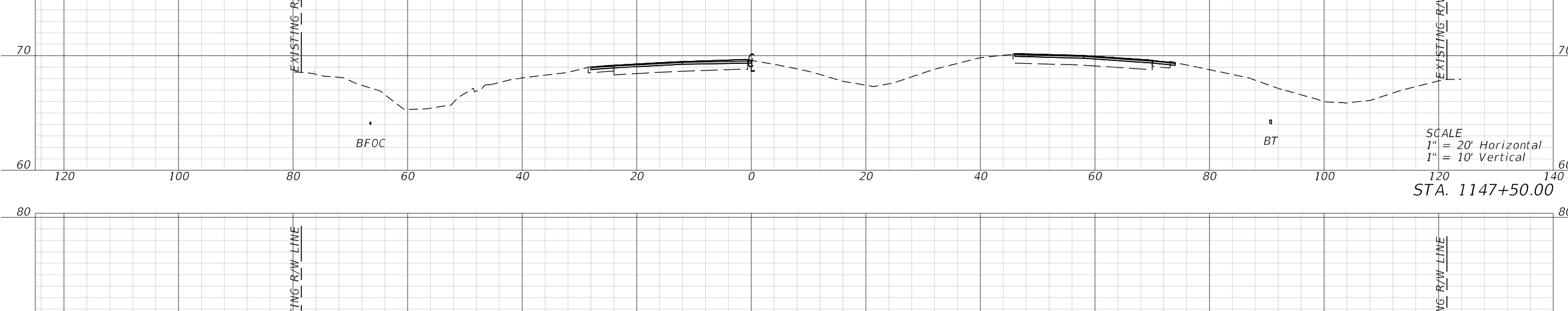
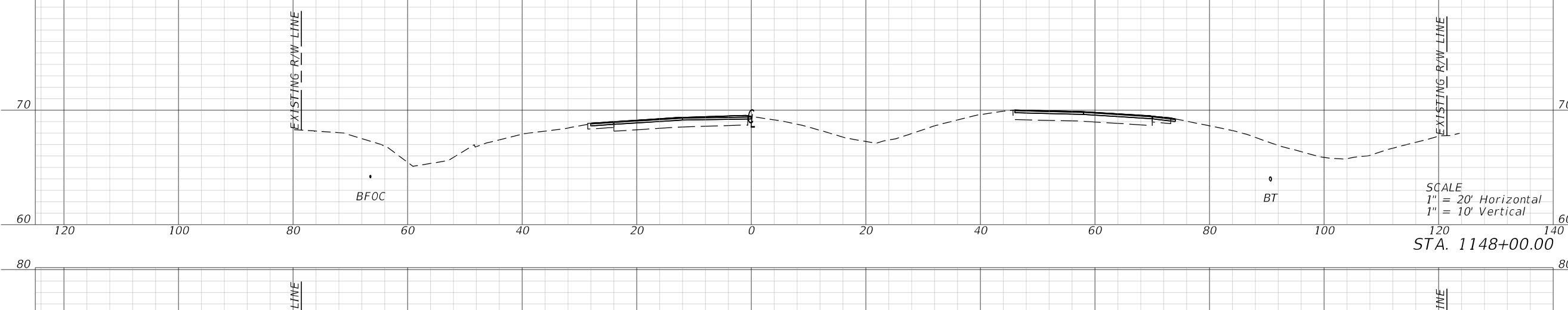
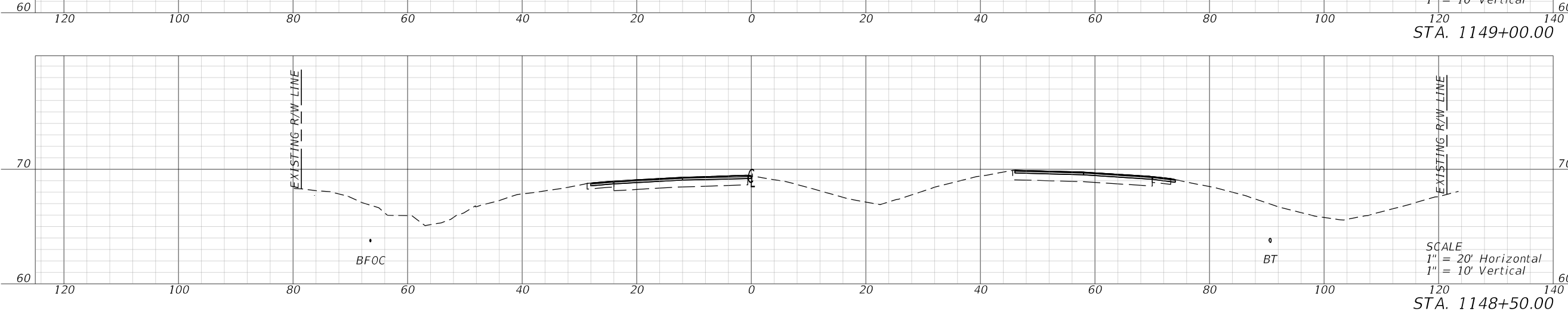
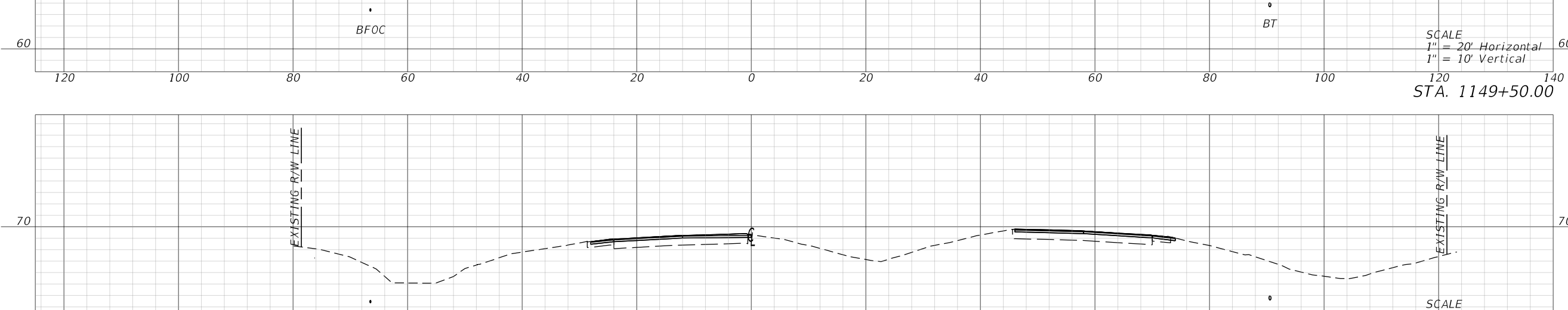
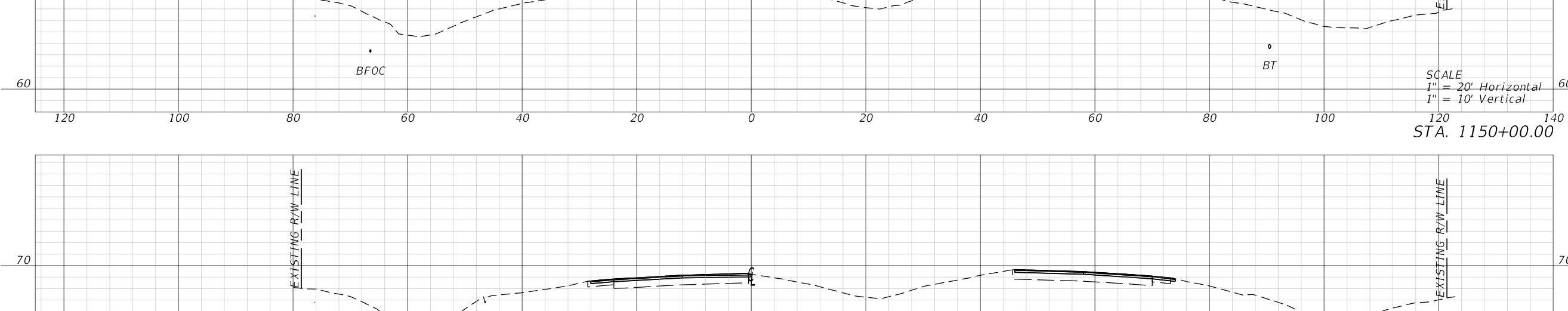
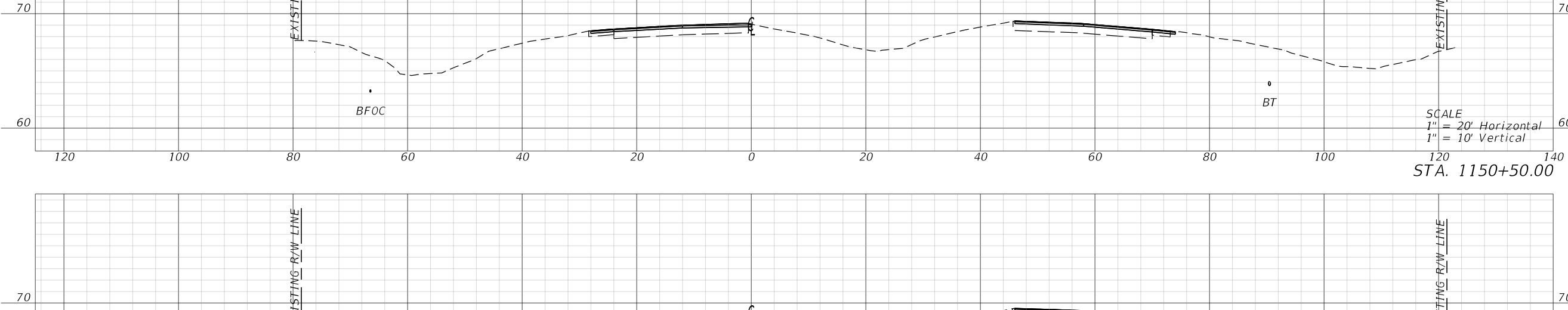
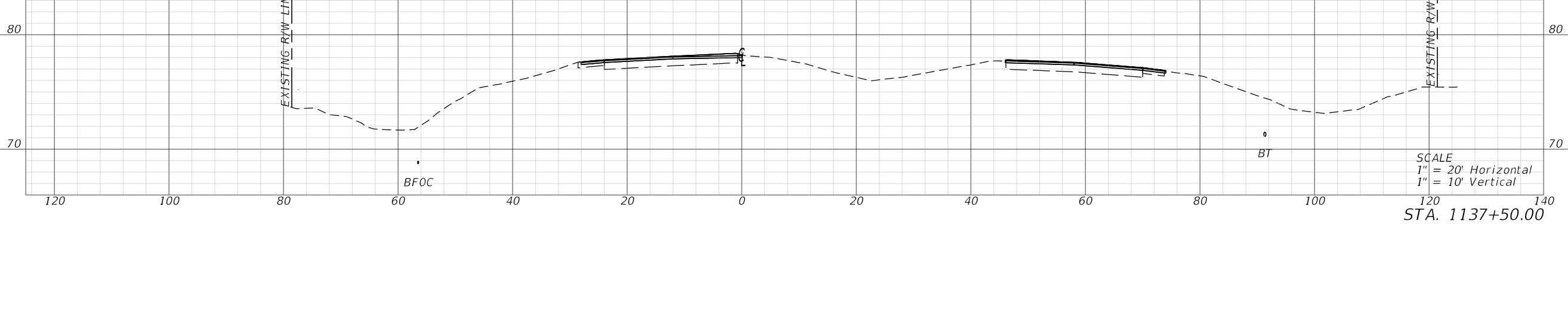
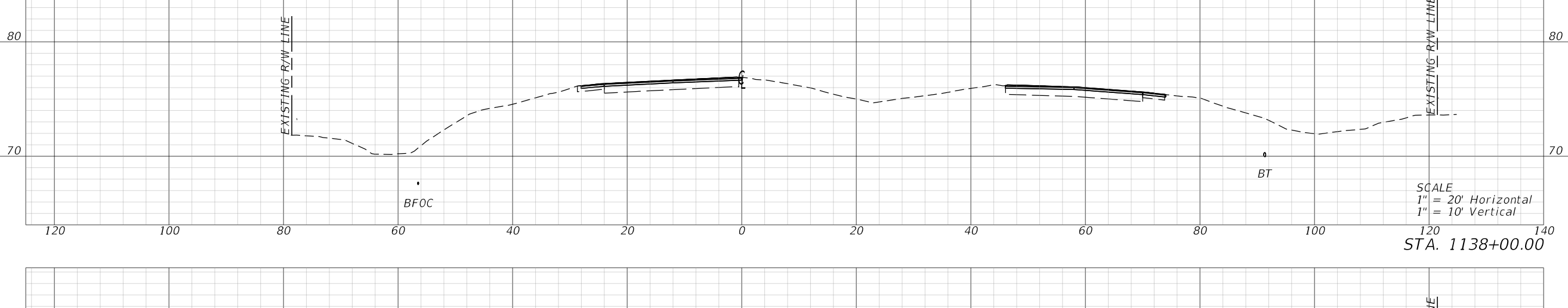
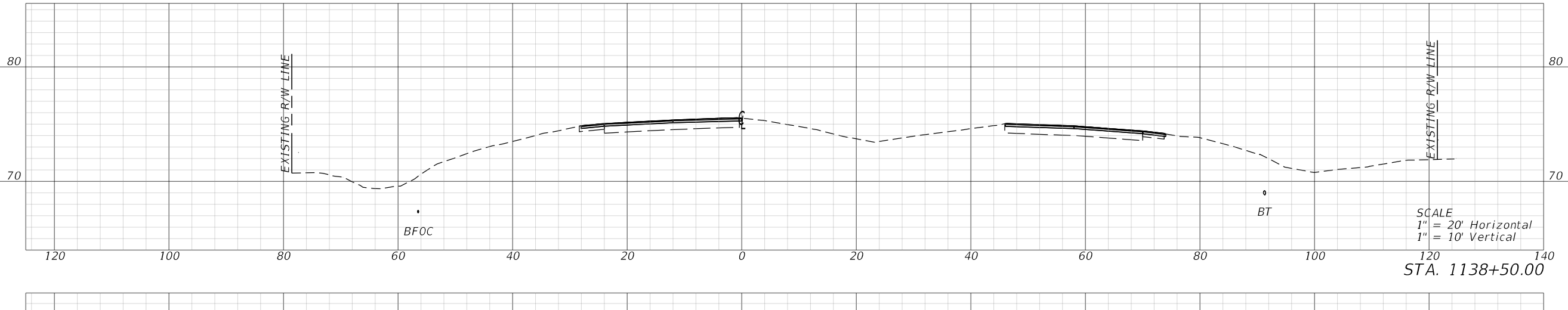
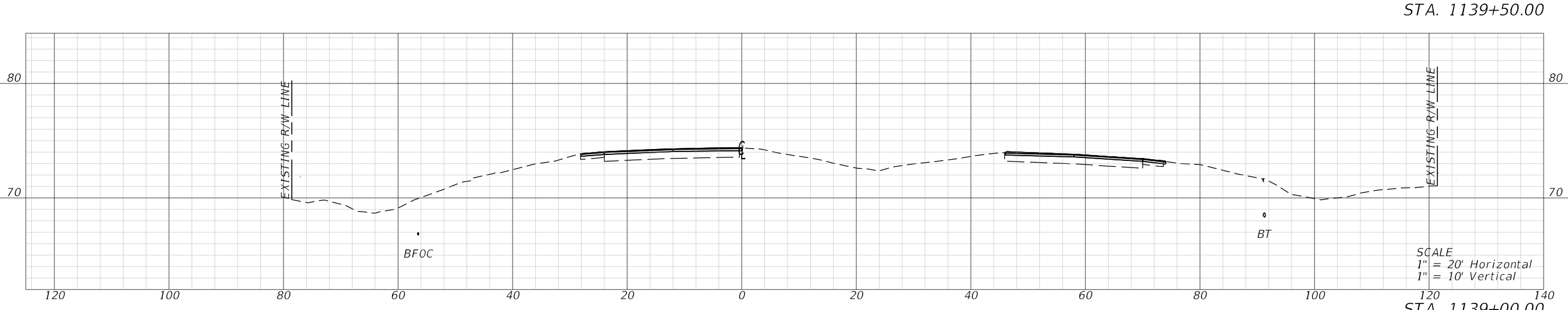
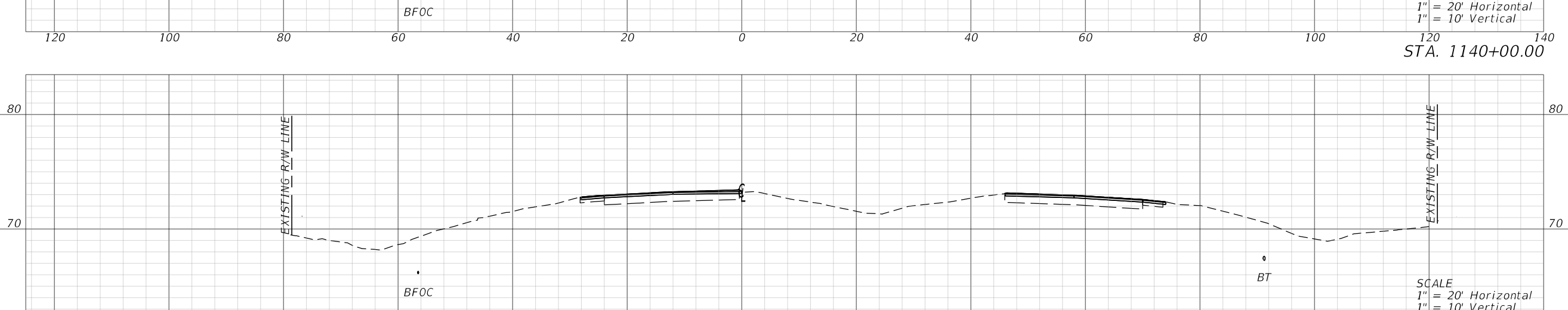
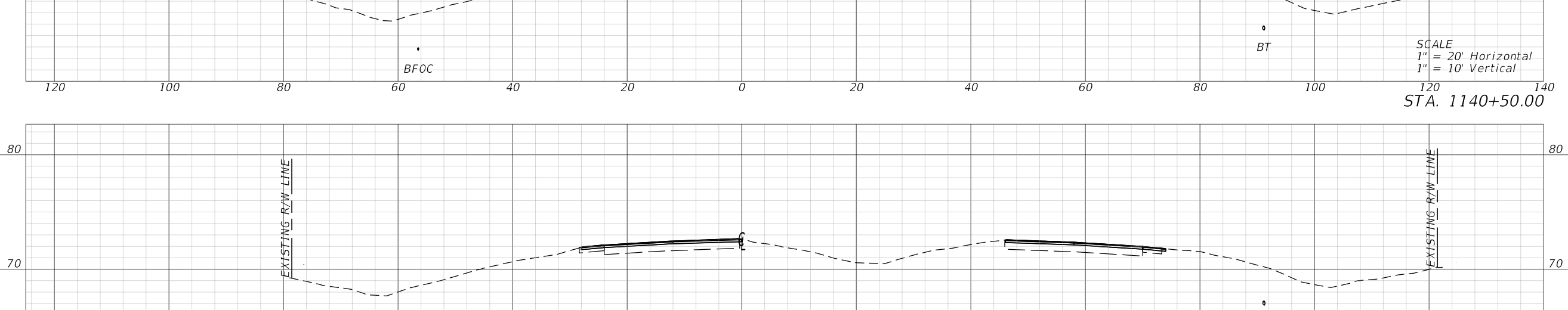
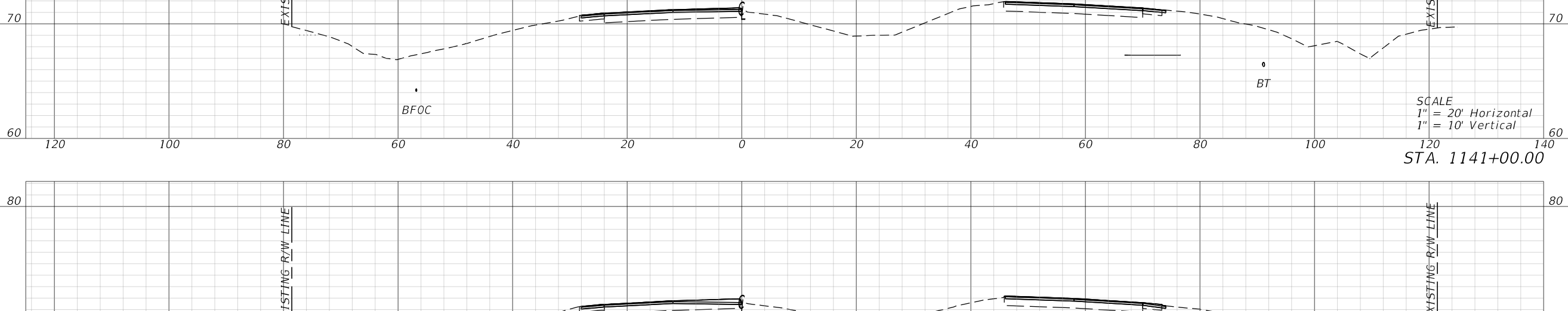
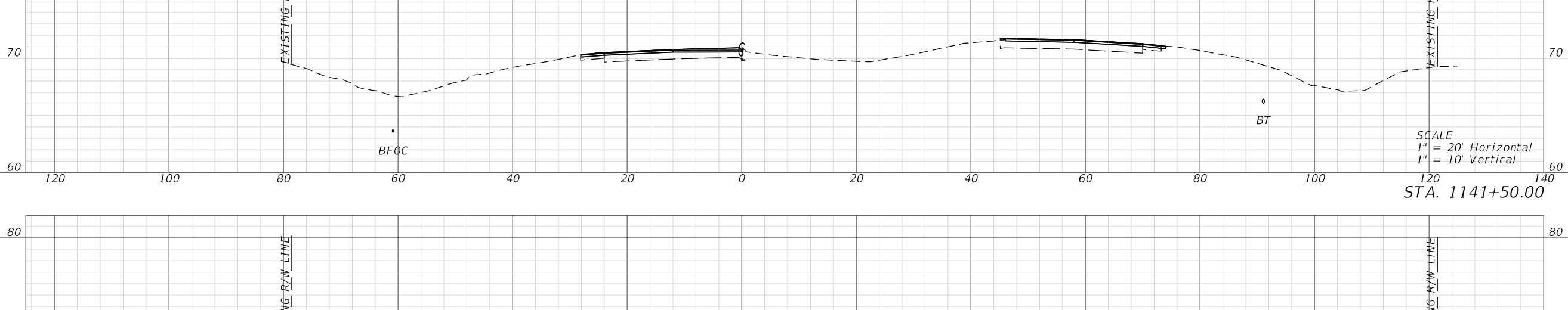
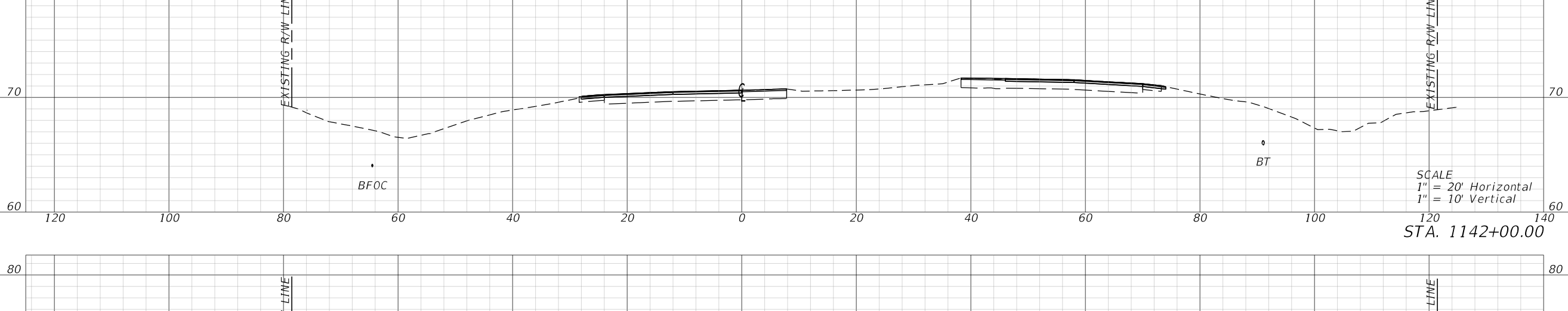
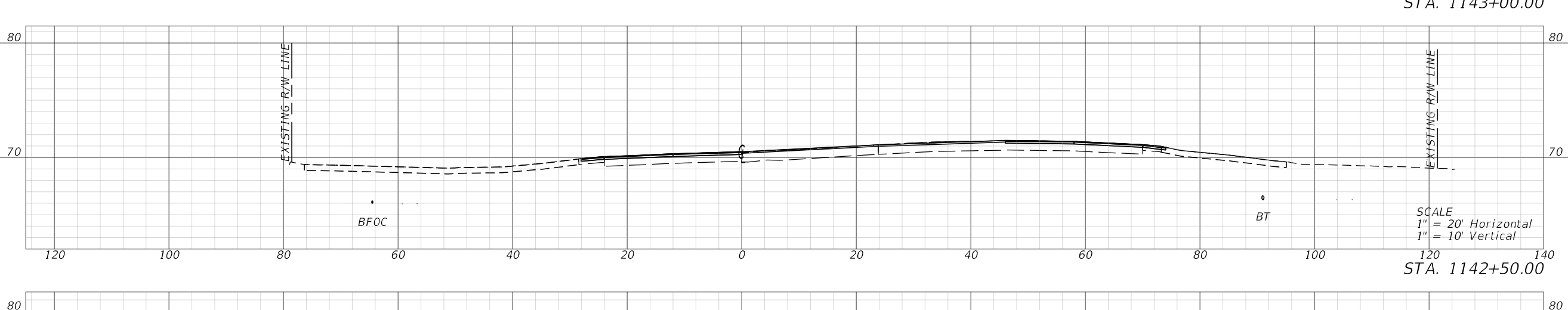
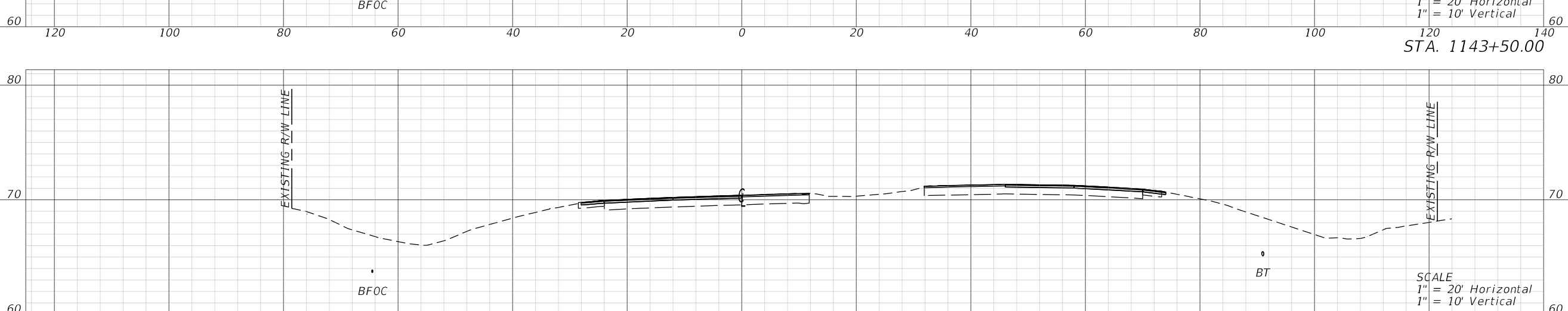
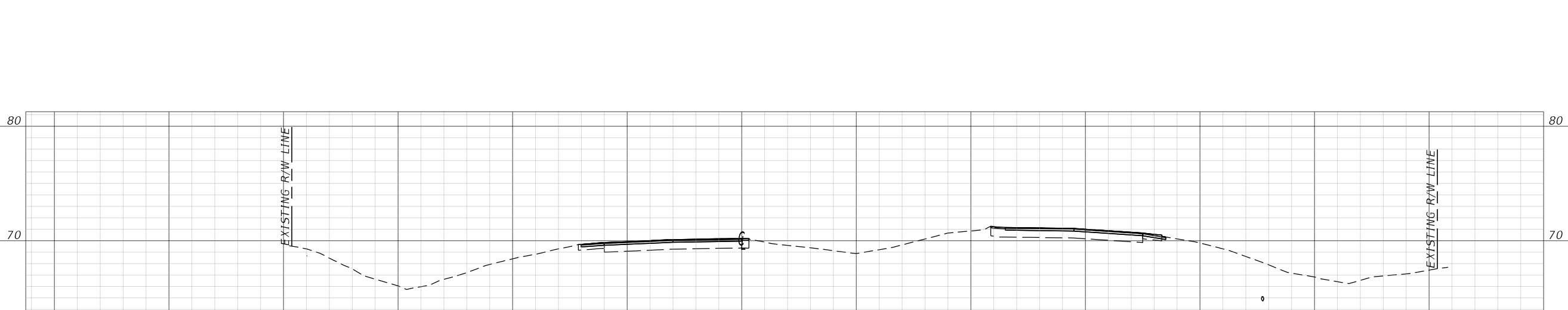
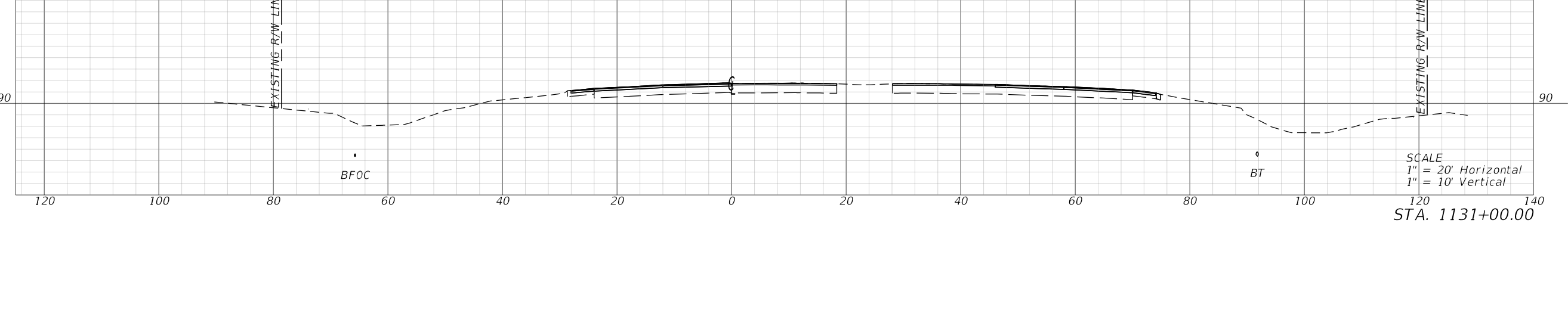
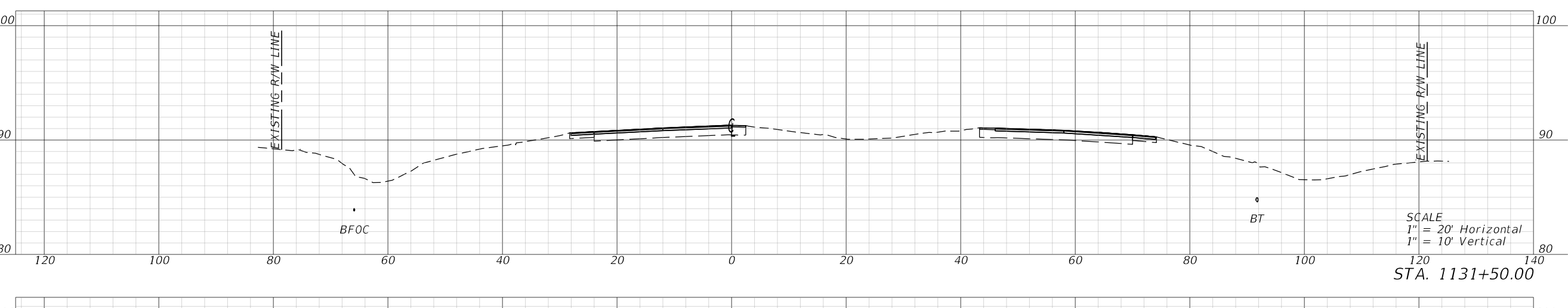
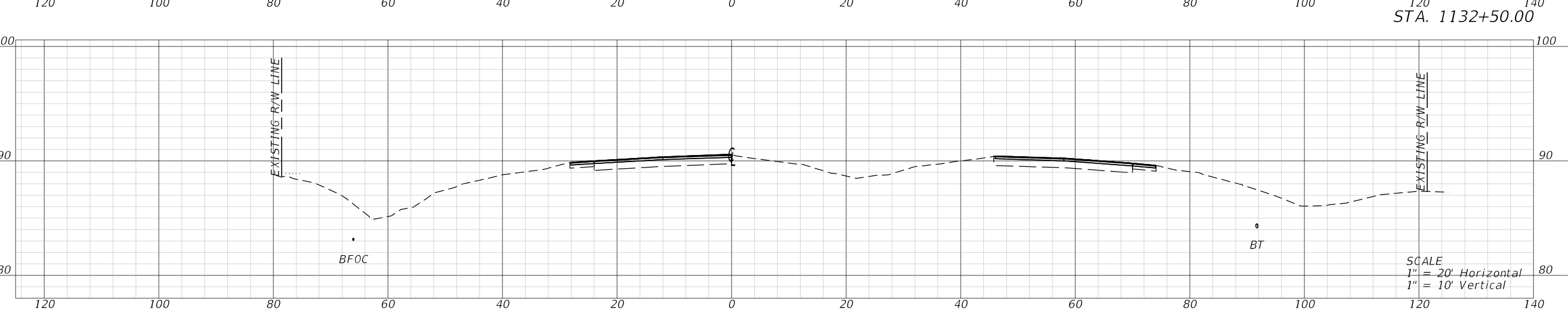
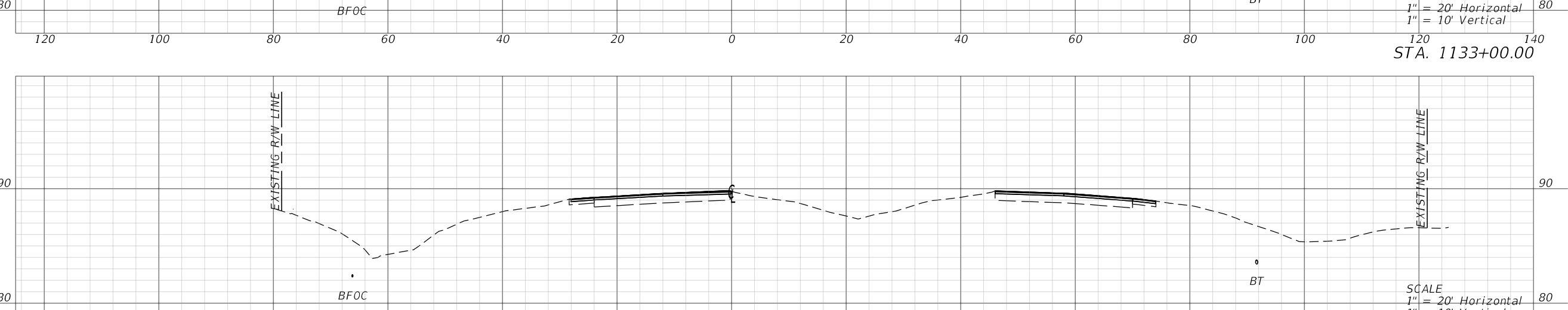
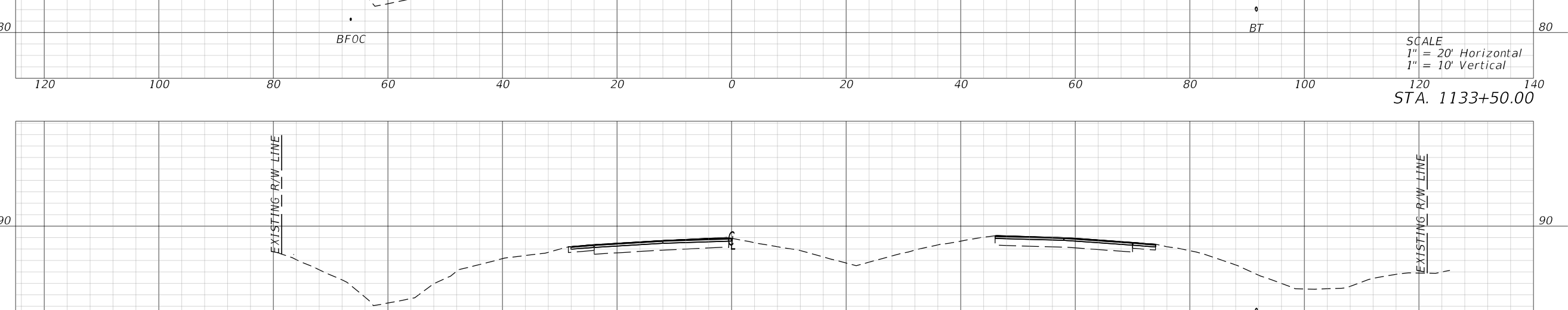
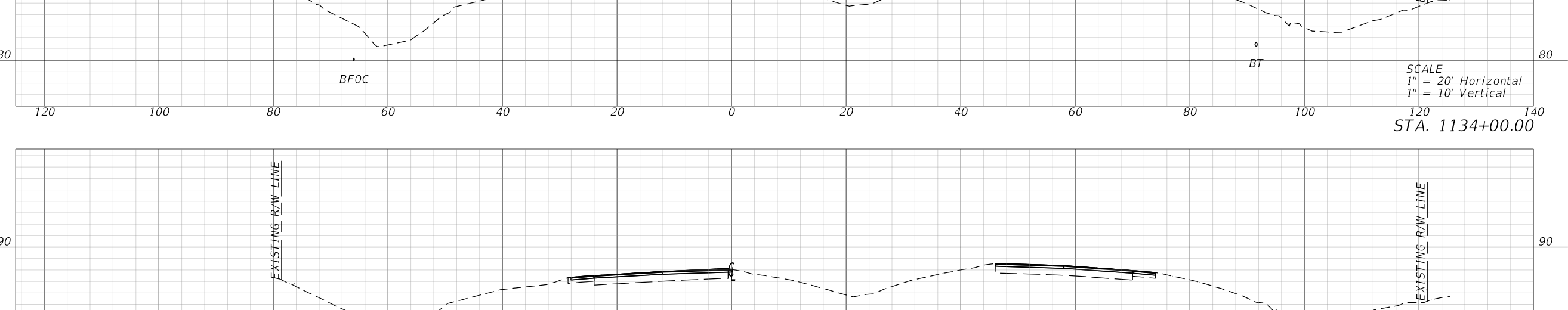
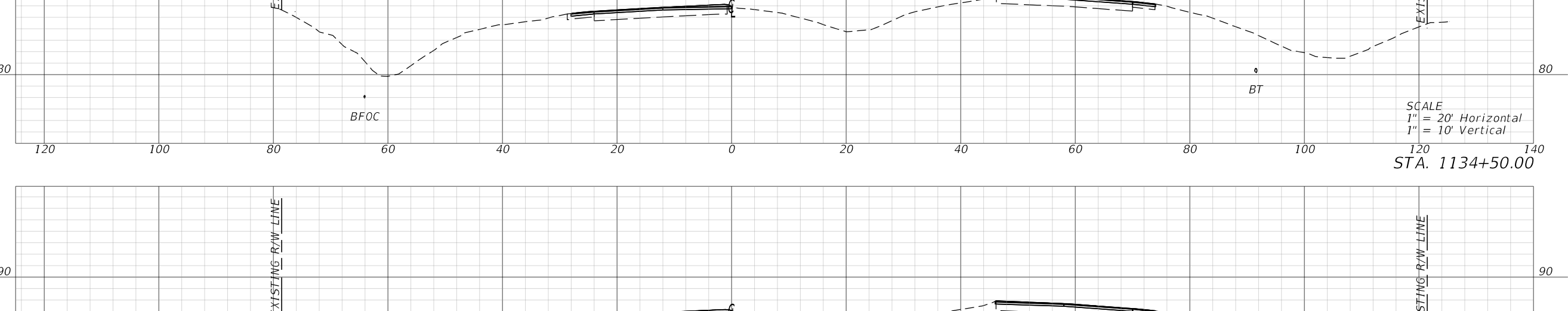
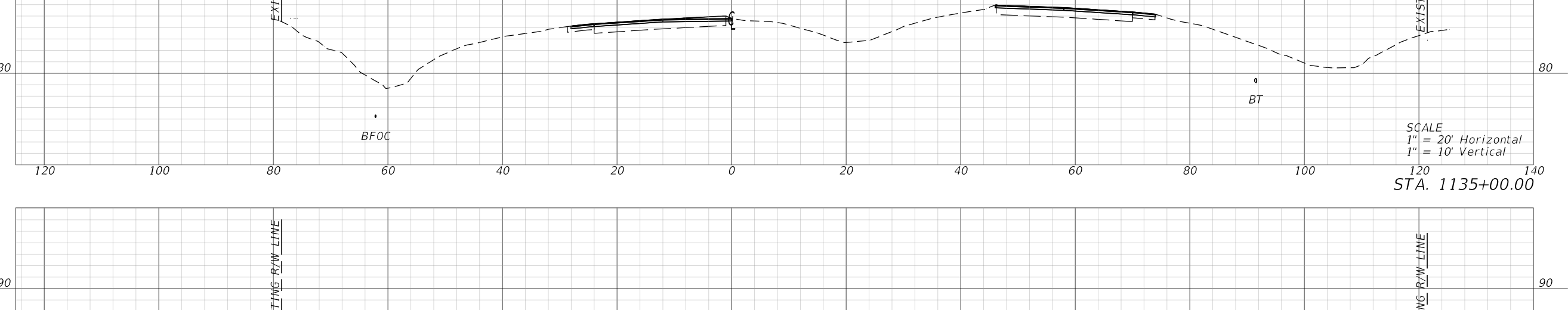
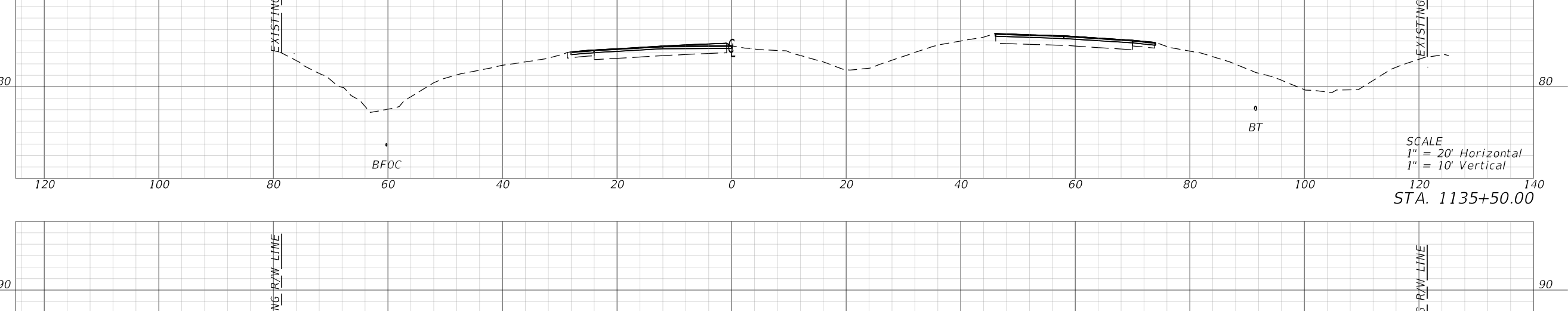
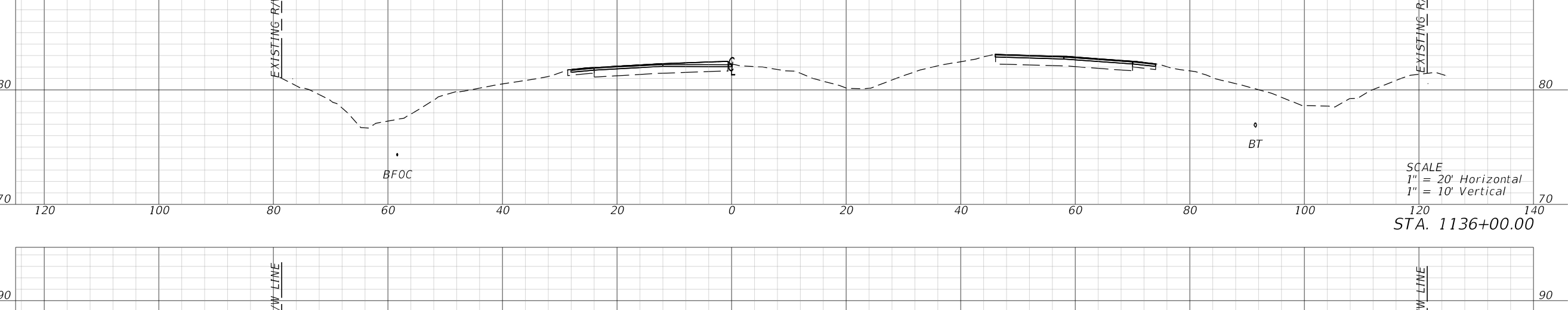
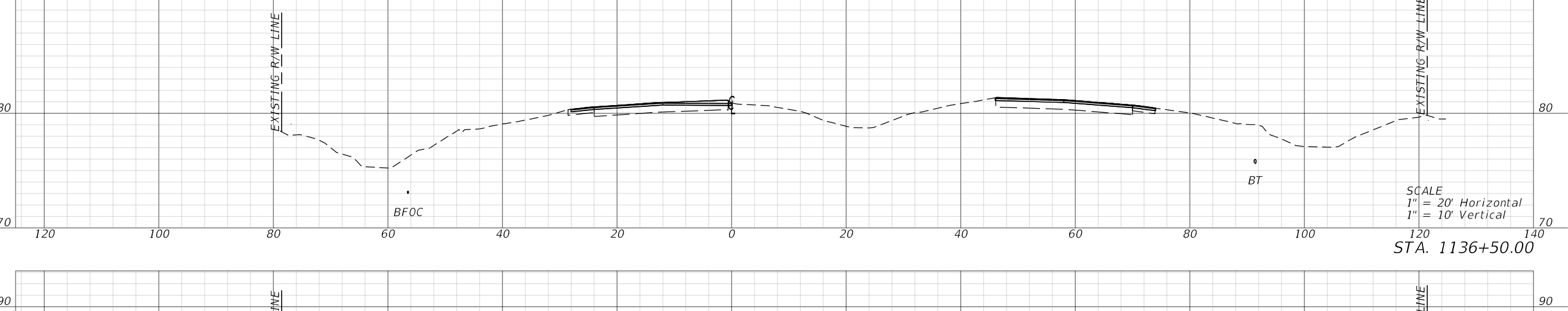
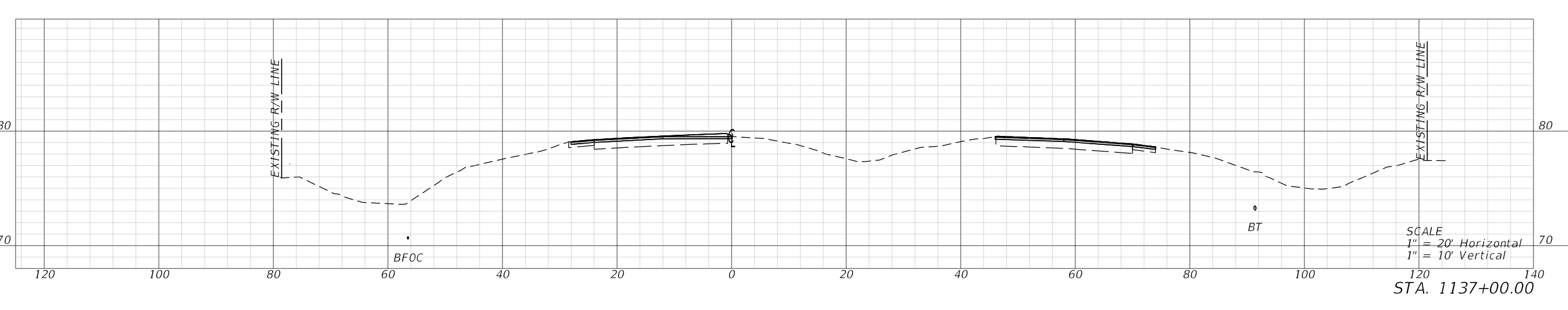
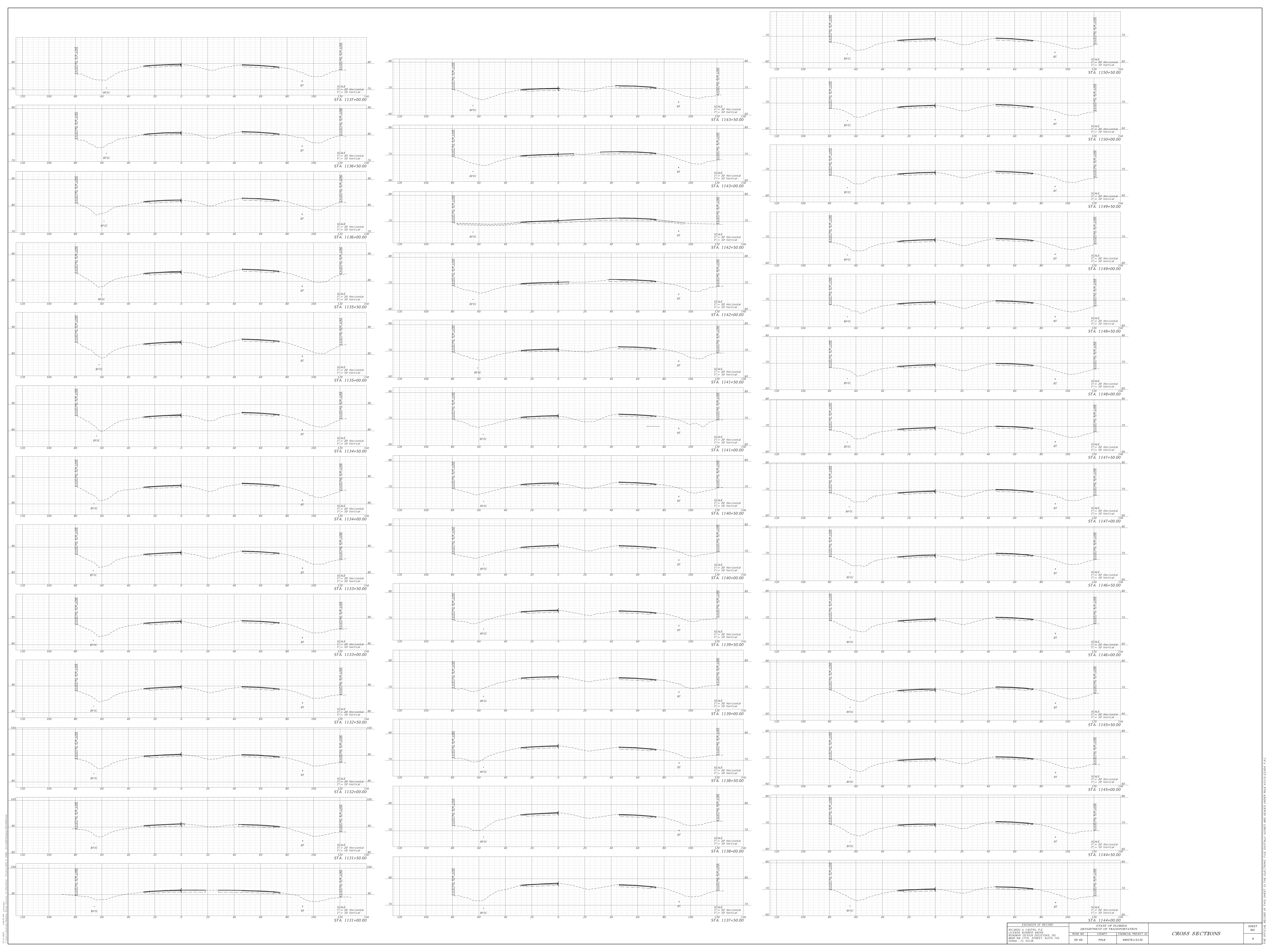



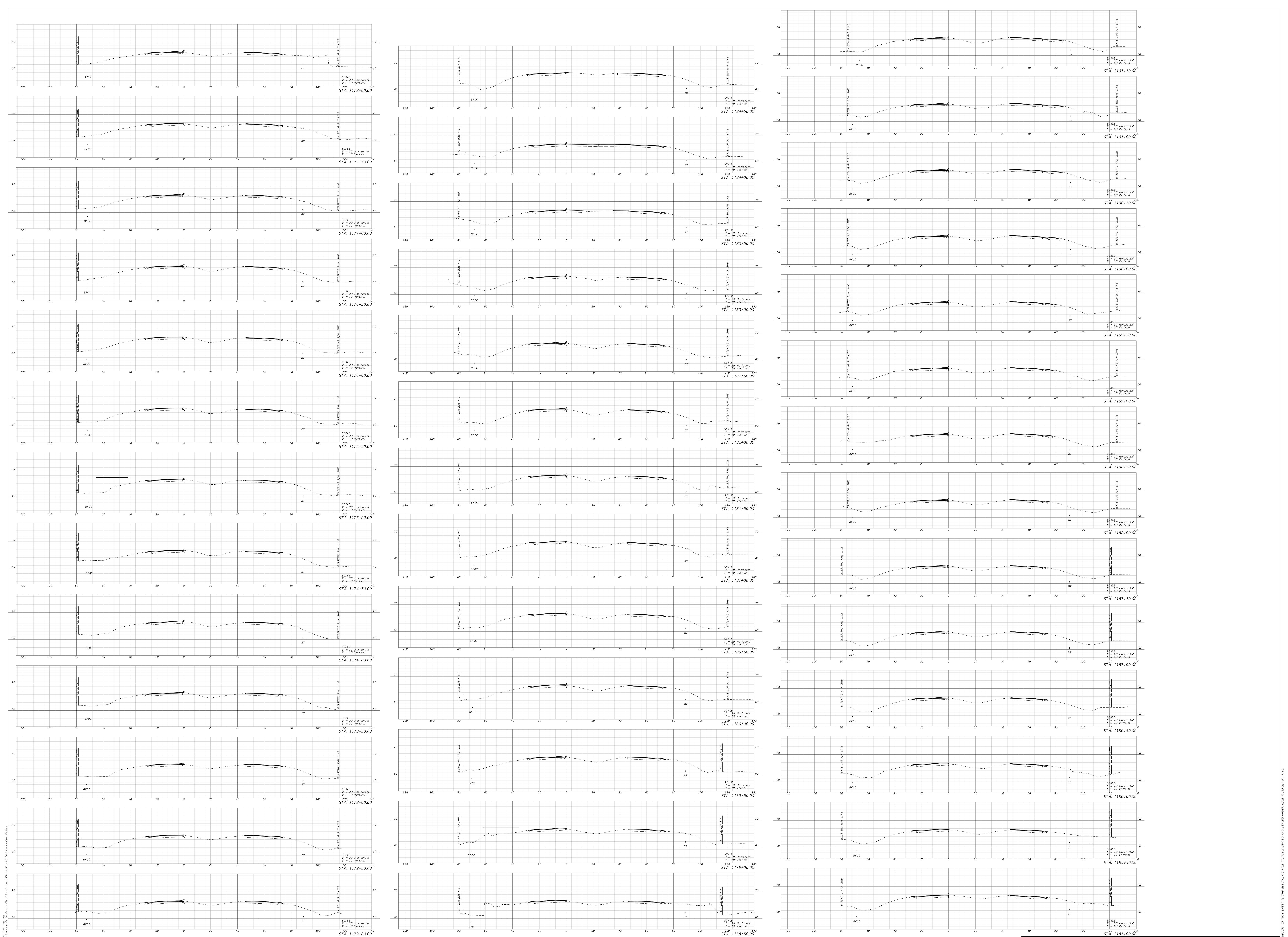

ENGINEER OF RECORD
 RICARDO A. CASTRO, P.E.
 LICENSE NUMBER 62274
 BOYDOR STATION SOLUTIONS, INC.
 DORAL, FL 33126

STATE OF FLORIDA
 DEPARTMENT OF TRANSPORTATION
 COUNTY POLK
 PROJECT 499276-52-01

CROSS SECTIONS

SHEET NO.
 8

THE OFFICIAL RECORD OF THIS SHEET IS THE ELECTRONIC FILE DIGITALLY SIGNED AND SEALED UNDER RULE 61B5-23.004, F.A.C.

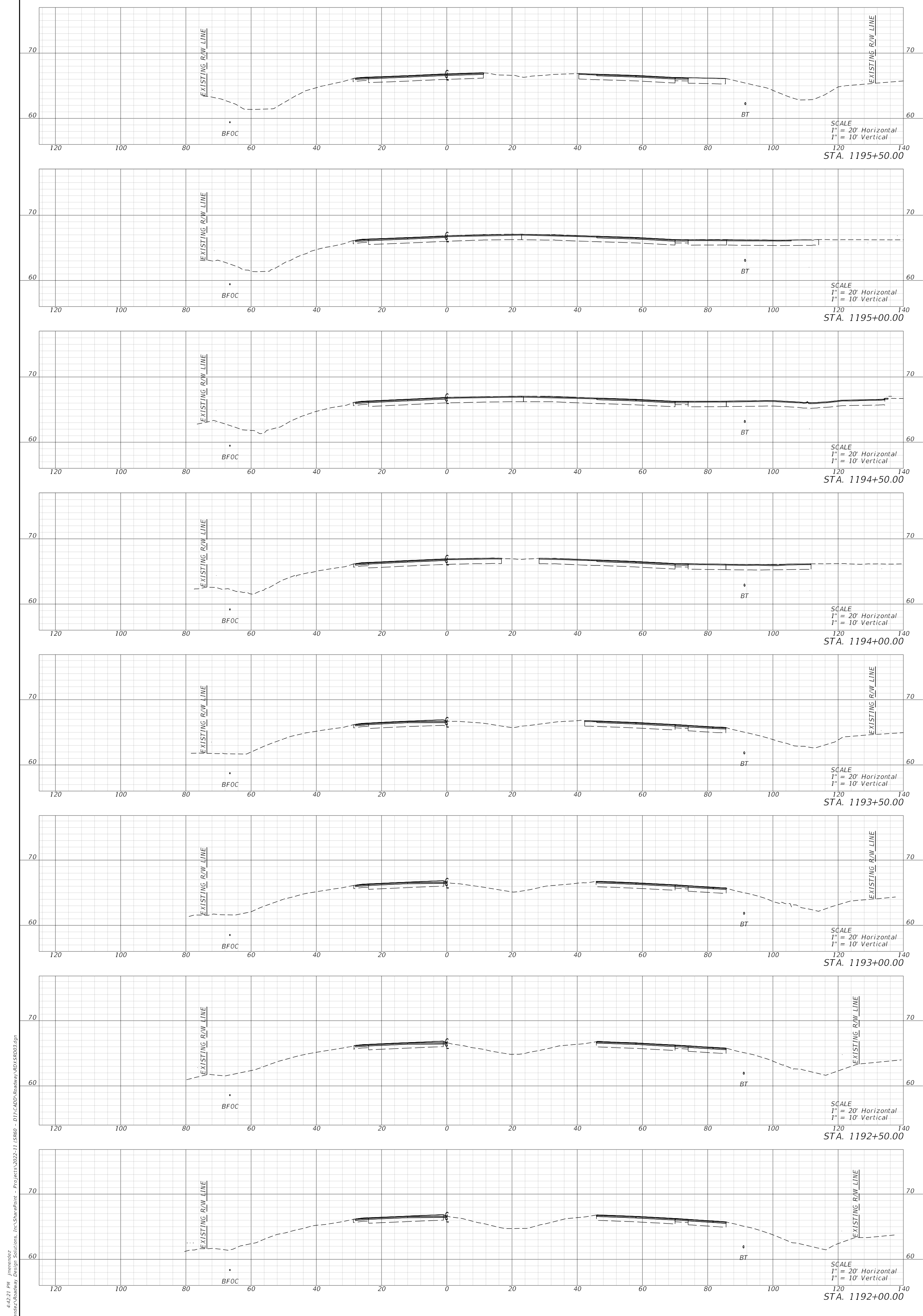

ENGINEER OF RECORD		STATE OF FLORIDA	
RICARDO A. CASTRO, P.E.		DEPARTMENT OF TRANSPORTATION	
ASIAN NO.	COUNTY	FINANCIAL PROJECT ID	
SR 60	POLK	4892763-52-01	

CROSS SECTIONS

SHEET NO.	12
-----------	----

THE OFFICIAL RECORD OF THIS SHEET IS THE ELECTRONIC FILE DIGITALLY SIGNED AND SEALED UNDER RULE 61G05-23.004, F.A.C.

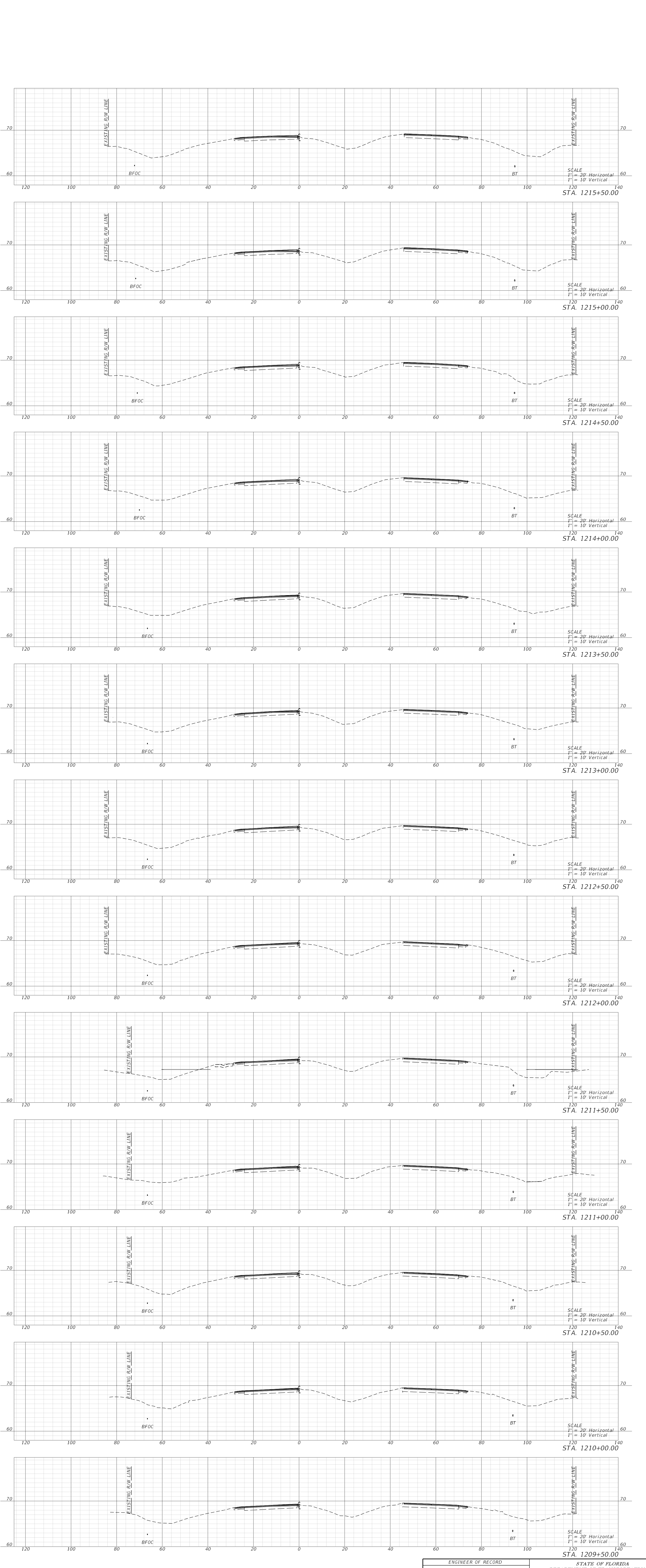
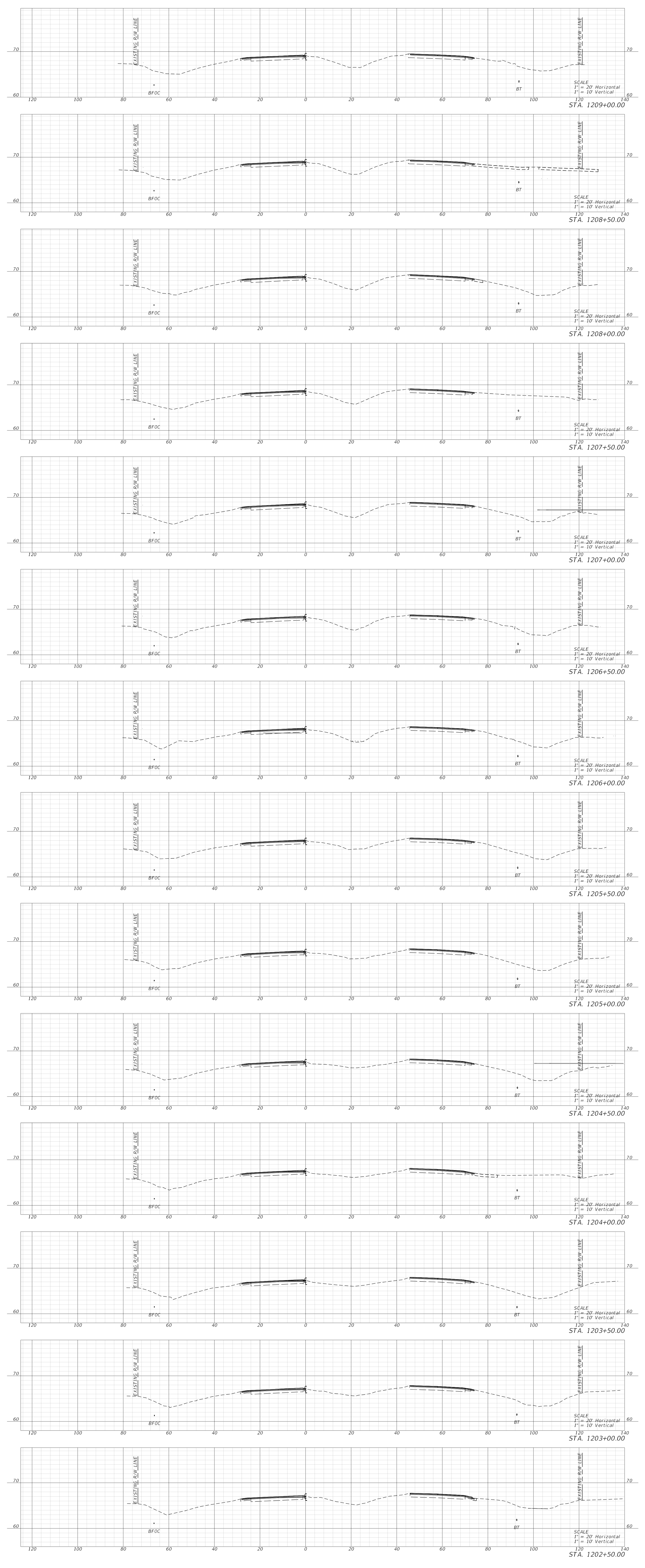
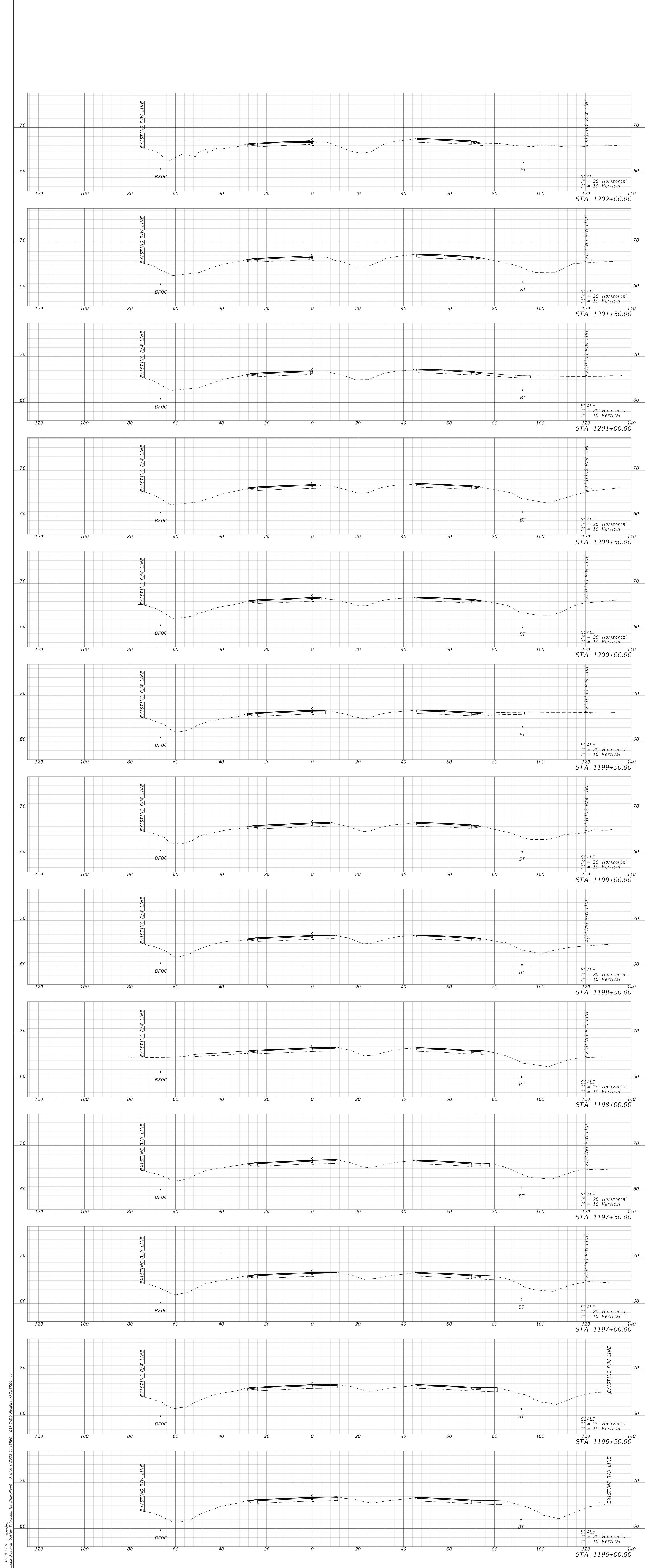

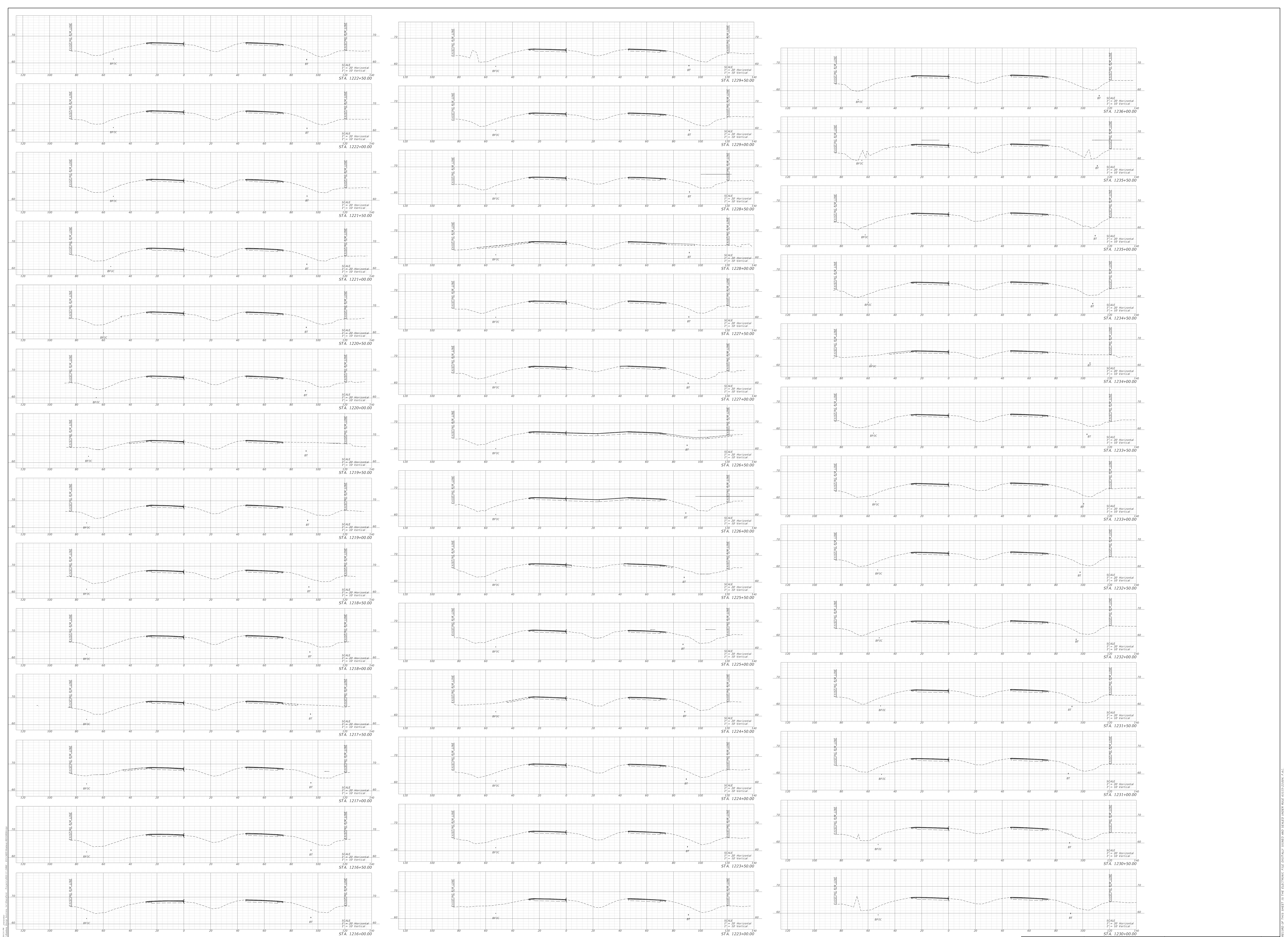

THE OFFICIAL RECORD OF THIS SHEET IS THE ELECTRONIC FILE DIGITALLY SIGNED AND SEALED UNDER RULE 61G5-23.004, F.A.C.

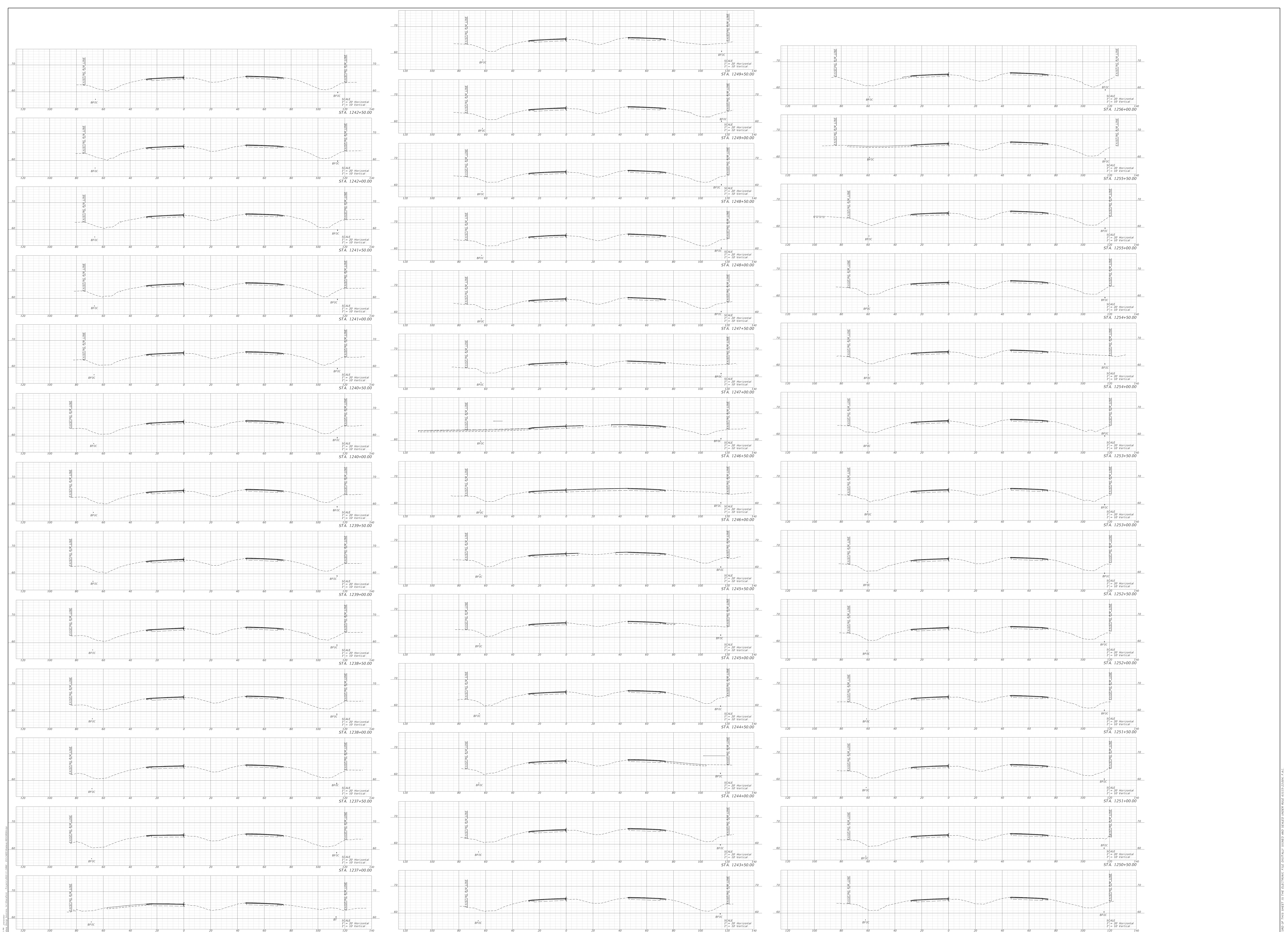

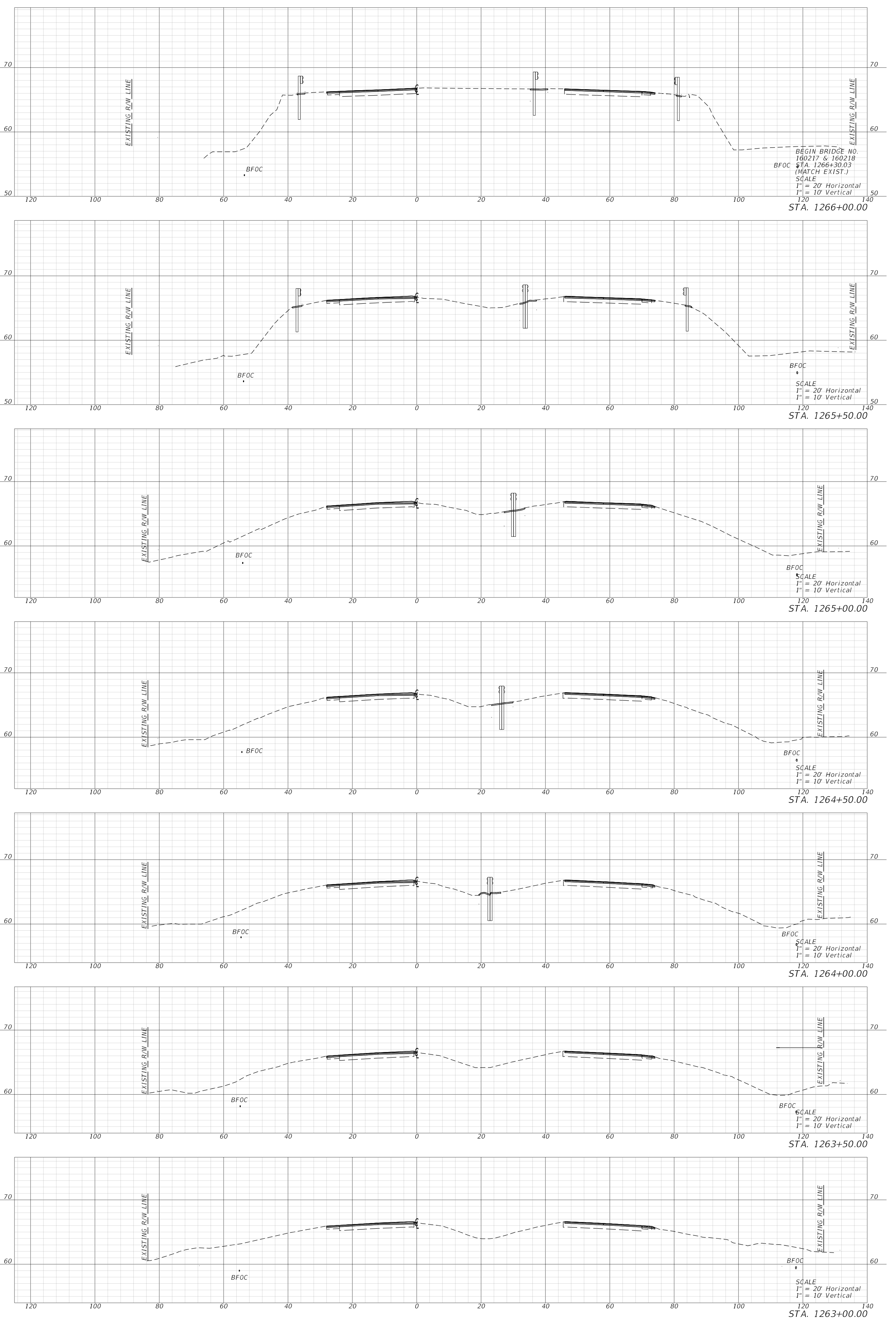
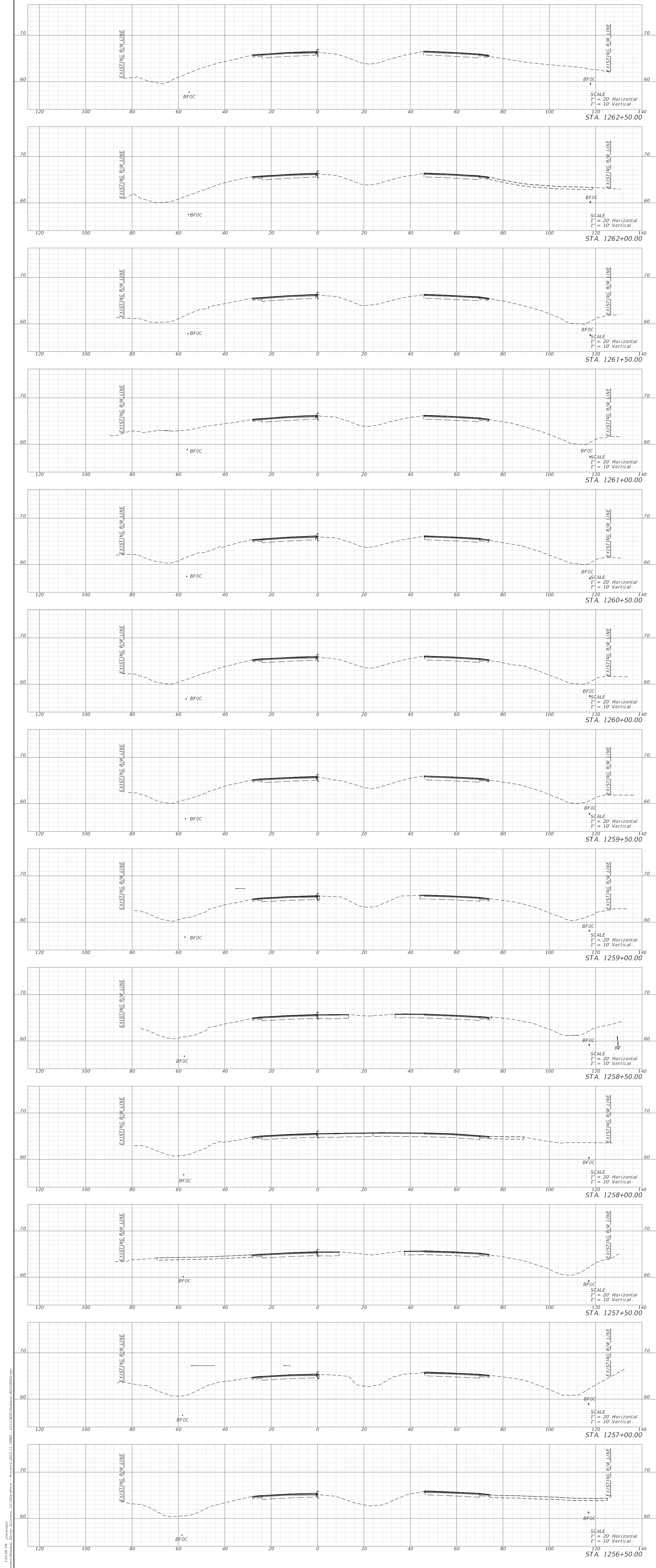

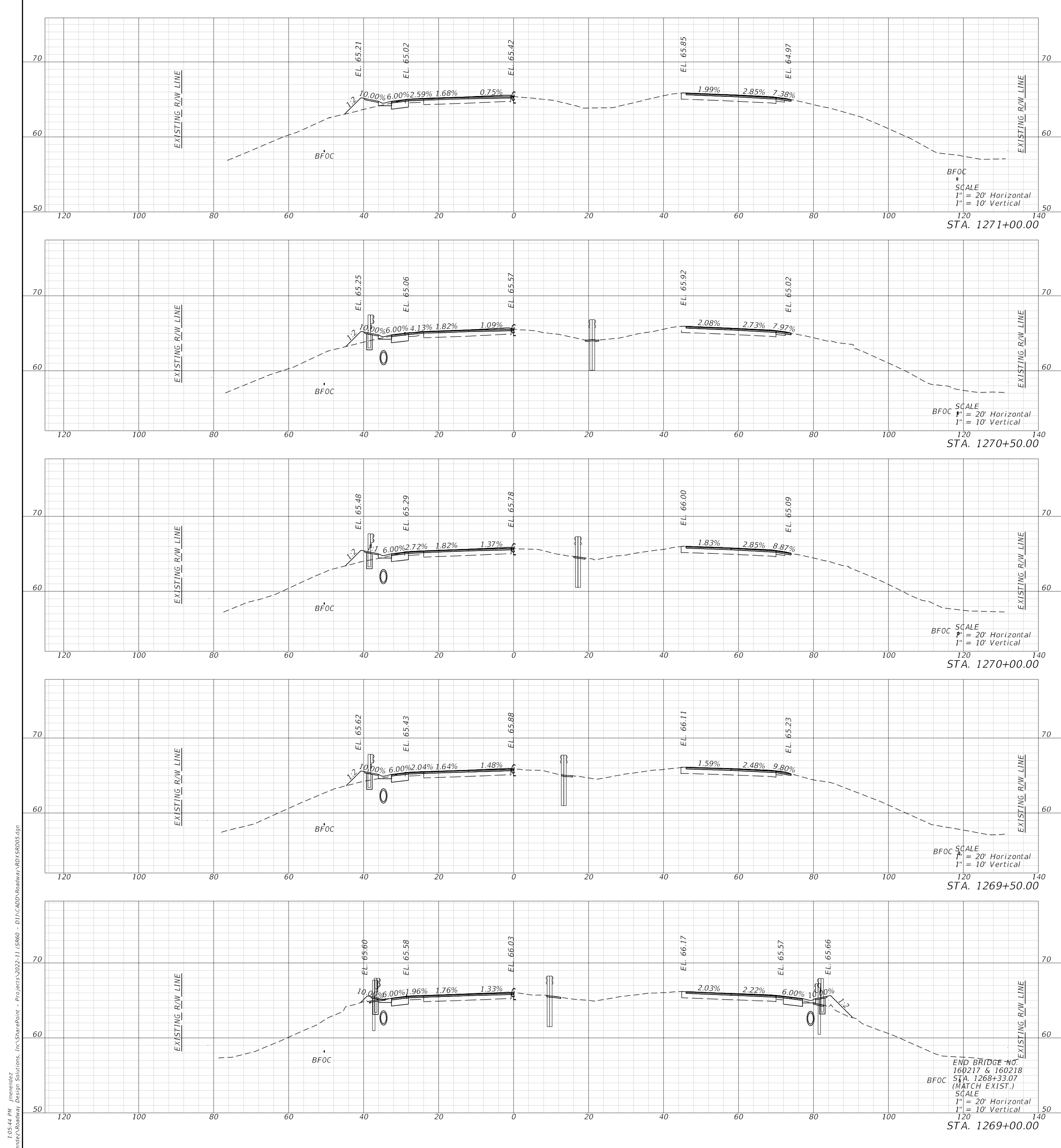

ENGINEER OF RECORD RICARDO A. CASTRO, P.E. LICENSE NUMBER 60234 RICHARD CASTRO CONSULTANTS, INC. 3000 W. 77th STREET, SUITE 140 DORAL, FL 33126		STATE OF FLORIDA DEPARTMENT OF TRANSPORTATION ADMIN NO. COUNTY FINANCIAL PROJECT ID SR 60 POLK 499766-52-01		SHEET NO. 17
--	--	--	--	-----------------

CROSS SECTIONS

THE OFFICIAL RECORD OF THIS SHEET IS THE ELECTRONIC FILE INITIALLY SIGNED AND SEALED UNDER RULE 61G15-23.004, F.A.C.

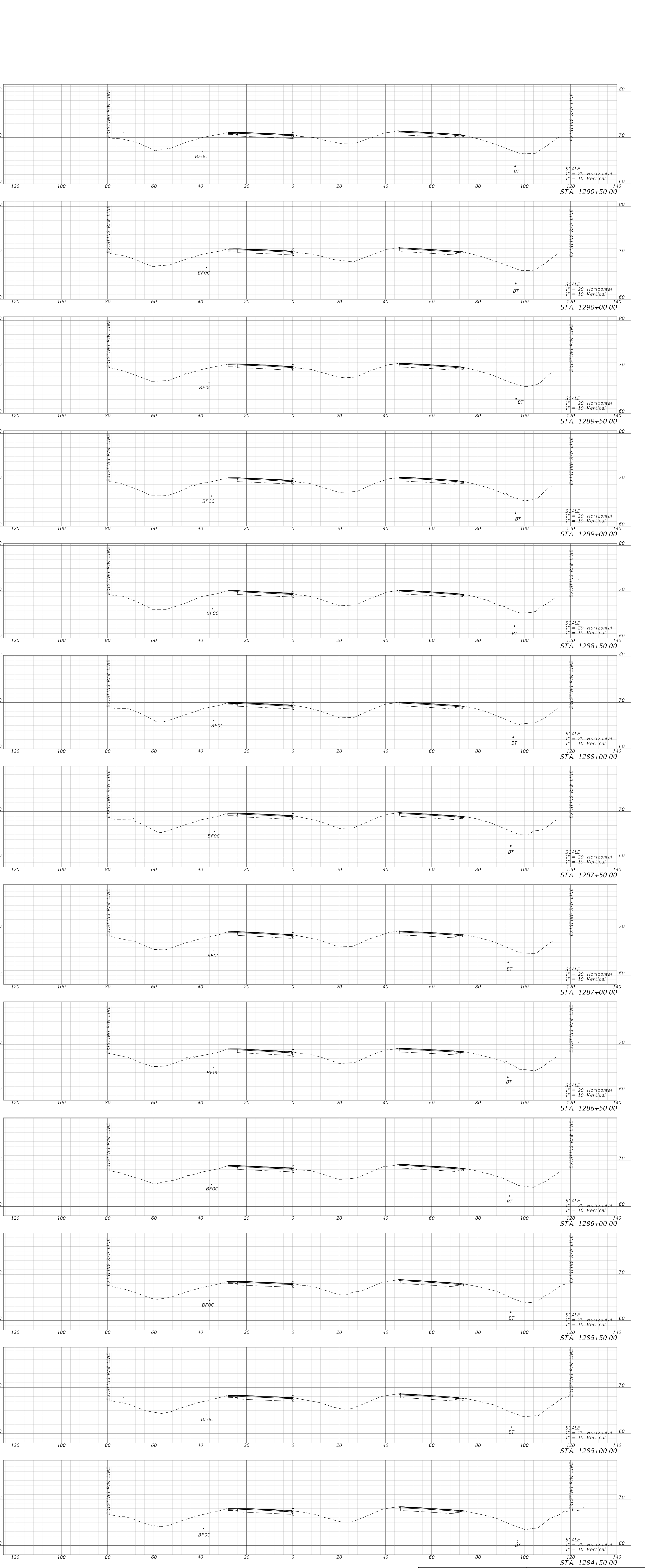
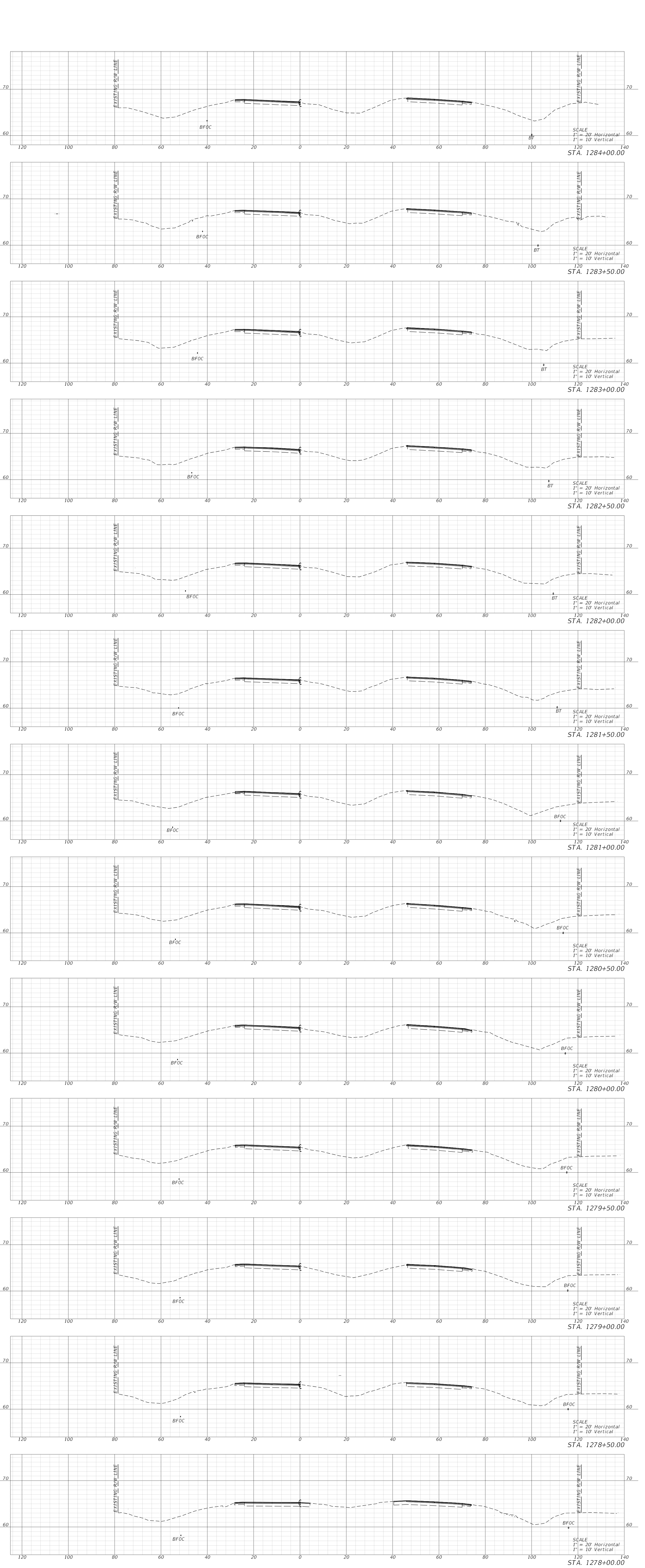
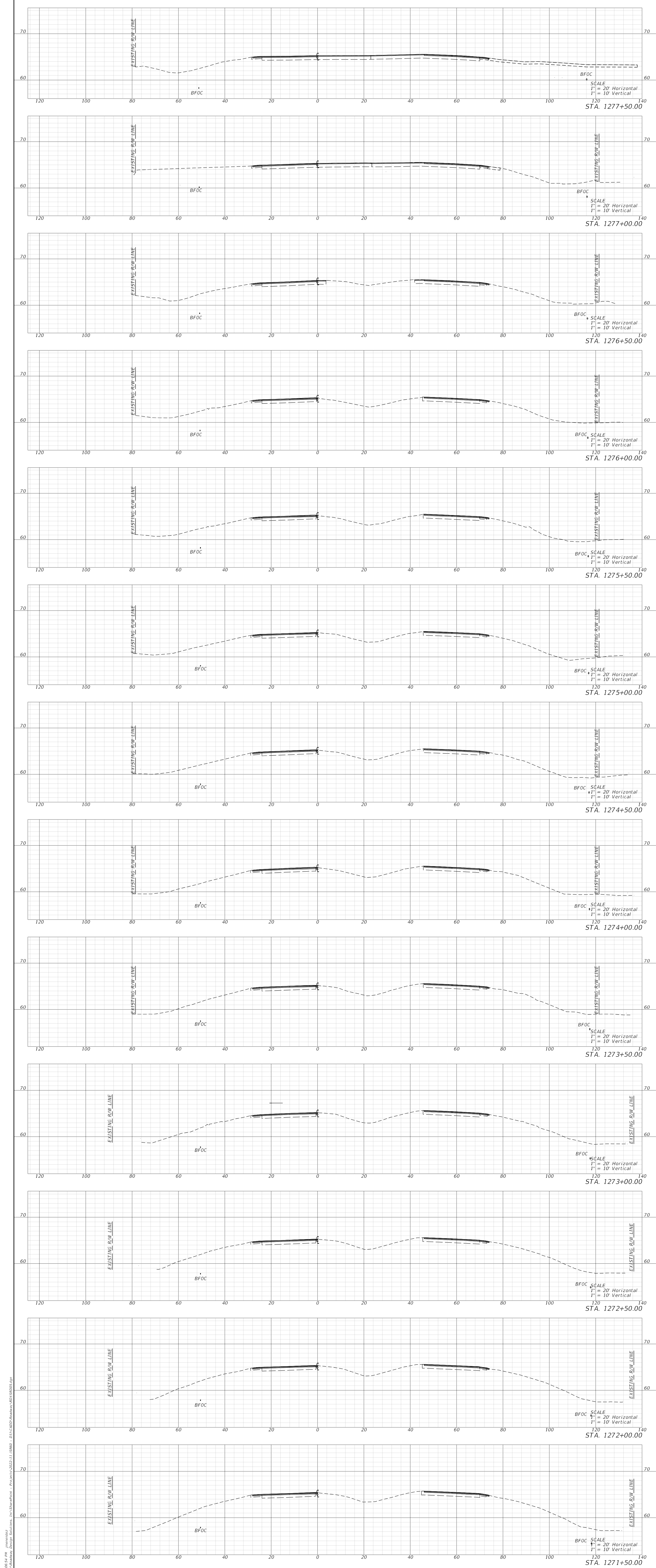

THE OFFICIAL RECORD OF THIS SHEET IS THE ELECTRONIC FILE DYNAMICALLY SHOWN AND SEALED UNDER RULE 61B5-23.004, F.A.C.

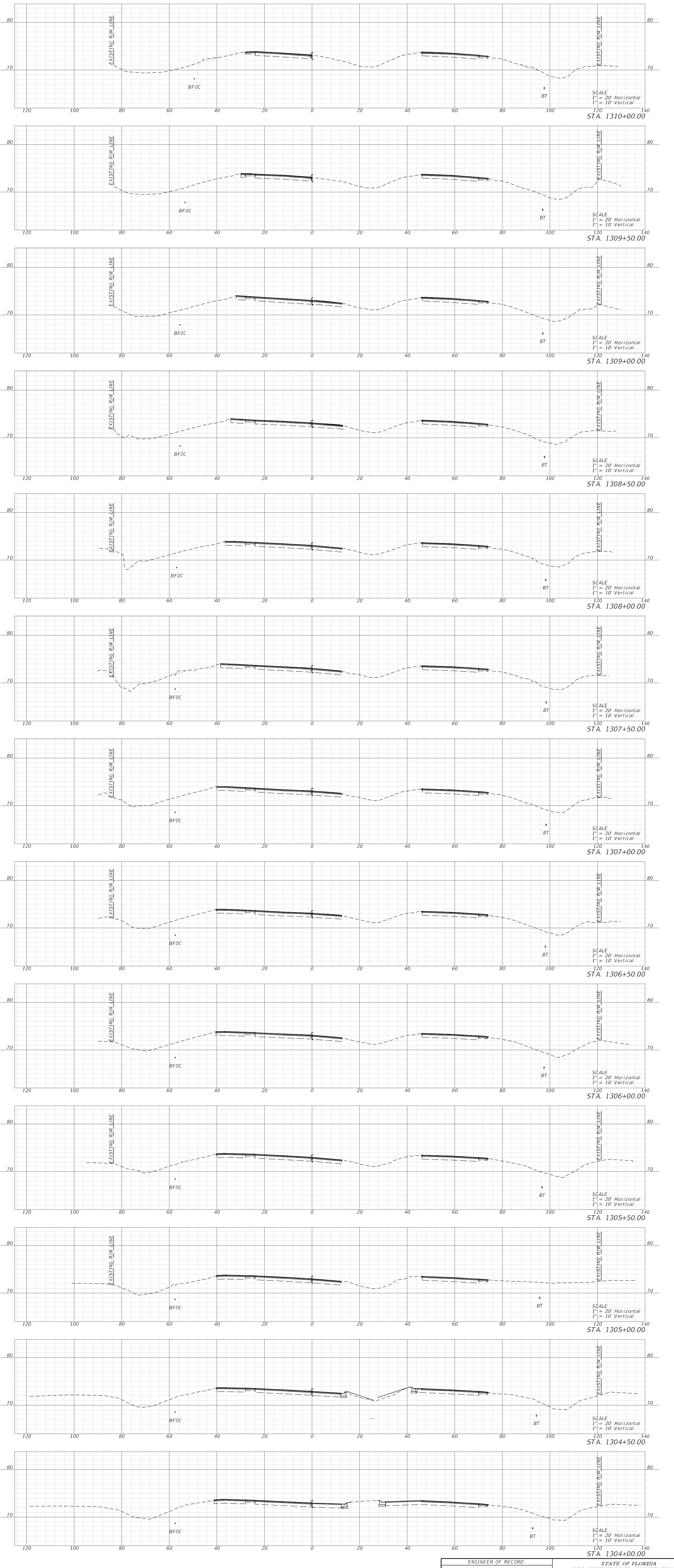
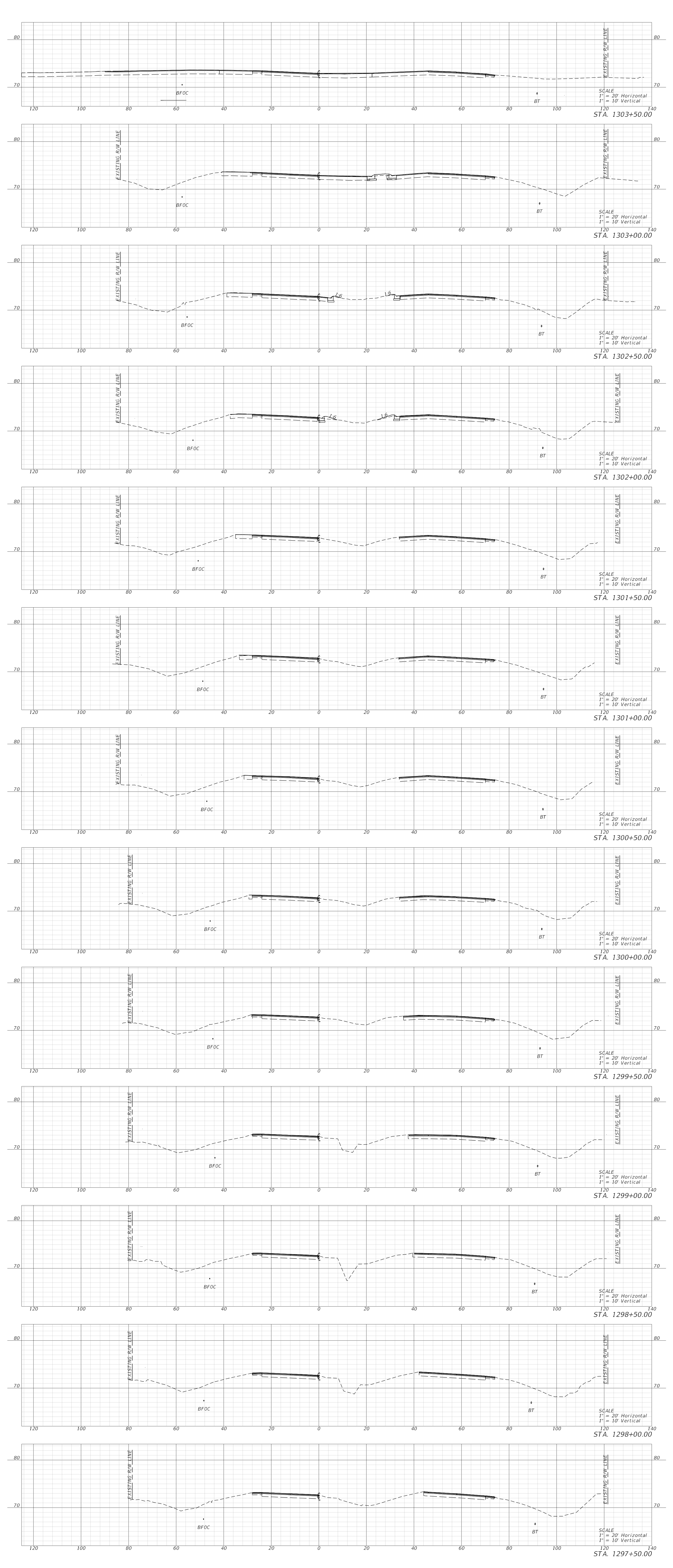
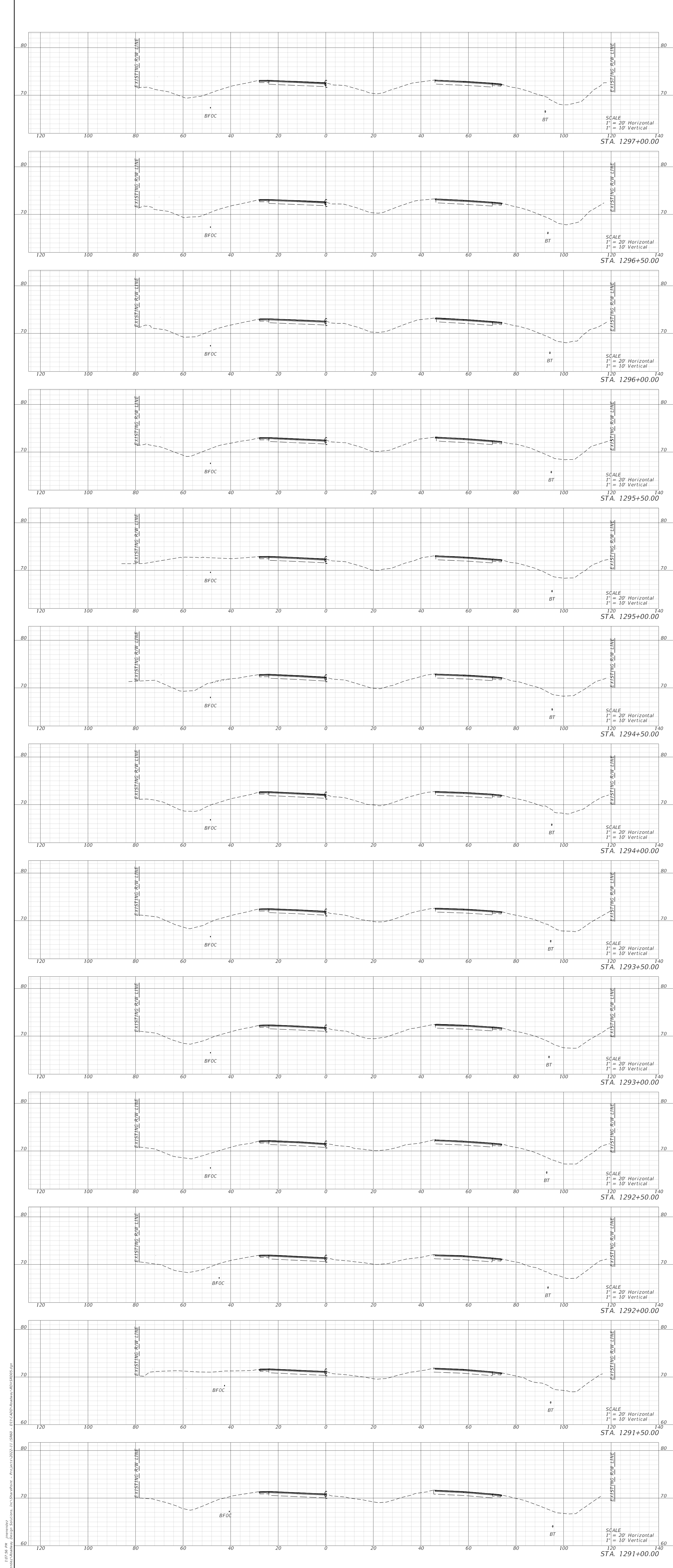

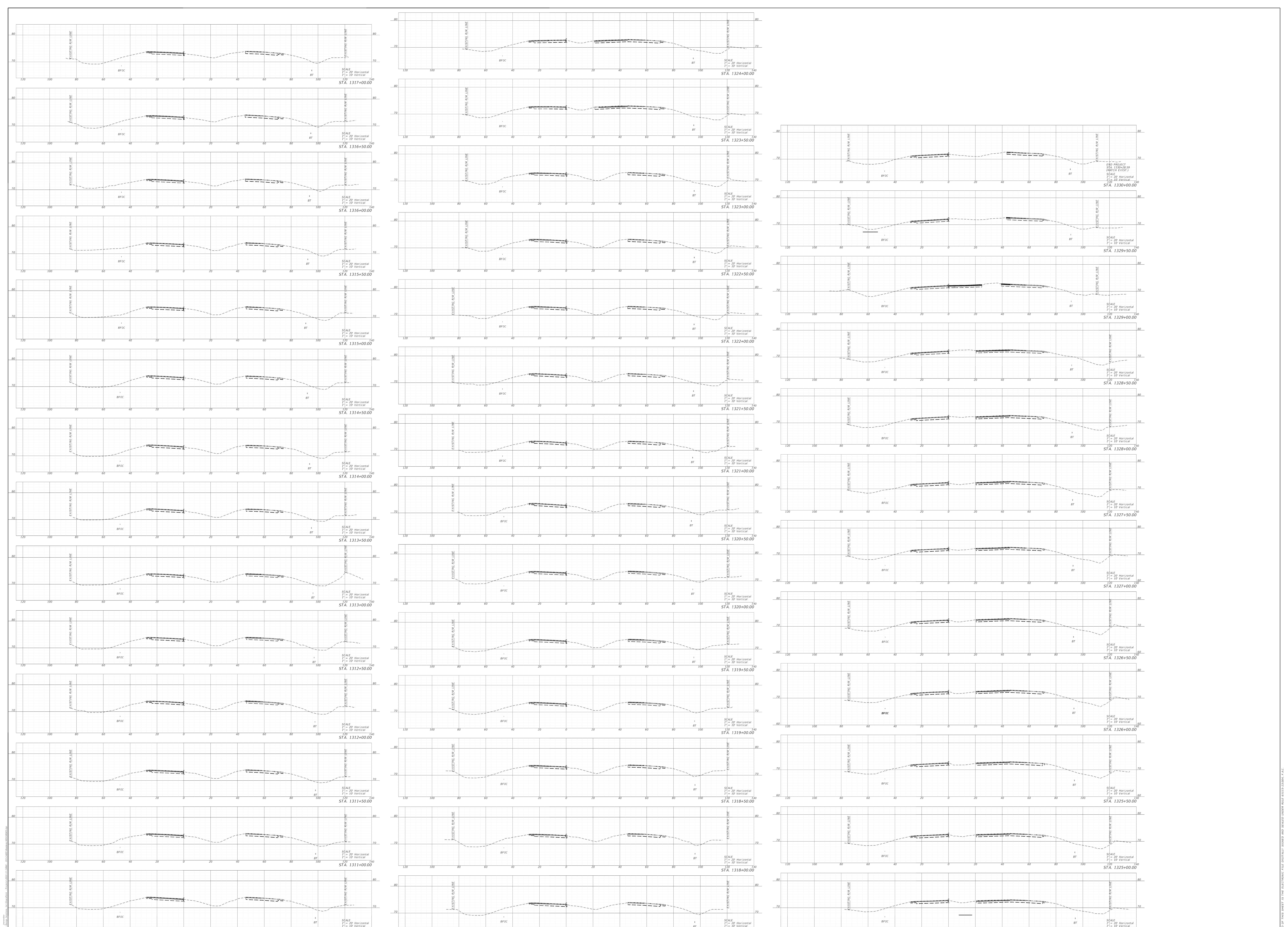

THE OFFICIAL RECORD OF THIS SHEET IS THE ELECTRONIC FILE DYNAMICALLY SHOWN AND SAVED UNDER FILE # 61672-23386.F.C