

SRT-350[®] 27
SRT-350[®] 31

Guardrail End Treatment
Assembly Manual

Part No. 620294B

Revised March 2010



TRINITY
HIGHWAY PRODUCTS
ENERGY ABSORPTION SYSTEMS

SRT™ -27 AND SRT™ -31



Guardrail End Treatment

Instructional Manual



IMPORTANT: These instructions are to be used only in conjunction with the installation of the SRT™ -27 and SRT™ -31 systems. These instructions are for standard installations specified by the state/specifying agency. In the event the specified system installation requires or involves special circumstances, contact the appropriate state/specifying agency before proceeding. Trinity Highway Products, LLC. representative is available for consultation if required.

This Manual should be available to the installation/maintenance/repair workers at all times. For additional copies, contact Trinity Highway Products, LLC. at 800-527-6050.

All information, illustrations, and specifications in this Manual are based on the latest SRT™ -27 and SRT™ -31 systems information available at the time of printing. We reserve the right to make changes at any time.

CUSTOMER SERVICE CONTACTS

Trinity Highway Products, LLC. is committed to the highest level of customer service. Feedback regarding the SRT™-27 and SRT™-31 systems, their installation procedures, supporting documentation, and performance is always welcome. Our goal is to enhance highway safety through innovation. Additional information for materials and product specifications can be obtained by calling the telephone numbers or writing to the email address below:

TRINITY HIGHWAY PRODUCTS:	
Telephone:	800-644-7976 (U.S. Calls) +1-214-589-8140 (International)
E-mail:	productinfo@trin.net
REGIONAL TELEPHONE CONTACTS:	
Dallas, Texas	800-527-6050
Centerville, Utah	800-772-7976
Elizabethtown, Kentucky	800-282-7668
Girard, Ohio	800-321-2755
Orangeburg, South Carolina	800-835-9307
International	+1-214-589-8140



SUGGESTED SAFETY RULES FOR INSTALLATION – MAINTENANCE - REPAIR

* IMPORTANT SAFETY INSTRUCTIONS *

Always keep this Manual in a location where it is easily accessed by persons who install, maintain, or repair the SRT™-27 and SRT™-31 systems.









SAFETY SYMBOLS









Below are the safety symbols that may appear on the SRT™-27 and SRT™-31 systems or in the documentation. Read the entire Manual for suggested safety, assembly, installation, maintenance, repair, and service information.

SYMBOL	MEANING
	<ul style="list-style-type: none"> SAFETY ALERT SYMBOL <p>Indicates Danger, Warning, or Caution. Failure to read and follow the Danger, Warning, and Safety or Caution indicators could result in serious injury or death to the workers and/or bystanders.</p>
	<ul style="list-style-type: none"> WARNING – READ MANUAL <p>Read the Manual(s) and follow all warnings and safety instructions. Failure to follow this warning could result in serious injury or death to the workers and/or bystanders.</p>

WARNINGS AND CAUTIONS

Read all warnings, cautions, and instructions, before installing/maintaining/repairing the SRT™ -27 and SRT™ -31 systems.

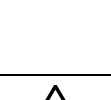
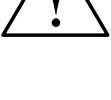
	<p>IMPORTANT: READ SAFETY INSTRUCTIONS THOROUGHLY AND FOLLOW THE SAFE OPERATION PRACTICES WHILE INSTALLING THE SRT™ -27 and SRT™ -31 SYSTEMS. Failure to follow this warning could result in serious injury or death to the workers and/or bystanders.</p>	
	<p>WARNING: Read the instructions carefully. Be familiar with the complete instructions for the SRT™ -27 and SRT™ -31 system before installing or repairing the SRT™ -27 and SRT™ -31 systems. Failure to follow this warning could result in serious injury or death in the event of a collision.</p>	
	<p>WARNING: Ensure that the necessary traffic control is setup and any debris that has encroached onto the traveled way or shoulder has been removed before beginning installation or repairs. Failure to follow this warning could result in serious injury or death in the event of a collision.</p>	
	<p>WARNING: Be sure adequate time is available for complete installation, before beginning the installation process. Failure to follow this warning could result in serious injury or death in the event of a collision.</p>	
	<p>WARNING: Do NOT perform installation, maintenance, or repair of the SRT™ -27 and SRT™ -31 systems when tired, ill, or under the influence of alcohol, drugs, or medication. Failure to follow this warning could result in serious injury or death in the event of a collision.</p>	
	<p>WARNING: Do not install, maintain, or repair the SRT™ -27 and SRT™ -31 systems, until you have read this Manual thoroughly. Please call Trinity Highway Products at 800-644-7976, if you do not understand the installation instructions. Failure to follow this warning could result in serious injury or death in the event of a collision.</p>	
	<p>WARNING: Use only Trinity Highway Products' parts on the SRT™ -27 and SRT™ -31 systems for installation, maintenance, or repair. The installation or co-mingling of unauthorized parts is strictly prohibited. Failure to follow this warning could result in serious injury or death in the event of a vehicle impact with a system that has not been accepted by the Federal Highway Administration ("FHWA"). The SRT™ -27 and SRT™ -31 systems and its component parts have been accepted for state use by FHWA. However, a co-mingled system has not been accepted.</p>	
	<p>WARNING: Do NOT modify the SRT™ -27 and SRT™ -31 systems in any way. Failure to follow this warning could result in serious injury or death in the event of a collision.</p>	
	<p>WARNING: Do NOT perform installation, maintenance, or repair, if the SRT™ -27 and SRT™ -31 system site, shoulder, or traveled area is covered or encroached by road debris. Failure to follow this warning could result in serious injury or death in the event of a collision.</p>	
	<p>WARNING: Safety measures, incorporating traffic control devices, must be used to protect all personnel while at the installation, maintenance, or repair site. Failure to follow this warning could result in serious injury or death to the workers and/or bystanders. Trinity Highway Products offers an economical and effective truck mounted attenuator, the MPS-350, for the protection of workers in work zones. For more information on the MPS-350, call 800-644-7976 or visit the Trinity Highway Products website at www.highwayguardrail.com.</p>	
	<p>WARNING: Ensure that the entire work zone site is visible at all times for safety. Failure to follow this warning could result in serious injury or death to the workers and/or bystanders.</p>	

	WARNING: Use caution when working near public roads. Be mindful of vehicles in motion nearby. Failure to follow this warning could result in serious injury or death to the workers and/or bystanders.
	WARNING: Ensure that all Guardrail products and delineation used meet all federal, state/specifying agency, and local specifications. Failure to follow this warning could result in serious injury or death in the event of a collision.
	WARNING: Ensure that your installation, repair, and maintenance meet all appropriate Manual on Uniform Traffic Control Devices (“MUTCD”) and local standards. Failure to follow this warning could result in serious injury or death in the event of a collision.
	WARNING: Ensure that the guardrail you install is terminated, as dictated by the state/specifying agency, pursuant to FHWA acceptance. Failure to follow this warning could result in serious injury or death in the event of a collision.
	WARNING: Ensure that there is proper site grading for tube and post placement, as dictated by the state/specifying agency, pursuant to FHWA acceptance. Failure to follow this warning could result in serious injury or death in the event of a collision.
	WARNING: Ensure that the proper Leaveout (specified area of open space in the pavement) around the posts is reserved and filled with state/specifying agency approved backfill material that will not prevent movement, for any posts installed in rigid pavement such as any thickness of concrete or asphalt more than 2 inches in thickness. Failure to follow this warning could result in serious injury or death in the event of a collision.
	WARNING: Ensure that all of the SRT™-27 and SRT™-31 system Warnings, Cautions, and Important statements within the SRT™-27 and SRT™-31 systems Manual are completely followed. Failure to follow this warning could result in serious injury or death in the event of a collision.
	WARNING: Always use safety precautions when performing installation, maintenance, repair, mixing chemicals, and/or moving heavy equipment. Wear steel toe shoes, gloves, safety goggles, and back protection. Failure to follow this warning could result in serious injury or death to the workers and/or bystanders
	WARNING: Ensure all wood blocks or composite blocks are routed. Failure to follow this warning could result in serious injury or death in the event of a collision.
	CAUTION: Ensure before installing, maintaining, or repairing the SRT™-27 and SRT™-31 systems that no parts are frayed, damaged, or broken. Failure to follow this warning could result in serious injury to the workers and/or bystanders.

BILL OF MATERIAL ENGLISH (METRIC) SRT™-27



WARNING: Use only Trinity Highway Products' parts on the SRT™-27 and SRT™-31 systems for installation, maintenance, or repair. The installation or co-mingling of unauthorized parts is strictly prohibited. Failure to follow this warning could result in serious injury or death in the event of a vehicle impact with a system that has not been accepted by the Federal Highway Administration ("FHWA"). SRT™-27 and SRT™-31 POST systems and its component parts have been accepted for state use by FHWA. However, a co-mingled system has not been accepted.

SRT™-27 SYSTEM (FOR SPECIFIC MATERIALS AND QUANTITIES, SEE STATE/SPECIFYING AGENCY OPTION(S))

PN	Quantity	Description
7G	1	12/6" (2.67/0.15) FLG PROTECTOR AT POST 2
9G	1	12/12.5' 6" 3" /S (2.67/3.81/1.905/S) GUARDRAIL
30G	1	12/12.5' 6" 3" /S (2.67/3.81/1.905/S) SRT-1 ANC (GUARDRAIL)
39G	1	12/12.5' 6" 3" /S (2.67/3.81/1.905/S) SRT-2 (GUARDRAIL)
700A	1	CABLE ANCHOR BRACKET
907G	1	12 (2.67)/BUFFER/ROLLED (TERMINAL)
3000G	1	CABLE ASSEMBLY □" x 6' 6" (19 x 1981)
3300G	10	5/8" (16) WASHER
3340G	68	5/8" HEX HGR NUT
3360G	52	5/8" DIA. x 1 □" (16 DIA. x 35) HGR SPLICE BOLT
3380G	8	5/8" DIA. x 1 □" (16 DIA. x 40) HEX HEAD BOLT
3400G	3	5/8" DIA x 2" (16 DIA. x 50) HGR POST BOLT (AT POST 2)
3500G	4	5/8" DIA. x 10" (16 DIA. x 255) HGR POST BOLT
3240G	2	5/16" (8) WASHER (AT POST 1)
3245G	2	5/16" (8) HEX NUT (AT POST 1)
3391G	1	5/8" DIA x 1 □" (19 DIA. x 75) HEX BOLT (A325) (AT STRUT)
3900G	2	1" (25) WASHER (AT CABLE)
3910G	2	1" (25) HEX NUT (AT CABLE)
14578G	5	6'0" (1830) SYT POST, W6 X 8.5 (W150 x 13)
4076B	4	ROUTED WOOD BLOCK 6" x 8" x 14" (150 x 200 x 360) DR
4211G	2	5/16" DIA X 1 □" (8 X 44) HEX BOLT (AT POST 1)
9960G	4	SLOT GUARD BRACKET
34052A	1	CR POST 1 BOT W6X15 (W150 x 22.5)
34056A	1	CR POST 1 TOP W6 x 8.5
34050G	1	ANGLE STRUT 3" X 3" X 1/4" (75 x 75 x 6)
33909G	1	CABLE ANCHOR BRACKET (AT POST 1)
4389G	2	7/16" FLAT WASHER
4390G	2	5/8" DIA x 1 □" HEX HD BOLT
4393G	2	7/16" LOCK WASHER
4396G	2	7/16" HEX NUT
34054G	1	POST SHELF ANGLE (AT POST 2)

Delineation Options

PN	Quantity	Description
6665B	1	16" x 16" (400 x 400) Striped (Yellow/Black) Reflective Sheeting Note: See state/specifying agency's MUTCD for options or proper delineation.

BILL OF MATERIAL ENGLISH (METRIC) SRT™-31



WARNING: Use only Trinity Highway Products' parts on the SRT™-27 and SRT™-31 systems for installation, maintenance, or repair. The installation or co-mingling of unauthorized parts is strictly prohibited. Failure to follow this warning could result in serious injury or death in the event of a vehicle impact with a system that has not been accepted by the Federal Highway Administration ("FHWA"). SRT™-27 and SRT™-31 POST systems and its component parts have been accepted for state use by FHWA. However, a co-mingled system has not been accepted.

SRT™-31 SYSTEM (FOR SPECIFIC MATERIALS AND QUANTITIES, SEE STATE/SPECIFYING AGENCY OPTION(S))



PN	Quantity	Description
7G	3	12/6"/ (2.67/0.15) FLG PROTECTOR AT POST 2, 4, & 6
30G	1	12/12.5'/6' 3"/S (2.67/3.81/1.905/S) SRT-1 ANC (GUARDRAIL)
39G	1	12/12.5'/6' 3"/S (2.67/3.81/1.905/S)SRT-2 (GUARDRAIL)
700A	1	CABLE ANCHOR BRACKET
907G	1	12 (2.67)/BUFFER/ROLLED (TERMINAL)
3000G	1	CABLE ASSEMBLY □" x 6' 6" (19 x 1981)
3300G	12	5/8"(16) WASHER
3340G	67	5/8"(16) HEX HGR NUT
3360G	52	5/8"DIA. x 1 □" (16 DIA. x 35) HGR SPLICE BOLT
3380G	8	5/8"DIA. x 1 □" (16 DIA. x 40) HEX HEAD BOLT
3400G	4	5/8" DIA x 2" (16 DIA. x 50) HGR POST BOLT (AT POST 2&4)
3240G	2	5/16" (8) WASHER (AT POST 1)
3245G	2	5/16" (8) HEX NUT (AT POST 1)
3391G	2	5/8"DIA X 1 □" (19 DIA. x 75) HEX BOLT (A325) (AT STRUCT)
3900G	2	1" (25) WASHER (AT CABLE)
3910G	2	1" (25) HEX NUT (AT CABLE)
15000G	5	6'0" (1830) SYT POST, W6 X 8.5 (W150 X 13)
4211G	2	5/16"DIA X 1 □" (8 X 44) HEX BOLT (AT POST 1)
4419G	1	5/8" DIA X 1 □" (16 X 44) COUNTERSUNK HD BOLT (AT POST 6)
9960G	4	SLOT GUARD
10967G	1	12/9'4.5/3'1.5/S SRT-3 GUARDRAIL
34052A	1	CR POST 1 BOT W6X15 (W150 X 22.5)
34053A	1	CR POST 1 TOP W6 x 8.5
34054G	1	HBA POST 1 & 2 BOT (TS 6 x 4) POST SHELF ANGLE (AT POST 2)
33875G	1	ANGLE STRUT 3" X 3" X □" (75 x 75 x 6)
33909G	1	CABLE ANCHOR BRACKET (AT POST 1)

Delineation Options

PN	Quantity	Description
6665B	1	16" x 16" (400 x 400) Striped (Yellow/Black) Reflective Sheeting Note: See state/specifying agency's MUTCD for options or proper delineation.

INSTALLING THE SRT™ -27 & 31 SYSTEMS

Use Trinity Highway Products' drawings for the SRT™ -27 and SRT™ -31 Systems with these instructions. Review the state/specifying agency's standard drawing(s) for this system. Details will be specific to the project or site locations. The SRT™ -27 and SRT™ -31 Systems have a straight flare like the SRT™ /HBA™ 6 Post System. At Posts 1, a CR Post is used in place of the HBA™ post. The Steel Yielding Terminal Post (SYTP) are used at Post 2-6. The SRT™ -27 system has blockouts on Posts 3 through 6. The SRT™ -31 system has no blockouts on any of the posts. The same equipment and expertise are required for both systems.

	WARNING: Ensure that there is proper site grading for tube and post placement as dictated by the state/specifying agency, pursuant to FHWA acceptance. Failure to follow this warning could result in serious injury or death in the event of a collision.
	WARNING: Ensure that the proper Leaveout (specified area of open space in the pavement) around the posts is reserved and filled with state/specifying agency approved backfill material that will not prevent movement, for any posts installed in rigid pavement such as any thickness of concrete or asphalt more than 2 inches in thickness. Failure to follow this warning could result in serious injury or death in the event of a collision.
	WARNING: Ensure that all Guardrail products and delineation used meet all federal, state/specifying agency, and local specifications. Failure to follow this warning could result in serious injury or death in the event of a collision.

MATERIALS

As packaged, the SRT™ -27 and SRT™ -31 systems include all materials needed for the installation. Note that concrete footings are NOT required.

TOOLS REQUIRED

The following list shows recommended tools for **installation** of the SRT™ -27 and SRT™ -31 systems:

- $\frac{9}{16}$ " (14 mm) Socket or Wrench
- $\frac{15}{16}$ " (24 mm) Socket or Wrench
- $1\frac{1}{4}$ " (32 mm) Socket or Wrench
- $1\frac{1}{2}$ " (38 mm) Socket or Wrench
- Augers
- Post Pounders (commonly used in driving posts)

The following list shows recommended tools for the **repair** of the SRT™ -27 and SRT™ -31 systems. However, since repair is directed by the state/specifying agency, they may have more specific guidelines.

- Channel lock pliers
- Sledge hammer
- Post removal tool and other normal guardrail tools

SITE PREPARATION

Site grading is usually necessary for the proper placement of the CR posts and the Steel Yielding Terminal (SYT) posts. Use the state/specifying agency's specifications and standard drawings for the site grading. Trinity does not direct grading. Complete this grading, before the start of the installation of the SRT™ -27 AND SRT™ -31 systems.

	WARNING: Ensure that there is proper site grading for tube and post placement as dictated by the state/specifying agency, pursuant to FHWA acceptance. Failure to follow this warning could result in serious injury or death in the event of a collision.
---	---

INSTALLATION

The post installation of the SRT™-27 AND SRT™-31 systems should be per the following Post Installation Sections. If there are special field conditions encountered when installing the SRT™-27 and SRT™-31 systems, contact the state/specifying agency. Trinity Highway Products, LLC. at 1-800-644-7976, is available to assist the state/specifying agency, if needed.

POST INSTALLATION

Complete the following instructions for the installation of the SYT posts and the CR posts. When installing posts in rigid pavement, see the Post Installed in Rigid Material section, below.

POST LAYOUT

The SRT™-27 and SRT™-31 Post System is a 37'6" (11.43m) that utilizes a straight flare. Complete the following steps to layout the posts. See Figure 1.

Step	Actions
1	Start at line Post 9 of the guardrail run and etc.
2	Extend the guardrail tangent line from Post 9 to establish Point 7T. (See Figure 1)
<p style="text-align: center;">SRT LAYOUT Figure 1</p>	
3	Extend the guardrail tangent line from Point 7T to establish Point 1T. See Figure 1.
4	Measure from Point 1T an offset of 4'0" (1.21 m) perpendicular to the road to establish the back side of the guardrail for Point 1.
5	Measure the offsets of Posts 8 and 7.
6	Establish a straight line between Point 1 and Point 7. This line represents to back side of the guardrail for both of the systems.
7	Between Points 1 and 7 on the back side of the guardrail line, establish Points 2 through 6 at 6'3" (1905 mm) intervals.

INSTALLING THE SYT POSTS

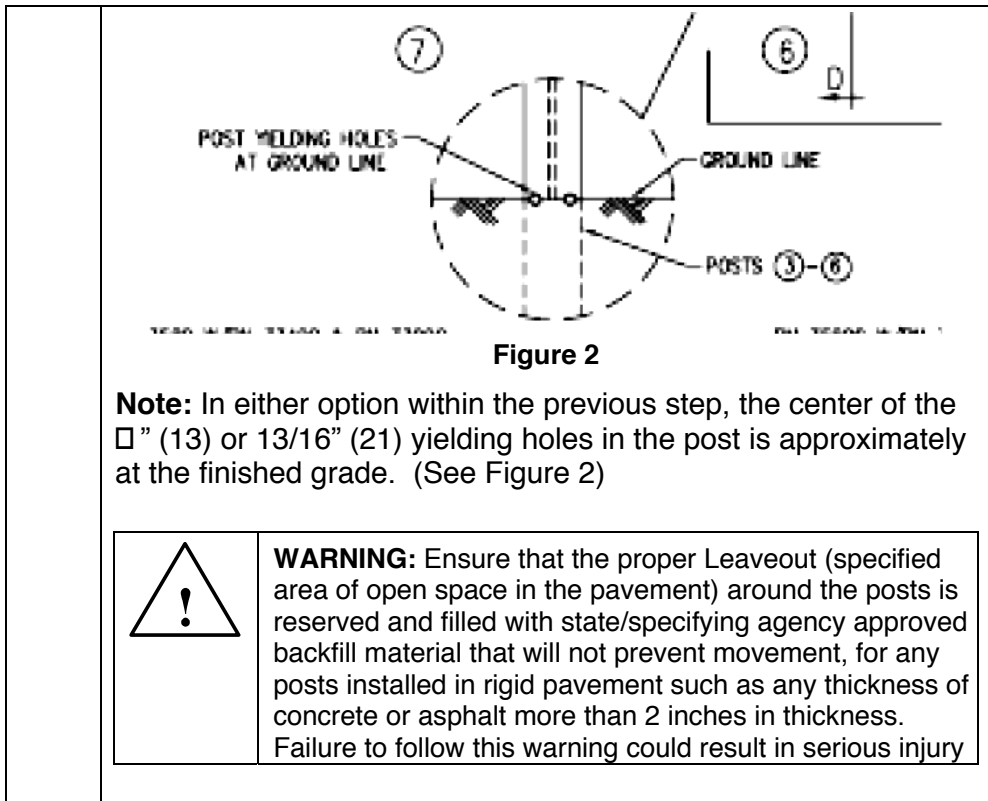

Complete the following steps to install the SYT posts:

Step	Actions				
1.	Install the SYT Post PN-14578G (SRT™-27) or SYT Post PN-15000G (SRT™-31) at location 6 through 2 , spaced at 6'3" (1905 mm). Select Option A or Option B for the post installation.				
	<table border="1" style="width: 100%;"> <tr> <td style="width: 15%; text-align: center;">Option A</td> <td>Drive posts into the ground.</td> </tr> <tr> <td style="width: 15%; text-align: center;">Option B</td> <td> <ol style="list-style-type: none"> 1. Drill 12" (300 mm) maximum diameter holes approximately 44" (1120 mm) deep for the SRT™-27 system or 40" (1020 mm) deep for the SRT™-31. 2. Insert the 6' 0" (1830 mm) SYT post into these holes. 3. Backfill the hole with compactable materials in 6" (150 mm) lifts and compact with pneumatic equipment to optimum compaction. <p>Note: If compactable, the material removed from the hole may be used for the backfill.</p> </td> </tr> </table>	Option A	Drive posts into the ground.	Option B	<ol style="list-style-type: none"> 1. Drill 12" (300 mm) maximum diameter holes approximately 44" (1120 mm) deep for the SRT™-27 system or 40" (1020 mm) deep for the SRT™-31. 2. Insert the 6' 0" (1830 mm) SYT post into these holes. 3. Backfill the hole with compactable materials in 6" (150 mm) lifts and compact with pneumatic equipment to optimum compaction. <p>Note: If compactable, the material removed from the hole may be used for the backfill.</p>
Option A	Drive posts into the ground.				
Option B	<ol style="list-style-type: none"> 1. Drill 12" (300 mm) maximum diameter holes approximately 44" (1120 mm) deep for the SRT™-27 system or 40" (1020 mm) deep for the SRT™-31. 2. Insert the 6' 0" (1830 mm) SYT post into these holes. 3. Backfill the hole with compactable materials in 6" (150 mm) lifts and compact with pneumatic equipment to optimum compaction. <p>Note: If compactable, the material removed from the hole may be used for the backfill.</p>				



INSTALLING CR BOTTOM POSTS

Complete the following steps to install CR Bottom Posts at **locations 1**:

Step	Actions				
1.	Orient the lower embedded CR Post so the $\frac{1}{2}$ " diameter Strut attachment hole will be closer to the nose of the system.				
2.	<p>Select Option A or Option B for this installation.</p> <table border="1" style="width: 100%; border-collapse: collapse;"> <tr> <td style="width: 15%; text-align: center; vertical-align: top;">Option A</td> <td style="padding: 5px;"> <ol style="list-style-type: none"> 1. Drive the CR Bottom Posts (PN-34052A) approximately 71.5" (1815 mm) to the optimum height, where the strut hole is approximately at finished grade. </td> </tr> <tr> <td style="width: 15%; text-align: center; vertical-align: top;">Option B</td> <td style="padding: 5px;"> <ol style="list-style-type: none"> 1. Drill a 12" (300 mm) pilot hole approximately 72" (1830 mm) deep. 2. Install the CR Bottom Post to the optimum height, where the strut hole is approximately at finished grade. 3. Backfill the hole with compactable materials in 6" (150 mm) lifts and compact with pneumatic equipment to optimum compaction. <p style="margin-top: 10px;">Note: If compactable, the material removed from the hole may be used for the backfill.</p> </td> </tr> </table>	Option A	<ol style="list-style-type: none"> 1. Drive the CR Bottom Posts (PN-34052A) approximately 71.5" (1815 mm) to the optimum height, where the strut hole is approximately at finished grade. 	Option B	<ol style="list-style-type: none"> 1. Drill a 12" (300 mm) pilot hole approximately 72" (1830 mm) deep. 2. Install the CR Bottom Post to the optimum height, where the strut hole is approximately at finished grade. 3. Backfill the hole with compactable materials in 6" (150 mm) lifts and compact with pneumatic equipment to optimum compaction. <p style="margin-top: 10px;">Note: If compactable, the material removed from the hole may be used for the backfill.</p>
Option A	<ol style="list-style-type: none"> 1. Drive the CR Bottom Posts (PN-34052A) approximately 71.5" (1815 mm) to the optimum height, where the strut hole is approximately at finished grade. 				
Option B	<ol style="list-style-type: none"> 1. Drill a 12" (300 mm) pilot hole approximately 72" (1830 mm) deep. 2. Install the CR Bottom Post to the optimum height, where the strut hole is approximately at finished grade. 3. Backfill the hole with compactable materials in 6" (150 mm) lifts and compact with pneumatic equipment to optimum compaction. <p style="margin-top: 10px;">Note: If compactable, the material removed from the hole may be used for the backfill.</p>				
	<table border="1" style="width: 100%; border-collapse: collapse;"> <tr> <td style="width: 20%; text-align: center; vertical-align: middle;">  </td> <td style="padding: 5px;"> <p>WARNING: Ensure that the proper Leaveout (specified area of open space in the pavement) around the posts is reserved and filled with state/specifying agency approved backfill material that will not prevent movement, for any posts installed in rigid pavement such as any thickness of concrete or asphalt more than 2 inches in thickness. Failure to follow this warning could result in serious injury or death in the event of a collision.</p> </td> </tr> </table>		<p>WARNING: Ensure that the proper Leaveout (specified area of open space in the pavement) around the posts is reserved and filled with state/specifying agency approved backfill material that will not prevent movement, for any posts installed in rigid pavement such as any thickness of concrete or asphalt more than 2 inches in thickness. Failure to follow this warning could result in serious injury or death in the event of a collision.</p>		
	<p>WARNING: Ensure that the proper Leaveout (specified area of open space in the pavement) around the posts is reserved and filled with state/specifying agency approved backfill material that will not prevent movement, for any posts installed in rigid pavement such as any thickness of concrete or asphalt more than 2 inches in thickness. Failure to follow this warning could result in serious injury or death in the event of a collision.</p>				

POST INSTALLED IN RIGID MATERIAL

Provide the proper Leaveout around a post when installing the post in any thickness of concrete or asphalt more than 2 inches thick. SYT posts require the leaveout shown in Figure 3.

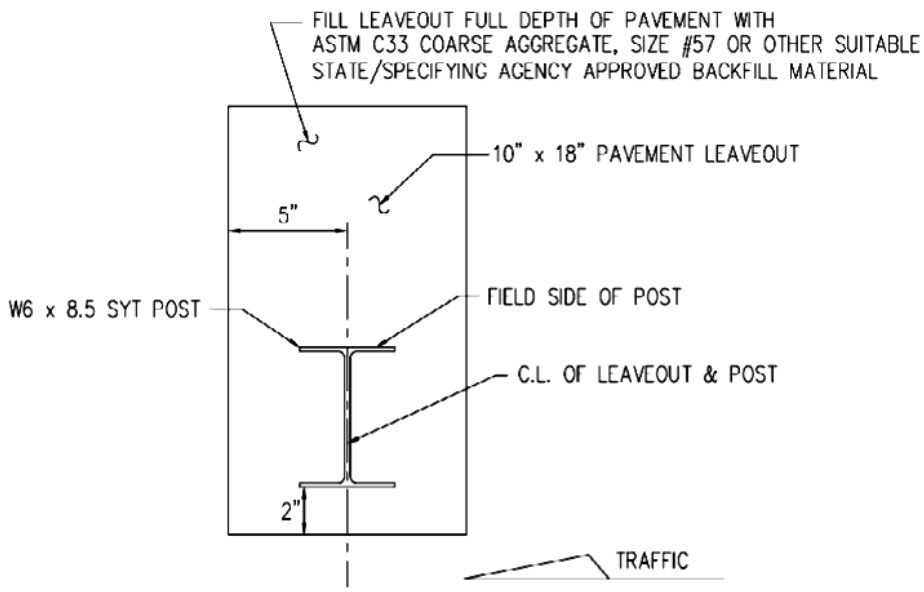



Figure 3

	<p>WARNING: Ensure that the proper Leaveout (specified area of open space in the pavement) around the posts is reserved and filled with state/specifying agency approved backfill material that will not prevent movement, for any posts installed in rigid pavement such as any thickness of concrete or asphalt more than 2 inches in thickness. Failure to follow this warning could result in serious injury or death in the event of a collision.</p>
--	---

INSTALLING CR & SYT POSTS WHEN ENCOUNTERING ROCK

Complete the following steps to install CR and SYT posts when encountering rock:

Step	Actions		
1	<p>Select Option A or Option B when encountering rock, unless there is a more restrictive state/specifying agency specification.</p> <table border="1" style="width: 100%; border-collapse: collapse; margin-top: 10px;"> <tr> <td style="width: 15%; text-align: center; vertical-align: top;">Option A</td> <td style="padding: 5px;"> <p>If rock is encountered with depth of 20" (510 mm) or less is required to install a full-length CR post or SYT post.</p> <ol style="list-style-type: none"> 1. Drill a 12" - 16" (300 mm - 400 mm) diameter hole into the rock 2" (50 mm) deeper than the required embedment depth. See the INSTALLING THE SYT POSTS or INSTALLING CR BOTTOM POST sections for depth location. 2. Place granular material or small pieces of the drilled rock in the bottom 2" (50 mm) of the hole for drainage. 3. Insert the CR Bottom Post or SYT Post into the hole. <p style="text-align: right; margin-top: 10px;">Continues on next page.</p> </td> </tr> </table>	Option A	<p>If rock is encountered with depth of 20" (510 mm) or less is required to install a full-length CR post or SYT post.</p> <ol style="list-style-type: none"> 1. Drill a 12" - 16" (300 mm - 400 mm) diameter hole into the rock 2" (50 mm) deeper than the required embedment depth. See the INSTALLING THE SYT POSTS or INSTALLING CR BOTTOM POST sections for depth location. 2. Place granular material or small pieces of the drilled rock in the bottom 2" (50 mm) of the hole for drainage. 3. Insert the CR Bottom Post or SYT Post into the hole. <p style="text-align: right; margin-top: 10px;">Continues on next page.</p>
Option A	<p>If rock is encountered with depth of 20" (510 mm) or less is required to install a full-length CR post or SYT post.</p> <ol style="list-style-type: none"> 1. Drill a 12" - 16" (300 mm - 400 mm) diameter hole into the rock 2" (50 mm) deeper than the required embedment depth. See the INSTALLING THE SYT POSTS or INSTALLING CR BOTTOM POST sections for depth location. 2. Place granular material or small pieces of the drilled rock in the bottom 2" (50 mm) of the hole for drainage. 3. Insert the CR Bottom Post or SYT Post into the hole. <p style="text-align: right; margin-top: 10px;">Continues on next page.</p>		

		<ol style="list-style-type: none"> 4. Backfill the hole with compactable materials in 6" (150 mm) lifts and compact with pneumatic equipment to optimum compaction. 5. Ensure that the finished guardrail height for the SRT™-27 is approximately 27 □" (706 mm) or SRT™-31 is approximately 31" (787 mm) above the finished grade or as the state/specifying agency plans indicate. 6. Ensure that the CR Post does not project more than 4" (100 mm) above the finished grade. <p>Note: If compactable, the material removed from the hole may be used for the backfill.</p>
	<p>Option B</p>	<p>If rock is encountered where a depth of more than 20" (510 mm) is required to install a full-length CR post or SYT post.</p> <ol style="list-style-type: none"> 1. Drill a 12" - 16" (300 mm - 400 mm) diameter hole 22" (560 mm) deep into the rock. 2. Insert the CR Post or SYT Post into the hole and measure from the bottom of the post to the finished grade. 3. Remove the post from the hole. Measure and mark from the top of the post the length to remove from the bottom. 4. Cut off the measured length from the bottom of the post. 5. Place granular material or small pieces of the drilled rock in the bottom 2" (50 mm) of the hole for drainage. 6. Install the CR Post or SYT Post in the hole. 7. Backfill the hole with compactable materials in 6" (150 mm) lifts and compact with pneumatic equipment to optimum compaction. 8. Ensure that the finished guardrail height for the SRT™-27 is approximately 27 □" (706 mm) or SRT™-31 is approximately 31" (787 mm) above the finished grade or as the state/specifying agency plans indicate. 9. Ensure that the Bottom CR Post does not project more than 4" (100) above the finished grade. <p>Note: If compactable, the material removed from the hole may be used for the backfill.</p>
		<p>WARNING: Ensure that the proper Leaveout (specified area of open space in the pavement) around the posts is reserved and filled with state/specifying agency approved backfill material that will not prevent movement, for any posts installed in rigid pavement such as any thickness of concrete or asphalt more than 2 inches in thickness. Failure to follow this warning could result in serious injury or death in the event of a collision.</p>

INSTALLING CR TOP POST

Complete the following steps to install the CR Top Posts after the Bottom Posts have been installed:

Step	Actions
1.	Install the Top post (PN-34056A) for SRT™-27 system or (PN-34053A) for SRT™-31 system at Post 1 , by aligning the ears of the top and bottom posts.
2.	Insert a 5/16" (8 mm) diameter x 1 □" (44 mm) Hex Head Bolt (PN-4211G) in each of the 3/8" (10 mm) holes in the bottom and top post plates. For the inserted bolts, place a 5/16" (8 mm) Washer (PN-3240G) under the 5/16" (8 mm) Hex Nut (PN-3245G) Tighten the bolt. (There is no torque requirement for these bolts.)

INSTALLING THE STRUT

Complete the following steps when installing the strut:

Note: Since a portion of the angle strut will be below grade, the installer must provide a shallow valley/trough for installation of the strut.

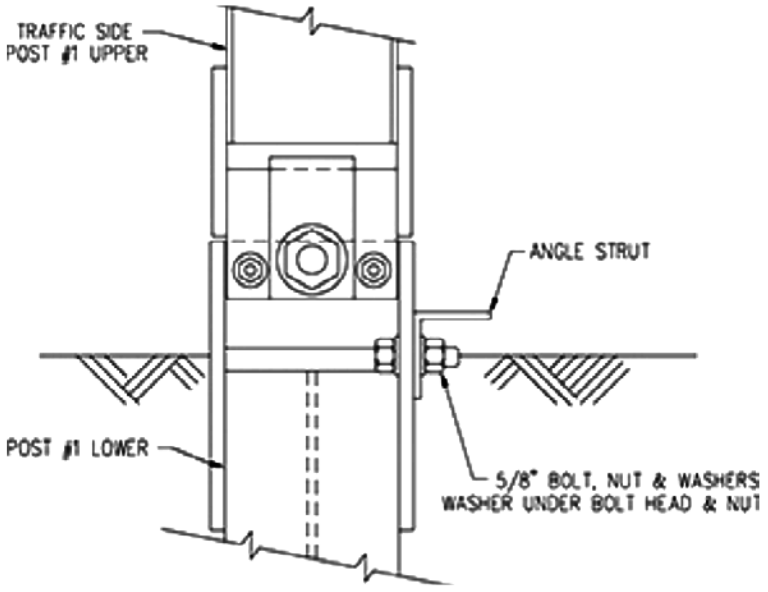
Step	Actions
1.	Place the Angle Strut (PN-34050G) SRT™-27 or (PN-33875G) SRT™-31 outside the post plate (ear) of Post 1 and the backside of the SYT post at Post 2 . (See Figure 4)
 <p style="text-align: center;">Figure 4</p>	
2.	Insert a 5/8" (16 mm) diameter x 1 1/4" (44 mm) High Strength Hex Head Bolt (PN-3391G) through the 1/2" (19 mm) hole in the post plate and through the slot in the strut at Post 1 . (See Figure 4)
3.	Place a 5/8" (16 mm) Washer (PN-3300G) on the bolt. Place a 5/8" (16 mm) Hex Nut (PN-3340G) on the end of the bolt. (See Figure 4)
4.	At Post 2 for the SRT™-27, insert a 7/16" (11 mm) diameter x 1 1/4" (44 mm) high strength Hex Head Bolt (PN-4390G) with a 7/16" (11 mm) Washer (PN-4389G) on the bolt through each of the 1/2" (13 mm) ground holes of the SYT post and through the slots of the strut. Place a 7/16" (11 mm) Lock Washer (PN-4393G) on each of the bolts. Place a 7/16" (11 mm) Hex Nut (PN-4396G) on the end of the bolts.
5.	At Post 2 for the SRT™-31, insert a 5/8" (16 mm) diameter x 1 1/4" (44 mm) high strength Hex Head Bolt (PN-3391G) with a 5/8" (16 mm) Washer (PN-3300G) on the bolt through the 13/16" (21 mm) ground hole of the SYT post and through the slot of the strut. Place a 5/8" (16 mm) Washer (PN-3300G) on the end bolt. Place a 5/8" (16 mm) Hex Nut (PN-3340G) on the end of the bolt.
6.	Tighten all of the bolts. (There is no torque requirements for these bolts.)

ARRANGING RAIL PANELS FOR SRT™-27 AND SRT-31

Complete the following steps to arrange the rail panels for the SRT™-27 and SRT-31 system:

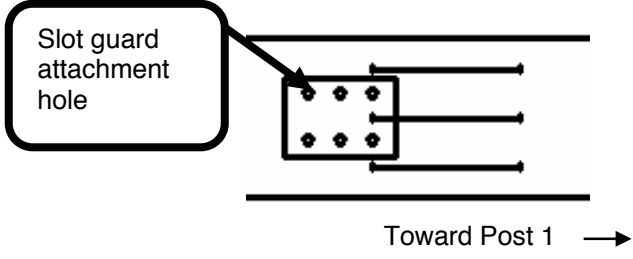
Step	Actions
1.	<p>Layout the guardrails (PN-30G, PN-39G) so the Slot Guard attachment holes are at the end of the slots AWAY from Post 1. (See Figure 5) Position the guardrails with the slots between Posts 1 and 2, Posts 2 and 3, Posts 3 and 4, and Posts 4 and 5.</p>  <p style="text-align: center;">Figure 5</p>

INSTALLING RAIL PANELS FOR THE SRT™-27 SYSTEM

Complete the following steps to install the rail panels for the SRT™-27 system:

Step	Actions
1.	<p>Splice and post bolt the 12' 6" (3.81m) rail panel (PN-9G) at Post 7, to the run of guardrail. Use hardware provided by the standard guardrail supplier.</p> <p>Note: Lap the terminal rail in the direction of traffic, unless the state/agency's policy dictates otherwise.</p>
2.	<p>Insert a 5/8" x 10" (16 mm x 255 mm) Post Bolt (PN-3500G) through the Routed Wood (4076B) or composite blockout at Posts 5, 4, and 3. Place a 5/8" (16 mm) Hex HGR Nut on inserted bolt to secure. Tighten the bolts. (There is no torque requirement for these bolts.)</p>
3.	<p>Insert a 5/8" x 2" (16 mm x 50 mm) HGR Post Bolt (PN-3400G) through the two holes in the Flange Protector (PN-7G) and the Post Shelf Angel (PN-34054G) at Post 2. Place a 5/8" (16 mm) Hex HGR Nut on inserted bolts to secure. Tighten the bolts. (There is no torque requirement for these bolts.)</p>
4.	<p>Splice the 12' 6" (3.81 m) Rail Panel (PN-9G) to the second 12' 6" (3.81 m) Rail Panel (PN-39G), at Post 5, with eight (8) 5/8" x 1 1/4" (16 mm x 32 mm) HGR Splice Bolts (PN-3360G). Place a 5/8" (16 mm) Hex HGR Nut on inserted bolt to secure. Tighten the bolt. (There is no torque requirement for these bolts.)</p>
5.	<p>Insert a 5/8" x 10" (16 mm x 255 mm) HGR Post Bolt through the rail panel, the Routed Wood Block (4076B), or composite blockout at Post 6. Place a 5/8" (16 mm) Hex HGR Nut on inserted bolt to secure. Tighten the bolts. (There is no torque requirement for these bolts.)</p>
6.	<p>Splice the 12' 6" (3.81 m) Rail Panel (PN-39G) to the first 12' 6" (3.81 m) Rail Panel (PN-30G), at Post 3, with eight (8) 5/8" x 1-1/4" (16 mm x 32 mm) HGR Splice Bolts (PN-3360G). Place a 5/8" (16 mm) Hex HGR Nut on inserted bolts to secure. Tighten the bolts. (There is no torque requirement for these bolts.)</p>
7.	<p>Insert a 5/8" x 2" (16 mm x 50 mm) HGR Post Bolt through the rail panel at Post 1. Place a 5/8" (16 mm) Hex HGR Nut on inserted bolt to secure. Tighten the bolts. (There is no torque requirement for these bolts.)</p>

INSTALLING RAIL PANELS FOR SRT™-31 SYSTEM

Complete the following steps to arrange the rail panels for the SRT™ -31 system:

Step	Actions
1.	Splice the 9'4.5" (2.86 m) Rail Panel (PN-10967G) to the run of the guardrail. Use hardware provided by the standard guardrail supplier. Note: Lap the terminal rail in the direction of traffic, unless the state/agency's policy dictates otherwise.
2.	Insert a 5/8" x 2" (16 mm x 50 mm) HGR Post Bolt (PN-3400G) through the Flange Protector (PN-7G) at Post 4 . Place a 5/8" (16 mm) Hex HGR Nut (PN-3340G) on inserted bolt to secure. Tighten the bolt. (There is no torque requirement for this bolt)
3.	Insert a 5/8" x 2" (16 mm x 50 mm) HGR Post Bolt (PN-3400G) through the two holes in the Flange Protector (PN-7G) and the Post Shelf Angel (PN-34054G) at Post 2 . Place a 5/8" (16 mm) Hex HGR Nut on inserted bolts to secure. Tighten the bolts. (There is no torque requirement for these bolts.)
4.	Insert a 5/8" x 1" (16 mm x 44 mm) Countersunk HD Bolt (PN-4491G) through the Rail Panel (PN-10967G) and Flange Protector at Post 6 . Place a 5/8" (16 mm) Hex HGR Nut on inserted bolt to secure. Tighten the bolts. (There is no torque requirement for these bolts)
5.	Splice the 9'4.5" (2.86 m) Rail Panel (PN-10967G) to the second 12'6" (3.81 m) Rail Panel (PN-39G), at Post 5 , with eight (8) 5/8" x 1-1/4" (16 mm x 32 mm) HGR Splice Bolts (PN-3360G). Place a 5/8" (16 mm) Hex HGR Nut (PN-3340G) on inserted bolts to secure. Tighten the bolts. (There is no torque requirement for these bolts.)
6.	Splice the 12'6" (3.81 m) Rail Panel (PN-39G) to the first 12'6" (3.81 m) Rail Panel (PN-30G), at Post 3 , with eight (8) 5/8" x 1-1/4" (16 mm x 32 mm) HGR Splice Bolts. Place a 5/8" (16 mm) Hex HGR Nut (PN-3340G) on inserted bolts to secure. Tighten the bolts. (There is no torque requirement for these bolts.)
7.	Insert a 5/8" x 2" (16 mm x 50 mm) HGR Post Bolt through the rail panel at Post 1 . Place a 5/8" (16 mm) Hex HGR Nut on inserted bolt to secure. Tighten the bolts. (There is no torque requirement for these bolts.)

INSTALLING THE SLOT GUARDS

Complete the following steps to install the Slot Guards:

Step	Actions
1.	Place the Slot Guards (PN-9960G) against the backside of the guardrail panels with the deflector angle gap opening toward (closest to) the elongated slots. Align the six holes in the Slot Guard with the six holes in the guardrail panel near the elongated slots.
2.	Bolt each Slot Guard to the backside of the guardrail panels with six (6) 5/8" x 1 1/4" (16 mm x 32 mm) Splice Bolts (PN-3340G) and Hex Nuts (PN-3360G).

INSTALLING THE CABLE ANCHOR ASSEMBLY

Complete the following steps to install the cable anchor assembly:

Step	Actions
1.	Place a 5/8" (16 mm) Round Washer (PN-3300G) on each of the eight (8) 5/8" x 1 1/2" (16 mm x 38 mm) Hex Head Bolt (PN-3380G).
2.	Insert the bolts through the traffic side of the rail panel and the Cable Anchor Bracket (PN-700A) on the backside of the Guardrail panel. Secure the Hex Head Bolts with a Hex HGR Nut (PN-3380G) on each bolt. Tighten each bolt. (There is no

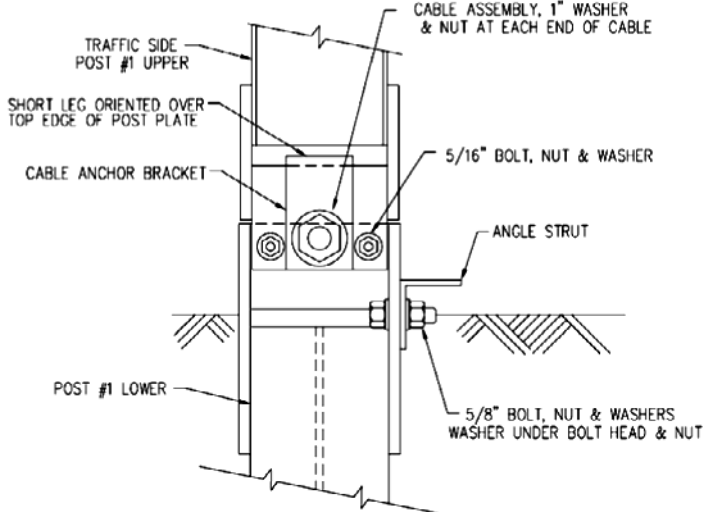
	torque requirement for these bolts.)
3.	Slide one end of the Cable (PN-3000G) into the Cable Anchor Bracket and the other end through the hole between the top and bottom CR posts at location 1 .
4.	Place a 1" (25 mm) Washer (PN-3900G) and a 1" (25 mm) Hex Nut (PN-3910G) on the end of the cable that extends through the Cable Anchor Bracket.
5.	Place the Cable Anchor Bracket (PN-33909G) on the cable end placed between the top and bottom CR posts.
6.	Place a 1" (25 mm) Washer and 1" (25 mm) Hex Nut on the end of the cable. (See Figure 6)
 <p style="text-align: center;">Figure 6</p>	
7.	Restrain the cable with vise grip pliers at the end being tightened to avoid twisting the cable.
8.	Tighten the Hex Nuts on the cable ends, until the cable is taut. The cable is considered taut, when it does not deflect more than 1 inch when pressure is applied by hand in an up or down direction.

INSTALLING THE END SECTION

Complete the following steps to install the end section:

Step	Actions
1.	Connect the end section (PN-907G) to the end of the guardrail panel with four (4) $\frac{5}{8}$ " x $1\frac{1}{4}$ " (16 mm x 32 mm) HGR Splice Bolts (PN-3360G). Place a $\frac{5}{8}$ " (16 mm) Hex HGR Nut (PN-3340G) on inserted bolts to secure. Tighten the bolts. (There is no torque requirement for these bolts.)
2.	<p>Install high intensity Reflective Sheeting (PN-6665B) on the front face of the end section, per the state/specifying agency's MUTCD for options or proper delineation.</p> <p>Note: The reflective sheeting is an option to the SRT™-27 and SRT™-31 systems and to be ordered separate from the SRT™-27 and SRT™-31 package.</p> <div style="border: 1px solid black; padding: 5px; margin-top: 10px;"> <div style="display: flex; align-items: center;"> <div style="text-align: center; margin-right: 10px;">  </div> <div> <p>WARNING: Ensure that all Guardrail products and delineation used meet all federal, state/specifying agency, and local specifications. Failure to follow this warning could result in serious injury or death in the event of a collision.</p> </div> </div> </div>

SRT™ -27 or SRT™ -31 INSTRUCTIONAL CHECKLIST

STATE: _____ PROJECT: _____





DATE: _____ LOCATION: _____

- The finished guardrail height is approximately 27³/₄" (706 mm) above the finished grade for the SRT™ -27 or 31" (787 mm) for the SRT™ -31 system, or as the state/specifying agency plans indicate.
- Any site grading needed was completed, before the start of the installation of the SRT™ -27 or SRT™ -31 system.
- The ears of the bottom CR posts do not protrude more than 4" (100 mm) above the finished grade measured by the AASHTO 5'0" (1.5 m) cord method. Site grading may be necessary to meet this requirement.
- The anchor cable is taut and correctly installed (the cable should be rechecked after installation to be sure it hasn't relaxed). The taut cable does not deflect more than 1 inch, when pressure is applied by hand in an up or down direction.
- The rail panel is **not** attached to the post at **locations 2, 3, 4, and 5**.
- No rectangular washers are used on the face of the rail.
- Slot Guards are in place against the backside of the guardrail panels with the deflector angle gap opening toward (closest to) the elongated slots. Slot Guards are oriented per Figure 5.
- Rail panels are oriented correctly and lapped in the direction of traffic unless the agency's policy dictates otherwise.
- If backfilled, the backfill material around the posts is properly compacted.
- The SYT posts (Posts 2 through 6) have four yielding holes. They are located parallel to the roadway with the center of the holes located approximately at the finished grade.
- The recesses are filled with state/specifying agency approved backfill material that will not prevent movement, for any posts installed in rigid pavement such as any thickness of concrete or asphalt more than 2 inches in thickness.
- The wood blocks or composite blocks are routed.

MAINTENANCE AND REPAIR INSTRUCTIONS



* IMPORTANT MAINTENANCE AND REPAIR INSTRUCTIONS *

Always keep the Manual in a location where it is easily accessed by persons who install, maintain, or repair the SRT™-27 and SRT™-31 systems. If you have any questions concerning the information in this Manual or about the SRT™-27 or SRT™-31 system, contact the state/specifying agency, then Trinity Highway Products, LLC. at 800-527-6050.

	WARNING: Use only Trinity Highway Products' parts on the SRT™-27 OR SRT™-31 systems for installation, maintenance, or repair. The installation or co-mingling of unauthorized parts is strictly prohibited. Failure to follow this warning could result in serious injury or death in the event of a vehicle impact with a system that has not been accepted by the Federal Highway Administration ("FHWA"). The SRT™-27 and SRT™-31 systems and its component parts have been accepted for state use by FHWA. However, a co-mingled system has not been accepted. Failure to follow this warning could result in serious injury or death in the event of a collision.
	WARNING: Ensure that the necessary traffic control is setup and any debris that has encroached onto the traveled way or shoulder has been removed before beginning installation or repairs. Failure to follow this warning could result in serious injury or death in the event of a collision.
	WARNING: Safety measures, incorporating traffic control devices, must be used to protect all personnel while at the installation, maintenance, or repair site. Failure to follow this warning could result in serious injury or death to the workers and/or bystanders. Trinity Highway Products offers an economical and effective truck mounted attenuator, the MPS-350, for the protection of workers in work zones. For more information on the MPS-350, call 800-644-7976 or visit the Trinity Highway Products website at www.highwayguardrail.com .
	WARNING: Do NOT perform installation, maintenance, or repair if the SRT™-27 or SRT™-31 system site, shoulder, or traveled area are covered or encroached by road debris. Failure to follow this warning could result in serious injury or death in the event of a collision.
	WARNING: Ensure that all Guardrail products and delineation used meet all federal, state/specifying agency, and local specifications. Failure to follow this warning could result in serious injury or death in the event of a collision.















MAINTENANCE

Complete the following steps periodically to check the safety of the system:

Step	Actions		
1.	<p>Ensure the nuts have not been removed from the cable. Replace nuts, if needed.</p> <table border="1" style="width: 100%; border-collapse: collapse; margin-top: 10px;"> <tr> <td style="width: 15%; text-align: center; vertical-align: middle;"></td> <td>WARNING: Use only Trinity Highway Products' parts on the SRT™-27 or SRT™-31 system for installation, maintenance, or repair. The installation or co-mingling of unauthorized parts is strictly prohibited. Failure to follow this warning could result in serious injury or death in the event of a vehicle impact with a system that has not been accepted by the Federal Highway Administration ("FHWA"). The SRT™-27 and SRT™-31 systems and its component parts have been accepted for state use by FHWA. However, a co-mingled system has not been accepted.</td> </tr> </table>		WARNING: Use only Trinity Highway Products' parts on the SRT™-27 or SRT™-31 system for installation, maintenance, or repair. The installation or co-mingling of unauthorized parts is strictly prohibited. Failure to follow this warning could result in serious injury or death in the event of a vehicle impact with a system that has not been accepted by the Federal Highway Administration ("FHWA"). The SRT™-27 and SRT™-31 systems and its component parts have been accepted for state use by FHWA. However, a co-mingled system has not been accepted.
	WARNING: Use only Trinity Highway Products' parts on the SRT™-27 or SRT™-31 system for installation, maintenance, or repair. The installation or co-mingling of unauthorized parts is strictly prohibited. Failure to follow this warning could result in serious injury or death in the event of a vehicle impact with a system that has not been accepted by the Federal Highway Administration ("FHWA"). The SRT™-27 and SRT™-31 systems and its component parts have been accepted for state use by FHWA. However, a co-mingled system has not been accepted.		
2.	Ensure the cable is taut. The cable is considered taut, when it does not deflect more than 1 inch when pressure is applied by hand in an up or down direction. Tighten, if needed.		
3.	Ensure routed wood blocks or composite blocks are in place and in good condition as defined by the state/specifying agency.		

REPAIR

Complete the following steps to repair the SRT™-27 or SRT™-31 system:

Step	Actions				
1.	<p>Setup necessary traffic control at the accident site and then remove any debris that has encroached onto the traveled way or shoulder.</p> <table border="1" data-bbox="459 459 1291 1005"> <tr> <td data-bbox="459 459 597 655"></td> <td data-bbox="597 459 1291 655">WARNING: Ensure that the necessary traffic control is setup and any debris that has encroached onto the traveled way or shoulder has been removed before beginning installation or repairs. Failure to follow this warning could result in serious injury or death in the event of a collision.</td> </tr> <tr> <td data-bbox="459 655 597 1005"></td> <td data-bbox="597 655 1291 1005">WARNING: Safety measures, incorporating traffic control devices, must be used to protect all personnel while at the installation, maintenance, or repair site. Failure to follow this warning could result in serious injury or death to the workers and/or bystanders. Trinity Highway Products offers an economical and effective truck mounted attenuator, the MPS-350, for the protection of workers in work zones. For more information on the MPS-350, call 800-644-7976 or visit the Trinity Highway Products website at www.highwayguardrail.com.</td> </tr> </table>		WARNING: Ensure that the necessary traffic control is setup and any debris that has encroached onto the traveled way or shoulder has been removed before beginning installation or repairs. Failure to follow this warning could result in serious injury or death in the event of a collision.		WARNING: Safety measures, incorporating traffic control devices, must be used to protect all personnel while at the installation, maintenance, or repair site. Failure to follow this warning could result in serious injury or death to the workers and/or bystanders. Trinity Highway Products offers an economical and effective truck mounted attenuator, the MPS-350, for the protection of workers in work zones. For more information on the MPS-350, call 800-644-7976 or visit the Trinity Highway Products website at www.highwayguardrail.com .
	WARNING: Ensure that the necessary traffic control is setup and any debris that has encroached onto the traveled way or shoulder has been removed before beginning installation or repairs. Failure to follow this warning could result in serious injury or death in the event of a collision.				
	WARNING: Safety measures, incorporating traffic control devices, must be used to protect all personnel while at the installation, maintenance, or repair site. Failure to follow this warning could result in serious injury or death to the workers and/or bystanders. Trinity Highway Products offers an economical and effective truck mounted attenuator, the MPS-350, for the protection of workers in work zones. For more information on the MPS-350, call 800-644-7976 or visit the Trinity Highway Products website at www.highwayguardrail.com .				
2.	Take inventory of the damaged system and determine what parts are reusable as defined by the state/specifying agency and what parts need to be replaced.				
3.	<p>Obtain the Trinity Highway Products' parts that need to be replaced from Trinity Highway Products, LLC. (See page 7 of this Manual for list of recommended tools for the repair of the SRT™-27 or SRT™-31 system.)</p> <table border="1" data-bbox="459 1292 1291 1645"> <tr> <td data-bbox="459 1292 597 1645"></td> <td data-bbox="597 1292 1291 1645">WARNING: Use only Trinity Highway Products' parts on the SRT™-27 and SRT™-31 systems for installation, maintenance, or repair. The installation or co-mingling of unauthorized parts is strictly prohibited. Failure to follow this warning could result in serious injury or death in the event of a vehicle impact with a system that has not been accepted by the Federal Highway Administration ("FHWA"). The SRT™-27 and SRT™-31 systems and its component parts have been accepted for state use by FHWA. However, a co-mingled system has not been accepted.</td> </tr> </table>		WARNING: Use only Trinity Highway Products' parts on the SRT™-27 and SRT™-31 systems for installation, maintenance, or repair. The installation or co-mingling of unauthorized parts is strictly prohibited. Failure to follow this warning could result in serious injury or death in the event of a vehicle impact with a system that has not been accepted by the Federal Highway Administration ("FHWA"). The SRT™-27 and SRT™-31 systems and its component parts have been accepted for state use by FHWA. However, a co-mingled system has not been accepted.		
	WARNING: Use only Trinity Highway Products' parts on the SRT™-27 and SRT™-31 systems for installation, maintenance, or repair. The installation or co-mingling of unauthorized parts is strictly prohibited. Failure to follow this warning could result in serious injury or death in the event of a vehicle impact with a system that has not been accepted by the Federal Highway Administration ("FHWA"). The SRT™-27 and SRT™-31 systems and its component parts have been accepted for state use by FHWA. However, a co-mingled system has not been accepted.				
4.	Return to the repair site with the replacement parts and tools needed.				
5.	Disconnect and remove the damaged rail from the posts.				
6.	Remove the CR Post that is damaged or twisted.				
7.	Remove any damaged SYT posts.				
8.	<p>Reconstruct the system following the installation instructions, after the site has been cleared of damaged debris.</p> <table border="1" data-bbox="459 1929 1291 2099"> <tr> <td data-bbox="459 1929 597 2099"></td> <td data-bbox="597 1929 1291 2099">WARNING: Do NOT perform installation, maintenance, or repair if the SRT™-27 or SRT™-31 systems site, shoulder, or traveled area are covered or encroached by road debris. Failure to follow this warning could result in serious injury or death in the event of a collision.</td> </tr> </table>		WARNING: Do NOT perform installation, maintenance, or repair if the SRT™-27 or SRT™-31 systems site, shoulder, or traveled area are covered or encroached by road debris. Failure to follow this warning could result in serious injury or death in the event of a collision.		
	WARNING: Do NOT perform installation, maintenance, or repair if the SRT™-27 or SRT™-31 systems site, shoulder, or traveled area are covered or encroached by road debris. Failure to follow this warning could result in serious injury or death in the event of a collision.				
9.	<p>Install proper delineation necessary for the repaired SRT™-27 or SRT™-31 system in accordance with the state/specifying agency's MUTCD.</p> <table border="1" data-bbox="459 2247 1291 2416"> <tr> <td data-bbox="459 2247 597 2416"></td> <td data-bbox="597 2247 1291 2416">WARNING: Ensure that all Guardrail products and delineation used meet all federal, state/specifying agency, and local specifications. Failure to follow this warning could result in serious injury or death in the event of a collision.</td> </tr> </table>		WARNING: Ensure that all Guardrail products and delineation used meet all federal, state/specifying agency, and local specifications. Failure to follow this warning could result in serious injury or death in the event of a collision.		
	WARNING: Ensure that all Guardrail products and delineation used meet all federal, state/specifying agency, and local specifications. Failure to follow this warning could result in serious injury or death in the event of a collision.				



TRINITY
HIGHWAY PRODUCTS
ENERGY ABSORPTION SYSTEMS

2525 Stemmons Freeway
Dallas, Texas 75207

888-323-6374 (USA only)

214-589-8140 (Outside USA)

www.energyabsorption.com

www.highwayguardrail.com