

Origination Form

Proposed Revisions to a Standard Plans Index

Originator:	Turley, Joshua	Index Number:	460-474
Date:	5/15/2024	Sheet Number(s):	1-4
E-mail:	Joshua.Turley@dot.state.fl.us	Index Title:	TRAFFIC RAILING - (THRIE-BEAM RETROFIT) INTERMEDIATE CURB

Summary of the changes:

Sheets 1-4: Added a note to the details captioning that what is shown is the Adhesive anchor option.

Commentary/Background:

We have recently finished research into screw anchors and are now allowing them as an option on this Standard and we needed to add a note clarifying that that is the case. Otherwise the user might think that what is shown is the only option.

Other Affected Documents/Offices	Person Contacted	Affected (Yes/No)
Other Standard Plans		No
FDOT Design Manual		No
Standard Specifications		No
Basis of Estimates Manual		No
Approved Product List		No
Construction Office		No
Maintenance Office		No

Implementation

["FY-Standard Plans (Next Release)"]

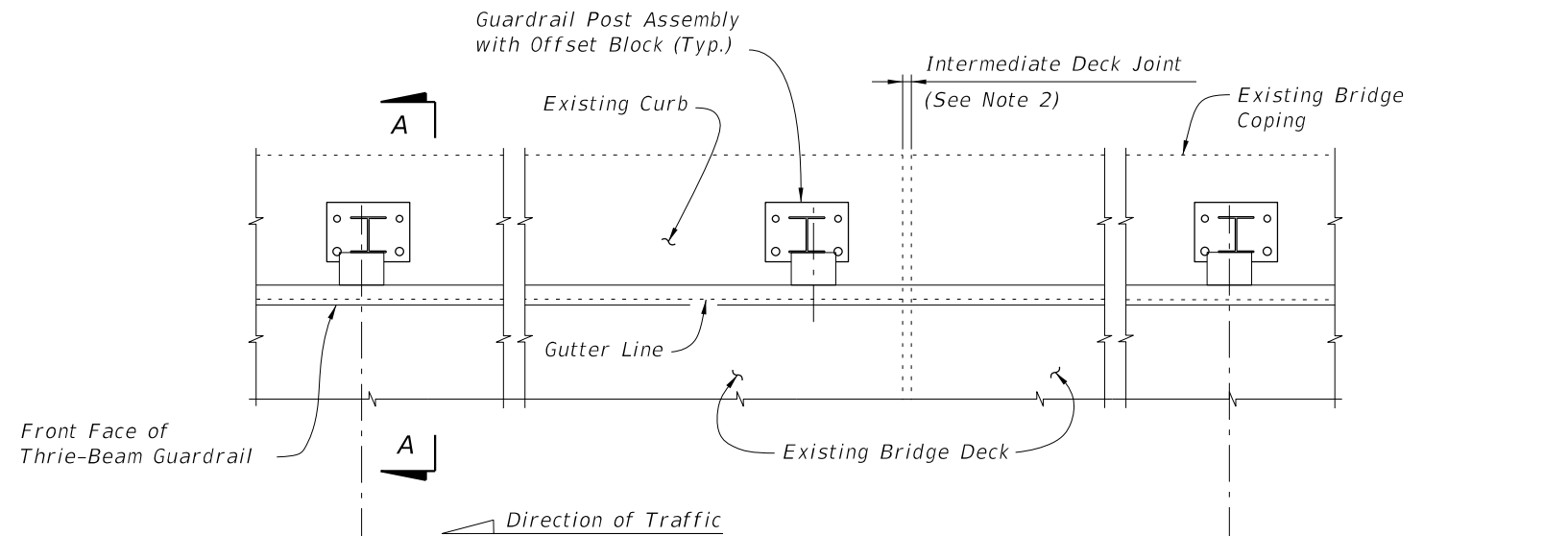

NOTES:

1. On approach end provide Index 536-002 (as shown) or other site specific treatment, see Roadway Plans. For treatment of trailing end see Roadway Plans.
2. Actual joint dimension and orientation vary. For Intermediate Deck Joints use the Modified Post Spacing at Intermediate Deck Joints Detail, Index 460-470, Sheet 2, as required.
3. Areas where existing structure has been removed shall match adjoining areas and shall be finished flat by grouting or grinding as required. Exposed existing reinforcing steel shall be burned off 1" below existing concrete and grouted over.

PARTIAL PLAN OF RAILING
(Adhesive Anchor Option shown, Screw Anchor Option similar)

⌀ Post Bolts and Match Line (Trailing End) (See Sheets 3 and 4)

⌀ Post Bolts and Match Line (Approach End) (See Sheets 3 and 4)

6'-3" spacing (Typ. except as noted along Bridge, see Note 2)

1'-6" Min. for non skewed joints. For treatment of skewed Intermediate Deck Joints see Skew Detail Index 460-470, Sheet 2 (Typ.)

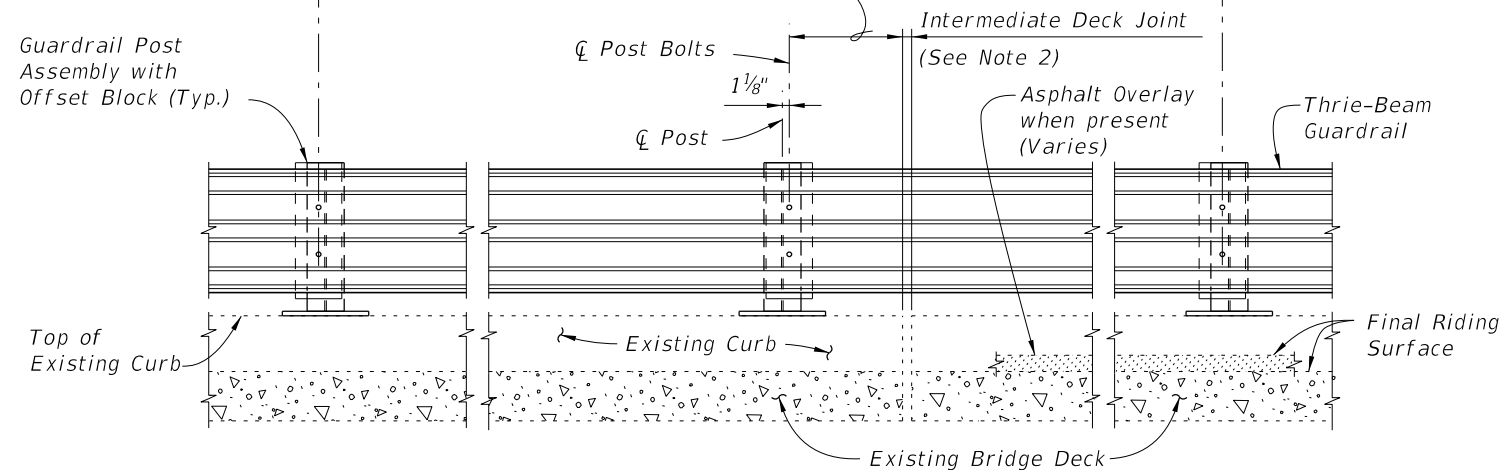

PARTIAL ELEVATION OF INSIDE FACE OF RAILING

==== **TYPICAL TREATMENT OF RAILING ALONG BRIDGE** ====

CROSS REFERENCES:

- For Match Line see Sheets 3 & 4.
- For Section A-A see Sheet 2.
- For Traffic Railing Notes and Details see Index 460-470.

10/14/2022 8:07:08 AM

LAST REVISION 01/01/08 11/01/24	REVISION DESCRIPTION:	 FY 2023-24 STANDARD PLANS	TRAFFIC RAILING - (THRIE-BEAM RETROFIT) INTERMEDIATE CURB	INDEX 460-474	SHEET 1 of 4
--	--------------------------	---	---	-------------------------	------------------------

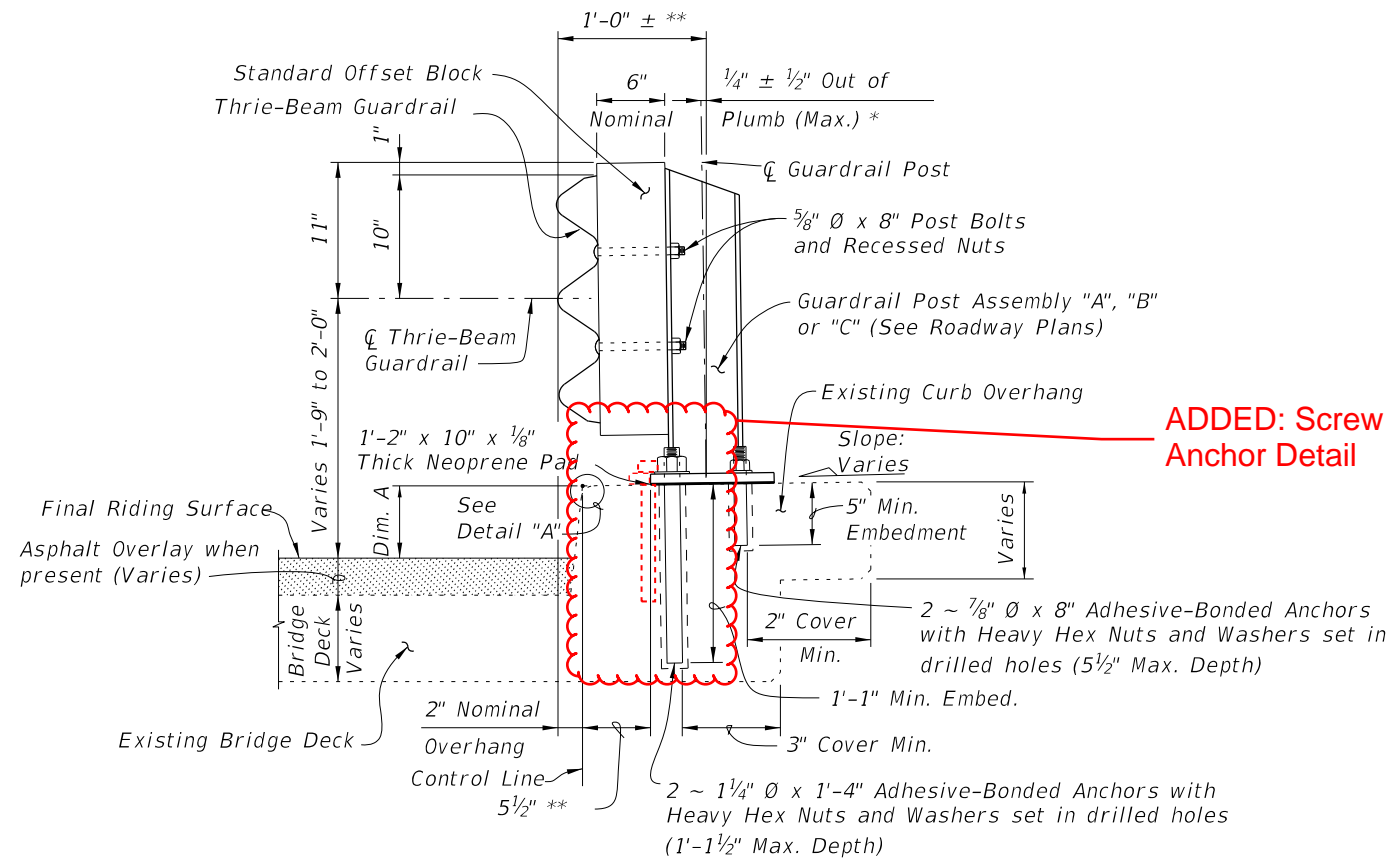

SECTION A-A
TYPICAL SECTION THRU RAILING ON BRIDGE DECK
*(Adhesive Anchor Option shown solid,
 Screw Anchor Option shown dashed)*

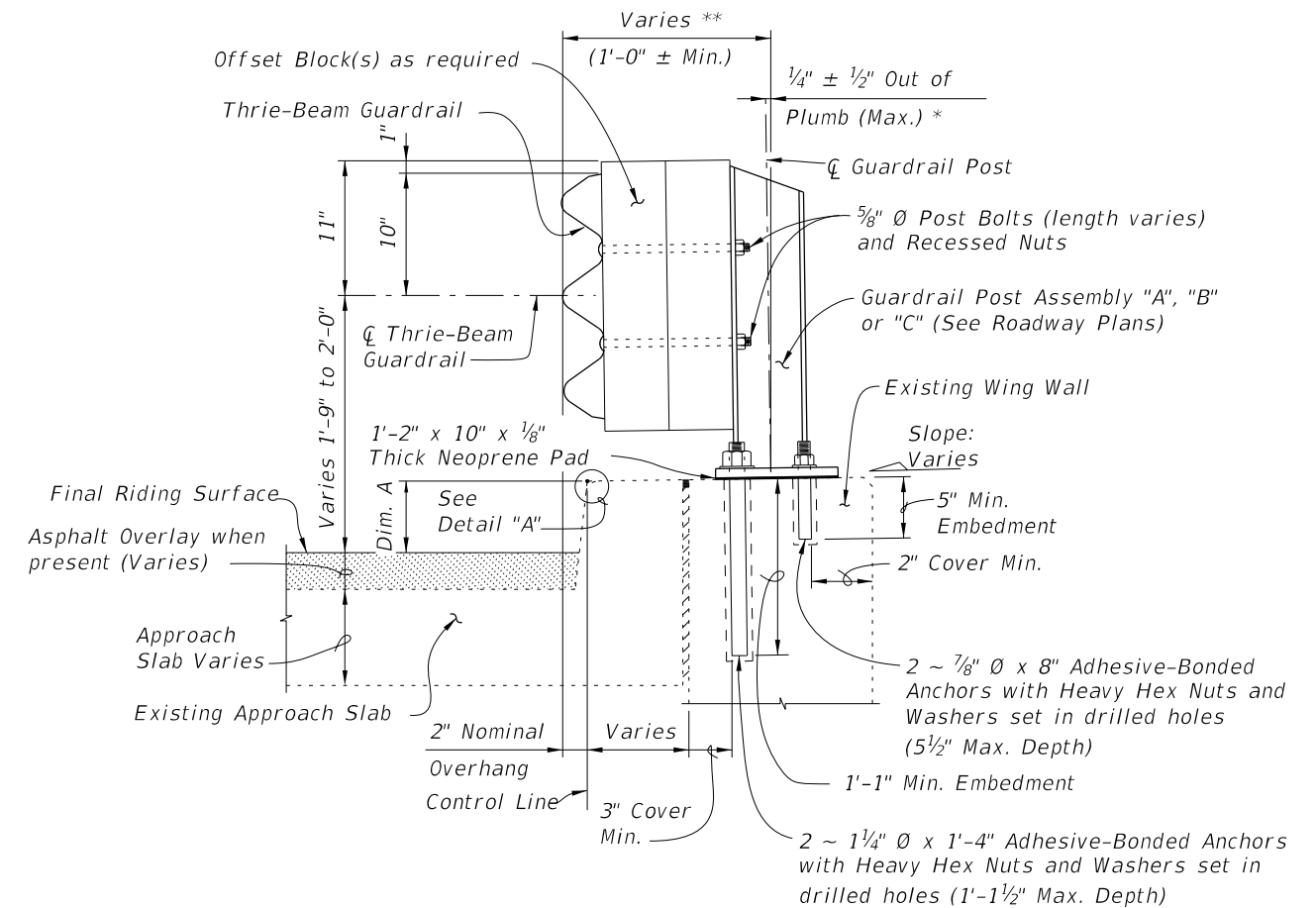

SECTION B-B (SCHEME 2)
TYPICAL SECTION THRU RAILING ALONG APPROACH SLAB

* Shim with washers around Anchor Bolts and Anchors as required to maintain tolerance.

** Offset may vary $\pm 1"$ for Adhesive-Bonded Anchors to clear existing curb reinforcing and provide minimum edge clearance. Offset shall be consistent along length of bridge.

BILL OF REINFORCING STEEL		
MARK	SIZE	LENGTH
L	4	4'-1"
BAR BENDING DIAGRAM		
DOWEL BAR 4L		
NOTE: All bar dimensions are out to out.		

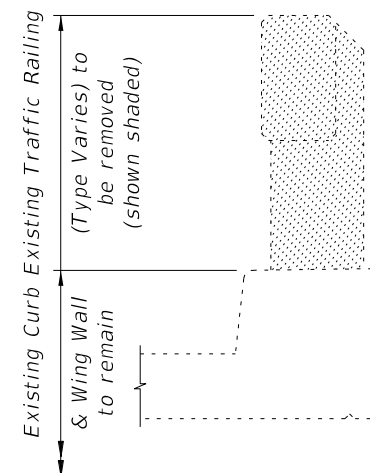

TYPICAL SECTION THRU EXISTING TRAFFIC RAILING SHOWING LIMITS OF REMOVAL (BRIDGE DECK SHOWN, WING WALL SIMILAR)

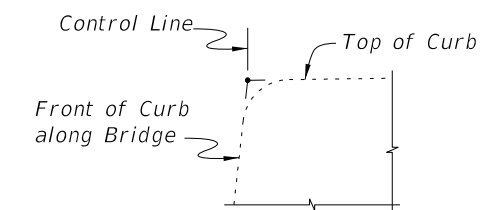

DETAIL "A"

CROSS REFERENCES:
 For location of Section A-A see Sheet 1 and 3.
 For location of Section B-B see Sheet 3
 For application of Dim. A see Post Dimension Table on Index 460-470, Sheet 3.

10/14/2022 8:07:10 AM

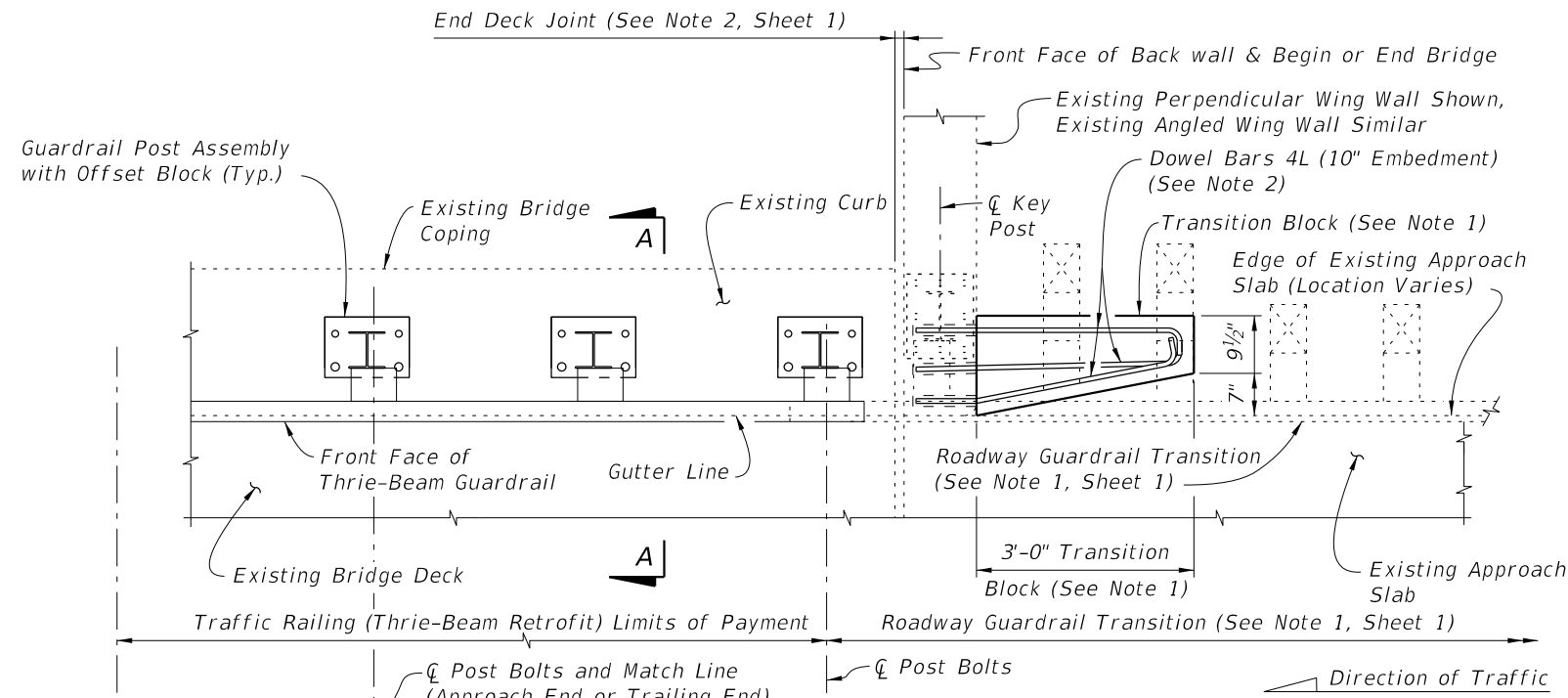

PARTIAL PLAN OF RAILING
(Adhesive Anchor Option shown, Screw Anchor Option similar)
 2 ~ Variable Spaces (6'-3" Max., 3'-1 1/2" Min.)
 11" Post Spacing as measured to ϕ Post Bolts

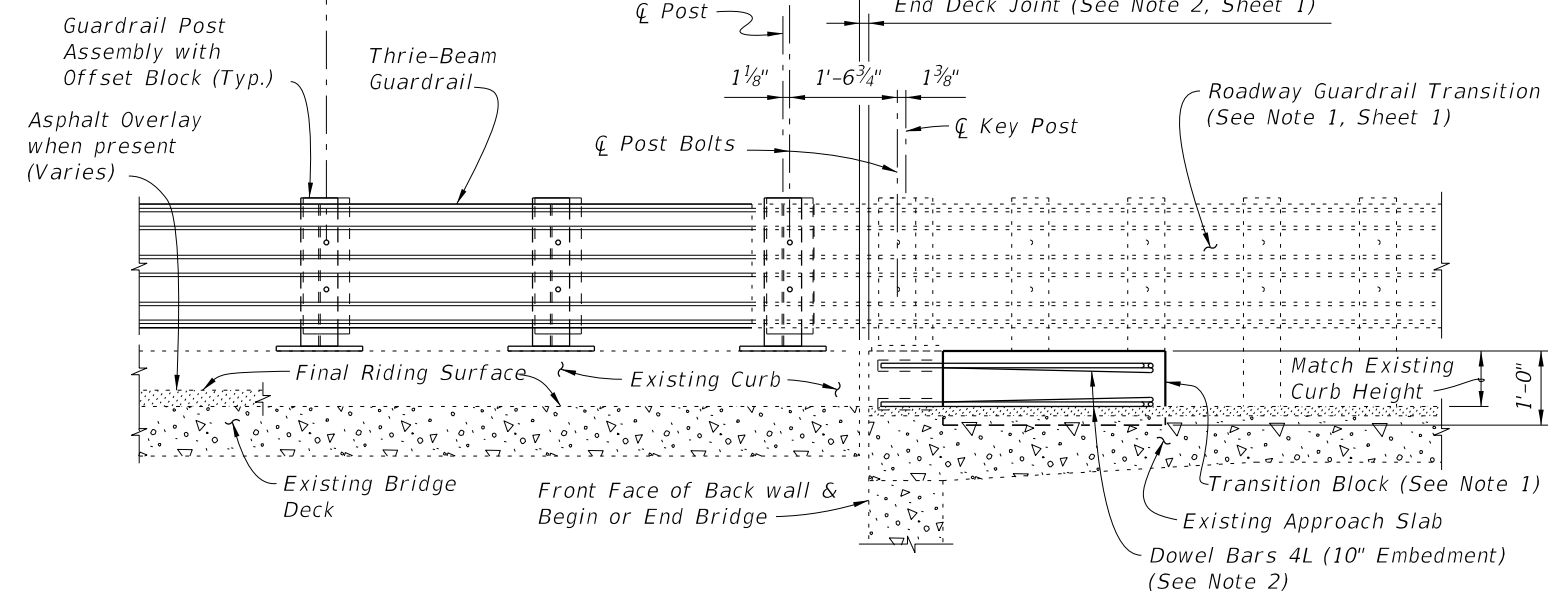

PARTIAL ELEVATION OF INSIDE FACE OF RAILING

SCHEME 1
RAILING END TREATMENT FOR PERPENDICULAR OR ANGLED WING WALLS

SCHEME 1 NOTES:

1. Provide Transition Block (as shown) or Curb if existing Approach Slab does not have a curb, see Roadway Plans. Shape and height of Transition Block or Curb shall match existing bridge curb. Transition Block may be omitted on trailing ends with no opposing traffic.
2. Field bend Dowel Bars 4L within Transition Block as required to maintain 2" top and side clearance and 3" bottom clearance.

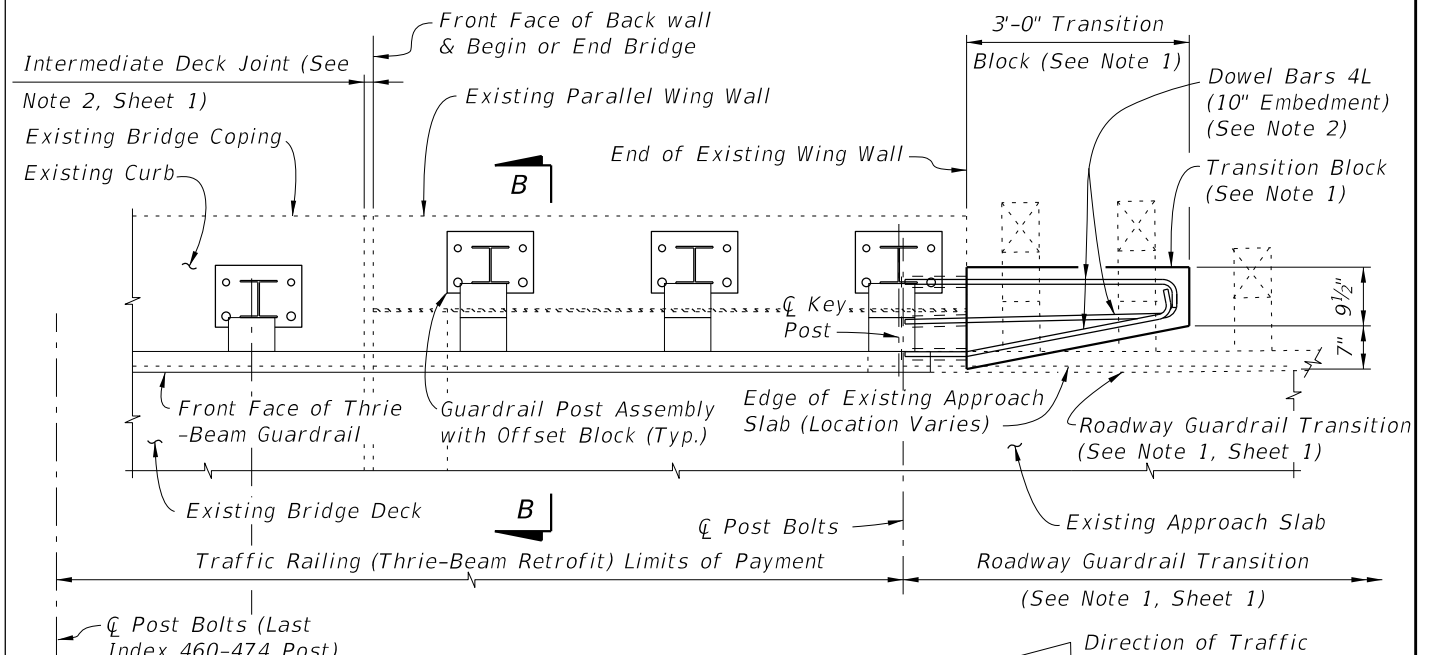

PARTIAL PLAN OF RAILING
(Adhesive Anchor Option shown, Screw Anchor Option similar)
 2 ~ Variable Spaces (6'-3" Max., 3'-1 1/2" Min.)
 11" Post Spacing as measured to ϕ Post Bolts

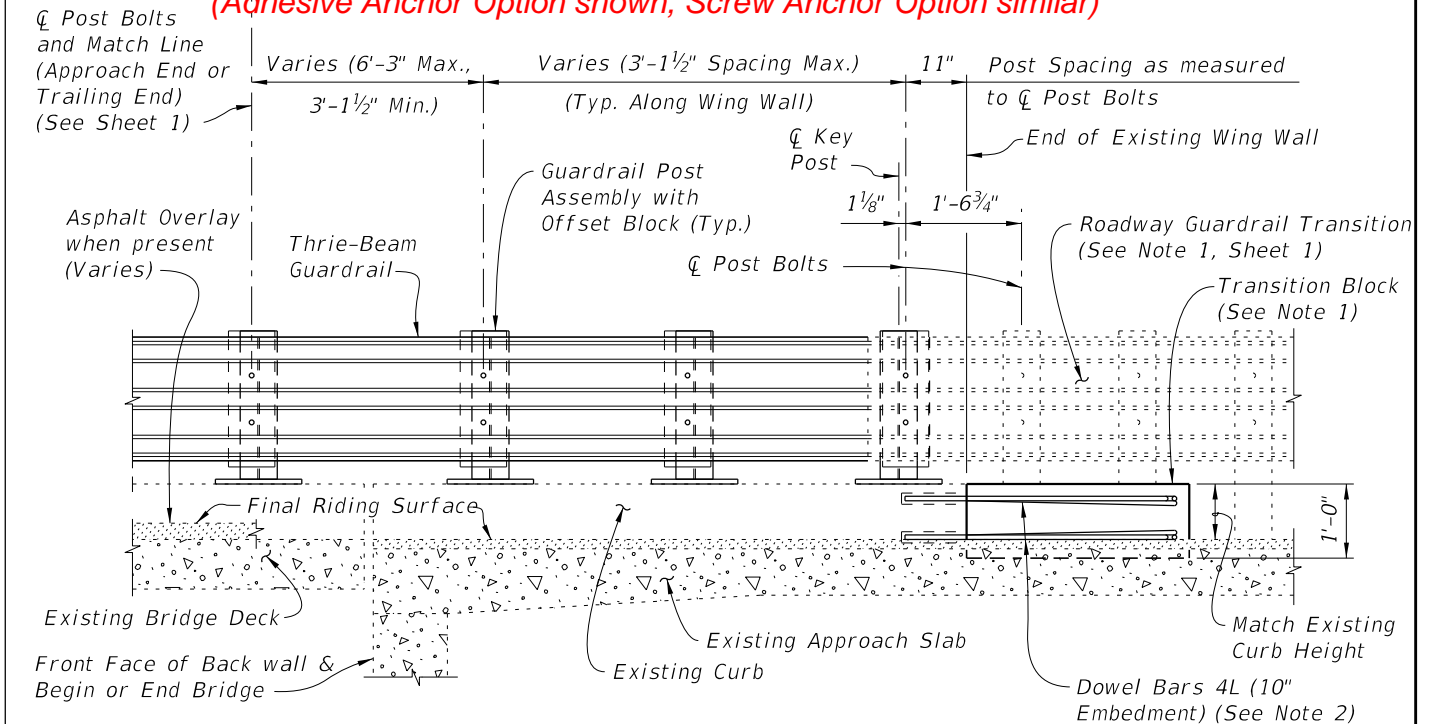

PARTIAL ELEVATION OF INSIDE FACE OF RAILING

SCHEME 2
RAILING END TREATMENT FOR PARALLEL WING WALLS

SCHEME 2 NOTES:

1. Provide Transition Block (as shown) or Curb if existing Approach Slab Curb does not extend to end of Approach Slab. Shape and height of Transition Block or Curb shall match existing bridge curb. Transition Block may be omitted on trailing ends with no opposing traffic.
2. Field bend Dowel Bars 4L within Transition Block as required to maintain 2" top and side clearance and 3" bottom clearance.

10/14/2022 8:07:12 AM

LAST REVISION 01/01/08 11/01/24	DESCRIPTION:	 FY 2023-24 STANDARD PLANS	TRAFFIC RAILING - (THRIE-BEAM RETROFIT) INTERMEDIATE CURB	INDEX 460-474	SHEET 3 of 4
---	--------------	---	--	-------------------------	------------------------

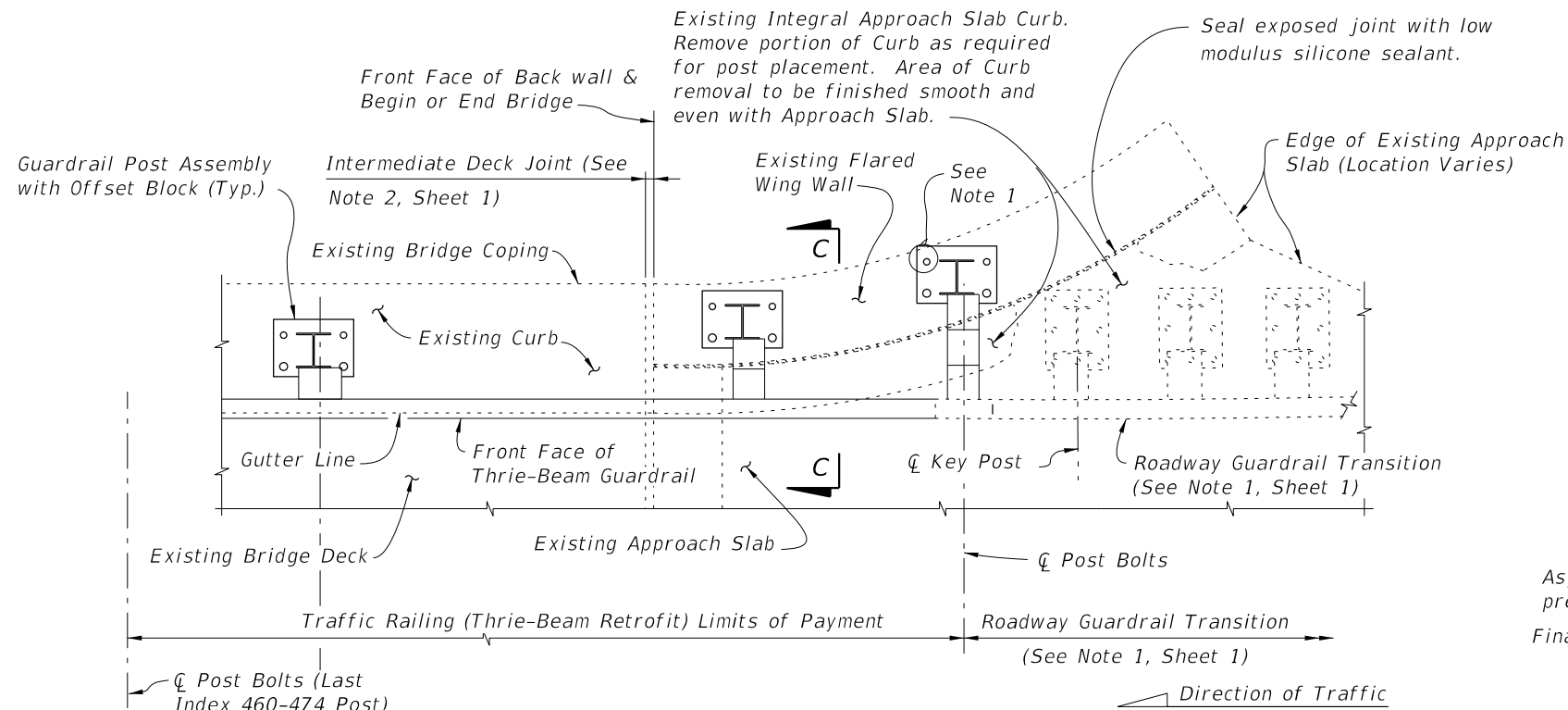

PARTIAL PLAN OF RAILING
(Adhesive Anchor Option shown, Screw Anchor Option similar)

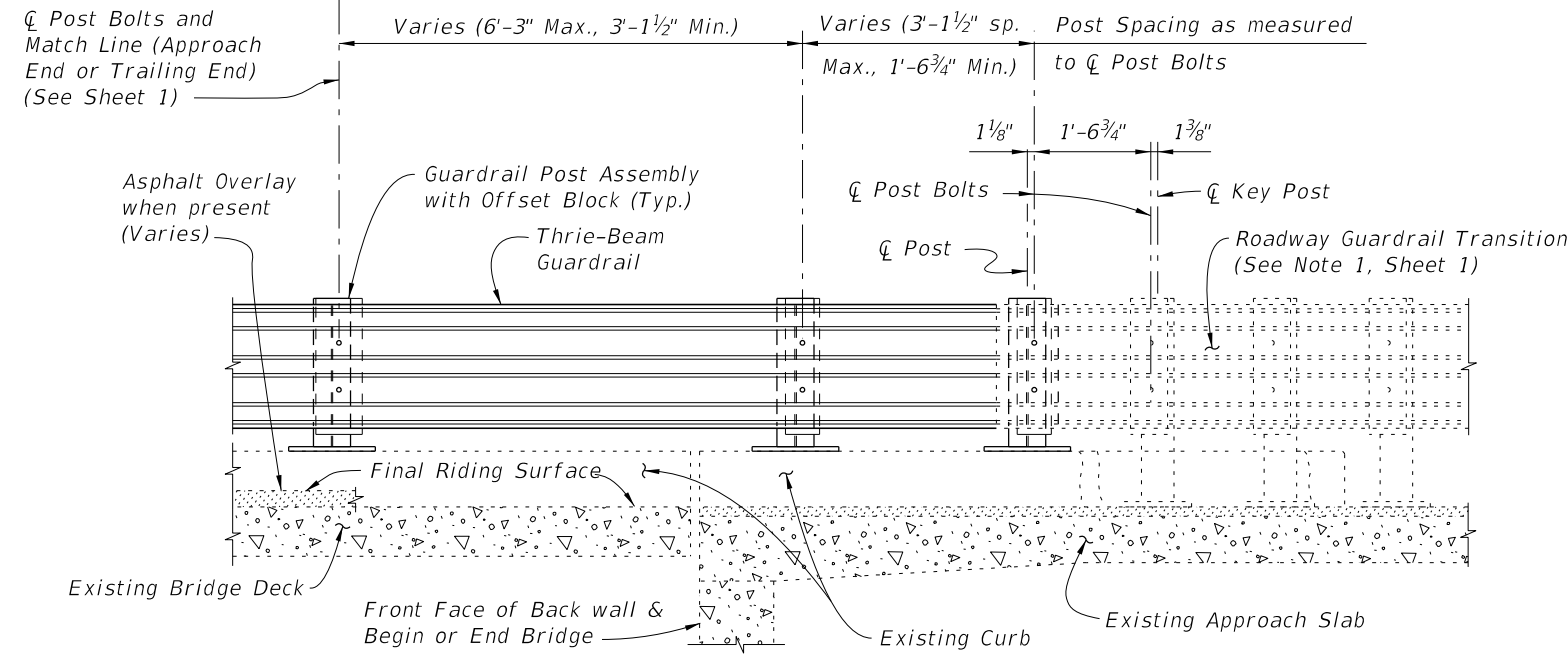

PARTIAL ELEVATION OF INSIDE FACE OF RAILING

SCHEME 3
RAILING END TREATMENT FOR FLARED WING WALLS

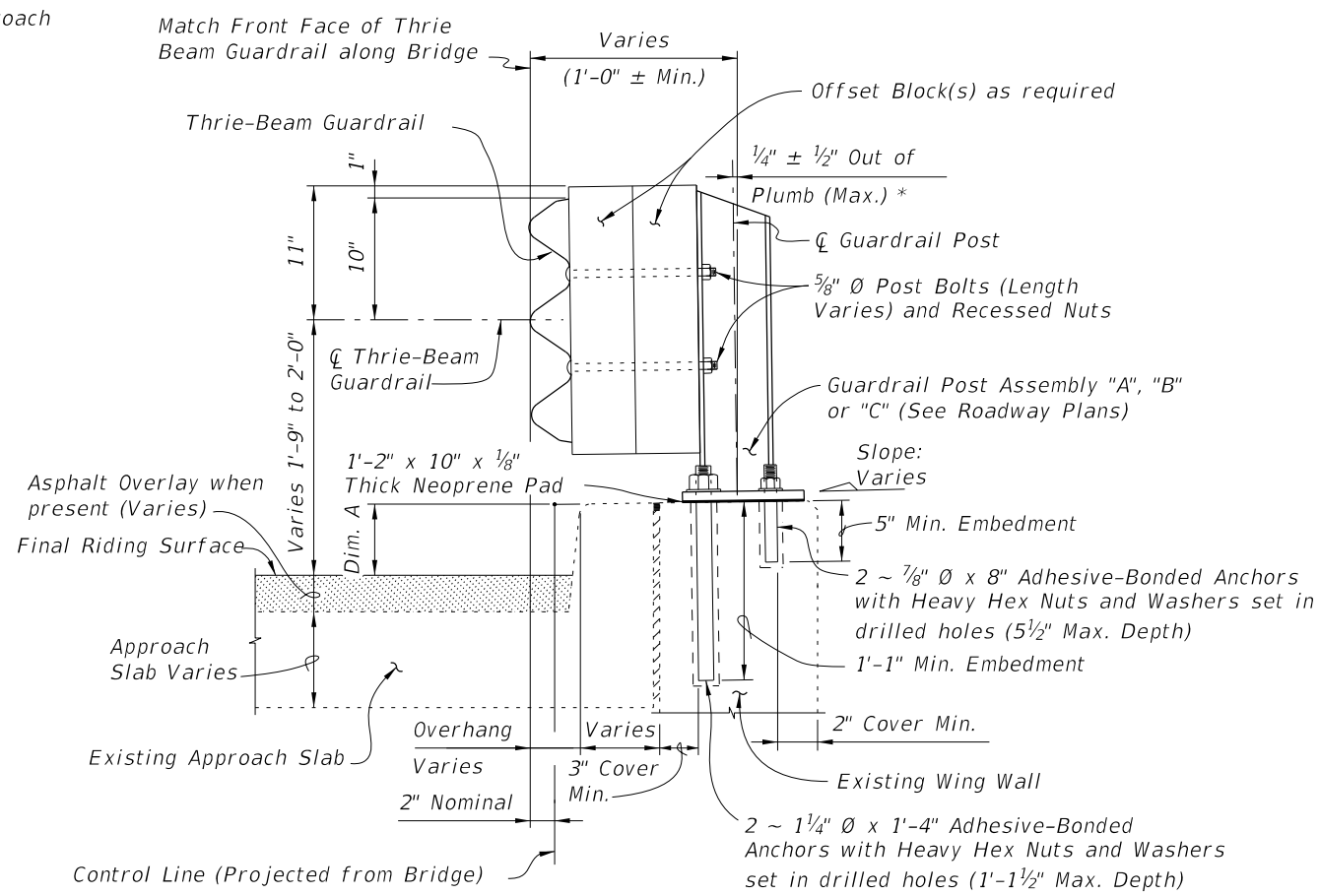

SECTION C-C (SCHEME 3)
TYPICAL SECTION THRU RAILING ALONG APPROACH SLAB
(Adhesive Anchor Option only)

SCHEME 3 NOTE:

1. A single $\frac{7}{8}$ " \varnothing x 8" Adhesive-Bonded Anchor may be omitted as shown when 2" clear cover cannot be provided (see Section C-C).

CROSS REFERENCE:

For application of Dim. A see Post Dimension Table on Index 460-470, Sheet 3.

10/14/2022 8:07:15 AM

LAST REVISION 07/01/09 11/01/24	DESCRIPTION:		FY 2023-24 STANDARD PLANS	TRAFFIC RAILING - (THRIE-BEAM RETROFIT) INTERMEDIATE CURB	INDEX 460-474	SHEET 4 of 4
--	---------------------	--	------------------------------	--	------------------	-----------------

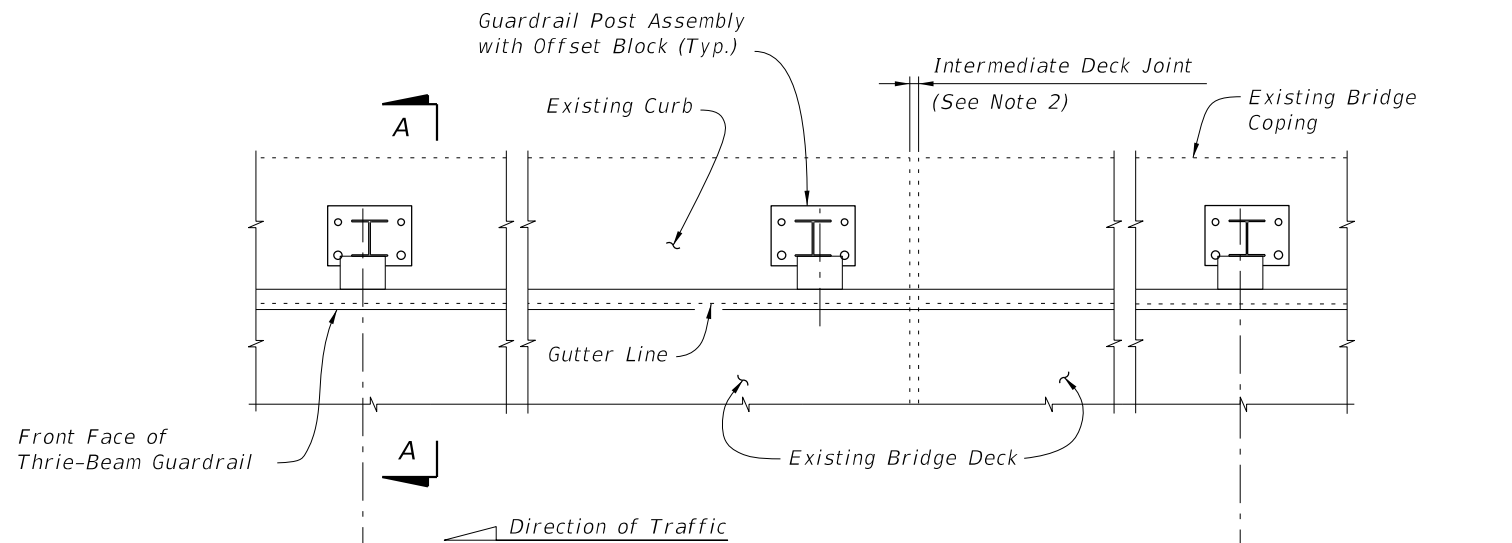

PARTIAL PLAN OF RAILING
(Adhesive Anchor Option shown, Screw Anchor Option similar)

CL Post Bolts and Match Line (Trailing End) (See Sheets 3 and 4)

CL Post Bolts and Match Line (Approach End) (See Sheets 3 and 4)

6'-3" spacing (Typ. except as noted along Bridge, see Note 2)

1'-6" Min. for non skewed joints. For treatment of skewed Intermediate Deck Joints see Skew Detail Index 460-470, Sheet 2 (Typ.)

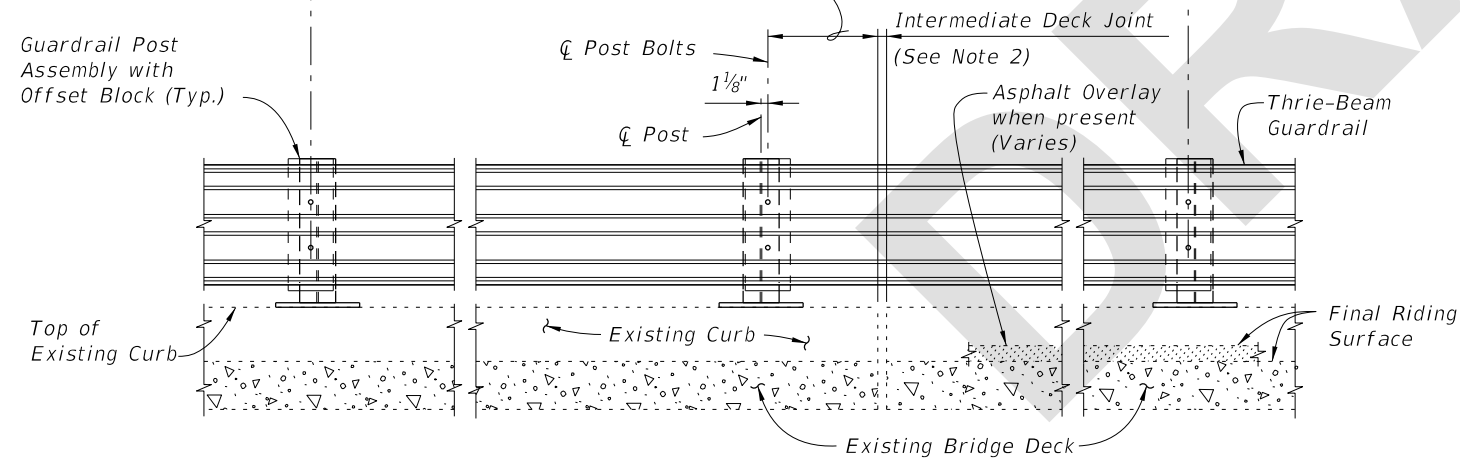

PARTIAL ELEVATION OF INSIDE FACE OF RAILING

==== TYPICAL TREATMENT OF RAILING ALONG BRIDGE ====

NOTES:

1. On approach end provide Index 536-002 (as shown) or other site specific treatment, see Roadway Plans. For treatment of trailing end see Roadway Plans.
2. Actual joint dimension and orientation vary. For Intermediate Deck Joints use the Modified Post Spacing at Intermediate Deck Joints Detail, Index 460-470, Sheet 2, as required.
3. Areas where existing structure has been removed shall match adjoining areas and shall be finished flat by grouting or grinding as required. Exposed existing reinforcing steel shall be burned off 1" below existing concrete and grouted over.

CROSS REFERENCES:

- For Match Line see Sheets 3 & 4.
- For Section A-A see Sheet 2.
- For Traffic Railing Notes and Details see Index 460-470.

5/31/2024 8:05:39 AM

LAST REVISION 11/01/24	REVISION	DESCRIPTION:	 FY 2025-26 STANDARD PLANS	TRAFFIC RAILING - (THRIE-BEAM RETROFIT) INTERMEDIATE CURB	INDEX 460-474	SHEET 1 of 4
---------------------------	----------	--------------	---	--	------------------	-----------------

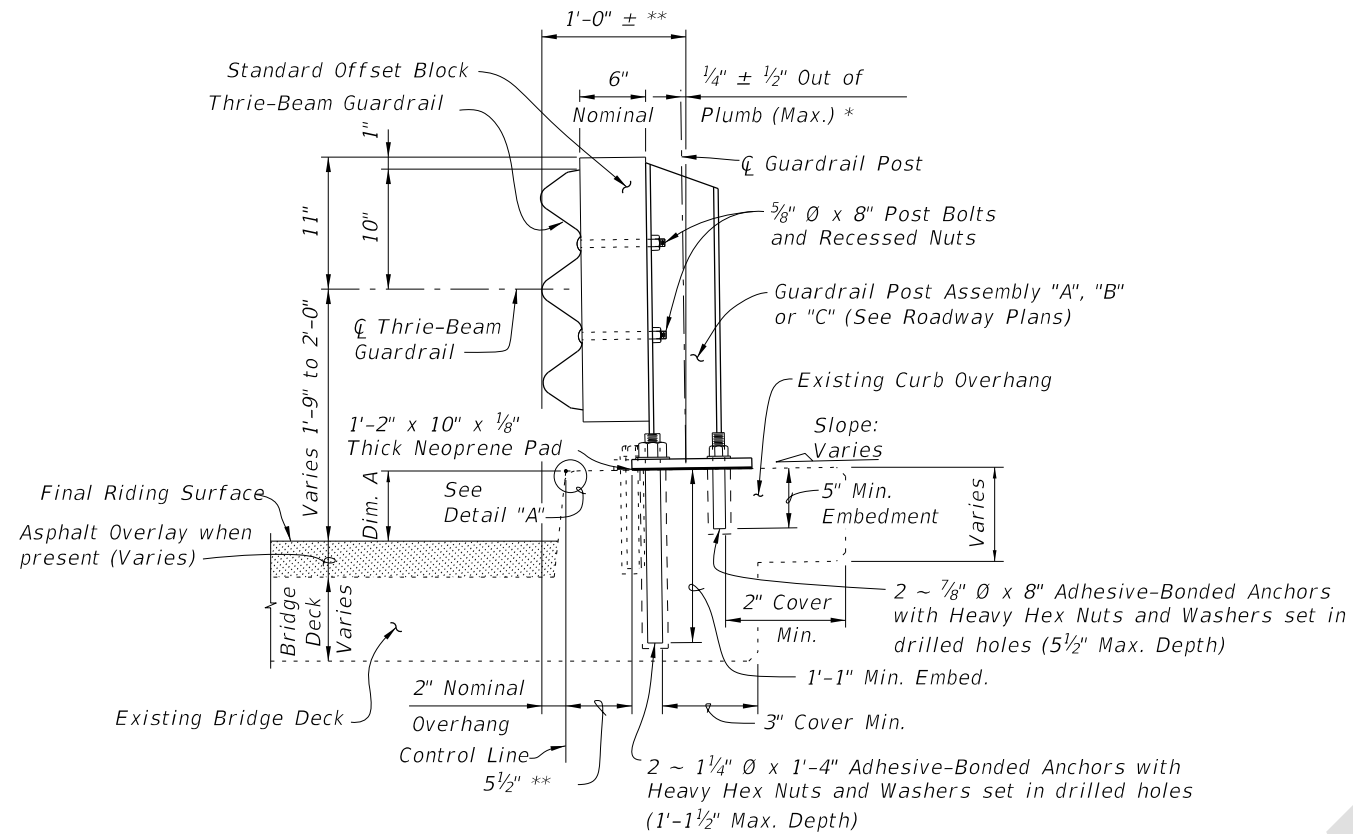

SECTION A-A
TYPICAL SECTION THRU RAILING ON BRIDGE DECK
 (Adhesive Anchor Option shown solid, Screw Anchor Option shown dashed)

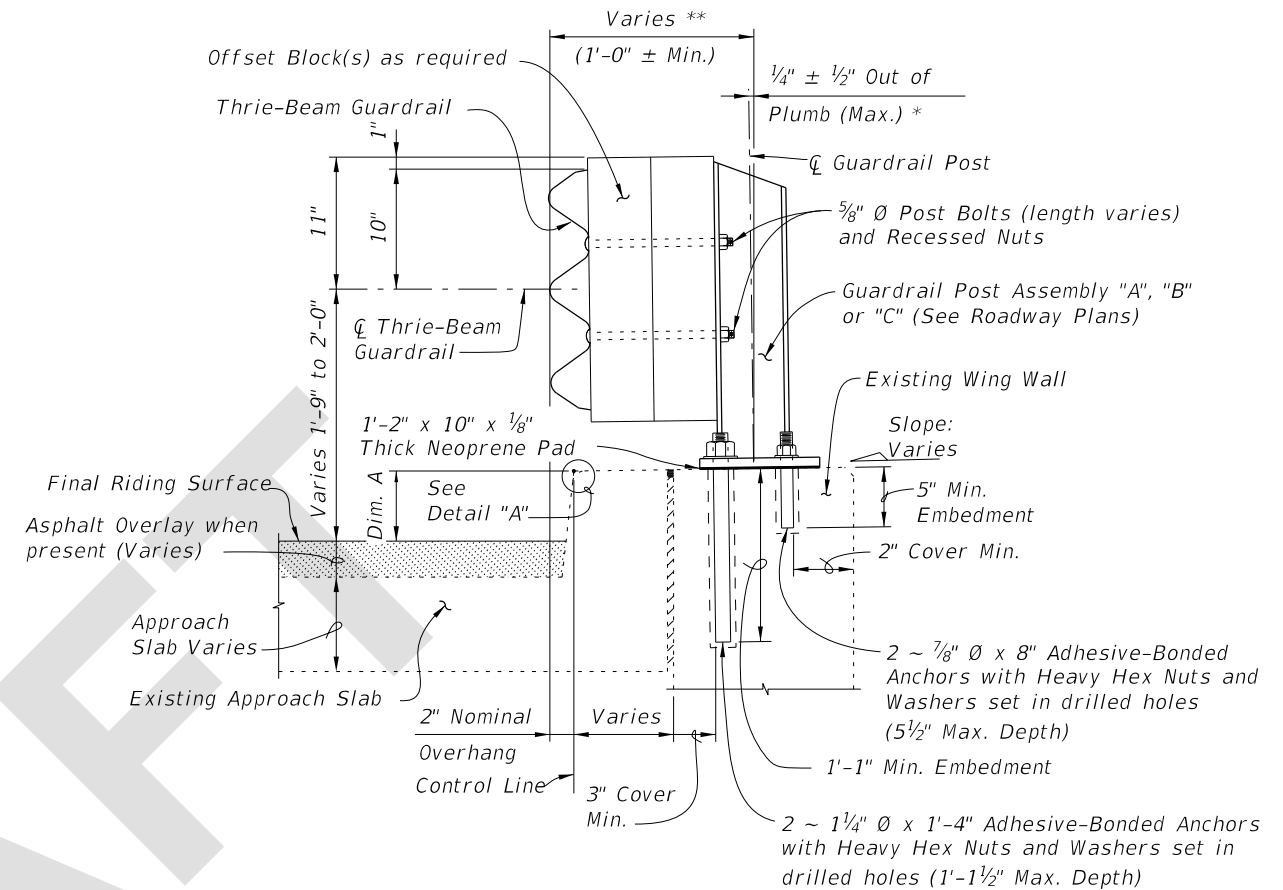

SECTION B-B (SCHEME 2)
TYPICAL SECTION THRU RAILING ALONG APPROACH SLAB

* Shim with washers around Anchor Bolts and Anchors as required to maintain tolerance.

** Offset may vary ± 1 " for Adhesive-Bonded Anchors to clear existing curb reinforcing and provide minimum edge clearance. Offset shall be consistent along length of bridge.

BILL OF REINFORCING STEEL		
MARK	SIZE	LENGTH
L	4	4'-1"
BAR BENDING DIAGRAM		
DOWEL BAR 4L		
NOTE: All bar dimensions are out to out.		

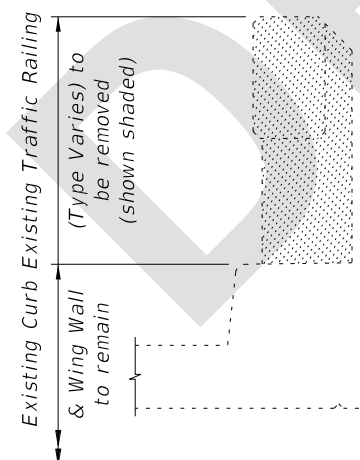

TYPICAL SECTION THRU EXISTING TRAFFIC RAILING SHOWING LIMITS OF REMOVAL (BRIDGE DECK SHOWN, WING WALL SIMILAR)

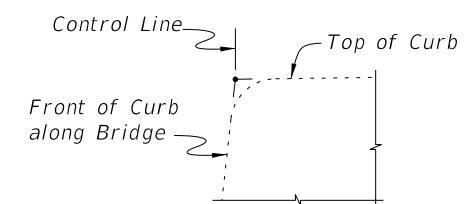

DETAIL "A"

CROSS REFERENCES:
 For location of Section A-A see Sheet 1 and 3.
 For location of Section B-B see Sheet 3
 For application of Dim. A see Post Dimension Table on Index 460-470, Sheet 3.

5/31/2024 8:06:12 AM

LAST REVISION 11/01/24	DESCRIPTION:		FY 2025-26 STANDARD PLANS	TRAFFIC RAILING - (THRIE-BEAM RETROFIT) INTERMEDIATE CURB	INDEX 460-474	SHEET 2 of 4
---------------------------	--------------	--	------------------------------	--	------------------	-----------------

5/31/2024 8:06:37 AM

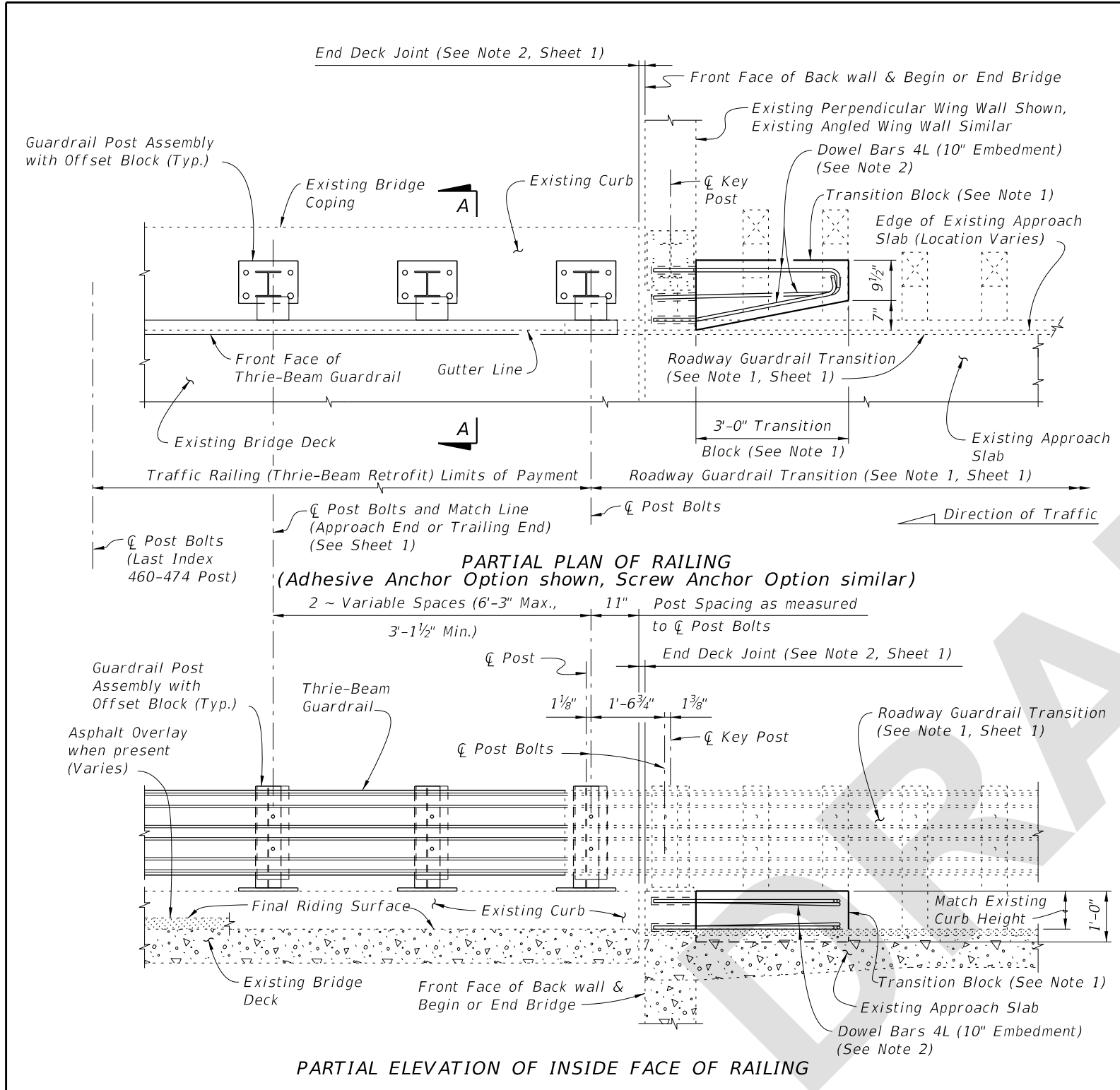

SCHEME 1
RAILING END TREATMENT FOR PERPENDICULAR OR ANGLED WING WALLS

- SCHEME 1 NOTES:**
1. Provide Transition Block (as shown) or Curb if existing Approach Slab does not have a curb, see Roadway Plans. Shape and height of Transition Block or Curb shall match existing bridge curb. Transition Block may be omitted on trailing ends with no opposing traffic.
 2. Field bend Dowel Bars 4L within Transition Block as required to maintain 2" top and side clearance and 3" bottom clearance.

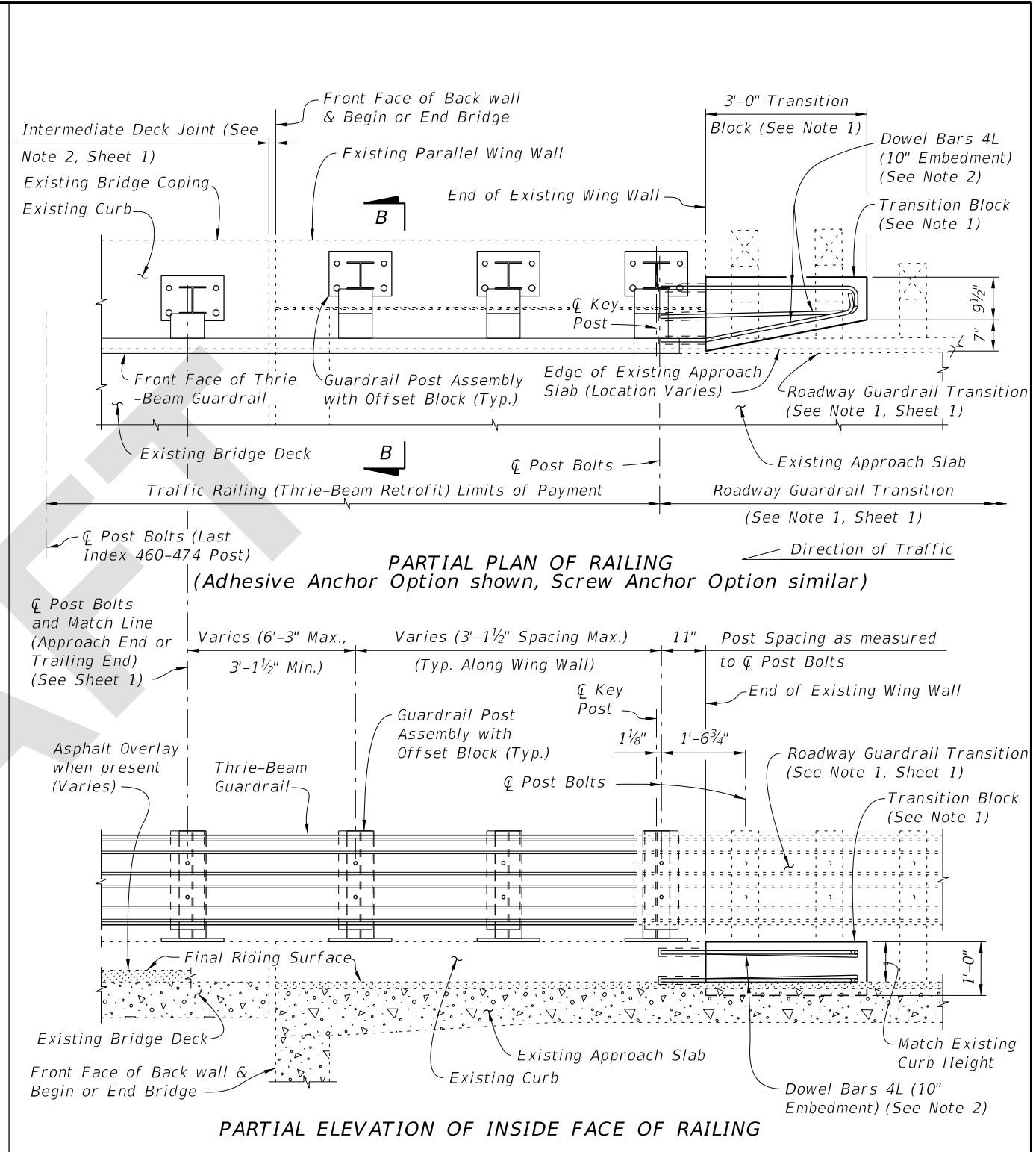

SCHEME 2
RAILING END TREATMENT FOR PARALLEL WING WALLS

- SCHEME 2 NOTES:**
1. Provide Transition Block (as shown) or Curb if existing Approach Slab Curb does not extend to end of Approach Slab. Shape and height of Transition Block or Curb shall match existing bridge curb. Transition Block may be omitted on trailing ends with no opposing traffic.
 2. Field bend Dowel Bars 4L within Transition Block as required to maintain 2" top and side clearance and 3" bottom clearance.

LAST REVISION 11/01/24	REVISION	DESCRIPTION:	 FY 2025-26 STANDARD PLANS	TRAFFIC RAILING - (THRIE-BEAM RETROFIT) INTERMEDIATE CURB	INDEX 460-474	SHEET 3 of 4
---------------------------	----------	--------------	---	--	-------------------------	------------------------

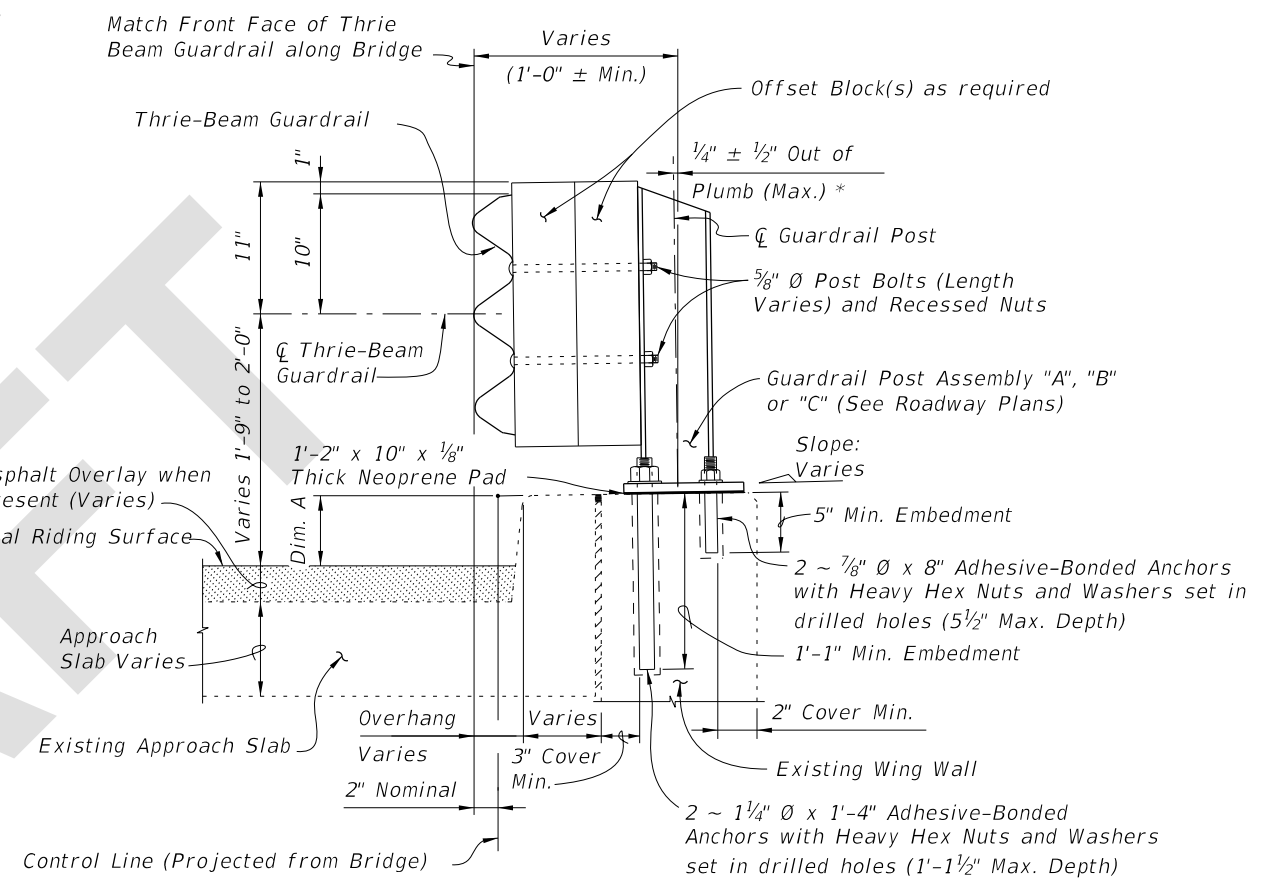
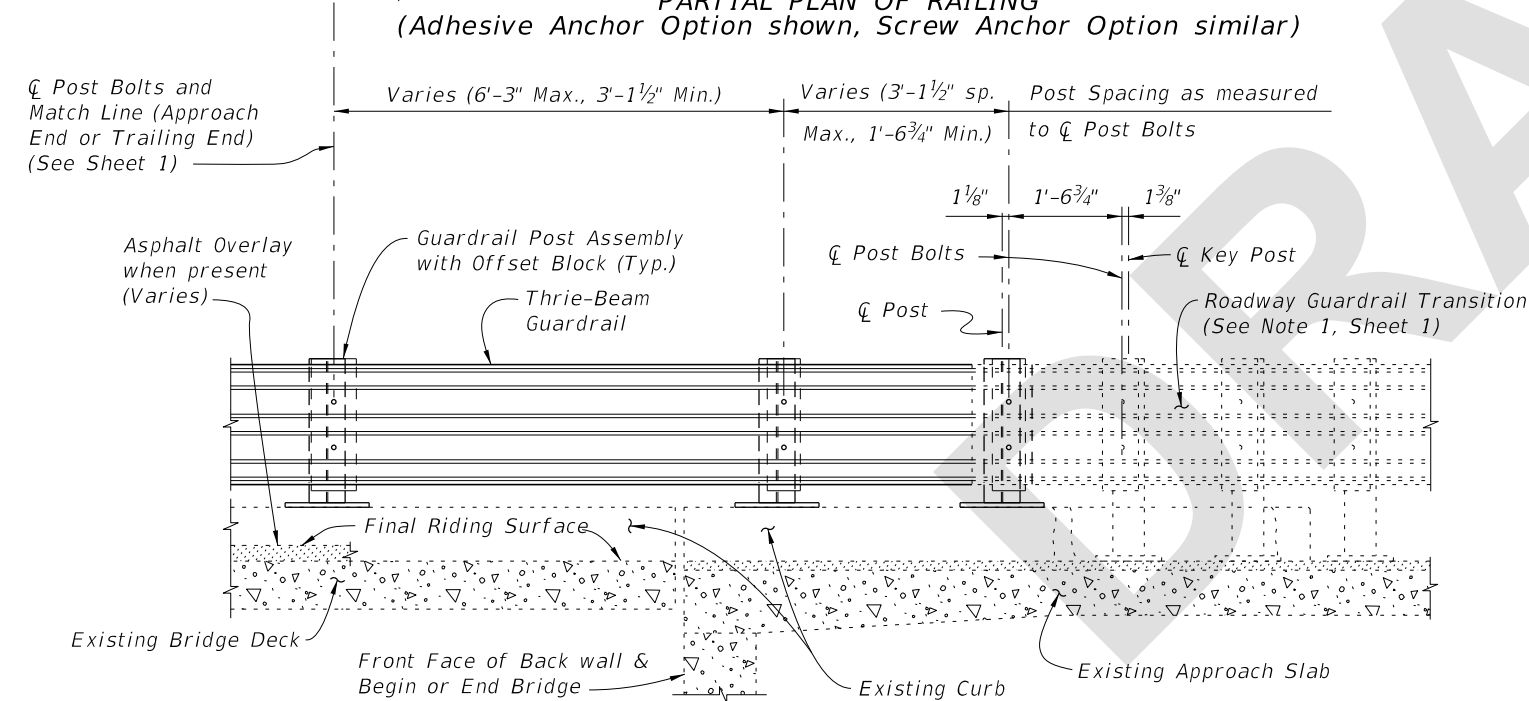
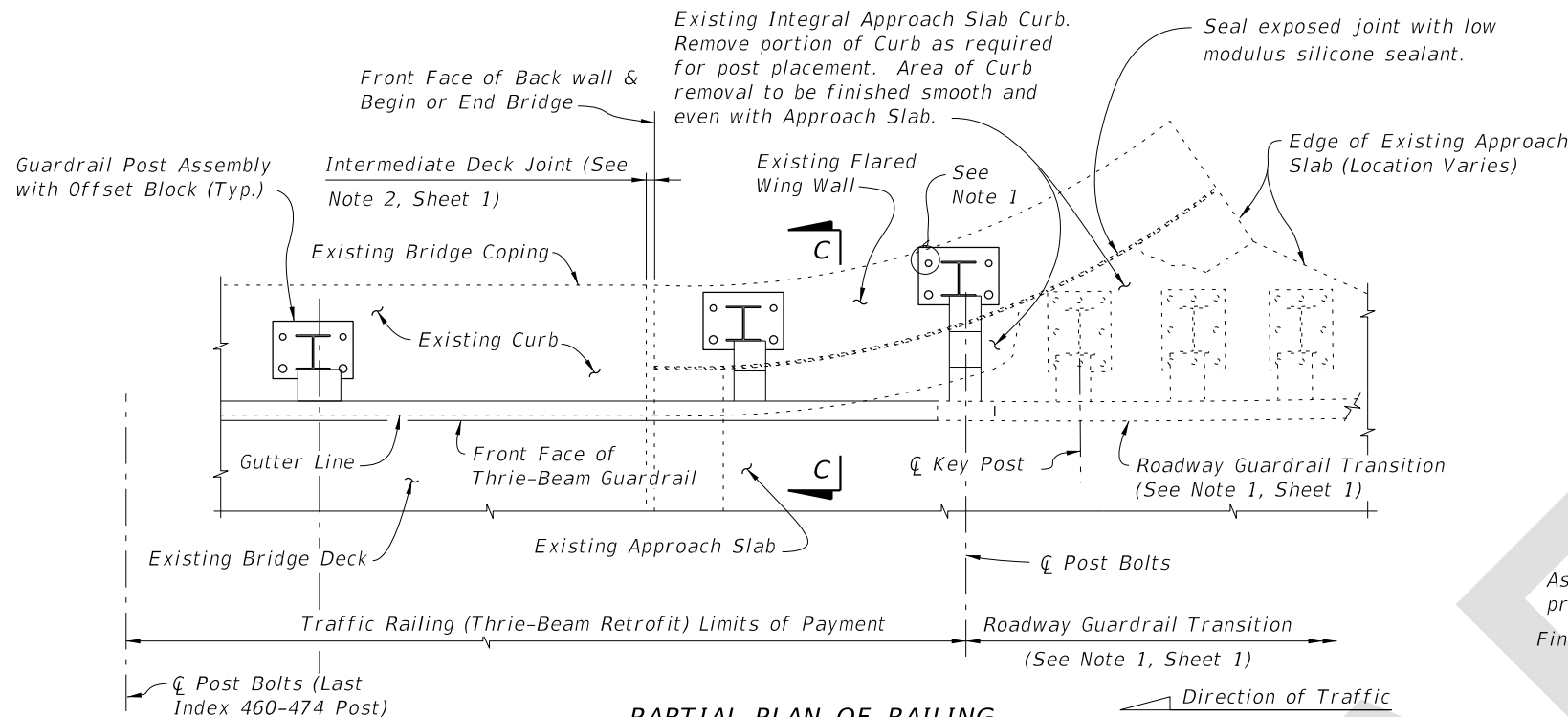

**SECTION C-C (SCHEME 3)
TYPICAL SECTION THRU RAILING ALONG APPROACH SLAB
(Adhesive Anchor Option only)**

SCHEME 3 NOTE:
1. A single 7/8" Ø x 8" Adhesive-Bonded Anchor may be omitted as shown when 2" clear cover cannot be provided (see Section C-C).

CROSS REFERENCE:
For application of Dim. A see Post Dimension Table on Index 460-470, Sheet 3.

**SCHEME 3
RAILING END TREATMENT FOR FLARED WING WALLS**

5/31/2024 8:07:07 AM

LAST REVISION 11/01/24	DESCRIPTION:		FY 2025-26 STANDARD PLANS	TRAFFIC RAILING - (THRIE-BEAM RETROFIT) INTERMEDIATE CURB	INDEX 460-474	SHEET 4 of 4