ORIGINATION FORM

Proposed Revisions to a Standard Plans Index
(Please provide all information — Incomplete forms will be returned)

Contact Information:

Date: June 3, 2020
Originator: Derwood Sheppard
Phone: (850) 414-4334
Email: derwood.sheppard@dot.state.fl.us

Standard Plans:

Index Number: 700-102
Sheet Number (s): All Sheets
Index Title: Special Sign Details

Summary of the changes:

Sheet 1: Renumbered.
Sheet 2: Renumbered.
Sheet 3: Renumbered.
Sheet 4: Renumbered.
Sheet 5: Deleted: FTP-26-06; Shifted Sings on sheet; Renumbered.
Sheet 6: Shifted Sings on sheet; Renumbered.
Sheet 7: Shifted Sings on sheet; Renumbered.
Sheet 8: Shifted Sings on sheet; Changed signs FTP-66-06 and FTP-67-06; Changed FTP-66 and FTP-67 Logo;
Added new sign FTP-68C-21; Renumbered.
Sheet 10: Seeded new sign FTP-86-21 and FTP-87-21; Shifted Sings on sheet; Renumbered.
Sheet 11: Shifted Sings on sheet; Added signs Mot-20-21, Mot-21-21, and Mot 23-21; Renumbered.
Sheet 12: New Sheet; added sign MOT-23-21, Bike Lane Closed Signs - MOT-24-21 (2'-6"x1'-6"),
MOT-25-21 (2'-0"x1'-6").

Commentary / Background:

Other Affected Offices / Documents: (Provide name of person contacted)

Yes	No	
<input checked="" type="checkbox"/>	<input type="checkbox"/>	Other Standard Plans – Rick Jenkins
<input type="checkbox"/>	<input checked="" type="checkbox"/>	FDOT Design Manual –
<input type="checkbox"/>	<input checked="" type="checkbox"/>	Basis of Estimates Manual –
<input checked="" type="checkbox"/>	<input type="checkbox"/>	Standard Specifications – Daniel Strickland
<input type="checkbox"/>	<input checked="" type="checkbox"/>	Approved Product List –
<input type="checkbox"/>	<input checked="" type="checkbox"/>	Construction –
<input type="checkbox"/>	<input checked="" type="checkbox"/>	Maintenance –

Origination Package Includes:

(Email or hand deliver package to Rick Jenkins)

Yes	N/A	
<input checked="" type="checkbox"/>	<input type="checkbox"/>	Redline Mark-ups
<input type="checkbox"/>	<input checked="" type="checkbox"/>	Proposed Standard Plan Instruction (SPI)
<input type="checkbox"/>	<input checked="" type="checkbox"/>	Revised SPI
<input type="checkbox"/>	<input checked="" type="checkbox"/>	Other Support Documents

Implementation:

Design Bulletin (Interim)
 DCE Memo
 Program Mgmt. Bulletin
 FY-Standard Plans (Next Release)

Contact the Roadway Design Office for assistance in completing this form

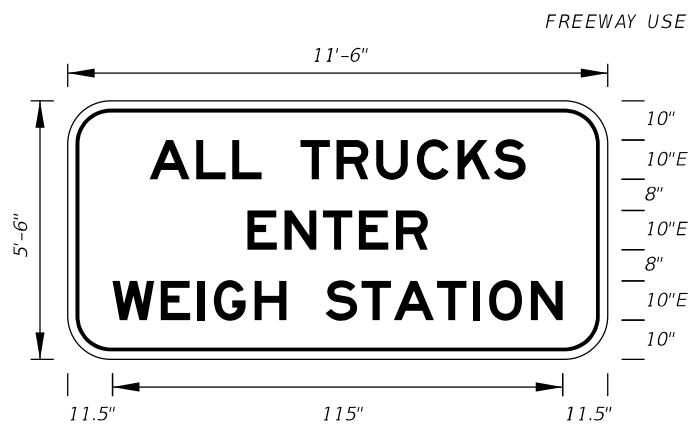

FTP-1-06
11'-6" X 5'-6"
9" Radii 2" Border

10" Series E Legend
White Background
Black Legend and Border

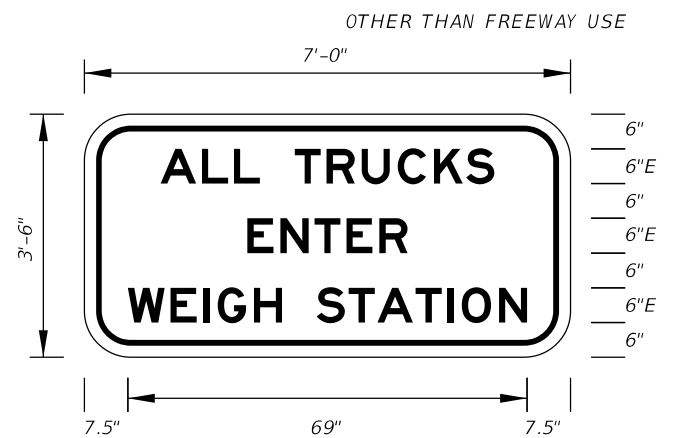

FTP-2-06
7' X 3'-6"
6" Radii 2" Border

6" Series E Legend
White Background
Black Legend and Border

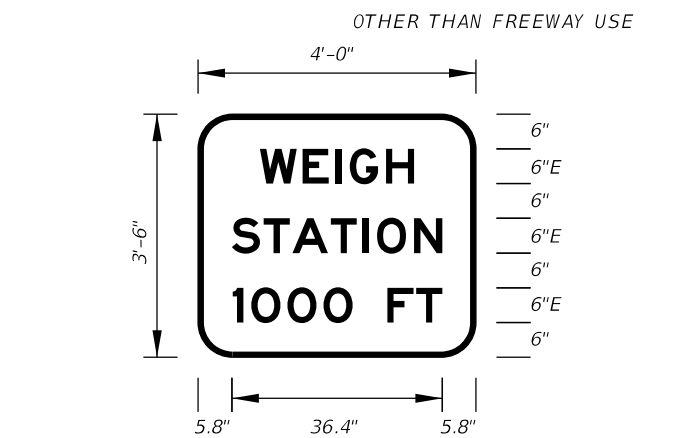

FTP-3-06
4' X 3'-6"
6" Radii 2" Border

6" Series E Legend
White Background
White Legend and Border

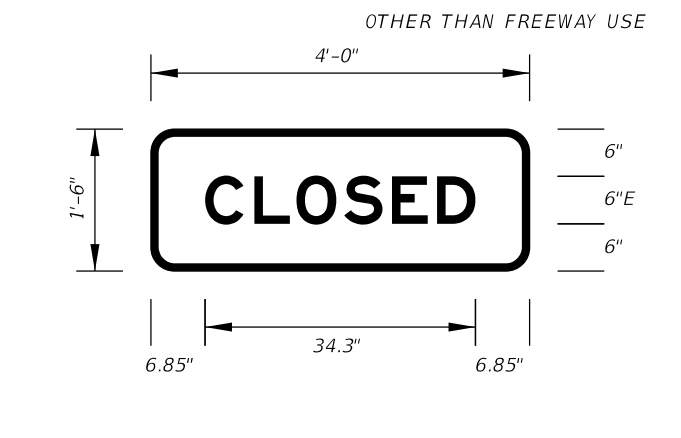

FTP-4-06
4' X 1'-6"
3" Radii 2" Border

6" Series E Legend
Green Background
White Legend and Border

Note:
FTP-4-06 to be
used with FTP-3-06

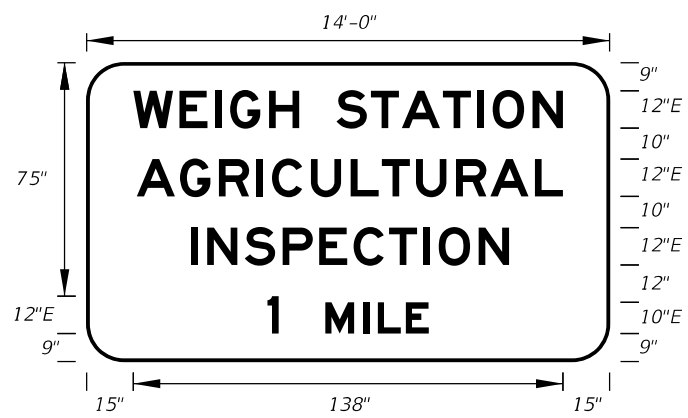

FTP-5-06
14' X 8'
12" Radii 2" Border

12" and 10" Series E Legend
Green Background
White Legend and Border

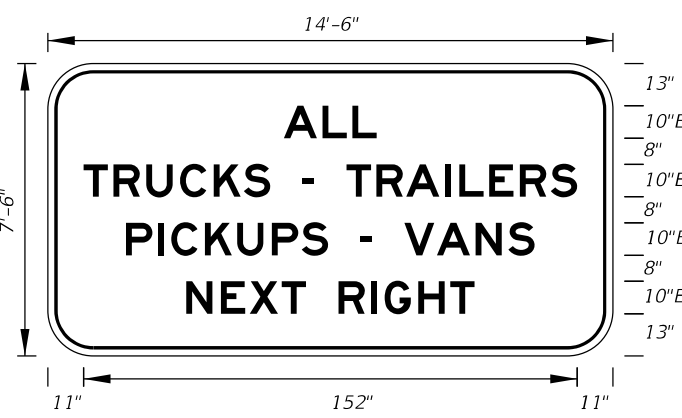

FTP-6A-06
14'-6" X 7'-6"
12" Radii 2" Border

10" Series E Legend
White Background
Black Legend and Border

On Interstate Station
Delete Pickups-Vans,
and reduce Sign height
accordingly.

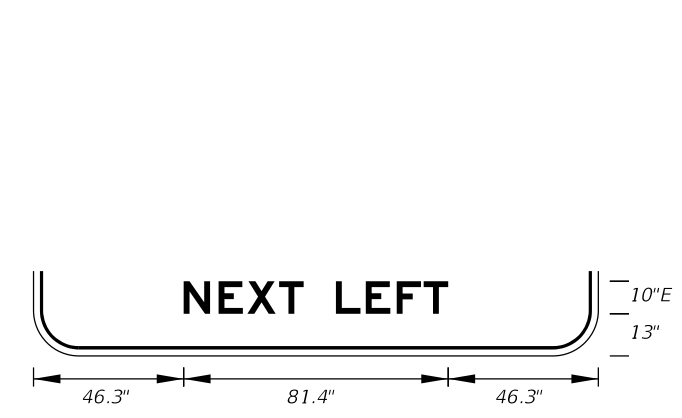

FTP-6B-06
14'-6" X 7'-6"
12" Radii 2" Border

10" Series E Legend
White Background
Black Legend and Border



FTP-7A-06
12' X 7'
11" Radii 2" Border

10" Series E Legend
Green Background
White Legend and Border

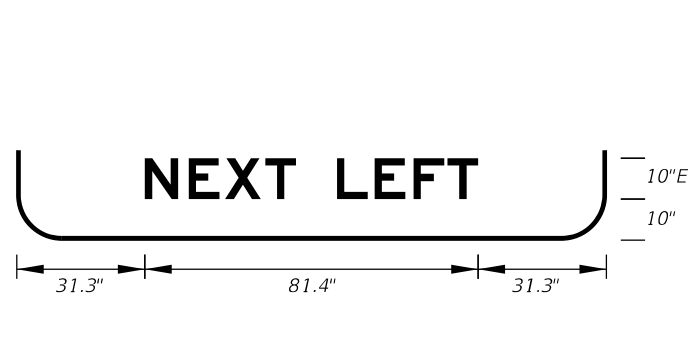

FTP-7B-06
12' X 7'
11" Radii 2" Border
10" Series E Legend
Green Background
White Legend and Border

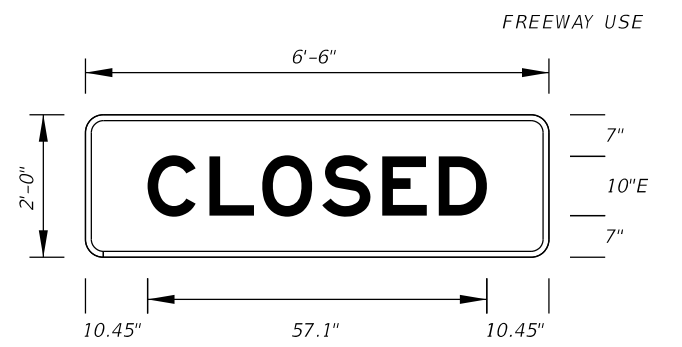

FTP-8-06
6'-6" X 2'
3" Radii 2" Border
10" Series E Legend
Green Background
White Legend and Border

Note:
FTP-8-06 to be
used with FTP-7A-06
& FTP-7B-06.

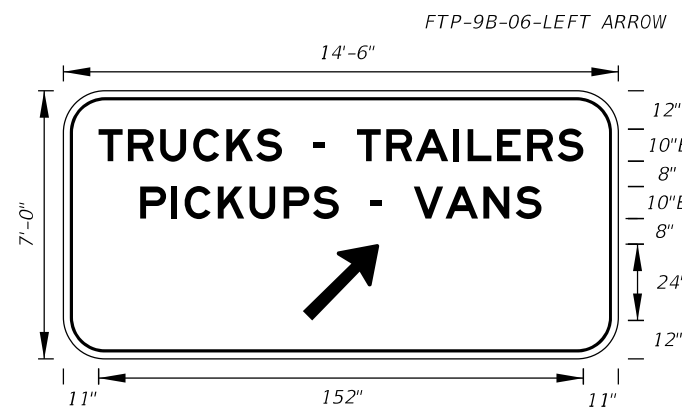

FTP-9A-06
14'-6" X 7'
11" Radii 2" Border

10" Series E Legend
Green Background
White Legend and Border

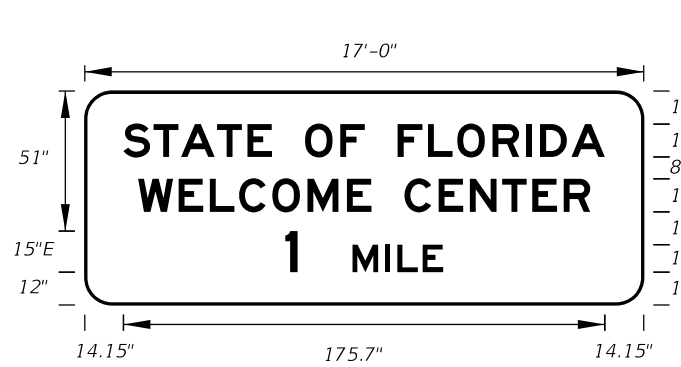

FTP-10-06
17' X 6'-6"
10" Radii 2" Border

12", 10" and 15" Series E Legend
Blue Background
White Legend and Border

10/14/2019 2:42:05 PM

LAST REVISION	DESCRIPTION:
11/01/17	11/01/20

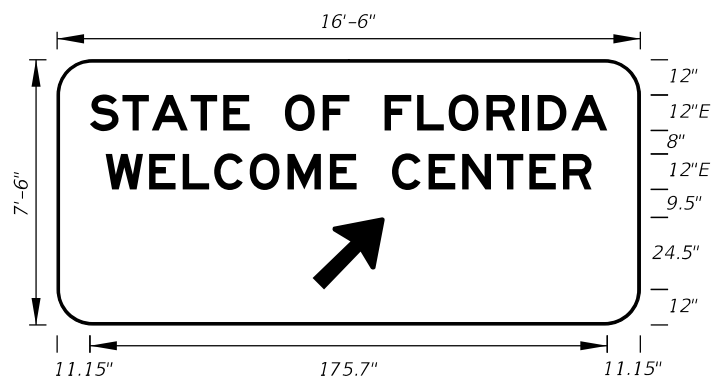

FTP-11-06
 16'-6" X 7'-6"
 12" Radii 2" Border
 12" Series E Legend
 Blue Background
 White Legend and Border

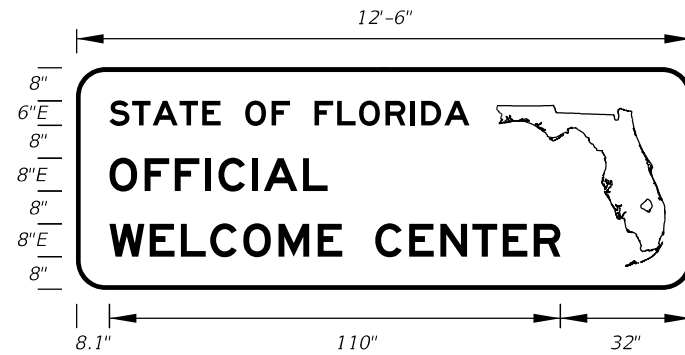

FTP-12-06
 12'-6" X 4'-6"
 7" Radii 2" Border
 6" and 8" Series E Legend
 Blue Background
 White Legend and Border

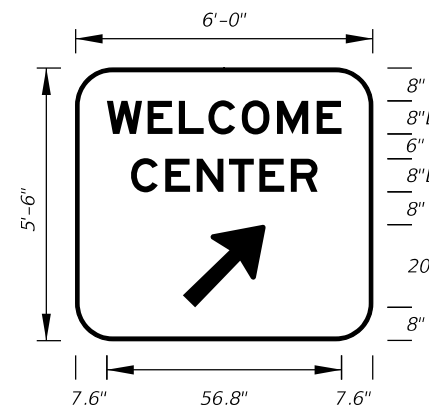

FTP-13-06
 6' 0" X 5'-6"
 9" Radii 2" Border
 8" Series E Legend
 Blue Background
 White Legend and Border

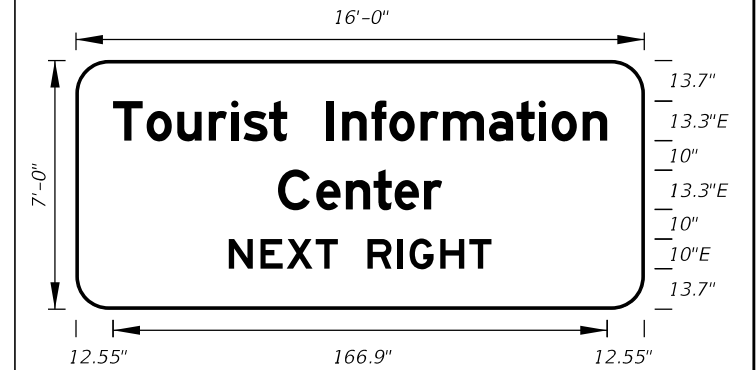

FTP-14-06
 16'-0" X 7'-0"
 11" Radii 2" Border
 13.3 and 10" Series E Legend
 Blue Background
 White Legend and Border

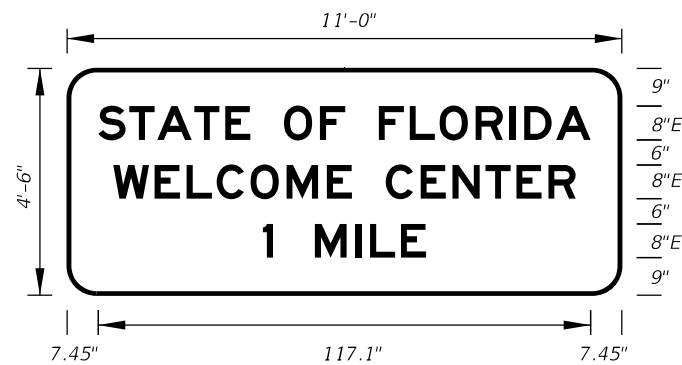

FTP-15A-06
 11'-0" X 4'-6"
 7" Radii 2" Border
 8" Series E Legend
 Blue Background
 White Legend and Border

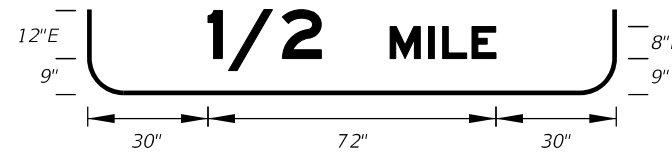

FTP-15B-06
 11'-0" X 5'-0"
 8" Radii 2" Border
 8" and 12" Series E Legend
 Blue Background
 White Legend and Border

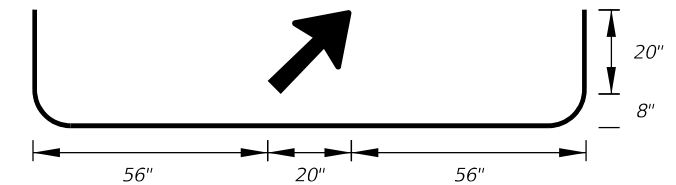

FTP-15C-06
 11'-0" X 5'-6"
 9" Radii 2" Border
 8" Series E Legend
 Blue Background
 White Legend and Border



FTP-16-10
 2'-6" X 3'-0"
 1.5" Radii 3/4" Border
 5" Series B Legend
 Green Background
 White Legend, Border,
 and Florida Symbol



FTP-17-10
 3'-0" X 4'-0"
 1.5" Radii 3/4" Border
 7" Series B Legend
 Green Background
 White Legend, Border,
 and Florida Symbol



FTP-18-10
 4'-0" X 5'-0"
 3" Radii 1 1/4" Border
 8" Series B Legend
 Green Background
 White Legend, Border,
 and Florida Symbol

10/14/2019 2:42:05 PM

LAST REVISION	DESCRIPTION:
11/01/17	11/01/20



FY 2020-21
 STANDARD PLANS

SPECIAL SIGN DETAILS

INDEX
 700-102

SHEET
 2 of 11

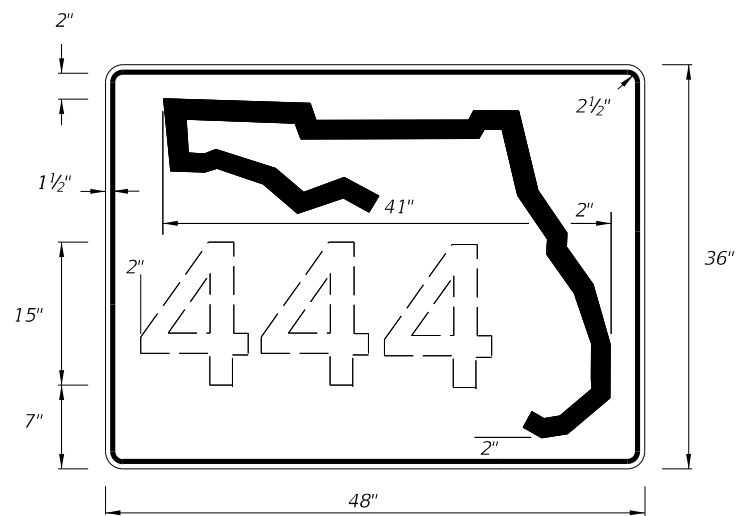

DIGITS	NUMERAL SIZE	SERIES LEGEND	PANEL SIZE
1-3	15"	C	48" x 36"
4	12"	C	48" x 36"

NOTES:

- Stroke width of State Outline shall be 1".
- 2 1/2" Radii

INDEPENDENT USE FOR FREEWAY

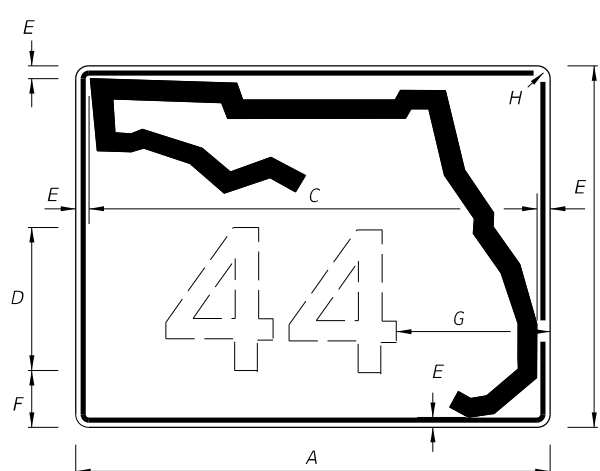

1 OR 2 DIGITS

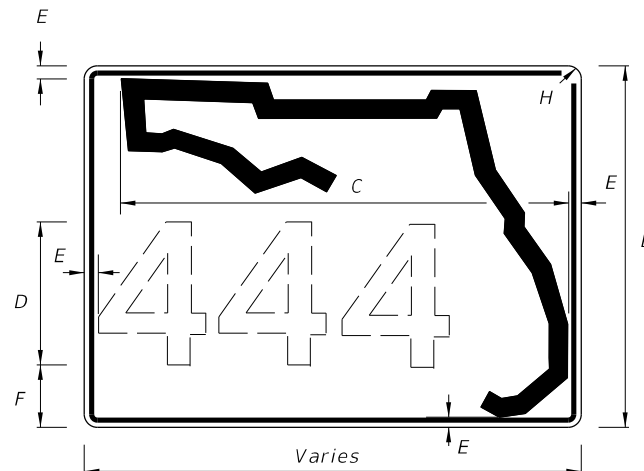

3 OR MORE DIGITS

NOTES:

- Florida marker shall have Black Legend with White Background.
- Stroke width of State outline shall be 1 3/4" for Guide Sign.
- Series D Legend.
- 5/8" Border

A	B	C	D	E	F	G	H
30"	24"	26"	12"	1 1/4"	2 3/4"	8 1/4"	1 1/4"
36"	30"	32"	15"	1 1/4"	3 1/4"	8 3/4"	1 1/4"
42"	36"	38"	15"	1 1/4"	6 1/4"	11"	1 1/4"

GUIDE SIGN USE

FTP-17-06 - FLORIDA ROUTE MARKER

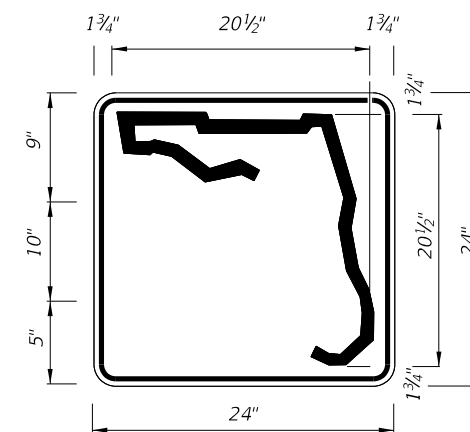

1 or 2 DIGITS

DIGITS	NUMERAL SIZE	SERIES LEGEND	PANEL SIZE
1-2	10"	D	24" x 24"

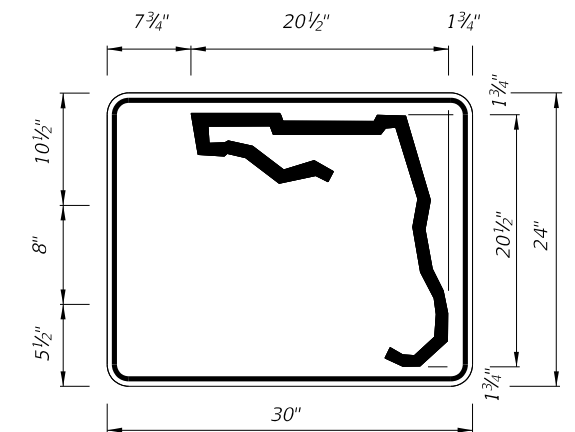

3 or 4 DIGITS

DIGITS	NUMERAL SIZE	SERIES LEGEND	PANEL SIZE
3	8"	D	30" x 24"
4	8"	C	30" x 24"

NOTES:

- Stroke width of State Outline shall be 1".
- The 24" X 24" panel shall only be used for a 3 digit route when the panel is to be used on a sign cluster with other 24" X 24" panels.
- 1 1/2" Radii

INDEPENDENT USE OTHER THAN FREEWAY

NOTES:

- Series D Legend.
- Color: Yellow Legend and Border on Blue Background.
- When used on a guide sign, marker must be overlaid on a rectangular Yellow Background as shown in chart.
- When two or more County Route Markers are mounted together, use the dimensions of the largest marker for all other markers.

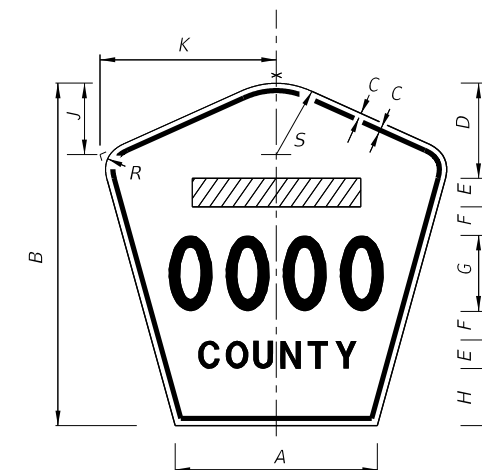

SIGN	DIMENSIONS													Rectangular Yellow Background Dimensions (See Note 3)
	A	B	C	D	E	F	G	H	J	K	R	S		
4 DIGIT POST MOUNTED	25 5/8"	42"	3/4"	10"	4"	4"	8"	8"	8 3/8"	22"	5"	8 3/4"		
2 DIGIT OVERHEAD	21 1/2"	36"	1/2"	7 1/2"	3"	3"	12"	4 1/2"	7 1/8"	18 7/8"	4 1/4"	7 1/2"	42" x 42"	
3 DIGIT OVERHEAD	25 1/8"	42"	3/4"	8"	4"	4"	12"	6"	8 3/8"	22"	5"	8 3/4"	48" x 48"	
4 DIGIT OVERHEAD	29 7/8"	48"	3/4"	8"	5"	5"	12"	8"	9 3/4"	25 5/8"	5 3/4"	10 1/4"	52" x 52"	

FTP-18-06 - COUNTY ROUTE MARKER (M1-6)

10/14/2019 2:42:06 PM

LAST REVISION	DESCRIPTION:
11/01/17	11/01/20

**FY 2020-21
STANDARD PLANS**

SPECIAL SIGN DETAILS

INDEX	SHEET
700-102	3 of 11

12



FTP-19-06
 1' X 1'-6"
 4" Radii 3/8" Border
 Top 4" Series D
 Bottom 2" Series C
 White Background
 Green Legend and Border

All Letters
 1" Series C
 1" Spacing
 Between Lines
 of Text

FTP-20-06
 1' X 1'-6"
 2" Radii 3/8" Border
 1" Series C Legend
 Color
 Background
 Legend and Border

Top Bottom
 Blue White
 White Black

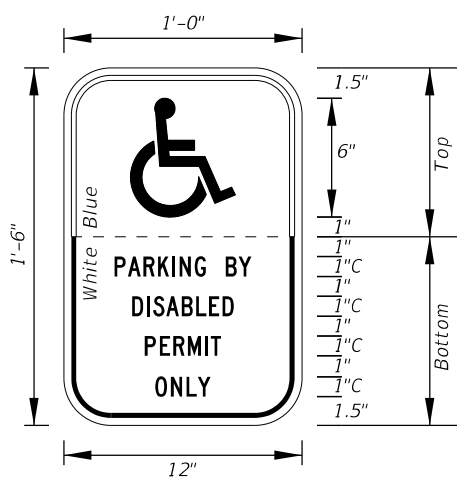

All Letters
 1.5" Series C
 1" Spacing
 Between Lines
 of Text

FTP-21-06
 1'-6" X 2'-6"
 2" Radii 3/8" Border
 1.5" Series C Legend
 Color
 Background
 Legend and Border

Top Bottom
 Blue White
 White Black

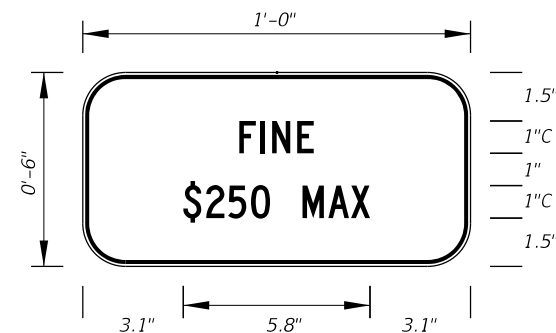
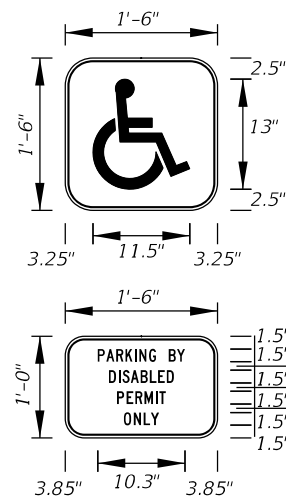

FTP-22-06
 1' X 6"
 1" Radii 3/8" Border
 1" Series C Legend
 White Background
 Black Legend and Border

Supplemental Panel
 for the FTP-20-06
 and FTP-21-06 signs

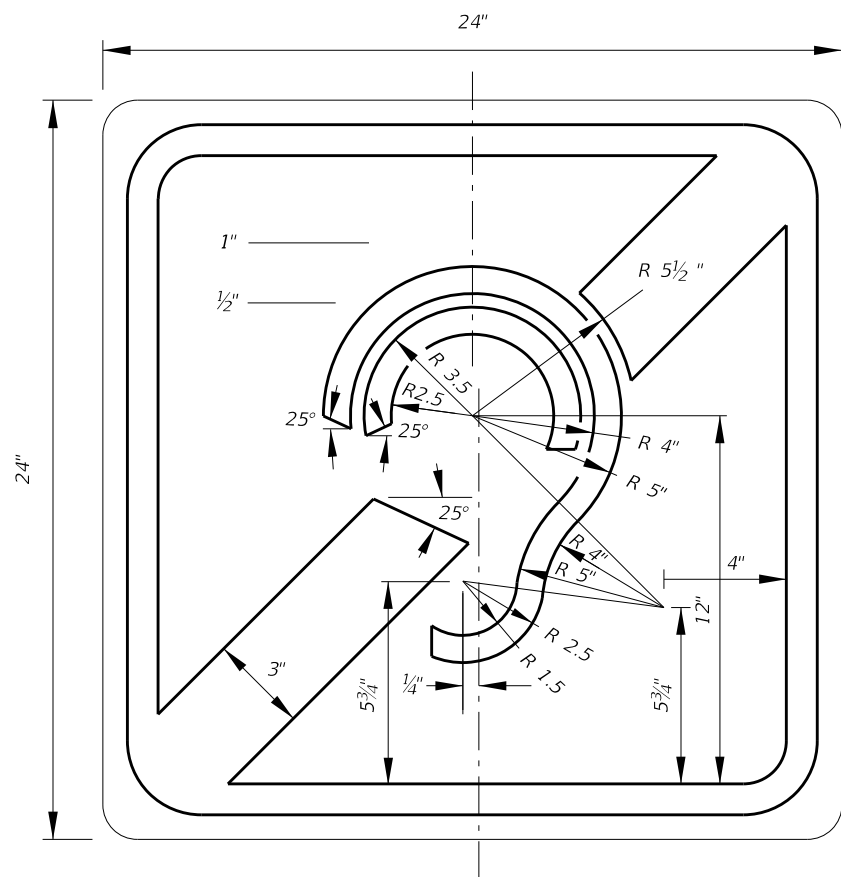

FTP-23-06
 2' X 2'
 1.5" Radii 5/8" Border
 Blue Background
 White Legend and Border

INTERNATIONAL SYMBOL OF
 ACCESS FOR HEARING LOSS

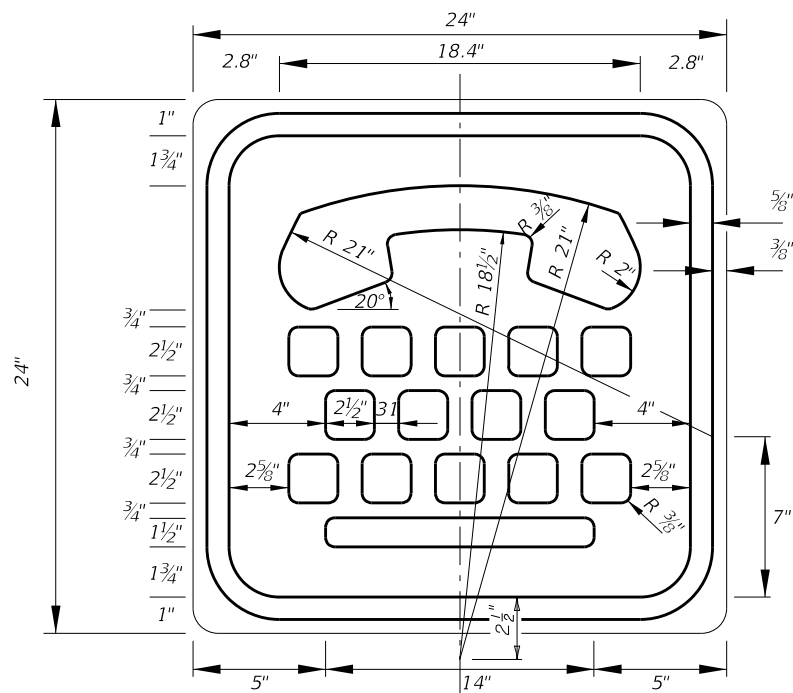

FTP-24-06
 2' X 2'
 1.5" Radii 5/8" Border
 Blue Background
 White Legend and Border

INTERNATIONAL TDD SYMBOL

10/14/2019 2:42:07 PM

LAST REVISION	DESCRIPTION:
11/01/17	11/01/20

12

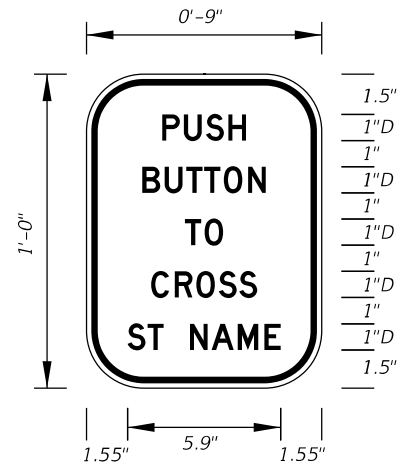

FTP-25-06
 9" X 1'-0"
 2" Radii 3/8" Border
 1" Series D Legend
 White Background
 Black Legend and Border

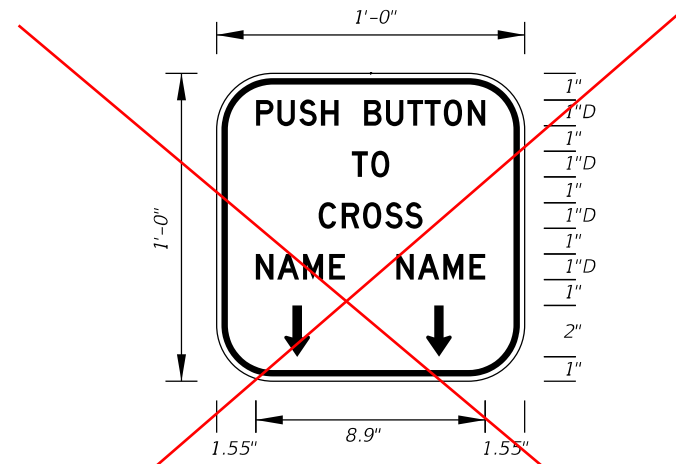

FTP-26-06
 1' X 1'
 2" Radii 3/8" Border
 1" Series D Legend
 White Background
 Black Legend and Border

DELETED

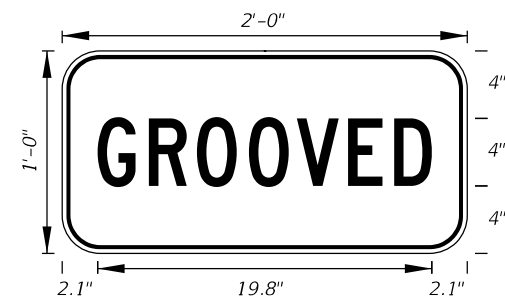

FTP-29-06
 2'-0" X 1'-0"
 2" Radii 5/8" Border
 4" Series C Legend
 Yellow Background
 Black Legend and Border

← Shifted

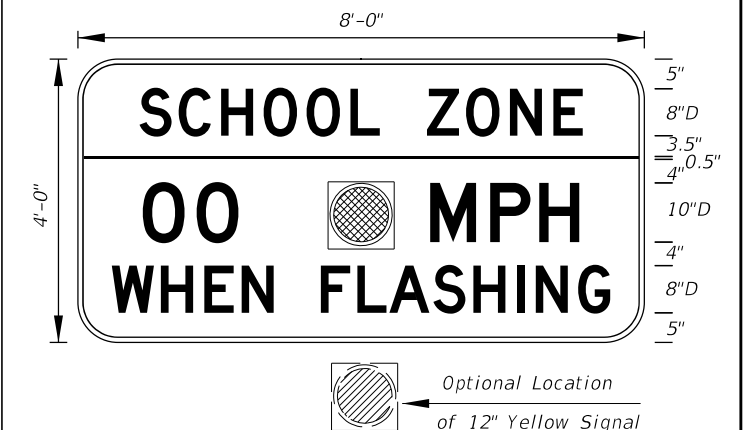

FTP-31-06
 8' X 4'
 6" Radii 3/4" Border
 Series D Legend
 Fluorescent Yellow-Green Background Top
 White Background Bottom
 Black Legend and Border

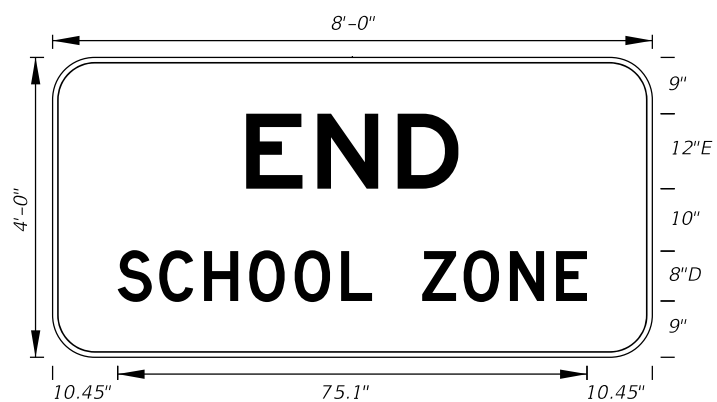

FTP-32-06
 8' X 4'
 6" Radii 3/4" Border
 12" Series E and 8" Series D Legend
 White Background
 Black Legend and Border

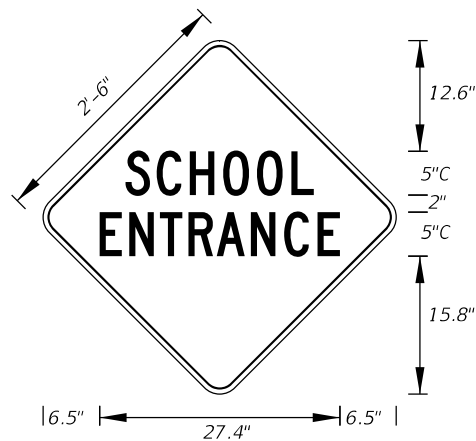

FTP-33-06
 2'-6" X 2'-6"
 2" Radii 3/4" Border
 5" Series C Legend
 Fluorescent Yellow-Green Background
 Black Legend and Border

← Shifted

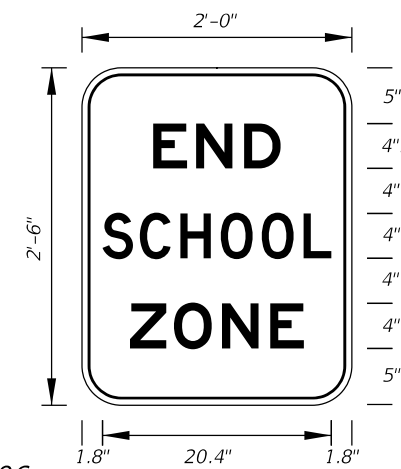

FTP-34-06
 2' X 2'-6"
 3" Radii 5/8" Border
 4" Series D and E Legend
 White Background
 Black Legend and Border

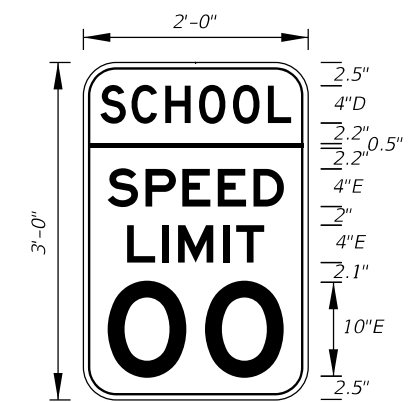

FTP-35-06
 2' X 3'
 3" Radii 5/8" Border
 Top 4" Series D Legend
 Bottom 4" and 10" Series E Legend
 Fluorescent Yellow-Green Background Top
 White Background Bottom
 Black Legend and Border

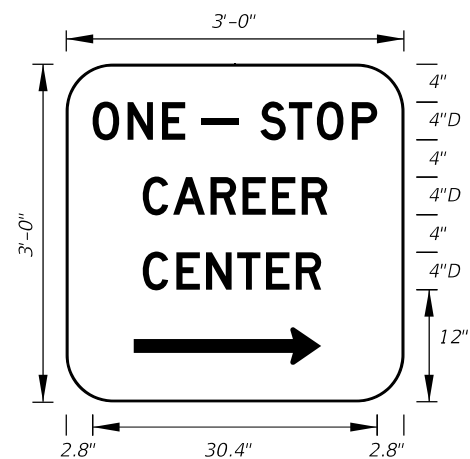

FTP-36-06
 3' X 3'
 5" Radii
 4" Series D Legend
 Green Background
 White Legend and Border

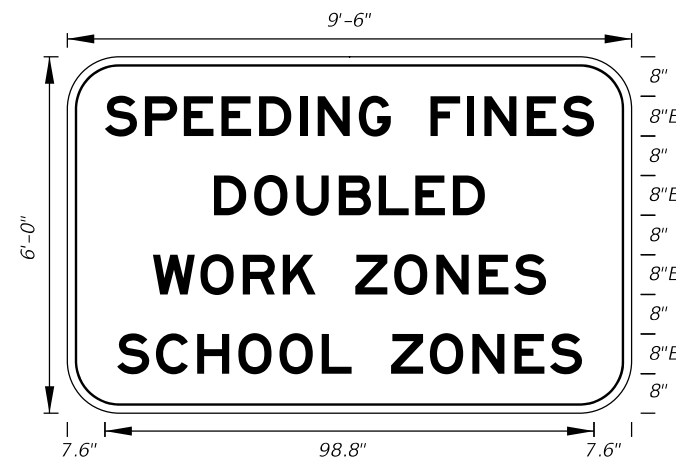

FTP-37-06
 9'-6" X 6'
 9" Radii 2" Border
 8" Series E Legend
 White Background
 Black Legend and Border

State Line Sign

← Shifted

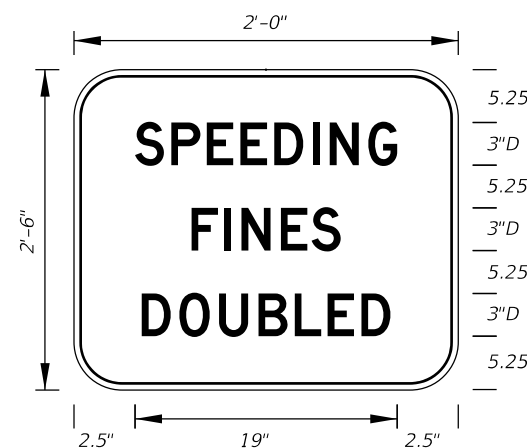

FTP-38-06
 2' X 2'-6"
 4" Radii 3/4" Border
 3" Series D Legend
 White Background
 Black Legend and Border

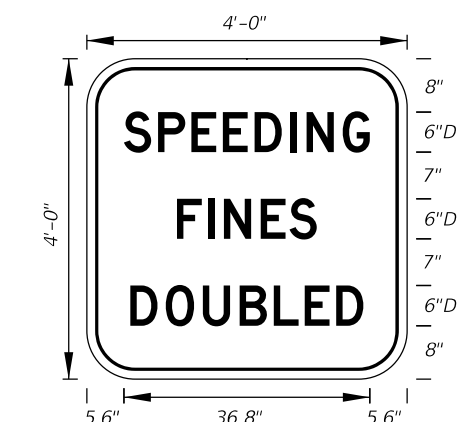

FTP-39-06
 4' X 4'
 6" Radii 3/4" Border
 6" Series D Legend
 White Background
 Black Legend and Border

Freeway Sign
 12

10/14/2019 2:42:08 PM

LAST REVISION	DESCRIPTION:
11/01/18	11/01/20



FTP-40-06
3'-6" X 4'
6" Radii 3/4" Border
3" and 6" Series C Legend
White Background
Black Legend and Border



FTP-41-06
2'-6" X 3'
4" Radii 3/4" Border
2" and 4" Series C Legend
White Background
Black Legend and Border

← Shifted



FTP-42-06
4' X 2'-6"
3" Radii
Top 4" Series C Legend
Bottom 2" Series EM Legend
White Background
Blue Legend and Border

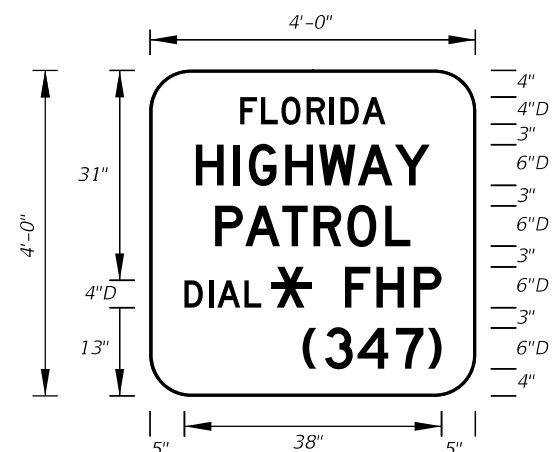

FTP-43-06
4' X 4'
6" Radii 1" Border
Top 4" Series D Legend
Bottom 6" Series D Legend
Blue Background
White Legend and Border

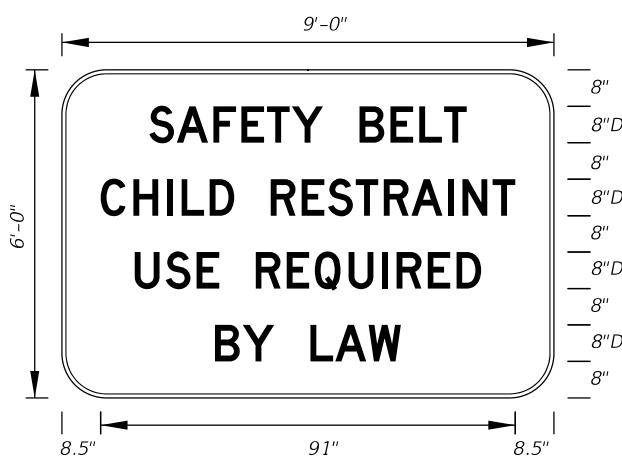

FTP-44-06
9' X 6'
9" Radii 3/4" Border
8" Series D Legend
White Background
Black Legend and Border

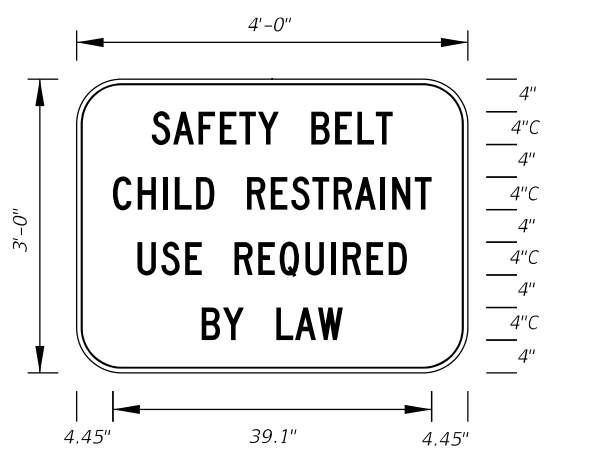

FTP-45-06
4' X 3'
5" Radii 3/4" Border
4" Series C Legend
White Background
Black Legend and Border

← Shifted

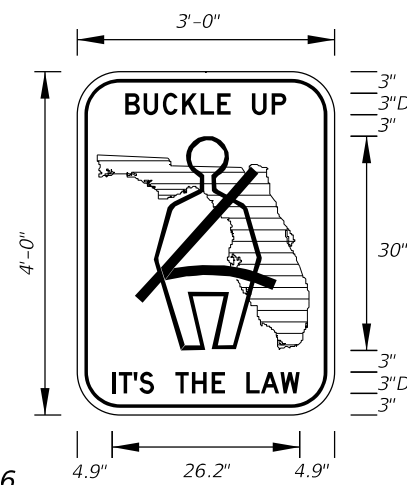

FTP-46-06
3' X 4'
5" Radii 3/4" Border
3" Series D Legend
White Background
Green Florida Symbol
Black Legend, Border and Man Belt Symbol

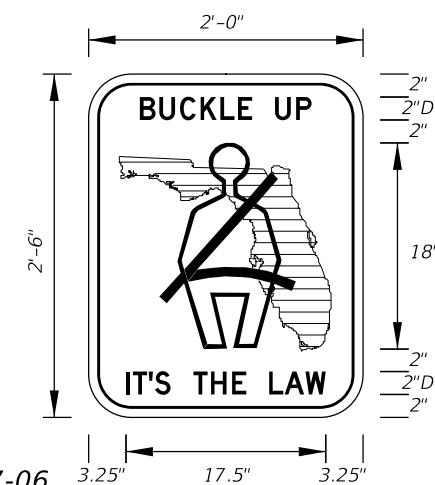

FTP-47-06
2' X 2'-6"
3" Radii 5/8" Border
2" Series D Legend
White Background
Green Florida Symbol
Black Legend, Border and Man Belt Symbol

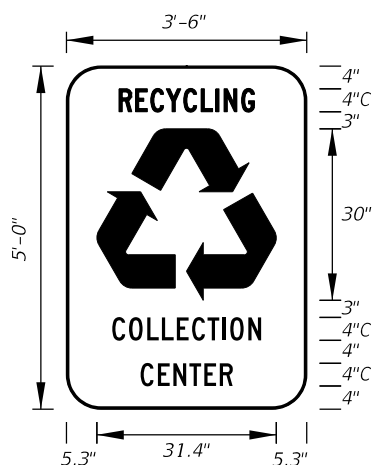

FTP-48-06
3'-6" X 5'
6" Radii
4" Series C Legend
Green Background
White Legend, Border and Symbol

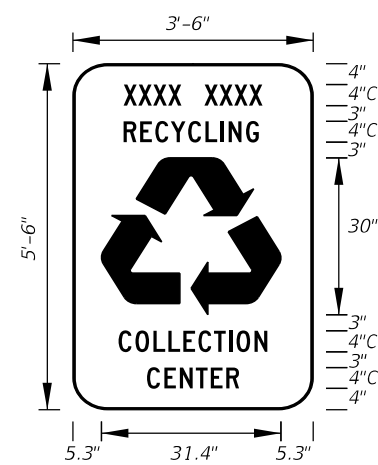

FTP-49-06
3'-6" X 5'-6"
6" Radii
4" Series C Legend
Green Background
White Legend, Border and Symbol
Municipality Name Optional

← Shifted

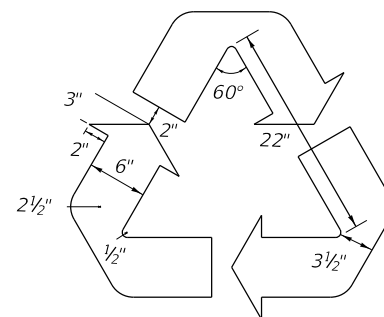

Detail for **FTP-48-06** and **FTP-49-06**

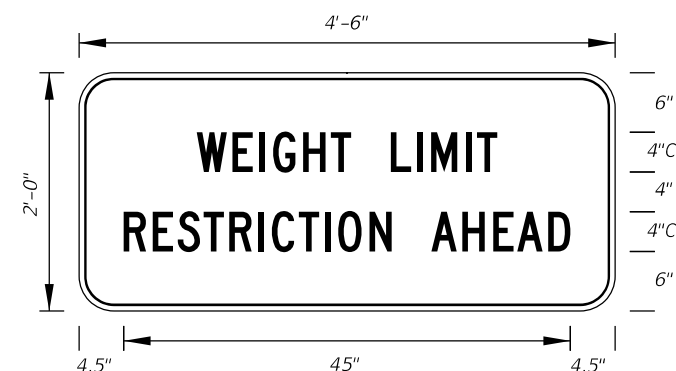

FTP-50-06
4'-6" X 2'
3" Radii 3/4" Border
4" Series C Legend
Yellow Background
Black Legend and Border

12

10/14/2019 2:42:09 PM

LAST REVISION	DESCRIPTION:
11/01/18	11/01/20



FY 2020-21
STANDARD PLANS

SPECIAL SIGN DETAILS

INDEX
700-102

SHEET
6 of 11

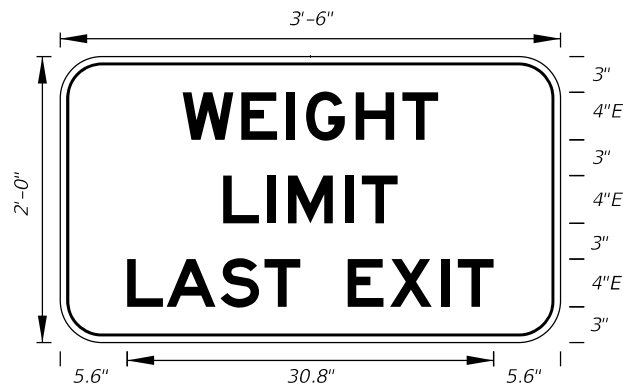

FTP-51-06
3' X 2'
3" Radii 3/4" Border
4" Series E Legend
White Background
Black Legend and Border

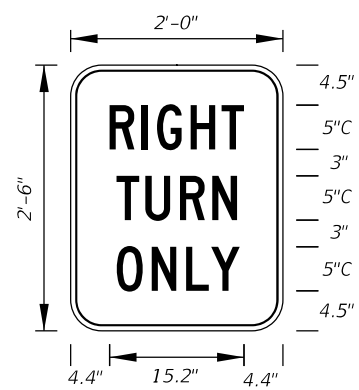

FTP-52-06
2' X 2'-6"
3" Radii 5/8" Border
5" Series C Legend
White Background
Black Legend and Border

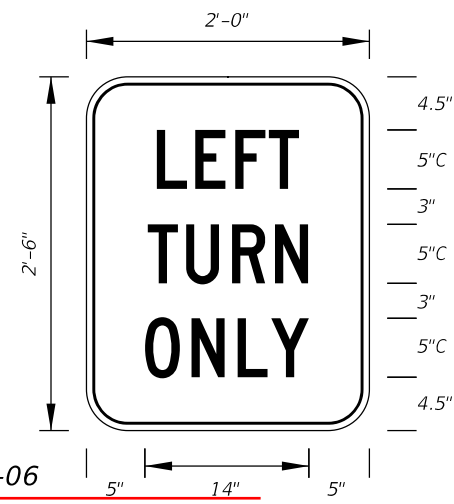

FTP-53-06
2' X 2'-6"
3" Radii 5/8" Border
5" Series C Legend
White Background
Black Legend and Border

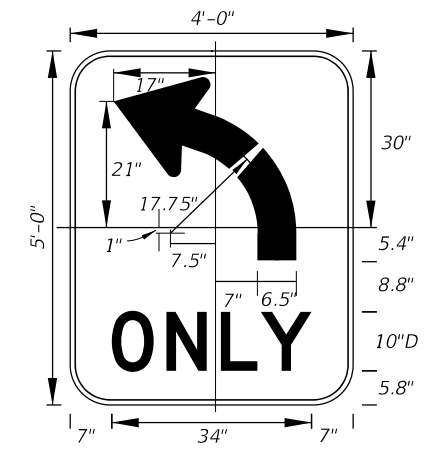

FTP-54L-06
4' X 5'
6" Radii 3/4" Border
10" Series D Legend
White Background
Black Legend and Border
FTP-54R-06 for (Right Turn Arrow)

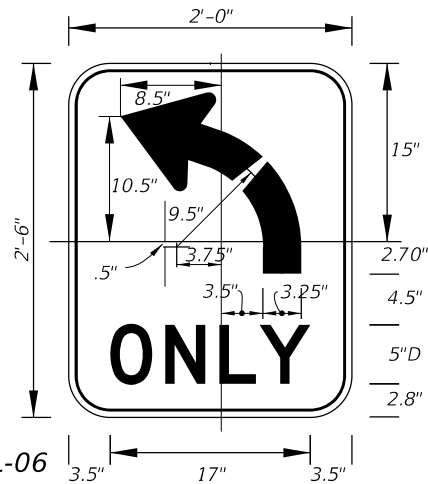

FTP-55L-06
2' X 2'-6"
3" Radii 3/8" Border
5" Series D Legend
White Background
Black Legend and Border
FTP-55R-06 for (Right Turn Arrow)



FTP-56-06
6'-6" X 4'
6" Radii 3/4" Border
8" and 6" Series D Legend
Blue Background
White Legend and Border
Design Project Manager or Transit Administrator will supply correct 1-8XX number.

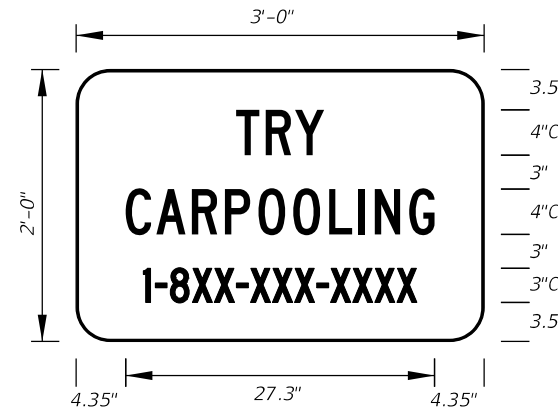

FTP-56A-06
3' X 2'
3" Radii
4" and 3" Series C Legend
Blue Background
White Legend and Border
Design Project Manager or Transit Administrator will supply correct 1-8XX number.

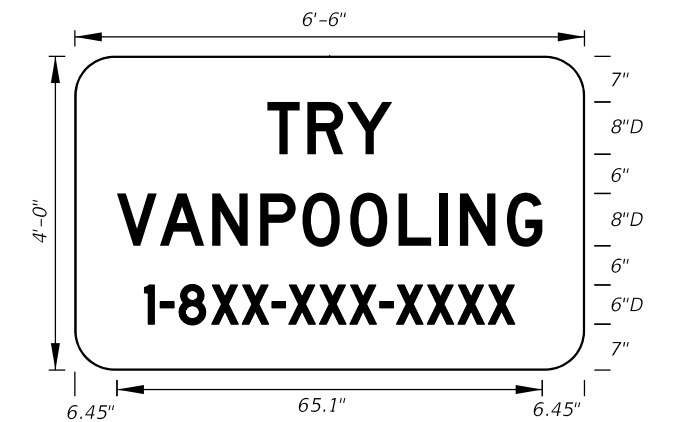

FTP-57-06
6'-6" X 4'
6" Radii
8" and 6" Series D Legend
Blue Background
White Legend and Border
Design Project Manager or Transit Administrator will supply correct 1-8XX number.

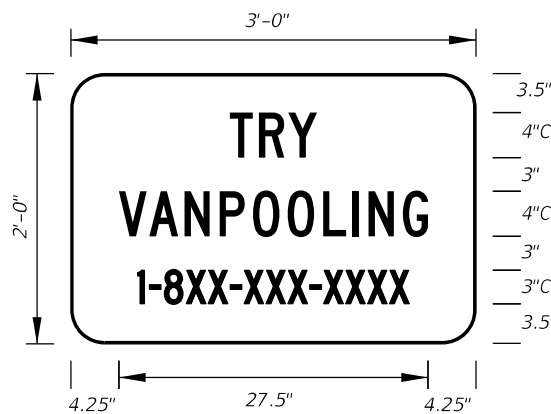

FTP-58-06
3' X 2'
3" Radii
4" and 3" Series C Legend
Blue Background
White Legend and Border
Design Project Manager or Transit Administrator will supply correct 1-8XX number.

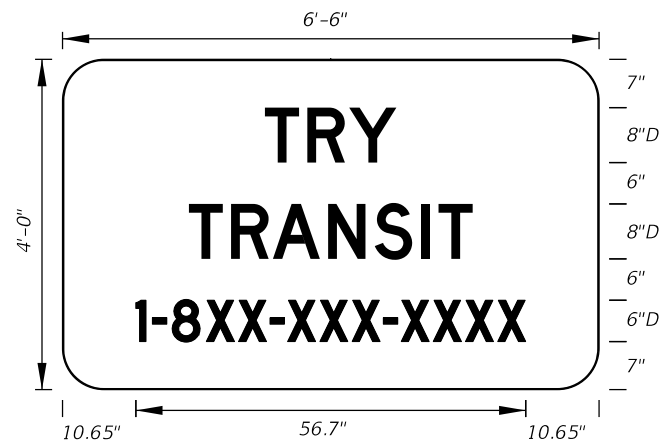

FTP-59-06
6'-6" X 4'
6" Radii
8" and 6" Series D Legend
Blue Background
White Legend and Border
Design Project Manager or Transit Administrator will supply correct 1-8XX number.

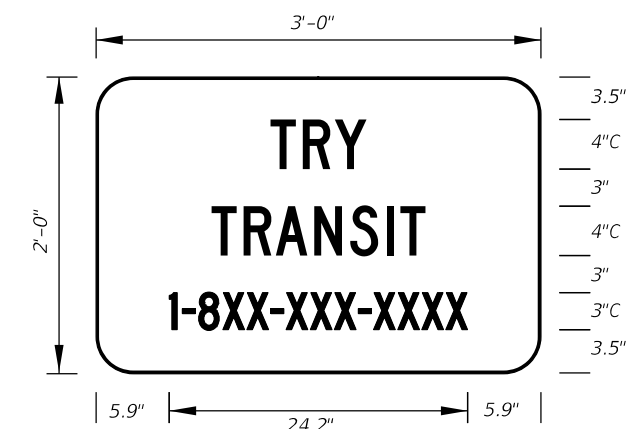

FTP-60-06
3' X 2'
3" Radii
4" and 3" Series C Legend
Blue Background
White Legend and Border
Design Project Manager or Transit Administrator will supply correct 1-8XX number.



FTP-61-06
3' X 2'
3" Radii 3/4" Border
4" and 3" Series C Legend
Yellow Background
Black Legend and Border

10/14/2019 2:42:10 PM

LAST REVISION	DESCRIPTION:
11/01/18	11/01/20

**FY 2020-21
STANDARD PLANS**

SPECIAL SIGN DETAILS

INDEX	SHEET
700-102	7 of 11

12

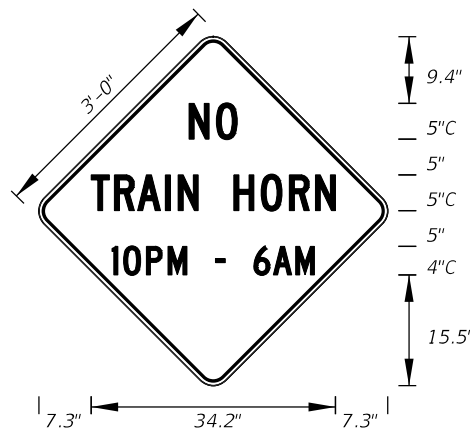

FTP-62-06
3' X 3'
2" Radii 3/4" Border 4" and 5" Series C Legend
Yellow Background Black Legend and Border

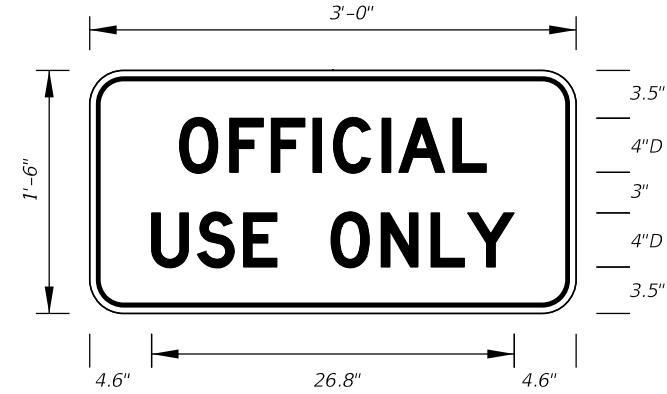

FTP-65-06
3' X 1'-6"
2" Radii 3/4" Border
4" Series D Legend
White Background
Black Legend and Border

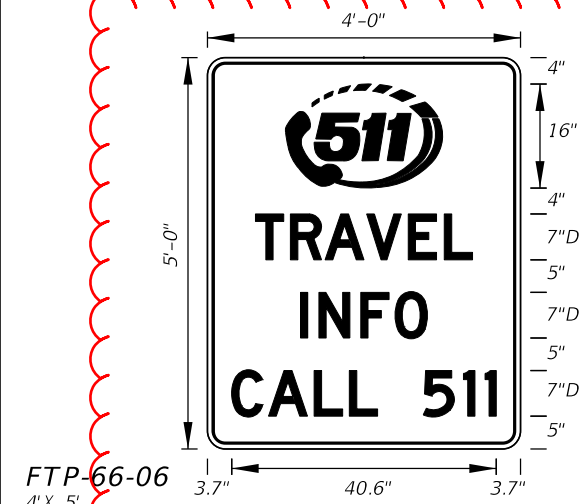

FTP-66-06
4' X 5'
2" Radii 3/4" Border
7" Series D Legend
Blue Background
White Legend and Border

CHANGED SIGNS:
FTP-66-21
and
FTP-67-21



FTP-67-06
3' X 4'
2" Radii 3/4" Border
5" Series D Legend
Blue Background
White Legend and Border

Sign Mounting Holes Can Be Punched Or Field Drilled With No Obstruction To Text Or Symbols From Holes Or Bolts.

Sign Mounting Holes Can Be Punched Or Field Drilled With No Obstruction To Text Or Symbols From Holes Or Bolts.

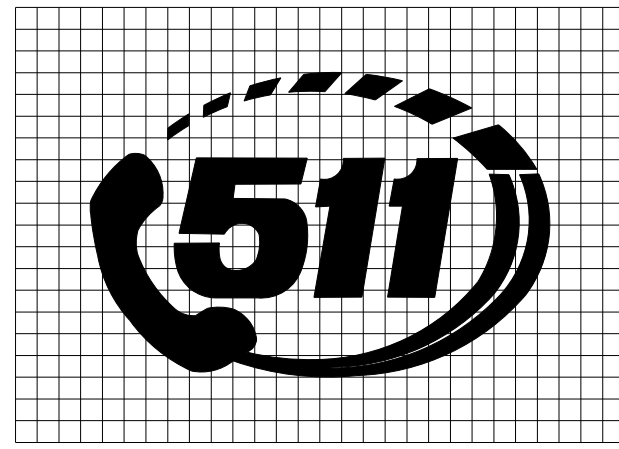

CHANGED LOGO

DETAIL for **FTP-66** AND **FTP-67**

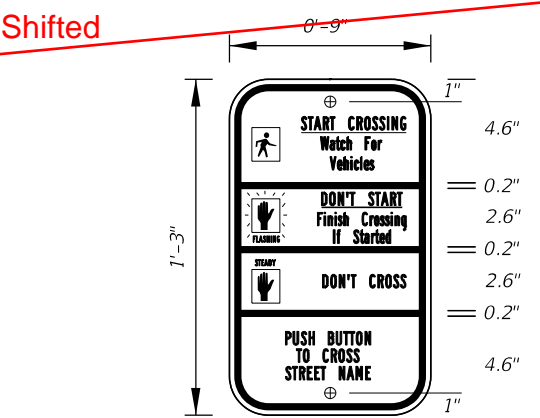

FTP-68A-06
9" X 1'-3"
1.5" Radii 3/4" Border
Series B Legend
White Background
Black Legend and Border

See Standard Highway Signs Manual, Sign R10-3b For Letter Size Spacing And Symbol Sizes.

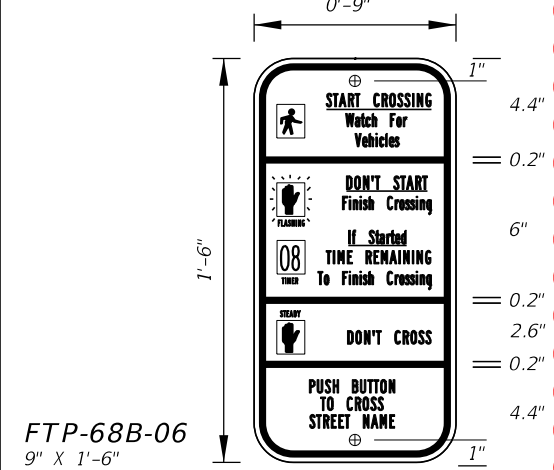

FTP-68B-06
9" X 1'-6"
1.5" Radii 3/4" Border
Series B Legend
White Background
Black Legend and Border

See Standard Highway Signs Manual, Sign R10-3b For Letter Size Spacing And Symbol Sizes.

ADDED;
New Sign
FTP-68C-21

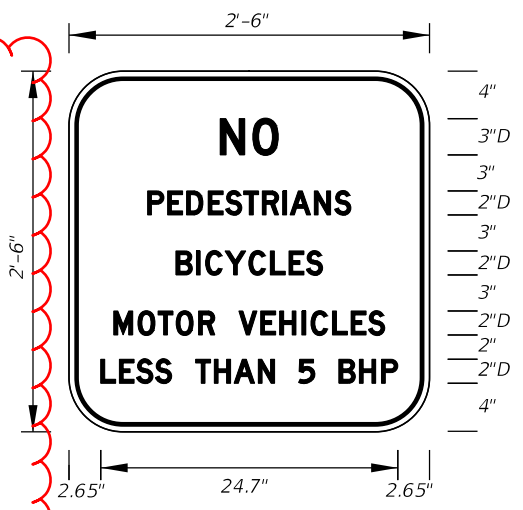

FTP-69-06
2'-6" X 2'-6"
4" Radii 3/4" Border
2" and 3" Series D Legend
White Background
Black Legend and Border

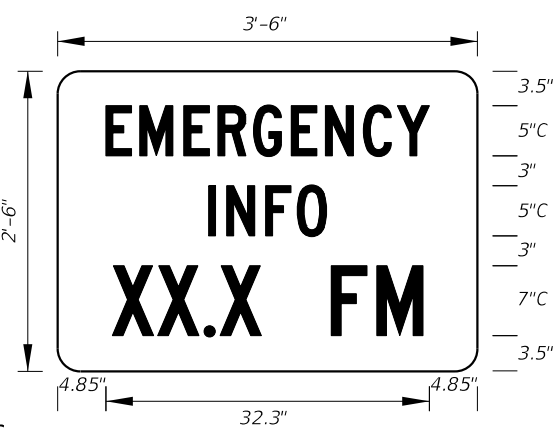

FTP-70-06
3'-6" X 2'-6"
2.25" Radii 3/4" Border
5" Series C and 7" Series C Legend
Blue Background
White Legend and Border

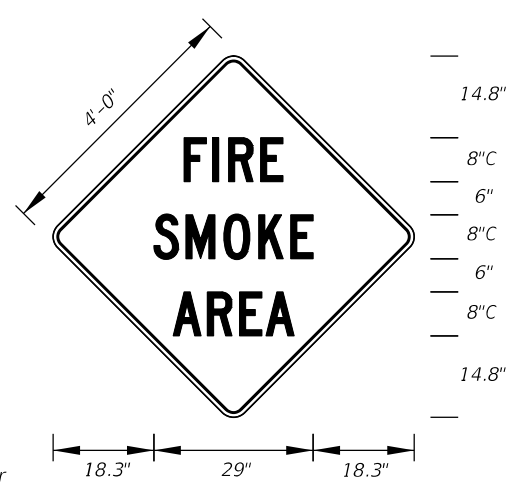

FTP-71-06
4' X 4'
2" Radii 3/4" Border
8" Series C Legend
Yellow Background
Black Legend and Border



FTP-72-06
3' X 3'
2" Radii 3/4" Border

6" Series C Legend
Yellow Background
Black Legend and Border

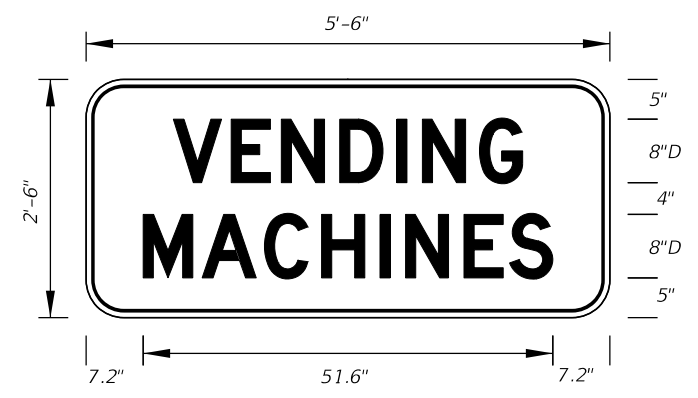

FTP-73-06
5'-6" X 2'-6"
4" Radii 3/4" Border

8" Series D Legend
Blue Background
White Legend and Border

10/14/2019 2:42:11 PM

LAST REVISION	DESCRIPTION:
11/01/17	
11/01/20	



FTP-74-06
 5'-6" X 2'-6"
 4" Radii 3/4" Border
 6" Series D Legend
 Blue Background
 White Legend and Border

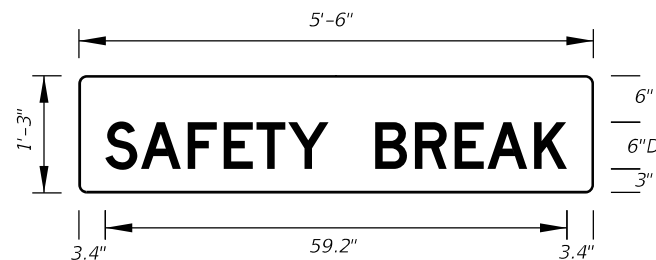

FTP-75-06
 5'-6" X 1'-3"
 1" Radii
 6" Series D Legend
 Blue Background
 White Legend

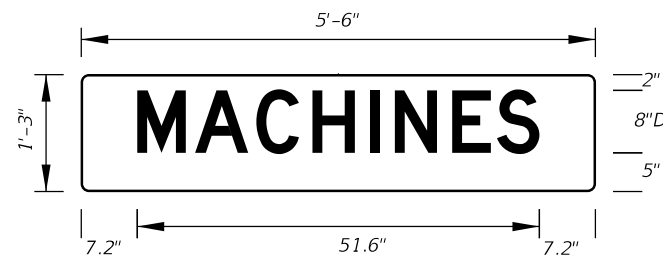

FTP-76-06
 5'-6" X 1'-3"
 1" Radii
 8" Series D Legend
 Blue Background
 White Legend

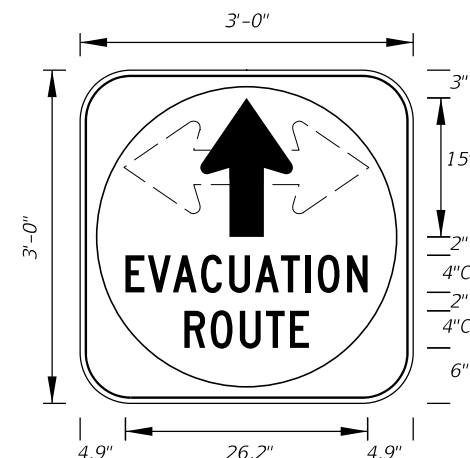

FTP-77-06
 3' X 3'
 5" Radii 3/4" Border
 4" Series C Legend
 White Background with Blue Circle Background
 White Legend and Black Border

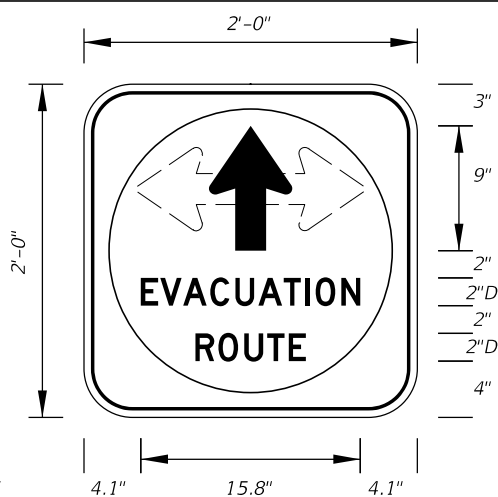

FTP-78-06
 2' X 2'
 3" Radii 3/4" Border
 2" Series D Legend
 White Background with Blue Circle Background
 White Legend and Black Border

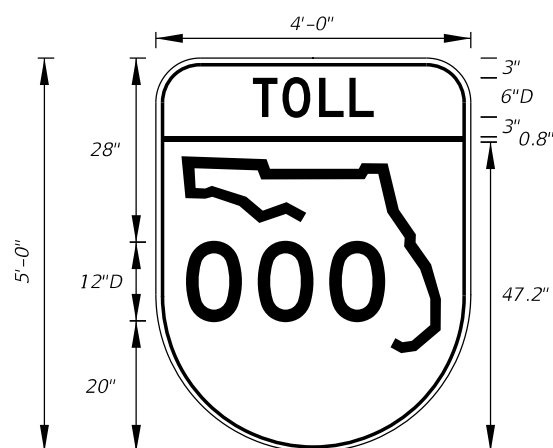

FTP-79-06
 4' X 5'
 6" Radii 3/4" Border
 6" and 12" Series D Legend
 Top Yellow Background with Black Legend and Black Border
 Bottom White Background with Black Legend and Border

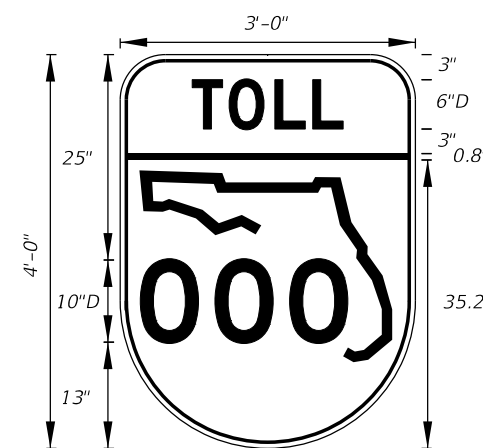

FTP-80-06
 3' X 4'
 5" Radii 3/4" Border
 6" and 10" Series D Legend
 Top Yellow Background with Black Legend and Black Border
 Bottom White Background with Black Legend and Border

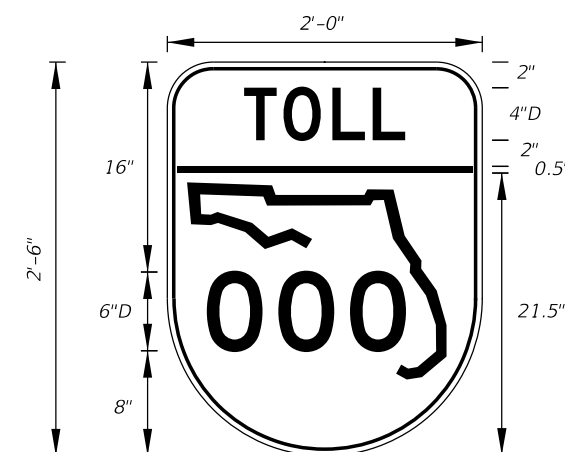

FTP-81-06
 2' X 2'-6"
 3" Radii 3/4" Border
 4" and 6" Series D Legend
 Top Yellow Background with Black Legend and Black Border
 Bottom White Background with Black Legend and Border

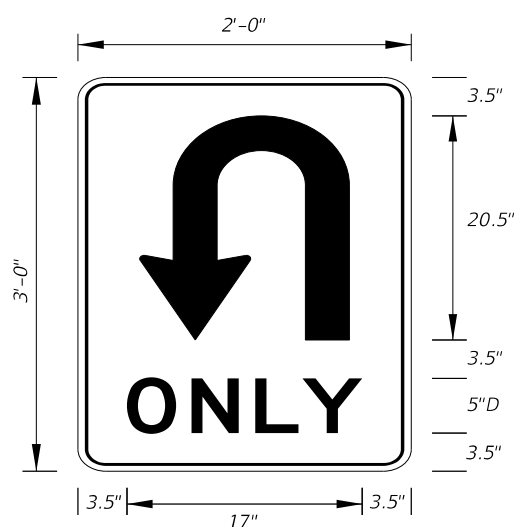

FTP-82-08
 2' X 3'
 1.5" Radii
 5" Series D Legend
 White Background
 Black Legend and Border

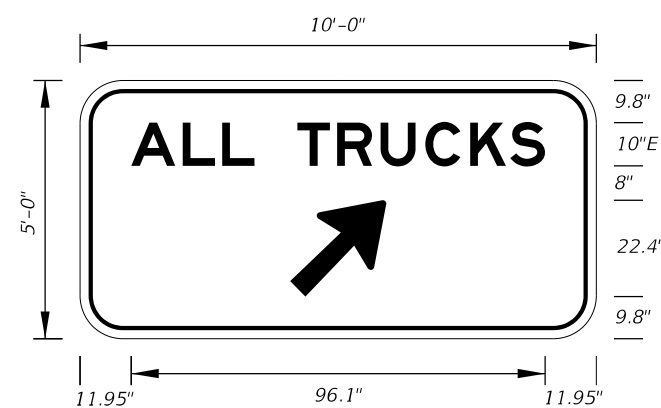
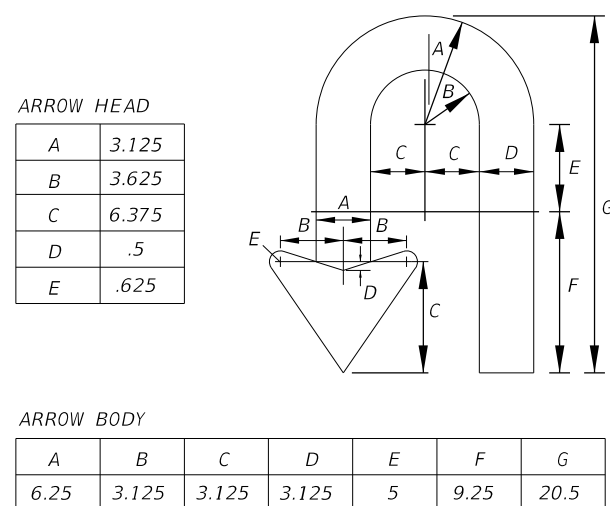

FTP-83-08
 10'-0" X 5'-0"
 8" Radii
 10" Series E Legend
 Green Background
 White Legend

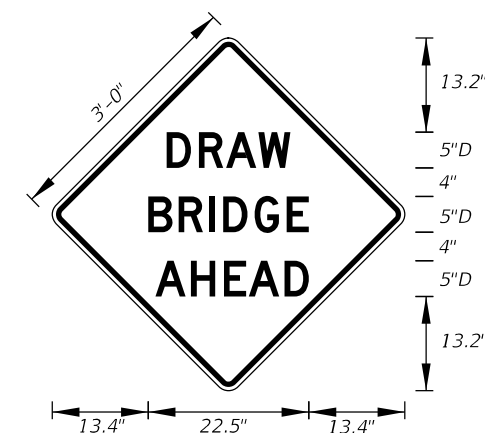

FTP-84-09
 3' X 3'
 1.5" Radii
 5" Series D Legend
 Yellow Background
 Black Legend and Border

10/14/2019 2:42:13 PM

LAST REVISION	DESCRIPTION:
11/01/17	
	11/01/20



FY 2020-21
 STANDARD PLANS

SPECIAL SIGN DETAILS

INDEX
 700-102

SHEET
 9 of 11

12

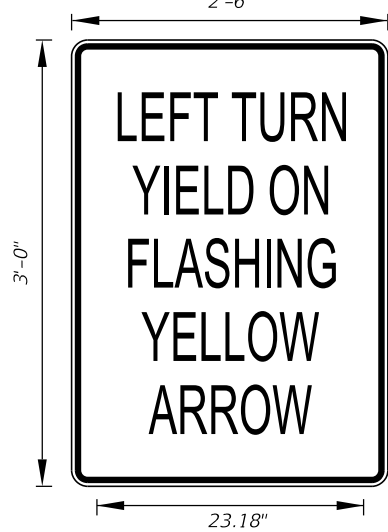

FTP-85-13
3' X 2'-6"
1.875" Radii 3/4" Border
3.5" Series C Legend
White Background
Black Legend and Border

ADDED:
New Sign
FTP-86-21
FTP-87-21
FTP-88-21
and
FTP-89-21

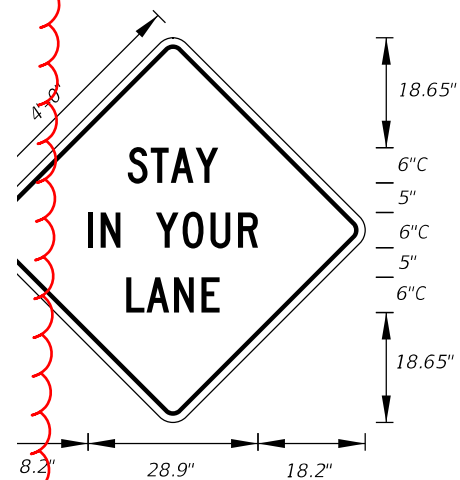

MOT-1-06
4' X 4'
2" Radii 3/4" Border
6" Series C Legend
Orange Background
Black Legend and Border

Shifted

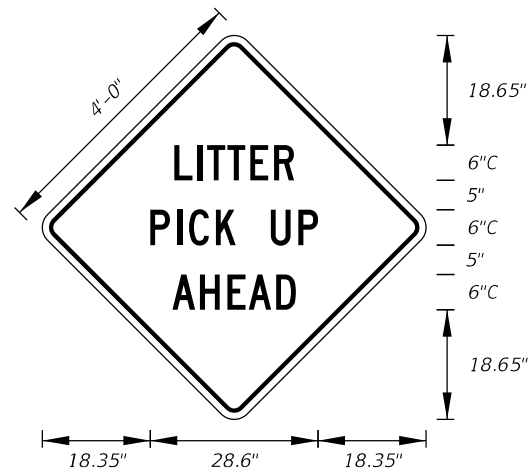

MOT-4-06
4' X 4'
2" Radii 3/4" Border
6" Series C Legend
Orange Background
Black Legend and Border

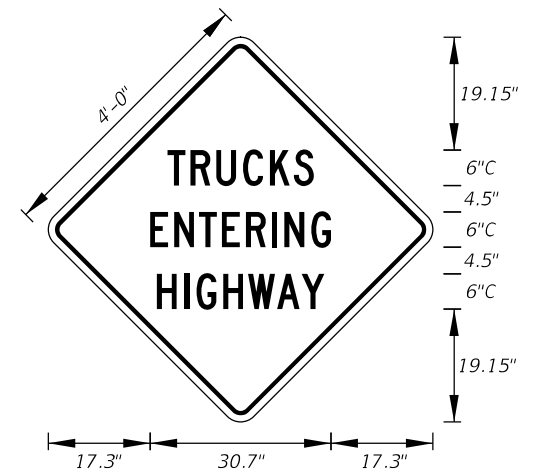

MOT-5-06
4' X 4'
2" Radii 3/4" Border
6" Series C Legend
Orange Background
Black Legend and Border

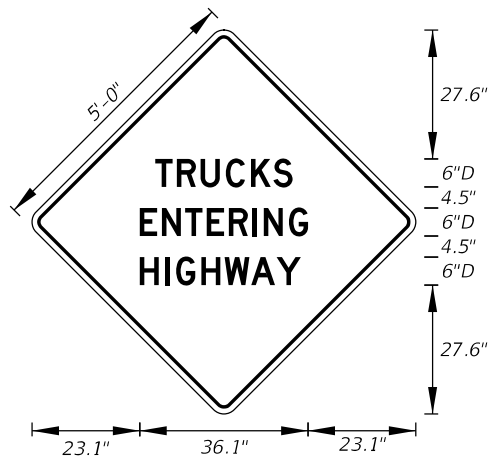

MOT-6-06
5' X 5'
2" Radii 3/4" Border
6" Series D Legend
Orange Background
Black Legend and Border

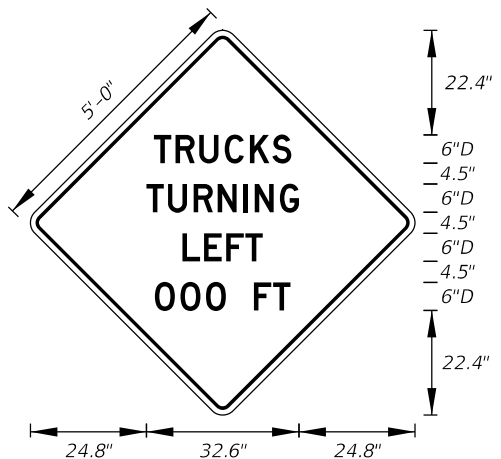

MOT-7-06
5' X 5'
2" Radii 3/4" Border
6" Series D Legend
Orange Background
Black Legend and Border

Shifted

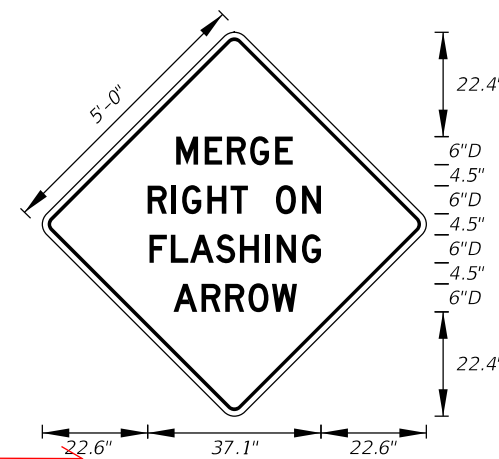

MOT-8-06
5' X 5'
2" Radii 3/4" Border
6" Series D Legend
Orange Background
Black Legend and Border

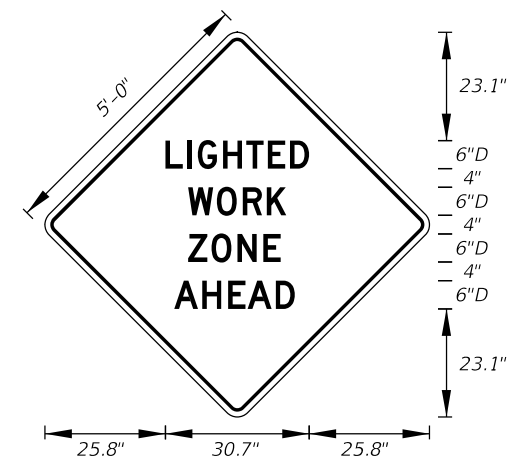

MOT-9-06
5' X 5'
2" Radii 3/4" Border
6" Series D Legend
Orange Background
Black Legend and Border

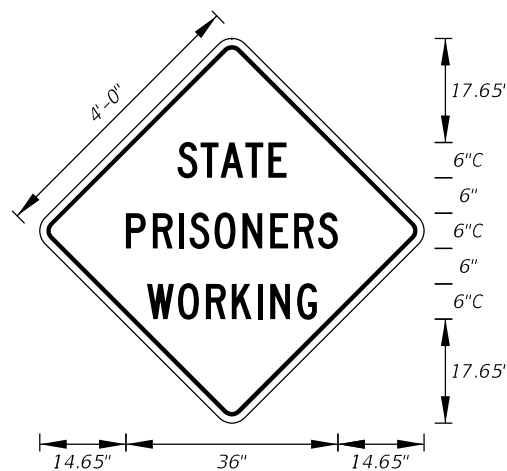

MOT-10-06
4' X 4'
2" Radii 3/4" Border
6" Series C Legend
Orange Background
Black Legend and Border

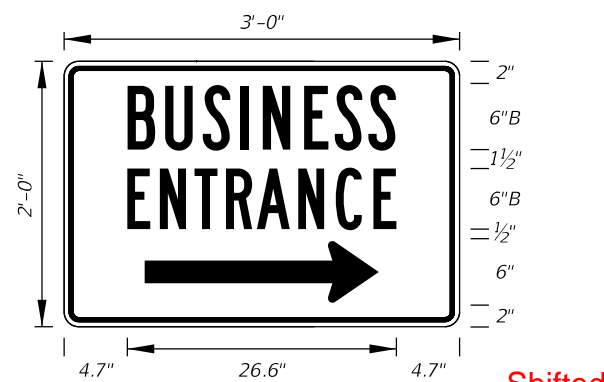

MOT-11-06
3' X 2'
2" Radii 3/4" Border
6" Series B Legend
Blue Background
White Legend and Border

Shifted

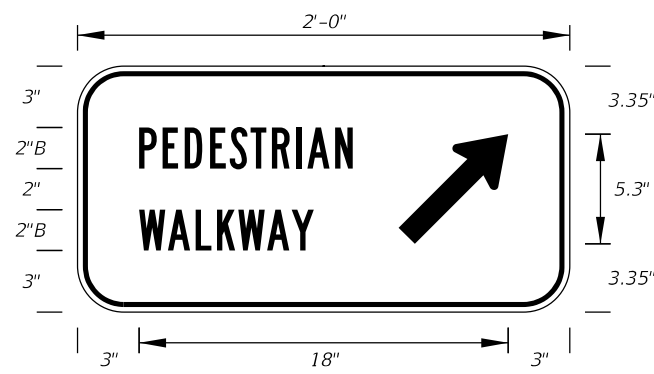

MOT-12R-06
2' X 1'
2" Radii 3/4" Border
2" Series B Legend
White Background
Black Legend and Border

MOT-12L-06
For Diversion
to the left

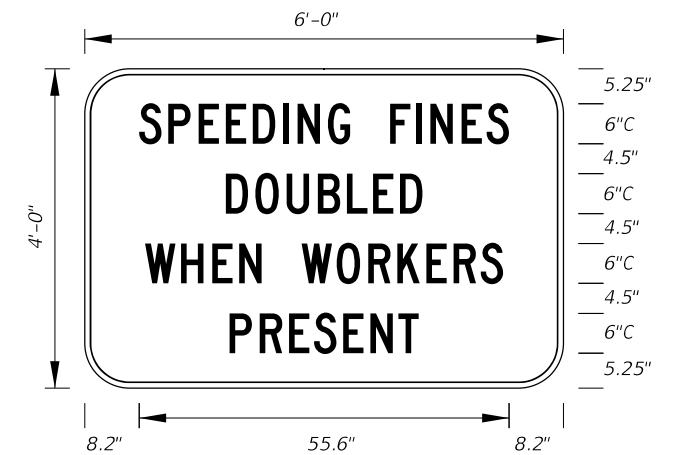

MOT-13-06
Freeway Sign
6' X 4'
6" Radii 3/4" Border
6" Series C Legend
White Background
Black Legend and Border

10/14/2019 2:42:14 PM

LAST REVISION	DESCRIPTION:
11/01/18	11/01/20



FY 2020-21
STANDARD PLANS

SPECIAL SIGN DETAILS

INDEX	SHEET
700-102	10 of 11

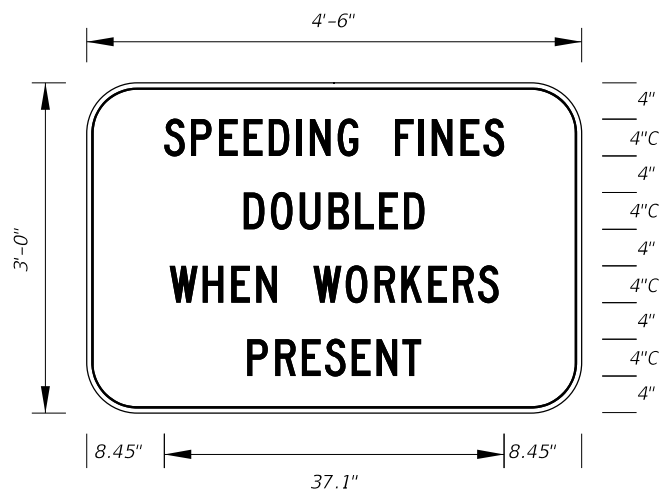

MOT-14-06
Arterial Sign
4'-6" X 3'
5" Radii 3/4" Border

4" Series C Legend
White Background
Black Legend and Border

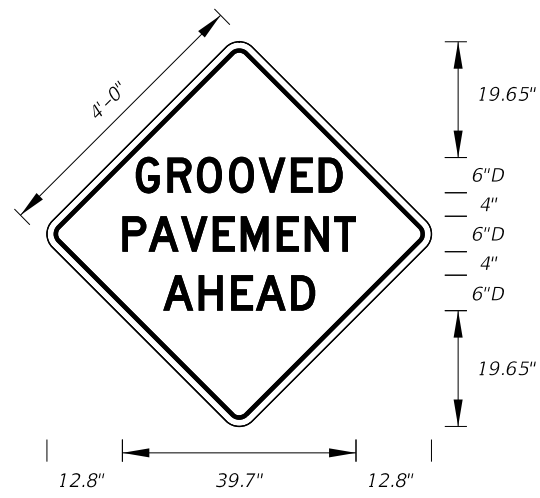

MOT-15-06
4' X 4'
2" Radii 3/4" Border

6" Series D Legend
~~Orange Background~~
Black Legend and Border

Shifted

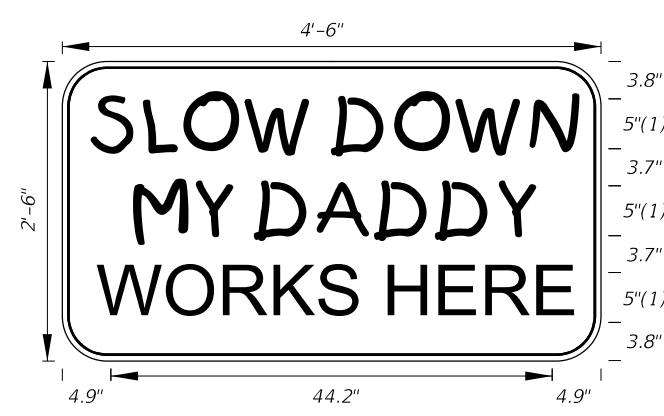

MOT-16-06
4' 6" X 2' 6"
4" Radii 3/4" Border

5" Kids Series Legend
Orange Background
Black Legend and Border

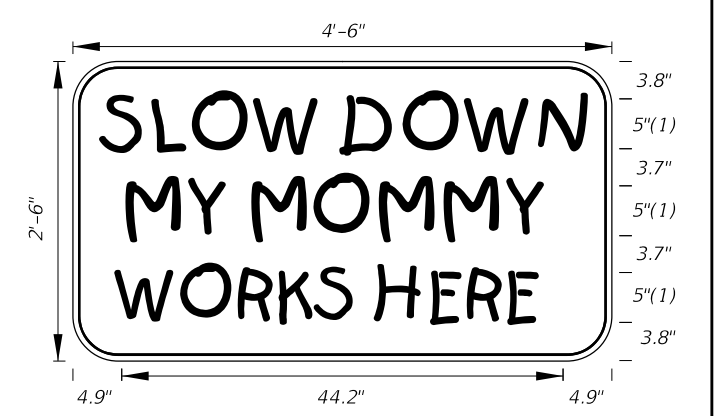

MOT-17-06
4'-6" X 2'-6"
4" Radii 3/4" Border

5" Kids Series Legend
Orange Background
Black Legend and Border

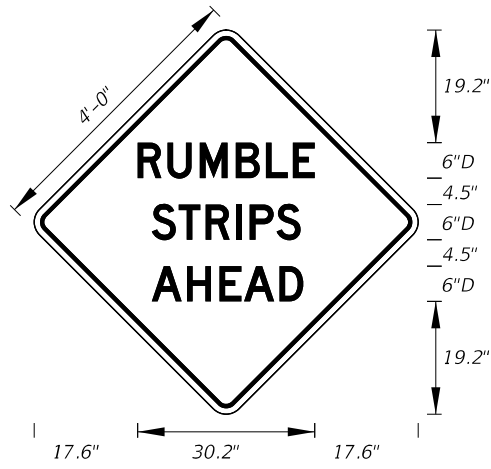

MOT-18-10
4' X 4'
2" Radii 3/4" Border

6" Series D Legend
Orange Background
Black Legend and Border

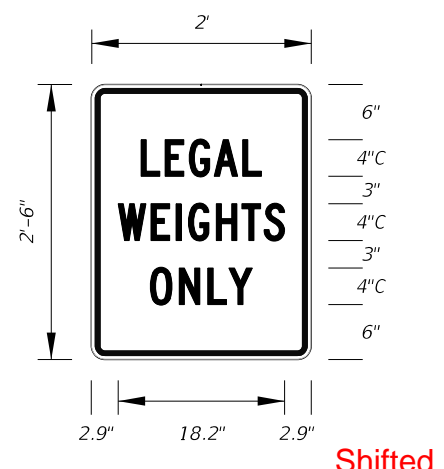

MOT-19-11
2' X 2'-6"
1.13" Radii 3/4" Border

4" Series C Legend
White Background
Red Legend and Border

Shifted

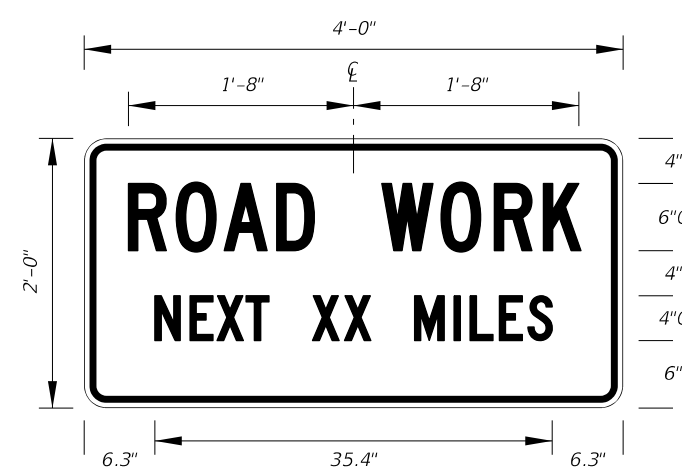

G20-1
2' X 4'
1.5" Radii 3/4" Border

Orange Background
Black Legend and Border

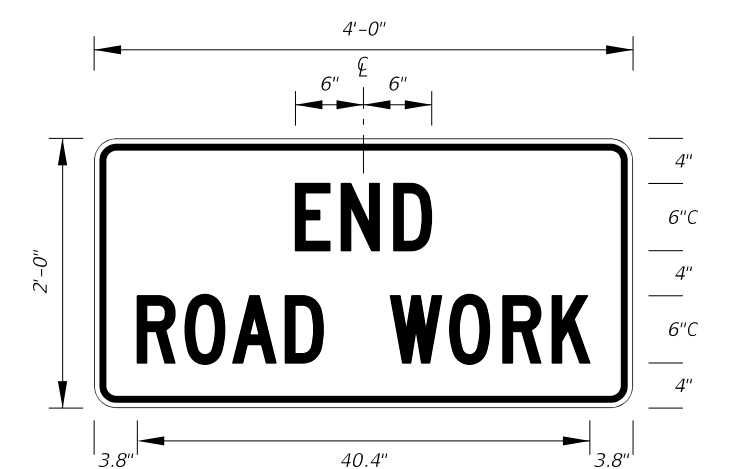

G20-2
2' X 4'
1.5" Radii 3/4" Border

Orange Background
Black Legend and Border

Moved

10/14/2019 2:42:14 PM

LAST REVISION
11/01/18

DESCRIPTION:
11/01/20



FY 2020-21
STANDARD PLANS

SPECIAL SIGN DETAILS

INDEX
700-102

12
SHEET
11 of 11

ADDED: New Sign
MOT-20-21

ADDED: New Sign
MOT-21-21

ADDED: New Sign
MOT-22-21

ADDED: New Sign
MOT-23-21

ADDED: New Sign
MOT-24-21

ADDED: New Sign
MOT-25-21

NEW SHEET

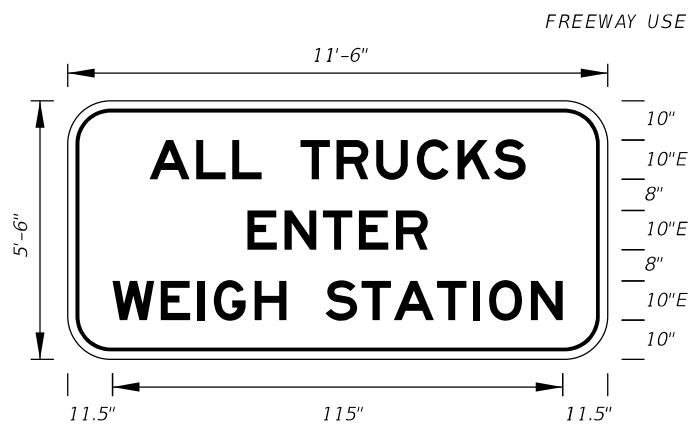

FTP-1-06
11'-6" X 5'-6"
9" Radii 2" Border

10" Series E Legend
White Background
Black Legend and Border

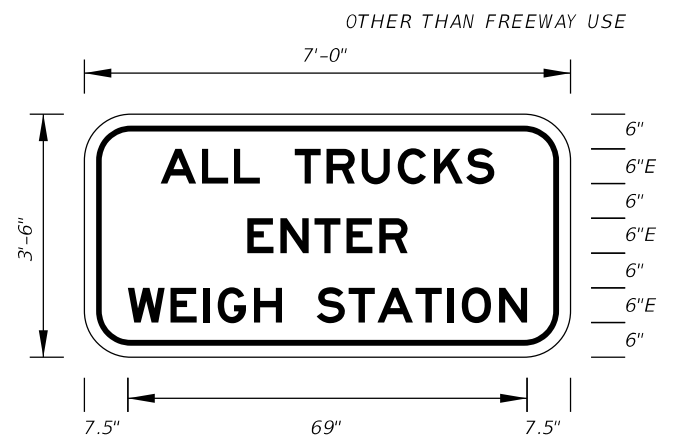

FTP-2-06
7' X 3'-6"
6" Radii 2" Border

6" Series E Legend
White Background
Black Legend and Border

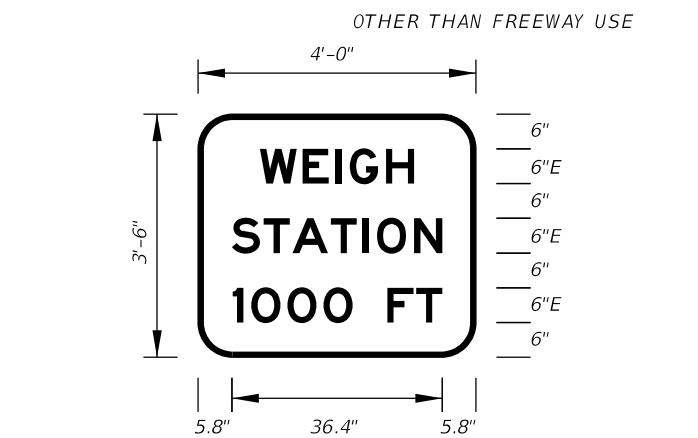

FTP-3-06
4' X 3'-6"
6" Radii 2" Border

6" Series E Legend
Green Background
White Legend and Border

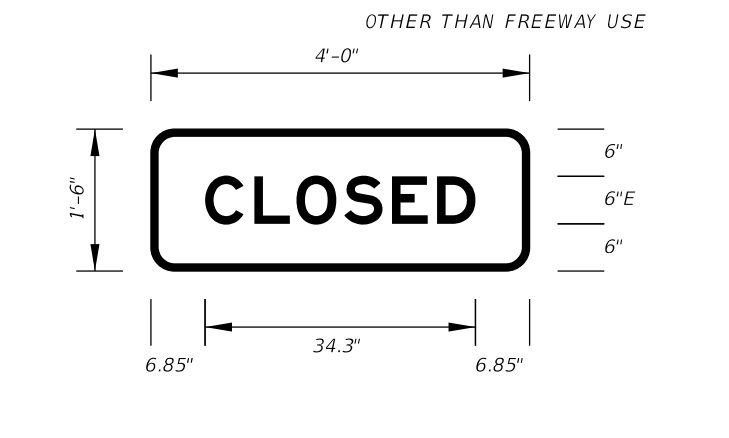

FTP-4-06
4' X 1'-6"
3" Radii 2" Border

6" Series E Legend
Green Background
White Legend and Border

Note:
FTP-4-06 to be
used with FTP-3-06

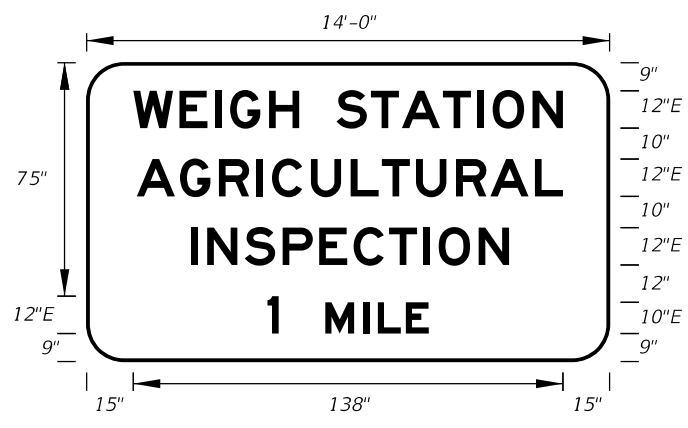

FTP-5-06
14' X 8'
12" Radii 2" Border

12" and 10" Series E Legend
Green Background
White Legend and Border

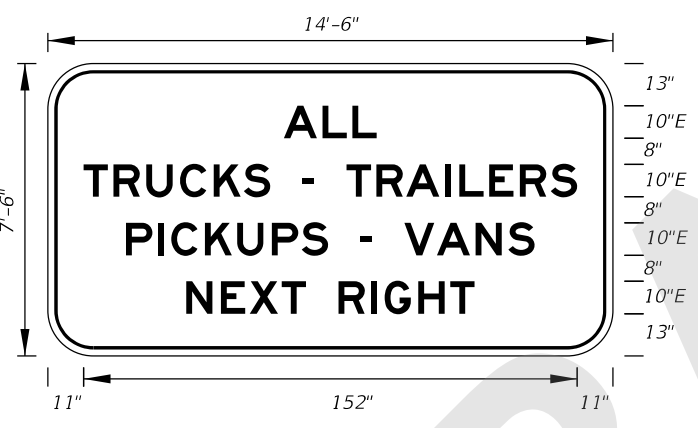

FTP-6A-06
14'-6" X 7'-6"
12" Radii 2" Border

10" Series E Legend
White Background
Black Legend and Border

On Interstate Station
Delete Pickups-Vans,
and reduce Sign height
accordingly.

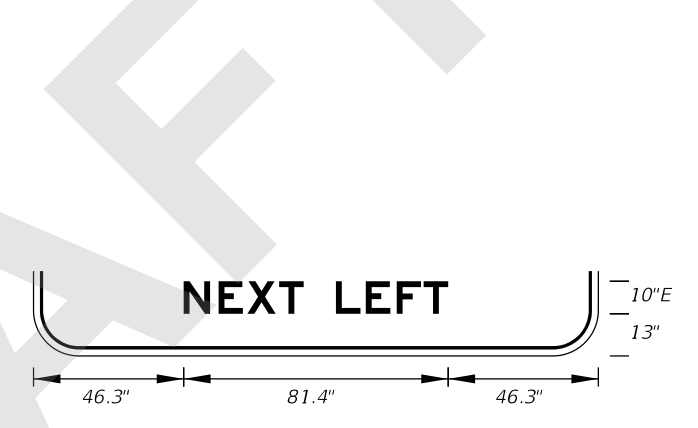

FTP-6B-06
14'-6" X 7'-6"
12" Radii 2" Border

10" Series E Legend
White Background
Black Legend and Border



FTP-7A-06
12' X 7'
11" Radii 2" Border

10" Series E Legend
Green Background
White Legend and Border

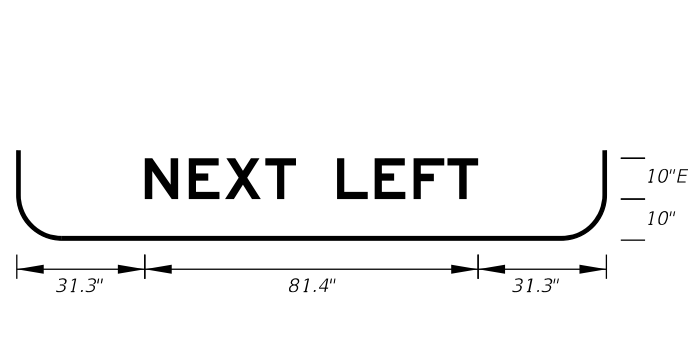

FTP-7B-06
12' X 7'
11" Radii 2" Border
10" Series E Legend
Green Background
White Legend and Border

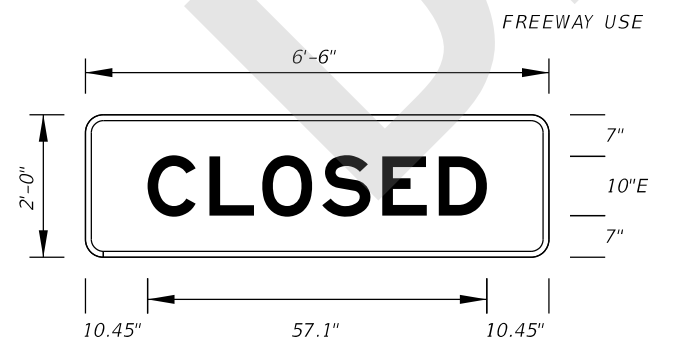

FTP-8-06
6'-6" X 2'
3" Radii 2" Border
10" Series E Legend
Green Background
White Legend and Border

Note:
FTP-8-06 to be
used with FTP-7A-06
& FTP-7B-06.

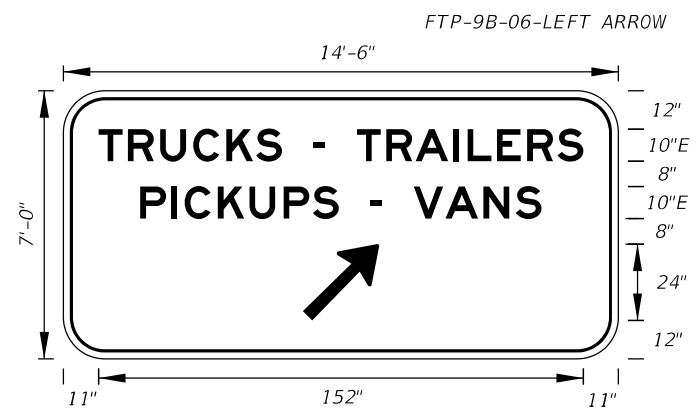

FTP-9A-06
14'-6" X 7'
11" Radii 2" Border

10" Series E Legend
Green Background
White Legend and Border

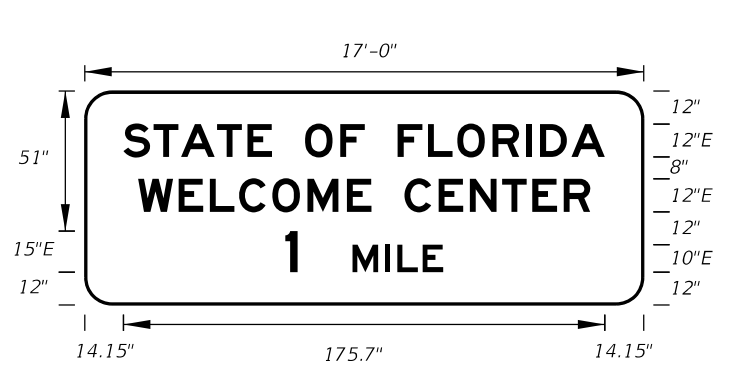

FTP-10-06
17' X 6'-6"
10" Radii 2" Border

12", 10" and 15" Series E Legend
Blue Background
White Legend and Border

9/22/2020 6:28:01 AM

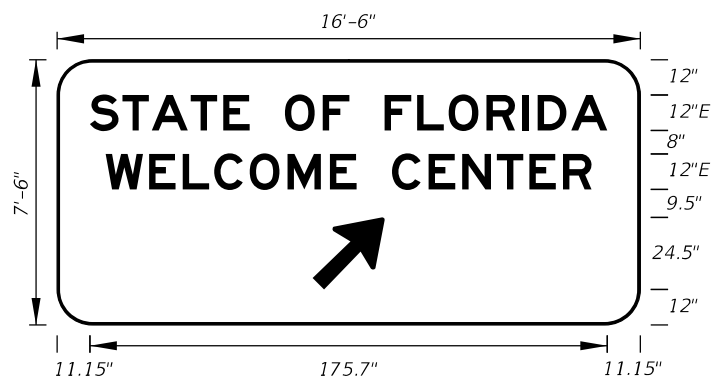

FTP-11-06
 16'-6" X 7'-6"
 12" Radii 2" Border
 12" Series E Legend
 Blue Background
 White Legend and Border

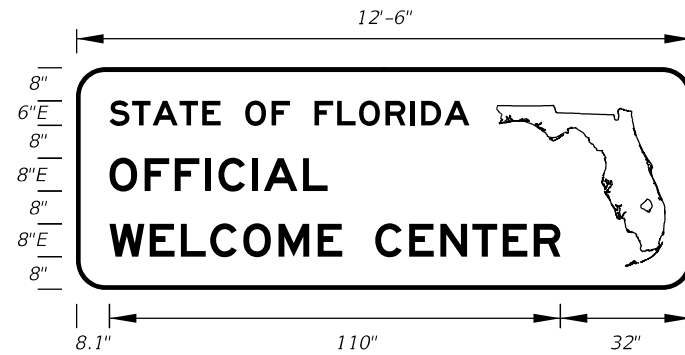

FTP-12-06
 12'-6" X 4'-6"
 7" Radii 2" Border
 6" and 8" Series E Legend
 Blue Background
 White Legend and Border

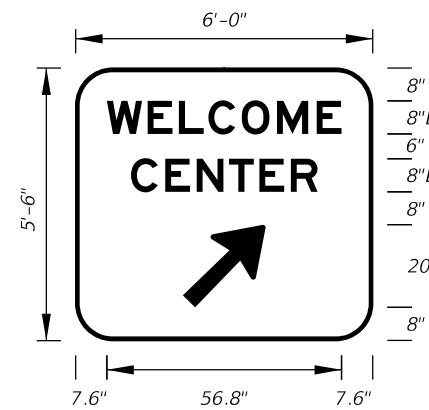

FTP-13-06
 6' 0" X 5'-6"
 9" Radii 2" Border
 8" Series E Legend
 Blue Background
 White Legend and Border

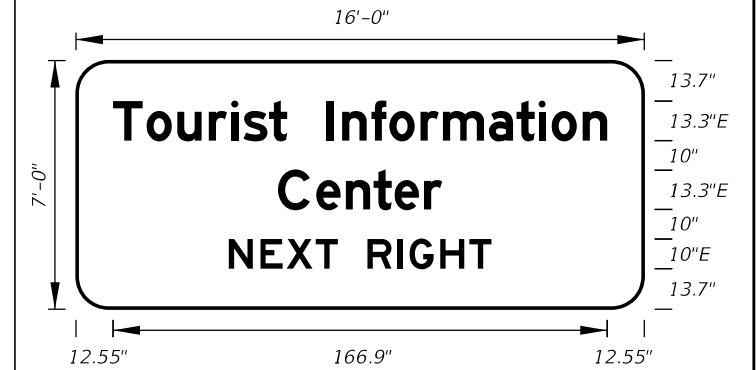

FTP-14-06
 16'-0" X 7'-0"
 11" Radii 2" Border
 13.3 and 10" Series E Legend
 Blue Background
 White Legend and Border

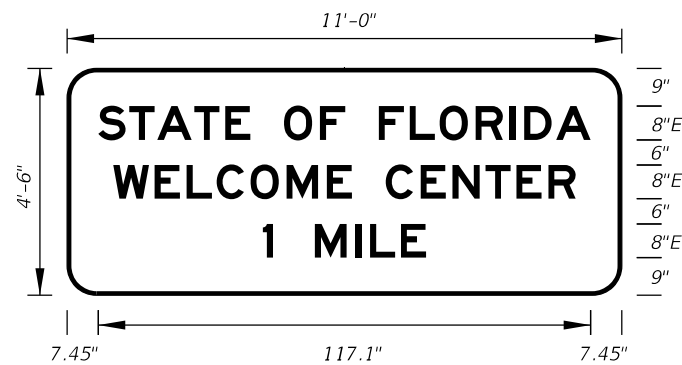

FTP-15A-06
 11'-0" X 4'-6"
 7" Radii 2" Border
 8" Series E Legend
 Blue Background
 White Legend and Border

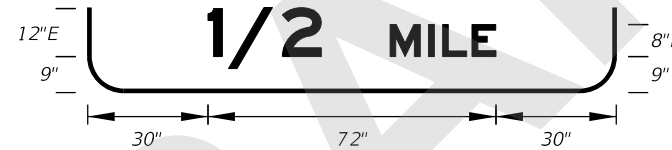

FTP-15B-06
 11'-0" X 5'-0"
 8" Radii 2" Border
 8" and 12" Series E Legend
 Blue Background
 White Legend and Border

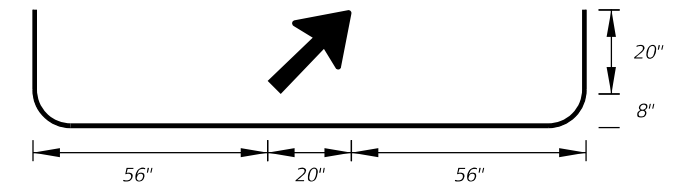

FTP-15C-06
 11'-0" X 5'-6"
 9" Radii 2" Border
 8" Series E Legend
 Blue Background
 White Legend and Border



FTP-16-10
 2'-6" X 3'-0"
 1.5" Radii 3/4" Border
 5" Series B Legend
 Green Background
 White Legend, Border,
 and Florida Symbol



FTP-17-10
 3'-0" X 4'-0"
 1.5" Radii 3/4" Border
 7" Series B Legend
 Green Background
 White Legend, Border,
 and Florida Symbol



FTP-18-10
 4'-0" X 5'-0"
 3" Radii 1 1/4" Border
 8" Series B Legend
 Green Background
 White Legend, Border,
 and Florida Symbol

9/22/2020 6:28:04 AM

LAST REVISION	DESCRIPTION:
11/01/20	



FY 2021-22
 STANDARD PLANS

SPECIAL SIGN DETAILS

INDEX
 700-102

SHEET
 2 of 12

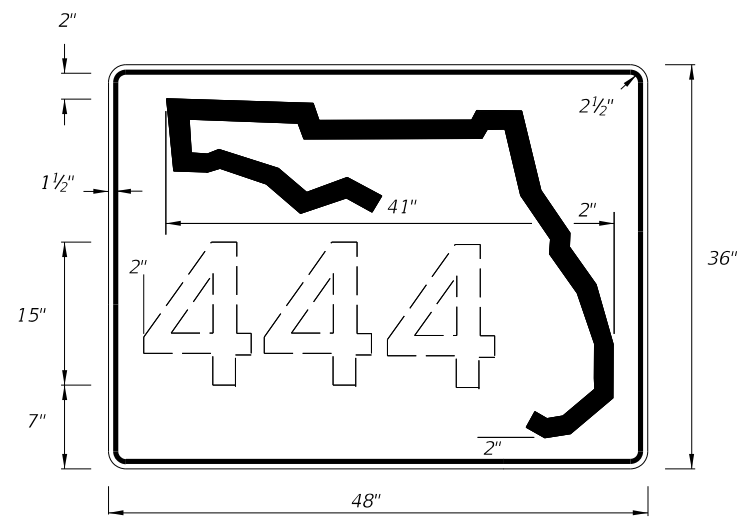

DIGITS	NUMERAL SIZE	SERIES LEGEND	PANEL SIZE
1-3	15"	C	48" x 36"
4	12"	C	48" x 36"

NOTES:

- Stroke width of State Outline shall be 1".
- 2 1/2" Radii

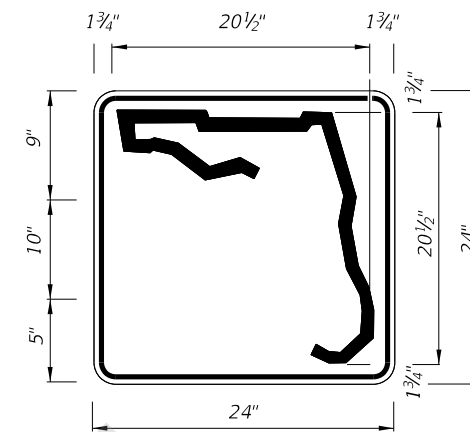

1 or 2 DIGITS

DIGITS	NUMERAL SIZE	SERIES LEGEND	PANEL SIZE
1-2	10"	D	24" x 24"

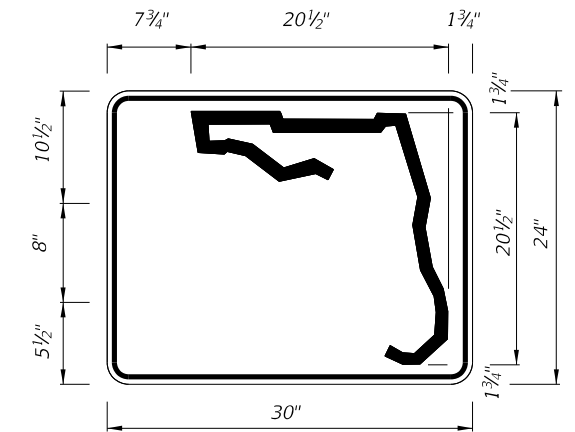

3 or 4 DIGITS

DIGITS	NUMERAL SIZE	SERIES LEGEND	PANEL SIZE
3	8"	D	30" x 24"
4	8"	C	30" x 24"

NOTES:

- Stroke width of State Outline shall be 1".
- The 24" X 24" panel shall only be used for a 3 digit route when the panel is to be used on a sign cluster with other 24" X 24" panels.
- 1 1/2" Radii

INDEPENDENT USE FOR FREEWAY

INDEPENDENT USE OTHER THAN FREEWAY

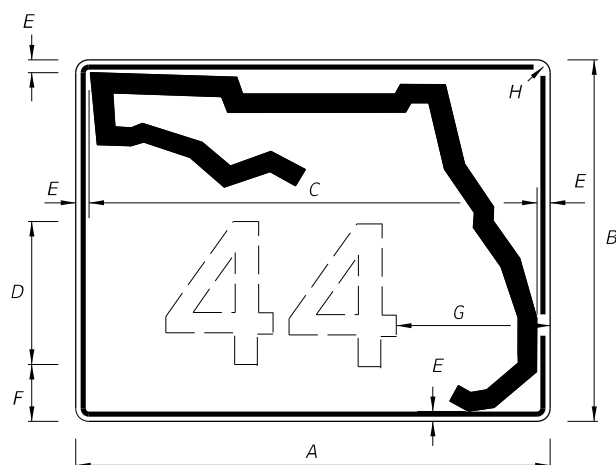

1 OR 2 DIGITS

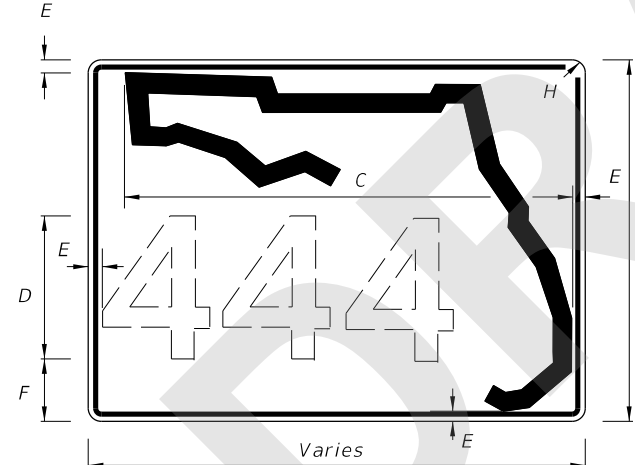

3 OR MORE DIGITS

NOTES:

- Florida marker shall have Black Legend with White Background.
- Stroke width of State outline shall be 1 3/4" for Guide Sign.
- Series D Legend.
- 5/8" Border

A	B	C	D	E	F	G	H
30"	24"	26"	12"	1 1/4"	2 3/4"	8 1/4"	1 1/4"
36"	30"	32"	15"	1 1/4"	3 1/4"	8 3/4"	1 1/4"
42"	36"	38"	15"	1 1/4"	6 1/4"	11"	1 1/4"

GUIDE SIGN USE

FTP-17-06 - FLORIDA ROUTE MARKER

NOTES:

- Series D Legend.
- Color: Yellow Legend and Border on Blue Background.
- When used on a guide sign, marker must be overlaid on a rectangular Yellow Background as shown in chart.
- When two or more County Route Markers are mounted together, use the dimensions of the largest marker for all other markers.

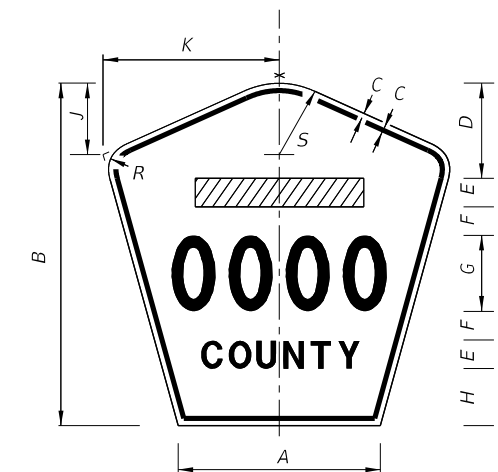

SIGN	DIMENSIONS													Rectangular Yellow Background Dimensions (See Note 3)
	A	B	C	D	E	F	G	H	J	K	R	S		
4 DIGIT POST MOUNTED	25 1/8"	42"	3/4"	10"	4"	4"	8"	8"	8 3/8"	22"	5"	8 3/4"		
2 DIGIT OVERHEAD	21 1/2"	36"	1/2"	7 1/2"	3"	3"	12"	4 1/2"	7 1/8"	18 1/8"	4 1/4"	7 1/2"	42" x 42"	
3 DIGIT OVERHEAD	25 1/8"	42"	3/4"	8"	4"	4"	12"	6"	8 3/8"	22"	5"	8 3/4"	48" x 48"	
4 DIGIT OVERHEAD	29 7/8"	48"	3/4"	8"	5"	5"	12"	8"	9 3/4"	25 5/8"	5 3/4"	10 1/4"	52" x 52"	

FTP-18-06 - COUNTY ROUTE MARKER (M1-6)

9/22/2020 6:28:06 AM



FTP-19-06
 1' X 1'-6"
 4" Radii 3/8" Border
 Top 4" Series D
 Bottom 2" Series C
 White Background
 Green Legend and Border

All Letters
 1" Series C
 1" Spacing
 Between Lines
 of Text

FTP-20-06
 1' X 1'-6"
 2" Radii 3/8" Border
 1" Series C Legend
 Color
 Background
 Legend and Border

Top Blue
 Bottom White
 White Black

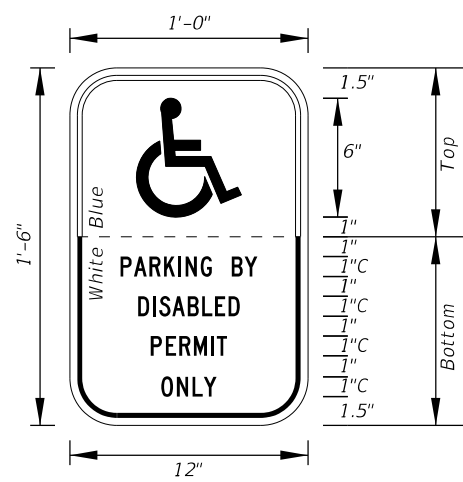

All Letters

1.5" Series C
 1" Spacing
 Between Lines
 of Text

FTP-21-06
 1'-6" X 2'-6"
 2" Radii 3/8" Border
 1.5" Series C Legend
 Color
 Background
 Legend and Border

Top Blue
 Bottom White
 White Black

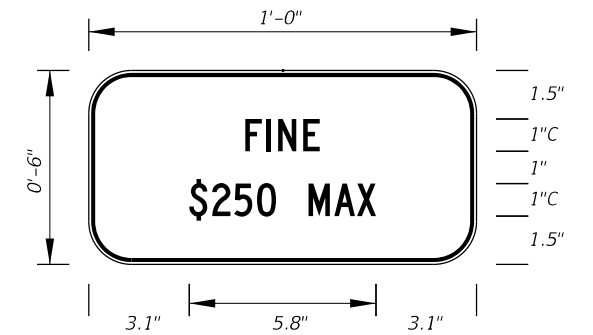
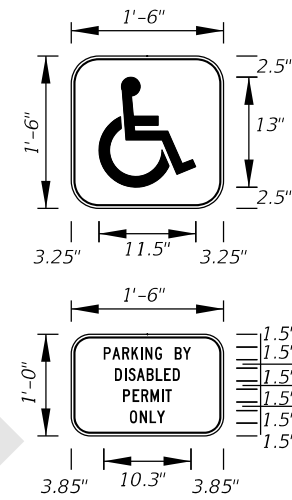

FTP-22-06
 1' X 6"
 1" Radii 3/8" Border
 1" Series C Legend
 White Background
 Black Legend and Border

Supplemental Panel
 for the FTP-20-06
 and FTP-21-06 signs

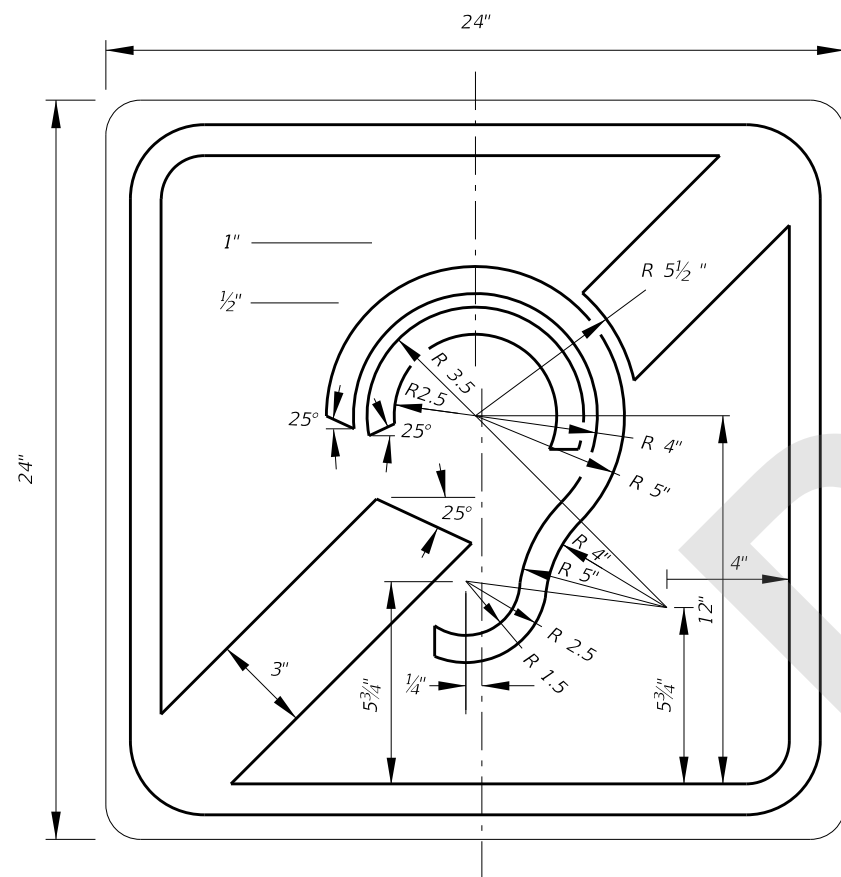

FTP-23-06
 2' X 2'
 1.5" Radii 5/8" Border
 Blue Background
 White Legend and Border

INTERNATIONAL SYMBOL OF
 ACCESS FOR HEARING LOSS

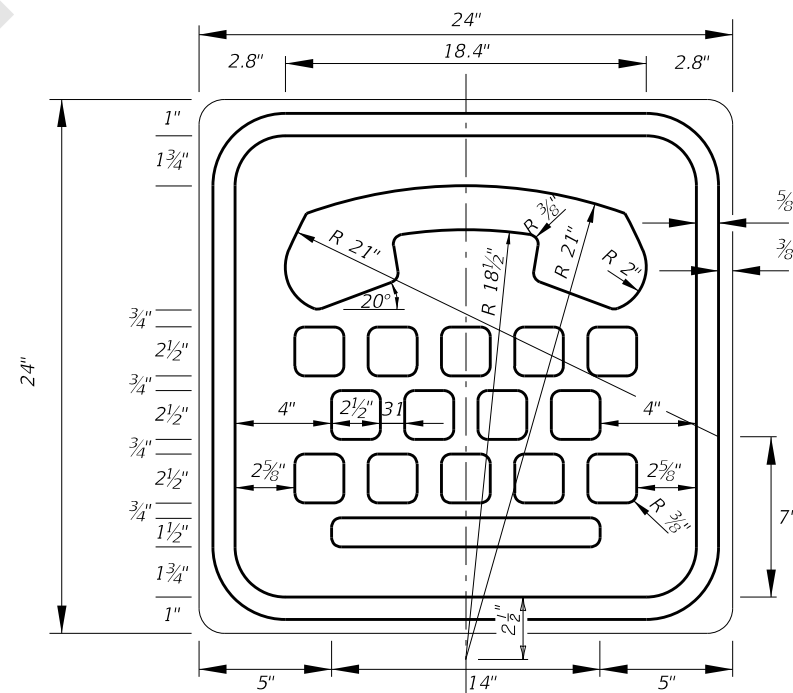

FTP-24-06
 2' X 2'
 1.5" Radii 5/8" Border
 Blue Background
 White Legend and Border

INTERNATIONAL TDD SYMBOL

6:28:09 AM
 9/22/2020

LAST REVISION 11/01/20	DESCRIPTION:
---------------------------	--------------



FY 2021-22
 STANDARD PLANS

SPECIAL SIGN DETAILS

INDEX
 700-102

SHEET
 4 of 12

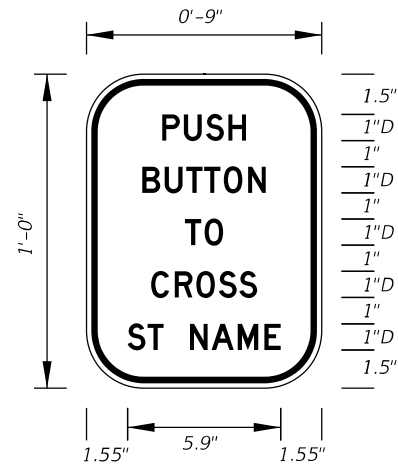

FTP-25-06
 9" X 1'-0"
 2" Radii 3/8" Border
 1" Series D Legend
 White Background
 Black Legend and Border

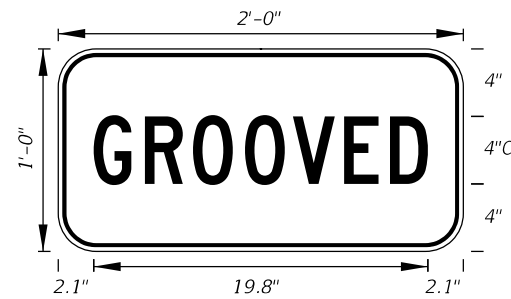

FTP-29-06
 2'-0" X 1'-0"
 2" Radii 5/8" Border
 4" Series C Legend
 Yellow Background
 Black Legend and Border

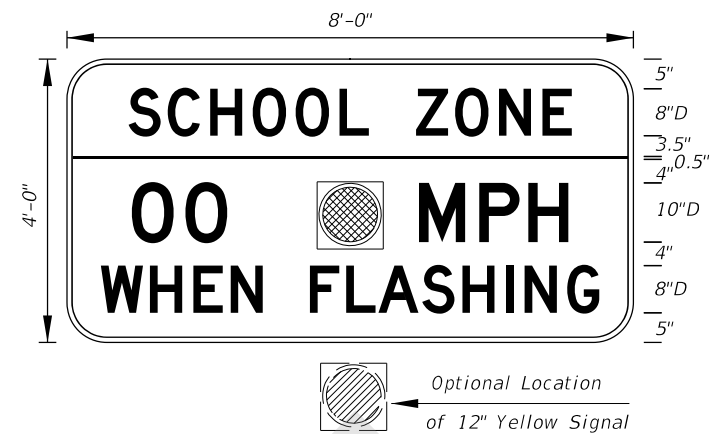

FTP-31-06
 8' X 4'
 6" Radii 3/4" Border
 Series D Legend
 Fluorescent Yellow-Green Background Top
 White Background Bottom
 Black Legend and Border

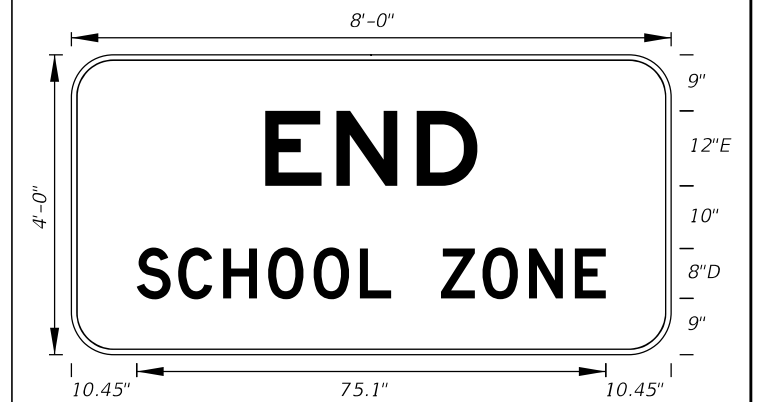

FTP-32-06
 8' X 4'
 6" Radii 3/4" Border
 12" Series E and 8" Series D Legend
 White Background
 Black Legend and Border

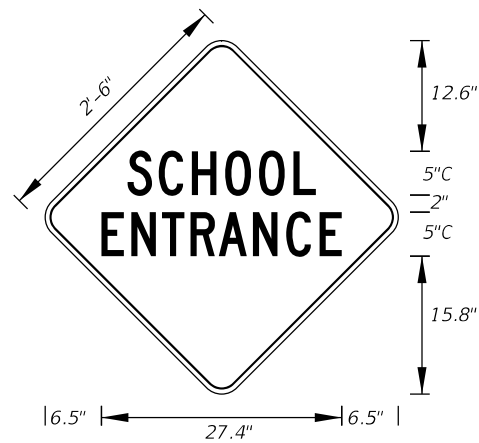

FTP-33-06
 2'-6" X 2'-6"
 2" Radii 3/4" Border
 5" Series C Legend
 Fluorescent Yellow-Green Background
 Black Legend and Border

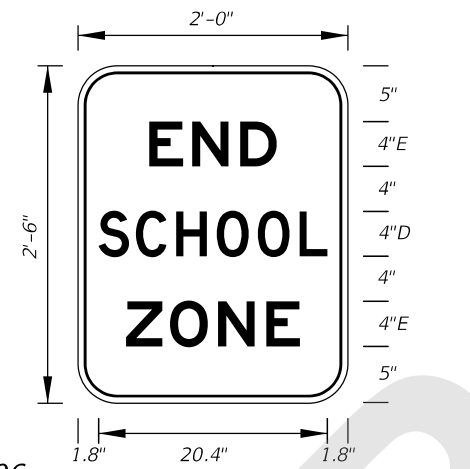

FTP-34-06
 2' X 2'-6"
 3" Radii 5/8" Border
 4" Series D and E Legend
 White Background
 Black Legend and Border

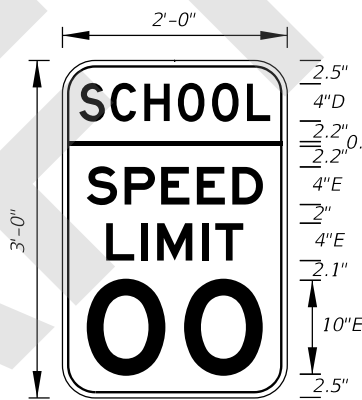

FTP-35-06
 2' X 3'
 3" Radii 5/8" Border
 Top 4" Series D Legend
 Bottom 4" and 10" Series E Legend
 Fluorescent Yellow-Green Background Top
 White Background Bottom
 Black Legend and Border

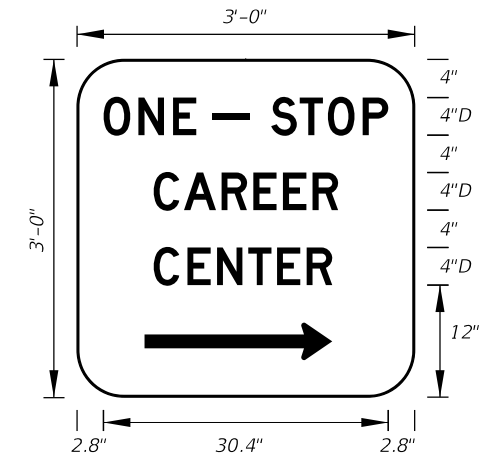

FTP-36-06
 3' X 3'
 5" Radii
 4" Series D Legend
 Green Background
 White Legend and Border

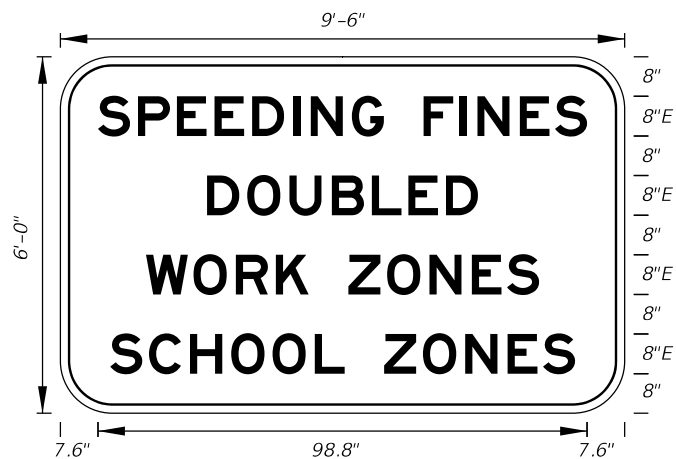

FTP-37-06
 9'-6" X 6'
 9" Radii 2" Border
 8" Series E Legend
 White Background
 Black Legend and Border
 State Line Sign

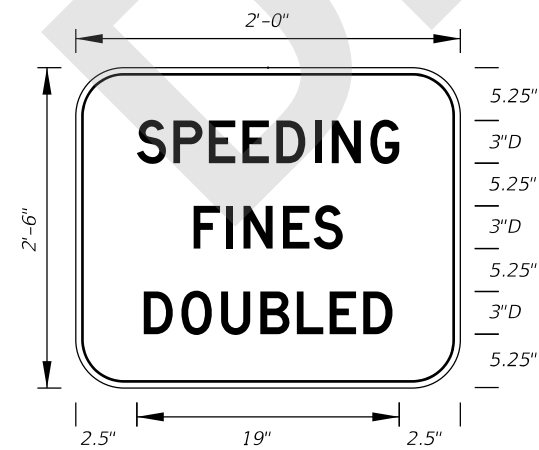

FTP-38-06
 2' X 2'-6"
 4" Radii 3/4" Border
 3" Series D Legend
 White Background
 Black Legend and Border

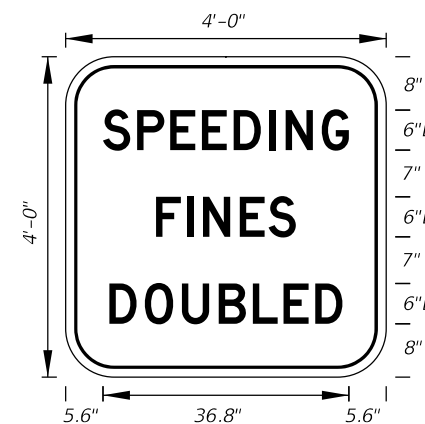

FTP-39-06
 4' X 4'
 6" Radii 3/4" Border
 6" Series D Legend
 White Background
 Black Legend and Border
 Freeway Sign

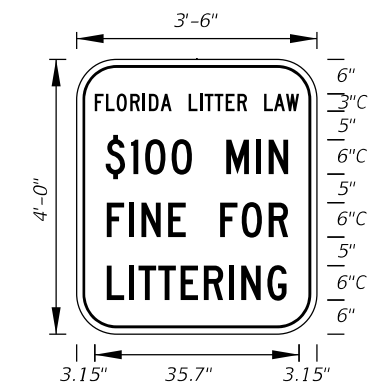

FTP-40-06
 3'-6" X 4'
 6" Radii 3/4" Border
 3" and 6" Series C Legend
 White Background
 Black Legend and Border

9/22/2020 6:28:12 AM

LAST REVISION	DESCRIPTION:
11/01/20	



FY 2021-22
 STANDARD PLANS

SPECIAL SIGN DETAILS

INDEX
 700-102

SHEET
 5 of 12



FTP-41-06
2'-6" X 3'
4" Radii 3/4" Border
2" and 4" Series C Legend
White Background
Black Legend and Border



FTP-42-06
4' X 2'-6"
3" Radii
Top 4" Series C Legend
Bottom 2" Series EM Legend
White Background
Blue Legend and Border

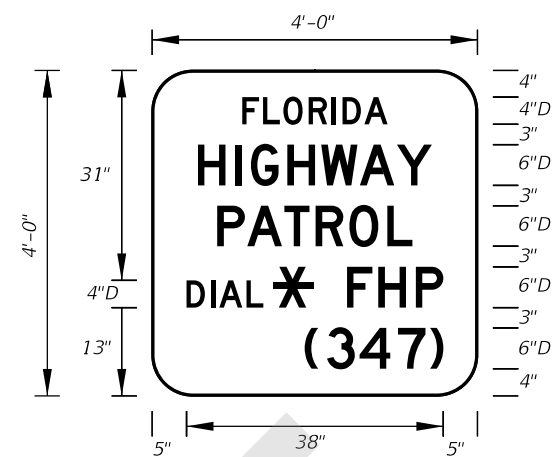

FTP-43-06
4' X 4'
6" Radii 1" Border
Top 4" Series D Legend
Bottom 6" Series D Legend
Blue Background
White Legend and Border



FTP-44-06
9' X 6'
9" Radii 3/4" Border
8" Series D Legend
White Background
Black Legend and Border



FTP-45-06
4' X 3'
5" Radii 3/4" Border
4" Series C Legend
White Background
Black Legend and Border

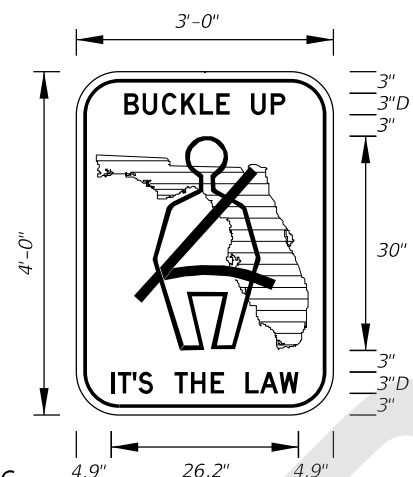

FTP-46-06
3' X 4'
5" Radii 3/4" Border
3" Series D Legend
White Background
Green Florida Symbol
Black Legend, Border and Man Belt Symbol

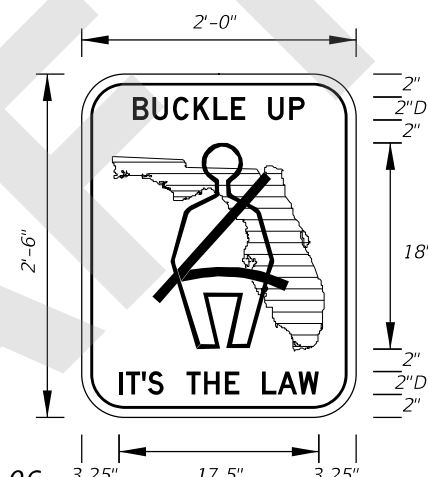

FTP-47-06
2' X 2'-6"
3" Radii 5/8" Border
2" Series D Legend
White Background
Green Florida Symbol
Black Legend, Border and Man Belt Symbol

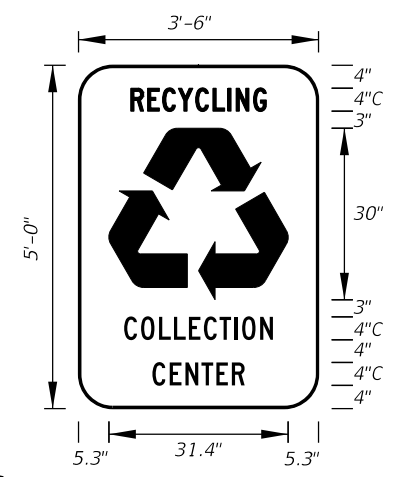

FTP-48-06
3'-6" X 5'
6" Radii
4" Series C Legend
Green Background
White Legend, Border and Symbol

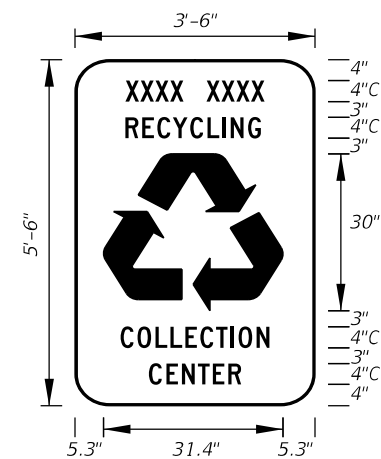

FTP-49-06
3'-6" X 5'-6"
6" Radii
4" Series C Legend
Green Background
White Legend, Border and Symbol
Municipality Name Optional

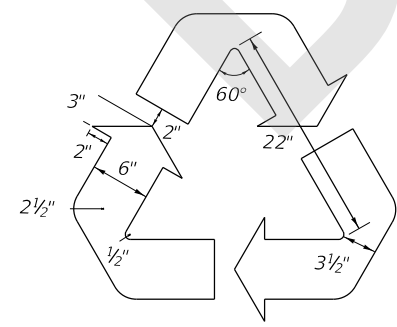

Detail for **FTP-48-06** and **FTP-49-06**

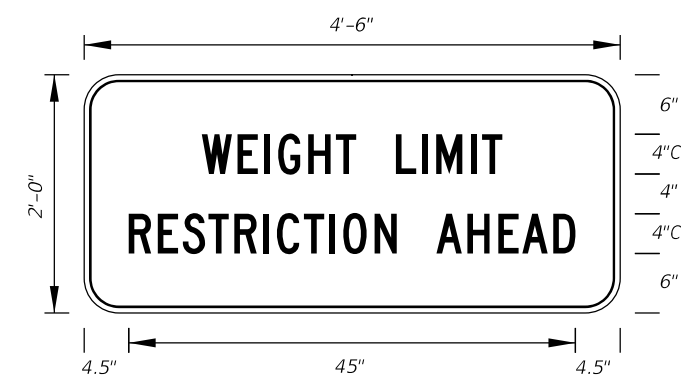

FTP-50-06
4'-6" X 2'
3" Radii 3/4" Border
4" Series C Legend
Yellow Background
Black Legend and Border

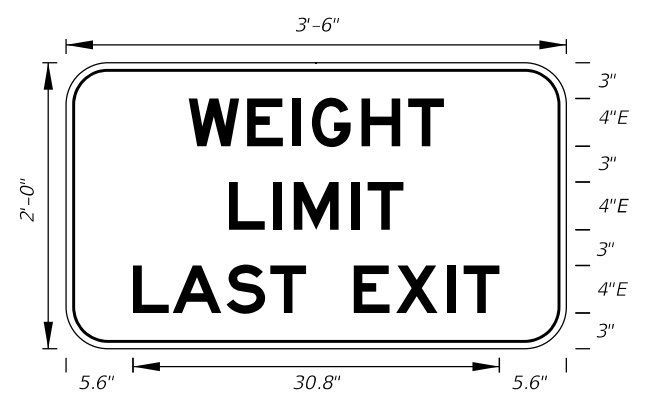

FTP-51-06
3' X 2'
3" Radii 3/4" Border
4" Series E Legend
White Background
Black Legend and Border

9/22/2020 6:28:15 AM

LAST REVISION	DESCRIPTION:
11/01/20	

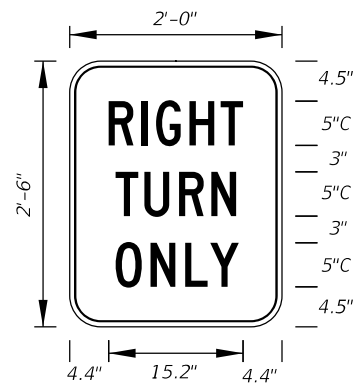

FTP-52-06
2' X 2'-6"
3" Radii 5/8" Border
5" Series C Legend
White Background
Black Legend and Border

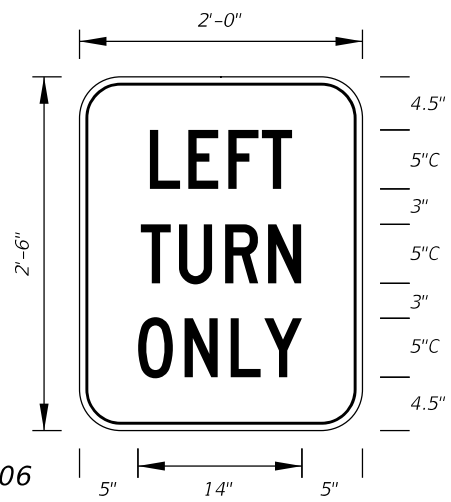

FTP-53-06
2' X 2'-6"
3" Radii 5/8" Border
5" Series C Legend
White Background
Black Legend and Border

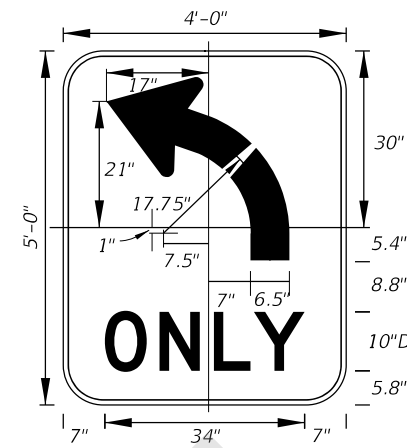

FTP-54L-06
4' X 5'
6" Radii 3/4" Border
10" Series D Legend
White Background
Black Legend and Border
FTP-54R-06 for
(Right Turn Arrow)

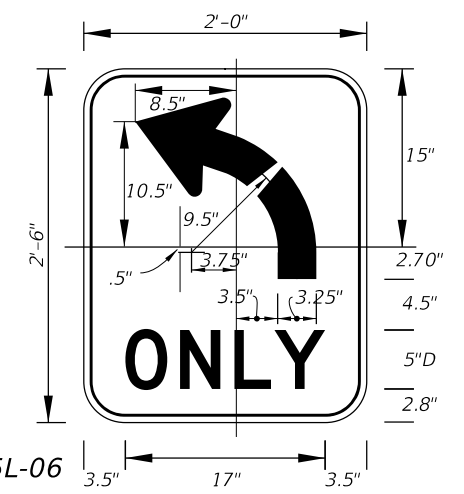

FTP-55L-06
2' X 2'-6"
3" Radii 3/8" Border
5" Series D Legend
White Background
Black Legend and Border
FTP-55R-06 for
(Right Turn Arrow)



FTP-56-06
6'-6" X 4'
6" Radii 3/4" Border
8" and 6" Series D Legend
Blue Background
White Legend and Border
Design Project Manager
or Transit Administrator
will supply correct 1-8XX
number.

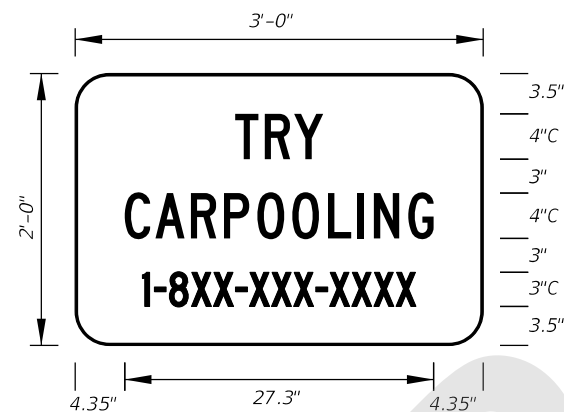

FTP-56A-06
3' X 2'
3" Radii
4" and 3" Series C Legend
Blue Background
White Legend and Border
Design Project Manager
or Transit Administrator
will supply correct 1-8XX
number.

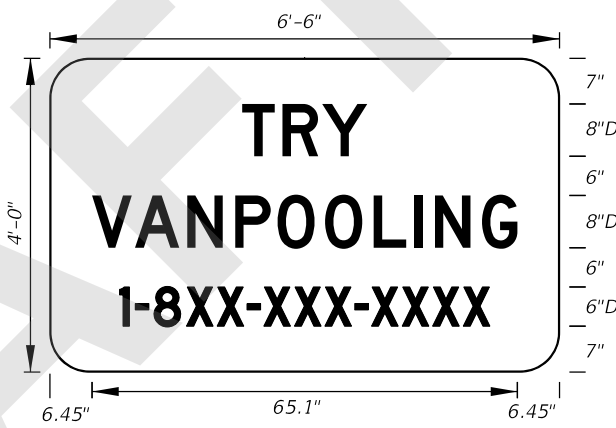

FTP-57-06
6'-6" X 4'
6" Radii
8" and 6" Series D Legend
Blue Background
White Legend and Border
Design Project Manager
or Transit Administrator
will supply correct 1-8XX
number.

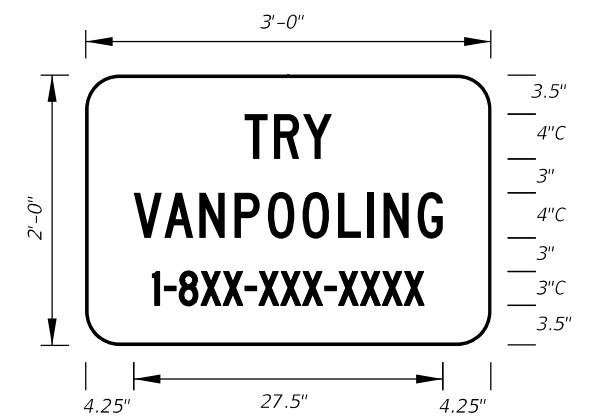

FTP-58-06
3' X 2'
3" Radii
4" and 3" Series C Legend
Blue Background
White Legend and Border
Design Project Manager
or Transit Administrator
will supply correct 1-8XX
number.

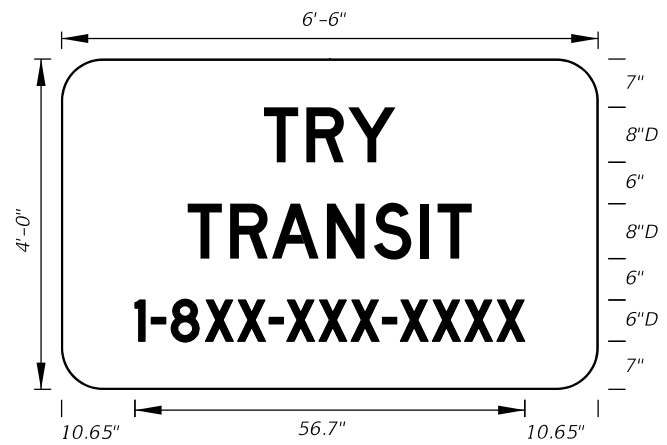

FTP-59-06
6'-6" X 4'
6" Radii
8" and 6" Series D Legend
Blue Background
White Legend and Border
Design Project Manager
or Transit Administrator
will supply correct 1-8XX
number.

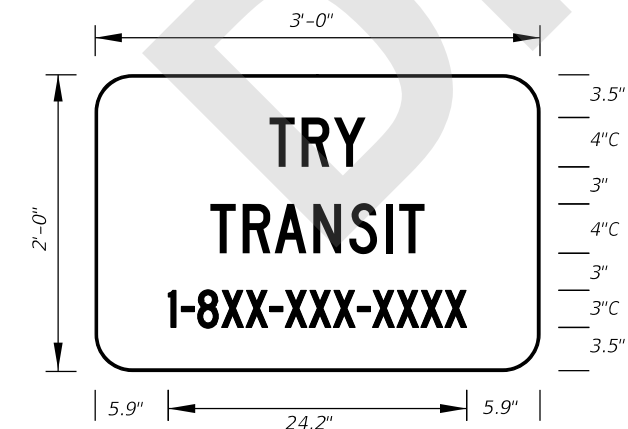

FTP-60-06
3' X 2'
3" Radii
4" and 3" Series C Legend
Blue Background
White Legend and Border
Design Project Manager
or Transit Administrator
will supply correct 1-8XX
number.



FTP-61-06
3' X 2'
3" Radii 3/4" Border
4" and 3" Series C Legend
Yellow Background
Black Legend and Border

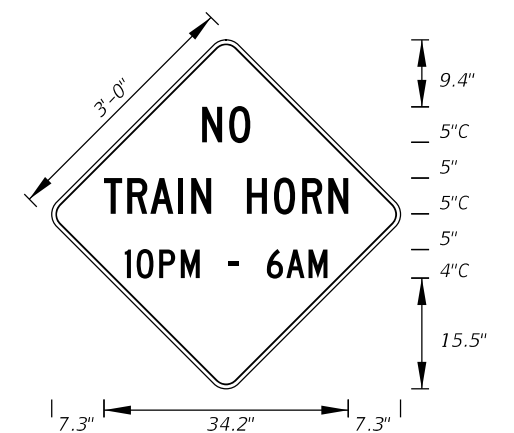

FTP-62-06
3' X 3'
2" Radii 3/4" Border 4" and 5" Series C Legend
Yellow Background Black Legend and Border

9/22/2020 6:28:18 AM

LAST REVISION	DESCRIPTION:
11/01/20	

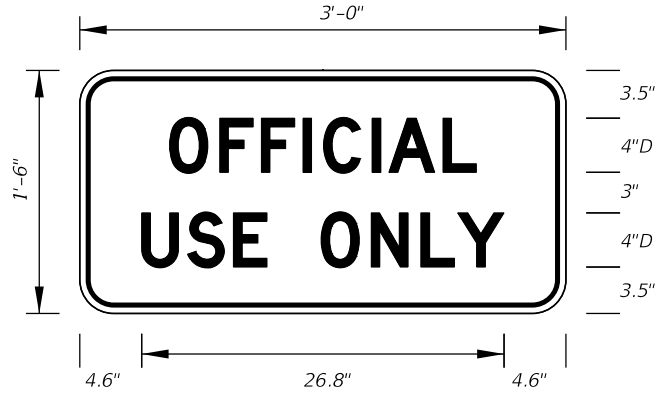

FTP-65-06
 3' X 1'-6"
 2" Radii 3/4" Border
 4" Series D Legend
 White Background
 Black Legend and Border

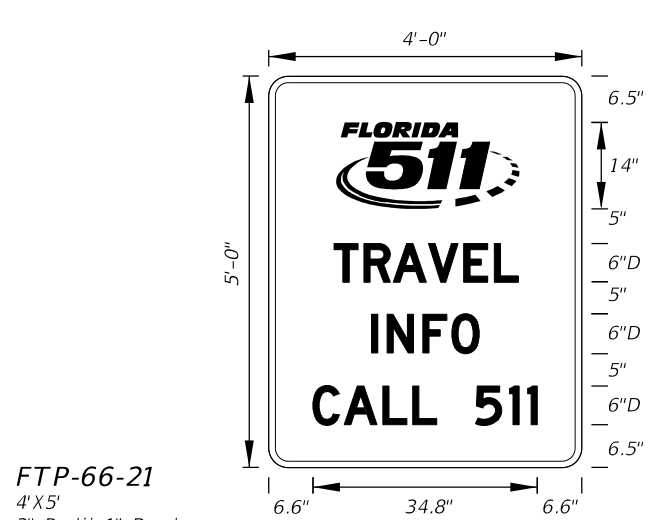

FTP-66-21
 4' X 5'
 3" Radii 1" Border
 6" Series D Legend
 Blue Background
 White Legend and Border



FTP-67-21
 5.5' X 6'
 3" Radii 1" Border
 8" Series D Legend
 Blue Background
 White Legend and Border



DETAIL for **FTP-66** AND **FTP-67**

Sign Mounting Holes Can Be Punched Or Field Drilled With No Obstruction To Text Or Symbols From Holes Or Bolts.

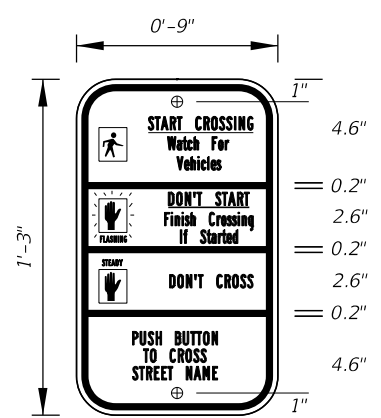

FTP-68A-06
 9" X 1'-3"
 1.5" Radii 3/4" Border
 Series B Legend
 White Background
 Black Legend and Border

See Standard Highway Signs Manual, Sign R10-3b For Letter Size Spacing And Symbol Sizes.

Sign Mounting Holes Can Be Punched Or Field Drilled With No Obstruction To Text Or Symbols From Holes Or Bolts.

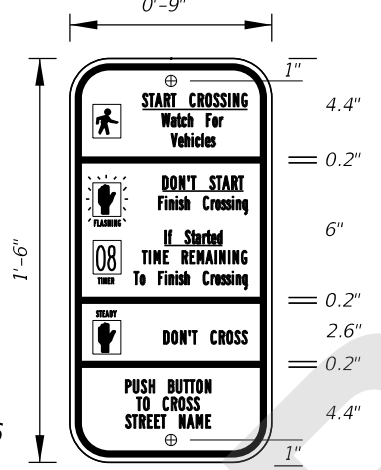

FTP-68B-06
 9" X 1'-6"
 1.5" Radii 3/4" Border
 Series B Legend
 White Background
 Black Legend and Border

See Standard Highway Signs Manual, Sign R10-3b For Letter Size Spacing And Symbol Sizes.

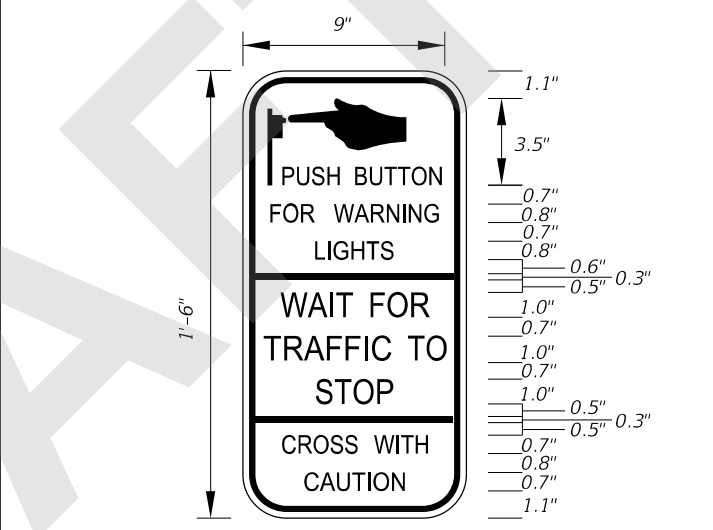

FTP-68C-21
 1'-6" X 9"
 1.5" Radii 1/4" Border

Series D Legend
 White Background
 Black Legend and Border

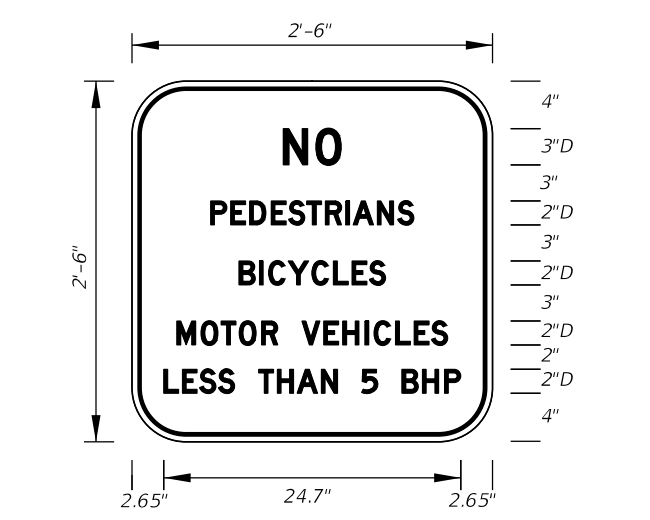

FTP-69-06
 2'-6" X 2'-6"
 4" Radii 3/4" Border

2" and 3" Series D Legend
 White Background
 Black Legend and Border

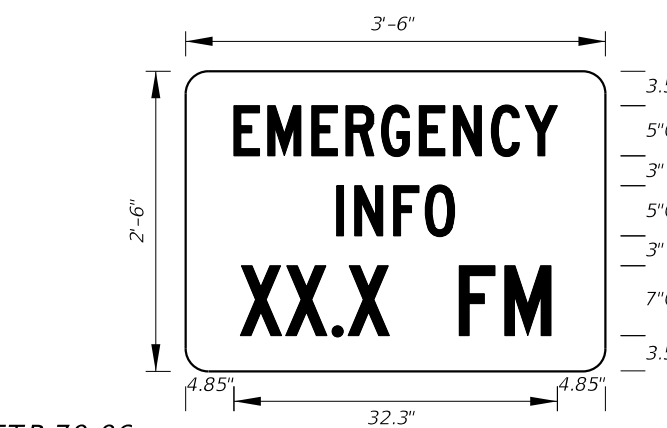

FTP-70-06
 3'-6" X 2'-6"
 2.25" Radii 3/4" Border
 5" Series C and 7" Series C Legend
 Blue Background
 White Legend and Border

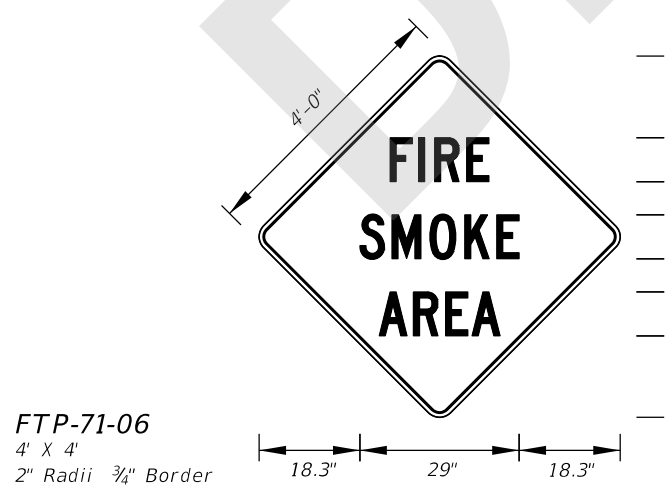

FTP-71-06
 4' X 4'
 2" Radii 3/4" Border
 8" Series C Legend
 Yellow Background
 Black Legend and Border



FTP-72-06
 3' X 3'
 2" Radii 3/4" Border

6" Series C Legend
 Yellow Background
 Black Legend and Border

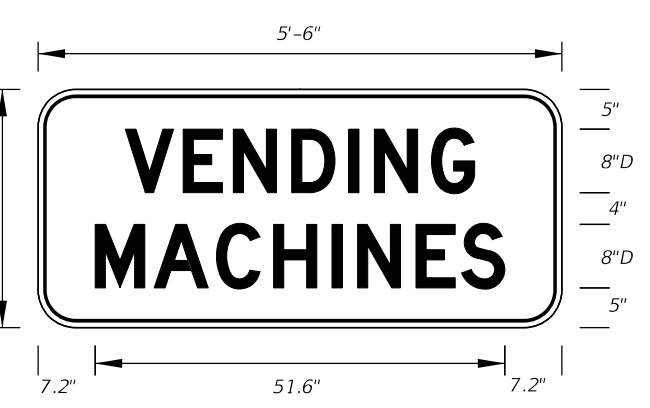

FTP-73-06
 5'-6" X 2'-6"
 4" Radii 3/4" Border

8" Series D Legend
 Blue Background
 White Legend and Border

9/22/2020 6:28:21 AM

LAST REVISION 11/01/20	REVISION	DESCRIPTION:		FY 2021-22 STANDARD PLANS	SPECIAL SIGN DETAILS	INDEX 700-102	SHEET 8 of 12
---------------------------	----------	--------------	--	------------------------------	----------------------	------------------	------------------



FTP-74-06
 5'-6" X 2'-6"
 4" Radii 3/4" Border
 6" Series D Legend
 Blue Background
 White Legend and Border

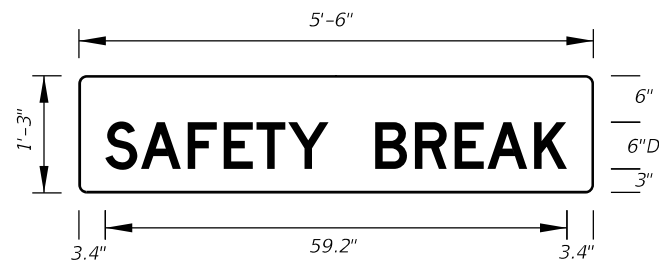

FTP-75-06
 5'-6" X 1'-3"
 1" Radii
 6" Series D Legend
 Blue Background
 White Legend

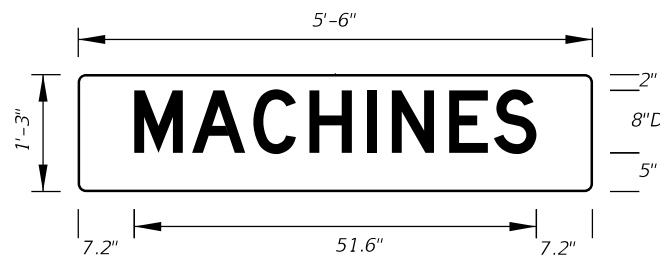

FTP-76-06
 5'-6" X 1'-3"
 1" Radii
 8" Series D Legend
 Blue Background
 White Legend

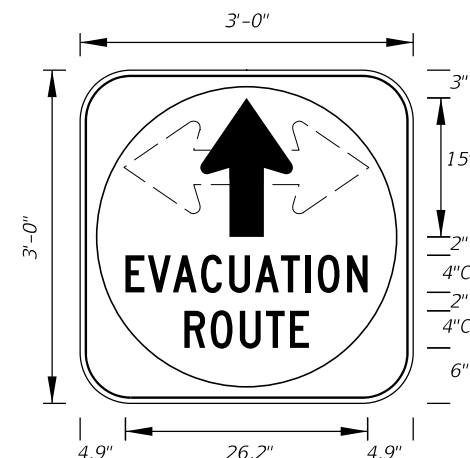

FTP-77-06
 3' X 3'
 5" Radii 3/4" Border
 4" Series C Legend
 White Background with Blue Circle Background
 White Legend and Black Border

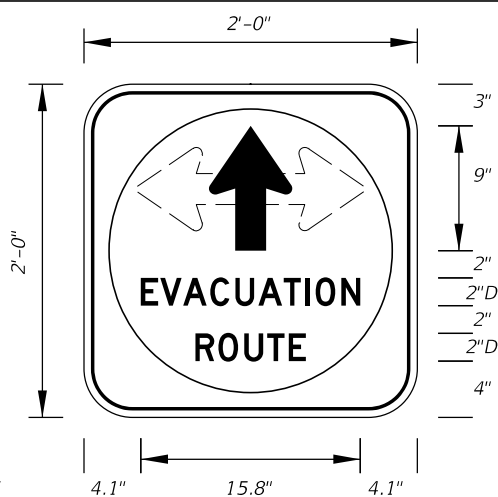

FTP-78-06
 2' X 2'
 3" Radii 3/4" Border
 2" Series D Legend
 White Background with Blue Circle Background
 White Legend and Black Border

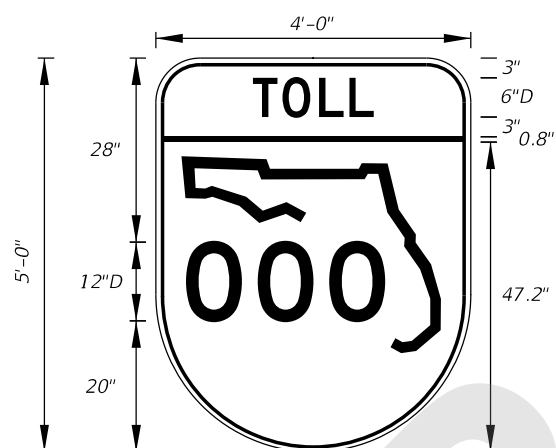

FTP-79-06
 4' X 5'
 6" Radii 3/4" Border
 6" and 12" Series D Legend
 Top Yellow Background with Black Legend and Black Border
 Bottom White Background with Black Legend and Border

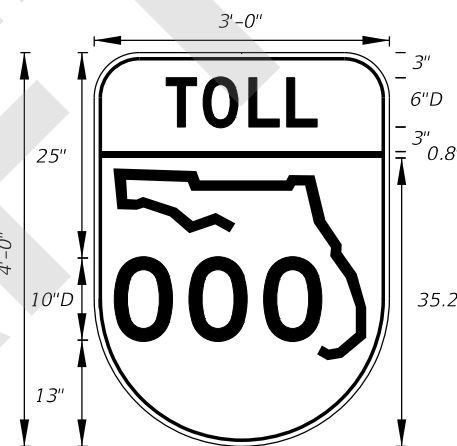

FTP-80-06
 3' X 4'
 5" Radii 3/4" Border
 6" and 10" Series D Legend
 Top Yellow Background with Black Legend and Black Border
 Bottom White Background with Black Legend and Border

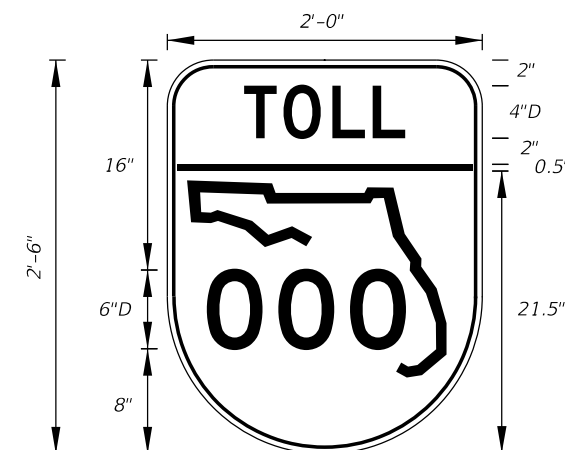

FTP-81-06
 2' X 2'-6"
 3" Radii 3/4" Border
 4" and 6" Series D Legend
 Top Yellow Background with Black Legend and Black Border
 Bottom White Background with Black Legend and Border

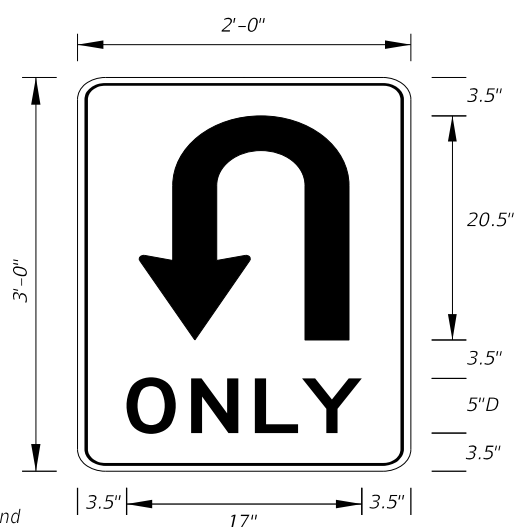

FTP-82-08
 2' X 3'
 1.5" Radii
 5" Series D Legend
 White Background
 Black Legend and Border

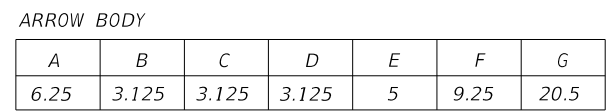
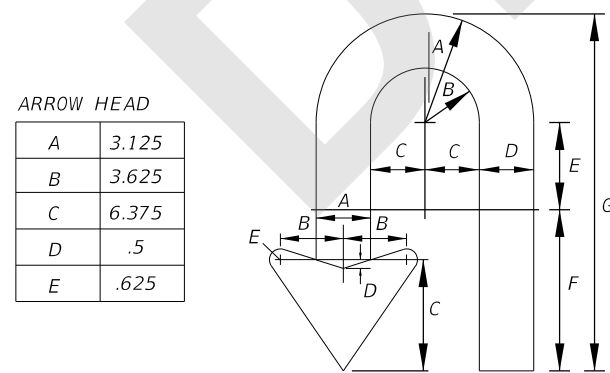

FTP-82-08
 Details

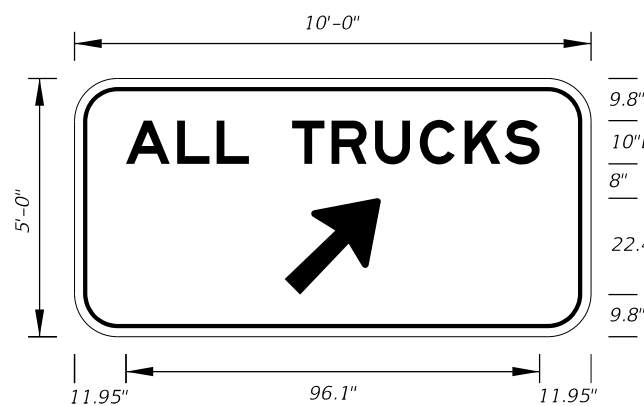

FTP-83-08
 10'-0" X 5'-0"
 8" Radii
 10" Series E Legend
 Green Background
 White Legend

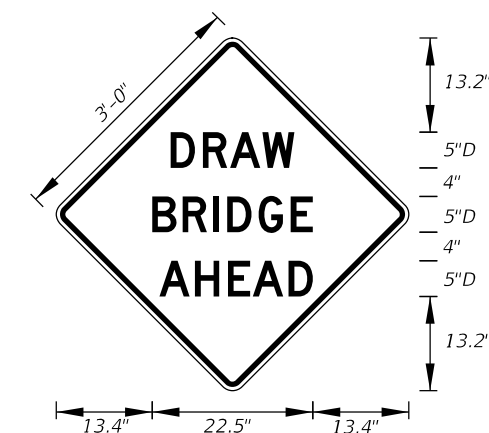

FTP-84-09
 3' X 3'
 1.5" Radii
 5" Series D Legend
 Yellow Background
 Black Legend and Border

9/22/2020 6:28:41 AM

LAST REVISION	DESCRIPTION:
11/01/20	



FY 2021-22
 STANDARD PLANS

SPECIAL SIGN DETAILS

INDEX
 700-102

SHEET
 9 of 12

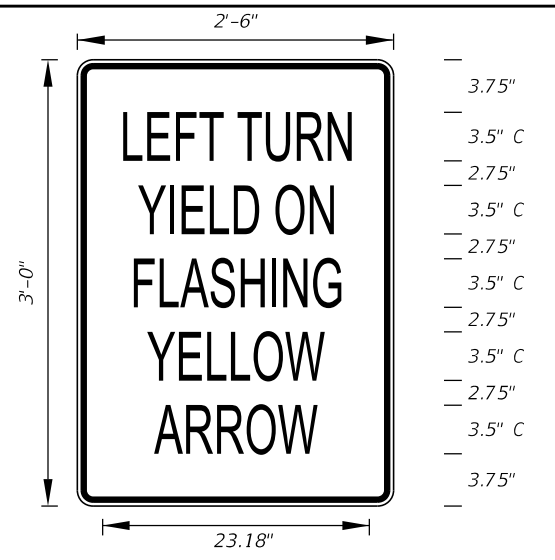

FTP-85-13
3' X 2'-6"
1.875" Radii 3/4" Border
3.5" Series C Legend
White Background
Black Legend and Border

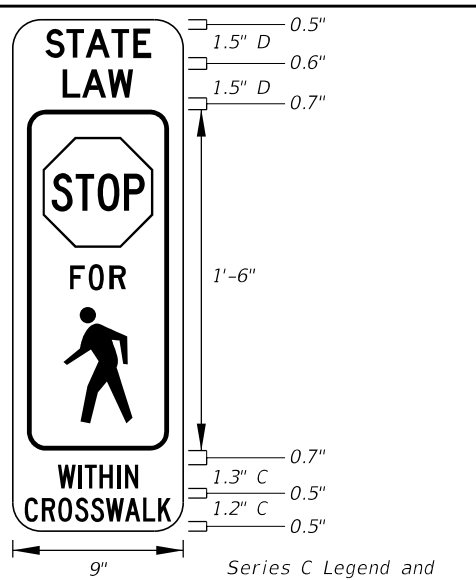

FTP-86-21
2'-3" X 9"
1.5" Radii No Border
Series C Legend and
Series D Legend
White on Yellow
Black Legend and Border

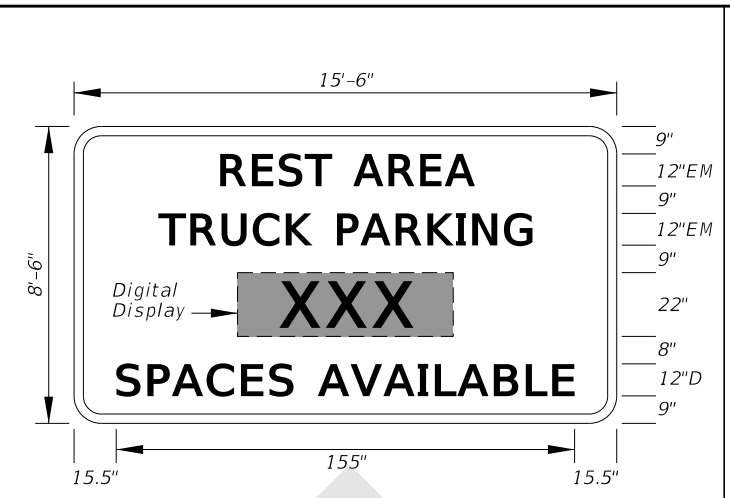

FTP-87-21
15'-6" x 8'-6"
12" Radii 2" Border
Series D Legend
Series EM Legend
Blue Background
White Legend and Border

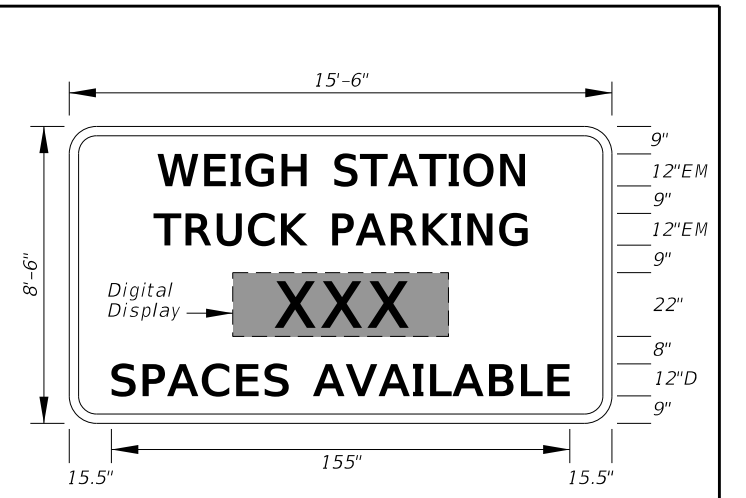

FTP-88-21
15'-6" x 8'-6"
12" Radii 2" Border
Series D Legend
Series EM Legend
Blue Background
White Legend and Border



FTP-89-21
15'-6" x 8'-6"
12" Radii 2" Border
Series D Legend
Series EM Legend
Blue Background
White Legend and Border

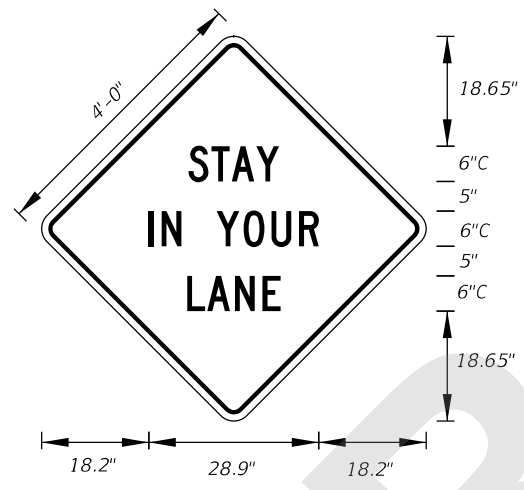

MOT-1-06
4' X 4'
2" Radii 3/4" Border
6" Series C Legend
Orange Background
Black Legend and Border

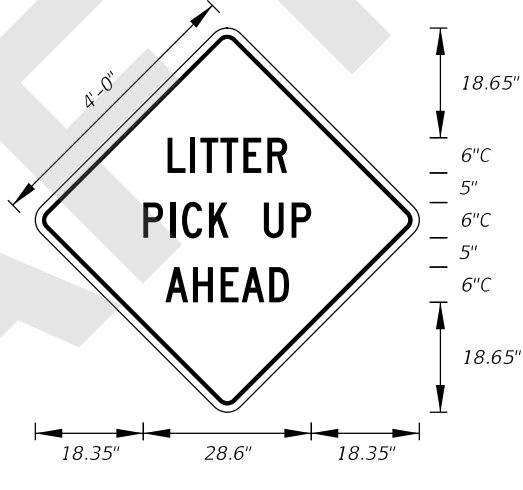

MOT-4-06
4' X 4'
2" Radii 3/4" Border
6" Series C Legend
Orange Background
Black Legend and Border

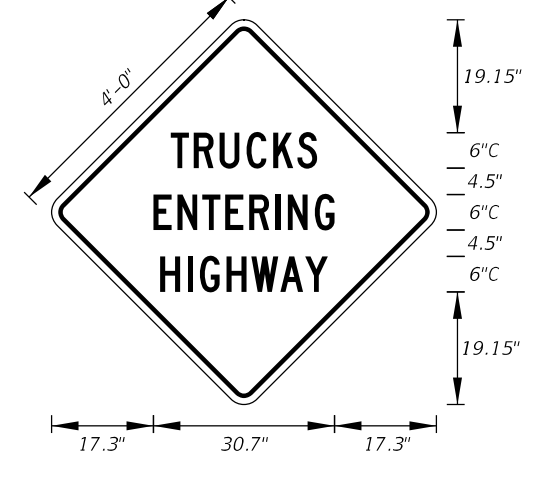

MOT-5-06
4' X 4'
2" Radii 3/4" Border
6" Series C Legend
Orange Background
Black Legend and Border

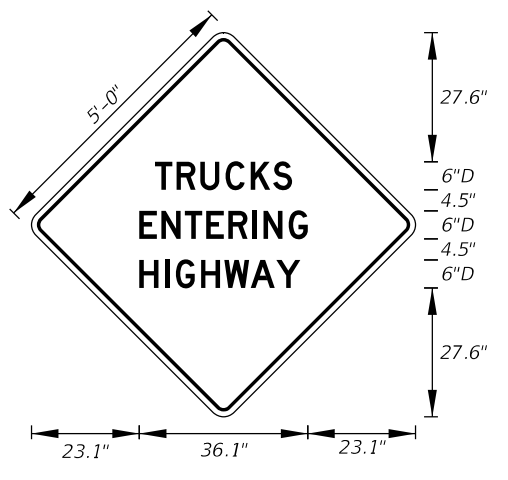

MOT-6-06
5' X 5'
2" Radii 3/4" Border
6" Series D Legend
Orange Background
Black Legend and Border

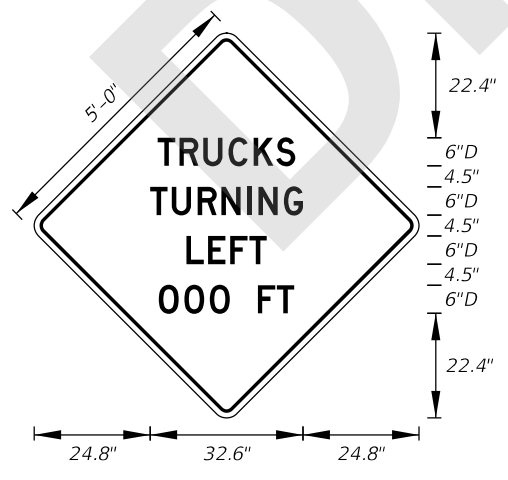

MOT-7-06
5' X 5'
2" Radii 3/4" Border
6" Series D Legend
Orange Background
Black Legend and Border

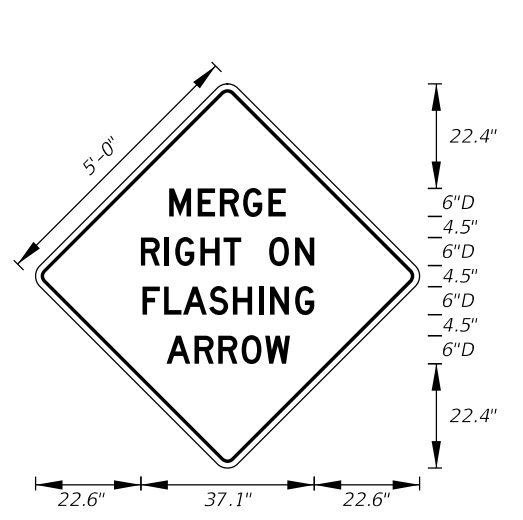

MOT-8-06
5' X 5'
2" Radii 3/4" Border
6" Series D Legend
Orange Background
Black Legend and Border

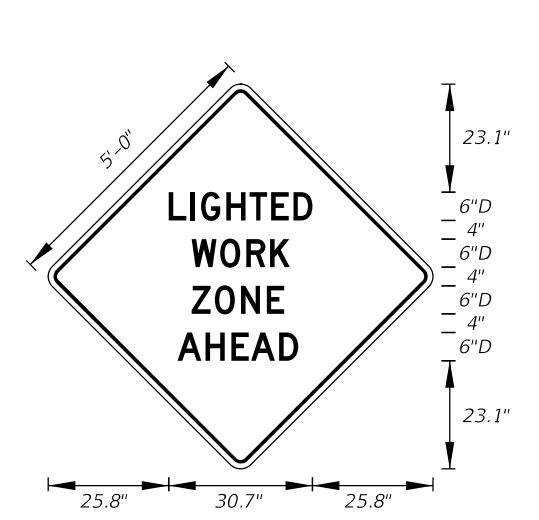

MOT-9-06
5' X 5'
2" Radii 3/4" Border
6" Series D Legend
Orange Background
Black Legend and Border

9/22/2020 11:06:17 AM

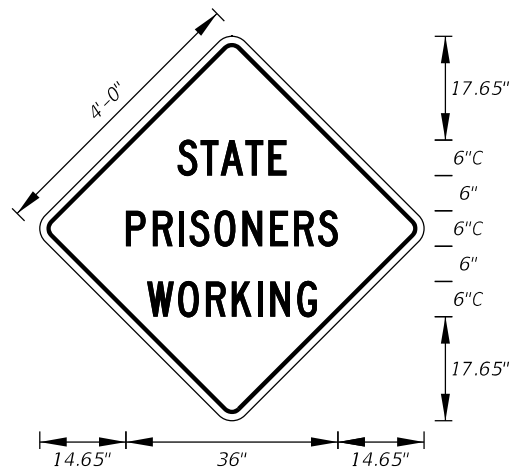

MOT-10-06
4' X 4'
2" Radii 3/4" Border
6" Series C Legend
Orange Background
Black Legend and Border

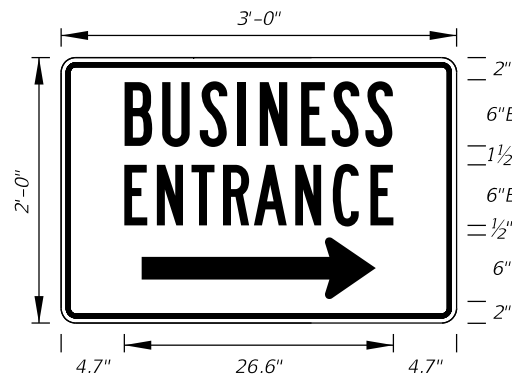

MOT-11-06
3' X 2'
2" Radii 3/4" Border
6" Series B Legend
Blue Background
White Legend and Border

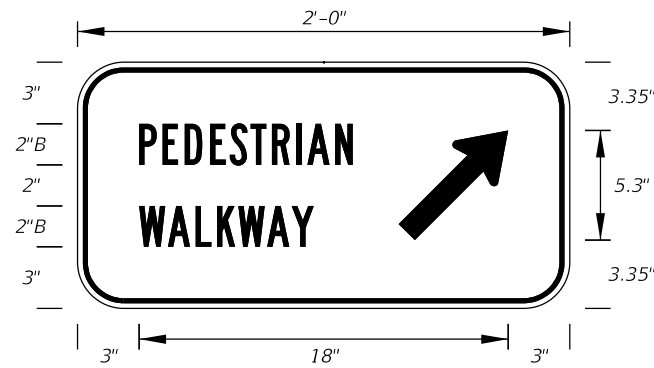

MOT-12R-06
2' X 1'
2" Radii 3/4" Border
2" Series B Legend
White Background
Black Legend and Border

MOT-12L-06
For Diversion
to the left

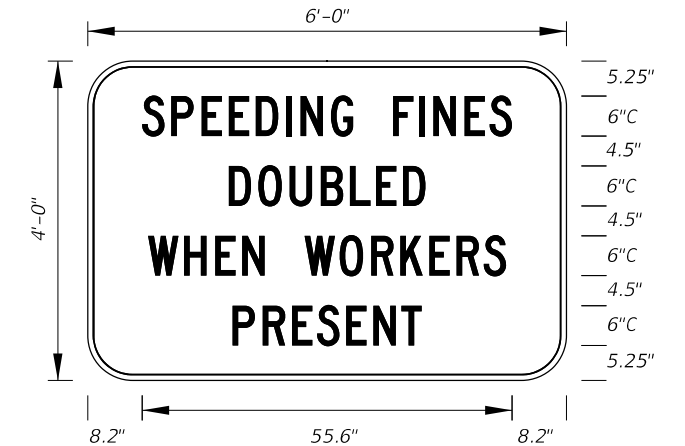

MOT-13-06
Freeway Sign
6' X 4'
6" Radii 3/4" Border
6" Series C Legend
White Background
Black Legend and Border

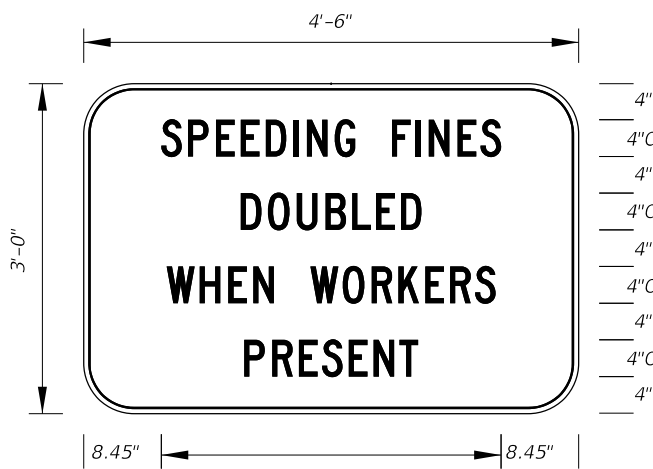

MOT-14-06
Arterial Sign
4'-6" X 3'
5" Radii 3/4" Border
4" Series C Legend
White Background
Black Legend and Border

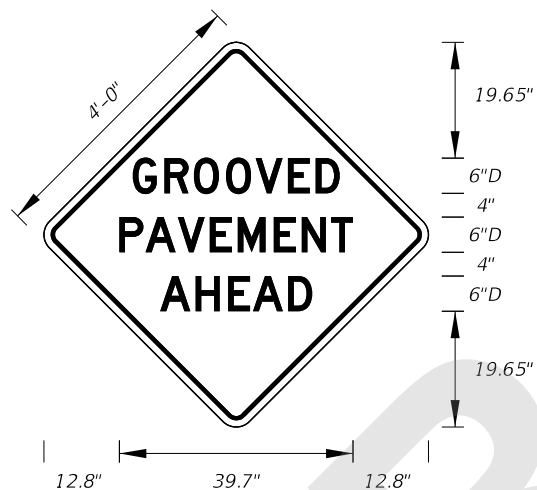

MOT-15-06
4' X 4'
2" Radii 3/4" Border
6" Series D Legend
Orange Background
Black Legend and Border

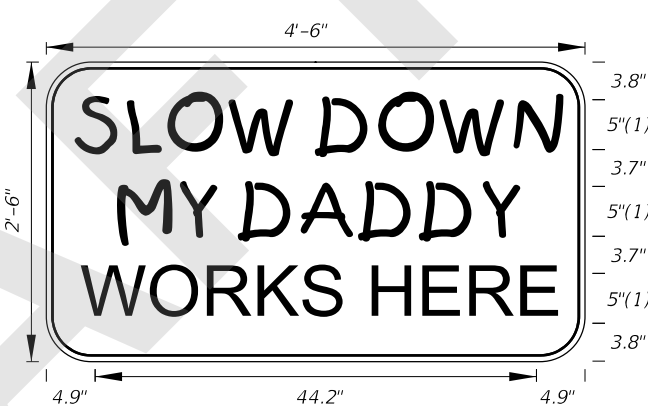

MOT-16-06
4'-6" X 2'-6"
4" Radii 3/4" Border
5" Kids Series Legend
Orange Background
Black Legend and Border

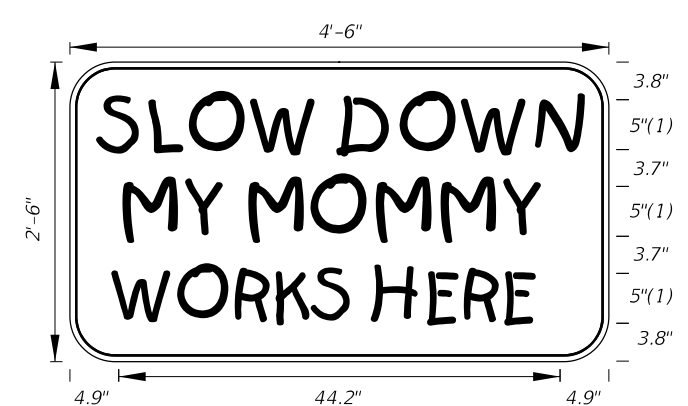

MOT-17-06
4'-6" X 2'-6"
4" Radii 3/4" Border
5" Kids Series Legend
Orange Background
Black Legend and Border

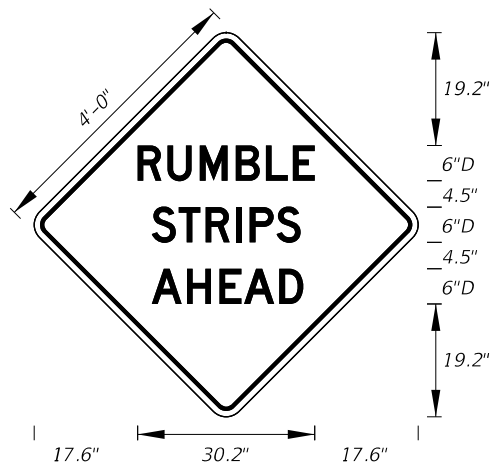

MOT-18-10
4' X 4'
2" Radii 3/4" Border
6" Series D Legend
Orange Background
Black Legend and Border

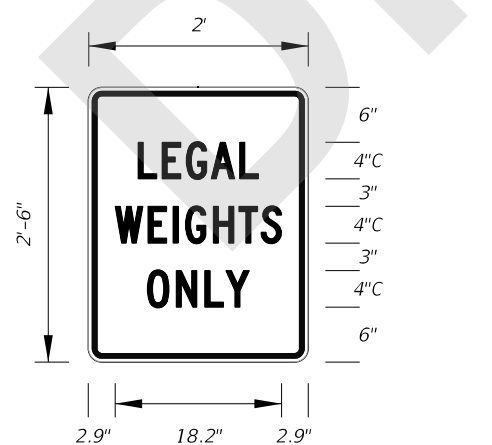

MOT-19-11
2' X 2'-6"
1.13" Radii 3/4" Border
4" Series C Legend
White Background
Red Legend and Border

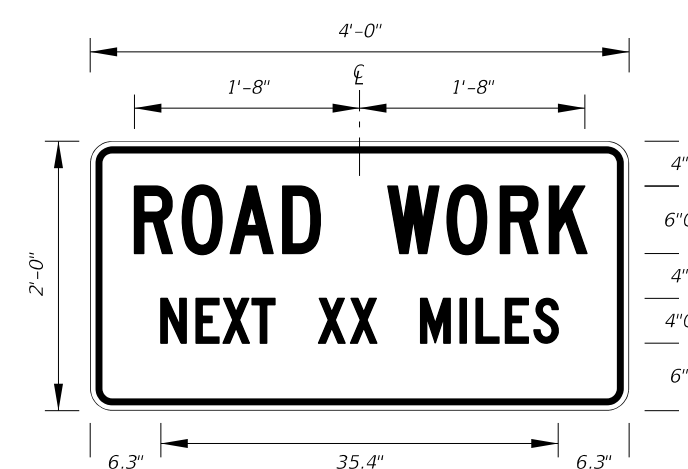

G20-1
2' X 4'
1.5" Radii 3/4" Border
Orange Background
Black Legend and Border

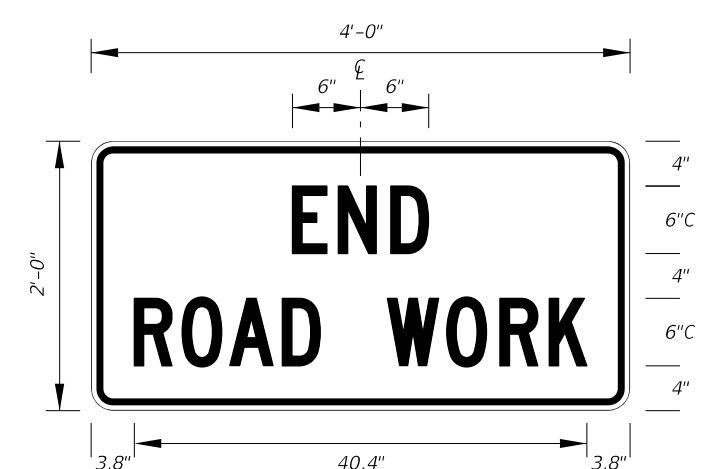

G20-2
2' X 4'
1.5" Radii 3/4" Border
Orange Background
Black Legend and Border

9/22/2020 6:29:22 AM

LAST REVISION 11/01/20	REVISION	DESCRIPTION:	 FY 2021-22 STANDARD PLANS	SPECIAL SIGN DETAILS	INDEX 700-102	SHEET 11 of 12
---------------------------	----------	--------------	--	----------------------	------------------	-------------------

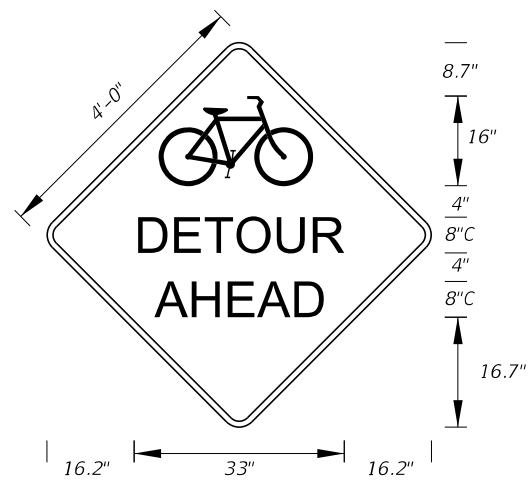

MOT-20-21
 4' X 4'
 3" Radii 3/4" Border
 8" Series C Legend
 Orange Background
 Black Legend and Border

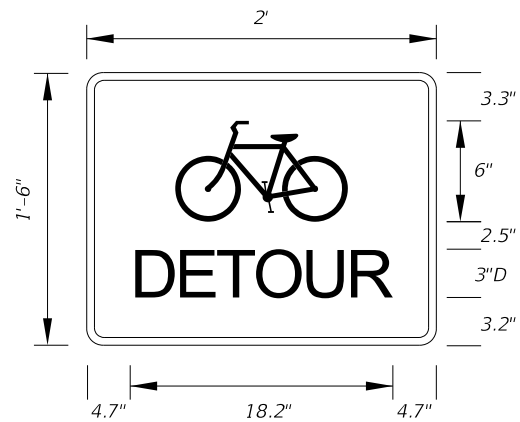

MOT-21-21
 2' X 1'-6"
 1.5" Radii 1/2" Border
 3" Series D Legend
 Orange Background
 Black Legend and Border

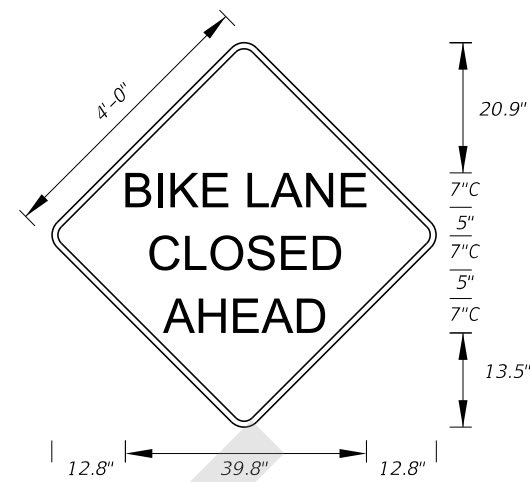

MOT-22-21
 4' X 4'
 3" Radii 3/4" Border
 7" Series C Legend
 Orange Background
 Black Legend and Border

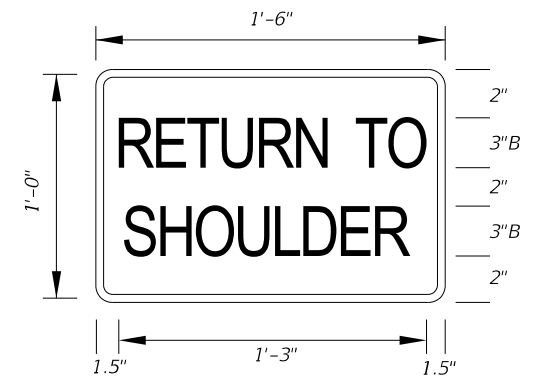

MOT-23-21
 1'-6" x 1'-0"
 1.5" Radii 1/4" Border
 3" Series B Legend
 Orange Background
 Black Legend and Border

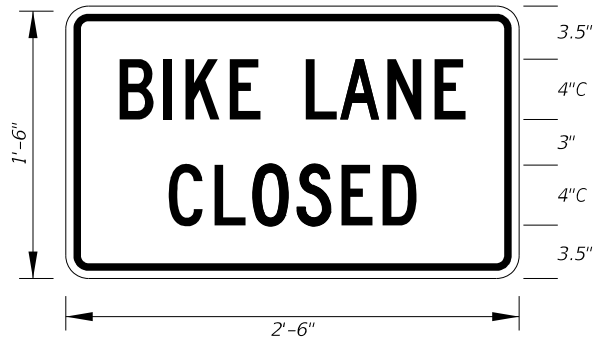

MOT-24-21
 2'-6" x 1'-6"
 1.5" Radii 1/2" Border
 4" Series C Legend
 White Background
 Black Legend and Border



MOT-25-21
 2'-0" x 1'-6"
 1.5" Radii 1/2" Border
 4" Series B Legend
 White Background
 Black Legend and Border

9/22/2020 6:29:28 AM

LAST REVISION 11/01/20	REVISION	DESCRIPTION:	 FY 2021-22 STANDARD PLANS	SPECIAL SIGN DETAILS	INDEX 700-102	SHEET 12 of 12
---------------------------	----------	--------------	---	----------------------	------------------	-------------------