

Index 460-470 Series Traffic Railing - (Thrie-Beam Retrofit)

Design Criteria

NCHRP Report 350, Test Level 4; **AASHTO LRFD Bridge Design Specifications**, 6th Edition, Section 13; **Structures Design Guidelines (SDG)**

Design Assumptions and Limitations

Index 460-470 is the lead standard for the Traffic Railing (Thrie-Beam Retrofit) standard series which includes Indexes 460-470 through 460-476. Use this standard with Indexes 536-002, 460-471, 460-472, 460-473, 460-474, 460-475 and 460-476.

The Traffic Railing (Thrie-Beam Retrofit) Indexes 460-470 through 460-476, are applicable for retrofitting specific types of existing bridge mounted traffic railings (a.k.a. concrete handrails) that are not based on crash tested designs. Indexes 460-470 through 460-476 are not acceptable as alternatives for new construction.

These Standards are to be used in conjunction with Index 536-002. The appropriate Index 536-002 approach transition retrofit for Index 460-470 Series bridge railing retrofits must be selected and specified in the plans based on the shapes and designs of the existing bridge traffic railings, approach slabs and end bent wing walls. See the Instructions for Index 536-002 and **SDG** 6.7 for more information.

The applicability of the Thrie-Beam Retrofit to a particular bridge shall be determined based on a review of the Load Rating of the existing bridge, a comparison of the existing bridge geometry to that shown for the Thrie-Beam Retrofit and an evaluation of the structural adequacy of the existing bridge deck and wing walls in accordance with the requirements of the **SDG**. See **SDG** 2.2 for average weight per linear foot of the retrofit.

The Traffic Railing (Thrie-Beam Retrofit) is based on a design that has been successfully crash tested in accordance with **NCHRP Report 350** Test Level 4 criteria. The Standards all utilize 10 Gauge Thrie-Beam Guardrail that is installed adjacent to the face of the existing curb and in front of, or in place of, all or part of the existing traffic railing. The Standards work with existing traffic railings that incorporate either solid concrete parapet type or concrete post and beam type railings with or without top mounted metal railings. These existing traffic railings are typically mounted on top of concrete curbs of varying widths and heights. The individual Standards address both narrow and wide curbs (a.k.a. "safety curbs"), and skewed and non-skewed bridges with parallel, perpendicular, angled or flared end bent wing walls. Each Standard includes several schemes that address the given wing wall configurations. Examples depicting existing curb and end bent wing wall configurations are shown in the Existing Curb Schematics and the Partial Plan Views of Existing Bridges herein.

Generally, the Roadway Plans shall include all of the sheets necessary to define and detail the retrofit of the existing traffic railings. Index 460-470, Traffic Railing (Thrie-Beam Retrofit) Typical Details & Notes shall be referenced in the Roadway Plans, or a similar project specific drawing depicting general notes and details, shall be included in

the Roadway Plans. In addition, one or more of the appropriate Indexes 460-471 through 460-476, that most closely matches the configuration of the existing traffic railing and curb is to be referenced in the Roadway Plans for each bridge as required. Generally, these Standards can be used without any modifications being made to them. More than one of the Indexes 460-471 through 460-476 may be required for a single bridge due to the curbs or sidewalks on the two sides of the bridge possibly having different widths. A separate Plan and Elevation sheet of the type used in Structures Plans is generally not required.

The heights of the exposed portions of the existing bridge curbs may vary and shall be determined by field measurement. These Indexes are applicable for bridges with exposed curb heights from 5" to 1'-0". If resurfacing of the bridge deck is proposed, then the Roadway Engineer shall ensure sufficient milling depth is shown in the Plans in order to maintain the 5" minimum exposed curb height. The appropriate post designation of "A", "B" or "C" shall be determined and shown in the Plans for each bridge based on the criteria given in the Post Dimension Table on **Standard Plans** Index 460-470. The selection of the appropriate post shall consider any proposed milling and resurfacing work.

The need to remove all or part of the existing traffic railing down to the top of the curb in order to provide room for the construction of the retrofit is addressed in the individual Indexes. Payment for the removal of all or part of the existing traffic railing shall be included in Removal of Existing Structures, Pay Item 110-3. As part of the overall retrofit concept for a bridge, the existing traffic railing may be removed, even though it is not specifically required to be, in order to reduce the dead load carried by the bridge. In these cases, the potential drop off hazard for pedestrians that will be created behind the retrofit shall be addressed in the Plans.

Where scuppers exist on bridge decks, project specific notes or details may be required to maintain scupper openings and avoid anchor bolt conflicts.

The treatment of the approach end of the retrofit shall consist of Index 536-002 or another appropriate site specific treatment. The appropriate treatment of the trailing end of the retrofit shall be determined by the Roadway Engineer. As a minimum, if no other hazards are present, an Index 536-001, W-Thrie Beam Transition Section a Trailing Anchorage shall be provided on the trailing end of the retrofit. On approach ends, a Transition Block or Curb is required if the existing Approach Slab does not have a curb. A Transition Block is not required on trailing ends with no opposing traffic; however, a Curb may be required due to drainage needs. An Index 520-001, Type D Concrete Curb is generally suitable for this application. The appropriate site specific approach and trailing end treatments shall be shown in the Plans.

Indexes 536-002 and 460-470 through 460-476 shall be supplemented as required with project specific details that may be deemed necessary to complete the installation of the retrofit. These details may include locations and details of any existing utilities, conduits, drainage structures (including scuppers), sign structures and luminaire supports, and/or any other needed information not included in these Standards. In the event that the designs and details presented in the Indexes do not closely match the existing

conditions, the Structures and/or Roadway Engineer(s) shall prepare a customized project specific retrofit design based on the crash tested bridge railing and guardrail transition designs presented in Indexes 536-002 and 460-470 through 460-476 as guides. Contact the Structures Design Office and Roadway Design Office for guidance in this event.

The Structures Engineer shall evaluate the thermal movements of the existing bridge using the following criteria and shall identify the locations in the Plans (if any are required) where a Thrie-Beam Expansion Section is to be included in the guardrail. If the total thermal movement at an individual bridge deck expansion joint is $1\frac{1}{2}$ " ($\frac{3}{4}$ " in each direction) or less, the Thrie-Beam Guardrail shall span the joint without the use of an expansion section. If the total thermal movement at an individual bridge deck expansion joint exceeds $1\frac{1}{2}$ ", a Thrie-Beam Expansion Section must be installed at that location. The total amount of thermal movement at bridge deck expansion joints shall be determined by theoretical calculation and confirmed by field measurements where possible. It should be noted that the actual in-service movement due to thermal effects may be less than the value determined by theoretical calculation.

The Utility Adjustment Plans, if required, shall contain all necessary utility adjustment information required for the construction of the retrofit. Utilities and/or conduits may exist in or adjacent to the existing traffic railings and will vary in size, number and location. The presence, size, number and locations of existing utilities and/or conduits shall be determined by a review of existing Plans and confirmed by field verification. It should be noted that utility and/or conduit installations may vary by location on a single bridge. Thus, a field verification shall be conducted for each individual installation of the retrofit. Existing utilities and/or conduits that conflict with the retrofit shall be relocated if possible or placed out of service. The required field verification work should be completed as early in the evaluation phase as possible.

The Traffic Control Plans for the construction of the retrofit shall be prepared in accordance with Index 102-600 Series. The Plans shall address all aspects of the full or partial removal of the existing traffic railing (when required) and construction of the retrofit. Generally, the use of Indexes 460-471 and 460-474 will require the removal of the existing traffic railing and will require traffic control consisting of shifting, narrowing and/or closing of travel lanes and/or shoulders. In this case, the use of crash tested Precast Concrete Temporary Barriers will also be required to protect the drop-off exposed by the removal of the existing traffic railing.

Indexes 460-470 through 460-476 do not address retrofitting of the existing traffic railings, curbs or sidewalks for pedestrian use. The potential need to retrofit the existing bridge for pedestrian use shall be evaluated on a project by project basis and the necessary Plans developed accordingly. Generally, the potential effects on pedestrian use of the bridge will be confined to bridges with sidewalks or wide curbs. The use of the Side Mounted Bridge Pedestrian/Bicycle Railing shown in Indexes 515-051 and 515-061, and the Pedestrian Safety Treatment shown in Index 536-001 shall be evaluated and noted in the Plans where appropriate. See the **SPI** for Indexes 515-051 and 515-061 for more information. The potential reduction in clear width of the curb or

sidewalk caused by the installation of the retrofit and Pedestrian Safety Treatment shall be considered.

It should be noted that the existing traffic railings and/or guardrail end transitions may have been previously retrofitted utilizing a scheme presented in Roadway and Traffic **Design Standards** Index 401 (2000 and earlier Editions). In this event, the requirements for removal or replacement of the prior retrofit shall be evaluated and addressed in the Plans as required.

The applicability of the individual Standard Plans Index to different curb widths and superstructure types is described as follows:

- 460-471 - Applicable for existing narrow curbs as shown below. This index requires removal of the existing traffic railing to the top of the existing curb along the entire length of the bridge and wing walls. On flat slab type superstructures, the potential reduction in the vertical clearance beneath the bridge due to the installation of this index shall be considered.
- 460-472 - Applicable for existing wide curbs or sidewalks as shown below. This index generally allows the entire existing traffic railing to remain in place.
- 460-473 - Applicable for existing wide curbs or sidewalks as shown below. This index generally allows the entire existing traffic railing to remain in place.
- 460-474 - Applicable for existing intermediate width curbs as shown below. This index requires removal of the existing traffic railing to the top of the existing curb along the entire length of the bridge and wing walls.
- 460-475 - Applicable for existing wide curbs or sidewalks as shown below on bridges with decks that do not meet the strength requirements for Index 460-472. This index generally allows the entire existing traffic railing to remain in place. This index is primarily intended for use on bridges with superstructures consisting of longitudinally prestressed, transversely post-tensioned, solid or voided concrete slab units but it can also be used for other types of superstructures.
- 460-476 - Applicable for existing wide curbs or sidewalks as shown below on bridges with decks that do not meet the strength requirements for Index 460-473. This index generally allows the entire existing traffic railing to remain in place. On flat slab type superstructures, the potential reduction in the vertical clearance beneath the bridge due to the installation of this index shall be considered. Indexes 460-471, 460-472 and 460-476 cannot be used on bridges with superstructures consisting of longitudinally prestressed, transversely post-tensioned, solid or voided concrete slab units.

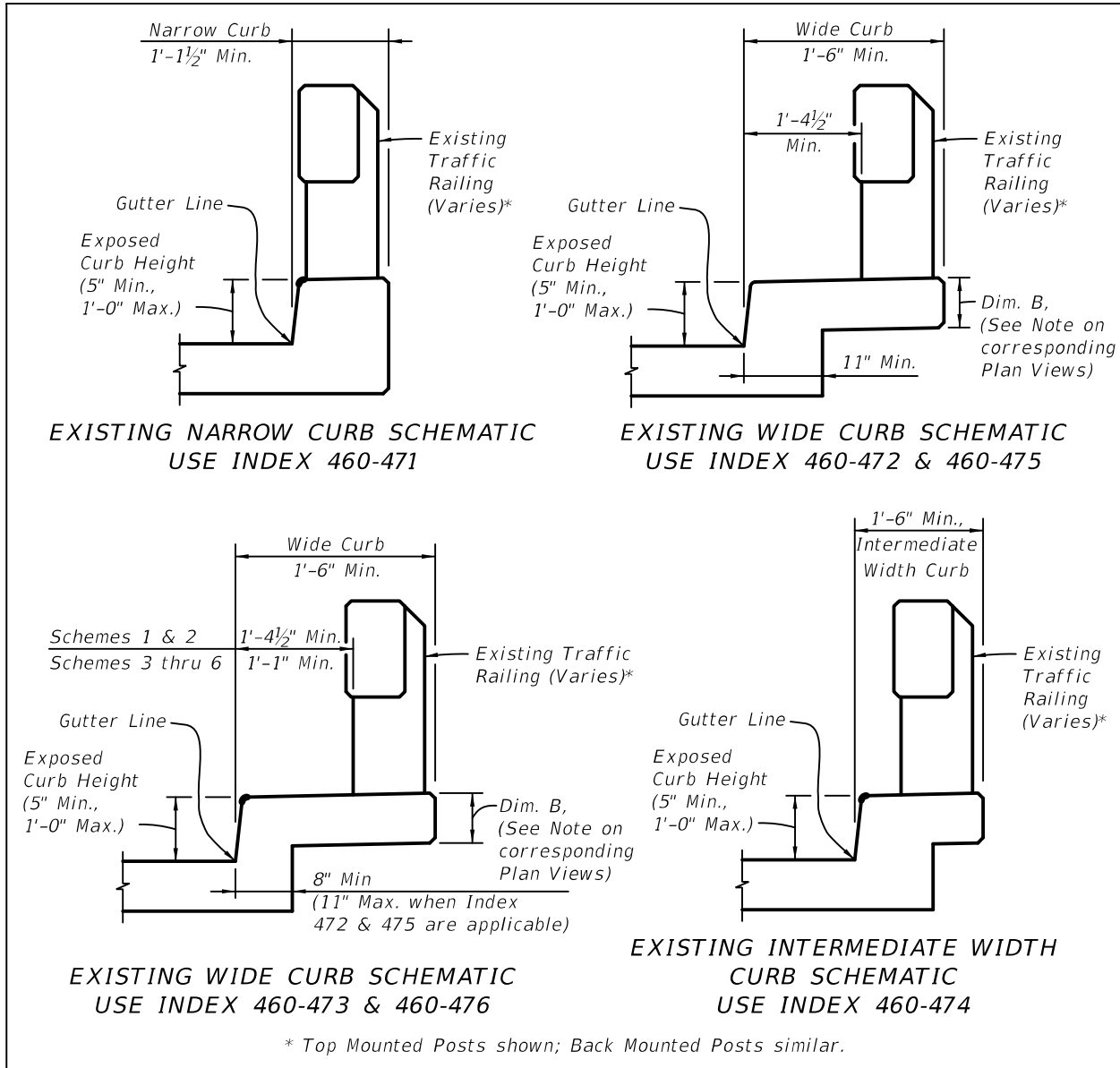

The applicability of the individual retrofit schemes to different wing wall configurations is shown below.

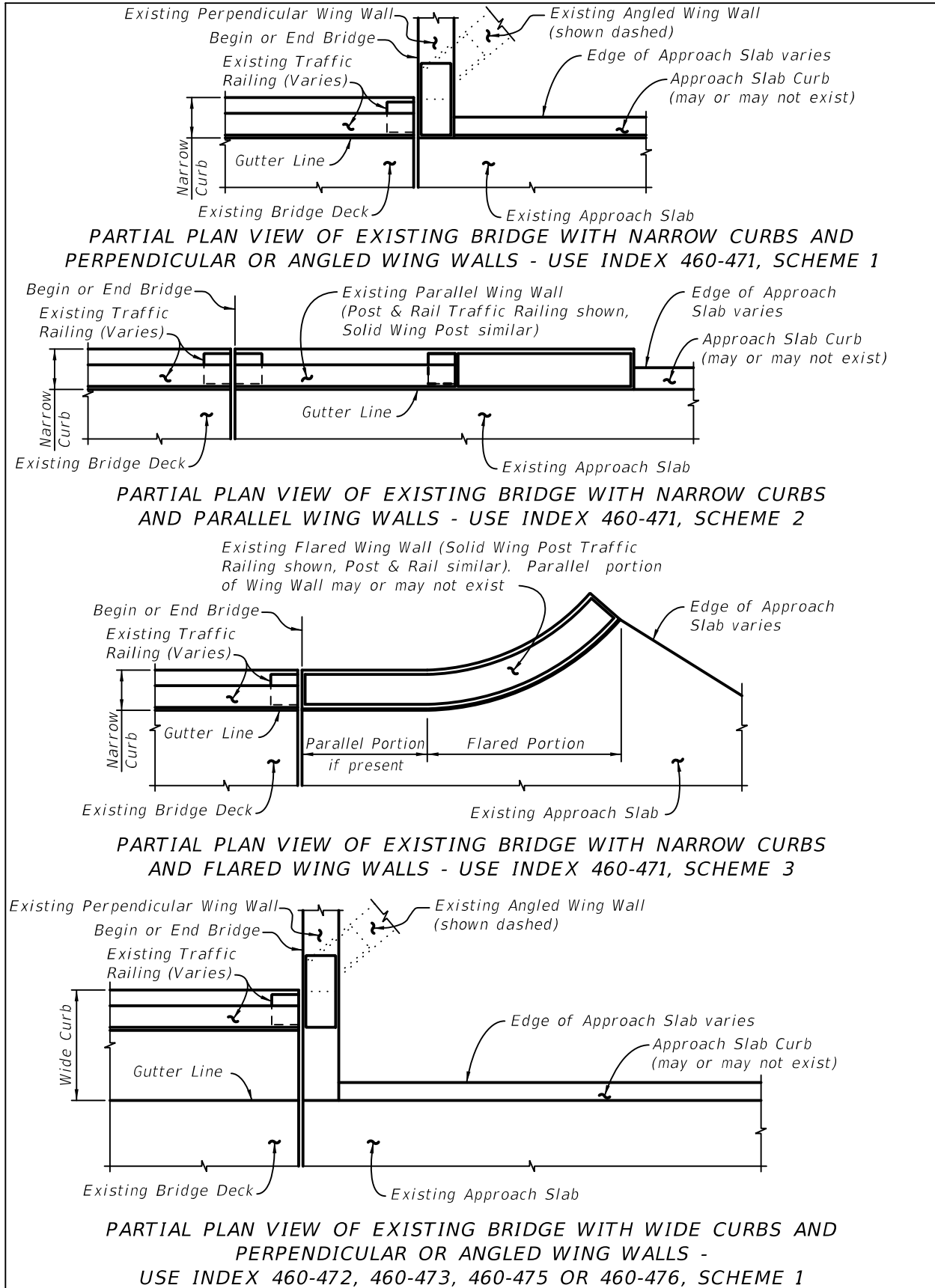

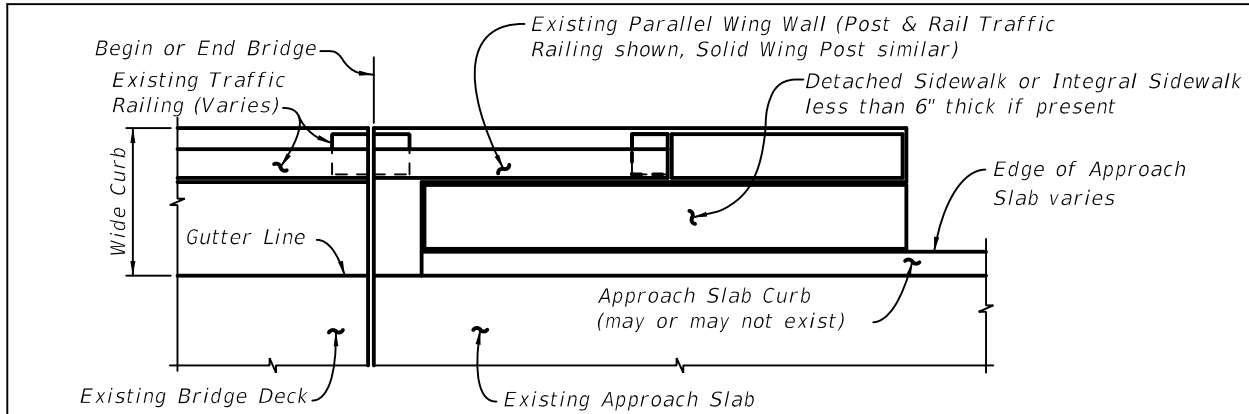

PARTIAL PLAN VIEW OF EXISTING BRIDGE WITH WIDE CURBS, PARALLEL WING WALLS AND APPROACH SLABS WITH DETACHED SIDEWALKS OR SIDEWALKS LESS THAN 6" THICK - USE INDEX 460-472, 460-473, 460-475 OR 460-476 SCHEME 2

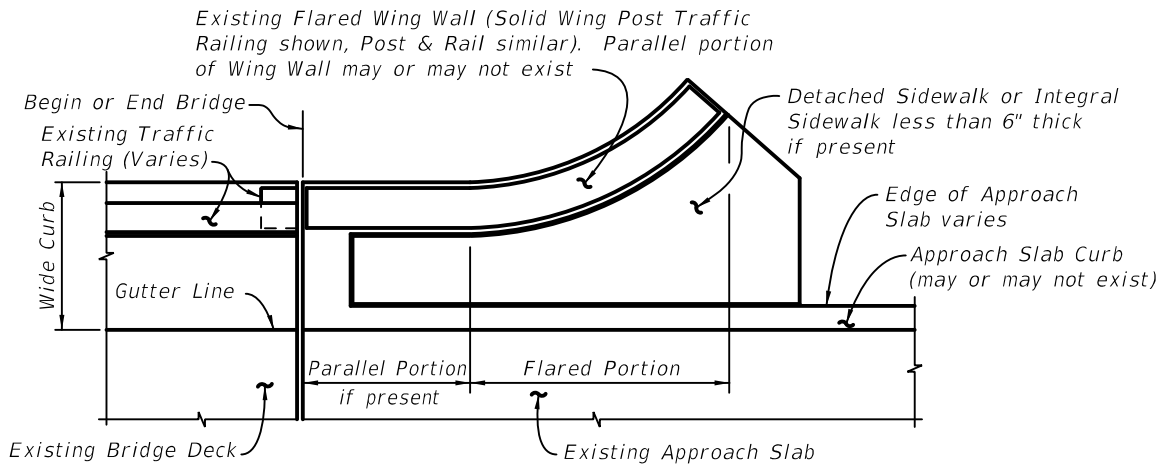

PARTIAL PLAN VIEW OF EXISTING BRIDGE WITH WIDE CURBS, FLARED WING WALLS AND APPROACH SLABS WITH DETACHED SIDEWALKS OR SIDEWALKS LESS THAN 6" THICK - USE INDEX 460-472, 460-473, 460-475 OR 460-476 SCHEME 2

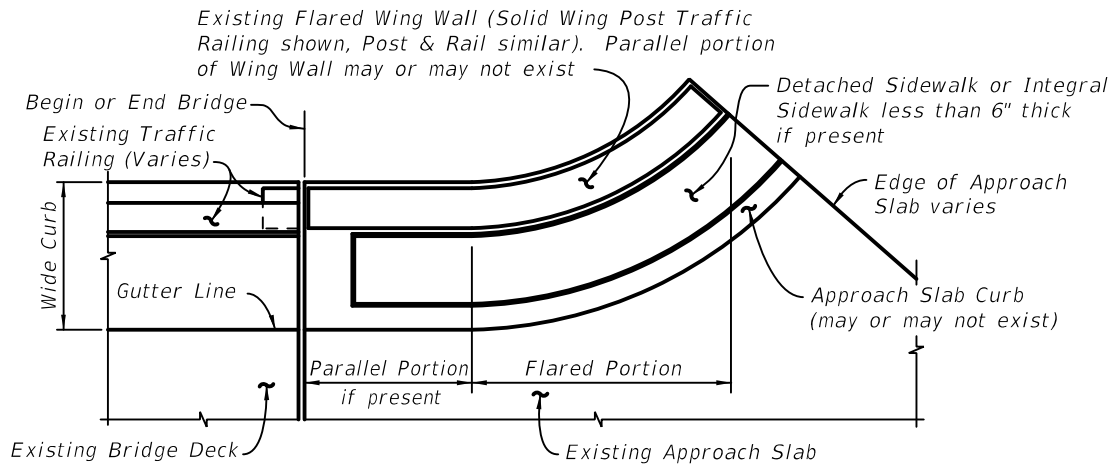

PARTIAL PLAN VIEW OF EXISTING BRIDGE WITH WIDE CURBS, FLARED WING WALLS AND APPROACH SLABS WITH DETACHED SIDEWALKS OR SIDEWALKS LESS THAN 6" THICK - USE INDEX 460-472, 460-473, 460-475 OR 460-476 SCHEME 2

NOTE: If Existing Curb or Wing Wall Dimension B is 1'-3" or greater use Scheme 3. If Existing Curb or Wing Wall Dimension B is equal to or greater than 6" but less than 1'-3", use Scheme 4. If Dimension B is less than 6", use Scheme 2. See Sheet 1 of 5 for Dimension B.

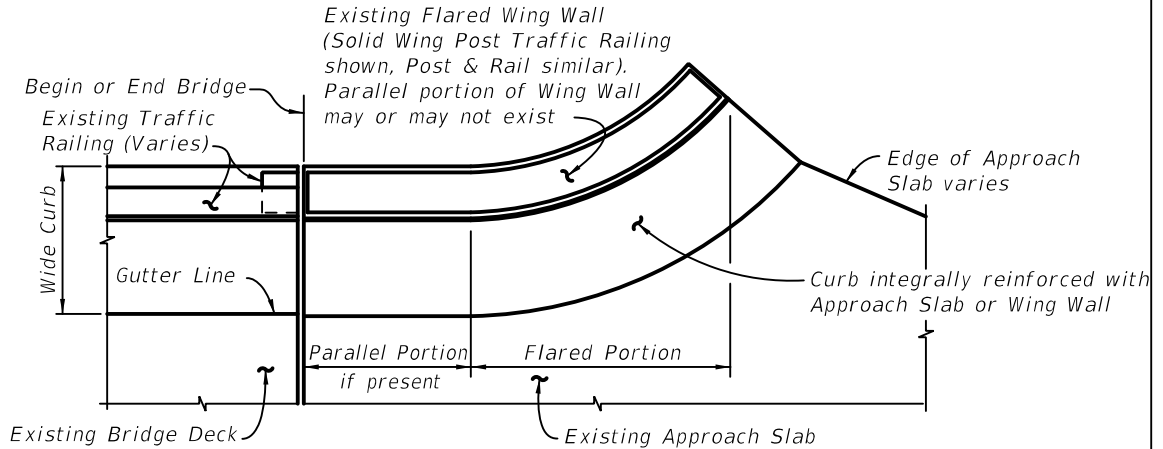

PARTIAL PLAN VIEW OF EXISTING BRIDGE WITH WIDE CURBS, FLARED WING WALLS AND FLARED INTEGRALLY REINFORCED APPROACH SLAB CURBS - USE INDEX 460-472, 460-473, 460-475 OR 460-476 SCHEMES 3 OR 4

NOTE: If Existing Curb or Wing Wall Dimension B is 1'-3" or greater use Scheme 5. If Existing Curb or Wing Wall Dimension B is equal to or greater than 6" but less than 1'-3", use Scheme 6. If Dimension B is less than 6", use Scheme 2. See Sheet 1 of 5 for Dimension B.

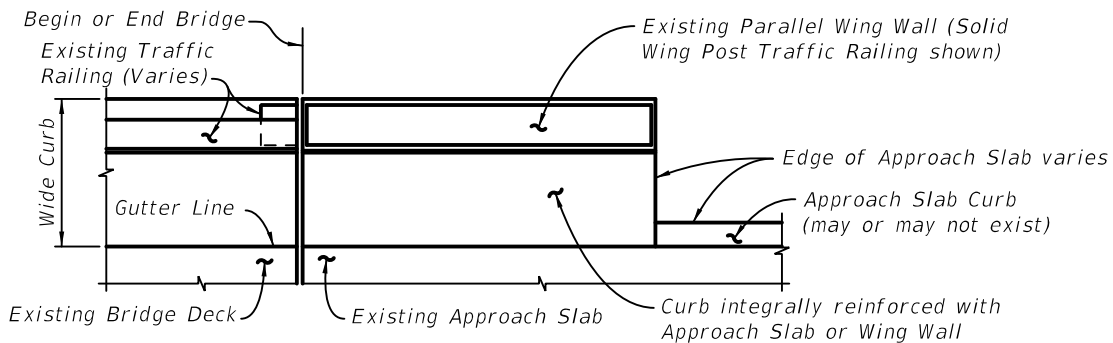

PARTIAL PLAN VIEW OF EXISTING BRIDGE WITH WIDE CURBS, PARALLEL WING WALLS AND INTEGRALLY REINFORCED APPROACH SLAB CURBS - USE INDEX 460-472, 460-473, 460-475 OR 460-476 SCHEMES 5 OR 6

NOTE: If Existing Curb or Wing Wall Dimension B is 1'-3" or greater use Scheme 5. If Existing Curb or Wing Wall Dimension B is equal to or greater than 6" but less than 1'-3", use Scheme 6. If Dimension B is less than 6", use Scheme 2. See Sheet 1 of 5 for Dimension B.

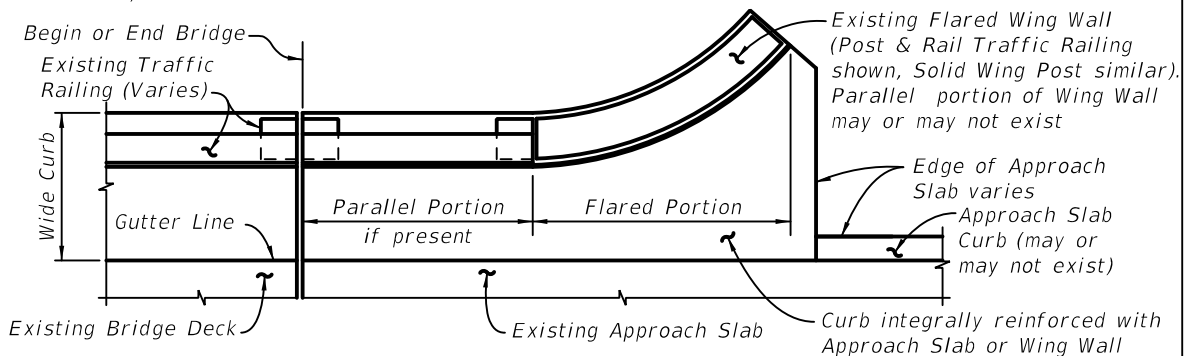

PARTIAL PLAN VIEW OF EXISTING BRIDGE WITH WIDE CURBS, FLARED WING WALLS AND PARALLEL INTEGRALLY REINFORCED APPROACH SLAB CURBS - USE INDEX 460-472, 460-473, 460-475 OR 460-476 SCHEMES 5 OR 6

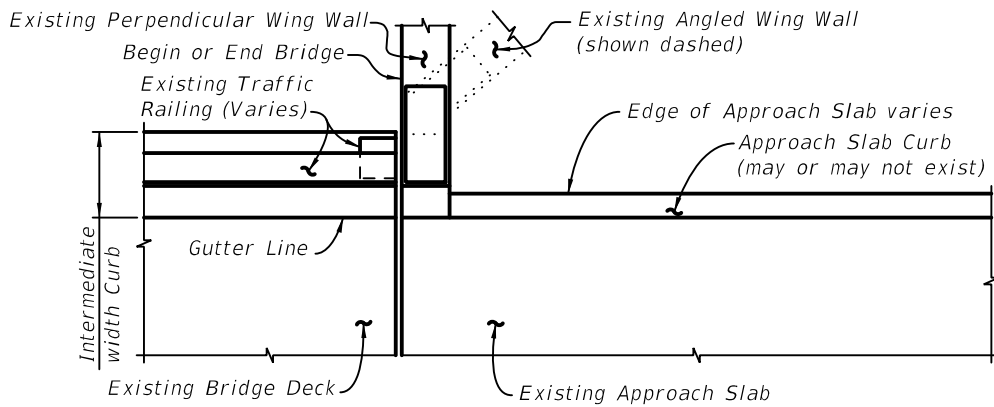

PARTIAL PLAN VIEW OF EXISTING BRIDGE WITH INTERMEDIATE WIDTH CURBS AND PERPENDICULAR OR ANGLED WING WALLS - USE INDEX 460-474, SCHEME 1

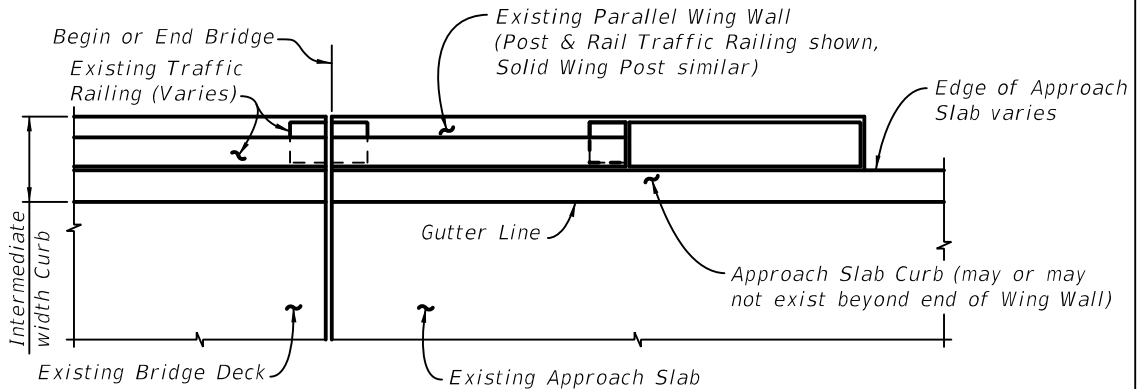

PARTIAL PLAN VIEW OF EXISTING BRIDGE WITH INTERMEDIATE WIDTH CURBS AND PERPENDICULAR OR ANGLED WING WALLS - USE INDEX 460-474, SCHEME 2

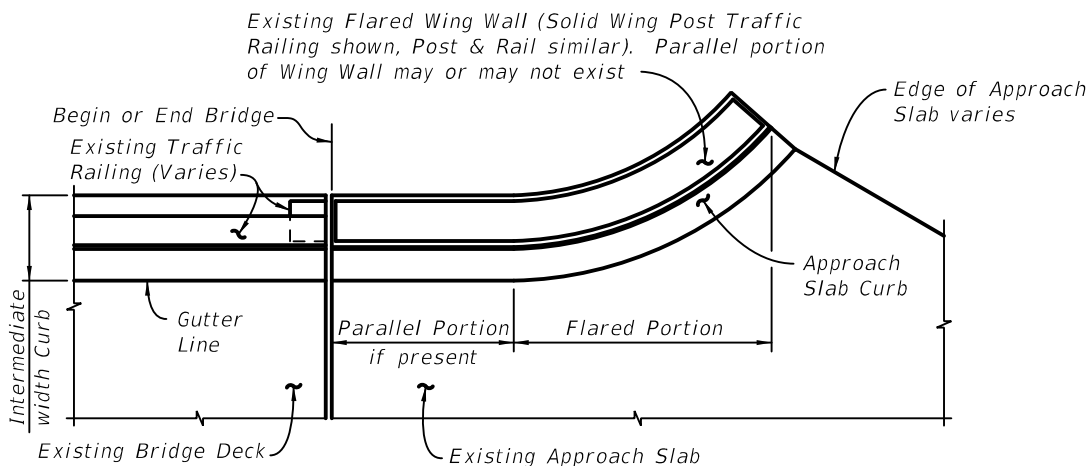

PARTIAL PLAN VIEW OF EXISTING BRIDGE WITH INTERMEDIATE WIDTH CURBS, FLARED WING WALLS AND FLARED INTEGRAL APPROACH SLAB CURBS - USE INDEX 460-474, SCHEME 3

Plan Content Requirements

The appropriate Index number and Scheme number shall be shown in the Roadway Plans for each bridge along with the limiting stations of the retrofit. The appropriate post designation of "A", "B" or "C" shall be determined and shown in the Plans for each bridge based on the criteria given in the Post Dimension Table on Index 460-470. The selection of the appropriate post shall consider any proposed milling and resurfacing work.

The limiting stations or overall length of the retrofit for each bridge shall also be shown. An example of a note containing the required information as it would appear on a Plan or Plan-Profile sheet is as follows:

"Construct Traffic Railing (Thrie-Beam Retrofit), Index 460-47X, Scheme X, from Sta. XX+XX.XX (at or near Begin Bridge) to Sta. XX+XX.XX (at or near End Bridge). On left side of bridge utilize Post "X". On right side of bridge utilize Post "X". See Standard Plans Index 460-470 for post details."

If the same height post can be used on both sides of the bridge, a single post designation is all that is required.

For projects with multiple bridges, a tabular format may be used to convey the necessary information.

A separate Plan and Elevation sheet of the type used in Structures Plans is generally not required.

Payment

Item number	Item Description	Unit Measure
460-71-1	Metal Traffic Railing, Thrie Beam Retrofit	LF
110-3-6*	Removal of Existing Structures	LF

* As required per the Design Assumptions and Limitations.

Example Quantity Calculations

The following examples cover the three general cases for quantity calculations for the length of payment along each side of a bridge:

CASE I - Indexes 460-471 and 460-474 Scheme 2 and Indexes 460-472, 460-473, 460-475 and 460-476 Schemes 5 and 6 - Traffic Railing (Thrie-Beam Retrofit) extends close to the end of the wing wall or parallel curb on the approach slab.

CASE II - Indexes 460-471, 460-472, 460-473, 460-474, 460-475 and 460-476 Scheme 1 and Indexes 460-472, 460-473, 460-475 and 460-476 Scheme 2 - Traffic Railing (Thrie-Beam Retrofit) extends close to the end of the bridge deck.

CASE III -Indexes 460-472, 460-473, 460-475 and 460-476 Schemes 3 and 4 and Index 460-474 Scheme 3 - Traffic Railing (Thrie-Beam Retrofit) extends far enough along the flared curb until the Special Steel Guardrail Post can be located on the approach slab.

In the following examples, it is assumed that the trailing end treatment is the same as the approach end treatment. For Case III, Indexes 460-472, 460-473, 460-475 and 460-476 Schemes 3 and 4, different trailing end treatments usually give an error of less than one foot for each side of the bridge. Different trailing end treatments for Case III, Index 460-474 Scheme 3 may give an error of $\pm 3'-0"$, due to the flexibility given to the Contractor for locating the posts on the flared wing wall. The Designer may need to show stationing limits in the plans for these Indexes when the location of a site specific end treatment is critical. Different trailing end treatments for Case I and Case II will have no effect on the length of payment.

For bridges with different wing wall lengths at begin and end bridge, such as skewed bridges, the calculated lengths should be adjusted accordingly for Cases I & III.

For curved bridges the length of payment shall be measured along the gutter line, and the arc angle projection of the gutter line for flared curbs (Case III).

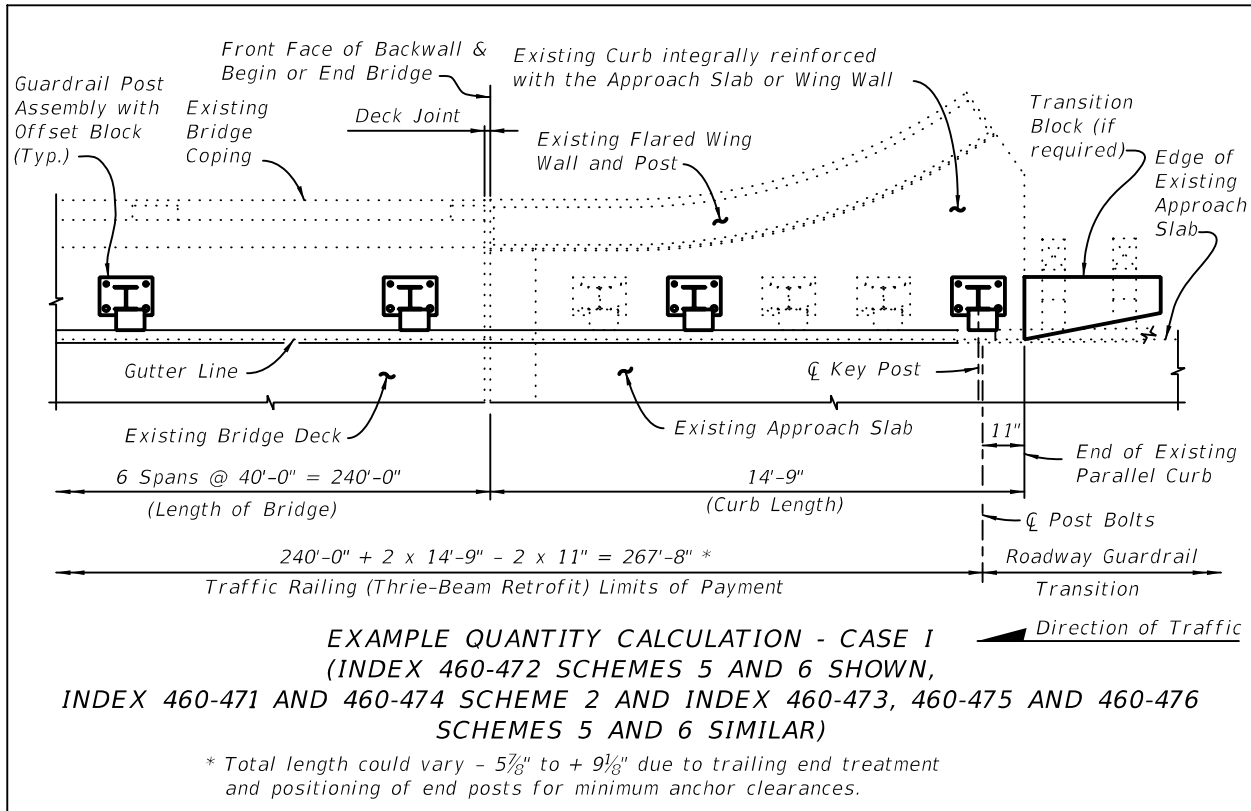

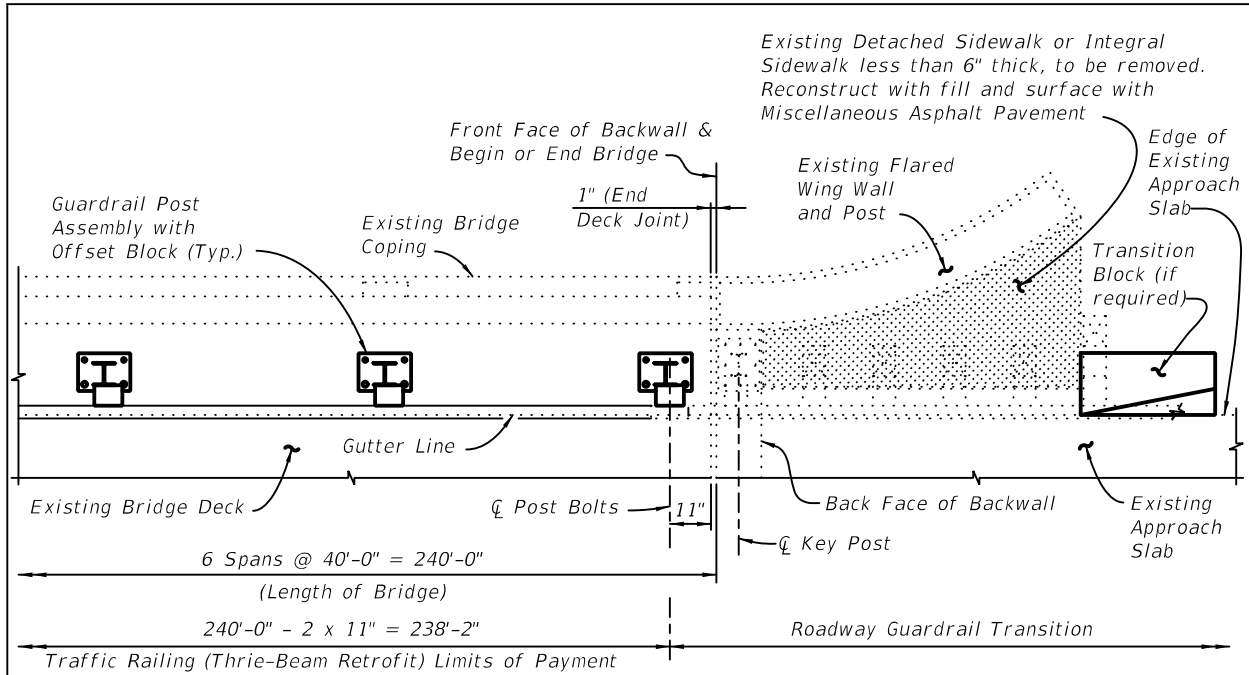

EXAMPLE QUANTITY CALCULATION - CASE II ▶ Direction of Traffic
 (INDEX 460-472 SCHEME 2 SHOWN,
 INDEX 460-471, 460-472, 460-473, 460-474, 460-475 AND 460-476
 SCHEME 1 AND INDEX 460-473 AND 460-476 SCHEME 2 SIMILAR)

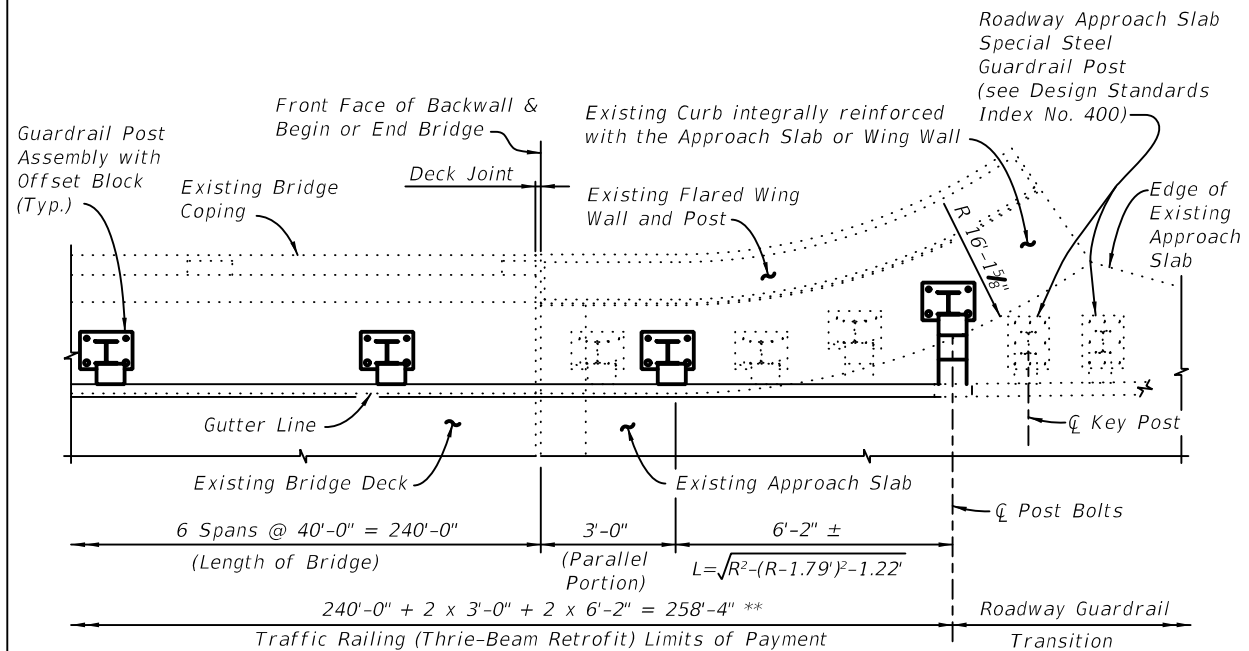

EXAMPLE QUANTITY CALCULATION - CASE III ▶ Direction of Traffic
 (INDEX 460-472 SCHEMES 3 AND 4 SHOWN,
 INDEX 460-473, 460-475 AND 460-476 SCHEMES 3 AND 4
 AND INDEX 460-474 SCHEME 3 SIMILAR)

** Total length could vary due to trailing end treatment.