

TABLE OF CONTENTS:	
Sheet	Description
1	Continuous Count Station Traffic Monitoring Site - TTMS/CCS - Cabinet Layout Details (Four Lanes or Less)
2	Continuous Count Station Traffic Monitoring Site - TTMS/CCS - Cabinet Layout Details (Five to Eight Lanes)
3	Continuous Count Station Traffic Monitoring site - TTMS/CCS - Cabinet Backplane Details
4	Continuous Count Station Traffic Monitoring Site - TTMS/CCS - Pinout Chart, Receptacle, and Plug Details
5	Continuous Count Station Traffic Monitoring Site - TTMS/CCS - Lane Layout for TMS Inductive Loop and Axle Sensors
6	Short Term Traffic Monitoring Site - PTMS - Cabinet Layout Details (Four Lanes or Less)
7	Short Term Traffic Monitoring Site - PTMS - Cabinet Layout Details (Five to Eight Lanes)
8	Short Term Traffic Monitoring Site - PTMS - Lane Layout for PTMS Inductive Loop and Axle Sensors
9	Weigh-In-Motion Monitoring Site - Cabinet Layout Details
10	Weigh-In-Motion Monitoring Site - Cabinet Backplane Details
11	Weigh-In-Motion Monitoring Site - Lane Layout for TTMS/CCS Inductive Loop and Weigh-In-Motion Sensors
12	Non-Motorized Monitoring Site - Cabinet Layout Details
13	Non-Motorized Monitoring Site - Cabinet Sideplane and Cabinet Backplane Details
14	Non-Motorized Monitoring Site - Regular Side Path Configurations
15	Non-Motorized Monitoring Site - Medium Shared Use Path Configurations
16	Non-Motorized Monitoring Site - Large Shared Use Path Configurations
17	Non-Motorized Monitoring Site - Extra Large Shared Use Path Configurations
18	Non-Motorized Monitoring Site - Paved Sidewalk Configuration
19	Details 'A' thru 'F'
20	Non-Intrusive Vehicle Sensor
21	Solar Power Pole With Pole Mounted Cabinet and Pedestal Mounted Cabinet Details

NOTES:

- Traffic monitoring site cabinet includes:
 - One adjustable shelf; (equipped as shown)
 - One backplane assembly; (equipped as shown)
 - One J1 receptacle with mounting bracket;
 - One P1 equipment cable 5 ft. long (See Sheet 4);
 - All associated wiring and wiring harnesses.
- Basic backplane assembly consists of:
 - Two inductive loop terminal strips;
 - One piezo sensor terminal strip;
 - One battery terminal strip;
 - One solar panel terminal strip.
- The contractor is responsible for contacting the TMS Manager at the Transportation Data and Analytics Office for lane number information and verification.
- Provide and install a Speed/Classification Unit, Modem, and Antenna.
- Cable ends must be fabricated to fit the vehicle speed/classification unit. See Sheet 4 for Pinout Charts, receptacle and plug details.
- Provide and install a 12-fiber single mode cable, a 12-port patch panel, and a managed field ethernet switch.

CABINET LAYOUT DETAILS
(Four Lanes or Less)

CONTINUOUS COUNT STATION TRAFFIC MONITORING SITE - TTMS/CCS

9/26/2025 3:26:41 PM

9/26/2025 3:26:48 PM

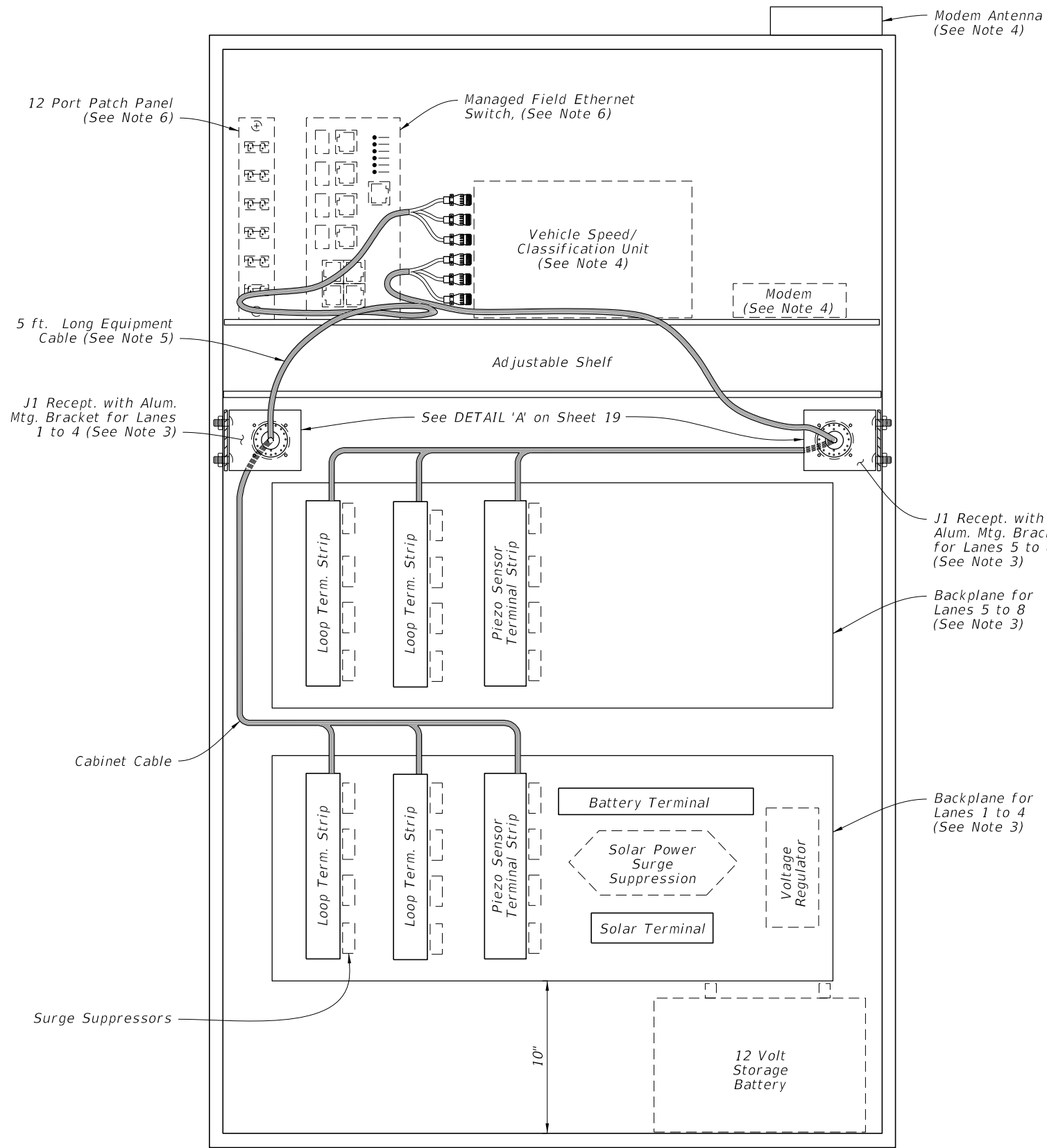

CABINET LAYOUT DETAILS
(Five to Eight Lanes)

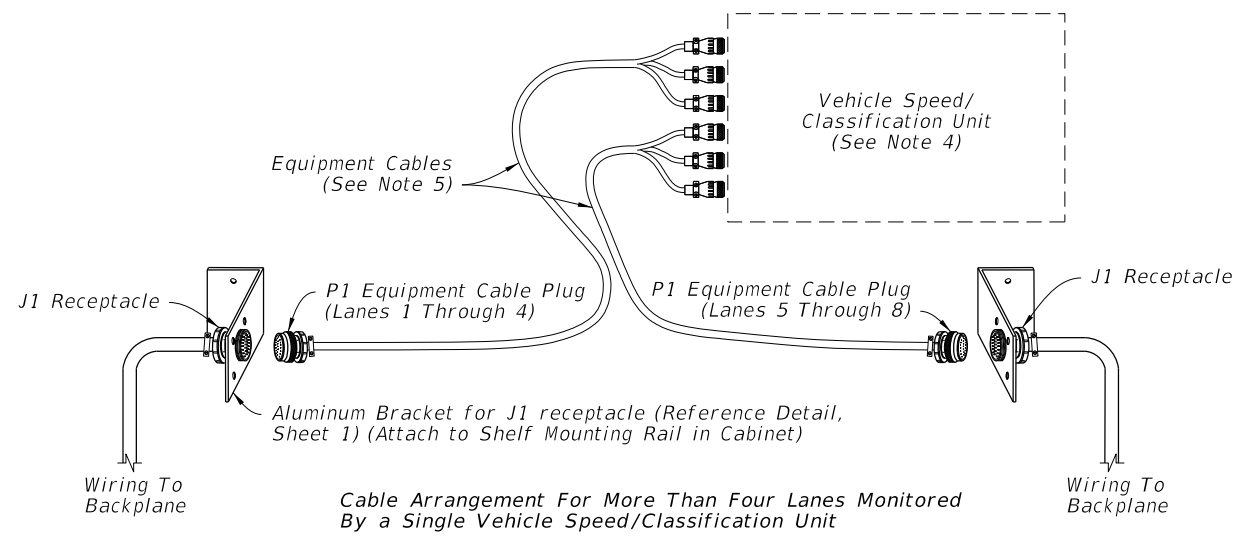

OPTION A
(Shown)

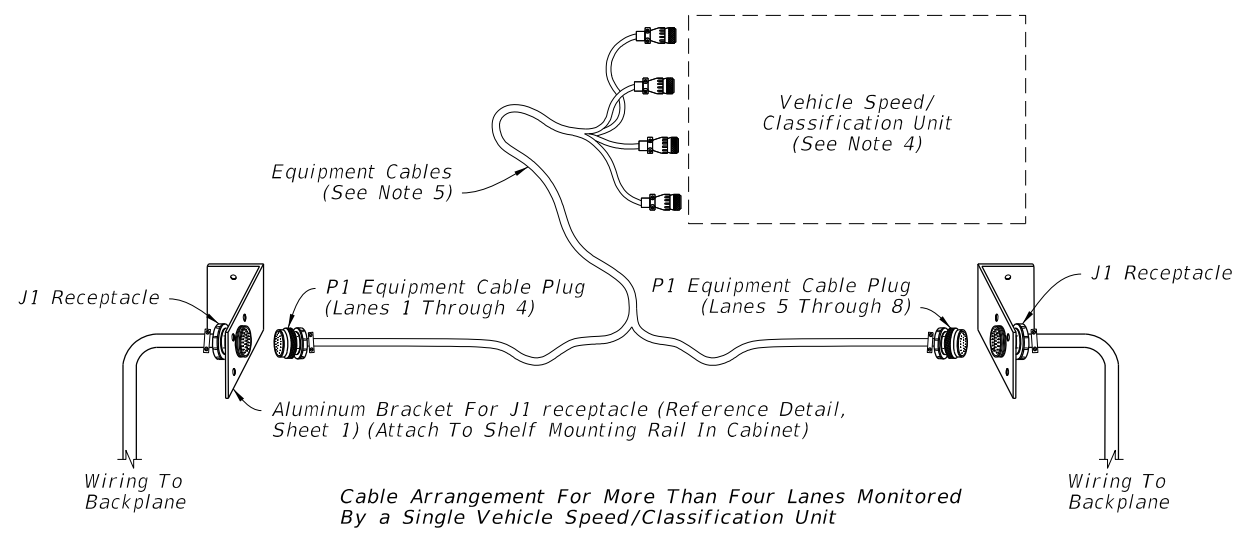

OPTION B

EQUIPMENT CABLE ASSEMBLY

- NOTES:**
- Traffic monitoring site cabinet includes:
 - One adjustable shelf; (equipped as shown)
 - Two backplane assembly; (equipped as shown)
 - Two J1 receptacle with mounting bracket;
 - One P1 equipment cable 5 ft. long (See Sheet 4);
 - All associated wiring and wiring harnesses.
 - Basic backplane assembly consists of:
 - Two inductive loop terminal strips;
 - One piezo sensor terminal strip;
 - One battery terminal strip;
 - One solar panel terminal strip.
 - The contractor is responsible for contacting the TMS Manager in the Transportation Data and Analytics Office for lane number information and verification.
 - Provide and install Speed/Classification Unit, Modem, and Antenna.
 - Cable ends must be fabricated to fit the vehicle speed/classification unit. See Sheet 4 for Pinout Charts, receptacle and plug details.
 - Provide and install a 12-fiber single mode cable, a 12-port patch panel, and a managed field ethernet switch.

CONTINUOUS COUNT STATION TRAFFIC MONITORING SITE - TTMS/CCS

LAST REVISION 11/01/25	DESCRIPTION:		FY 2026-27 STANDARD PLANS	TRAFFIC MONITORING SITE	INDEX 695-001	SHEET 2 of 21

To J1 Receptacle

NOTES:

- 1. Reference Sheet 1 or 2, Note 2 for items to be included with backplane.
- 2. All terminal strip contacts are on 9/16" centers (Cinch 142 Series or equal) Use insulated fork wire terminations.
- 3. The contractor is responsible for contacting the TMS Manager in the Transportation Data and Analytics Office for lane number information and verification.

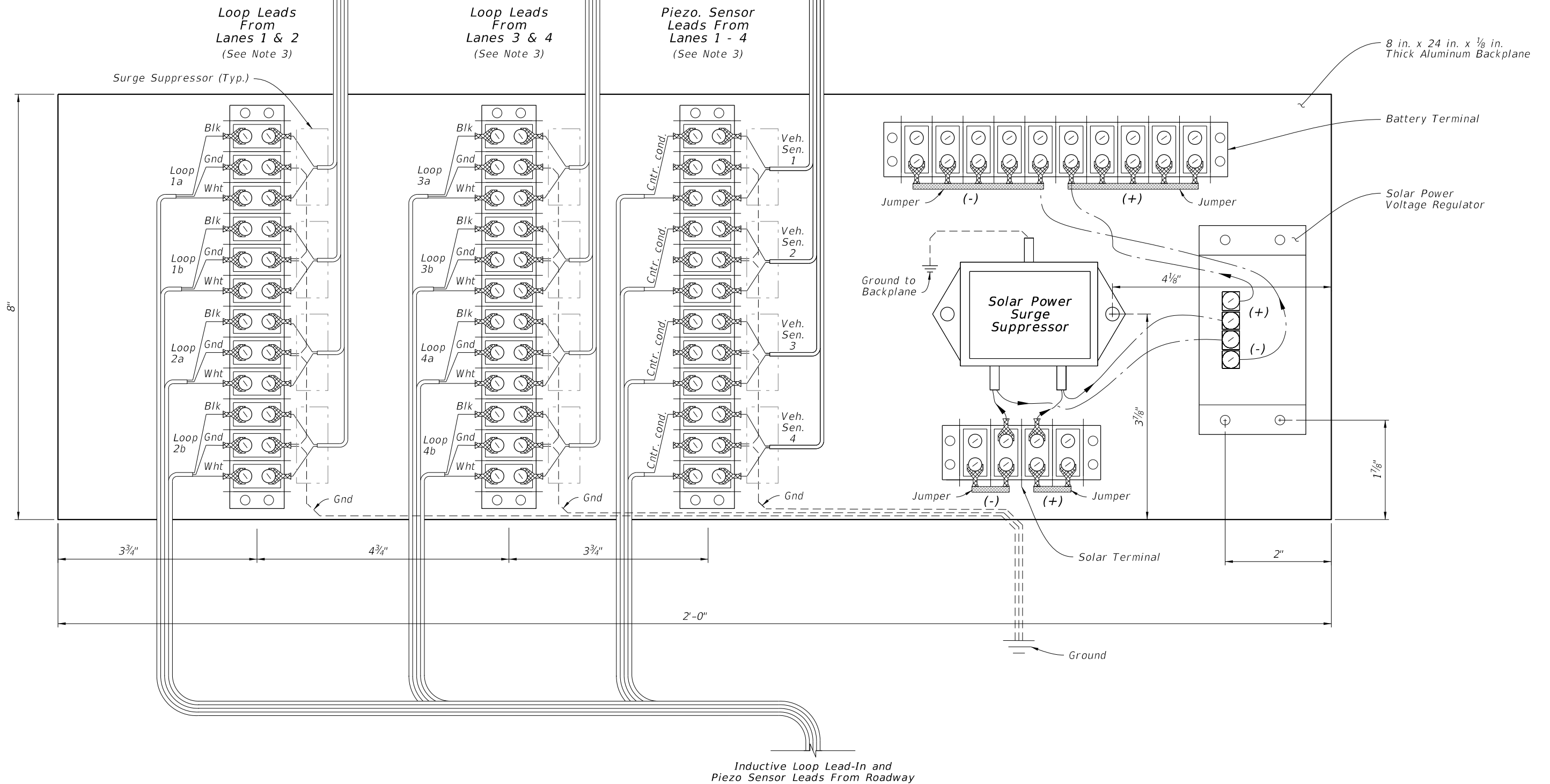

CABINET BACKPLANE DETAIL

CONTINUOUS COUNT STATION TRAFFIC MONITORING SITE - TTMS/CCS

9/26/2025 3:26:54 PM

LAST REVISION 11/01/25	REVISION DESCRIPTION:	 FY 2026-27 STANDARD PLANS	TRAFFIC MONITORING SITE	INDEX 695-001	SHEET 3 of 21
---------------------------	--------------------------	--	-------------------------	------------------	------------------

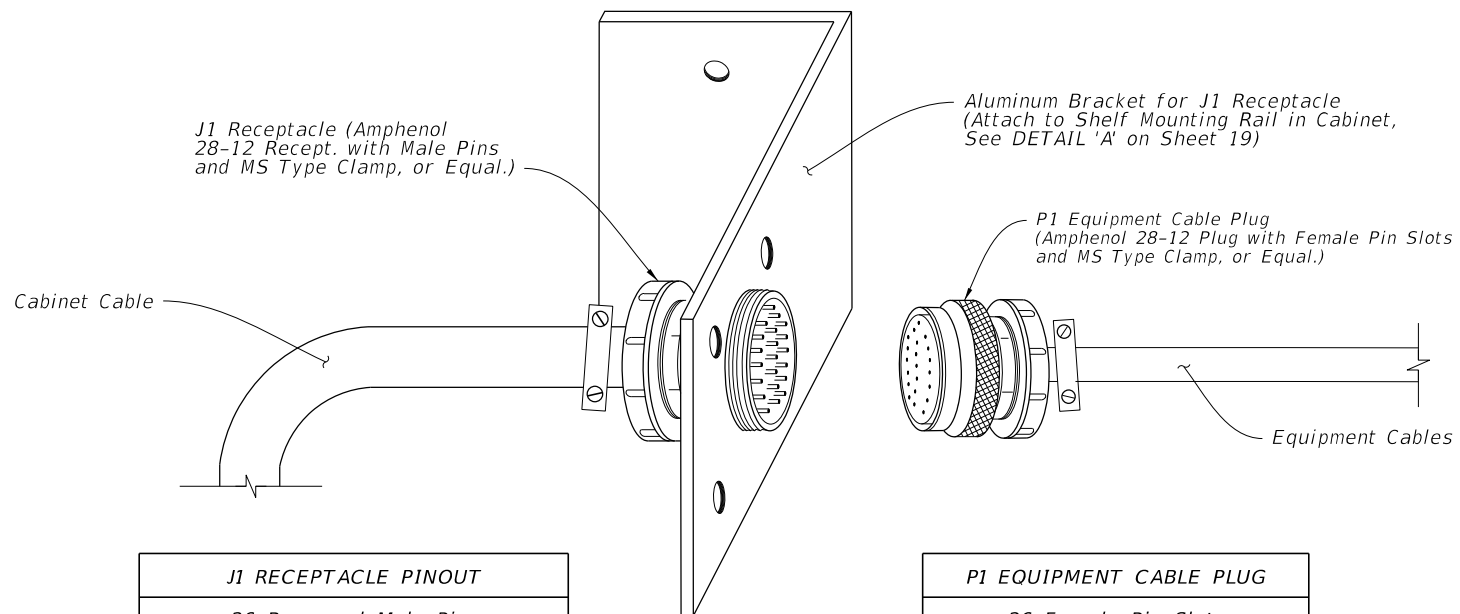

J1 RECEPTACLE PINOUT	
26 Recessed Male Pins	
A	Loop 1a (5a) white
B	Loop 1a (5a) black
C	Loop 1b (5b) red
D	Loop 1b (5b) black
E	Loop 2a (6a) green
F	Loop 2a (6a) blue
G	Loop 2b (6b) orange
H	Loop 2b (6b) tan
J	Loop 3a (7a) white
K	Loop 3a (7a) green
L	Loop 3b (7b) red
M	Loop 3b (7b) black
N	Gnd
P	Loop 4a (8a) w/white
R	Loop 4a (8a) w/black
S	Loop 4b (8b) w/red
T	Loop 4b (8b) w/green
U	Piezo 1 (5) (+) w/blue
V	Piezo 1 (5) sh w/orange
W	Piezo 2 (6) (+) w/green
X	Piezo 2 (6) sh w/red
Y	Piezo 3 (7) (+) w/black
Z	Piezo 3 (7) sh w/red/blk
a	Piezo 4 (8) (+) red/ green
b	Piezo 4 (8) sh red/white
d	Gnd green

P1 EQUIPMENT CABLE PLUG		
26 Female Pin Slots		
A	Loop 1a (5a)	Connect To Electronics Unit
B	Loop 1a (5a)	
C	Loop 1b (5b)	
D	Loop 1b (5b)	
E	Loop 2a (6a)	
F	Loop 2a (6a)	
G	Loop 2b (6b)	
H	Loop 2b (6b)	
N	Gnd	Connect To Electronics Unit
J	Loop 3a (7a)	
K	Loop 3b (7b)	
L	Loop 3b (7b)	
M	Loop 3b (7b)	
P	Loop 4a (8a)	
R	Loop 4a (8a)	
S	Loop 4b (8b)	
T	Loop 4b (8b)	Connect To Electronics Unit
d	Gnd	
U	Piezo 1 (5) (+)	
V	Piezo 1 sh	
W	Piezo 2 (6) (+)	
X	Piezo 2 sh	
Y	Piezo 3 (7) (+)	
Z	Piezo 3 sh	
a	Piezo 4 (8) (+)	
b	Piezo 4 sh	

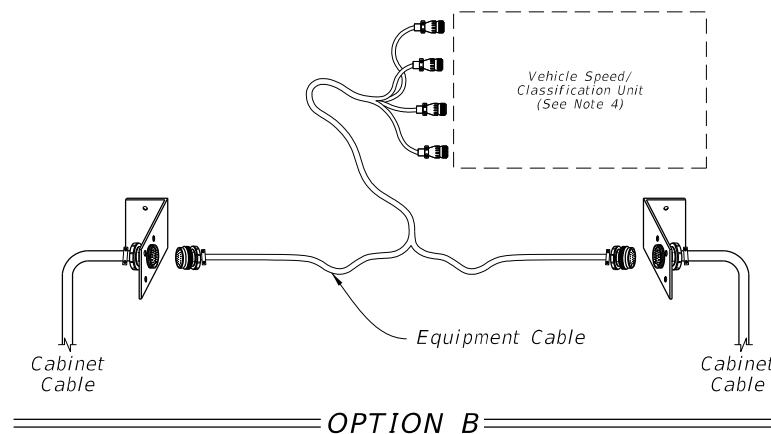
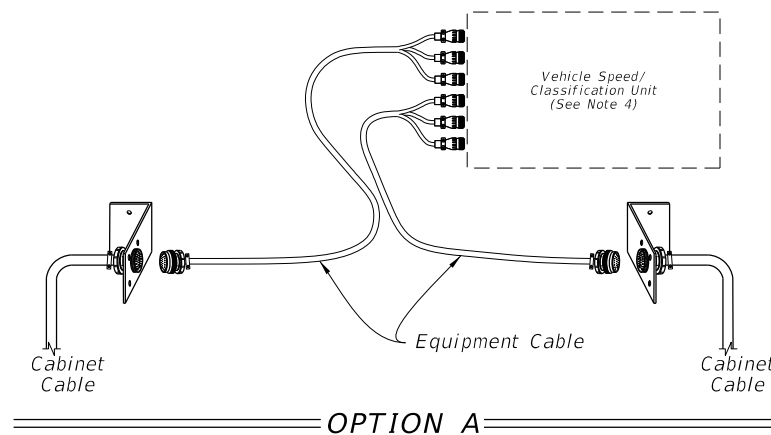

NOTES:

- The contractor is responsible for contacting the TMS Manager in the Transportation Data and Analytics Office for lane number information and verification.
- The equipment cable can accommodate up to four lanes of inductive loop and piezo sensor inputs. (See Sheet 1 for cabinet layout)
- For more than four lanes and up to eight lanes of inputs, the following options are available:
 - Second Vehicle Speed/Classification Unit and separate equipment cable connecting to a second J1 receptacle; or
 - Single Vehicle Speed/Classification Unit capable of up to eight lanes of inputs and a single equipment cable with split ends to fit two J1 receptacles. (See Sheet 2 detail)
- Numbers in parenthesis in the pinout chart identify lane numbers when a second backplane for lanes 5 through 8 is required.
- Cable Ends must be fabricated to fit the vehicle Speed/Classification Unit.

PINOUT, RECEPTACLE, AND PLUG DETAILS

CONTINUOUS COUNT STATION TRAFFIC MONITORING SITE - TTMS/CCS

9/26/2025 3:27:01 PM

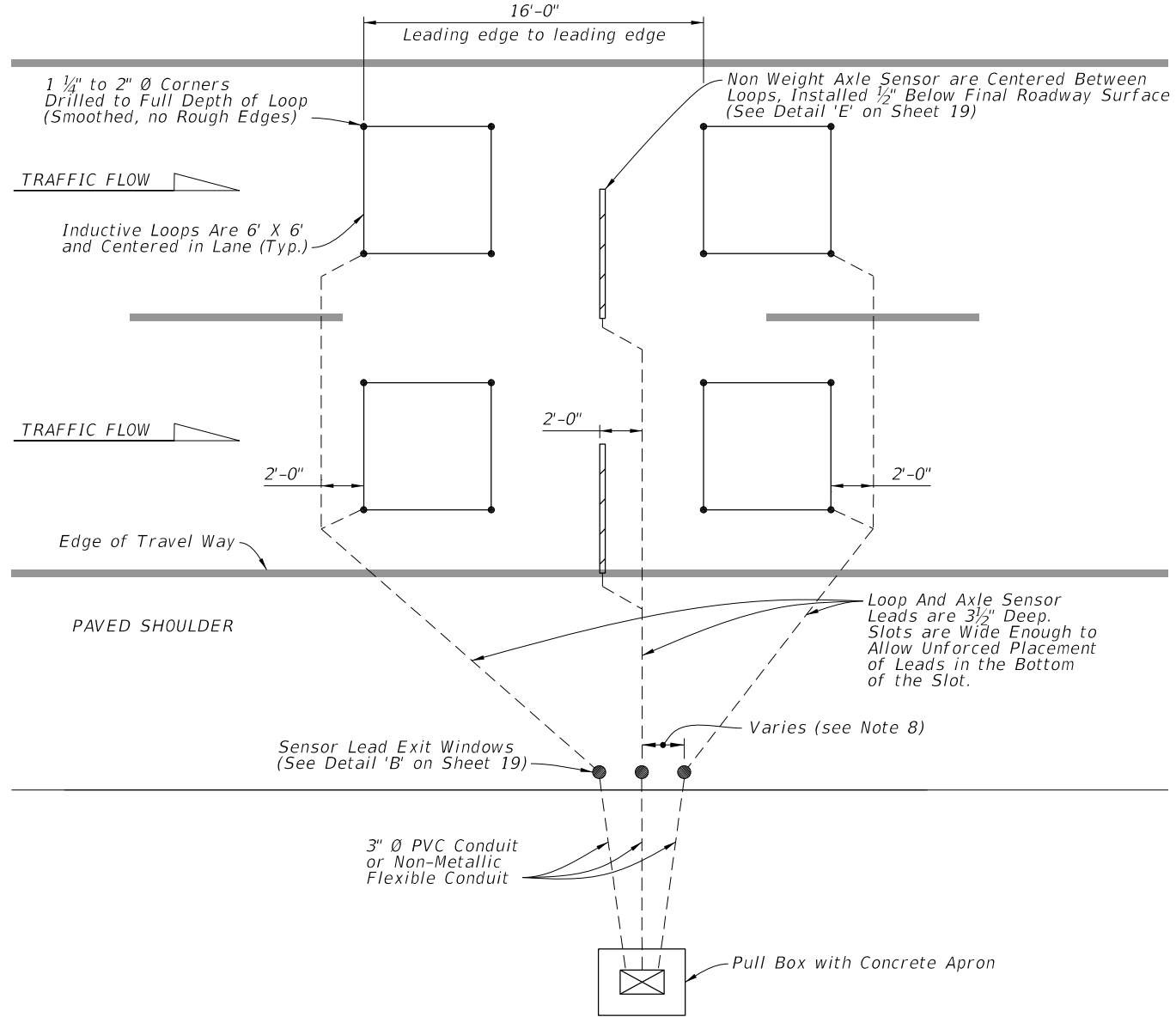

ROADWAYS WITH PAVED SHOULDERS

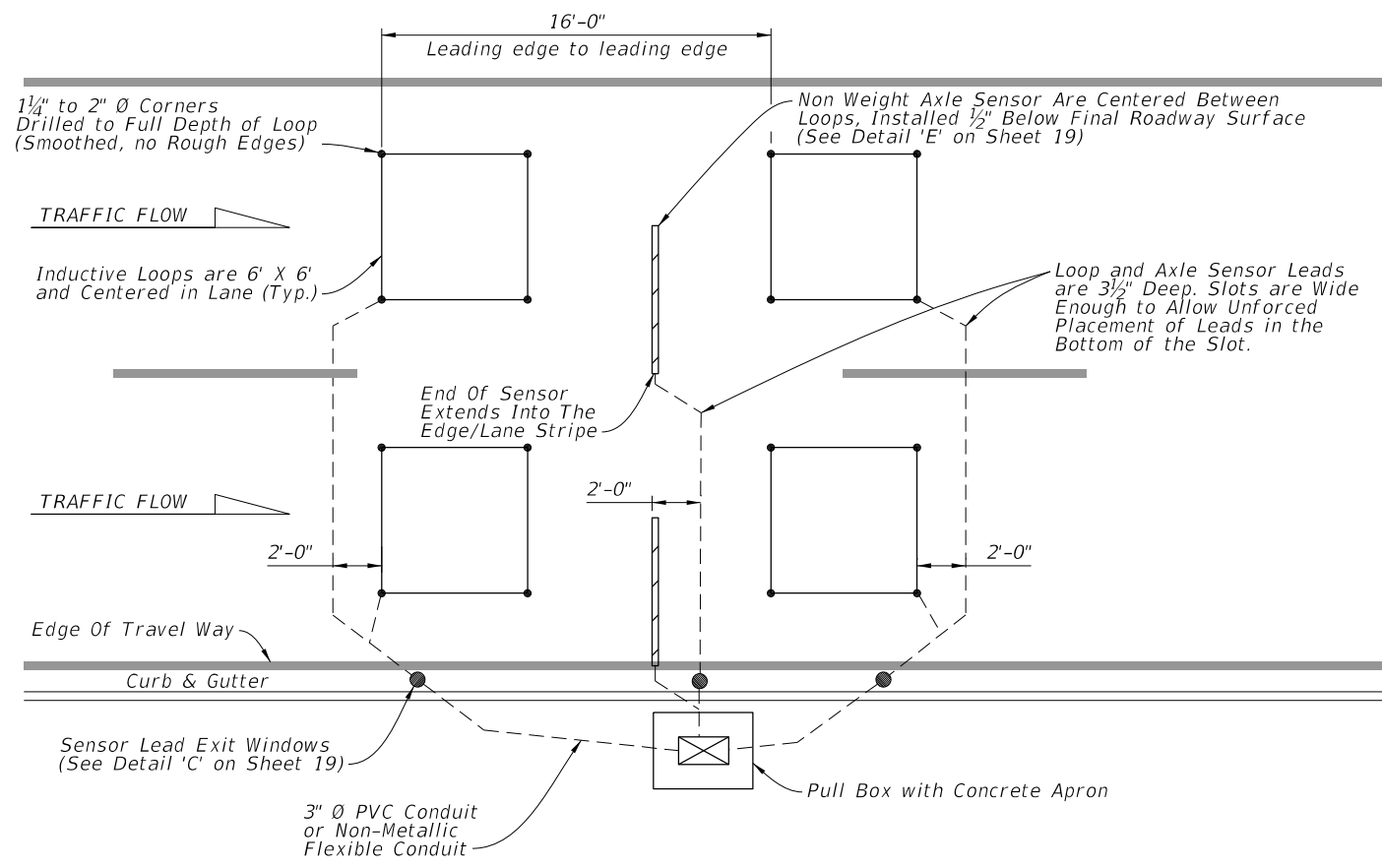

CURB & GUTTER ROADWAYS

NOTES:

1. Install axle sensors and loops associated with axle sensors after placement of the friction course.
2. Cut a 3 1/2" deep slot for the Inductive loops. Loop slots will be cut wide enough to allow unforced placement of the wire into the bottom of the slot. Place four turns of #14 AWG, place the IMSA 51-7 copper wire in the slot. Place short pieces of backer rod (2" to 3" in length) every 18" to 24" to hold the loop wire in the bottom of the slot and start wire twist at the beginning of the home run slot.
3. Twist loop leads at the rate of 8 to 16 twist per foot. Extend the twisted pair loop wire directly to the cabinet. No splicing of the loop leads will be permitted. Install a home run slot with a minimum width of 5/8".
4. Marking will consist of two rounds of contrasting colored tape, one color for the lane number and the second color for the lead loop location in the lane. The first band closest to the cabinet will represent the lane number, one round of tape will be for lane 1 and two rounds will be lane 2, etc. The lead loop in lane one would have one round of tape and a second round of a contrasting colored tape for the lead loop in the lane. The trailing loop would not have a second contrasting colored band of tape.
5. See Index 635-001 for pull box and concrete apron details.
6. Use a chalk line or string and paint to layout the position of the sensor and lead-in cable slots. Ensure saw cuts do not deviate more than 1/2" from the chalk line. Use a single blade or ganged blade saw wide enough to cut the axle sensor slot at full width in a single pass. Cutting two slots and chipping out roadway material between them is not allowed.
7. All sensor slots and any cuts in the roadway will be thoroughly blown out to ensure there is no dust or debris prior to installation of sensors or leads.
8. Install Exit Windows at least 2' apart.

LANE LAYOUT FOR TTMS/CCS INDUCTIVE LOOP AND AXLE SENSORS
(Typical for up to 4 Lanes of Sensor Leads Pulled to one Side of the Roadway)

CONTINUOUS COUNT STATION TRAFFIC MONITORING SITE - TTMS/CCS

LAST REVISION 11/01/25	REVISION	DESCRIPTION:		FY 2026-27 STANDARD PLANS	TRAFFIC MONITORING SITE	INDEX 695-001	SHEET 5 of 21
---------------------------	----------	--------------	---	------------------------------	-------------------------	------------------	------------------

9/26/2025 3:27:07 PM

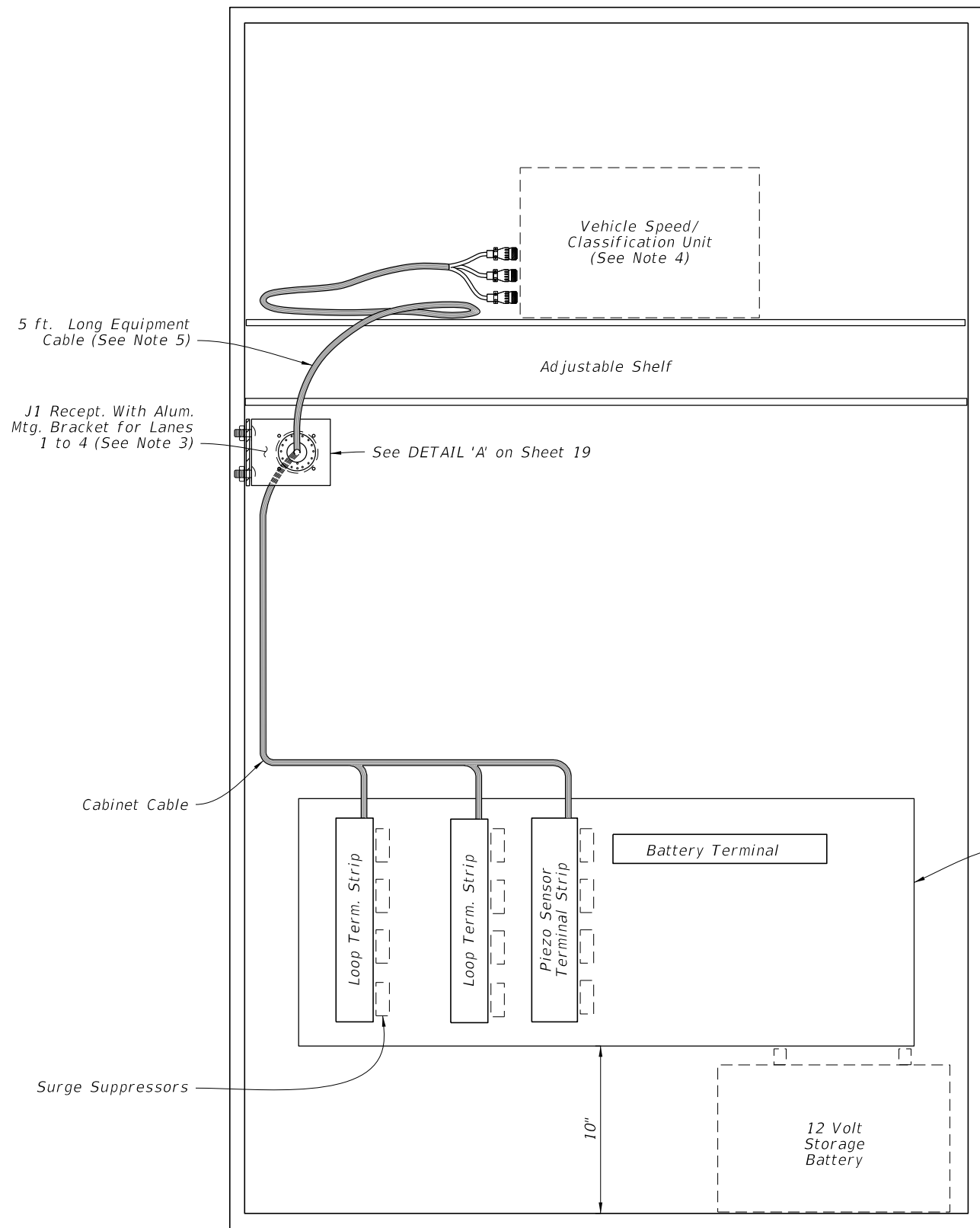

NOTES:

1. Traffic monitoring site cabinet includes:
 - A. One adjustable shelf; (equipped as shown)
 - B. One backplane assembly; (equipped as shown)
 - C. One J1 receptacle with mounting bracket;
 - D. One P1 equipment cable 5 ft. long (See Sheet 4);
 - E. All associated wiring and wiring harnesses.
2. Basic backplane assembly consists of:
 - A. Two inductive loop terminal strips;
 - B. One piezo sensor terminal strip;
 - C. One battery terminal strip.
3. The contractor is responsible for contacting the District Data Collection Coordinator for lane numbering.
4. Provide and install a Speed/Classification Unit.
5. Cable ends must be fabricated to fit the vehicle speed/classification unit. See Sheet 4 for Pinout Charts, receptacle and plug details.

CABINET LAYOUT DETAILS
(Four Lanes or Less)

SHORT TERM TRAFFIC MONITORING SITE - PTMS

9/26/2025 3:27:14 PM

LAST REVISION 11/01/25	REVISION	DESCRIPTION:	 FY 2026-27 STANDARD PLANS	TRAFFIC MONITORING SITE	INDEX 695-001	SHEET 6 of 21
---------------------------	----------	--------------	---	-------------------------	------------------	------------------

9/26/2025 3:27:20 PM

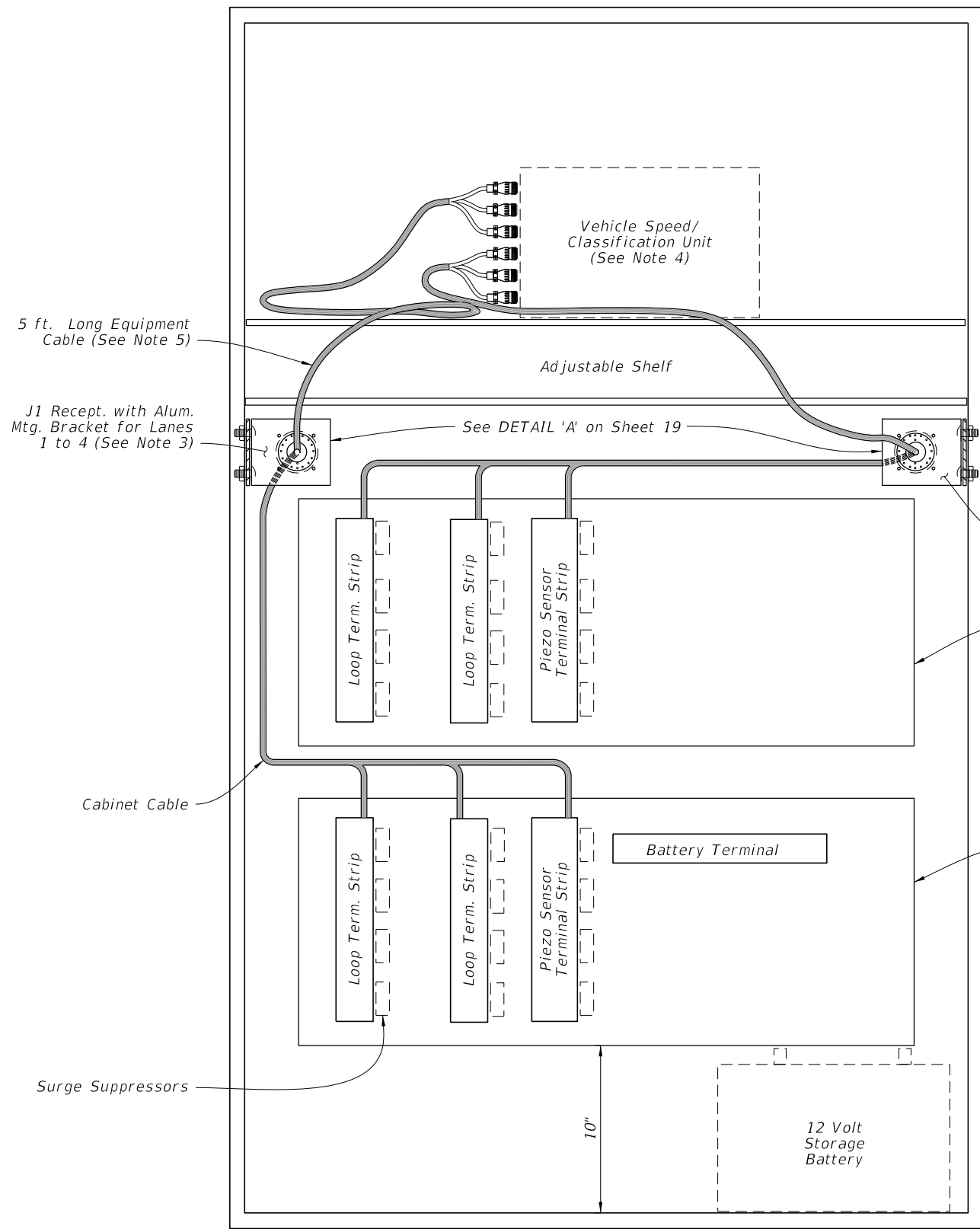

CABINET LAYOUT DETAILS
(Five to Eight Lanes)

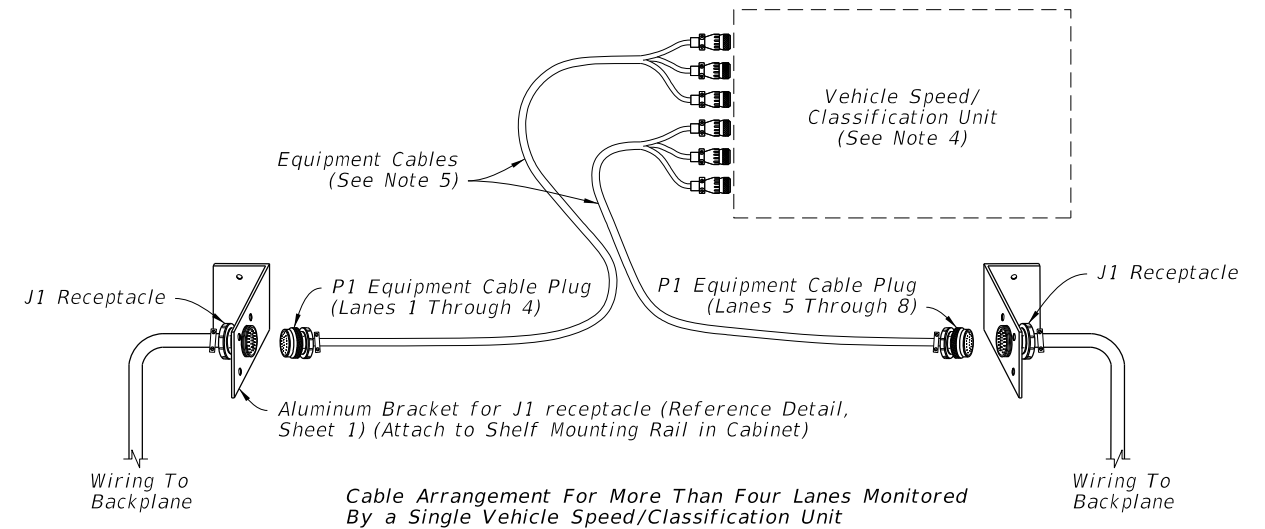

OPTION A
(Shown)

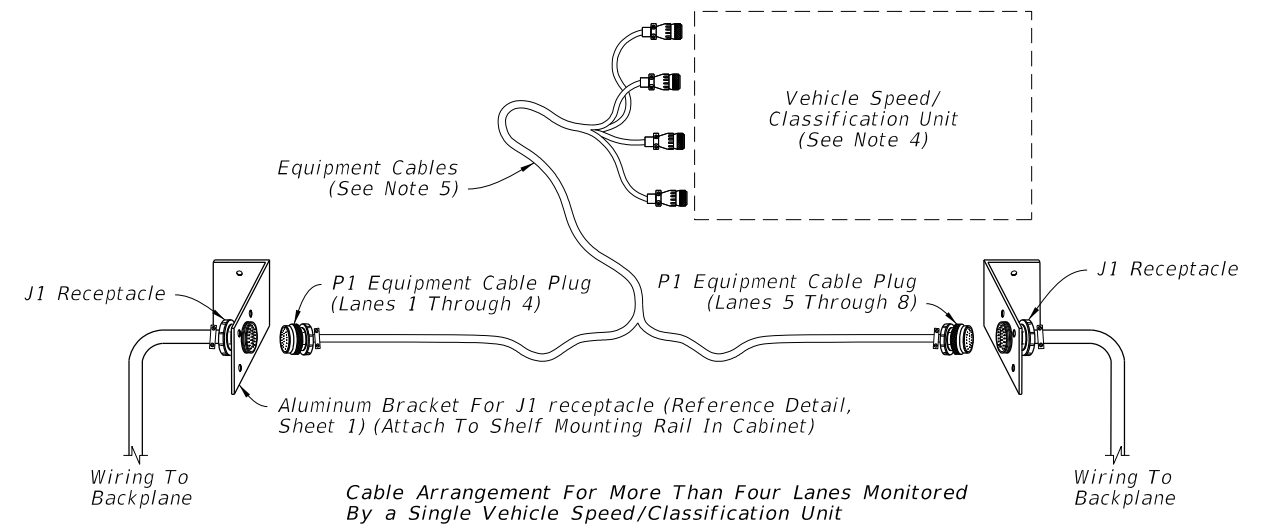

OPTION B

EQUIPMENT CABLE ASSEMBLY

NOTES:

1. Traffic monitoring site cabinet includes:
 - A. One adjustable shelf; (equipped as shown)
 - B. Two backplane assembly; (equipped as shown)
 - C. Two J1 receptacle with mounting bracket;
 - D. One P1 equipment cable 5 ft. long (See Sheet 4);
 - E. All Associated wiring and wiring harnesses.
2. Basic backplane assembly consists of:
 - A. Two inductive loop terminal strips;
 - B. One piezo sensor terminal strip;
 - C. One battery terminal strip.
3. The contractor is responsible for contacting the TMS Manager in the Transportation Data and Analytics Office for lane number information and verification.
4. Provide and install Speed/Classification Unit.
5. Cable ends must be fabricated to fit the vehicle speed/classification unit. See Sheet 4 for Pinout Charts, receptacle and plug details.

SHORT TERM TRAFFIC MONITORING SITE - PTMS

LAST REVISION 11/01/25	REVISION	DESCRIPTION:	 FY 2026-27 STANDARD PLANS	TRAFFIC MONITORING SITE	INDEX 695-001	SHEET 7 of 21
---------------------------	----------	--------------	---	--------------------------------	------------------	------------------

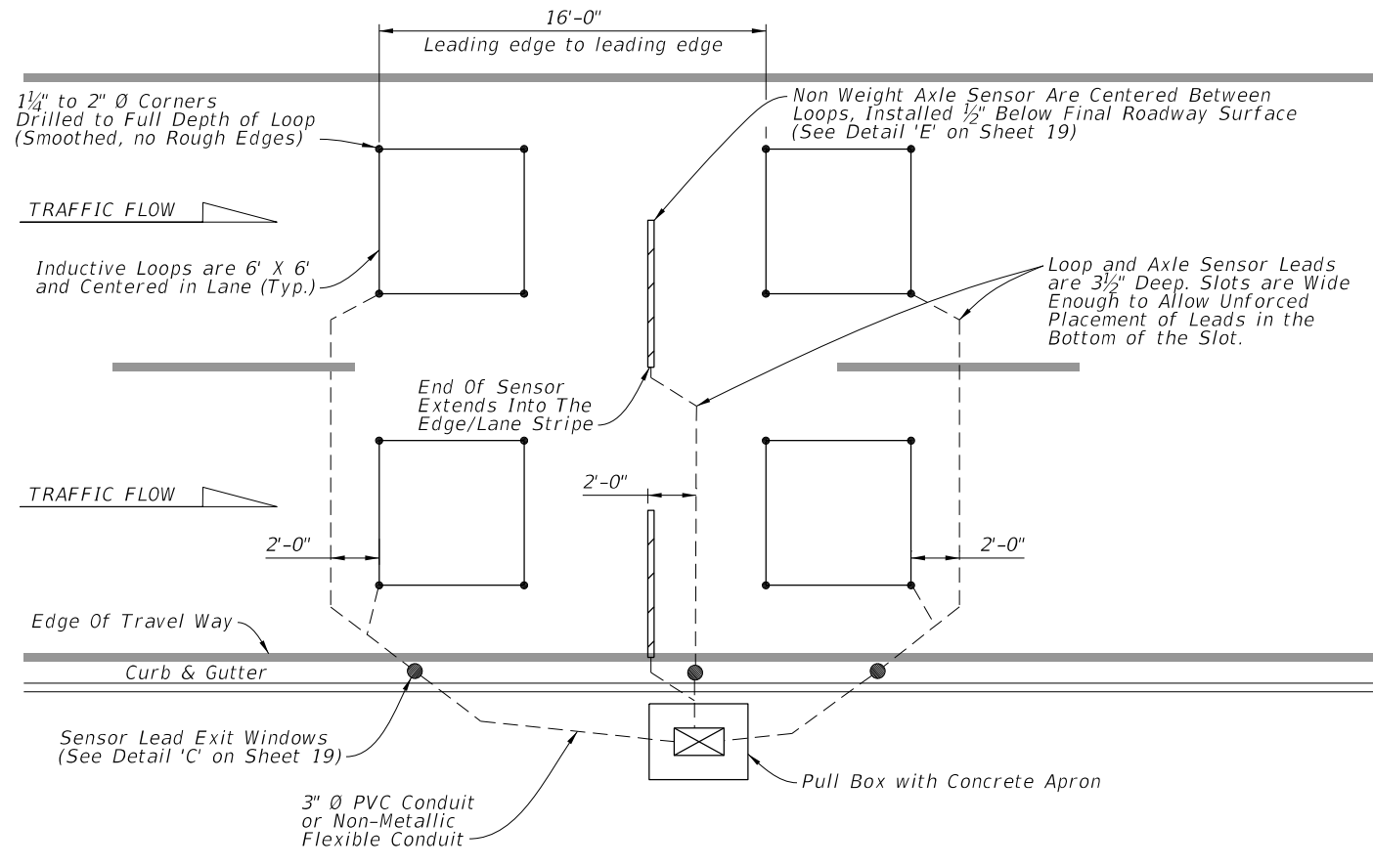
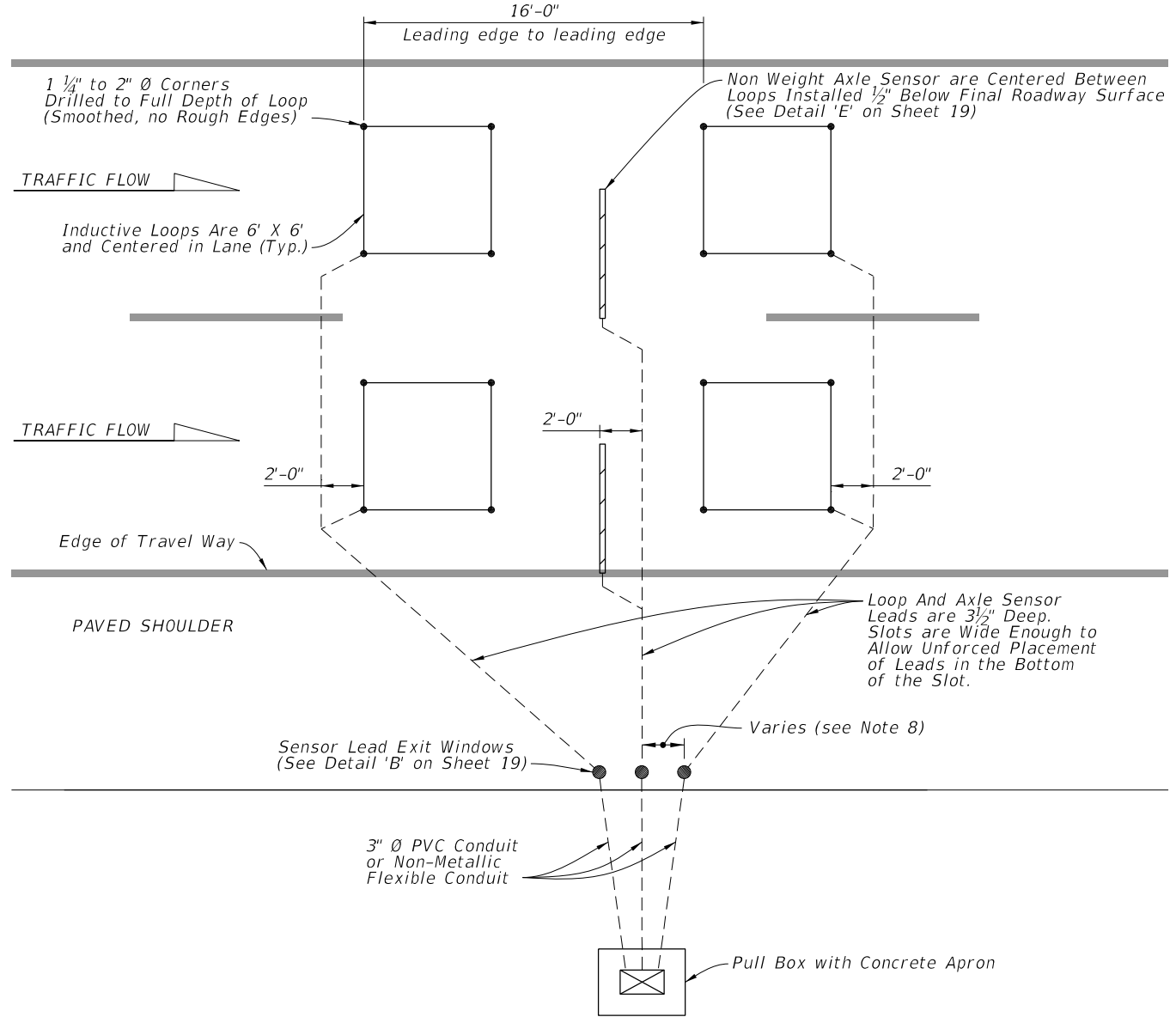

ROADWAYS WITH PAVED SHOULDERS

CURB & GUTTER ROADWAYS

NOTES:

1. Install axle sensors and loops associated with axle sensors after placement of the friction course.
2. Cut a 3 1/2" deep slot for the Inductive loops. Loop slots will be cut wide enough to allow unforced placement of the wire into the bottom of the slot. Place four turns of #14 AWG IMSA 51-7 copper wire in the slot. Place short pieces of backer rod (2" to 3" in length) every 18" to 24" to hold the loop wire in the bottom of the slot and start wire twist at the beginning of the home run slot.
3. Twist loop leads at the rate of 8 to 16 twists per foot. Extend the twisted pair loop wire directly to the cabinet. No splicing of the loop leads will be permitted. Install a home run slot with a minimum width of 5/8".
4. Marking will consist of two rounds of contrasting colored tape, one color for the lane number and the second color for the lead loop location in the lane. The first band closest to the cabinet will represent the lane number, one round of tape will be for lane 1 and two rounds will be lane 2, etc. The lead loop in lane one would have one round of tape and a second round of a contrasting colored tape for the lead loop in the lane. The trailing loop would not have a second contrasting colored band of tape.
5. See Index 635-001 for pull box and concrete apron details.
6. Use a chalk line or string and paint to layout the position of the sensor and lead-in cable slots. Ensure saw cuts do not deviate more than 1/2" from the chalk line. Use a single blade or ganged blade saw wide enough to cut the axle sensor slot at full width in a single pass. Cutting two slots and chipping out roadway material between them is not allowed.
7. All sensor slots and any cuts in the roadway will be thoroughly blown out to ensure there is no dust or debris prior to installation of sensors or leads.
8. Install Exit Windows at least 2' apart.

LANE LAYOUT FOR PTMS INDUCTIVE LOOP AND AXLE SENSORS
(Typical for up to 4 Lanes of Sensor Leads Pulled to one Side of the Roadway)

SHORT TERM TRAFFIC MONITORING SITE - PTMS

9/26/2025 3:27:27 PM

LAST REVISION 11/01/25	REVISION	DESCRIPTION:		FY 2026-27 STANDARD PLANS	TRAFFIC MONITORING SITE	INDEX 695-001	SHEET 8 of 21
---------------------------	----------	--------------	--	------------------------------	-------------------------	------------------	------------------

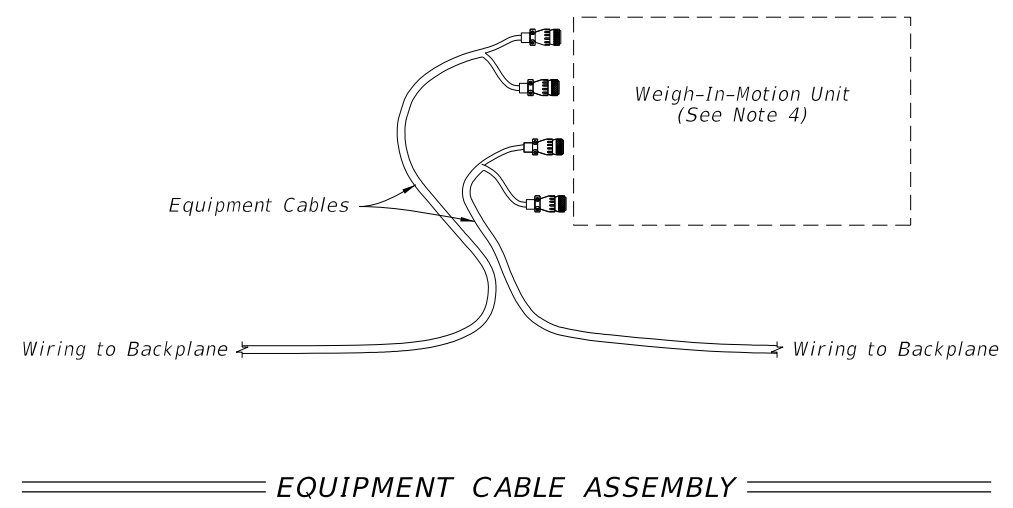
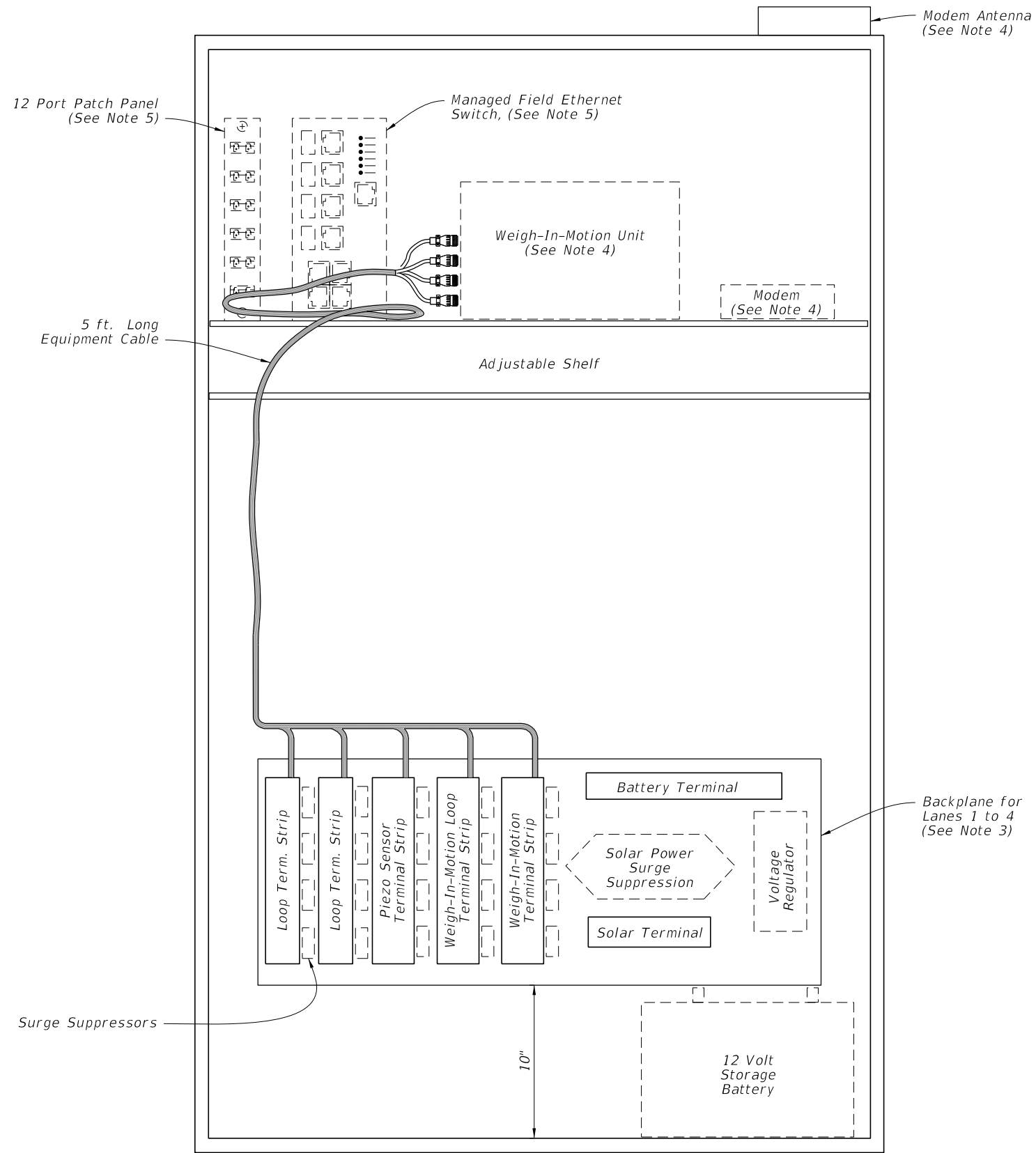

NOTES:

1. Traffic monitoring site cabinet includes:
 - A. One adjustable shelf; (equipped as shown)
 - B. One backplane assembly; (equipped as shown)
 - C. All associated wiring and wiring harnesses.
2. Basic backplane assembly consists of:
 - A. Two inductive loop terminal strips;
 - B. One piezo sensor terminal strip;
 - C. Two weigh-in-motion terminal strips;
 - D. One battery terminal strip;
 - E. One solar panel terminal strip.
3. The contractor is responsible for contacting the TMS Manager at the Transportation Data and Analytics Office for lane number information and verification.
4. Provide and install a Weigh-In-Motion Unit, Modem, and Antenna.
5. Provide and install a 12-fiber single mode cable, a 12-port patch panel, and a managed field ethernet switch.

CABINET LAYOUT DETAILS

WEIGH-IN-MOTION MONITORING SITE

9/26/2025 3:27:33 PM

LAST REVISION 11/01/25	REVISION	DESCRIPTION:	 FY 2026-27 STANDARD PLANS	TRAFFIC MONITORING SITE	INDEX 695-001	SHEET 9 of 21
---------------------------	----------	--------------	----------------------------------	-------------------------	------------------	------------------

To Weigh-In-Motion Unit

NOTES:

1. Reference Sheet 9, Note 2 for items to be included with backplane.
2. All terminal strip contacts are on 9/16" centers (Cinch 142 Series or equal) Use insulated fork wire terminations.
3. The contractor is responsible for contacting the TMS Manager in the Transportation Data and Analytics Office for lane number information and verification.

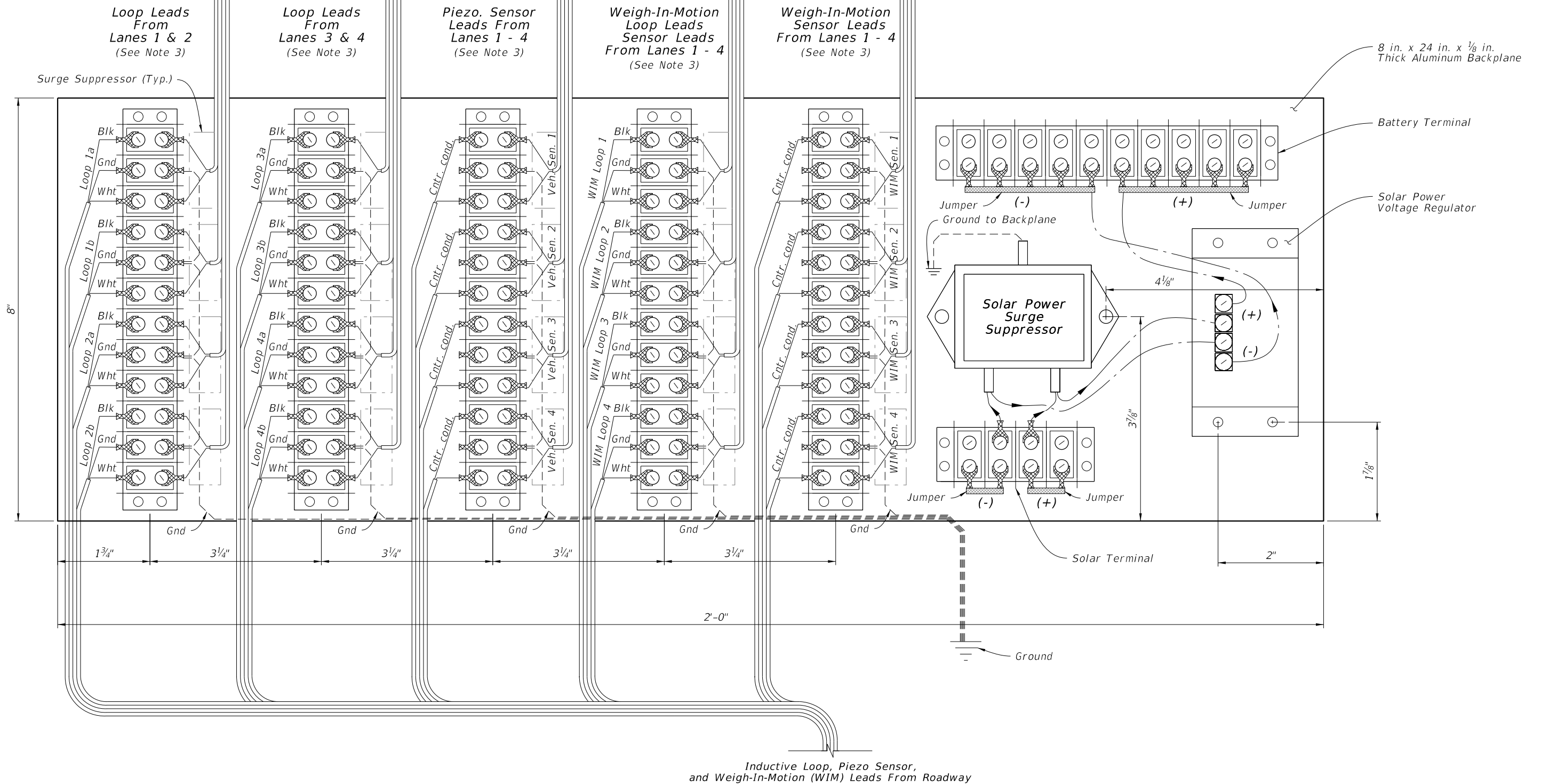

CABINET BACKPLANE DETAILS

Inductive Loop, Piezo Sensor, and Weigh-In-Motion (WIM) Leads From Roadway

WEIGH-IN-MOTION MONITORING SITE

9/26/2025 3:27:40 PM

LAST REVISION 11/01/25	DESCRIPTION:		FY 2026-27 STANDARD PLANS	TRAFFIC MONITORING SITE	INDEX	SHEET
					695-001	10 of 21

NOTES:

1. Install axle sensors and loops associated with axle sensors after placement of the friction course.
2. Cut a 3½" deep slot for the Inductive loops. Loop slots will be cut wide enough to allow unforced placement of the wire into the bottom of the slot. Place four turns of #14 AWG IMSA 51-7 copper wire in the slot. Place short pieces of backer rod (2" to 3" in length) every 18" to 24" to hold the loop wire in the bottom of the slot.
3. Twist loop leads at the rate of 8 to 16 twists per foot. Extend the twisted pair loop wire directly to the cabinet. No splicing of the loop leads will be permitted.
4. Marking will consist of two rounds of contrasting colored tape, one color for the lane number and the second color for the lead loop location in the lane. The first band closest to the cabinet will represent the lane number, one round of tape will be for lane 1 and two rounds will be lane 2, etc. The lead loop in lane one would have one round of tape and a second round of a contrasting colored tape for the lead loop in the lane. The trailing loop would not have a second contrasting colored band of tape.
5. See Index 635-001 for pull box and concrete apron details.
6. Use a chalk line or string and paint to layout the position of the sensor and lead-in cable slots. Ensure saw cuts do not deviate more than ½" from the chalk line. Install the sensor according to manufacturer's recommendations.
7. All sensor slots and any cuts in the roadway will be thoroughly blown out to ensure there is no dust or debris prior to installation of sensors or leads.
8. Install Exit Windows at least 2' apart.

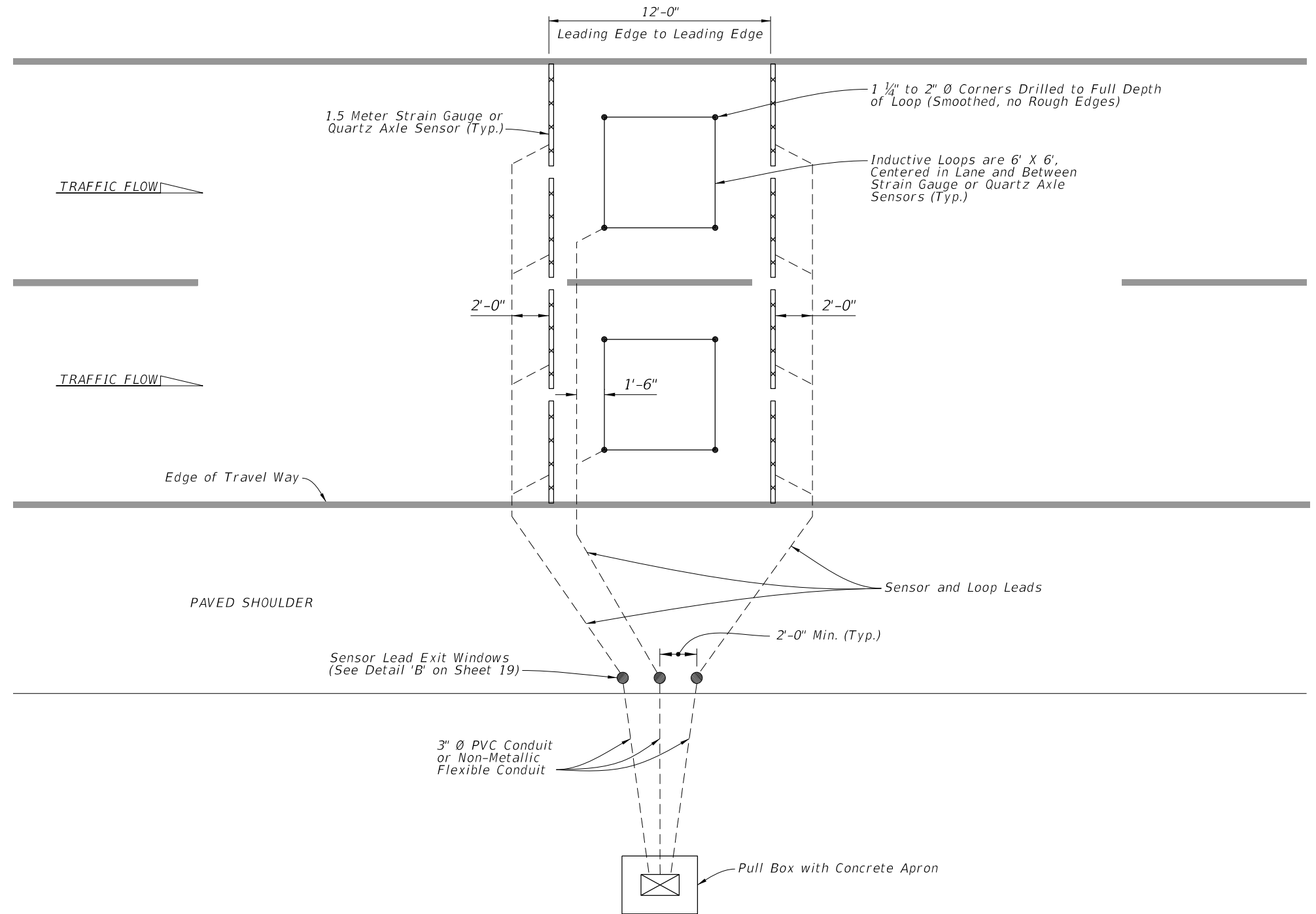

LANE LAYOUT FOR TTMS/CCS INDUCTIVE LOOP AND WEIGH-IN-MOTION SENSORS

WEIGH-IN-MOTION MONITORING SITE

9/26/2025 3:27:46 PM

LAST REVISION 11/01/25	REVISION	DESCRIPTION:		FY 2026-27 STANDARD PLANS	TRAFFIC MONITORING SITE	INDEX 695-001	SHEET 11 of 21
---------------------------	----------	--------------	---	------------------------------	-------------------------	------------------	-------------------

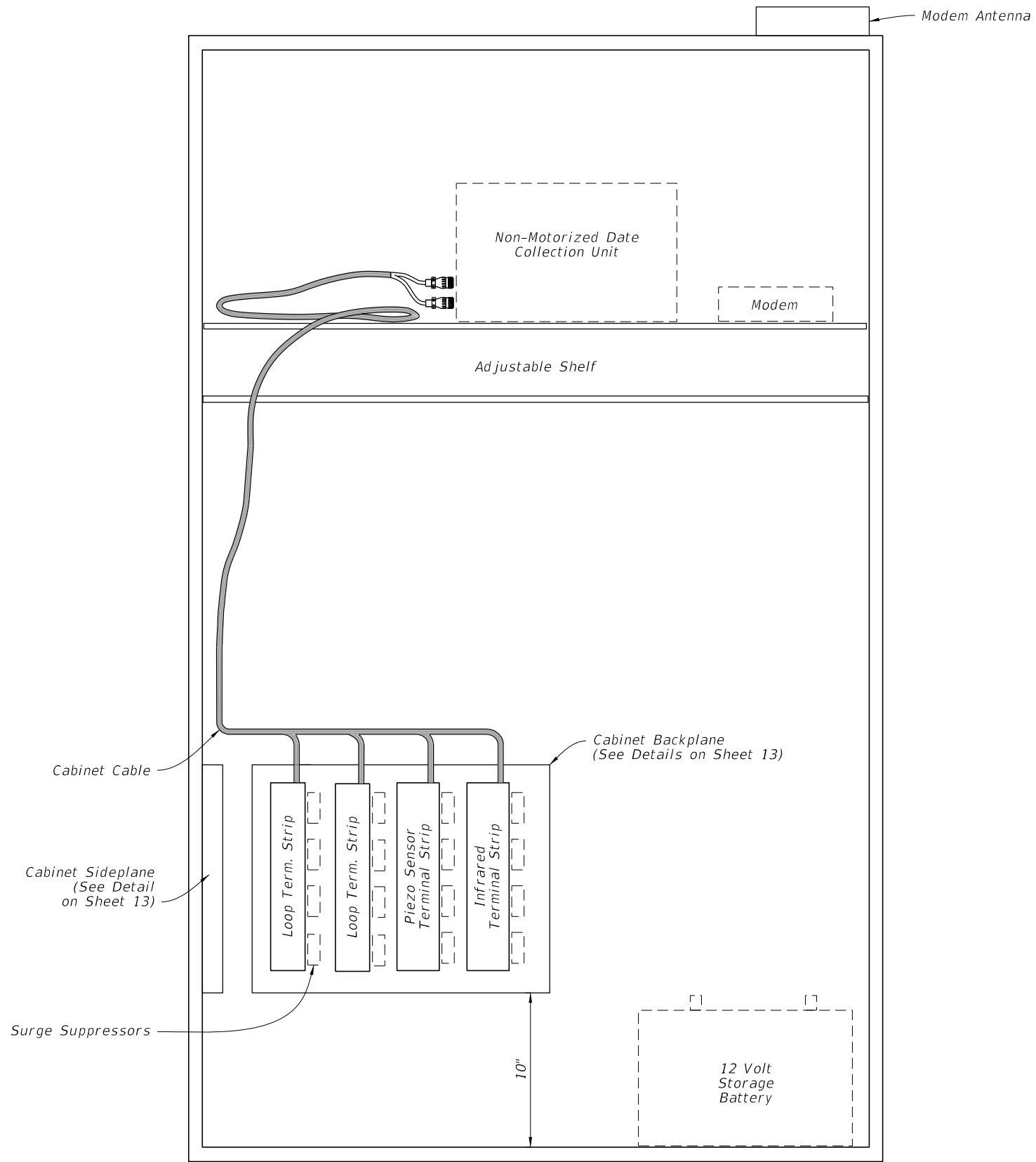

NOTES:

1. Traffic monitoring site cabinet includes:
 - A. One adjustable shelf; (equipped as shown)
 - B. One backplane assembly; (equipped as shown)
 - C. One sideplane assembly; (equipped as shown);
 - D. Infrared sensor and piezo sensor cables.
2. Basic backplane assembly consists of:
 - A. Two inductive loop terminal strips;
 - B. One piezo sensor terminal strip;
 - C. One infrared sensor terminal strip;
3. Basic sideplane assembly consists of:
 - A. One battery terminal strip;
 - B. One solar panel terminal strip.

CABINET LAYOUT DETAILS

NON-MOTORIZED MONITORING SITE

9/26/2025 3:27:53 PM

LAST REVISION 11/01/25	REVISION	DESCRIPTION:	 FY 2026-27 STANDARD PLANS	TRAFFIC MONITORING SITE	INDEX 695-001	SHEET 12 of 21
---------------------------	----------	--------------	---	-------------------------	------------------	-------------------

NOTES:

1. Reference Sheet 12, Note 2 for items to be included with backplane.
2. All terminal strip contacts are on $\frac{9}{16}$ " centers (Cinch 142 Series or equal) Use insulated fork wire terminations.
3. The contractor is responsible for contacting the TMS Manager in the Transportation Data and Analytics Office for lane number information and verification.

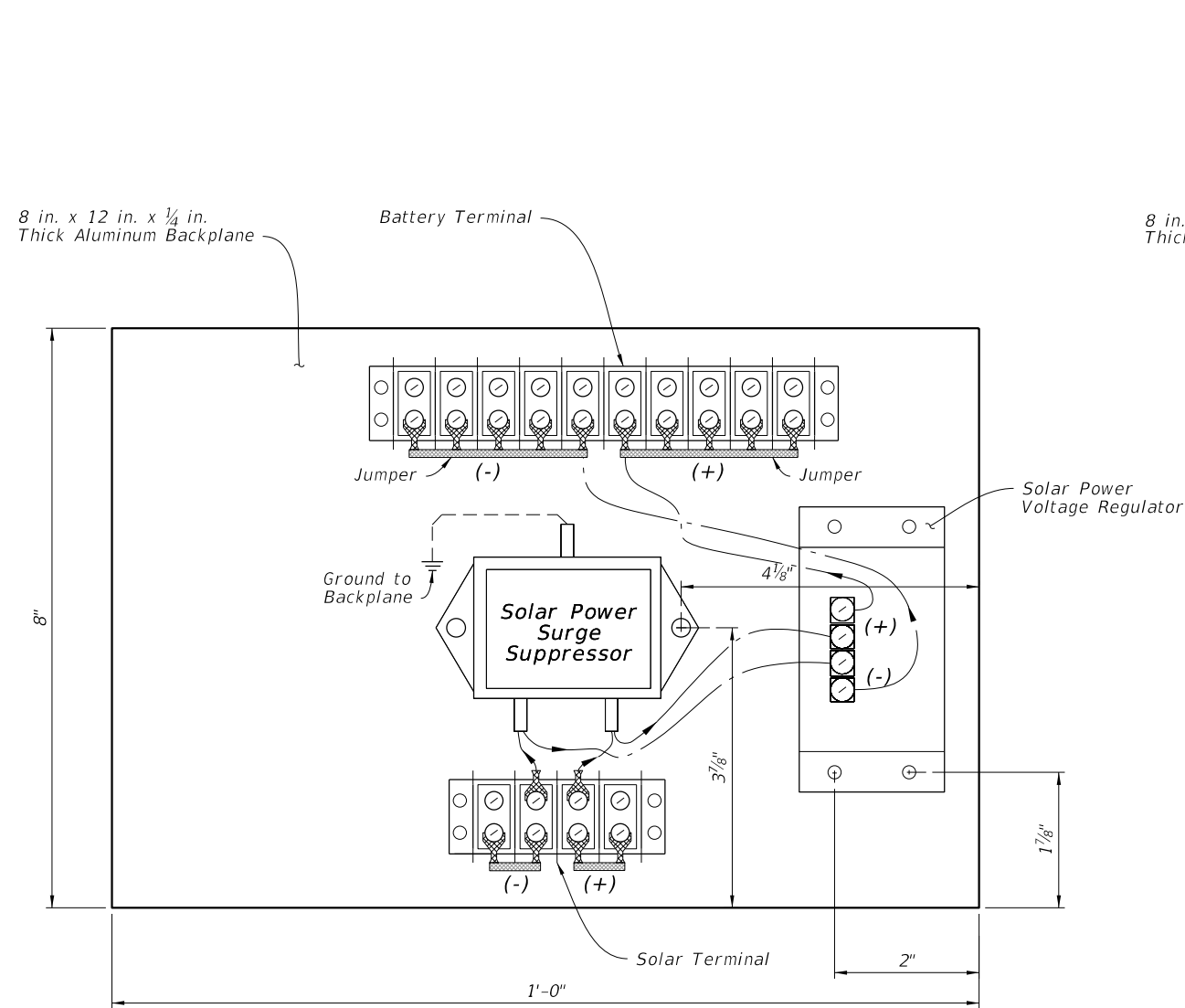

CABINET SIDEPLANE DETAILS

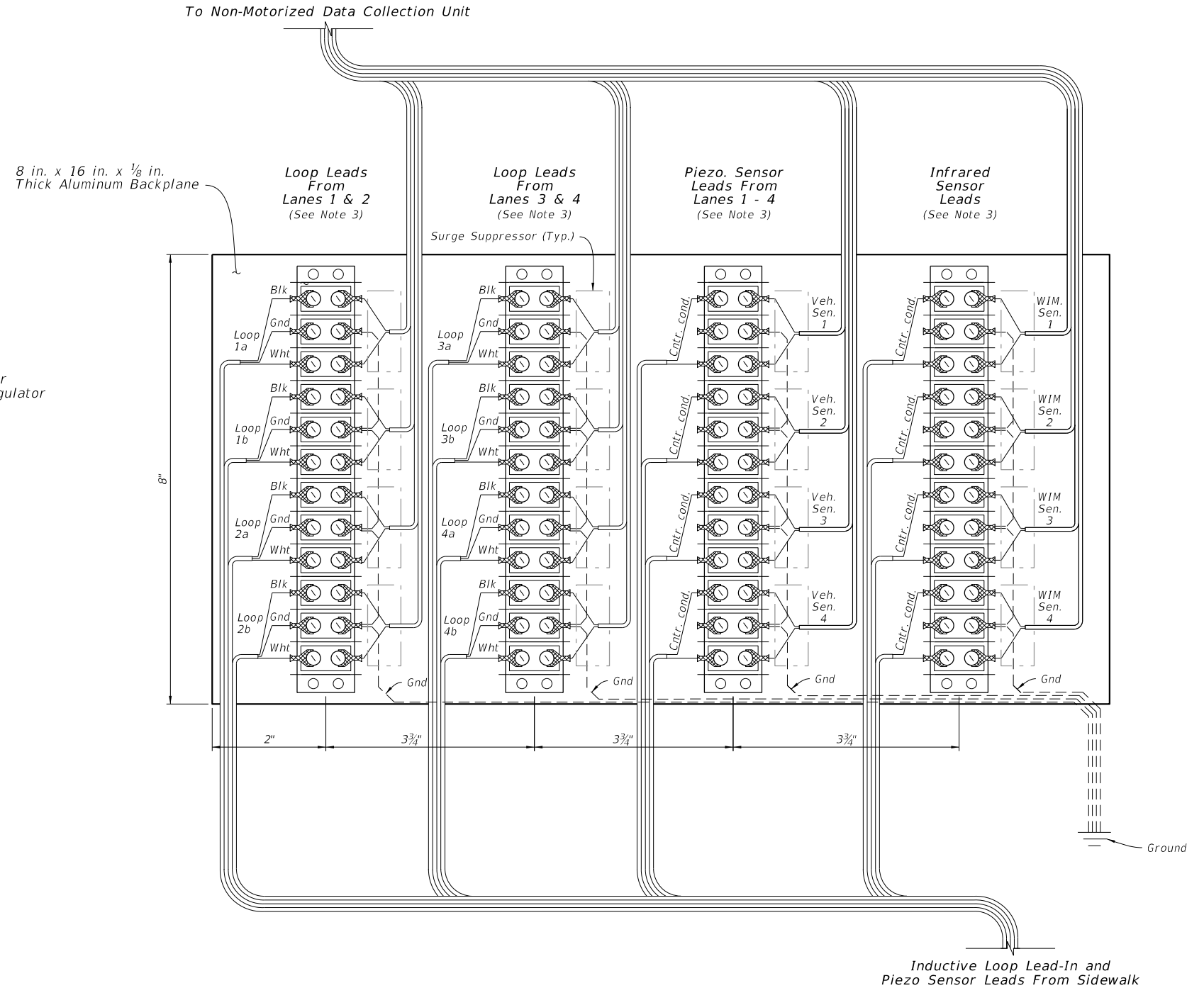

CABINET BACKPLANE DETAILS

Inductive Loop Lead-In and Piezo Sensor Leads From Sidewalk

NON-MOTORIZED MONITORING SITE

9/26/2025 3:27:59 PM

LAST REVISION 11/01/25	DESCRIPTION:
---------------------------	--------------



FY 2026-27
STANDARD PLANS

TRAFFIC MONITORING SITE

INDEX
695-001

SHEET
13 of 21

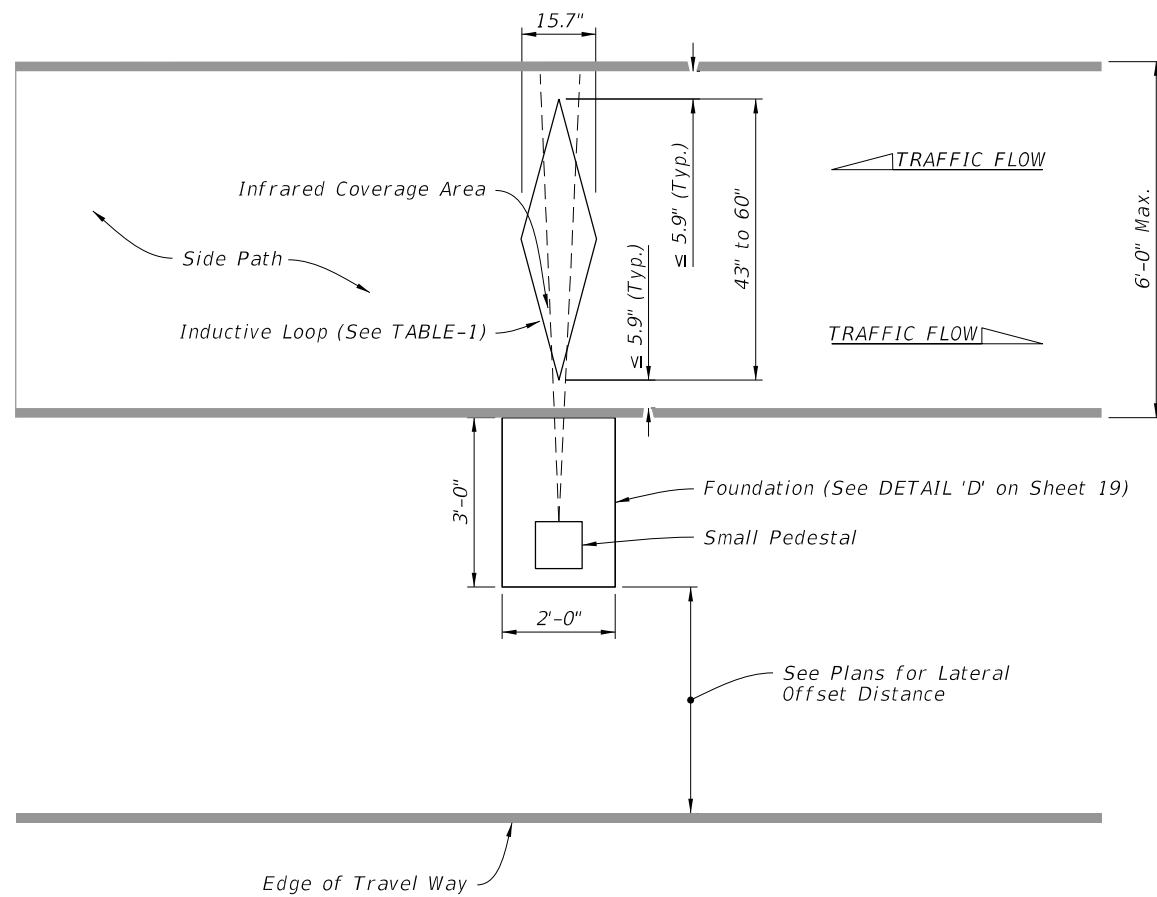

SINGLE LOOP ASSEMBLY
(Directional Recognition With Infrared)

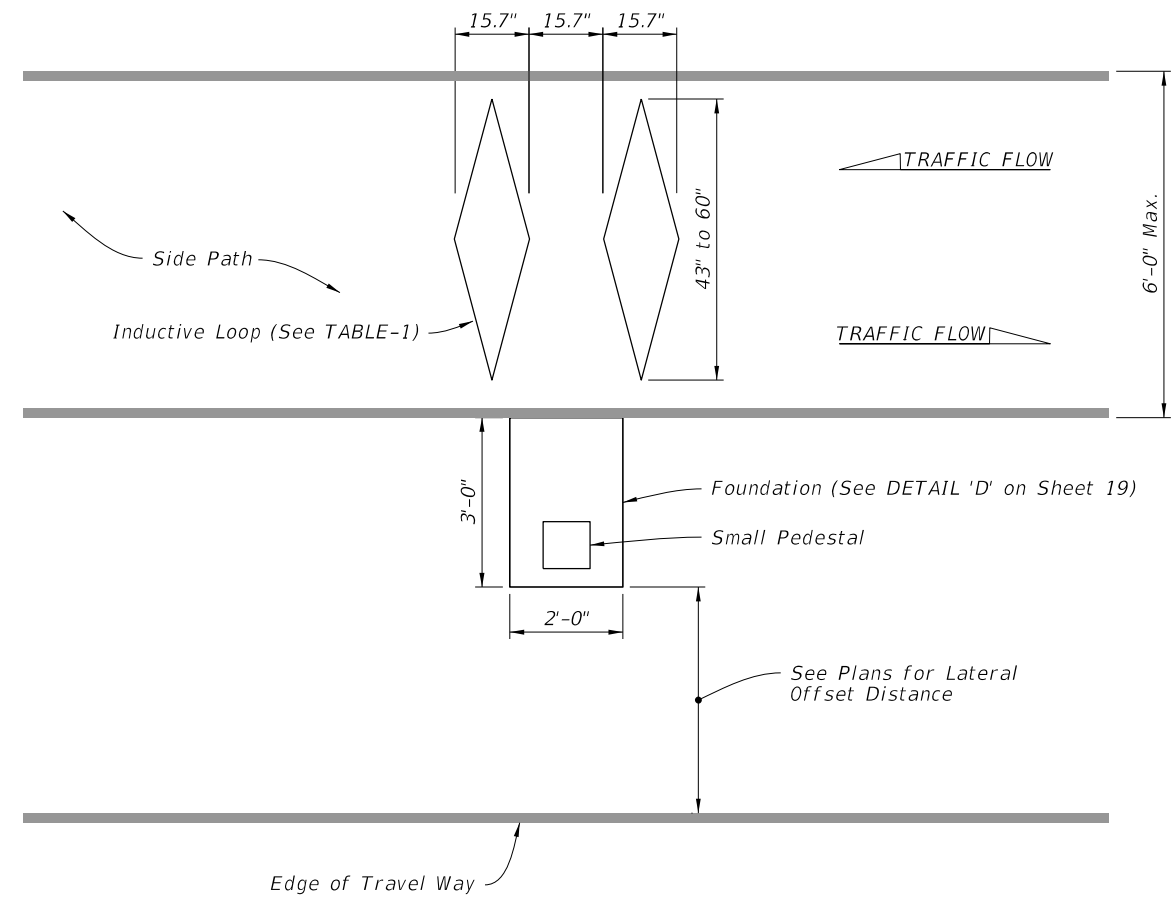

DUAL LOOP ASSEMBLY
(Directional Recognition Without Infrared)

NON-MOTORIZED MONITORING SITE NOTES:

1. Use a chalk line or string and paint to layout the position of the sensor and lead-in cable slots. Ensure saw cuts do not deviate more than 0.5 inches from the chalk line. Use a single blade or ganged blade saw wide enough to cut the axle sensor at full width in a single pass. Cutting two slots and chipping out roadway material between them is not allowed.
2. Cut a 1/4" to 1/2" wide slot.
3. All sensor slots and any cuts in the pathway will be thoroughly blown out to ensure there is no dust or debris prior to installation of the loops and leads.
4. Place eight turns of loop wire in each slot.
5. Twist loop leads at the rate of 10 twists per foot.
6. Extend the twisted pair loop wire directly to the termination point with no splices.
7. For the side-by-side configuration, install the farthest loop lead through the near side loop slot.
8. At the termination point, for north-south pathways, mark the north piezometer and inductive loop sensor lead(s) with one tape. For east-west pathways, mark the east piezometer and inductive loop sensor lead(s) with one tape. Mark the south and west sensor lead(s) with two tapes.
9. Do not point infrared sensors towards a path where motor vehicles pass, a metallic or reflective surface, surfaces exposed to sunlight or vegetation that are likely to move.
10. Avoid placing infrared sensors near heat sources, steep surfaces, high voltage power cables, and telecommunications equipment.
11. If crossing pavement joints see DETAIL "F" on Sheet 19.

Lane Width	Loop Length
43.3"	39.4" to 43.3"
47.2"	43.3" to 47.2"
51.2"	47.2" to 51.2"
55.1"	51.2" to 55.1"
59"	55.1" to 59.1"
63" to 70.9"	59.1"
72.8" to 76.8"	Contact Manufacturer

REGULAR SIDE PATH CONFIGURATIONS

NON-MOTORIZED MONITORING SITE

9/26/2025 3:28:05 PM

LAST REVISION 11/01/25	REVISION	DESCRIPTION:		FY 2026-27 STANDARD PLANS	TRAFFIC MONITORING SITE	INDEX 695-001	SHEET 14 of 21
---------------------------	----------	--------------	---	------------------------------	-------------------------	------------------	-------------------

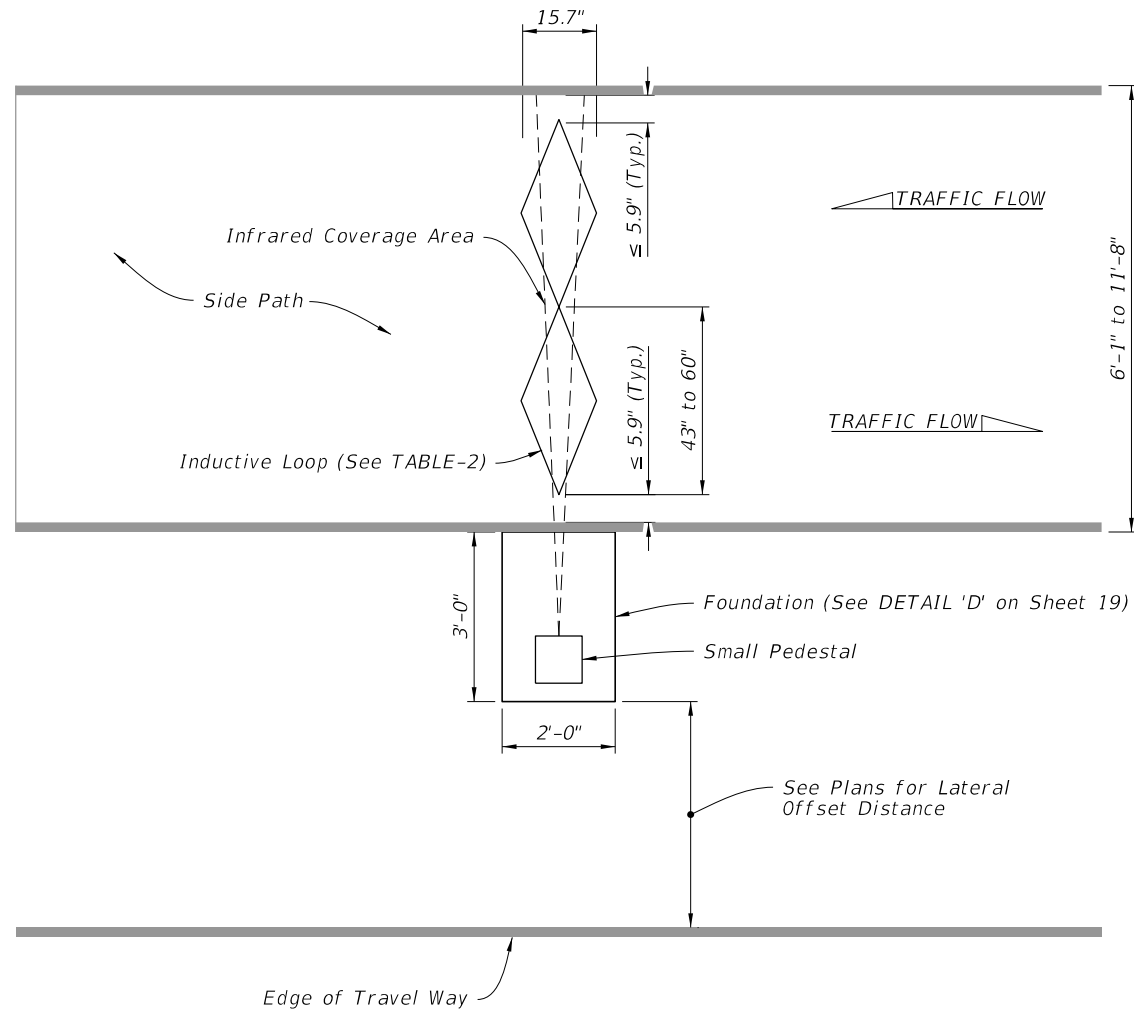

DUAL LOOP ASSEMBLY
(Directional Recognition With Infrared)

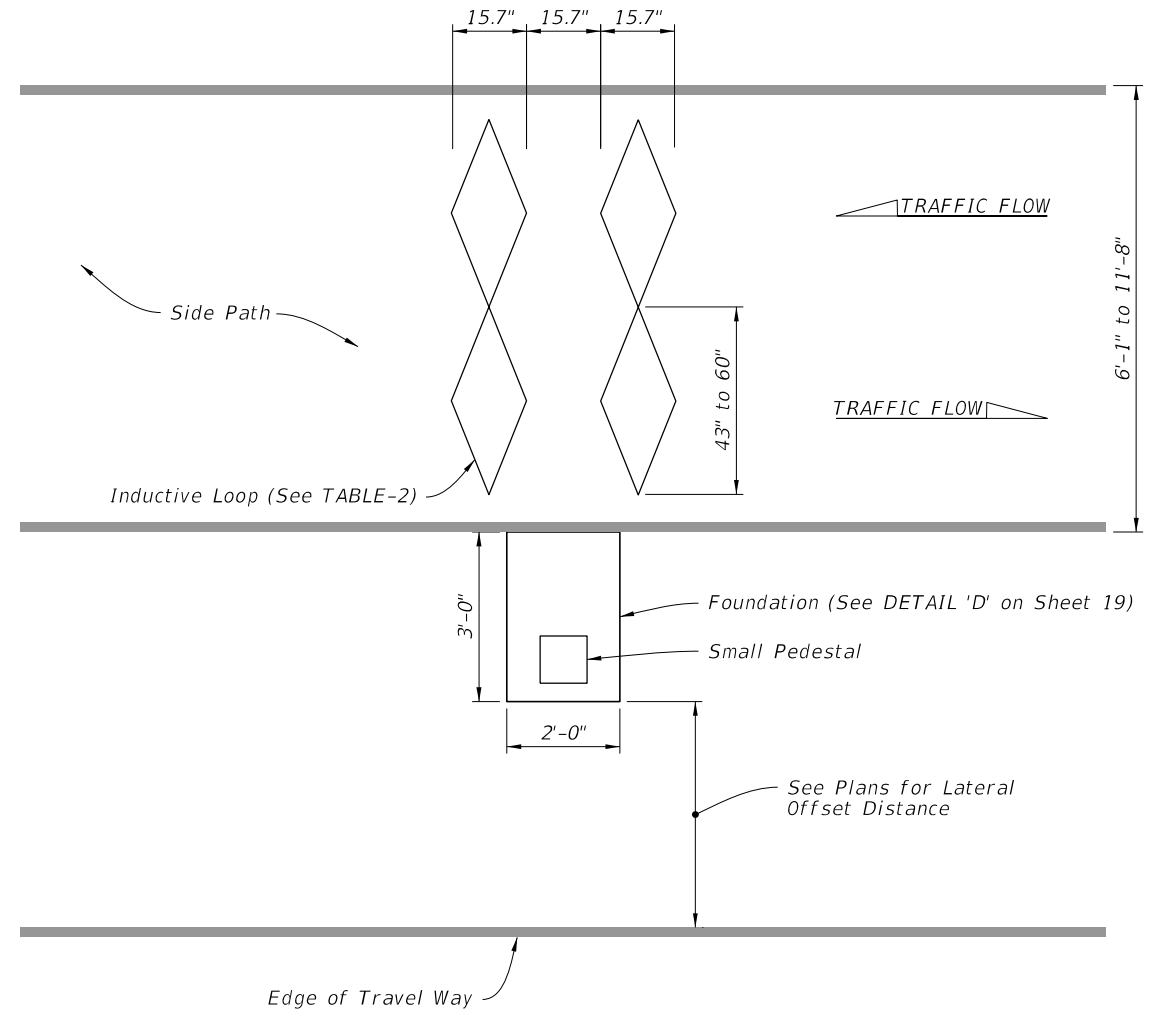

QUAD LOOP ASSEMBLY
(Directional Recognition Without Infrared)

Lane Width	Loop Length
78.7" to 82.7"	39.4"
86.6" to 98.4"	43.3"
102.7" to 106.3"	47.2"
110.2" to 114.2"	51.2"
118.1" to 122"	55.1"
126" to 133.9"	59.1"
≥133.9"	Contact Manufacturer

MEDIUM SHARED USE PATH CONFIGURATIONS

NON-MOTORIZED MONITORING SITE

9/26/2025 3:28:12 PM

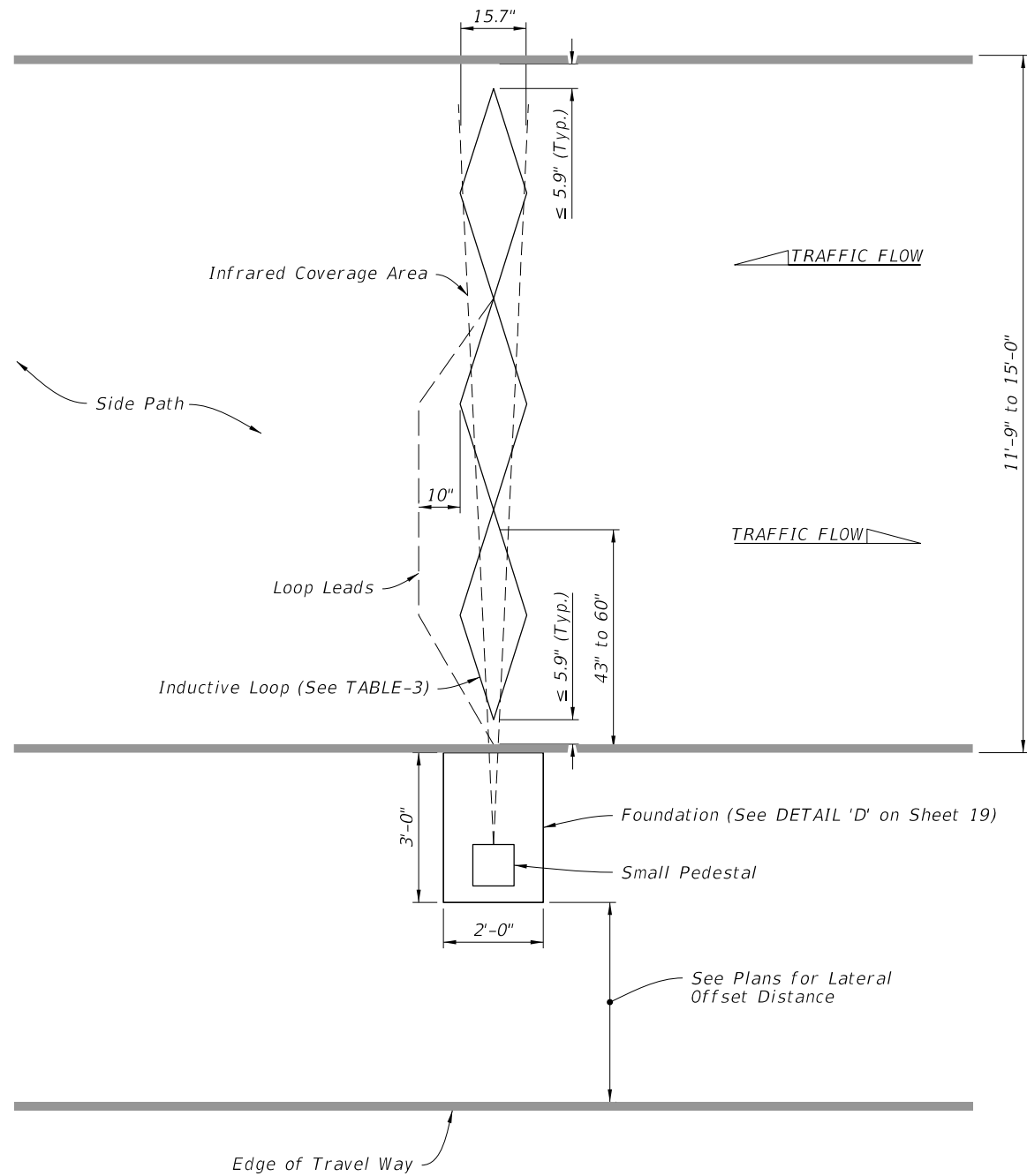

TRIPLE LOOP ASSEMBLY
(Directional Recognition With Infrared)

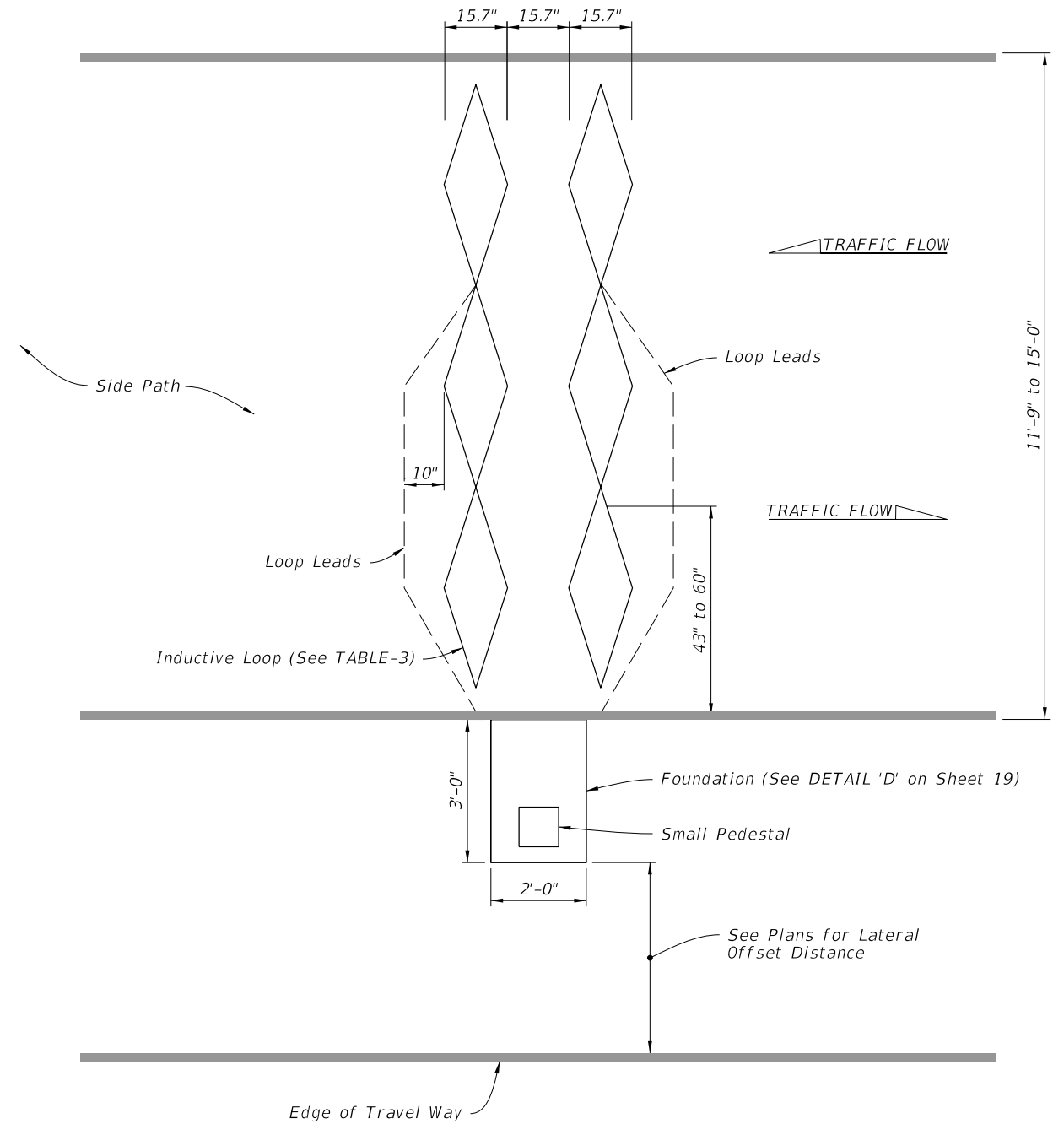

SEXTUPLE LOOP ASSEMBLY
(Directional Recognition Without Infrared)

Lane Width	Loop Length
133.9" to 141.7"	43.3"
145-7" to 153.5"	47.2"
157.5" to 165.4"	51.2"
169.2" to 177.2"	55.1"
181.1" to 189"	59.1"

LARGE SHARED USE PATH CONFIGURATIONS

NON-MOTORIZED MONITORING SITE

10/15/2025 7:59:34 AM

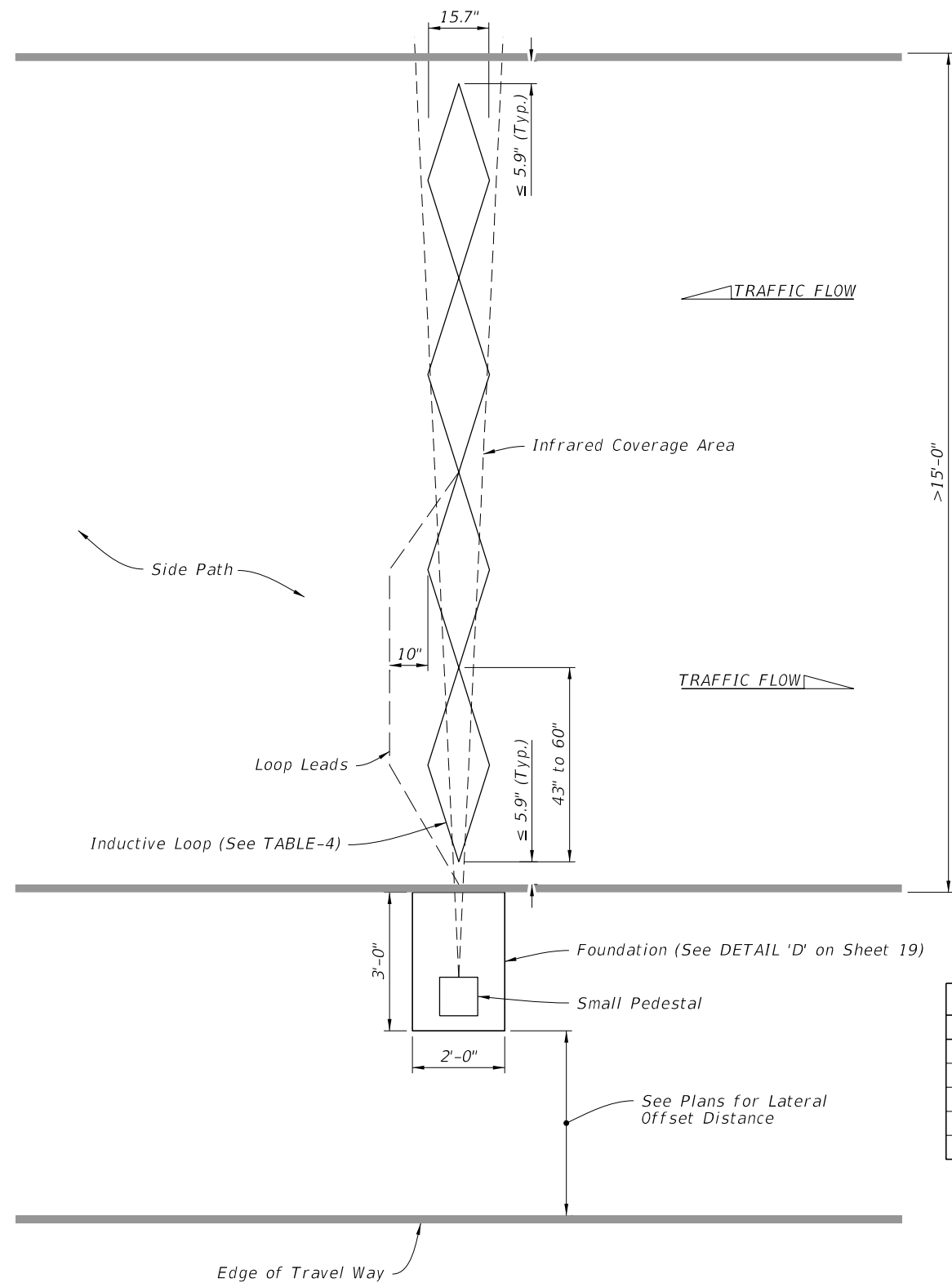

FOUR LOOP ASSEMBLY
(Directional Recognition With Infrared)

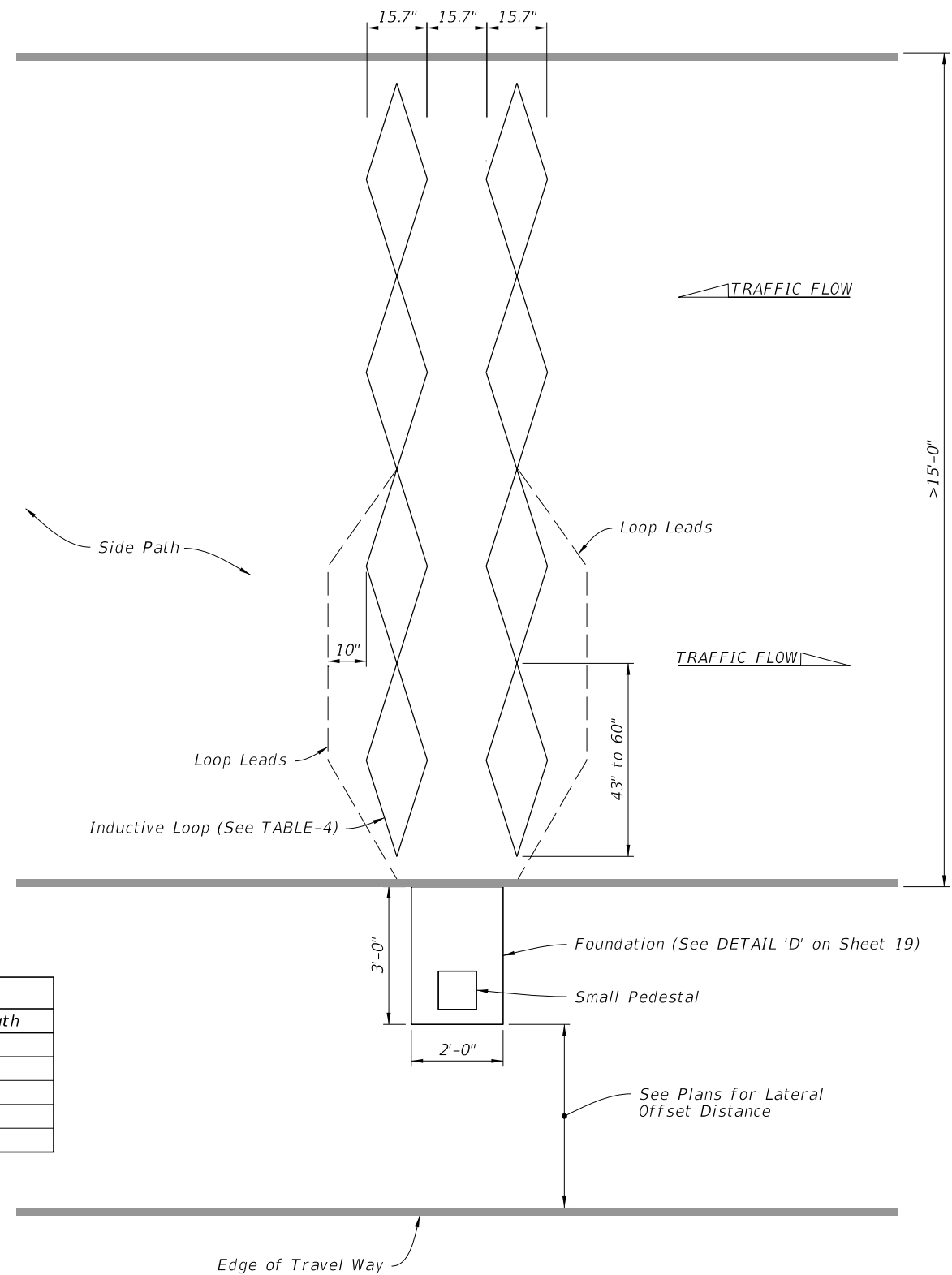

QUADRUPLE LOOP ASSEMBLY
(Directional Recognition Without Infrared)

TABLE - 4

Lane Width	Loop Length
173.2" to 185"	43.3"
188" to 200.8"	47.2"
204.7" to 216.5"	51.2"
220.5" to 232.3"	55.1"
236.2" to 248"	59.1"

EXTRA LARGE SHARED USE PATH CONFIGURATIONS

NON-MOTORIZED MONITORING SITE

9/26/2025 3:28:25 PM

LAST REVISION 11/01/25	REVISION	DESCRIPTION:
---------------------------	----------	--------------

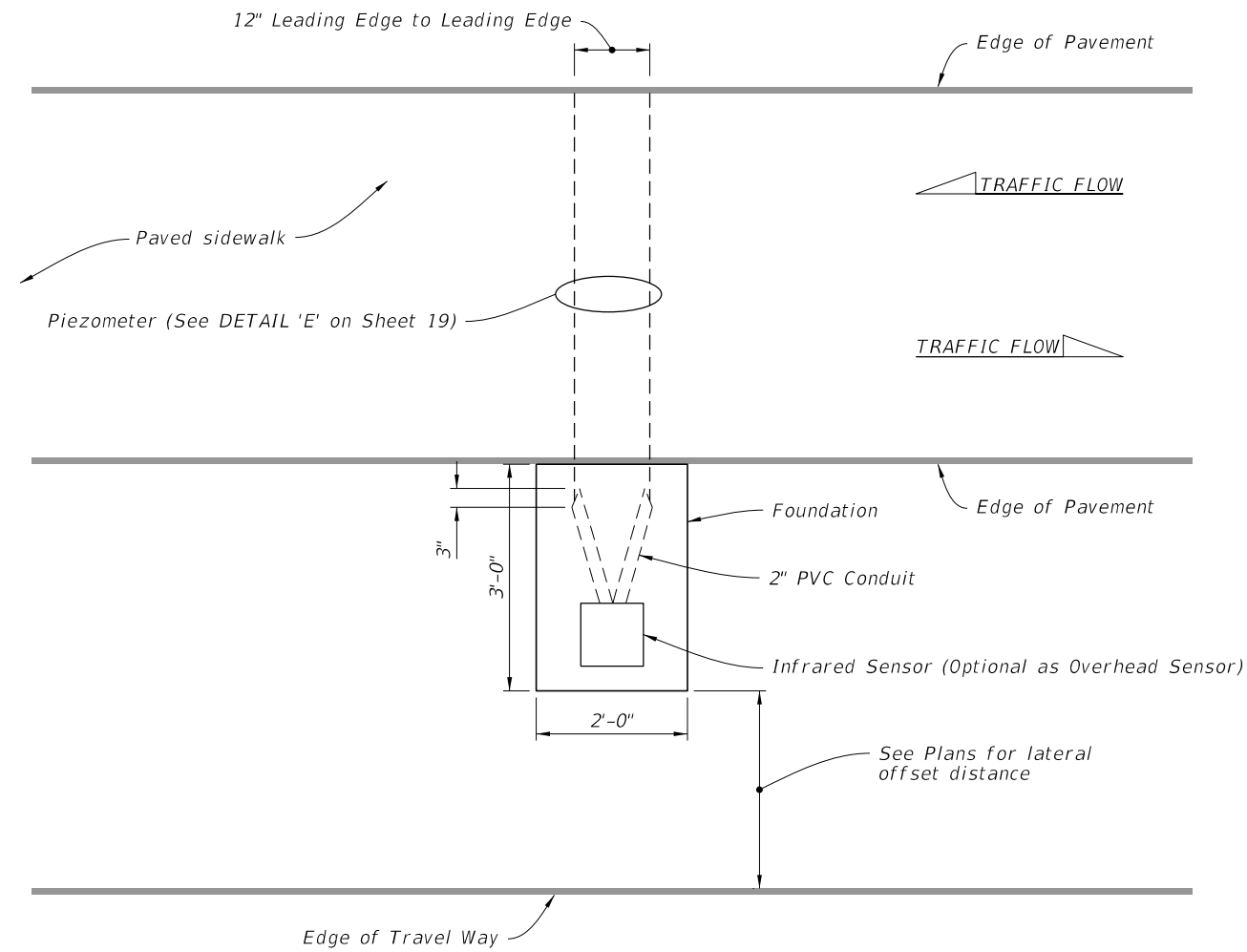

PLAN VIEW

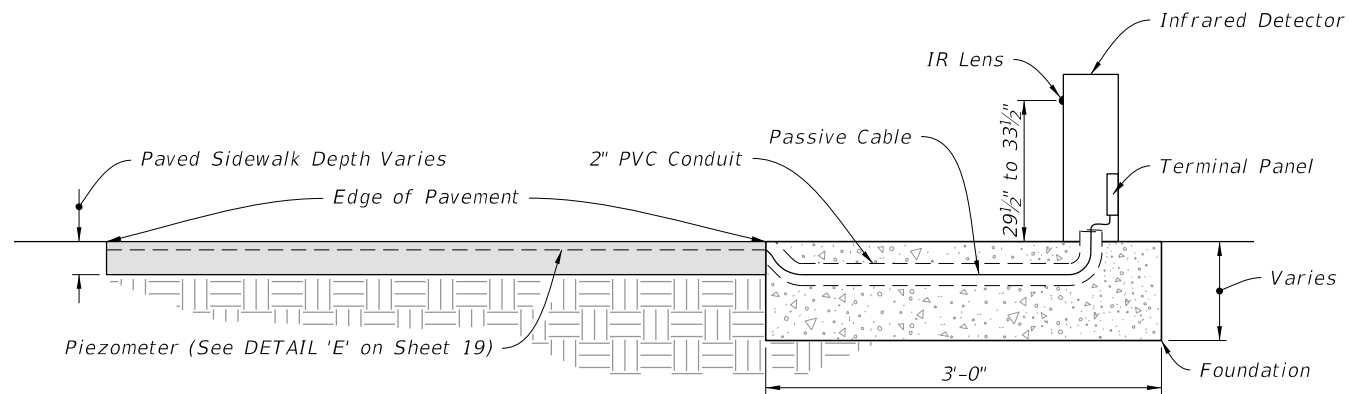

ELEVATION

PAVED SIDEWALK CONFIGURATION

NON-MOTORIZED MONITORING SITE

9/26/2025 3:28:31 PM

LAST REVISION 11/01/25	REVISION	DESCRIPTION:
------------------------------	----------	--------------



FY 2026-27
STANDARD PLANS

TRAFFIC MONITORING SITE

INDEX
695-001

SHEET
18 of 21

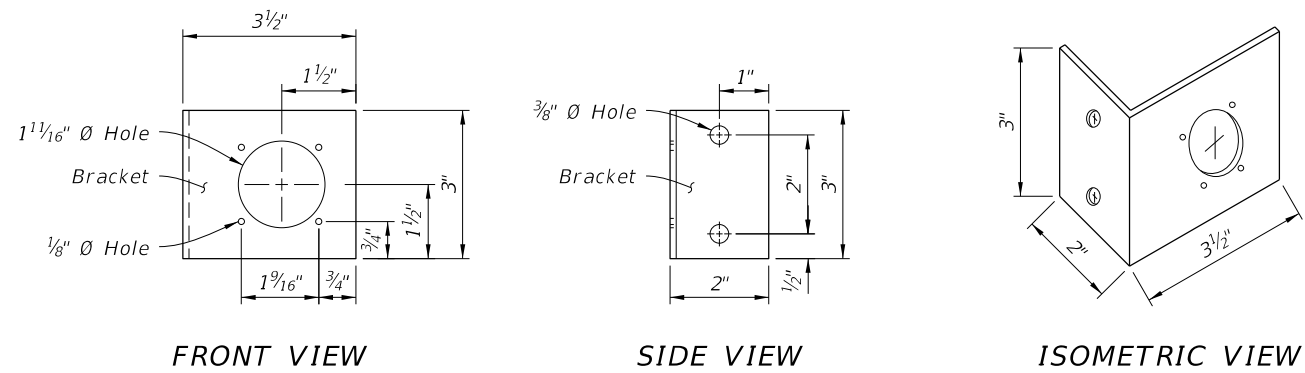

NOTE:
Fabricate bracket out of 3/32" - 1/8" inch thick aluminum. Dimensions may vary depending on the manufacturer of the J1 receptacle being furnished. The cabinet manufacturer will construct the mounting bracket to fit the receptacle.

J1 MOUNTING BRACKET

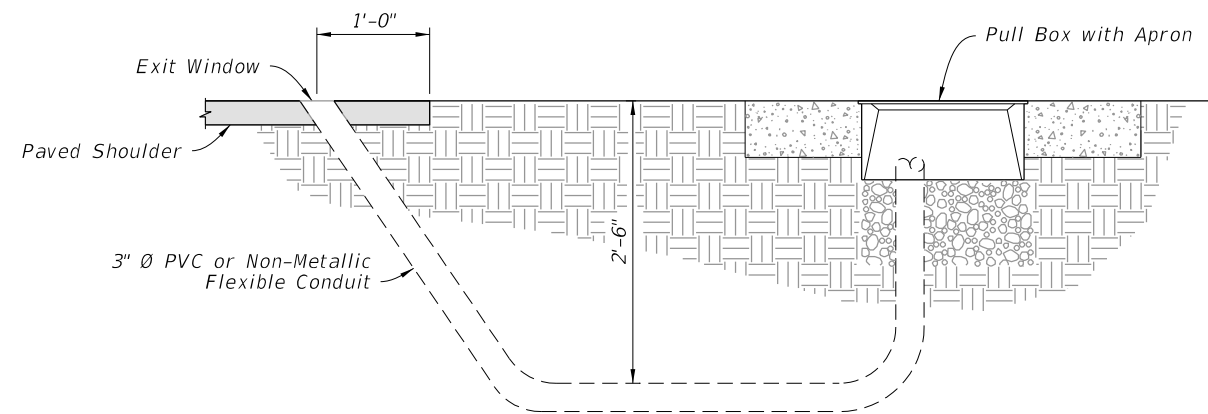

DETAIL 'B'

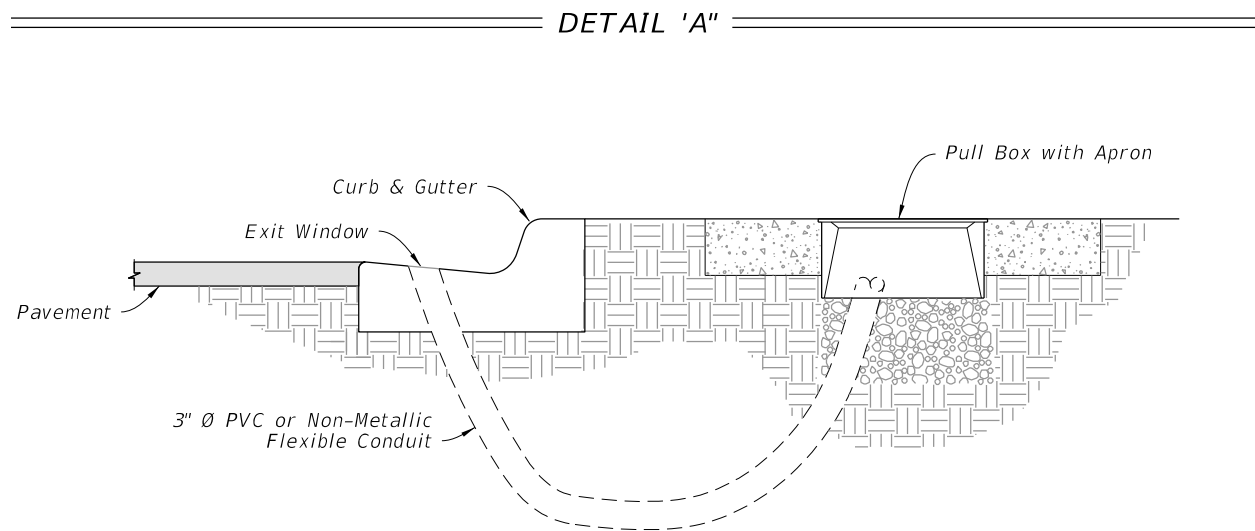

DETAIL 'C'

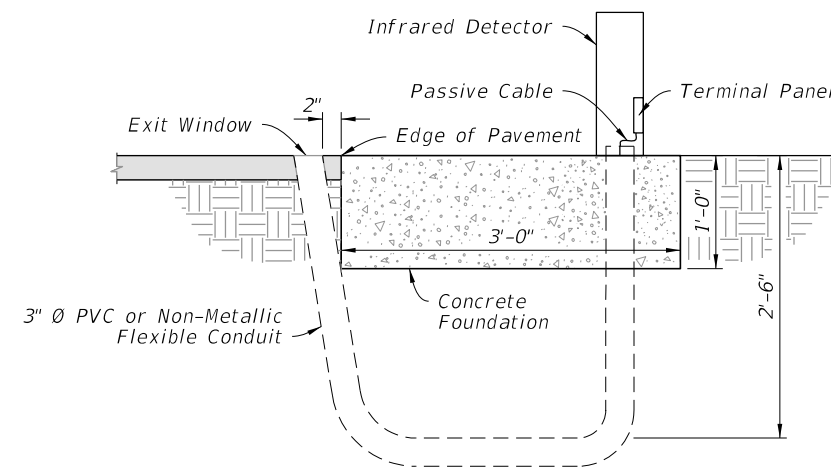

DETAIL 'D'

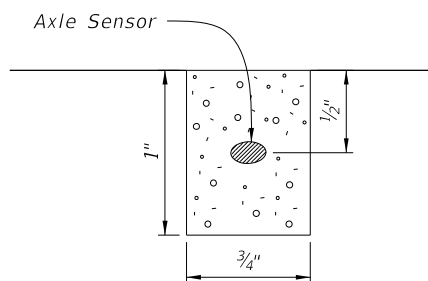

**END VIEW
(Axle Sensor Slot)**

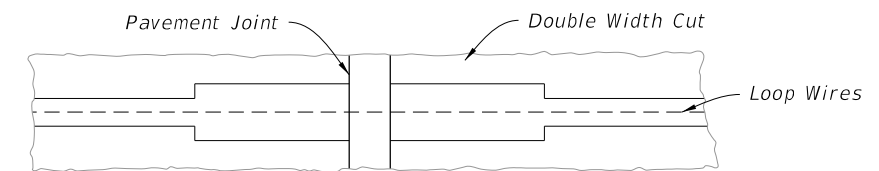

PLAN VIEW

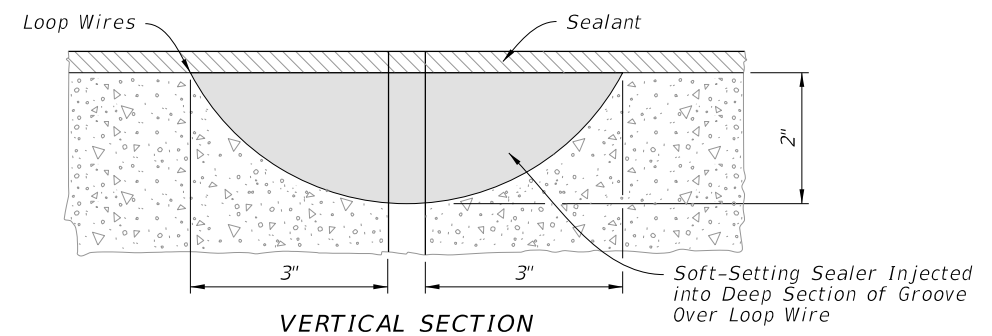

VERTICAL SECTION

Soft-Setting Sealer Injected into Deep Section of Groove Over Loop Wire

DETAIL 'F'

DETAILS 'A' THRU 'F'

9/26/2025 3:28:36 PM

LAST REVISION 11/01/25	DESCRIPTION:
---------------------------	--------------



**FY 2026-27
STANDARD PLANS**

TRAFFIC MONITORING SITE

INDEX
695-001

SHEET
19 of 21

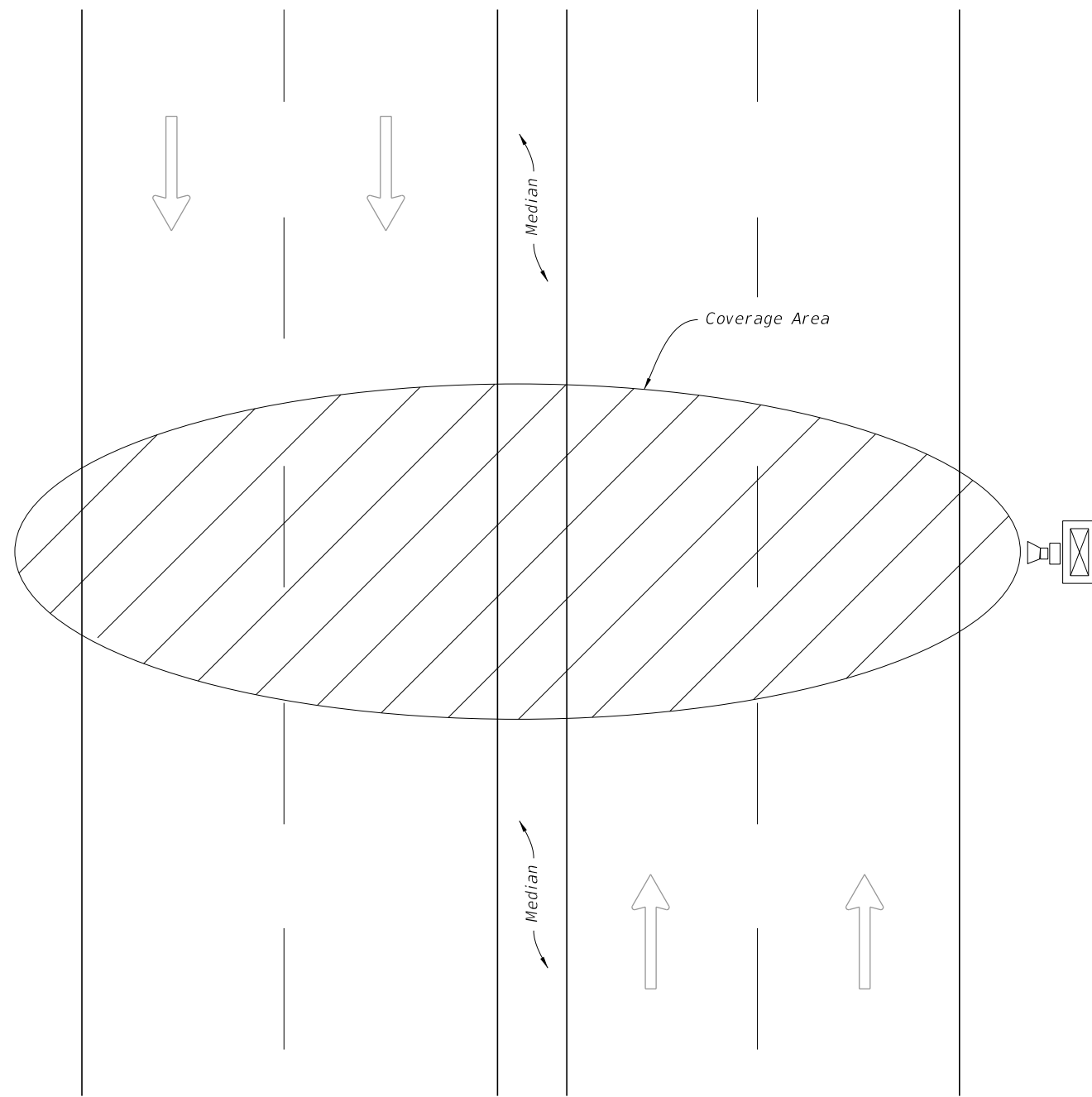

PLAN

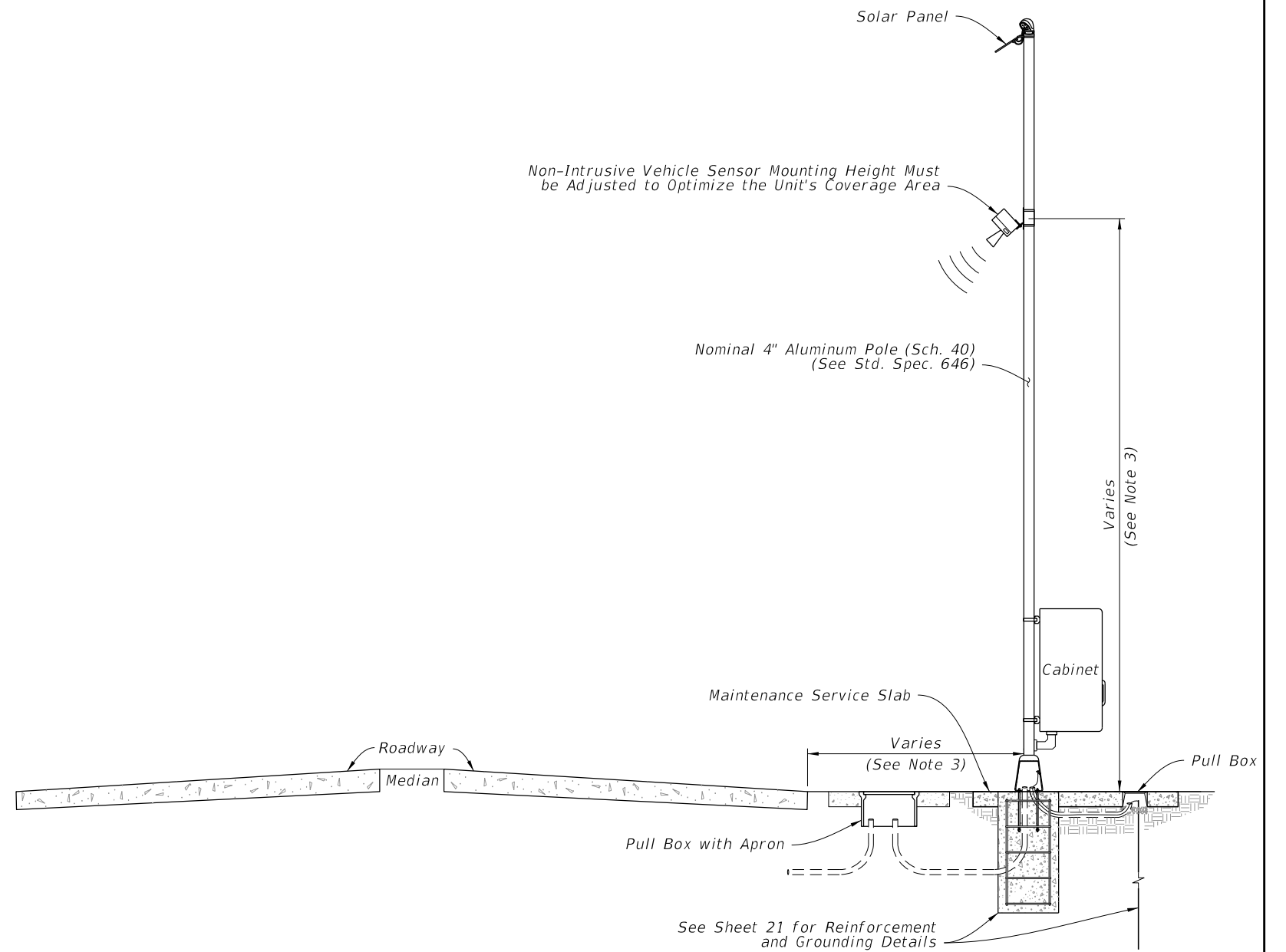

ELEVATION

NOTES:

1. The unit must be capable of detecting up to eight lanes of traffic (in either or both directions) when mounted perpendicular to the roadway.
2. Coverage area of the unit is affected by the roadway geometry: distance from the travel lanes, median type and width, barrier walls, etc.
3. Mounting height of the unit and offset from the roadway must be determined on a site-by-site basis, in accordance with the manufacturer's recommended guidelines. Offset of pole must be greater than or equal to minimum clear zone requirements.
4. Cabinet, ground rod pull box, and maintenance service slab installed per Index 676-010, except cabinet center will be 4 feet above grade.

NON-INTRUSIVE VEHICLE SENSOR

9/26/2025 3:28:45 PM

LAST REVISION 11/01/25	REVISION	DESCRIPTION:		FY 2026-27 STANDARD PLANS	TRAFFIC MONITORING SITE	INDEX 695-001	SHEET 20 of 21
---------------------------	----------	--------------	---	------------------------------	-------------------------	------------------	-------------------

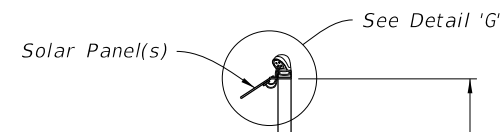

NOTES:

1. Cabinet, ground rod pull box, and maintenance service slab installed per Index 676-010, except cabinet center will be 4 feet above grade.
2. Meet the requirements of Specification 646.
3. Use #10 AWG stranded copper wire for Solar Panel Array installations, Red insulation is THHN or THWN for positive 12 volts wiring, Black insulation is THHN or THWN for negative, 12 volts wiring, Green insulation is THHN or THWN for ground bonding of the solar panel frame to the pole and earth.
4. Solar panel should be installed facing due south with angle of tilt equal to the sum of the following equation. The Latitude of the panel's location, multiplied by 0.76, plus 3.1 degrees. Equation expressed as $(LAT) \times (0.76) + (3.1^\circ)$
5. Encase all wiring from the weather head to the solar panel in outdoor flexible conduit.

Nominal 4" Aluminum Pole (Sch. 40)
(See Std. Spec. 646)

35'-0"

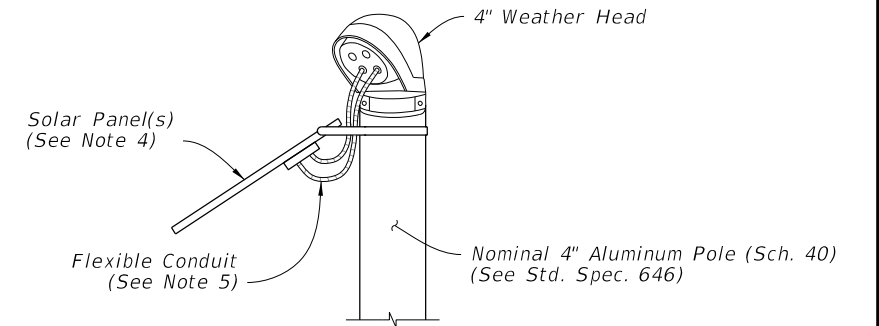

DETAIL 'G'

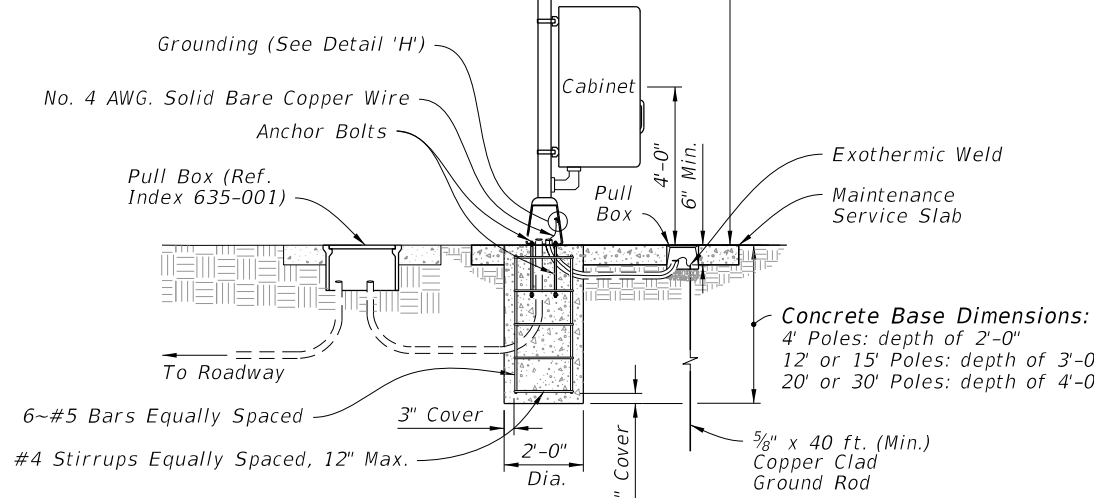

ELEVATION

SOLAR POWER POLE WITH POLE MOUNTED CABINET
(Continuous Count Site - TTMS/CCS)

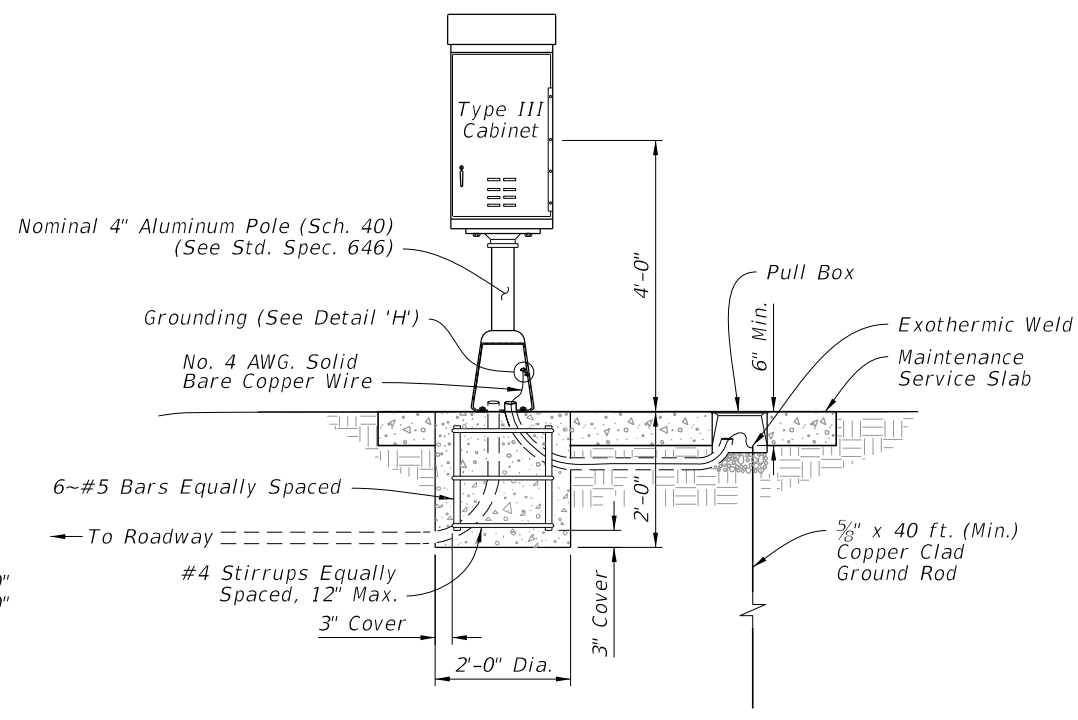

ELEVATION

PEDESTAL MOUNTED CABINET
(Short Term Traffic Monitoring Sites - PTMS)

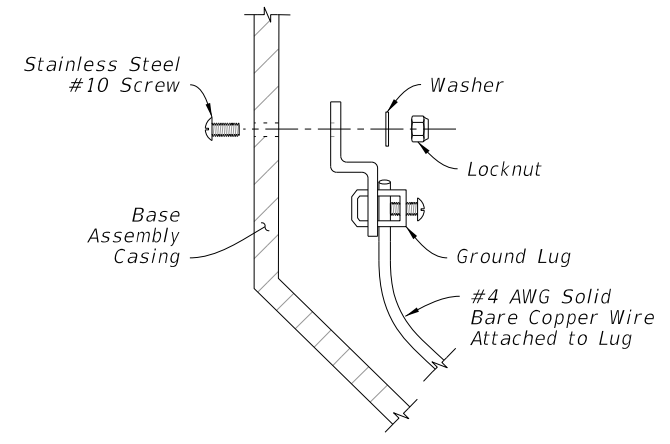

DETAIL 'H'

SOLAR POWER POLE WITH POLE MOUNTED CABINET AND PEDESTAL MOUNTED CABINET DETAILS

9/26/2025 3:28:51 PM

LAST REVISION 11/01/25	REVISION	DESCRIPTION:		FY 2026-27 STANDARD PLANS	TRAFFIC MONITORING SITE	INDEX 695-001	SHEET 21 of 21
---------------------------	----------	--------------	--	------------------------------	-------------------------	------------------	-------------------