

PLAN

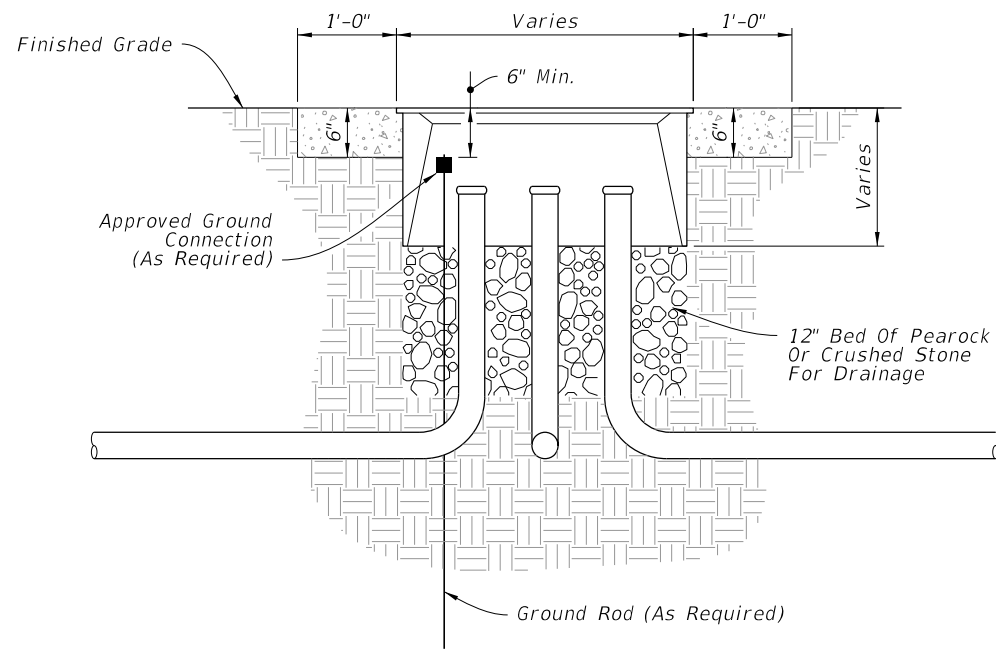

ELEVATION

PULL BOX

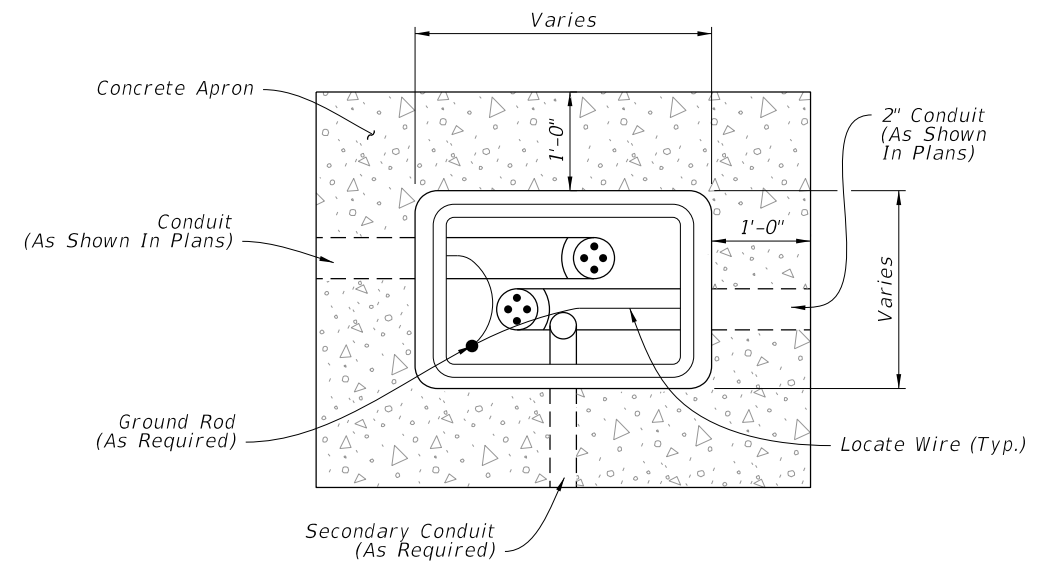

PLAN

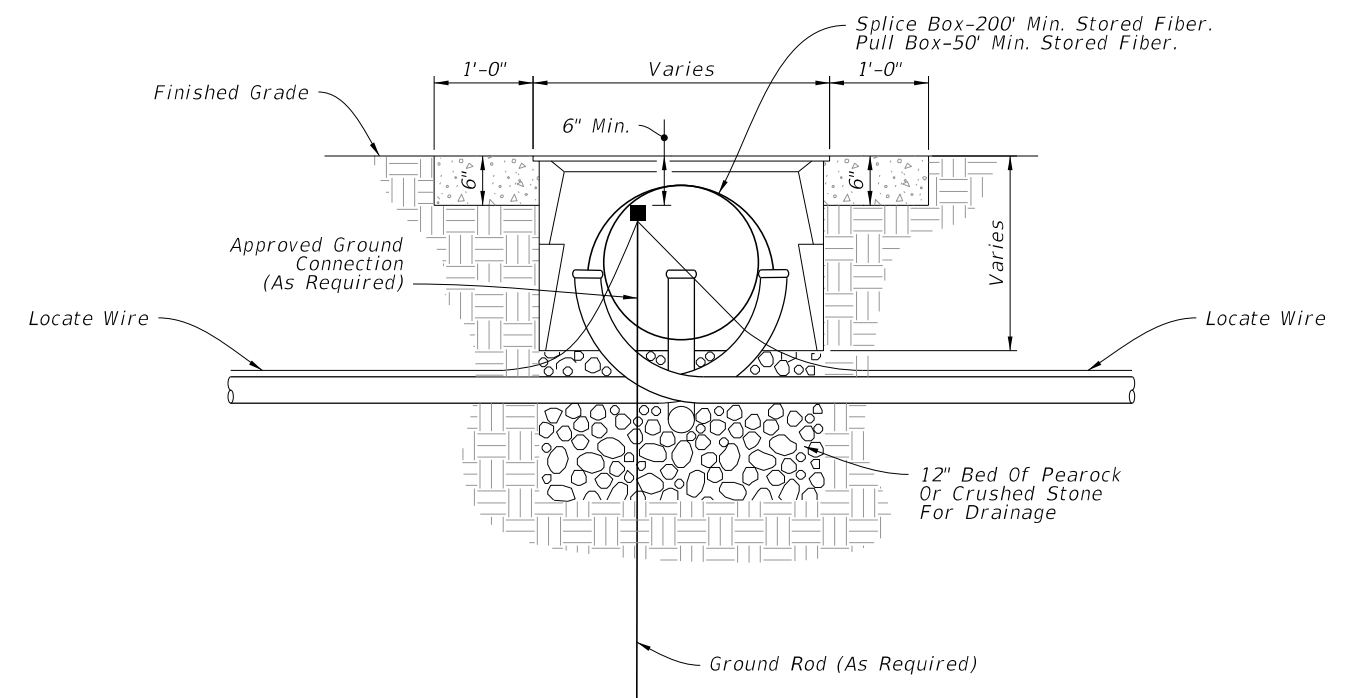

ELEVATION

FIBER OPTIC BOX

NOTES:

1. Provide fiber optic splice boxes with cable hanger racks designed to support cables and splice enclosures.
2. Install a 1'-0" wide (Min.) concrete apron around all boxes using Class NS concrete. Slope the apron away from the box.
3. Where multiple pull boxes are placed side by side, maintain at least 8" between the pull boxes.
4. Rectangular boxes shown, others similar.

9/26/2025 3:08:19 PM

LAST REVISION 11/01/18	REVISION	DESCRIPTION:		FY 2026-27 STANDARD PLANS	PULL AND SPLICE BOXES	INDEX 635-001	SHEET 1 of 1
---------------------------	----------	--------------	---	------------------------------	-----------------------	------------------	-----------------