

**GENERAL NOTES:**

1. Use Class II concrete.
2. Reinforcing steel is either Grade 40 or 60.
3. Endwalls may be cast in place or precast concrete. The Contractor or the Supplier will determine the additional reinforcement necessary for handling precast units.
4. Chamfer all exposed edges and corners  $\frac{3}{4}$ " unless otherwise shown.
5. Quantities shown are for estimating purposes only.

TABLE OF CONTENTS:	
Sheet	Description
1	General Notes and Contents
2	Single 84" Pipe Endwall Details

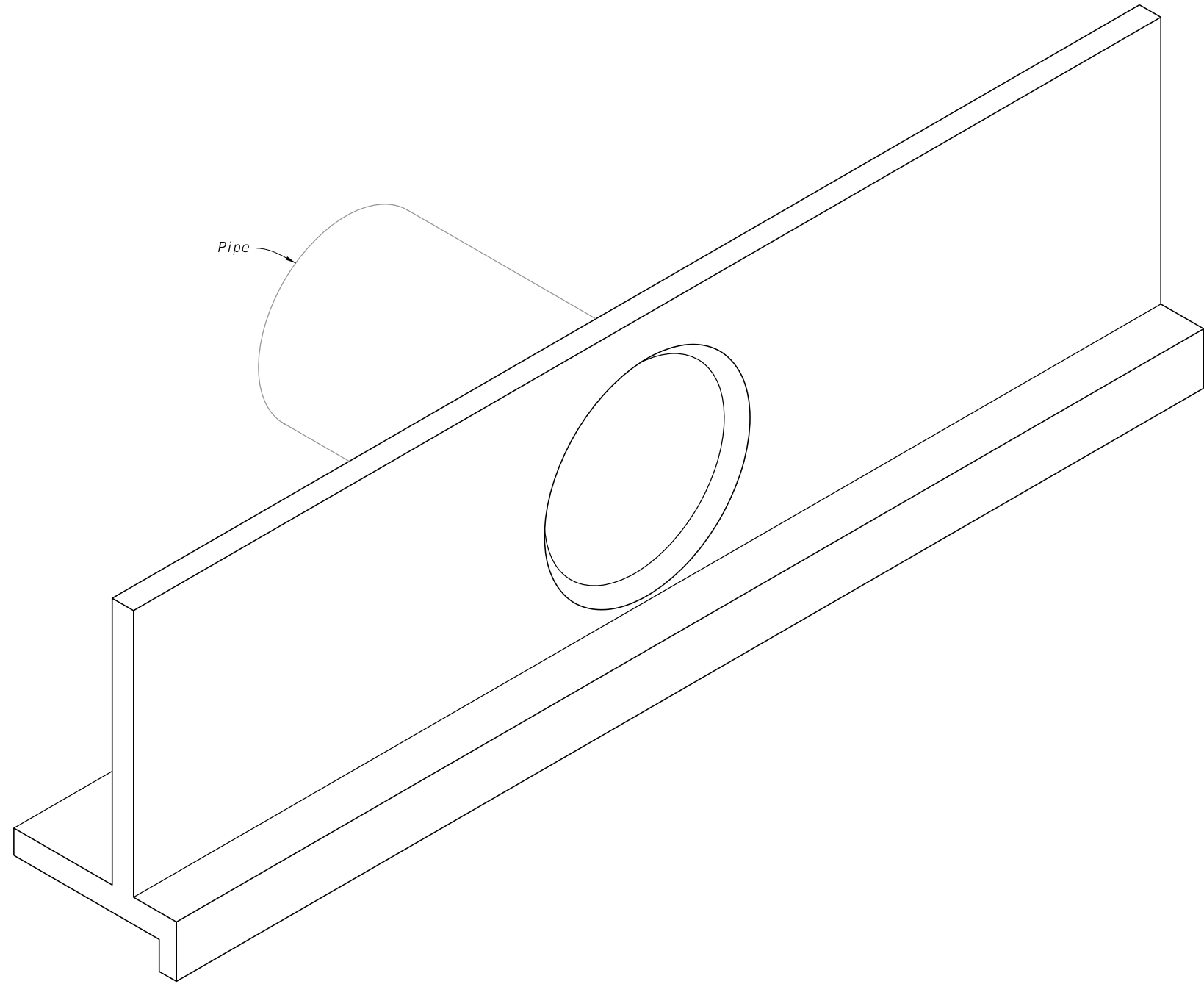

===== STRAIGHT CONCRETE ENDWALL SINGLE 84" PIPE =====

9/26/2025 1:04:09 PM

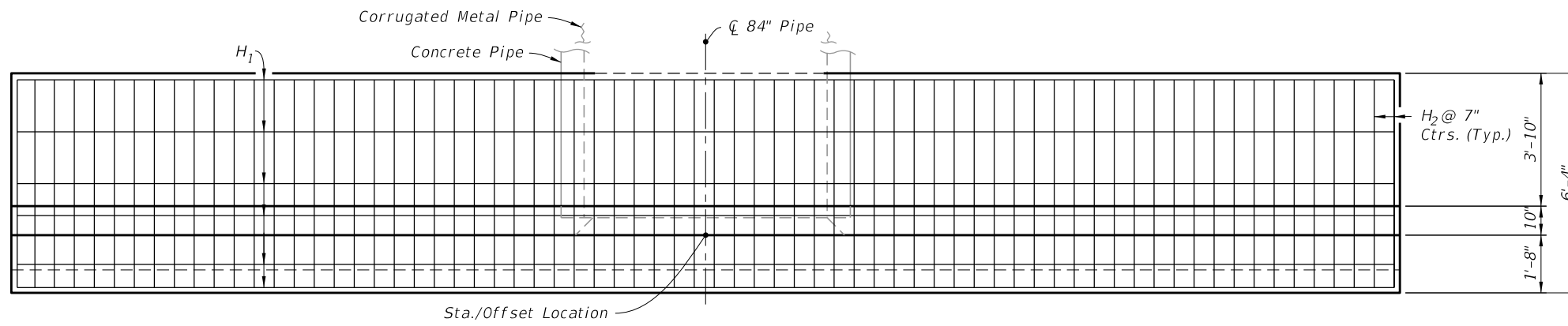

**PLAN**  
(Showing Bars In Footing)

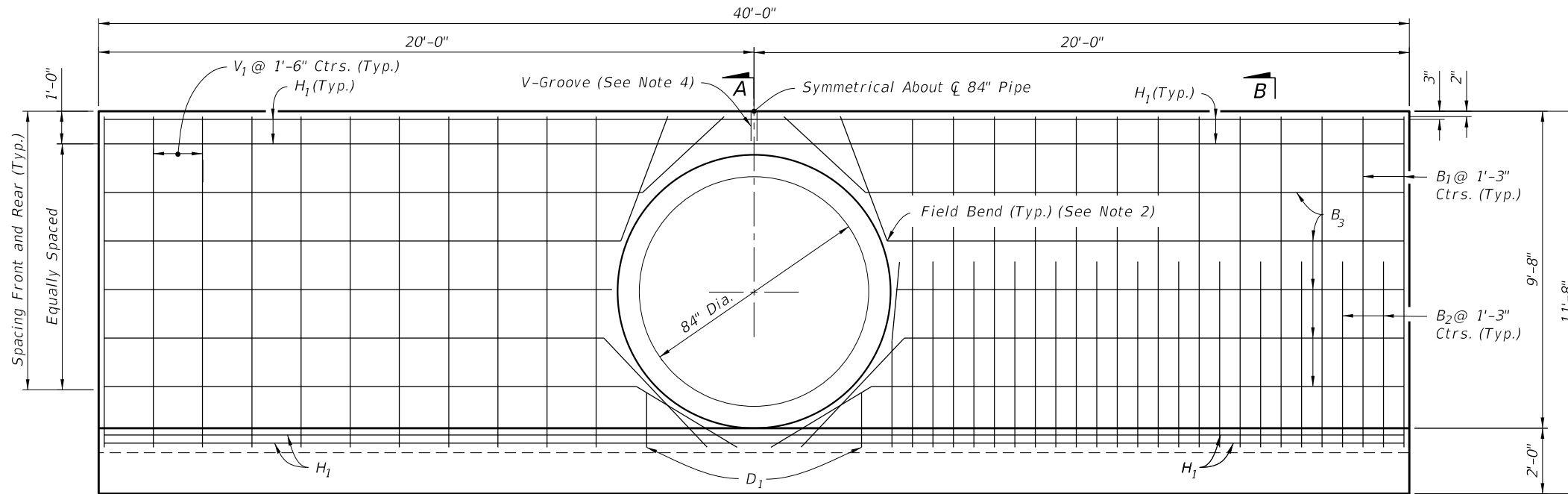

**HALF ELEVATION**  
(Showing Bars in Front Face of Wall)

**HALF ELEVATION**  
(Showing Bars in Back Face of Wall)

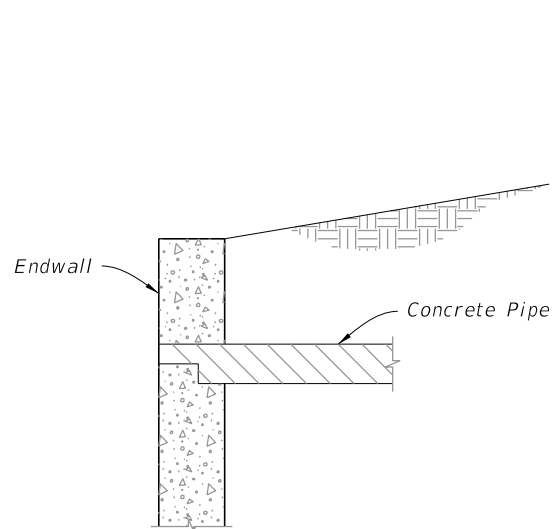

**DETAIL "A"**  
(Concrete Pipe Optional Entrance)

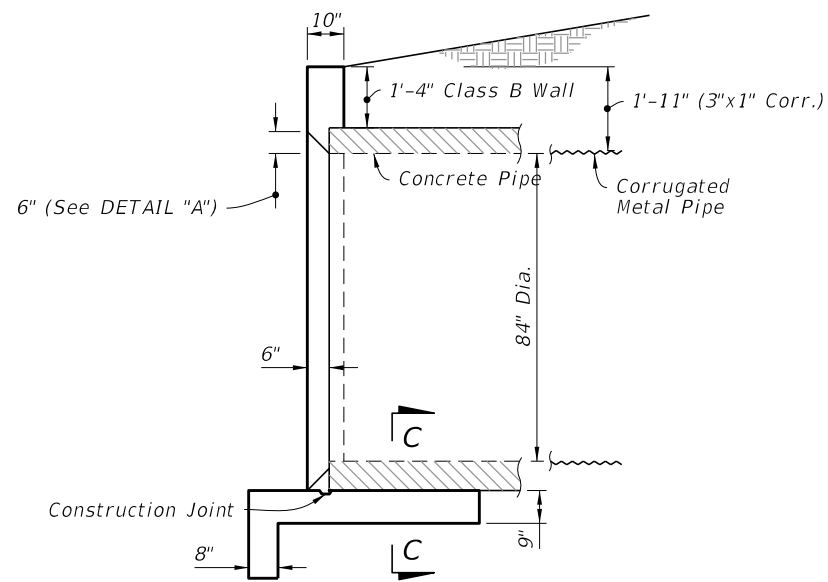

**SECTION A-A**  
(Rebar Not Shown)

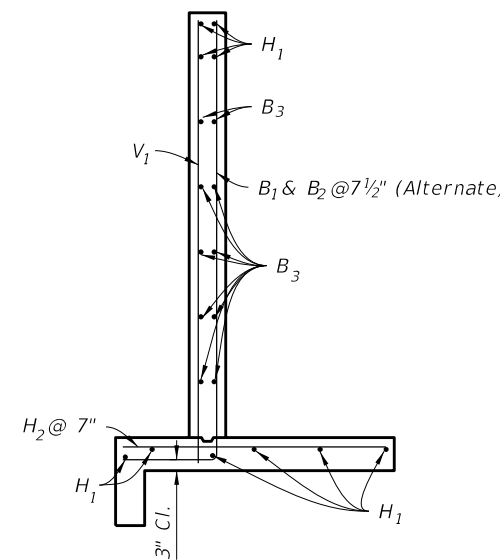

**SECTION B-B**  
(Typical Section)

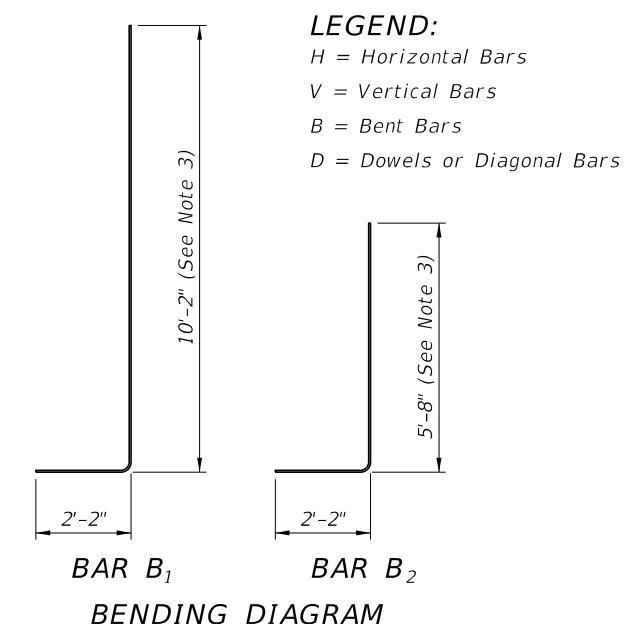

**BAR B<sub>1</sub>**      **BAR B<sub>2</sub>**  
**BENDING DIAGRAM**

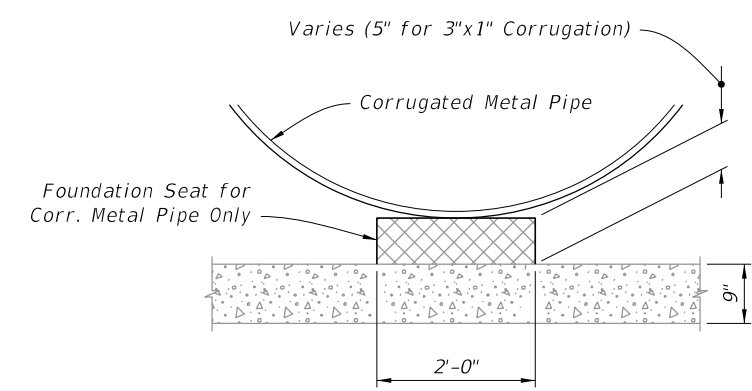

**SECTION C-C**  
**SINGLE 84" PIPE ENDWALL DETAILS**

- NOTES:**
- 2" clearance on all reinforcement, unless otherwise shown.
  - Cut and/or bend B<sub>3</sub> Bars as shown.
  - All bar dimensions are out to out.
  - Install a 3/4" V-Groove at the top, front and back.

**SINGLE 84" PIPE ENDWALL ESTIMATED QUANTITIES**

ITEM	UNIT	RCP	CMP
Class II Concrete	Cu. Yd.	20.0	20.2
Reinforcing Steel	Lb.	2,095	2,095

**BILL OF REINFORCING STEEL**

MARK	SIZE	NO. REQD.	LENGTH
H <sub>1</sub>	4	6	39'-8"
H <sub>2</sub>	6	69	6'-0"
V <sub>1</sub>	4	22	10'-2"
B <sub>1</sub>	6	26	12'-4"
B <sub>2</sub>	6	26	7'-10"
B <sub>3</sub>	4	14	39'-8"
D <sub>1</sub>	4	4	2'-0"

- LEGEND:**
- H = Horizontal Bars
  - V = Vertical Bars
  - B = Bent Bars
  - D = Dowels or Diagonal Bars

9/26/2025 1:04:15 PM