

STAIR TREAD AND RISER DETAILS

* The greatest riser height within the flight of steps shall not exceed the smallest by more than 3/8".
 ** The greatest tread depth within the flight of steps shall not exceed the smallest by more than 3/8".

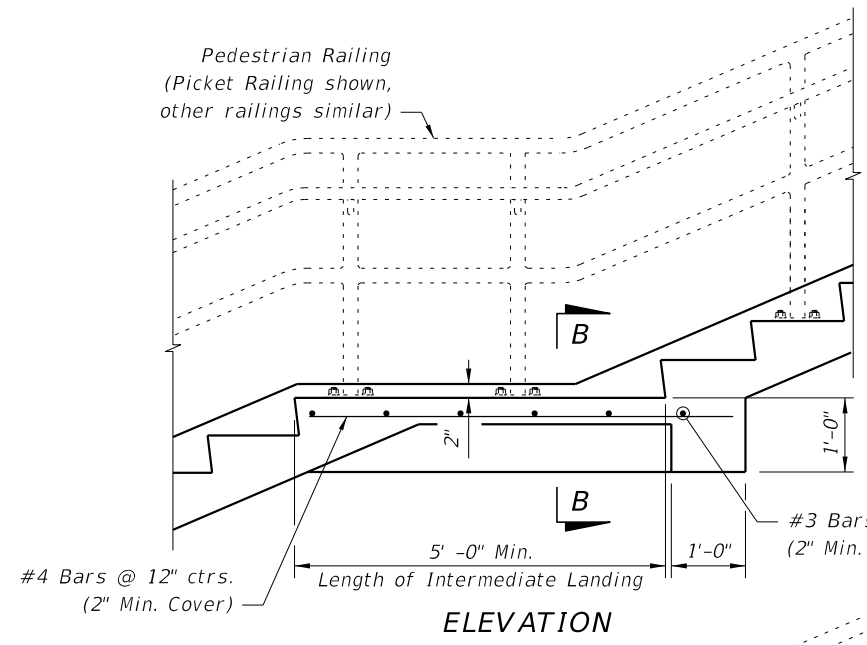

ELEVATION

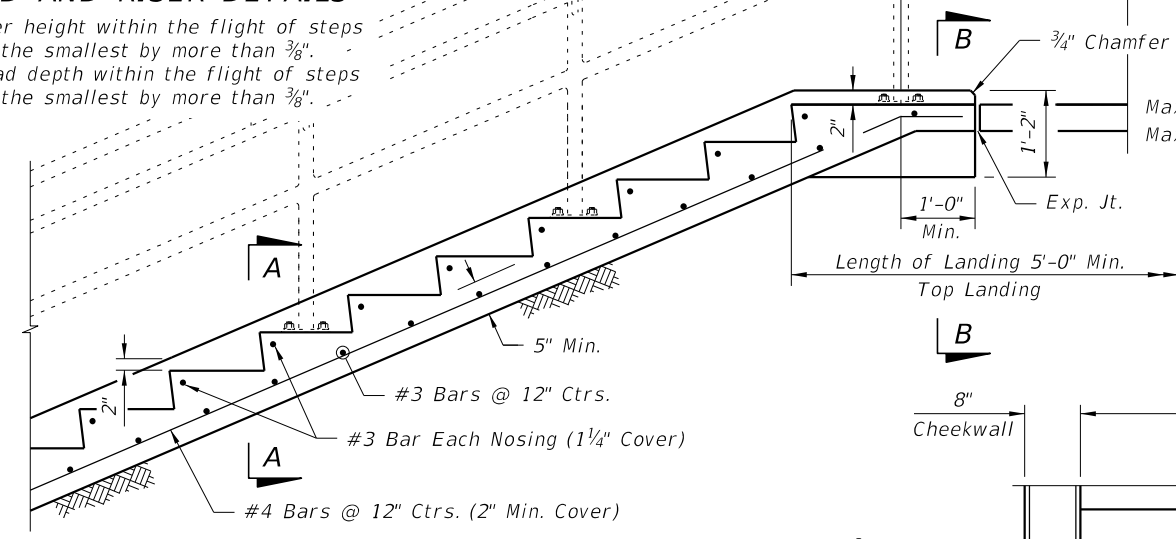

NOTE: Provide a maximum of 12 risers between landings.

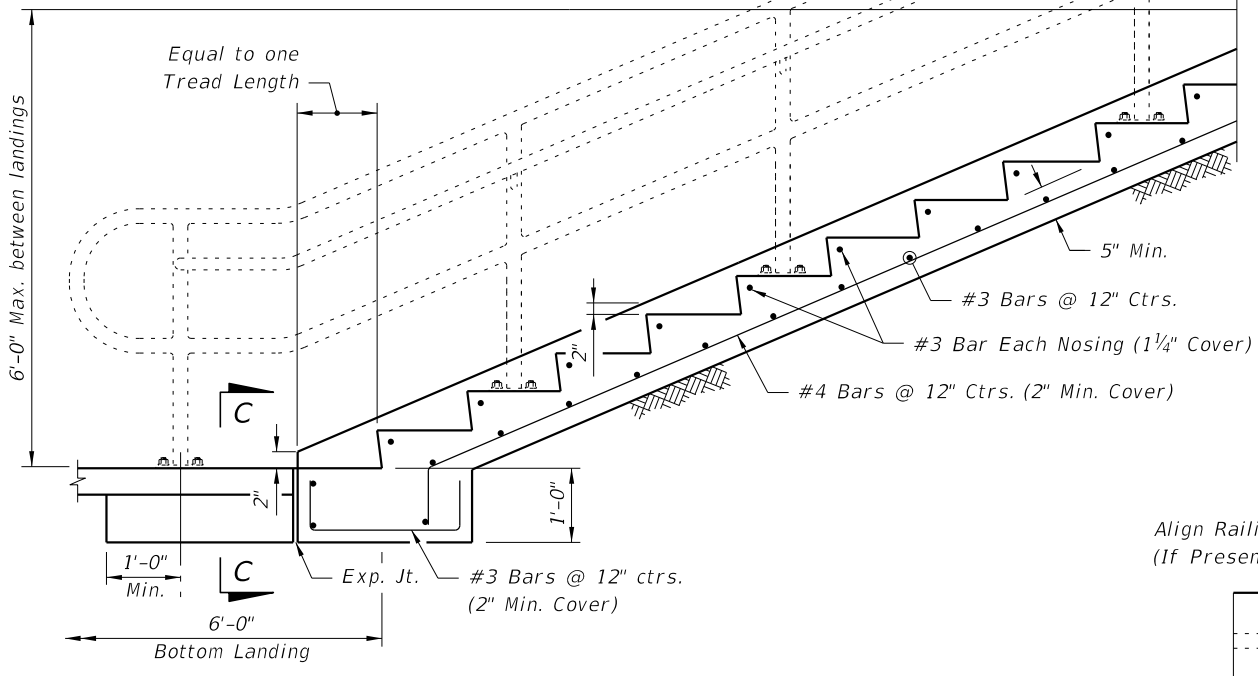

Max Landing Slope = 2%
 Max Landing Cross-Slope = 2%

- NOTES:
1. Do not use this Index for suspended (structural) steps or stairways.
 2. Construct steps in accordance with Specification 522.
 3. Concrete: Class NS, Specification 347.
 4. Tread Finish: Broom finish parallel to steps unless otherwise shown in Plans.
 5. Pedestrian Railing: See Indexes 515-052, 515-062, 515-070, 515-080 or Project Specific Design.
 6. Cost of concrete steps, landings and cheekwalls shall be paid for under the contract unit price for Class NS Concrete (Concrete Steps), CY. Cost of reinforcing steel shall be paid for under the contract unit price for Reinforcing Steel (Miscellaneous), LB.

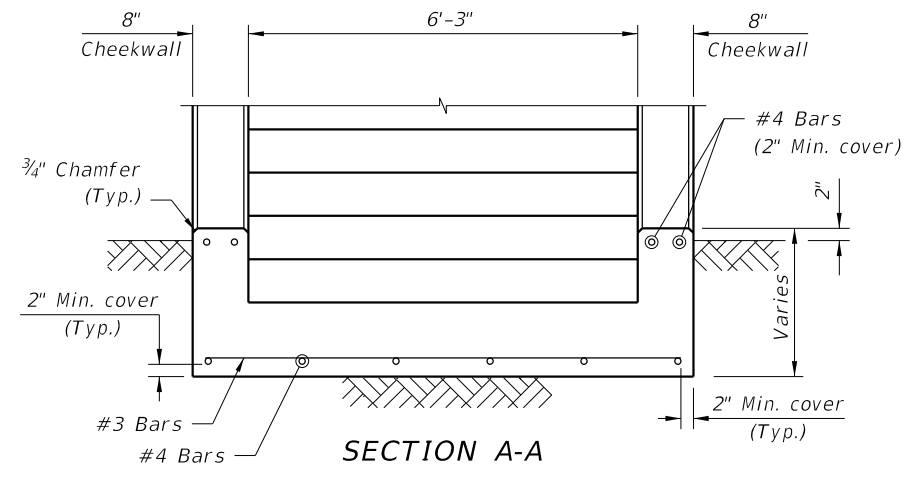

SECTION A-A

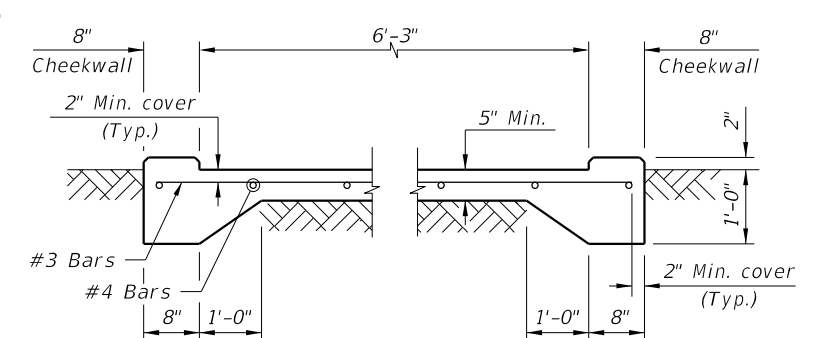

SECTION B-B

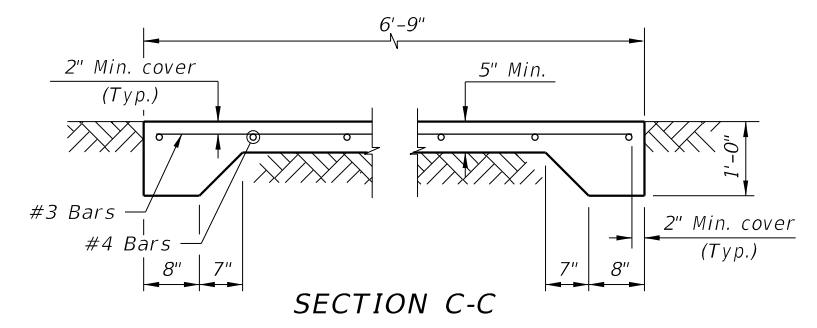

SECTION C-C

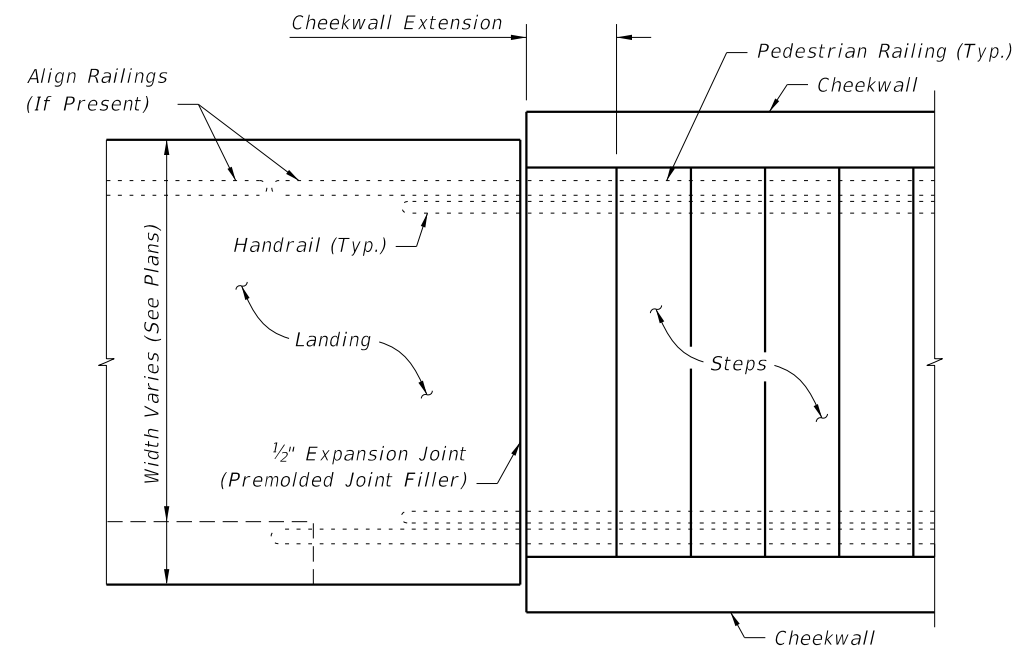

PLAN AT JUNCTION OF STEPS & LANDING
 (Bottom Landing shown, Top Landing similar)

9/26/2025 11:45:15 AM

LAST REVISION 11/01/17	DESCRIPTION:		FY 2026-27 STANDARD PLANS	CONCRETE STEPS	INDEX 400-021	SHEET 1 of 1
---------------------------	--------------	--	------------------------------	----------------	------------------	-----------------