

## Index 430-030 to 430-034 Straight Concrete Endwalls

### Design Criteria

*FDOT Design Manual (FDM); Drainage Manual (DM); Drainage Design Guide (DDG)*

### Design Assumptions and Limitations

Locate endwalls in accordance with the *Drainage Manual Chapter 3*.

For sod around end treatments, see *Index 570-001*.

See example below for positioning of the endwalls.

### Plan Content Requirements

In the Roadway Plans:

Summarize quantity by location in the Summary of Drainage Structures, Summary of Sidedrain, or Summary of Miscellaneous Drainage Items in accordance with *FDM 916*.

Clearly show the location of each Endwall.

### Payment

Item number	Item Description	Unit Measure
430-5AA-BCD	Endwalls	EA
570-1-A	Performance Turf	SY

See the *BOE* and *Specification 430* for additional information on payment, pay item use and compensation.

### Example

Position is set by the intersection of the front slope and Point A where this intersection falls outside the clear zone.

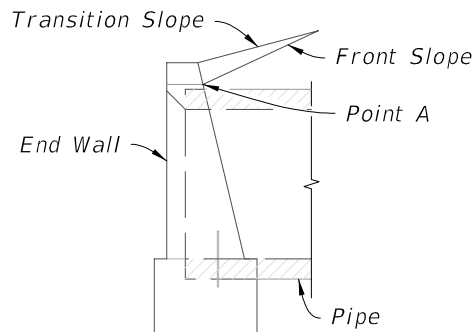

SIDE ELEVATION

Where the front slope and Point A intersects inside the clear zone, the endwall is positioned so the Station/Offset Location is at the clear zone limit. The front slope is transitioned to the endwall as shown in *Index 430-001*.