

GENERAL NOTES:

1. Meet the requirements of Specification 700.
2. Work with Index 700-010.
3. Shop Drawings: Not required.
4. Construction:
 - A. Locate Sign Support a minimum of 5 feet from an open joint or transition (sign stationing may be adjusted to accommodate this requirement)
 - B. Base plate must be flush with top of Railing
 - C. Anchors in Traffic Railings:
 - a. Install Adhesive Anchors in accordance with Specification 416 except perform field test on one anchor per sign support location
 - b. Use template and tie anchors as necessary to maintain correct placement of C-I-P Embedded Anchors
 - c. Do not drill into existing reinforcing
 - D. Temporary Signs on Permanent Traffic Railings, Same as Permanent except field testing of anchors is not required
 - E. Temporary Signs on Temporary Railings/Barriers:
 - a. Install Sign Supports at the midpoint along the length of a single segment
 - b. Avoid drilling through existing reinforcement; use of metal detector not required.
 - c. Field testing of anchors is not required
5. Removal of Temporary Signs on Permanent Traffic Railings:
 - A. Cut anchor rods flush with the top of the railing
 - B. Coat anchors with Type F-1 epoxy to prevent corrosion
 - a. Extend coating 2 inches beyond edge of cut anchor rods
 - b. Epoxy coating 1/16" thick minimum
6. Materials:
 - A. Steel Plate: ASTM A36 or ASTM A709 Grade 36
 - B. Steel Pipe (Support Post): ASTM A53 Grade B Schedule 40
 - C. Galvanized U-Bolts, Nuts and Plate Washer
 - a. U-Bolts: ASTM A449
 - b. Hex Nuts: ASTM A 563 Lock Nuts
 - c. Plate Washer: ASTM A 36 or ASTM A709 Grade 36 or 50
 - D. Galvanized Anchor Bolts, Nuts and Washers:
 - a. Anchor Rod: ASTM F1554 Grade 55 fully threaded (for Adhesive Anchors)
 - b. Anchor Bolts: ASTM F1554 Grade 55 Grade A Hex
 - c. Nuts: ASTM A563 Heavy Hex Locking
 - d. Washers: ASTM F436

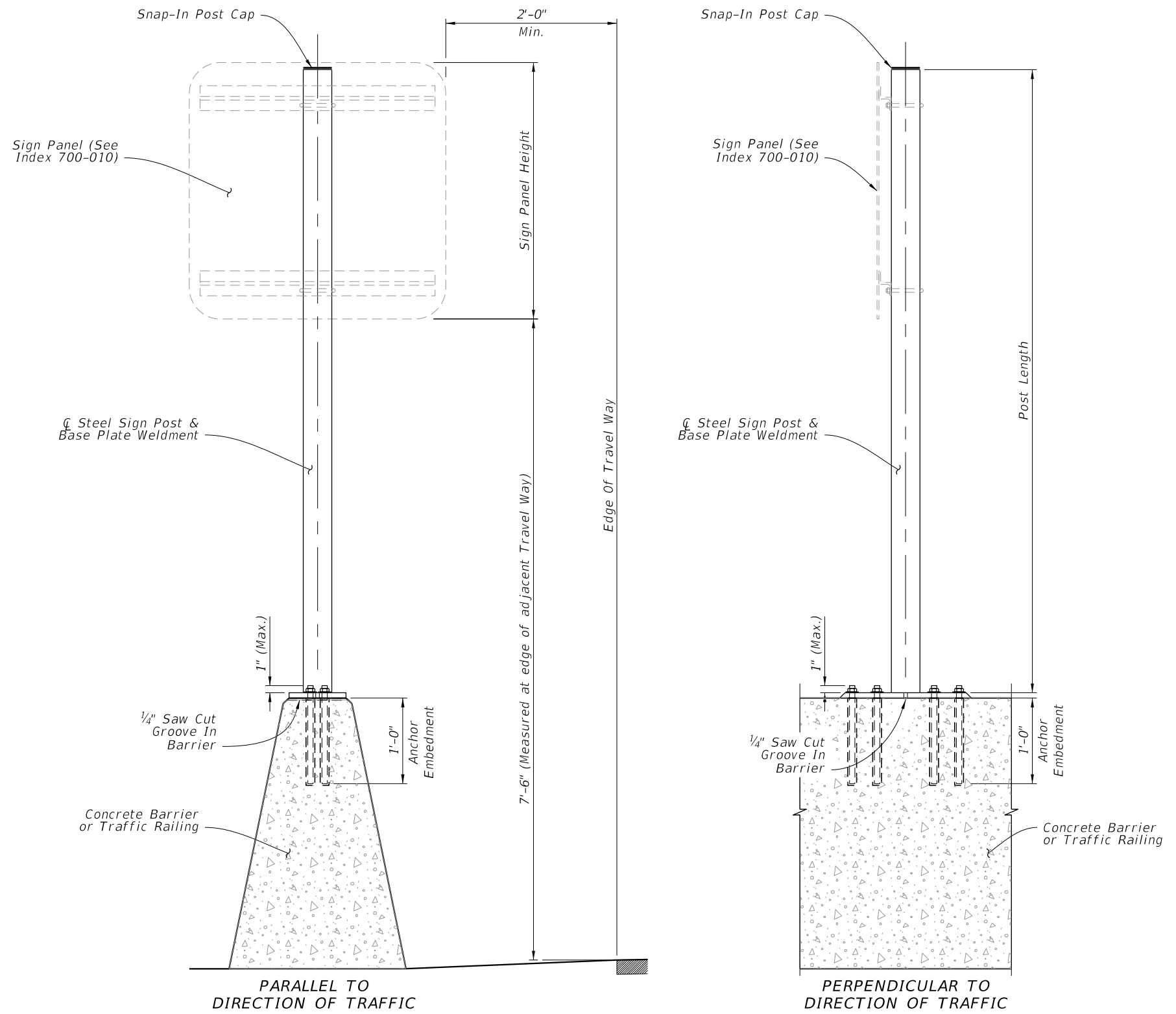

(Index 521-001 Median Barrier shown; others similar)

ELEVATION

	Max. Sign Area (SF)	Post (NPS)
Temporary Signs	≤ 24	3.0
Permanent Signs	< 13.5	3.0
	13.5 < Sign < 20	3.5

9/10/2024 2:42:19 PM

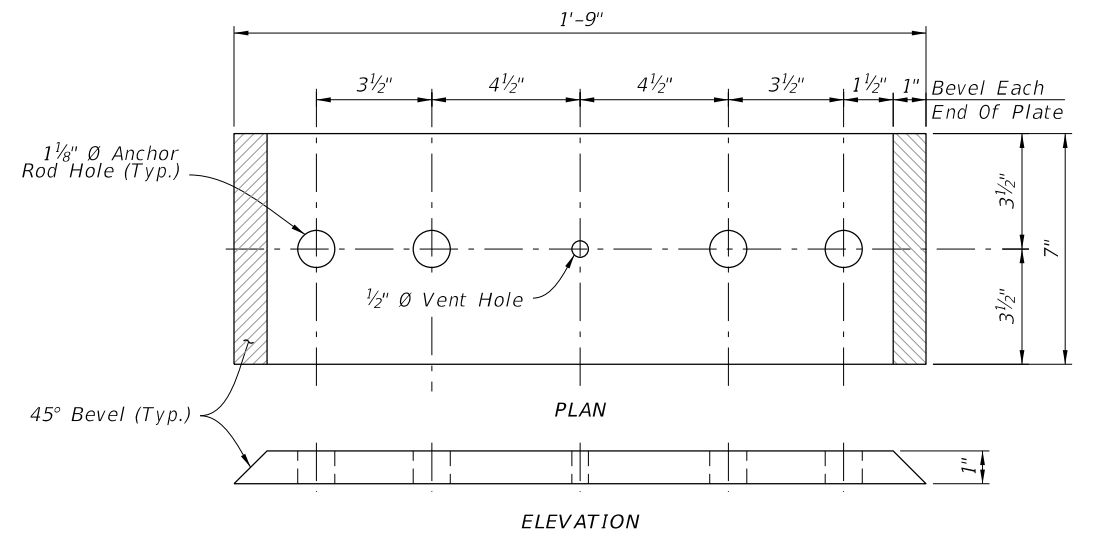

BASE PLATE TYPE A
(Linear Anchor Rod Pattern)

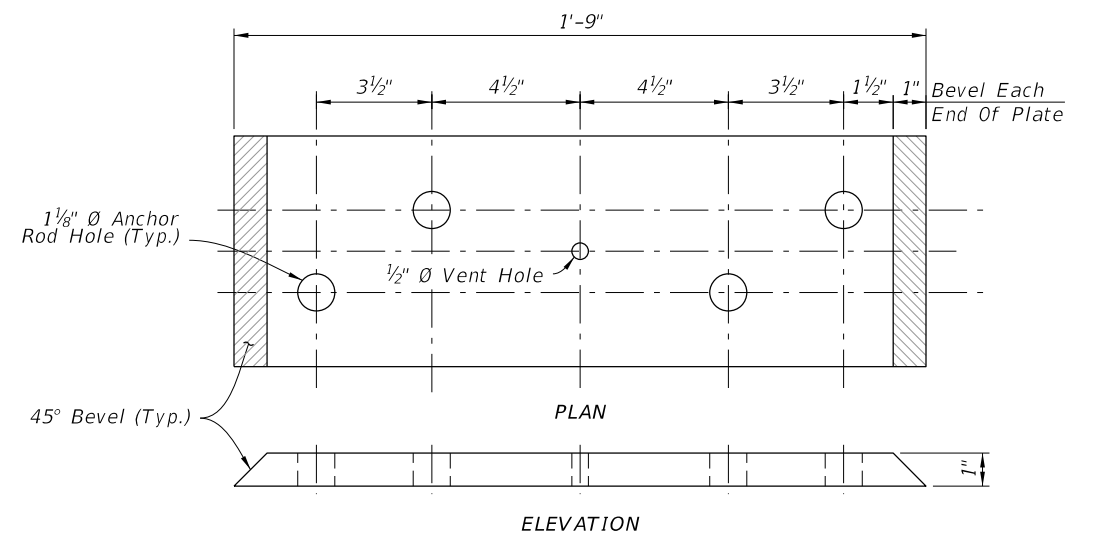

BASE PLATE TYPE B
(Staggered Anchor Rod Pattern)

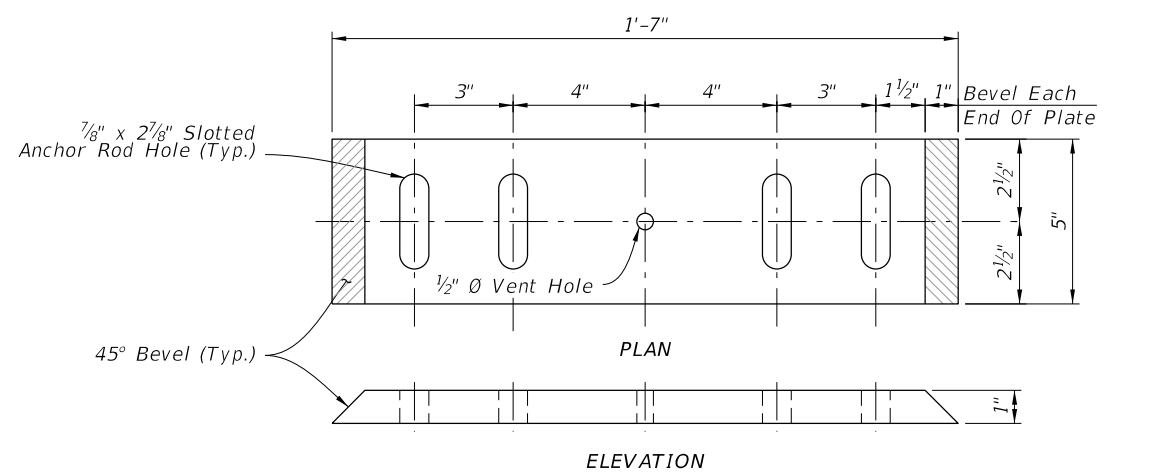

BASE PLATE TYPE C

NOTES:

1. Place anchor rods in a staggered or linear pattern as necessary to avoid reinforcing.
2. Use a staggered pattern for all temporary barriers.

Index	Type/Application	Base Plate Type	Anchor Rod \emptyset
521-001	Full Wall	B	1"
521-001	Cantilever or L-Wall	A	
All listed above Plus 102-110 & 102-100	Temporary Signs	C	3/4"

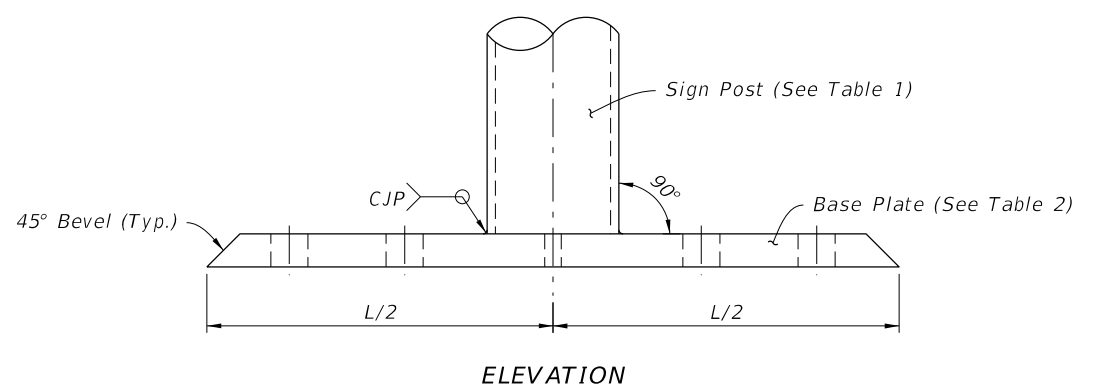
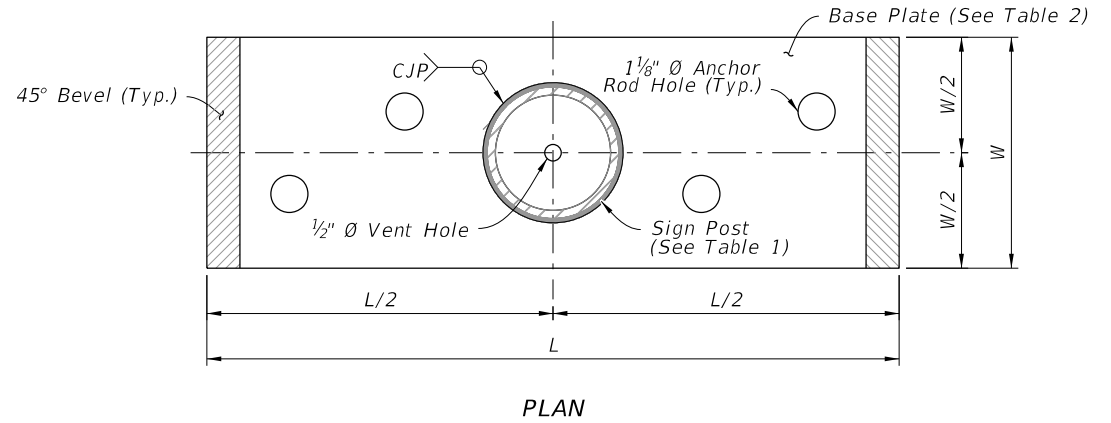

SIGN SUPPORT WELDMENT DETAIL
(Staggered Anchor Rod Pattern shown)

9/10/2024 2:42:26 PM