

SOP 1

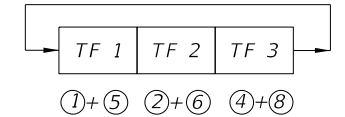

SOP 2

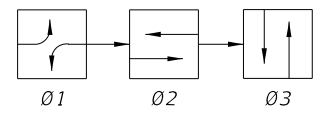
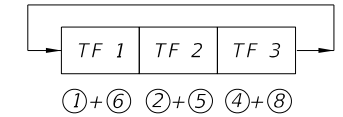
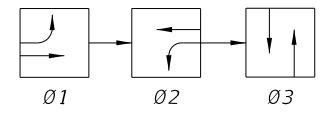

SOP 3

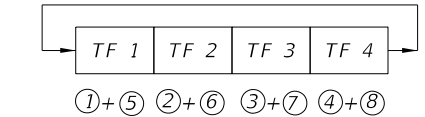
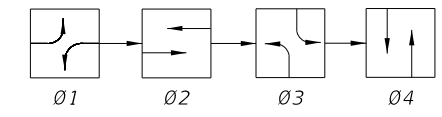

SOP 4

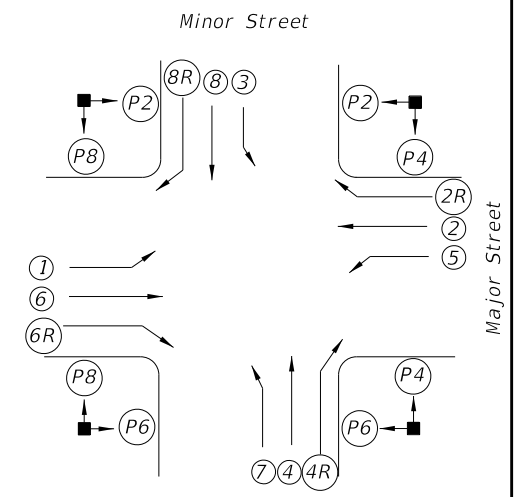

SIGNALIZED INTERSECTION

Vehicle movements & signal head number assignments are not directionally oriented but shall maintain their relative orientation about the intersection (I.E., movements 7 and 4 are always to the right of movements 1 and 6 etc.).

LEGEND

- ⊗ Vehicle Movement Number
- ⊗PX Pedestrian Movement Number
- TF X Timing Function Number
- ØX Phase Number
- ↔ Green Arrow (Left or Right)
- ↔R Red Arrow
- ↔ Yellow Arrow

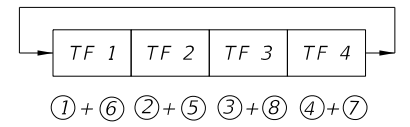
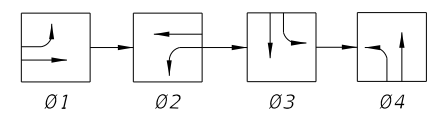

SOP 5

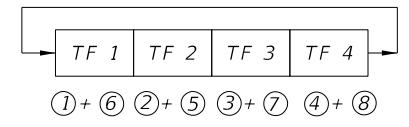
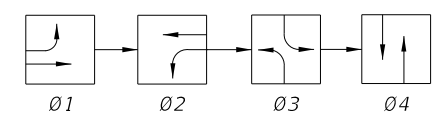

SOP 6

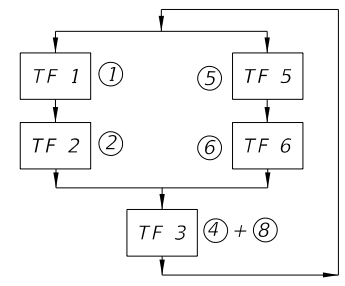
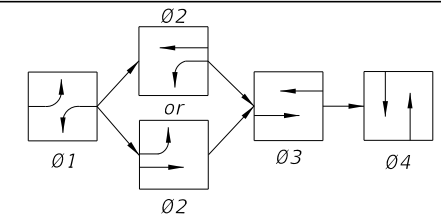

SOP 7

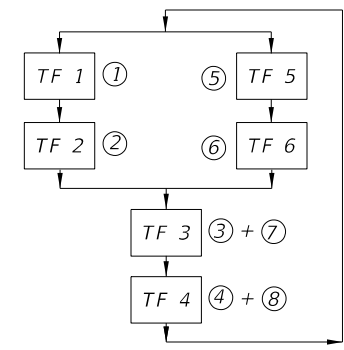
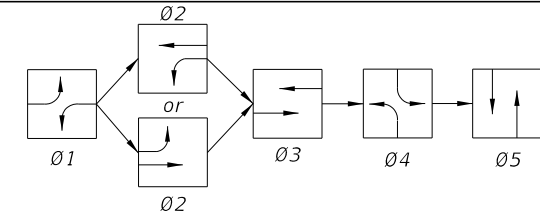

SOP 8

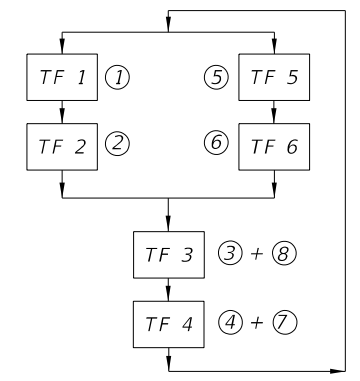
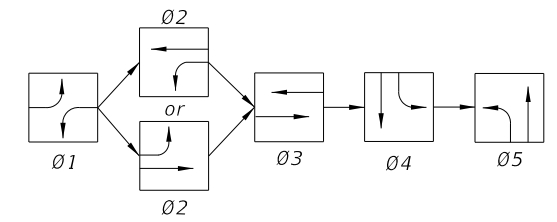

SOP 9

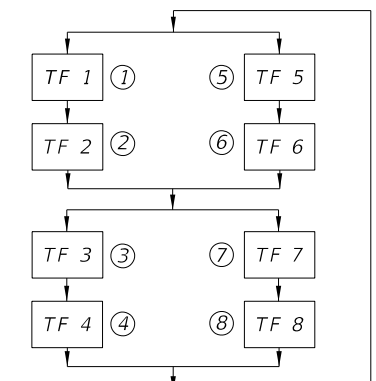
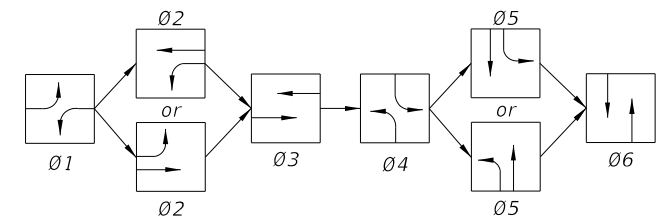

SOP 10

SIGNAL CLEARANCE TABLE
(Blank Indicates No Clearance Required)

		SIGNAL INDICATIONS						
		R	↔	G	↔	↔	WALK	DONT WALK
SIGNAL INDICATIONS	R			Y	↔	Y		
	↔			Y	↔	Y		
	G				↔			
	↔							
	↔							
	WALK							
	DONT WALK						Flash DONT WALK	

9/10/2024 2:32:24 PM

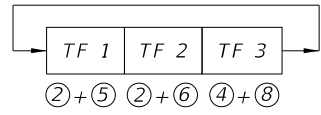
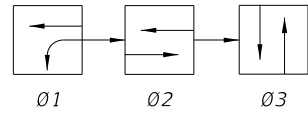

SOP 11

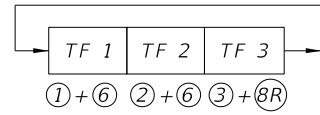
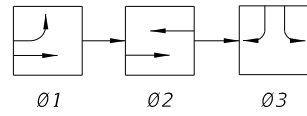

SOP 12

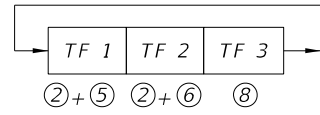
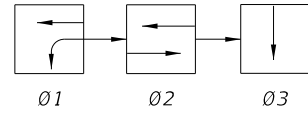

SOP 13

(ONE-WAY STREET INTERSECTION)

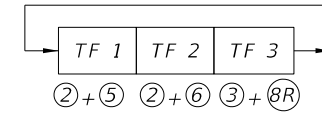
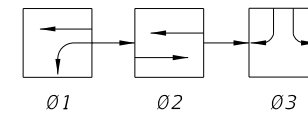

SOP 14

(DIAMOND INTERCHANGE OPERATION)

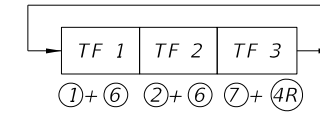
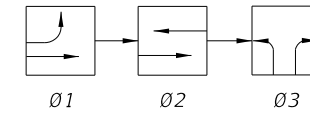

SOP 15

(DIAMOND INTERCHANGE OPERATION)

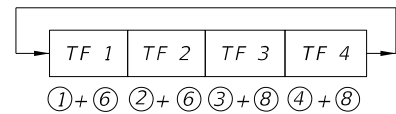
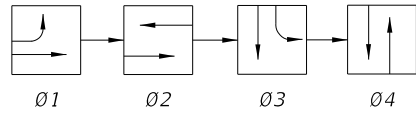

SOP 16

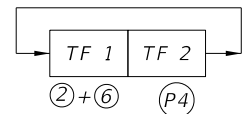
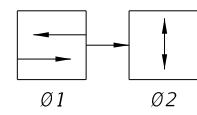

SOP 17

(MIDBLOCK)

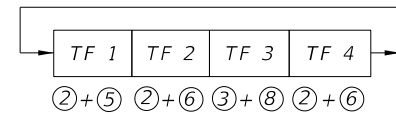
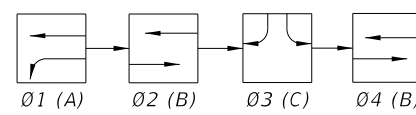

SOP 18

NOTE:
Only Ø2 Or Ø4 Used, Not Both To Obtain
ABC, Or ACB Operation.

(DIAMOND INTERCHANGE OPERATIONS)

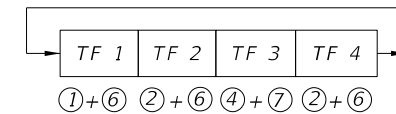
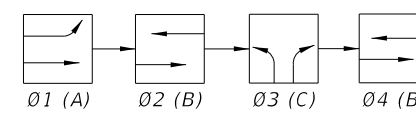

SOP 19

(DIAMOND INTERCHANGE OPERATIONS)

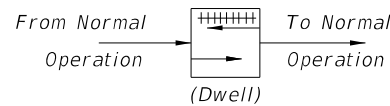

POP 1

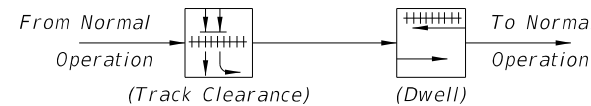

POP 2

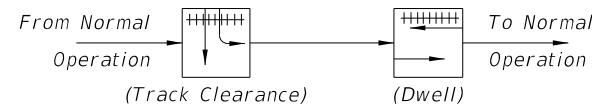

POP 3

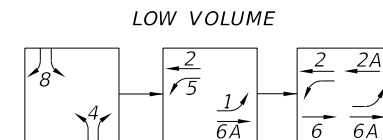
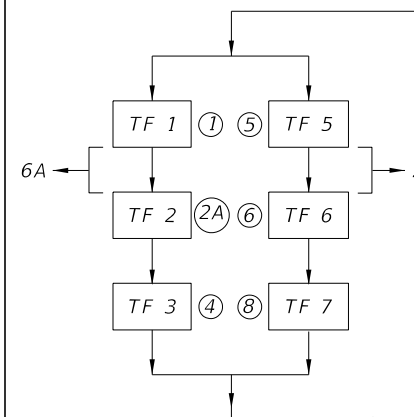
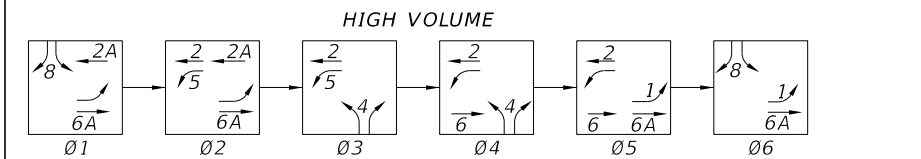

SOP 20
(DIAMOND INTERCHANGE OPERATIONS)

9/10/2024 2:32:30 PM

LAST REVISION
11/01/17

REVISION

DESCRIPTION:



FY 2025-26
STANDARD PLANS

STANDARD SIGNAL OPERATING PLANS

INDEX
671-001

SHEET
2 of 2