

PRESTRESSED CONCRETE
PEDESTAL POLE

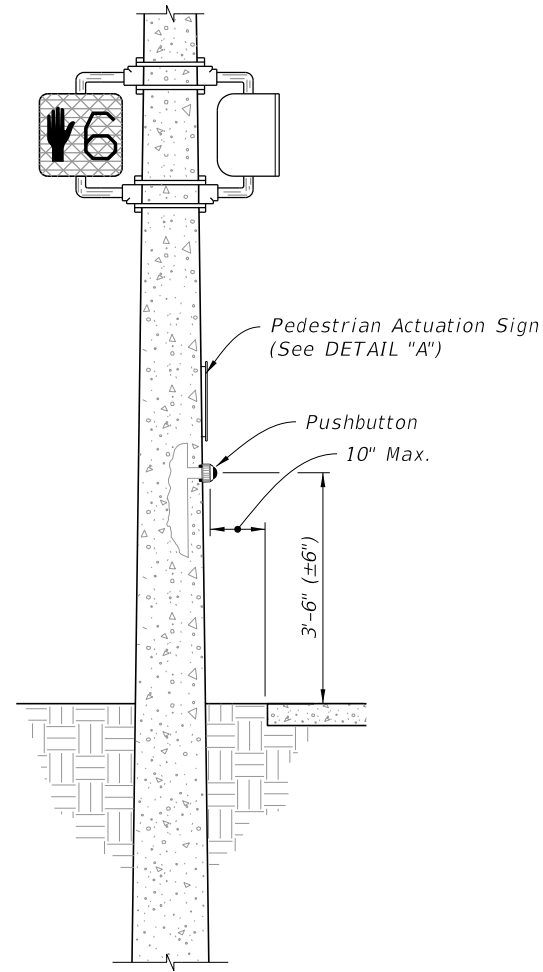

PRESTRESSED CONCRETE
STRAIN POLE

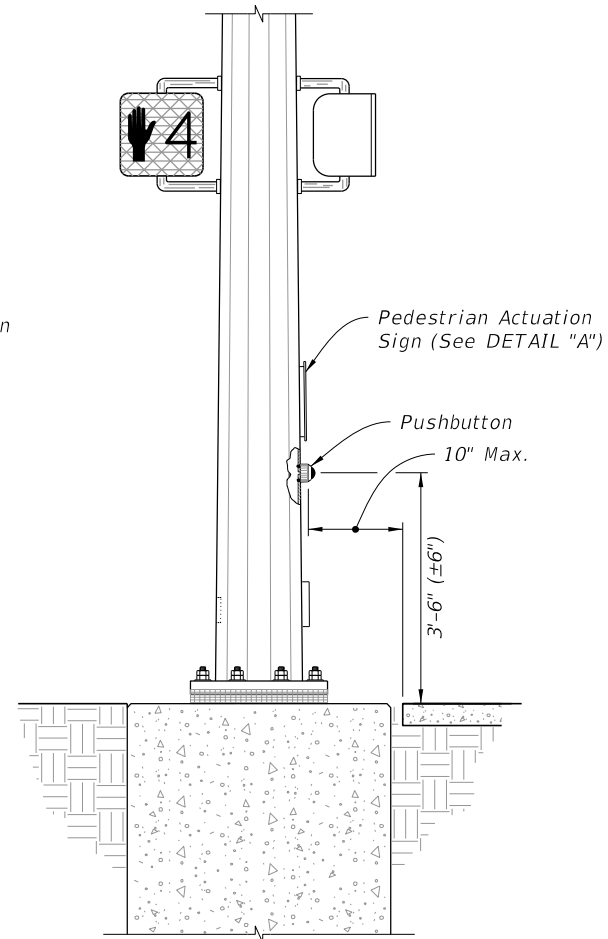

STEEL STRAIN POLE

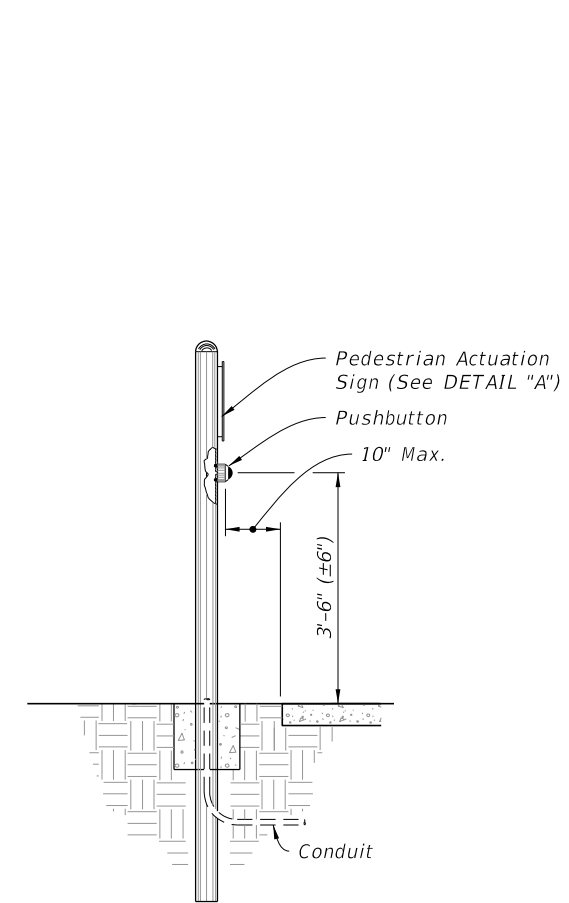

ALUMINUM POLE

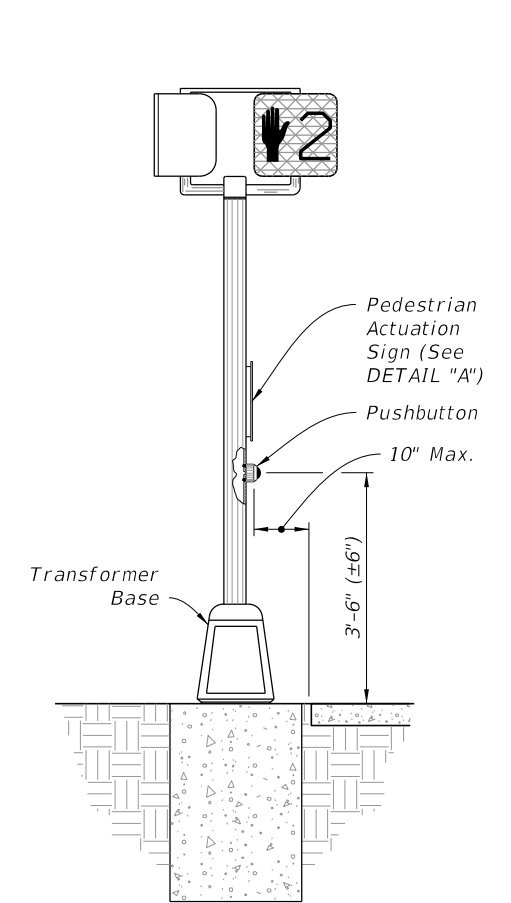

PEDESTAL

PUSHBUTTON PEDESTRIAN DETECTORS

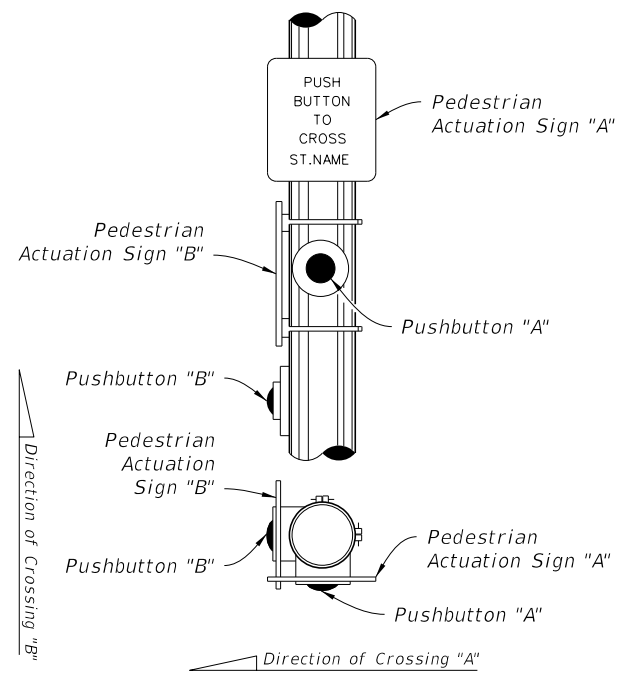

DETAIL "A"

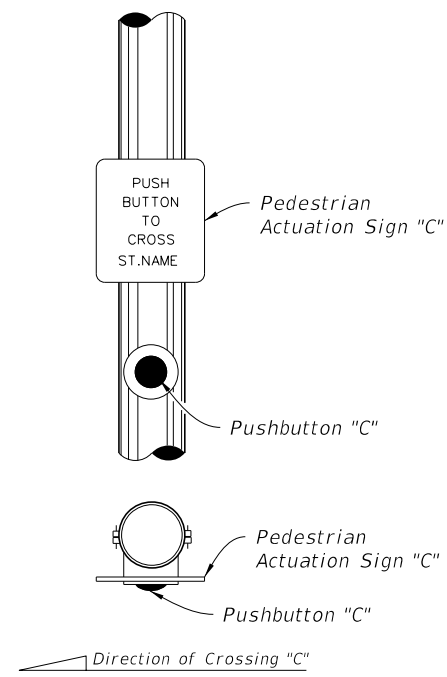

DETAIL "B"

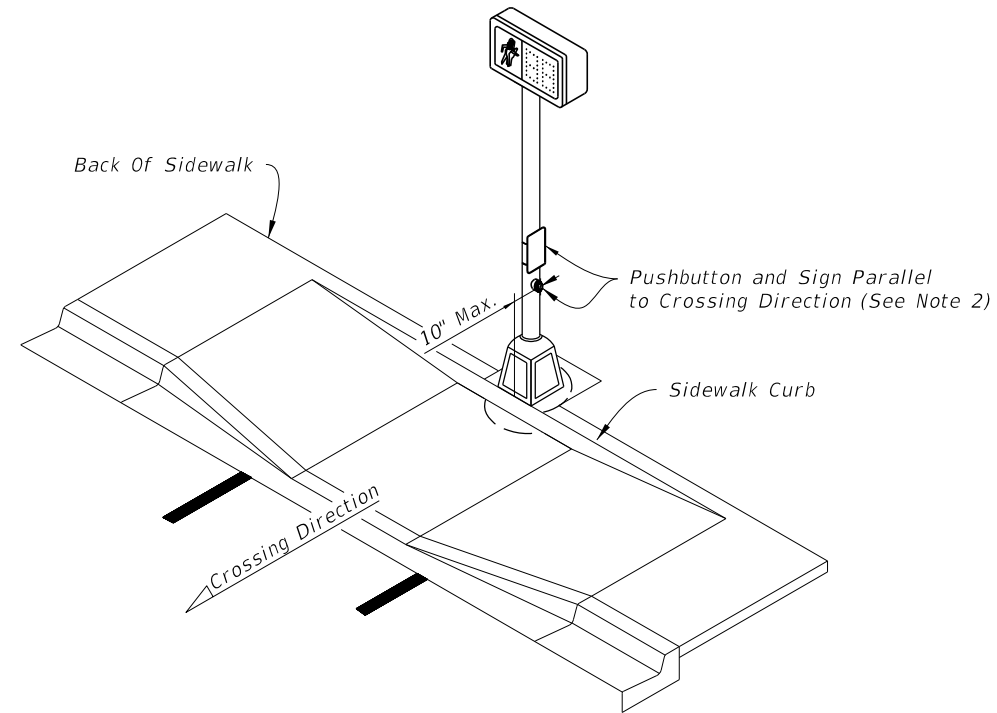

NOTES:

1. Mount Signs above the detectors. See Index 700-102 for sign details.
2. Install Pushbuttons and Pedestrian Actuation Signs with faces parallel to the crossing direction, see DETAIL "B".
3. Mount pushbuttons and Signs in accordance with Specification 665.
4. Pushbutton mounting height shown is taken at the center of the actuation switch.
5. for pedestrian control signal see index 653-001.
6. For Aluminum Pole and Pedestal supports see Index 646-001.

9/10/2024 2:31:36 PM

LAST REVISION 11/01/20	REVISION	DESCRIPTION:		FY 2025-26 STANDARD PLANS	PEDESTRIAN DETECTOR ASSEMBLY INSTALLATION DETAILS	INDEX 665-001	SHEET 1 of 1
---------------------------	----------	--------------	--	------------------------------	--	------------------	-----------------