

NOTES:

1. For Sections D-D, & E-E, see Index 455-112, 455-114, 455-118, 455-124 or 455-130 for applicable concrete pile size and Pile Splice Reinforcement Details.
2. Prestressing strands, spiral ties and/or reinforcement are not shown for clarity.
3. In cases where pile splices are desired due to length limitations in shipping and/or handling, the "Drivable Preplanned Prestressed Precast Splice Detail" shall be used.
4. When preformed dowel holes are utilized, the 1" spiral tie pitch shall be continued to 4'-0" below the head of the pile, See Index 455-118, 455-124. Preformed holes shall utilize either removable preforming material or stay-in-place corrugated galvanized steel ducts. Stay-in-place ducts shall be fabricated from galvanized sheet steel meeting the requirements of ASTM A653, Coating Designation G90, 26 gauge. Ducts shall be 1½" diameter for CFRP Bars, and 2" diameter for SS Bars with a minimum corrugation (rib) height of 0.12 in. Ducts shall be fabricated with either welded or interlocked seams. Galvanizing of welded seams will not be required.
5. For tension piles where top of Prestressed Pile is less than 3 feet below Pile Cut-off Elevation, extend No. 6 CFRP Bars or No. 10 SS into cap beyond Pile Cut-off Elevation to achieve development as approved by the Engineer.

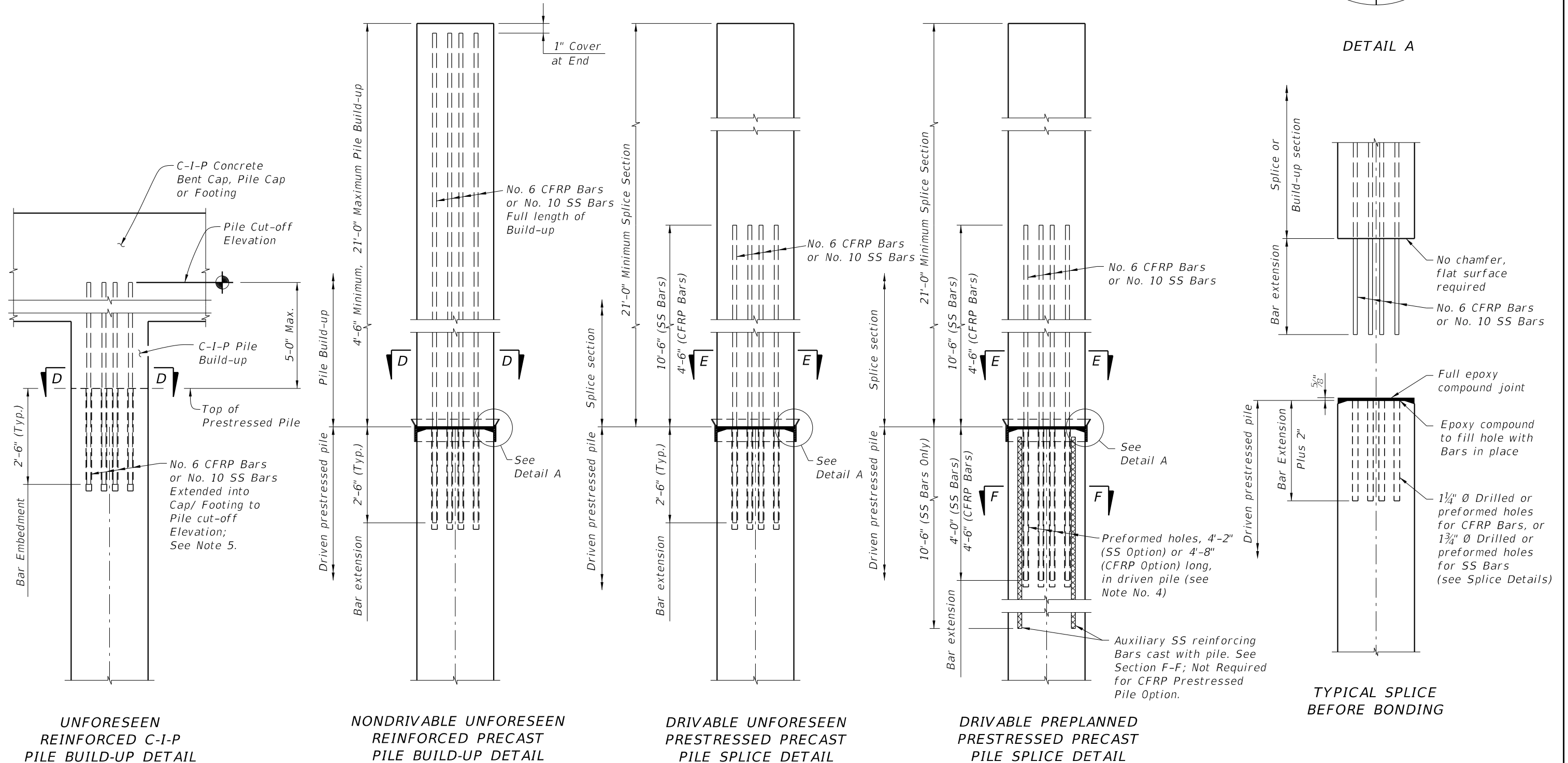
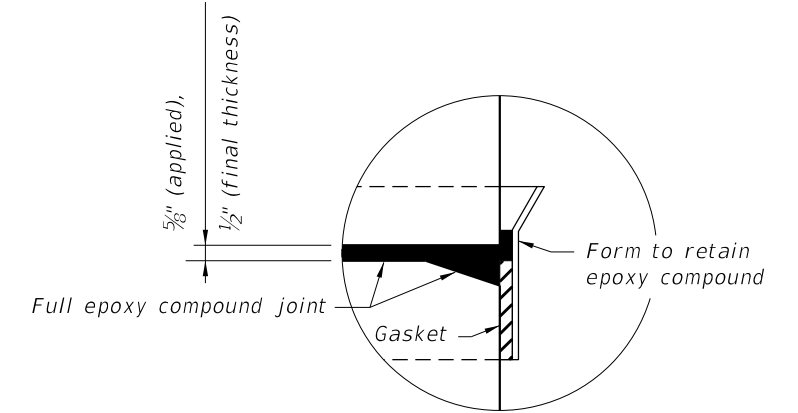

10/17/2024 10:05:55 AM

LAST REVISION 01/01/16	DESCRIPTION:		FY 2025-26 STANDARD PLANS	SQUARE CFRP & SS PRESTRESSED CONCRETE PILE SPLICES	INDEX 455-102	SHEET 1 of 1
---------------------------	--------------	--	------------------------------	---	------------------	-----------------