

BOX GIRDER MAINTENANCE LIGHTING NOTES:

1. Submit shop drawings to the Engineer detailing the layout of the maintenance lighting system for the entire structure. The shop drawings must include, but not be limited to, the following items:
 - a. Conduit layout and installation details through diaphragms, around post-tensioning (PT) ducts, lateral bracing and cross frames as necessary.
 - b. Conduit access through box girder end diaphragms with minimum 1" clearance in all directions.
 - c. Conduit expansion fitting details.
 - d. Fastener details for the interior electrical system.
 - e. Single line diagram showing mini power centers, switches, contactors, timers, etc.
 - f. Mini power center details including circuit breaker details.
 - g. Mini power center mounting details if required.
 - h. Feeder schedule.
2. Ensure installation meets all requirements of the latest edition of the National Electrical Code (NEC) and local ordinances. Install grounding in accordance with NEC Article 250. Maintain separation between 480V and 120V Conductors / Conduits throughout.
3. Furnish all labor, equipment, materials, and incidentals required for a complete and functional installation.
4. Use only new, unused and Underwriters Laboratories (UL) listed equipment and materials for outdoor use.
5. Furnish and install polyvinyl chloride (PVC) conduit in conformance with UL Section 651, NEC Section 347 and NEMA TC-2, UV-resistant and schedule 80. Bend conduits as necessary to connect to loads.
6. Provide PVC sleeve 2" larger in diameter than conduit to accommodate construction tolerance.
7. Install a UL labeled expansion fitting for specified PVC conduit at all structure expansion joints. Provide certification that the expansion fitting meets the following minimum requirements: Compatibility with the connected conduits, waterproof, UV protected and allows longitudinal movement equal to that of the Expansion Joint.
8. Use only Alloy 316 stainless steel supporting hardware. Provide minimum 3/16" Ø fasteners. For concrete or SIP form mounting, provide anchor bolts (expansion, drop-in or adhesive) suitable for dynamic loading (due to vibration caused by traffic). Install fasteners to avoid conflicts with reinforcing steel and PT ducts. For structural steel mounting, do not attach fasteners to main members, i.e. webs and flanges.
9. Furnish power distribution at 480V AC, 1 phase, with step down transformers at regular intervals. Furnish 7.5 KVA mini power center with eight 20A breakers as the step down transformer, feeding a maximum of 20 lamps and 20 receptacles. Each mini power center will provide power to no more than 1000' of bridge, preferably 500' on each side of the mini power center. 480V top feed, 120V bottom feed to maintain separation.
10. Furnish and install lighting contactors to switch the 480V AC feeding the mini power centers.
11. Furnish and install copper conductors, Type XHHW. Do not use any conductor larger than #4 AWG.
12. Provide enough slack in all interior cable terminations to allow for minor shifting of the structure.
13. Furnish and install National Electric Manufacturers Association (NEMA) Type 4X (non-metallic) surface mounted boxes sized in conformance with the NEC.
14. Furnish and install 120V duplex receptacles (GFI, NEMA Type 5-20R), in non-metallic outlet boxes at 50' maximum on centers. Provide each receptacle with a gasketed weather-protective outdoor plate. Maximum wire size to connect to receptacles is #12 AWG.
15. Furnish and install surface mounted, fully enclosed, incandescent light fixtures with gasketed clear globes and wire guards at 50' maximum on centers. Provide 100 watt, 130 volt, vibration resistant and brass base incandescent lamps.
16. Provide six hour reset timers for each circuit to turn off the lighting system automatically.

CROSS REFERENCES:

1. For Maintenance Light Details, see Sheet 2.
2. For actual bridge section, see Structures Plans.

10/14/2023 12:29:56 PM

LAST REVISION 07/01/14	REVISION	DESCRIPTION:	 FY 2024-25 STANDARD PLANS	MAINTENANCE LIGHTING FOR BOX GIRDERS	INDEX 715-240	SHEET 1 of 2
------------------------------	----------	--------------	---	---	-------------------------	------------------------

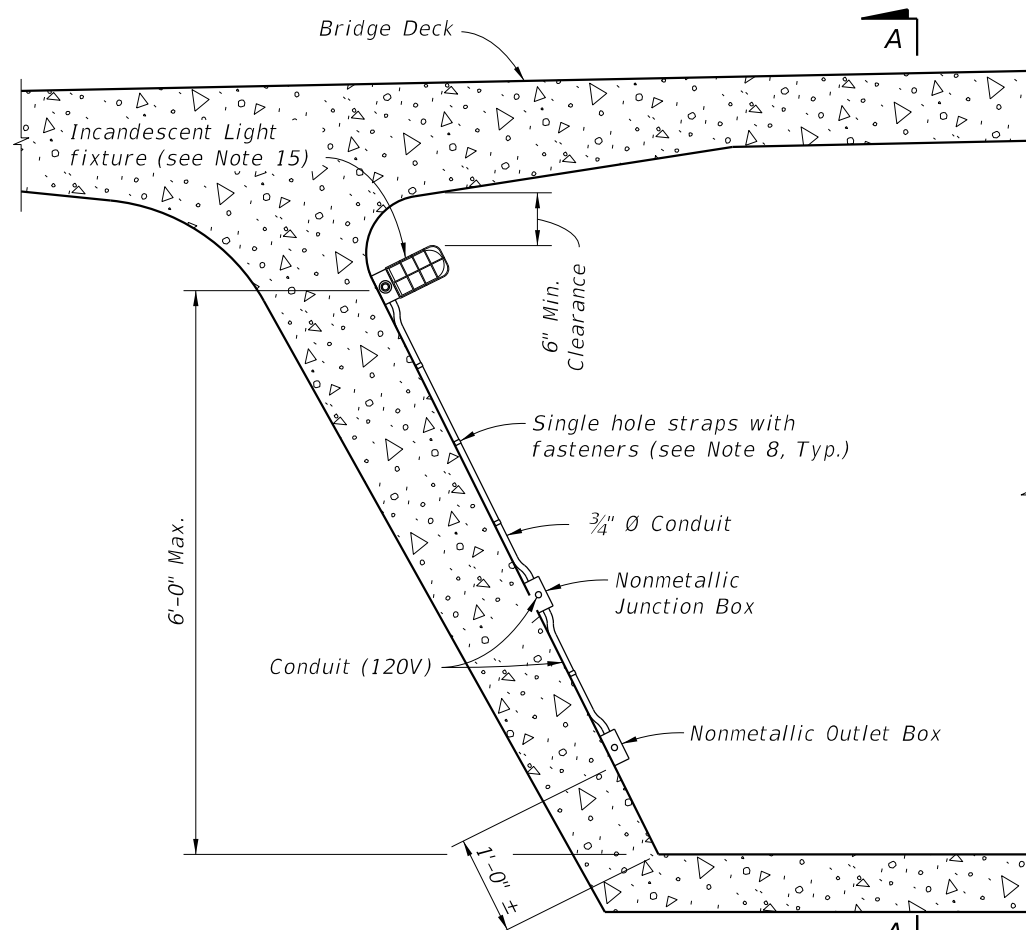

LIGHTING DETAILS FOR CONCRETE BOX GIRDER BRIDGE

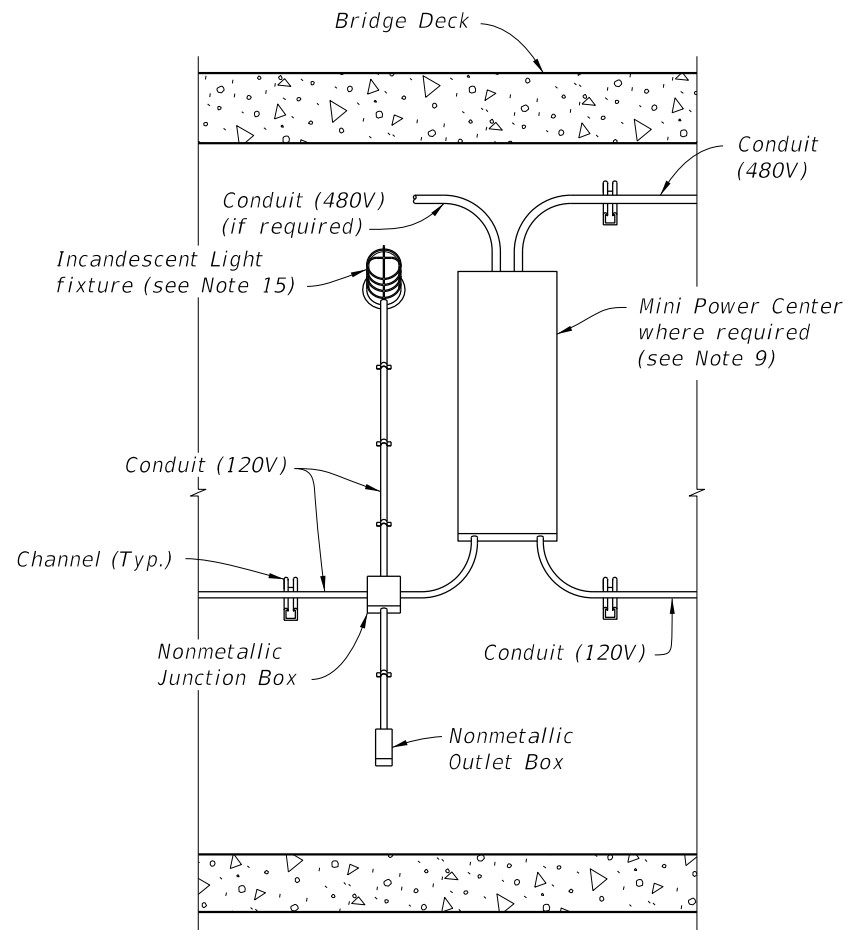

SECTION A-A

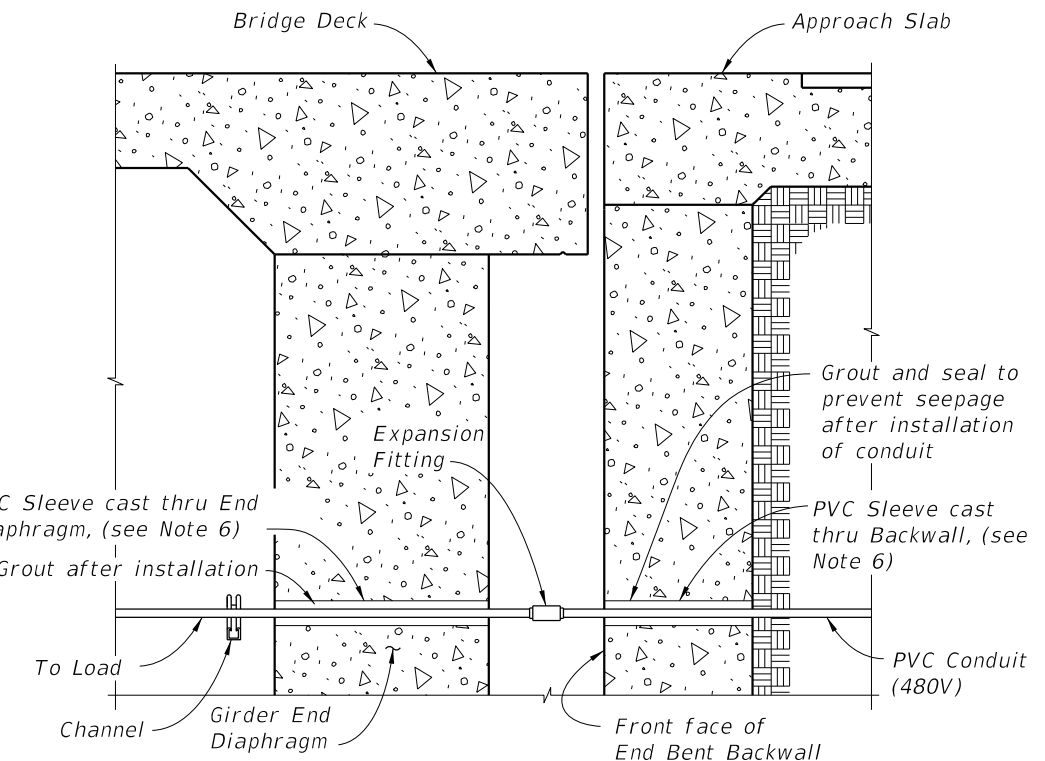

CONCRETE BOX GIRDER BRIDGE SECTION THRU END BENTS

CROSS REFERENCE:
1. For Box Girder Maintenance Lighting Notes see Sheet 1.

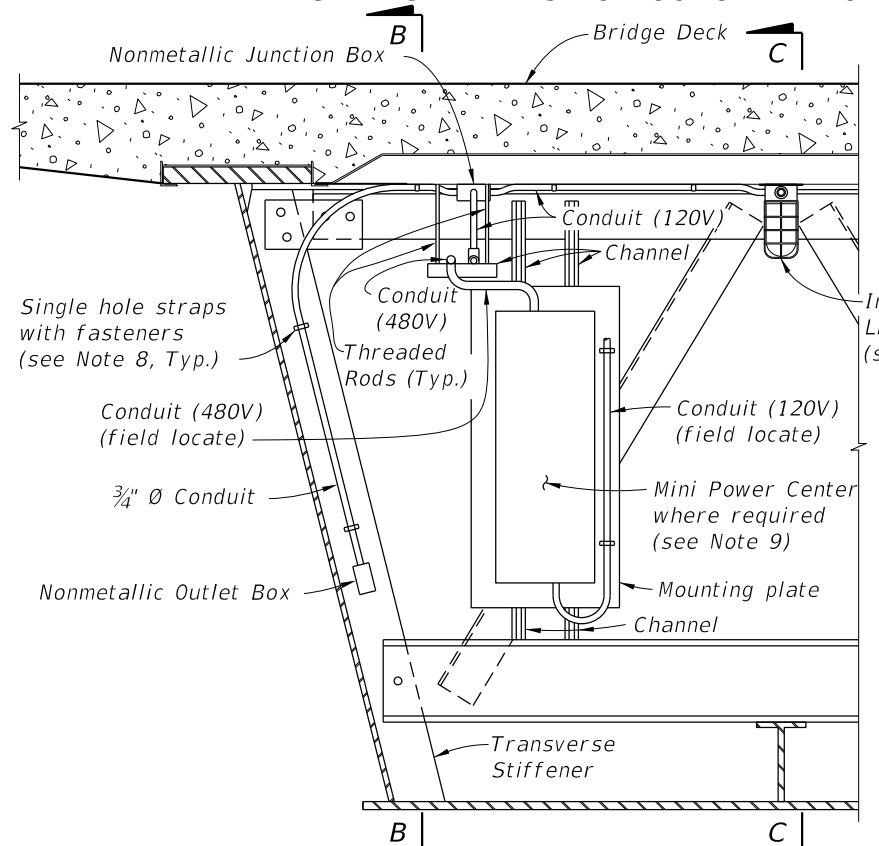

LIGHTING DETAILS FOR STEEL BOX GIRDER BRIDGE

(Cross Frame section shown, other Transverse Stiffener sections similar)

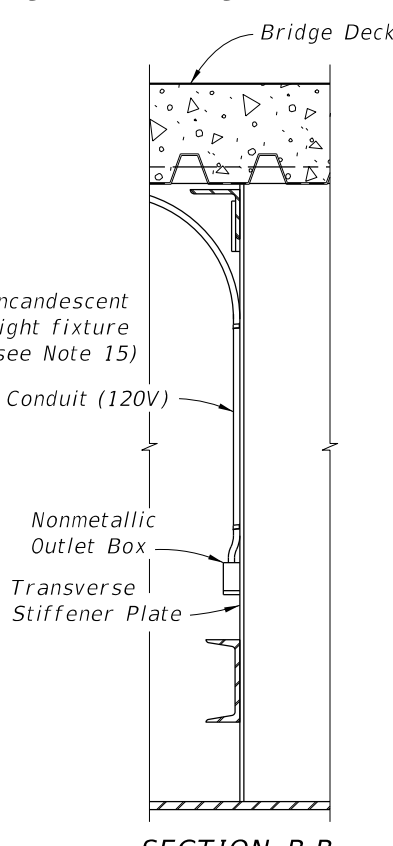

SECTION B-B

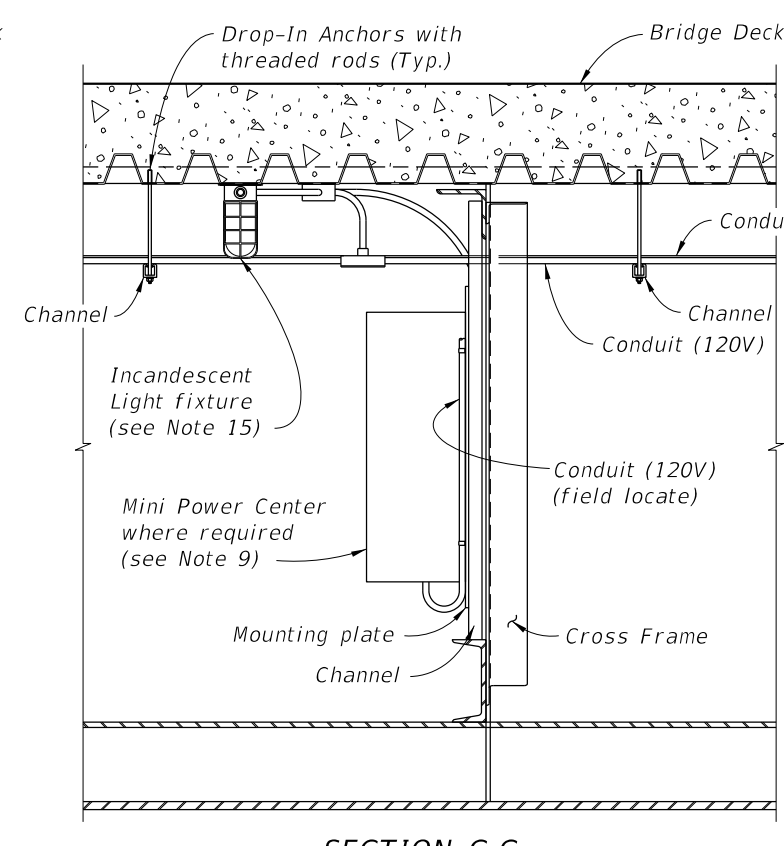

SECTION C-C

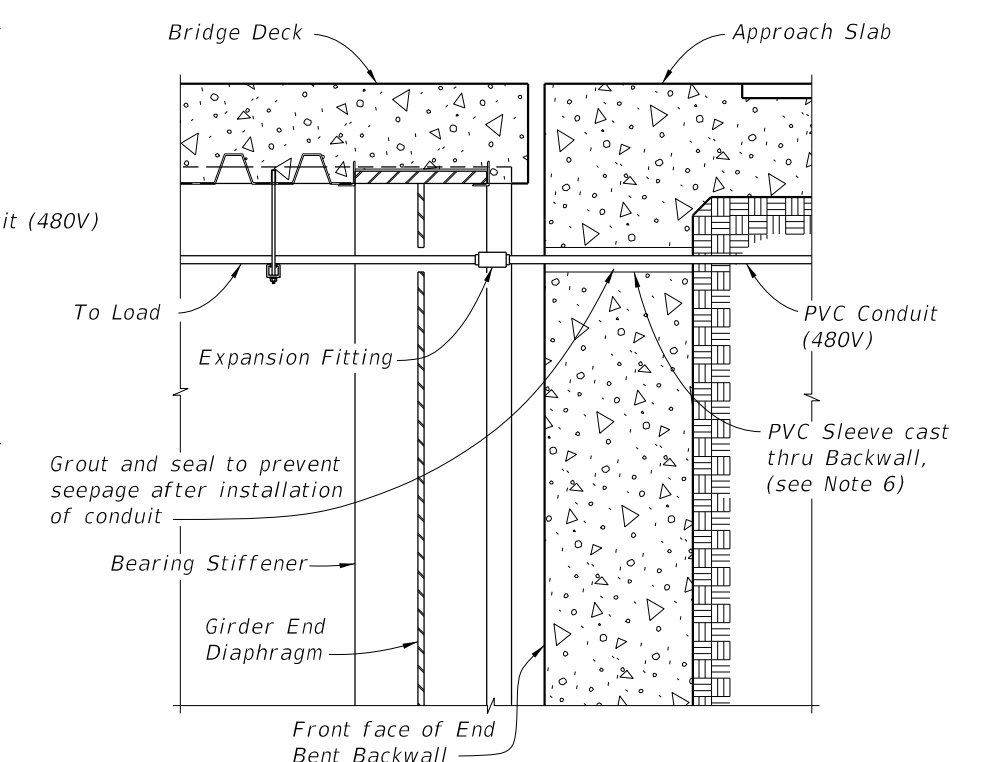

STEEL BOX GIRDER BRIDGE SECTION THRU END BENTS

10/14/2023 12:30:05 PM

LAST REVISION 07/01/05	REVISION	DESCRIPTION:	 FY 2024-25 STANDARD PLANS	MAINTENANCE LIGHTING FOR BOX GIRDERS	INDEX 715-240	SHEET 2 of 2
---------------------------	----------	--------------	--	--------------------------------------	------------------	-----------------