

100% Acrylic Aliphatic Polyurethane top coating. (Notes 1 & 2)

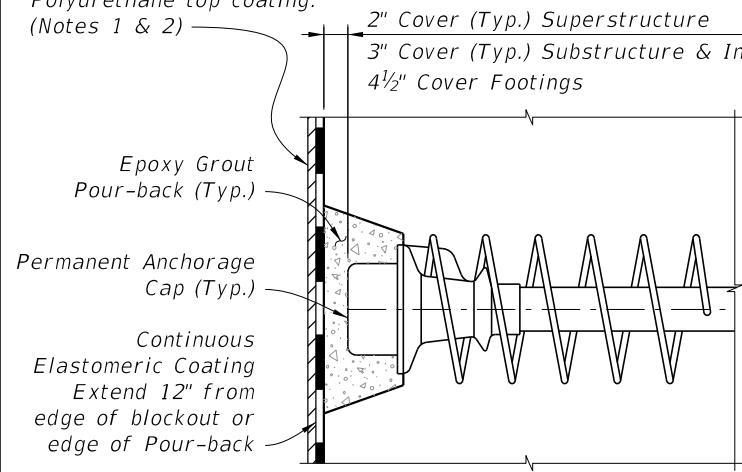

TYPE 1

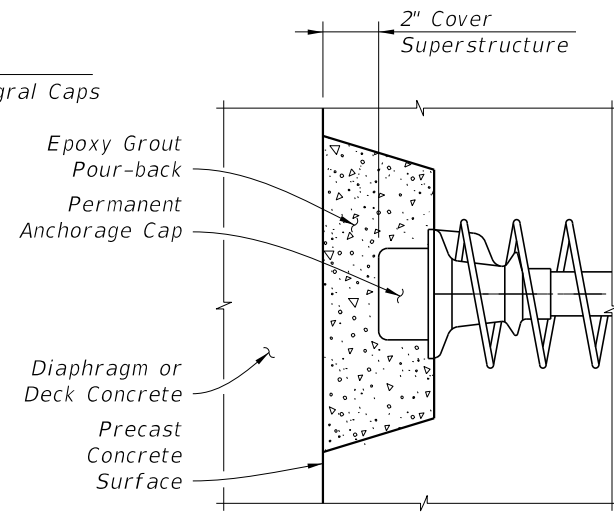

TYPE 2

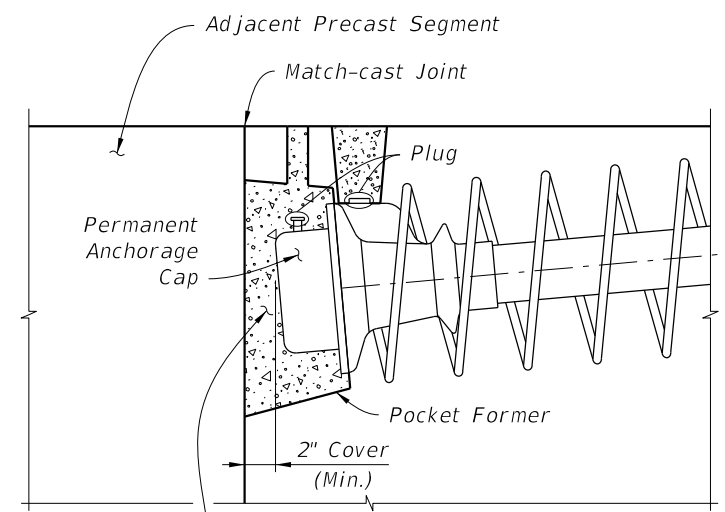

TYPE 3A

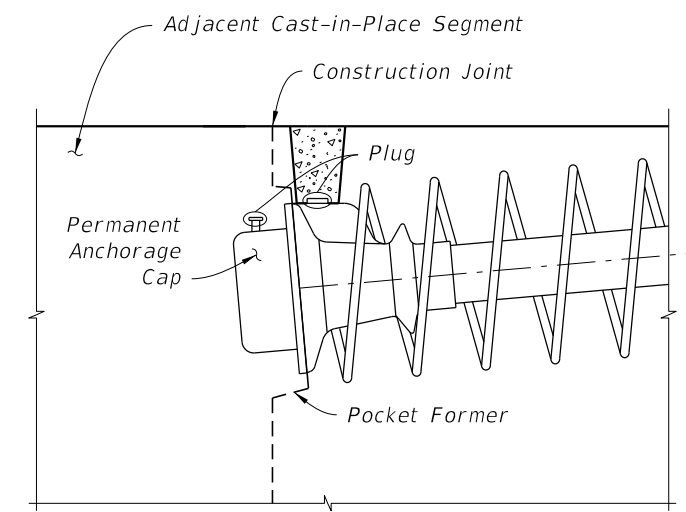

TYPE 3B

Epoxy Grout Pour-back placed after permanent tendons anchored in adjacent segment have been stressed

Notes:

1. Meet the requirements of Specification Section 975-5.
2. Extend top coat 1" beyond limits of Elastomeric Coating.

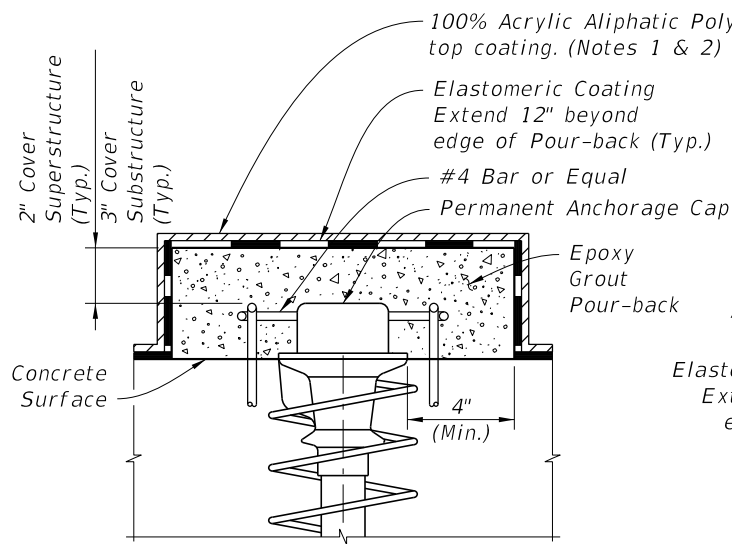

TYPE 4

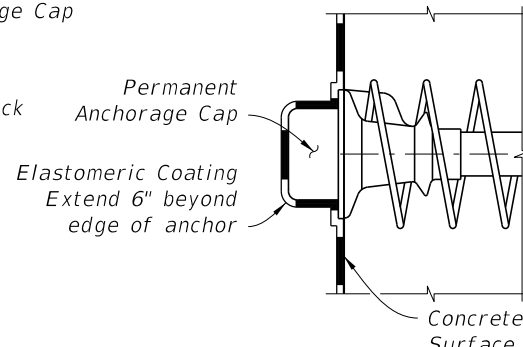

TYPE 5

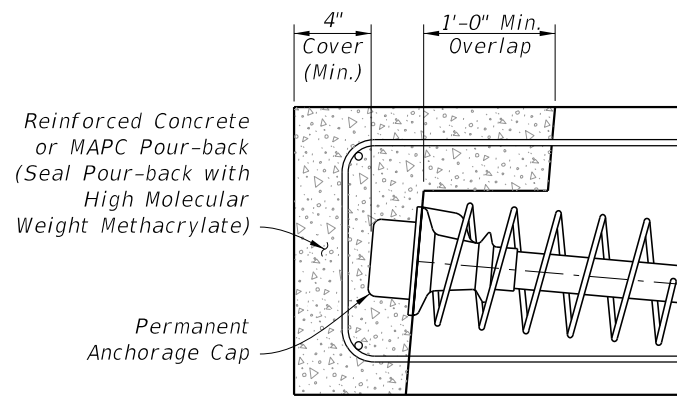

TYPE 6

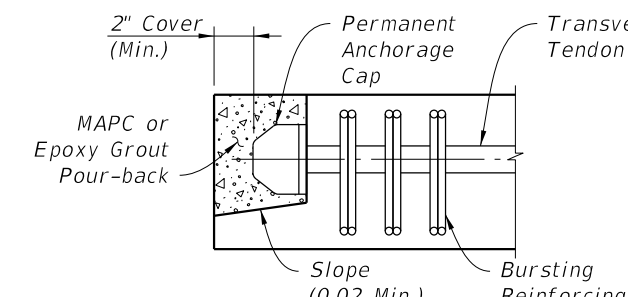

TYPE 7

Type 7 Notes:

1. Traffic or Pedestrian/Bicycle Railing not shown for clarity.
2. Where Pour-back is not protected by Traffic or Pedestrian/Bicycle Railing, Coat Pour-back with High Molecular Weight Methacrylate.

ANCHORAGE PROTECTION FOR STRAND TENDONS

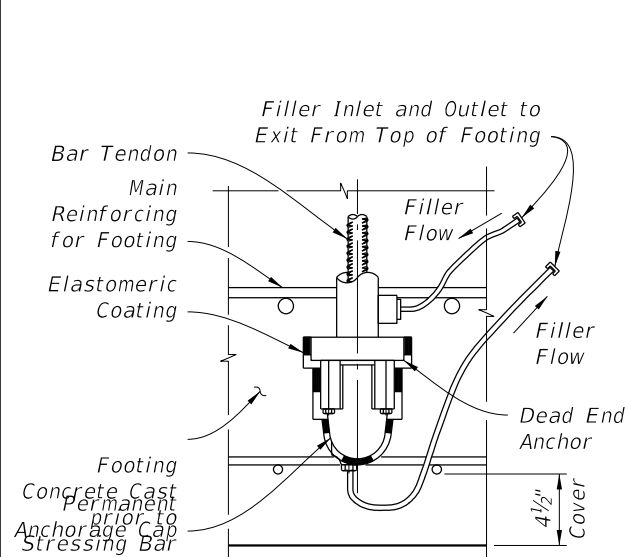

TYPE 8

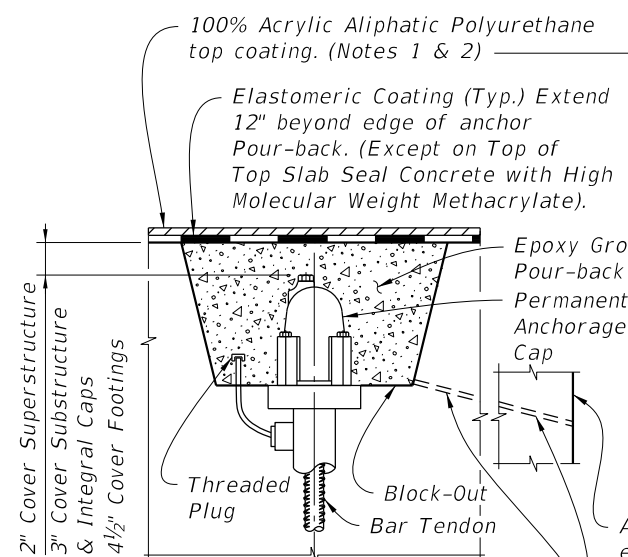

TYPE 9

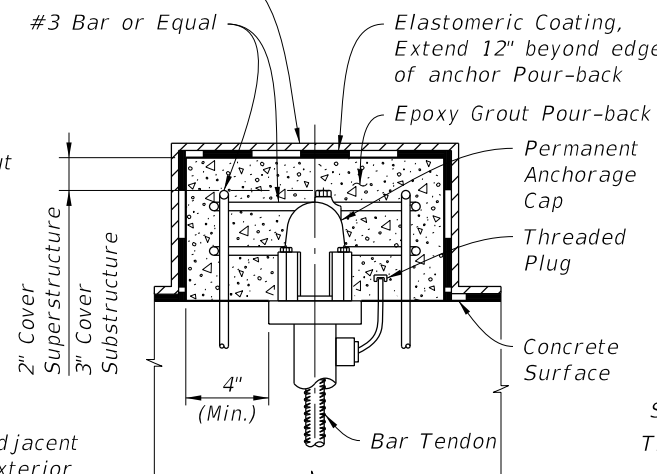

TYPE 10

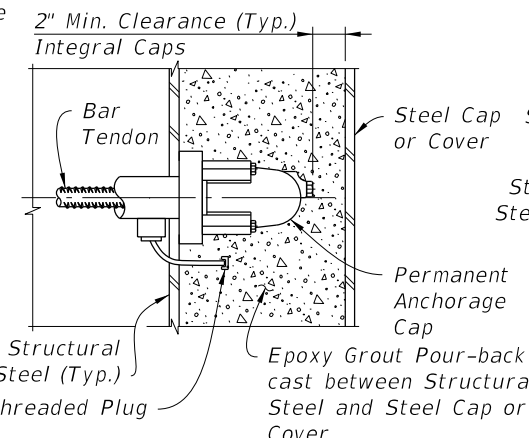

TYPE 11

(Shear Studs not Shown for Clarity)

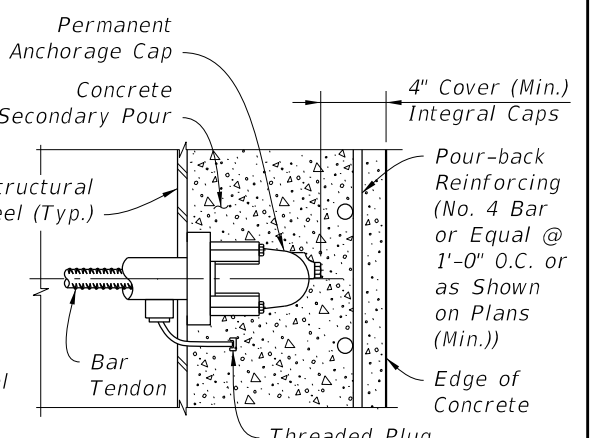

TYPE 12

(Shear Studs not Shown for Clarity)

ANCHORAGE PROTECTION FOR BAR TENDONS

10/6/2022 11:18:39 AM

LAST REVISION 11/01/18	DESCRIPTION:
---------------------------	--------------



FY 2023-24
STANDARD PLANS

POST-TENSIONING ANCHORAGE PROTECTION

INDEX
462-002

SHEET
1 of 1