





**GENERAL NOTES:**

1. Work this Index with Specification 522.
2. Refer to Index 520-001 for drop curb details and Index 522-001 for joints between driveway, sidewalks, and curb.
3. Existing Curb and Gutter:  
Remove existing curb and gutter to either the nearest joint beyond the flared point or to where no remaining section is less than 5 feet long.
4. Grades and cross slopes shown are maximums.
5. Longitudinal Joints:  
Construct  $\frac{1}{8}$ " open joints placed at equal (20' max.) intervals for driveways over 20' wide. Match joints in curb and gutter to match joints in driveways.
6. Transverse Joints:  
Construct  $\frac{1}{8}$ " open joints @ 10' Centers and  $\frac{1}{2}$ " expansion joints with preformed joint filler every 5th joint.
7. Construct driveways (6" thick concrete) to a uniform width (W) to the R/W line or the extent shown in the Plans.
8. Width of Sidewalk Thru Driveway is 4'-0" minimum. Match sidewalk width when shown in Plans or when utility strip width is equal to or greater than the depth of the Driveway Apron.
9. Alpha-Numeric Identification:  
Concrete Flared Driveway Alpha-Numeric Identifications (e.g. G4) are provided for reference purposes in the Plans.

**LEGEND:**

-  Sidewalk
-  Flared Driveway (6" Thick Concrete)
-  Sidewalk Thru Driveway (6" Thick Concrete)
-  Utility Strip
- $G_A$  Grade of Apron
- $G_D$  Grade of Driveway (Per Plans)

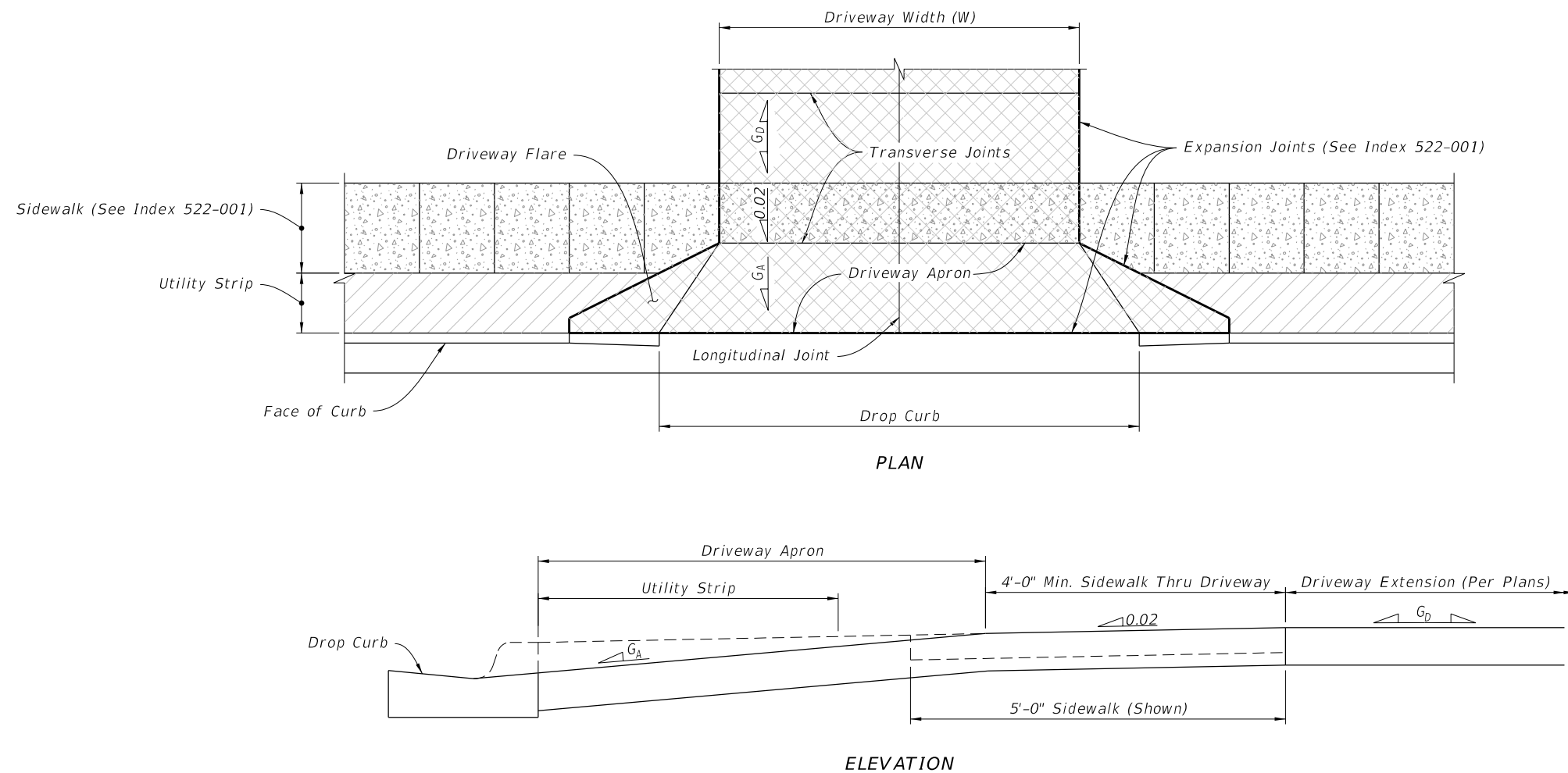

CONCRETE FLARED DRIVEWAY NOMENCLATURE

9/22/2021 8:51:34 AM

LAST REVISION 11/01/18	REVISION	DESCRIPTION:	 FY 2022-23 STANDARD PLANS	CONCRETE FLARED DRIVEWAYS	INDEX 522-003	SHEET 1 of 4
---------------------------	----------	--------------	---	---------------------------	------------------	-----------------

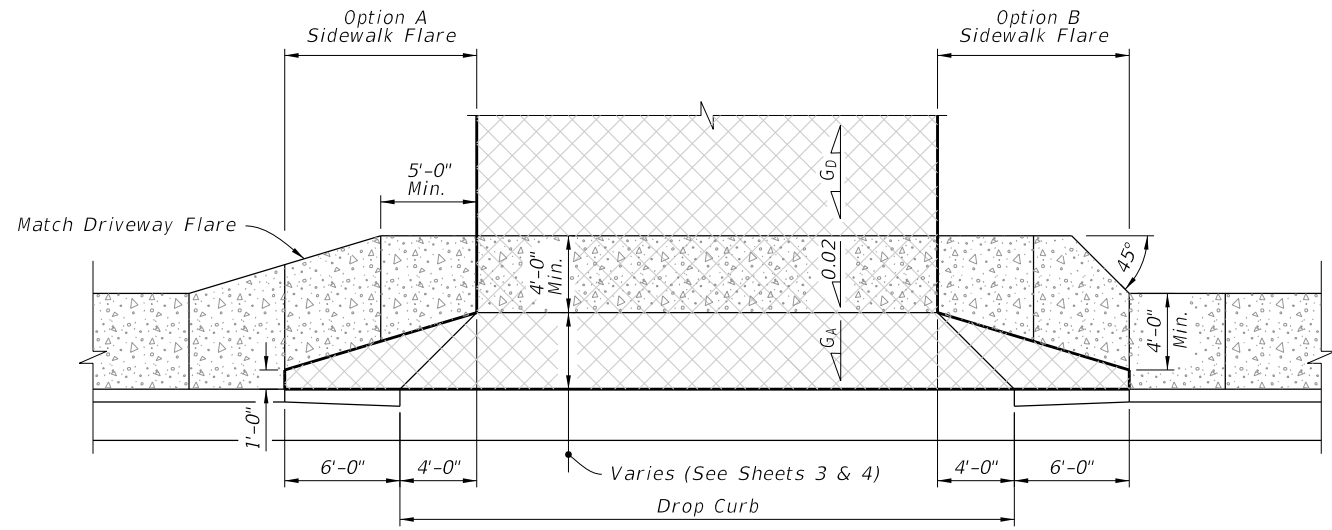

SIDEWALK WITHOUT UTILITY STRIP

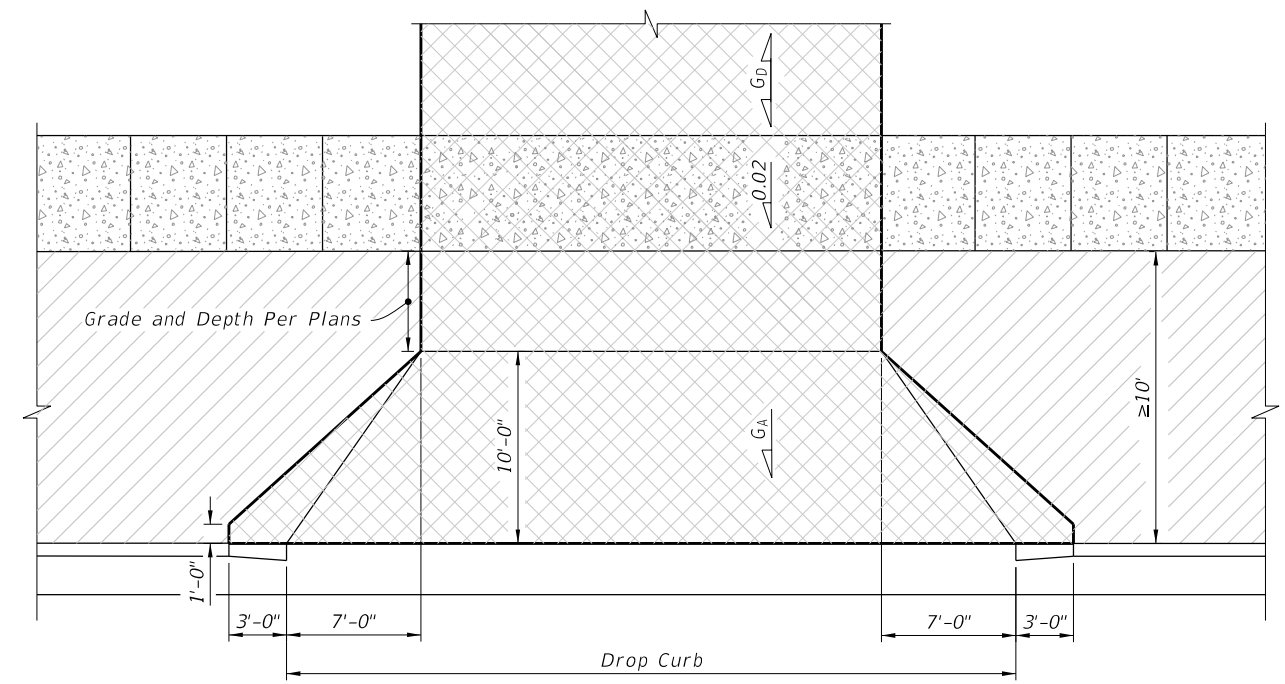

WITHOUT SIDEWALK OR UTILITY STRIP ≥ 10' WIDE

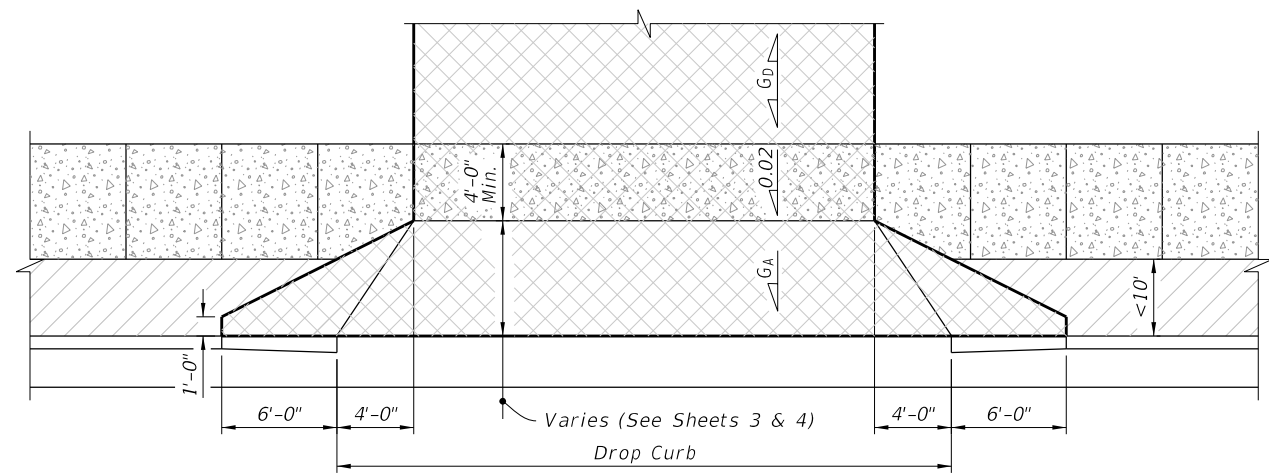

UTILITY STRIP < 10' WIDE

LEGEND:

-  Sidewalk
-  Flared Driveway (6" Thick Concrete)
-  Sidewalk Thru Driveway (6" Thick Concrete)
-  Utility Strip

9/22/2021 8:51:39 AM

LAST REVISION 11/01/18	REVISION	DESCRIPTION:		FY 2022-23 STANDARD PLANS	CONCRETE FLARED DRIVEWAYS	INDEX 522-003	SHEET 2 of 4
---------------------------	----------	--------------	--	------------------------------	---------------------------	------------------	-----------------

9/22/2021 8:51:42 AM

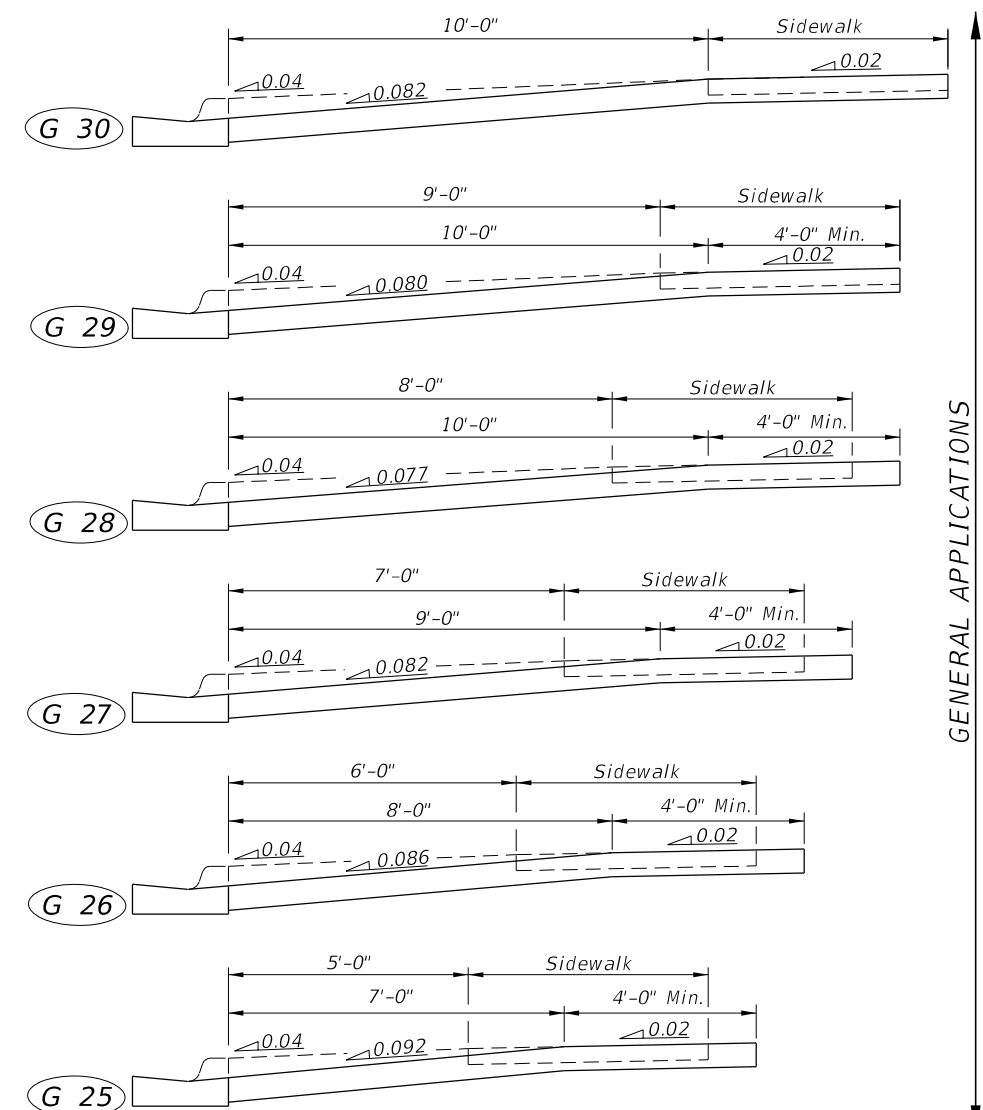
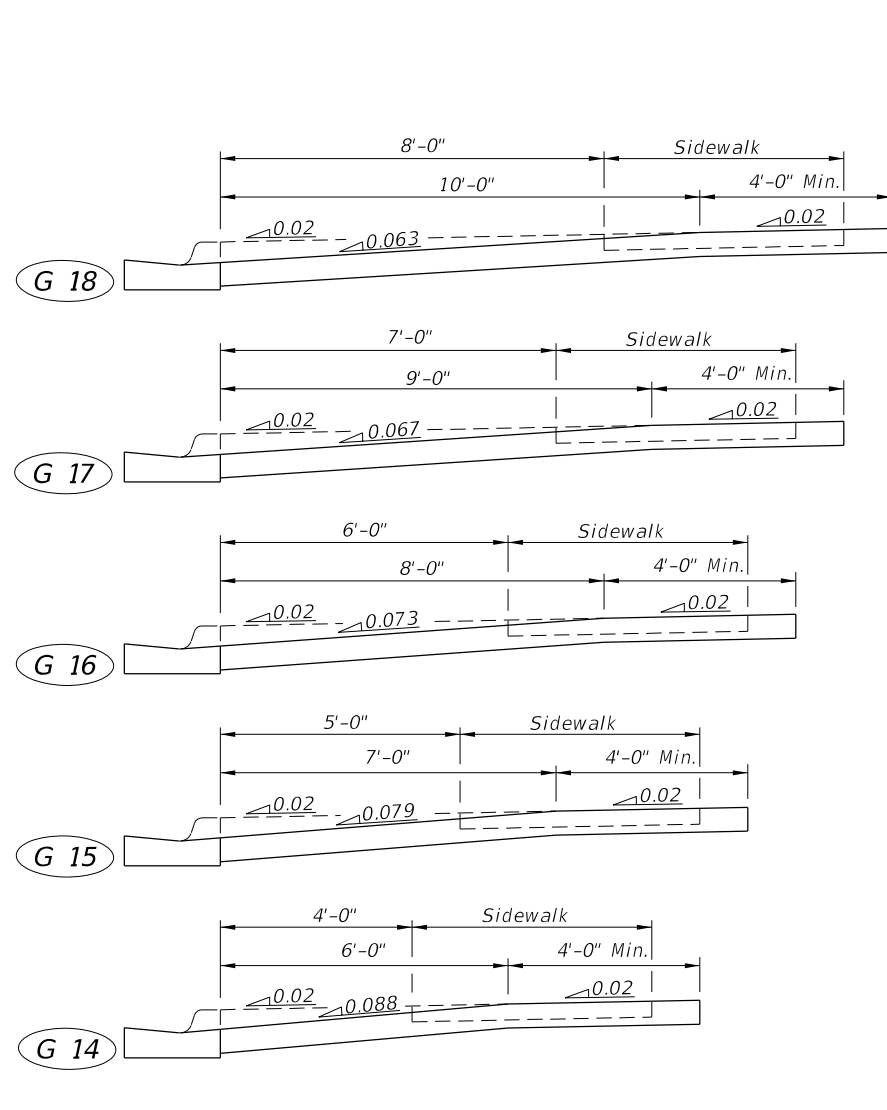
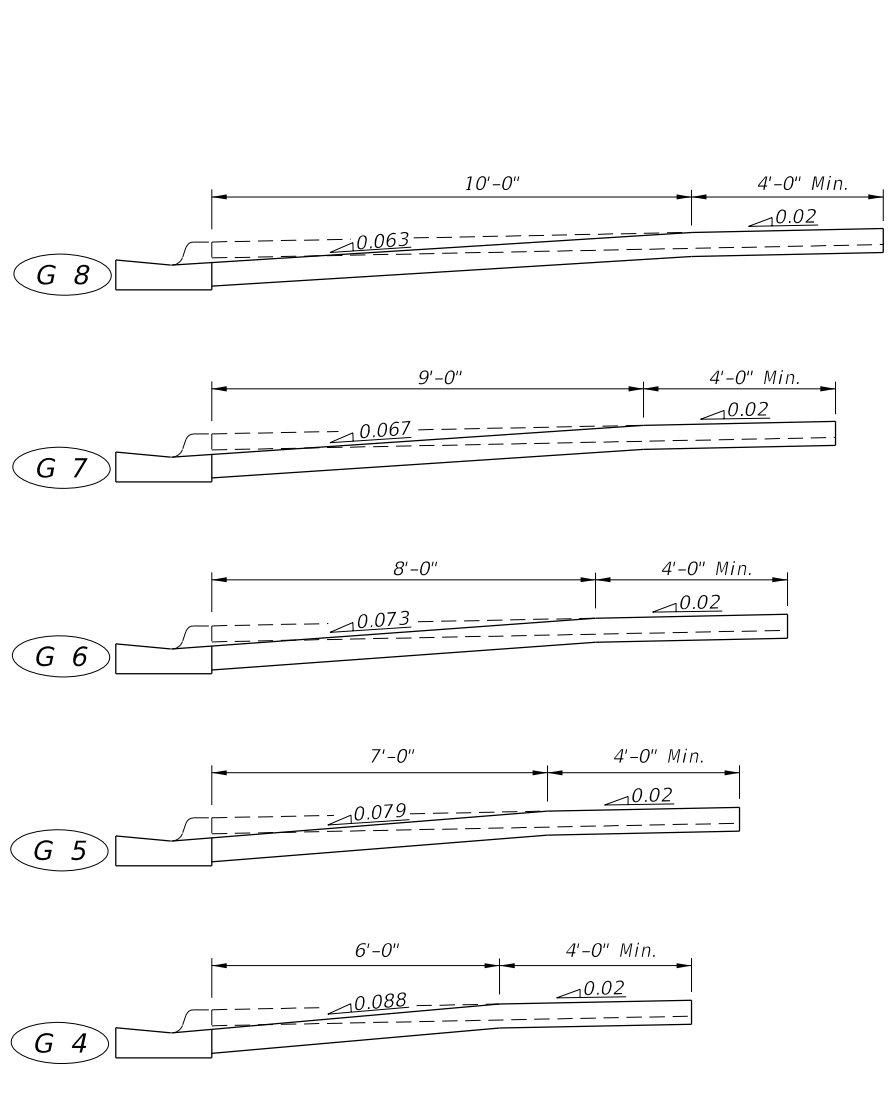

GENERAL APPLICATIONS

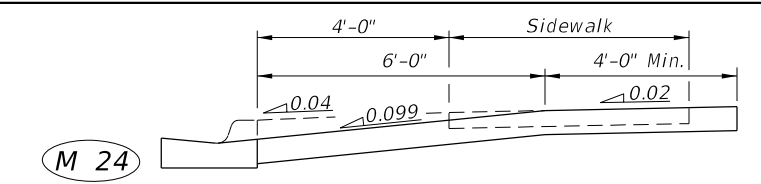
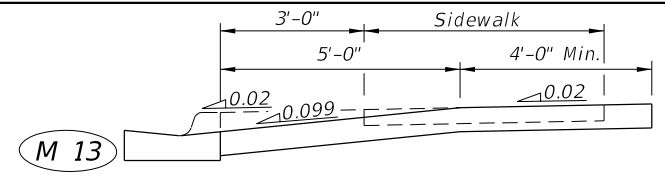
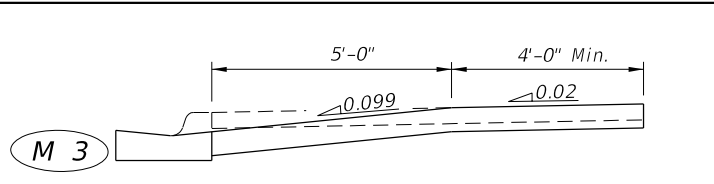

MARGINAL

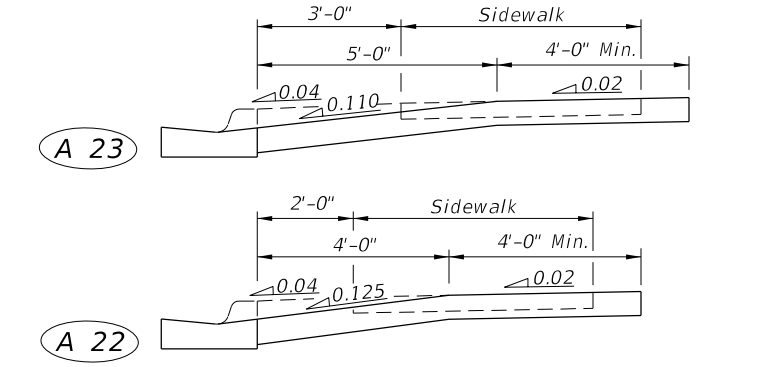
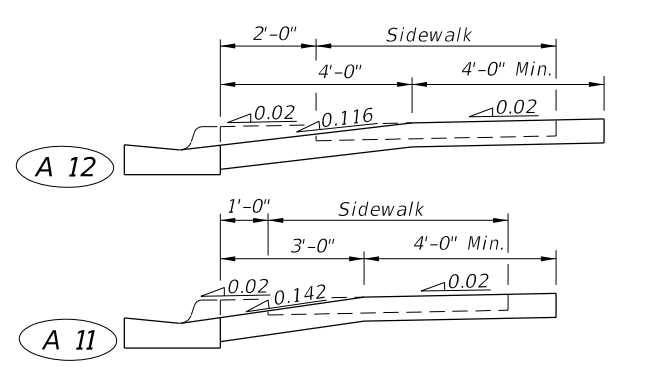
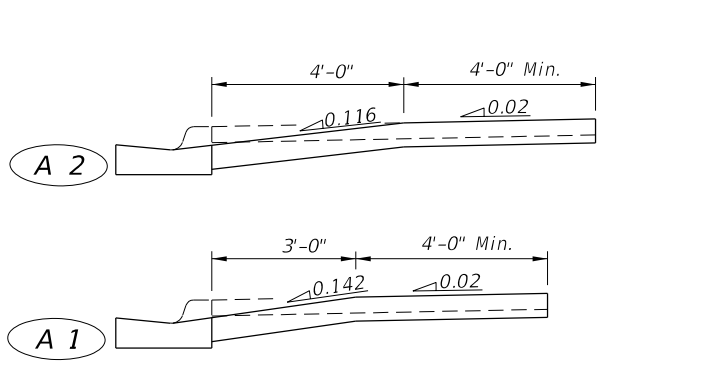

ADVERSE

==== SIDEWALK WITHOUT UTILITY STRIP =====

==== SIDEWALK WITH UTILITY STRIP ON 0.02 SLOPE =====

==== SIDEWALK WITH UTILITY STRIP ON 0.04 SLOPE =====

NOTE:  
5' sidewalks shown.

DRIVEWAY SECTIONS ON CURBED FACILITIES WITH SIDEWALKS

LAST REVISION 11/01/18	REVISION	DESCRIPTION:
---------------------------	----------	--------------

**FY 2022-23  
STANDARD PLANS**

**CONCRETE FLARED DRIVEWAYS**

INDEX 522-003	SHEET 3 of 4
------------------	-----------------

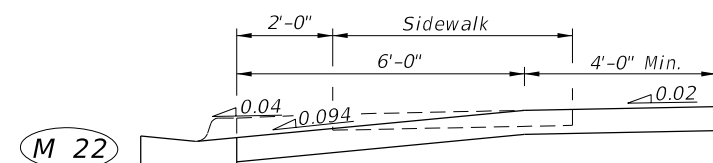
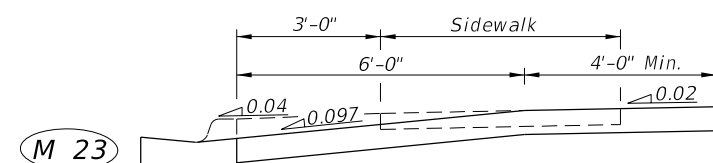
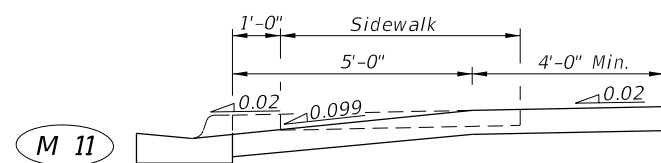
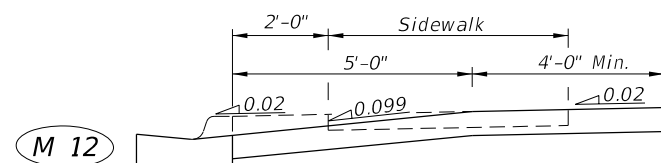
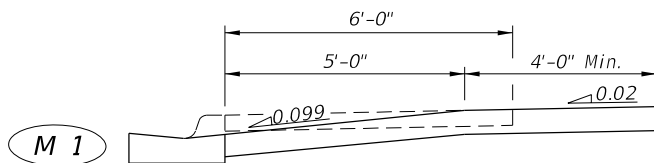
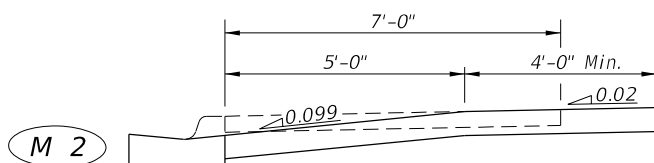
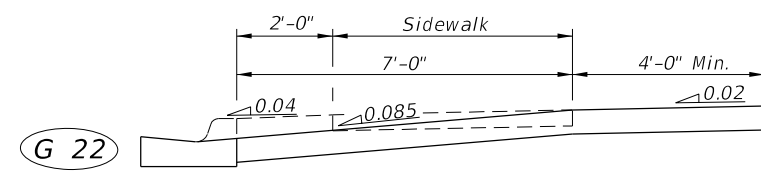
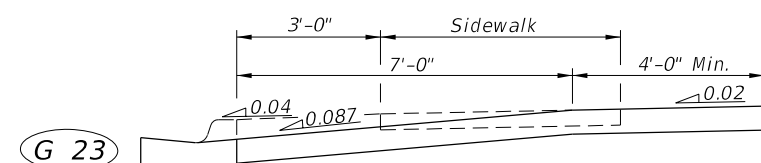
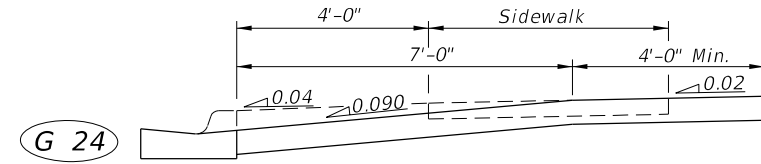
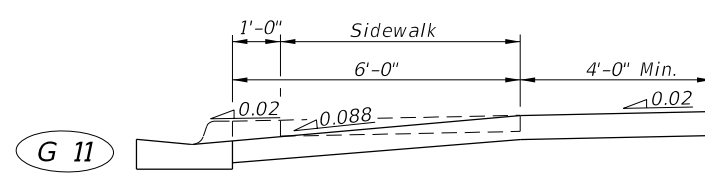
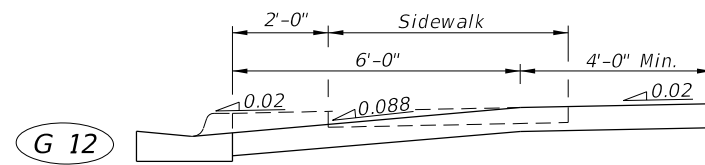
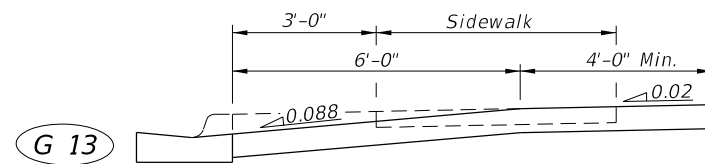
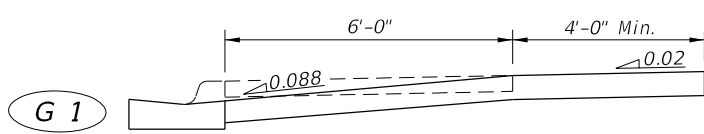
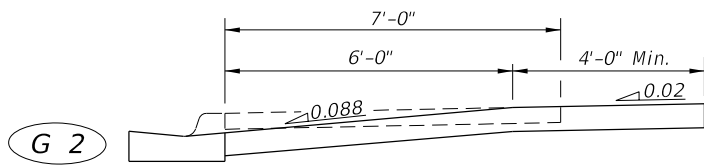
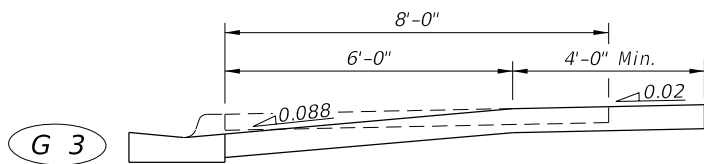

GENERAL APPLICATIONS

MARGINAL

==== SIDEWALK WITHOUT UTILITY STRIP ====

==== SIDEWALK WITH UTILITY STRIP ON 0.02 SLOPE ====

==== SIDEWALK WITH UTILITY STRIP ON 0.04 SLOPE ====

NOTE:  
5' sidewalks shown.

DRIVEWAY SECTIONS ON CURBED FACILITIES WITH SIDEWALKS

CONCRETE FLARED DRIVEWAYS



FY 2022-23  
STANDARD PLANS

INDEX  
522-003

SHEET  
4 of 4

LAST REVISION  
11/01/18

REVISION DESCRIPTION:

9/22/2021 8:51:44 AM