

4/6/2021 2:09:41 PM

LAST REVISION	DESCRIPTION:
11/01/20	

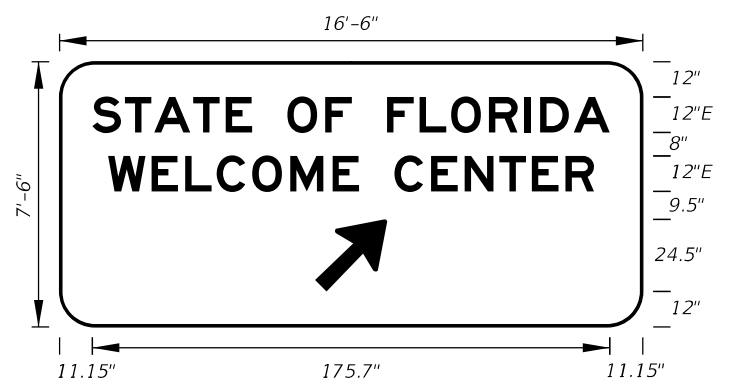

**FTP-11-06**  
 16'-6" X 7'-6"  
 12" Radii 2" Border  
 12" Series E Legend  
 Blue Background  
 White Legend and Border

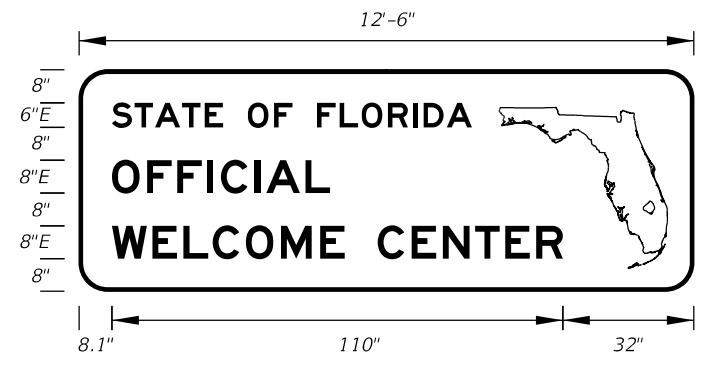

**FTP-12-06**  
 12'-6" X 4'-6"  
 7" Radii 2" Border  
 6" and 8" Series E Legend  
 Blue Background  
 White Legend and Border

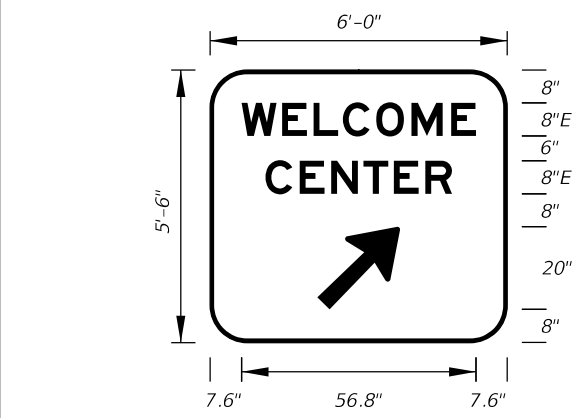

**FTP-13-06**  
 6' 0" X 5'-6"  
 9" Radii 2" Border  
 8" Series E Legend  
 Blue Background  
 White Legend and Border

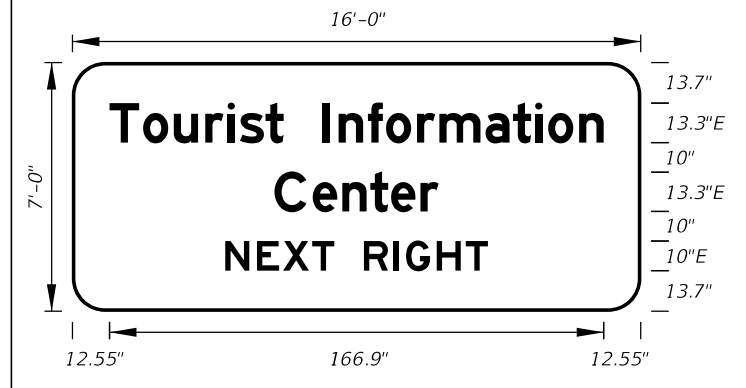

**FTP-14-06**  
 16'-0" X 7'-0"  
 11" Radii 2" Border  
 13.3 and 10" Series E Legend  
 Blue Background  
 White Legend and Border

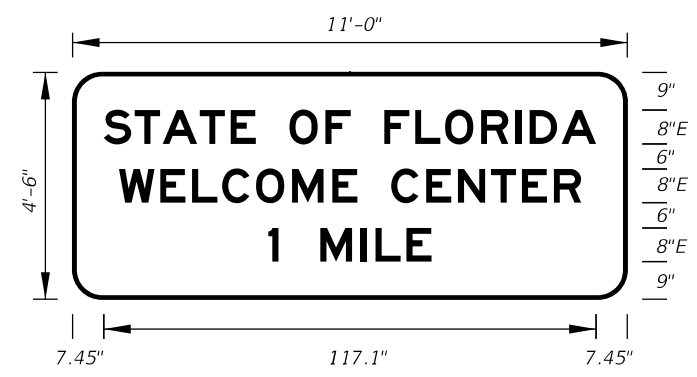

**FTP-15A-06**  
 11'-0" X 4'-6"  
 7" Radii 2" Border  
 8" Series E Legend  
 Blue Background  
 White Legend and Border

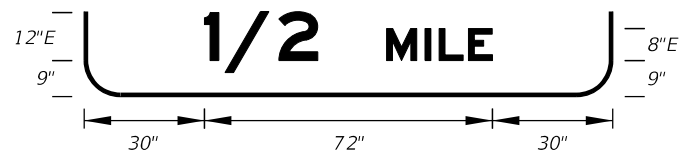

**FTP-15B-06**  
 11'-0" X 5'-0"  
 8" Radii 2" Border  
 8" and 12" Series E Legend  
 Blue Background  
 White Legend and Border

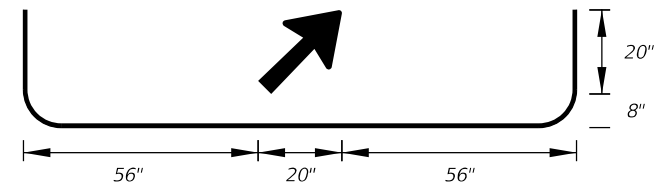

**FTP-15C-06**  
 11'-0" X 5'-6"  
 9" Radii 2" Border  
 8" Series E Legend  
 Blue Background  
 White Legend and Border

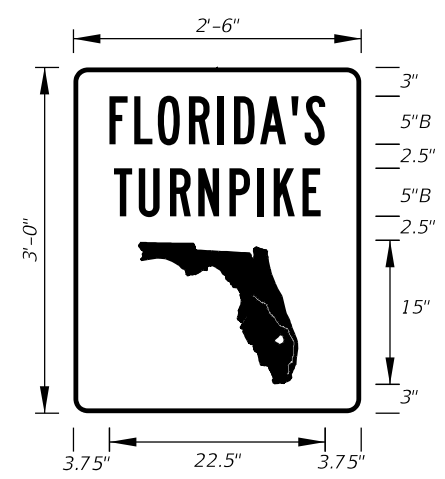

**FTP-16-10**  
 2'-6" X 3'-0"  
 1.5" Radii 3/4" Border  
 5" Series B Legend  
 Green Background  
 White Legend, Border,  
 and Florida Symbol



**FTP-17-10**  
 3'-0" X 4'-0"  
 1.5" Radii 3/4" Border  
 7" Series B Legend  
 Green Background  
 White Legend, Border,  
 and Florida Symbol



**FTP-18-10**  
 4'-0" X 5'-0"  
 3" Radii 1 1/4" Border  
 8" Series B Legend  
 Green Background  
 White Legend, Border,  
 and Florida Symbol

4/6/2021 2:02:12 PM

LAST REVISION	DESCRIPTION:
11/01/20	

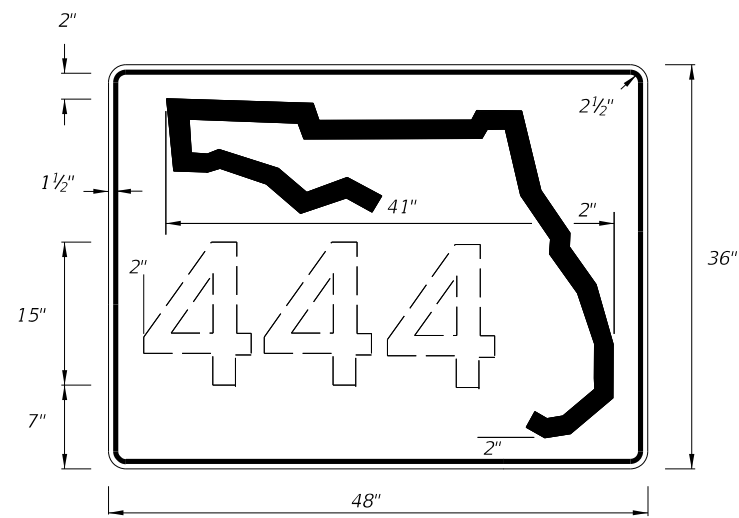

DIGITS	NUMERAL SIZE	SERIES LEGEND	PANEL SIZE
1-3	15"	C	48" x 36"
4	12"	C	48" x 36"

**NOTES:**

- Stroke width of State Outline shall be 1".
- 2 1/2" Radii

INDEPENDENT USE FOR FREEWAY

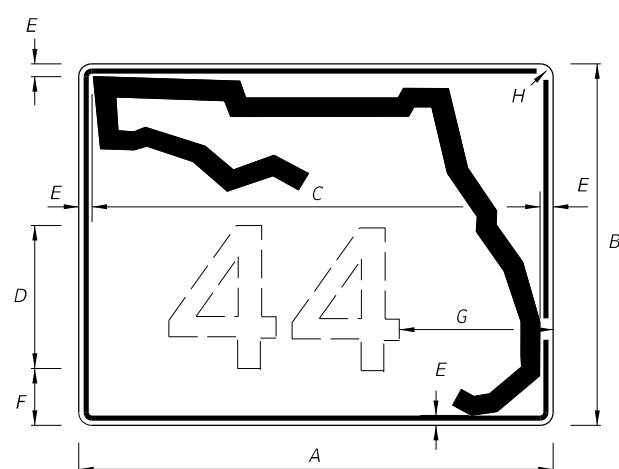

1 OR 2 DIGITS

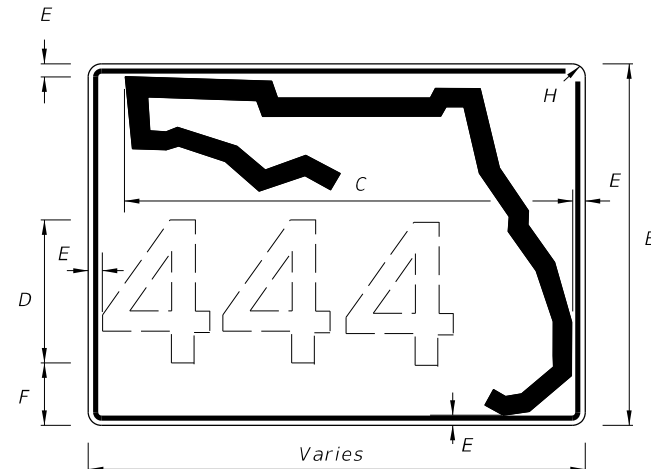

3 OR MORE DIGITS

**NOTES:**

- Florida marker shall have Black Legend with White Background.
- Stroke width of State outline shall be 1 3/4" for Guide Sign.
- Series D Legend.
- 5/8" Border

A	B	C	D	E	F	G	H
30"	24"	26"	12"	1 1/4"	2 3/4"	8 1/4"	1 1/4"
36"	30"	32"	15"	1 1/4"	3 1/4"	8 3/4"	1 1/4"
42"	36"	38"	15"	1 1/4"	6 1/4"	11"	1 1/4"

GUIDE SIGN USE

FTP-17-06 - FLORIDA ROUTE MARKER

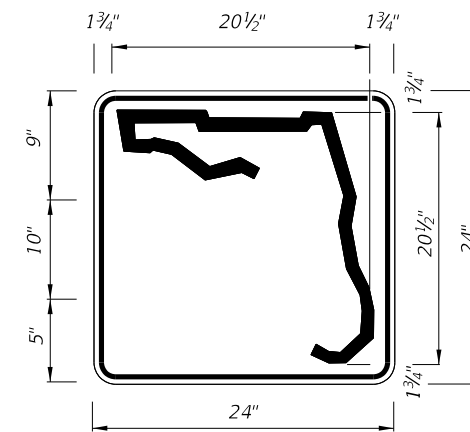

1 or 2 DIGITS

DIGITS	NUMERAL SIZE	SERIES LEGEND	PANEL SIZE
1-2	10"	D	24" x 24"

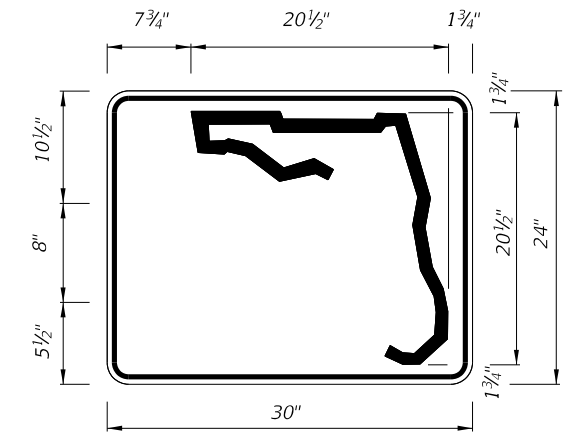

3 or 4 DIGITS

DIGITS	NUMERAL SIZE	SERIES LEGEND	PANEL SIZE
3	8"	D	30" x 24"
4	8"	C	30" x 24"

**NOTES:**

- Stroke width of State Outline shall be 1".
- The 24" X 24" panel shall only be used for a 3 digit route when the panel is to be used on a sign cluster with other 24" X 24" panels.
- 1 1/2" Radii

INDEPENDENT USE OTHER THAN FREEWAY

**NOTES:**

- Series D Legend.
- Color: Yellow Legend and Border on Blue Background.
- When used on a guide sign, marker must be overlaid on a rectangular Yellow Background as shown in chart.
- When two or more County Route Markers are mounted together, use the dimensions of the largest marker for all other markers.

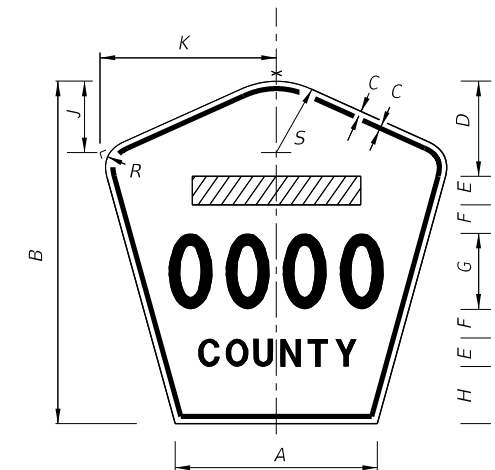

SIGN	DIMENSIONS													Rectangular Yellow Background Dimensions (See Note 3)
	A	B	C	D	E	F	G	H	J	K	R	S		
4 DIGIT POST MOUNTED	25 1/8"	42"	3/4"	10"	4"	4"	8"	8"	8 3/8"	22"	5"	8 3/4"		
2 DIGIT OVERHEAD	21 1/2"	36"	1/2"	7 1/2"	3"	3"	12"	4 1/2"	7 1/8"	18 1/8"	4 1/4"	7 1/2"	42" x 42"	
3 DIGIT OVERHEAD	25 1/8"	42"	3/4"	8"	4"	4"	12"	6"	8 3/8"	22"	5"	8 3/4"	48" x 48"	
4 DIGIT OVERHEAD	29 7/8"	48"	3/4"	8"	5"	5"	12"	8"	9 3/4"	25 5/8"	5 3/4"	10 1/4"	52" x 52"	

FTP-18-06 - COUNTY ROUTE MARKER (M1-6)

4/6/2021 2:02:31 PM

LAST REVISION	DESCRIPTION:
11/01/20	



FY 2021-22  
STANDARD PLANS

SPECIAL SIGN DETAILS

INDEX  
700-102-1

SHEET  
3 of 12



**FTP-19-06**  
 1' X 1'-6"  
 4" Radii 3/8" Border  
 Top 4" Series D  
 Bottom 2" Series C  
 White Background  
 Green Legend and Border

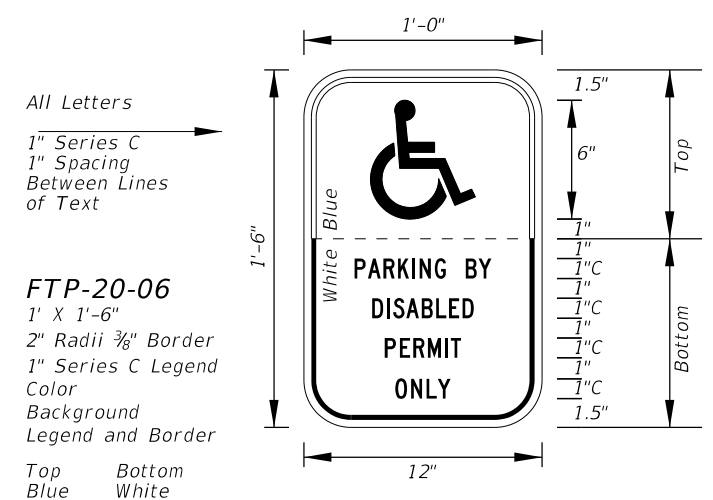

**FTP-20-06**  
 1' X 1'-6"  
 2" Radii 3/8" Border  
 1" Series C Legend  
 Color  
 Background  
 Legend and Border  
 Top Blue  
 Bottom White  
 White Black

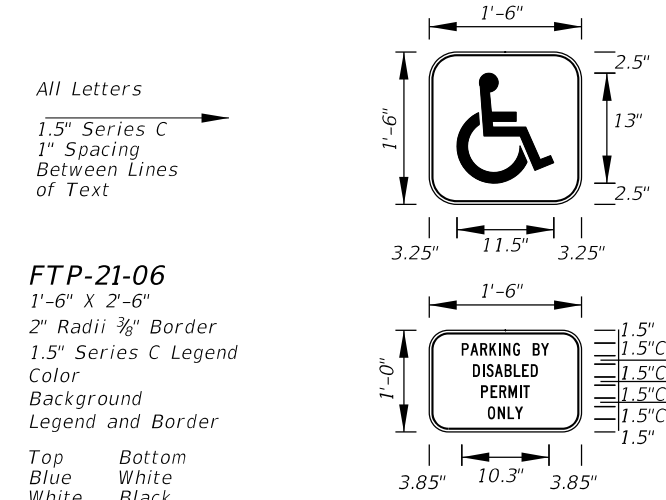

**FTP-21-06**  
 1'-6" X 2'-6"  
 2" Radii 3/8" Border  
 1.5" Series C Legend  
 Color  
 Background  
 Legend and Border  
 Top Blue  
 Bottom White  
 White Black

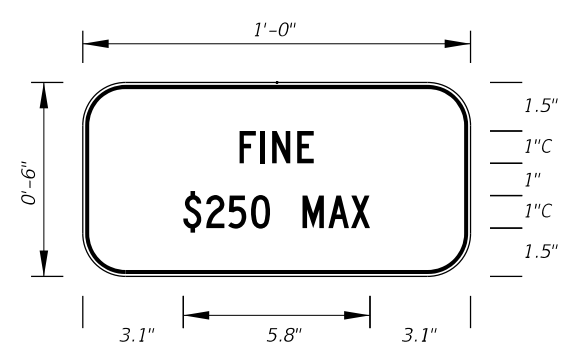

**FTP-22-06**  
 1' X 6"  
 1" Radii 3/8" Border  
 1" Series C Legend  
 White Background  
 Black Legend and Border  
 Supplemental Panel  
 for the FTP-20-06  
 and FTP-21-06 signs

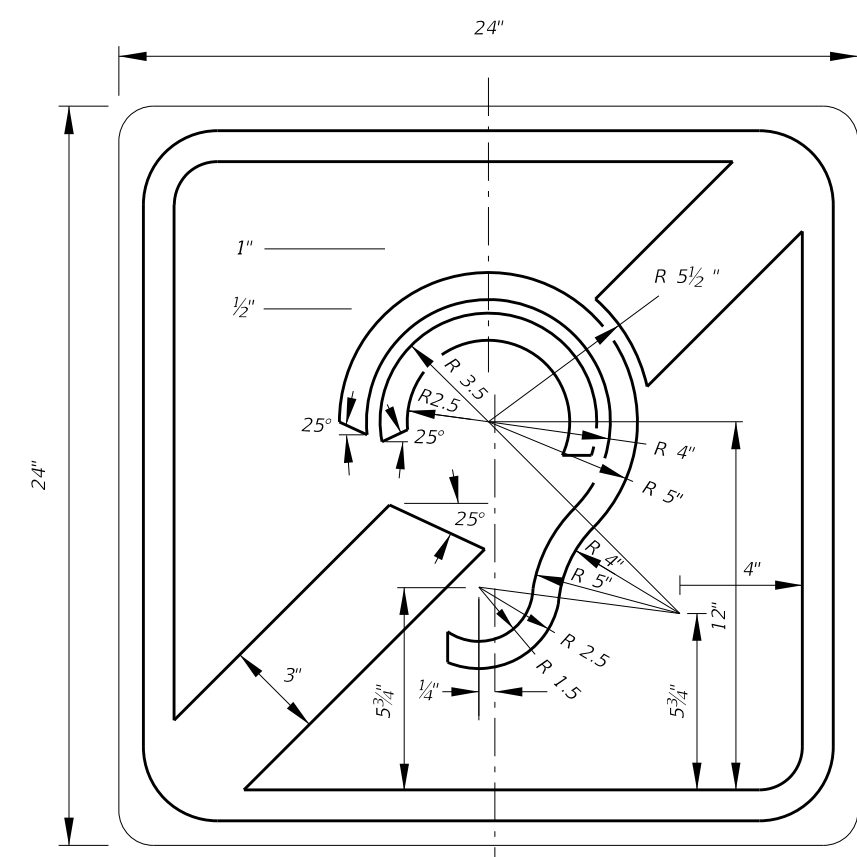

**FTP-23-06**  
 2' X 2'  
 1.5" Radii 5/8" Border  
 Blue Background  
 White Legend and Border

INTERNATIONAL SYMBOL OF  
 ACCESS FOR HEARING LOSS

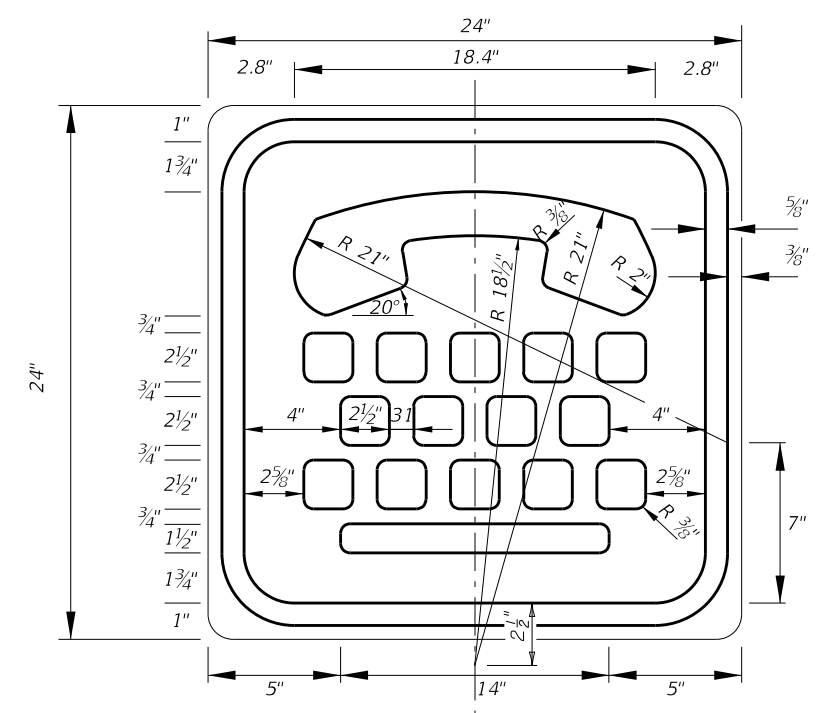

**FTP-24-06**  
 2' X 2'  
 1.5" Radii 5/8" Border  
 Blue Background  
 White Legend and Border

INTERNATIONAL TDD SYMBOL

4/6/2021 2:03:09 PM

LAST REVISION 11/01/20	REVISION	DESCRIPTION:		FY 2021-22 STANDARD PLANS	SPECIAL SIGN DETAILS	INDEX 700-102-1	SHEET 4 of 12
---------------------------	----------	--------------	--	------------------------------	----------------------	--------------------	------------------

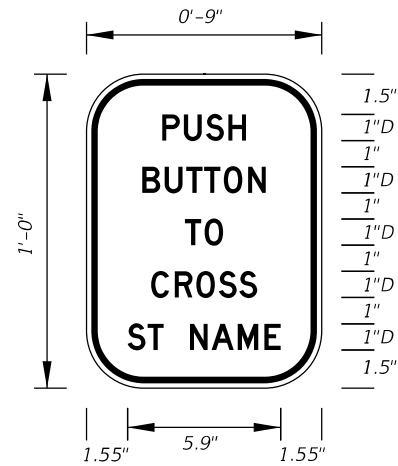

**FTP-25-06**  
 9" X 1'-0"  
 2" Radii 3/8" Border  
 1" Series D Legend  
 White Background  
 Black Legend and Border

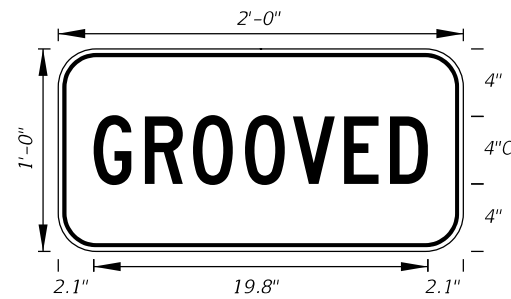

**FTP-29-06**  
 2'-0" X 1'-0"  
 2" Radii 5/8" Border  
 4" Series C Legend  
 Yellow Background  
 Black Legend and Border

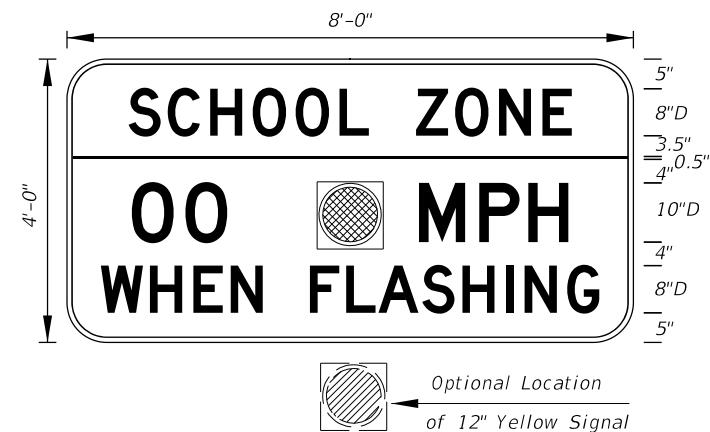

**FTP-31-06**  
 8' X 4'  
 6" Radii 3/4" Border  
 Series D Legend  
 Fluorescent Yellow-Green Background Top  
 White Background Bottom  
 Black Legend and Border

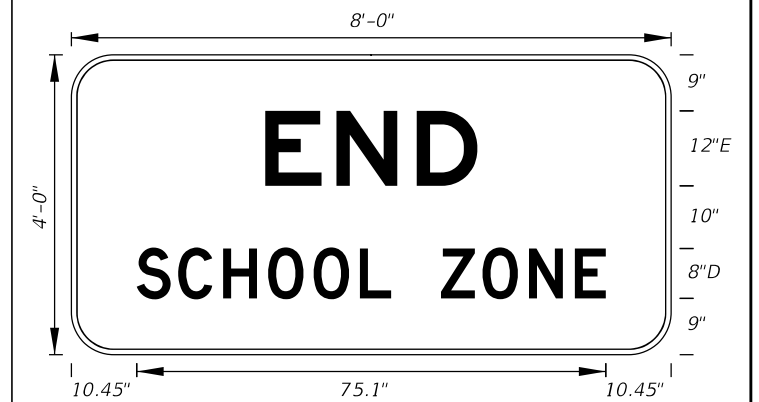

**FTP-32-06**  
 8' X 4'  
 6" Radii 3/4" Border  
 12" Series E and 8" Series D Legend  
 White Background  
 Black Legend and Border

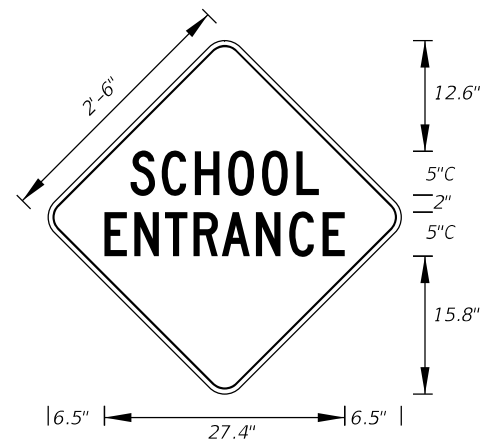

**FTP-33-06**  
 2'-6" X 2'-6"  
 2" Radii 3/4" Border  
 5" Series C Legend  
 Fluorescent Yellow-Green Background  
 Black Legend and Border

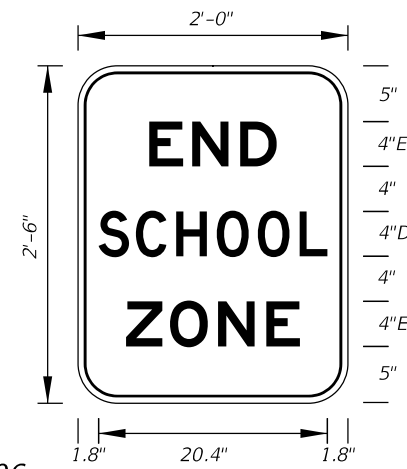

**FTP-34-06**  
 2' X 2'-6"  
 3" Radii 5/8" Border  
 4" Series D and E Legend  
 White Background  
 Black Legend and Border

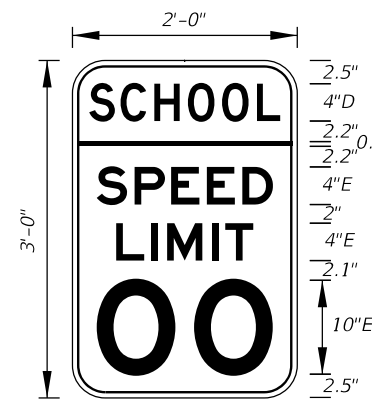

**FTP-35-06**  
 2' X 3'  
 3" Radii 5/8" Border  
 Top 4" Series D Legend  
 Bottom 4" and 10" Series E Legend  
 Fluorescent Yellow-Green Background Top  
 White Background Bottom  
 Black Legend and Border

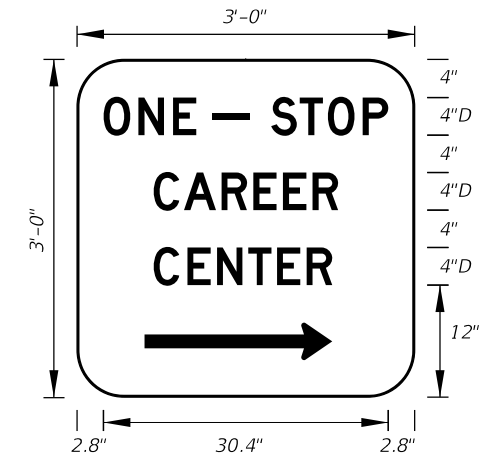

**FTP-36-06**  
 3' X 3'  
 5" Radii  
 4" Series D Legend  
 Green Background  
 White Legend and Border

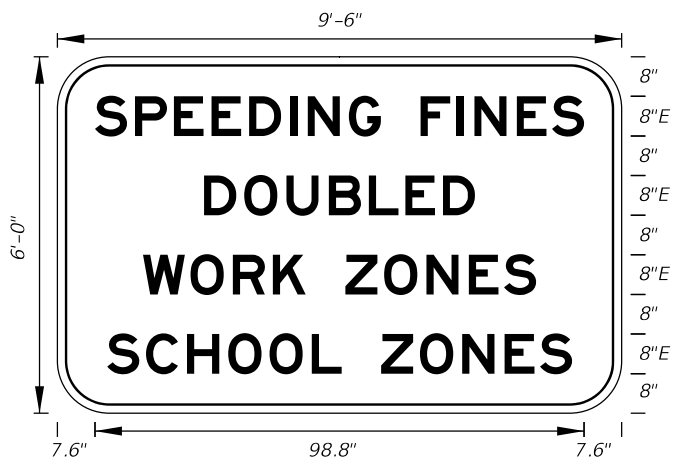

**FTP-37-06**  
 9'-6" X 6'  
 9" Radii 2" Border  
 8" Series E Legend  
 White Background  
 Black Legend and Border  
 State Line Sign

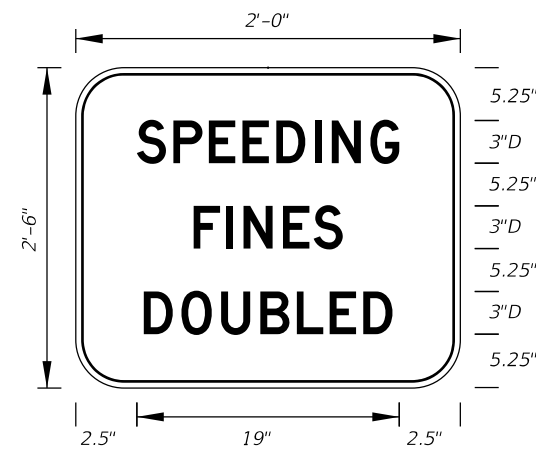

**FTP-38-06**  
 2' X 2'-6"  
 4" Radii 3/4" Border  
 3" Series D Legend  
 White Background  
 Black Legend and Border

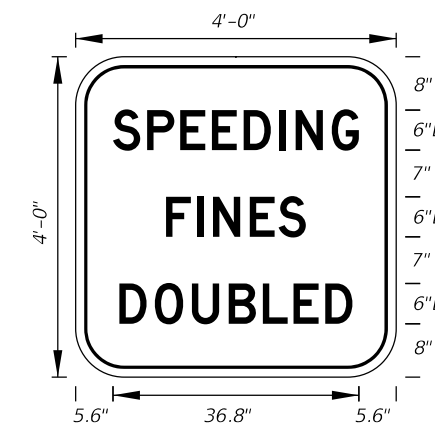

**FTP-39-06**  
 4' X 4'  
 6" Radii 3/4" Border  
 6" Series D Legend  
 White Background  
 Black Legend and Border  
 Freeway Sign

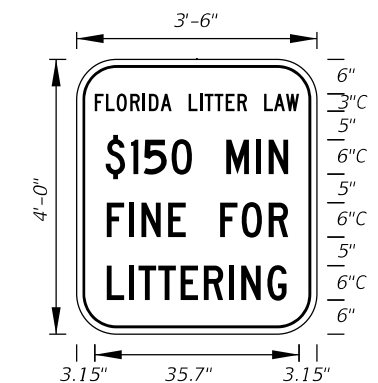

**FTP-40-21**  
 3'-6" X 4'  
 6" Radii 3/4" Border  
 3" and 6" Series C Legend  
 White Background  
 Black Legend and Border

4/6/2021 2:03:25 PM

LAST REVISION	DESCRIPTION:
04/06/21	Changed the fine amount on FTP-40-06.



FY 2021-22  
 STANDARD PLANS

SPECIAL SIGN DETAILS

INDEX SHEET  
 700-102-1 5 of 12



**FTP-41-21**  
2'-6" X 3'  
4" Radii 3/4" Border  
2" and 4" Series C Legend  
White Background  
Black Legend and Border



**FTP-42-06**  
4' X 2'-6"  
3" Radii  
Top 4" Series C Legend  
Bottom 2" Series EM Legend  
White Background  
Blue Legend and Border

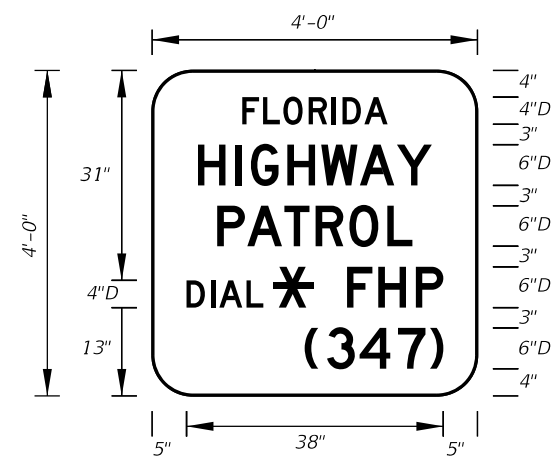

**FTP-43-06**  
4' X 4'  
6" Radii 1" Border  
Top 4" Series D Legend  
Bottom 6" Series D Legend  
Blue Background  
White Legend and Border



**FTP-44-06**  
9' X 6'  
9" Radii 3/4" Border  
8" Series D Legend  
White Background  
Black Legend and Border



**FTP-45-06**  
4' X 3'  
5" Radii 3/4" Border  
4" Series C Legend  
White Background  
Black Legend and Border

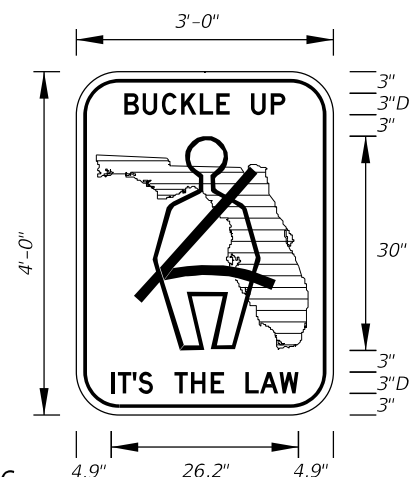

**FTP-46-06**  
3' X 4'  
5" Radii 3/4" Border  
3" Series D Legend  
White Background Green Florida Symbol  
Black Legend, Border and Man Belt Symbol

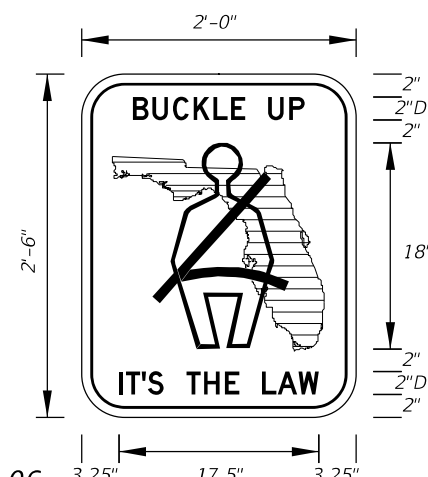

**FTP-47-06**  
2' X 2'-6"  
3" Radii 5/8" Border  
2" Series D Legend  
White Background Green Florida Symbol  
Black Legend, Border and Man Belt Symbol

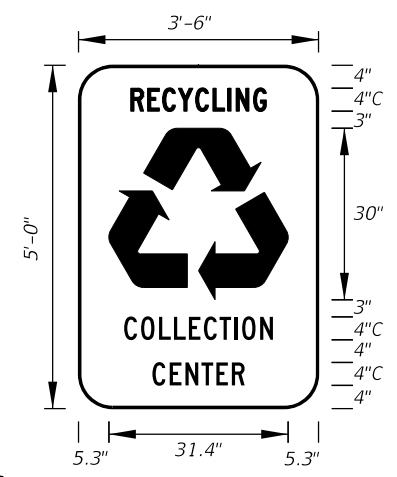

**FTP-48-06**  
3'-6" X 5'  
6" Radii  
4" Series C Legend  
Green Background  
White Legend, Border and Symbol

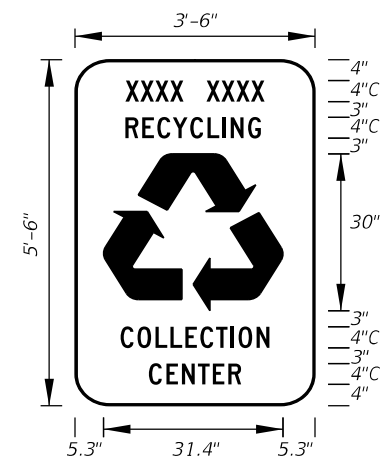

**FTP-49-06**  
3'-6" X 5'-6"  
6" Radii  
4" Series C Legend  
Green Background Municipality Name Optional  
White Legend, Border and Symbol

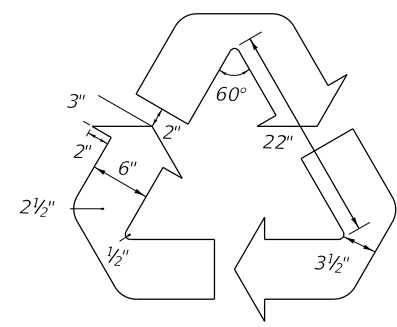

Detail for **FTP-48-06** and **FTP-49-06**

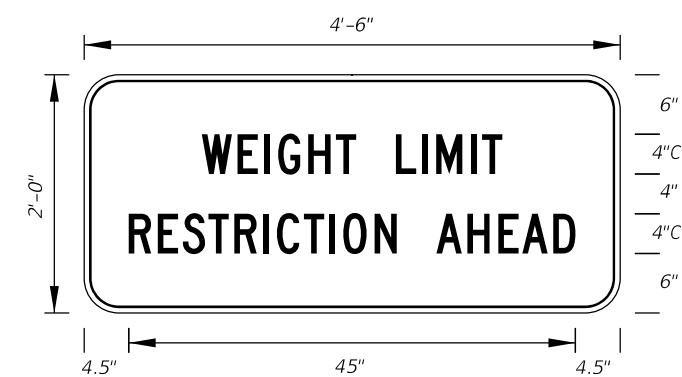

**FTP-50-06**  
4'-6" X 2'  
3" Radii 3/4" Border  
4" Series C Legend  
Yellow Background  
Black Legend and Border

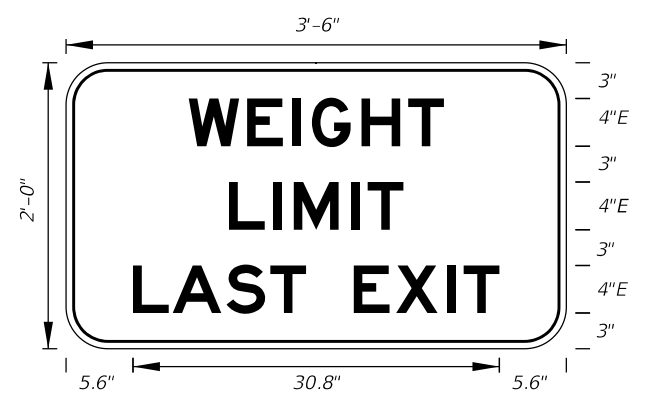

**FTP-51-06**  
3' X 2'  
3" Radii 3/4" Border  
4" Series E Legend  
White Background  
Black Legend and Border

4/6/2021 2:03:45 PM

LAST REVISION	DESCRIPTION:
04/06/21	Changed the fine amount on FTP-41-06.

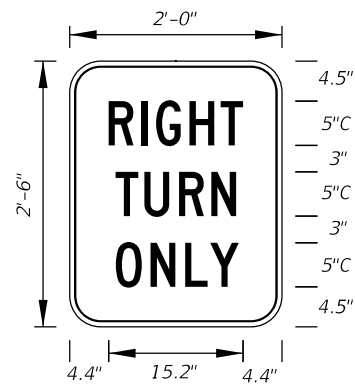

**FTP-52-06**  
2' X 2'-6"  
3" Radii 5/8" Border  
5" Series C Legend  
White Background  
Black Legend and Border

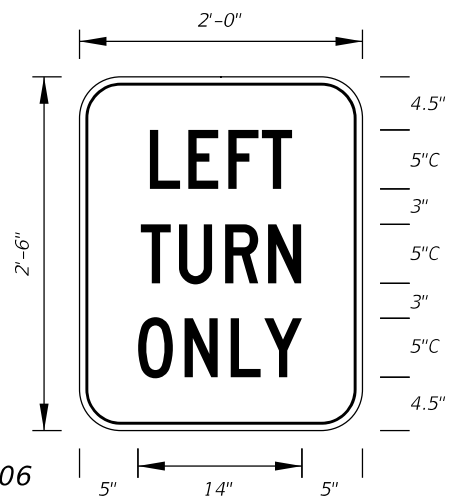

**FTP-53-06**  
2' X 2'-6"  
3" Radii 5/8" Border  
5" Series C Legend  
White Background  
Black Legend and Border

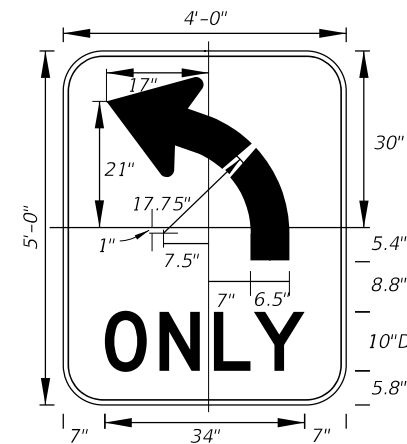

**FTP-54L-06**  
4' X 5'  
6" Radii 3/4" Border  
10" Series D Legend  
White Background  
Black Legend and Border  
FTP-54R-06 for (Right Turn Arrow)

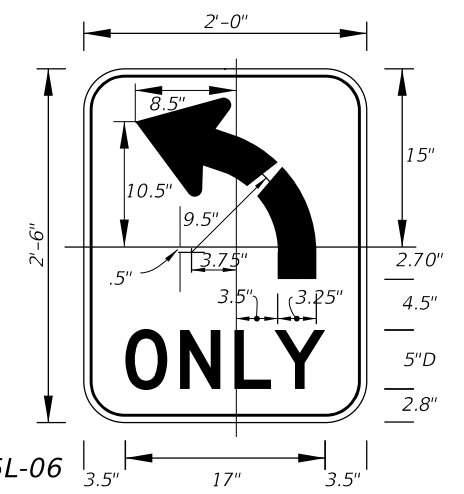

**FTP-55L-06**  
2' X 2'-6"  
3" Radii 3/8" Border  
5" Series D Legend  
White Background  
Black Legend and Border  
FTP-55R-06 for (Right Turn Arrow)

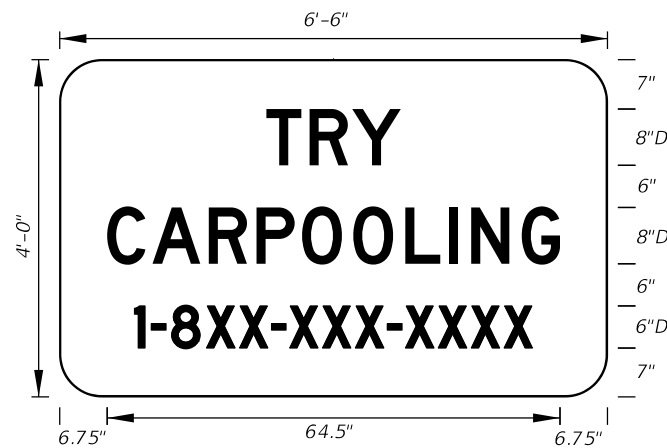

**FTP-56-06**  
6'-6" X 4'  
6" Radii 3/4" Border  
8" and 6" Series D Legend  
Blue Background  
White Legend and Border  
Design Project Manager or Transit Administrator will supply correct 1-8XX number.

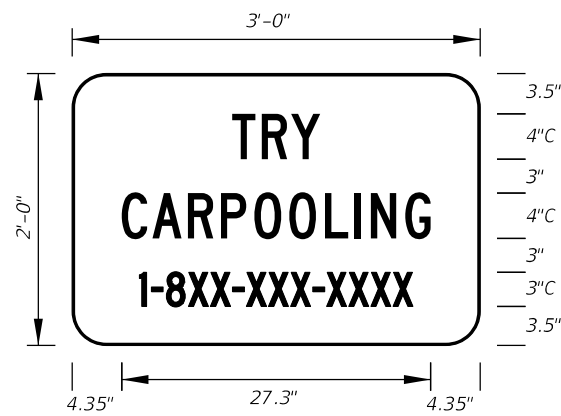

**FTP-56A-06**  
3' X 2'  
3" Radii  
4" and 3" Series C Legend  
Blue Background  
White Legend and Border  
Design Project Manager or Transit Administrator will supply correct 1-8XX number.

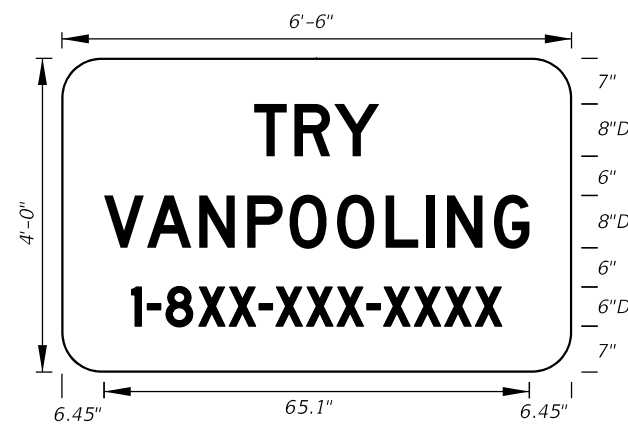

**FTP-57-06**  
6'-6" X 4'  
6" Radii  
8" and 6" Series D Legend  
Blue Background  
White Legend and Border  
Design Project Manager or Transit Administrator will supply correct 1-8XX number.

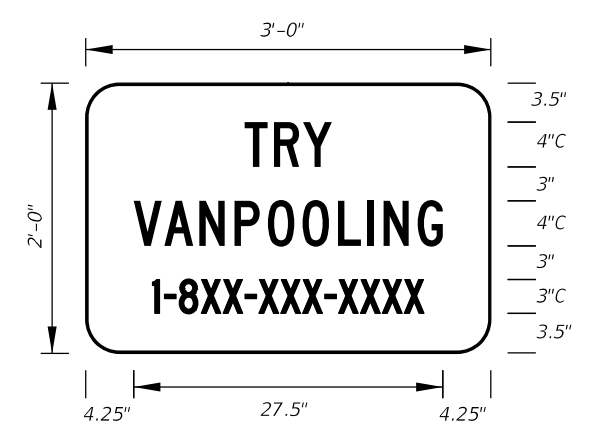

**FTP-58-06**  
3' X 2'  
3" Radii  
4" and 3" Series C Legend  
Blue Background  
White Legend and Border  
Design Project Manager or Transit Administrator will supply correct 1-8XX number.

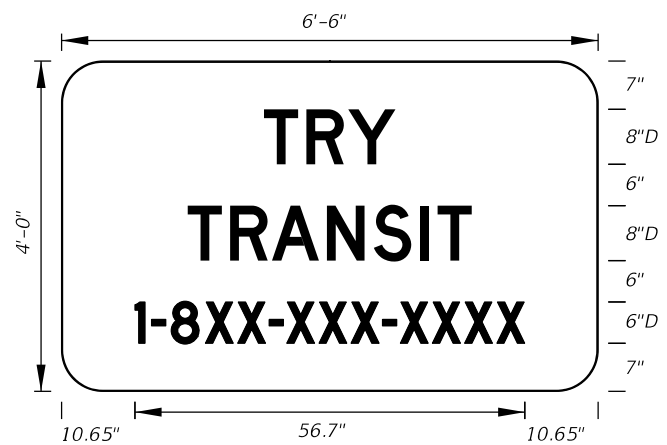

**FTP-59-06**  
6'-6" X 4'  
6" Radii  
8" and 6" Series D Legend  
Blue Background  
White Legend and Border  
Design Project Manager or Transit Administrator will supply correct 1-8XX number.

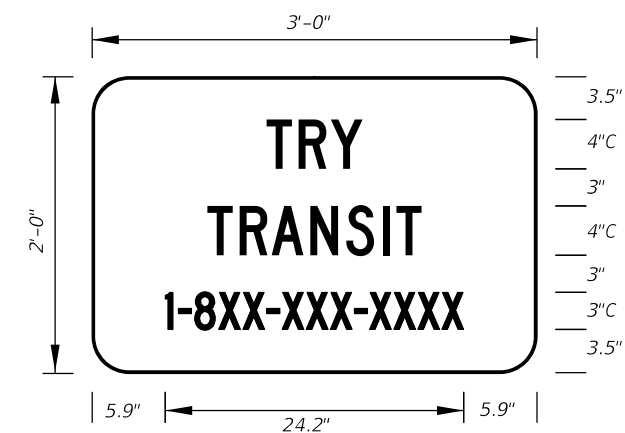

**FTP-60-06**  
3' X 2'  
3" Radii  
4" and 3" Series C Legend  
Blue Background  
White Legend and Border  
Design Project Manager or Transit Administrator will supply correct 1-8XX number.



**FTP-61-06**  
3' X 2'  
3" Radii 3/4" Border  
4" and 3" Series C Legend  
Yellow Background  
Black Legend and Border

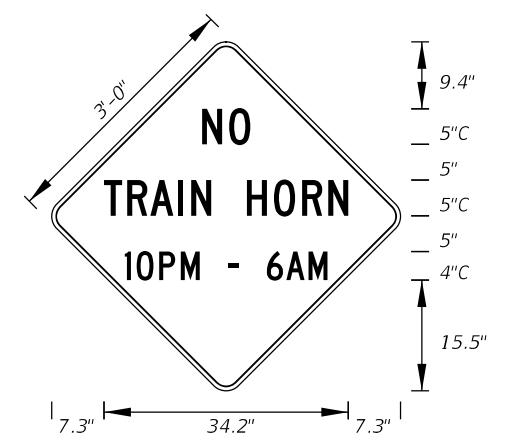

**FTP-62-06**  
3' X 3'  
2" Radii 3/4" Border 4" and 5" Series C Legend  
Yellow Background Black Legend and Border

4/6/2021 2:04:08 PM

LAST REVISION	DESCRIPTION:
11/01/20	



FY 2021-22  
STANDARD PLANS

SPECIAL SIGN DETAILS

INDEX  
700-102-1

SHEET  
7 of 12

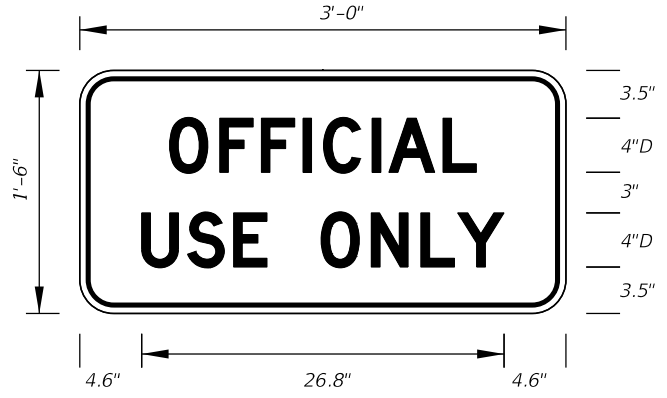

**FTP-65-06**  
 3' X 1'-6"  
 2" Radii 3/4" Border  
 4" Series D Legend  
 White Background  
 Black Legend and Border

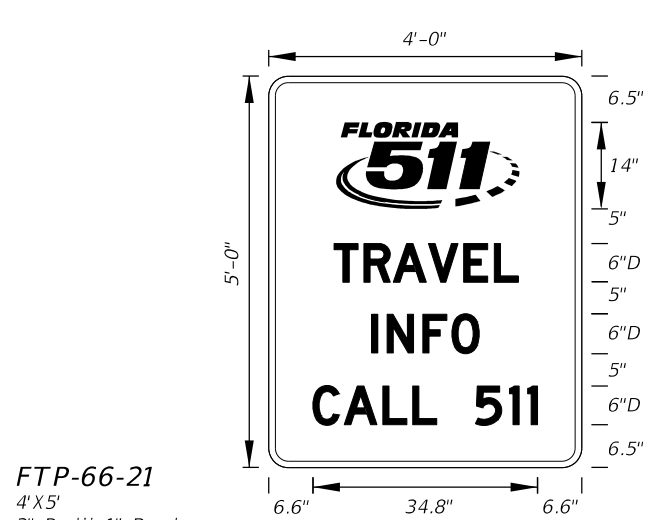

**FTP-66-21**  
 4' X 5'  
 3" Radii 1" Border  
 6" Series D Legend  
 Blue Background  
 White Legend and Border



**FTP-67-21**  
 5.5' X 6'  
 3" Radii 1" Border  
 8" Series D Legend  
 Blue Background  
 White Legend and Border



DETAIL for **FTP-66** AND **FTP-67**

Sign Mounting Holes Can Be Punched Or Field Drilled With No Obstruction To Text Or Symbols From Holes Or Bolts.

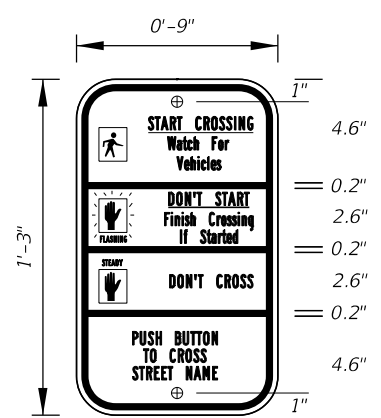

**FTP-68A-06**  
 9" X 1'-3"  
 1.5" Radii 3/4" Border  
 Series B Legend  
 White Background  
 Black Legend and Border

See Standard Highway Signs Manual, Sign R10-3b For Letter Size Spacing And Symbol Sizes.

Sign Mounting Holes Can Be Punched Or Field Drilled With No Obstruction To Text Or Symbols From Holes Or Bolts.

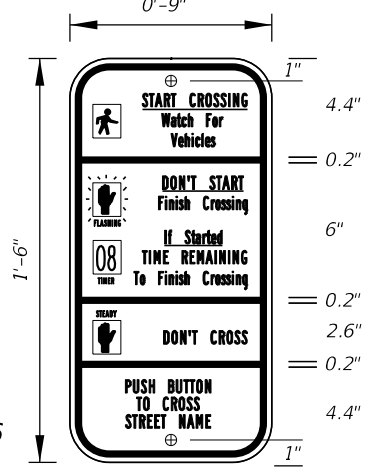

**FTP-68B-06**  
 9" X 1'-6"  
 1.5" Radii 3/4" Border  
 Series B Legend  
 White Background  
 Black Legend and Border

See Standard Highway Signs Manual, Sign R10-3b For Letter Size Spacing And Symbol Sizes.

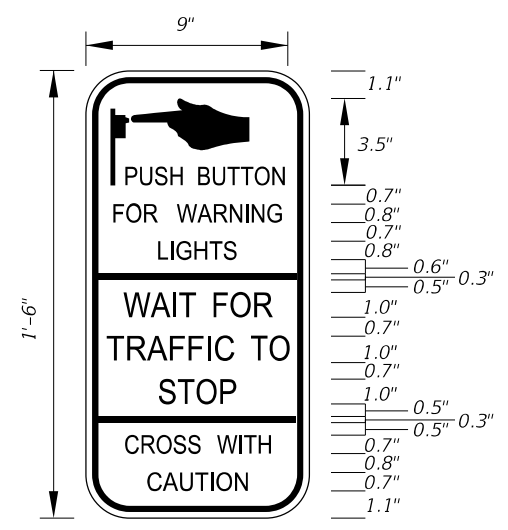

**FTP-68C-21**  
 9" X 1'-6"  
 1.5" Radii 1/4" Border

Series D Legend  
 White Background  
 Black Legend and Border

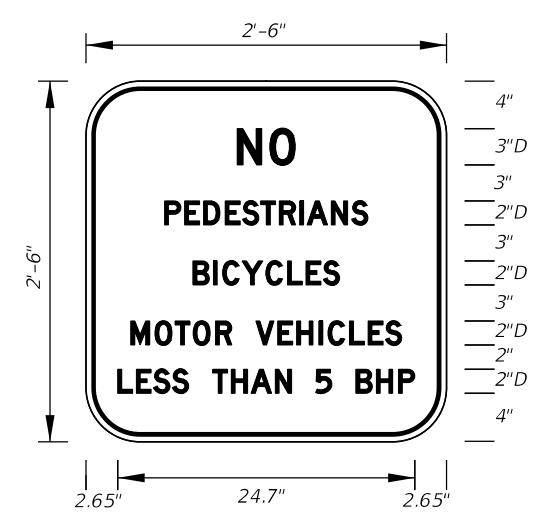

**FTP-69-06**  
 2'-6" X 2'-6"  
 4" Radii 3/4" Border

2" and 3" Series D Legend  
 White Background  
 Black Legend and Border

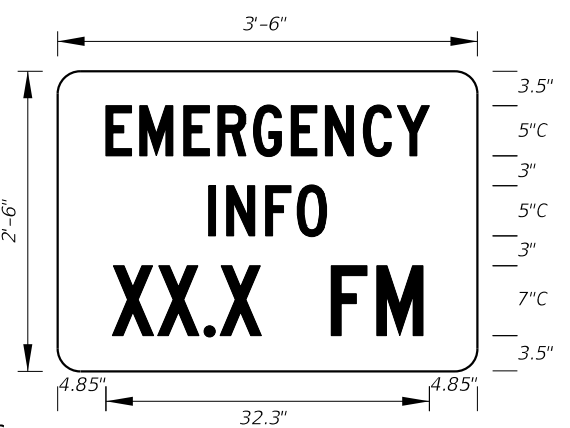

**FTP-70-06**  
 3'-6" X 2'-6"  
 2.25" Radii 3/4" Border  
 5" Series C and 7" Series C Legend  
 Blue Background  
 White Legend and Border

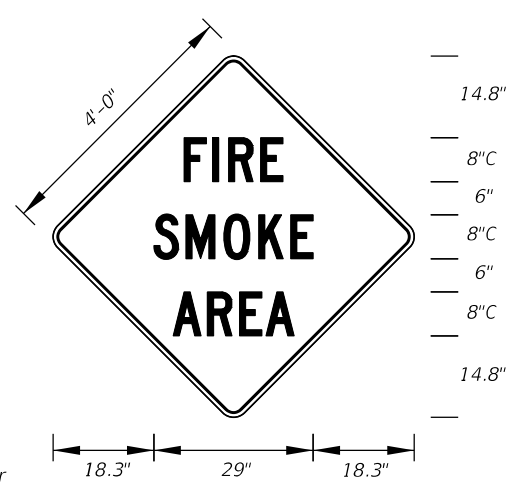

**FTP-71-06**  
 4' X 4'  
 2" Radii 3/4" Border  
 8" Series C Legend  
 Yellow Background  
 Black Legend and Border

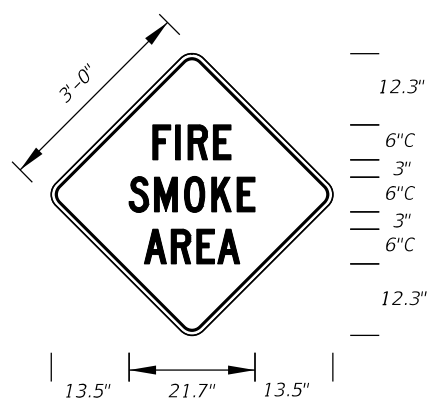

**FTP-72-06**  
 3' X 3'  
 2" Radii 3/4" Border

6" Series C Legend  
 Yellow Background  
 Black Legend and Border

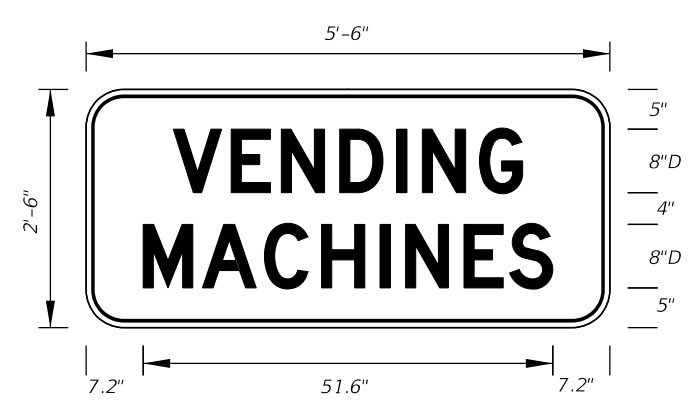

**FTP-73-06**  
 5'-6" X 2'-6"  
 4" Radii 3/4" Border

8" Series D Legend  
 Blue Background  
 White Legend and Border

4/6/2021 2:04:31 PM

LAST REVISION	DESCRIPTION:
11/01/20	





**FTP-74-06**  
 5'-6" X 2'-6"  
 4" Radii 3/4" Border  
 6" Series D Legend  
 Blue Background  
 White Legend and Border

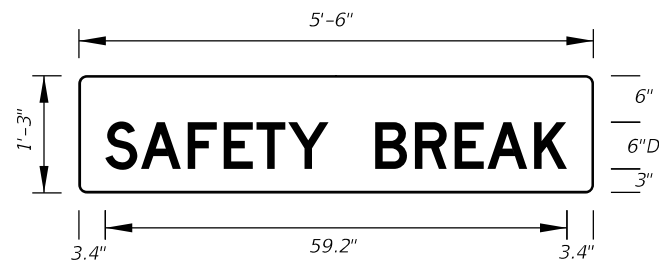

**FTP-75-06**  
 5'-6" X 1'-3"  
 1" Radii  
 6" Series D Legend  
 Blue Background  
 White Legend

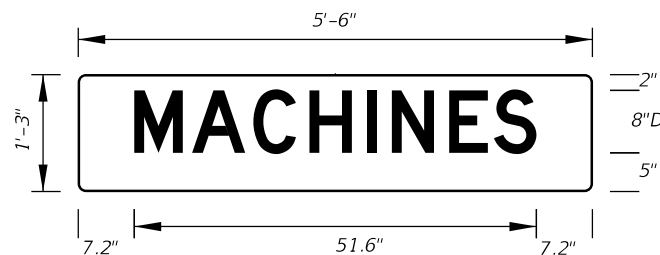

**FTP-76-06**  
 5'-6" X 1'-3"  
 1" Radii  
 8" Series D Legend  
 Blue Background  
 White Legend

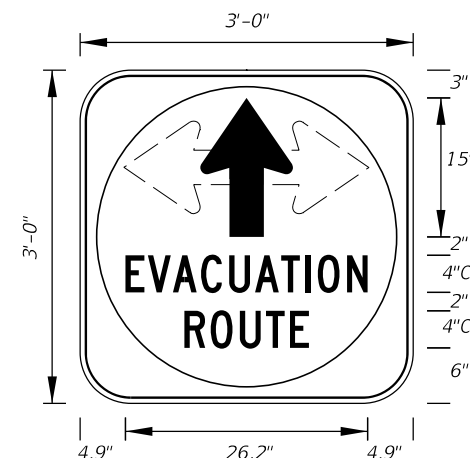

**FTP-77-06**  
 3' X 3'  
 5" Radii 3/4" Border  
 4" Series C Legend  
 White Background with Blue Circle Background  
 White Legend and Black Border

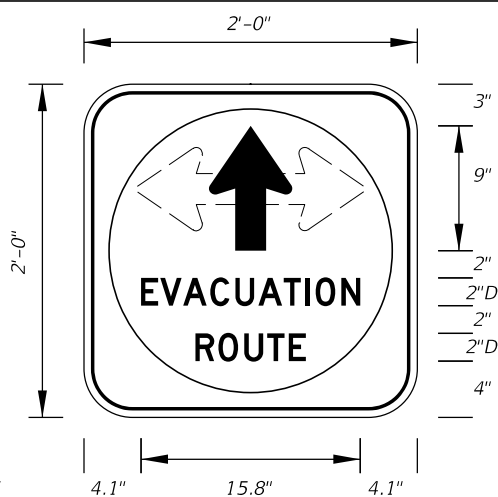

**FTP-78-06**  
 2' X 2'  
 3" Radii 3/4" Border  
 2" Series D Legend  
 White Background with Blue Circle Background  
 White Legend and Black Border

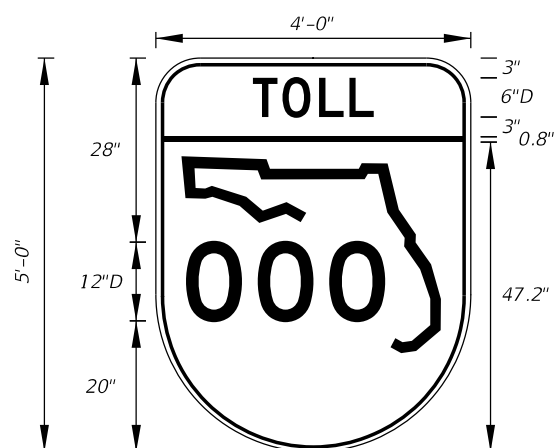

**FTP-79-06**  
 4' X 5'  
 6" Radii 3/4" Border  
 6" and 12" Series D Legend  
 Top Yellow Background with Black Legend and Black Border  
 Bottom White Background with Black Legend and Border

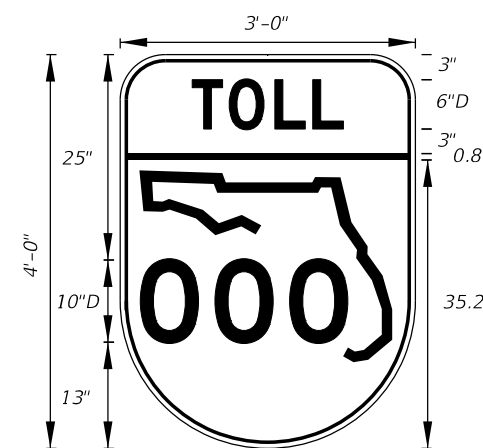

**FTP-80-06**  
 3' X 4'  
 5" Radii 3/4" Border  
 6" and 10" Series D Legend  
 Top Yellow Background with Black Legend and Black Border  
 Bottom White Background with Black Legend and Border

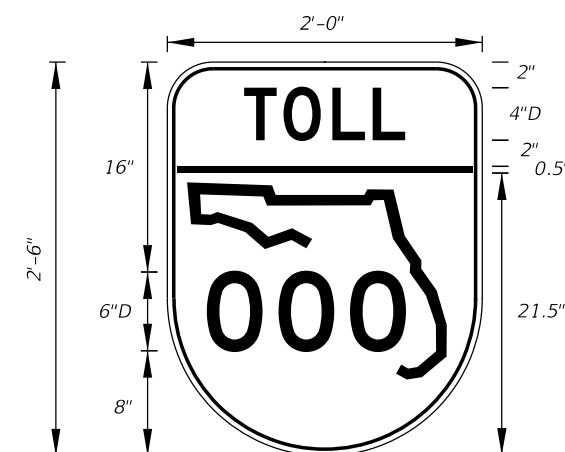

**FTP-81-06**  
 2' X 2'-6"  
 3" Radii 3/4" Border  
 4" and 6" Series D Legend  
 Top Yellow Background with Black Legend and Black Border  
 Bottom White Background with Black Legend and Border

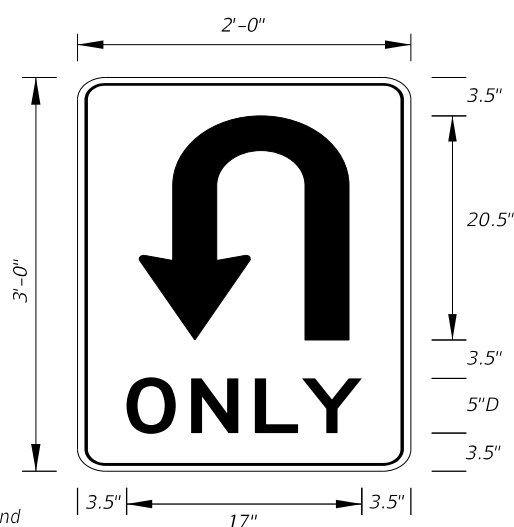

**FTP-82-08**  
 2' X 3'  
 1.5" Radii  
 5" Series D Legend  
 White Background  
 Black Legend and Border

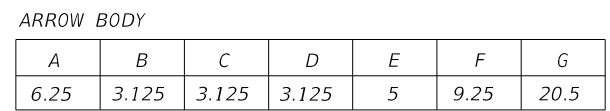
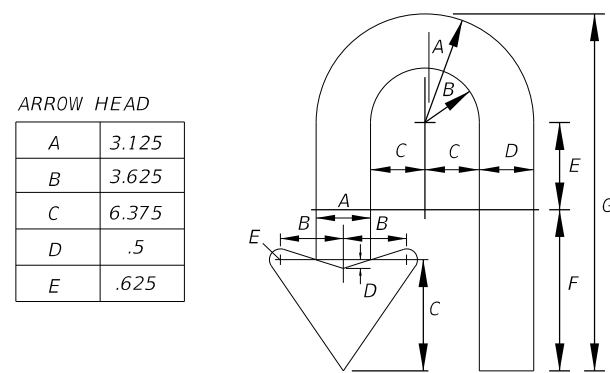

**FTP-82-08**  
 Details

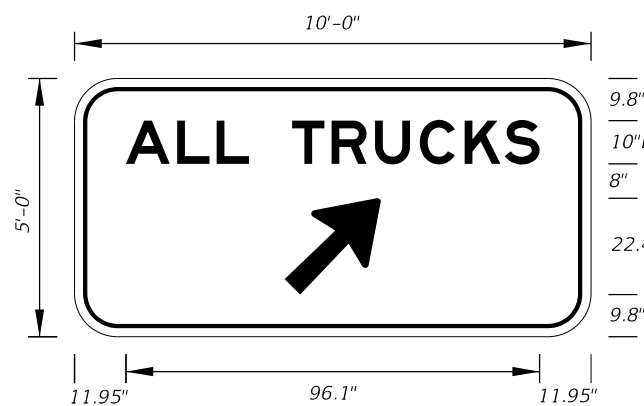

**FTP-83-06**  
 10'-0" X 5'-0"  
 8" Radii  
 10" Series E Legend  
 Green Background  
 White Legend

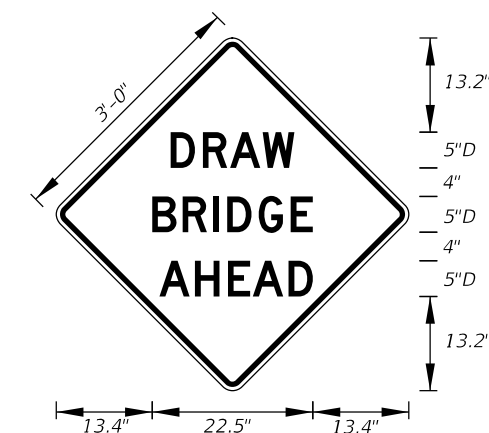

**FTP-84-09**  
 3' X 3'  
 1.5" Radii  
 5" Series D Legend  
 Yellow Background  
 Black Legend and Border

4/6/2021 2:05:00 PM

LAST REVISION	DESCRIPTION:
11/01/20	



FY 2021-22  
 STANDARD PLANS

SPECIAL SIGN DETAILS

INDEX	SHEET
700-102-1	9 of 12

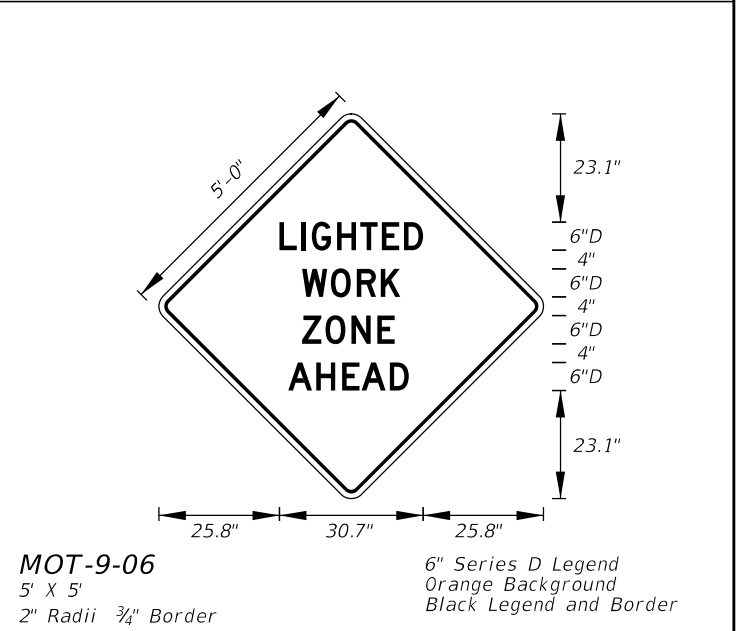
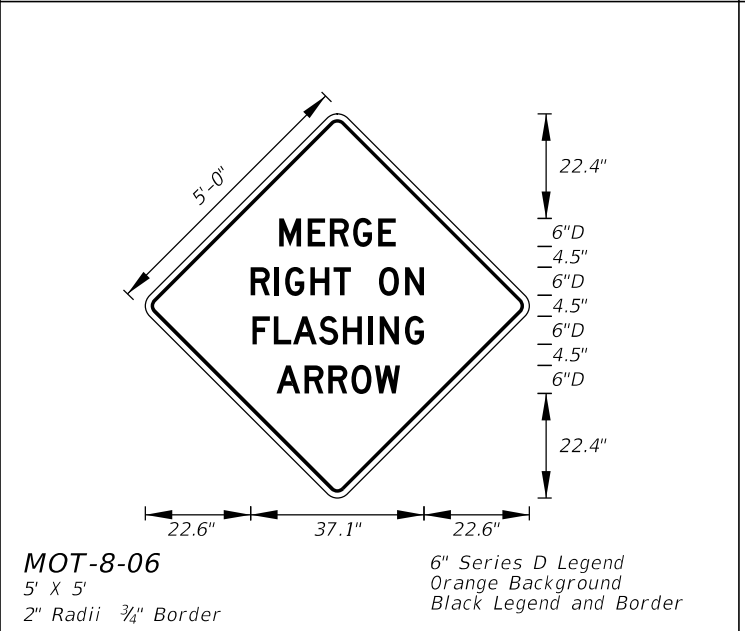
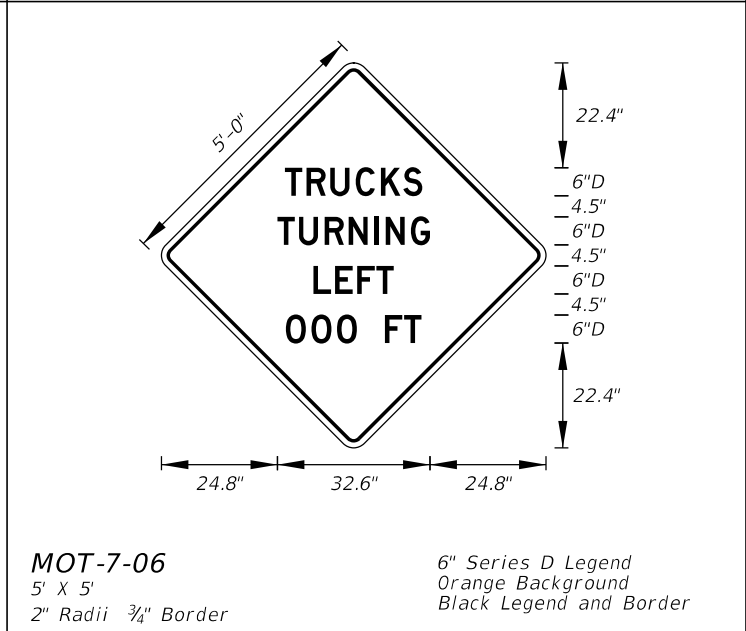
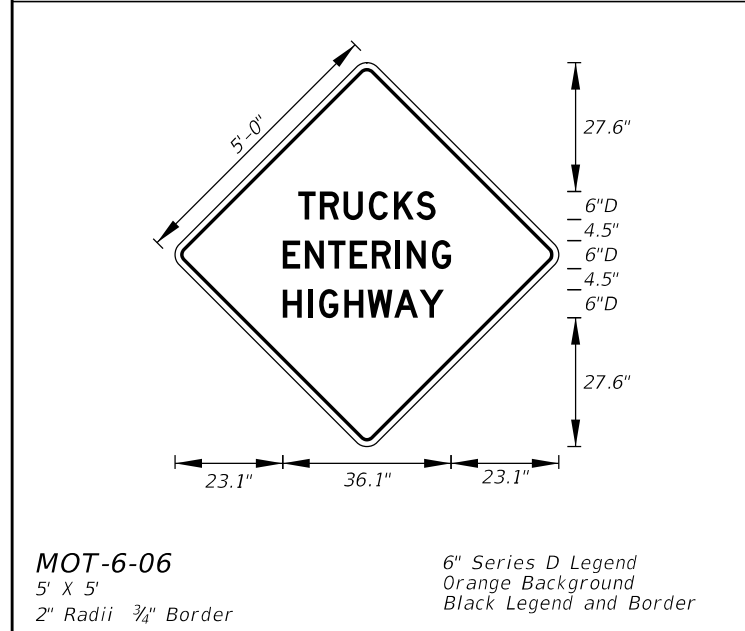
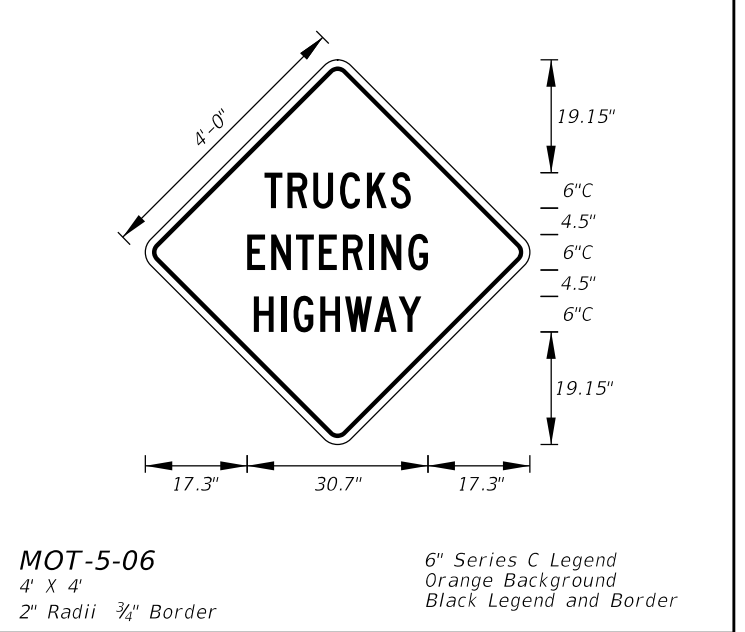
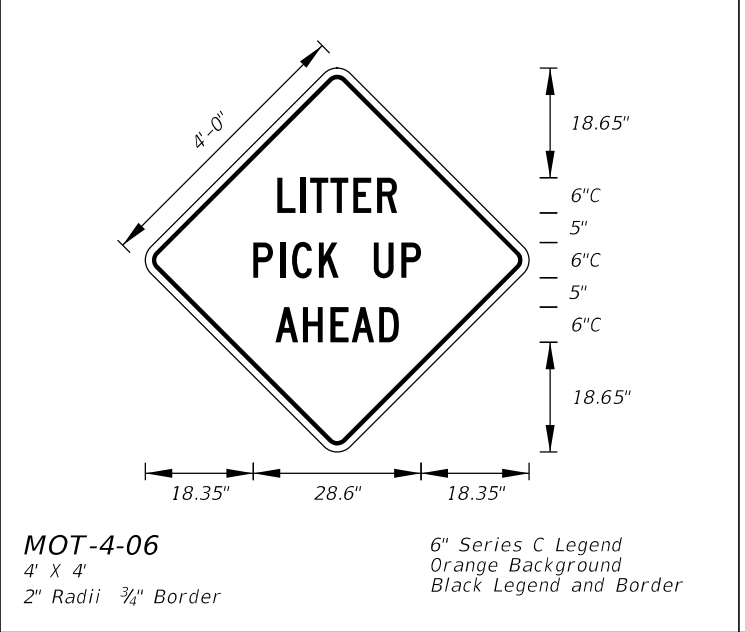
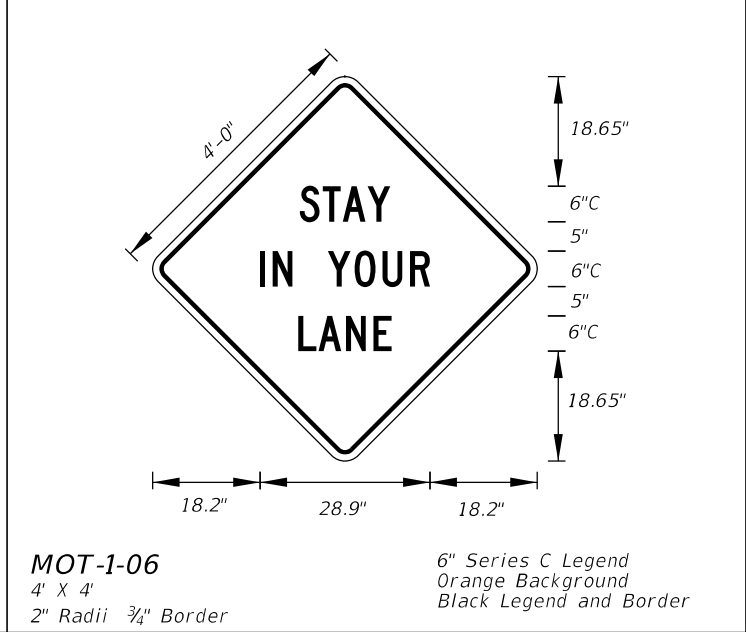
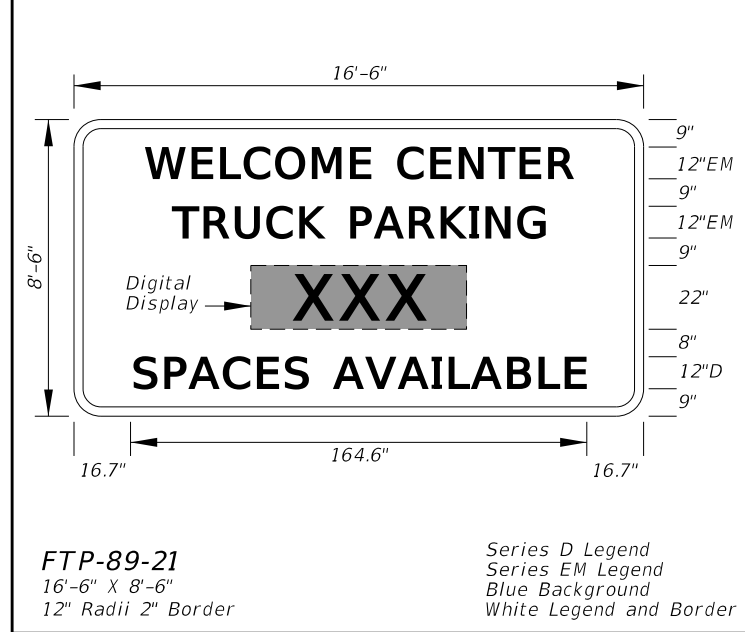
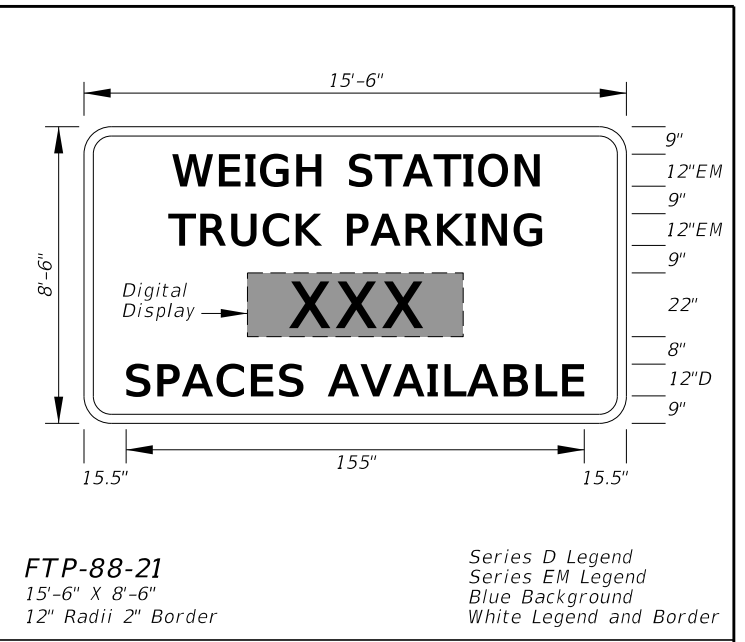
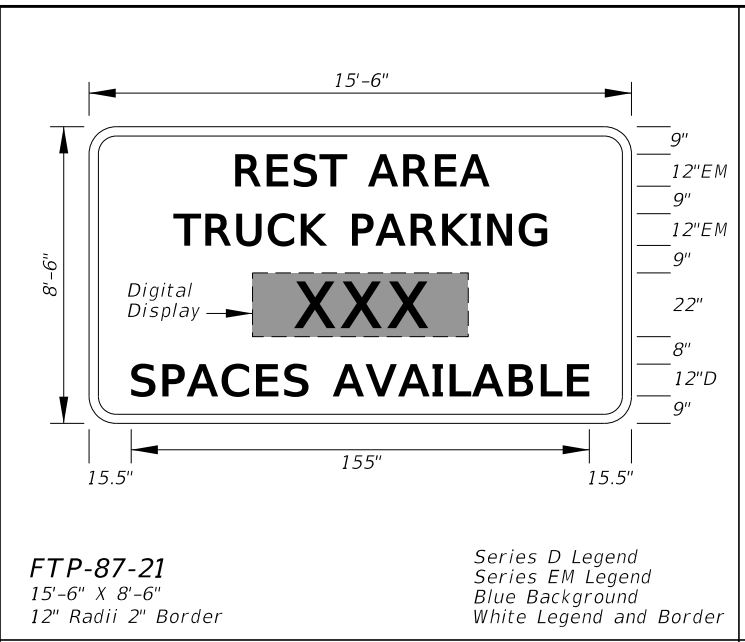
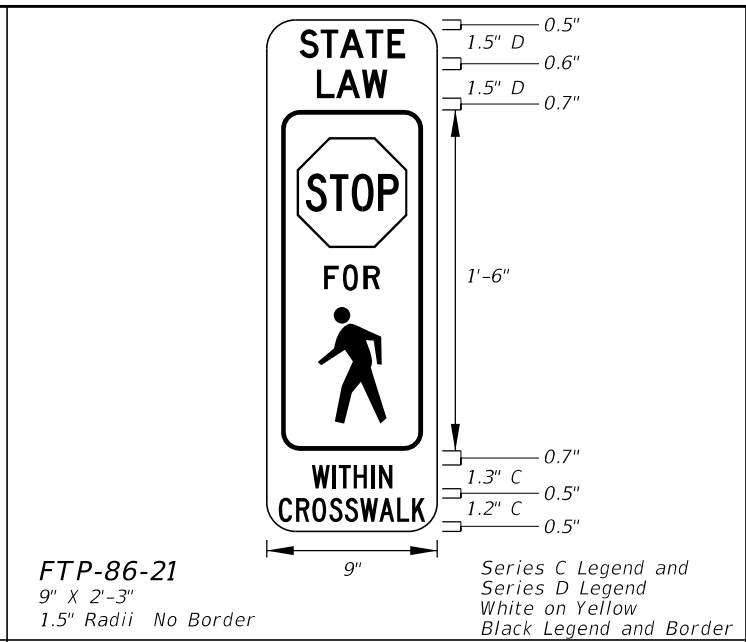
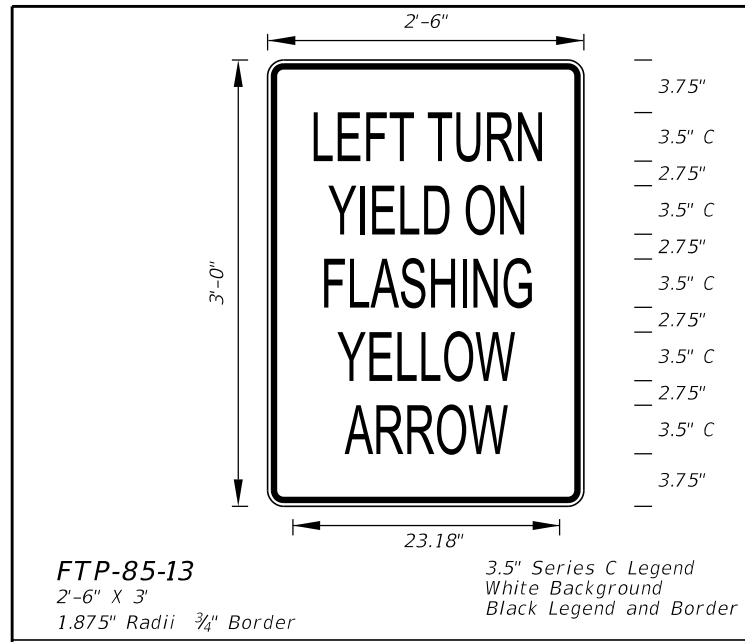

4/6/2021 2:05:32 PM

LAST REVISION	DESCRIPTION:
11/01/20	



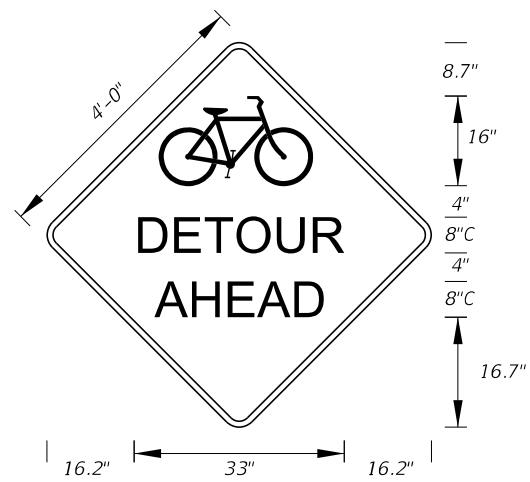

**MOT-20-21**  
 4' X 4'  
 3" Radii 3/4" Border  
 8" Series C Legend  
 Orange Background  
 Black Legend and Border

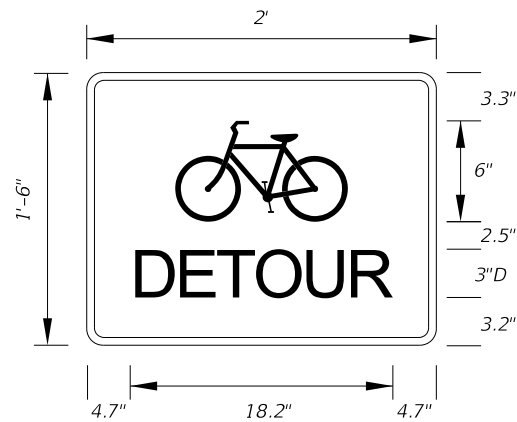

**MOT-21-21**  
 2' X 1'-6"  
 1.5" Radii 1/2" Border  
 3" Series D Legend  
 Orange Background  
 Black Legend and Border

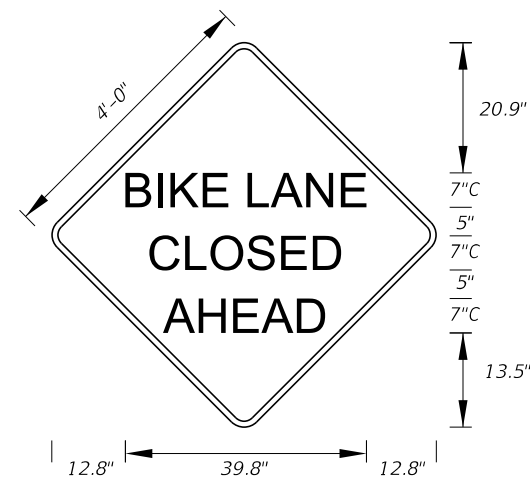

**MOT-22-21**  
 4' X 4'  
 3" Radii 3/4" Border  
 7" Series C Legend  
 Orange Background  
 Black Legend and Border

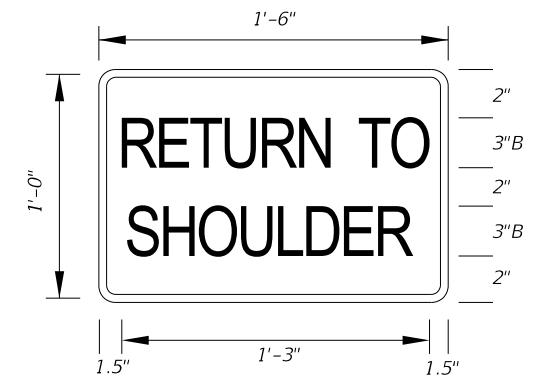

**MOT-23-21**  
 1'-6" X 1'-0"  
 1.5" Radii 1/4" Border  
 3" Series B Legend  
 Orange Background  
 Black Legend and Border

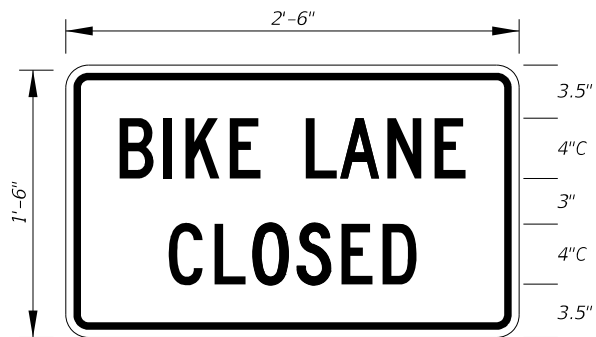

**MOT-24-21**  
 2'-6" X 1'-6"  
 1.5" Radii 1/2" Border  
 4" Series C Legend  
 White Background  
 Black Legend and Border



**MOT-25-21**  
 2'-0" X 1'-6"  
 1.5" Radii 1/2" Border  
 4" Series B Legend  
 White Background  
 Black Legend and Border

4/6/2021 2:06:16 PM