

PLAN
 (Rails, Posts and Reinforcing Steel not shown for clarity)

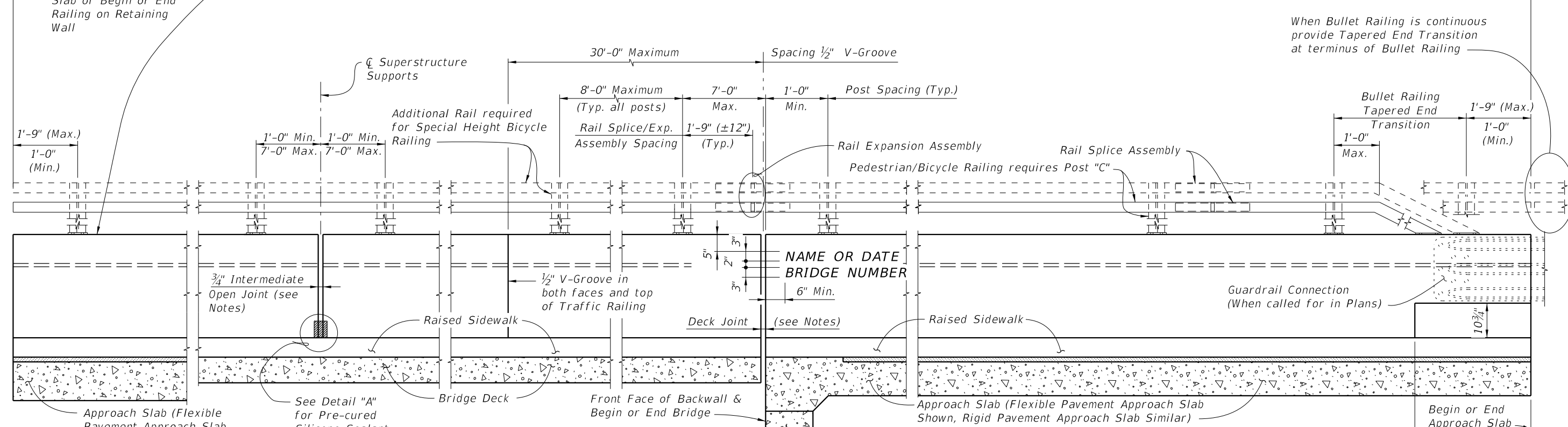

ELEVATION OF INSIDE FACE OF RAILING
 (Reinforcing Steel not shown for clarity)

TRAFFIC RAILING NOTES

1. Materials: See Structures Plans, General Notes
2. Guardrail Connection Details: See Index 534-001
3. Traffic Railings may be constructed perpendicular to the sidewalk surface. If an adjoining railing is constructed plumb, transition the end of the Traffic Railing from perpendicular to plumb over a minimum distance of 20'-0". The cost of all modifications will be at the Contractor's expense.
4. Name, Date & Bridge Number: Place the Name and Bridge Number on the Traffic Railing on the driver's right side when approaching the bridge. Place the Date on the driver's left side when approaching the bridge. Use the Name as shown in the General Notes of the Structures Plans. The Date is the year the bridge is completed. For a widening when the existing railing is removed, use both the date on the removed rail and the year of the widening. Form letters and figures with 3/8" V-Grooves using preformed letters and figures. Black plastic letters and figures 3" tall may be used, if approved by the Engineer.
5. Open Joints: See the Superstructure Plans, Approach Slab and Retaining Wall Sheets for Deck Joint dimensions and orientation. Provide Open Railing Joints matching the dimensions of the Deck Joint at Deck Expansion Joint locations.
 - A. For treatment of railings on skewed bridges see Sheet 3.
6. Open Joints: Provide 3/4" Open Joints at:
 - A. Superstructure supports where the slab is continuous.
 - B. At ends of approach slabs when adjacent to retaining walls and at expansion joints on retaining wall junction slabs.

7. V-Grooves: Construct 1/2" V-Grooves plumb. Space V-Grooves equally between 3/4" Open Joints and/or Deck Joints and the at V-Groove locations on the Retaining Wall footing/junction slabs.
8. Barrier Delineators: Install Barrier Delineators on top of the Traffic Railing 2" from the face of the traffic side in accordance with Specification Section 705. Match the Barrier Delineator to the color (white or yellow) of the near edgeline.
9. For embedded conduit and junction boxes see Index 630-010.
10. For Traffic Railings with Pedestrian/Bicycle Bullet Railings see Index 515-021 and 515-022 for Notes, Details and post spacing.

CROSS REFERENCE:
 For Section A-A and View B-B, see Sheet 2.
 For Detail "A" see Sheet 3.

10/8/2020 9:58:22 AM

LAST REVISION 11/01/20	REVISION	DESCRIPTION:	 FY 2021-22 STANDARD PLANS	TRAFFIC RAILING - (32" VERTICAL SHAPE)	INDEX 521-423	SHEET 1 of 3
---------------------------	----------	--------------	--	---	------------------	-----------------

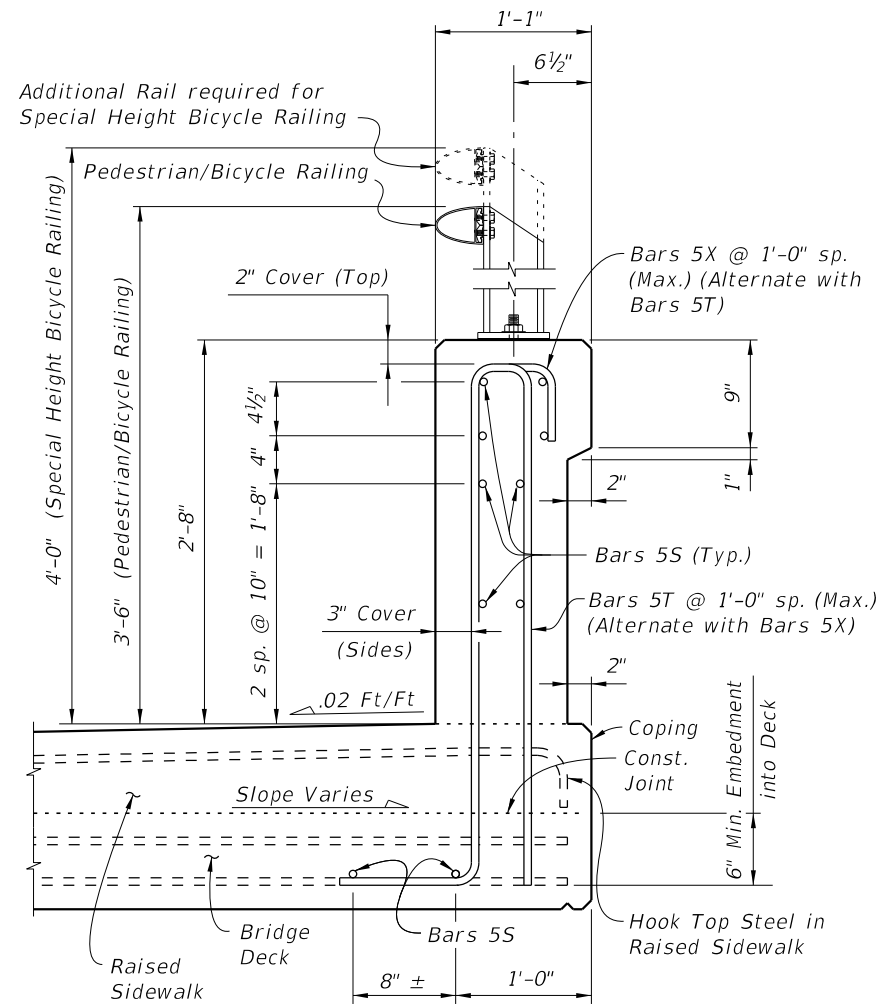

SECTION A-A
TYPICAL SECTION THRU TRAFFIC RAILING
(Section Thru Bridge Deck shown)

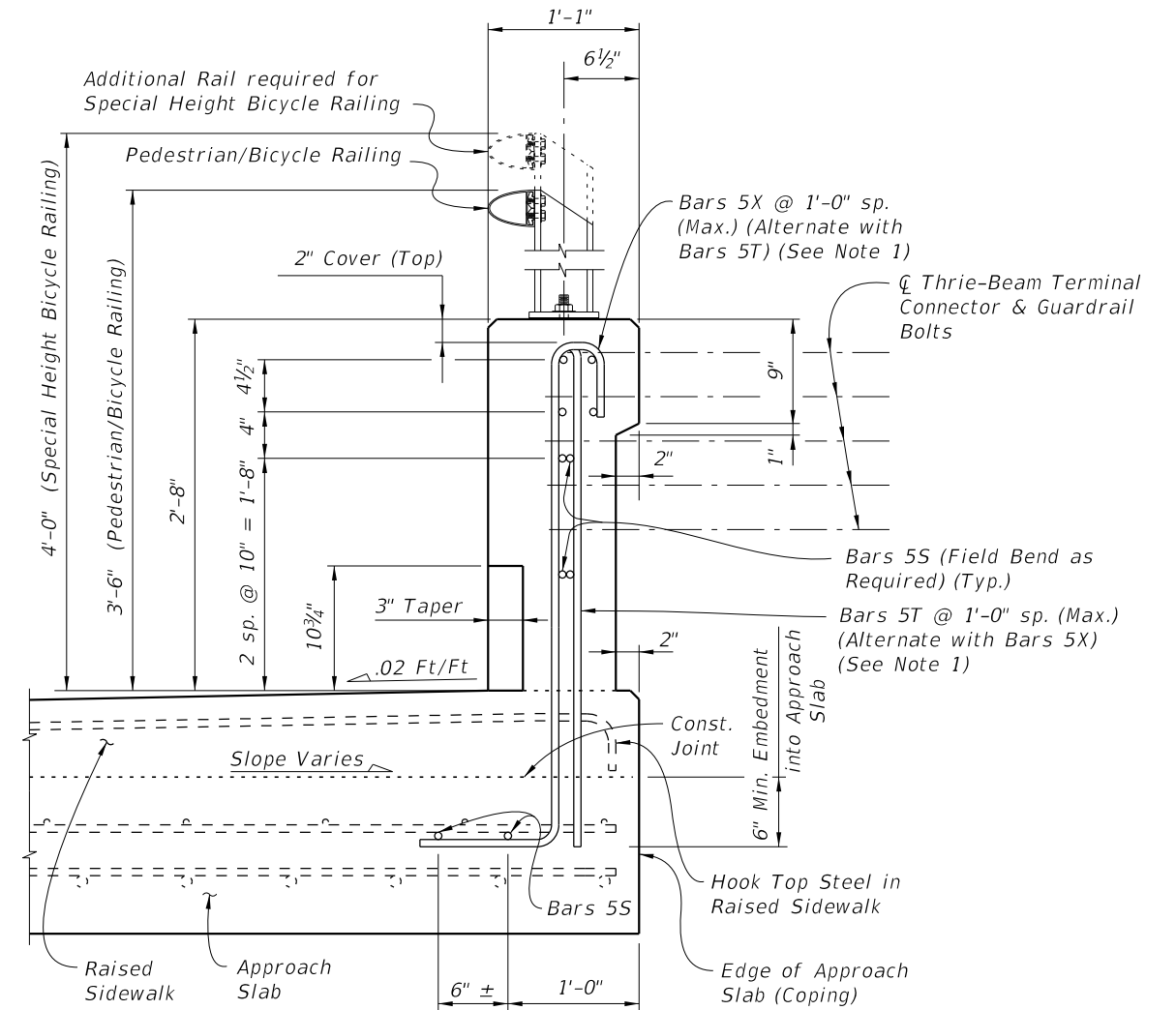

VIEW B-B
APPROACH SLAB END VIEW
OF TRAFFIC RAILING

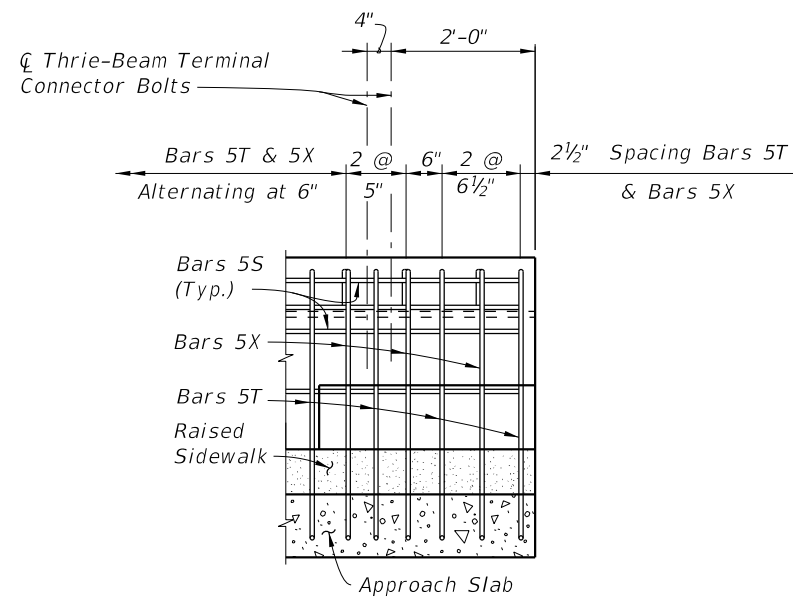

RAILING END DETAIL
(Guardrail Not Shown For Clarity)

CROSS REFERENCE:
For location of Section A-A and View B-B
see Sheet 1.

NOTE: For Bullet Railing Details,
see Index 515-022.

NOTES:

1. Begin placing Railing Bars 5T and 5X on Approach Slab at the railing end and proceed toward Begin or End Bridge to avoid conflict with guardrail bolt holes. If required, adjustments to the bar spacing for Bars 5T and 5X shall be made immediately adjacent to Begin or End Bridge. Cut, shift and rotate Bars 5T and 5X as required to maintain cover in Railing End Transition.
2. Omit Railing End Transition and Guardrail if Concrete Traffic Railing is used beyond the Approach Slab or Retaining Wall. See Structures Plans, Plan and Elevation Sheet and Roadway Plans. If Taper and Railing End Transition is omitted, extend Typical Section to end of the Approach Slab or limiting station on Retaining Wall, and space Bars 5T and 5X at 1'-0" (Typ.)

10/01/2020 9:58:24 AM

LAST REVISION 11/01/17	REVISION	DESCRIPTION:	 FY 2021-22 STANDARD PLANS	TRAFFIC RAILING - (32" VERTICAL SHAPE)	INDEX 521-423	SHEET 2 of 3
---------------------------	----------	--------------	---	--	------------------	-----------------

CONVENTIONAL REINFORCING STEEL BENDING DIAGRAMS

BILL OF REINFORCING STEEL		
MARK	SIZE	LENGTH
S	5	As Req'd.
T	5	9'-0"
X	5	5'-10"

ROADWAY CROSS-SLOPE	ØA	
	LOW GUTTER	HIGH GUTTER
0% to 2%	90°	90°
2% to 6%	87°	93°
6% to 10%	84°	96°

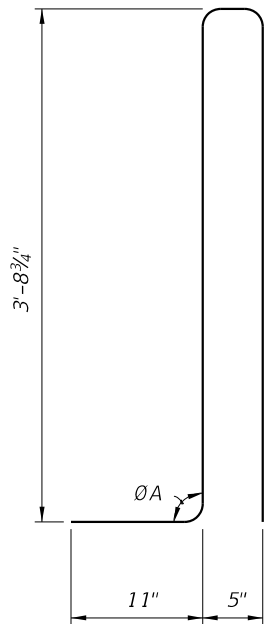

STIRRUP BAR 5T

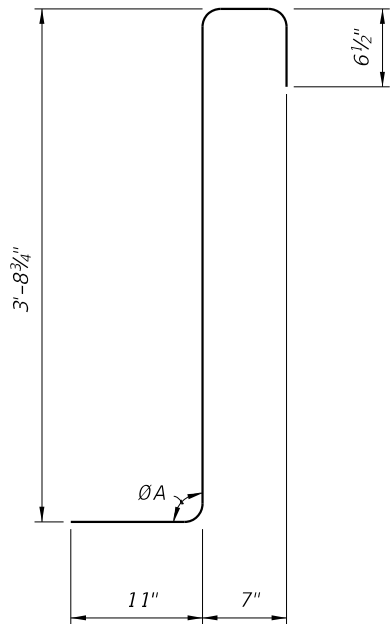

STIRRUP BAR 5X

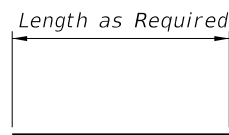

BAR 5S

REINFORCING STEEL NOTES:

- All bar dimensions in the bending diagrams are out to out.
- The 3'-8 3/4" vertical dimensions shown for Bars 5T and 5X are based on a bridge deck with a 6" thick x 6' wide raised sidewalk at low side of deck, 2% deck cross slope and a counter 2% raised sidewalk cross slope. If the raised sidewalk thickness, width or cross slopes vary from the above amounts, adjust these vertical dimensions accordingly to achieve a 6" minimum embedment into the bridge deck.
- The reinforcement for the railing on a Retaining Wall shall be the same as detailed with ØA = 90°.
- All reinforcing steel at the open joints shall have a 2" minimum cover.
- Bars 5S may be continuous or spliced at the construction joints. Bar splices for Bars 5S shall be a minimum of 2'-2".
- The Contractor may utilize Welded Wire Reinforcement (WWR) when approved by the Engineer. WWR must consist of Deformed wire meeting the requirements of Specification Section 931.

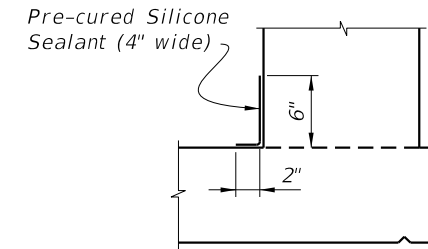

DETAIL "A" - SECTION AT INTERMEDIATE OPEN JOINT

INTERMEDIATE JOINT SEAL NOTES:

- At Intermediate Open Joints, seal the lower 6" portion of the open joint with Pre-cured Silicone Sealant in accordance with Specification Section 932.
- Apply sealant prior to any Class V finish coating and remove all curing compound and loose material from the surface prior to application of bonding agent.
- The cost of the Pre-cured Silicone Sealant shall be included in the Contract Unit Price for the Traffic Railing.

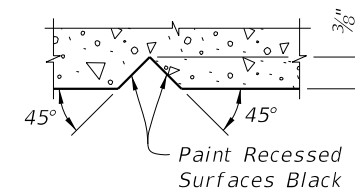

SECTION THRU RECESSED "V" GROOVE TO FORM INSCRIBED LETTERS AND FIGURES

ESTIMATED TRAFFIC RAILING QUANTITIES		
ITEM	UNIT	QUANTITY
Concrete	CY/LF	0.095
Reinforcing Steel	LB/LF	25.90

(The above quantities are based on a 6" thick x 6' wide raised sidewalk at low side of deck, 2% deck cross slope and counter 2% sidewalk cross slope.)

10/01/2020 9:58:26 AM

LAST REVISION 07/01/13	DESCRIPTION:
---------------------------	--------------



FY 2021-22
STANDARD PLANS

TRAFFIC RAILING - (32" VERTICAL SHAPE)

INDEX
521-423

SHEET
3 of 3