

10/12/2020 7:32:17 AM

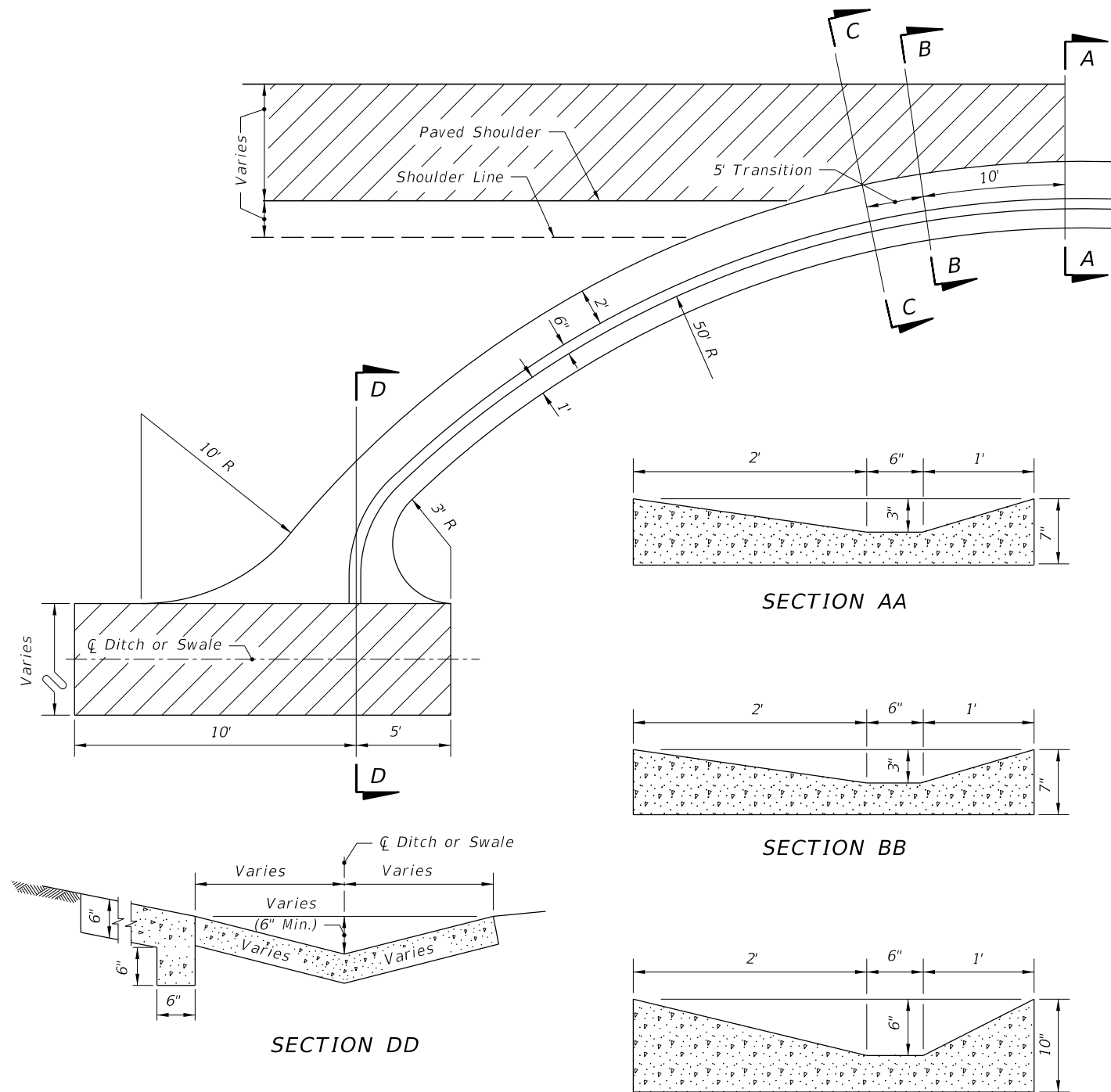

1. Spillway to be paid for as Shoulder Gutter, L.F.
2. If spillway empties into an unpaved ditch, the detail should be modified as necessary.

DETAIL OF CONCRETE SPILLWAY AT END OF SHOULDER GUTTER
 (TO BE USED WHERE INLETS, PIPES & ENDWALLS ARE IMPRACTICAL)

LAST REVISION 11/01/17	REVISION	DESCRIPTION:
---------------------------	----------	--------------



FY 2021-22
STANDARD PLANS

CONCRETE SHOULDER GUTTER SPILLWAY

INDEX
520-005

SHEET
1 of 1