

ELEVATION

** See Note 4 on Index 455-002

ALTERNATE STRAND PATTERNS

- 12 ~ 0.6" Ø, Grade 270 LRS, at 35 kips
- 12 ~ 1/2" Ø (Special), Grade 270 LRS, at 34 kips
- 16 ~ 1/2" Ø, Grade 270 LRS, at 26 kips
- 20 ~ 7/16" Ø, Grade 270 LRS, at 21 kips
- 24 ~ 3/8" Ø, Grade 270 LRS, at 17 kips

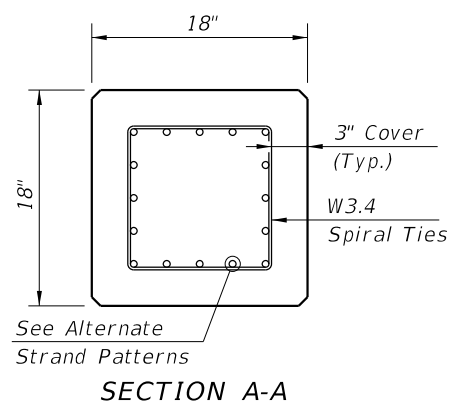

NOTES:

1. Work this Index with Index 455-001 - Typical Details and Notes for Square Prestressed Concrete Piles and Index 455-002 - Square Prestressed Concrete Pile Splices.
2. Any of the given Alternate Strand Patterns may be utilized. The strands shall be located as follows:
Place one strand at each corner and place the remaining strands equally spaced between the corner strands. The total strand pattern shall be concentric with the nominal concrete section of the pile.

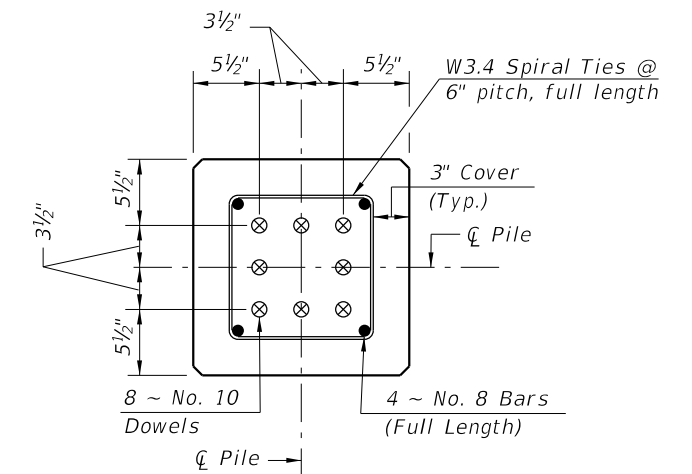

SECTION D-D
(See Non-Drivable Unforeseen Reinforced Precast Splice Detail)

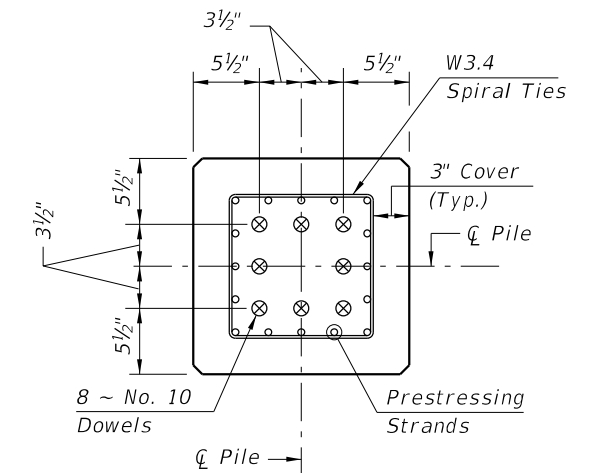

SECTION E-E
(See Drivable Prestressed Precast Splice Detail)

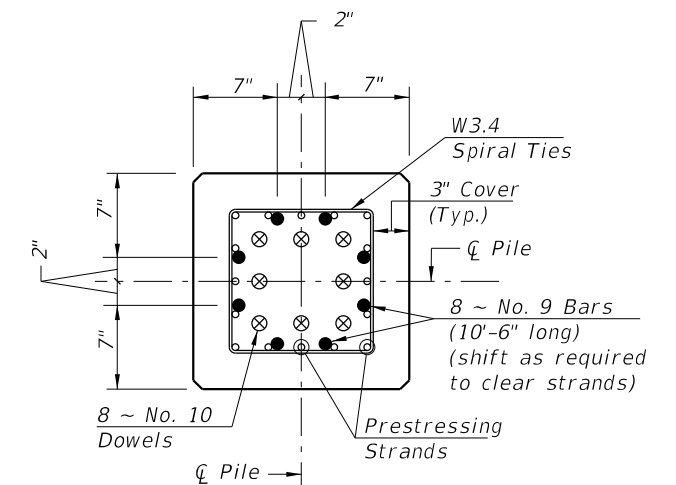

SECTION F-F
(See Drivable Preplanned Splice Detail)
PILE SPLICE REINFORCEMENT DETAILS

10/8/2020 10:29:26 AM

LAST REVISION	01/01/12	REVISION	DESCRIPTION:
---------------	----------	----------	--------------



FY 2021-22
STANDARD PLANS

18" SQUARE PRESTRESSED CONCRETE PILE

INDEX
455-018

SHEET
1 of 1