

ELEVATION

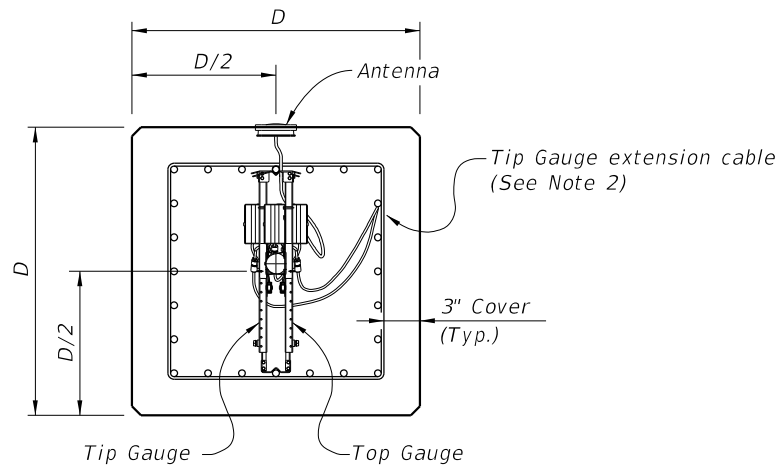

SECTION A-A
(Strand Pattern with odd number of strands per face)

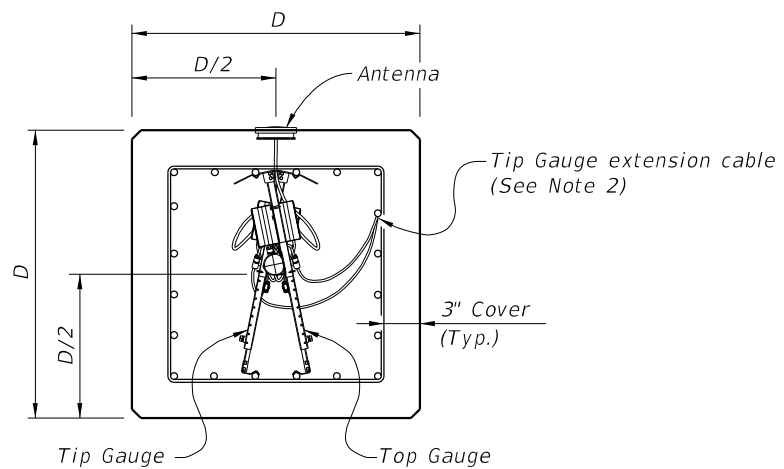

SECTION A-A
(Strand Pattern with even number of strands per face)

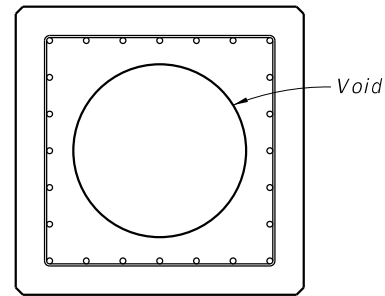

SECTION B-B
(Showing Voided Pile,
Solid Pile Similar)

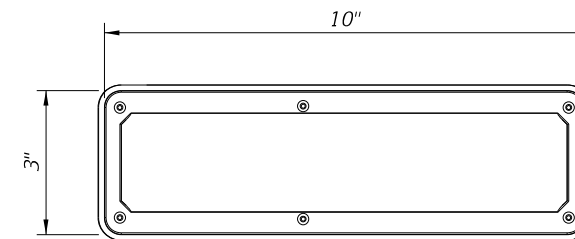

ANTENNA TOP VIEW

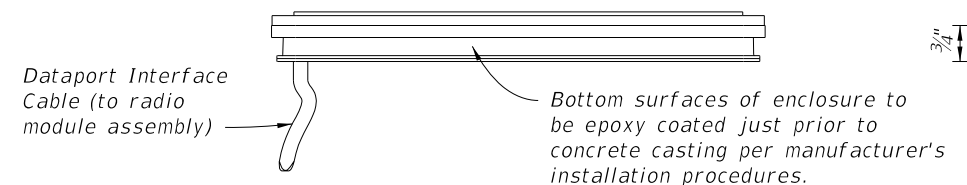

ANTENNA SIDE VIEW

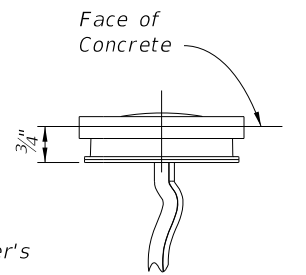

ANTENNA END VIEW

NOTES:

1. For piles 18" and larger installed for bridge foundations, provide EDC Instrumentation in accordance with Specification Section 455.
2. Attach Tip Gauge extension cable to the underside of the strand shown in Section A-A. Secure cable to strand with nylon wire ties spaced a maximum of 6ft. along cable.

10/8/2020 10:30:15 AM

LAST REVISION 11/01/20	REVISION	DESCRIPTION:		FY 2021-22 STANDARD PLANS	SQUARE PRESTRESSED CONCRETE PILES - EDC INSTRUMENTATION	INDEX 455-003	SHEET 1 of 1
---------------------------	----------	--------------	--	------------------------------	--	------------------	-----------------