

TYPICAL SECTION TYPE D, E & AA PAD

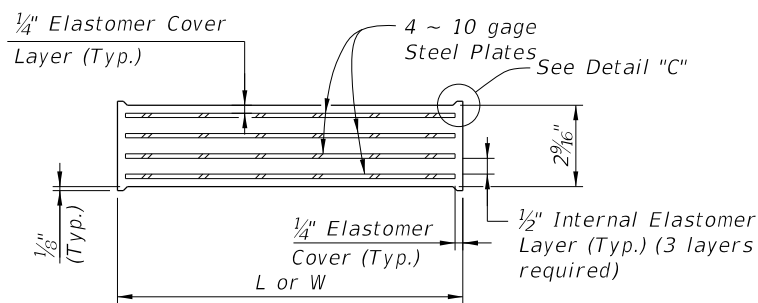

TYPICAL SECTION TYPE F, G & AB PAD

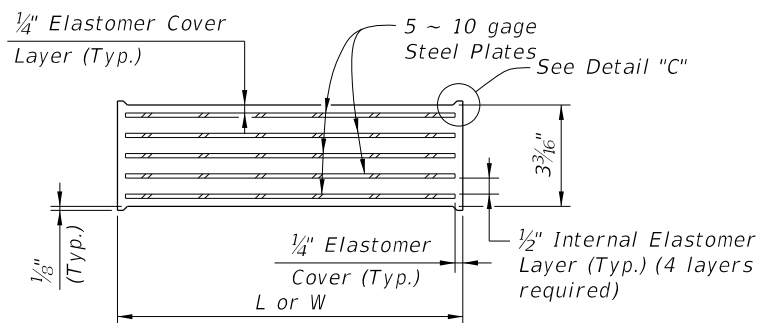

TYPICAL SECTION TYPE H PAD

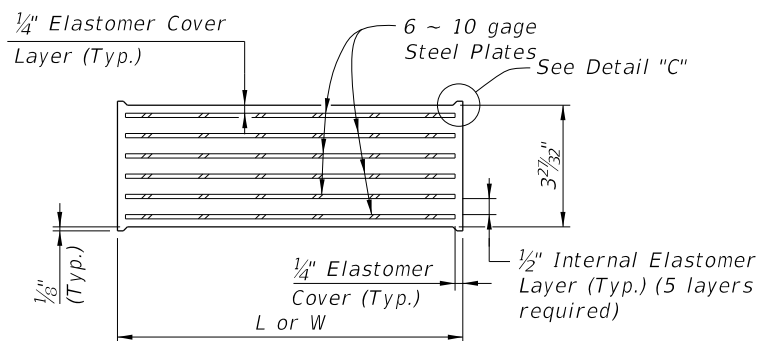

TYPICAL SECTION TYPE J & K PAD

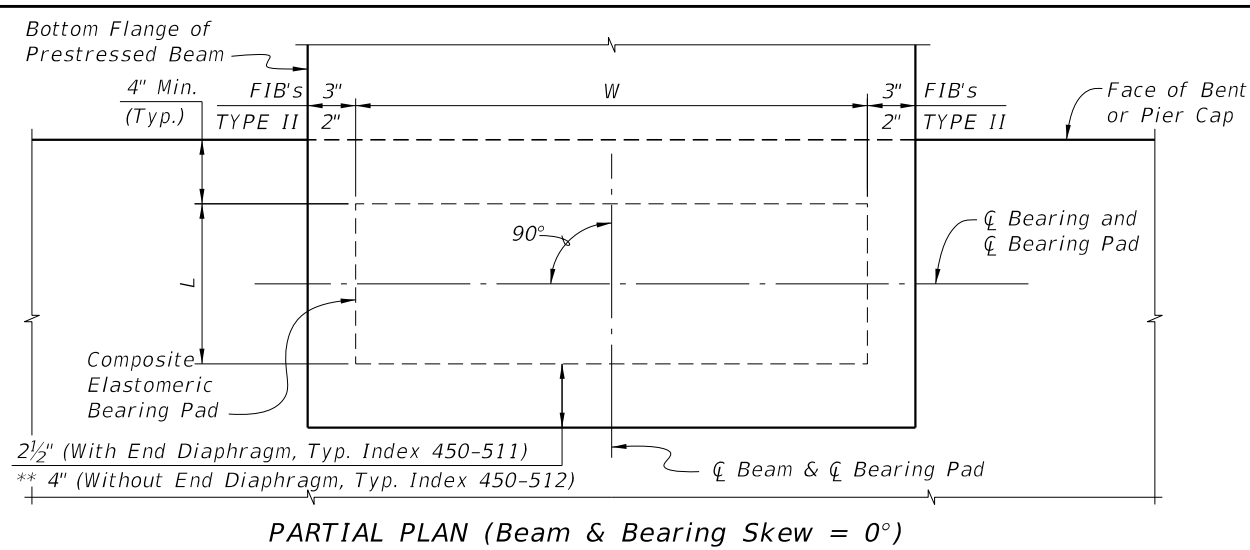

PARTIAL PLAN (Beam & Bearing Skew = 0°)

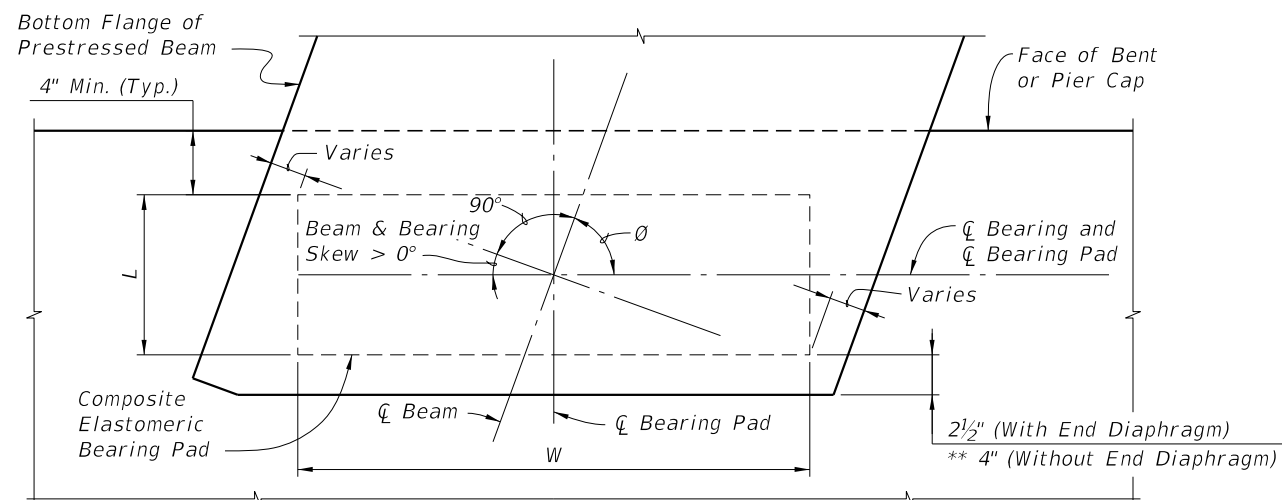

PARTIAL PLAN (Beam & Bearing Skew > 0°) (Use Index 450-511)

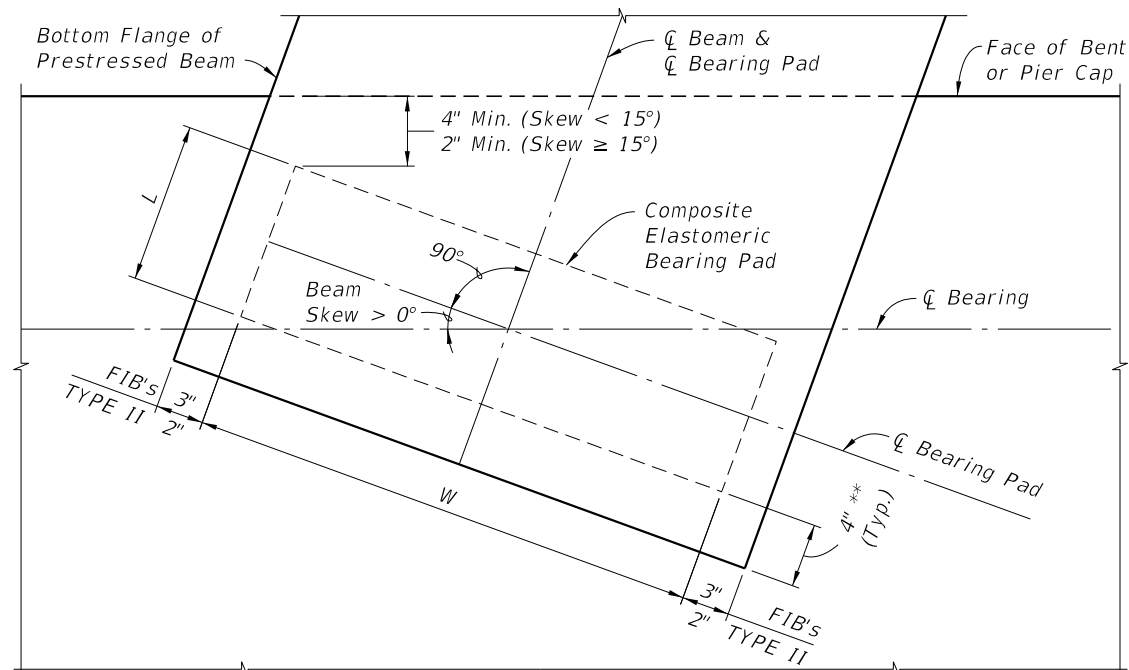

PARTIAL PLAN WITH SQUARED END BEAM (Use Index 450-512)  
(Beam Skew > 0°; Bearing Skew = 0°)

PAD TYPE (See Note 1)	BEAM TYPE	BEARING PAD DIMENSIONS		*BEVELED BEARING PLATE DIMENSIONS	
		L	W	C	D
D (G=110psi)	FLORIDA I-BEAM	8"	2'-8"	1'-0"	3'-0"
E (G=110psi)		10"	2'-8"	1'-0"	3'-0"
F (G=110psi)		10"	2'-8"	1'-0"	3'-0"
G (G=150psi)		10"	2'-8"	1'-0"	3'-0"
H (G=150psi)		10"	2'-8"	1'-0"	3'-0"
J (G=150psi)		10"	2'-8"	1'-0"	3'-0"
K (G=150psi)		1'-0"	2'-8"	1'-1 1/2"	3'-0"
AA (G=110psi)	AASHTO TYPE II	10"	1'-2"	1'-0"	1'-4"
AB (G=150psi)		10"	1'-2"	1'-0"	1'-4"

\* Work this sheet with the appropriate type Bearing Plate Detail (See Bearing Plate Data Table) and BEARING PAD DATA TABLE in the Structures Plans. See TABLE OF BEAM VARIABLES and BEARING PLATE DATA TABLE in the Structures Plans for locations where beveled bearing plates are required.

\*\* Offset to End of Beam is reduced to 2" for Type K Pad.

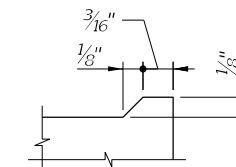

DETAIL "C"

BEARING PAD NOTES:

1. Neoprene in Type D, E, F & AA bearing pads shall have a shear modulus (G) of 110 psi. Neoprene in Type G, H, J, K & AB bearing pads shall have a shear modulus (G) of 150 psi.
2. Steel Plates in bearing pads shall conform to ASTM A1011 Grade 36, Type 1.
3. See Bearing Pad Data Table in Structures Plans for quantities of Type D, E, F, G, H, J, K, AA and/or AB Bearing Pads.

10/8/2020 10:41:05 AM