

34 S.F.

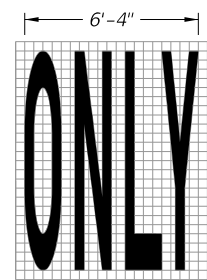

22 S.F.

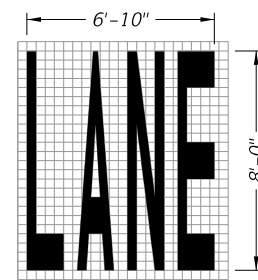

23 S.F.

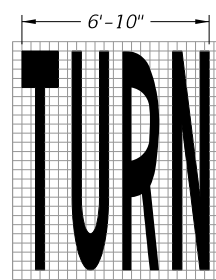

24 S.F.

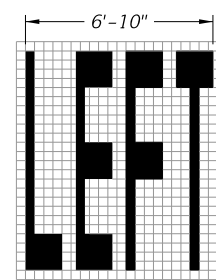

20 S.F.

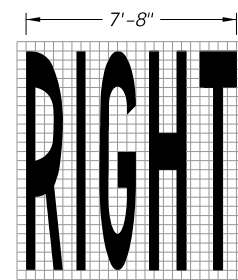

26 S.F.

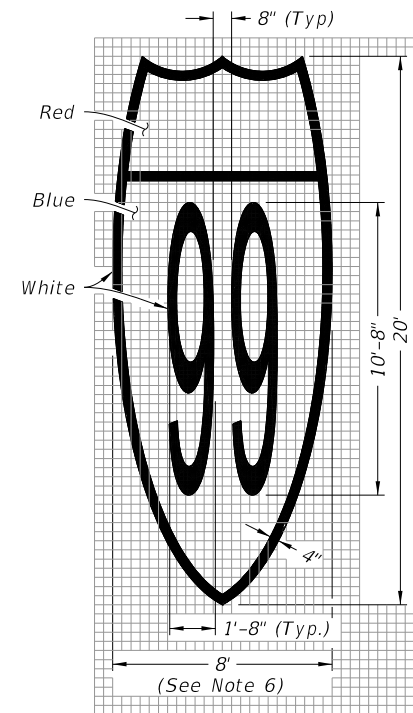

Route Shield for Limited Access Roadways (Interstate Route Shield Shown; U.S. and State Route Shield Similar)

128 S.F.

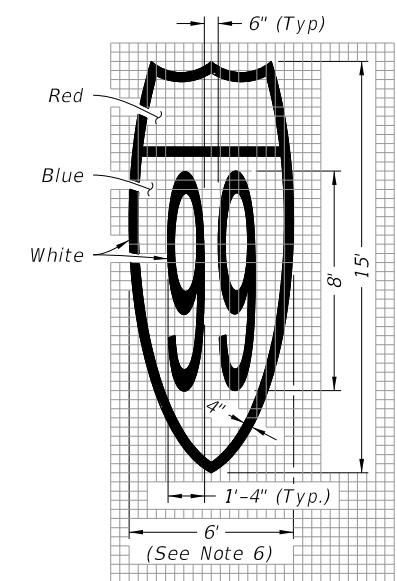

Route Shield for Arterials and Collectors (Interstate Route Shield Shown; U.S. and State Route Shield Similar)

72 S.F.

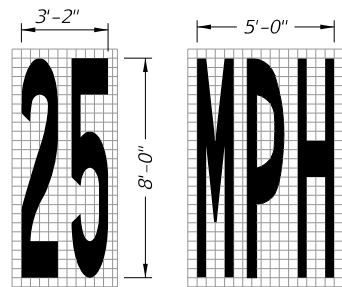

13 S.F.

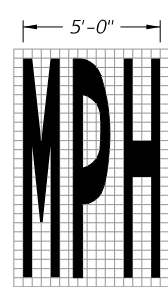

20 S.F.

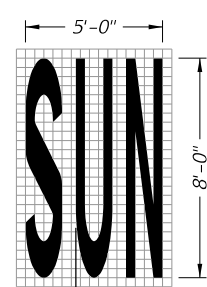

20 S.F.

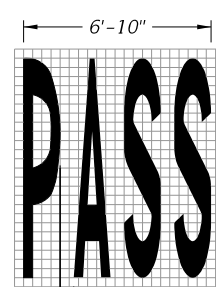

23 S.F.

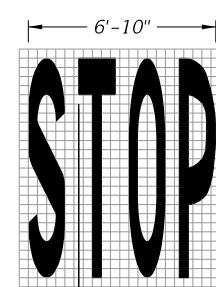

22 S.F.

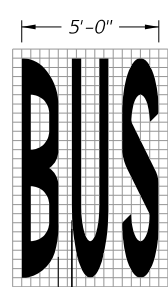

20 S.F.

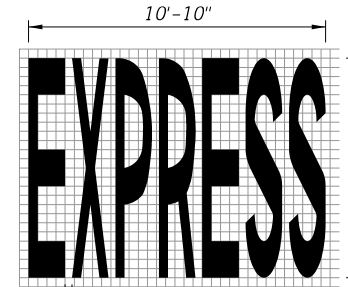

43 S.F.

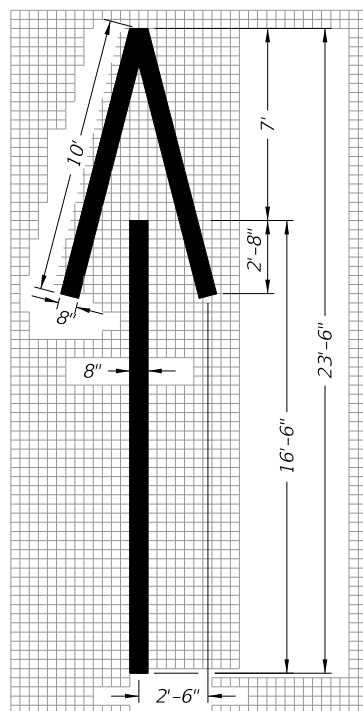

Wrong-Way Arrow  
24 S.F.

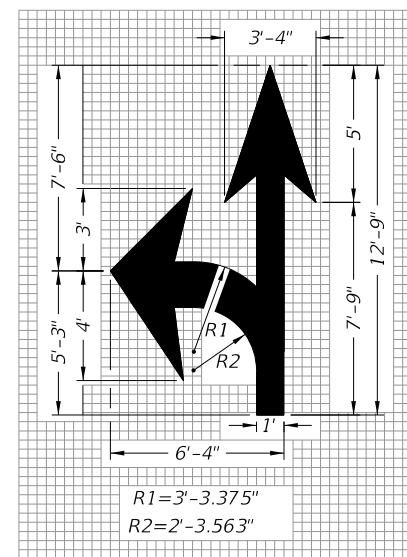

Turn and Through Lane-Use Arrow  
29 S.F.

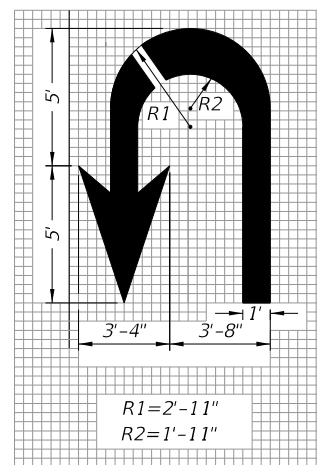

U Turn Lane-Use Arrow  
27 S.F.

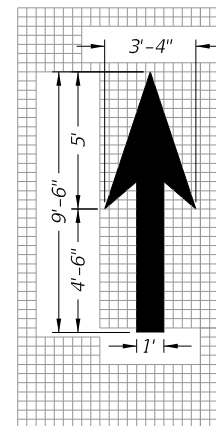

Through Lane-Use Arrow  
12 S.F.

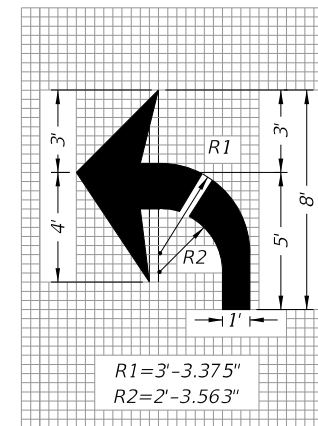

Turn Lane-Use Arrow (Left Turn Shown - Right Turn Similar)  
17 S.F.

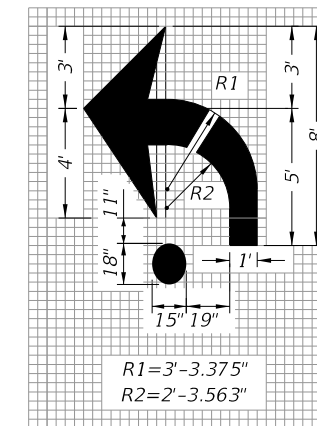

Roundabout Approach Arrow  
19 S.F.

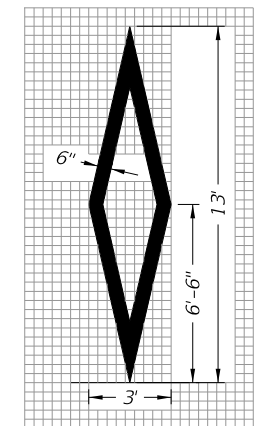

Preferential Lane Symbol  
11 S.F.

**NOTES FOR PAVEMENT MESSAGES:**

- When an arrow or another pavement message is used with a pavement message, maintain a minimum distance of "S" between items, measured from the base of each item. See the Pavement Message Spacing Table for "S" value.
- Place all pavement messages 25' back from the stop line.
- Dimensions are within 1" ±.
- All grids are 4" x 4".
- All pavement messages must be white except route shields.
- Increase width of route shield for routes with three digits.

PAVEMENT MESSAGE SPACING TABLE	
Posted Speed (mph)	Distance "S" (feet)
≤ 25	40
30 - 35	56
40 - 45	72
≥ 50	88

**PAVEMENT MESSAGE AND ARROW DETAILS**

**GENERAL NOTE:**

- See Index 509-070 for pavement markings at railroad crossings.

2/5/2021 12:06:14 PM

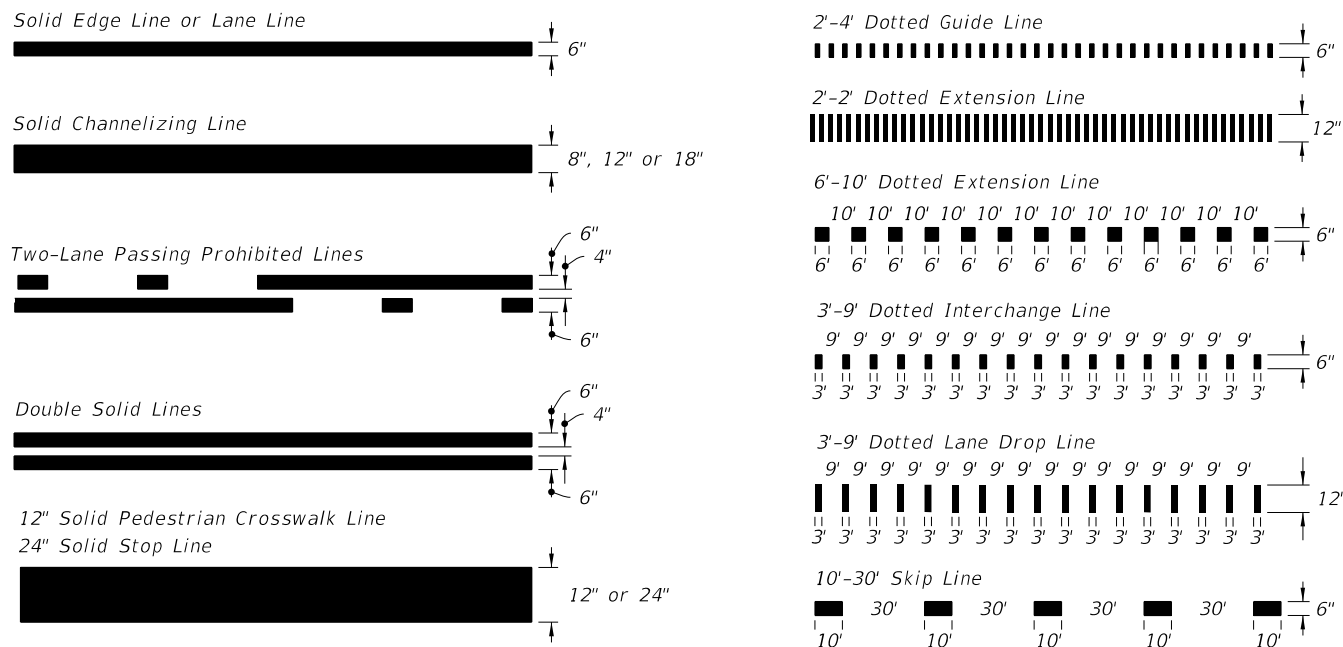

PAVEMENT MARKING LINES



10'-30' SKIP LINE WITH SHADOW MARKINGS

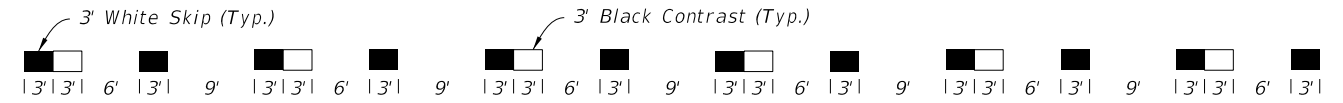

DOTTED LINE WITH ALTERNATING SHADOW MARKINGS  
(3'-9' Dotted Line Shown, Other Dotted Lines Similar)

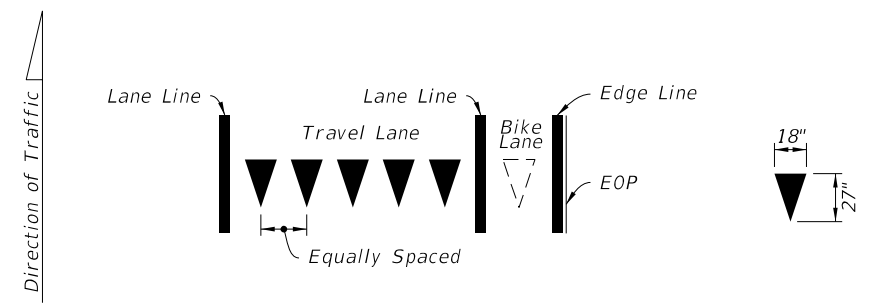

Yield Lines consist of five - 18" X 27" white triangles which face traffic. Equally space triangles within traffic lane. When a bike lane is present, add one additional triangle in the center of the bike lane.

YIELD LINES

12:06:17 PM  
2/5/2021

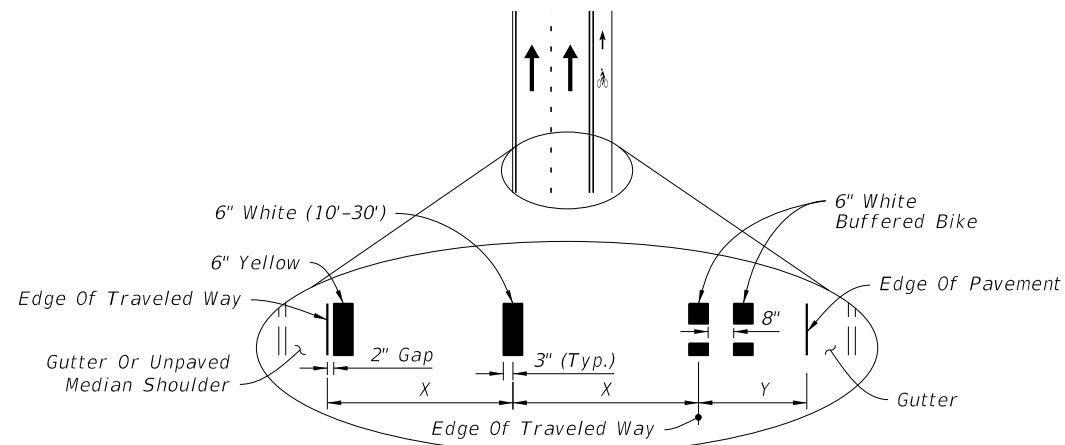

**CURB AND GUTTER**

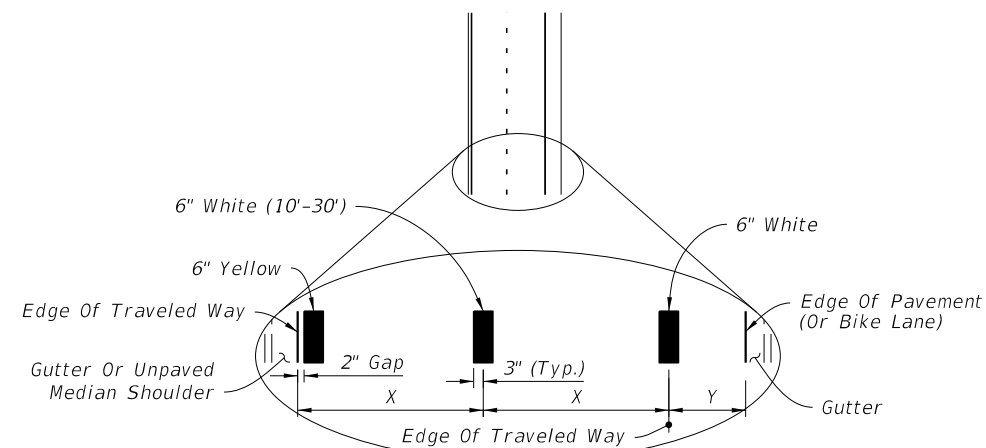

**CURB AND GUTTER**

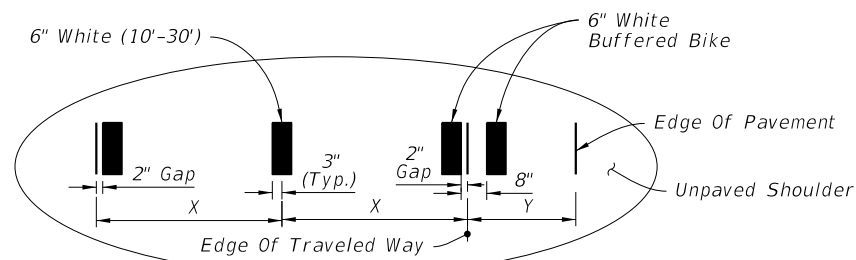

**FLUSH SHOULDER**

X = LANE WIDTH (FT.)  
Y = BUFFERED BIKE LANE WIDTH (FT.)

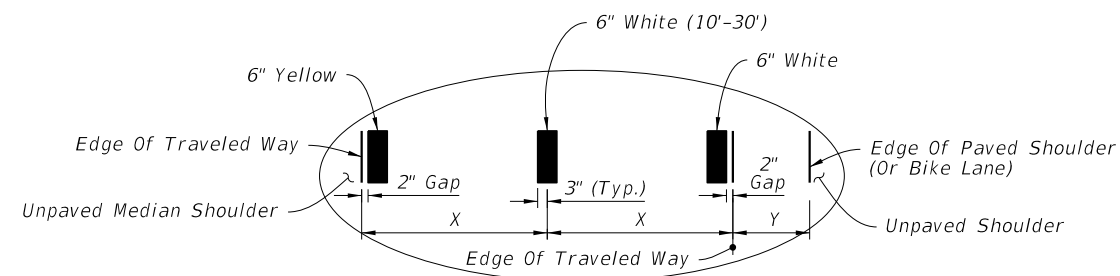

**FLUSH SHOULDER**

X = LANE WIDTH (FT.)  
Y = PAVED SHOULDER / BIKE LANE

STRIPING FOR BUFFERED BIKE LANE

STRIPING WITH SHOULDER OR NON-BUFFERED BIKE LANE

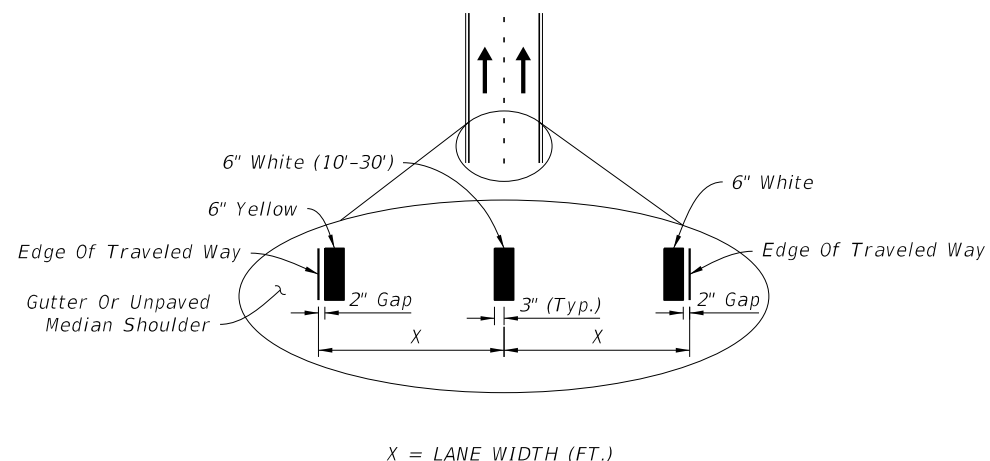

X = LANE WIDTH (FT.)

STRIPING WITH NO SHOULDER OR BIKE LANE

**NOTES:**

1. Lane widths (X) may not be same for each lane in the section.
2. For placement of RPMs, see Index 706-001.

12:06:18 PM 2/5/2021

LAST REVISION 02/05/21	REVISION	DESCRIPTION: Added railroad pavement marking details.
---------------------------	----------	--



FY 2020-21  
STANDARD PLANS

PAVEMENT MARKINGS

INDEX  
711-001-1

SHEET  
3 of 14

PLACEMENT OF LONGITUDINAL PAVEMENT MARKINGS

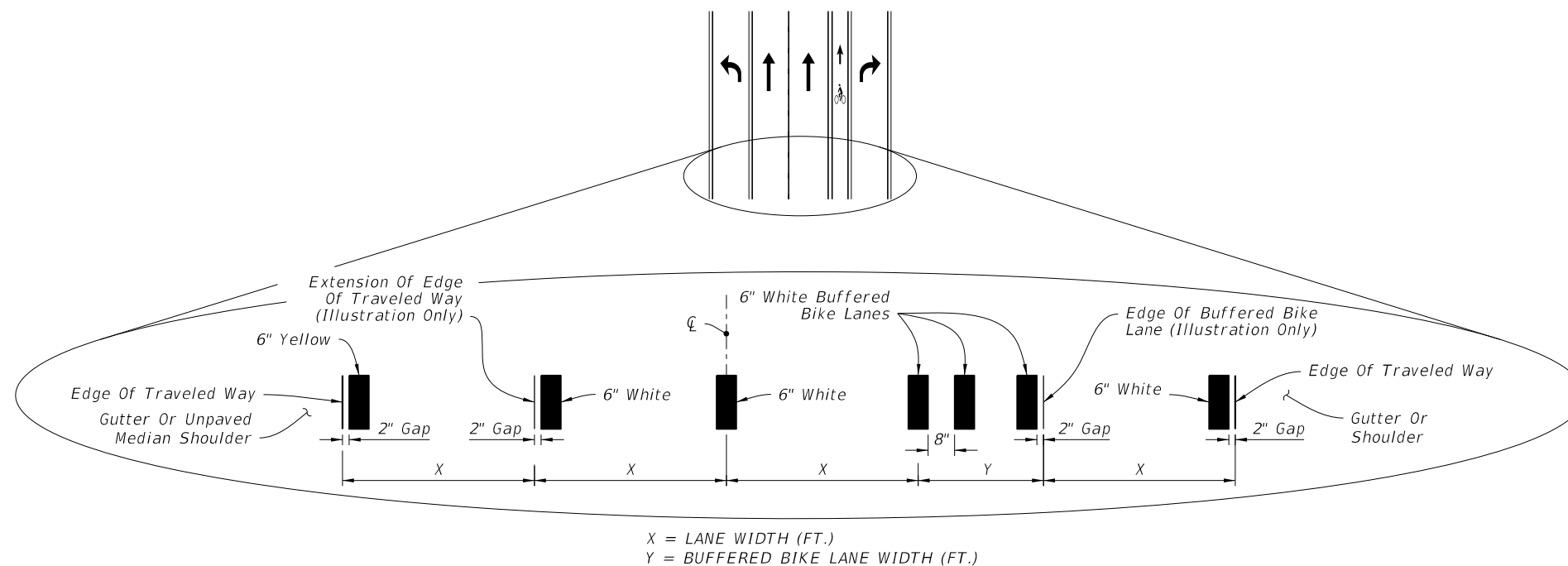

**INTERSECTION APPROACH STRIPING WITH TURN LANES AND BUFFERED BIKE LANE KEY HOLE**

**NOTES:**

1. Lane widths (X) may not be same for each lane in the section.
3. For placement of RPMs, see Index 706-001.
4. For placement of Express Lane markers and associated RPMs, see the Plans.

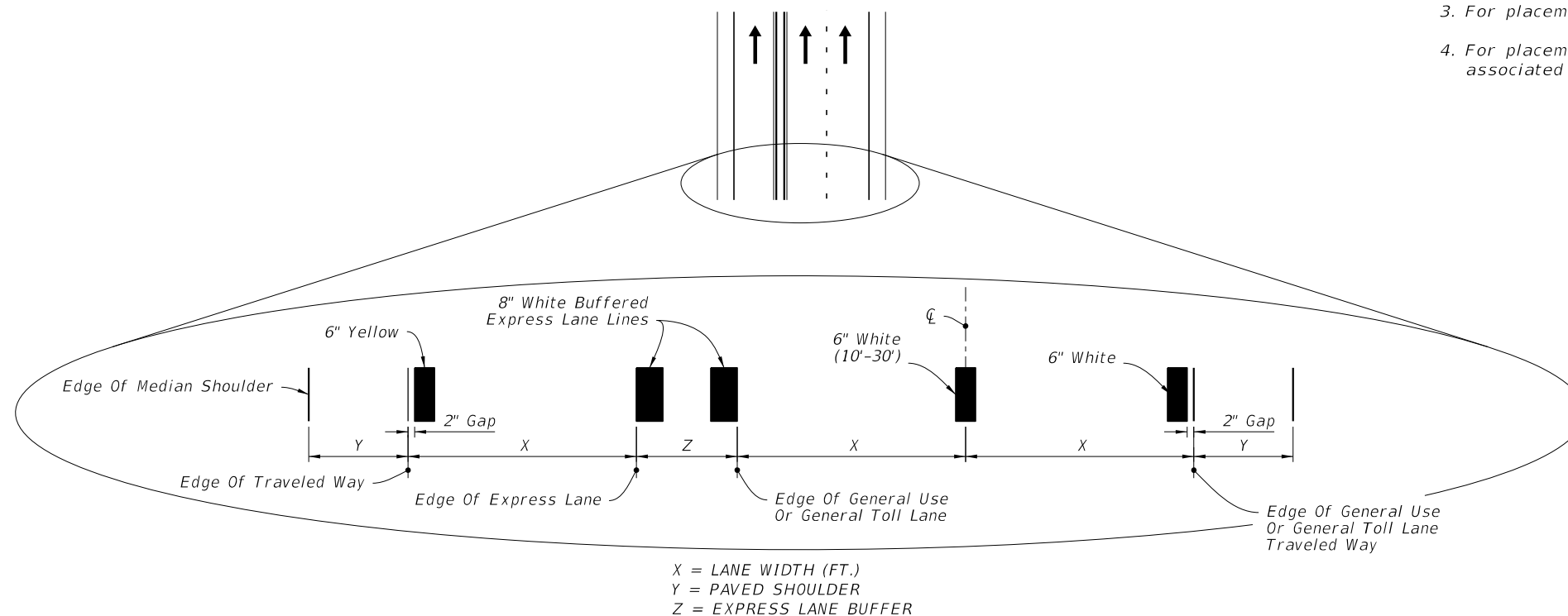

**BUFFERED EXPRESS LANE STRIPING**

**PLACEMENT OF LONGITUDINAL PAVEMENT MARKINGS**

12:06:20 PM  
2/5/2021

LAST REVISION 02/05/21	REVISION	DESCRIPTION: Added railroad pavement marking details.
---------------------------	----------	--



FY 2020-21  
STANDARD PLANS

PAVEMENT MARKINGS

INDEX  
711-001-1

SHEET  
4 of 14

12:06:21 PM  
2/5/2021

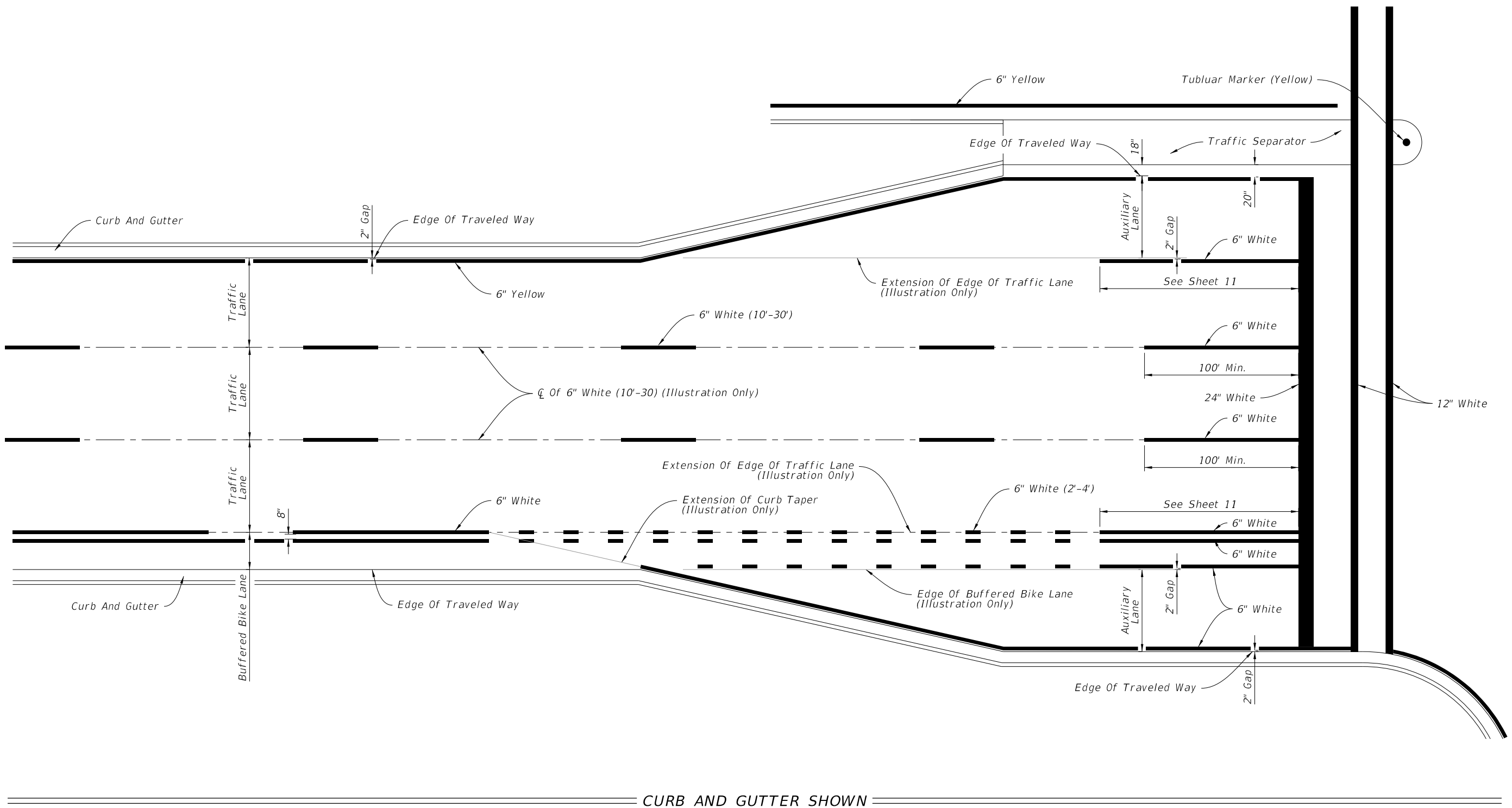

CURB AND GUTTER SHOWN

PLACEMENT OF LONGITUDINAL PAVEMENT MARKINGS

LAST REVISION 02/05/21	DESCRIPTION: Added railroad pavement marking details.
---------------------------	--

**FY 2020-21  
STANDARD PLANS**

PAVEMENT MARKINGS

INDEX 711-001-1	SHEET 5 of 14
--------------------	------------------

12:06:22 PM  
2/5/2021

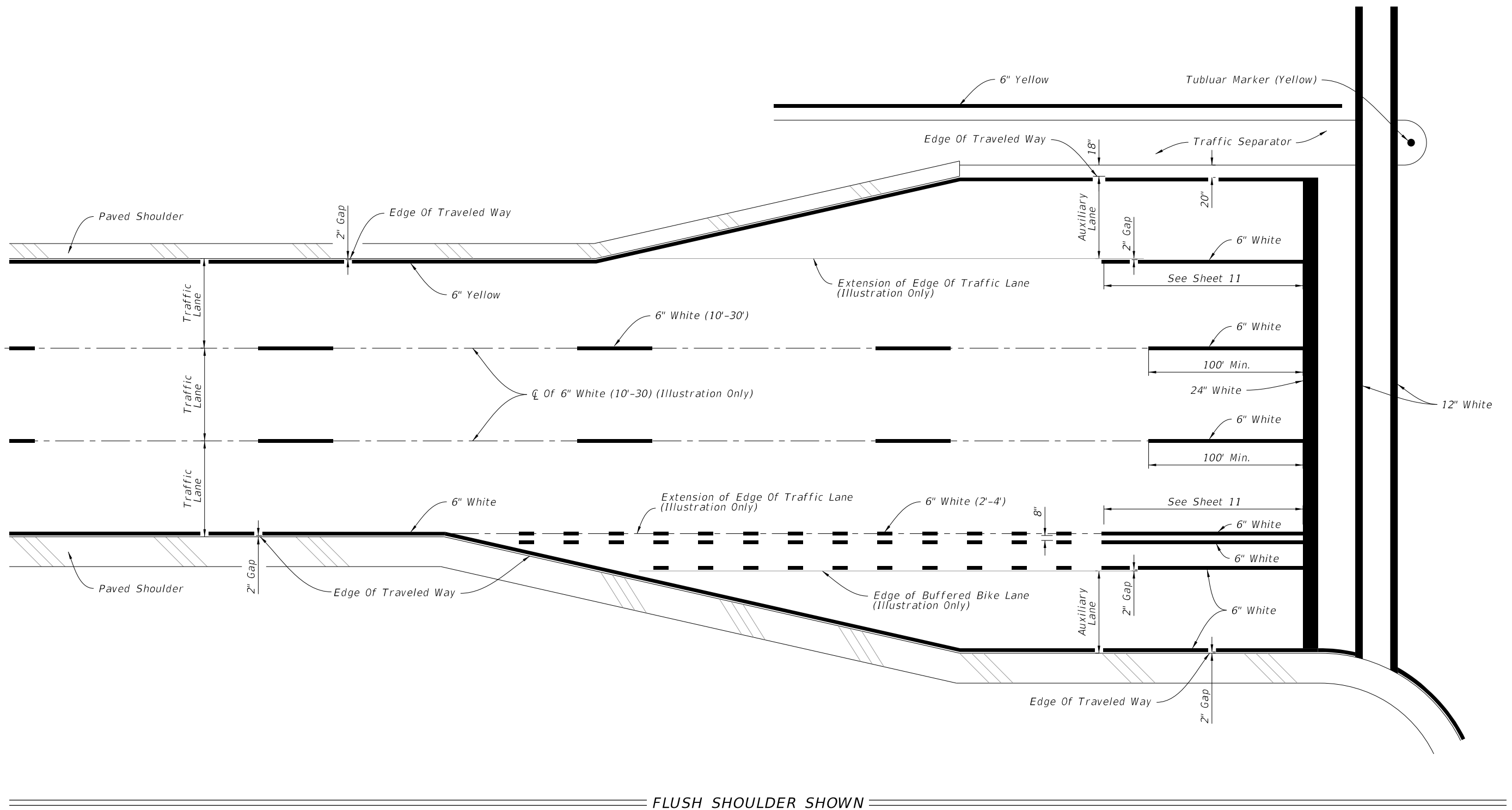

FLUSH SHOULDER SHOWN

PLACEMENT OF LONGITUDINAL PAVEMENT MARKINGS

LAST REVISION 02/05/21	DESCRIPTION: Added railroad pavement marking details.
---------------------------	--



FY 2020-21  
STANDARD PLANS

PAVEMENT MARKINGS

INDEX  
711-001-1

SHEET  
6 of 14

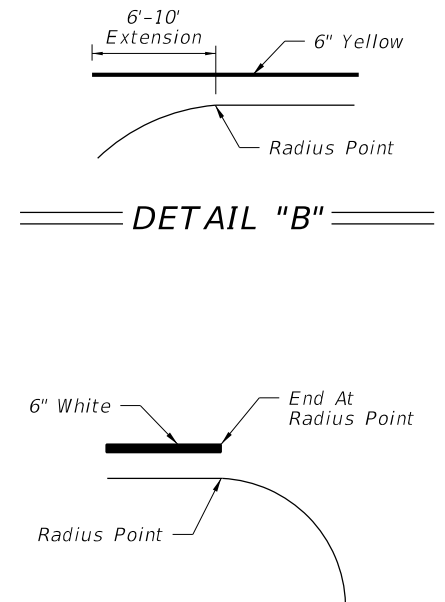
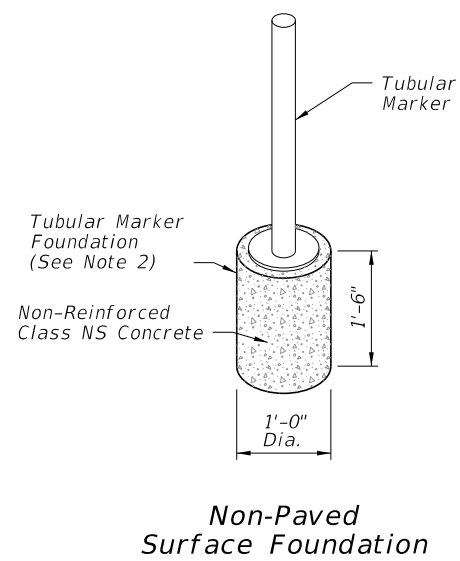
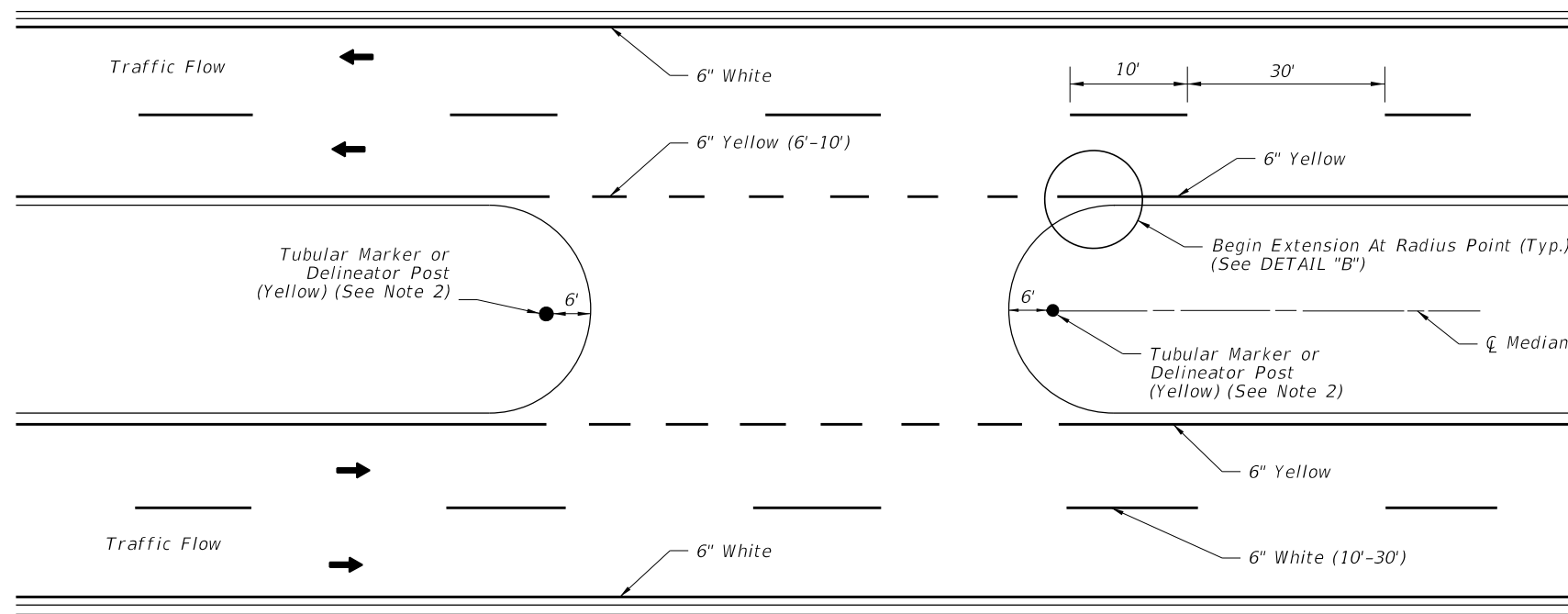

PAVEMENT MARKINGS AND DELINEATORS FOR MEDIAN CROSSOVER

DETAIL "A"

DETAIL "C"

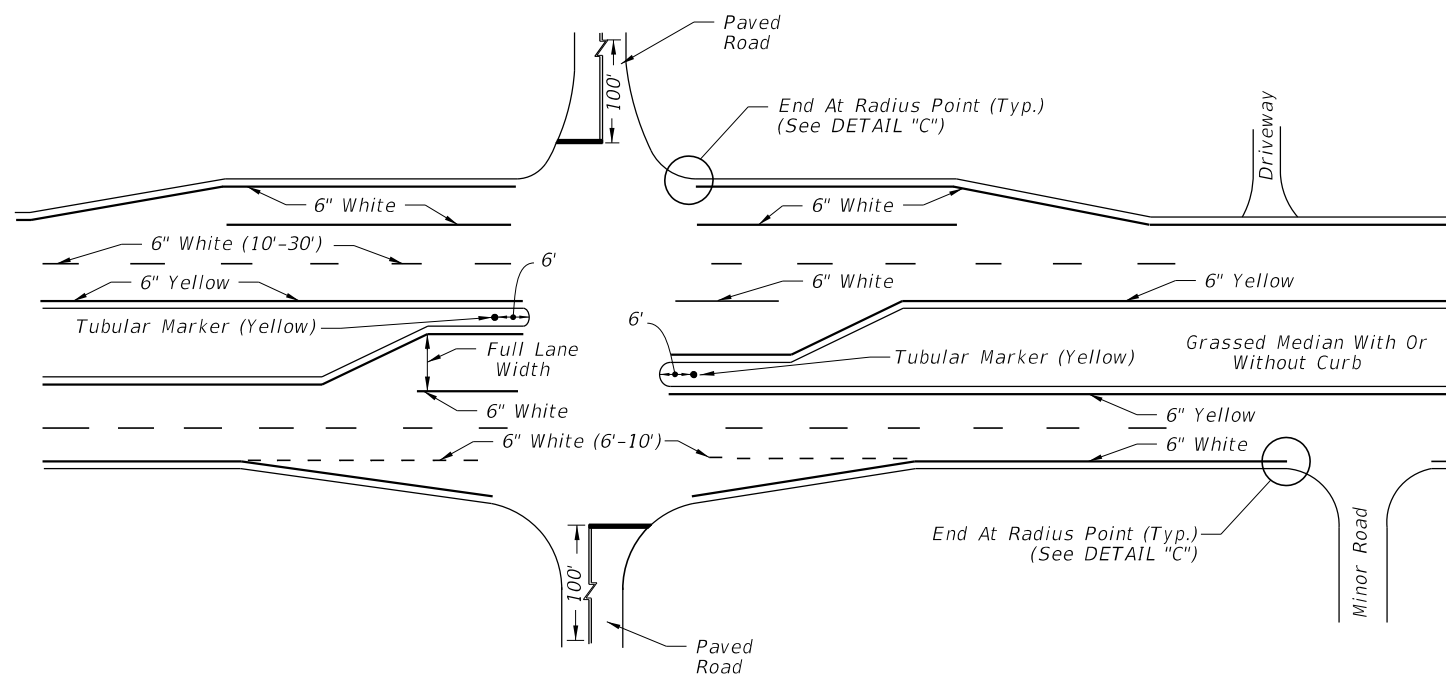

NOTE:

1. Apply yellow reflective paint to the noses of curbed medians, traffic separators, and raised islands. When applying yellow reflective paint in conjunction with Raised Pavement Markers, see Index 706-001.
2. Options for grassed medians:
  - A. Option 1: Tubular Marker (Yellow). Attach Tubular Marker according to manufacturer's instructions. Non-Paved Surface Foundation (See Detail "A") is provided as an option if no other suitable surface is provided. Install Non-Paved Surface Foundation flush with the surrounding ground surface.
  - B. Option 2: Delineator Post. Use yellow retro-reflective sheeting on both sides of the delineator. Install the post so that the top is 4'-0" above the grade at the edge of the pavement.
3. Extend double yellow centerlines 100' back from intersection on all approaches or 50' for unmarked cross roads.

PAVEMENT MARKINGS FOR INTERSECTIONS WITH MAJOR AND MINOR ROADS

12:06:25 PM 2/5/2021

LAST REVISION 02/05/21	REVISION	DESCRIPTION: Added railroad pavement marking details.	 FY 2020-21 STANDARD PLANS	PAVEMENT MARKINGS	INDEX 711-001-1	SHEET 7 of 14
---------------------------	----------	--	---	-------------------	--------------------	------------------

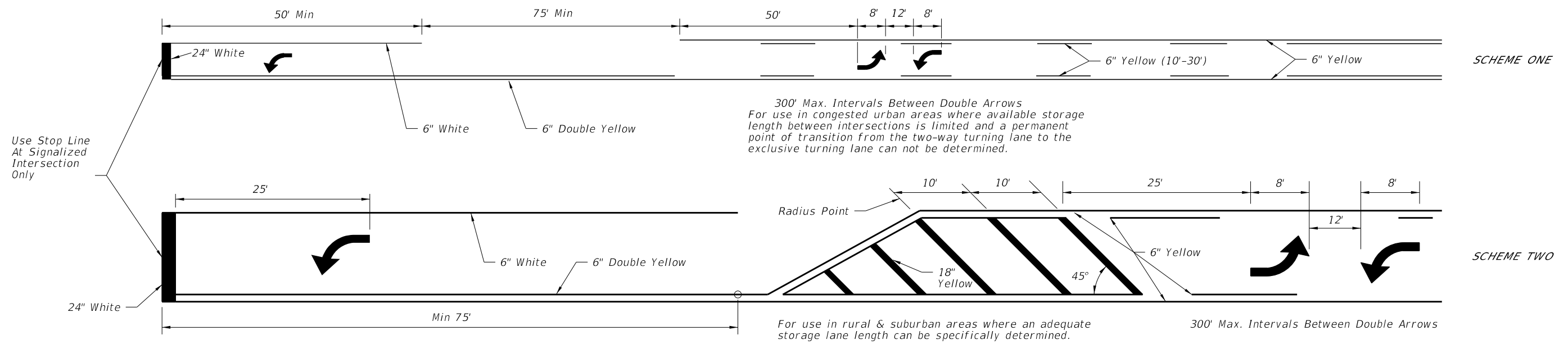

**TWO WAY LEFT TURN LANE**  
 (With Single Lane Left Turn Channelization)

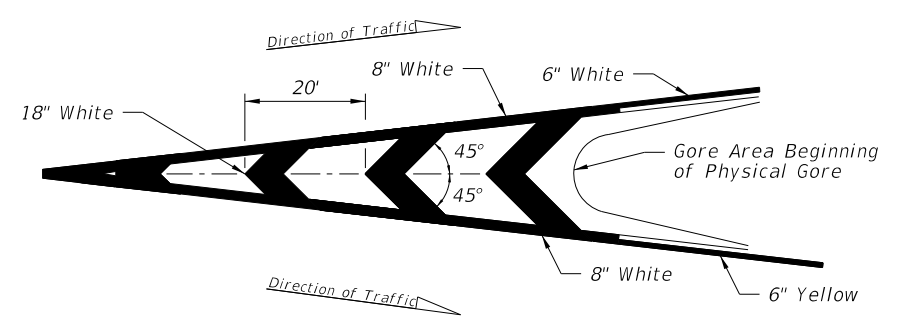
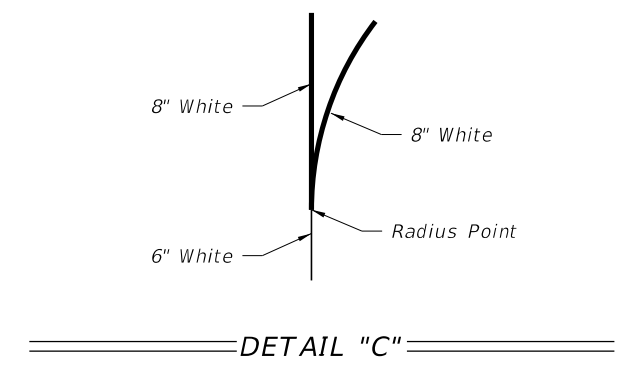
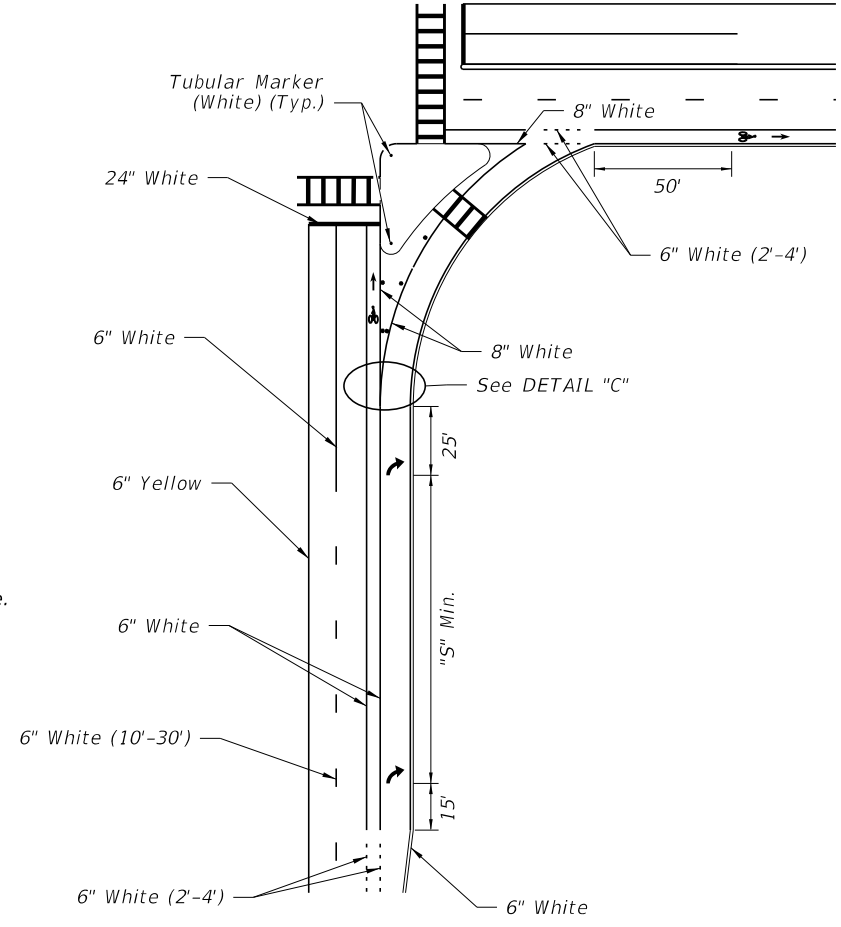
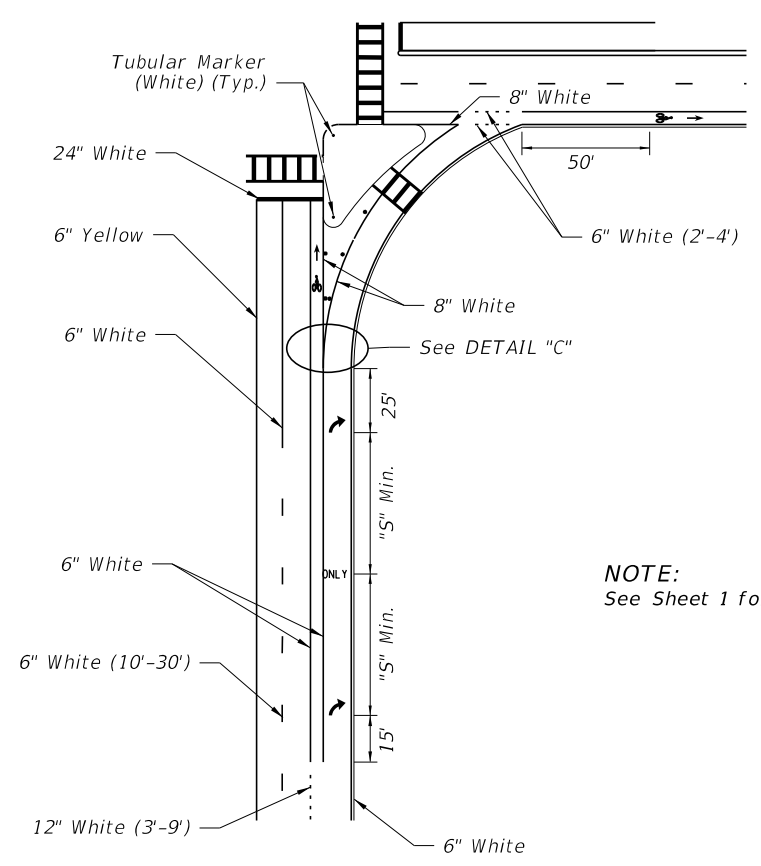

**RIGHT TURN LANE DROP AND ISLAND DETAILS**  
 LEFT TURN LANE DROP IS MIRROR IMAGE

**RIGHT TURN LANE AND ISLAND DETAILS**

12:06:27 PM  
 2/5/2021

LAST REVISION 02/05/21	DESCRIPTION: Added railroad pavement marking details.	FDOT	FY 2020-21 STANDARD PLANS	PAVEMENT MARKINGS	INDEX 711-001-1	SHEET 8 of 14
---------------------------	--	------	------------------------------	-------------------	--------------------	------------------



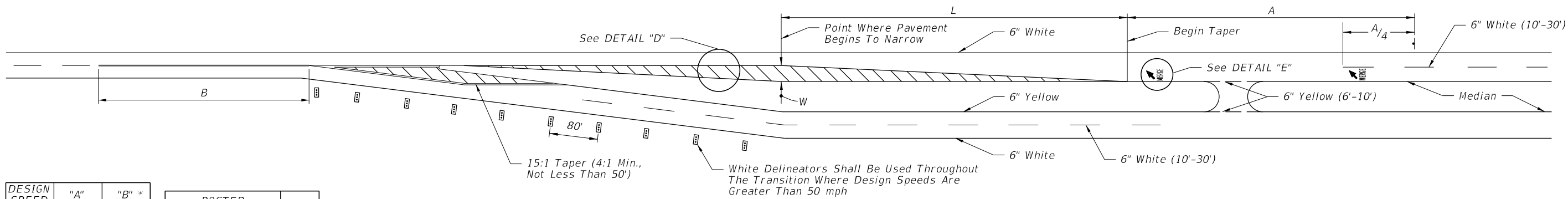

DESIGN SPEED (MPH)	"A" (FT.)	"B" * (FT.)
60	---	640
55	950	595
50	850	550
45	750	500
40	650	455
30	450	365

\* 50' Minimum

POSTED SPEED LIMIT MPH	"y" (FT.)
30 OR LESS	10
35	20
40	20
45	30
50 OR MORE	40

DESIGN SPEED 'S' (MPH)	Length 'L' (FT.)
40 or Less	$L = WS^2/60$
45 or Greater	$L = WS$

LEFT ROADWAY CENTERED ON EXISTING ROADWAY

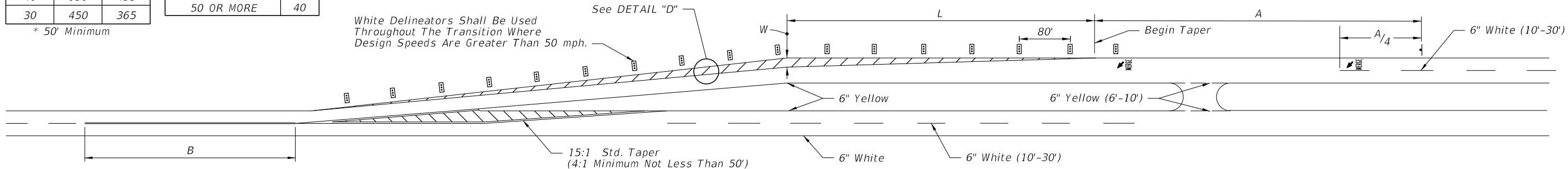

RIGHT ROADWAY CENTERED ON EXISTING ROADWAY

SCHEMES FOR TRANSITION - 2 LANE / 4 LANE ROADWAY

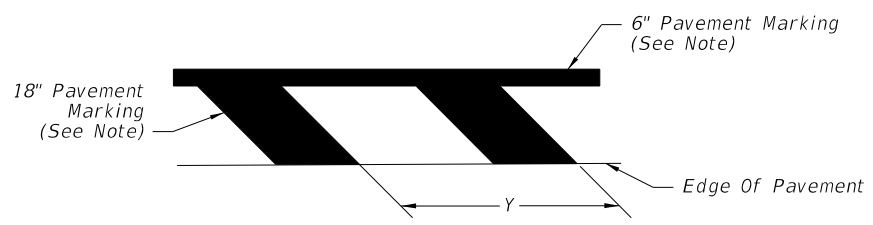

**NOTE:**  
Make pavement markings yellow for left roadway centered on existing roadway. Right roadway centered on existing roadway is similar with white pavement markings.

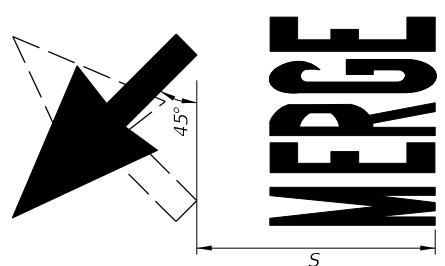

**NOTE:** See Sheet 1 for "S" value.

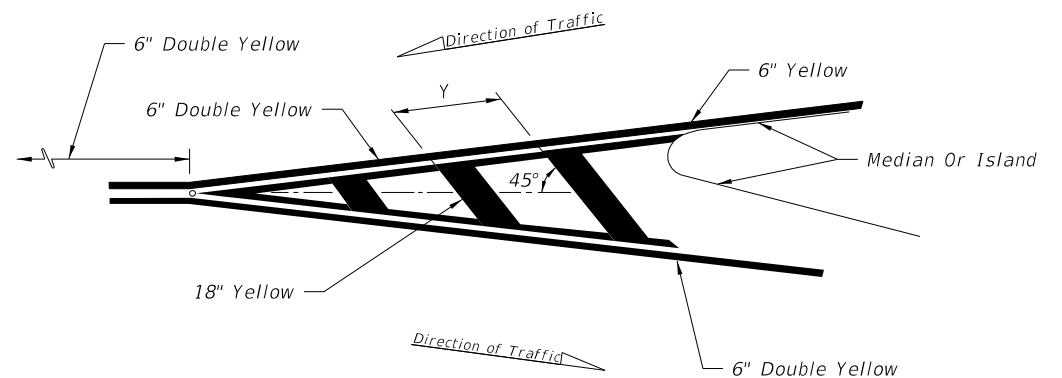

DETAIL "D"

DETAIL "E"

MARKINGS FOR TRAFFIC SEPARATION

2/5/2021 12:06:28 PM

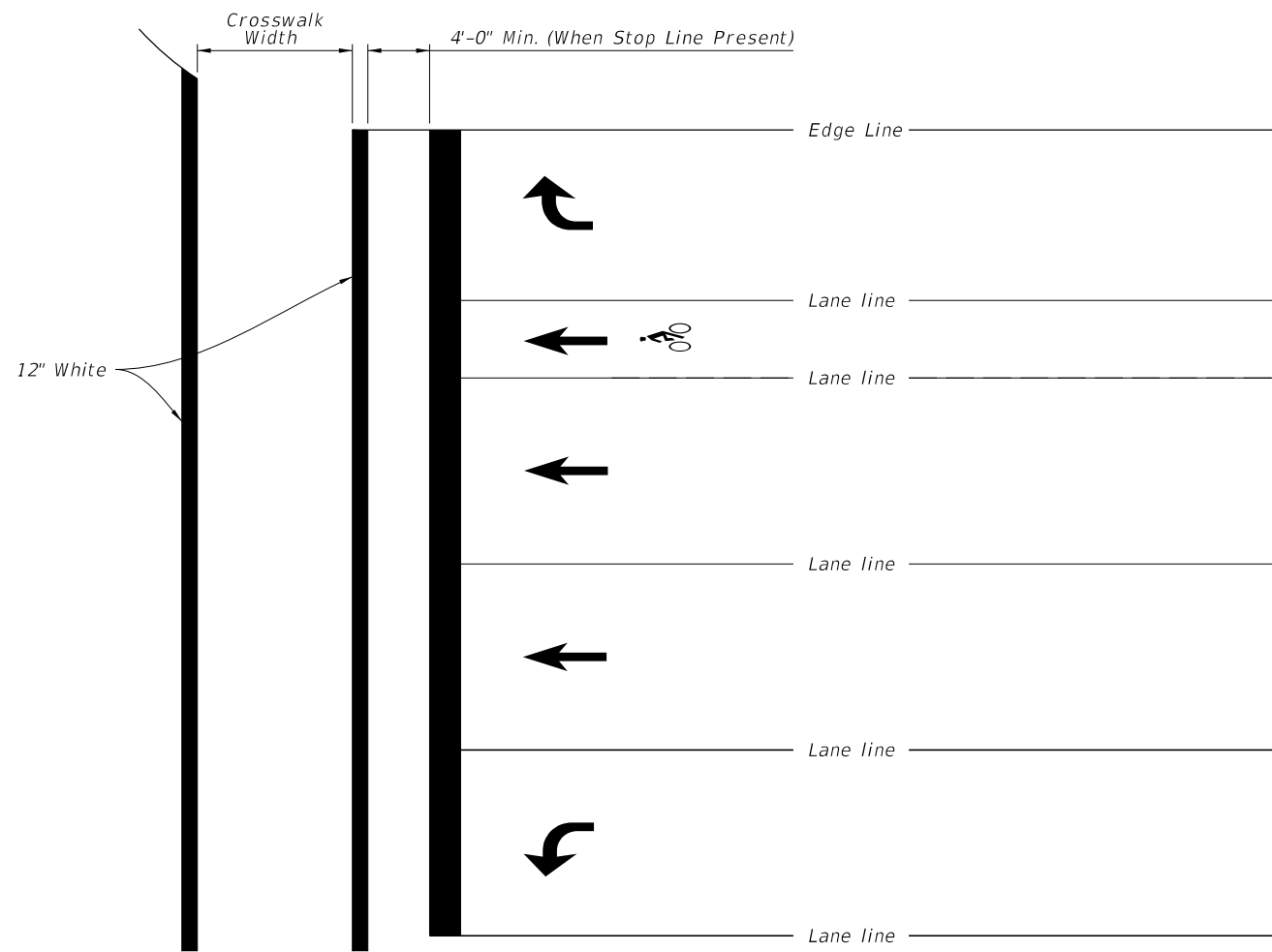

STANDARD CROSSWALK DETAILS

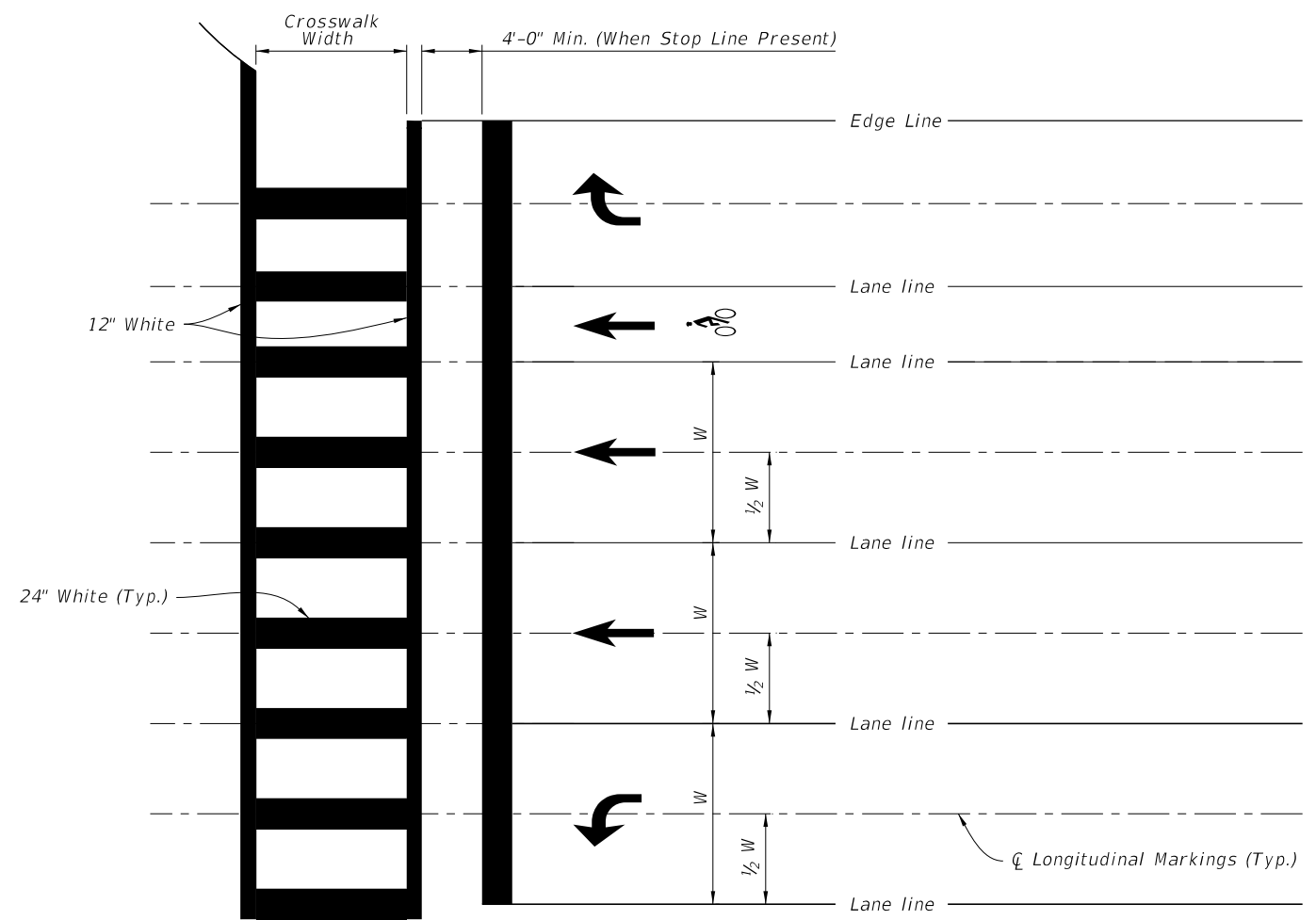

SPECIAL EMPHASIS CROSSWALK DETAILS

**NOTES:**

1. For crosswalk width, exceed width of the adjacent sidewalk, but do not make width less than 6' for intersection crosswalks and 10' for midblock crosswalks. Measure width from the inside of the transverse crosswalk markings.
2. When the Special Emphasis Crosswalk is not perpendicular to the lane lines, make the longitudinal markings parallel to the lane lines.
3. Refer to Index 522-002 when Curb Ramps are present.

12:06:29 PM  
2/5/2021

LAST REVISION 02/05/21	REVISION	DESCRIPTION: Added railroad pavement marking details.
---------------------------	----------	--



FY 2020-21  
STANDARD PLANS

PAVEMENT MARKINGS

INDEX  
711-001-1

SHEET  
10 of 14

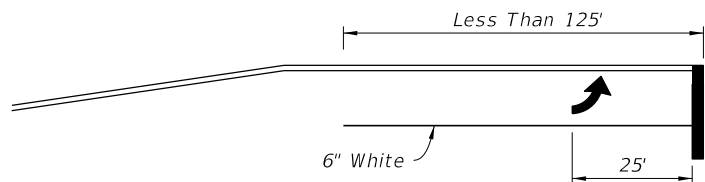

1 ARROW

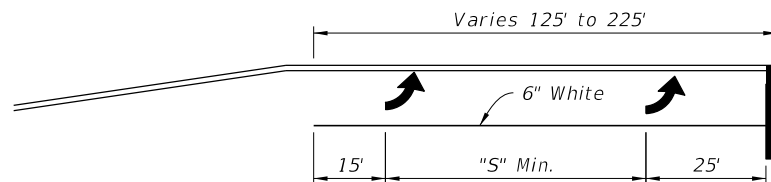

2 ARROW

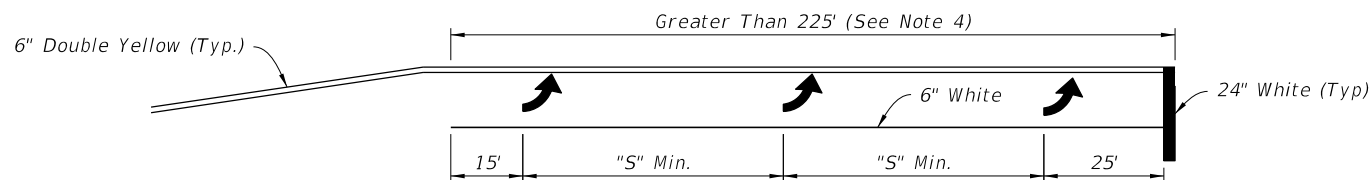

3 ARROW

**NOTES:**

1. This Index also applies to right turn lanes.
2. Make pavement marking yellow for left-turn lanes and white for right-turn lanes.
3. See Sheet 1 for "S" value.
4. Space arrows evenly between the first and last arrow with a minimum spacing of "S" between arrows.
5. For turn lanes greater than 225' in length, use a minimum of three arrows. Use additional arrows in accordance with the Plans or as directed by the Engineer. Space arrows evenly throughout the available length with a minimum spacing of "S" between arrows.

**SINGLE LEFT TURNS**

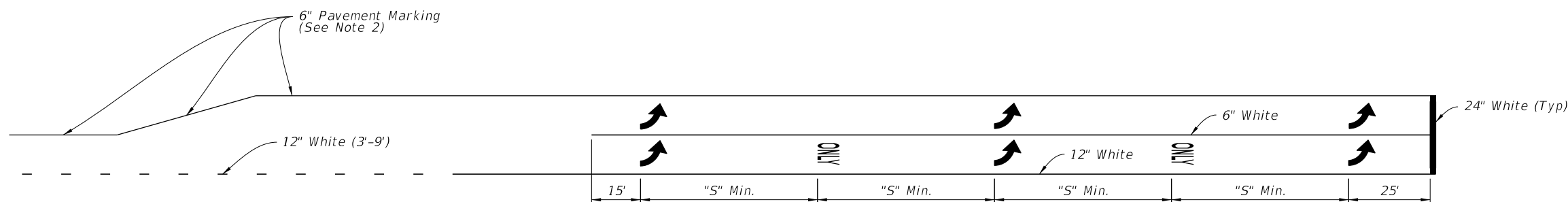

Through Lane Becomes Exclusive Left Turn

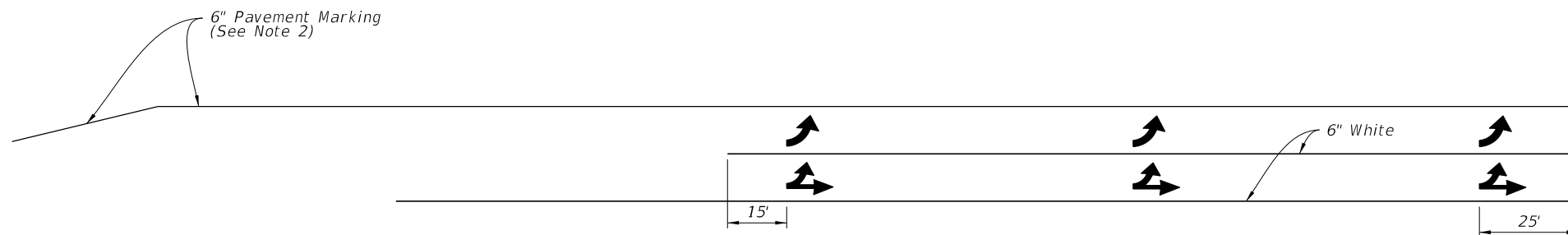

Through Lane Becomes Optional Left Turn

**DOUBLE LEFT TURNS**

2/5/2021 12:06:31 PM

LAST REVISION	02/05/21	REVISION	DESCRIPTION: Added railroad pavement marking details.
---------------	----------	----------	--



FY 2020-21  
STANDARD PLANS

PAVEMENT MARKINGS

**TURN LANE MARKINGS**

INDEX  
711-001-1

SHEET  
11 of 14

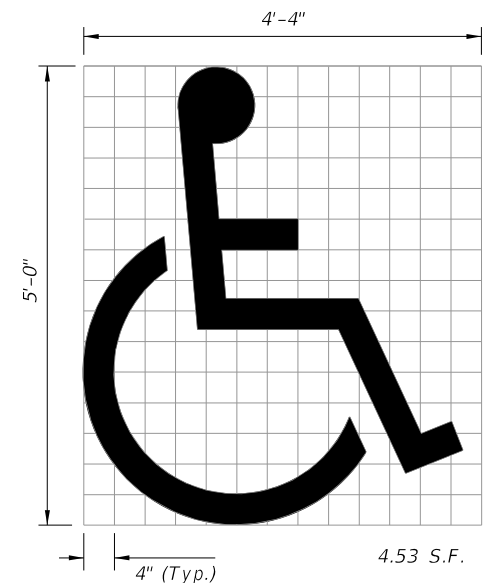
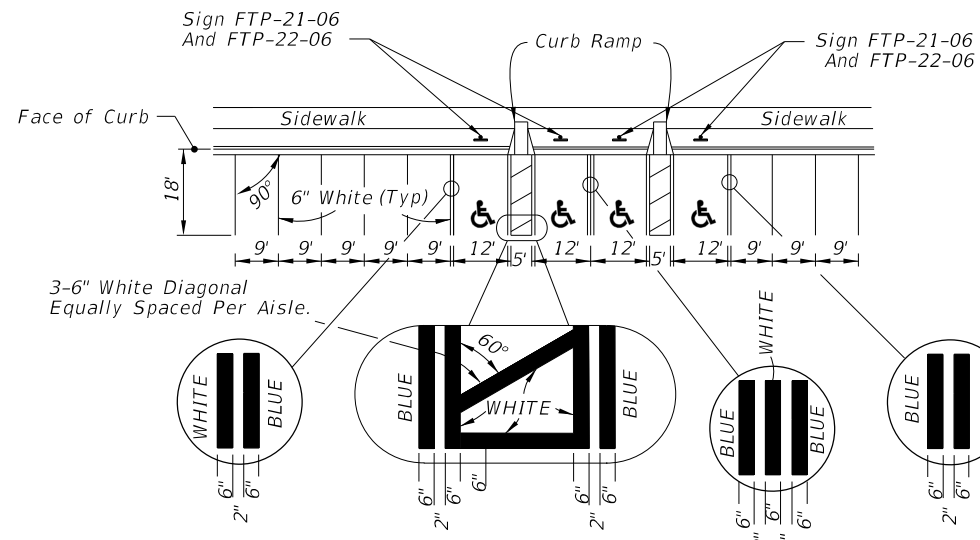
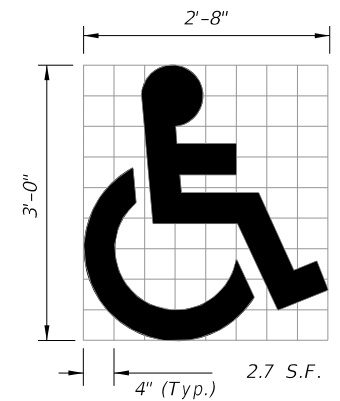
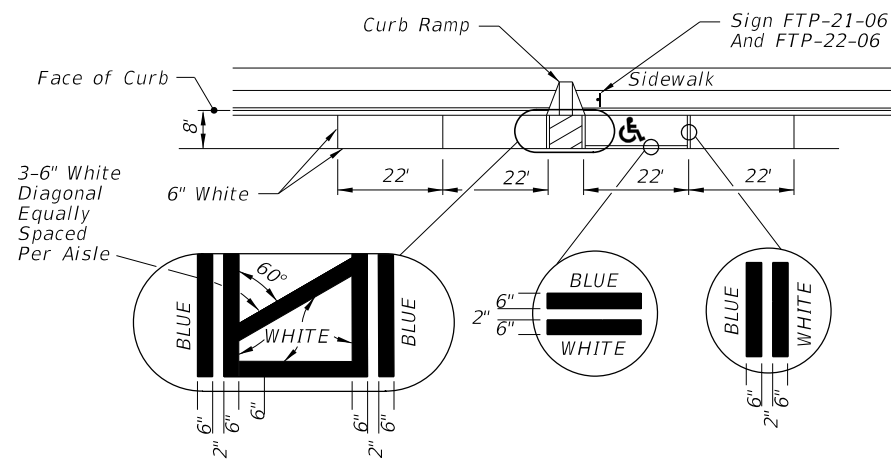

TYPICAL

(See Note 6)

UNIVERSAL SYMBOL OF ACCESSIBILITY

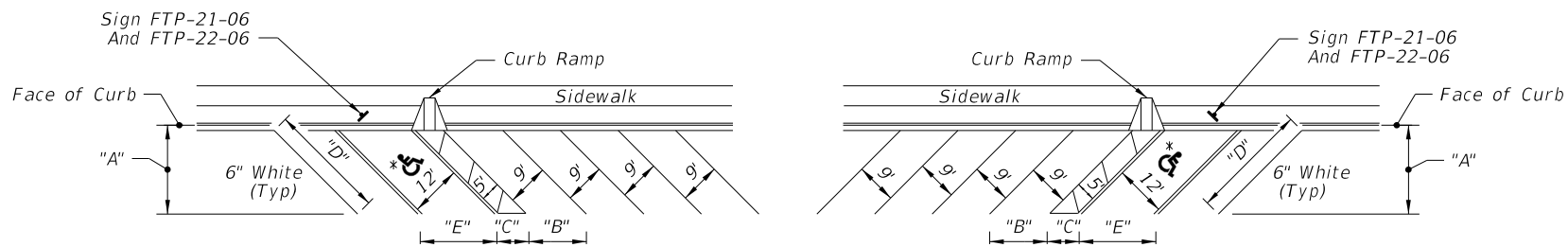

FORWARD-IN PARKING

REVERSE-IN PARKING

\* FOR ACCESSIBLE MARKINGS - SEE ABOVE

DIMENSIONS					
∠ θ	"A"	"B"	"C"	"D"	"E"
45°	17'-0"	12'-9"	7'-0"	24'-0"	17'-0"

PAVEMENT MARKING FOR PARKING

NOTES:

1. Dimensions are to the centerline of markings.
2. An Access Aisle is required for each accessible space when angle parking is used.
3. Criteria for pavement markings only, not public sidewalk curb ramp locations. For ramp locations refer to plans.
4. Tint blue pavement markings to match color 15180 of Federal Standards 595a.
5. Mount FTP-22-06 sign below the FTP-21-06 sign.
6. Use of the pavement symbol in accessible parking spaces is optional. When pavement symbol is used, the symbol is either 3'-0" or 5'-0" high and white in color.

2/5/2021 12:06:32 PM

LAST REVISION  
02/05/21

DESCRIPTION:  
Added railroad pavement marking details.



FY 2020-21  
STANDARD PLANS

PAVEMENT MARKINGS

INDEX  
711-001-1

SHEET  
12 of 14

33 S.F.

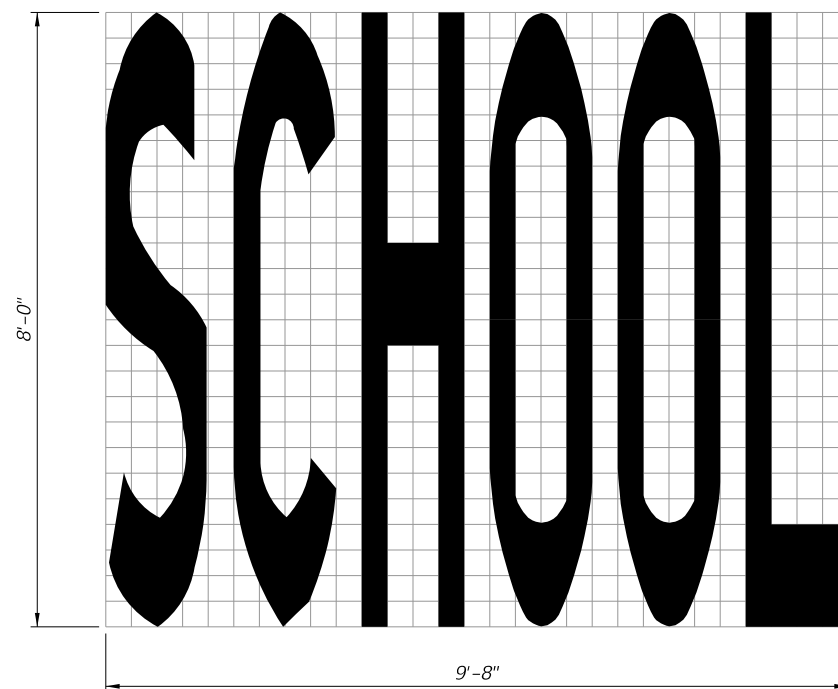

SCHOOL PAVEMENT MARKING

**NOTES:**

1. All grids are 4" x 4".
2. Pavement Marking Should Not Extend Into Opposing Lane.
3. Center School Pavement Marking in lane.

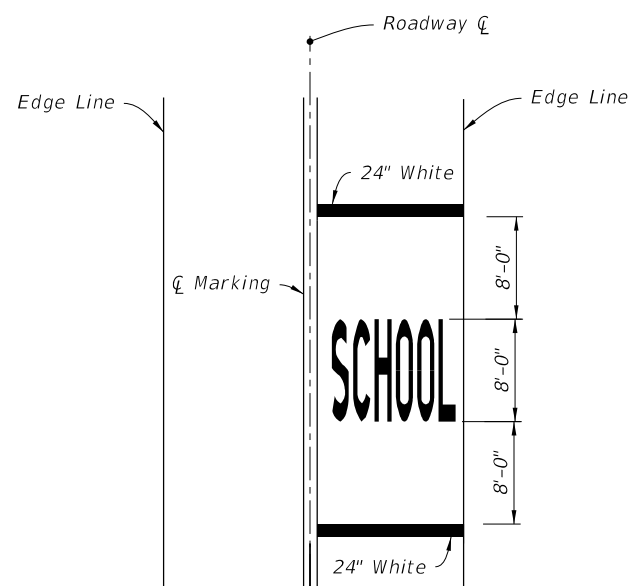

SINGLE-LANE APPROACH

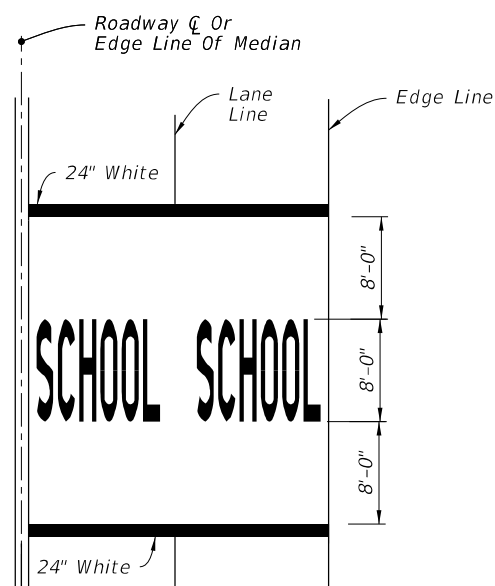

TWO-LANE APPROACH

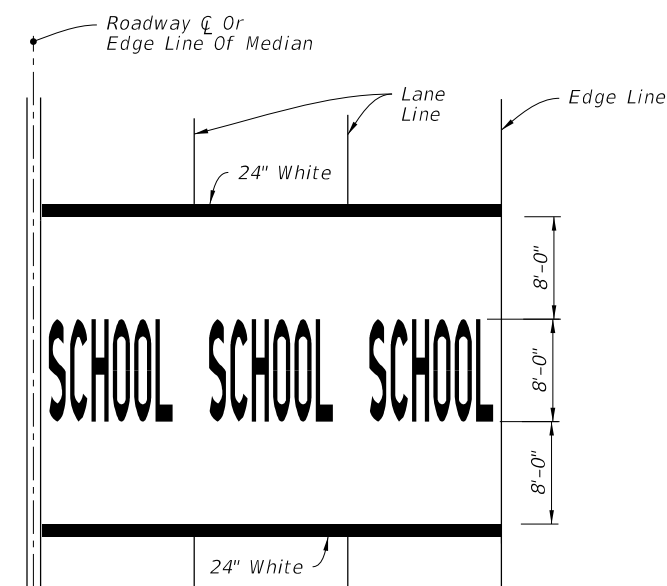

MULTI-LANE APPROACH  
(Three or More)

MARKINGS FOR SCHOOL ZONES

12:06:35 PM 2/5/2021

LAST REVISION	02/05/21	REVISION	DESCRIPTION: Added railroad pavement marking details.
---------------	----------	----------	--



FY 2020-21  
STANDARD PLANS

PAVEMENT MARKINGS

INDEX  
711-001-1

SHEET  
13 of 14

**NOTE:**

Orient Railroad Dynamic Envelope Marking as shown in the Plans.

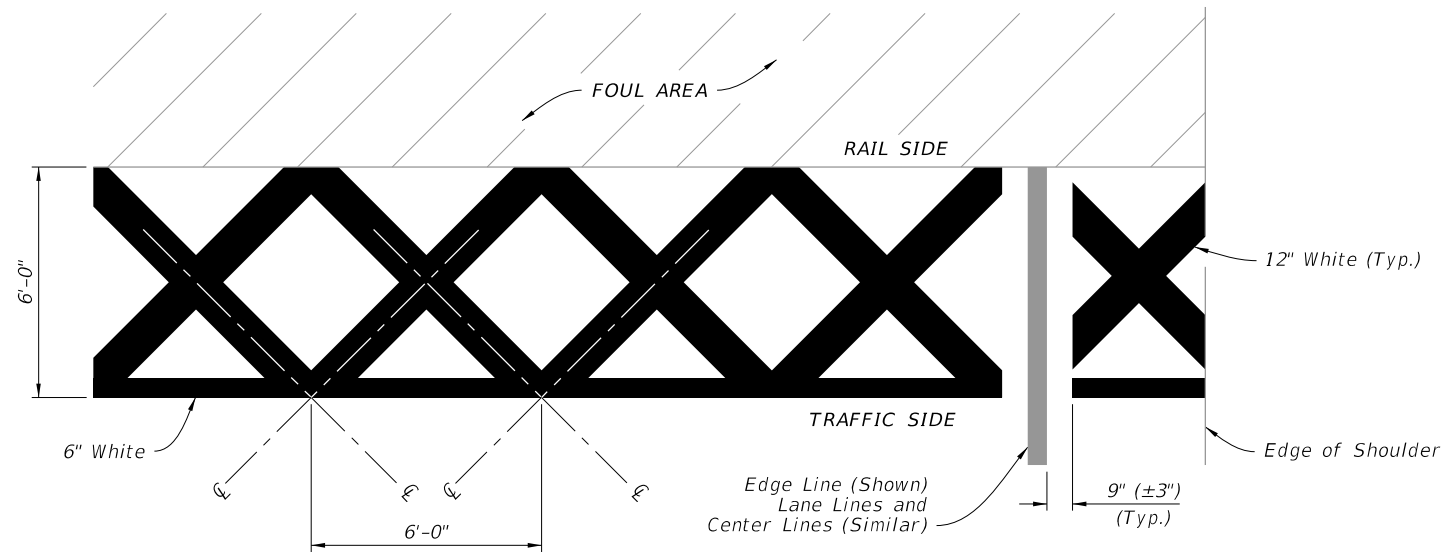

RAILROAD DYNAMIC ENVELOPE (RDE) PAVEMENT MARKING DETAIL

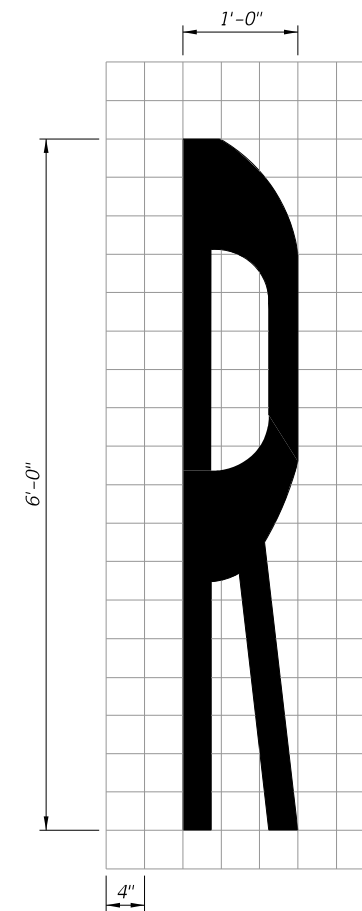
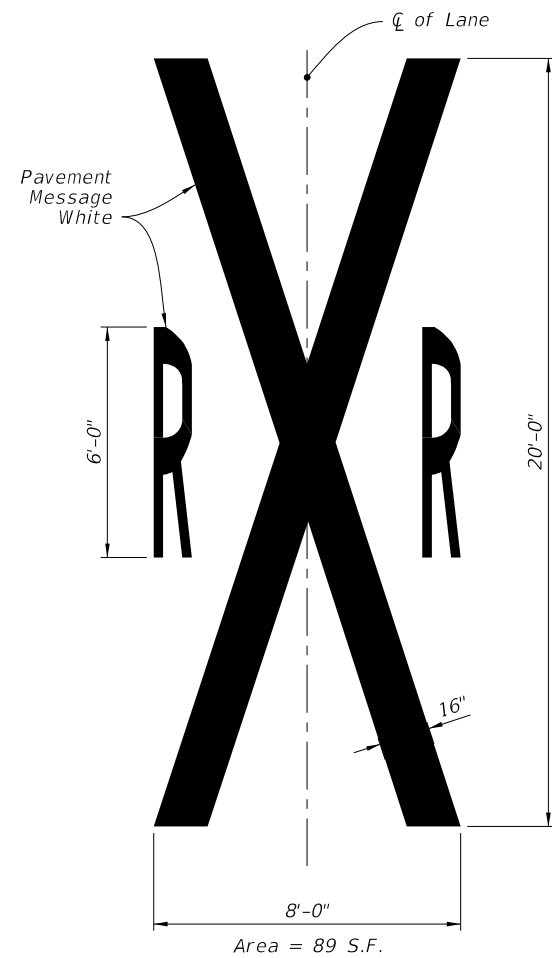

RAILROAD CROSSING PAVEMENT MESSAGE

12:06:36 PM  
2/5/2021

<p>LAST REVISION 02/05/21</p>	<p>REVISION</p> <p>DESCRIPTION: Added railroad pavement marking details.</p>	 <p>FY 2020-21 STANDARD PLANS</p>	<p>PAVEMENT MARKINGS</p>	<p>INDEX 711-001-1</p>	<p>SHEET 14 of 14</p>
-----------------------------------	--	--	--------------------------	----------------------------	---------------------------