

FTP-1-06
 11'-6" X 5'-6"
 9" Radii 2" Border
 10" Series E Legend
 White Background
 Black Legend and Border

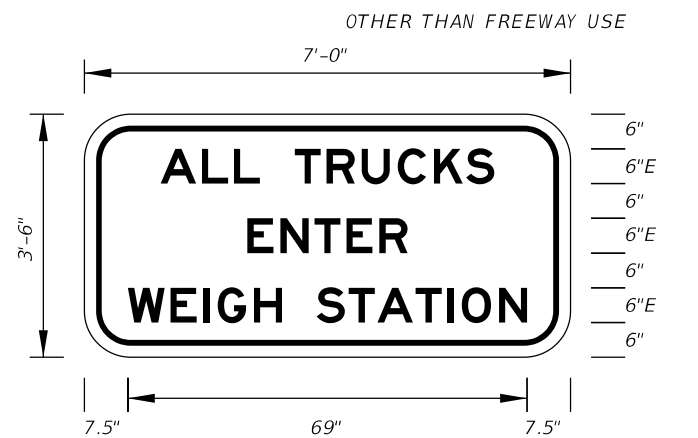

FTP-2-06
 7' X 3'-6"
 6" Radii 2" Border
 6" Series E Legend
 White Background
 Black Legend and Border

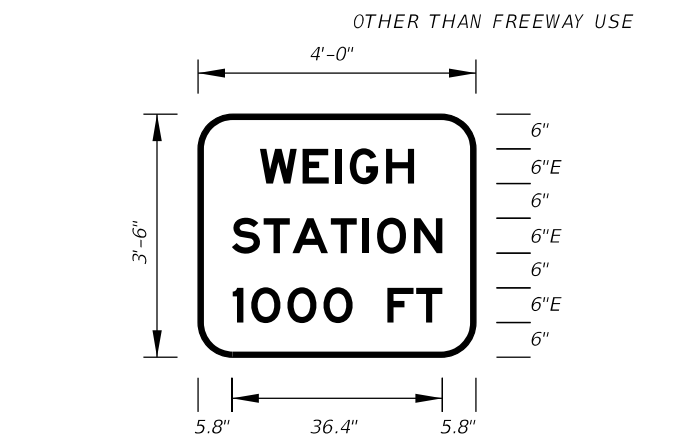

FTP-3-06
 4' X 3'-6"
 6" Radii 2" Border
 6" Series E Legend
 White Background
 Black Legend and Border

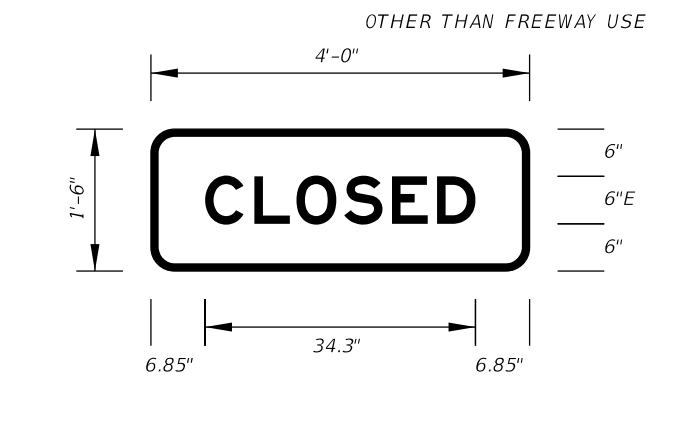

FTP-4-06
 4' X 1'-6"
 3" Radii 2" Border
 6" Series E Legend
 Green Background
 White Legend and Border
 Note:
 FTP-4-06 to be
 used with FTP-3-06

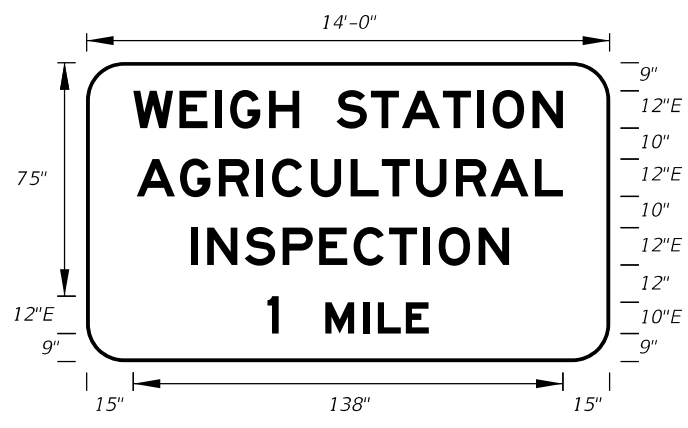

FTP-5-06
 14' X 8'
 12" Radii 2" Border
 12" and 10" Series E Legend
 Green Background
 White Legend and Border

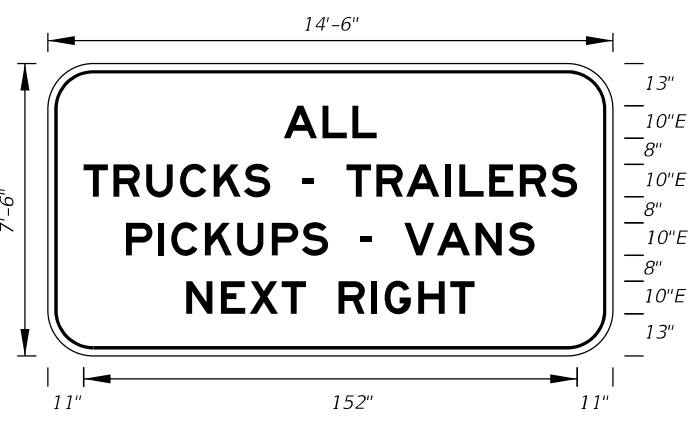

FTP-6A-06
 14'-6" X 7'-6"
 12" Radii 2" Border
 10" Series E Legend
 White Background
 Black Legend and Border
 On Interstate Station
 Delete Pickups-Vans,
 and reduce Sign height
 accordingly.

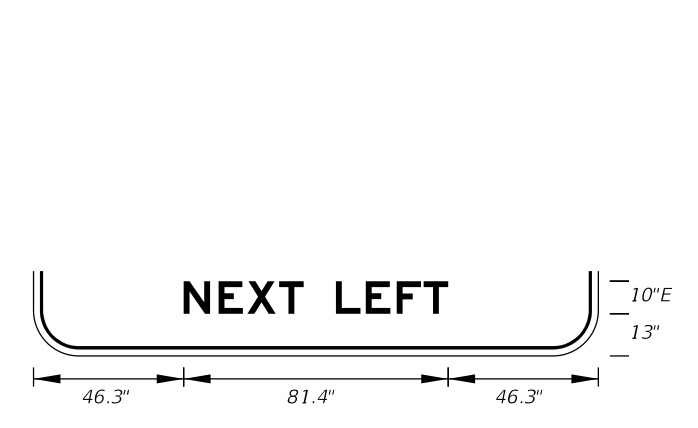

FTP-6B-06
 14'-6" X 7'-6"
 12" Radii 2" Border
 10" Series E Legend
 White Background
 Black Legend and Border



FTP-7A-06
 12' X 7'
 11" Radii 2" Border
 10" Series E Legend
 Green Background
 White Legend and Border

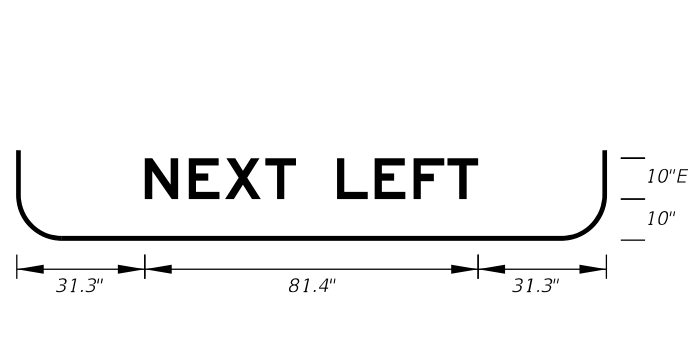

FTP-7B-06
 12' X 7'
 11" Radii 2" Border
 10" Series E Legend
 Green Background
 White Legend and Border

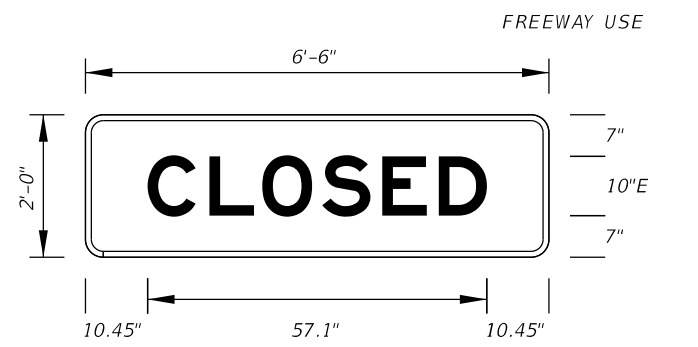

FTP-8-06
 6'-6" X 2'
 3" Radii 2" Border
 10" Series E Legend
 Green Background
 White Legend and Border
 Note:
 FTP-8-06 to be
 used with FTP-7A-06
 & FTP-7B-06.

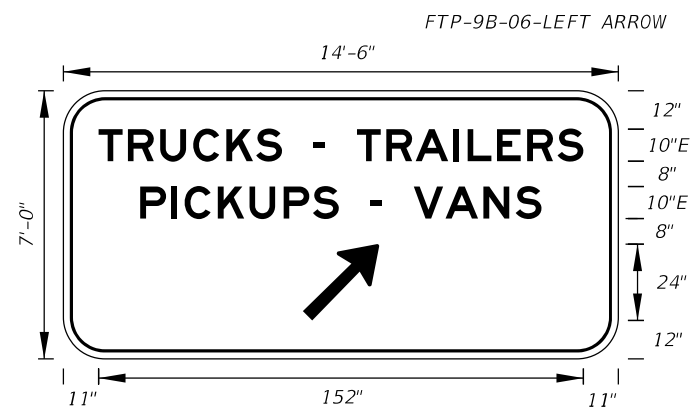

FTP-9A-06
 14'-6" X 7'
 11" Radii 2" Border
 10" Series E Legend
 Green Background
 White Legend and Border

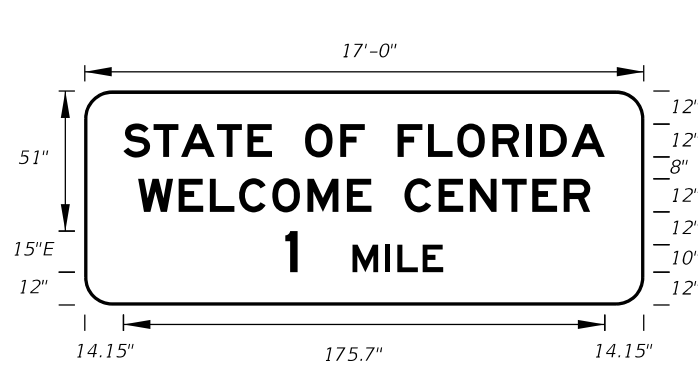

FTP-10-06
 17' X 6'-6"
 10" Radii 2" Border
 12", 10" and 15" Series E Legend
 Blue Background
 White Legend and Border

10/14/2019 2:42:05 PM

LAST REVISION 11/01/17	REVISION	DESCRIPTION:	 FY 2020-21 STANDARD PLANS	SPECIAL SIGN DETAILS	INDEX 700-102	SHEET 1 of 11
---------------------------	----------	--------------	--	-----------------------------	-------------------------	-------------------------

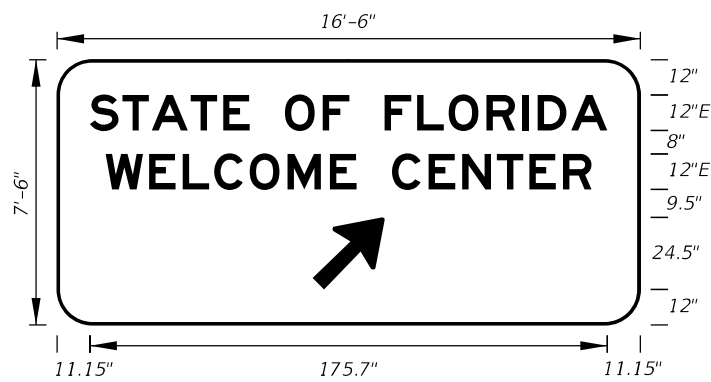

FTP-11-06
 16'-6" X 7'-6"
 12" Radii 2" Border
 12" Series E Legend
 Blue Background
 White Legend and Border

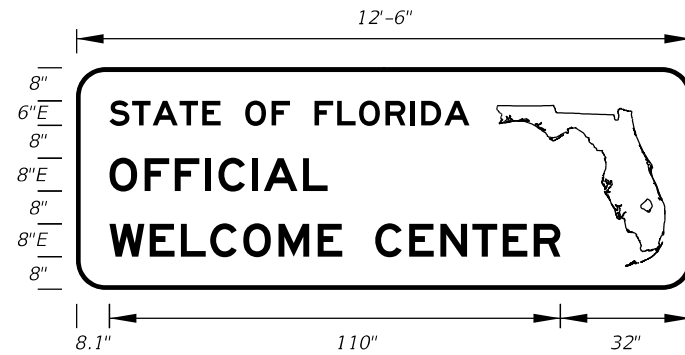

FTP-12-06
 12'-6" X 4'-6"
 7" Radii 2" Border
 6" and 8" Series E Legend
 Blue Background
 White Legend and Border

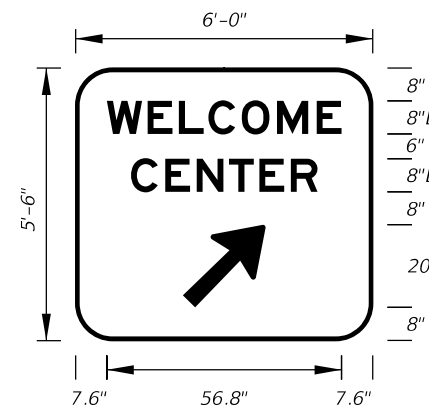

FTP-13-06
 6' 0" X 5'-6"
 9" Radii 2" Border
 8" Series E Legend
 Blue Background
 White Legend and Border

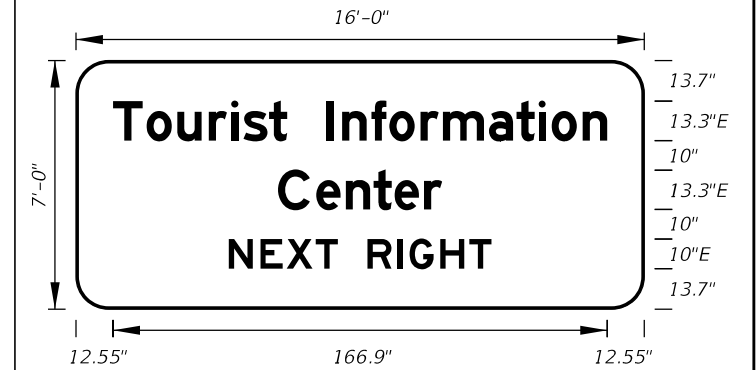

FTP-14-06
 16'-0" X 7'-0"
 11" Radii 2" Border
 13.3 and 10" Series E Legend
 Blue Background
 White Legend and Border

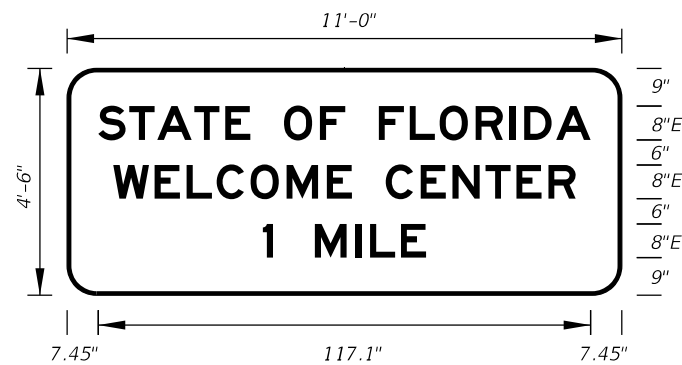

FTP-15A-06
 11'-0" X 4'-6"
 7" Radii 2" Border
 8" Series E Legend
 Blue Background
 White Legend and Border

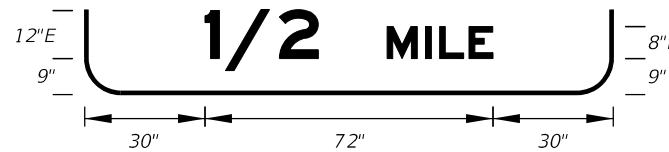

FTP-15B-06
 11'-0" X 5'-0"
 8" Radii 2" Border
 8" and 12" Series E Legend
 Blue Background
 White Legend and Border

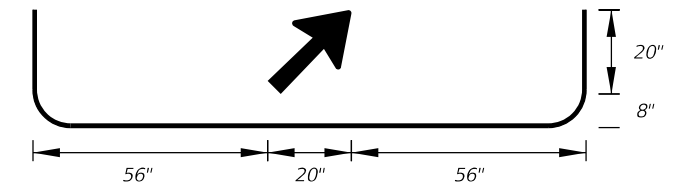

FTP-15C-06
 11'-0" X 5'-6"
 9" Radii 2" Border
 8" Series E Legend
 Blue Background
 White Legend and Border



FTP-16-10
 2'-6" X 3'-0"
 1.5" Radii 3/4" Border
 5" Series B Legend
 Green Background
 White Legend, Border,
 and Florida Symbol



FTP-17-10
 3'-0" X 4'-0"
 1.5" Radii 3/4" Border
 7" Series B Legend
 Green Background
 White Legend, Border,
 and Florida Symbol



FTP-18-10
 4'-0" X 5'-0"
 3" Radii 1 1/4" Border
 8" Series B Legend
 Green Background
 White Legend, Border,
 and Florida Symbol

10/14/2019 2:42:05 PM

LAST REVISION	DESCRIPTION:
11/01/17	



FY 2020-21
 STANDARD PLANS

SPECIAL SIGN DETAILS

INDEX
 700-102

SHEET
 2 of 11

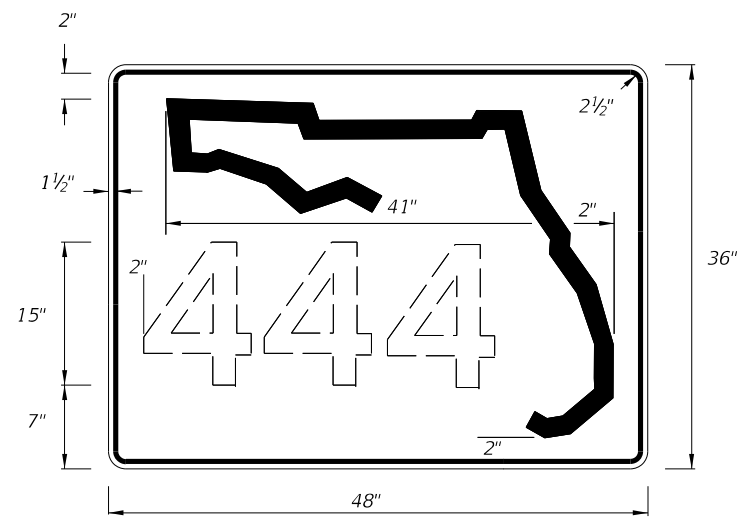

DIGITS	NUMERAL SIZE	SERIES LEGEND	PANEL SIZE
1-3	15"	C	48" x 36"
4	12"	C	48" x 36"

NOTES:

- Stroke width of State Outline shall be 1".
- 2 1/2" Radii

INDEPENDENT USE FOR FREEWAY

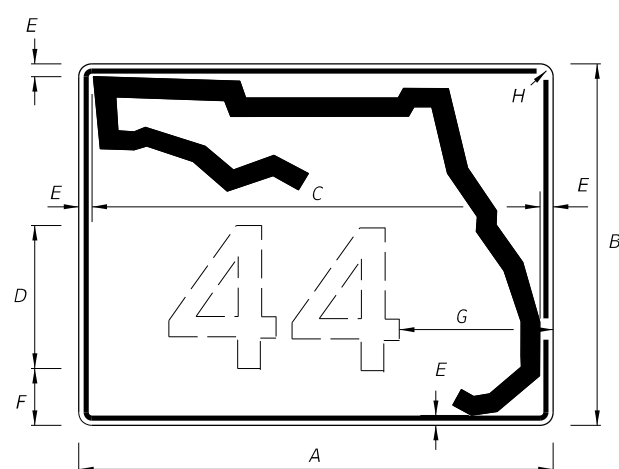

1 OR 2 DIGITS

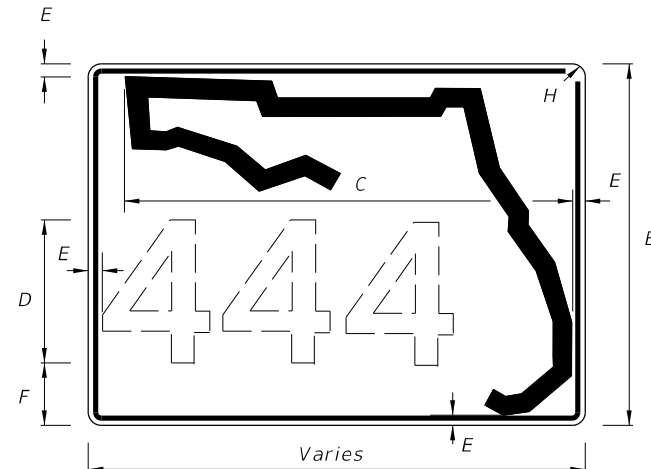

3 OR MORE DIGITS

NOTES:

- Florida marker shall have Black Legend with White Background.
- Stroke width of State outline shall be 1 3/4" for Guide Sign.
- Series D Legend.
- 5/8" Border

A	B	C	D	E	F	G	H
30"	24"	26"	12"	1 1/4"	2 3/4"	8 1/4"	1 1/4"
36"	30"	32"	15"	1 1/4"	3 1/4"	8 3/4"	1 1/4"
42"	36"	38"	15"	1 1/4"	6 1/4"	11"	1 1/4"

GUIDE SIGN USE

FTP-17-06 - FLORIDA ROUTE MARKER

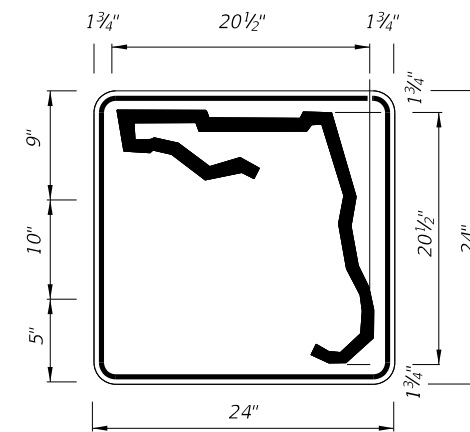

1 or 2 DIGITS

DIGITS	NUMERAL SIZE	SERIES LEGEND	PANEL SIZE
1-2	10"	D	24" x 24"

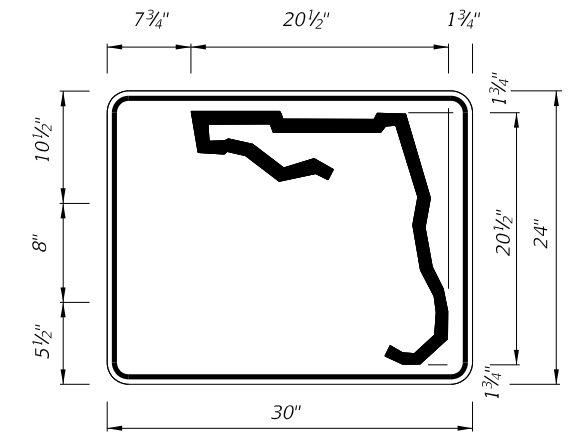

3 or 4 DIGITS

DIGITS	NUMERAL SIZE	SERIES LEGEND	PANEL SIZE
3	8"	D	30" x 24"
4	8"	C	30" x 24"

NOTES:

- Stroke width of State Outline shall be 1".
- The 24" X 24" panel shall only be used for a 3 digit route when the panel is to be used on a sign cluster with other 24" X 24" panels.
- 1 1/2" Radii

INDEPENDENT USE OTHER THAN FREEWAY

NOTES:

- Series D Legend.
- Color: Yellow Legend and Border on Blue Background.
- When used on a guide sign, marker must be overlaid on a rectangular Yellow Background as shown in chart.
- When two or more County Route Markers are mounted together, use the dimensions of the largest marker for all other markers.

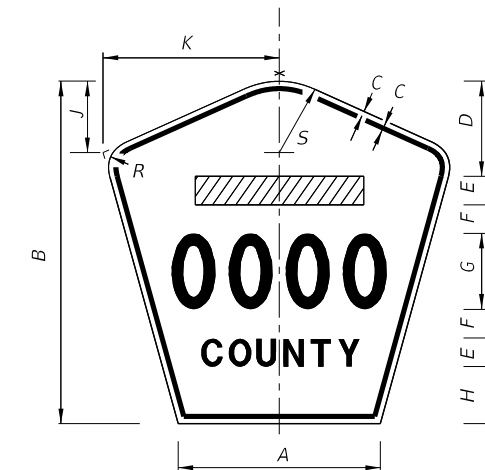

SIGN	DIMENSIONS													Rectangular Yellow Background Dimensions (See Note 3)
	A	B	C	D	E	F	G	H	J	K	R	S		
4 DIGIT POST MOUNTED	25 5/8"	42"	3/4"	10"	4"	4"	8"	8"	8 3/8"	22"	5"	8 3/4"		
2 DIGIT OVERHEAD	21 1/2"	36"	1/2"	7 1/2"	3"	3"	12"	4 1/2"	7 1/8"	18 1/8"	4 1/4"	7 1/2"	42" x 42"	
3 DIGIT OVERHEAD	25 1/8"	42"	3/4"	8"	4"	4"	12"	6"	8 3/8"	22"	5"	8 3/4"	48" x 48"	
4 DIGIT OVERHEAD	29 7/8"	48"	3/4"	8"	5"	5"	12"	8"	9 3/4"	25 5/8"	5 3/4"	10 1/4"	52" x 52"	

FTP-18-06 - COUNTY ROUTE MARKER (M1-6)

10/14/2019 2:42:06 PM

LAST REVISION	DESCRIPTION:
11/01/17	



**FY 2020-21
STANDARD PLANS**

SPECIAL SIGN DETAILS

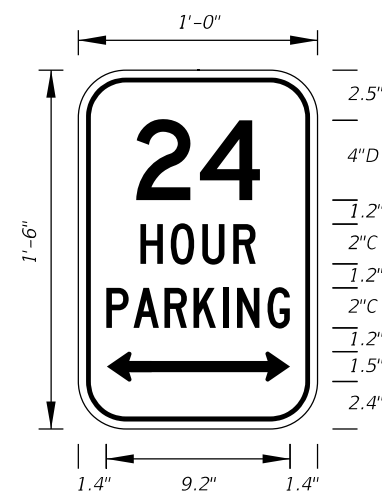
INDEX	SHEET
700-102	3 of 11

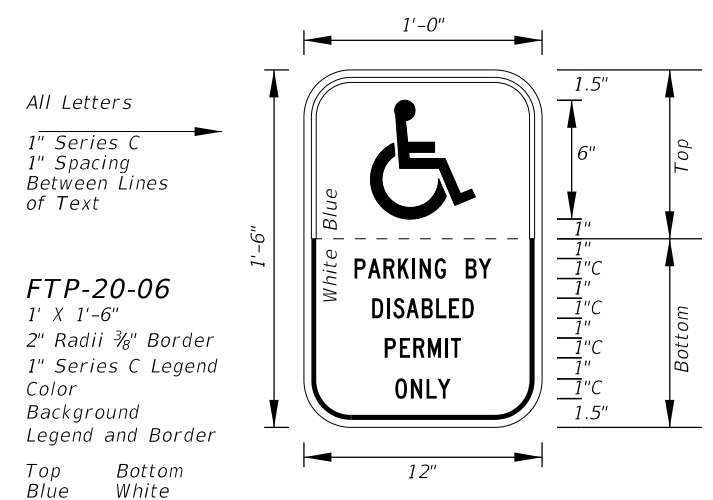

FTP-19-06
 1' X 1'-6"
 4" Radii 3/8" Border
 Top 4" Series D
 Bottom 2" Series C
 White Background
 Green Legend and Border



FTP-20-06
 1' X 1'-6"
 2" Radii 3/8" Border
 1" Series C Legend
 Color
 Background
 Legend and Border
 Top Blue
 Bottom White
 White Black

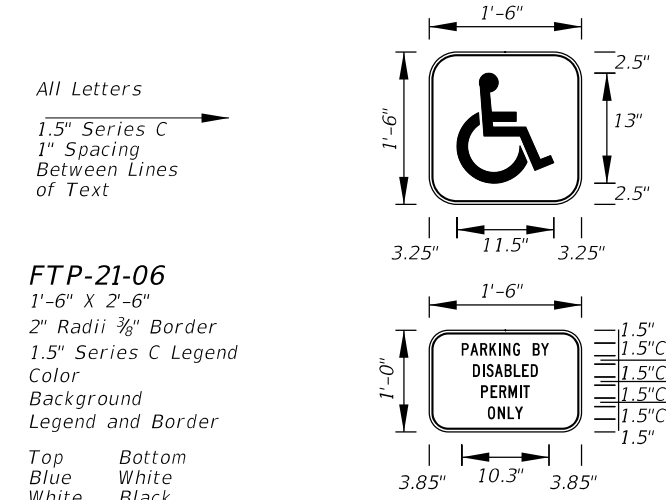

FTP-21-06
 1'-6" X 2'-6"
 2" Radii 3/8" Border
 1.5" Series C Legend
 Color
 Background
 Legend and Border
 Top Blue
 Bottom White
 White Black

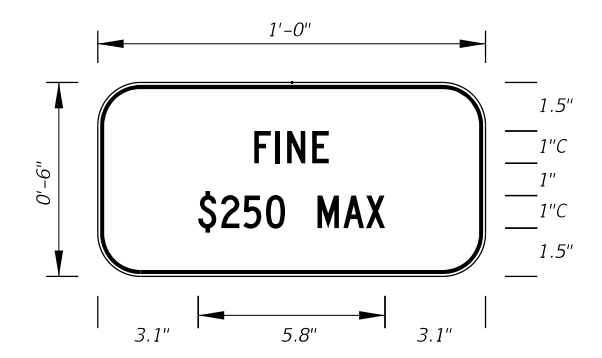

FTP-22-06
 1' X 6"
 1" Radii 3/8" Border
 1" Series C Legend
 White Background
 Black Legend and Border
 Supplemental Panel
 for the FTP-20-06
 and FTP-21-06 signs

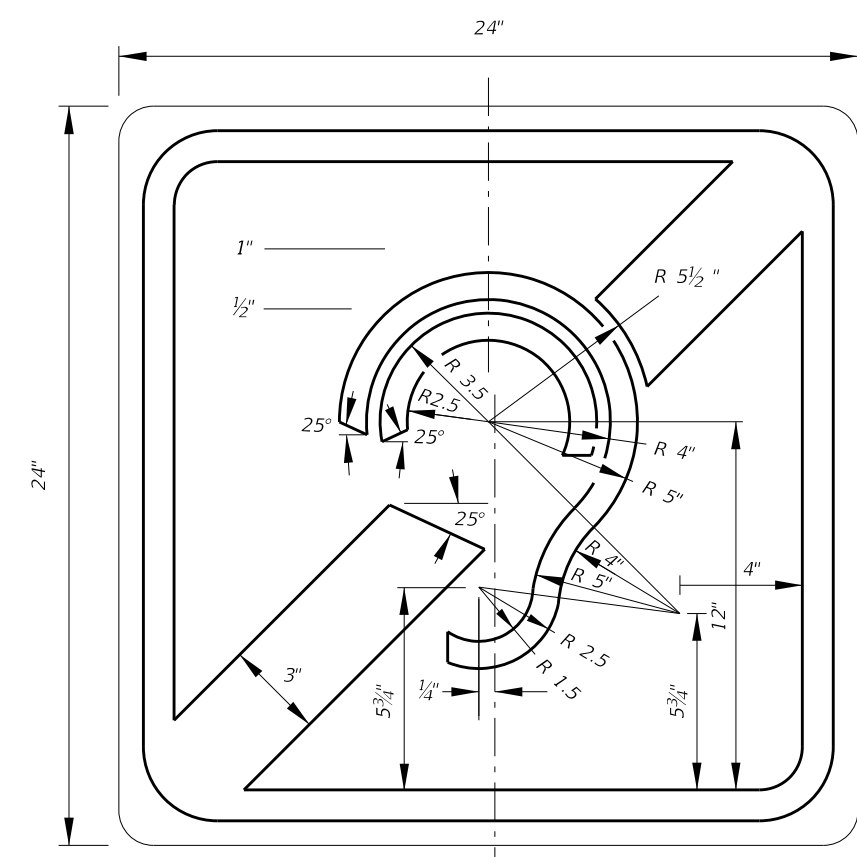

FTP-23-06
 2' X 2'
 1.5" Radii 5/8" Border
 Blue Background
 White Legend and Border

INTERNATIONAL SYMBOL OF ACCESS FOR HEARING LOSS

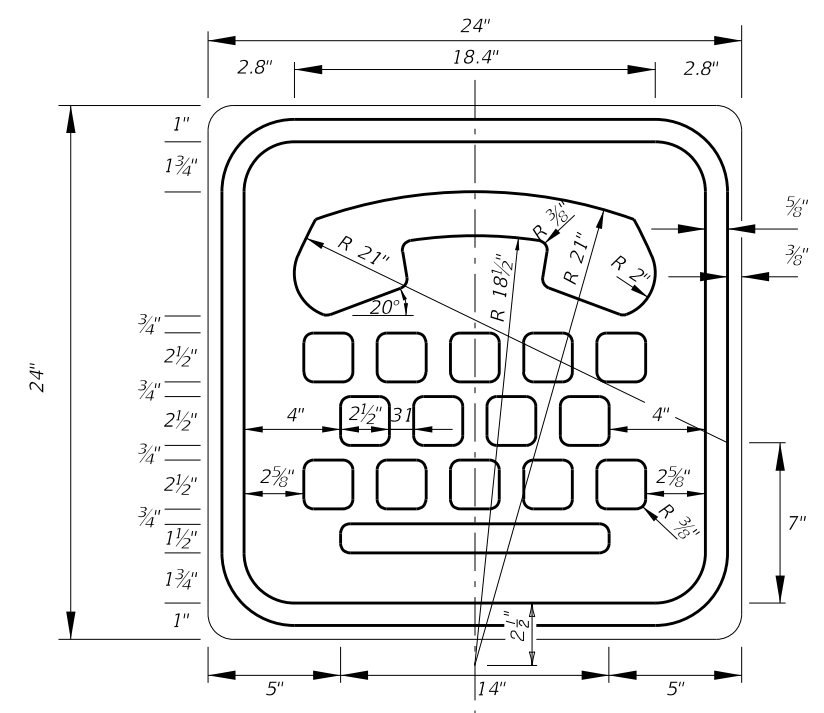

FTP-24-06
 2' X 2'
 1.5" Radii 5/8" Border
 Blue Background
 White Legend and Border

INTERNATIONAL TDD SYMBOL

10/14/2019 2:42:07 PM

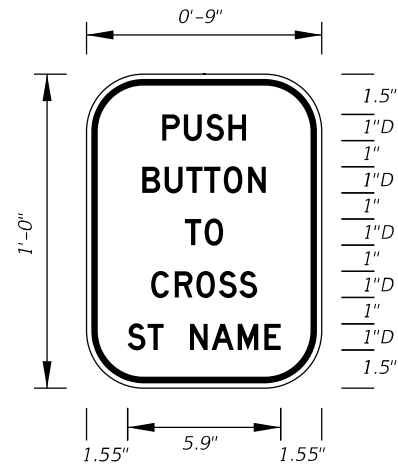

FTP-25-06
 9" X 1'-0"
 2" Radii 3/8" Border
 1" Series D Legend
 White Background
 Black Legend and Border

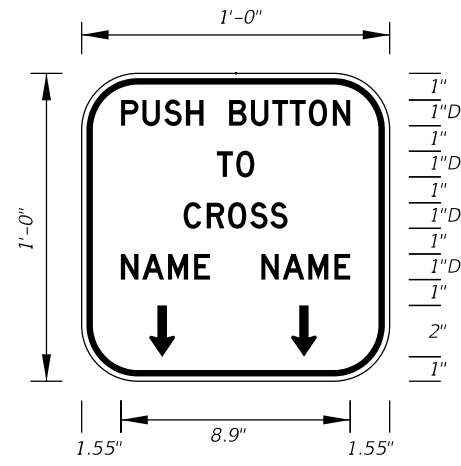

FTP-26-06
 1' X 1'
 2" Radii 3/8" Border
 1" Series D Legend
 White Background
 Black Legend and Border

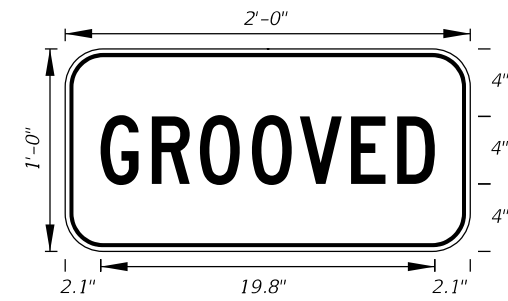

FTP-29-06
 2'-0" X 1'-0"
 2" Radii 5/8" Border
 4" Series C Legend
 Yellow Background
 Black Legend and Border

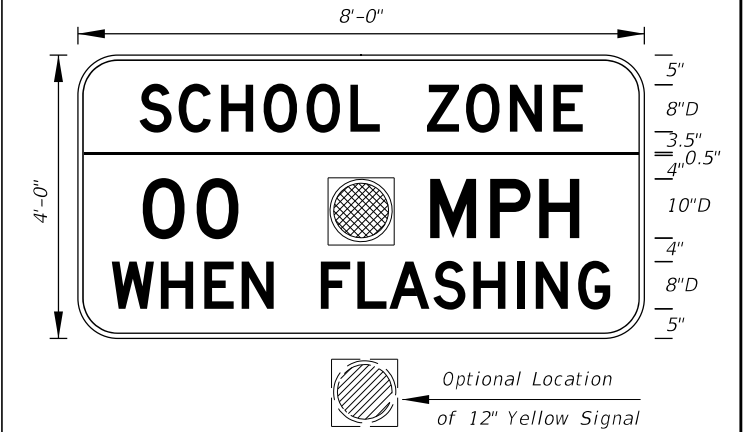

FTP-31-06
 8' X 4'
 6" Radii 3/4" Border
 Series D Legend
 Fluorescent Yellow-Green Background Top
 White Background Bottom
 Black Legend and Border

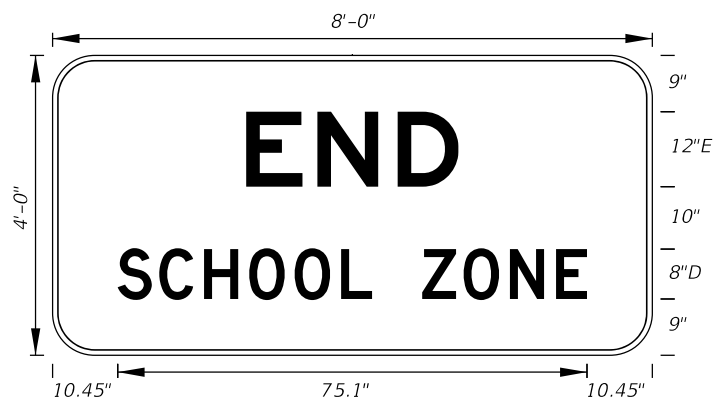

FTP-32-06
 8' X 4'
 6" Radii 3/4" Border
 12" Series E and 8" Series D Legend
 White Background
 Black Legend and Border

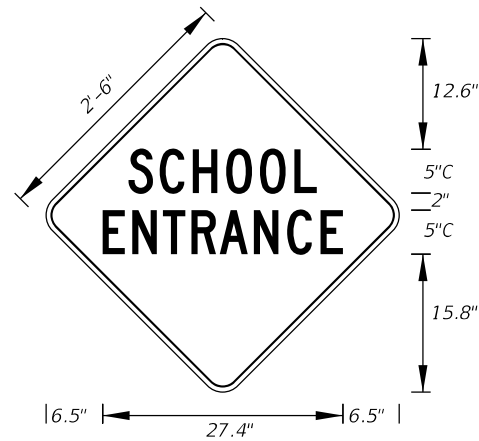

FTP-33-06
 2'-6" X 2'-6"
 2" Radii 3/4" Border
 5" Series C Legend
 Fluorescent Yellow-Green Background
 Black Legend and Border

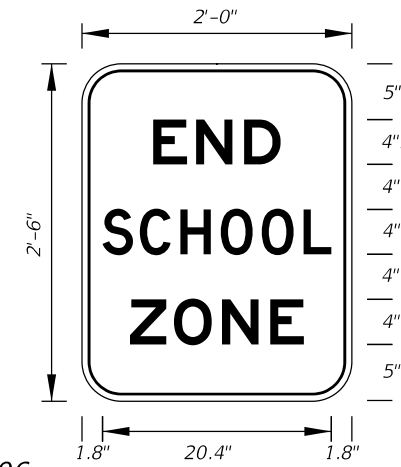

FTP-34-06
 2' X 2'-6"
 3" Radii 5/8" Border
 4" Series D and E Legend
 White Background
 Black Legend and Border

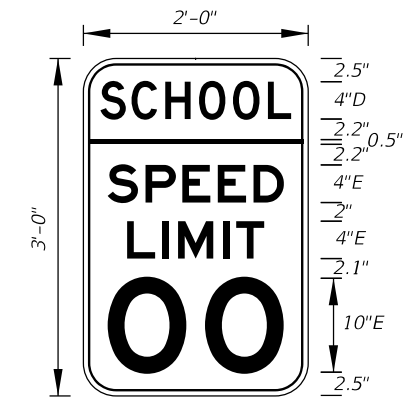

FTP-35-06
 2' X 3'
 3" Radii 5/8" Border
 Top 4" Series D Legend
 Bottom 4" and 10" Series E Legend
 Fluorescent Yellow-Green Background Top
 White Background Bottom
 Black Legend and Border

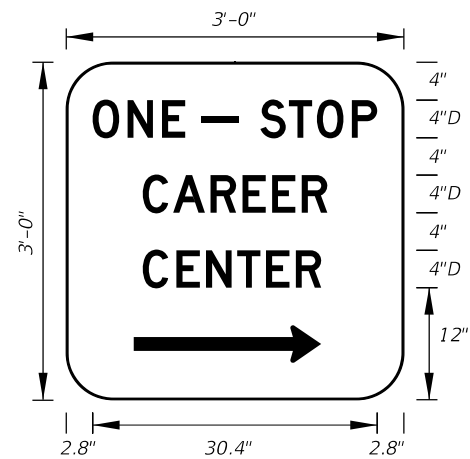

FTP-36-06
 3' X 3'
 5" Radii
 4" Series D Legend
 Green Background
 White Legend and Border

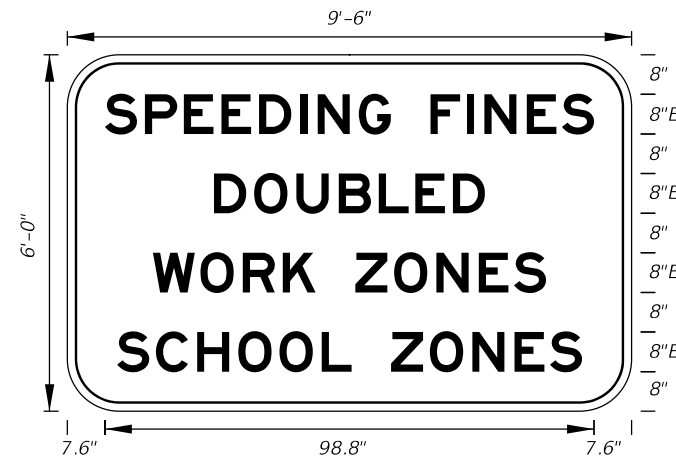

FTP-37-06
 9'-6" X 6'
 9" Radii 2" Border
 8" Series E Legend
 White Background
 Black Legend and Border
 State Line Sign

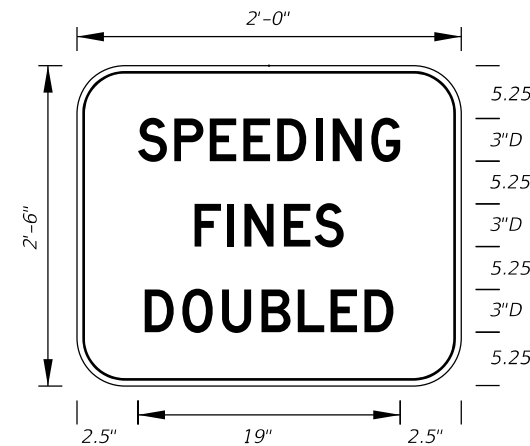

FTP-38-06
 2' X 2'-6"
 4" Radii 3/4" Border
 3" Series D Legend
 White Background
 Black Legend and Border

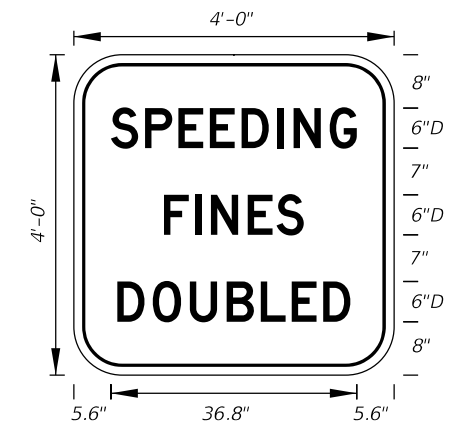

FTP-39-06
 4' X 4'
 6" Radii 3/4" Border
 6" Series D Legend
 White Background
 Black Legend and Border
 Freeway Sign

10/14/2019 2:42:08 PM

LAST REVISION	DESCRIPTION:
11/01/18	



FTP-40-06
3'-6" X 4'
6" Radii 3/4" Border
3" and 6" Series C Legend
White Background
Black Legend and Border



FTP-41-06
2'-6" X 3'
4" Radii 3/4" Border
2" and 4" Series C Legend
White Background
Black Legend and Border



FTP-42-06
4' X 2'-6"
3" Radii
Top 4" Series C Legend
Bottom 2" Series EM Legend
White Background
Blue Legend and Border

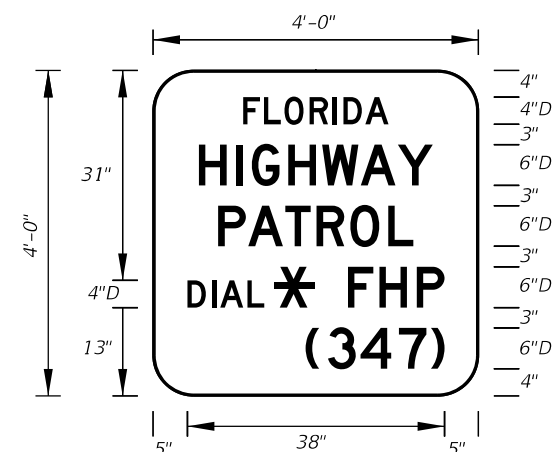

FTP-43-06
4' X 4'
6" Radii 1" Border
Top 4" Series D Legend
Bottom 6" Series D Legend
Blue Background
White Legend and Border

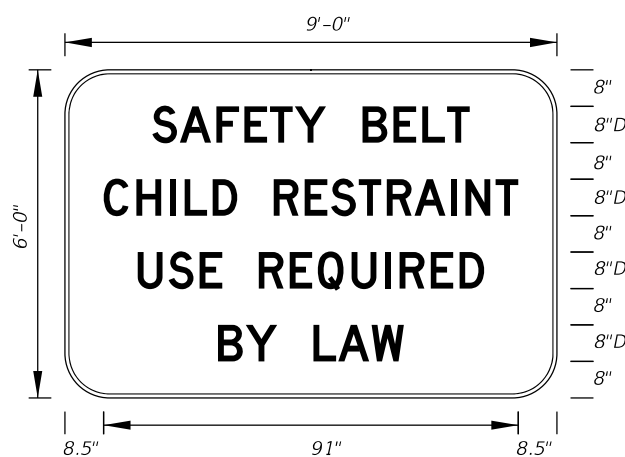

FTP-44-06
9' X 6'
9" Radii 3/4" Border
8" Series D Legend
White Background
Black Legend and Border

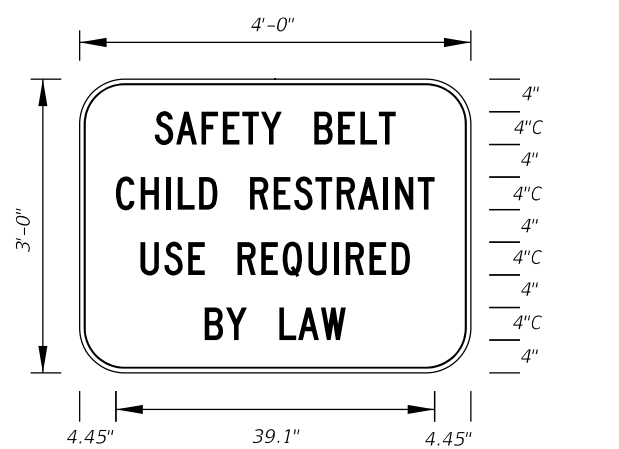

FTP-45-06
4' X 3'
5" Radii 3/4" Border
4" Series C Legend
White Background
Black Legend and Border

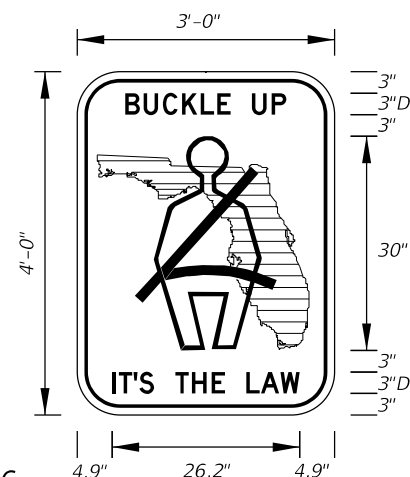

FTP-46-06
3' X 4'
5" Radii 3/4" Border
3" Series D Legend
White Background
Green Florida Symbol
Black Legend, Border and Man Belt Symbol

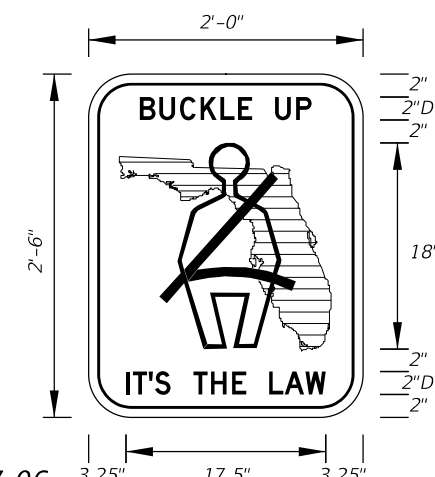

FTP-47-06
2' X 2'-6"
3" Radii 5/8" Border
2" Series D Legend
White Background
Green Florida Symbol
Black Legend, Border and Man Belt Symbol

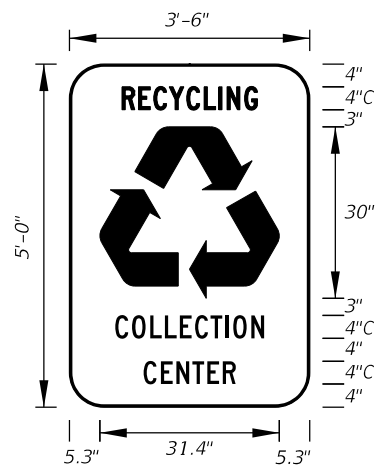

FTP-48-06
3'-6" X 5'
6" Radii
4" Series C Legend
Green Background
White Legend, Border and Symbol

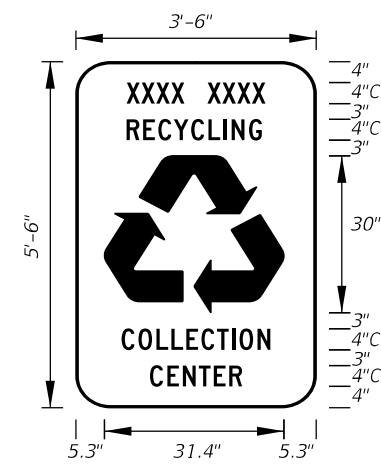

FTP-49-06
3'-6" X 5'-6"
6" Radii
4" Series C Legend
Green Background
White Legend, Border and Symbol
Municipality Name Optional

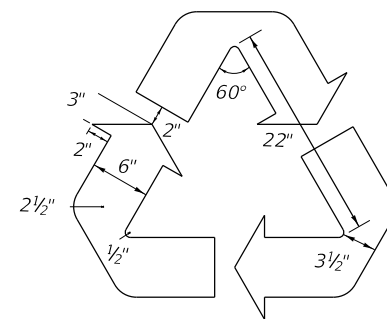

Detail for **FTP-48-06** and **FTP-49-06**

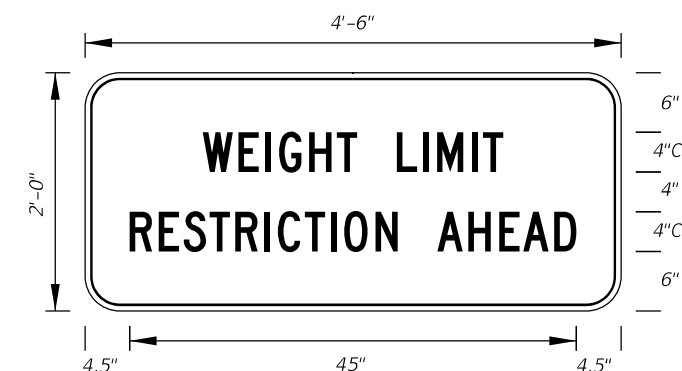

FTP-50-06
4'-6" X 2'
3" Radii 3/4" Border
4" Series C Legend
Yellow Background
Black Legend and Border

10/14/2019 2:42:09 PM

LAST REVISION	DESCRIPTION:
11/01/18	

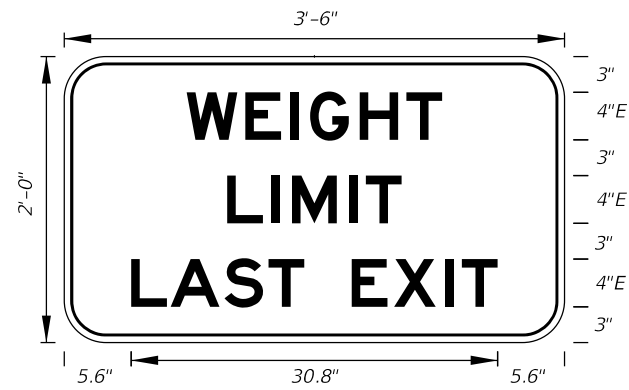

FTP-51-06
3' X 2'
3" Radii 3/4" Border
4" Series E Legend
White Background
Black Legend and Border

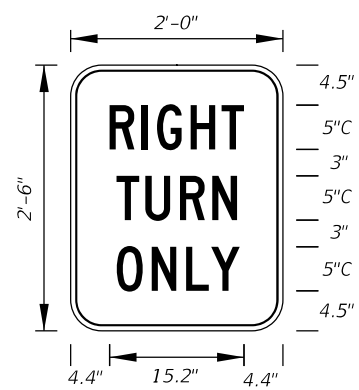

FTP-52-06
2' X 2'-6"
3" Radii 5/8" Border
5" Series C Legend
White Background
Black Legend and Border

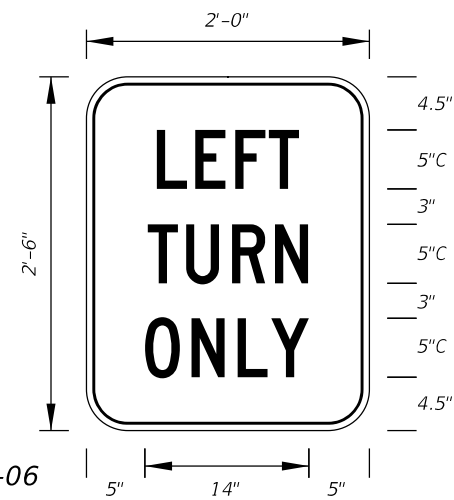

FTP-53-06
2' X 2'-6"
3" Radii 5/8" Border
5" Series C Legend
White Background
Black Legend and Border

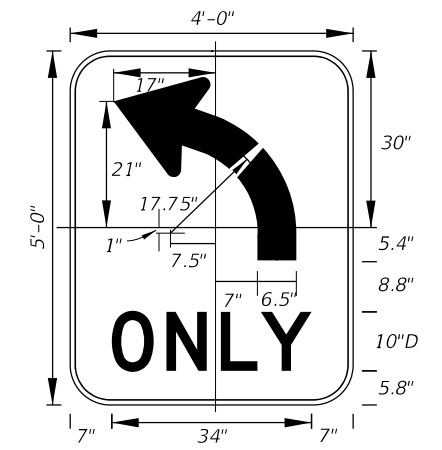

FTP-54L-06
4' X 5'
6" Radii 3/4" Border
10" Series D Legend
White Background
Black Legend and Border
FTP-54R-06 for (Right Turn Arrow)

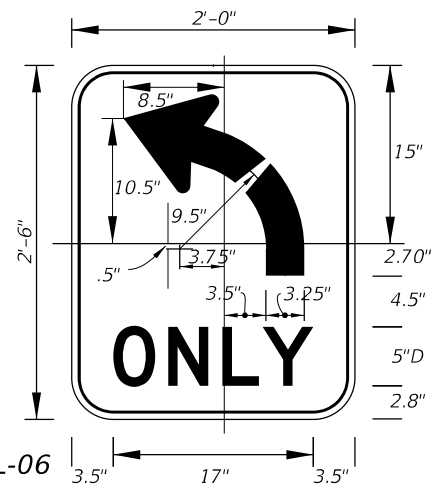

FTP-55L-06
2' X 2'-6"
3" Radii 3/8" Border
5" Series D Legend
White Background
Black Legend and Border
FTP-55R-06 for (Right Turn Arrow)

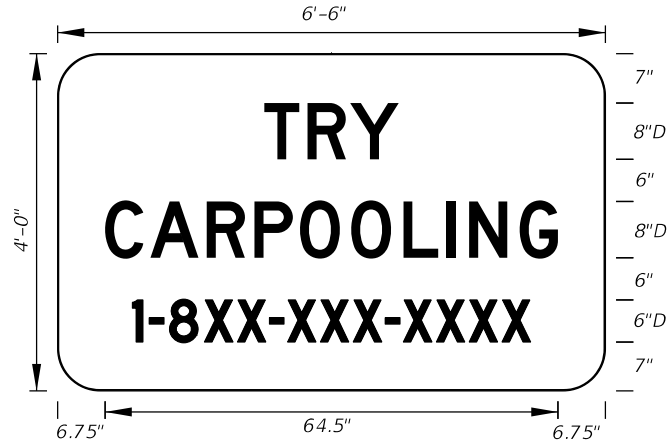

FTP-56-06
6'-6" X 4'
6" Radii 3/4" Border
8" and 6" Series D Legend
Blue Background
White Legend and Border
Design Project Manager or Transit Administrator will supply correct 1-8XX number.

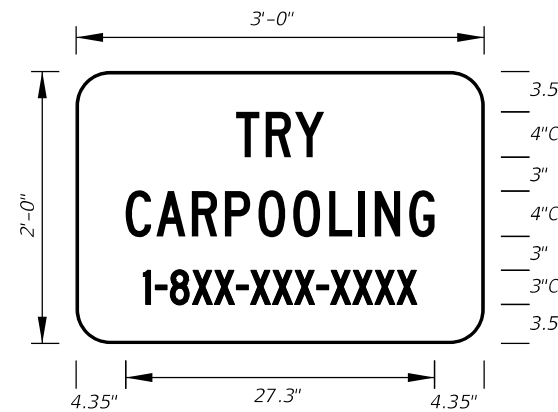

FTP-56A-06
3' X 2'
3" Radii
4" and 3" Series C Legend
Blue Background
White Legend and Border
Design Project Manager or Transit Administrator will supply correct 1-8XX number.

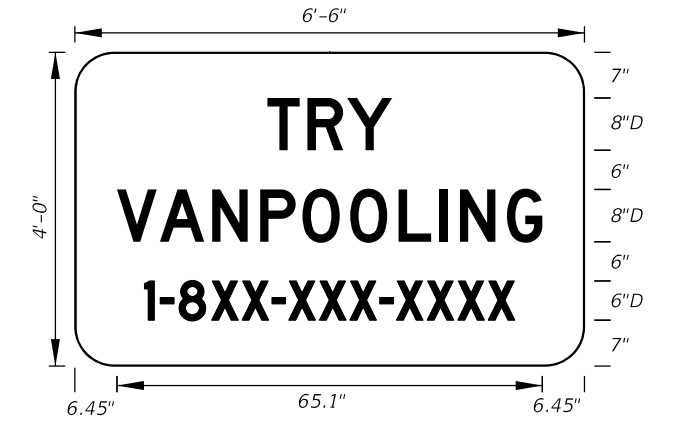

FTP-57-06
6'-6" X 4'
6" Radii
8" and 6" Series D Legend
Blue Background
White Legend and Border
Design Project Manager or Transit Administrator will supply correct 1-8XX number.

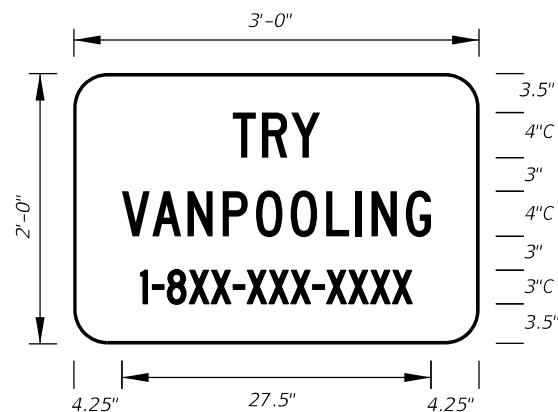

FTP-58-06
3' X 2'
3" Radii
4" and 3" Series C Legend
Blue Background
White Legend and Border
Design Project Manager or Transit Administrator will supply correct 1-8XX number.

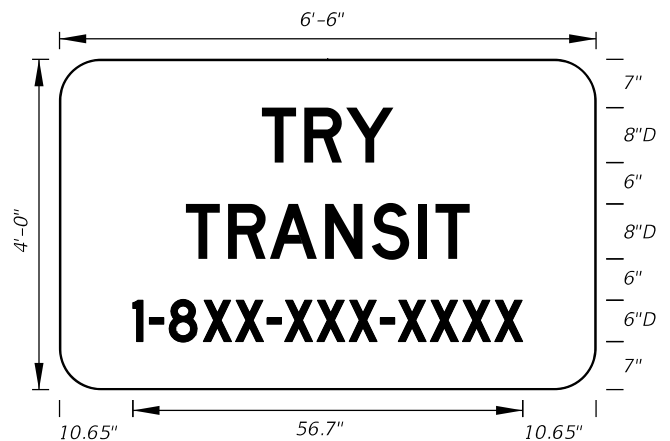

FTP-59-06
6'-6" X 4'
6" Radii
8" and 6" Series D Legend
Blue Background
White Legend and Border
Design Project Manager or Transit Administrator will supply correct 1-8XX number.

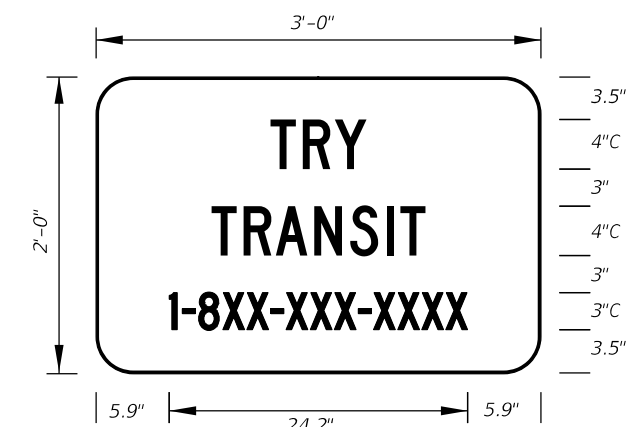

FTP-60-06
3' X 2'
3" Radii
4" and 3" Series C Legend
Blue Background
White Legend and Border
Design Project Manager or Transit Administrator will supply correct 1-8XX number.



FTP-61-06
3' X 2'
3" Radii 3/4" Border
4" and 3" Series C Legend
Yellow Background
Black Legend and Border

10/14/2019 2:42:10 PM

LAST REVISION 11/01/18	DESCRIPTION:	 FY 2020-21 STANDARD PLANS	SPECIAL SIGN DETAILS	INDEX 700-102	SHEET 7 of 11
---------------------------	--------------	--	-----------------------------	------------------	------------------

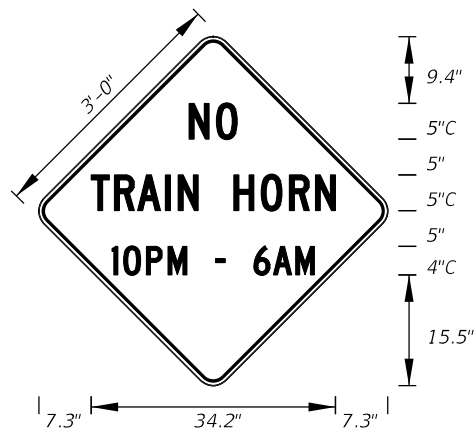

FTP-62-06
3' X 3'
2" Radii 3/4" Border 4" and 5" Series C Legend
Yellow Background Black Legend and Border

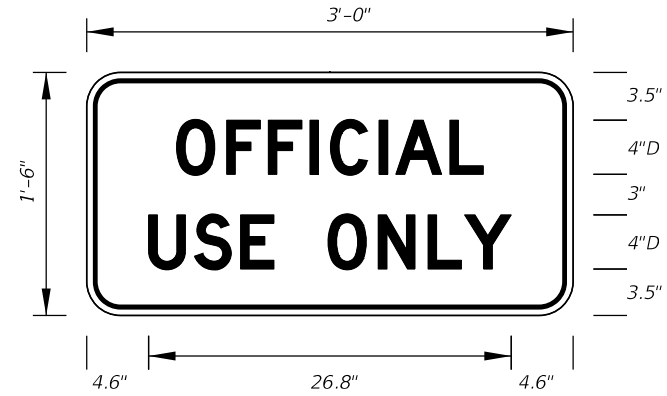

FTP-65-06
3' X 1'-6"
2" Radii 3/4" Border
4" Series D Legend
White Background
Black Legend and Border



FTP-66-06
4' X 5'
2" Radii 3/4" Border
7" Series D Legend
Blue Background
White Legend and Border



FTP-67-06
3' X 4'
2" Radii 3/4" Border
5" Series D Legend
Blue Background
White Legend and Border

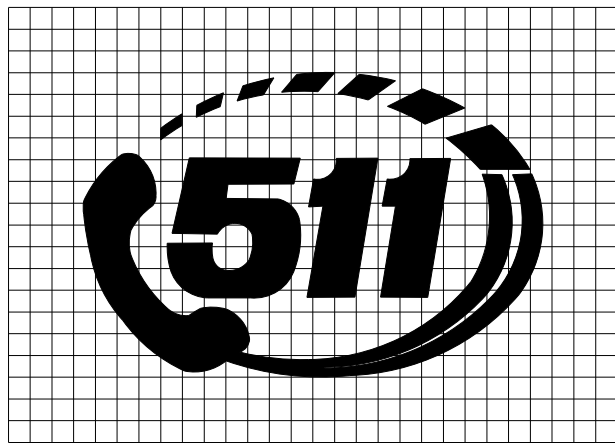

DETAIL for FTP-66 AND FTP-67

Sign Mounting Holes Can Be Punched Or Field Drilled With No Obstruction To Text Or Symbols From Holes Or Bolts.

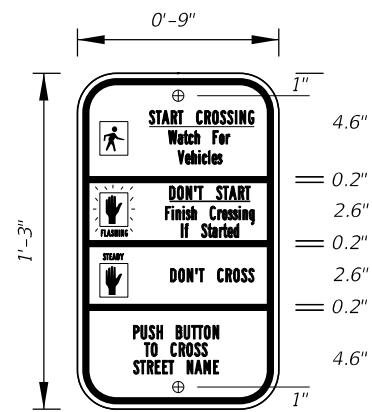

FTP-68A-06
9" X 1'-3"
1.5" Radii 3/4" Border
Series B Legend
White Background
Black Legend and Border

See Standard Highway Signs Manual, Sign R10-3b For Letter Size Spacing And Symbol Sizes.

Sign Mounting Holes Can Be Punched Or Field Drilled With No Obstruction To Text Or Symbols From Holes Or Bolts.

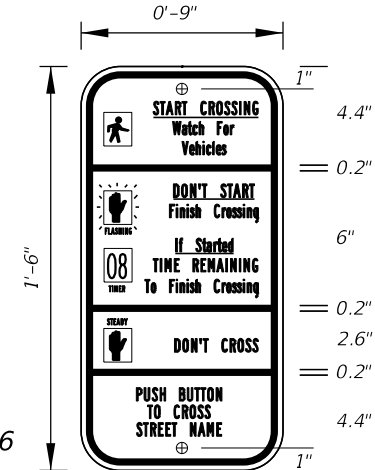

FTP-68B-06
9" X 1'-6"
1.5" Radii 3/4" Border
Series B Legend
White Background
Black Legend and Border

See Standard Highway Signs Manual, Sign R10-3b For Letter Size Spacing And Symbol Sizes.

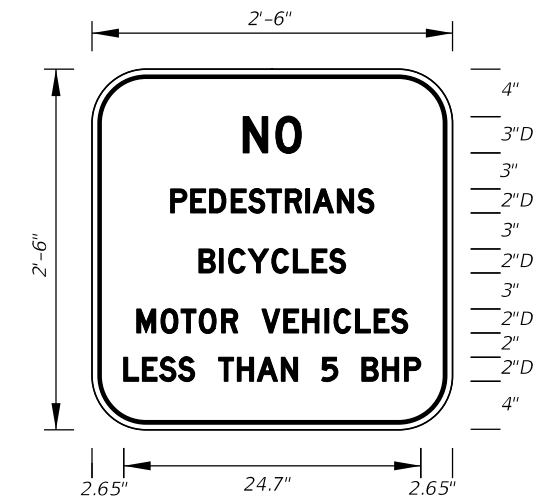

FTP-69-06
2'-6" X 2'-6"
4" Radii 3/4" Border
2" and 3" Series D Legend
White Background
Black Legend and Border

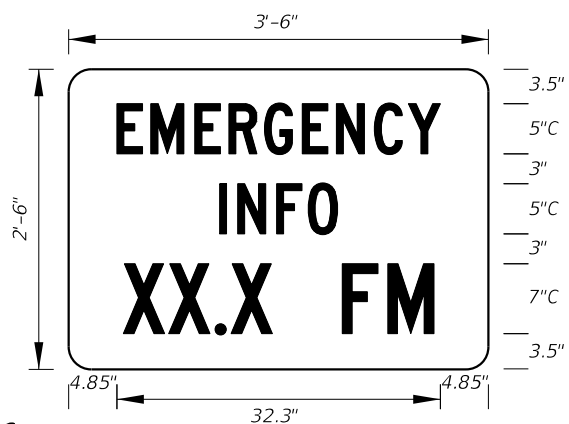

FTP-70-06
3'-6" X 2'-6"
2.25" Radii 3/4" Border
5" Series C and 7" Series C Legend
Blue Background
White Legend and Border

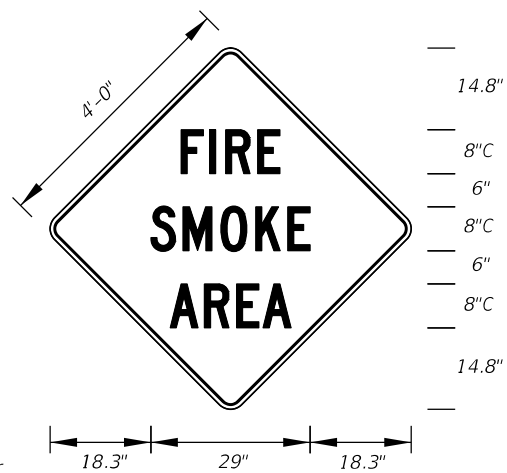

FTP-71-06
4' X 4'
2" Radii 3/4" Border
8" Series C Legend
Yellow Background
Black Legend and Border



FTP-72-06
3' X 3'
2" Radii 3/4" Border
6" Series C Legend
Yellow Background
Black Legend and Border

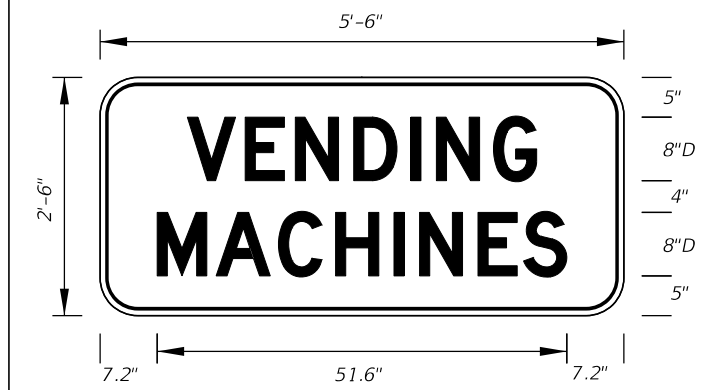

FTP-73-06
5'-6" X 2'-6"
4" Radii 3/4" Border
8" Series D Legend
Blue Background
White Legend and Border

10/14/2019 2:42:11 PM

LAST REVISION	DESCRIPTION:
11/01/17	



FY 2020-21
STANDARD PLANS

SPECIAL SIGN DETAILS

INDEX
700-102

SHEET
8 of 11



FTP-74-06
 5'-6" X 2'-6"
 4" Radii 3/4" Border
 6" Series D Legend
 Blue Background
 White Legend and Border

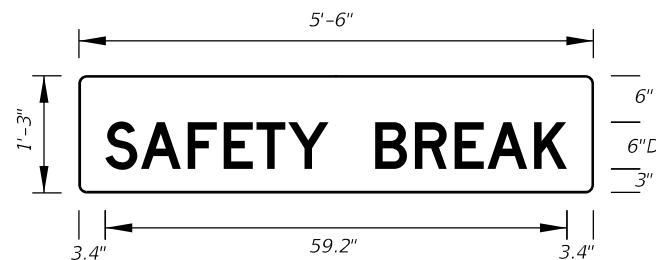

FTP-75-06
 5'-6" X 1'-3"
 1" Radii
 6" Series D Legend
 Blue Background
 White Legend

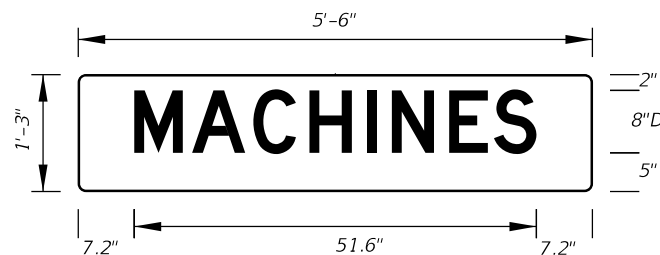

FTP-76-06
 5'-6" X 1'-3"
 1" Radii
 8" Series D Legend
 Blue Background
 White Legend

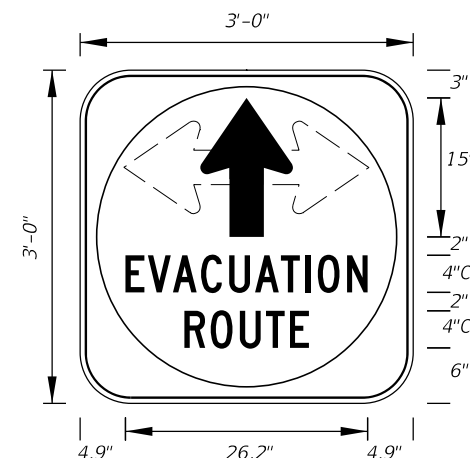

FTP-77-06
 3' X 3'
 5" Radii 3/4" Border
 4" Series C Legend
 White Background with Blue Circle Background
 White Legend and Black Border

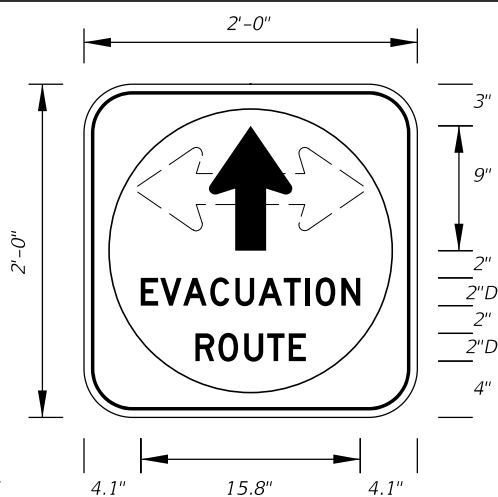

FTP-78-06
 2' X 2'
 3" Radii 3/4" Border
 2" Series D Legend
 White Background with Blue Circle Background
 White Legend and Black Border

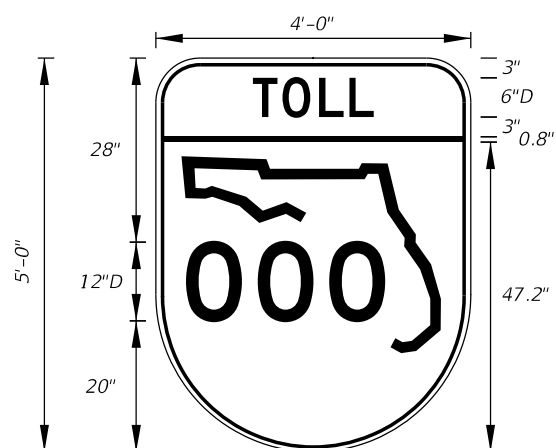

FTP-79-06
 4' X 5'
 6" Radii 3/4" Border
 6" and 12" Series D Legend
 Top Yellow Background with Black Legend and Black Border
 Bottom White Background with Black Legend and Border

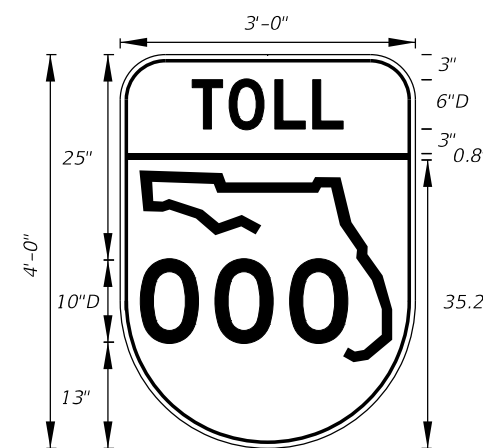

FTP-80-06
 3' X 4'
 5" Radii 3/4" Border
 6" and 10" Series D Legend
 Top Yellow Background with Black Legend and Black Border
 Bottom White Background with Black Legend and Border

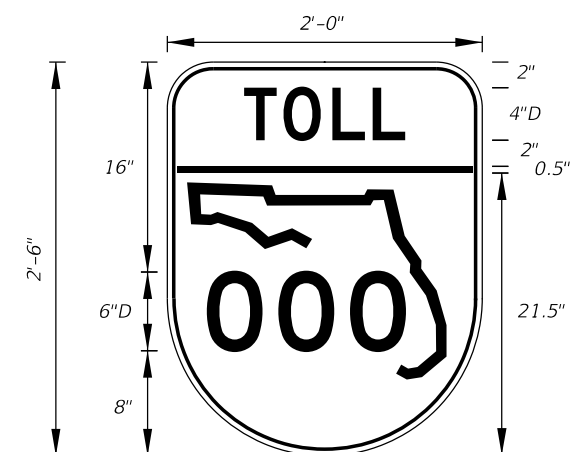

FTP-81-06
 2' X 2'-6"
 3" Radii 3/4" Border
 4" and 6" Series D Legend
 Top Yellow Background with Black Legend and Black Border
 Bottom White Background with Black Legend and Border

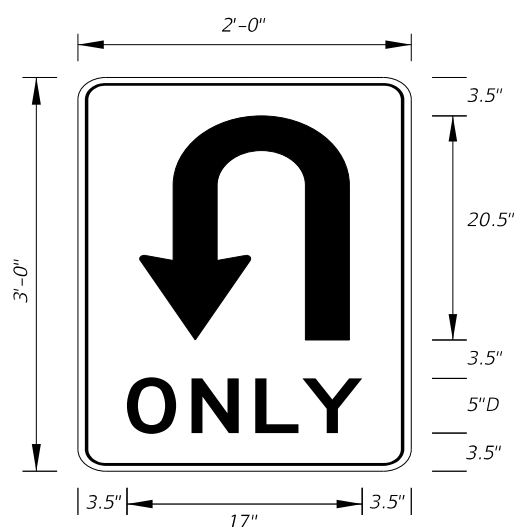

FTP-82-08
 2' X 3'
 1.5" Radii
 5" Series D Legend
 White Background
 Black Legend and Border

ARROW HEAD

A	3.125
B	3.625
C	6.375
D	.5
E	.625

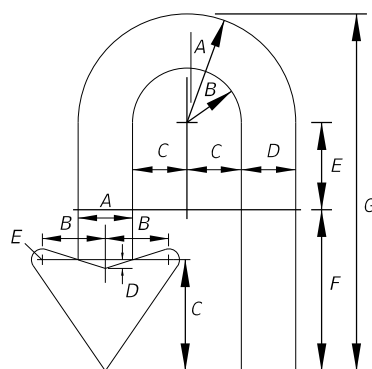

ARROW BODY

A	B	C	D	E	F	G
6.25	3.125	3.125	3.125	5	9.25	20.5

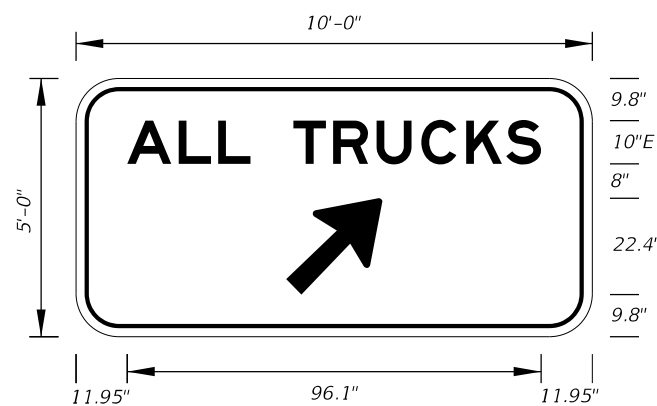

FTP-83-08
 10'-0" X 5'-0"
 8" Radii
 10" Series E Legend
 Green Background
 White Legend

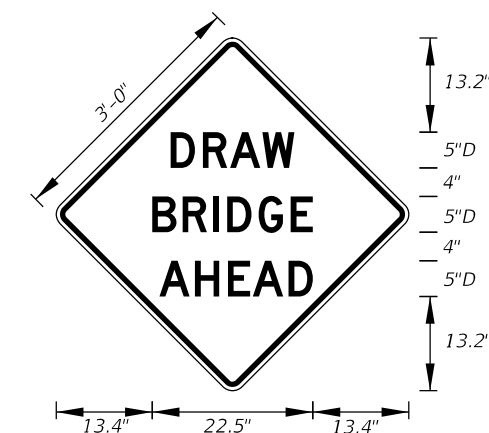

FTP-84-09
 3' X 3'
 1.5" Radii
 5" Series D Legend
 Yellow Background
 Black Legend and Border

10/14/2019 2:42:13 PM



FY 2020-21
 STANDARD PLANS

SPECIAL SIGN DETAILS

INDEX
 700-102

SHEET
 9 of 11

LAST REVISION
 11/01/17

REVISION

DESCRIPTION:

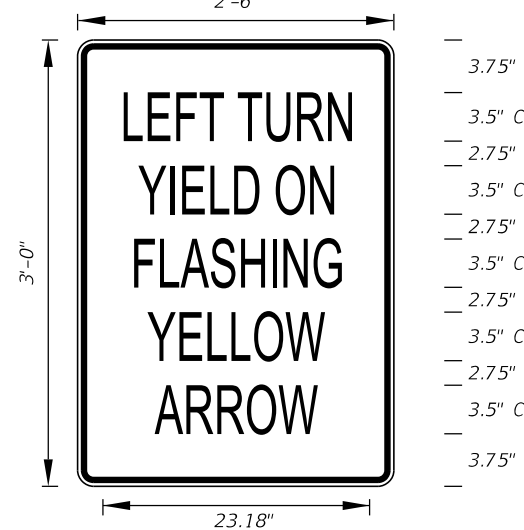

FTP-85-13
3' X 2'-6"
1.875" Radii 3/4" Border
3.5" Series C Legend
White Background
Black Legend and Border

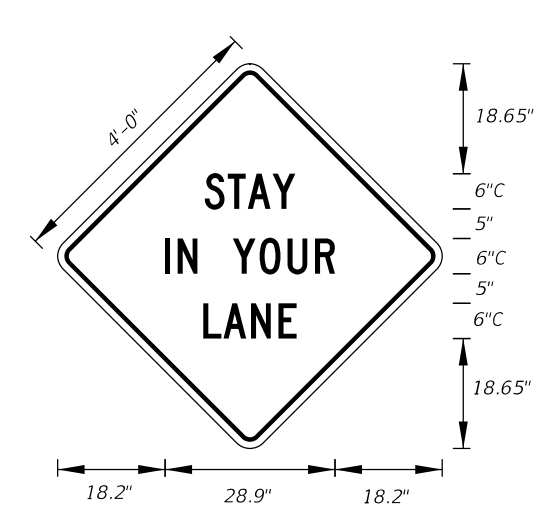

MOT-1-06
4' X 4'
2" Radii 3/4" Border
6" Series C Legend
Orange Background
Black Legend and Border

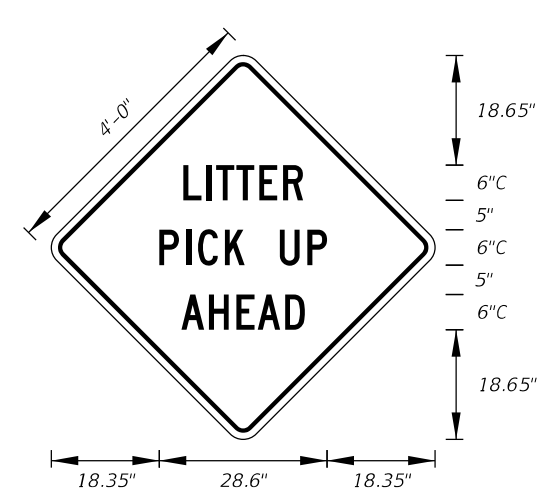

MOT-4-06
4' X 4'
2" Radii 3/4" Border
6" Series C Legend
Orange Background
Black Legend and Border

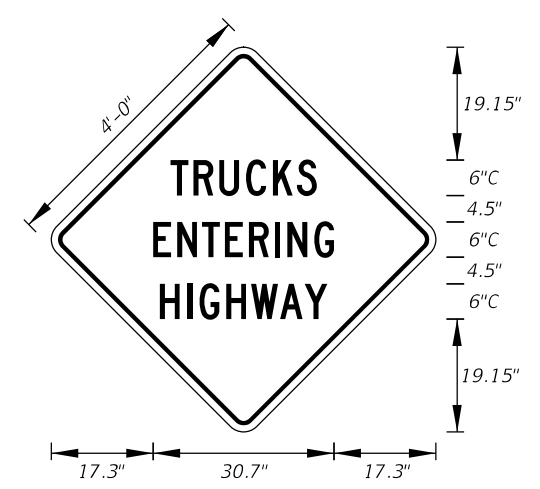

MOT-5-06
4' X 4'
2" Radii 3/4" Border
6" Series C Legend
Orange Background
Black Legend and Border

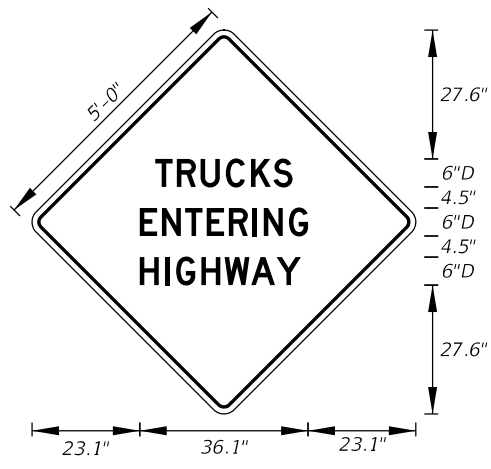

MOT-6-06
5' X 5'
2" Radii 3/4" Border
6" Series D Legend
Orange Background
Black Legend and Border

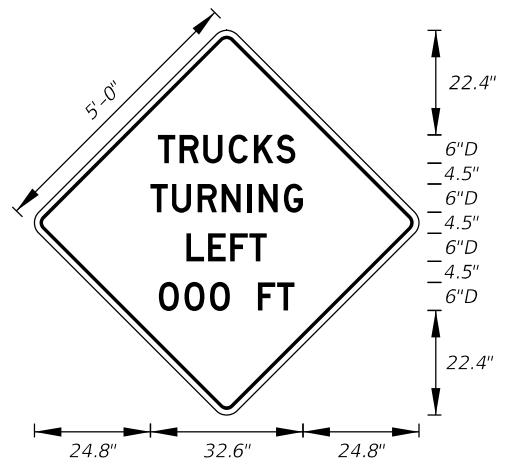

MOT-7-06
5' X 5'
2" Radii 3/4" Border
6" Series D Legend
Orange Background
Black Legend and Border

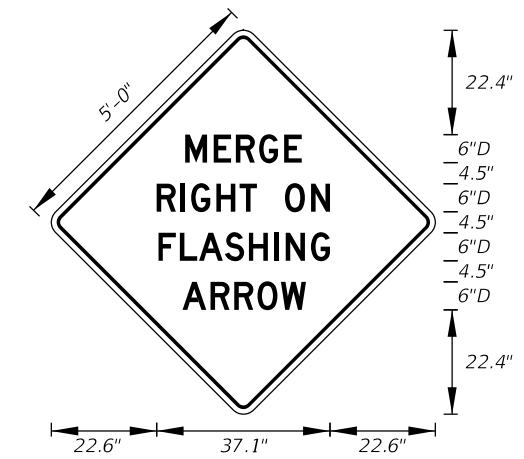

MOT-8-06
5' X 5'
2" Radii 3/4" Border
6" Series D Legend
Orange Background
Black Legend and Border

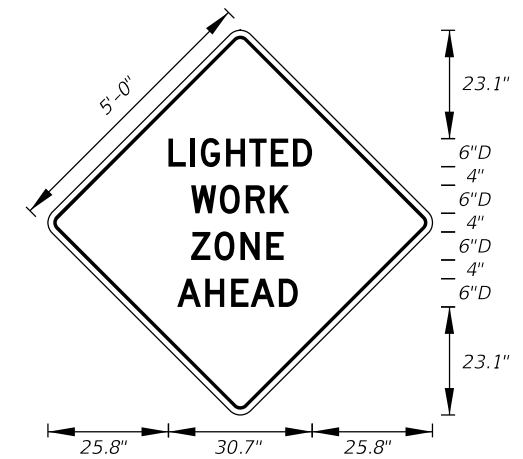

MOT-9-06
5' X 5'
2" Radii 3/4" Border
6" Series D Legend
Orange Background
Black Legend and Border

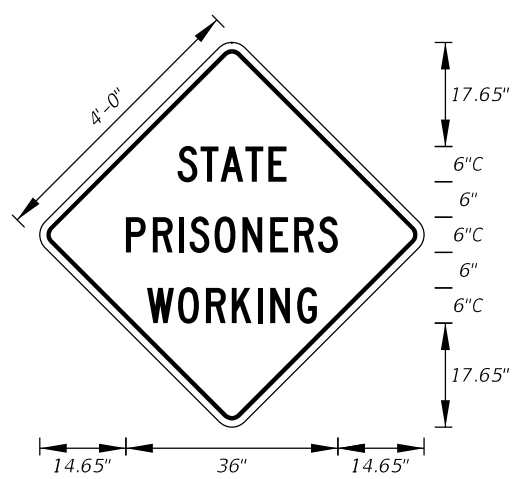

MOT-10-06
4' X 4'
2" Radii 3/4" Border
6" Series C Legend
Orange Background
Black Legend and Border

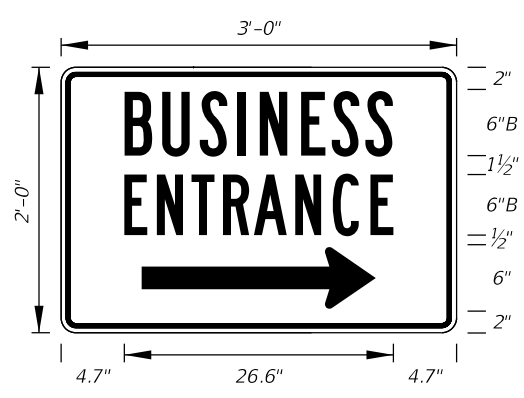

MOT-11-06
3' X 2'
2" Radii 3/4" Border
6" Series B Legend
Blue Background
White Legend and Border

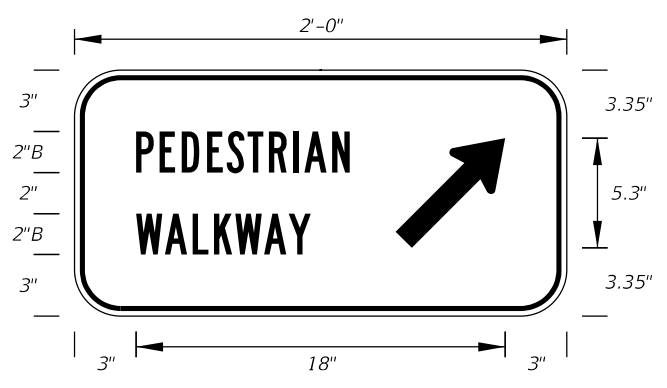

MOT-12R-06
2' X 1'
2" Radii 3/4" Border
2" Series B Legend
White Background
Black Legend and Border

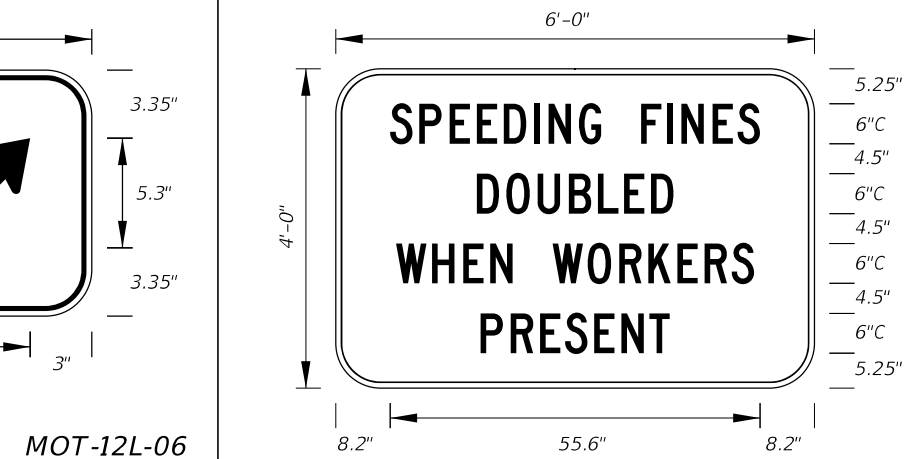

MOT-12L-06
For Diversion to the left
MOT-13-06
Freeway Sign
6' X 4'
6" Radii 3/4" Border
6" Series C Legend
White Background
Black Legend and Border

10/14/2019 2:42:14 PM

LAST REVISION	DESCRIPTION:
11/01/18	

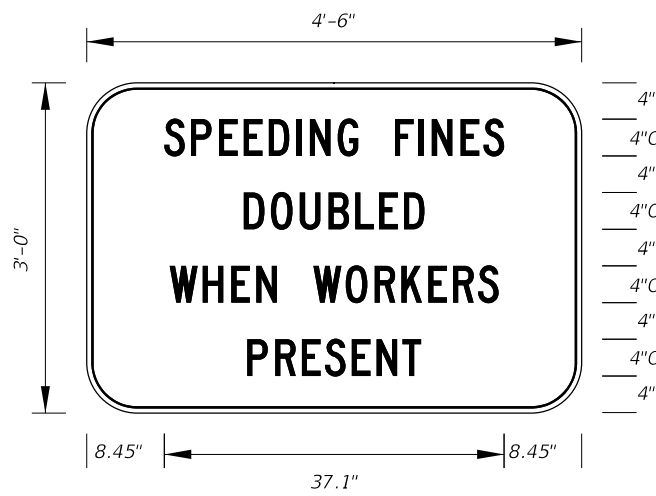

MOT-14-06
 Arterial Sign
 4'-6" X 3'
 5" Radii 3/4" Border

4" Series C Legend
 White Background
 Black Legend and Border

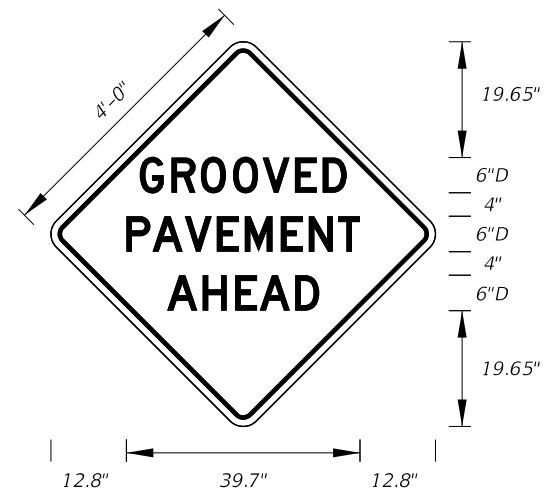

MOT-15-06
 4' X 4'
 2" Radii 3/4" Border

6" Series D Legend
 Orange Background
 Black Legend and Border

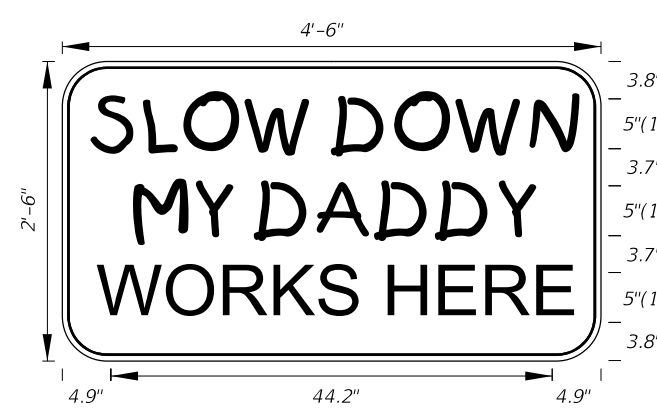

MOT-16-06
 4'-6" X 2'-6"
 4" Radii 3/4" Border

5" Kids Series Legend
 Orange Background
 Black Legend and Border

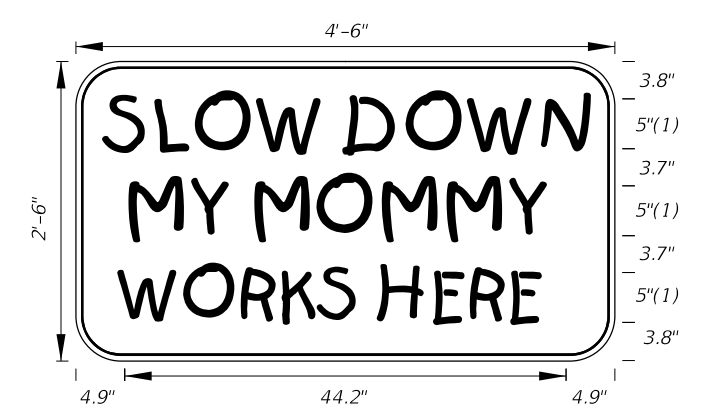

MOT-17-06
 4'-6" X 2'-6"
 4" Radii 3/4" Border

5" Kids Series Legend
 Orange Background
 Black Legend and Border

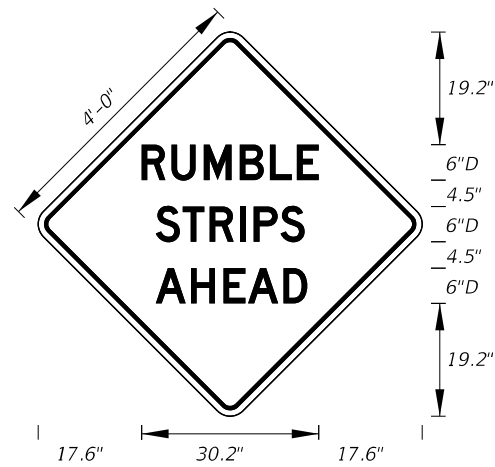

MOT-18-10
 4' X 4'
 2" Radii 3/4" Border

6" Series D Legend
 Orange Background
 Black Legend and Border

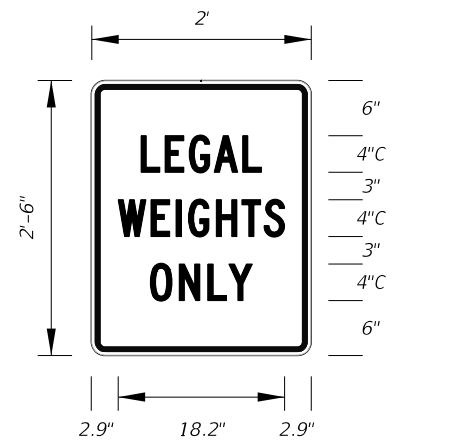

MOT-19-11
 2' X 2'-6"
 1.13" Radii 3/4" Border

4" Series C Legend
 White Background
 Red Legend and Border

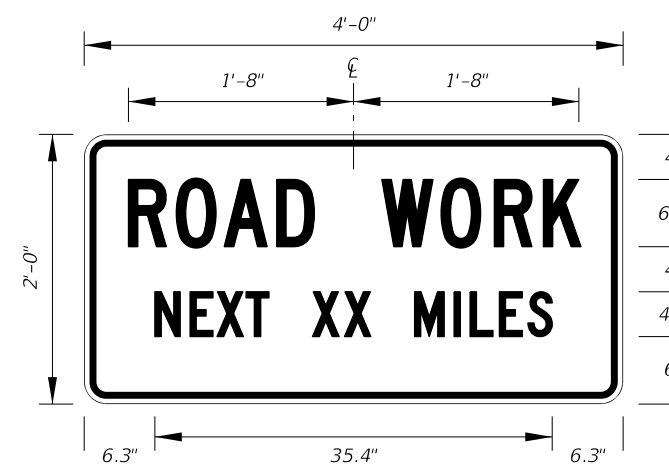

G20-1
 2' X 4'
 1.5" Radii 3/4" Border

Orange Background
 Black Legend and Border

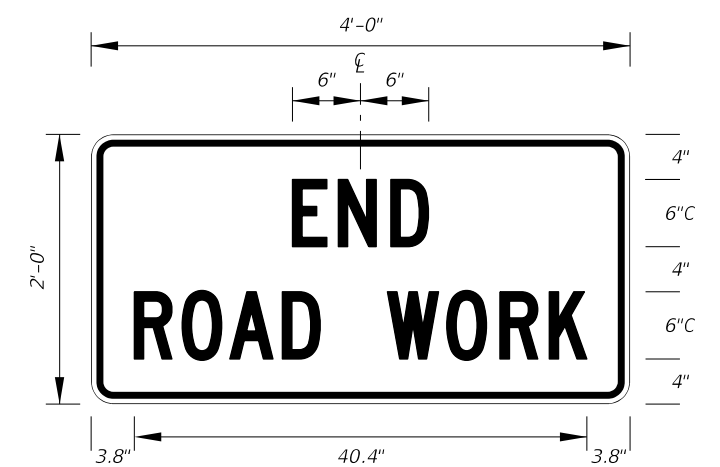

G20-2
 2' X 4'
 1.5" Radii 3/4" Border

Orange Background
 Black Legend and Border

10/14/2019 2:42:14 PM

LAST REVISION 11/01/18	REVISION	DESCRIPTION:	 FY 2020-21 STANDARD PLANS	SPECIAL SIGN DETAILS	INDEX 700-102	SHEET 11 of 11
---------------------------	----------	--------------	---	----------------------	------------------	-------------------