

SOP 1

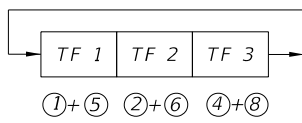

SOP 2

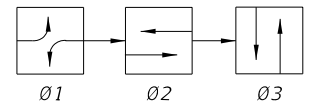
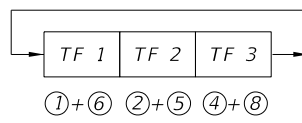
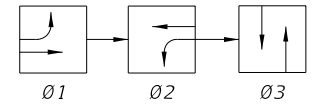

SOP 3

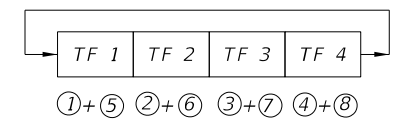
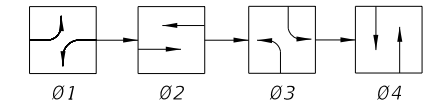

SOP 4

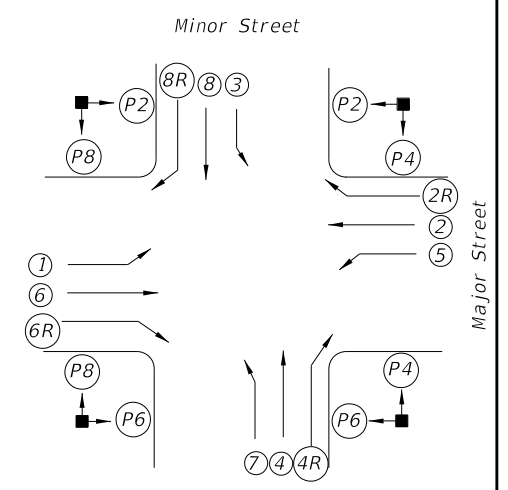

SIGNALIZED INTERSECTION

Vehicle movements & signal head number assignments are not directionally oriented but shall maintain their relative orientation about the intersection (I.E., movements 7 and 4 are always to the right of movements 1 and 6 etc.).

LEGEND

- (X) Vehicle Movement Number
- (PX) Pedestrian Movement Number
- TF X Timing Function Number
- ØX Phase Number
- ↔ Green Arrow (Left or Right)
- ↔R Red Arrow
- ↔ Yellow Arrow

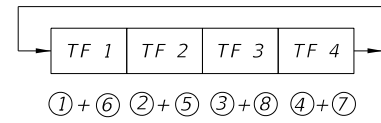
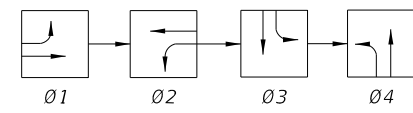

SOP 5

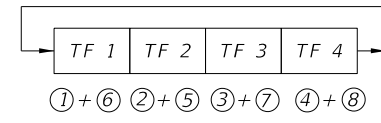
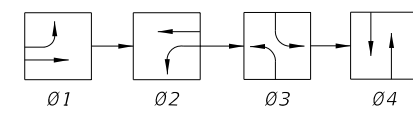

SOP 6

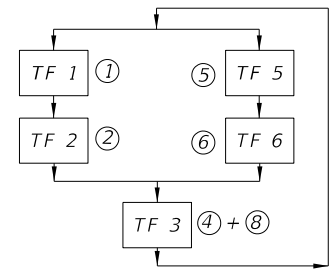
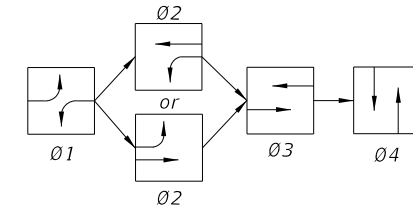

SOP 7

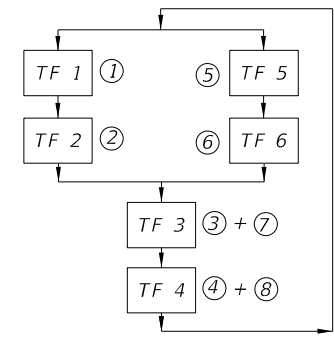
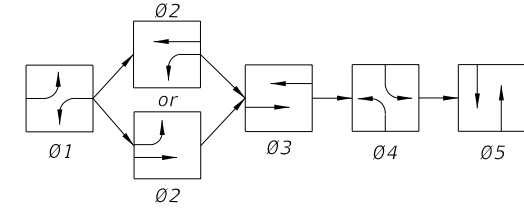

SOP 8

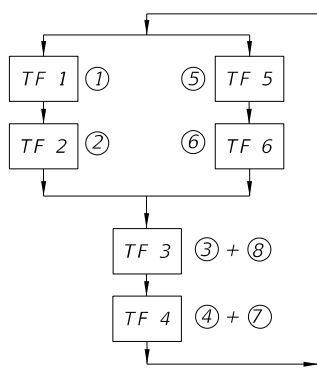
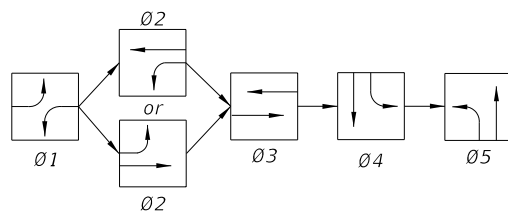

SOP 9

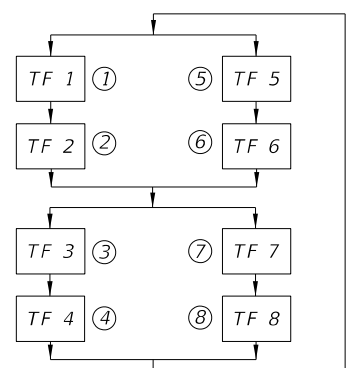
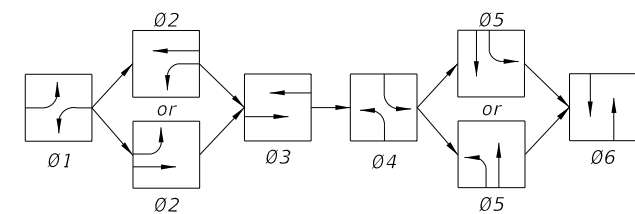

SOP 10

SIGNAL CLEARANCE TABLE
(Blank Indicates No Clearance Required)

From To		SIGNAL INDICATIONS						
		R	↔	G	↔	↔	WALK	DONT WALK
SIGNAL INDICATIONS	R			Y	↔	Y		
	↔			Y	↔	Y		
	G				↔			
	↔							
	↔							
	WALK							
	DONT WALK						Flash DONT WALK	

10/14/2019 2:20:29 PM

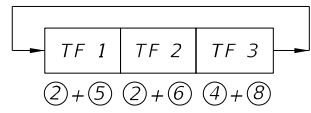
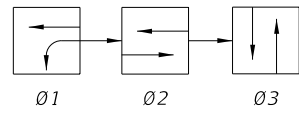

SOP 11

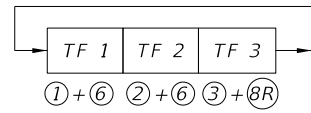
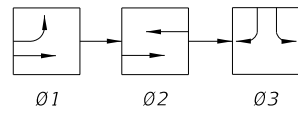

SOP 12

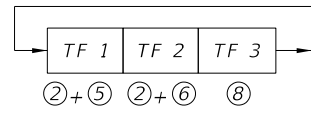
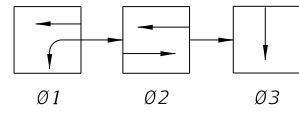

SOP 13
(ONE- WAY STREET INTERSECTION)

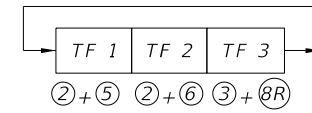
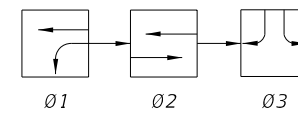

SOP 14
(DIAMOND INTERCHANGE OPERATION)

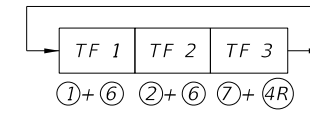
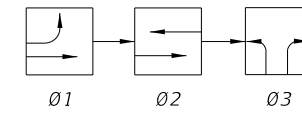

SOP 15
(DIAMOND INTERCHANGE OPERATION)

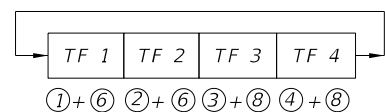
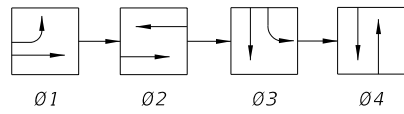

SOP 16

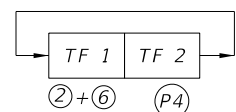
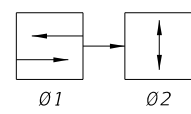

SOP 17
(MIDBLOCK)

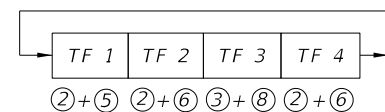
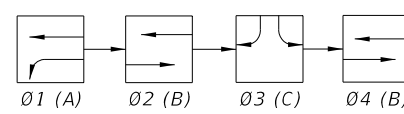

NOTE:
Only Ø2 Or Ø4 Used, Not Both To Obtain
ABC, Or ACB Operation.

SOP 18
(DIAMOND INTERCHANGE OPERATIONS)

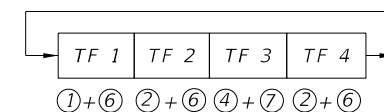
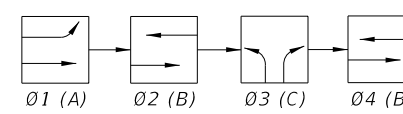

NOTE:
Only Ø2 Or Ø4 Used, Not Both To Obtain
ABC, Or ACB Operation.

SOP 19
(DIAMOND INTERCHANGE OPERATIONS)

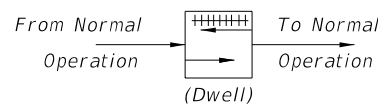

POP 1

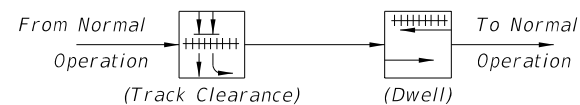

POP 2

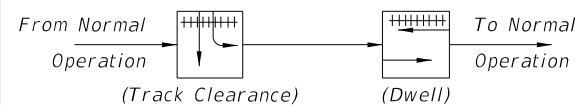

POP 3

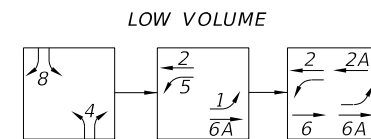
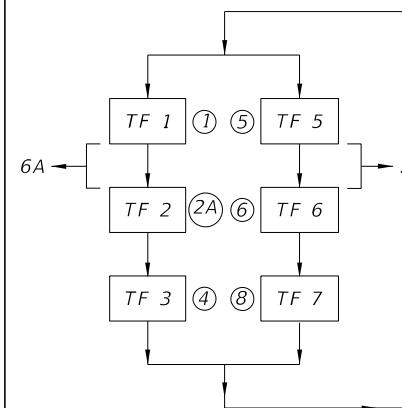
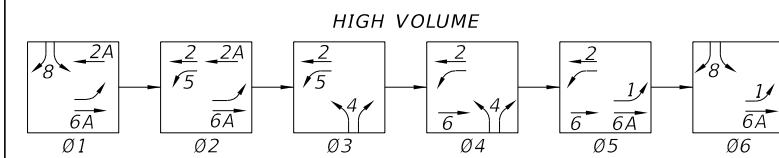

SOP 20
(DIAMOND INTERCHANGE OPERATIONS)

10/14/2019 2:20:29 PM

LAST REVISION 11/01/17	DESCRIPTION:
---------------------------	--------------