

Index 522-001, Sidewalks & Index 522-002, Detectable Warnings and Sidewalk Curb Ramps

Design Criteria

FDOT Design Manual (FDM); Americans with Disabilities Accessibility Guidelines (ADAAG), 2004; Public Rights-of-Way Accessibility Guidelines, PROWAG 2011.

Design Assumptions and Limitations

Refer to the *FDM 222* for limitations relative to sidewalk accessibility conditions.

Sidewalk Curb Ramps are designed based on accessibility guidelines from the *Americans with Disabilities Act Standards for Transportation Facilities 2006*.

Sidewalk Curb Ramp preferences for *Index 522-002* are taken from the *Public Rights-of-Way Accessibility Guidelines (PROWAG) 2011*.

Alpha-identifications have been provided in *Index 522-002* for the various curb ramp options (e.g. CR-A, CR-B, etc.) to facilitate ease of callouts in the Plans. Use the curb ramp options as follows:

- Curb Ramps CR-A, CR-B & CR-C are for use where ramp and landing depths are not restricted.
- Curb Ramps CR-D, CR-E, CR-F, CR-G and CR-H are for linear pedestrian traffic.
- Curb Ramps CR-K and CR-L are for use where ramp and landing depths are restricted.

Limitations on Sidewalk Curb Ramp designs: When proposed sidewalk curb ramps cannot be designed within existing accessibility guidelines, then a project specific design is required to be in accordance with ADA requirements. When compliance with ADA curb ramp requirements is determined to be technically infeasible (i.e. no engineering solution is available), documentation as a Design Variation is required. This may occur where existing right of way is inadequate and where conflicts may occur with existing features which cannot be feasibly relocated or adjusted (drainage inlets, signal poles, pull and junction boxes, etc.).

Geometric designs (typical radii for 90 degree curb returns) for the table of detectable warnings of turning roadways is taken from the *Florida Intersection Design Guide*.

Limitations on detectable warning surfaces: The Surface Area of Detectable Warnings is provided as Table 1. These typical areas are provided for the 10 standard curb ramp types (see all alpha-identifications) and 2 flush shoulder options. Quantities for the total area were generated based on typical radii for 90 degree curb returns. The total area of detectable warning quantities are intended to aid the designer in quantifying detectable warning surfaces for typical sidewalk curb ramp applications. For detectable warnings total area calculations see Design Aids below.

Plan Content Requirements

Summary Boxes:

Summarize quantities in the *Summary of Sidewalk and Detectable Warnings*, see [BOE](#), Chapter 8.

Roadway Plan Views:

1. Location (Station)
2. Side (either Left, Right or Median)
3. Sidewalk Curb Ramp alpha-identification

Payment

Item number	Item Description	Unit Measure
520-1-AA	Concrete Curb and Gutter	LF
520-2-AA	Concrete Curb	LF
522-1	Concrete Sidewalk and Driveways, 4" Thick	SY
522-2	Concrete Sidewalk and Driveways, 6" Thick	SY
527-2	Detectable Warnings	SF

See the [BOE](#) and [Specifications 520, 522, & 527](#) for additional information on payment, pay item use and compensation.

Detectable Warnings and Sidewalk Curb Ramps are paid as follows:

- Curb transitions and reconstructed curbs are paid under the contract unit price of Concrete Curb and Gutter, LF, and is based on the adjacent curb type (i.e. Type E or Type F)
- Sidewalk curb ramps, reconstructed sidewalks, walk around sidewalks, sidewalk landings, and sidewalk curb are paid under the contract unit price for Concrete Sidewalk and Driveways, SY. Include 6" thick concrete for all sidewalk and curb ramps located within the return radii of curbed intersections and driveways, see [Index 522-001](#).
- The cost of furnishing and installing detectable warnings for new construction or retrofit and all incidental items are included in the pay item for Detectable Warnings, SF.

Table 1 Surface Area of Detectable Warnings

Curb Ramp Type	Curb Radius (ft)	Total Area (sf)
CR-A	N/A	8
CR-B	N/A	8
CR-C	N/A	8
CR-D	25	11
CR-E	N/A	8
CR-F	10	9
	20	11
	25	13
	30	14
CR-G	10	10
	20	11
	25	12
	30	14
CR-H	20	8
	25	8
	30	8
CR-K	N/A	8
CR-L	10	18
	15	13
Flush Shoulder Option A	10	11
	20	14
	25	15
	30	17
	40	19
	50	21
Flush Shoulder Option B	10	10
	20	10
	25	10

Design Aids

Detectable Warnings Total Area Calculations:

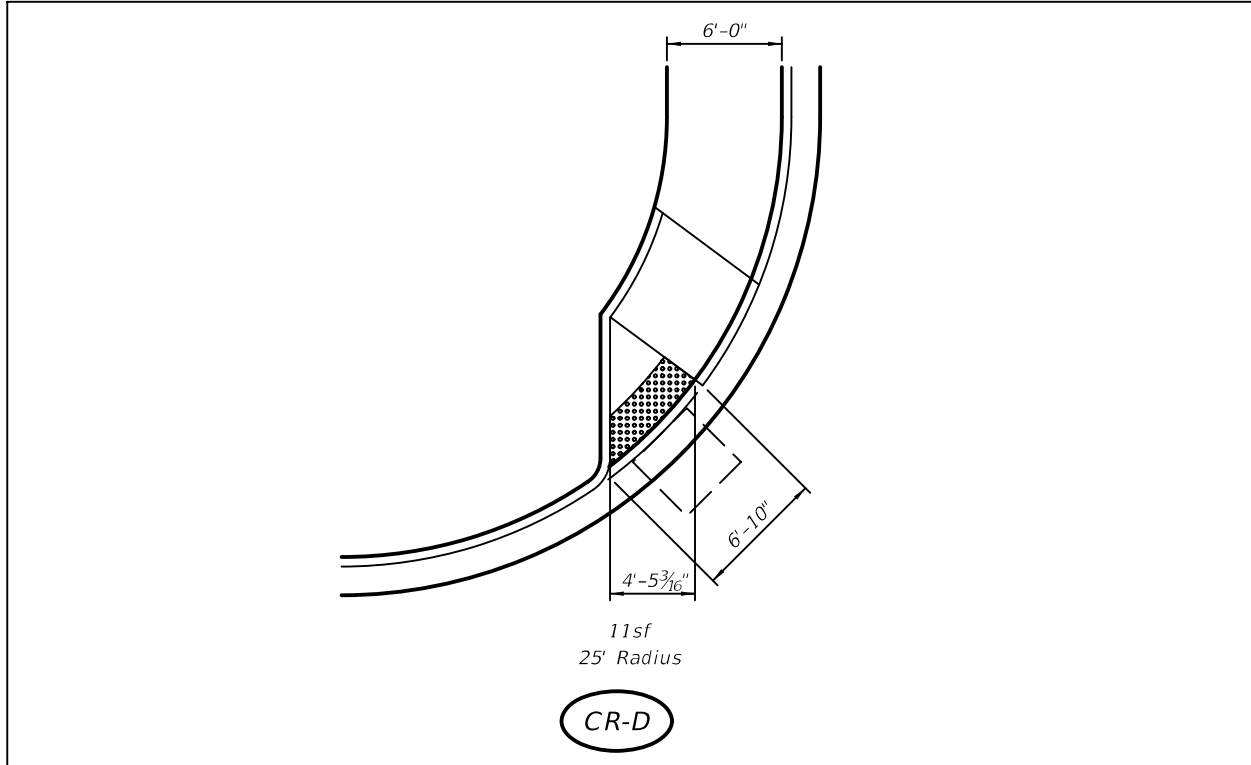

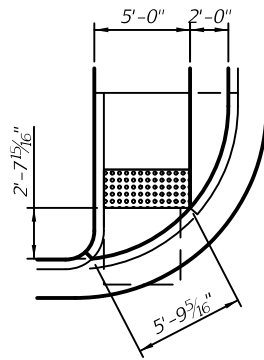

9sf
10' Radius

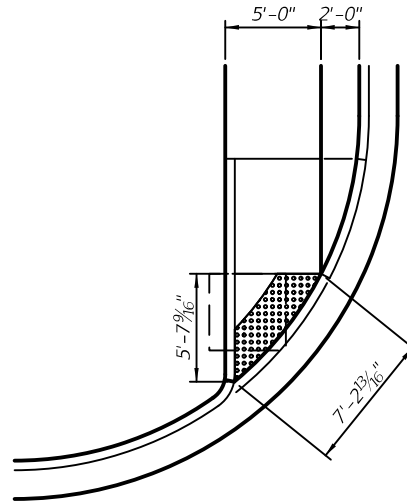

11sf
20' Radius

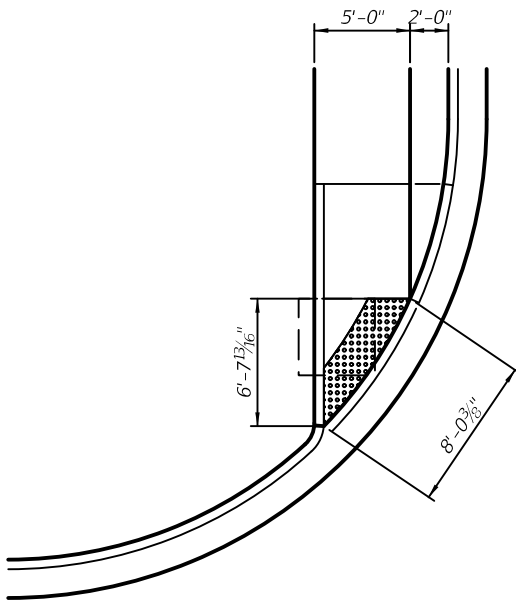

13sf
25' Radius

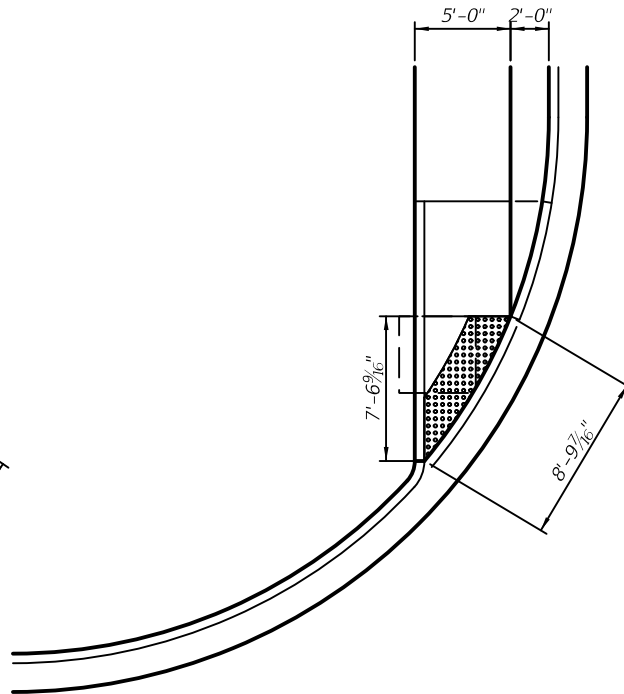

14sf
30' Radius

CR-F

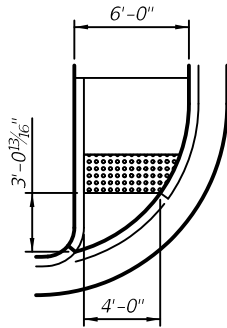

10sf
10' Radius

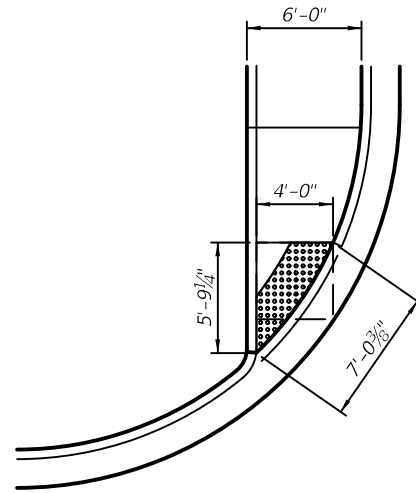

11sf
20' Radius

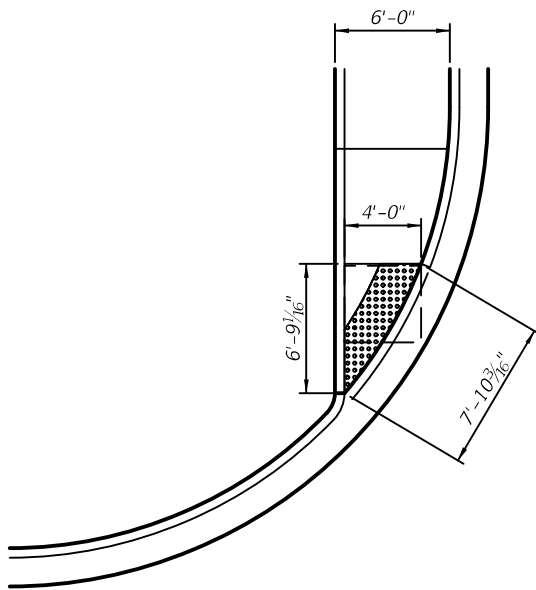

12sf
25' Radius

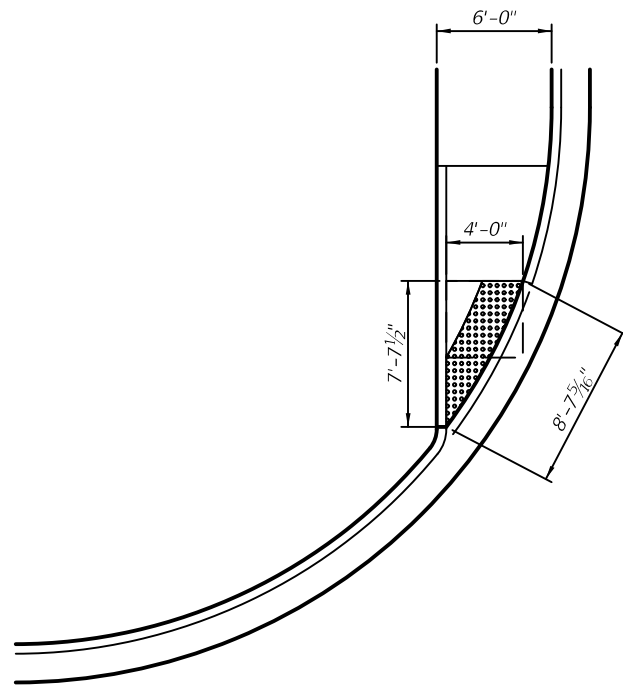

14sf
30' Radius

CR-G

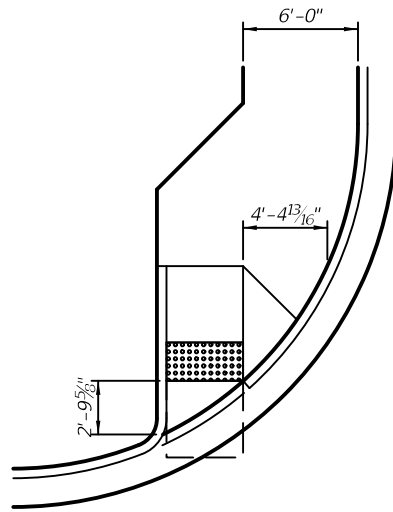

8sf
20' Radius

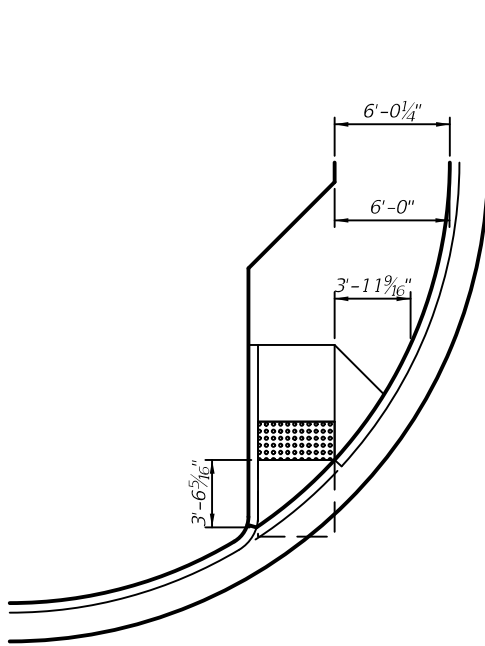

8sf
25' Radius

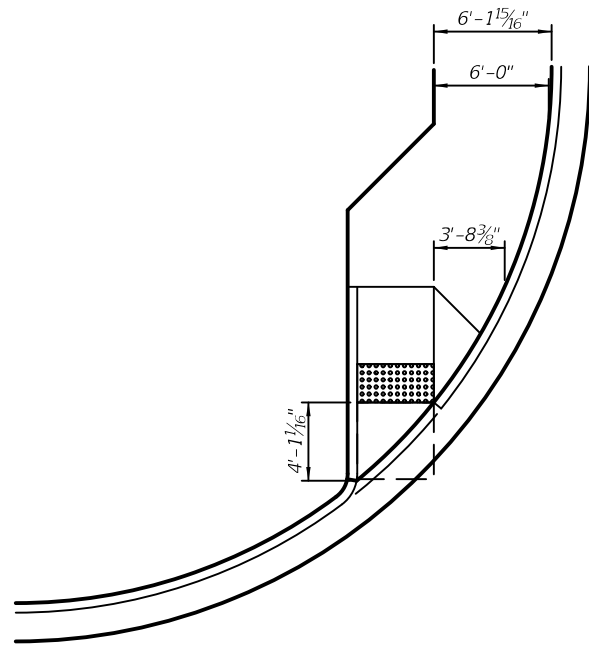

8sf
30' Radius

CR-H

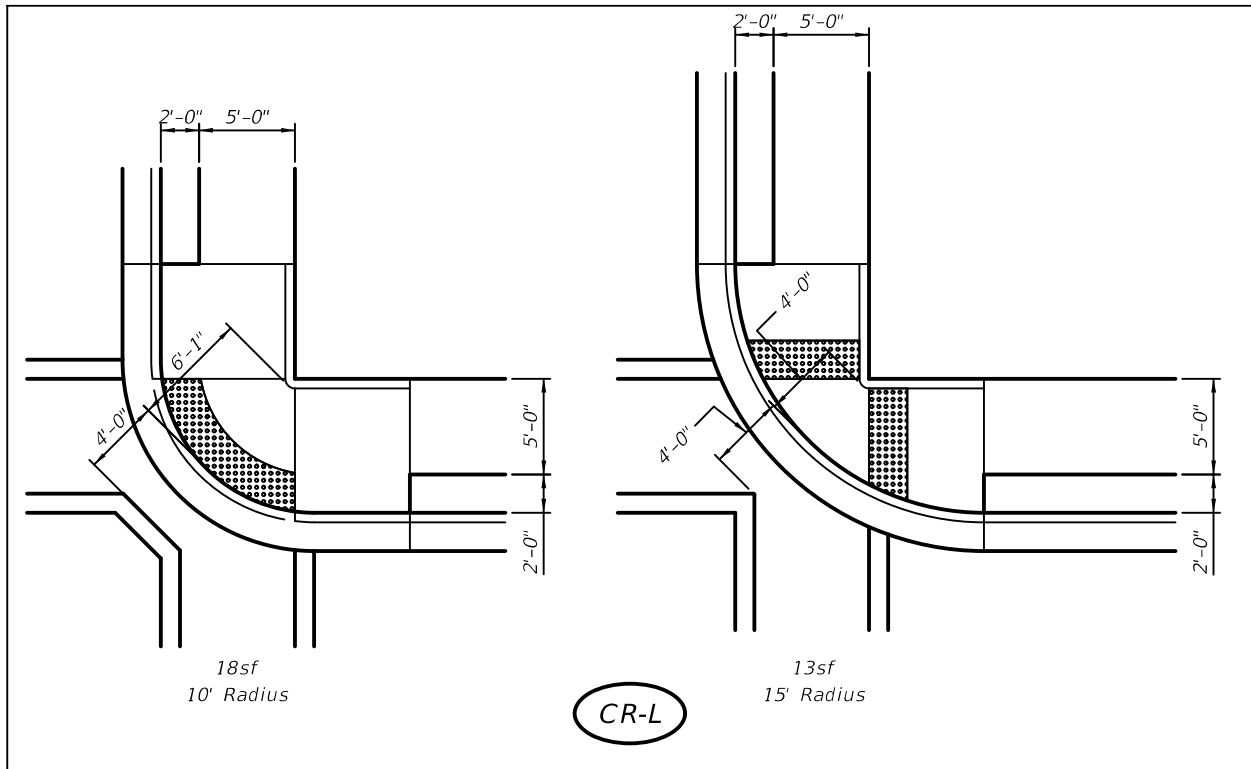

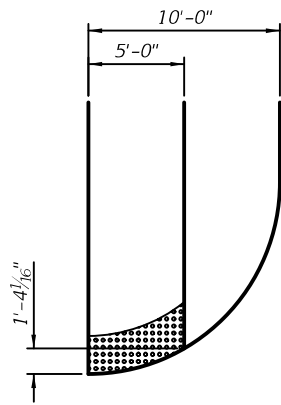

11sf
10' Radius

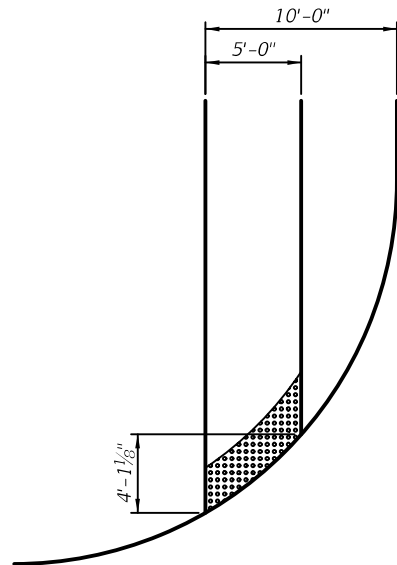

14sf
20' Radius

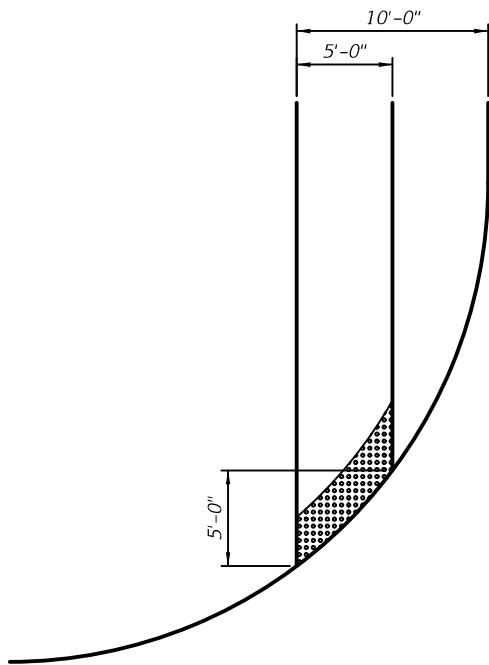

15sf
25' Radius

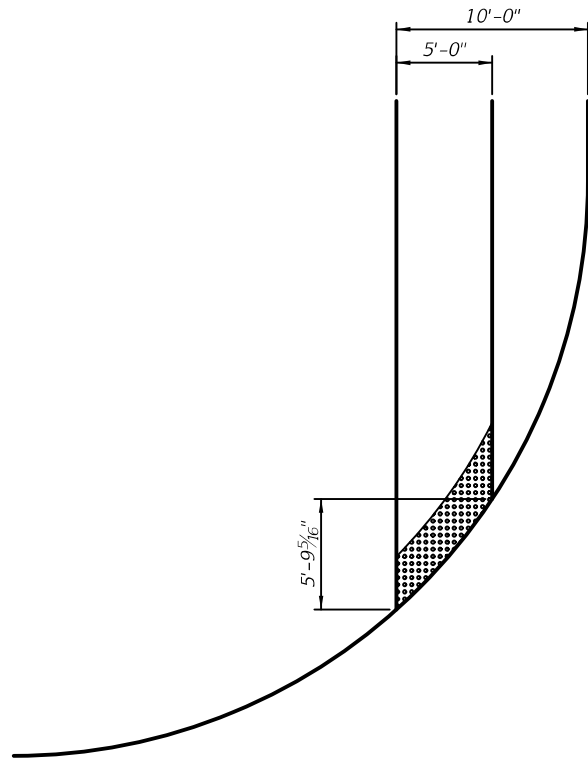

17sf
30' Radius

Flush Shoulder
Option A

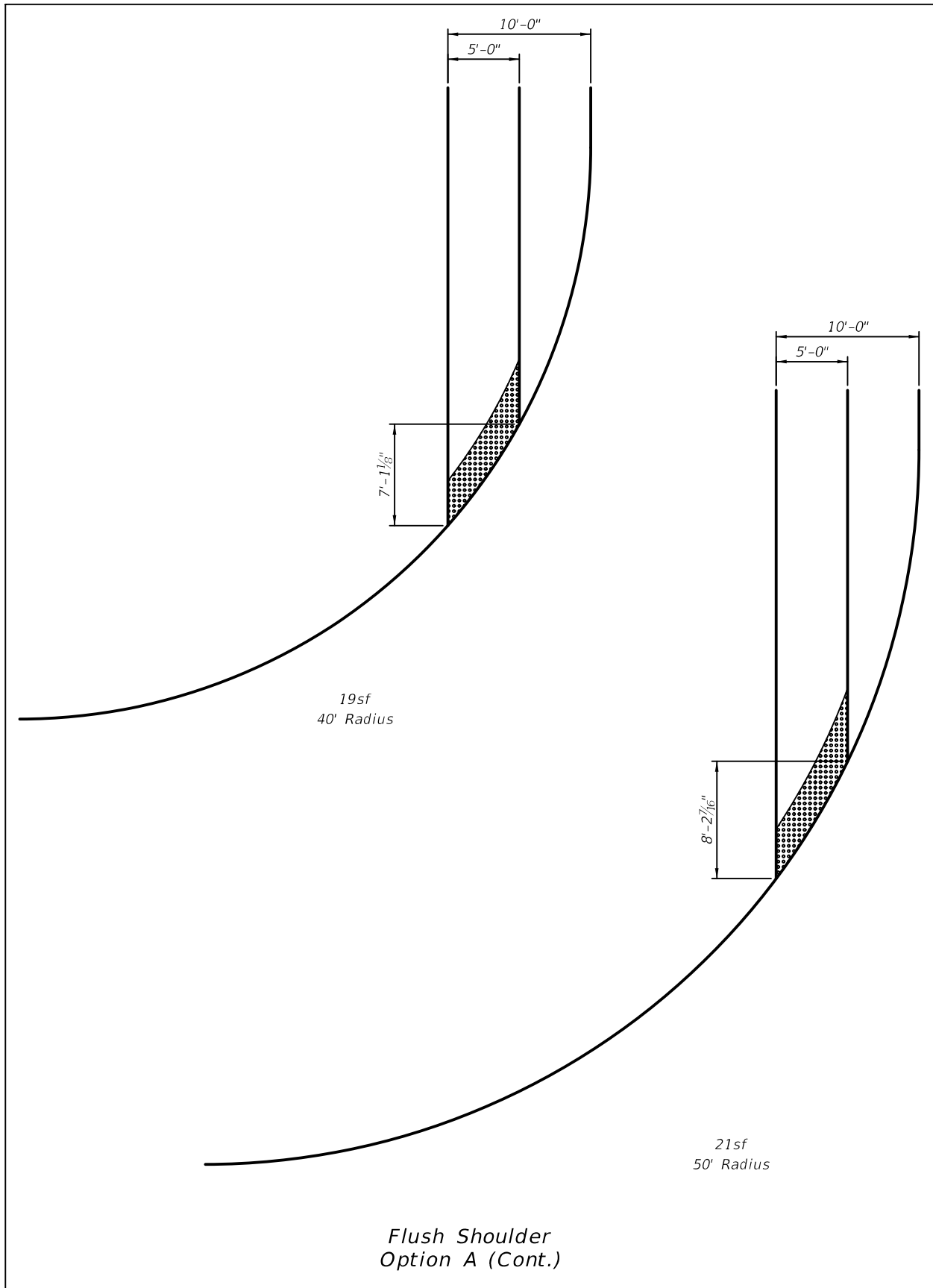

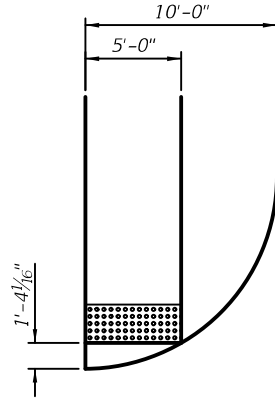

10sf
10' Radius

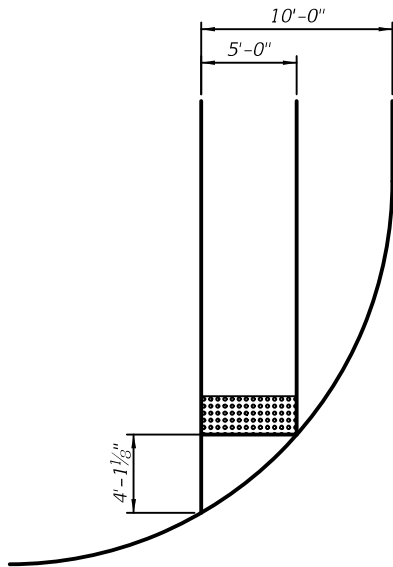

10sf
20' Radius

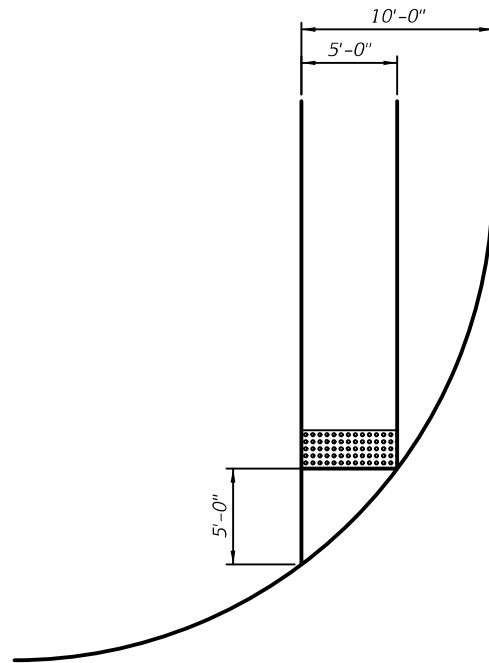

10sf
25' Radius

*Flush Shoulder
Option B*